

ACCESSORIES AND OPTIONS

PAPER

Model	P1 (58mmW)	P-5880T (58mmW)
Applicable model	DR-models except DR-T120/DR-T140/DR-T220 All HR/FR-models	DR-T120 DR-T140 DR-T220

INK-ROLL/ INK RIBBON

INK-ROLL

Model	IR-40	IR-40T
Applicable model	HR-8TE HR-8TM	FR-2650DT FR-2650PLUS FR-2650T HR-100TE

INK RIBBON

Model	RB-02 (Black/Red)
Applicable model	All DR-models

- Standard accessory (included with product)
- Commercially available (no CASIO brand available)
- Optionally available

BATTERY

SILVER OXIDE BATTERY

Model	LR44/G-13				LR54/LR1130/G-10											
Applicable model	AX-12V AX-120TV AX-120V D-20L D-40L D-60L D-20M D-40M D-60M D-120TV	DF-120TV DF-320TM DJ-20T DJ-120T DM-1200T DM-1200TEV DM-1400TV DM-1600TV DS-1TV DS-2TV	DS-3V DS-10TV DS-20TV DX-12V DX-120TV DX-120V FC-200V FC-50F PLUS fx-65 fx-85ES	fx-85MS fx-115MS fx-350MS fx-570MS fx-820MS fx-901 fx-991ES fx-991MS fx-992s fx-3650P	fx-3950P MJ-100T MJ-120T JF-120TV JF-200TV MS-170T MS-270T MS-20TV MS-310TM JS-20TV JS-40V JS-110TV JS-120TV JS-140V	GX-12V GX-14V GX-16V GX-120V	DW-120TV HL-4T HL-820L HL-820LV HL-820V HL-820VA HS-8L HS-8LV HS-8VA JW-120TV	LC-160L LC-160LV LC-401L LC-401LV LC-403LD LC-403TV LC-1000T LC-1000TV MC-100 MS-5VC	MS-8TV MS-10TV MS-10VC MS-20TV MS-80T MS-80TV MS-100TV MS-120TV MS-12V MS-120V	OH-300MS SL-100L SL-100VC SL-160 SL-200TE SL-210TE SL-220TE SL-240V SL-240LB SL-300LV SL-300T	SL-300TV SL-315TE SL-315TV SL-320TE SL-320TV SL-340V SL-340VA SL-787LT SL-787TV SL-797TM SL-910TM SL-1000TV SX-100 SX-220 SX-300 SX-300P SX-320P					

LITHIUM BATTERY

Model	CR2032				CR2025	
Applicable model	ALGEBRA FX 2.0 PLUS CFX-9850GB PLUS CFX-9850GC PLUS CFX-9950GB PLUS DJ-120 DJ-220 DJ-240	DR-T120 DR-T140 DR-T220 DS-120TV FC-200 FX 1.0 PLUS fx-4500PA	fx-4800P fx-5000F fx-5500LA fx-7400G PLUS fx-9750G fx-9750G PLUS fx-9860G	fx-9860G SD MJ-100 MJ-120 SF-2000 SF-2500 SF-3990 SF-4990	SF-6990 SF-7990 WD-220T WM-200T WM-220T	FC-100 FC-1000 JZ-12T

DRY BATTERY

Model	AA					AAA			
Applicable model	EA-100 EA-200 fx-82MS fx-82SX fx-95MS fx-100MS	HL-4 HL-100LB HL-122L HL-122TV HL-815L HR-8TE	HR-8TM HR-100TE HR-100TM HR-150TE HR-150TM HR-150TV MW-5V MW-8V KL-60	KL-60SR KL-170 KL-780 MW-5V MW-8V OH-10	OH-9860	ALGEBRA FX 2.0 PLUS CFX-9850GB PLUS CFX-9850GC PLUS CFX-9950GB PLUS ClassPad 300 ClassPad 300PLUS	FC-100V FX 1.0 PLUS fx-82ES fx-350ES fx-500ES fx-570ES	fx-5800P fx-7400G PLUS fx-9750G fx-9750G PLUS fx-9860G fx-9860G SD	JZ-12W

AC ADAPTOR

Model	AD-A60024			AD-A60024	AD-A60050	AD-A95100
Applicable model	EA-100 EA-200 HR-8TE	HR-8TM HR-100TE HR-100TM	HR-150TE HR-150TM RM-ClassPad PLUS SET	RM-7000 SET RM-9000 SET RM-ALGEBRA FX 2.0 SET	OH-9860	KL-780

*AA=AM3 (UM-3), AAA=AM4(UM-4)

CABLE

PC-LINK CABLE

Model	SB-87	
Applicable model	RM-ALGEBRA FX 2.0 SET RM-7000 SET RM-9000 SET	ALGEBRA FX 2.0 PLUS CFX-9850GB PLUS CFX-9850GC PLUS CFX-9950GB PLUS FX 1.0 PLUS fx-7400G PLUS fx-9750G fx-9750G PLUS

INTERFACE UNIT

Model	FA-123/FA-123USB	FA-124USB	FA-129	FA-129
Applicable model	ALGEBRA FX 2.0 PLUS CFX-9850GB PLUS CFX-9850GC PLUS CFX-9950GB PLUS FX 1.0 PLUS fx-7400G PLUS fx-9750G fx-9750G PLUS	fx-9860G fx-9860G SD	SF-4990	SF-6990 SF-7990

DATA TRANSFER CABLE

Model	SB-62	
Applicable model	CFX-9850GB PLUS CFX-9850GC PLUS CFX-9950GB PLUS EA-100 EA-200 fx-7400G PLUS fx-9750G fx-9750G PLUS fx-5800P	ALGEBRA FX 2.0 PLUS FX 1.0 PLUS fx-9860G fx-9860G SD RM-7000 SET RM-9000 SET RM-ALGEBRA FX 2.0 SET RM-ClassPad PLUS SET

CASIO®

Your Best Answer **Reliable & Durable**

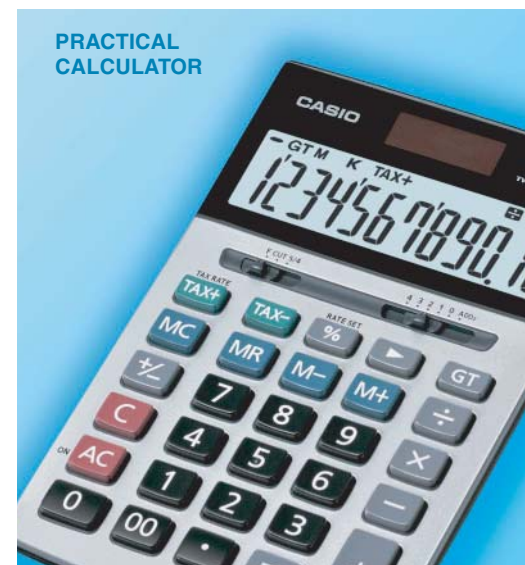

Practical Calculator



Scientific Calculator



Printing Calculator

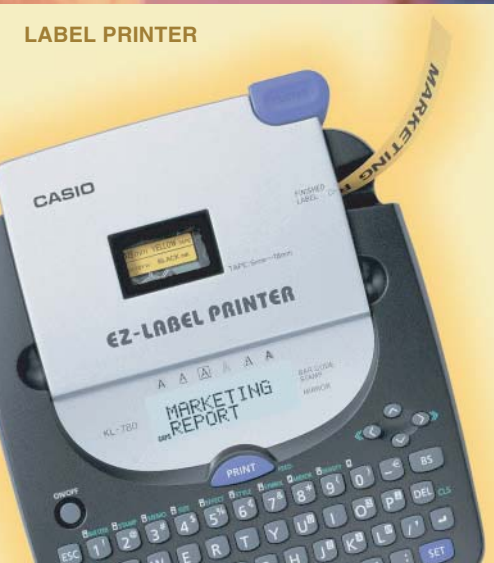

Label Printer

OFFICE & SCHOOL & HOUSEHOLD EQUIPMENT

ELECTRONIC CALCULATORS

General Catalogue 2006-2007

CASIO®
CASIO COMPUTER CO., LTD.
Tokyo, Japan

*Designs and specifications are subject to change without notice.
BS0608-035001A [DI] Printed in Japan/ Printed on recycled paper

<http://world.casio.com>

FUNCTION SYMBOLS

Scientific Calculator / Financial Consultant

763 FUNCTIONS
Number of functions

NATURAL TEXTBOOK
Natural textbook display
Display expression same as textbook.

S-V.P.A.M.
S-V.P.A.M. The CASIO S-V.P.A.M. series was developed with the mathematics classroom in mind. It gives you all the features of the existing V.P.A.M. series plus a new 2-line display and a useful Replay function. All this helps to make mathematics easier to use and easier to understand than ever before.

V.P.A.M.
V.P.A.M. models let you input calculations exactly as they are written. Calculation status symbols and intermediate display capabilities help make calculations easier.

STAT-data
STAT-data editor
Back-step viewing and editing of input data.

Multi-replay
Quick and easy recall of previously executed formulas for editing and re-execution.

10+2 DIGITS
10 + 2 digits
10-digit mantissa + 2-digit exponential display.

COLOUR LCD
Colour display
Data is shown in three colours for quick and easy comprehension.

ICON MENU
Icon menu
Specify the operation you want to perform by selecting an icon or inputting a number.

DOT MATRIX
Dot matrix display
High-resolution screen provides beautiful looking graphs every time.

TWO WAY POWER
Two-way power (Solar + Battery)
Solar powered in sunlight, battery powered when lighting is low.

DATA COMMUNICATION
Data communication with a personal computer
Allows data communication with a personal computer.

BEST VIEW
Best view
Larger display characters are easier on the eyes, taking some of the fatigue out of your work.

SUPER SOLAR
Super solar
Solar cell powers calculations even when lighting is relatively dim.

PLASTIC KEYS
Plastic keys
Designed and engineered for easy operation.

Profit Margin %
Profit margin percent
☒ key gives quick access to prices and profits, and also delivers add-ons, discounts, ratios, increase/decrease values and regular percentages.

Function command signs
A symbol (+, -, ×, ÷) on the display indicates the type of operation you are currently performing.

Practical Calculator / Printing Calculator

EXTRA BIG DISPLAY
Extra big display
Larger display makes more data easier to read.

BIG DISPLAY
Big display
Big, easy-to-read display.

BEST VIEW
Best view
Larger display characters are easier on the eyes, taking some of the fatigue out of your work.

TWO WAY POWER
Two-way power (Solar + Battery)
Solar powered in sunlight, battery powered when lighting is low.

SUPER SOLAR
Super solar
Solar cell powers calculations even when lighting is relatively dim.

Key Rollover
Key rollover
Key operations are stored in a buffer, so nothing is lost even during high-speed input.

PLASTIC KEYS
Plastic keys
Designed and engineered for easy operation.

Metal Cover
Durable metal cover
Tough cover stands up to rough treatment.

Tax & Exchange
Tax & exchange function
Tax calculation and currency conversion functions.

TAX
Tax calculation
Automatic calculation and printout of price plus tax, price less tax, discount, selling price, tax amount, discount amount, and margin amount.

Time
Time calculation
Time calculation allows easy input and calculation of hour, minute, and second values.

Conversion
Metric conversion function
Conversion between metric units and another measurement unit.

Profit Margin %
Profit margin percent
☒ key gives quick access to prices and profits, and also delivers add-ons, discounts, ratios and increase/decrease values.

MARK-UP %
Mark-up percent
☒ key provides instant access to prices and profits, mark-ups, add-ons, discounts, ratios and increase/decrease values.

%
Regular percent
Regular percentage calculations.

Function command signs
A symbol (+, -, ×, ÷) on the display indicates the type of operation you are currently performing.

BIG DISPLAY
Super command signs
Big, easy-to-read command signs show your current operation at a glance.

MU MU MD
Mark-up / Mark-down
All the mark-up/mark-down capabilities of an adding machine for simplified cost and profit calculations.

120 STEPS CHECK
120 steps check
Displays up to 120 previous calculation steps.

LINE PRINT
Line printing
Line printing for higher speed, superior print quality, and quieter operation.

2 COLOUR PRINT
2-colour printing
Positive values are shown in black, and negative values are shown in red for easy checking.

2 COLOUR DISPLAY
2-colour display
Negative values are displayed in red for easier understanding.

3.5 LINES/SEC
3.5 line-per-second printing
The value indicates the number of lines printed per second.

Double-injection keys
Keys are produced by injecting plastic of two different colours. Key markings are plastic, which means they do not wear or fade with use.

Digital Diary

6 Language
Multi-lingual messages
In addition to English, you get a choice of other languages for message displays.

Backlight
Backlight display
Easy reading, even in the dark.

TEL
Telephone directory
Enter the first letter of a name to recall the name in an instant (Initial Search). Data is sorted automatically in alphabetical order.

Schedule
Schedule keeper
Keep track of appointments by entering the day, month, and year.

Memo
Memo function
Store text data such as price lists, airplane schedules, movies schedules, concert schedules, anniversaries, and more.

To do
To do list
Keep track of daily tasks, checking off items as you complete them.

Calendar
Calendar function
A collection of calendars up to the year 2099.

World time
World time
Find out the current time in virtually any location on the globe.

Data communication
Data communication with a personal computer
Allows data communication with a personal computer.

Secret memory area
The secret memory area keeps personal data private. Once a password is registered, data is locked away until the password is used to access the secret area.

Alarm
Alarm
A message appears and a buzzer sounds when a scheduled appointment time arrives.

Metric conversion function
Conversion between metric units and another measurement unit.

Currency conversion function
Instant conversion between two monetary units.

Function command signs
A symbol (+, -, ×, ÷) on the display indicates the type of operation you are currently performing.

CATEGORY INDEX

SCIENTIFIC CALCULATORS

Scientific Calculator Tools for the classroom, the research laboratory, and everywhere in between.
Financial Consultant Quick solutions to complex financial calculations at your fingertips.



PAGE 3

PRACTICAL CALCULATORS

A full lineup of easy-to-use models to meet a variety of different needs.



PAGE 14

PRINTING CALCULATORS

Printouts of results along with each calculation step can be attached to documents.



PAGE 25

DIGITAL DIARY

Packed with a host of powerful data management features.



PAGE 27

LABEL PRINTERS

The CASIO EZ-LABEL PRINTER has something for just about every type of office or household labeling needs.



PAGE 28

OTHER PRODUCT INFORMATION

PAGE 29

CONTENTS PAGE

SCIENTIFIC CALCULATORS 3

PRACTICAL CALCULATORS 14

PRINTING CALCULATORS 25

DIGITAL DIARY 27

LABEL PRINTERS 28

OTHER PRODUCT INFORMATION 29

Packing and Manual Lists 29
•Package sizes and weights for models.
•Availability of user documentation for each model in various languages.

Sales Promotion Materials, Newspaper/Magazine Advertisement and Activities 30
•Dealer information on availability of POP, display materials, advertisement and activities.

Accessories and Options the back cover
•Accessory and option availability for each model.

MODEL INDEX

Red numbers indicate new models.

Model	Page	Model	Page	Model	Page	Model	Page	Model	Page
A ALGEBRA FX 2.0 PLUS6		D DX-120V23		G GX-12V23		L LC-160LV-BK21		R RM-ALGEBRA FX 2.0 SET ...10	
AX-12V24		E EA-210		GX-14V23		LC-160LV-WE21		RM-ClassPad PLUS SET10	
AX-120TV24		EA-20010		GX-16V23		LC-401LV-BK21		RM-7000 SET10	
AX-120V24		F FA-123USB10		GX-120V23		LC-401LV-WE21		RM-9000 SET10	
C CFX-9850GC PLUS6		FA-12927		H HL-422		LC-403TV21		S SF-250027	
ClassPad 300PLUS3		FA-CP300A/B Ver. 3.010		HL-100LB22		LC-1000TV21		SF-399027	
D D-20L18		FC-100V7		HL-122TV22				SF-499027	
D-40L18		FC-200V7		HL-815L-BK22				SF-699027	
D-60L18		FR-2650DT25		HL-815L-WE22				SF-799027	
D-120TV18		FR-2650T25		HL-820LV-BK22		M MC-10015		SL-100L21	
DF-120TV16		fx-50F PLUS7		HL-820LV-WE22		MJ-100T15		SL-100VC-BU14	
DF-320TM15		fx-659		HL-820VA22		MJ-120T15		SL-100VC-GN14	
DJ-20T15		fx-82ES8		HR-820VA22		MS-SVC-BU14		SL-100VC-OE14	
DJ-120T15		fx-82MS9		HR-8TM-BK25		MS-SVC-GN14		SL-200TE21	
DJ-22015		fx-82MS-BU9		HR-8TM-GY25		MS-SVC-PK14		SL-210TE21	
DJ-24015		fx-85ES8		HR-100TM25		MS-10V-BU14		SL-220TE21	
DM-1200T17		fx-85MS9		HR-150TM25		MS-10V-GN14		SL-240LB21	
DM-1200TEV18		fx-95MS9		HS-8LV22		MS-10V-OE14		SL-300LV21	
DM-1400TV18		fx-100MS9		HS-8LV-WE22		MS-10VC-RD14		SL-300TV21	
DM-1600TV17		fx-115MS9		HS-8VA22		MS-20TV20		SL-315TV21	
DR-120LB-GY25		fx-130MS8				MS-30TV20		SL-320TV21	
DR-120LB-WE25		fx-150MS8		J J-120TV19		MS-40TV20		SL-340VA21	
DR-140L26		fx-155MS8		JF-120TV19		MS-50TV20		SL-450L7	
DR-210HT26		fx-350ES8		JF-200TV-BK14		MS-100TV20		SL-760LB-BK22	
DR-220HD26		fx-350MS8		JF-200TV-BU14		MS-170T20		SL-760LB-GDB22	
DR-240HT26		fx-500ES8		JF-200TV-RD14		MS-270T20		SL-787TV-BK22	
DR-270HT26		fx-570ES8		JS-10TV19		MS-310TM16		SL-787TV-GD22	
DR-1212LA26		fx-570MS9		JS-20TV19		MS-470LB20		SL-797TV-BK22	
DR-112026		fx-820MS9		JS-40V19		MS-797TV-GD22		SL-797TV-GD22	
DR-T14026		fx-9018		JS-110TV19		MW-5V-BK20		SL-910TM16	
DR-T22026		fx-911MS8		JS-120TV19		MW-5V-WE20		SL-1000TV-BK14	
DS-1TV17		fx-992S9		JS-140V19		MW-8V-BK20		SL-1000TV-BU14	
DS-2TV17		fx-3650P7		JW-120TV19		MW-8V-WE20		SL-1000TV-RD14	
DS-3V17		fx-3950P7		JZ-12W15		MX-12V24		SX-10024	
DS-10TV17		fx-4500PA7		K KL-6028		MX-120V24		SX-22024	
DS-20TV17		fx-4800P7		KL-60SR28				SX-30024	
DS-120TV17		fx-5500LA7		KL-17028				SX-300P24	
DW-120TV18		fx-5800P7		KL-78028				SX-320P24	
DX-12V23		fx-7400G PLUS6				N NS-10T20		WD-220T16	
DX-120TV23		fx-9750G PLUS6				NS-20T20		WM-200T16	
		fx-9860G5				NS-310TM16		WM-220T16	
		fx-9860G Manager PLUS...10							
		fx-9860G SD5				O OH-300ES10			
						OH-300MS10			
						OH-986010			

SCIENTIFIC CALCULATORS

Scientific Calculator Tools for the classroom, the research laboratory, and everywhere in between.
Financial Consultant Quick solutions to complex financial calculations at your fingertips.



*Comes with snap-on hard case

ClassPad 300PLUS

New Crisp & Clear Display

CASIO's new ClassPad 300PLUS incorporates an impressive bold-type font and a crisp & clear display that provides almost double the character-visibility of the previous model.

Big Display

The ClassPad 300PLUS features a large 160 by 240-dot LCD that enables easy and definite entering of data and selection of menu commands with the stylus.

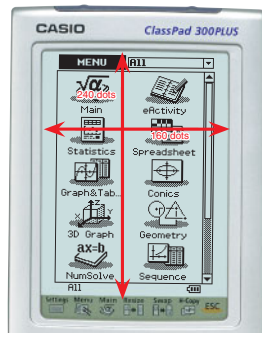

Pen Touch Operation

Various commands can be selected from the pull-down menu using the stylus. Also, you can use the Drag & Drop or Copy & Paste functions for efficient operations.

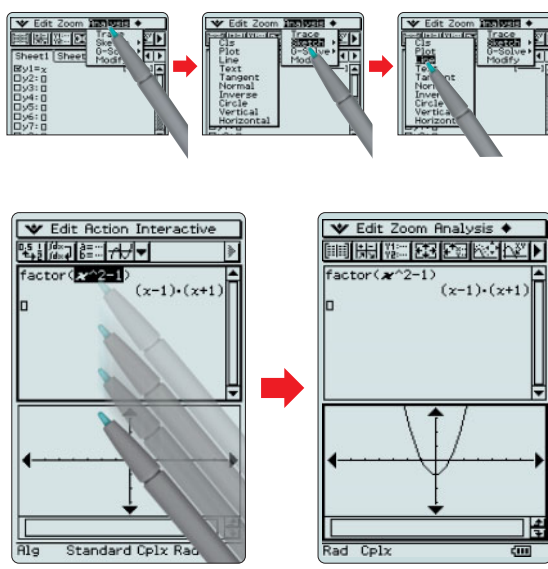

Soft Keyboard

The Soft Keyboard is very efficient for entering various commands or entering complex expressions in natural display format, and it makes the input operations remarkably simple. With this function, it is unnecessary to follow the complicated input method unique to conventional scientific calculators. The ClassPad 300PLUS provides Soft Keyboards of four different display types.

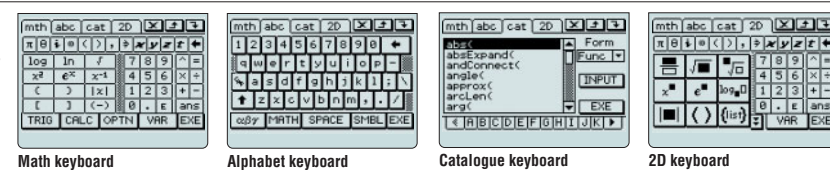

Natural Input

The Natural Input/Output function enables you to input and display expressions or display the results of the calculation in the same format shown in the textbook.

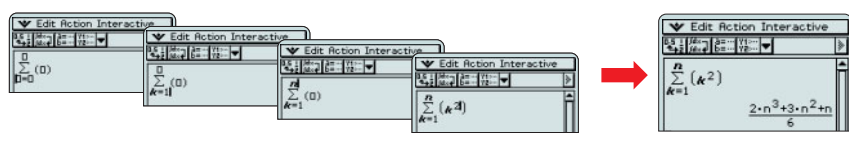

Geometric Graphing Functions

Geometric Graphing

As shown in the following examples, the students can learn the general theorem by drawing the figures, and they can confirm that the theorem still holds true even when they deform the triangle.

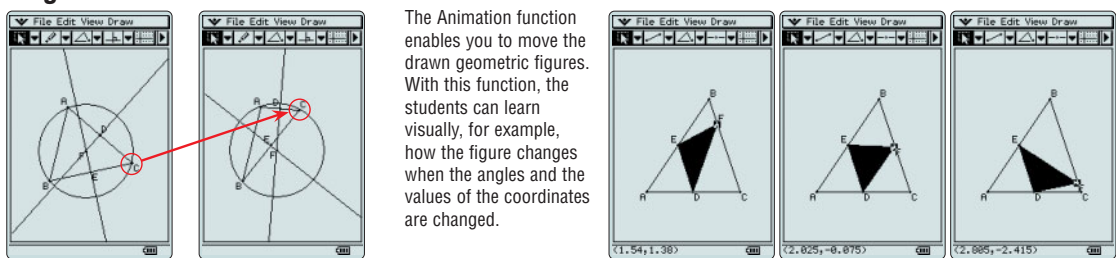

The Animation function enables you to move the drawn geometric figures. With this function, the students can learn visually, for example, how the figure changes when the angles and the values of the coordinates are changed.

Geometric Graphing by using the Drag & Drop Function

By dragging and dropping a geometric figure to the main application window, you can obtain the numerical data for the figure. And by dragging and dropping the numerical data to the Geometry window, the data can be reflected in the figure.

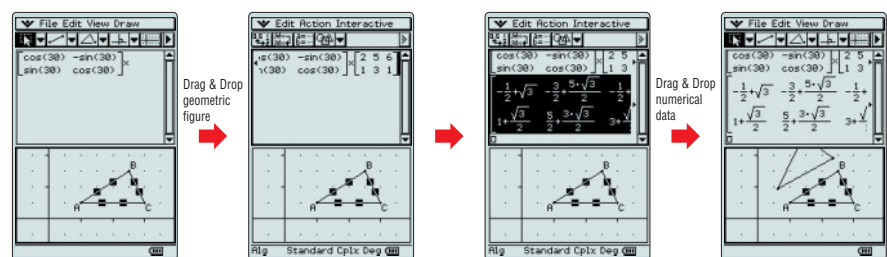

Geometry Link Function

The Geometry Link function enables you to dynamically link the eActivity data and the Geometry window data.

eActivity and Presentation Applications

eActivity The eActivity has four advantages over using paper:

1. You can create and prepare your own original activities for the class with eActivity.
2. Students can work on a problem at their own pace.
3. Students can try out various approaches to solving a problem by themselves.
4. It enables texts, expressions, figures and graphs to be presented on the screen of the ClassPad 300PLUS.

3-dimensional Graphing

3-dimensional Graphing

The 3-dimensional Graphing function enables you to draw and display a 3-dimensional graph defined by the formula $z = f(x, y)$. You can split the display window into 3D Graph Editor window and 3D Graph window, or enlarge the 3D Graph window to see a larger graph.

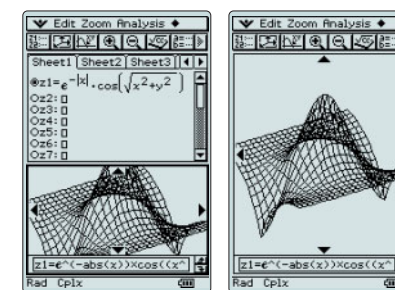

You can rotate the graph as you like by selecting and tapping one of the following commands from the menu.

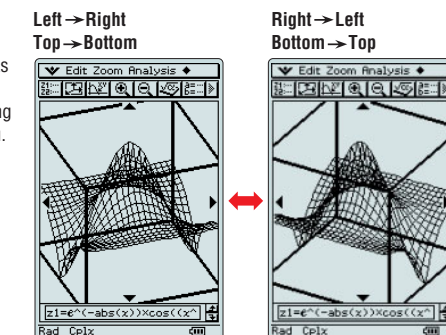

Built-in Software

Spreadsheet

With this function, you can organize and tabularize the collected data or use it for analysis after drawing a statistical graph. Of course, it can also be used effectively for table calculations.

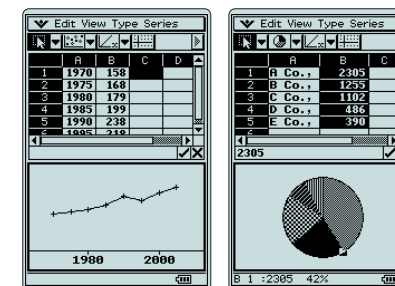

Verify

With the Verify function, you can transform expressions or adopt solutions in your own way. The unit will verify whether the input calculation formula is in an equivalent relation with the adjacent expression. This function is just perfect for learning how to do equation and integration calculations.

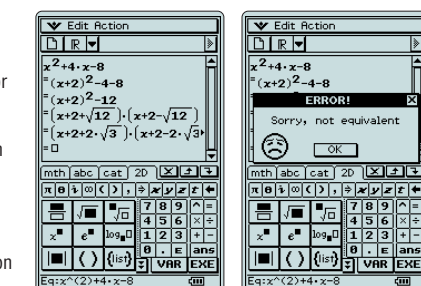

ClassPad 300PLUS Specifications

ALGEBRA

• CAS (Computer Algebra System) • Algebra Assistant • Fraction • Transformation function (simplify, expand, factor) • Algebraic ($\sqrt{\quad}$, x^2 , x^{-1} , x^i , $\sqrt[n]{\quad}$, x^n) • Simultaneous equation • Real and complex results • Data (List, Matrix) • Combination nCr , Permutation nPr • Exponent (\log , \ln , 10^{\quad} , e^{\quad}) • Trigonometric (\sin , \cos , \tan , \sin^{-1} , \cos^{-1} , \tan^{-1}) • Angle unit (Deg, Rad) • Graph functions, polar, parametric and $x = f(y)$ equations • Numeric evaluation of functions in tables • Graph solve (root, max, integral, inflection, distance) • Conics graphs (Parabola, Circle, Ellipse, Hyperbola, General figure) • Conics graphs solve (Focus, Vertex, Directrix, Symmetry, Center, Radius) • Recursive and explicit sequence numerical tables and plots

CALCULUS

• Hyperbolic (\sinh , \cosh , \tanh , \sinh^{-1} , \cosh^{-1} , \tanh^{-1}) • Integration, differential • Differential equation • Σ , Π , \lim

STATISTICS

• List-based one- and two-variable statistical analysis • Statistical regression calculations • Statistical plot (Scatter Plot, xy Line, Normal Probability Plot, Histogram, Box Plot) • Statistical regression graphs • Advanced statistical calculations (Tests, Intervals, Probability)

GEOMETRY

• Constraint geometry (for education) • Construction figures (Perpendicular, Midpoint, Intersection, Angle Bisector) • Geometry figures (Circle, Ellipse, Triangle, Rectangle, n -gon, Point, Line Segment) • Geometry animation • Numeric evaluation of geometry animation in tables

eActivity APPLICATION

• Creating eActivity • Exploring (performing) eActivity • Geometry Link in eActivity

ADD-IN APPLICATIONS

• E-Con EA-200

OTHER EFFECTIVE FEATURES

• Drag & Drop operation • Natural format input of equations and expressions • Natural format display of results • Math, Alphabet, 2D soft keyboards • Command catalogue soft keyboard • Calculation History • Mantissa + exponent: $15 + 3$ • Interactive manipulation for solving equations • 3-dimensional graphs • Numeric equation solver • Presentation feature • User memory capacity: 515,000 bytes (max.) – Depending on remaining memory capacity • Icon menus • Full screen display/Split screen display • Software upgradability (maintenance, feature upgrades) • User-defined variable • User-defined function (extends built-in functionality) • Memory Management to create folders • Sending screen image from unit to unit • Resetting/initializing memory • Selection of display language • Auto Power Off (APO) • Ending screen/User-defined ending screen

HARDWARE

• Dimensions: 21.0 (H) × 84.0 (W) × 189.5 (D) mm • Approximate weight: 280 g • Battery type: Four AAA-size batteries LR03 (AM4) • Battery life: Approx. 140 hours continuous operation (assuming 5 minutes calculation and 55 minutes display per hour) • Display type: 160 × 240-dot display (LCD) • Touch Panel (Pen Touch Operation) • User-available RAM: 500KB • User-available Flash ROM (Add-in area): 4MB • Data communication (via USB and 3-pin cables) • USB cable for connecting with PC • 3-pin cable for connecting with other ClassPad unit or EA-200

OPTIONS

• ClassPad Manager • EA-200 Data Analyzer • RM-ClassPad PLUS (SET) (Overhead projectable model)

For more information on the ClassPad 300PLUS, please visit our website: <http://classpad.net/>

Graphic Models with Flash Memory

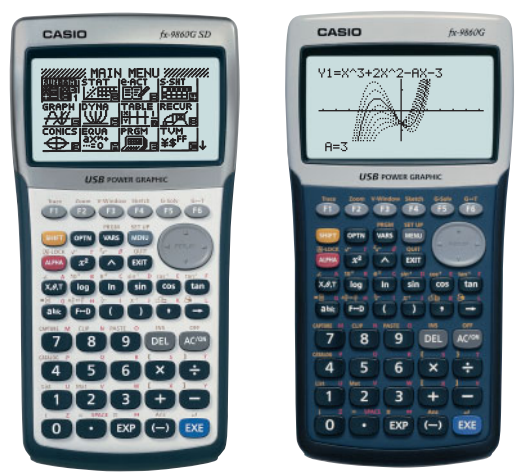

- OVER 1,000 FUNCTIONS
- 64,000 bytes
- NATURAL TEXTBOOK
- STAT-data
- Multi-replay
- 21 OPERATIONS
- 10+2 DIGITS
- ICON MENU
- DOT MATRIX
- PLASTIC KEYS
- SD CARD

An innovative approach for the math & science class environment



Free Add-in software for fx-9860G series
 ● E-CON2 ● Physium ● Geometry

For more information on the fx-9860G series, please visit our website:
<http://world.casio.com/edu/>

fx-9860G SD fx-9860G

Hardware Features

High-resolution LCD

The fx-9860G series features a sharp, crisp display of the high-resolution LCD with enlarged dot-area, assuring larger and even sharper images of formulas, graphs and graphics. The clear, eye-friendly, large-sized 64 × 128 dot display improves the efficiency of study.

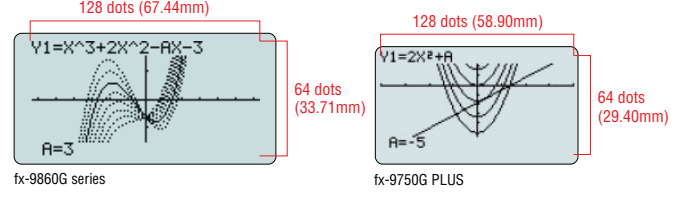

Software Features

Natural Input Display

Just like writing in a notebook, fractions, roots, powers and integrals can be input and displayed as written in the textbook. In this way, the Natural Input Display deepens the understandings of the student. Also, it displays the result of the fraction calculation as it is shown in the textbook.

High-speed CPU

By employing high-performance, high-speed CPU, the fx-9860G series remarkably accelerated the processing speed. The speed increased dramatically compared to conventional models.

A large capacity 1.5MB Flash Memory

With an ample 1.5MB Flash Memory, various data and applications can be downloaded and stored without worrying about memory capacity.

Ready-to-use USB functions

Since USB cable, unit-to-unit cable and Program-Link Software are included in the package, high-speed data communication between PC and the unit, or unit-to-unit data communication and program exchange can be performed immediately from the day of purchase.

SD Card Slot (SD model only)

The fx-9860G SD is equipped with a SD card slot which allows easy data exchange.

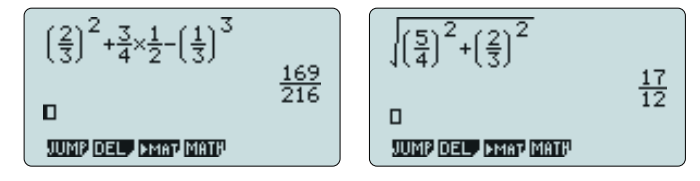

eActivity

This unit is equipped with the popular eActivity function of the ClassPad 300. The innovative eActivity functions of the fx-9860G series allow the students, not to mention teachers, to create their own problems or study materials. With this function, students can learn at their own pace and study more efficiently at school or at home. By making full use of the superb features of the eActivity function, motivation for learning and understanding can be greatly improved.

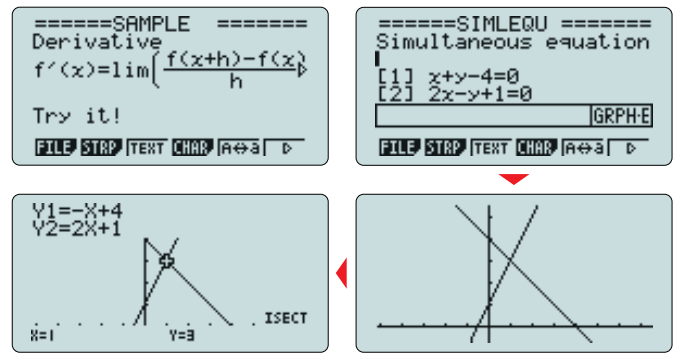

Built-in Software

Table calculations come easy with the built-in Spreadsheet function. Since the multi-function Spreadsheet even includes a built-in Graphing Function, it can be used effectively for exercises in table calculation lessons.

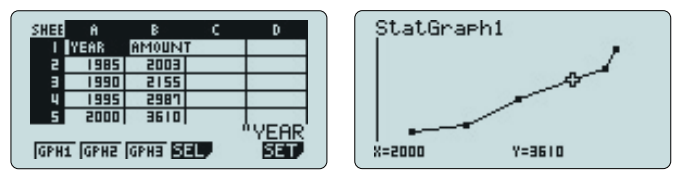

Peripheral environment

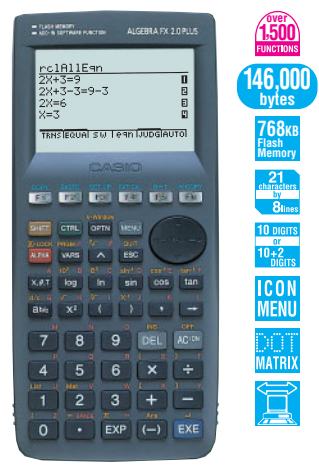
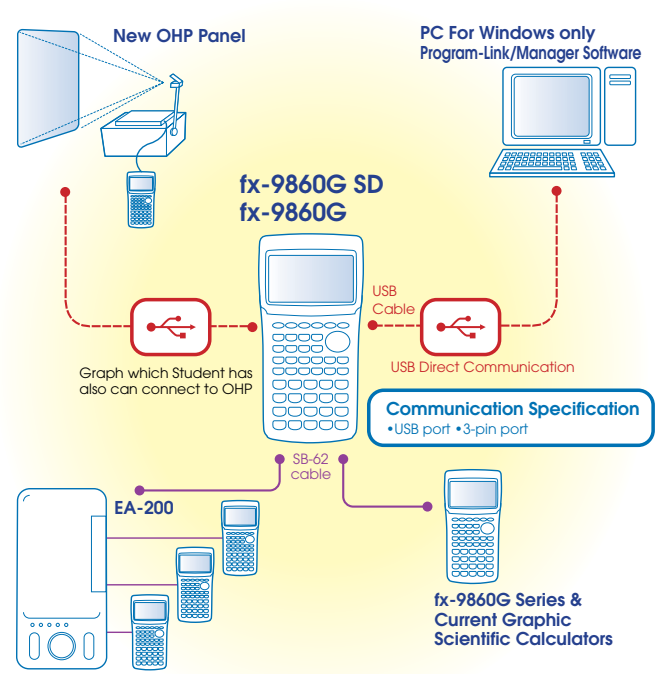

ALGEBRA FX 2.0 PLUS

- OVER 1,500 FUNCTIONS
- 146,000 bytes
- 768Kb Flash Memory
- 21 OPERATIONS
- 10 DIGITS
- 10+2 DIGITS
- ICON MENU
- DOT MATRIX



*Comes with slide-on hard case

Graphic Models

COLOUR POWER GRAPHIC

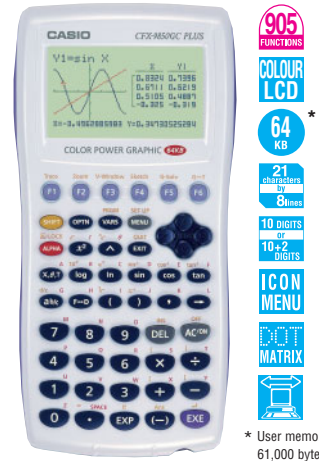

POWER GRAPHIC

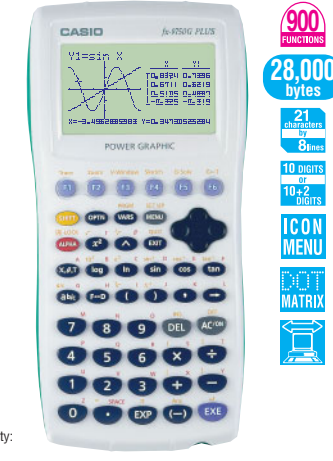

CFX-9850GC PLUS fx-9750G PLUS



POWER GRAPHIC

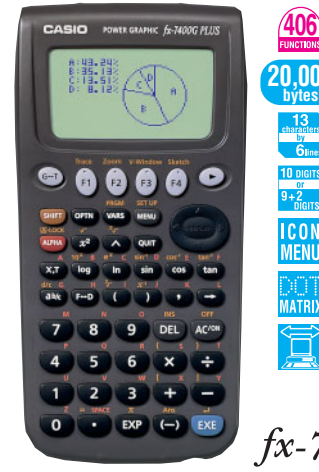

- Large display (128 × 64 dots)
- Algebra Applications (Computer Algebra System, Algebra, Tutor)
- Graphic functions & Graph solve functions
- Dynamic graph
- Dual graph (Graph & Table, Graph & Graph)
- Conic section graph
- Complex functions
- List function & list-based statistics
- Statistical calculations & graphs
- Graph solve
- Integrations
- Differential and quadratic differential calculations
- BASIC-like program functions
- Linear equations from 2 to 30 unknowns
- 2 to 30 order equations
- Matrix operations with complex numbers
- Base-n calculations/conversions
- Add-in application with Flash Memory
- Includes a connecting cable for data transfer between two units
- Data communications (requires separately available FA-123/FA-123USB)

- Large 3-colour display (128 × 64 dots) (CFX-9850GC PLUS)
- Large display (128 × 64 dots) (fx-9750G PLUS)
- Graphic functions (Rectangular coordinate graph, Polar coordinate graph, Parameter graph, Inequality graph, Integration graph, Statistical graph)
- Dynamic graph
- Dual graph
- Conic section graph
- Regression graph (Logistic regression graph, Sinusoidal regression graph, Linear regression graph, and more)
- Graph solve
- Integrations
- Differential and quadratic differential calculations
- Complex number calculations
- Table and graph
- Recursion graph
- List-based statistics
- Advanced statistics
- BASIC-like program functions
- Linear equations from two to six unknowns
- Quadratic equations, Cubic equations
- Matrix operations
- Base-n calculations/conversions
- Financial function
- Data communications



*Comes with snap-on hard case

fx-7400G PLUS

Main Functions

Algebra Applications

Computer Algebra System (CAS) Using the Computer Algebra System (CAS), students can factor expressions, find limits of functions and calculate derivatives, integration and Taylor series expressions.

CASIO's CAS is based on the CASIO's original algebra system and enhanced by our R & D team, Professor John Kenely and other math instructors, adopting teachers' advice and suggestion.

Factorization	Differential	Taylor expansion
$f(x) = (x+8)(x-2)(x+2)$	$\frac{d}{dx}(e^{\cos(x)} \sin(x)) = e^{\cos(x)} + e^{\cos(x)} \sin(x)$	$f(x) = \sin(x)$ $T_3(x) = x - \frac{x^3}{6}$

Algebra

This application helps students manipulate equations. They can, for example, expand or simplify equations by themselves in an attempt to arrive at the correct solution. After they learn how to solve the problem in Tutor application, they can make use of this application to master how to solve the algebra problems.

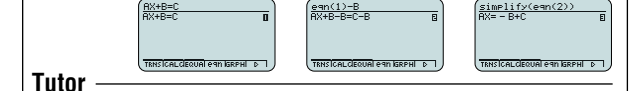

Tutor

Students can study how to solve algebra problems as ALGEBRA FX 2.0 PLUS shows each step to arrive at the final solution, in a similar way as a teacher does it in class. It works under three different modes. • Auto Mode • Manual Mode • Verify Mode

Main Functions (CFX-9850GC PLUS/fx-9750G PLUS)

Icon menu	Dynamic graph	Dual graph	Conic section graph
Inequality graph	Integration graph	Logistic regression graph	
List-based statistics Store a list of values in memory for use when performing function and statistical calculations, when drawing graphs, or when generating tables of numeric values.			
Advanced statistics t-test, confidence interval, probability analysis, and other calculations and graphing.			
2-sample F-test graphing	1-sample z-test graphing		

Displays shown are CFX-9850GC PLUS.

Main Functions

- GRAPHS** Draws the following types of graphs.
 - Rectangular coordinates
 - Parameter graph
 - Inequality graph
- TRIGONOMETRY** Performs calculations for trigonometric & inverse trigonometric functions.
- STATISTICS Standard Deviation** Performs calculations of single-variable statistical data and graphs the result.
 - Histogram
 - Pie chart
 - Bar graph and line graph
- Regression** Performs calculations of paired-variable statistical data and graphs the result.

Standard Models

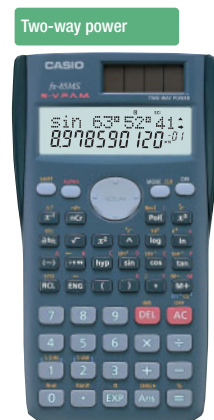
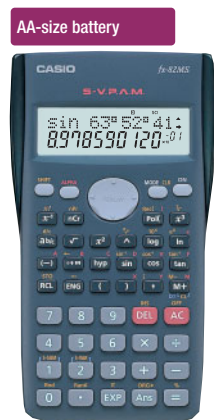

240 FUNCTIONS
2-LINE DISPLAY
10+2 DIGITS
DOT MATRIX
STAT-data
Multi-replay
S-V.P.A.M.
PLASTIC KEYS

- Multi-replay function
- 2-line display
- Fraction calculations
- Combination and permutation
- Statistics (STAT-data editor, Standard deviation, Regression analysis)
- 9 variable memories
- Plastic keys
- Comes with slide-on hard case

fx-82MS

fx-82MS-BU

fx-350MS

fx-85MS

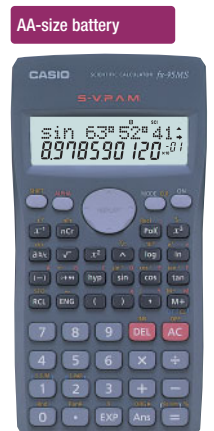

244 FUNCTIONS
2-LINE DISPLAY
10+2 DIGITS
DOT MATRIX
STAT-data
Multi-replay
S-V.P.A.M.
PLASTIC KEYS

Added functions of the fx-95MS:

- Equation calculations

fx-95MS

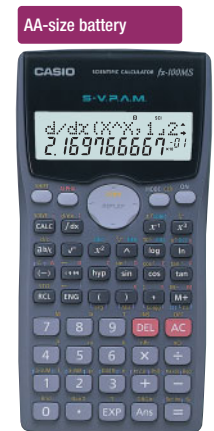

AA-size battery

300 FUNCTIONS
2-LINE DISPLAY
10+2 DIGITS
DOT MATRIX
STAT-data
Multi-replay
S-V.P.A.M.
PLASTIC KEYS

Added functions of the fx-100MS/115MS:

- Equation calculations
- Integration/differential calculations
- Base-*n* calculations/conversions
- Complex number calculations

fx-100MS

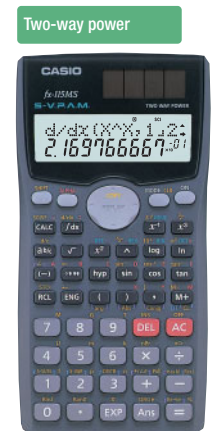

Two-way power

fx-115MS

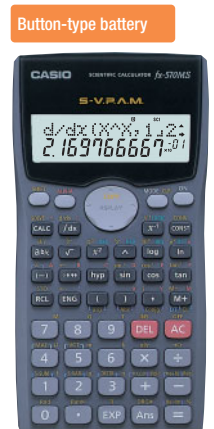

fx-570MS

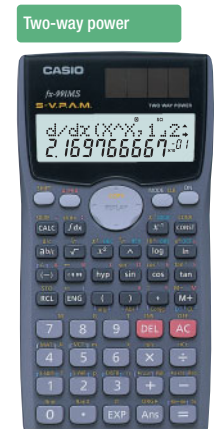

fx-991MS

401 FUNCTIONS
2-LINE DISPLAY
10+2 DIGITS
DOT MATRIX
STAT-data
Multi-replay
S-V.P.A.M.
PLASTIC KEYS

Added functions of the fx-570MS/991MS:

- Equation calculations
- Integration/differential calculations
- Base-*n* calculations/conversions
- Complex number calculations
- Matrix calculations
- Vector calculations
- 40 scientific constants



fx-820MS

Large, easy-to-view tilt display!

240 FUNCTIONS
2-LINE DISPLAY
10+2 DIGITS
DOT MATRIX
STAT-data
Multi-replay
S-V.P.A.M.
PLASTIC KEYS

All the function as the fx-82MS plus a large, easy-to-view tilt display!

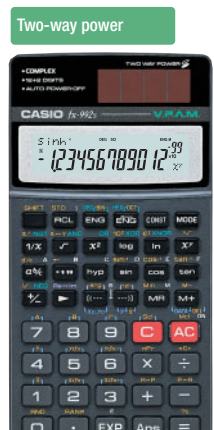

fx-992s

383 FUNCTIONS
V.P.A.M.
12+2 DIGITS



Built-in complex number calculations plus 128 scientific constants

- Statistical calculations
- Engineering symbol calculations
- Base-*n* calculations/conversions

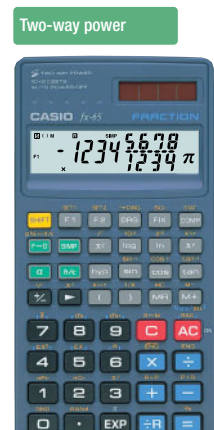

fx-65

158 FUNCTIONS
10+2 DIGITS

The scientific calculator with true fraction display

- Fraction reduction
- Permutation and combination
- Integer division
- Cube roots
- Back space key
- Cube calculations/conversions
- Comes with slide-on hard case

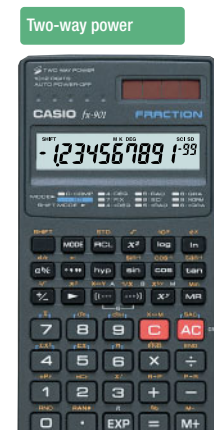

fx-901

150 FUNCTIONS
10+2 DIGITS



Includes cube calculations and angle unit conversions

- Fraction functions
- Permutation and combination

Calculators in the Classroom

Supporting options for graphic scientific calculators

SUPPORT CLASSROOM TECHNOLOGY

Data Analysis System

Quick and accurate data accumulation assists analysis in intensive studies.



EA-200

- Collect data at rates of up to 50,000 points per second for up to 120,000 points.
- All flash-ROM for upgrading function version.
- Compatible with the CASIO fx-7400 series, CFX-9850 series, ALGEBRA FX 2.0 series, fx-9860G series, and ClassPad 300 series.

Includes:

- CASIO Data Analyzer
- Temperature probe
- Optical probe
- Voltage probe
- Data communication cable: SB-62
- AC adaptor: AD-A60024
- Soft case
- Four AA-size alkaline batteries

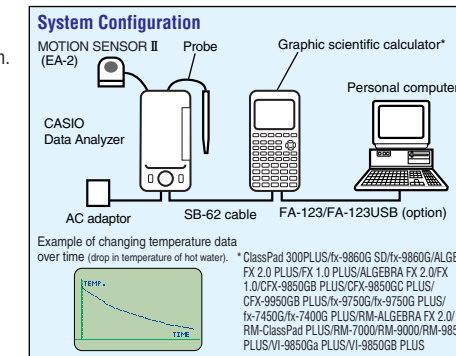

The EA-2 emits ultrasonic pulses and detects pulses returned as echoes from the target. It can be connected to the CASIO EA-200 Data Analyzer to accumulate and analyze data.

Graphic Scientific Calculator Projection Set

All the functions of the ClassPad 300PLUS



Includes:

- Graphic scientific unit: RM-ClassPad PLUS (same functions as ClassPad 300PLUS)
- Projection unit: OH-30
- Data transfer cable: SB-62
- PC-Link cable: USB
- Carrying bag

RM-ClassPad PLUS SET

All the functions of the ALGEBRA FX 2.0 PLUS

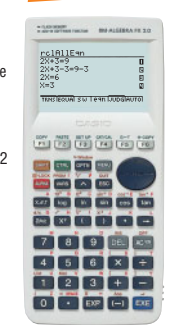

Includes:

- Graphic scientific unit: RM-ALGEBRA FX 2.0 (same functions as ALGEBRA FX 2.0 PLUS)
- Projection unit: OH-15
- Data transfer cable: SB-62
- PC-Link cable: SB-87
- AC adaptor: AD-A60024
- Carrying bag

RM-ALGEBRA FX 2.0 SET

All the functions of the CFX-9850GC PLUS



Includes:

- Graphic scientific unit: RM-9000 (same functions as CFX-9850GC PLUS)
- Projection unit: OH-15
- Data transfer cable: SB-62
- PC-Link cable: SB-87
- CD-ROM for Windows® (Program-Link software, fx-7400G PLUS and CFX-9850GC PLUS function data)
- Carrying bag

RM-9000 SET RM-7000 SET

All the functions of the fx-7400G PLUS

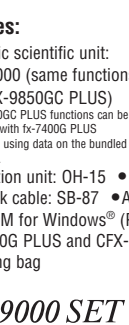

- Graphic scientific unit: RM-7000 (same functions as fx-7400G PLUS)
- Data transfer cable: SB-62
- AC adaptor: AD-A60024

OHP Projection Model

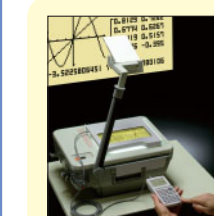

This optional set allows the displayed contents of the calculator to be projected onto a wall screen, an effective function in classrooms. The set unit mounts on the OHP and can be remote controlled by a hand-held calculator.

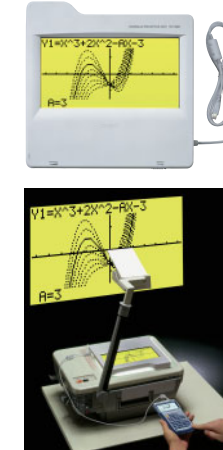

OH-9860 activates class activity

By connecting the fx-9860G SD or fx-9860G to the optional OHP unit with a USB cable, you can project the displayed contents of the fx-unit on the screen. With this function, each student can make a presentation in the class or teachers can use it as a powerful tool for teaching. Thus, the application of the unit broadens, class activities will be activated, and the efficiency of learning and the student's understanding will be improved.

Project display contents onto a big screen using an OHP! A powerful classroom presentation tool!

- OH-300ES provides the same powerful functions of fx-82ES/85ES/350ES.
- OH-300MS provides the same powerful functions of fx-82MS/85MS/350MS.

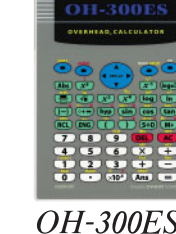

OH-300ES



OH-300MS



The transparent properties of this product let you place it onto an OHP to explain both screen contents and key operations.

Software

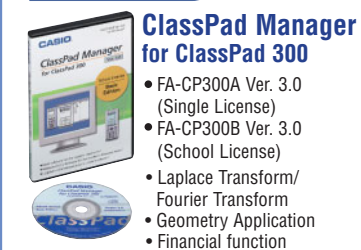

ClassPad Manager for ClassPad 300

- FA-CP300A Ver. 3.0 (Single License)
- FA-CP300B Ver. 3.0 (School License)
- Laplace Transform/Fourier Transform
- Geometry Application
- Financial function
- Differential Equation Application
- Spreadsheet Application
- Data communication with ClassPad 300 series calculators

System Requirements
Computer: Recommended Intel® Pentium® III 500 MHz with USB
Operating Systems: Windows® 98SE/Me or Windows® 2000/XP
Disk Space: 100 MB available for installation
Memory: Recommended for operating system



fx-9860G Manager PLUS

Simulates the functions of the fx-9860G series on your PC!

- Classroom Activity Support Functions of the fx-9860G series: Key-Log File Creation and Screen Capture Function
- Screen Receiver Function: Allows real-time reproduction of the fx-9860G series' display on your PC screen.

System Requirements
Computer: Recommended Intel® Pentium® III 500 MHz with USB
Operating Systems: Windows® 98SE/Me or Windows® 2000/XP
Disk Space: 50 MB available for installation
Memory: Recommended for operating system

FA-123USB Data Communication Package

Includes: Program-Link software for Windows® PC (CD-ROM), SB-88 PC-Link cable

System Requirements

- Computer: IBM PC/AT or compatible
- Operating System: Windows® 98/Windows® Me/Windows® 2000 SP3/Windows® XP SP1
- Monitor: Colour (256 colours or more)
- Minimum free space on hard drive: 1MB
- RAM: 1MB free • CD-ROM drive • USB port : 1 port free

The Program-Link software can be downloaded from the WEB.
<http://world.casio.com/edu/>

* The Program-Link software needs the SB-88 PC-Link cable. Those users who had downloaded the software from the WEB are asked to purchase the cable.

* Windows is a registered trademark of Microsoft Corporation.

Scientific Calculators Specification Table

Model	Graphic Models					Programmable Models					
	fx-9860G SD	fx-9860G	ALGEBRA FX 2.0 PLUS	CFX-9850GC PLUS	fx-9750G PLUS	fx-7400G PLUS	fx-5800P	fx-50F PLUS	fx-3650P	fx-3950P	
Specifications	Number of functions	Over 1,000	Over 1,000	Over 1,500	905	900	406	664	406	279	279
	Power supply (Main)	AAA × 4	AAA × 4	AAA × 4	AAA × 4	AAA × 4	AAA × 2	AAA × 1 (LR03)	Two-way power (Solar + LR44 × 1)	Two-way power (Solar + LR44 × 1)	LR44 × 1
	Power supply (Backup)	CR2032 × 1	CR2032 × 1	CR2032 × 1	CR2032 × 1	CR2032 × 1	CR2032 × 1	—	—	—	—
	Approximate battery life Main (hours)	300 (LR03)*1	300 (LR03)*1	140 (R03)*2/230 (LR03)*2	180 (R03)*2/320 (LR03)*2	240 (R03)*2/420 (LR03)*2	900 (R03)*2/1,500 (LR03)*2	1 year	3 years (LR44)*3	3 years (LR44)*3	9,000*4/3 years*4
	Approximate battery life Backup (years)	5	5	2	2	2	2	—	—	—	—
	Dimensions H × W × D (mm)	24 × 92.5 × 184.5	24 × 92.5 × 184.5	19.5 × 82 × 178	24.5 × 90 × 182.5	24.5 × 90 × 182.5	23 × 85.5 × 169	15.1 × 81.5 × 163	12.2 × 80 × 161	11.8 × 80 × 159	11.8 × 80 × 159
	Approximate weight (g)	265	260	213	215	215	185	150	105	100	100
	Case style	Slide-on hard	Slide-on hard	Slide-on hard	Snap-on hard	Snap-on hard	Snap-on hard	Integrated hard	Slide-on hard	Snap-on hard	Snap-on hard
	Dot matrix display	64 × 128 dots	64 × 128 dots	64 × 128 dots	64 × 128 dots	64 × 128 dots	48 × 80 dots	31 × 96 dots	5 × 7 dots × 16 digits	5 × 6 dots × 12 digits	5 × 6 dots × 12 digits
	Display capacity (characters)	21 × 8	21 × 8	21 × 8	21 × 8	21 × 8	13 × 6	16	16	12	12
Mantissa + exponent digits	10 + 2	10 + 2	10 + 2	10 + 2	10 + 2	10 (9 + 2)	10 + 2	10 + 2	10 + 2	10 + 2	
Icon menus	●	●	●	●	●	●	—	—	—	—	
Internal operation digits	15	15	15	15	15	15	15	15	12	12	
Parentheses level	26	26	26	26	26	26	26	24	24	24	
Programming Functions	Program logic	● (BASIC-like)	● (BASIC-like)	● (BASIC-like)	● (BASIC-like)	● (BASIC-like)	● (BASIC-like)	● (BASIC-like)	● (BASIC-like)	●	●
	Memory (bytes)	64,000	64,000	146,000	61,000	28,000	20,000	28,500	680	360	360
	Program areas	Limited to memory capacity	Limited to memory capacity	Limited to memory capacity	Limited to memory capacity	Limited to memory capacity	Limited to memory capacity	Limited to memory capacity	4	4	4
	Storage memory area (Flash memory)	1.5MB	1.5MB	768KB	—	—	—	—	—	—	—
Utilities	Natural textbook display	●	●	—	—	—	—	—	—	—	—
	Key rollover function	●	●	—	—	—	—	—	—	—	—
	Replay function	●	●	—	—	—	—	—	—	—	—
	Multi-replay functions	●	●	—	—	—	—	—	—	—	—
	Replay copy	—	—	—	—	—	—	—	—	—	—
	Backspace	●	●	—	—	—	—	—	—	—	—
	CALC function	●	●	—	—	—	—	—	—	—	—
	SOLVE function	●	●	—	—	—	—	—	—	—	—
	Answer function	●	●	—	—	—	—	—	—	—	—
	Variable memory	28	28	28	28	28	26	26 – 2398	7	7	7
Special Features	Base-n calculations (Binary/Octal/Hexadecimal)	●	●	●	●	●	—	—	—	—	—
	Logical operations	●	●	●	●	●	—	—	—	—	—
	Complex number calculation	●	●	●	●	●	—	—	—	—	—
	Engineering symbol calculations	●	●	●	●	●	—	—	—	—	—
	Engineering notations (ENG/ENG)	●	●	●	●	●	—	—	—	—	—
	Scientific constants	—	—	—	—	—	—	40	40	—	—
	Metric conversions	—	—	—	—	—	—	—	—	—	—
	Trigonometric, inverse trigonometric (sin/cos/tan/sin ⁻¹ /cos ⁻¹ /tan ⁻¹)	●	●	●	●	●	●	●	●	●	●
Hyperbolic, inverse hyperbolic (sinh/cosh/tanh/sinh ⁻¹ /cosh ⁻¹ /tanh ⁻¹)	●	●	●	●	●	—	—	—	—	—	
Exponential, logarithmic (log, ln, 10 ^x , e ^x)	●	●	●	●	●	●	●	●	●	●	
Base specified logarithmic	●	●	—	—	—	—	—	—	—	—	
Square and square root (x ² /√)	●	●	●	●	●	●	●	●	●	●	
Cubic and cubic root (x ³ / ³ √)	●	●	●	●	●	●	●	●	●	●	
Power and radical root (x ² / ² √)	●	●	●	●	●	●	●	●	●	●	
Independent key for x ² / ³ √	—	—	—	—	—	—	—	—	—	—	
Fraction	●	●	●	●	●	●	●	●	●	●	
Percentage calculation (%)	—	—	—	—	—	—	—	—	—	—	
Rounding	●	●	●	●	●	●	●	●	●	●	
Simplification	—	—	—	—	—	—	—	—	—	—	
Integer division	—	—	—	—	—	—	—	—	—	—	
Sexagesimal ↔ decimal	●	●	●	●	●	●	●	●	●	●	
Display format (FIX, SCI)	●	●	●	●	●	●	●	●	●	●	
Angle unit (Deg, Rad, Grad)	●	●	●	●	●	●	●	●	●	●	
Angle unit conversion (Deg, Rad, Grad)	●	●	●	●	●	●	●	●	●	●	
Calculus	Differentiation calculation	●	●	●	●	●	●	●	●	●	●
	Integration calculation	●	●	●	●	●	●	●	●	●	●
Algebra	Simultaneous equation	● (6 unknowns)	● (6 unknowns)	● (30 unknowns)	● (6 unknowns)	● (6 unknowns)	—	● (5 unknowns)	—	—	—
	Polynomial equation	● (Degree 2, 3)	● (Degree 2, 3)	● (Degree 2–30)	● (Degree 2, 3)	● (Degree 2, 3)	—	● (Degree 2, 3)	—	—	—
Geometry	Table function	●	●	●	●	●	●	●	●	●	
	Matrix calculations	●	●	●	●	●	●	●	●	●	
Probability	Coordinate conversion (Pol, Rec)	●	●	●	●	●	●	●	●	●	
	Vector calculations	—	—	—	—	—	—	—	—	—	
Statistics	Combination, permutation (nCr, nPr)	●	●	●	●	●	●	●	●	●	
	Random numbers	●	●	●	●	●	●	●	●	●	
	List-based STAT data editor	●	●	●	●	●	●	●	●	●	
	Standard deviation	●	●	●	●	●	●	●	●	●	
	Regression analysis	●	●	●	●	●	●	●	●	●	
	Linear regression	●	●	●	●	●	●	●	●	●	
Others	Other regressions	Med, Quad, Cubic, Quart, Log, Exp, Pwr, Sin, Lgst	Med, Quad, Cubic, Quart, Log, Exp, Pwr, Sin, Lgst	Med, Quad, Cubic, Quart, Log, Exp, Pwr, Sin, Lgst	Med, Quad, Cubic, Quart, Log, Exp, Pwr, Sin, Lgst	Med, Quad, Cubic, Quart, Log, Exp, Pwr, Sin, Lgst	Med, Quad, Log, Exp, Pwr	Log, Exp, Pwr, Inv, Quad	Log, Exp, Pwr, Inv, Quad	Log, Exp, Pwr, Inv, Quad	
	eActivity	●	●	—	—	—	—	—	—	—	
Others	Data communication	●	●	—	—	—	—	—	—	—	
	Label printer link	—	—	●	●	●	—	—	—	—	
Others	Advanced statistics, Financial function, Spreadsheet	Advanced statistics, Financial function, Spreadsheet	Advanced statistics, Financial function	Advanced statistics, Financial function	Advanced statistics, Financial function	—	—	—	—	—	
	Recursions	—	—	—	—	—	—	—	—	—	

*1 Continuous operation (assuming 5 minutes calculation and 55 minutes display per hour) *2 Continuous display of main menu *3 1 hour use per day *4 Continuous display of flashing cursor

Model	Programmable Models			Standard Models						
	fx-4500PA	fx-4800P	fx-5500LA	fx-82ES	fx-85ES	fx-350ES	fx-500ES	fx-991ES	fx-570ES	
Specifications	Number of functions	242	297	250	249	249	253	403	403	
	Power supply (Main)	CR2032 × 1	CR2032 × 1	CR2032 × 2	AAA × 1 (R03)	Two-way power (Solar + LR44 × 1)	AAA × 1 (LR03)	AAA × 1 (R03)	Two-way power (Solar + LR44 × 1)	AAA × 1 (R03)
	Power supply (Backup)	CR2032 × 1	CR2032 × 1	CR2032 × 1	—	—	—	—	—	—
	Approximate battery life Main (hours)	5,000*4	900*6	350*7	17,000*4	3 years (LR44)*3	8,700*1	17,000*4	3 years (LR44)*3	17,000*4
	Approximate battery life Backup (years)	2	2	2	—	—	—	—	—	—
	Dimensions H × W × D (mm)	9.9 × 73 × 141.5	Ⓣ 15 × 81.5 × 157 Ⓤ 11 × 165 × 157	9.9 × 73 × 141.5	13.7 × 80 × 161	12.2 × 80 × 161	13.7 × 80 × 161	13.7 × 80 × 161	12.2 × 80 × 161	13.7 × 80 × 161
	Approximate weight (g)	85	133	85	110	105	110	110	105	110
	Case style	Wallet	Integrated hard	Wallet	Slide-on hard	Slide-on hard	Slide-on hard	Slide-on hard	Slide-on hard	Slide-on hard
	Dot matrix display	5 × 7 dots × 12 digits	5 × 7 dots × 16 digits × 4 lines	5 × 7 dots × 16 digits × 2 lines	31 × 96 dots	31 × 96 dots	31 × 96 dots	31 × 96 dots	31 × 96 dots	31 × 96 dots
	Display capacity (characters)	12	16	16	15	15	15	15	15	15
Mantissa + exponent digits	10 + 2	10 + 2	10 + 2	10 + 2	10 + 2	10 + 2	10 + 2	10 + 2	10 + 2	
Icon menus	—	—	—	—	—	—	—	—	—	
Internal operation digits	12	15	12	15	15	15	15	15	15	
Parentheses level	24	26	26	24	24	24	24	24	24	
Programming Functions	Program logic	●	●	●	—	—	—	—	—	
	Memory (bytes)	1,103	4,500	1,095	—	—	—	—	—	
	Program areas	Limited to memory capacity	Limited to memory capacity	—	—	—	—	—	—	
	Storage memory area (Flash memory)	—	—	—	—	—	—	—	—	
Utilities	Natural textbook display	—	—	—	●	●	●	●	●	
	Key rollover function	●	●	●	●	●	●	●	●	
	Replay function	●	●	●	●	●	●	●	●	
	Multi-replay functions	—	—	—	—	—	—	—	—	
	Replay copy	—	—	—	—	—	—	—	—	
	Backspace	●	—	—	●	●	●	●	●	
	CALC function	●	●	●	—	—	—	—	—	
	SOLVE function	—	—	—	—	—	—	—	—	
	Answer function	●	●	●	●	●	●	●	●	
	Variable memory	26 – 163	26 – 476	26	7	7	7	7	7	
Special Features	Base-n calculations (Binary/Octal/Hexadecimal)	●	●	●	—	—	—	—	—	
	Logical operations	●	●	●	—	—	—	—	—	
	Complex number calculation	—	●	●	—	—	—	—	—	
	Engineering symbol calculations	●	●	●	—	—	—	—	—	
	Engineering notations (ENG/ENG)	●	●	●	●	●	●	●	●	
	Scientific constants	—	20	—	—	—	—	—	40	
	Metric conversions	—	—	—	—	—	—	—	40	
	Trigonometric, inverse trigonometric (sin/cos/tan/sin ⁻¹ /cos ⁻¹ /tan ⁻¹)	●	●	●	●	●	●	●	●	
Hyperbolic, inverse hyperbolic (sinh/cosh/tanh/sinh ⁻¹ /cosh ⁻¹ /tanh ⁻¹)	●	●	●	●	●	●	●	●		
Exponential, logarithmic (log, ln, 10 ^x , e ^x)	●	●	●	●	●	●	●	●		
Base specified logarithmic	—	—	—	●	●	●	●	●		
Square and square root (x ² /√)	●	●	●	●	●	●	●	●		
Cubic and cubic root (x ³ / ³ √)	●	●	●	●	●	●	●	●		
Power and radical root (x ² / ² √)	●	●	●	●	●	●	●	●		
Independent key for x ² / ³ √	—	—	—	●	●	●	●	●		
Fraction	●	●	●	●	●	●	●	●		
Percentage calculation (%)	—	—	—	—	—	—	—	—		
Rounding	●	●	●	●	●	●	●	●		
Simplification	—	—	—	—	—	—	—	—		
Integer division	—	—	—	—	—	—	—	—		
Sexagesimal ↔ decimal	●	●	●	●	●	●	●	●		
Display format (FIX, SCI)	●	●	●	●	●	●	●	●		
Angle unit (Deg, Rad, Grad)	●	●</								

Scientific Calculators Specification Table

		Standard Model											
Model		fx-82MS	fx-350MS	fx-85MS	fx-95MS	fx-100MS	fx-115MS	fx-570MS	fx-991MS	fx-820MS	fx-992s	fx-65	fx-901
Specifications	Number of functions	240	240	240	244	300	300	401	401	240	383	158	150
	Power supply (Main)	AA × 1	LR44 × 1	Two-way power (Solar + LR44 × 1)	AA × 1	AA × 1	Two-way power (Solar + LR44 × 1)	LR44 × 1	Two-way power (Solar + LR44 × 1)	Two-way power (Solar + LR44 × 1)	Two-way power (Solar + LR44 × 1)	Two-way power (Solar + LR44 × 1)	Two-way power (Solar + LR44 × 1)
	Power supply (Backup)	—	—	—	—	—	—	—	—	—	—	—	—
	Approximate battery life Main (hours)	17,000**/2 years**	9,000**/3 years**	3 years (LR44)**	17,000**/2 years**	17,000**/2 years**	3 years (LR44)**	9,000**/3 years**	3 years (LR44)**	3 years (LR44)**	3 years (LR44)**	3 years (LR44)**	3 years (LR44)**
	Approximate battery life Backup (years)	—	—	—	—	—	—	—	—	—	—	—	—
	Dimensions H × W × D (mm)	18.6 × 85 × 156	22.2 × 85 × 155	12.2 × 85 × 155	19.5 × 78 × 155	20 × 78 × 155	12.7 × 78 × 154.5	27.7 × 78 × 154.5	12.7 × 78 × 154.5	12 × 89 × 173	8.8 × 73 × 144	13.5 × 73 × 144.5	13.5 × 73 × 144.5
	Approximate weight (g)	125	100	100	130	133	105	105	105	120	74.3	67	67
	Case style	Slide-on hard	Slide-on hard	Slide-on hard	Slide-on hard	Slide-on hard	Slide-on hard	Slide-on hard	Slide-on hard	Hard case	Slide-on hard	Slide-on hard	Slide-on hard
	Dot matrix display	5 × 6 dots × 12 digits	5 × 6 dots × 12 digits	5 × 6 dots × 12 digits	5 × 6 dots × 12 digits	5 × 6 dots × 12 digits	5 × 6 dots × 12 digits	5 × 6 dots × 12 digits	5 × 6 dots × 12 digits	5 × 6 dots × 12 digits	5 × 5 dots × 4 digits	—	—
	Display capacity (characters)	12	12	12	12	12	12	12	12	12	—	—	—
Mantissa + exponent digits	10 + 2	10 + 2	10 + 2	10 + 2	10 + 2	10 + 2	10 + 2	10 + 2	10 + 2	12 + 2	10 + 2	10 + 2	
Icon menus	—	—	—	—	—	—	—	—	—	—	—	—	
Internal operation digits	12	12	12	12	12	12	12	12	12	14	12	12	
Parentheses level	24	24	24	24	24	24	24	24	24	18	18	18	
Programming Functions	Program logic	—	—	—	—	—	—	—	—	—	—	—	
	Memory (bytes)	—	—	—	—	—	—	—	—	—	—	—	
	Program areas	—	—	—	—	—	—	—	—	—	—	—	
	Storage memory area (Flash memory)	—	—	—	—	—	—	—	—	—	—	—	
Utilities	Built-in formulas	—	—	—	—	—	—	—	—	—	—	—	
	Natural textbook display	—	—	—	—	—	—	—	—	—	—	—	
	Key rollover function	●	●	●	●	●	●	●	●	●	●	●	
	Replay function	●	●	●	●	●	●	●	●	●	●	●	
	Multi-replay functions	—	—	—	—	—	—	—	—	—	—	—	
	Replay copy	—	—	—	—	—	—	—	—	—	—	—	
	Backspace	●	●	●	●	●	●	●	●	●	●	●	
	CALC function	—	—	—	—	—	—	—	—	—	—	—	
	SOLVE function	—	—	—	—	—	—	—	—	—	—	—	
	Answer function	●	●	●	●	●	●	●	●	●	●	●	
Variable memory	9	9	9	9	9	9	9	9	9	7	1	3	
Auto power off	●	●	●	●	●	●	●	●	●	●	●	●	
Special Features	Base-n calculations (Binary/Octal/Hexadecimal)	—	—	—	—	—	—	—	—	—	—	—	
	Logical operations	—	—	—	—	—	—	—	—	—	—	—	
	Complex number calculation	—	—	—	—	—	—	—	—	—	—	—	
	Engineering symbol calculations	—	—	—	—	—	—	—	—	—	—	—	
	Engineering notations (ENG/ENG)	●	●	●	●	●	●	●	●	●	●	●	
	Scientific constants	—	—	—	—	—	—	40	40	—	128	—	
Basic Functions	Metric conversions	—	—	—	—	—	—	40	40	—	—	—	
	Trigonometric, inverse trigonometric (sin/cos/tan/sin ⁻¹ /cos ⁻¹ /tan ⁻¹)	●	●	●	●	●	●	●	●	●	●	●	
	Hyperbolic, inverse hyperbolic (sinh/cosh/tanh/sinh ⁻¹ /cosh ⁻¹ /tanh ⁻¹)	●	●	●	●	●	●	●	●	●	●	●	
	Exponential, logarithmic (log, ln, 10 ^x , e ^x)	●	●	●	●	●	●	●	●	●	●	●	
	Base specified logarithmic	—	—	—	—	—	—	—	—	—	—	—	
	Square and square root (x ² /√)	●	●	●	●	●	●	●	●	●	●	●	
	Cubic and cubic root (x ³ /∛)	●	●	●	●	●	●	●	●	●	3√ only	●	
	Power and radical root (x ² /√)	●	●	●	●	●	●	●	●	●	—	●	
	Independent key for x ² /√	●	●	●	●	●	●	●	●	●	—	●	
	Fraction	●	●	●	●	●	●	●	●	●	—	●	
	Percentage calculation (%)	●	●	●	●	●	●	●	●	●	—	●	
	Rounding	●	●	●	●	●	●	●	●	●	—	●	
	Simplification	—	—	—	—	—	—	—	—	—	—	—	
	Integer division	—	—	—	—	—	—	—	—	—	—	—	
	Sexagesimal ↔ decimal	●	●	●	●	●	●	●	●	●	—	●	
	Display format (FIX, SCI)	●	●	●	●	●	●	●	●	●	—	●	
Angle unit (Deg, Rad, Grad)	●	●	●	●	●	●	●	●	●	—	●		
Angle unit conversion (Deg, Rad, Grad)	●	●	●	●	●	●	●	●	●	—	●		
Calculus	Differentiation calculation	—	—	—	—	—	—	—	—	—	—	—	
	Integration calculation	—	—	—	—	—	—	—	—	—	—	—	
Algebra	Simultaneous equation	—	—	—	● (3 unknowns)	● (3 unknowns)	● (3 unknowns)	● (3 unknowns)	● (3 unknowns)	—	—	—	
	Polynomial equation	—	—	—	● (Degree 2, 3)	● (Degree 2, 3)	● (Degree 2, 3)	● (Degree 2, 3)	● (Degree 2, 3)	—	—	—	
Geometry	Table function	—	—	—	—	—	—	—	—	—	—	—	
	Matrix calculations	—	—	—	—	—	—	—	—	—	—	—	
Probability	Coordinate conversion (Pol, Rec)	●	●	●	●	●	●	●	●	●	●	●	
	Vector calculations	—	—	—	—	—	—	—	—	—	—	—	
Statistics	Combination, permutation (nCr, nPr)	●	●	●	●	●	●	●	●	●	●	●	
	Random numbers	●	●	●	●	●	●	●	●	●	●	●	
	List-based STAT data editor	●	●	●	●	●	●	●	●	●	●	●	
	Standard deviation	●	●	●	●	●	●	●	●	●	●	●	
	Regression analysis	●	●	●	●	●	●	●	●	●	●	●	
	Linear regression	●	●	●	●	●	●	●	●	●	●	●	
Others	ab Exponential regression	—	—	—	—	—	—	—	—	—	—	—	
	Other regressions	Log, Exp, Pwr, Inv, Quad	Log, Exp, Pwr, Inv, Quad	Log, Exp, Pwr, Inv, Quad	Log, Exp, Pwr, Inv, Quad	Log, Exp, Pwr, Inv, Quad	Log, Exp, Pwr, Inv, Quad	Log, Exp, Pwr, Inv, Quad	Log, Exp, Pwr, Inv, Quad	Log, Exp, Pwr, Inv, Quad	—	—	
Others	eActivity	—	—	—	—	—	—	—	—	—	—	—	
	Data communication	—	—	—	—	—	—	—	—	—	—	—	
	Label printer link	—	—	—	—	—	—	—	—	—	—	—	
Others	Others	S-V.P.A.M.	S-V.P.A.M.	S-V.P.A.M.	S-V.P.A.M.	S-V.P.A.M., Formula memory (79 bytes), Normal distribution	S-V.P.A.M., Formula memory (79 bytes), Normal distribution	S-V.P.A.M., Formula memory (79 bytes), Normal distribution	S-V.P.A.M., Formula memory (79 bytes), Normal distribution	S-V.P.A.M.	V.P.A.M.	True fraction display	—

PRACTICAL CALCULATORS

A full lineup of easy-to-use models to meet a variety of different needs.

CASIO's unique value added calculators

Colourful & Friendly Design Choose from a selection of fresh colours.

NEW Mini desk type MS-10VC 10 DIGITS

Baby leaf Green, Radish Red, Carrot Orange, Peppermint Blue

Carrot Orange, Peppermint Blue

Mini desk type MS-5VC 8 DIGITS

Fresh Blueberry, Muscat Green, Peach Pink

Portable type SL-100VC 8 DIGITS

Carrot Orange, Peppermint Blue

NEW

Mini desk type MS-5VC 8 DIGITS

Fresh Blueberry, Muscat Green, Peach Pink

Stylish & Cool Design

The stylish calculator with the look and feel of a finely tuned sports car!

BURNING RED, COOL BLUE, KNIGHT BLACK

BURNING RED, KNIGHT BLACK

Compact desk type JF-200TV 12 DIGITS

EXTRA BIG DISPLAY, TWO WAY POWER, Key Rollover, PLASTIC KEYS, Metal Cover, Tax & Exchange, Profit Margin %

Portable type SL-1000TV 10 DIGITS

EXTRA BIG DISPLAY, TWO WAY POWER, Key Rollover, PLASTIC KEYS, Metal Cover, Profit Margin %

Model	Digits	Independent memory	GT	%	Profit margin %	□	+/-	▶	3-digit comma markers	H/M/S	Tax calculation	Exchange calculation	5/4	Cut	Decimal selector	ADD mode	Power supply	Dimensions H×W×D (mm)	Approximate weight (g)	Case
MS-10VC	10	●	—	●	●	●	●	●	●	●	—	—	—	—	—	—	Two-way power	26.2×105.5×144	100	—
SL-100VC	8	●	—	●	●	—	—	—	—	—	—	—	—	—	—	—	Two-way power	13.5×91×55 9.4×91×110.5	55	—
MS-5VC	8	●	—	●	●	—	—	—	—	—	—	—	—	—	—	—	Two-way power	25×86×118	60	—
JF-200TV	12	●	—	●	●	—	—	—	—	—	—	—	●	●	0,1,2,3,4	●	Two-way power	29.3×107×175.5	165	—
SL-1000TV	10	●	—	●	●	—	—	—	—	—	—	—	—	—	—	—	Two-way power	7.5×70×118	50	Wallet

Ⓢ Folded Ⓣ Unfolded

Check Calculator



DJ-240 12 DIGITS DJ-240

- 120 STEPS CHECK
- BIG DISPLAY
- TWO WAY POWER
- Key Rollover
- PLASTIC KEYS
- Metal Cover
- TAX
- Profit Margin %
- ±/∓
- +
-

DJ-120T 12 DIGITS

- 100 STEPS CHECK
- EXTRA BIG DISPLAY
- TWO WAY POWER
- Key Rollover
- PLASTIC KEYS
- TAX
- %
- ±/∓
- MU



NEW DJ-20T 12 DIGITS

- 100 STEPS CHECK
- EXTRA BIG DISPLAY
- TWO WAY POWER
- Key Rollover
- PLASTIC KEYS
- TAX
- %
- ±/∓
- MU

MJ-120T 12 DIGITS MJ-120T

- 100 STEPS CHECK
- EXTRA BIG DISPLAY
- TWO WAY POWER
- Key Rollover
- PLASTIC KEYS
- TAX
- %
- ±/∓
- MU

120 Steps CHECK

※100 STEPS --DJ-20T/DJ-120T/MJ-100T/MJ-120T

Review and Auto Review

120 STEPS CHECK Review up to 120 calculation steps.

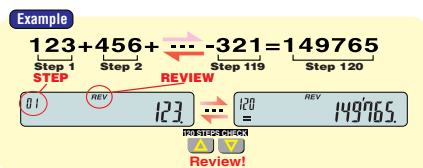

AUTO REVIEW Auto Review at the touch of a key!

Correct (all models)

CORRECT Quick and easy editing of steps!

Double Check (DJ-220 / DJ-240 only)

ANSI/CHECK Compare the results of two calculations!

Answer Memory (DJ-220 / DJ-240 only)

ANSI/CHECK Recall a previous calculation result and use it in the next calculation!

Insert / Delete (DJ-220 / DJ-240 only)

INSERT **DELETE** To add steps to or delete steps from a calculation

You can add steps to or delete steps from Calculation Memory. Also, remember that if the number of steps in Calculation Memory exceeds 120, you will not be able to review them later.

Example
Current calculation: $(20-5-5) \times 3 \div 5 = 6$
Revised calculation: $[(20-5) \times 3 \div 5 = 9] + 10 = 19$

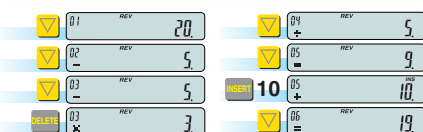

Metric Converter



MC-100 8 DIGITS

- BIG DISPLAY
- TWO WAY POWER
- Conversion
- Profit Margin %
- ±/∓
- +
-

Wireless Calculator



JZ-12W 12 DIGITS

- EXTRA BIG DISPLAY
- TAX
- TWO WAY POWER
- Time
- Key Rollover
- Profit Margin %
- PLASTIC KEYS
- ±/∓
- +
-
- Metal Cover

A wireless & trouble-free PC compatible calculator.

- Just plug in the accessory receiver in the USB port on the PC. It allows wireless data communication between the calculator unit and PC, and easy transmitting of input numbers, calculation results and operation symbols.
- Equipped with Tab, Backspace and Cursor keys for smooth and easy data communications using Microsoft® Excel and Microsoft® Words, providing higher affinity with the PC.

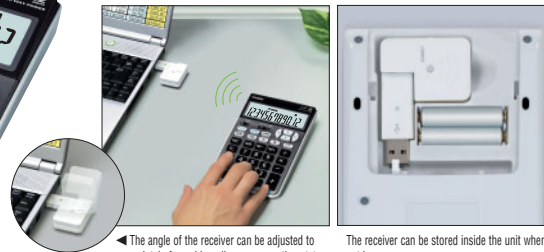

◀ The angle of the receiver can be adjusted to maintain favorable radio wave reception status. The receiver can be stored inside the unit when not in use.

- Minimum System Requirements**
- Operating System: Pre-installed Windows® XP/2000 Professional/Me/98.
 - Computer: IBM PC/AT or compatible PC (DOS/V) which meets the following requirements: Run on Windows® XP/2000 Professional/Me/98, with a built-in USB port.
 - * Microsoft and Windows are registered trademarks of Microsoft Corporation in the United States and other countries.
 - * IBM PC/AT is a registered trademark of International Business Machines Corporation.

Water-protected and Dust-proof Calculator



Desk top type

WD-220T 12 DIGITS

Durability and endurance for professional and general users

- Complies with IEC 60529 IP 54 (water protect and dust proof)

Mini desk type



WM-220T 12 DIGITS

WM-200T 12 DIGITS

- BIG DISPLAY
- TWO WAY POWER
- Key Rollover
- PLASTIC KEYS
- TAX
- Time
- Profit Margin %
- ±/∓
- +
-

3-Line Display Calculator



Desk top type

DF-320TM 12 DIGITS



Mini desk type

MS-310TM 12 DIGITS



Portable type

NS-310TM 12 DIGITS

Cost, Selling Price and Margin Calculations

For Shopkeepers & Traders

Perform the operations shown below to calculate cost, selling price, and margin.

Example: $1234567890.12 \times 25\% = 308641972.51$

cost: 1234567890.12
margin: 25%
selling price: 1646090520.16

Currency Conversion Mode (DF-320TM only)

For Money Exchanger, Bank & Travel Agent

You can have up to seven currency conversion rates registered in memory for instant recall whenever you need them. After you select a currency name and register a rate, you can use it for conversion from one currency to another.

Example: Currency A 1.234 = Currency B 2,413.49422

A 1.234
B 195583
241349422

Change Calculations (DF-320TM only)

For Retailers, Restaurant & Bar

The calculation result is obtained in accordance with the current rounding setting.

Tax Calculations

For Accounting & Bookkeeper, Retailer

Automatic calculation and display of price plus tax, price less tax, discount, selling price, tax amount, discount amount, and margin amount.

Cost, Selling Price and Margin Calculator

Portable type
The only business calculator you'll ever need!



SL-910TM 10 DIGITS

- BIG DISPLAY
- TAX
- TWO WAY POWER
- Profit Margin %
- Key Rollover
- ±/∓
- +
-
- PLASTIC KEYS

Calculation Examples

Cost

What is the cost of an item that sells for \$2,550 after a 30% margin is added?

2550

SELL> 2550

SELL> 2550

30

SELL> 2550

30

SELL> 2550

30%

1785

Selling Price

What would the selling price be for an item that costs \$1,785 after a 30% margin is added?

1785

COST> 1785

COST> 1785

30

COST> 1785

30

COST> 1785

30%

2550

Margin

What is the margin on an item that costs \$1,785 and sells for \$2,550?

1785

COST> 1785

COST> 1785

2550

COST> 1785

2550

30

SELL> 2550

30%

*Example displays are from NS-310TM.

Model	Digits	Independent memory	GT	%	Profit margin %	±/∓	+	-	3-digit comma markers	H/M/S	Tax calculation	5/4	Cut	Up	Decimal selector	ADD mode	Power supply	Dimensions H×W×D (mm)	Approximate weight (g)	Case	Others
DJ-240	14	●	●	●	●	●	●	●	●	—	—	●	●	●	0,1,2,3,4	●	Two-way power	35.7×147×203.5	250	—	120 STEPS CHECK
DJ-220	12	●	●	●	●	●	●	●	●	—	—	●	●	●	0,1,2,3,4	●	Two-way power	35.7×147×203.5	250	—	120 STEPS CHECK
DJ-120T	12	●	●	●	—	●	●	●	●	—	—	●	●	●	0,1,2,3,4	●	Two-way power	35×140×191	205	—	100 STEPS CHECK
DJ-20T	12	●	●	●	—	●	●	●	●	—	—	●	●	●	0,1,2,3,4	●	Two-way power	35×123.5×165.5	150	—	100 STEPS CHECK
MJ-120T	12	●	●	●	●	●	●	●	●	—	—	●	●	●	—	—	Two-way power	30.1×123×140	130	—	100 STEPS CHECK
MJ-100T	10	●	●	●	—	●	●	●	●	—	—	●	●	●	—	—	Two-way power	30.1×123×140	130	—	100 STEPS CHECK
MC-100	8	●	●	●	—	—	—	—	—	—	—	—	—	—	—	—	Two-way power	6.1×70×117	42	Wallet	Metric conversion
JZ-12W	12	●	●	●	—	●	●	●	●	—	—	●	●	●	0,1,2,3,4	●	Two-way power	35×110×176.5	225	—	USB receiver

Model	Digits	Independent memory	GT	%	Profit margin %	±/∓	+	-	3-digit comma markers	H/M/S	Tax calculation	Exchange calculation	5/4	Cut	Up	Decimal selector	ADD mode	Power supply	Dimensions H×W×D (mm)	Approximate weight (g)
WD-220T	12	●	●	●	●	●	●	●	●	●	—	—	—	—	—	—	—	Two-way power	34×139×187.5	255
WM-220T	12	●	●	●	●	●	●	●	●	●	—	—	—	—	—	—	—	Two-way power	34.6×104×153.5	135
WM-200T	10	●	●	●	●	●	●	●	●	●	—	—	—	—	—	—	—	Two-way power	34.6×104×153.5	135
DF-320TM	12	●	●	●	●	●	●	●	●	●	●	●	●	●	●	0,1,2,3,4	●	Two-way power	32.3×124×179.5	200
MS-310TM	10	●	●	●	●	●	●	●	●	●	●	●	●	●	●	0,1,2,3,4	●	Two-way power	30×103×156	120
NS-310TM	10	●	●	●	●	●	●	●	●	●	●	●	●	●	●	0,1,2,3,4	●	Two-way power	11×87×149.5	95
SL-910TM	10	●	●	●	●	●	●	●	●	●	●	●	●	●	●	—	—	Two-way power	9.9×73×125	55

Desk Top Type

Professional Calculator

- EXTRA BIG DISPLAY
- Metal Cover
- Time
- Key Rollover
- Profit Margin %
- PLASTIC KEYS



DS-3V ¹⁴ DIGITS

Professional Calculator

- EXTRA BIG DISPLAY
- Metal Cover
- TAX
- Key Rollover
- Profit Margin %
- PLASTIC KEYS



DS-2TV ¹² DIGITS
DS-1TV ¹⁰ DIGITS

Adding Machine

- EXTRA BIG DISPLAY
- TAX
- Time
- Key Rollover
- Profit Margin %
- PLASTIC KEYS
- Metal Cover



DS-20TV ¹² DIGITS
DS-10TV ¹⁰ DIGITS

Adding Machine

- EXTRA BIG DISPLAY
- TAX
- MU MD
- Key Rollover
- Profit Margin %
- PLASTIC KEYS



DS-120TV ¹² DIGITS

Professional Calculator

- BIG DISPLAY
- PLASTIC KEYS
- TAX
- Key Rollover
- %



DM-1200T ¹² DIGITS

Professional Calculator

- BIG DISPLAY
- PLASTIC KEYS
- Metal Cover
- TAX
- %



DM-1600TV ¹² DIGITS

Desk Top Type

Professional Calculator

- BIG DISPLAY
- PLASTIC KEYS
- %
- TWO WAY POWER
- Metal Cover
- Key Rollover
- TAX



DM-1400TV ¹² DIGITS

Professional Calculator

- BIG DISPLAY
- Metal Cover
- TWO WAY POWER
- Tax & Exchange
- Key Rollover
- Profit Margin %
- PLASTIC KEYS



DM-1200TEV ¹² DIGITS

Adding Machine

- BIG DISPLAY
- PLASTIC KEYS
- TWO WAY POWER
- MARK-UP %
- Key Rollover



D-60L ¹⁵ DIGITS
D-40L ¹⁴ DIGITS
D-20L ¹² DIGITS

Adding Machine

- BIG DISPLAY
- Time
- TWO WAY POWER
- Profit Margin %
- Key Rollover
- PLASTIC KEYS
- TAX



D-120TV ¹² DIGITS

Professional Calculator

- EXTRA BIG DISPLAY
- Tax & Exchange
- TWO WAY POWER
- Profit Margin %
- Key Rollover
- PLASTIC KEYS
- Metal Cover



DF-120TV ¹² DIGITS

Adjustable Tilt Display

- EXTRA BIG DISPLAY
- Metal Cover
- TWO WAY POWER
- Tax & Exchange
- Key Rollover
- Profit Margin %
- PLASTIC KEYS

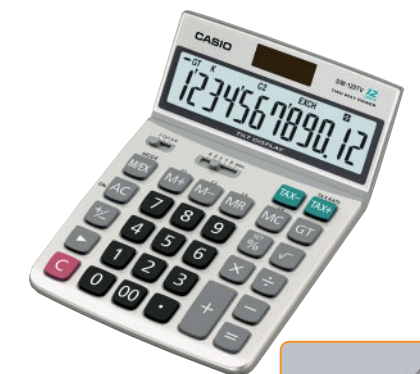

NEW
DW-120TV ¹² DIGITS



The degree of display can be adjusted freely.

Model	Digits	Adding machine	Independent memory	GT	%	Profit margin %	✓	+/-	▶	3-digit comma markers	H/M/S	Tax calculation	5/4	Cut	Up	Decimal selector	ADD mode	Power supply	Dimensions H×W×D (mm)	Approximate weight (g)
DS-3V	14	—	●	●	●	●	—	●	●	●	●	—	—	—	—	0,1,2,3,4	●	Two-way power	47.8×148×186	290
DS-2TV	12	—	●	●	●	●	—	●	●	●	●	—	—	—	—	0,1,2,3,4	●	Two-way power	47.8×148×186	290
DS-1TV	10	—	●	●	●	●	—	●	●	●	●	—	—	—	—	0,1,2,3,4	●	Two-way power	47.8×148×186	290
DS-20TV	12	—	●	●	●	●	—	●	●	●	●	—	—	—	—	0,1,2,3,4,5	●	Two-way power	34.8×135×188	275
DS-10TV	10	—	●	●	●	●	—	●	●	●	●	—	—	—	—	0,1,2,3,4,5	●	Two-way power	34.8×135×188	275
DS-120TV	12	●	●	●	●	●	—	●	●	●	●	—	—	—	—	0,1,2,3,4	●	Two-way power	40.9×184×186	300
DM-1200T	12	—	●	—	—	—	—	●	●	●	●	—	—	—	—	0,1,2,4	●	Two-way power	34.5×155×210	230
DM-1600TV	16	—	●	—	—	—	—	●	●	●	●	—	—	—	—	0,1,2,4	●	Two-way power	35.5×155×210	270

Model	Digits	Independent memory	GT	%	Profit margin %	Mark-up %	✓	+/-	▶	3-digit comma markers	H/M/S	Tax calculation	Exchange calculation	5/4	Cut	Up	Decimal selector	ADD mode	Power supply	Dimensions H×W×D (mm)	Approximate weight (g)
DM-1400TV	14	●	—	●	—	—	—	●	●	●	●	—	—	—	—	—	0,1,2,4	●	Two-way power	35.5×155×210	270
DM-1200TEV	12	●	●	●	●	—	—	●	●	●	●	—	—	—	—	—	0,1,2,3,4	●	Two-way power	35.5×155×210	265
D-60L	16	●	—	●	—	—	—	●	●	●	●	—	—	—	—	—	0,1,2,4	●	Two-way power	32×151×158	195
D-40L	14	●	—	●	—	—	—	●	●	●	●	—	—	—	—	—	0,1,2,4	●	Two-way power	32×151×158	195
D-20L	12	●	—	●	—	—	—	●	●	●	●	—	—	—	—	—	0,1,2,4	●	Two-way power	32×151×158	195
D-120TV	12	●	—	●	—	—	—	●	●	●	●	—	—	—	—	—	0,1,2,3,4	●	Two-way power	35×126×175	170
DF-120TV	12	●	●	●	●	—	—	●	●	●	●	—	—	—	—	—	0,1,2,3,4	●	Two-way power	35×126×175	195
DW-120TV	12	●	●	●	●	—	—	●	●	●	●	—	—	—	—	—	0,1,2,3,4	●	Two-way power	32.7×122.5×177.5	195

Compact Desk Type

Adjustable Tilt Display

- EXTRA BIG DISPLAY
- TWO WAY POWER
- Key Rollover
- PLASTIC KEYS
- Metal Cover

JS-140V

The degree of display can be adjusted freely.

Adjustable Tilt Display

- EXTRA BIG DISPLAY
- TAX
- Profit Margin %
- Key Rollover
- PLASTIC KEYS
- Metal Cover

JS-120TV

JS-110TV

Professional Calculator

- EXTRA BIG DISPLAY
- TWO WAY POWER
- Key Rollover
- PLASTIC KEYS
- Metal Cover

JS-40V

Professional Calculator

- EXTRA BIG DISPLAY
- TAX
- Profit Margin %
- Key Rollover
- PLASTIC KEYS
- Metal Cover

JS-20TV

JS-10TV

- BIG DISPLAY
- TWO WAY POWER
- Key Rollover
- PLASTIC KEYS
- TAX

J-120TV

- EXTRA BIG DISPLAY
- Tax & Exchange
- Profit Margin %
- Key Rollover
- PLASTIC KEYS
- Metal Cover

JF-120TV

- EXTRA BIG DISPLAY
- Tax & Exchange
- Profit Margin %
- Key Rollover
- PLASTIC KEYS
- Metal Cover

NEW JW-120TV

The degree of display can be adjusted freely.

Model	Digits	Independent memory	GT	%	Profit margin %	✓	+/-	▶	3-digit comma markers	H/M/S	Tax calculation	Exchange calculation	5/4	Cut	Decimal selector	ADD mode	Power supply	Dimensions H×W×D (mm)	Approximate weight (g)
JS-140V	14	●	●	●	●	●	●	●	●	●	●	●	●	●	0.1,2,3,4	●	Two-way power	24.6×107×176.5	180
JS-120TV	12	●	●	●	●	●	●	●	●	●	●	●	●	●	0.1,2,3,4	●	Two-way power	24.6×107×176.5	180
JS-110TV	10	●	●	●	●	●	●	●	●	●	●	●	●	●	0.1,2,3,4	●	Two-way power	24.6×107×176.5	180
JS-40V	14	●	●	●	●	●	●	●	●	●	●	●	●	●	0.1,2,3,4	●	Two-way power	24.2×107×174.5	195
JS-20TV	12	●	●	●	●	●	●	●	●	●	●	●	●	●	0.1,2,3,4	●	Two-way power	24.2×107×174.5	195
JS-10TV	10	●	●	●	●	●	●	●	●	●	●	●	●	●	0.1,2,3,4	●	Two-way power	24.2×107×174.5	195
J-120TV	12	●	●	●	●	●	●	●	●	●	●	●	●	●	0.1,2,3,4	●	Two-way power	25×107×176	145
JF-120TV	12	●	●	●	●	●	●	●	●	●	●	●	●	●	0.1,2,3,4	●	Two-way power	29.3×107×175.5	165
JW-120TV	12	●	●	●	●	●	●	●	●	●	●	●	●	●	0.1,2,3,4	●	Two-way power	26.1×107×178.5	170

Mini Desk Type

- BIG DISPLAY
- TWO WAY POWER
- Key Rollover
- PLASTIC KEYS

MS-470LB

- BIG DISPLAY
- Metal Cover
- TWO WAY POWER
- Tax & Exchange
- Key Rollover
- Profit Margin %
- PLASTIC KEYS

MS-120TV

MS-100TV

MS-80TV

- BIG DISPLAY
- TAX
- TWO WAY POWER
- Key Rollover
- PLASTIC KEYS

MS-20TV

- BIG DISPLAY
- Profit Margin %
- TWO WAY POWER
- PLASTIC KEYS
- TAX

MS-8TV

- BIG DISPLAY
- TAX
- TWO WAY POWER
- Key Rollover
- PLASTIC KEYS

MS-270T

MS-170T

- BIG DISPLAY
- TWO WAY POWER
- Key Rollover
- PLASTIC KEYS
- TAX

MS-7T

- BIG DISPLAY
- PLASTIC KEYS
- %

MW-8V

BK (Black) WE (White)

- BIG DISPLAY
- PLASTIC KEYS
- %

MW-5V

BK (Black) WE (White)

- BIG DISPLAY
- Metal Cover
- TWO WAY POWER
- TAX
- Key Rollover
- Time
- Profit Margin %
- PLASTIC KEYS

NS-20T

NS-10T

Model	Digits	Independent memory	GT	%	Profit margin %	✓	+/-	▶	3-digit comma markers	H/M/S	Tax calculation	Exchange calculation	5/4	Cut	Decimal selector	ADD mode	Power supply	Approximate battery life (years)	Dimensions H×W×D (mm)	Approximate weight (g)
MS-470LB	14	●	●	●	●	●	●	●	●	●	●	●	●	●	—	—	Two-way power	—	32×111×133.5	110
MS-120TV	12	●	●	●	●	●	●	●	●	●	●	●	●	●	—	—	Two-way power	—	30.7×103×145	120
MS-100TV	10	●	●	●	●	●	●	●	●	●	●	●	●	●	—	—	Two-way power	—	30.7×103×145	120
MS-80TV	8	●	●	●	●	●	●	●	●	●	●	●	●	●	—	—	Two-way power	—	30.7×103×145	120
MS-20TV	12	●	●	●	●	●	●	●	●	●	●	●	●	●	—	—	Two-way power	—	31.7×103×145	100
MS-10TV	10	●	●	●	●	●	●	●	●	●	●	●	●	●	—	—	Two-way power	—	31.7×103×145	100
MS-8TV	8	●	●	●	●	●	●	●	●	●	●	●	●	●	—	—	Two-way power	—	31.7×103×145	100
MS-270T	12	●	●	●	●	●	●	●	●	●	●	●	●	●	—	—	Two-way power	—	32×111×133.5	110
MS-170T	10	●	●	●	●	●	●	●	●	●	●	●	●	●	—	—	Two-way power	—	32×111×133.5	110
MS-7T	8	●	●	●	●	●	●	●	●	●	●	●	●	●	—	—	Two-way power	—	32×111×133.5	110
MW-8V	8	●	●	●	●	●	●	●	●	●	●	●	●	●	—	—	AA×1 (R6P×1)	2	28.8×103×145	120
MW-5V	8	●	●	●	●	●	●	●	●	●	●	●	●	●	—	—	AA×1 (R6P×1)	2	25.1×84×118	85
NS-20T	12	●	●	●	●	●	●	●	●	●	●	●	●	●	0.1,2,3,4	●	Two-way power	—	10.7×87×145	90
NS-10T	10	●	●	●	●	●	●	●	●	●	●	●	●	●	0.1,2,3,4	●	Two-way power	—	10.7×87×145	90

R6P=UM-3

Portable Type

LC-1000TV (10 Digits) **LC-401LV** (8 Digits) **LC-403TV** (8 Digits) **LC-160LV** (8 Digits)

EXTRA BIG DISPLAY, Profit Margin %, Key Rollover, PLASTIC KEYS, Metal Cover, TAX, EXTRA BIG DISPLAY, Profit Margin %, Key Rollover, PLASTIC KEYS, Metal Cover, TAX, BIG DISPLAY, Profit Margin %, Key Rollover, PLASTIC KEYS, Metal Cover, TAX, EXTRA BIG DISPLAY, Profit Margin %, Key Rollover, PLASTIC KEYS, Metal Cover, TAX, BIG DISPLAY, Profit Margin %, Key Rollover, PLASTIC KEYS, Metal Cover, TAX

LC-403TV (8 Digits) **LC-160LV** (8 Digits)

EXTRA BIG DISPLAY, Profit Margin %, Key Rollover, PLASTIC KEYS, Metal Cover, TAX, BIG DISPLAY, Profit Margin %, Key Rollover, PLASTIC KEYS, Metal Cover, TAX, EXTRA BIG DISPLAY, Profit Margin %, Key Rollover, PLASTIC KEYS, Metal Cover, TAX, BIG DISPLAY, Profit Margin %, Key Rollover, PLASTIC KEYS, Metal Cover, TAX

SL-340VA (14 Digits) **SL-320TV** (12 Digits) **SL-315TV** (10 Digits) **SL-300TV** (8 Digits) **SL-300LV** (8 Digits)

EXTRA BIG DISPLAY, Profit Margin %, Key Rollover, PLASTIC KEYS, Metal Cover, TAX, EXTRA BIG DISPLAY, Profit Margin %, Key Rollover, PLASTIC KEYS, Metal Cover, TAX, EXTRA BIG DISPLAY, Profit Margin %, Key Rollover, PLASTIC KEYS, Metal Cover, TAX, EXTRA BIG DISPLAY, Profit Margin %, Key Rollover, PLASTIC KEYS, Metal Cover, TAX, EXTRA BIG DISPLAY, Profit Margin %, Key Rollover, PLASTIC KEYS, Metal Cover, TAX

SL-240LB (14 Digits) **SL-220TE** (12 Digits) **SL-210TE** (10 Digits) **SL-200TE** (8 Digits) **SL-100L** (8 Digits)

BIG DISPLAY, Profit Margin %, Key Rollover, PLASTIC KEYS, Metal Cover, TAX, EXTRA BIG DISPLAY, Profit Margin %, Key Rollover, PLASTIC KEYS, Metal Cover, TAX, EXTRA BIG DISPLAY, Profit Margin %, Key Rollover, PLASTIC KEYS, Metal Cover, TAX, EXTRA BIG DISPLAY, Profit Margin %, Key Rollover, PLASTIC KEYS, Metal Cover, TAX

Model	Digits	Independent memory	GT	%	Profit margin %	Key Rollover	3-digit comma markers	H/M/S	Tax calculation	Exchange calculation	5/4	Cut	Decimal selector	Power supply	Approximate battery life (hours)	Dimensions HxWxD (mm)	Approximate weight (g)	Case
LC-1000TV	10	●	—	●	●	—	—	—	—	—	—	—	—	LR54x1	5,500	7.5x70x118.5	50	Wallet
LC-401LV	8	●	—	●	●	—	—	—	—	—	—	—	—	LR54x1	4,500	10.7x75x120 7.3x151.5x120	70	Hard
LC-403TV	8	●	—	●	●	—	—	—	—	—	—	—	—	LR54x1	7,500	7.5x70x118.5	50	Wallet
LC-160LV	8	●	—	●	●	—	—	—	—	—	—	—	—	LR54x1	6,500	10x87x58 8x87x117.5	35	Hard
SL-340VA	14	●	—	●	●	—	—	—	—	—	—	—	Two-way power	—	7.5x70x118.5	50	Wallet	
SL-320TV	12	●	—	●	●	—	—	—	—	—	—	—	Two-way power	—	7.5x70x118.5	50	Wallet	
SL-315TV	10	●	—	●	●	—	—	—	—	—	—	—	Two-way power	—	7.5x70x118.5	50	Wallet	
SL-300TV	8	●	—	●	●	—	—	—	—	—	—	—	Two-way power	—	7.5x70x118.5	50	Wallet	
SL-300LV	8	●	—	●	●	—	—	—	—	—	—	—	Two-way power	—	7.5x70x118.5	50	Wallet	
SL-240LB	14	●	—	●	●	—	—	—	—	—	—	2	Two-way power	—	12.5x120x73 6.5x120x141	76	—	
SL-220TE	12	●	—	●	●	—	—	—	—	—	—	2	Two-way power	—	12.5x120x73 6.5x120x141	76	—	
SL-210TE	10	●	—	●	●	—	—	—	—	—	—	2	Two-way power	—	12.5x120x73 6.5x120x141	75.5	—	
SL-200TE	8	●	—	●	●	—	—	—	—	—	—	—	Two-way power	—	12.5x120x73 6.5x120x141	76	—	
SL-100L	8	●	—	●	●	—	—	—	—	—	—	—	Two-way power	—	13.5x91x55 9.4x91x110.5	55	—	

LR54=LR1130 (F) Folded (U) Unfolded

Portable Type

SL-797TV (8 Digits) **SL-787TV** (8 Digits) **SL-760LB** (8 Digits)

BIG DISPLAY, Tax & Exchange, Profit Margin %, Key Rollover, PLASTIC KEYS, Metal Cover, EXTRA BIG DISPLAY, Profit Margin %, Key Rollover, PLASTIC KEYS, Metal Cover, BEST VIEW, SUPER SOLAR, Profit Margin %, Key Rollover, PLASTIC KEYS, Metal Cover, TAX

HL-122TV (12 Digits) **HL-100LB** (10 Digits) **HL-820VA** (8 Digits)

BIG DISPLAY, TAX, Profit Margin %, Key Rollover, PLASTIC KEYS, Metal Cover, BIG DISPLAY, Profit Margin %, Key Rollover, PLASTIC KEYS, Metal Cover, BIG DISPLAY, Profit Margin %, Key Rollover, PLASTIC KEYS, Metal Cover, TAX

HL-820LV (8 Digits) **HL-815L** (8 Digits)

BIG DISPLAY, Profit Margin %, Key Rollover, PLASTIC KEYS, Metal Cover, BIG DISPLAY, Profit Margin %, Key Rollover, PLASTIC KEYS, Metal Cover, TAX

HL-4 (8 Digits) **HS-8VA** (8 Digits) **HS-8LV** (8 Digits)

BIG DISPLAY, Profit Margin %, Key Rollover, PLASTIC KEYS, Metal Cover, BIG DISPLAY, MARK-UP %, Profit Margin %, Key Rollover, PLASTIC KEYS, Metal Cover, BIG DISPLAY, Profit Margin %, Key Rollover, PLASTIC KEYS, Metal Cover, TAX

Model	Digits	Independent memory	GT	%	Profit margin %	Mark-up %	Key Rollover	3-digit comma markers	Tax calculation	Exchange calculation	5/4	Cut	Decimal selector	Power supply	Approximate battery life (hours)	Dimensions HxWxD (mm)	Approximate weight (g)	Case
SL-797TV	8	●	—	●	●	—	—	—	—	—	—	—	—	Two-way power	—	6.9x57x102	35	Wallet
SL-787TV	8	●	—	●	●	—	—	—	—	—	—	—	—	Two-way power	—	6.3x91.5x58	30	Wallet
SL-760LB	8	●	—	●	●	—	—	—	—	—	—	—	Solar	—	2.9x85.5x54	15	Soft	
HL-122TV	12	●	—	●	●	—	—	—	—	—	—	2	LR6x1(R6Px1)	17,500	19.5x77x141	115	Soft	
HL-100LB	10	●	—	●	●	—	—	—	—	—	—	—	LR6x1(R6Px1)	2 yrs.	18x69.5x118	65	—	
HL-820VA	8	●	—	●	●	—	—	—	—	—	—	—	LR54x1	2 yrs.	6.9x57x102	35	Wallet	
HL-820LV	8	●	—	●	●	—	—	—	—	—	—	—	LR54x1	6,500	10x62.5x104 7.5x127x104	45	Hard	
HL-815L	8	●	—	●	●	—	—	—	—	—	—	—	LR6x1(R6Px1)	2 yrs.	18x69.5x118	65	—	
HL-4	8	●	—	●	●	—	—	—	—	—	—	—	LR54x1	6,500	8.8x56x87	25	—	
HS-8VA	8	●	—	●	●	—	—	—	—	—	—	—	Two-way power	—	6.9x57x102	35	Wallet	
HS-8LV	8	●	—	●	●	—	—	—	—	—	—	—	Two-way power	—	6.7x57x102	35	Wallet	

LR54=LR1130 (F) Folded (U) Unfolded
LR6=AM3, R6P=UM-3

PRACTICAL CALCULATORS

Value Series

Desk Top Type

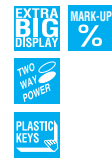

GX-16V

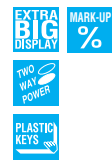

GX-14V



GX-120V

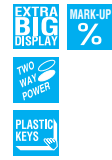

GX-12V



Adjustable Tilt Display



NEW DX-120TV



The degree of display can be adjusted freely.



DX-120V

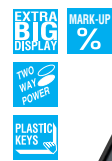

DX-12V

Model	Digits	Independent memory	GT	%	Mark-up %	✓	+/-	▶	3-digit comma markers	Item counter	5/4	Cut	Up	Decimal selector	ADD mode	Power supply	Dimensions H×W×D (mm)	Approximate weight (g)
GX-16V	16	●	—	●	●	●	●	●	●	—	●	●	●	0,1,2,4	●	Two-way power	34.5×155×210	230
GX-14V	14	●	—	●	●	●	●	●	●	●	●	●	●	0,1,2,4	●	Two-way power	34.5×155×210	230
GX-120V	12	●	—	●	●	●	●	●	●	●	●	●	●	0,1,2,4	●	Two-way power	35.5×155×210	260
GX-12V	12	●	—	●	●	●	●	●	●	●	●	●	●	0,1,2,4	●	Two-way power	34.5×155×210	230
DX-120TV	12	●	●	●	●	●	●	●	●	—	●	●	●	0,1,2,4	●	Two-way power	32.7×122.5×177.5	195
DX-120V	12	●	●	●	●	●	●	●	●	—	●	●	●	0,1,2,4	●	Two-way power	36×126×175	190
DX-12V	12	●	●	●	●	●	●	●	●	—	●	●	●	0,1,2,4	●	Two-way power	35×126×175	170

PRACTICAL CALCULATORS

Compact Desk Type



Adjustable Tilt Display



NEW AX-120TV



The degree of display can be adjusted freely.



AX-120V



AX-12V

Mini Desk Type



MX-120V



MX-12V



SX-320P

Portable Type



SX-300P



SX-300



DUAL LEAF SX-220



DUAL LEAF SX-100



Model	Digits	Independent memory	GT	%	Mark-up %	✓	+/-	▶	3-digit comma markers	5/4	Cut	Up	Decimal selector	ADD mode	Power supply	Dimensions H×W×D (mm)	Approximate weight (g)	Case
AX-120TV	12	●	●	●	●	●	●	●	●	●	●	●	0,1,2,4	●	Two-way power	26.1×107×178.5	170	—
AX-120V	12	●	●	●	●	●	●	●	●	●	●	●	0,1,2,4	●	Two-way power	29.3×107×175.5	165	—
AX-12V	12	●	●	●	●	●	●	●	●	●	●	●	0,1,2,4	●	Two-way power	25×107×176	145	—
MX-120V	12	●	—	●	—	—	—	—	—	—	—	—	—	—	Two-way power	30.7×103×145	120	—
MX-12V	12	●	—	●	—	—	—	—	—	—	—	—	—	—	Two-way power	31.7×103×145	100	—
SX-320P	12	●	—	●	—	●	●	●	●	—	—	—	—	—	Two-way power	7.5×70×118.5	50	Wallet
SX-300P	8	●	—	●	—	●	●	●	●	—	—	—	—	—	Two-way power	7.5×70×118.5	50	Wallet
SX-300	8	●	—	●	—	●	●	●	●	—	—	—	—	—	Two-way power	7.5×70×118.5	50	Wallet
SX-220	12	●	●	●	—	●	●	●	●	—	—	—	—	—	Two-way power	Ⓢ12.5×120×73 Ⓢ6.5×120×141	80	—
SX-100	8	●	—	●	—	●	●	●	●	—	—	—	—	—	Two-way power	Ⓢ13.5×91×55 Ⓢ9.4×91×110.5	55	—

ⓈFolded ⓉUnfolded

PRINTING CALCULATORS

Printouts of results along with each calculation step can be attached to documents.

Mini-printer

- 1.6 LINES/SEC.
- Tax & Exchange
- BIG DISPLAY
- Print Margin %
- Key Rollover

BK (Cool black)



HR-8TM DIGITS

GY (Light gray)

Compact Type

- 2 COLOUR PRINT
- PLASTIC KEYS
- MU MD
- 2.0 LINES/SEC.
- Tax & Exchange
- EXTRA BIG DISPLAY
- Print Margin %
- Key Rollover

NEW

HR-100TM DIGITS



- 2 COLOUR PRINT
- PLASTIC KEYS
- MU MD
- 2.4 LINES/SEC.
- Tax & Exchange
- EXTRA BIG DISPLAY
- Print Margin %
- Key Rollover

NEW

HR-150TM DIGITS



Main Functions & Printing Sample

Cost, Selling Price and Margin Calculations

For Shopkeepers & Traders

Perform the operations shown to the right to calculate cost, selling price, and margin.

Exchange Functions

Present rates for converting between U.S. dollars and up to three national currencies at the touch of a key. A simple operation also converts between national currencies, with intermediate conversion to U.S. dollars.

Tax Calculations

Set the rate you want for easy calculation of amount plus tax, amount less tax, and tax amount.

Cost

What is the cost of an item that sells for \$150 after a 30% margin is added?

1 AC 0.
 2 150 (SELL) 150.
 3 30 (MAR) COST 105.
 4 (MAR) MAR 45.
 (COST) COST 105.

0-c 1
 150-c 2 Selling price
 30-M 3 Margin (%)
 105-c 4 Cost
 30-M 5 Margin (%)
 45-M 6 Margin amount

Selling Price

What would the selling price be for an item that costs \$120 after a 40% margin is added?

1 AC 0.
 2 120 (COST) 120.
 3 40 (MAR) SELL 200.
 4 (MAR) MAR 80.
 (SELL) SELL 200.

0-c 1
 120-c 2 Cost
 40-M 3 Margin (%)
 200-c 4 Selling price
 40-M 5 Margin (%)
 80-M 6 Margin amount

Margin

What is the margin on an item that costs \$1000 and sells for \$2,000?

1 AC 0.
 2 1000 (COST) 1'000.
 3 2000 (SELL) MAR % 50.

0-c 1
 1,000-c 2 Cost
 2,000-c 3 Selling price
 50-M 4 Margin (%)

*Print sample: HR-8TM

Desk-top Type

- 2 COLOUR PRINT
- TAX
- MU MD
- 2.4 LINES/SEC.
- BEST VIEW

FR-2650T DIGITS



- 2 COLOUR PRINT
- TAX
- MU MD
- 3.0 LINES/SEC.
- BEST VIEW

FR-2650DT DIGITS



- 2 COLOUR PRINT
- %
- MU MD
- 3.5 LINES/SEC.
- LINE PRINT

DR-120LB DIGITS



WE (White)

Model	Display	Digits	Simple algebraic logic	Adding machine	Sub-total/Total	GT	Independent memory	Cost/Sell/Margin	%	Profit margin %	MU/MD	+/-	3-digit comma markers	2-colour printing	Tax calculation	Exchange calculation	Item counter	5/4	Cut	Up	Decimal selector	ADD mode	AC only	Ink ribbon	Paper width (mm)	Dimensions H×W×D (mm)	Approximate weight (kg)	Others
HR-8TM	LCD	12	●	—	—	—	●	●	●	●	—	—	●	—	●	—	—	—	—	—	0,2	—	—	—	58	41.1×99×196	340g	Function command signs, Auto power off function
HR-100TM	LCD	12	—	●	●	●	●	●	●	●	●	—	●	●	●	●	●	●	●	—	0,2,3	●	—	—	58	67×165.5×285	520g	Average calculation
HR-150TM	LCD	12	—	●	●	●	●	●	●	●	●	—	●	●	●	●	●	●	●	—	0,2,3	●	—	—	58	67.4×196×317	700g	Average calculation
FR-2650T	Digitron	12	—	●	●	●	—	—	—	—	—	—	—	—	—	—	—	—	—	4,3,2,0	—	—	—	58	70×206×335	1.1kg	—	
FR-2650DT	Digitron	12	—	●	●	●	—	—	—	—	—	—	—	—	—	—	—	—	—	4,3,2,0	—	—	—	58	88×213×343	1.3kg	—	
DR-120LB	Digitron	12	—	●	●	●	—	—	—	—	—	—	—	—	—	—	—	—	—	0-6	—	—	—	58	75×212×358	1.5kg	—	

Desk-top Type

- 2 COLOUR PRINT
- %
- 3.5 LINES/SEC.
- MU MD
- LINE PRINT

DR-140L DIGITS



Heavy-duty Type

- 2 COLOUR PRINT
- TAX
- MU MD
- 3.5 LINES/SEC.
- LINE PRINT
- BIG DISPLAY
- %

DR-210HT DIGITS



- 2 COLOUR DISPLAY
- Tax & Exchange
- MU MD
- Built in Backup Battery
- 2 COLOUR PRINT
- LINE PRINT
- 3.5 LINES/SEC.
- %
- BIG DISPLAY

DR-220HD DIGITS



2-colour Display
 Positive value: 1234567890.12
 Negative value: 1234567890.12

- 2 COLOUR PRINT
- TAX
- MU MD
- 3.5 LINES/SEC.
- LINE PRINT
- BIG DISPLAY
- %

DR-240HT DIGITS



- 2 COLOUR PRINT
- TAX
- MU MD
- 3.5 LINES/SEC.
- LINE PRINT
- BIG DISPLAY
- %

DR-270HT DIGITS



Huge Display

- 2 COLOUR PRINT
- LINE PRINT
- MU MD
- 3.5 LINES/SEC.
- %
- BIG DISPLAY

DR-1212LA DIGITS



Thermal Printer

High-speed printing (approximately 8 lines/sec.) & quiet printing

- 8.0 LINES/SEC.
- MU MD
- Built in Backup Battery
- BIG DISPLAY
- LINE PRINT
- %

DR-T120 DIGITS



- 8.0 LINES/SEC.
- MU MD
- Built in Backup Battery
- BIG DISPLAY
- LINE PRINT
- %

DR-T140 DIGITS



- 8.0 LINES/SEC.
- %
- Built in Backup Battery
- 200 STEPS CHECK
- MU MD
- BIG DISPLAY
- LINE PRINT

DR-T220 DIGITS



Model	Display	Digits	Adding machine	Sub-total/Total	GT	Independent memory	%	MU/MD	+/-	3-digit comma markers	2-colour printing	H/M/S	Tax calculation	Exchange calculation	Item counter	5/4	Cut	Up	Decimal selector	ADD mode	AC only	Ink ribbon	Paper width (mm)	Dimensions H×W×D (mm)	Approximate weight (kg)	Others
DR-140L	Digitron	14	●	●	●	●	●	●	—	—	●	—	—	—	●	●	●	●	0-6	●	—	—	58	75×212×358	1.5	□□□
DR-210HT	Digitron	12	●	●	●	●	●	●	—	—	●	—	—	—	●	●	●	●	0-6	●	—	—	58	85×217×329	1.8	—
DR-220HD	Digitron	12	●	●	●	●	●	●	—	—	●	—	—	—	●	●	●	●	0-6	●	—	—	58	85×217×329	1.92	2-colour display
DR-240HT	Digitron	14	●	●	●	●	●	●	—	—	●	—	—	—	●	●	●	●	0-6	●	—	—	58	85×217×329	1.7	□□□
DR-270HT	Digitron	12	●	●	●	●	●	●	—	—	●	—	—	—	●	●	●	●	0-6	●	—	—	58	85×217×329	1.9	—
DR-1212LA	Digitron	12	●	●	●	●	●	●	—	—	●	—	—	—	●	●	●	●	0-6	●	—	—	58	81×230×381	1.7	□□□, Average

Model	Digits	Independent memory	Date/time display	%	Constant calculation	Total and grand total	Repeat addition, subtraction, ADD mode	Item counter	□□□ key	□□□ key	3-digit separator display	3-digit separator printing	Auto power off	Cut off/Round off	Paper width (mm)	Print speed (lines/s)	Per character print size (mm)	Variable print font	Memory print	Calculation check	Power Supply	Dimensions H×W×D (mm) (excluding battery)
DR-T120	12	●	●	●	●	●	●	●	□□□	□□□	●	●	No (30-minute auto return to timekeeping)	●	58	8	Font - B	—	—	—	AC only (built-in backup battery)	91×340×213, 1.7
DR-T140	14	●	●	●	●	●	●	●	□□□	□□□	●	●	—	●	58	8	Font - B	—	—	—	AC only (built-in backup battery)	91×340×213, 1.7
DR-T220	12	●	●	●	●	●	●	●	□□□	□□□	●	●	—	●	58	8	Font - B, A(2.332), C(3.459)	●	●	●	AC only (built-in backup battery)	91×340×213, 1.7

DIGITAL DIARY

Packed with a host of powerful data management features.

Digital Diary with PC-link

1 MB

SF-7990 Supplies extremely limited

512 KB

SF-6990 Supplies extremely limited

256 KB

SF-4990 Supplies extremely limited

6 Language

Includes Cable

Includes Software

6 Language

Includes Cable

Includes Software

6 Language

Includes Cable

Includes Software

Main Functions (SF-7990/6990/4990)

Telephone Directory (2 Files)

Schedule Keeper

Memo

To Do

- Conversion Function (Currency, Metric)
- Clock / World time
- Expense Function
- Anniversary
- Multi-lingual Messages (English, Spanish, French, German, Italian, Portuguese)

Digital Diary

6 Language

SF-3990

128 KB

950 Telephone Directory records!

SF-2500

32 KB

Digital Diary Specifications

Model	SF-7990	SF-6990	SF-4990	SF-3990	SF-2500
Memory	1MB	512KB	256KB	128KB	32KB
Display	17 × 6	17 × 6	17 × 6	12 + 12 × 2	12 + 12 × 2
Backlight	●	●	●	●	●
Data communications with a PC	●	●	Option	—	—
Telephone directory (URL/e-mail address)	●	●	●	●	●
Calendar	●	●	●	●	●
Schedule	●	●	●	●	●
Expense	●	●	●	●	●
Anniversary	●	●	●	●	●
Conversion (currency/metric)	●	●	●	●	●
Memo	●	●	●	●	●
To Do	●	●	●	●	●
Clock	●	●	●	●	●
World time	●	●	●	●	●
Alarm	●	●	●	●	●
Calculator	10-digit	10-digit	10-digit	10-digit	12-digit
Secret	●	●	●	●	●
Multi-lingual messages (6 languages for message displays)	●	●	●	●	—
Data exchange between two digital diary units (optionally available SB-63 cable)	●	●	●	●	—
Power supply	CR2032 × 2	CR2032 × 2	CR2032 × 2	CR2032 × 2	CR2032 × 2
Approximate battery life	1 year*1	1 year*1	1 year*1	2 years*2	1 year*2
Dimensions H × W × D (mm)	Ⓛ 14.7 × 145 × 91 Ⓧ 11.1 × 145 × 178	Ⓛ 14.7 × 145 × 91 Ⓧ 11.1 × 145 × 178	Ⓛ 14.7 × 145 × 91 Ⓧ 11.1 × 145 × 178	Ⓛ 13.9 × 145 × 91 Ⓧ 10.3 × 145 × 178	Ⓛ 14.7 × 136.5 × 83.5 Ⓧ 10.8 × 136.5 × 162.5
Approximate weight (g)	130	130	130	120	110

*1 Unit turned on one hour each day (5 minutes operation, 55 minutes no operation), with two backlight operations, one Daily Alarm operation per day and Hourly Time Signal turned on.
*2 Unit turned on one hour each day Ⓛ Folded Ⓧ Unfolded

Personal Computer Link for Windows®

The easiest way to exchange data with your CASIO Digital Diary!

• Uploading of data to a computer from a Digital Diary for hard disk or diskette storage

Data communication package all in one!

FA-129

CD-ROM Cable

Model Supported
SF-4990/SF-6990/SF-7990

Minimum System Requirements	RAM	Processor
Operating System		
Windows® XP Home Edition/Professional	64MB	Pentium 233MHz
Windows® Me	32MB	Pentium 150MHz
Windows® 2000 Professional	64MB	Pentium 150MHz
Windows® 98/98 Second Edition	24MB	Pentium 150MHz
Windows® 95	16MB	Pentium 75MHz
Windows® NT Workstation 4.0 (Service Pack 3 or later)	32MB	Pentium 150MHz

LABEL PRINTERS

The CASIO EZ-LABEL PRINTER has something for just about every type of office or household labeling needs.

EZ-Label Printer

KL-780

Introducing a new compact & handy label printer...

A useful tool for the home or office.

- Supports label tape sizes: 18mm/12mm/9mm/6mm
- 12mm printer head
- Big easy-to-read 10-digit × 2-line display
- Prints up to 3 lines on a single label
- 95 characters memory
- Characters for 14 languages
- Barcode printing

Supports label tape four sizes (18mm/12mm/9mm/6mm)

24 character sizes

3 text effects Shading, underline, box

4 character styles Standard, outline, shadow, raised

Barcode printing Print barcodes using EAN-8 or EAN-13 format

12mm printer head The 12mm printer head ensures that large font sizes are crisp and clear.

Prints up to 3 lines on a single label Up to 3 lines of text makes your labels more useful and informative.

Characters for 14 languages Support for a wide range of alphabet-based text input and printing.

JOHN ANDERSON
Sales Division
CASIO COMPUTER CO.,LTD.

KL-60SR

KL-60

Create your own original labels anytime, anywhere!

- Supports label tape sizes: 12mm/9mm/6mm
- Prints up to 2 lines on a single label
- Characters for 14 languages
- 6 character sizes
- 3 text effects

KL-170

The portable, easy-to-use Chinese label printer

- Supports label tape sizes: 18mm/12mm/9mm/6mm
- Prints up to 2 lines on a single label
- Character styles: Normal, outline
- Character effects: Box

Model	Keyboard Layout	Display	Display size	Resolution (dpi)	Speed (mm/sec.)	Max. width (mm)	No. of lines	Tape Width (mm)	Memory Text (character)	Character Fonts	Effects	Printing Mirror	Direction	Language support**	Power supply	Approximate battery life***	Auto power off	Dimensions H × W × D (mm)	Approximate weight (g)***
KL-780	QWERTY	(5 × 7 dots) × 10 digits*	10 × 2	200	6.58	12	3	6.9, 12, 18	95	Sans-serif	Shading, underline, box	●	Horizontal	14	AA × 6	4 tape cartridges [LR6(AM3)]	●	51.5 × 180 × 217	470
KL-60SR	QWERTY	(5 × 8 dots) × 4 digits*	4 × 1	160	11.6	5	2	6.9, 12	63	Sans-serif	Shading, underline, box	●	Horizontal	14	AA × 6	2 tape cartridges [LR6(AM3)]	●	51.5 × 168 × 114	300
KL-170	QWERTY	(16 × 15 dots) × 4 digits*	4 × 1	200	6.76	7.5	2	6.9, 12, 18	126	Sans-serif, Roman, Stencil, Logo style, 明體, Ming Chao	Box	●	Horizontal, Vertical	2	AA × 6	2 tape cartridges	●	53 × 178 × 111	370

* Including the dots of the bottom part of the display used for displaying the cursor. ** Language for input: English / Spanish / French / Portuguese / Czech / Polish / Hungarian / German / Italian / Dutch / Finnish / Swedish / Danish / Norwegian (KL-170: Chinese & English)
*** Continuous printing *** Not including batteries

Label Printer Options

Basic Colour Tape (8m)

BLACK on WHITE	XR-24WE1 (24mm) XR-18WE1 (18mm) XR-12WE1 (12mm)	XR-9WE1 (9mm) XR-6WE1 (6mm)
BLACK on YELLOW	XR-24YW1 (24mm) XR-18YW1 (18mm) XR-12YW1 (12mm)	XR-9YW1 (9mm) XR-6YW1 (6mm)
BLACK on GOLD	XR-18GD1 (18mm) XR-12GD1 (12mm)	XR-9GD1 (9mm)
BLACK on CLEAR	XR-24X1 (24mm) XR-18X1 (18mm) XR-12X1 (12mm)	XR-9X1 (9mm) XR-6X1 (6mm)
BLACK on BLUE	XR-24BU1 (24mm) XR-18BU1 (18mm)	XR-12BU1 (12mm) XR-9BU1 (9mm)
BLACK on SILVER	XR-18SR1 (18mm) XR-12SR1 (12mm)	XR-9SR1 (9mm)
BLACK on RED	XR-24RD1 (24mm) XR-18RD1 (18mm) XR-12RD1 (12mm)	XR-9RD1 (9mm) XR-6RD1 (6mm)
BLACK on GREEN	XR-24GN1 (24mm) XR-18GN1 (18mm) XR-12GN1 (12mm)	XR-9GN1 (9mm) XR-6GN1 (6mm)
Iron-on Transfer Tape (5m)	XR-118 BK1 (18mm)	

Basic Colour Tape (Colour letter · 8m)

RED on WHITE	XR-18WER1 (18mm) XR-12WER1 (12mm)	XR-9WER1 (9mm)
BLUE on WHITE	XR-18WEB1 (18mm) XR-12WEB1 (12mm)	XR-9WEB1 (9mm)

