

# BEETLE /Multi IO Hub

Generation 2

User manual

01750354402A



# Table of Content

<b>1</b>	<b>Manufacturer´s Certification</b> .....	<b>3</b>
<b>2</b>	<b>Important notes</b> .....	<b>3</b>
2.1	Safety Information .....	3
2.2	System maintenance .....	4
<b>3</b>	<b>Introduction</b> .....	<b>5</b>
3.1	About This Manual .....	5
3.2	Warranty .....	5
3.3	Recycling .....	6
<b>4</b>	<b>Before Putting Into Service</b> .....	<b>6</b>
4.1	Checking the Scope of Supply .....	6
4.2	Setting up the Hub Gen.2 .....	7
4.2.1	Horizontal .....	8
4.2.2	Vertical .....	9
<b>5</b>	<b>Exterior</b> .....	<b>10</b>
<b>6</b>	<b>Interfaces</b> .....	<b>11</b>
6.1	COM a and COM b .....	12
6.2	COM c* and COM d* .....	12
6.3	LAN (RJ45).....	13
6.4	LAN pass through (2x RJ45) .....	14
6.5	USB-C 3.1 .....	14
6.5.1	USB-C Uplink.....	15
6.5.2	USB-C 1 (DP) .....	15
6.6	USB-A 2.0.....	15
6.7	USB-A 3.0.....	15
6.8	PoweredUSB 2.0.....	16
6.9	Cash drawer (RJ12).....	16
6.10	Status LED .....	17
6.11	Power supply (24 V DC in) .....	18
6.12	Power supply (24 V DC out) .....	18
6.13	Power supply (19 V DC out) .....	18
<b>7</b>	<b>Cabling the BEETLE /Multi IO Hub Gen.2</b> .....	<b>19</b>
<b>8</b>	<b>Appendix</b> .....	<b>20</b>
8.1	Technical Data.....	20
8.2	Block Diagram.....	21
8.3	Total Current Consumption of Interfaces.....	22
8.4	Abbreviations .....	23
8.5	Notes .....	24

# 1 Manufacturer's Certification

**CE** This device meets the requirements of the EU Guidelines 2014/30/EU "Electromagnetic Compatibility" and 2014/35/EU "Low Voltage Directive" and 2011/65/EU "Restriction of Hazardous Substances". For this, it bears the CE label on the rear side or the icon is printed on the packaging.

**WARNING:** This equipment is compliant with Class A of EN55032. In a residential environment, this equipment may cause radio interference.

## 2 Important notes



The device may be repaired only by authorized qualified personnel. Improper repairs will lead to the loss of any liability claims.

### 2.1 Safety Information

The BEETLE /Multi IO Hub Gen.2 corresponds to the pertinent safety precautions pertaining to data processing facilities.

- If this device is moved from a cold environment to its working environment, condensation may occur. The device must be absolutely dry prior to commissioning, therefore allow for an acclimatization time of at least two hours before putting it into operation
- The external power supply unit is fitted with a safety-tested power cable. Only the released 24 V/5 A power supply unit (see chapter "Checking the Scope of Supply") which is connected to a properly grounded contactor contact socket is permitted to be used.
- When installing the device, please ensure that the device plug-in fixture and the protective contact electrical socket are easily accessible.
- The device must be fully disconnected from the supply voltage when performing any work at the device and when inserting or removing data cables. To completely disconnect the appliance from the mains voltage, switch off the device and unplug the power plug of the power supply unit.
- USB devices may be connected to the system or removed from it during ongoing operations if these devices comply with the specifications pursuant to usb.org. Other peripherals (e.g. PoweredUSB printer) should not – for safety reasons – be connected to or disconnected from BEETLE systems unless such systems are switched off.

- Before you begin any assembly work on the device, you should discharge yourself, e.g. by touching a grounded object (such as a radiator).
- Please make sure that no objects (e.g. paperclips) are able to enter the inside of the device, as this may result in electrical shocks or short circuits.
- No data cables may be plugged in or unplugged during storms.
- Protect devices from vibrations, dust, moisture and heat.
- Make sure that used parts are disposed of in a way that is environmentally compatible.
- In the event of emergencies (e.g. damaged housing or damaged power cable, penetration of liquids or foreign bodies), switch the device off immediately, pull the power plug and inform the technical customer service of Diebold Nixdorf or the authorized service partner of your dealer.
- Your BEETLE /Multi IO Hub Gen.2 is the result of state-of-the-art technical innovation. Please ensure therefore equally state-of-the-art constructional and technical ambient conditions to permit flawless and efficient functioning of the Multi IO Hub Gen.2. You should connect the Multi IO Hub Gen.2 or any other IT system only to power supply networks with separate protective conductors (PE).
- This type of power supply network is called a TN-S network. Do not use PEN conductors! Please also observe the recommendations of DIN VDE 0100 part 540, Annex C2. This will help you avoid any potential malfunctions.

## **2.2 System maintenance**

Clean your system at regular intervals with a dry, lint-free cloth. For greater amounts of soiling, please use a cleaning agent suitable for plastic surfaces, as can be ordered from Diebold Nixdorf. Make sure that the device is deactivated during cleaning, that the power plug is disconnected, and that no fluid enters the inside of the device.

## 3 Introduction

The BEETLE /Multi IO Hub Gen.2 provides a large number of classic peripheral interfaces for the required devices and thus acts as a service point for each individual POS workplace.

This means that the POS-specific peripheral devices are connected to the POS system via the Multi IO Hub Gen.2 by only a single cable, by means of a USB-C uplink cable.

In the event of error and replacement of the POS system, the entire peripheral remains at the Multi IO Hub Gen.2. The replacement of the POS system is thus accomplished exceptionally quickly.

No matter which configuration you may require, Diebold Nixdorf can provide you with the correct solution.

In case of questions about your BEETLE /Multi IO Hub Gen.2 or other products and solutions of Diebold Nixdorf, please visit us on the Internet.

### 3.1 About This Manual

The objective of this document is to aid you in the use of the system and also enable you to use the Table of Contents to find the desired information quickly.



#### NOTICE

Notes in the manual are marked by this symbol

---



#### CAUTION

Attention notifications are identified by this sign.

---

As the type and scope of the application programs depend on the individual specific choice of each customer, this manual will not deal with any detailed issues pertaining to software. Dedicated manuals are available for the peripherals that can be connected. These devices will therefore not be described in detail here. Please inform yourself by studying the respective manuals.

### 3.2 Warranty

In general, Diebold Nixdorf (DN) guarantees a warranty of 12 months after delivery or acceptance date. This warranty covers all defects that have occurred during normal use of the product.

Defects resulting from incorrect or inadequate maintenance, incorrect use or any unauthorized changes to the product, unsuitable locations or unsuitable environments are not covered.

More details about the warranty regulation can be found in your contract documents.

If no claim to product warranty exists and if you do not have a service contract with Diebold Nixdorf, then the Customer Care Center (CCC) is available for accepting orders without a contract.

Tel.: 0180 1 (Vanity Number, subject to a charge)

Tel.: 0180 1 1 99 2 99 (subject to a charge)

### **3.3 Recycling**

This product was designed in accordance with our internal standard "Environmentally friendly product design and development".

The system is manufactured without the use of CFC and CHC and the majority of the components and materials used in production are recyclable.

You are helping us with the recycling if you do not attach any labels to the device.

For materials which currently cannot be used for a new purpose, Diebold Nixdorf offers environmentally friendly disposal at a recycling center that is certified in accordance with ISO 9001 and ISO 14001.

If your system can no longer be used, please send it in for this environmentally friendly and contemporary form of recycling.

Additional information about returns, recycling and disposal of our products can be obtained from your responsible branch office or from our recycling center in Paderborn.

<mailto:info@dieboldnixdorf.com>

We look forward to your E-mail.

## **4 Before Putting Into Service**

### **4.1 Checking the Scope of Supply**

Unpack the parts and check whether the scope of supply corresponds with the parts listed on the delivery note.

The BEETLE /Multi IO Hub Gen.2 is in the box.

Should you detect any transport damages or inconsistencies between package content and the delivery note, please inform your contractual partner or sales outlet of Diebold Nixdorf immediately. Please specify delivery note number, delivery note item number and serial number of the device when doing so.

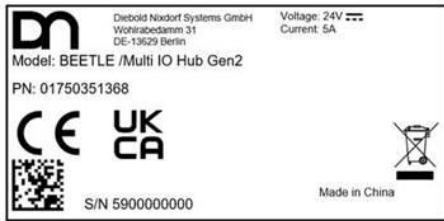

The serial number is located on the label next to the barcode.

The following parts should be considered for the operation of the Multi IO Hub Gen.2 when ordering:

D:CRNT-24V-V1 (01750266555) Power Supply 24 V/5 A  
(is required only if not already available with DN BEETLE /A1xx0 POS system)

D:CRKB-D1-3M (01750341520) USB-C Cable, 3m  
(uplink to DN BEETLE /A1xx0 system)

Alternative/optional available for ordering:

D:CRKB-1033 (01750301474) power supply cable, 3m

D:CRKB-1031 (01750283504) power supply cable, 5m  
(for DN BEETLE /iPOS system)

D:CRKB-1032 (01750298073) power supply cable, 3m  
(for AURES YUNO POS system)

We recommended keeping the original packaging for any subsequent transporting (protection against jolts and impact).

## 4.2 Setting up the Multi IO Hub Gen.2

Fasten or set up the BEETLE /Multi IO Hub Gen.2 in such a way that the Hub Gen.2 is not exposed to any extreme ambient conditions. Protect the Hub Gen.2 against vibrations, dust, moisture, heat and strong magnetic fields.

Take care to ensure that you maintain a minimum distance of 50 mm (1.97 in.) around the device.

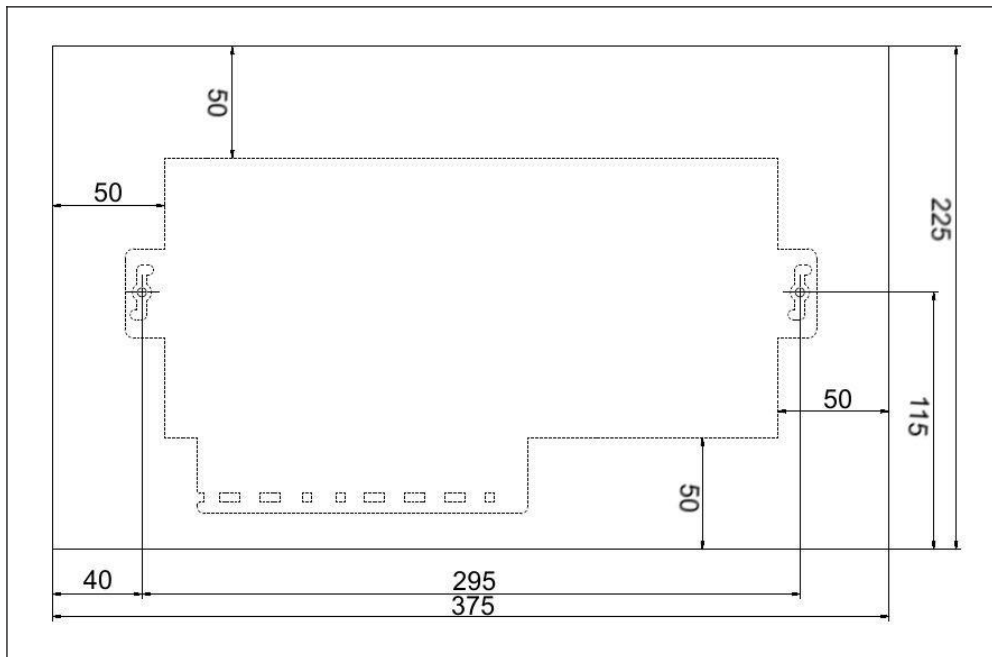

Use commercially available screws for the fastening which are adapted to the subsurface. To fasten the Multi IO Hub Gen.2, use screws with a screw head diameter of 5-8 mm (0.20-0.31 inches), with a shaft diameter of max. 4.2 mm (0.17 inches). Even if you want to incorporate the device, it is mandatory that you adhere to the specified minimum distances and ensure constant aeration and ventilation. The immediate ambient temperature around the Multi IO Hub Gen.2 may not exceed 40°C.

#### 4.2.1 Horizontal

On the underside can be found four rubber pads.

The BEETLE /Multi IO Hub Gen.2 can be fastened horizontally above or below.



*Illustration 1:* Horizontal installation, above

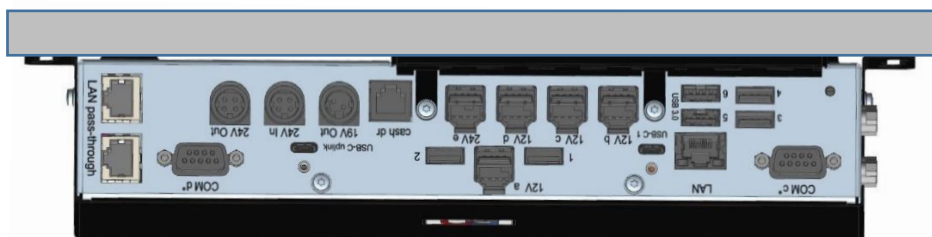

*Illustration 2:* Horizontal installation, below



## 4.2.2 Vertical

In order to ensure that correct ventilation continues to be guaranteed, the following minimum distances must be maintained for free convection, even with vertical setup. Around all 5 sides of the device: 50 mm (1.97 inch)

You can fasten the suspended BEETLE /Multi IO Hub Gen.2 on either the left or the right.

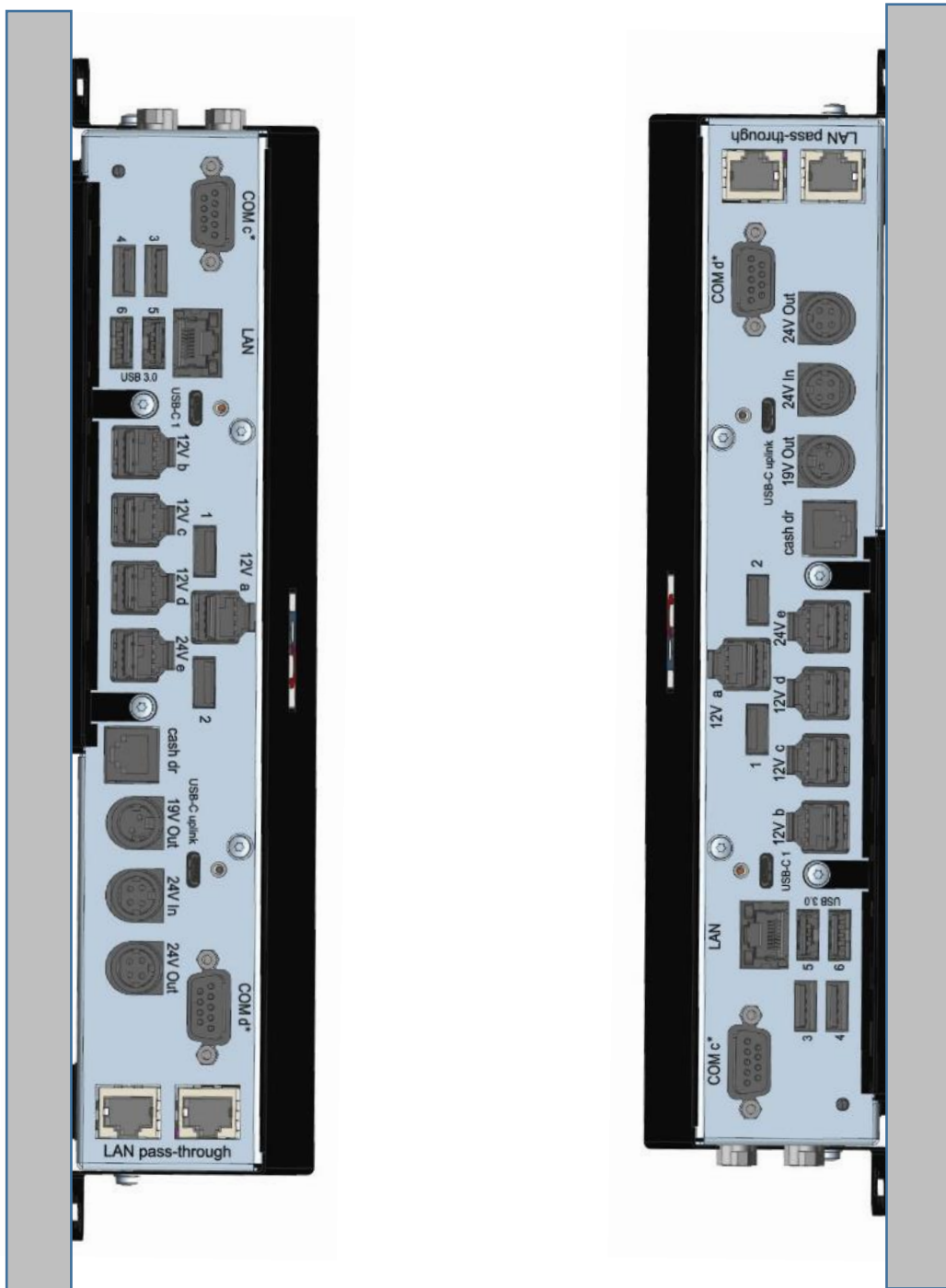

Illustration 3: Vertical installation

## 5 Exterior

The following illustration shows the BEETLE /Multi IO Hub Gen.2.



Front view



Rear view

## 6 Interfaces

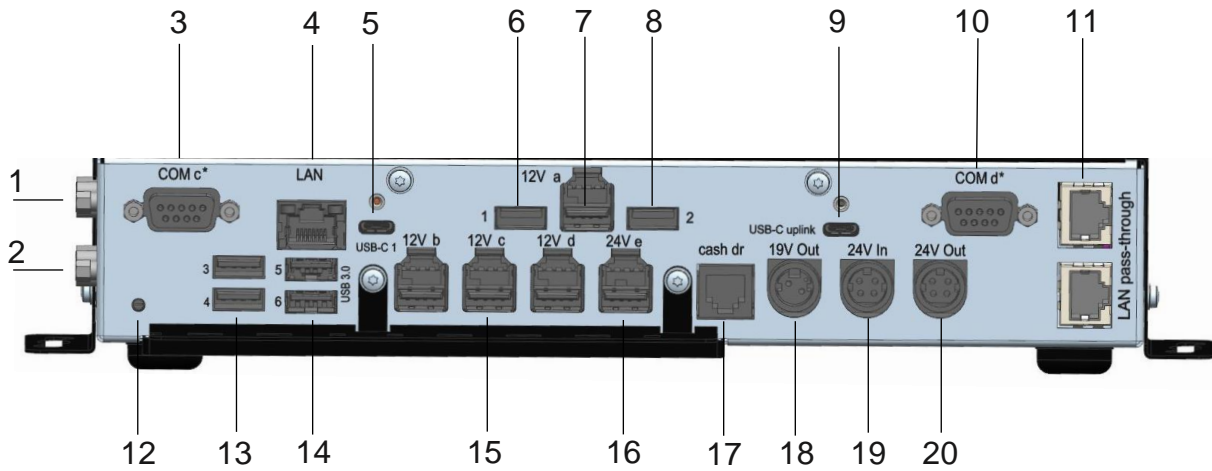

- |    |                               |    |  |
|----|-------------------------------|----|--|
| 1  | COM a Standard RS232 (plug)   | 11 | LAN Pass-through (RJ45/RJ45)   |
| 2  | COM b Standard RS232 (plug)   | 12 | Status LED   |
| 3  | COM c* RS232 powered (socket) | 13 | 2x USB-A 2.0   |
| 4  | LAN 10/100/1000 Mbit/s        | 14 | 2x USB-A 3.0   |
| 5  | USB-C 3.1 - 1 (DP)            | 15 | 3 x powered USB 2.0/12V  |
| 6  | USB-A 2.0                     | 16 | PoweredUSB 2.0/24V   |
| 7  | PoweredUSB 2.0/12V            | 17 | Cash drawer (RJ12)   |
| 8  | USB-A 2.0                     | 18 | Power supply 19 V (DC out) only as alternative to (20) for Aures YUNO POS system |
| 9  | USB-C 3.1 uplink              | 19 | Power supply 24 V (DC in)  |
| 10 | COM d* RS232 powered (socket) | 20 | Power supply 24 V (DC out) for BEETLE POS system                                 |

\*supplied with power supply



### CAUTION

Do not plug in data or power supply cables if the system is plugged in!



### CAUTION

Never use the 24 V (DC out) and 19 V (DC out) power supplies together.

## 6.1 COM a and COM b

Connect for example a scale with dedicated power supply to the COM a or COM b interface. COM a and COM b are designed as standard 9-pin D-Sub plugs (male). The COM Interface connector with knurled screw can be disengaged by hand.

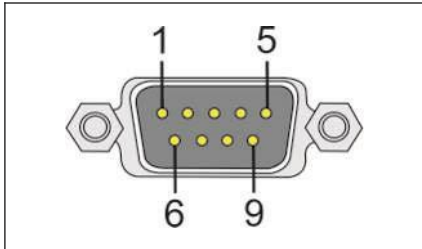

### PIN Function

1	DCD – Data Carrier Detect
2	RXD – Serial Data In
3	TXD – Serial Data Out
4	DTR – Data Terminal Ready
5	GND
6	DSR – Data Set Ready
7	RTS – Request to Send
8	CTS – Clear to Send
9	RI - Ring Indicator

## 6.2 COM c\* and COM d\*

Each of these is a 9-pin power-supplied D-Sub socket (female).



### NOTICE

Scanners, customer or operator displays without dedicated power supplies will be connected to this interface independent of the existing configuration (see chapter "Total Power Consumption").



### WARNING

Take care to ensure that the plug for the peripheral devices is tightly screw-connected with the socket because otherwise malfunctions could occur. The power supply is provided through this socket.

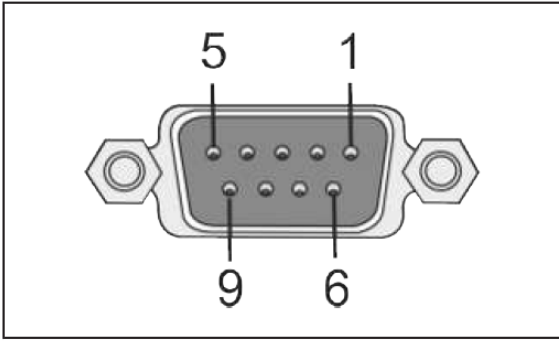

PIN	Function
1	+12 V
2	RXD – Serial Data In
3	TXD – Serial Data Out
4	DTR – Data Terminal Ready
5	GND
6	DSR – Data Set Ready
7	RTS – Request To Send
8	CTS – Clear To Send
9	+ 5 V

### 6.3 LAN (RJ45)

The cable for the connection to a network (LAN) will be plugged in here.

#### LEDs

Left LED	Constant green	Network connection established
	Flashes green	Data transfer
Right LED	off	10 MBit
	Constant green	100 MBit
	Constant orange	1000 MBit

This LAN connection is provided through an internal USB 3.1 interface. Device drivers for Windows and Linux operating systems are available.



#### NOTICE

Use only shielded LAN cables marked with a CAT5 or CAT5e (for 1000 MBit). These offer greater protection against malfunctions in the network.



#### NOTICE

The Multi IO Hub Gen.2 and the POS system each has a MAC address of its own.

## 6.4 LAN pass through (2x RJ45)

It may happen in some installation environments that the installed LAN connection (via USB) cannot be used. The Multi IO Hub Gen.2 therefore offers a so-called LAN pass-through, meaning the Multi IO Hub Gen.2 can be used to loop the LAN through to the POS system.

The plugs for the LAN pass-through connection can be plugged at random into two available sockets.

LAN in: Network infrastructure connection

LAN out: Connection to the POS system



### NOTICE

The LAN pass-through interface of the Multi IO Hub Gen.2 has no MAC address of its own. The MAC address of the POS system applies.

## 6.5 USB-C 3.1

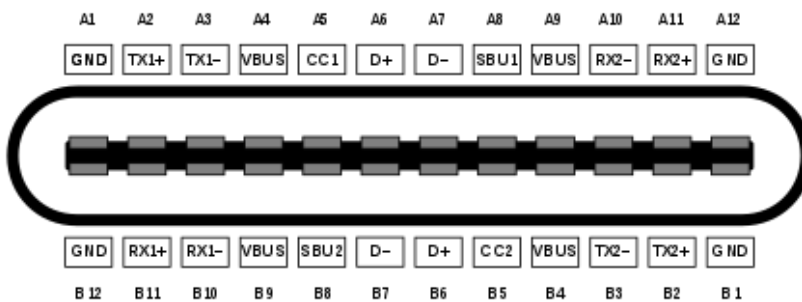

USB-C receptacle A pin layout		
Pin	Name	Description
A1	GND	Ground return
A2	SSTXp1	SuperSpeed differential pair #1, TX, positive
A3	SSTXn1	SuperSpeed differential pair #1, TX, negative
A4	V <sub>BUS</sub>	Bus power
A5	CC1	Configuration channel
A6	Dp1	USB 2.0 differential pair, position 1, positive
A7	Dn1	USB 2.0 differential pair, position 1, negative
A8	SBU1	Sideband use (SBU)
A9	V <sub>BUS</sub>	Bus power
A10	SSRXn2	SuperSpeed differential pair #4, RX, negative
A11	SSRXp2	SuperSpeed differential pair #4, RX, positive
A12	GND	Ground return

USB-C receptacle B pin layout		
Pin	Name	Description
B12	GND	Ground return
B11	SSRXp1	SuperSpeed differential pair #2, RX, positive
B10	SSRXn1	SuperSpeed differential pair #2, RX, negative
B9	V <sub>BUS</sub>	Bus power
B8	SBU2	Sideband use (SBU)
B7	Dn2	USB 2.0 differential pair, position 2, negative <sup>[a]</sup>
B6	Dp2	USB 2.0 differential pair, position 2, positive <sup>[a]</sup>
B5	CC2	Configuration channel
B4	V <sub>BUS</sub>	Bus power
B3	SSTXn2	SuperSpeed differential pair #3, TX, negative
B2	SSTXp2	SuperSpeed differential pair #3, TX, positive
B1	GND	Ground return

### 6.5.1 USB-C Uplink

This connection is used to set up the connection between the BEETLE /Multi IO Hub Gen.2 and the DN A-family POS system via USB-C Uplink cable. Take care to ensure while doing so that this cable matches the current USB specifications.

### 6.5.2 USB-C 1 (DP)

This connection is used to set up the connection between the BEETLE /Multi IO Hub Gen.2 and a USB-C display via USB-C Display Port (DP) and Power Delivery (PD). Take care to ensure while doing so that this cable matches the current USB specifications.

## 6.6 USB-A 2.0

Various USB 2.0 peripherals can be connected to these ports.

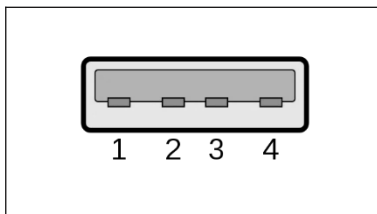

PIN	Function
1	+ 5 V
2	USB data-
3	USB data+
4	GND

## 6.7 USB-A 3.0

Various USB 2.0/3.0 peripherals can be connected to these ports, e.g. not only scanners, scales or dongles, but also even graphic cards or monitors. USB can provide the required power for devices with little wattage such as keyboards.



### NOTICE

Only devices and cables that are in accordance with the valid USB specifications can be connected to the USB interfaces.

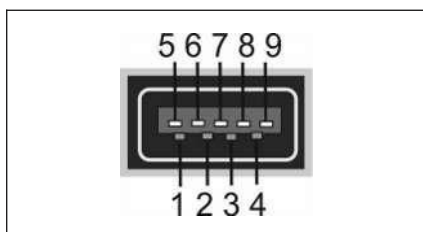

PIN	Function
1	+ 5 V
2	USB data-
3	USB data+
4	GND
5	StdA:SSRX-
6	StdA:SSRX+
7	GND
8	StdA:SSTX-
9	StdA:SSTX+

## 6.8 PoweredUSB 2.0

USB peripherals, whose energy demand is higher than the supply provided by the standard USBs, e.g. printers, barcode scanners or displays, can be operated at PoweredUSB ports.



### WARNING

The power supply is 24 V (marked in red, for POS printers) or 12 V (marked in turquoise) (see chapter "Total Power Consumption").

A mechanical coding prevents a USB 12 V plug from being accidentally plugged into a USB 24 V socket. The lower half of the PoweredUSB socket can also be used as a USB-A socket.

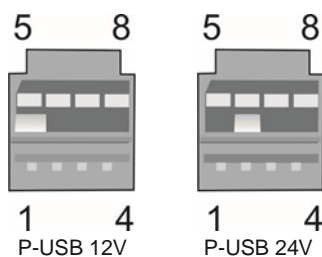

PIN	Function
1	+ 5 V
2	USB data-
3	USB data+
4	GND
5	GND
6	+12 V or +24 V
7	+12 V or +24 V
8	GND

## 6.9 Cash drawer (RJ12)

The BEETLE /Multi IO Hub Gen.2 includes an RJ12 socket for the connection of a cash drawer. This connection must be used only to connect a cash drawer.



### NOTICE

Please ensure that the plug has a tight contact with the socket because otherwise it can lead to malfunctions.

Once plugged in, RJ12 plugs are locked. The power supply (P24V +5% / -15%) of the cash drawer is provided through this socket.



### CAUTION



The connection of sub-drawers (the so-called looping through) and the connection of 12 V OEM cash drawers is not permitted!

---

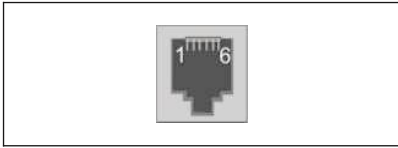

PIN	Function
1	FG – Frame ground
2	OPEN1 – Opening signal for drawer
3	KLE1N – Status drawer (open/closed)
4	+24 V – Supply voltage
5	<not used>
6	GND – Signal Ground

The cash drawer interface is addressed on the system side via a virtual COM port.

RS-232 settings:

- Baud rate 1200
- 8 Bits
- 1 stop bit
- No parity
- No flow control

Commands:

- Hub version: 0x1d 0x48 (GS H)  
Answer: "DN Hub Gen 1.0"  
"DN Hub Gen 2.0"  
"DN Hub Gen 2.1"  
"DN Hub Gen 2.2"
- FW Info: 0x1d 0xFF  
Answer: e.g. "V2.0"
- Info: 0x1d 0x49 (GS I)  
Answer: "Cash Drawer"
- To open CD: 0x1b 0x70 (ESC p)
- Status query: 0x1b 0x75 (ESC u)  
Answer: "0" or "1" (depending on the cash drawer used)

## 6.10 Status LED

The green LED indicates that an USB uplink from the system is in effect.

## 6.11 Power supply (24 V DC in)

The power supply is provided through this socket. Please plug the appropriate end of the power cable of the external power supply unit into this socket. Pull on the sleeve of the locked plug to deenergize the device.

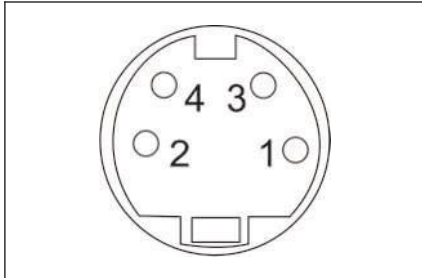

PIN	Function
1	GND
2	+24 V in
3	GND
4	+24 V in

## 6.12 Power supply (24 V DC out)

The power supply of the BEETLE /iPOS plus POS system is provided through this socket.

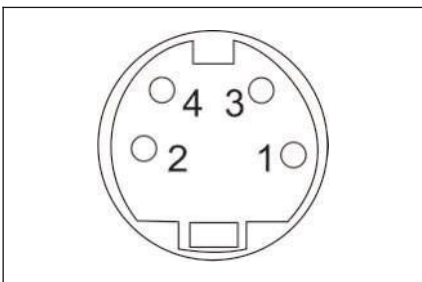

PIN	Function
1	GND
2	+24 V out
3	GND
4	+24 V out

## 6.13 Power supply (19 V DC out)

The power supply of the AURES YUNO POS system is provided through this socket as an **alternative** to the 24 V DC out.

Use the power supply cable that can be ordered from Diebold Nixdorf (see chapter "Checking the Scope of Supply").

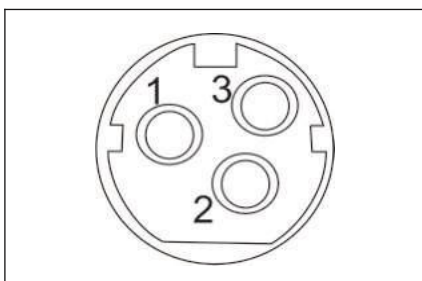

PIN	Function
1	+19 V out
2	GND
3	Power Control



### CAUTION

Never use the 24 V (DC out) and 19 V (DC out) power supplies together!

## 7 Cabling the BEETLE /Multi IO Hub Gen.2

All devices that are part of the BEETLE /Multi IO Hub Gen.2 and that have their own dedicated mains voltage cable must be connected to the same circuit.

- Ensure that the USB-C uplink cable from the POS system USB-C is connected, all data cables are plugged into the Multi IO Hub Gen.2 and peripherals.
- Use cable ties to secure the cables. A cable tie can be used to secure plugs without interlocks against being pulled out accidentally. Pull the cable tie (1) through the pre-punched opening in the sheet metal. Surround the cable and pull the cable tie tight.

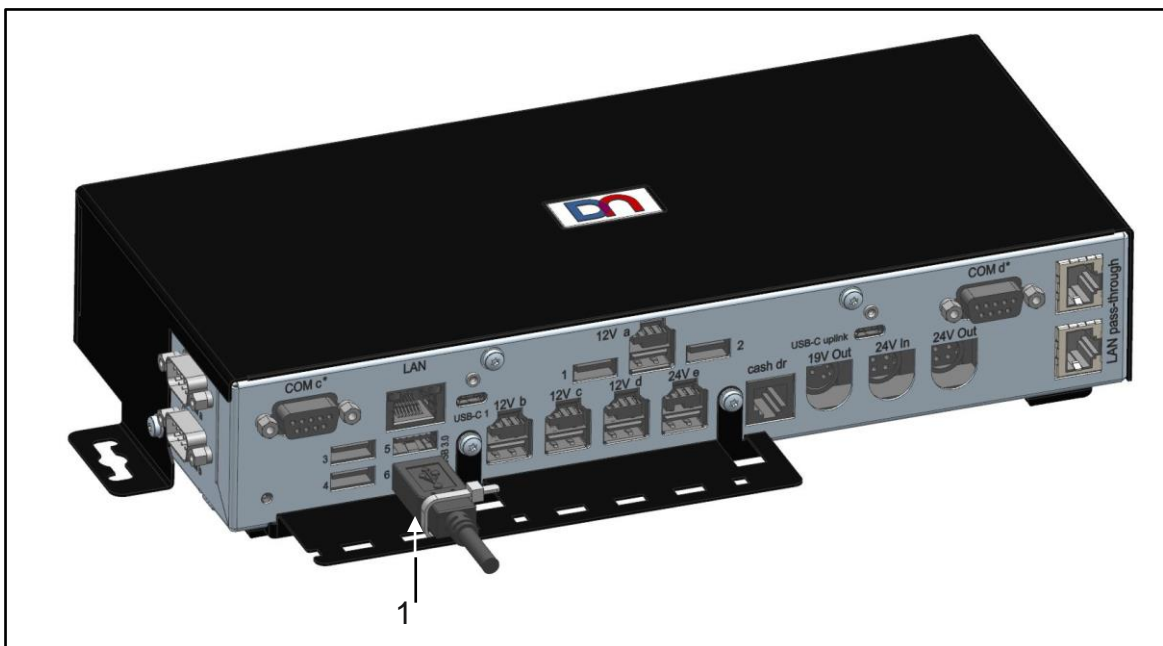

- Next, plug the power supply cable into the 24 V (DC in) socket of the BEETLE /Multi IO Hub Gen.2.
- Plug the power cable into the socket of the external power supply and plug the other end into the protective contact electrical outlet of the house installation.
- The device is ready for operation as soon as a USB uplink signal is presented via the POS system.



### NOTICE

Observe the performance specifications in the chapter "Total Current Consumption of Interfaces" in the Appendix of the manual.

# 8 Appendix

## 8.1 Technical Data

<b>Size</b>	
Width	310 mm (12.20 in.)
Depth	157 mm (6.18 in.)
Height	58 mm (2.28 in.)
Weight	approx. 1.2 kg (2.64 lb)
<b>Ambient conditionen (Temperature)</b>	
Operation	- 5°C to + 40°C (5%-85% r.h.)
Transport	- 25°C to + 60°C (15%-98% r.h.)
Storage	- 5°C to + 40°C (15%-85% r.h.)
<b>Power supply</b>	
Input voltage (24V DC in)	max. 5 A
Output voltage (24 V DC out)	max. 4 A
Output voltage (19 V DC out)	max. 3.5 A
<b>Interfaces</b>	
RS232 standard (non-powered)	2
RS232 powered	2
USB A 2.0	4
USB A 3.0	2
PoweredUSB 12 V/24 V	4/1
Cash drawer (24 V)	1
LAN (10/100/1000 Mbit/s)	1
LAN (pass-through)	1
<b>Software</b>	
Operating System Support	Windows 10 Linux (CentOS 9)
Cash drawers driver	Legacy Support, JavaPOS DS
COM via USB	Driver from the chip manufacturer (FTDI)
LAN	Driver from the chip manufacturer (Realtek)

## 8.2 Block Diagram

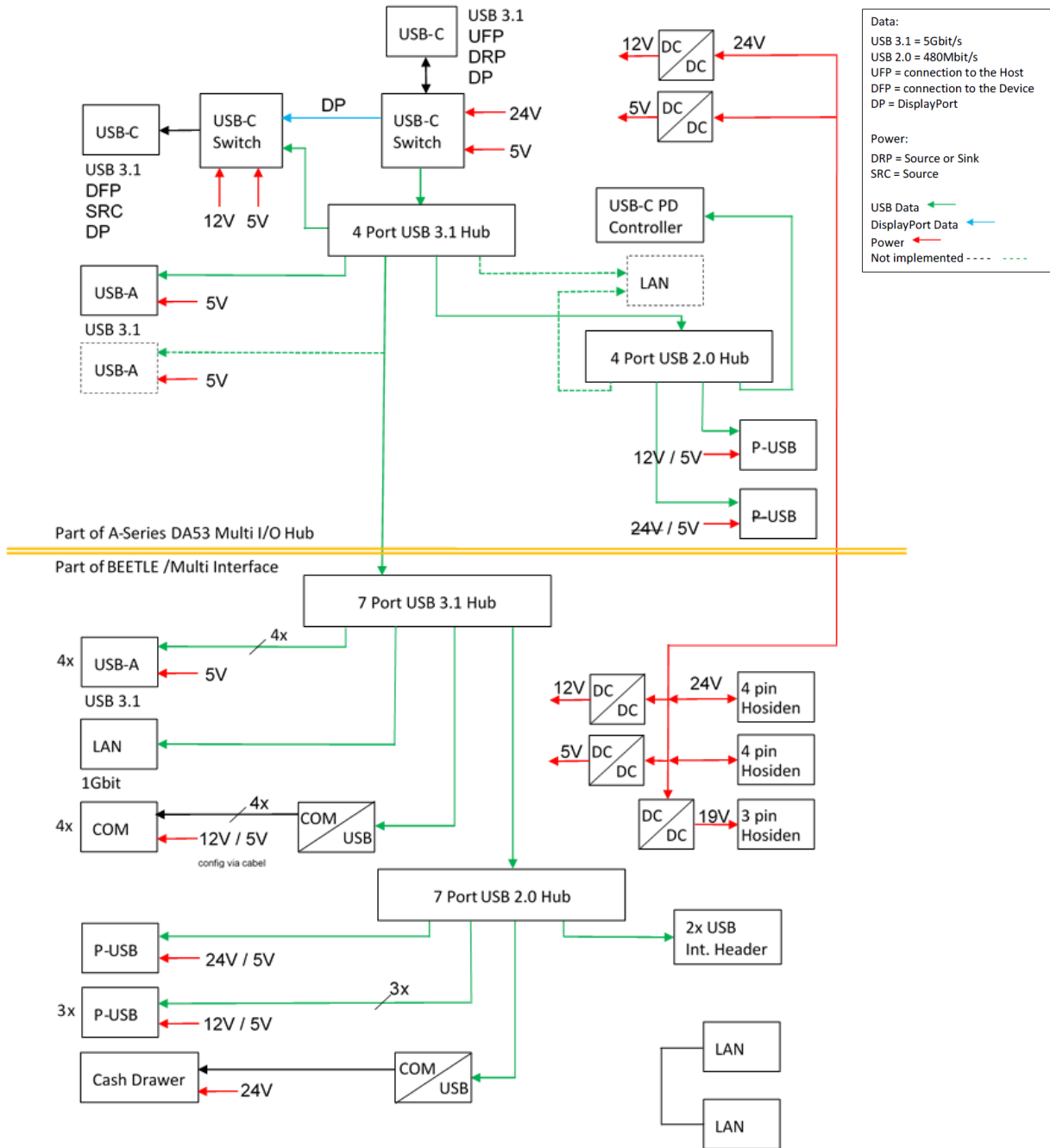

### 8.3 Total Current Consumption of Interfaces

The max. total output power connected to the BEETLE /Multi IO Hub Gen.2 shall never exceed 100W!

The total power consumption **at 5 V** interfaces must not exceed 5 A:

Every Powered COM*	= 300 mA, total of 900 mA
Every USB 2.0	= 500 mA each port
Every PoweredUSB2.0	= 500 mA each port
Every USB 3.1	= 900 mA each port

The total power consumption **at 12 V** interfaces must not exceed 3 A:

Every Powered COM*	= 600 mA, total of 900 mA
Every PoweredUSB 2.0	= 1.5 A, total of 3 A

I/O Port	Rated Voltage	Rated Current per Port	Rated Current per Port Type
USB3.1 Type C with DP and PD Source 5V, 12V	5V and 12V	3.0A	-
USB3.1 Type C with DP and PD Source 24V	24V	4.0A	-
USB3.1, Type A	5V	0,9A	-
USB2.0, Type A and Powered USB	5V	0.5A	-
Powered USB 12V	12V	1.5A	3A
Powered USB 24V	24V	3.0A	-
Cash Drawer Port	12V	2.0A pulse	-
Powered COM Ports	5V	0.3A	0.9A
Powered COM Ports	12V	0.6A	0.9A
19V Power Output Port	19V	3.5A	-
24V Power Output Port	24V	4A	-
24V Power Input Port	24V	5A	-

All output voltages have a tolerance of +/-5%.

Maximum ampere per power rail.

- 5V / 5A
- 12V / 5A
- 24V / 5A

Maximum power delivery from I/O ports will be limited by power delivery from 24V power adapter and total power consumption of various internal circuitry within the Multi IO Hub Gen.2.

The 24 V PoweredUSB interface is provided for the operation of retail thermal printers authorized by Diebold Nixdorf.

## 8.4 Abbreviations

Abbreviations	Descriptions
A	Ampere
CE	European Symbol of Conformity
COM	RS232 interface
COM*	RS232 interface, power supplied
DIN	Deutschen Institut für Normung (German Institute for Standards)
D-Sub	D-Shaped Subminiature
EFT	Electronic funds transfer
ESD	Electrostatic Sensitive Devices
EU	European Union
ISO	Internationale Organisation für Normung (International Organization for Standardization)
LAN	Local Area Network
LED	Light Emitting Diode
PEN conductor	Protective Earth Neutral Conductor
POS	Point of Sales
RJ	Registered Jack, e.g. RJ45
TN-S	Terre Neutre Separé
USB	Universal Serial Bus
V	Volt
VDE	Verband für Elektrotechnik, Elektronik und Informationstechnik e.V. (Association for Electrical, Electronic & Information Technologies)
W	Watt
WLAN	Wireless Local Area Network

## 8.5 Notes



Diebold Nixdorf  
D-33094 Paderborn

Order No.: 01750354402A