

WINCOR
NIXDORF



BEETLE /S-II plus

(G1- Motherboard)

Modular POS System

User Manual

We would like to know your opinion on this publication.

Please send us a copy of this page if you have any constructive criticism.

We would like to thank you in advance for your comments.

With kind regards,

Your opinion:

Wincor Nixdorf International GmbH
Documentation RD PD15
Rohrdamm 7
D-13629 Berlin

E-Mail: retail.documentation@wincor-nixdorf.com

Order No.: **01750177662A**

BEETLE /S-II plus

(G1 Motherboard)

Modular POS System



All brand and product names mentioned in this document are trademarks of their respective owners.

Copyright© Wincor Nixdorf International GmbH, 2009

The reproduction, transmission or use of this document or its contents is not permitted without express authority.

Offenders will be liable for damages.

All rights, including rights created by patent grant or registration of a utility model or design, are reserved.

Delivery subject to availability; technical modifications possible.

Contents

Manufacturer's Certification.....	1
Tested Safety.....	1
FCC-Class A Declaration.....	1
Important notes.....	2
Introduction.....	4
About this manual.....	4
Care of the BEETLE /S-II plus.....	5
Recycling the BEETLE /S-II plus.....	5
Warranty.....	6
BEETLE /S-II plus- the modular POS System	7
Overview.....	7
Before switching on the System	8
Unpacking and checking the System.....	8
Setting up the device.....	8
Horizontal installation.....	9
Vertical installation of the equipment.....	10
Cabling of the BEETLE /S-II plus.....	12
Basic settings.....	13
The System BEETLE /S-II plus	14
Front Side View.....	14
ON Button.....	15
Light-emitting Diode (LED).....	15
USB (Universal Serial Bus)- A, USB 2.0.....	15
Interior view.....	16
Power Supply.....	17
Connector Panel.....	17
Power Connector.....	18
Power Output.....	18
DC24V (Modular Printer).....	18
RJ12 (CASHDR, Geldlade).....	19
Power Consumption.....	19

System Unit	20
Jack Plug 3.5 mm (MIC, SPK)	21
Mini-DIN (KYBD).....	21
D- Sub Plug (COM1).....	21
D- Sub- Jack power supplied (COM2*/COM3*/COM4*).....	22
USB (Universal Serial Bus)- A, USB 2.0	22
RJ45 (LAN)	22
CRT	23
PLINK TFT (TFT- VGA Monitor).....	23
 Disconnecting cables	 24
 Storage Media	 26
Change of the Hard Disk Drive	26
 USB- Controller (optional)	 30
 COM5*- COM8*- Interfaces (optional)	 31
 CRT- or TFT- Adapter (optional)	 32
 Starting up the system	 33
Start and runup behaviour	33
 Appendix	 35
Technical Data BEETLE /S-II plus	35
Interfaces	36
Extensions	37
Rear Panel (CRT/VGA, PanelLink)	37
Rear Panel (CRT/VGA, DVI).....	37
Rear Panel (CRT/VGA, DVI*, USB)	37
Rear Panel (CRT/VGA, DVI*, USB, COM).....	38
Total Current Consumption of Interfaces	39
Glossary.....	40
Abbreviations	42

Manufacturer's Certification



The device complies with the requirements of the EEC directive 2004/108/EC with regard to 'Electromagnetic compatibility' and 2006/95/EG "Low Voltage Directive".

Therefore, you will find the CE mark on the device or packaging.

Tested Safety



The POS system has been provided with the symbol for "Tested Safety".



In addition, the BEETLE has received the UL symbol and cUL symbol.

FCC-Class A Declaration

This equipment has been tested and found to comply with the limits for a Class A digital device, pursuant to part 15 of the FCC Rules. These limits are designed to provide reasonable protection against harmful interference when the equipment is operated in a commercial environment. This equipment generates, uses, and can radiate radio frequency energy and, if not installed and used in accordance with the instruction manual, may cause harmful interference to radio communications.

Operation of this equipment in a residential area is likely to cause harmful interference in which case the user will be required to correct the interference at his own expense. Modifications not authorized by the manufacturer may void users authority to operate this device. This class A digital apparatus complies with Canadian ICES-003.

Cet appareil numérique de la classe A est conforme à la norme NMB-003 du Canada.

Important notes

The modular POS system BEETLE /S-II plus conforms to the current safety standards for data processing equipment.

- If this device is taken from a cold environment into the operating room, moisture condensation may form. The device must be absolutely dry before being put into service; an acclimatization period of at least two hours must therefore be observed.
- This device is equipped with a safety-tested power cable and may be connected only to a prescribed grounded-contact power socket.
- When setting up the device, ensure that the power socket on the device and the grounded-contact power socket are easily accessible.
- To disconnect the device from the supply voltage completely, switch off the device and disconnect the power plug of the power supply.
- Ensure that no foreign objects (e.g. office clips) find their way into the device, as this may lead to electric shocks or short-circuits.
- Never plug in or unplug data communication lines during thunderstorms.
- Protect devices from vibrations, dust, moisture and heat.
- Always dispose of used parts, such as batteries, in an environmentally safe manner.
- The ventilation slots of the power supply must remain unobstructed to ensure sufficient ventilation of the equipment. If the equipment is to be fitted, you must ensure that the specified minimum distances are maintained and constant ventilation is provided.
- In emergencies (e.g. damaged housing or damaged power cable, penetration by liquids or foreign bodies), the device must be switched off immediately, the power plug disconnected and the Customer Service of Wincor Nixdorf or your dealer must be notified.
- The lithium battery must be disposed of in accordance with local regulations for special waste. In case of an improper change of the lithium battery it exist an explosion risk.

- The device may only be repaired by authorized qualified personnel. Unauthorized opening of the device and inexpertly carried-out repairs may not only seriously jeopardize the safety of the user, but also cancel all warranty and liability agreements.

- Your BEETLE system is the result of modern technical innovation. So please see for according structural and technical surroundings to guarantee a faultless and efficient work of your BEETLE. Therefore, you should connect your BEETLE or other IT-devices only to power supply systems with separately guided protective earth conductor (PE). This kind of electricity system is known as TN-S network. Do not use PEN conductors!
Please also observe the recommendations of the norm DIN VDE 0100, Part 540, Appendix C2 as well as EN50174-2, §5.4.3. Thus you can help to avoid possible malfunctions.

- You can connect or disconnect USB devices during operation of your BEETLE, provided that these devices comply with the specifications according to usb.org.
Other peripheral devices with higher power requirement (such as PoweredUSB printer) should be connected to or disconnected from your BEETLE system only after the BEETLE has been switched off.

Introduction

The BEETLE /S-II plus is the powerful and economical basis for your POS system. The system offers state-of-the-art computing power on the basis of the most modern, energy-saving single and dual core processor technology from the Intel desktop portfolio. These processors consume more than 30 percent less energy than the processors of the previous generation (Pentium 4) and with a higher performance.

You can connect a variety of different peripheral devices to your BEETLE /S-II plus and even the choice of the software is not limited to a certain product.

This provides you with a considerable degree of flexibility when arranging the configuration of your POS system. The BEETLE can also be connected to a network once an appropriate network card has been installed. Either hard disk or solid state disk (flash memory) can be used as the data memory.

Whatever configuration you need: Wincor Nixdorf International GmbH offers the right solution. So, whenever you want to expand your BEETLE /S-II plus, please contact your Wincor Nixdorf International GmbH branch office or your dealer.

About this manual

This documentation is intended to help you to work with the POS system and to serve as a reference work. The detailed table of contents help you find the desired information quickly and easily.



Notes in the manual are marked by this symbol.



This symbol is used for warnings.

The type and scope of application programs depend on the customer's own selection; therefore, software will not be discussed further in this manual.

You will find a description of the BIOS Setup and the Central Processing Unit in a separate manual ("POS Motherboard"), see <http://www.wincor-nixdorf.com/internet/us/Services/Support/TechnicalSupport/POSSystems/index.html>.

Care of the BEETLE /S-II plus

Clean your BEETLE /S-II plus at regular intervals with a suitable plastic-surface cleaner which can be ordered from Wincor Nixdorf International GmbH. Make sure that the power plug is disconnected and that no liquid finds its way into the device.

Recycling the BEETLE /S-II plus

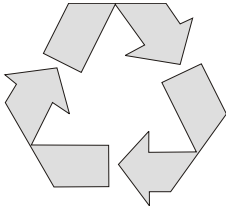

Environmental protection does not begin when the time has come to dispose of the BEETLE; it begins with the manufacturer. This product was designed according to our internal norm “Environmental conscious product design and development”.

The modular BEETLE /S-II plus system is manufactured without the use of CFCs and CCHS and is produced mainly from reusable components and materials.

The processed plastics can, for the most part, be recycled. Even the precious metals can be recovered, thus saving energy and costly raw materials.

Please do not stick labels onto plastic case parts. This would help us to re-use components and material.

You can protect our environment by only switching on your equipment when it is actually needed. If possible, even avoid the stand-by-mode as this wastes energy, too. Also switch your equipment off when you take a longer break or finish your work.

At this time, there are still some parts that are not reusable. Wincor Nixdorf International GmbH guarantees the environmentally safe disposal of these parts in a Recycling Center, which is certified pursuant to ISO 9001 and ISO 14001.

So don't discard your BEETLE /S-II plus system on the garbage when it has served its time, but take advantage of the environmentally smart, up-to-date recycling methods!

Please contact your competent branch or the Recycling Center Paderborn (for European countries) for information on how to return and re-use devices and disposable materials under the following mail address.

Email: info@wincor-nixdorf.com
or on the internet.

We look forward to your mail.

Warranty

Wincor Nixdorf guarantees generally a warranty engagement for 12 months beginning with the date of delivery. This warranty engagement covers all damages which occur despite a normal use of the product.

Damages because of

- improper or insufficient maintenance,
- improper use of the product or unauthorized modifications of the product,
- inadequate location or surroundings

will not be covered by the warranty.

For further information on the stipulation consult your contract.

All parts of the product which are subject to wear and tear are not included in the warranty engagement. For detailed warranty arrangements please consult your contract documents.

Please order spare parts at the Wincor Nixdorf customer service.

BEETLE /S-II plus- the modular POS System

Overview

You can connect a variety of peripherals to your modular POS system BEETLE /S-II plus and thus implement a wide range of expansion stages. You can connect a four-line alphanumeric customer display and a four line cashier display. Alternatively, you can connect flat screens.

You can

- use various types of scanners such as distance, touch or stationary scanners,
- use scales and scanner scales (please take into account the official certification regulations),
- connect various printers,
- use POS keyboards,
- use different types of cash drawers,
- connect a monitor,
- integrate the BEETLE /S-II plus in a network and
- upgrade the BEETLE /S-II plus, since it can accommodate two PCI cards (PCI and PCI-e).

This means that the BEETLE /S-II plus can meet your requirements at all times, without having to exchange the complete system for a new one, thus saving you time and money.

Before switching on the System

Unpacking and checking the System

Unpack the components and verify that the scope of delivery is identical to the information on the delivery ticket.

The carton contains the basic unit and a country-specific accessories kit. Some ordered composition may be installed.

Should you notice any transport damages or discrepancies between package contents and delivery ticket or functional defects please inform your contracting parties or the branch office of Wincor Nixdorf immediately. Please indicate the number of your delivery ticket and delivery ticket position and serial numbers of the respective devices.

The serial numbers can be found on the label illustrated below which are located at the bottom side of the housing.

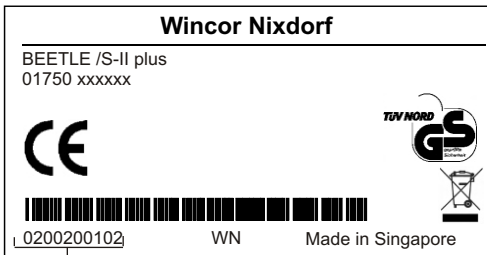

serial number

Transport the device only in its original packaging (to protect it against impact and shock).

Setting up the device



Set up the BEETLE /S-II plus system where it will not be exposed to extreme environmental conditions. Protect the device from vibrations, dust, moisture, heat and strong magnetic fields.

Horizontal installation

Mind the **minimum distances** indicated below! If the equipment is to be fitted, you also must ensure that the specified minimum distances are maintained and constant ventilation is provided. The immediate ambient temperature of the system must not exceed 40° C (104° F).

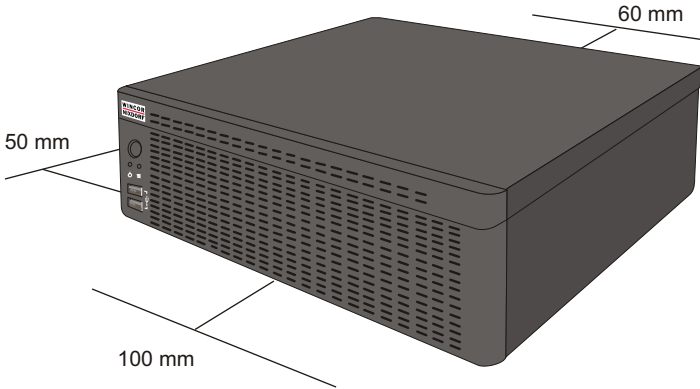

Vertical installation of the equipment

The minimum top and bottom distances listed in the figure must be maintained; otherwise, a sufficient ventilation of the equipment is not guaranteed.

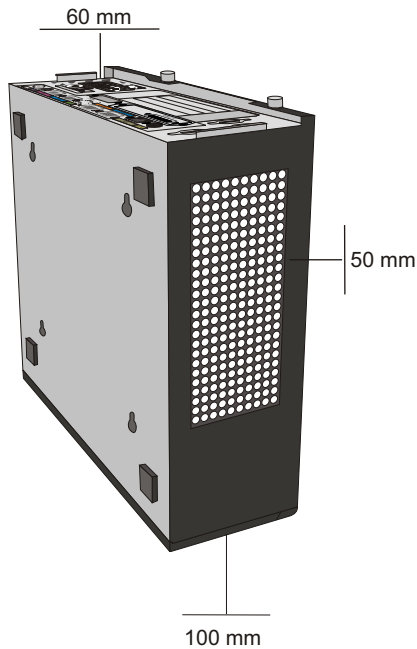

The minimum distances listed in the figure must be maintained; otherwise, a sufficient ventilation of the equipment is not guaranteed.

The BEETLE /S-II plus is designed for horizontal mounting. If you install the BEETLE /S-II plus in vertical position, you have attend to the following:

- Mind the following minimum clearances also for vertical mounting to ensure sufficient ventilation:
 - forward: 100 mm,
 - backward: 60 mm
 - sideways (left): 50 mm

- A surface made of nonflammable material (e.g. concrete or metal) must be located underneath the vertically mounted power supply unit.

Cabling of the BEETLE /S-II plus

Follow the steps below in the order given when installing devices:

- Plug one end of the power cable into the socket of the BEETLE /S-II plus.
- Plug in and secure the data cable.
- Plug the other end of the power cable into the main power supply.

Always make sure that all power plugs from the grounded-contact power sockets are unplugged.

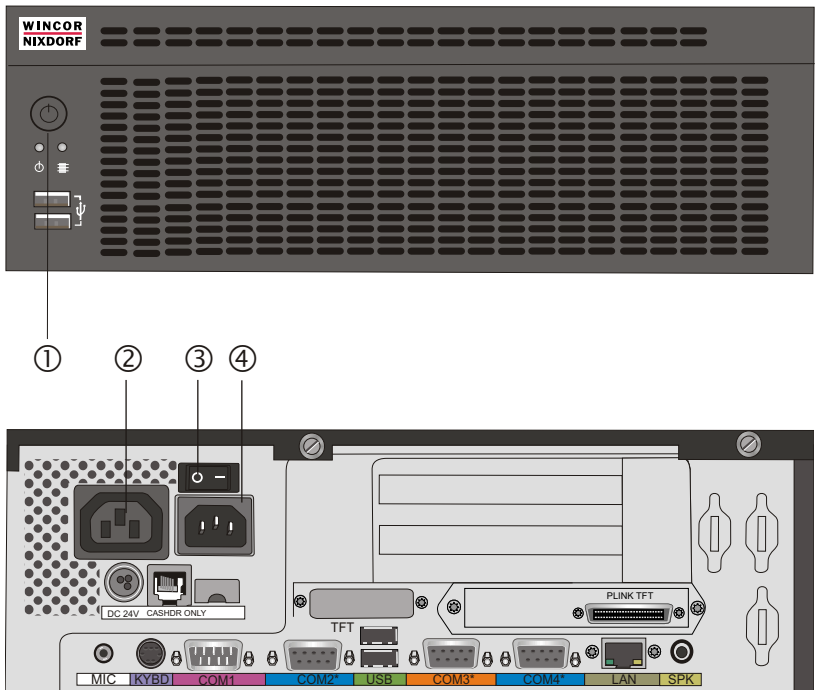

①	ON Button
②	Power Output Socket
③	Power Switch
④	Power Input Jack

Now switch on the power switch at the rear side. Then, push the power ON button on the front side of the system.

The power supply can be connected to all conventional power supply networks. It automatically adjusts itself to the particular voltage. The power output of the power pack is maximum 304 W.

Basic settings

Ex works, the BEETLE /S-II plus is configured to your order. Your configuration must be subsequently adapted to support supplementary devices such as scanners. For more information, contact the Wincor Nixdorf International GmbH branch office responsible for your area.

The System BEETLE /S-II plus

Front Side View

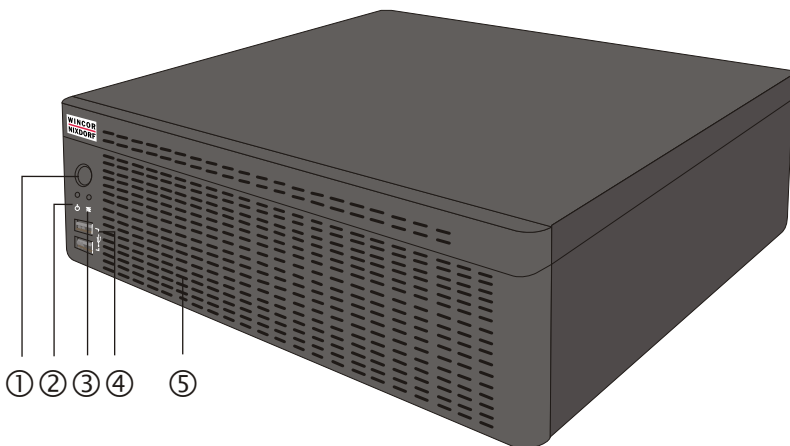

①	ON Button
②	Power LED
③	HDD- LED
④	2 USB Intervaces
⑤	Ventilation Slots NOT COVERING

ON Button

With a power supplied power unit (power switch switched to 1) you switch on the system with the power ON button on the front side of the system unit.

Light-emitting Diode (LED)

The LEDs are labelled with HDD for the right LED and with POWER for the left LED.

HDD	flashes yellow	while the hard disk is beeing accessed
POWER	lights orange	Stand by operating
	lights green	the device is switched on

USB (Universal Serial Bus)- A, USB 2.0

You can connect several USB peripheral devices e.g. scanner or scales to the USB.

Only connect devices equipped with a shielded cable to the USB-interface.

Interior view

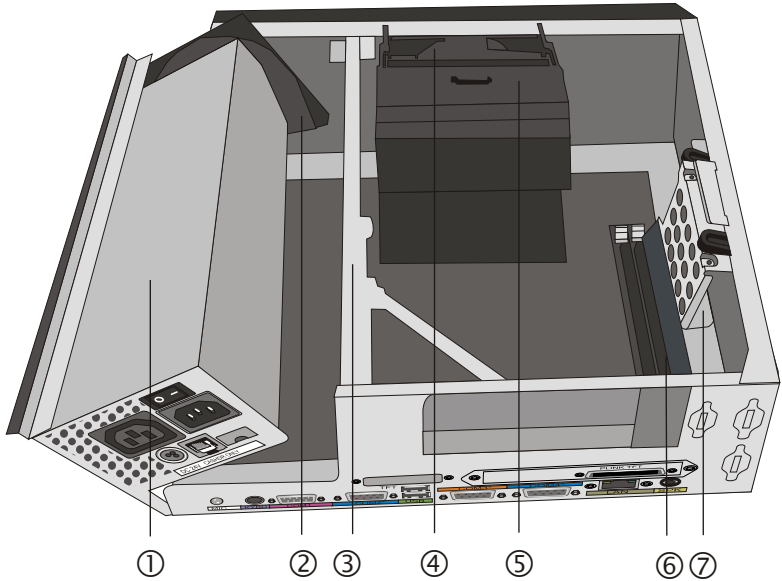

①	Power Supply
②	Ventilator (power supply)
③	Carrier for PCI cards
④	Ventilator (processor)
⑤	Cable channel
⑥	RAM
⑦	Hard Disk

Power Supply

The power supply can be connected to all conventional power supply networks. It automatically adjusts itself to the particular voltage and is fan-cooled. The power output of the power pack is maximum 304 W.



The Power Supply Unit (PSU) carries the 80plus certificate. This means that the PSU will reach an efficiency of at least 80% with each a load of 20%, 50% or 100%. So, less energy is needed and less noise is generated as the fan is much lesser activated due to lower lost heat.

Connector Panel

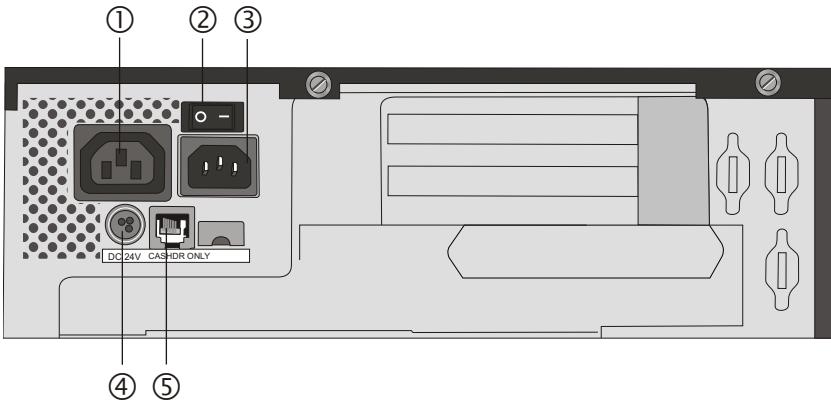

①	Power output (for a monitor)
②	Power switch
③	Power input
④	DC24V (Power supply for the printer, HOSIDEN socket)
⑤	RJ12 (Cashdrawer socket)

At the front side of the box you will find the ON button which will turn on the system.

The system is automatically switched off, when the operating system is shut down. Pushing (approx. 5 seconds) the ON button at any time will shut down the system. The proper function of the On button is defined by the settings of the operating system and the BIOS. The power cord receptacle, the power output socket for the monitor and the power socket for the printer are located on the back of the BEETLE system.



The power pack must be removed or replaced by authorized qualified personnel only. Only replace power packs released by Wincor Nixdorf.



To disconnect the device from the supply voltage completely, switch off the device and disconnect the power plug.

Power Connector

This connector provides the power. Connect the according end of the power cable to this port and the other end to the power socket.

Pull the mains plug to power-off the device.

Power Output

The power supply for external devices (e.g. CRT screen) is provided by the power output socket.

DC24V (Modular Printer)

Appropriate POS printers can be connected via the low-voltage jack 24V, max. 3A via non-UPS. A connecting cable with a HOSIDEN plug is required for this.



Connect only cables to the 24V connector which are marked with DP-1 or DP-2.



Do not connect the HOSIDEN plug when the system is turned on, this can lead to an automatical reboot of the system.

RJ12 (CASHDR, Geldlade)

The power supply unit has one RJ12 socket for connecting a cash drawer. Make sure that the connector is plugged firmly into the socket to prevent malfunctioning. RJ12 plugs lock in when you insert them. Power is supplied to the cash drawer via this socket, P24V +5% / -15%.



Connecting daisy chained cash drawers and 12V OEM-drawers is prohibited!



Connect cash drawers only (no telephon).

Power Consumption

The POS system is usually not disconnected from the mains. The energy consumption is therefore directly depending on the operating state.

All measurements refer to a system configuration of 512MB RAM, 80GB 3.5" 7200rpm SATA-HDD, analog flat screen with 1024x768x16 screen resolution, WoL enabled, Windows XP Professional operating system.

Power Off (soft-off)	2W
Standby/ Sleep Mode	3W
Idle Modes	38W
Performance Mode (full load)	72W*/58W**

* Dual Core E2160- processor

** Celeron 440- processor

System Unit

Always make sure that the system is switched off when you do cabling works.

Connecting peripherals with the system switched on is not allowed (exception: USB devices).

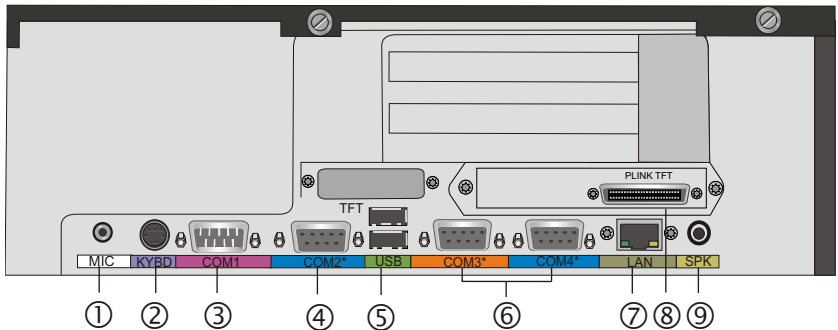

①	Jack plug, 3.5 mm, MIC
②	Mini DIN (KYBD)
③	D- Sub (COM1)
④	D- Sub power supplied (COM2*)
⑤	USB- A (USB 2.0)
⑥	D- Sub power supplied (COM3*/COM4*)
⑦	RJ45 socket
⑧	PLINK-TFT (optional)
⑨	Jack plug, 3.5 mm, SPK

Jack Plug 3.5 mm (MIC, SPK)

Physically the microphone (MIC) and the head phone (SPK) jacks are identical as both require 3.5 mm phone jack for data transfer. However, both differ concerning the pin assignment so that a faultless transmission is only ensured with the designated connection.

Besides a microphone a headset can be used alternatively via this interface.

You can set the volume as desired by means of a menu in the BIOS Setup (see chapter "BIOS setup" in the manual "POS Motherboard").

Mini-DIN (KYBD)

The BEETLE /S-II plus has a 6-pin mini-DIN jack for connecting a keyboard. Make sure that the connector is plugged firmly into the socket to prevent malfunctioning. Power is supplied to the keyboard via this socket. If you wish to connect an older standard PC keyboard with DIN connector, you must use a special adapter cable, obtainable from the WN branch office responsible for your area.



You can connect a mouse in parallel via a Y-cable.

D- Sub Plug (COM1)

Connect scales with their own power supply to the COM1 interface. COM1 is designed as a 9-pin D-sub plug.

Make sure that the connector is plugged securely into the socket to prevent possible malfunctioning.

If scales which are not supplied by Wincor Nixdorf International GmbH are connected to the BEETLE /S-II plus, you must obtain a Wincor Nixdorf licence for the driver software.

The COM1 interface is without effect if a TFT adapter with touchscreen function is installed (adjustment necessary in the BIOS setup).

D- Sub- Jack power supplied (COM2*/COM3*/COM4*)

The interface connections are a 9-pin D-sub jack for scanner, user or customer displays without own power supply.



Make sure that the connector for the customer display is screwed firmly to the socket to prevent possible malfunctioning. Power is supplied via this jack.

USB (Universal Serial Bus)- A, USB 2.0

You can connect several USB peripheral devices to the USB or powered USB interface (12V or 24V).



Only connect devices equipped with a shielded cable to the USB-interface.

RJ45 (LAN)

The system can be connected to a network (LAN) from the POS terminal back panel.

LEDs

left LED	flashes green	With running network connection (Network cable connection ON, e.g. HUB, Router) "Up link"
right LED	flashes yellow	during network traffic



Only connect shielded LAN cables (CAT5) as these offer a better protection in case of interferences in a network.

CRT

If a CRT adapter is installed, you can connect a monitor to the BEETLE /S-II plus via the 15-pin D-sub jack on the CRT adapter. Power is supplied to the monitor via the AC-outlet on the BEETLE /S-II plus, located on the back of the housing.

A LCD screen can be connected alternatively if a TFT adapter is installed.

PLINK TFT (TFT- VGA Monitor)

If a TFT adapter is installed you can connect a Panellink-TFT to the BEETLE /S-II plus. Connect the 40-pin data cable of the LCD to the system. The signals for the touch screen function and the power supply is also made via this cable. To implement the touch screen functionality for the COM1 or COM2* interface you have to change some system settings in the BIOS setup.

The COM1 or COM2* interface is without effect if the onboard TFT adapter with touch screen function is installed. In this case the interface is not available for other peripherals.

Disconnecting cables

Never unplug a cable by pulling on the cable; always take direct hold of the plug itself. Follow the procedure below when disconnecting cables:

- Turn off all power and equipment switches.
- Unplug all data communication cables from the sockets of the data networks.
- Unplug all power plugs from the grounded-contact power sockets.
- Unplug all cables from the devices.

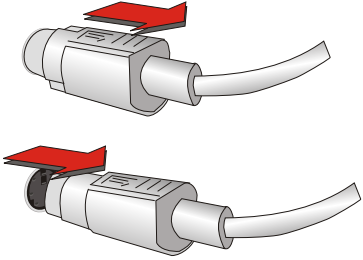
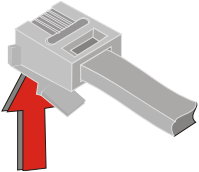
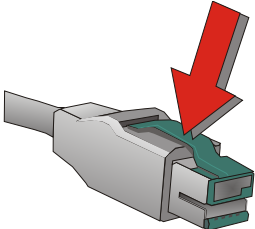
	<p>With MINI-DIN plugs (Wincor Nixdorf), the plug remains inserted until released.</p> <p>Pull the plastic covering from the connecting socket with your thumb. The lock is released. The metal of the plug is visible.</p>
	<p>RJ12 plugs lock in when you insert them. To release them push the latch under the plug to the top.</p>
	<p>The powered USB connector is disengaged by pressing the spring that is marked by an arrow.</p>

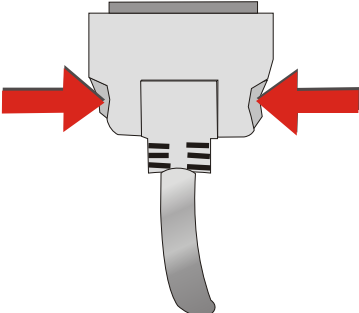
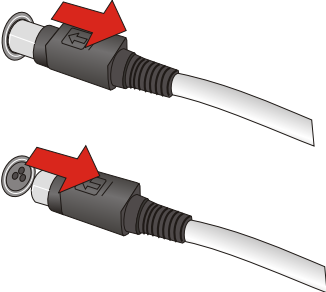
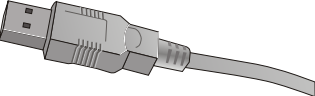
	<p>To release TFT (LCD) connectors, press the interlocks on the left and right side.</p>
	<p>Der Hosiden-Stecker (Druckeranschluss) ist mit einer Verriegelung gegen unbeabsichtigtes Lösen der Verbindung versehen. Um diesen Stecker zu lösen, ziehen Sie die Plastikummhüllung von der Anschlussbuchse weg. Die Verriegelung wird gelöst. Das Metall des Steckers ist sichtbar und kann aus der Buchse gezogen werden.</p>
	<p>You loosen the USB-A- connector by pushing the covering of the connector.</p>

Storage Media

Following storage media are available:

- one or two 2.5" SATA- hard disk,
- one or two 2.5" solid state disk drive.

A solid state disk drive is a data storage drive that uses memory elements in place of a rotating disk to store data. The SSD easily substitutes the hard disk and emulates a hard disk drive interface. The most SSDs are flash memory based.

Change of the Hard Disk Drive

First ensure that the device is switched off and that the power connector is disconnected.

Open your BEETLE /S-II plus. Loosen the two screws at the back side (1) and pull it out of the front guide (2). Lift the top cover at the back side (3).

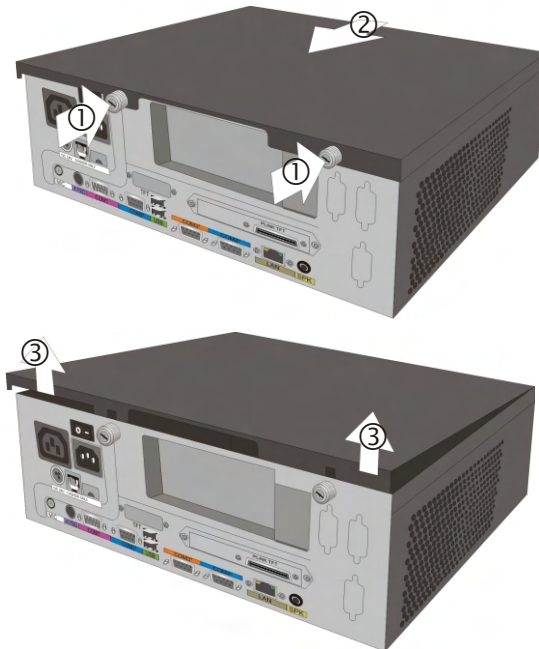

Push the metal plate (1). Tilt the hard disk holder into the direction of arrow (2).

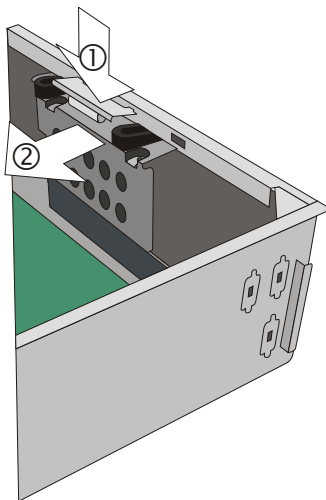

Lift up the drive and remove it. Loosen the connecting cables.

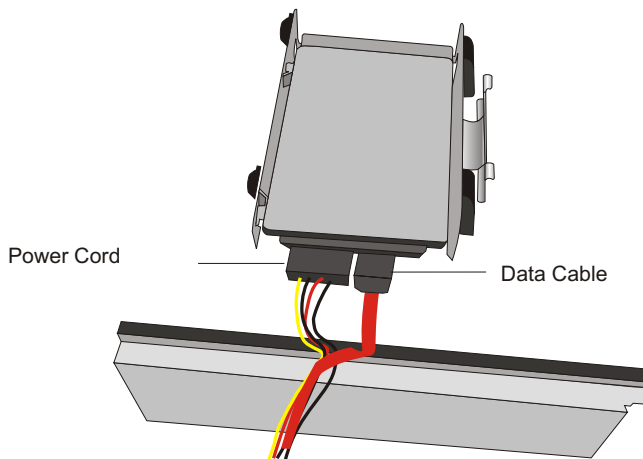

Loosen the four Phillips head screws (see arrows) at the holder with a screwdriver.

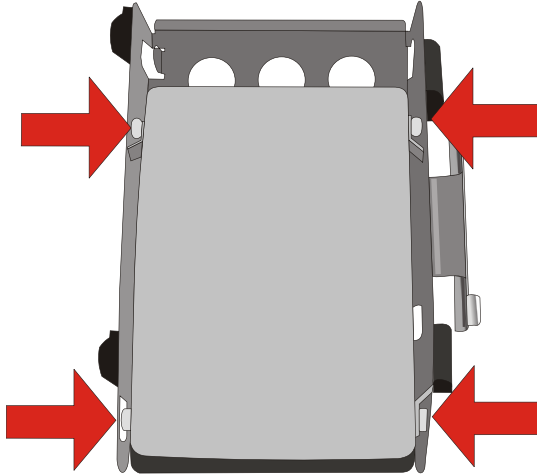

Ensure that you handle the hard disk with extreme caution during the installation. Never touch bare electronics.

Change the hard disk. Please pay regard to the correct fitting position. A 2.5" hard disk is being installed at the upper position on the drive holder.

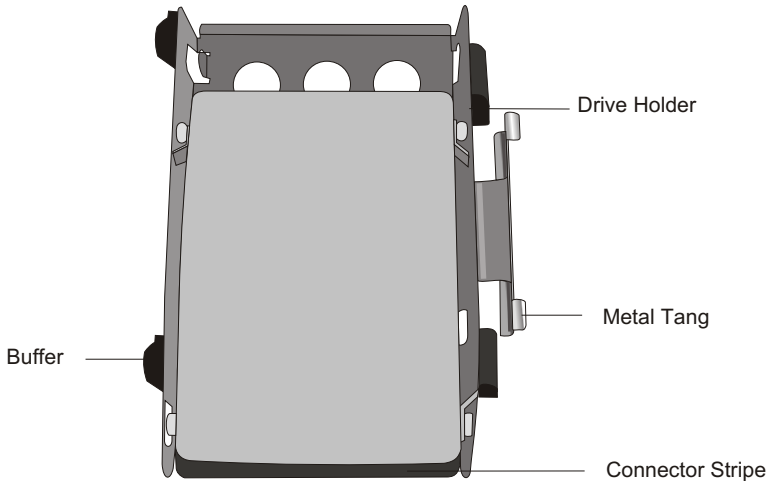

Connect both cables to the hard disk.
Insert the drive holder.
Make sure that the buffers are corresponding to the stampings in the base plate (see arrows).

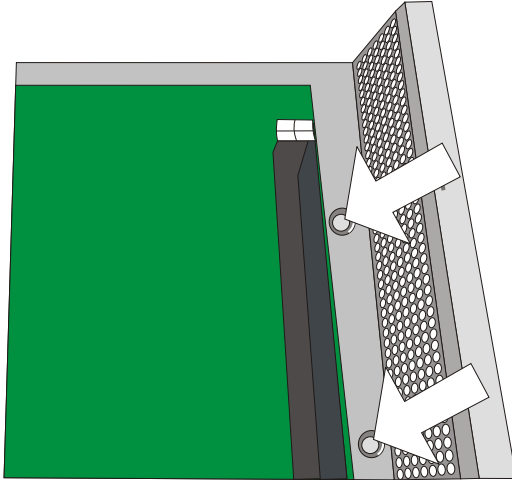

Carefully tilt the hard disk carrier into the originally position. Make sure that the drive holder will not pinsh cables. The metal tangs snap in place.

Close the cover and connect the main plugs. Now you can switch on the system.

USB- Controller (optional)

There are three 12V and one 24V USB interfaces on an optional available board.

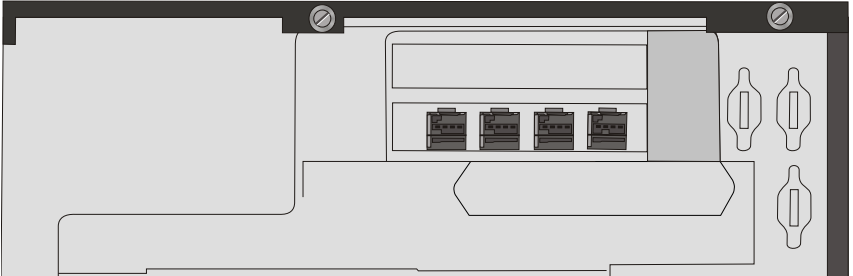

You can connect or disconnect USB devices during operation of your BEETLE, provided that these devices comply with the specifications according to usb.org.

Other peripheral devices with higher power requirement (such as PoweredUSB printer) should be connected to or disconnected from your BEETLE system only after the BEETLE has been switched off.

COM5*- COM8*- Interfaces (optional)

The standard system is configured with three further COM* interfaces. In addition you can install an optional PCI board with maximal four COM* interfaces (COM5*, COM6*, COM7*, COM8*).

Scanners, customer and operator displays without own power supply are connected to these serial interfaces.

The interface connection is a 9-pin D-sub jack.

Make sure that the connector for the customer display is screwed firmly to the socket to prevent possible malfunctioning. Power is supplied via this jack.

The interfaces COM7/COM8 are also available without own power supply.

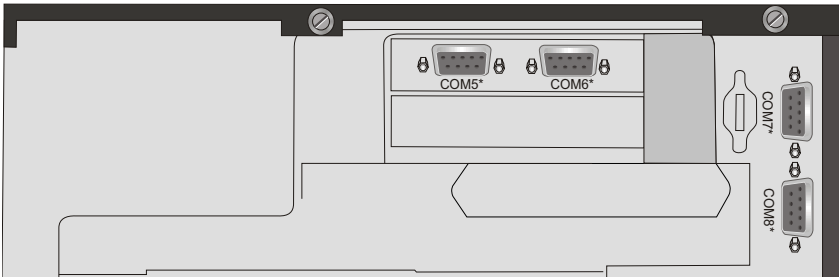

CRT- or TFT- Adapter (optional)

Both adapters may be installed in parallel. You can connect a CRT monitor or/and a TFT-LCD module with optional touch screen functionality.

When installing a TFT- adapter with touchscreen functionality the cable for the internal loudspeaker must be removed to activate the loudspeaker in the screen display.

The touch functionality must be activated via BIOS setup.

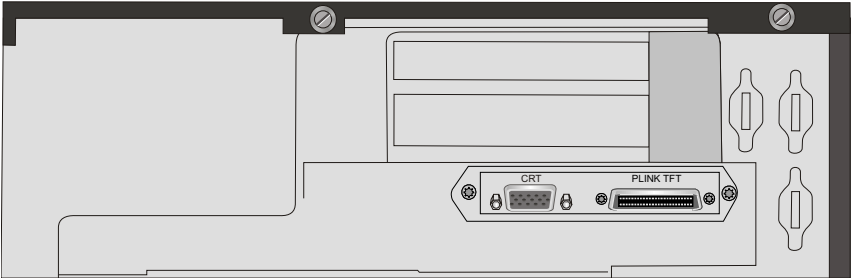

NOTE



Expansion cards with electrostatically sensitive devices (ESD) can be marked with this sticker.

When you handle boards fitted with ESDs (electronical components), you must observe the following aspects under all circumstances:

- You must always discharge yourself (e. g. by touching a grounded object) before working with boards containing ESDs.
- The equipment and tools you use must be free of static charges.
- Pull out the power plug before inserting or pulling out boards containing ESDs.
- Always hold boards with ESDs by their edges.

Never touch pins or conductors on boards fitted with ESDs.

Starting up the system

The configuration label shows you the equipment included in your modular BEETLE /S-II plus system.

The label is located at the underside of the BEETLE /S-II plus. The data specified there are required for entering the setup parameters (see section BIOS Setup in the manual “BEETLE POS Motherboard”).

Start and runup behaviour

After installing the BEETLE /S-II plus, switch on the POS system using the ON/OFF button on the front panel and the power switch on the power supply.

The system first performs an automatic self-test to test its basic functions.

For example, you may see the following message (irrespective of processor type) on the four-line cashier display or on the monitor:

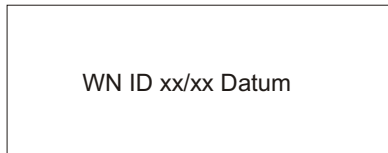

xx/xx is the placeholder of the BIOS version number.

The system then determines the medium from which the operating system and POS application are to be booted. Each medium is assigned a logical drive according to the configuration of your BEETLE /S-II plus.

The following media can be assigned a drive:

- Network
- Hard disk
- CD-ROM

The logical drives are designated C: and D:.

The network is always assigned to the C: drive during the runup procedure. The hard disk can be assigned to the C: or D: drive. The system can only be started from the hard disk if the disk has been configured as the C: drive.

Corresponding to the Setup configuration the modular BEETLE /iClick system can be booted from the following drives:

- Hard disk in drive C:
- CDROM in EL TORITO format
- Network

Please mind that the storage medium must be system-boot-capable.

The following priorities apply:

Network (C:)	High priority
Hard disk (C:)	Medium priority

If the POS system does not find a CD-ROM, it automatically continues the loading process from drive C:.

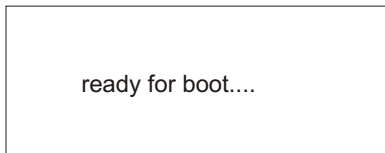

If the operating system has started up without error, the POS application software is automatically booted if necessary.

A message is displayed as soon as the BEETLE /iClick is ready for operation. For more detailed information, see the description of your application program.

Appendix

Technical Data BEETLE /S-II plus

Dimensions	
Width	310 mm
Depth	280 mm (w/o cable cover) 352 mm (with cable cover)
Height	103 mm
Weight	
	approx. 6.5 kg
Climatic category	
Class 3K3	DIN IEC 721-3-3
Class 2K2	DIN IEC 721-3-2
Class 1K2	DIN IEC 721-3-1
Temperature:	
Operating(3K3)	+5°C up to +40°C
Transport (2K2)	-25 C up to +60 C
Storage (1K2)	+5 C up to +40 C
Input voltage	
	100- 120 V 200- 240 V
Max. power consumption	
	4A / 7A
Frequency of the system voltage	
	50/60 Hz
Noise development	
	70 dB(A) or less
Mains power outlet	
	100 - 120 V /2 A max 200 - 240 V /1 A max

Interfaces

COM	COM1 (w/o power supply), COM2* (with power supply) Optional: COM5*- COM8* (with power supply) via PCI- COM- board
USB	2 Standard USB + 2 Standard USB at the front side Optional: 3 PoweredUSB 12V and 1 PoweredUSB 24V via a Hub controller
LPT	optional onboard
Graphic adapter	supports on board adapter for VGA-, CRT screens and Panellink or DVI Resolution: CRT up to 2048x1536 (32 Bit colours); Panellink up to 1600x1200 (24 Bit colours)
MIC, SPK	Ports for microphone and loudspeaker
PS/2	1 (keyboard and mouse)
RJ12	cash drawer, Geldlade, the jack is situated on the integrated power supply
DC24V	POS- printer with low voltage on the integrated power supply
LAN	RJ45- jack, 10/100 Mbit/s
PCI-Bus	1 x PCI 2.1, 32 Bit, 33MHz
PCIe	1 x PCIe
SATA II	for internal hard disk
RAID Controller	optional

Extensions

Rear Panel (CRT/VGA, PanelLink)

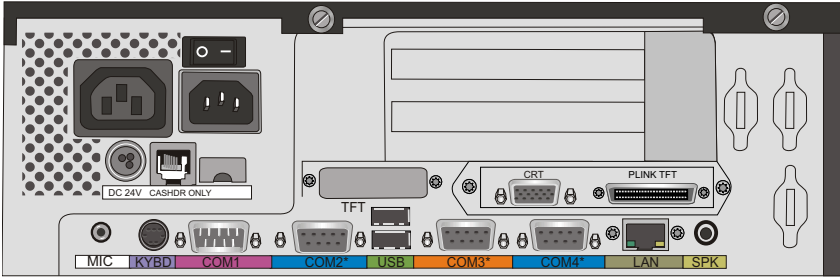

Rear Panel (CRT/VGA, DVI)

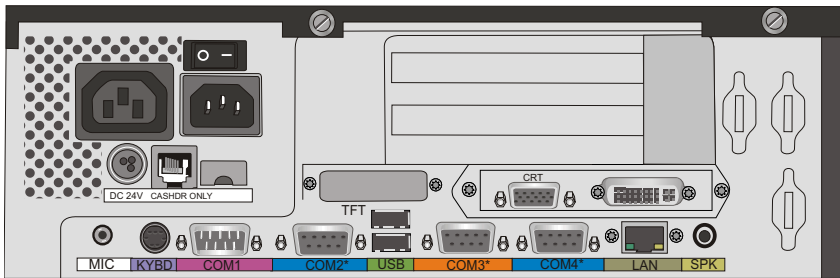

Rear Panel (CRT/VGA, DVI*, USB)

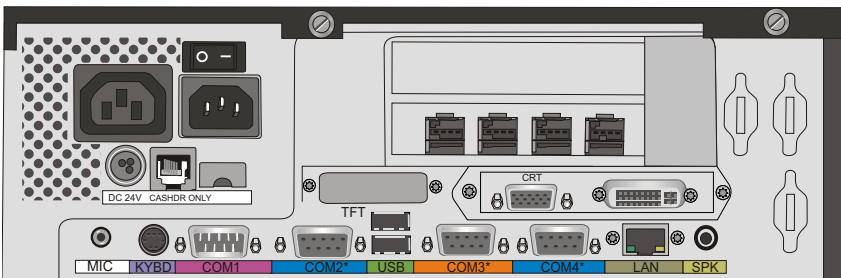

Rear Panel (CRT/VGA, DVI*, USB, COM)

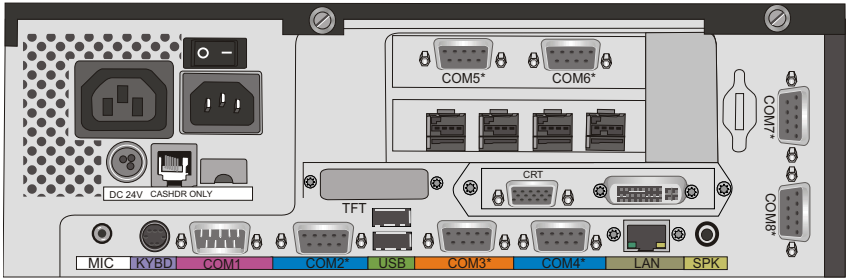

*DVI or PanelLink

Total Current Consumption of Interfaces

The total current consumption at **5V interfaces** must not exceed **5A**.

each COM*	= 300mA, in total 500mA
each USB	= 500mA, in total 2A
each USB (HUB)	= 500mA, in total 2A
<u>TFT/LCD-Display</u>	
Max. 5A @ 5V	

The total current consumption at **12V interfaces** must not exceed **5A**.

each COM*	= 600mA, in total 900mA
each USB	= 1,5A, in total 2A
each USB (HUB)	= 1,5A, in total 2A
<u>TFT/LCD-Display</u>	
Max. 5A @ 12V	

The total current consumption at **24V interfaces** must not exceed **3A**.

each USB (HUB)	= 3,0A, in total 3,0A
<u>DC24 (power supply)</u>	
Max. 3A @ 24V	

Power loss of additionally implemented PCI- and PCIe- Controllers is - for thermic reasons - limited to 10W for each slot and all together to 20W.

Glossary

Bit

A bit is a binary digit (0 or 1). It is the smallest unit used in data processing.

Controller

Serves to control data input and output in a data processing system or between a computer and the connected peripherals.

CPU

Abbreviation of central processing unit. It includes the main components of a data processing system. The CPU monitors all operations and provides data and programs. It comprises the control unit for input and output, the computer and the main memory, divided into ROM and immediate access storage.

DVI

It is a new standard for digital data transfer. A DVI connection transfers a digital signal to the monitor without converting it to analog, thereby making sure that no information is lost or garbled in the digital-to-analog conversion and following analog-to-digital conversion that can occur in current digital display devices. DVI has three subsets: DVI-A, for analog signals, DVI-D, for digital signals, and DVI-I (*integrated*), for both analog and digital signals. In the future PCs and laptops are not only equipped with DVI, but also video devices as DVD.

Interface

Designates the transition point between different hardware units and software units or between hardware and software units of computers or their peripherals.

JEIDA

Abbreviation of Japan Electronic Industry Development Association. Industry standard for memory cards.

Operating system

Refers to all programs that are a component of a computer and are required for operating the system and executing application programs.

PCIe

Abbreviation of Peripheral Component Interconnect Express. The basis for the „classical“ bus structure is a parallel architecture, i.e. all connected terminals share an available bandwidth. With the new technology - PCI

Express - the transfer rates are increased by switched point-to-point connections. A switch connects two PCIe components at a time with full bandwidth and speed.

PCMCIA

Abbreviation for Personal Computer Memory Card International Association. Industry standard for memory cards.

Plug and PLayer (PnP)

PnP means the automatic recognition of hardware components by the system. Thus the installation, integration and configuration of new components is made substantially easier.

Peripherals

Devices serving as an input/output device or storage for a computer. This includes, for example, document readers, keyboards, printers and disk storage.

SATA

Abbreviation for "Serial Advanced Technology Attachments", a serial interface. By using the serial transmission SATA will do with a thin four-wired conductor and a small plug. ATA so far was known for the broad ribbon cable.

Server

This is a computer connected to a local network and whose services are available to all of the network subscribers, e.g. a print server for printing the data from all of the network subscribers on the printer connected to the server.

VGA

Stands for Video Graphics Array and is the interface for connecting colour monitors.

Abbreviations

CE	European Symbol of Conformity
COM	RS 232 Schnittstelle
CPU	Central Processor Unit (for example INTEL Celeron-M)
CRT	Cathode Ray Tube
cUL	Canadian Registration (Recognized by UL)
DIMM	Dual Inline Memory Module
DIN	Deutsches Institut für Normen (German Institute for Standards)
D-Sub	D- Shaped Subminiature
DVD-ROM	Digital Versatile Disc Random Access Memory
DVD-RW	Digital Versatile Disc Rewritable
EMV	Electromagnetic Compatibility
FCKW/CKW	Fluorchlorkohlenwasserstoffe/Chlorkohlenwasserstoffe
HDD	Hard Disk Drive
IEC	International Electrotechnical Commission
ISO	International Organization for Standardization,
LAN	Local Area Network
LCD	Liquid Crystal Display
LED	Light Emitting Diode
NV RAM	non volatile RAM
OS	Operating System
PCI	Peripheral Component Interconnect
PCIe	Peripheral Component Interconnect express
PEN-Leiter	Protective Earth Neutral- Leiter
PLINK	Panel-Link
PnP	Plug and Play, Plug & Play
POS	Point Of Sales
PS	Power Supply
RAID	Redundante Anordnung unabhängiger Festplatten (Redundant Array of Independent Disks)
RAM	Random Access Memory
S-ATA	Serial Advanced Technology Attachment
SSD	Solid State Disk (flash medium)
TCO	Total Cost of Ownership
TDP	Thermal Design Power (INTEL specification)
TFT	Thin Film Transistor
TN-S	Terre Neutre- Separé
UL	Underwriters Laboratory (standards)
UPS	Uninterruptable Power Supply
USB	Universal Serial Bus

VDE	Verband der Elektrotechnik, Elektronik und Informationstechnik e.V. German Association for Electrical, Electronic and Information Technologies
WAN	Wide Area Network
W LAN	Wireless Local Area Network
WN	Wincor Nixdorf International GmbH
ZC	Zero Cache

Herausgegeben von/Published by Wincor Nixdorf International GmbH
D-33094 Paderborn

Bestell-Nr./Order No.: **01750177662A**