

EXPLANATORY NOTES TO THE COMBINED NOMENCLATURE OF THE EUROPEAN UNION

(2006/C 50/01)

Publication made in accordance with Article 9(1) of Council Regulation (EEC) No 2658/87 of 23 July 1987 on the tariff and statistical nomenclature and on the Common Customs Tariff ⁽¹⁾

⁽¹⁾ OJ L 256, 7.9.1987, p. 1.

FOREWORD

Council Regulation (EEC) No 2658/87 of 23 July 1987 on the tariff and statistical nomenclature and on the Common Customs Tariff ⁽¹⁾ established a nomenclature, known as the ‘Combined Nomenclature’ or abbreviated to the ‘CN’, based on the International Convention on the Harmonised Commodity Description and Coding System ⁽²⁾, known as ‘the Harmonised System’ or abbreviated to the ‘HS’.

The HS has been supplemented by its own Explanatory Notes (HSEs). Those notes in English and French are issued and kept up to date by the:

WORLD CUSTOMS ORGANISATION (WCO)
Customs Cooperation Council (CCC),
30, rue du Marché,
B-1210 Brussels

By virtue of Article 9(1)(a), second indent, and Article 10 of Regulation (EEC) No 2658/87, the Commission adopts explanatory notes to the Combined Nomenclature (CNENs), following consideration by the Tariff and Statistical Nomenclature Section of the Customs Code Committee. Although the CNENs may refer to the HSEs, they do not take the place of the latter, but should be regarded as complementary to and used in conjunction with them.

This version of the CNENs includes and, where appropriate, replaces those published in the *Official Journal of the European Union*, C series, up to ~~10 February 2011~~ December 2012 ⁽³⁾. CNENs published in the Official Journal, C series, subsequent to that date remain in force and will be incorporated in the CNENs when revised.

~~In addition, the CN heading and subheading codes to which reference is made reflect those codes in the Combined Nomenclature for 2011, as set out in Commission Regulation (EU) No 861/2010.~~ In addition, the CN heading and subheading codes to which reference is made reflect those codes in the Combined Nomenclature for 2013, as set out in Commission Regulation (EU) No 927/2012 ⁽⁴⁾.

(1) OJ L 256, 7.9.1987, p. 1.

(2) OJ L 198, 20.7.1987, p. 1.

(3) ~~OJ C 041, 10.2.2011, p. 1~~ OJ C 377, 7.12.2012, p. 8.

(4) ~~OJ L 284, 29.10.2010, p. 1~~ OJ L 304, 31.10.2012, p. 1.

A. General rules for the interpretation of the Combined Nomenclature

General rule 5(b) Packing containers normally used for marketing beverages, jam, mustard, spices, etc., are to be classified with the goods they contain even if clearly suitable for repetitive use.

C. General rules applicable both to nomenclature and to duties

- General rule 3**
1. In Article 18(1) and (2) of Council Regulation (EEC) No 2913/92 ⁽¹⁾, all days other than the published public holidays of the European Commission services in Brussels, and Saturdays and Sundays, are 'working days'.
 2. Where no rate is published in the *Official Journal of the European Union* on the penultimate working day of the month or the penultimate working day before the fifteenth of the month, the rate referred to in Article 18(1) of the above Regulation to be used for converting the euro into national currencies shall be the last rate published before the penultimate working day of the month or before the fifteenth.

(1) OJ L 302, 19.10.1992, p. 1.

SECTION I

LIVE ANIMALS; ANIMAL PRODUCTS

CHAPTER 1

LIVE ANIMALS

0101	Live horses, asses, mules and hinnies
0101 90 11 0101 29 10 and 0101 90 19 0101 29 90	Horses Wild horses, such as the Przewalski horse or tarpan (Mongolian horse), are included in these subheadings. However, zebras (<i>Equus zebra</i> , <i>Equus grevyi</i> , <i>Equus burchelli</i> , <i>Equus quagga</i> , etc.) are classified in subheading 0106 19 90 0106 19 00 , even though they belong to the Equidae family. Hybrids of the mare and zebra (zebrule) are classified in subheading 0106 19 90 0106 19 00 .
0101 90 30 0101 30 00	Asses Both domestic and non-domestic asses fall in this subheading. Among the latter are Mongolian djiggetai, the Tibetan kiang, the onager and the hemione or half-ass (<i>Equus hemionus</i>). Hybrids of the ass and zebra (zebrass) are classified in subheading 0106 19 90 0106 19 00 .
0101 90 90 0101 90 00	Mules and hinnies Other This subheading covers the animals described in the final paragraph of the HS Explanatory Note to heading 0101.
0102	Live bovine animals
0102 90 05 0102 21 10 to to 0102 90 79 0102 29 99	Domestic species Cattle These subheadings cover all the animals of the domestic bovine species (including buffaloes) of the genera These subheadings include the animals described in the HS Explanatory Note to heading <i>Bos</i> and <i>Bubalus</i>, irrespective of their intended use (stock, raising, fattening, breeding, slaughter, etc.), but excluding pure-bred breeding animals (subheadings 0102 10 100102 21 10 to to first paragraph, (1), 0102 10 90 These subheadings include the animals described in the HS Explanatory Note to heading Yaks have 14 pairs of ribs, while all the other animals of the bovine species (with the exception of the European and American bison) have only 13 pairs of ribs. 0102 , first paragraph, (1), (2) and (7).
0102 31 00 and 0102 39 90	Buffalo These subheadings include the animals described in the HS Explanatory Note to heading 0102 , first paragraph, (2). The European bison (<i>Bison bonasus</i>) and the American bison (<i>Bison bison</i>) have 14 pairs of ribs, while all the other animals of the bovine species (with the exception of yaks) have only 13 pairs of ribs.
0102 39 10	Domestic species This subheading covers all the animals of the domestic bovine species of the genera <i>Bubalus</i> , <i>Syncerus</i> and <i>Bison</i> , irrespective of their intended use (stock, raising, fattening, breeding, slaughter, etc.), but excluding pure-bred breeding animals (subheading 0102 31 00).
0102 90 90 0102 90 20 to 0102 90 99	Other This subheading covers all the animals of the non-domestic bovine species (including buffaloes). This subheading includes the animals described in the HS Explanatory Note to heading These subheadings include the animals described in the HS

Explanatory Note to heading 0102, first paragraph, (3), (4), (5), (6), and the musk ox or sheep ox (, first paragraph (3), *Ovibos moschatus*):

Yaks and bisons have 14 pairs of ribs, while all the other animals of the bovine species (including true buffaloes) have only 13 pairs of ribs.

0102 90 91

Domestic species

This subheading covers all of the animals of the domestic bovine species not included above, irrespective of their intended use (stock, raising, fattening, breeding, slaughter, etc.), but excluding pure-bred breeding animals (subheading 0102 90 20).

0103

Live swine

0103 91 90

Other

Live swine of non-domestic species include:

1. wild boar (*Sus scrofa*);
2. warthogs (*Phacochoerus aethiopicus*), river hogs or pig deer (*Potamochoerus porcus*), and the black forest pig;
3. babiroussa (*Babyrousa babyrousa*);
4. peccary (wild swine) (*Dicotyles tajacu*).

- 0103 92 90** **Other**
See the explanatory note to subheading 0103 91 90.
- 0104** **Live sheep and goats**
- 0104 10 10 to 0104 10 80** **Sheep**
These subheadings include domestic animals of the ovine species (*Ovis aries*), the different varieties of moufflon, such as the European moufflon (*Ovis musimon*), the Canadian or 'bighorn' (*Ovis canadensis*), the Asiatic or Shapoor ural (*Ovis orientalis*), the moufflon Pamir argali (*Ovis ammon*) as well as the Aoudad or Barbary sheep (*Ammotragus lervia*) which are known as 'maned sheep' although more akin to goats than sheep.
- 0104 20 10 and 0104 20 90** **Goats**
These subheadings include domestic animals of the goat species, the ibex goat (*Capra ibex*) and the Bezoar goat or Persian goat (*Capra aegagrus* or *Capra hircus*).
The following, however, are excluded from these subheadings and classified in subheading ~~0106 19 90~~ 0106 19 00: the musk-deer (*Moschus moschiferus*), the African water-chevrotain (*Hyemoschus*) and the Asiatic chevrotain (*Tragulus*) which do not belong to the goat species. Also excluded are animals known as goat antelopes (hemitragues (half-goats), chamois, etc.).
- 0105** **Live poultry, that is to say, fowls of the species *Gallus domesticus*, ducks, geese, turkeys and guinea fowls**
This heading covers only live domestic birds of the kinds specified in the heading (fowls of the species *Gallus domesticus* include chickens and capons), whether bred for laying, for their meat, for their feathers or for any other purpose (for example, for the stocking of aviaries, parks or lakes).
Wild birds (for example, wild turkeys — *Meleagris gallopavo*), even though they may be bred and slaughtered in a similar manner to the domestic birds specified in this heading, are classified in subheading ~~0106 39 90~~ 0106 39 80.
Pigeons of the domestic species are classified in subheading 0106 39 10.
- 0106** **Other live animals**
- 0106 13 00** **Camels and other camelids (Camelidae)**
This subheading covers camels, dromedaries and other animals of the camel family (llamas, alpacas, guanacos, vicunas).
- ~~**0106 19 10**~~ **0106 14 10** **Domestic rabbits**
This subheading covers only rabbits of the domestic species, whether bred for their meat, their fur (for example, the angora rabbit) or for any other purpose.
- 0106 14 90** **Other**
This subheading covers wild rabbits (*Oryctolagus cuniculus*) and hares.
- ~~**0106 19 90**~~ **0106 19 00** **Other**
This subheading covers all live mammals, with the exception of domestic and non-domestic horses, asses, mules and hinnies (heading 0101), bovine animals (heading 0102), swine (heading 0103), sheep and goats (heading 0104), primates (subheading 0106 11 00), ~~whales, dolphins, porpoises, manatees and dugongs (subheading), whales, dolphins, porpoises, manatees and dugongs, seals, sea lions and walruses (subheading 0106 12 00) and domestic rabbits (subheading), and rabbits and hares (subheadings ~~0106 19 10~~ 0106 14 10 and 0106 14 90).~~
Examples of the mammals included in this subheading are:
1. ~~wild rabbits (*Oryctolagus cuniculus*) and hares;~~
2. ~~1.~~ stags (fallow) deer, roe-deer, chamois or wild goats (*Rupicapra rupicapra*), the common or American elk (*Alces alces*); eland (*Taurotragus*), goat antelopes (goral (*Naemorhedus*), *Hemitragus* or pronghorn) and antelopes proper;
3. ~~2.~~ lions, tigers, bears, rhinoceroses, hippopotami, elephants, giraffes, okapis, kangaroos, zebras, etc.;
4. ~~camels, dromedaries and other animals of the camel family (llamas, alpacas, guanacos, vicunas);~~
5. ~~3.~~ squirrels, foxes, visons (American mink), marmots, beavers, musquash or muskrats, otters, guinea-pigs;
6. ~~4.~~ reindeer;
7. ~~5.~~ dogs and cats.

0106 20 00**Reptiles (including snakes and turtles)**

This subheading covers all reptiles, lizards, tortoises and turtles (marine or fresh water).

0106 39 10**Pigeons**

This subheading covers all the birds of the pigeon (dove) family, whether wild or domestic, irrespective of the intended use of the latter (farmyard pigeons, ornamental pigeons, carrier pigeons).

The non-domestic pigeons include the ring-dove or wood pigeon (*Columba palumbus*), the stock dove (*Columba oenas*), the rock pigeon (*Columba livia*), the Australian bronze pigeon, doves and turtle-doves (*Streptopelia turtur*, *Streptopelia risoria*).

However, certain closely related gallinaceous species, such as nicobars (*Caloenas nicobarica*), columbars, crowned pigeons, gaugas and syrrhaptas, are excluded from this subheading and are classified in subheading ~~0106 39 90~~0106 39 80.

~~0106 39 90~~0106 39 80**Other**

This subheading covers all live birds, other than fowls of the species *Gallus domesticus*, ducks, geese, turkeys and guinea fowls (heading 0105) and other than birds of prey (subheading 0106 31 00), psittaciformes (subheading 0106 32 00) ~~and domestic and non-domestic pigeons (subheading -), ostriches and emus (subheading 0106 33 00), and domestic and non-domestic pigeons (subheading 0106 39 10).~~

Examples of the birds included in this subheading are:

1. the greylag goose (*Anser anser*), brent goose (*Branta bernicla*), sheldrake (*Tadorna tadorna*), mallard (*Anas platyrhynchos*), gadwall (*Anas strepera*), widgeon (*Anas penelope*), pintail (*Anas acuta*), shoveller (*Anas clypeata*), teal (*Anas querquedula*, *Anas crecca*), scoter and eider;
2. swans and peacocks;
3. partridges, pheasants, quail, woodcocks, snipe, grouse, hazel-grouse, wild ducks, wild geese, ortolan, thrushes, blackbirds, larks;
4. finches, tits, canaries, humming-birds, etc.

0106 49 00**Other**

This subheading covers silk-worms, butterflies, beetles and other insects.

0106 90 00**Other**

This subheading covers:

1. all other species of live animals, with the exception of fish, crustaceans, molluscs and other aquatic invertebrates (Chapter 3) and microbial cultures (heading 3002);
2. bees (whether or not in travelling boxes or cages or hives);
3. silk-worms, butterflies, beetles and other insects;
- 4.2. frogs.

CHAPTER 2
MEAT AND EDIBLE MEAT OFFAL

General

1. Meat and offal, fit and suitable for human consumption, remain classified in this chapter even if presented, for example, as intended for the manufacture of pet food.
2. For the purposes of this chapter, the scope of the words ‘meat’ and ‘offal’ is as described in the HS General Explanatory Note to this chapter.
3. Guidance on the different states in which meat and offal of this chapter can occur (fresh, chilled, frozen, salted or in brine, dried or smoked) is given in the HS General Explanatory Note to this chapter. It should be noted that deep-frozen meat and partially or totally de-frozen meat are to be classified in the same way as frozen meat. Moreover, ‘frozen’ covers not only meat which has been frozen when fresh but also meat which has first been slightly dried and then frozen in so far as its actual and lasting preservation depends essentially upon such freezing.
4. Guidance is also given, in the HS General Explanatory Note to this chapter, on the distinction between meat and offal of this chapter and that of Chapter 16. However, this chapter covers meat offal, raw, minced, or finely chopped but not further prepared, wrapped in plastic material (even in the form of sausages) solely for ease of handling or transport.
5. For the purposes of distinguishing between bone-in and boneless cuts, cartilage and tendons shall not be regarded as bone.

Additional note 1(A)(d) and additional note 1(A)(e) For the purposes of additional notes 1(A)(d) and 1(A)(e) to this chapter (read in conjunction with additional note 1(C) to this chapter), whilst determining whether the conditions of the minimum and maximum number of ribs are fulfilled, only the ribs, whole or cut, directly attached to the vertebral column are to be counted. According to this explanation, the diagram below shows an example of a bovine forequarter which would comply with additional notes 1(A)(d) and 1(A)(e) read in conjunction with additional note 1(C) to this chapter.

FOREQUARTER HINDQUARTER

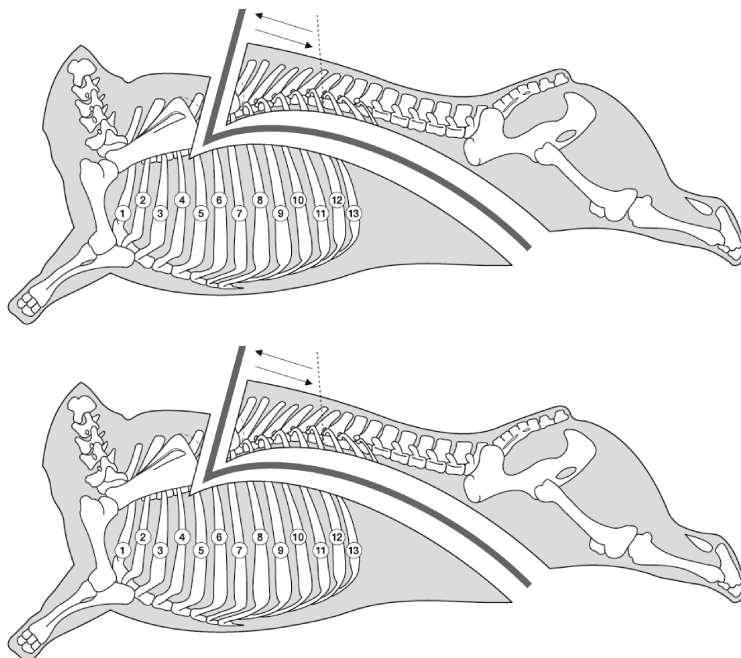

Additional note 2(C)

For the purposes of additional note 2(C) to this chapter, as regards the two different cutting techniques and the parts 'jowls', 'chaps' and 'chaps and jowls together', see the diagrams below:

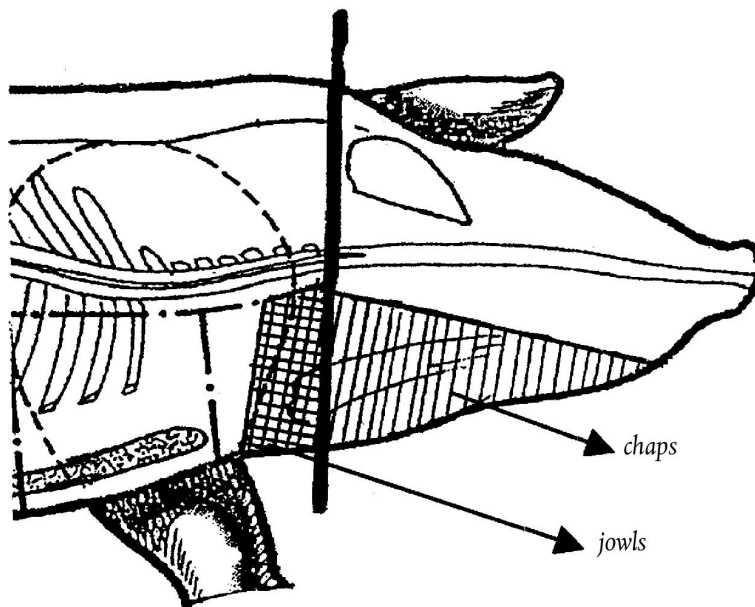
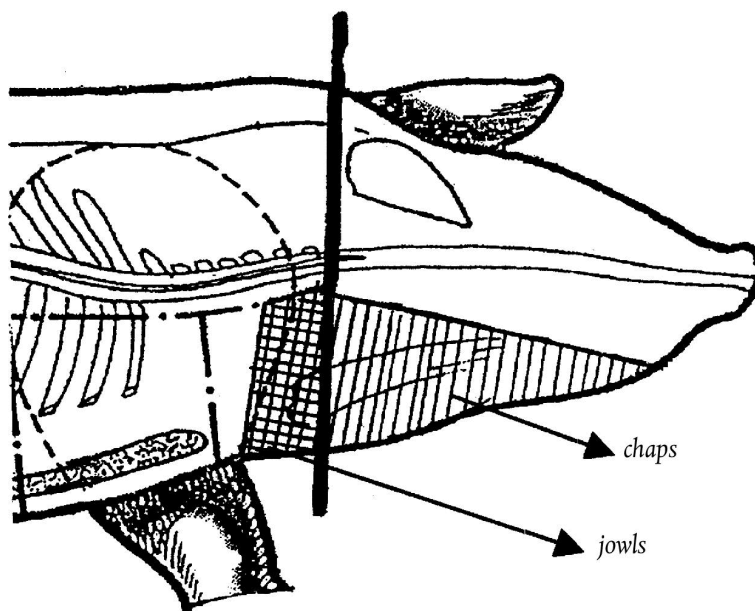
Straight cut parallel to the cranium**Straight cut parallel to the cranium**

Cut parallel to the cranium up to the level of the eyes and then inclined to the front of the head

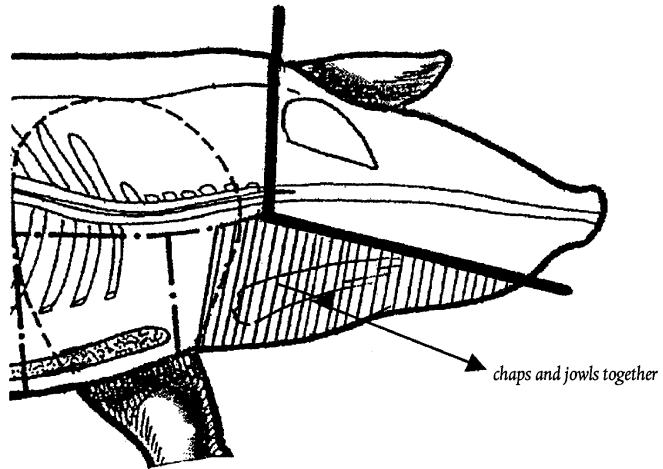

Cut parallel to the cranium up to the level of the eyes and then inclined to the front of the head

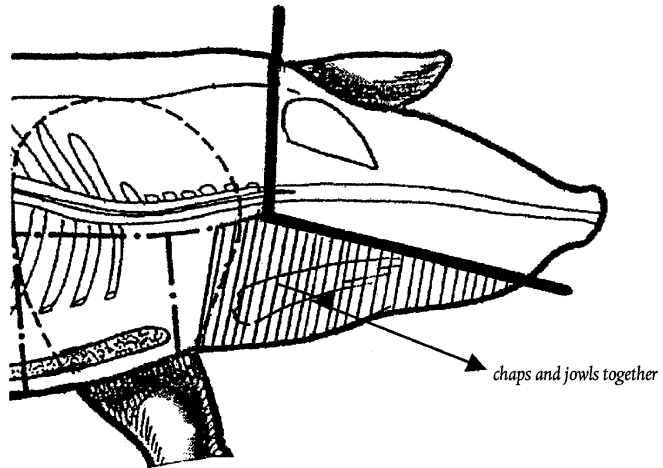

- Additional note 6(a)** Salt is not considered to be a seasoning within the meaning of this additional note. See also additional note 7 to this chapter.
- 0201** **Meat of bovine animals, fresh or chilled**
This heading covers only fresh or chilled meat of the animals of heading 0102.
For the purposes of the definitions of forequarters and hindquarters, the following considerations apply:
(a) the ‘scrag and neck’ is taken to be the muscular part of the neck with the seven cervical half vertebrae;
(b) the ‘shoulder’ is taken to be the foreleg joint comprising the scapulum, humerus, radius and cubitus bones and the muscles which surround them;
(c) the ‘sirloin’ is taken to be the tenderloin and the striploin; the rump may or may not include the gooseskirt.
- 0201 10 00** **Carcases and half-carcases**
The terms ‘carcasses’ and ‘half-carcases’ are defined in paragraphs (a) and (b) of additional note 1(A) to this chapter. The first eight or nine dorsal vertebral apophyses may be left on either the right or the left half-carcase.
- 0201 20 20** **‘Compensated’ quarters**
The term ‘compensated quarters’ is defined in paragraph (c) of additional note 1(A) to this chapter.
- 0201 20 30** **Unseparated or separated forequarters**
The terms ‘unseparated forequarters’ and ‘separated forequarters’ are defined in paragraphs (d) and (e) of additional note 1(A) to this chapter. It follows from this additional note that the front parts of half-carcases, for example, which with all the corresponding bones include fewer than four ribs, from which the neck or shoulder is missing, or from which a bone, for example, the Atlas bone, has been removed, are excluded from this subheading and are classified in subheading 0201 20 90.
- 0201 20 50** **Unseparated or separated hindquarters**
The terms ‘unseparated hindquarters’ and ‘separated hindquarters’ are defined in paragraphs (f) and (g) of additional note 1(A) to this chapter. It follows from this additional note that the rear parts of half-carcases, for example, which with all the corresponding bones include fewer than three ribs or from which the thigh or sirloin, including the fillet, is missing are excluded from this subheading and are classified in subheading 0201 20 90. However, hindquarters without kidneys or kidney fat, with or without the thin flank, remain classified as hindquarters.
- 0201 20 90** **Other**
This subheading includes, for example, the shoulder, the thigh and the sirloin, unboned (bone in). Also included here are the front and rear parts of half-carcases (bone in) which do not answer to the definitions of ‘compensated’ quarters, forequarters or hindquarters.
- 0201 30 00** **Boneless**
This subheading includes all cuts of meat of bovine animals, fresh or chilled, from which all bones have been removed, for example, boneless fillets and flanks.
- 0202** **Meat of bovine animals, frozen**
This heading covers only frozen meat of the animals of heading 0102.
- 0202 10 00** **Carcases and half-carcases**
The terms ‘carcasses’ and ‘half-carcases’ are defined in paragraphs (a) and (b) of additional note 1(A) to this chapter.

- 0202 20 10** **‘Compensated’ quarters**
The term ‘compensated quarters’ is defined in paragraph (c) of additional note 1(A) to this chapter.
- 0202 20 30** **Unseparated or separated forequarters**
The terms ‘unseparated forequarters’ and ‘separated forequarters’ are defined in paragraphs (d) and (e) of additional note 1(A) to this chapter.
- 0202 20 50** **Unseparated or separated hindquarters**
The terms ‘unseparated hindquarters’ and ‘separated hindquarters’ are defined in paragraphs (f) and (g) of additional note 1(A) to this chapter.
- 0202 20 90** **Other**
The explanatory note to subheading 0201 20 90 applies, *mutatis mutandis*.
- 0202 30 50** **Crop, chuck and blade and brisket cuts**
The terms ‘crop’, ‘chuck and blade’ and ‘brisket’ are defined in paragraph (h) of additional note 1(A) to this chapter.
- 0202 30 90** **Other**
This subheading covers all cuts of meat of bovine animals, frozen, which are completely boneless, with the exception of the frozen blocks mentioned in subheading 0202 30 10 and the cuts of subheading 0202 30 50.
- 0203** **Meat of swine, fresh, chilled or frozen**
This heading covers only meat of the animals of heading 0103.
The meat of animals of the swine species certified by the competent authorities in Australia as meat of swine living in the wild in Australia is considered as meat of swine other than of domestic swine.
- 0203 11 10 to 0203 19 90** **Fresh or chilled**
These subheadings cover only fresh or chilled meat of animals falling in heading 0103.
- 0203 11 10** **Of domestic swine**
The term ‘carcasses or half-carcasses’ is defined in paragraph (a) of additional note 2(A) to this chapter.
- 0203 12 11** **Hams and cuts thereof**
The term ‘hams’ is defined in paragraph (b) of additional note 2(A) to this chapter.
This subheading includes shank with bone in from the hind legs.
- 0203 12 19** **Shoulders and cuts thereof**
The term ‘shoulders’ is defined in paragraph (d) of additional note 2(A) to this chapter.
This subheading includes mini spare ribs or ‘riblets’ and shank with bone in from the forelegs.
- 0203 19 11** **Fore-ends and cuts thereof**
The term ‘fore-ends’ is defined in paragraph (c) of additional note 2(A) to this chapter.
This subheading does not include shank with bone in from the forelegs, nor mini spare ribs nor ‘riblets’ (subheading 0203 12 19).

- 0203 19 13** **Loins and cuts thereof, with bone in**
The term ‘loins’ is defined in paragraph (e) of additional note 2(A) to this chapter.
This subheading includes loin ribs.
- 0203 19 15** **Bellies (streaky) and cuts thereof**
The terms ‘bellies’ and ‘cuts’ are defined in paragraph (f) of additional note 2(A) and in additional note 2(B) to this chapter.
Cuts thereof are not classified under this subheading unless they contain the rind and the subcutaneous fat.
This subheading does not include spare ribs without rind or subcutaneous fat (subheading 0203 19 59).
- 0203 19 59** **Other**
This subheading also includes spare ribs without rind or subcutaneous fat.
- 0203 19 90** **Other**
This subheading includes only the meat of the animals falling in subheadings 0103 91 90 or 0103 92 90, in particular the meat of wild boar, other than carcasses, half-carcasses, legs, shoulders, parts of legs and parts of shoulders.
- 0203 21 10 to 0203 29 90** **Frozen**
The explanatory notes to subheadings 0203 11 10 to 0203 19 90 and to the subdivision thereof apply, *mutatis mutandis*.
- 0204** **Meat of sheep or goats, fresh, chilled or frozen**
This heading includes only fresh, chilled or frozen meat of animals of heading 0104, whether domestic or wild, in particular meat of the ovine species (domestic or wild sheep), as well as meat of the ibex.
- 0204 10 00** **Carcasses and half-carcasses of lamb, fresh or chilled**
The terms ‘carcasses’ and ‘half-carcasses’ are defined in paragraphs (a) and (b) of additional note 3(A) to this chapter.
The definition of meat of lamb is set out in the HS Explanatory Note to subheadings 0204 10 and 0204 30.
- 0204 21 00** **Carcasses and half-carcasses**
The terms ‘carcasses’ and ‘half-carcasses’ are defined in paragraphs (a) and (b) of additional note 3(A) to this chapter.
- 0204 22 10** **Short forequarters**
The term ‘short forequarters’ is defined in paragraphs (c) and (d) of additional note 3(A) to this chapter.
- 0204 22 30** **Chines and/or best ends**
The term ‘chines and/or best ends’ is defined in paragraphs (e) and (f) of additional note 3(A) to this chapter.
- 0204 22 50** **Legs**
The term ‘legs’ is defined in paragraphs (g) and (h) of additional note 3(A) to this chapter.
- 0204 30 00** **Carcasses and half-carcasses of lamb, frozen**
The explanatory note to subheading 0204 10 00 applies, *mutatis mutandis*.

0204 41 00~~to~~ to 0204 43 90 Other meat of sheep, frozen

The explanatory notes to subheadings 0204 21 00, 0204 22 10, 0204 22 30 and 0204 22 50 apply, *mutatis mutandis*, to subheadings 0204 41 00, 0204 42 10, 0204 42 30 and 0204 42 50, respectively.

0204 50 11~~to~~ to 0204 50 79 Meat of goats

The terms ‘carcases’ and ‘half-carcases’ (subheadings 0204 50 11 and 0204 50 51), ‘short forequarters’ (subheadings 0204 50 13 and 0204 50 53), ‘chines and/or best ends’ (subheadings 0204 50 15 and 0204 50 55) and ‘legs’ (subheadings 0204 50 19 and 0204 50 59) are defined in additional note 3(A) to this chapter, in paragraphs (a) and (b), (c) and (d), (e) and (f) and (g) and (h), respectively.

0206 Edible offal of bovine animals, swine, sheep, goats, horses, asses, mules or hinnies, fresh, chilled or frozen

This heading covers the offal of animals falling in headings 0101 to 0104. Offal intended for the manufacture of pharmaceutical products does not fall in the subheadings concerned, unless it complies with the conditions laid down by the competent authorities.

Further guidance is given in the HS Explanatory Note to heading 0206.

0206 10 10~~to~~ to 0206 10 98 Of bovine animals, fresh or chilled

These subheadings cover only fresh or chilled offal of animals falling in heading 0102.

0206 10 95 Thick skirt and thin skirt

Thick skirt and thin skirt are muscular parts of the diaphragm.

0206 21 00~~to~~ to 0206 29 99 Of bovine animals, frozen

These subheadings cover only frozen offal of animals of heading 0102.

0206 30 00 Of swine, fresh or chilled

This subheading covers only fresh or chilled offal of animals of heading 0103.

The explanatory note to subheading 0206 49 00, first paragraph, applies, *mutatis mutandis*.

This subheading also includes feet, tails, livers, kidneys, hearts, tongues, lungs, edible rind, brains and caul.

0206 41 00~~and~~ and 0206 49 00 Of swine, frozen

These subheadings cover only frozen offal of animals of heading 0103.

0206 49 00 Other

This subheading includes heads and halves of heads, with or without the brains, cheeks or tongues, and parts of heads (additional note 2(C) to this chapter); the term ‘parts of heads’ is defined in the third paragraph of the said additional note.

This subheading also includes feet, tails, kidneys, hearts, tongues, lungs, edible rind, brains and caul.

This subheading includes offal of wild boar.

0206 80 91 Of horses, asses, mules and hinnies

This subheading covers only fresh or chilled offal of animals of heading 0101.

0206 80 99 Of sheep and goats

This subheading covers only fresh or chilled offal of animals of heading 0104.

- 0206 90 91** **Of horses, asses, mules and hinnies**
This subheading covers only frozen offal of animals of heading 0101.
- 0206 90 99** **Of sheep and goats**
This subheading covers only frozen offal of animals of heading 0104.
- 0207** **Meat and edible offal, of the poultry of heading 0105, fresh, chilled or frozen**
- 0207 11 10** **Plucked and gutted, with heads and feet, known as ‘83 % chickens’**
This subheading includes plucked fowls, with heads and feet, from which the guts have been withdrawn, but with the other entrails (particularly the lungs, the liver, the gizzard, the heart, the ovaries) remaining in position.
- 0207 11 30** **Plucked and drawn, without heads and feet but with necks, hearts, livers and gizzards, known as ‘70 % chickens’**
This subheading includes roasting chickens, which are plucked chickens without heads and feet, but with the neck, completely drawn, but inside the carcass of which the heart, liver and gizzard have been replaced.
- 0207 11 90** **Plucked and drawn, without heads and feet and without necks, hearts, livers and gizzards, known as ‘65 % chickens’, or otherwise presented**
This subheading includes roasting chickens, which are plucked chickens without heads and feet, and completely drawn. It also covers fowls presented in a form other than those mentioned under subheadings 0207 11 10 and 0207 11 30, for example, unplucked, ungutted chickens, with heads and feet.
- 0207 12 10 and 0207 12 90** **Not cut in pieces, frozen**
The explanatory notes to subheadings 0207 11 30 and 0207 11 90 apply, *mutatis mutandis*.
- 0207 13 10** **Boneless**
This subheading covers meat of fowls, without bones, regardless of the part of the carcass from which it comes.
- 0207 13 20** **Halves or quarters**
The term ‘halves’ is defined in additional note 4(a) and (b) to this chapter.
The term ‘quarters’ is defined in additional note 4(a) and (c) to this chapter. This subheading includes hindquarters consisting of the drumstick (tibia and fibula), leg (femur), rear part of the back and rump as well as forequarters consisting essentially of one half of the breast with the wing attached.
- 0207 13 30** **Whole wings, with or without tips**
The term ‘whole wings, with or without tips’ is defined in additional note 4(a) and (d) to this chapter.
- 0207 13 40** **Backs, necks, backs with necks attached, rumps and wing-tips**
See additional note 4(a) to this chapter.
This subheading includes backs with necks attached consisting of a piece of the neck, the back and possibly the rump; backs; necks; rumps (tails); wing tips.
- 0207 13 50** **Breasts and cuts thereof**
The term ‘breasts’ is defined in additional note 4(a) and (e) to this chapter.

0207 13 60**Legs and cuts thereof**

The term 'legs' is defined in additional note 4(a) and (f) to this chapter.

The cut separating the leg from the back should be made between the two lines demarcating the joints as shown in the diagram below:

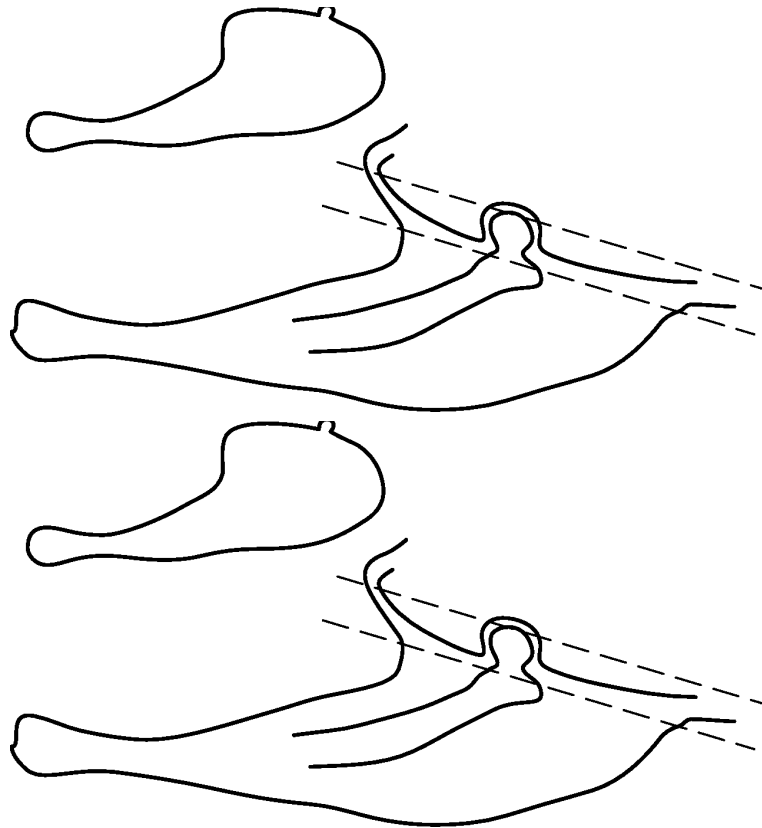
**0207 13 91****Livers**

See the HS Explanatory Note to heading 0207, final paragraph.

0207 13 99**Other**

This subheading covers edible offal, in particular hearts, combs and wattles, but excluding livers. This subheading also includes the feet of fowls.

0207 14 10 to 0207 14 99 Cuts and offal, frozen

The explanatory notes to subheadings 0207 13 10 to 0207 13 99 apply, *mutatis mutandis*.

0207 24 10**Plucked and drawn, without heads and feet but with necks, hearts, livers and gizzards, known as '80 % turkeys'**

This subheading includes plucked turkeys without heads and feet but with the neck, completely drawn, but inside the carcass of which the heart, liver and gizzard have been replaced.

0207 24 90**Plucked and drawn, without heads and feet and without necks, hearts, livers and gizzards, known as '73 % turkeys', or otherwise presented**

This subheading includes plucked turkeys, ready for roasting, without heads, necks and feet and completely drawn. It also covers turkeys presented in a form other than those mentioned under subheadings 0207 24 10 and 0207 24 90.

0207 25 10 and 0207 25 90**Not cut in pieces, frozen**

The explanatory notes to subheadings 0207 24 10 and 0207 24 90 apply, *mutatis mutandis*.

0207 26 10**Boneless**

The explanatory note to subheading 0207 13 10 applies, *mutatis mutandis*.

0207 26 20**Halves or quarters**

The explanatory note to subheading 0207 13 20 applies, *mutatis mutandis*.

0207 26 30

Whole wings, with or without tips

The term 'whole wings, with or without tips' is defined in additional note 4(a) and (d) to this chapter.

0207 26 40

Backs, necks, backs with necks attached, rumps and wing-tips

The explanatory note to subheading 0207 13 40 applies, *mutatis mutandis*.

0207 26 50

Breasts and cuts thereof

The term 'breasts' is defined in additional note 4(a) and (e) to this chapter.

0207 26 60

Drumsticks and cuts of drumsticks

The term 'drumsticks' is defined in additional note 4(a) and (g) to this chapter.

The cut separating the drumstick from the femur should be made between the two lines demarcating the joints as shown in the diagram below:

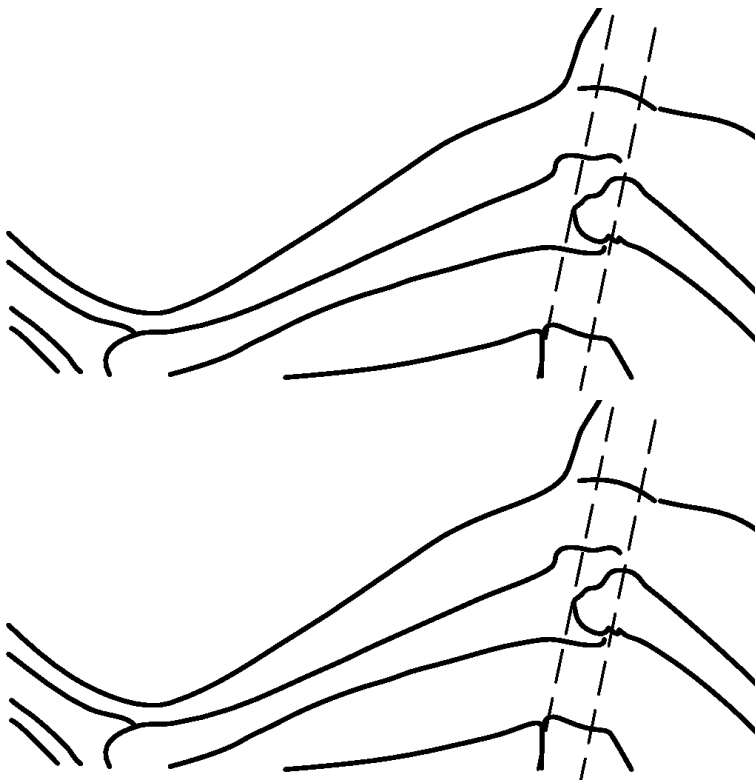

0207 26 70

Other

This subheading includes the cuts defined in additional note 4(a) and (h) to this chapter.

The cut separating the femur (sometimes known commercially as thigh) or whole leg from the back should be made between the two lines demarcating the joints, as shown in the diagram in the explanatory note to subheading 0207 13 60. The cut separating the femur from the drumstick should be made between the two lines demarcating the joints as shown in the diagram in the explanatory note to subheading 0207 26 60.

0207 26 91

Livers

See the HS Explanatory Note to heading 0207, final paragraph.

0207 26 99

Other

The explanatory note to subheading 0207 13 99 applies, *mutatis mutandis*.

0207 27 10 ~~to~~ to 0207 27 99 **Cuts and offal, frozen**

The explanatory notes to subheadings 0207 26 10 to 0207 26 99 apply, *mutatis mutandis*.

~~0207 32 15~~ 0207 41 30**Plucked and drawn, without heads and feet but with necks, hearts, livers and gizzards, known as '70 % ducks'**

This subheading includes plucked ducks, without heads and feet but with the neck, completely drawn, but inside the carcass of which the heart, liver and gizzard have been replaced.

- ~~0207 32 19~~0207 41 80 **Plucked and drawn, without heads and feet and without necks, hearts, livers and gizzards, known as ‘63 % ducks’, or otherwise presented**
This subheading includes plucked ducks, ready for roasting, without heads, necks and feet and completely drawn. It also covers ducks presented in a form other than those mentioned under subheadings ~~0207 32 11~~0207 41 20, ~~0207 32 15~~0207 41 30 and ~~0207 32 19~~0207 41 80.
- ~~0207 32 59~~ **Plucked and drawn, without heads and feet, with or without hearts and gizzards, known as ‘75 % geese’, or otherwise presented**
This subheading includes plucked geese, without heads and feet, completely drawn, but inside the carcase of which the heart and gizzard have been replaced, as well as plucked geese, ready for roasting, without heads and feet, and completely drawn. It also covers geese presented in a form other than those mentioned under subheadings ~~0207 32 51~~ and ~~0207 32 59~~, for example, slaughtered geese which have been plucked and bled, but not drawn, and without their heads and feet.
- ~~0207 33 11~~0207 42 30 **Plucked and drawn, without heads and feet but with necks, hearts, livers and gizzards, known as ‘70 % ducks’**
The explanatory note to subheading ~~0207 32 15~~0207 41 30 applies, *mutatis mutandis*.
- ~~0207 33 19~~0207 42 80 **Plucked and drawn, without heads and feet and without necks, hearts, livers and gizzards, known as ‘63 % ducks’, or otherwise presented**
The explanatory note to subheading ~~0207 32 19~~0207 41 80 applies, *mutatis mutandis*.
- ~~0207 33 59~~ **Plucked and drawn, without heads and feet, with or without hearts and gizzards, known as ‘75 % geese’, or otherwise presented**
The explanatory note to subheading ~~0207 32 59~~ applies, *mutatis mutandis*.
- ~~0207 34 10~~0207 43 00**and**
~~0207 34 90~~ **Fatty livers, fresh or chilled**
See the HS Explanatory Note to heading 0207, final paragraph.
- ~~0207 35 11~~0207 44 10**and**
~~0207 35 15~~ **Boneless**
The explanatory note to subheading 0207 13 10 applies, *mutatis mutandis*.
- ~~0207 35 21~~0207 44 21**to**
~~0207 35 25~~ **Halves or quarters**
The explanatory note to subheading 0207 13 20 applies, *mutatis mutandis*.
- ~~0207 35 31~~0207 44 31 **Whole wings, with or without tips**
The term ‘whole wings, with or without tips’ is defined in additional note 4(a) and (d) to this chapter.
- ~~0207 35 41~~0207 44 41 **Backs, necks, backs with necks attached, rumps and wing-tips**
The explanatory note to subheading 0207 13 40 applies, *mutatis mutandis*.
- ~~0207 35 51~~0207 44 51**and**
~~0207 35 53~~ **Breasts and cuts thereof**
The term ‘breasts’ is defined in additional note 4(a) and (e) to this chapter.
- ~~0207 35 61~~0207 44 61**and**
~~0207 35 63~~ **Legs and cuts thereof**
The term ‘legs’ is defined in additional note 4(a) and (f) to this chapter.

0207 35 71 <u>0207 44 71</u>	Goose or duck paletots Paletots The term 'goose or duck paletots' is defined in additional note 4(ij) to this chapter. The term 'duck or goose paletots' is defined in additional note 4(ij) to this chapter.
0207 35 91 <u>0207 44 91</u>	Livers, other than fatty livers See the HS Explanatory Note to heading 0207, final paragraph.
0207 35 99 <u>0207 44 99</u>	Other The explanatory note to subheading 0207 13 99 applies, <i>mutatis mutandis</i> .
0207 36 11 <u>0207 45 10</u> and 0207 36 15	Boneless The explanatory note to subheading 0207 13 10 applies, <i>mutatis mutandis</i> .
0207 36 21 <u>0207 45 21</u> to 0207 36 79 <u>0207 45 81</u>	With bone in The explanatory notes to subheadings 0207 13 20 to 0207 13 60 and 0207 35 71 <u>0207 44 71</u> apply, <i>mutatis mutandis</i> .
0207 36 81 <u>0207 45 93</u> to and 0207 36 89 <u>0207 45 95</u>	Livers See the HS Explanatory Note to heading 0207, final paragraph.
0207 36 90 <u>0207 45 99</u>	Other The explanatory note to subheading 0207 13 99 applies, <i>mutatis mutandis</i> .
<u>0207 51 90</u>	<u>Plucked and drawn, without heads and feet, with or without hearts and gizzards, known as '75 % geese', or otherwise presented</u> This subheading includes plucked geese, without heads and feet, completely drawn, but inside the carcass of which the heart and gizzard have been replaced, as well as plucked geese, ready for roasting, without heads and feet, and completely drawn. It also covers geese presented in a form other than those mentioned under subheadings 0207 51 10 and 0207 51 90, for example, slaughtered geese which have been plucked and bled, but not drawn, and without their heads and feet.
<u>0207 52 90</u>	<u>Plucked and drawn, without heads and feet, with or without hearts and gizzards, known as '75 % geese', or otherwise presented</u> The explanatory note to subheading 0207 51 90 applies, <i>mutatis mutandis</i> .
<u>0207 53 00</u>	<u>Fatty livers, fresh or chilled</u> See the HS Explanatory Note to heading 0207, final paragraph.
<u>0207 54 10</u>	<u>Boneless</u> The explanatory note to subheading 0207 13 10 applies, <i>mutatis mutandis</i> .
<u>0207 54 21</u>	<u>Halves or quarters</u> The explanatory note to subheading 0207 13 20 applies, <i>mutatis mutandis</i> .
<u>0207 54 31</u>	<u>Whole wings, with or without tips</u> The term 'whole wings, with or without tips' is defined in additional note 4(a) and (d) to this chapter.
<u>0207 54 41</u>	<u>Backs, necks, backs with necks attached, rumps and wing-tips</u> The explanatory note to subheading 0207 13 40 applies, <i>mutatis mutandis</i> .
<u>0207 54 51</u>	<u>Breasts and cuts thereof</u> The term 'breasts' is defined in additional note 4(a) and (e) to this chapter.
<u>0207 54 61</u>	<u>Legs and cuts thereof</u> The term 'legs' is defined in additional note 4(a) and (f) to this chapter.
<u>0207 54 71</u>	<u>Paletots</u> The term 'duck or goose paletots' is defined in additional note 4(ij) to this chapter.
<u>0207 54 91</u>	<u>Livers, other than fatty livers</u> See the HS Explanatory Note to heading 0207, final paragraph.
<u>0207 54 99</u>	<u>Other</u> The explanatory note to subheading 0207 13 99 applies, <i>mutatis mutandis</i> .
<u>0207 55 10</u>	<u>Boneless</u> The explanatory note to subheading 0207 13 10 applies, <i>mutatis mutandis</i> .
<u>0207 55 21 to 0207 55 81</u>	<u>With bone in</u> The explanatory notes to subheadings 0207 13 20 to 0207 13 60 and 0207 44 71 apply, <i>mutatis mutandis</i> .
<u>0207 55 93 and 0207 55 95</u>	<u>Livers</u> See the HS Explanatory Note to heading 0207, final paragraph.
<u>0207 55 99</u>	<u>Other</u> The explanatory note to subheading 0207 13 99 applies, <i>mutatis mutandis</i> .
<u>0207 60 10</u>	<u>Boneless</u> The explanatory note to subheading 0207 13 10 applies, <i>mutatis mutandis</i> .
<u>0207 60 21</u>	<u>Halves or quarters</u> The explanatory note to subheading 0207 13 20 applies, <i>mutatis mutandis</i> .
<u>0207 60 31</u>	<u>Whole wings, with or without tips</u> The term 'whole wings, with or without tips' is defined in additional note 4(a) and (d) to this chapter.

0207 60 41**Backs, necks, backs with necks attached, rumps and wing-tips**

The explanatory note to subheading 0207 13 40 applies, *mutatis mutandis*.

0207 60 51**Breasts and cuts thereof**

The term 'breasts' is defined in additional note 4(a) and (e) to this chapter.

0207 60 61**Legs and cuts thereof**

The term 'legs' is defined in additional note 4(a) and (f) to this chapter.

0207 60 99**Other**

The explanatory note to subheading 0207 13 99 applies, *mutatis mutandis*.

0208**Other meat and edible meat offal, fresh, chilled or frozen**

This heading covers only meat and edible meat offal of the animals classified in heading 0106, fresh, chilled or frozen.

0208 10 10**Of domestic rabbits**

This subheading covers meat and edible meat offal of the animals falling in subheading ~~0106 19 10~~0106 14 10.

0208 90 10**Of domestic pigeons**

This subheading covers the meat and edible meat offal of domestic pigeons (farmyard pigeons, ornamental pigeons, carrier pigeons). The meat and edible meat offal of pigeons described as 'non-domestic' in the explanatory note to subheading 0106 39 10 are, therefore, excluded from this subheading and are classified in subheading 0208 90 30.

0208 90 30**Of game, other than of rabbit or hares**

This subheading includes the meat and edible meat offal of:

1. furred game: fallow deer, roe-deer, chamois or ibex (*Rupicapra rupicapra*), moose or elk, goat-antelope, antelopes, gazelles, bears and kangaroos;
2. feathered game: wild pigeons, wild geese, wild duck, partridges, pheasants, woodcock, snipe, grouse, ortolans and ostriches.

The meat and edible meat offal of animals generally the object of hunting and shooting (pheasants, fallow deer, ostriches, etc.) remain classified as meat and edible meat offal of game even when such animals have been raised in captivity.

The meat and edible meat offal of reindeer is excluded from this subheading (subheading 0208 90 60). However, the meat and edible meat offal of certain species of reindeer (for example, caribou) are classified in this subheading provided that proof is furnished that such meat and edible meat offal come from animals which lived in the wild and which were hunted. This subheading does not cover the meat and edible meat offal of wild rabbits (*Oryctolagus cuniculus*) or hares, which fall in subheading 0208 10 90.

- 0208 90 60** **Of reindeer**
See the explanatory note to subheading 0208 90 30, third paragraph.
- ~~0209-00-00~~**0209** **Pig fat, free of lean meat, and poultry fat, not rendered or otherwise extracted, fresh, chilled, frozen, salted, in brine, dried or smoked**
- ~~0209-00-11~~**0209 10 11****and**
~~and 0209-00-19~~**0209 10 19** **Subcutaneous pig fat**
The term 'subcutaneous pig fat' is defined in additional note 2(D) to this chapter.
- ~~0209-00-30~~**0209 10 90** **Pig fat, other than that of subheading ~~0209-00-11~~0209 10 11 or ~~0209-00-19~~0209 10 19**
See the HS Explanatory Note to heading 0209, second paragraph.
- ~~0209-00-90~~**0209 90 00** **Poultry fat****Other**
See the HS Explanatory Note to heading 0209, third paragraph.
- 0210** **Meat and edible meat offal, salted, in brine, dried or smoked; edible flours and meals of meat or meat offal**
With the exception of subcutaneous fat and other fat of heading ~~0209-00-00~~0209, this heading covers meat and offal, salted, in brine, dried or smoked, of all the animals falling in headings 0101 to 0106.
As regards the terms 'dried or smoked' and 'salted, in brine', see additional notes 2(E) and 7 to this chapter.
- ~~0210 11 11~~**to** ~~0210 11 90~~ **Hams, shoulders and cuts thereof, with bone in**
For the definition of the term 'with bone in', see the HS Explanatory Note to subheading 0210 11.
- ~~0210 11 11~~**to** ~~0210 11 39~~ **Of domestic swine**
The terms 'hams' and 'shoulders' are defined in additional note 2(A)(b) and (d) to this chapter.
- ~~0210 11 11~~**and** ~~and~~
~~0210 11 19~~ **Salted or in brine**
These subheadings cover only hams, shoulders and parts thereof, with bone in, of domestic swine, which have been preserved by deep dry salting or pickling in brine. They may, however, have been further subjected to some slight drying or smoking but not to the extent that they are regarded as dried or smoked for the purposes of subheadings 0210 11 31 and 0210 11 39 (as defined in additional note 2(E) to this chapter).
- ~~0210 11 31~~**and** ~~and~~
~~0210 11 39~~ **Dried or smoked**
These subheadings cover hams, shoulders and cuts thereof, with bone in, of domestic swine, preserved by a drying or smoking process, even if these methods of preservation are combined with a prior salting or pickling treatment. This is particularly so in the case of hams which have been salted before being partially dehydrated, whether in the open air (hams of the Parma or Bayonne types) or by smoking (hams of the Ardennes type).
Hams, shoulders and cuts thereof which have been partially dehydrated, but the actual preservation of which is ensured by freezing or deep-freezing, fall in subheading 0203 22 11 or 0203 22 19.
- ~~0210 12 11~~**and** ~~and~~
~~0210 12 19~~ **Of domestic swine**
The terms 'bellies' and 'cuts' are defined in paragraph (f) of additional note 2(A) and in additional note 2(B) to this chapter.
- ~~0210 12 11~~ **Salted or in brine**
The explanatory note to subheadings 0210 11 11 and 0210 11 19 applies, *mutatis mutandis*.

- 0210 12 19** **Dried or smoked**
The explanatory note to subheadings 0210 11 31 and 0210 11 39 applies, *mutatis mutandis*.
- 0210 19 10** **Bacon sides or spencers**
The terms ‘bacon sides’ and ‘spencers’ are defined in paragraphs (g) and (h) of additional note 2(A) to this chapter.
- 0210 19 20** **Three-quarter sides or middles**
The terms ‘three-quarter sides’ and ‘middles’ are defined in paragraphs (ij) and (k) of additional note 2(A) to this chapter.
- 0210 19 30** **Fore-ends and cuts thereof**
The term ‘fore-ends’ is defined in paragraph (c) of additional note 2(A) to this chapter.
- 0210 19 40** **Loins and cuts thereof**
The term ‘loins’ is defined in paragraph (e) of additional note 2(A) to this chapter.
- 0210 19 60** **Fore-ends and cuts thereof**
The term ‘fore-ends’ is defined in paragraph (c) of additional note 2(A) to this chapter.
- 0210 20 10**~~and~~ **and** **Meat of bovine animals**
0210 20 90 These subheadings cover only the meat of animals of heading 0102, salted, in brine, dried or smoked; offal of bovine animals falls in subheading 0210 99 51 or 0210 99 59.
- 0210 99 10** **Of horses, salted, in brine or dried**
This subheading covers only the meat of animals of subheadings ~~0101 10 10~~ 0101 21 00, to ~~0101 90 11~~ 0101 29 90 and ~~0101 90 19~~, salted, in brine or dried. Smoked horsemeat falls in subheading 0210 99 39. Horse offal falls in subheading ~~0210 99 80~~ 0210 99 85.
- 0210 99 21**~~and~~ **and** **Of sheep and goats**
0210 99 29 These subheadings cover the meat of animals of heading 0104, salted, in brine, dried or smoked. Offal of these species falls in subheading ~~0210 99 60~~ 0210 99 85.
- 0210 99 31** **Of reindeer**
See the explanatory note to subheading 0208 90 30, third paragraph.
- 0210 99 49** **Other**
This subheading includes heads or halves of heads of domestic swine, with or without the brains, cheeks or tongues, including parts thereof (see additional note 2(C) to this chapter). Parts of heads are defined in the third paragraph of the aforementioned additional note.
For a definition of offal, see the HS Explanatory Note to heading 0206.
- 0210 99 90** **Edible flours and meals of meat or meat offal**
This subheading also covers pellets of these flours and meals.

CHAPTER 3

FISH AND CRUSTACEANS, MOLLUSCS AND OTHER AQUATIC INVERTEBRATES

General

1. Fish and crustaceans, molluscs and other aquatic invertebrates which have been deep-frozen are classified in the same way as fish and crustaceans, molluscs and other aquatic invertebrates which have been frozen.
2. Simple scalding (blanching), consisting of a light heat treatment which does not entail cooking as such does not affect the classification. It is often used before freezing, particularly for tunny fish and the flesh of crustaceans or molluscs.
3. The following are excluded from Chapter 3:
 - (a) swim bladders, dried or salted, whether or not fit for human consumption (subheading 0511 91 10);
 - (b) lightly salted fish, dried or smoked and steeped in a vegetable oil in order to ensure provisional preservation — products known as 'semi-preserved' — (heading 1604);
 - (c) fish, simply pickled in oil or vinegar, whether or not further prepared (heading 1604);
 - (d) molluscs which have undergone heat treatment that is sufficient to bring about the coagulation of their proteins (heading 1605).

0301**Live fish**~~0301 10 10~~ **0301 11 00** and**Ornamental fish**~~0301 10 90~~ **0301 19 00**See the HS Explanatory Note to subheading ~~0301 10 30~~ See the HS Explanatory Note to subheadings ~~0301 10 30~~ 11 and 0301 19.~~0301 10 10~~ **0301 11 00****Freshwater fish**

This subheading includes:

1. *Hemigrammus ocellifer*;
2. goldfish (*Carassius auratus*) and the golden carp;
3. mollies, including the black molly (*Molliensia latipinna* and *velifera*), the green swordtail and its red and albino variants (*Xiphophorus helleri*), the red, gold, black and white platys (*Platypoecilus maculatus*) and the swordtail and platy hybrids (*Xiphophorus* and *Okattoiecukys*), namely the black swordtail and the Berlin swordtail;
4. Siamese fighting fish (*Betta splendens*), the paradise fish (*Macropodus opercularis* or *viridi-auratus*), the gouramis and the dwarf gouramis (*Trichogaster trichopterus* and *Colisa lalia* and *fasciata*);
5. angel fish (*Pterophyllum scalare* and *eimckei*).

~~0301 10 90~~ **0301 19 00**~~Saltwater fish~~ **Other**

This subheading includes:

1. the Chaetodontidae;
2. the Labridae;
3. the Scaridae (parrot fish, false parrot fish and *scarichthys*).

0302 Fish, fresh or chilled, excluding fish fillets and other fish meat of heading 0304**0302 11 10 to 0302 11 80****Trout (*Salmo trutta*, *Oncorhynchus mykiss*, *Oncorhynchus clarki*, *Oncorhynchus aguabonita*, *Oncorhynchus gilae*, ~~*Oncorhynchus apache*~~ *Oncorhynchus apache* and *Oncorhynchus chrysogaster*)**

These subheadings cover:

1. sea trout (*Salmo trutta trutta*);
2. river trout or common trout (*Salmo trutta fario*);
3. lake trout (*Salmo trutta lacustris*);
4. rainbow trout or American trout or steelhead (*Oncorhynchus mykiss*);
5. cutthroat trout (*Oncorhynchus clarki*);
6. golden trout (*Oncorhynchus aguabonita*);
7. gila trout (*Oncorhynchus gilae*);
8. trout of the species *Oncorhynchus apache*;
9. trout of the species *Oncorhynchus chrysogaster*.

~~0302 12 00~~ 0302 13 00**Pacific salmon (*Oncorhynchus nerka*, *Oncorhynchus gorbuscha*, *Oncorhynchus keta*, *Oncorhynchus tshawytscha*, *Oncorhynchus kisutch*, *Oncorhynchus masou* and *Oncorhynchus rhodurus*); ~~Atlantic salmon (*Salmo salar*) and Danube salmon (*Hucho hucho*)~~**

In addition to the Atlantic salmon and the Danube salmon, this subheading covers the following species of Pacific salmon: ~~This subheading covers:~~

1. red salmon or sockeye salmon or Alaska red salmon (*Oncorhynchus nerka*);
2. pink salmon or humpback salmon (*Oncorhynchus gorbuscha*);
3. keta salmon or dog salmon or chum salmon (*Oncorhynchus keta*);
4. chinook or king salmon or Californian salmon or spring salmon (*Oncorhynchus tshawytscha*);
5. silver salmon or coho salmon (*Oncorhynchus kisutch*);
6. Japanese salmon or Japanese cherry salmon (*Oncorhynchus masou*);
7. salmon of the species *Oncorhynchus rhodurus*.

0302 19 00**Other**

Among the other freshwater salmonidae included here are:

1. lake whitefish or white fish, vendace and powan (*Coregonus clupeaformis*, *Coregonus fera*, *Coregonus albula*, *Coregonus lavaretus*);
2. houting (*Coregonus oxyrinchus*);
3. char (*Salvelinus alpinus*), brook trout sometimes called 'Fountain salmon' (*Salvelinus fontinalis*), lake char or namaycush or christivomer (*Salvelinus namaycush* or *Christivomer namaycush*).

0302 21 10 to**~~0302 29 90~~ 0302 29 80****Flat fish (Pleuronectidae, Bothidae, Cynoglossidae, Soleidae, Scophthalmidae and Citharidae), excluding livers and roes**

Flat fish are not flattened in a vertical plane like skate but in a horizontal plane, with two eyes on the upper side.

- 0302 29 90 0302 29 80** **Other**
This subheading includes: turbot (This subheading includes: brill (*Scophthalmus maximus* or *Psetta maxima*), and brill (*Scophthalmus rhombus*), common dab (*Pleuronectes limanda* or *Limanda limanda*), lemon sole (*Pleuronectes microcephalus* or *Microstomus kitt*), the European or mud flounder (*Platichthys flesus* or *Flesus flesus*).
- 0302 31 10 and 0302 31 90** **Albacore or longfinned tunas (*Thunnus alalunga*)**
Albacore or longfinned tunas are recognisable by their long pectoral fins, which reach to behind the anus and by their dark blue backs and blue-grey flanks and belly.
- 0302 32 10 and 0302 32 90** **Yellowfin tunas (*Thunnus albacares*)**
Yellowfin tunas are easily recognised by the sickle-shape of their anal and second dorsal fins.
- 0302 33 10 and 0302 33 90** **Skipjack or stripe-bellied bonito**
Skipjack or stripe-bellied bonito (*Euthynnus (Katsuwonus) pelamis*) are distinguished by the presence of four to seven dark, longitudinal stripes on their bellies. Their dark blue backs are accentuated by a clearly defined area of green above the pectoral fin which fades away towards the middle of the body. They have silvery flanks and bellies and short fins. These subheadings do not cover the Atlantic or belted bonitos (*Sarda sarda*), which have oblique bands on their backs; these fish, if fresh or chilled, are classified in subheading 0302 69 99 0302 89 90.
- 0302 40 00 0302 41 00** **Herrings (*Clupea harengus*, *Clupea pallasii*), excluding livers and roes**
For the purpose of this subheading, the term 'herring' is to be taken to mean only Clupeidae of the species *Clupea harengus* (Nordic herring) and *Clupea pallasii* (Pacific herring). The fish known as 'Indian herring' (*Chirocentrus dorab*) are classified in subheading 0302 69 99 0302 89 90 when imported fresh or chilled.
- 0302 50 10 and 0302 50 90** **Cod (*Gadus morhua*, *Gadus ogac*, *Gadus macrocephalus*), excluding livers and roes**
Cod may be up to 1,5 m in length. They have olive-coloured backs with dark spots and a clear belly with a white lateral line. They have three dorsal fins, a short ventral fin and a barbel on the chin.
- 0302 61 10 0302 43 10** **Sardines of the species *Sardina pilchardus***
This subheading also includes large adult sardines (up to 25 cm) known as 'pilchards'.
- 0302 61 80 0302 43 90** **Brisling or sprats (*Sprattus sprattus*)**
For the purpose of this subheading, the term 'sprats' is to be taken to mean only Clupeidae of the species *Sprattus sprattus*; these fish, closely related to herring but of a much smaller size, are often wrongly called 'Norwegian anchovy'.
- 0302 51 10 and 0302 51 90** **Cod (*Gadus morhua*, *Gadus ogac*, *Gadus macrocephalus*)**
Cod may be up to 1,5 m in length. They have olive-coloured backs with dark spots and a clear belly with a white lateral line. They have three dorsal fins, a short ventral fin and a barbel on the chin.
- 0302 63 00 0302 53 00** **Coalfish (*Pollachius virens*)**
Coalfish are more commonly known as saithe or coley.
- 0302 74 00** **Eels (*Anguilla* spp.)**
For the purposes of this subheading, the term 'eels' is to be taken to apply only to eels properly so-called (*Anguilla* spp.), including the European eel (*Anguilla anguilla*) in its two forms (the large-headed eel and the pointed-nosed or long-snouted eel), the American eel (*Anguilla rostrata*), the Japanese eel (*Anguilla japonica*) and the Australian eel (*Anguilla australis*). Consequently, fish which are wrongly called eels such as conger-eels, also known as 'sea-eels' (*Conger conger*), moray or murrey, also known as 'moray eels' (*Muraena helena*) and sand-eels or lance (*Ammodytes* spp.) are excluded from this subheading and fall in subheading 0302 89 90.
- 0302 65 20 0302 81 10** **Dogfish of the species *Squalus acanthias***
Dogfish are spiny sharks with lateral gill slits located above the pectorals; their bodies are rounded and smooth; their backs are grey and their bellies white; they may be up to 1 m in length.
- 0302 65 95 0302 81 90** **Other**
This subheading includes the tope (*Galeorhinus galeus* or *Galeus canis*).

0302 66 00**Eels (*Anguilla* spp.)**

For the purposes of this subheading, the term 'eels' is to be taken to apply only to eels properly so-called (*Anguilla* spp.); including the European eel (*Anguilla anguilla*) in its two forms (the large-headed eel and the pointed-nosed or long-snouted eel), the American eel (*Anguilla rostrata*), the Japanese eel (*Anguilla japonica*) and the Australian eel (*Anguilla australis*). Consequently, fish which are wrongly called eels such as conger-eels, also known as 'sea-eels' (*Conger conger*), moray or murry, also known as 'moray eels' (*Muraena helena*) and sand-eels or lance (*Ammodytes* spp.) are excluded from this subheading and fall in subheading 0302 69 99.

0302 69 180302 89 10**Other Freshwater fish**

The freshwater fish falling in this subheading include:

1. tench (*Tinca tinca*);
2. barbel (*Barbus* spp.);
3. perch: common perch (*Perca fluviatilis*), black-bass perch (*Micropterus* spp.), sun perch (*Lepomis gibbosus*) and ruff or pope (*Gymnocephalus cernuus* or *Acerina cernua*);
4. common bream (*Abramis brama*) and silver bream (*Blicca bjoerkna*);
5. pike (*Esox* spp.) and spear pike (*Lepisosteus* spp.);
6. bleak (*Alburnus alburnus*), common gudgeon (*Gobio gobio*), Danube gudgeon (*Gobio uranoscopus*), bullhead pike (*Cottus gobio*), and river burbot (eel-pout) (*Lota lota*);
7. river lampreys or small lampern (*Lampetra fluviatilis*) and brook lamprey (*Lampetra planeri*);
8. fish of the genera *Leuciscus* spp., *Rutilus* spp. and *Idus* spp., for example, roach, dark or dusky ide, wall-eyed ide or red roach, chub or large-headed European chub, dace;
9. grayling (*Thymallus* spp.);
10. pike-perch or zander (*Stizostedion lucioperca*).

0302 69 990302 89 90**Other**

The saltwater fish falling in this subheading include:

1. whiting-pout (*Trisopterus luscus* and *Trisopterus esmarki*);
2. sea-spotted bass (~~comber~~ (*Dicentrarchus punctatus*); ~~comber~~ (*Serranus* spp.) and grouper (*Epinephelus* spp.);
3. ~~stripped mullet~~ (~~striped mullet~~ (*Mullus barbatus*) and red mullet or surmullet (*Mullus surmuletus*);
4. gurnard or gurnet (*Trigla*, *Eutrigla*, *Aspitrigla*, *Lepidotrigla* and *Trigloporus* spp.);
5. scorpion fish (*Scorpaena* spp.);
6. sea lamprey (*Petromyzon marinus*);
7. garfish or needle-fish (*Belone belone*) and weevers (*Trachinus* spp.);
8. rays and skate (*Raja* or *Raia* spp.);
- 9-8. smelt (*Osmerus* spp.);
- 10-9. capelin (*Mallotus villosus*);
- 11-10 fish of the species *Kathetostoma giganteum*.

0302 70 000302 90 00**Livers and roes**

Livers and roes of fish, fresh or chilled, which by reason of their species and condition are fit for human consumption remain in this subheading even if intended for industrial use.

- 0303** **Fish, frozen, excluding fish fillets and other fish meat of heading 0304**
The provisions of the explanatory notes to the subheadings of heading 0302 apply, *mutatis mutandis*, to the subheadings of this heading.
- 0304** **Fish fillets and other fish meat (whether or not minced), fresh, chilled or frozen**
- ~~0304 11 10~~ **Fillets**
See the HS Explanatory Note to heading 0304, (1).
This subheading also covers fillets cut into pieces, provided that the pieces can be identified as having been obtained from fillets.
This subheading also covers pieces of the anatomical right and left side of the fish, i.e. the part of the fish known as fillets. Sometimes, these pieces are cut directly from the fish or part of the fish without first cutting a whole fillet.
- ~~0304 12 10~~ **Fillets**
See the explanatory note to subheading 0304 11 10.
- ~~0304 19 01~~~~0304 31 00~~to
~~0304 19 39~~~~0304 49 90~~ **Fillets****Fresh or chilled fillets**
See the HS Explanatory Note to heading 0304, (1), first paragraph, (1).
These subheadings also cover fillets cut into pieces, provided that the pieces can be identified as having been obtained from fillets. The species most used for this purpose are trout, salmon, cod, haddock, saithe, redfish (for example, Norway haddock), whiting, hake, gilt head bream or dorade, sole, plaice, turbot, ling, tuna, mackerel, herring and anchovy. These subheadings also cover pieces of the anatomical right and left side of the fish, i.e. the part of the fish known as fillets. Sometimes, these pieces are cut directly from the fish or part of the fish without first cutting a whole fillet. This may occur in the case of big fish, such as tuna, etc.
- ~~0304 19 39~~~~0304 49 90~~ **Other**
~~This subheading includes fillets of sole, plaice and herring.~~This subheading includes fillets of herring.
- ~~0304 21 00~~~~0304 61 00~~to
~~0304 29 99~~~~0304 89 90~~ **Frozen fillets**
See the explanatory note to subheadings ~~0304 19 01~~~~0304 31 00~~ to ~~0304 19 39~~~~0304 49 90~~.
These subheadings include deep-frozen blocks or slabs consisting of fillets or pieces of fillets (usually from cod), whether or not mixed with a small amount (not exceeding 20 % by weight) of separate flakes of the same species of fish used merely to fill up spaces in the blocks or slabs. The blocks or slabs are intended to be cut up into smaller pieces (portions, fingers, etc.) which are packed for retail.
- ~~0304 99 10~~~~0304 93 10~~ **Surimi**
Surimi is an intermediate product marketed in a frozen state. It consists of a whitish paste with practically no smell or taste and made from finely minced, washed and sieved fish meat. Successive washings remove most of the fat and water-soluble protein. In order to improve the consistency and stabilise the product in the frozen state, small quantities of additives (for example, sugar, salt, D-glucitol (sorbitol) and di- or triphosphate) are added.
This subheading does not cover surimi-based preparations (subheading 1604 20 05).
- 0304 94 10 **Surimi**
See the explanatory note to subheading 0304 93 10.
- 0304 95 10 **Surimi**
See the explanatory note to subheading 0304 93 10.
- 0304 99 10 **Surimi**
See the explanatory note to subheading 0304 93 10.

- 0305** **Fish, dried, salted or in brine; smoked fish, whether or not cooked before or during the smoking process; flours, meals and pellets of fish, fit for human consumption**
- 0305 10 00** **Flours, meals and pellets of fish, fit for human consumption**
Flours and meals of fish are generally rendered edible by de-oiling and de-odorisation and may sometimes be known as 'fish concentrate'.
This subheading also covers products known as 'instant fish' obtained from the flesh of fresh fish, frozen, cut into small pieces, finely shredded and dried.
- ~~0305 30 11~~**0305 31 00** to ~~0305 30 90~~**0305 39 90** **Fish fillets, dried, salted or in brine, but not smoked**
The explanatory note to subheadings ~~0304 19 04~~**0304 31 00** to ~~0304 19 39~~**0304 49 90** applies, *mutatis mutandis*. Smoked fish fillets are classified in subheadings 0305 41 00 to 0305 49 80.
- 0305 41 00** to **0305 49 80** ~~Smoked fish, including fillets~~**Smoked fish, including fillets, other than edible fish offal**
See the HS Explanatory Note to heading 0305, ~~fifth paragraph.~~ fourth paragraph.
- 0305 63 00** **Anchovies (*Engraulis Engraulis* spp.)**
This subheading covers only anchovies in brine which have not undergone any other preparation. They are put up in small barrels or jars or often in hermetically sealed cans without having undergone any heat treatment after closure of the can.
- 0306** ~~Crustaceans, whether in shell or not, live, fresh, chilled, frozen, dried, salted or in brine; crustaceans, in shell, cooked by steaming or by boiling in water, whether or not chilled, frozen, dried, salted or in brine; flours, meals and pellets of crustaceans, fit for human consumption~~**Crustaceans, whether in shell or not, live, fresh, chilled, frozen, dried, salted or in brine; smoked crustaceans, whether in shell or not, whether or not cooked before or during the smoking process; crustaceans, in shell, cooked by steaming or by boiling in water, whether or not chilled, frozen, dried, salted or in brine; flours, meals and pellets of crustaceans, fit for human consumption**
Crustaceans, whether or not in shell, which have been smoked, and crustaceans which have been shelled and cooked (for example, cooked and peeled tails of shrimps, usually frozen), are classified in heading Crustaceans which have been shelled and cooked (for example, cooked and peeled tails of shrimps, usually frozen), are classified in heading 1605. Partially shelled parts of crabs (for example, claws) which have been cooked by steaming or by boiling in water and are ready to eat without further shelling are also classified in heading 1605.
- ~~0306 11 10~~**0306 11 05** and to ~~0306 11 90~~**0306 11 90** **Rock lobster and other sea crawfish (*PalinurusPalinurus* spp., *PanulirusPanulirus* spp., *JasusJasus* spp.)**
Unlike true lobsters, rock lobsters and other sea crawfish are red and have only very small claws but strongly developed antennae. In addition, they have a spiny, knobby carapace.
- 0306 11 10** **Crawfish tails**
This subheading covers crawfish tails in shell, whole or divided into two parts, as well as shelled tails.
- 0306 11 90** **Other**
This subheading covers crawfish in shell, whole or split lengthwise, as well as crawfish meat.
- ~~0306 12 10~~**0306 12 05** and to ~~0306 12 90~~**0306 12 90** **Lobsters (*HomarusHomarus* spp.)**
Lobsters are crustaceans with large claws. Uncooked lobsters are dark blue in colour with white or yellowish marbling; they become red only on cooking.
Lobsters are put up in virtually the same way as rock lobsters and other sea crawfish.

~~0306 13 10 to 0306 13 80~~**Shrimps and prawns**

These subheadings include:

1. prawns, some varieties of which are sometimes known as 'pink shrimps' (although certain varieties do not really turn pink until cooked) of the family Pandalidae;
2. brown or grey shrimps of the genus *Crangon*;
3. shrimps and prawns of the families Palaemonidae and Penaeidae. Included among them are the common prawn (*Palaemon serratus*) and the royal or caramota shrimp (*Penaeus caramota* or *Penaeus kerathurus*).

~~0306 14 10~~ ~~0306 14 05 to~~
~~0306 14 90~~**Crabs**

The term 'crabs' covers a large variety of claw-bearing crustaceans of widely differing sizes which are distinguished from crawfish, lobsters, shrimps and prawns, and crayfish by the absence of a fleshy articulated tail.

~~0306 14 90~~**Other**This subheading includes, in addition to the European sea crabs such as the swimming crab (*Portunus puber*) and the spider crab (*Maia squinado*), a large number of other species (*Cancer*, *Carcinus*, *Portunus*, *Neptunus*, *Charybdis*, *Scylla*, *Erimacrus*, *Limulus*, *Maia*, *Menippi* spp., in particular), as well as the freshwater crab known as the 'Chinese crab' (*Eriocheir sinensis*).~~0306 15 10 and 0306 15 90~~**Norway lobsters (*Nephrops norvegicus*)**

Norway lobsters, also known as Dublin Bay prawns, are recognisable by their long, slender and prismatic claws.

~~0306 16 10 to 0306 17 99~~**Cold-water shrimps and prawns (*Pandalus* spp., *Crangon crangon*); other shrimps and prawns**

These subheadings include:

1. prawns, some varieties of which are sometimes known as 'pink shrimps' (although certain varieties do not really turn pink until cooked) of the family Pandalidae;
2. brown or grey shrimps of the genus *Crangon*;
3. shrimps and prawns of the families Palaemonidae and Penaeidae. Included among them are the common prawn (*Palaemon serratus*) and the royal or caramota shrimp (*Penaeus caramota* or *Penaeus kerathurus*).

~~0306 19 10~~**Freshwater crayfish**Crayfish are freshwater crustaceans, the most important species of which belong to the genera *Astacus*, *Cambarus*, *Orconectes* and *Pacifastacus*.

This subheading also covers tails.

~~0306 19 30~~**Norway lobsters (*Nephrops norvegicus*)**

Norway lobsters, also known as Dublin Bay prawns, are recognisable by their long, slender and prismatic claws.

~~0306 21 10~~ ~~0306 21 10 and~~
~~0306 21 90~~**Rock lobster and other sea crawfish (*Palinurus* spp., *Panulirus* spp., *Jasus* spp.)**See the explanatory notes to subheadings ~~0306 11 05 and~~ ~~to 0306 11 90.~~~~0306 22 10 to 0306 22 99~~**Lobsters (*Homarus* spp.)**See the explanatory note to subheadings ~~0306 12 05 and~~ ~~to 0306 12 90.~~~~0306 23 10 to 0306 23 90~~**Shrimps and prawns**

See the explanatory note to subheadings 0306 13 10 to 0306 13 80.

~~0306 24 10~~ ~~0306 24 10 and to~~
~~0306 24 80~~**Crabs**See the explanatory notes to subheadings ~~0306 14 05 to~~ 0306 14 90.~~0306 24 80~~**Other**This subheading includes, in addition to the European sea crabs such as the swimming crab (*Portunus puber*) and the spider crab (*Maia squinado*), a large number of other species (*Paralithodes chamchaticus*, *Callinectes sapidus*, *Chionoecetes* spp., *Cancer*, *Carcinus*, *Portunus*, *Neptunus*, *Charybdis*, *Scylla*, *Erimacrus*, *Limulus*, *Maia*, *Menippi* spp., in particular), as well as the freshwater crab known as the 'Chinese crab' (*Eriocheir sinensis*).

- 0306 25 10 and 0306 25 90** **Norway lobsters (*Nephrops norvegicus*)**
See the explanatory note to subheadings 0306 15 10 and 0306 15 90.
- 0306 26 10 to 0306 27 99** **Cold-water shrimps and prawns (*Pandalus* spp., *Crangon crangon*); other shrimps and prawns**
See the explanatory note to subheadings 0306 16 10 to 0306 17 99.
- 0306 29 10** **Freshwater crayfish**
See the explanatory note to subheading 0306 19 10.
- ~~0306 29 30~~** **~~Norway lobsters (*Nephrops norvegicus*)~~**
~~See the explanatory note to subheading 0306 19 30.~~
- 0307** **Molluscs, whether in shell or not, live, fresh, chilled, frozen, dried, salted or in brine; aquatic invertebrates other than crustaceans and molluscs, live, fresh, chilled, frozen, dried, salted or in brine; flours, meals and pellets of aquatic invertebrates other than crustaceans, fit for human consumption**
Molluscs, whether in shell or not, live, fresh, chilled, frozen, dried, salted or in brine; smoked molluscs, whether in shell or not, whether or not cooked before or during the smoking process; flours, meals and pellets of molluscs, fit for human consumption
- ~~0307 10 10~~**0307 11 10 and to 0307 19 90**** **Oysters**
These subheadings cover only the bivalve molluscs of the genera *Ostrea*, *Crassostrea* (also called *Gryphaea*) and *Pycnodonta*.
A distinction is usually made between flat oysters (of the genus *Ostrea*) and those with irregular shells such as the Portuguese oyster (*Crassostrea angulata*) and the Blue Point or Virginian oyster (*Crassostrea virginica*).
- ~~0307 10 10~~**0307 11 10**** **Flat oysters (of the genus *Ostrea*), live and weighing (shell included) not more than 40 g each**
Only oysters of the genus *Ostrea* weighing not more than 40 g each (including the shell) are classified in this subheading. The flat oysters gathered in Europe are in general of the species *Ostrea edulis*. There are other species such as, in particular, *Ostrea lurida* of the Pacific coast of North America and *Ostrea chilensis* of Chile.
- ~~0307 10 90~~**0307 11 90 to 0307 19 90**** **Other**
Oysters of the genus *Ostrea* weighing more than 40 g each, as well as all oysters, immature or adult, of the genus *Crassostrea* (called also *Gryphaea*) and of the genus *Pycnodonta* ~~are classified here; are classified in these subheadings.~~
The genus *Crassostrea* includes the Portuguese oyster (*Crassostrea angulata*), the Japanese oyster (*Crassostrea gigas*) and the oyster known as the Blue Point or Virginian (*Crassostrea virginica*).
- 0307 71 00 to 0307 79 90** **Clams, cockles and ark shells (families Arcidae, Arctiidae, Cardiidae, Donacidae, Hiatellidae, Mactridae, Mesodesmatidae, Myidae, Semelidae, Solecurtidae, Solenidae, Tridacnidae and Veneridae)**
These subheadings include:
1. clams (*Scrobicularia plana*), thresher clams (*Mactra* spp.) and cockles (*Cardium* spp.);
 2. razor shells (*Solen* spp.), such as razor clams (*Solen marginatus*, *Solen siliqua* and *Solen ensis*), and hardshell clams (*Venus mercenaria* and *Venus verrucosa*);
- 0307 91 00 to 0307 99 90** **~~Other, including flours, meals and pellets of aquatic invertebrates other than crustaceans, fit for human consumption~~**
Other, including flours, meals and pellets, fit for human consumption
These subheadings include:
1. sea snails such as the common whelk (*Buccinum undatum*);
 2. winkles (*Littorina* and *Lunatia* spp.);
 3. ~~ormer or sea-ear~~ (cuttle fish of the species *Haliotis tuberculata* *Sepia pharaonis*);
 4. clams (*Scrobicularia plana*), thresher clams (*Mactra* spp.) and cockles (*Cardium* spp.);
 5. razor shells (*Solen* spp.), such as razor clams (*Solen marginatus*, *Solen siliqua* and *Solen ensis*), and hardshell clams (*Venus mercenaria* and *Venus verrucosa*);
 6. aquatic invertebrates other than crustaceans and those molluscs specified or included in subheadings 0307 10 10 to 0307 60 00, in particular sea-urchins, sea cucumbers (*bêches-de-mer*), jellyfish and cuttlefish of the species *Sepia pharaonis*.

CHAPTER 4

DAIRY PRODUCE; BIRDS' EGGS; NATURAL HONEY; EDIBLE PRODUCTS OF ANIMAL ORIGIN, NOT ELSEWHERE SPECIFIED OR INCLUDED**General**

Caseinates obtained from milk casein are used, for example, as emulsifiers (sodium caseinate) or as a source of protein (calcium caseinate). Products containing caseinates in excess of 3 % by weight of the dry matter are excluded from headings 0401 to 0404, since those caseinates do not occur naturally in milk at this level (in particular, see heading 1901).

0401 Milk and cream, not concentrated nor containing added sugar or other sweetening matter

In so far as the products contain no additions other than those provided for in the HS General Explanatory Note to this chapter, second paragraph, this heading includes:

1. full-cream milk, unprocessed, and such milk partially or completely skimmed;
2. pasteurised milk, i.e., milk, the keeping qualities of which have been improved by partial elimination of microbial growths by means of heat treatment;
3. sterilised milk, including UHT milk, which keeps longer, the microbial growths having been virtually eliminated by a more extensive heat treatment;
4. homogenised milk, in which the fat globules of the natural emulsion have been fragmented — by mechanical means under very high pressure linked with heat treatment — into glomerules of smaller dimensions, which partially prevents the formation of cream;
5. peptonised milk, i.e. milk, the digestibility of which has been improved by adding pepsins to process the proteins;
6. cream, which is the fatty layer which forms naturally on the top of standing milk by slow agglomeration of the fatty emulsifying globules. Whether removed by hand or extracted by centrifuging the milk in a cream separator, it contains, in addition to the other constituents of milk, a fairly high fat content (usually exceeding 10 % by weight). Certain centrifuge processes produce creams with a fat content in excess of 50 % by weight.

Cream is regarded as 'not concentrated' within this heading, no matter what its percentage of fat content, so long as it has been obtained wholly:

- (a) by skimming the surface of the milk,
- (b) by centrifuging.

However, 'concentrated' cream produced by different means, such as the evaporation of water during heat treatment, falls in heading 0402.

0402 Milk and cream, concentrated or containing added sugar or other sweetening matter.

This heading includes milk powders to which disinfection centrifugate has been added back, provided that the ratio of natural milk constituents is not disturbed (otherwise, heading 0404).

Products containing soya lecithin (emulsifier) in excess of 3 % by weight of the dry matter are excluded from this heading. See also the HS Explanatory Note to heading 0404, exclusion (d).

0403 Buttermilk, curdled milk and cream, yogurt, kephir and other fermented or acidified milk and cream, whether or not concentrated or containing added sugar or other sweetening matter or flavoured or containing added fruit, nuts or cocoa

Products in paste form which are normally eaten with a spoon are not to be classified as products in powder, granules or other solid forms.

For the purposes of this heading, the term 'buttermilk' covers both sweet (i.e., non-acidified) and acidified buttermilk.

- 0403 10 11to 0403 10 99** **Yogurt**
These subheadings apply only to products which are obtained by the lactic fermentation of *Streptococcus thermophilus* and *Lactobacillus delbrueckii* subsp. *bulgaricus*, exclusively.
These subheadings do not apply to products which, after fermentation, have been subjected to a heat treatment which has deactivated the yogurt cultures (subheading 0403 90).
- 0403 90 11to 0403 90 99** **Other**
See the explanatory note to subheadings 0403 10 11 to 0403 10 99.
These subheadings do not cover products of the type ‘cagliata’ as described in the explanatory note to subheadings 0406 10 20 and 0406 10 80, third paragraph.
- 0404** **Whey, whether or not concentrated or containing added sugar or other sweetening matter; products consisting of natural milk constituents, whether or not containing added sugar or other sweetening matter, not elsewhere specified or included**
See the explanatory note to heading 0402, first paragraph.
- 0404 90 21to 0404 90 89** **Other**
The explanatory note to heading 0402 applies, *mutatis mutandis*.
These subheadings include concentrated milk proteins obtained by partially removing the lactose and mineral salts from skimmed milk and in which the protein content amounts to 85 % or less by weight of the dry matter. The protein content is calculated by multiplying the nitrogen content by a conversion factor of 6,38.
When the protein content of a concentrated milk protein exceeds 85 % by weight of the dry matter, the product is covered by heading 3504 (see additional note 1 to Chapter 35).
- 0405** **Butter and other fats and oils derived from milk; dairy spreads**
- 0405 10 11to 0405 10 90** **Butter**
The term ‘butter’ is defined in note 2(a) and in subheading note 2 to this chapter.
See also the HS Explanatory Note to heading 0405, (A).
Butter is an aqueous emulsion in milk-fat, the water being its dispersed phase and the fat its dispersion medium.
On the other hand, cream (headings 0401 and 0402) — in which the percentage of fat may in some cases equal that of butter — is an emulsion of fat globules in water, the water being its dispersion medium and the fat the dispersed phase.
From this difference in structure, it follows that, by adding the appropriate quantity of water to cream, one can approximately reconstitute the original milk, but this is not possible with butter.
- 0405 20 10to 0405 20 90** **Dairy spreads**
The expression ‘dairy spreads’ is defined in note 2(b) to this chapter.
See also the HS Explanatory Note to heading 0405, (B).
- 0405 90 10and 0405 90 90** **Other**
See subheading note 2 to this chapter and the HS Explanatory Note to heading 0405, (C).
- 0406** **Cheese and curd**
Products in which the milk-fat has been wholly or partially replaced by other (for example, vegetable) types of fat are not regarded as cheese within this heading (generally, heading 2106).

- 0406 10 20 and 0406 10 80** **Fresh (unripened or uncurd) cheese, including whey cheese, and curd**
 For whey cheese, see the HS Explanatory Note to heading 0406, second paragraph.
 Curd or 'white cheese' is the product obtained from curdled milk from which most of the serum has been extracted (for example, by draining or squeezing). Curd (other than in powder) with up to 30 % by weight of added sugar and fruit is regarded as retaining the character of curd and remains classified in these subheadings.
 These subheadings include products of the type 'cagliata', i.e., products obtained by coagulating with rennet, other enzymes or acid treatment, full-cream milk, milk partially or completely skimmed, from which most of the serum has been extracted. These products are presented in the form of a paste not yet plastic-curd, smooth, easy to separate into grains, with an intense characteristic smell and with a sodium chloride content not exceeding 0,3 % by weight. They are 'intermediate' products, needing to be further processed, mainly to obtain cheeses.
- 0406 20 10 and 0406 20 90** **Grated or powdered cheese, of all kinds**
 These subheadings cover:
1. grated cheeses, usually used as seasonings or for other purposes in the food-processing industry. They are most often obtained from hard cheeses (for example, Grana, Parmigiano Reggiano, Emmental, Reggianito, Sbrinz, Asiago, Pecorino, etc.). These cheeses may have been partially dehydrated with a view to ensuring the longest possible preservation.
 This classification also covers cheeses which, after grating, are agglomerated;
 2. powdered cheeses usually used in the food industry. They are made from all kinds of cheeses which have been either liquefied and then powdered, or reduced to a paste and dried and ground.
- 0406 30 10 to 0406 30 90** **Processed cheese, not grated or powdered**
 See the HS Explanatory Note to heading 0406, first paragraph, (3).
- 0406 40 10 to 0406 40 90** **Blue-veined cheese and other cheese containing veins produced by *Penicillium roqueforti***
 See the HS Explanatory Note to subheading 0406 40.
 The main feature of these cheeses is an irregular pigmentation due to the development of mould in the body of the cheese.
- 0406 40 90** **Other**
 This subheading includes cheeses with a clearly visible white/greyish irregular pigmentation in the body of the cheese, obtained by using colourless *Penicillium roqueforti* strains.
- ~~0407 00 0407~~ **Birds' eggs, in shell, fresh, preserved or cooked**
 This heading also covers rotten eggs in shell, as well as eggs in which the incubation process has started.
 Preservation may be achieved by treating the outside of the eggs with a fat, wax or paraffin wax, by immersion in a solution of lime or silicate (soda or potash), or by other methods.
 The term 'poultry' means the birds of heading 0105.
- ~~0407 00 11 to 0407 00 30~~ **Of poultry**
 Poultry eggs are the eggs of the birds of heading 0105.
- ~~0407 00 11 0407 11 00 and to 0407 00 19 0407 19 90~~ **For hatching Fertilised eggs for incubation**
 These subheadings cover only poultry eggs meeting the terms laid down by the competent authorities. These subheadings cover only eggs of poultry and of other birds meeting the terms laid down by the competent authorities.

- 0408** **Birds' eggs, not in shell, and egg yolks, fresh, dried, cooked by steaming or by boiling in water, moulded, frozen or otherwise preserved, whether or not containing added sugar or other sweetening matter**
- 0408 11 80** **Other**
This subheading includes egg yolks suitable for human consumption and egg yolks unfit for human consumption other than those falling under subheading 0408 11 20.
This also includes dried egg yolk which has been preserved by the addition of small quantities of chemicals and is intended for making cakes and pastries, products of the macaroni type and similar products.
- 0408 19 81 and 0408 19 89** **Other**
The first sentence of the explanatory note to subheading 0408 11 80 applies, *mutatis mutandis*.
- 0408 91 80** **Other**
The explanatory note to subheading 0408 11 80 applies, *mutatis mutandis*.
- 0408 99 80** **Other**
The explanatory note to subheading 0408 11 80 applies, *mutatis mutandis*.
In addition to whole eggs with their shell removed, which may be presented fresh, this subheading covers preserved fluid whole eggs preserved, for example, by adding salt or chemical preservatives and frozen whole eggs. It also includes eggs cooked by steaming or by boiling in water, and moulded eggs (for example, cylindrical 'long' eggs made up from the yolks and whites of several eggs).

SECTION II

VEGETABLE PRODUCTS

CHAPTER 6

LIVE TREES AND OTHER PLANTS; BULBS, ROOTS AND THE LIKE; CUT FLOWERS AND ORNAMENTAL FOLIAGE

0601	Bulbs, tubers, tuberous roots, corms, crowns and rhizomes, dormant, in growth or in flower; chicory plants and roots other than roots of heading 1212
0601 20 30	Orchids, hyacinths, narcissi and tulips This subheading includes epiphytic orchids (for example, orchids of the genera <i>Cattleya</i> and <i>Dendrobium</i>).
0602	Other live plants (including their roots), cuttings and slips; mushroom spawn
0602 10 10 and <u>and</u>	Unrooted cuttings and slips These subheadings cover:
0602 10 90	
	1. the live parts of plants without roots which have been separated from the parent plant to become independent plants (cuttings);
	2. the live parts of plants with buds (eyes) which are intended for grafting on to plants (slips).
0602 40 00	Roses, grafted or not This subheading covers both cultivated roses and dog or wild roses.
0602 90 10	Mushroom spawn Mushroom spawn is the term given to a net of fragile threads (<i>Thallus</i> or <i>Mycelium</i>), often found underground, which lives and grows on the surface of decomposing animal or vegetable matter and develops in the tissues themselves and produces mushrooms. Mushroom spawn bred for commercial purposes is sold in the form of squares, comprising fragments of half-decomposed straw on which are deposited layers of mycelium. This subheading also includes a product consisting of mushroom spawn, not fully developed, placed in microscopic amounts on a layer of cereal grains enclosed in a compost of sterilised horse manure (a mixture of straw and horse dung).
0602 90 41	Forest trees This subheading includes young plants from the seeds of coniferous or deciduous trees, normally used for afforestation. They are generally supplied without balled roots.
0602 90 45	Rooted cuttings and young plants This subheading includes young plants, not elsewhere specified or included, i.e., plants requiring further nursery cultivation before being planted. These are one- to two-year-old seedlings, also rooted cuttings, grafted or budded root-stocks or plants, layers and plants which are generally not older than two to three years.
0602 90 49	Other This subheading includes trees and shrubs of European or exotic species, not elsewhere specified or included, which are not normally used for afforestation. They are generally supplied with balled roots.

- 0602 90 50** **Other outdoor plants**
 This subheading includes winter-hardy plants which are intended for permanent planting, whose non-woody stem above the ground dies in autumn and sends out new shoots in spring.
 This subheading also includes ferns, marsh and aquatic plants (other than those of heading 0601 and of subheading 0602 90 99).
 This subheading also includes turf rolls and turf slabs for making lawns.
- 0603** **Cut flowers and flower buds of a kind suitable for bouquets or for ornamental purposes, fresh, dried, dyed, bleached, impregnated or otherwise prepared**
- 0603 11 00** ~~to~~ **Fresh**
~~0603 19 90~~ **0603 19 80**
 These subheadings include flowers and flower buds, the natural colour of which has been modified or enhanced, particularly by absorption treatment with coloured solutions before or after cutting or merely by soaking, provided that these products are imported fresh.
- ~~0603 19 90~~ **0603 19 80** **Other**
 This subheading includes sunflowers and reseda. However, the stems and leaves of these two plants (without flowers) fall in subheading 1404 90 00.
 This subheading also includes willow branches with buds or flowers. However, willow branches without buds or flowers fall in subheading 1401 90 00.
- 0604** **Foliage, branches and other parts of plants, without flowers or flower buds, and grasses, mosses and lichens, being goods of a kind suitable for bouquets or for ornamental purposes, fresh, dried, dyed, bleached, impregnated or otherwise prepared**
- ~~0604 10 10~~ **0604 20 11** **Reindeer moss**
 This is a plant of the Cladoniaceae family (*Cladonia rangiferina*, *Cladonia silvatica* and *Cladonia alpestris*).
- ~~0604 91 90~~ **0604 20 90** **Other**
 This subheading does not cover fresh ears of sweetcorn (*Zea mays* var. *saccharata*) (Chapter 7) or of cereal plants (Chapter 10).
- 0604 90 11** **Reindeer moss**
 See the explanatory note to subheading 0604 20 11.
- ~~0604 99 10~~ **0604 90 91** **Not further prepared than dried**
 This subheading does not cover dried branches which have been twisted or formed into spirals, regardless of whether they were twisted or formed into spirals before being dried (subheading ~~0604 99 90~~ 0604 90 99).
 This subheading does not cover the simply dried ears of sweetcorn (*Zea mays* var. *saccharata*) (Chapter 7) or of cereal plants (Chapter 10).
- ~~0604 99 90~~ **0604 90 99** **Other**
 This subheading includes the dried ears of cereal plants (for example, maize) which have been bleached, dyed, impregnated or otherwise treated for ornamental purposes. This subheading also includes dried branches which have been twisted or formed into spirals.

CHAPTER 7

EDIBLE VEGETABLES AND CERTAIN ROOTS AND TUBERS

General

Sprouts (vegetable sprouts and other sprouts) are sprouted seeds used for human consumption, eaten either raw or cooked. Sprouting is the practice of germinating seeds by moistening them (this increases the water content in the seeds and brings them out of dormancy), until a new plant starts growing upward and leaves develop.

Generally, sprouts that are ready for human consumption can be presented in three ways:

- (a) as a germinating plant with seed leaves (cotyledons, embryonic first leaves), remains of the seeds and roots;
- (b) as a plant consisting of the sprouting cereal grain, for example, sprouted barley, so-called 'green malt' (see also the explanatory note to subheadings 1107 10 11 to 1107 10 99), which can be used either raw in salads or, after further processing, for the production of mainly beer or whisky;
- (c) as a 'baby plant' consisting only of seed leaves, without the remains of seeds or roots and not bearing 'adult leaves' (true leaves, formed post-embryonically). These kinds of sprout are usually presented, with a growth medium, in little boxes.

When classifying sprouts, the following principles are to be applied:

- sprouts of the vegetables named in Chapter 7 are to be classified as fresh vegetables in Chapter 7 under their respective headings, given that fresh vegetables fall in this Chapter whether intended for use as food, for sowing or for planting, with the exception of seedling vegetables in a condition for replanting of heading 0602 (see the HS General Explanatory Note to Chapter 7, tenth paragraph),
- beans used for bean-sprout production are to be classified under heading 0713 as dried leguminous vegetables (see the HS Subheading Explanatory Note to subheading 0713 31). However, bean sprouts germinated from these, and sprouts from other dried leguminous vegetables, are classified as fresh leguminous vegetables under heading 0708,
- although, in the form of just seeds, some plants qualify for classification in another chapter of the Combined Nomenclature, such as Chapter 9 or 12, once they have been germinated they become suitable for consumption as a vegetable and are to be classified accordingly in Chapter 7, since they have lost the objective characteristics of Chapter 9 or 12. See the HS Explanatory Note to heading 0709, first paragraph, (14), as regards bamboo shoots and soya-bean sprouts,
- sprouts made from the grains of cereals of Chapter 10 (heading 1001, 1002, 1003, 1004, 1006 or 1008), for example, sprouted barley, are to be classified in subheading 1107 10 (sprouted barley is excluded from Chapter 10, see the HS Explanatory Note to heading 1003, exclusion (a)) which is the most specific heading for sprouted cereals, the heading not being limited to dried sprouted cereals (malt). 'Green malt' is classified in subheadings 1107 10 11 to 1107 10 99 (see the explanatory note to subheadings 1107 10 11 to 1107 10 99, first paragraph) and is considered as grain that has started to germinate but has not yet been dried,
- sprouts made from the variety *Zea mays* var. *saccharata* (sweetcorn), to be classified in Chapter 7 by application of note 2 to Chapter 7 and note 2 to Chapter 10, are to be classified in heading 0709 (subheading 0709 99 60).

Non-exhaustive list of sprouts together with their CN codes:

CN code	Description (<i>Latin name</i>)
0703 10 19	Sprouts of onion (<i>Allium cepa</i>)
0703 20 00	Sprouts of garlic (<i>Allium sativum</i>)
0703 90 00	Sprouts of leeks (<i>Allium porrum</i>)
0704 90 90	Broccoli sprouts (<i>Brassica oleracea</i> var. <i>italica</i>)
0704 90 90	Rocket sprouts (<i>Eruca sativa</i> ; syn. <i>Eruca vesicaria</i> ssp. <i>sativa</i> (Miller) Thell., <i>Brassica eruca</i> L.)
0706 90 90	Beetroot sprouts (<i>Beta vulgaris</i> ssp. <i>vulgaris</i>)
0706 90 90	Sprouts of radishes (<i>Raphanus sativus</i>)
0708 10 00	Sprouts of peas (<i>Pisum sativum</i>)
0708 20 00	Azuki bean sprouts (<i>Phaseolus angularis</i>)
0708 20 00	Mung bean sprouts (<i>Vigna radiata</i>)
0708 20 00	Rice bean sprouts (<i>Phaseolus pubescens</i>)
0708 90 00	Chickpea sprouts (<i>Cicer arietinum</i>)
0708 90 00	Dragon's-teeth sprouts (<i>Lotus maritimus</i>)
0708 90 00	Lentil sprouts (<i>Lens culinaris</i>)
0708 90 00	Pigeon pea sprouts (<i>Cajanus cajan</i>)

- 0709 99 50 Fennel sprouts (*Foeniculum vulgare* var. *azoricum*)
- 0709 99 60 Sweetcorn sprouts (*Zea mays* var. *saccharata*)
- 0709 99 90 Basil sprouts (*Ocimum* spp.)
- 0709 99 90 Black mustard sprouts (*Brassica nigra*, syn.: *Sinapis nigra* L., *Sisymbrium nigrum* (L.) Prantl.)
- 0709 99 90 Blue giant hyssop sprouts (*Agastache foeniculum*)
- 0709 99 90 Borage sprouts (*Borago officinalis*)
- 0709 99 90 Chinese mahogany sprouts (*Toona sinensis*)
- 0709 99 90 Common glasswort sprouts (*Salicornia europaea*)
- 0709 99 90 Coriander sprouts (*Coriandrum sativum*)
- 0709 99 90 Cress sprouts (*Lepidium sativum*)
- 0709 99 90 Fenugreek sprouts (*Trigonella foenum-graecum*)
- 0709 99 90 Sprouts of green shiso or purple shiso (*Perilla frutescens*)
- 0709 99 90 Sunflower sprouts (*Helianthus annuus*)
- 0709 99 90 White mustard sprouts (*Sinapis alba*)
- 1107 10 19 Green malt of wheat (*Triticum aestivum*)
- 1107 10 99 Green malt of barley (*Hordeum vulgare*)
- 1107 10 99 Green malt of millet (*Panicum miliaceum*)
- 1107 10 99 Green malt of oats (*Avena sativa*)
- 1107 10 99 Green malt of rice (*Oryza sativa*)
- 1107 10 99 Green malt of rye (*Secale cereale*)
- 1214 90 90 Alfalfa sprouts (*Medicago sativa*)

-
- 0701 Potatoes, fresh or chilled**
- 0701 90 50 New, from 1 January to 30 June**
New potatoes are distinguished by their pale colouring (usually, white or pink) and by their thin skin which is not set firm and is easily removed by scraping. In addition, they show no signs of germination.
- 0703 Onions, shallots, garlic, leeks and other alliaceous vegetables, fresh or chilled**
- 0703 10 11 to 0703 10 90 Onions and shallots**
These subheadings cover all varieties of onion (*Allium cepa*) and shallots (*Allium ascalonicum*).
- 0703 10 11 Sets**
This subheading covers one-year-old onion bulbs grown from seed, for planting out. Their diameter is generally 1 to 2 cm.
- 0703 20 00 Garlic**
This subheading covers all varieties of garlic (*Allium sativum*) which are suitable for human consumption. Garlic consisting of a single bulb without separate cloves, having an approximate diameter of between 25 mm and 50 mm and described in the trade as 'solo garlic', 'pearl garlic', 'single bulb garlish', 'single clove garlic' or 'monobulb garlic' (or any similar commercial denomination), is also covered by this subheading. This subheading does not cover so-called 'great round-headed garlic' or 'elephant garlic' (*Allium ampeloprasum*, falling under subheading 0703 90 00), which consists of a single bulb of an approximate diameter of 60 mm or more (i.e., significantly bigger and heavier than a multi-clove garlic bulb). The species *Allium sativum* and *Allium ampeloprasum* differ also regarding their respective gene pools.
- 0703 90 00 Leeks and other alliaceous vegetables**
This subheading includes the common edible leek (*Allium porrum*), the Welsh onion or stone leek (*Allium fistulosum*) and chives (*Allium schoenoprasum*).
- 0704 Cabbages, cauliflowers, kohlrabi, kale and similar edible brassicas, fresh or chilled**
- 0704 10 00 Cauliflowers and headed broccoli**
See the HS Explanatory Notes to heading See the HS Explanatory Note to heading 0704, first paragraph, (1).
- 0704 90 10 White cabbages and red cabbages**
This subheading covers white cabbage (*Brassica oleracea* L. var. *capitata* L. f. *alba* D. C.), including pointed cabbage (*Brassica oleracea* L. var. *capitata* L. f. var. *alba* D. C. subvar. *conica* and subvar. *pyramidalis*) and red cabbage (*Brassica oleracea* L. var. *capitata* L. f. *rubra* (L.) Thell).
- 0704 90 90 Other**

This subheading includes Savoy cabbage (*Brassica oleracea* L. var. *bullata* D. C. and var. *sabauda* L.), Chinese cabbage (for example, *Brassica sinensis* and *Brassica pekinensis*), kohlrabi or turnip-rooted cabbage (*Brassica oleracea* var. *gongylodes*) and sprouting broccoli or calabres (*Brassica oleracea* L. convar. *botrytis* (L.) Alef var. *italica* Plenck).

However, this subheading does not include:

- (a) edible roots of the genus *Brassica* (turnips fall in heading 0706, and swedes or rutabagas (*Brassica napus* var. *napobrassica*) fall in heading 1214);
- (b) forage kale, such as red or white marrowstem kale (*Brassica oleracea* var. *medullosa*) and cow cabbage (*Brassica oleracea* var. *viridis*) which fall in heading 1214.

0706 Carrots, turnips, salad beetroot, salsify, celeriac, radishes and similar edible roots, fresh or chilled**0706 10 00 Carrots and turnips**

This subheading covers only varieties of turnip and carrot (red or pink) suitable for human consumption. Forage carrots, generally white or pale yellow, forage turnips (*Brassica campestris* var. *rapa*) and swedes or rutabagas (*Brassica napus* var. *napobrassica*) fall in subheading 1214 90 10.

0706 90 90 Other

This subheading includes:

1. salad beetroot (*Beta vulgaris* var. *conditiva*);
2. salsify (*Tragopogon porrifolius*) and scorzonera (*Scorzonera hispanica*);
3. radishes of all kinds: white, black, pink etc. (*Raphanus sativus* var. *sativus* and *niger* especially);
4. turnip-rooted parsley (*Petroselinum crispum* var. *tuberosum*) and rooted chervil (*Chaerophyllum bulbosum*);
5. parsnips (*Pastinaca sativa*);
6. Japanese artichokes or chorogi (*Stachys affinis* or *Stachys sieboldii*), which are elongated rhizomes, yellowish white in colour and generally the size of the little finger with a number of constrictions.

However, edible roots and tubers with a high starch or inulin content, such as Jerusalem artichokes, sweet potatoes, taro and yams, fall in heading 0714.

0707 00 Cucumbers and gherkins, fresh or chilled**0707 00 90 Gherkins**

The gherkins which fall in this subheading are a variety of small cucumber (85 or more to the kilogram).

0708 Leguminous vegetables, shelled or unshelled, fresh or chilled**0708 10 00 Peas (*Pisum sativum*)**

This subheading covers all peas of the species *Pisum sativum*, including forage peas (*Pisum sativum* var. *arvense*). It does not cover cowpeas (including the black-eyed variety), which are beans falling in subheading 0708 20 00, or chickpeas of the genus *Cicer* falling in subheading 0708 90 00.

0708 90 00 Other leguminous vegetables

This subheading includes the products referred to in the HS Explanatory Note to heading 0708, first paragraph, (3), (4), (5) and (6).

0709 Other vegetables, fresh or chilled**0709 20 00 Asparagus**

This subheading covers only the young shoots or 'spears' of asparagus (*Asparagus officinalis*).

0709 40 00 Celery other than celeriac

This subheading covers celery of the varieties '*Apium graveolens* L. var. *dulce* (Mill.) Pers.' (ribbed, stick or winter celery) and '*Apium graveolens* var. *secalinum* Alef.' (leaf celery). (leaf celery).

- 0709 59 10 Chanterelles**
This subheading covers only chanterelles or girolles (egg mushroom), generally of the colour of egg yolk, of the species *Cantharellus cibarius* Fries and *Cantharellus friesii* Quélet. Similar edible kinds such as the false chanterelle (*Clitocybe aurantiaca*) and the horn-of-plenty (*Craterellus cornucopioides*), sometimes used as a substitute for truffles in charcuterie, fall in subheading 0709 59 90.
- 0709 59 30 Flap mushrooms**
This subheading covers only flap or boletus mushrooms of the genus *Boletus* and, in particular, the common flap mushroom or cep (*Boletus edulis*).
- 0709 60 10 to 0709 60 99 Fruits of the genus *Capsicum* or of the genus *Pimenta***
See the HS Explanatory Note to heading 0709, first paragraph, (5).
- 0709 92 10 and 0709 92 90 Olives**
Olives having had oil extracted but with a fatty-matter content higher than 8 % remain in these subheadings.
- 0709 90 10 to 0709 99 10 Salad vegetables, other than lettuce (*Lactuca sativa*) and chicory (*Cichorium* spp.)**
This subheading covers all types of salad plants, other than garden lettuce (*Lactuca sativa*), chicory and endives (*Cichorium* spp.); these include:
1. lamb's lettuce;
2. dandelions (*Taraxacum officinale*).
- 0709 90 20 to 0709 99 20 Chard (or white beet) and cardoons**
This subheading covers chard, also called white beet, spinach beet, silver beet or leaf beet (*Beta vulgaris* subvar. *cicla*) and cardoons (*Cynara cardunculus*).
- 0709 90 31 and 0709 90 39 Olives**
Olives having had oil extracted but with a fatty-matter content higher than 8 % remain in these subheadings.
- 0709 90 40 to 0709 99 40 Capers**
Capers are the unopened flower buds of a spiny perennial shrub (*Capparis spinosa*).
- 0709 90 90 to 0709 99 90 Other**
This subheading includes:
1. okra, gumbo or ladies fingers (*Hibiscus esculentus*);
2. marrows, squashes and pumpkins (for example, *Cucurbita maxima* and *Cucurbita pepo*, excluding *Cucurbita pepo* L. convar. *citrullinia* Greb. var. *styriaca* and *Cucurbita pepo* L. var. *oleifera* Pietsch);
3-2. rhubarb;
4-3. sorrel (*Rumex acetosa*);
5-4. oxalis (*Oxalis crenata*);
6-5. skirret (*Sium sisarum*);
7-6. various types of cress: garden cress (*Lepidium sativum*), watercress (*Nasturtium officinale*), winter cress (*Barbarea verna*), nasturtium or Indian cress (*Tropaeolum majus*), etc.;
8-7. common purslain (*Portulaca oleracea*);
9-8. parsley and chervil, other than turnip-rooted parsley and rooted chervil which fall in subheading 0706 90 90;
10-9. tarragon (*Artemisia dracuncululus*) and savory (*Satureja hortensis* or summer savory, and *Satureja montana* or winter savory);
11-10. cultivated or sweet marjoram (*Origanum majorana*);
12-11. bulbs of the family Liliaceae of the species '*Muscari comosum*' (common names 'lampasciolo', 'wild onions', 'lilas de terre', 'feather hyacinth').
- It should be noted that:
(a) roots and tubers with a high starch or inulin content fall in heading 0714;
(b) a certain number of plants are excluded from this subheading although they are used for human consumption; this applies particularly to the following:
1. thyme (subheadings 0910 99 31 to 0910 99 39);
2. bay leaves (subheading 0910 99 50);
3. wild marjoram or oregano (*Origanum vulgare*), sage (*Salvia officinalis*), basil (*Ocimum basilicum*), mint (all varieties), vervain (*Verbena* spp.), rue (*Ruta graveolens*), hyssop (*Hyssopus officinalis*) and borage (*Borago officinalis*), which fall in heading 1211.

- 0710** **Vegetables (uncooked, or cooked by steaming or boiling in water), frozen**
The expression 'frozen' as defined in the HS General Explanatory Note to this chapter, third paragraph, is also to be seen by the criteria set out in the judgment of the Court of Justice of the European Union in Case 120/75. By analogy, following the Court's interpretation of these criteria in its judgment in Case C-423/09, the process of freezing must give rise to substantial and irreversible changes, with the result that the product is no longer in its natural state. Therefore, products are 'frozen' when the products which are subjected to the freezing processes undergo certain irreversible changes as a result of this very process, in particular to the structure of the cells, with the result that these products are no longer in their natural state, even after they have started to thaw or have thawed out completely.
- 0711** **Vegetables provisionally preserved (for example, by sulphur dioxide gas, in brine, in sulphur water or in other preservative solutions), but unsuitable in that state for immediate consumption**
- 0711 20 10 and 0711 20 90** **Olives**
These subheadings cover olives, normally in pickling brine, which have not yet been subjected to a process to remove their bitter flavour. Olives rendered edible — even by a simple prolonged soaking in brine — are excluded from these subheadings and are classified in subheading 2005 70 00.
- 0711 40 00** **Cucumbers and gherkins**
This subheading includes cucumbers and gherkins simply put into large vessels containing brine which, possibly with added vinegar or acetic acid, ensures that they are provisionally preserved during transportation and storage in as far as they are unsuitable for consumption in that state. These products usually contain by weight at least 10 % of salt. Before being finally used, these products are usually treated in the following way, which renders them classifiable in Chapter 20:
- partial removal of salt, followed by seasoning (which usually consists of adding a vinegar-based aromatised covering liquid),
 - pasteurisation intended to support the stabilising action of the salt and vinegar after the products have been transferred to small containers (tins, bottles, glass jars, etc.).
- However, cucumbers and gherkins, whether or not preserved in brine, having undergone complete lactic fermentation, fall in Chapter 20. Cucumbers and gherkins that have undergone complete lactic fermentation can be distinguished by the fact that, in cross-section, the entire surface of the pulp appears glassy (i.e., somewhat transparent).
- 0711 51 00** **Mushrooms of the genus *Agaricus***
Mushrooms of the present subheading may be preserved in a strong brine solution to which vinegar or acetic acid has been added.
- 0711 90 70** **Capers**
Capers of this subheading are usually preserved in barrels of pickling brine.
- 0712** **Dried vegetables, whole, cut, sliced, broken or in powder, but not further prepared**
Substances are not included in this heading which, in their dried form, are not used as vegetables but are used primarily in perfumery, in pharmacy or for insecticidal, fungicidal or similar purposes (heading 1211).

- 0712 90 30 Tomatoes**
See the explanatory note to subheadings 2002 90 11 to 2002 90 99 concerning the classification of tomato powder.
- 0712 90 90 Other**
This subheading excludes dried leaves and roots of the dandelion plant (*Taraxacum officinale*), dried sorrel (*Rumex acetosa*) and dried nasturtium or Indian cress (*Tropaeolum majus*) which are used for medicinal purposes (subheading 1211 90 85/1211 90 86).
- 0713 Dried leguminous vegetables, shelled, whether or not skinned or split**
Goods falling in this heading which are intended for sowing are the products of plant breeding and are generally identifiable by their packaging (for example, sacks bearing labels indicating their use) and by their higher price.
- 0713 10 10 and 0713 10 90 Peas (*Pisum sativum*)**
The explanatory note to subheading 0708 10 00 applies, *mutatis mutandis*.
- 0713 20 00 Chickpeas (garbanzos)**
Chickpeas of this subheading are of the genus *Cicer* (mainly, *Cicer arietinum*), whether for sowing, human consumption or feeding animals.
- 0713 31 00 Beans of the species ~~Vigna mungo~~ *Vigna mungo* (L.) Hepper or ~~Vigna radiata~~ *Vigna radiata* (L.) Wilczek**
See the HS Explanatory Note to subheading 0713 31.
- 0713 32 00 Small red (Adzuki) beans (~~Phaseolus~~ *Phaseolus* or *Vigna angularis*)**
Adzuki beans are always marketed dry. Before the Adzuki plant has reached maturity, the beans are green and contain a high proportion of water. Once the plant has reached maturity, the bean turns red and becomes dry.
- ~~0713 39 00~~ 0713 35 00 Other Cow peas (*Vigna unguiculata*)**
This subheading includes horsegram (formerly *Dolichos sinensis* spp. *ssp. sesquipedalis*) which is to be considered as a bean of the species *Vigna unguiculata* (L.) Walp. The names '*Dolichos unguiculata*' and '*Dolichos sinensis*' are synonyms no longer in use for beans of the species '*Vigna unguiculata*' are synonyms no longer in use for beans of the genus *Vigna*. Consequently, the horsegram is correctly named '*Vigna unguiculata* (L.) Walp. *Vigna unguiculata* spp. (L.) Walp. *ssp. sesquipedalis*'.
- 0713 40 00 Lentils**
This subheading covers only lentils of the genus *Ervum* or *Lens*, for example, the many varieties of the common lentil (*Ervum lens* or *Lens esculenta*) and the lentil vetch or ervil (*Ervum ervilia*).
- 0713 90 00 Other**
This subheading includes, with the exception of the horsegram of subheading 0713 39 00/0713 35 00, ~~dolichos of the genus Dolichos~~ and of the pigeon pea (*Cajanus cajan*) of subheading 0713 60 00 ~~dolichos of the genus Dolichos~~ such as the lablab (*Dolichos lablab*), the pigeon pea (*Cajanus cajan*), the jack bean (*Canavalia ensiformis*), the velvet bean (*Mucuna utilis*) and seeds of guar (*Cyamopsis tetragonoloba*). The following are excluded from this subheading: vetches of species other than *Vicia faba* and seeds of lupins (subheading 1209 29 45) and seeds of lupins (*Lupinus*) (subheading 1209 29 40 or 1209 29 50).
- 0714 Manioc, arrowroot, salep, Jerusalem artichokes, sweet potatoes and similar roots and tubers with high starch or inulin content, fresh, chilled, frozen or dried, whether or not sliced or in the form of pellets; sago pith**
The term 'in the form of pellets' is defined in note 1 to this section.

~~0714 10 91~~ ~~0714 10 00~~ and
~~0714 10 98~~

Manioc (cassava)

~~These subheadings include:~~ This subheading includes:

1. the tuberous roots of manioc, of which there are two main varieties (*Manihot utilissima* and *Manihot aipi*); the roots are arranged like the spokes of a wheel; their weight on harvesting can vary from 500 g to 3 kg or more;
2. pellets made from agglomerated fragments of manioc roots or agglomerated flour or meal of the roots (see the HS Explanatory Note to heading 0714, second paragraph).

~~0714 20 10~~ and ~~0714 20 90~~

Sweet potatoes

Sweet potatoes are tubers with flesh which is white, yellow or red depending on variety and come from a herbaceous climbing plant (*Ipomea batatas*).

~~0714 90 11~~ ~~0714 90 20~~ and
~~0714 90 19~~

Arrowroot, salep and similar roots and tubers with high starch content

~~These subheadings include:~~ This subheading includes:

1. the roots of arrowroot, which belong to various vegetable species according to their origin: arrowroot (*Maranta arundinacea*), Indian arrowroot (*Maranta indica*), tacca (*Tacca pinnatifida*), Queensland arrowroot (*Canna edulis*);
2. the roots of salep taken from different varieties of plant of the genus *Orchis*;
3. the dead roots of dahlias and other dead tuberous roots of flowers;
4. ~~the rhizomes of taros or dasheens (the tubers of chufa (*Colocasia esculenta* ~~Cyperus esculentus~~ or), also known as 'tiger nut', *Colocasia antiquorum*);~~
5. yams of many different varieties (*Dioscorea batatas*, *D. trifida*, *D. alata*, *D. bulbifera*, etc.).

~~0714 90 90~~

Other

This subheading includes the different varieties of Jerusalem artichoke (for example, *Helianthus tuberosus*, *Helianthus strumosus* and *Helianthus decapetalus*) and the starchy pith called 'sago' taken from the trunks of certain palms of a wide variety of species (*Metroxylon*, *Rumphii*, *Raphia ruffia*, *Arenga*, etc.).

CHAPTER 8

EDIBLE FRUIT AND NUTS; PEEL OF CITRUS FRUIT OR MELONS

General

This chapter includes fruit for distillation purposes in the form of a coarse pulp, even if natural fermentation has commenced.

- 0801 Coconuts, Brazil nuts and cashew nuts, fresh or dried, whether or not shelled or peeled**
- 0801 21 00 and 0801 22 00 Brazil nuts**
These are nuts with a hard shell reminiscent of mandarin segments in shape and size; the shell encloses a large kernel of triangular cross-section in a brownish fibrous envelope.
- 0802 Other nuts, fresh or dried, whether or not shelled or peeled**
- 0802 21 00 and 0802 22 00 Hazelnuts or filberts (*Corylus* spp.)**
These subheadings include hazelnuts or cobs (fruit of *Corylus avellana*), Turkish hazel (fruit of *Corylus colurna*) and filberts (fruit of *Corylus maxima*).
- ~~0802 40 00~~ **0802 41 00 and 0802 42 00 Chestnuts (*Castanea* spp.)**
~~This subheading covers only edible sweet chestnuts of the genus *Castanea*; it does not therefore include water chestnuts or caltrops (fruit of *Trapa natans*) which fall in subheading 0802 90 85 or horse chestnuts (*Aesculus hippocastanum*) which fall in heading 2308.~~
- ~~0802 50 00~~ **0802 51 00 and 0802 52 00 Pistachios**
Pistachios are the fruit of the pistachio tree (*Pistacia vera*), which is cultivated mainly in Sicily, Greece and the Middle East.
The pistachio nut is the size of a small olive consisting of a soft, thin and usually moist husk which is red-brown in colour, very rough on the surface and slightly aromatic, a bivalve shell which is light in colour and woody, and an elongated kernel with a red-brown skin which is pale green inside and has a pleasant, mild flavour.
- 0802 90 50 Pine nuts**
This subheading includes pine kernels (fruit of *Pinus pinea*), whether or not contained in the cone.
- 0802 90 85 Other**
This subheading includes seeds of the Arolla pine (fruits of *Pinus cembra*), whether or not contained in the cone.
- ~~0803 00 00~~ **0803 Bananas, including plantains, fresh or dried**
- ~~0803 00 10~~ **0803 10 10 Plantains Fresh**
Plantains can be up to 50 cm long, and are bigger and have a more angular cross-section than bananas of subheading ~~0803 00 10~~ 0803 90 10. The starch contained in plantains differs from that contained in table bananas in that it does not become sweet during ripening. Plantains do not have a distinctive smell. They are not suitable for eating raw. They are usually harvested when green and eaten cooked.
- 0804 Dates, figs, pineapples, avocados, guavas, mangoes and mangosteens, fresh or dried**
- 0804 40 00 Avocados**
Avocado pears or avocados are the fruit of the avocado tree (*Persea americana* Mill.); they are drupes, often quite large, spherical, pear-shaped or like a long-necked flask depending on variety, enclosing a sometimes large stone. The skin is dark green, crimson, purple or yellow in colour. The firm flesh beneath the skin is greenish white in colour when ripe and paler near the stone.

- 0804 50 00** **Guavas, mangoes and mangosteens**
Guavas are the fruit of the guava tree (*Psidium guayava L.*); guavas are berries whose flesh is of varying colour (whitish, pink, cream, reddish or green) and which contain many small seeds.
Mangoes are the fruit of the mango tree (*Mangifera indica*); mangoes are drupes containing a flat stone with trailing fibres. Several varieties of mango exist, varying in weight (from 150 g to 1 kg), sweetness and flavour (some having a slight taste of turpentine).
Mangosteens are fruit of the mangosteen tree (*Garcinia mangostana*). The fruit is a berry of brownish-purple colour when ripe, with a thick pericarp containing several seeds surrounded by a spongy aril which is white, sugary and has a particularly delicate taste.
- 0805** **Citrus fruit, fresh or dried**
- 0805 10 20** **Sweet oranges, fresh**
This subheading covers only oranges of the species *Citrus sinensis*.
They include sanguine and semi-sanguine oranges.
Sanguine oranges are oranges whose skin (often over half its surface), flesh and juice have a pigmentation due to the presence of carotene. In the case of semi-sanguines, the pigmentation is generally less pronounced and is limited to the flesh and juice.
Sanguine oranges include 'Blood ovals', 'sanguinas redondas', 'Navels sanguinas', 'Sanguinelli', 'Doubles fines', 'Washington sanguines' or 'improved doubles fines' or 'large sanguines' and 'Portuguese'.
- 0805 10 80** **Other**
This subheading includes bitter oranges (Seville oranges), the fruit of the species *Citrus aurantium*. They are used chiefly for preserves.
- 0805 20 30** **Monreales and satsumas**
Satsumas (*Citrus reticulata Blanco* var. *unshiu* (*Swing*)) are an early variety of mandarin. The fruit is large, yellow-orange in colour, juicy, non-acid and without pips.
- 0805 20 50** **Mandarins and wilkings**
Mandarins (*Citrus nobilis Lour.* or *Citrus reticulata Blanco*) may be distinguished from ordinary oranges by their smaller, flattened shape, by easier peeling, by a more distinct division of their segments and by their sweeter and more perfumed taste.
Wilkings are hybrids of a variety (cultivar) of the Willow leaf mandarin and the Temple mandarin (King mandarin) (itself a hybrid of mandarins and bitter oranges). They resemble mandarins, but are larger and pointed at one end.
- 0805 20 70** **Tangerines**
This subheading covers tangerines (*Citrus reticulata Blanco* var. *tangerina*).
- 0805 20 90** **Other**
This subheading includes:
1. tangelos, hybrids of tangerine and grapefruit, including pomelos;
 2. ortaniques, hybrids of orange and tangerine;
 3. malaquinas, hybrids of orange and mandarin;
 4. tangors.
- 0805 40 00** **Grapefruit, including pomelos**
This subheading covers fruit of the species *Citrus grandis* and *Citrus paradisi*. These fruit have a light yellowish skin and are generally larger than oranges, with the shape of a sphere which may be slightly flattened, the flesh being yellow or pinkish and acid in taste.

0805 50 90**Limes (*Citrus aurantifolia*, *Citrus latifolia*)**

This subheading covers all the varieties of the species *Citrus aurantifolia* and *Citrus latifolia*.

Limes are small fruit, almost round or ovoid, with a thin, adhering green or greenish yellow skin. The juicy pulp is green and highly acid.

0805 90 00**Other**

This subheading includes:

1. citrons (*Citrus medica*), like a large lemon with very thick peel having a knobbed surface; the flesh is very fragrant, the pulp is acidulous and the candied rind is much used for cakes and confectionery;
2. kumquats (*Fortunella japonica*, *F. hindsii* and *F. margarita*), a fruit the size of a large olive, round or oblong without flattening at the ends, with a smooth skin, a small amount of pulp and a slightly acid taste; their skin is sweet and eaten raw or puréed; they are also sometimes used for confectionery;
3. chinottos (*Citrus aurantium* var. *myrtifolia*);
4. bergamots (*Citrus aurantium* var. *bergamia*), a species of orange, pale yellow in colour and pear-shaped, with a slightly acid flavour, mainly used for making essential oil;
5. oroblanco or sweetie (*Citrus grandis* Osbeck × *Citrus paradisi* Macf.), a cross between an acidless pomelo and a white grapefruit, with a thick rind in a bright green or golden colour; it is slightly larger in size than a grapefruit but with fewer seeds and a sweeter taste.

0806**Grapes, fresh or dried****0806 10 10****Table grapes**

Table grapes generally differ from wine grapes in both appearance and type of packaging. Whereas table grapes are most often presented in boxes, cartons, trays, crates or small sealed panniers, wine grapes are presented either in large baskets, open packing cases or in tubs in which the grapes are often tightly packed, crushed or semi-pressed.

0806 20 10**Currants**

The products of this subheading are dried grapes from the vine of the species Currants are the dried product obtained from grapes of the varieties (cultivars) Korinthiaki N. (*Vitis eorinthica* Black Corinth; they are small, round, without stalks and practically without seeds, dark purple in colour tending to black, and very sweet.) (*Vitis vinifera* L.). They are small, round, without stalks, and almost seedless, dark purple in colour tending to black, and very sweet.

0806 20 30**Sultanas**

Sultanas are the dried product obtained from grapes of the varieties (cultivars) Soutlanina B. (or Thompson seedless) (*Vitis vinifera* L.). They are seedless, medium-sized, golden in colour tending to brown, and sweet.

0806 20 90**Other**

This subheading includes all dried grapes, other than currants and sultanas.

Dried muscatel grapes are the dried product obtained from grapes of the varieties (cultivars) of Moschato Alexandreas B. (or Muscatel or Malaga) (*Vitis vinifera* L.). They contain seeds.

0807**Melons (including watermelons) and papaws (papayas), fresh****0807 11 00****Watermelons**

Watermelons are the fruit of the species *Citrullus vulgaris* Schrad. They can grow to a weight of 20 kg. The flesh is not very sugary, is very watery and is usually bright red in colour and contains black seeds.

0807 19 00**Other**

This subheading includes fruit of the species *Cucumis melo*, of which several varieties exist, in particular the musk-melon (var. *reticulatus* Naud.) with reticulate skin, the sugary melon (var. *saccharus* Naud.) which also has reticulate skin, the cantaloupe (var. *cantalupensis* Naud.) with marked ridges on the skin, the winter melon (var. *inodorus* Naud.) and the smooth-skinned melon. The fruit is normally bulky, spherical or ovoid, with either a smooth or a rough rind; the flesh is firm and juicy, yellowish orange or white, with a sugary flavour. The centre of the fruit, which has more filaments and is hollow, contains a large number of flat, oval seeds which are shiny and yellowish-white.

0807 20 00**Papaws (papayas)**

Papayas (*Carica papaya*), also known as papaws, are elongated or rounded fruit, either smooth or slightly ribbed, yellowish green to orange when ripe, which may vary in weight from a few hundred grams to several kilograms. The flesh, similar in consistency to melons, yellow tending to orange in colour, sugary and fragrant to varying degrees, encloses a cavity containing a large number of round, black seeds embedded in pulp.

- 0808 Apples, pears and quinces, fresh**
- 0808 10 10 Cider apples, in bulk, from 16 September to 15 December**
This subheading covers apples which, because of their appearance and characteristics (ungraded and unsorted fruit, generally smaller than dessert fruit with an acid or unpalatable flavour, low value, etc.), can be used only in the manufacture of beverages, fermented or not. They must be in bulk, without separators, in their means of transport (for example, railway wagons, large containers, lorries or lighters).
- ~~0808 20 10~~**0808 30 10 Perry pears, in bulk, from 1 August to 31 December**
The explanatory note to subheading 0808 10 10 applies, *mutatis mutandis*.
- 0809 Apricots, cherries, peaches (including nectarines), plums and sloes, fresh**
- ~~0809 20 05~~**0809 21 00** and ~~0809 20 95~~**0809 29 00** **Cherries**
These subheadings cover all varieties of cherries, including wild cherries and in particular the common cherry (fruit of *Prunus cerasus*), morello cherries (fruit of *Prunus cerasus* var. *austera*), heart cherries (fruit of *Prunus avium* var. *juliana*) and hard-fleshed heart cherries (fruit of *Prunus avium* var. *duracina*), and geans (fruit of *Prunus avium* or *Cerasus avium*).
- 0809 30 10** and **0809 30 90** **Peaches, including nectarines**
Unlike peaches, nectarines are smooth-skinned.
- 0809 40 90 Sloes**
Sloes are the fruit of the wild plum or blackthorn (*Prunus spinosa*).
- 0810 Other fruit, fresh**
- 0810 20 10 Raspberries**
This subheading includes the fruit of *Rubus idaeus*, *Rubus illecebrosus*, *Rubus occidentalis* and *Rubus strigosus*. Some varieties have red fruit, others white.
- 0810 30 10 Blackcurrants**
This subheading covers the globular fruit of *Ribes nigrum* L.
- 0810 30 30 Redcurrants**
This subheading covers the fruit of *Ribes rubrum* L.
- 0810 40 10 Cowberries, foxberries or mountain cranberries (fruit of the species *Vaccinium vitis-idaea*)**
The fruit is red or pink in colour.
- 0810 40 30 Fruit of the species *Vaccinium myrtillus***
The fruit is bluish-black in colour.
- 0810 50 00 Kiwifruit**
This subheading covers the kiwifruit of the species *Actinidia chinensis* Planch. or *Actinidia deliciosa*. These fruits, which are the size of an egg, are pulpy, with a bitter-sweet taste, and their hairy skin is a greenish-brown colour.
- 0810 90 20 Tamarinds, cashew apples, lychees, jackfruit, sapodillo plums, passion fruit, carambola and pitahaya**
Tamarinds (fruit of *Tamarindus indica* and *Tamarindus officinalis*), as normally presented in international trade (pods, or pulp not containing added sugar or other substances nor otherwise treated), are classified in subheading 0813 40 65. Jackfruit is the fruit of *Artocarpus heterophylla* and of *Artocarpus integrifolia*. The lychee is the fruit of *Litchi chinensis*. The sapodillo plum or naseberry is the fruit of *Achras sapota*. This subheading includes passion fruit or granadillas or passifloras (for example, 'maracuja'), such as the following species: the purple granadilla (*Passiflora edulis*), the giant granadilla (*Passiflora quadrangularis*) and the sweet granadilla (*Passiflora ligularis*).

0810 90 50**Blackcurrants**

This subheading covers the globular fruit of *Ribes nigrum L.*

0810 90 60**Redcurrants**

This subheading covers the fruit of *Ribes rubrum L.*

0810 90 950810 90 75**Other**

In addition to the products given in the HS Explanatory Note to heading 0810, second paragraph, (7) (except lychees and sapodilla plums), this subheading includes:

1. fruit of the arbutus (fruit of *Arbutus unedo*);
2. barberries (fruit of *Berberis vulgaris*);
3. fruit of the sea-buckthorn (fruit of *Hippophæ rhamnoides*);
4. sorbs (or sorb apples) or service-berries (for example, fruit of *Sorbus domestica* and *Sorbus aria*);
5. annouaceous fruits (fruit of *Annona cherimola* (cherimoya) and *Annona reticulata* (bullock's heart));
6. the various species of *Physalis* or alkekengy (fruit of *Physalis alkekengi* (Chinese lantern) or *Physalis pubescens*);
7. flacourtia fruit or Madagascar plum or governors plum (*Flacourtia cataphracta* and *Idesia polycarpa*);
8. medlars (fruit of *Mespilus germanica*) and loquats or Japanese medlars (fruit of *Eriobotrya japonica*);
9. the fruit of various species of *Sapotaceae*, for example, sapotas (fruit of *Lucuma mammosa*), but excluding sapodillo plums which come under subheading 0810 90 20;
10. edible species of *Actinidia*, other than kiwifruit (*Actinidia chinensis Planch.* or *Actinidia deliciosa*) falling in subheading 0810 50 00;
11. the fruit of various species of *Sapindaceae*, for example, rambutants (fruit of *Nephelium lappaceum*) and pulasans (fruit of *Nephelium mutabile*), but excluding lychees (fruit of *Litchi chinensis*) which come under subheading 0810 90 20.

0811

~~Fruit and nuts, uncooked or cooked by steaming or boiling in water, frozen, whether or not containing added sugar or other sweetening matter~~ Fruit and nuts, uncooked, or cooked by steaming or boiling in water, frozen, whether or not containing added sugar or other sweetening matter

The term 'frozen' is defined in the HS General Explanatory Note to this chapter, second paragraph. The expression 'frozen' as defined in the HS General Explanatory Note to this chapter, second paragraph, is also to be seen by the criteria set out in the judgment of the Court of Justice of the European Union in Case 120/75. By analogy, following the Court's interpretation of these criteria in its judgment in Case C-423/09, the process of freezing must give rise to substantial and irreversible changes, with the result that the product is no longer in its natural state.

Therefore, products are 'frozen' when the products which are subjected to the freezing processes undergo certain irreversible changes as a result of this very process, in particular to the structure of the cells, with the result that these products are no longer in their natural state, even after they have started to thaw or have thawed out completely.

See additional note 1 to this chapter, regarding subheadings involving sugar content.

0811 20 31**Raspberries**

See the explanatory note to subheading 0810 20 10.

0811 20 39**Blackcurrants**

See the explanatory note to subheading 0810 90 500810 30 10.

0811 20 51**Redcurrants**

See the explanatory note to subheading 0810 90 600810 30 30.

CHAPTER 9
COFFEE, TEA, MATÉ AND SPICES

General

The classification of spices which have been mixed together or have had other substances added to them is determined by note 1 to this chapter.

In accordance with this note, mixtures of spices with other substances, not having the essential character of spices, are excluded from this chapter. They fall in heading 2103 if they constitute mixed condiments or mixed seasonings. In the case of mixtures used directly for flavouring drinks or in the preparation of extracts intended for the manufacture of drinks, composed of spices or plants, parts of plants, seeds, fruits or nuts (whole, sliced, crushed or powdered) or species included in other chapters (Chapters 7, 11, 12, etc.), see the HS General Explanatory Note to this chapter, sixth and seventh paragraphs.

Debris and waste of spices, which inevitably arise during harvesting and subsequent working (for example, sorting or drying) or during storage operations or transportation, are classified as 'neither crushed nor ground', except where a product is identifiable (for example, by reason of its homogeneous composition) as having undergone an intentional crushing operation.

The expression 'crushed or ground' used in various headings of this chapter does not cover products cut into pieces.

0901	Coffee, whether or not roasted or decaffeinated; coffee husks and skins; coffee substitutes containing coffee in any proportion
0901 11 00 and and 0901 12 00	Coffee, not roasted These subheadings cover all forms of unroasted coffee, whether or not decaffeinated (including beans or fragments separated in sorting, sifting, etc.) even if intended for uses other than human consumption (for example, extraction of caffeine).
0901 11 00	Not decaffeinated This subheading covers unroasted coffee, provided that it has not undergone any process to extract the caffeine.
0901 12 00	Decaffeinated This subheading covers unroasted coffee which has undergone a process to extract the caffeine. Usually, coffee which has been treated in this way has a caffeine content of not more than 0,2 % by weight, calculated on the dry matter.
0901 21 00 and and 0901 22 00	Coffee, roasted These subheadings cover the coffee mentioned in the explanatory notes to subheadings 0901 11 00 and 0901 12 00 which has been roasted, whether or not washed, ground or concentrated.
0901 21 00	Not decaffeinated The explanatory note to subheading 0901 11 00 applies, <i>mutatis mutandis</i> .
0901 22 00	Decaffeinated The explanatory note to subheading 0901 12 00 applies, <i>mutatis mutandis</i> .
0901 90 10	Coffee husks and skins Husks are the hulls within the fruit (berry) enclosing the beans, of which there are normally two. Skins are the inner or 'parchment' skins enclosing each bean which are removed during roasting.
0901 90 90	Coffee substitutes containing coffee This subheading covers the products referred to in the HS Explanatory Note to heading 0901, first paragraph, (5). These mixtures may be ground or unground or even compressed.

0904	Pepper of the genus <i>Piper</i>; dried or crushed or ground fruits of the genus; <u>dried or crushed or ground fruit of the genus <i>Capsicum</i> or of the genus <i>Pimenta</i></u>
0904 11 00	Neither crushed nor ground This subheading covers the products referred to in the HS Explanatory Note to heading 0904, (1). It should be noted that broken peppercorns and fragments of pepper remain classified in this subheading, provided that they are obviously not the result of intentional grinding or crushing. This also applies to spice dust or sweepings, consisting of impure pepper. This subheading includes green peppercorns preserved in a vinegar solution or brine, even with the addition of small quantities of citric acid.
0904 20 10 0904 20 90	Fruits of the genus <i>Capsicum</i> or of the genus <i>Pimenta</i>; <u>dried or crushed or ground</u> These subheadings include products covered by the HS Explanatory Note to heading 0904, (2), when dried or crushed or ground.
0904 20 10 0904 21 10	Sweet peppers Sweet peppers (<i>Capsicum annuum</i>) The peppers of this subheading (<i>Capsicum annuum</i> var.) are relatively large in size and have a sweet flavour (without a burning taste). They can have different colours. This subheading covers only dry peppers, whole or in pieces but neither crushed nor ground. <i>grossum</i> are relatively large in size and have a sweet flavour. They are gathered either when still green or already red in colour. This subheading covers only dry peppers, whole or in pieces but neither crushed nor ground.
0906	Cinnamon and cinnamon-tree flowers
0906 11 00 0906 19 00	Neither crushed nor ground These subheadings cover, for example: 1. sticks consisting of strips of bark or 'quills' rolled up inside each other and attaining a length of up to 110 cm; 2. pieces made by cutting cinnamon sticks to specific lengths (for example, 5 to 10 cm); 3. bark in pieces of various lengths and widths, such as 'quillings' (fragments and waste arising from the cutting of cinnamon sticks to standard lengths), 'featherings' and 'chips' (small pieces of cinnamon bark obtained during debarking and used particularly in the manufacture of cinnamon essence).
0906 11 00	Cinnamon (<i>Cinnamomum zeylanicum</i> Blume) See the HS Explanatory Note to subheading 0906 11.
0907 00 00 0907 00 90	Cloves (whole fruit, cloves and stems) This heading also covers crushed or ground cloves.
0908	Nutmeg, mace and cardamoms
0908 10 00 0908 11 00	Nutmeg Neither crushed nor ground See the HS Explanatory Note to heading 0908, paragraph (a) , (a). This subheading covers nutmeg which is the seed of the nutmeg tree (<i>Myristica fragrans</i>). This subheading also includes whole nutmegs for the industrial manufacture of essential oils or resinoids, which are often treated with lime water as a protection from insects, and nutmegs of inferior quality such as those which have shrivelled or have been broken during harvesting, and are marketed under the descriptions 'waste', 'BWP' (broken, wormy, punky) or 'defective'.
0908 20 00 0908 21 00 0908 22 00	Mace See the HS Explanatory Note to heading 0908, paragraph (b) , (b).
0908 30 00 0908 31 00 0908 32 00	Cardamoms See the HS Explanatory Note to heading 0908, paragraph (c) , (1) to (4), (c), (1) to (4).

0909	Seeds of anise, badian, fennel, coriander, cumin or caraway; juniper berries
0909 20 00 0909 21 00 and 0909 22 00	Seeds of coriander See the HS Explanatory Note to heading 0909, first and third paragraphs. Seeds of coriander are spherical with a light yellow-brown colour. They are sugary to the taste and slightly pungent.
0909 30 00 0909 31 00 and 0909 32 00	Seeds of cumin See the HS Explanatory Note to heading 0909, first and third paragraphs. Seeds of cumin are ovoid and ridged.
0909 40 00 0909 61 00 and 0909 62 00	Seeds of caraway Seeds of anise, badian, caraway or fennel; juniper berries See the HS Explanatory Note to heading 0909, first and third paragraphs. Seeds of caraway are ovoid, elongated and ridged.
0910	Ginger, saffron, turmeric (curcuma), thyme, bay leaves, curry and other spices
0910 10 00 0910 11 00 and 0910 12 00	Ginger See the HS Explanatory Note to heading 0910, paragraph (a), (a). <u>This subheading covers rhizomes of ginger (<i>Amomum zingiber</i> L.), which may be presented fresh, dried or crushed. This subheading includes 'grey' (known as 'black' ginger) ginger (unscraped) and 'white' ginger (scraped) L., which may be presented fresh, dried or crushed. These subheadings include 'grey' (known as 'black' ginger) ginger (unscraped) and 'white' ginger (scraped).</u>
0910 20 10 and and 0910 20 90	Saffron See the HS Explanatory Note to heading 0910, (b).
0910 30 00	Turmeric (curcuma) See the HS Explanatory Note to heading 0910, (c). Commercial round turmeric comes from the main tuber, which is large and rounded, while long turmeric comes from the side growths on the tuber, which are ovoid or cylindrical.
0910 91 05 to to 0910 91 90	Mixtures referred to in note 1(b) to this chapter See the HS Explanatory Note to heading 0910, (e) and (g).
0910 91 05	Curry Curry powders are described in the HS Explanatory Note to heading 0910, (e); the addition as minor ingredients of other substances (salt, mustard seeds, flour from legumes) does not alter the classification of these mixtures.
0910 99 31 to to 0910 99 39	Thyme These subheadings cover the many species of thyme (<i>Thymus vulgaris</i> , <i>Thymus zygis</i> , <i>Thymus serpyllum</i> or wild thyme), whether or not dried.
0910 99 31	Wild thyme (<i>Thymus serpyllum</i>) This subheading covers only thyme of the species <i>Thymus serpyllum</i> .
0910 99 33	Other This subheading includes the plucked and dried leaves and flowers of <i>Thymus vulgaris</i> and <i>Thymus zygis</i> .

0910 99 50**Bay leaves**

This subheading covers the leaves of the bay laurel (*Laurus nobilis*), whether or not dried.

0910 99 91 and 0910 99 99**Other**

These subheadings include dill seed (*Anethum graveolens*), Kani and 'negro pepper' produced from the fruit of *Xylopia aethiopica*.

However, despite the fact that they are commonly used as spices, the following are not classified in these subheadings:

- (a) mustard seeds (heading 1207);
- (b) all types of galanga rhizomes (heading 1211);
- (c) the product called 'bastard saffron' or 'safflower', the colour of which is more red than true saffron and which consists of the flowers of safflower or zaffre — *Carthamus tinctorius* or *Carthamus oxyacantha* or *Carthamus palaestinus* (heading 1404).

Many seasoning plants which are not properly speaking spices are also excluded from this chapter and classified in particular in Chapters 7 and 12 (see the explanatory notes to those chapters).

CHAPTER 10

CEREALS

General

Dried ears of cereal (for example, maize) which have been bleached, dyed, impregnated or otherwise treated for ornamental purposes are classified in subheading ~~0604 99 90~~0604 90 99.

Cereals remain classified in this chapter although they have undergone heat treatment for preservation purposes which may cause the grains to partially gelatinise and sometimes burst. The partial gelatinisation (pregelatinisation) occurs in the drying process and concerns only a small quantity of the grains. This transformation of the starch is not the aim of the heat treatment, but only a side effect. That treatment is not to be considered as 'otherwise worked' within the meaning of note 1(B) to Chapter 10.

1001	Wheat and meslin
1001 10 00 <u>1001 11 00 and 1001 19 00</u>	Durum wheat See subheading note 1 to this chapter and the HS Explanatory Note to heading 1001, first paragraph, (2).
1001 90 91 <u>1001 91 20</u>	Common wheat and meslin seed Seeds are selected and may generally be distinguished by their packaging (for example, in bags with labels showing their purpose) and by their higher prices. These seeds can be treated to protect them from pests or birds, after sowing.
1003 00 <u>1003</u>	Barley
1003 00 10 <u>1003 10 00</u>	Seed See the explanatory note to subheading 1001 90 91 <u>1001 91 20</u> .
1006	Rice See additional note 1 to this chapter.
1008	Buckwheat, millet and canary seed; other cereals
1008 90 10 <u>1008 60 00</u>	Triticale Triticale is a hybrid cereal resulting from crossing wheat with rye. The grain is generally larger and more elongated than that of rye and often larger and more elongated than that of wheat; the outer layer is wrinkled.

CHAPTER 11

PRODUCTS OF THE MILLING INDUSTRY; MALT; STARCHES; INULIN; WHEAT GLUTEN

- 1101 00** **Wheat or meslin flour**
See note 2 to this chapter.
Flours of this heading may contain small quantities of salt (generally, not more than 0,5 %), as well as small quantities of amylase, milled germs and roasted malt.
- 1102** **Cereal flours other than of wheat or meslin**
See note 2 to this chapter.
Flours of this heading may contain small quantities of salt (generally, not more than 0,5 %), as well as small quantities of amylase, milled germs and roasted malt.
- 1102 20 10 and 1102 20 90** **Maize (corn) flour**
For the determination of the fat content, the analytical method set out in Annex III, part H, to Commission Regulation (EC) No 152/2009 (OJ L 054, 26.2.2009, p. 1) is to be applied in accordance with Commission Regulation (EEC) No 1748/85 (OJ L 167, 27.6.1985, p. 26).
These subheadings include maize flour described as ‘masa flour’ which is obtained by the ‘nixtamalisation’ method that is characterised by the cooking and soaking of maize grains in a calcium hydroxide solution and subsequent drying and grinding.
Any additional processing, such as roasting, leads however to the exclusion of such a product from heading 1102 (generally, Chapter 19)
- 1103** **Cereal groats, meal and pellets**
- 1103 11 10 to 1103 19 90** **Groats and meal**
1. See notes 2 and 3 to this chapter.
 2. See the HS Explanatory Note to heading 1103, first six paragraphs.
 3. — Products which do not comply with the sieving criteria laid down in note 3 to this chapter are classified in heading 1104.
— Products which comply with the sieving criteria laid down in note 3 to this chapter but which, having been pearled, are in the form of round-shaped grain fragments, fall in one of the subheadings of heading 1104 covering pearled grains.
- 1103 13 10 and 1103 13 90** **Of maize (corn)**
For the determination of the fat content, see the explanatory note to subheadings 1102 20 10 and 1102 20 90.
These subheadings include groats and meal of maize described as ‘masa flour’ which is obtained by the ‘nixtamalisation’ method that is characterised by the cooking and soaking of maize grains in a calcium hydroxide solution and subsequent drying and grinding.
Any additional processing, such as roasting, leads however to the exclusion of such a product from heading 1103 (generally, Chapter 19).

1103 20 10 1103 20 25 1103 20 90	Pellets See the HS Explanatory Note to heading 1103, last paragraph.
1104	Cereal grains otherwise worked (for example, hulled, rolled, flaked, pearled, sliced or kibbled), except rice of heading 1006; germ of cereals, whole, rolled, flaked or ground The flaked grains which fall in subheadings 1104 12 90, 1104 19 69 and 1104 19 91 are grains which have been hulled and rolled.
1104 22 20 1104 22 40 1104 29 89	Other worked grains (for example, hulled, pearled, sliced or kibbled) See the HS Explanatory Note to heading 1104, second paragraph, (2) to (5).
1104 22 50	Pearled In addition to the pearled grains referred to in the HS Explanatory Note to heading 1104, second paragraph, (4), this subheading covers grain fragments which, having been pearled, are in the form of round granules.
1104 22 90 1104 22 95	Not otherwise worked than kibbled Other This subheading covers products obtained from the fragmentation of non-hulled cereal grains which do not comply with the sieving criteria laid down in note 3 to this chapter.
1104 23 30 1104 23 40	Pearled Hulled (shelled or husked), whether or not sliced or kibbled; pearled See the explanatory note to subheading For the term 'pearled', see the explanatory note to subheading 1104 22 50.
1104 23 90 1104 23 98	Not otherwise worked than kibbled Other See the explanatory note to subheading 1104 22 90 1104 22 95. Broken maize grains recovered during the sifting of cleaned unhulled maize grains and satisfying the criteria laid down in note 2(A) to this chapter are classified in this subheading as grains 'not otherwise worked than kibbled'.
1104 29 05	Pearled See the explanatory note to subheading 1104 22 50.
1104 29 07 1104 29 08	Not otherwise worked than kibbled Other See the explanatory note to subheading 1104 22 90 1104 22 95.
1104 29 30	Pearled See the explanatory note to subheading 1104 22 50.
1104 29 51 to 1104 29 59	Not otherwise worked than kibbled See the explanatory note to subheading 1104 22 90 1104 22 95.
1104 30 10 and 1104 30 90	Germ of cereals, whole, rolled, flaked or ground See the HS Explanatory Note to heading 1104, second paragraph, (6).
1106	Flour, meal and powder of the dried leguminous vegetables of heading 0713, of sago or of roots or tubers of heading 0714 or of the products of Chapter 8 The terms 'flour', 'meal' and 'powder' are defined in additional note 2 to this chapter. Products presented in paste form are excluded from this heading.

1107**Malt, whether or not roasted****1107 10 11 to 1107 10 99****Not roasted**

All malt in which the diastatic activity necessary for the saccharification of grain starch is present falls in these subheadings. Such malt includes green malt, aerated malt and kilned malt, the latter often being subdivided commercially into pale malt (of the Pilsen type) and dark malt (of the Munich type).

These subheadings also include green malt used for human consumption and consumed in the same way as vegetable sprouts, being a cereal grain that has started to germinate but has not yet been dried.

The whole malt falling in these subheadings is characterised by a floury, white, crumbly kernel. However, in the case of dark malt (of the Munich type), the colour of the kernel in about 10 % of the grains varies from yellow to brown. The kernels have a dry, crumbly consistency. When milled, they produce a fine soft meal.

1107 20 00**Roasted**

This subheading covers any malt in which the diastatic activity has been reduced or has completely disappeared following roasting and which, consequently, acts only during brewing as an additive to the unroasted malt in order to give the beer a special colour and flavour.

The colour of the kernels in such malt varies from dirty white to black, according to the type.

This subheading includes:

1. roasted malt which has been roasted without prior saccharification or after partial saccharification according to the degree of humidity of the pale malt used. This malt has a shiny exterior surface and its endosperm is black without being glassy;
2. caramelised malt of which the sugar formed by prior saccharification has been caramelised. The colour of this malt is dull yellow to pale brown; the endosperm in at least 90 % of the grains is glassy in appearance and dirty white to dark brown in colour. Diastatic activity is still present to some degree in very pale caramelised malt. A proportion of 10 % of non-caramelised grains may occur.

CHAPTER 12

OIL SEEDS AND OLEAGINOUS FRUITS; MISCELLANEOUS GRAINS, SEEDS AND FRUIT; INDUSTRIAL OR MEDICINAL PLANTS; STRAW AND FODDER

- ~~1201 00~~1201 **Soya beans, whether or not broken**
Soya beans (seeds of *Glycine max*), vary in colour between brown, green and black. They contain practically no starch but are rich in protein and oil.
Special care should be taken with the tariff classification of some seeds marketed as 'green soya beans' or 'green beans'. These are often not soya beans but beans classified in heading 0713.
- 1202 **Groundnuts, not roasted or otherwise cooked, whether or not shelled or broken**
The groundnut or peanut, the seed of *Arachis hypogaea*, contains a high level of edible oil.
- 1205 **Rape or colza seeds, whether or not broken**
- 1205 10 10 and 1205 10 90 **Low-erucic-acid rape or colza seeds**
See subheading note 1 to this chapter and the HS Explanatory Note to heading 1205.
- 1206 00 **Sunflower seeds, whether or not broken**
- 1206 00 91 **Shelled; in grey-and-white-striped shell**
The sunflower seeds of this subheading are usually intended for the production of confectionery, for bird feed or for immediate consumption. In general, their length is only half the length of the shell which can exceed 2 cm. These seeds normally have an oil content of approximately 30 to 35 % by weight.
- 1206 00 99 **Other**
This subheading includes sunflower seeds for the production of oil for human consumption. They are normally delivered in their shell which is of uniform black colour. In general, the length of the seeds and the shells is almost identical. These seeds normally have an oil content of approximately 40 to 45 % by weight.
- 1207 **Other oil seeds and oleaginous fruits, whether or not broken**
- 1207 40 10 and 1207 40 90 **Sesamum seeds**
These subheadings cover the seeds of *Sesamum indicum*.
- 1207 50 10 and 1207 50 90 **Mustard seeds**
Mustard seeds are obtained from various vegetable species, for example, *Sinapis alba*, *Brassica hirta*, *Brassica nigra* and *Brassica juncea*.
- ~~1207 99 97~~1207 99 96 **Other**
Provided that they are not included in a previous subheading of this heading, fruit and seeds mentioned in the second paragraph of the HS Explanatory Note to heading 1207 come under this subheading.
This subheading also includes green soft-skinned pumpkin seeds genetically lacking the suberised outer layer of the seed coat (*Cucurbita pepo* L. *Cucurbita pepo* convar. L. convar. *citrullinia* Greb. *citrullinia* var. Greb. var. *styriaca* and *Cucurbita pepo* L. *Cucurbita pepo* var. L. var. *oleifera* Pietsch *oleifera*). These pumpkins are cultivated mainly for their oil and not for use as a vegetable, the latter seeds coming under subheading ~~1209 91 90~~1209 91 80.
This subheading does not include roasted pumpkin seeds (subheading 2008 19).

- 1208 Flours and meals of oil seeds or oleaginous fruits, other than those of mustard**
See note 2 to this chapter.
- 1209 Seeds, fruit and spores, of a kind used for sowing**
- 1209 10 00 Sugar-beet seed**
This subheading covers only seeds of sugar beet (*Beta vulgaris* var. *altissima*). Also included here are seeds called monogerm seeds, obtained either through genetic process or by segmentation of the glomerules (seed called segmented or pre-thinned), whether or not enveloped by a coating, the most common being clay-based.
- 1209 29 60 Fodder-beet seed (~~Beta vulgaris~~ *Beta vulgaris* var. *alba*)**
This subheading also covers seeds called monogerm seeds, obtained either through genetic process or by segmentation of the glomerules (seed called segmented or pre-thinned), whether or not enveloped by a coating, the most common being clay-based.
- 1209 30 00 Seeds of herbaceous plants cultivated principally for their flowers**
This subheading includes the seeds of herbaceous plants cultivated exclusively or mainly for their flowers (flowers for cutting, decoration, etc.). The seeds of the species may be presented on a support medium, for example, in cellulose wadding or in peat. This subheading includes sweet-pea seeds (*Lathyrus odoratus*).
- ~~1209 91 90~~ **1209 91 80 Other**
This subheading includes the seeds of pumpkins cultivated as vegetables when used for sowing, for eating (for example, in salads), in the food industry (for example, in bakery products) or for medicinal purposes. This subheading includes the seeds of pumpkins when used for sowing.
See also the explanatory note to subheading ~~1207 99 97~~ 1207 99 96 and 1212 99 95.
- 1209 99 10 Forest-tree seeds**
This subheading covers grains and other seeds of forest trees, even if they are intended for the production of ornamental trees or shrubs in the importing country.
For the purposes of this subheading, the term ‘trees’ is taken to mean all trees, shrubs or shrublike trees whose trunks, stems and branches are of a woody consistency.
This subheading covers all the seeds and fruit of a kind used for sowing:
1. trees of European as well as exotic species intended for the afforestation of land, with a view to the production of timber but also for the purpose of retaining soils or as a defence against erosion;
 2. trees used for ornamental purposes or in the landscaping of parks, public or private gardens or for lining public squares, town streets, roads, canals, etc.
- Among the trees of the second group — which for the most part belong to the same species as those of the first group — are included those trees which are used not only for their shape or the colour of their foliage (for example, certain types of poplar, maple, conifers, etc.) but also for their flowers (for example, mimosa, tamarisk, magnolia, lilac, laburnum, Japanese cherry, Judas tree, roses) or for the bright colour of their fruit (for example, cherry laurel, cotoneaster, pyracantha or ‘fire-thorn’).
However, the following seeds and fruit are excluded from this subheading even if intended to be used for sowing:
- (a) the fruit or nuts falling in Chapter 8 (in particular, nuts, for example, chestnuts, walnuts, hazelnuts, pecans, almonds, etc.);
 - (b) the seeds and fruit falling in Chapter 9 (for example, juniper seeds);
 - (c) oilseeds and oleaginous nuts falling in headings ~~1201 00~~ 1201 to 1207 (for example, beechnuts, palm kernels).
- This subheading also excludes:
- (a) tamarind seeds (subheading 1209 99 99); and
 - (b) acorns and horse chestnuts (subheading 2308 00 40).

- 1210 Hop cones, fresh or dried, whether or not ground, powdered or in the form of pellets; lupulin**
- 1210 20 10 Hop cones, ground, powdered or in the form of pellets, with higher lupulin content; lupulin**
In addition to lupulin, this subheading covers the products with higher lupulin content obtained by milling the hop cones after mechanical removal of the leaves, stalks, bracts and rachides.
- 1211 Plants and parts of plants (including seeds and fruit), of a kind used primarily in perfumery, in pharmacy or for insecticidal, fungicidal or similar purposes, fresh or dried, whether or not cut, crushed or powdered**
- 1211 20 00 Ginseng roots**
This subheading covers the roots of ginseng (*Panax quinquefolium* and *Panax ginseng*). The root is cylindrical to spindle-shaped, with circular wrinkles round the upper third; they are often divided into several branches. The outer colour ranges from yellowish white to brown-yellow, and the interior is white and farinaceous (or hard like horn if it has been boiled in water). This subheading also covers crushed or ground ginseng roots.
- 1211 90 30 Tonquin beans**
This subheading covers the seed of *Dipteryx odorata* ~~(family~~ (family *Leguminosae*). They are also called tonga or tonka beans and coumaru. They contain coumarin and are used in the perfumery industry and in the manufacture of essences for diet drinks. *Leguminosae*). ~~They are also called tonga or tonka beans and coumaru. They contain coumarin and are used in the perfumery industry and in the manufacture of essences for diet drinks.~~
- ~~1211 90 85~~ **1211 90 86 Other**
Provided that they are not included in a previous subheading of this heading, this subheading includes the plants, parts of plants, seeds and fruit mentioned in the HS Explanatory Note to heading 1211, eleventh paragraph, and the following:
1. parts of the cannabis plant, whether or not mixed with inorganic or organic substances (used simply as extenders);
 2. 'orange peas' or 'orangettes' which are immature, inedible oranges which fall soon after the tree has blossomed and gathered dry, with a view, in particular, to extraction of their essential oil (petit-grain);
 3. leaves of dried dandelion (*Taraxacum officinale*);
 4. dried sorrel (*Rumex acetosa*);
 5. dried nasturtium or Indian cress (*Tropaeolum majus*).
- This subheading does not include algae (heading 1212) or pumpkin seeds (heading 1207 or 1209).

- 1212** **Locust beans, seaweeds and other algae, sugar beet and sugar cane, fresh, chilled, frozen or dried, whether or not ground; fruit stones and kernels and other vegetable products (including unroasted chicory roots of the variety *Cichorium intybus sativum*) of a kind used primarily for human consumption, not elsewhere specified or included**
- ~~1212 20 00~~ **1212 21 00** and **1212 29 00** **Seaweeds and other algae**
See the HS Explanatory Note to heading 1212, (A).
- 1212 91 20** and **1212 91 80** **Sugar beet**
These subheadings apply only to non-desugared beet having a sucrose content generally exceeding 60 % by weight calculated on the dry matter. Partly or wholly desugared, it falls in subheading 2303 20 10 or 2303 20 90.
- ~~1212 99 30~~ **1212 92 00** ~~Locust beans~~ **Locust beans (carob)**
See the HS Explanatory Note to heading 1212, (C), first and second paragraphs.
- 1212 99 41** and **1212 99 49** **Locust-bean seeds**
See the HS Explanatory Note to heading 1212, (C), third paragraph.
- ~~1212 99 70~~ **1212 99 95** **Other**
In addition to the products cited in the HS Explanatory Note to heading 1212, (D), third, fourth and fifth paragraphs, this subheading includes:
1. tubers of konjak or konnyaku, whole, ground or powdered;
 2. 'pollen flour' — small lumps consisting of pollen collected by bees and agglomerated with nectar, honey and bees' saliva.
- Pumpkin seeds (heading 1207 or 1209) are not included in this subheading. are not included in this subheading, with the exception of shelled pumpkin seeds which are to be classified under heading 1212 in accordance with the provisions laid down in the judgment of the Court of Justice of the European Union in Case C-229/06.
- 1214** **Swedes, mangolds, fodder roots, hay, lucerne (alfalfa), clover, sainfoin, forage kale, lupines, vetches and similar forage products, whether or not in the form of pellets**
- 1214 90 10** **Mangolds, swedes and other fodder roots**
This subheading covers:
1. mangolds (or fodder beet) (*Beta vulgaris* var. *alba*);
 2. swedes or rutabagas (*Brassica napus* var. *napobrassica*);
 3. other fodder roots, for example, forage turnips and forage carrots.
- The various species and varieties of Jerusalem artichoke (for example, *Helianthus tuberosus*) are classified in heading 0714, while parsnips (*Pastinaca sativa*) are classified in Chapter 7 as vegetables (heading 0706, if fresh or chilled).

CHAPTER 13

LAC; GUMS, RESINS AND OTHER VEGETABLE SAPS AND EXTRACTS

- 1301 Lac; natural gums, resins, gum-resins and oleoresins (for example, balsams)**
- 1301 20 00 Gum Arabic**
Gum Arabic (or acacia gum or Senegal gum) is presented in yellowish or reddish pieces, is translucent and is soluble in water but not in spirit.
- 1302 Vegetable saps and extracts; pectic substances, pectinates and pectates; agar-agar and other mucilages and thickeners, whether or not modified, derived from vegetable products**
- 1302 11 00 Opium**
See the HS Explanatory Note to heading 1302, (A), (1).
- 1302 12 00 Of liquorice**
See the HS Explanatory Note to heading 1302, (A), (2).
- ~~1302 19 80~~ **1302 19 70 Other**
See the HS Explanatory Note to heading 1302, (A), (4) to (20).
- 1302 20 10 and 1302 20 90 Pectic substances, pectinates and pectates**
These subheadings cover the products referred to in the HS Explanatory Note to heading 1302, (B).
- 1302 31 00 Agar-agar**
See the HS Explanatory Note to heading 1302, (C), (1).
- 1302 32 10 and 1302 32 90 Mucilages and thickeners, whether or not modified, derived from locust beans, locust bean seeds or guar seeds**
See the HS Explanatory Note to heading 1302, (C), (2).
These subheadings do not include guar seed endosperm ('guar splits') in the form of small, light-yellow, irregularly shaped flakes (heading 1404).
- 1302 39 00 Other**
In addition to the products listed in the HS Explanatory Note to heading 1302, (C), (3) to (5), this subheading also includes:
1. the extract prepared from the alga *Furcellaria fastigiata*, harvested on the coasts of Denmark, which is obtained in the same way and put up in the same form as agar-agar;
 2. mucilages derived from quince seeds;
 3. mucilages derived from Iceland moss;
 4. carrageenin and calcium, sodium and potassium carrageenates, even when standardised with sugar (for example, sucrose, glucose) added to ensure a constant activity in use. The content of added sugar generally does not exceed 25 %.

SECTION III

ANIMAL OR VEGETABLE FATS AND OILS AND THEIR CLEAVAGE PRODUCTS; PREPARED EDIBLE FATS; ANIMAL OR VEGETABLE WAXES

CHAPTER 15

ANIMAL OR VEGETABLE FATS AND OILS AND THEIR CLEAVAGE PRODUCTS; PREPARED EDIBLE FATS; ANIMAL OR VEGETABLE WAXES**General**

For the purposes of the subheadings of this chapter which include the term, 'industrial uses' is to be taken to apply only to those uses which involve transformation of the basic product.

On the other hand, 'technical uses', a term also found in some subheadings, implies no such transformation.

Treatments such as purification, refining or hydrogenation are not regarded as 'industrial uses' or 'technical uses'.

It is stressed that even products suitable for human consumption may be intended for technical or industrial uses.

The subheadings of this chapter which are devoted to products for technical or industrial uses other than the manufacture of foodstuffs for human consumption include oils and fats for the manufacture of animal feedingstuffs.

Additional note 1(a) The fluid fraction of vegetable oils obtained by separating off the solid phase, for example, by cooling, use of organic solvents, surfactants, etc., cannot be considered as crude oils.

~~1502-00~~1502**Fats of bovine animals, sheep or goats, other than those of heading 1503**

This heading includes in addition to rendered fats, unrendered fats, i.e., fat enclosed in its cellular membranes.

The following are therefore included in this heading:

1. unrendered fats, raw or in the form of tallow (slaughterhouse fat, butcher's fat, gut-dressing fat);
2. rendered fats, including:
 - (a) 'Premier jus' fat which is the best grade of edible tallow;
 - (b) 'Greaves' fat;
 - (c) 'Acid' fat, obtained by boiling the lowest-quality unrendered fat in an aqueous solution of sulphuric acid which hydrolyses the albuminoid substances in the tissues, thus releasing the fat;
3. fats obtained from the bones or waste of bovine animals, sheep or goats.

However, this heading does not include bone and marrow oil and foot oil (heading 1506 00 00).

1503 00

Lard stearin, lard oil, oleostearin, oleo-oil and tallow oil, not emulsified or mixed or otherwise prepared

1503 00 11 and and

Lard stearin and oleostearin

1503 00 19

These subheadings cover the products referred to in the second and penultimate paragraphs of the HS Explanatory Note to heading 1503.

1503 00 30**Tallow oil for industrial uses other than the manufacture of foodstuffs for human consumption**

This subheading covers the product described in the fifth paragraph of the HS Explanatory Note to heading 1503, provided that it is intended for industrial uses other than the manufacture of foodstuffs for human consumption (see the general explanatory note to this chapter).

- 1503 00 90** **Other**
In addition to the products referred to in the third and fourth paragraphs of the HS Explanatory Note to heading 1503, this subheading includes tallow oil which does not meet the conditions laid down in subheading 1503 00 30, for example, tallow oil for technical uses.
- 1504** **Fats and oils and their fractions, of fish or marine mammals, whether or not refined, but not chemically modified**
See the HS General Explanatory Note to this chapter, part (A), sixth and seventh paragraphs.
- 1504 10 10** ~~to~~ **to 1504 10 99** **Fish-liver oils and their fractions**
See the HS Explanatory Note to heading 1504, second paragraph.
- 1504 10 10** **Of a vitamin A content not exceeding 2 500 IU/g**
The vitamin A content of the liver oil obtained from Gadidae (cod, haddock, ling, hake, etc.) generally does not exceed 2 500 IU/g.
- 1504 10 91** ~~and~~ **and** **Other**
1504 10 99 The vitamin A content of the liver oil obtained from tunny-fish, halibut and several kinds of shark, for example, generally exceeds 2 500 IU/g.
Oils with an increased vitamin content remain classified in these subheadings provided that they have not lost the character of fish-liver oil. This is, for example, the case of fish-liver oils with a vitamin A content not exceeding 100 000 IU/g.
- 1504 20 10** ~~and~~ **and** **Fats and oils and their fractions, of fish, other than liver oils**
1504 20 90 These subheadings cover the fats and oils obtained from all species of fish, and their fractions, except the oils extracted exclusively from their livers, and include:
1. oils obtained from herring and menhaden (a clupeid similar to herring, fished exclusively for oil extraction);
 2. oils obtained from the residues from the preserving process, of less value than the oils above. Those of commercial significance are the oils from Clupeidae residues, the oils from tunny-fish and bonito residues and the oils from Salmonidae residues;
 3. oils from residues from the fish trade which are of a very mixed composition and even less value;
 4. fish stearin, which is described in the fifth paragraph of the HS Explanatory Note to heading 1504.
- The fats and oils of this subheading are used primarily for technical and industrial uses such as tanning, paint preparations, cutting oils.
- 1504 30 10** ~~and~~ **and** **Fats and oils and their fractions, of marine mammals**
1504 30 90 These subheadings include:
1. whale oil and crude sperm oil which are described in the third and fourth paragraphs of the HS Explanatory Note to heading 1504;
 2. blubber of marine mammals;
 3. oils from pinnipeds (seals, walruses and sea-lions).
- These subheadings cover all oils of marine mammals, and their fractions, including those extracted from their livers such as sperm whale liver-oil which, being very rich in vitamin A, has properties similar to those of the fish-liver oils of subheadings 1504 10 10, 1504 10 91 and 1504 10 99.

1505 00	Wool grease and fatty substances derived therefrom (including lanolin)
1505 00 10	Wool grease, crude See the first paragraph of the HS Explanatory Note to heading 1505.
1505 00 90	Other This subheading covers: <ol style="list-style-type: none">lanolin, which is described in the second, third and fourth paragraphs of the HS Explanatory Note to heading 1505;fatty substances derived from wool grease (wool grease olein and wool grease stearin), which are the liquid and solid parts respectively obtained after distilling and then pressing the wool grease.
1506 00 00	Other animal fats and oils and their fractions, whether or not refined, but not chemically modified This heading does not include inedible mixtures or preparations of animal fats and oils, for example, slaughterhouse fats from various animals or mixtures or preparations of animal and vegetable fats and oils, for example, waste frying fats (heading 1518).
1507	Soya-bean oil and its fractions, whether or not refined, but not chemically modified
1507 10 10 and and 1507 10 90	Crude oil, whether or not degummed For a definition of the term 'crude', see additional note 1 to this chapter, paragraphs (a), (b) and (c).
1507 90 10 and and 1507 90 90	Other These subheadings include refined soya-bean oil.
1508	Groundnut oil and its fractions, whether or not refined, but not chemically modified
1508 10 10 and and 1508 10 90	Crude oil See additional note 1(a) and (b) to this chapter.
1508 90 10 and and 1508 90 90	Other These subheadings include refined groundnut oil.
1509	Olive oil and its fractions, whether or not refined, but not chemically modified Olive oil falling in this heading must meet the following three requirements: <ol style="list-style-type: none">it must have been obtained solely from the treatment of the fruit of the olive tree (<i>Olea europaea L.</i>);it must have been obtained solely by mechanical or other physical means (for example, by pressing), thus excluding the use of solvents (see note 2 to this chapter);it must not have been re-esterified or mixed with other oils, including olive-pomace oil falling in heading 1510 00.
1509 10 10	Lampante olive oil See additional note 2(B)(1) to this chapter.

1509 10 90	Other See additional note 2(B)(2) to this chapter.
1509 90 00	Other See additional note 2(C) to this chapter. This subheading includes not only refined olive oil but also refined olive oil blended with virgin olive oil.
1510 00	Other oils and their fractions, obtained solely from olives, whether or not refined, but not chemically modified, including blends of these oils or fractions with oils or fractions of heading 1509 This heading covers only those oils meeting the requirement set out in item 1 of the explanatory note to heading 1509. Like those falling in heading 1509, oils falling in heading 1510 00 must not have been re-esterified or mixed with other oils, i.e., oils other than olive oil, but: — they may be extracted by means of solvents or by physical means; — they may be blended with oils or fractions falling in heading 1509; the most common blend consists of a mixture of refined olive-pomace oil and virgin olive oil.
1510 00 10	Crude oils See additional note 2(D) to this chapter.
1510 00 90	Other This subheading includes refined olive-pomace oil and blends of refined olive-pomace oil with virgin olive oil.
1511	Palm oil and its fractions, whether or not refined, but not chemically modified
1511 10 10 and and 1511 10 90	Crude oil See additional note 1(a) and (b) to this chapter. Crude palm oil decomposes more rapidly than other oils and consequently has a high free-fatty-acid content.
1511 90 11 and and 1511 90 19	Solid fractions These subheadings cover palm stearin.
1511 90 91 and and 1511 90 99	Other These subheadings include: 1. refined palm oil; 2. the fluid fraction of palm oil obtained when the solid phase is separated off by cooling or by the use of organic solvents or surfactants. This fraction (palm olein), which may have a fatty-acid composition in some cases very similar to that of unfractionated palm oil, can normally be distinguished by comparing the relative proportions of its component triglycerides with that of typical unfractionated palm oil. The triglycerides containing higher number carbon atoms (C ₅₂ and C ₅₄) are found in greater amounts in the fluid fraction than in the unfractionated oil, whereas triglycerides containing the relatively lower number carbon atoms (C ₅₀ and C ₄₈) predominate in the solid fraction.
1512	Sunflower-seed, safflower or cotton-seed oil and fractions thereof, whether or not refined, but not chemically modified
1512 11 91	Sunflower-seed oil See additional note 1(a) and (b) to this chapter, together with part (A) of the HS Explanatory Note to heading 1512.

- 1512 11 99 Safflower oil**
See additional note 1(a) and (b) to this chapter, together with part (B) of the HS Explanatory Note to heading 1512.
- 1512 19 90 Other**
This subheading includes refined sunflower-seed oil and refined safflower oil.
- 1512 21 10~~to~~ to 1512 29 90 Cotton-seed oil and its fractions**
See the HS Explanatory Note to heading 1512, part (C).
- 1514 Rape, colza or mustard oil and fractions thereof, whether or not refined, but not chemically modified**
- 1514 11 10~~to~~ to 1514 19 90 Low-erucic-acid rape or colza oil and its fractions**
See subheading note 1 to this chapter and the HS Explanatory Note to heading 1514, part (A), second paragraph, second sentence.
- 1515 Other fixed vegetable fats and oils (including jojoba oil) and their fractions, whether or not refined, but not chemically modified**
- 1515 30 10~~and~~ and 1515 30 90 Castor oil and its fractions**
Castor oil is also known as 'palma Christi oil' and 'kerva oil'.
These subheadings do not cover Curcas oil (or purgative oil) extracted from the seeds of the '*Jatropha curcas*' tree, of the Euphorbiaceae family, often called 'American castor oil' or 'wild castor oil' (subheadings 1515 90 40 to 1515 90 99).
- 1517 Margarine; edible mixtures or preparations of animal or vegetable fats or oils or of fractions of different fats or oils of this chapter, other than edible fats or oils or their fractions of heading 1516**
For the definition of the term 'margarine', see the HS Explanatory Note to subheadings 1517 10 and 1517 90.
- 1517 10 10~~and~~ and 1517 10 90 Margarine, excluding liquid margarine**
See the HS Explanatory Note to heading 1517, fifth paragraph, (A).
It should be noted that the water content is not a determining factor in the classification of products in these subheadings.
- 1517 90 91 Fixed vegetable oils, fluid, mixed**
This subheading includes mixtures of chemically modified vegetable oils.
- 1521 Vegetable waxes (other than triglycerides), beeswax, other insect waxes and spermaceti, whether or not refined or coloured**
- 1521 10 00 Vegetable waxes**
In addition to the products described in the HS Explanatory Note to heading 1521, part (I), this subheading includes coffee wax which occurs naturally in all parts of the coffee shrub (beans, parchment skin, leaves, etc.) and is a by-product of the manufacture of decaffeinated coffee. It is black, has a coffee-like smell and is used in the manufacture of certain cleaning products.
- 1521 90 91 Raw**
This subheading includes waxes in natural combs.
- 1521 90 99 Other**
This subheading includes waxes, pressed or refined, whether or not bleached or coloured.
- 1522 00 Degras; residues resulting from the treatment of fatty substances or animal or vegetable waxes**
- 1522 00 31~~and~~ and 1522 00 39 Containing oil having the characteristics of olive oil**
See additional note 3 to this chapter, which specifies the residues which are excluded from these subheadings.

SECTION IV

**PREPARED FOODSTUFFS; BEVERAGES, SPIRITS AND VINEGAR; TOBACCO AND MANUFACTURED TOBACCO
SUBSTITUTES**

CHAPTER 16

PREPARATIONS OF MEAT, OF FISH OR OF CRUSTACEANS, MOLLUSCS OR OTHER AQUATIC INVERTEBRATES**General**

For the classification of composite food preparations (including so-called 'prepared meals') consisting of, for example, sausage, meat, meat offal, fish or crustaceans, molluscs or other aquatic invertebrates or any combination thereof, together with vegetables, spaghetti, sauce, etc., see note 2 to this chapter and the HS General Explanatory Note to this chapter, penultimate paragraph.

The second sentence of the first paragraph of note 2 (classification in the heading corresponding to the component which predominates by weight) also applies to the determination of the subheadings. The foregoing does not apply, however, to preparations containing liver, of headings 1601 00 and 1602 (see paragraph 2 of the note).

Additional note 2 As a general rule, the cut from which a part is obtained is identifiable only where the part measures approximately 100 × 80 × 2 mm or more.
The expression 'parts thereof' applies solely to parts when the cut from which they were obtained (for example, hams) can be determined by positive means, rather than by a process of elimination.

- 1601 00** **Sausages and similar products, of meat, meat offal or blood; food preparations based on these products**
The fact that products may be considered to be 'sausages and similar products' for trade purposes is not a determining factor for the purposes of classification in this heading.
Chopped or comminuted meat preparations which have become moulded into shape as a result of being packed in cans or other rigid containers, whether or not cylindrical, are not regarded as 'sausages' for the purposes of this heading.
- 1601 00 10** **Of liver**
This subheading includes sausages and similar products containing liver, with or without the addition of meat, meat offal, fat, etc., provided that the liver gives the products their essential character. These products, generally cooked and sometimes smoked, are recognisable essentially by the characteristic taste of liver.
- 1601 00 91** **Sausages, dry or for spreading, uncooked**
This subheading covers uncooked sausages, provided that they have been matured (for example, by drying in the air) and are ready for immediate consumption.
Such products can also be smoked, provided that the smoking does not cause a total coagulation of the albumins brought about by a heat treatment such as smoking at a high temperature.
Consequently, this subheading covers sausages which are normally eaten in slices (such as salami, Arles sausages, Plockwurst), as well as sausages for spreading, for example, Teewurst.
- 1601 00 99** **Other**
This subheading includes:
1. sausages and the like, fresh, which have not undergone any maturing process;

2. cooked sausages, for example, Frankfurter sausages, Strasbourg sausages, Vienna sausages, mortadellas, sausages made from chitterlings known as 'andouilles' and 'andouillettes', white puddings, black puddings and other similar specialities.

1602	Other prepared or preserved meat, meat offal or blood
1602 10 00	Homogenised preparations See subheading note 1 to this chapter.
1602 20 10 and and 1602 20 90	Of liver of any animal These subheadings cover prepared or preserved products containing liver, whether or not mixed with meat or other meat offal, provided that the liver gives the products their essential character. The main products of these subheadings are obtained from goose or duck livers (subheading 1602 20 10).
1602 31 11 to to 1602 39 80 1602 39 85	Of poultry of heading 0105 These subheadings include poultry and parts of poultry preserved after cooking. These products include: <ol style="list-style-type: none"> 1. chicken in jelly; 2. halves or quarters of chicken in sauce and whole legs of turkey, goose or chicken, whether frozen or not; 3. poultry pâté (consisting essentially of poultrymeat to which veal, pig fat, truffles and spices have been added), whether or not frozen; 4. prepared dishes containing poultrymeat as the basic ingredient, together with other products such as vegetables, rice or products of the macaroni type as a supplement to the meat dish itself. Examples of dishes within this category are preparations known as 'chicken with rice' and 'chicken with mushrooms', as well as frozen prepared poultry dishes put up on a tray, holding separately the meat itself and the various other items. <p>In determining the percentage of poultrymeat or offal, the weight of any bones must be disregarded.</p>
1602 31 11	Containing exclusively uncooked turkey meat See additional note 1 to this chapter.
1602 32 11	Uncooked See additional note 1 to this chapter.
1602 39 21	Uncooked See additional note 1 to this chapter.
1602 41 10 and and 1602 41 90	Hams and cuts thereof See additional note 2 to this chapter for the scope of the term 'cuts thereof', and the relevant explanatory notes. Chopped or finely comminuted preparations are excluded from these subheadings, even if they are made from hams or cuts thereof.
1602 42 10 and and 1602 42 90	Shoulders and cuts thereof See additional note 2 to this chapter for the scope of the term 'cuts thereof', and the relevant explanatory notes. Chopped or finely comminuted preparations are excluded from these subheadings, even if they are made from shoulders or cuts thereof.
1602 49 11 to to 1602 49 50	Of domestic swine For the determination of the percentages of meat or meat offal of any kind, including fats of any kind or origin, see Commission Regulation (EEC) No 226/89 (OJ L 029, 31.1.1989, p. 11). In determining these percentages, gelatines and sauces are not to be taken into account.

- 1602 49 15** **Other mixtures containing hams (legs), shoulders, loins or collars, and cuts thereof**
See additional note 2 to this chapter for the scope of the term ‘cuts thereof’, and the relevant explanatory notes. Mixtures falling in this subheading must contain at least one of the cuts (and/or parts thereof) referred to in the title of the subheading, though that cut need not confer on the mixture its essential character. The mixture may also contain meat or meat offal of other animals.
- 1602 50 10** **Uncooked; mixtures of cooked meat or offal and uncooked meat or offal**
See additional note 1 to this chapter.
- 1602 50 31** **Corned beef, in airtight containers**
For the purposes of subheading 1602 50 31, the expression ‘in airtight containers’ is taken to mean products put up in containers which have been sealed up, whether or not under vacuum, to prevent air or other gases from coming in or out of them. Once the container is opened, the original seal is permanently broken.
~~This subheading includes products put up, inter alia, in sealed plastic bags whether or not under vacuum.~~ *inter alia, in sealed plastic bags whether or not under vacuum.*
- 1602 90 61** **Uncooked; mixtures of cooked meat or offal and uncooked meat or offal**
See additional note 1 to this chapter.
- ~~**1602 90 72 and 1602 90 74** **Uncooked; mixtures of cooked meat or offal and uncooked meat or offal**~~
See additional note 1 to this chapter.
- 1604** **Prepared or preserved fish; caviar and caviar substitutes prepared from fish eggs**
See subheading note 2 to this chapter.
- 1604 12 91** **In airtight containers**
See the explanatory note to subheading 1602 50 31.
- 1604 14 16** **Fillets known as ‘loins’**
This subheading covers only fillets within the meaning of the HS Explanatory Note to heading 0304, (1), which have the three following characteristics:
— cooked;
— packed, without a liquid covering medium, in bags (or wrappers) of a kind used for packaging food, whether or not vacuum-packed or heat-sealed; and
— frozen.
- 1604 19 31** **Fillets known as ‘loins’**
See the explanatory note to subheading 1604 14 16.
- 1604 20 05** **Preparations of surimi**
See the explanatory note to subheading ~~0304 99 10~~ 0304 93 10.
The preparations falling in this subheading are made from surimi mixed with other products (for example, flour, starch, proteins, the meat of crustaceans, spices, flavourings and colourings). They are subjected to heat treatment and generally presented in a frozen state.
- 1605** **Crustaceans, molluscs and other aquatic invertebrates, prepared or preserved**
See subheading note 2 to this chapter.
- ~~**1605 20 10**~~ **1605 29 00** ~~**In airtight containers**~~ **Other**
See the explanatory note to subheading ~~This subheading covers shrimps and prawns packed in airtight containers (see the explanatory note to subheading 1602 50 31-).~~
- ~~**1605 90 11**~~ **1605 53 10** **In airtight containers**
See the explanatory note to subheading 1602 50 31.

CHAPTER 17
SUGARS AND SUGAR CONFECTIONERY

1701	Cane or beet sugar and chemically pure sucrose, in solid form
1701 11 10 1701 12 90 <u>1701 12 10</u> <u>1701 14 90</u>	Raw sugar not containing added flavouring or colouring matter See subheading note 1 to this chapter. These subheadings include: <ol style="list-style-type: none"> 1. certain white unrefined sugars; 2. brown sugars with a low degree of polarisation, obtained from the second and third strikes in the sugar-manufacturing process and ranging in colour from yellow to dark brown as a result mainly of the molasses they contain, having a sucrose content generally between 85 and 98 % by weight; 3. less pure sugars resulting from the refining process or from the manufacture of sugar candy, for example, fourths, pieces and brown sugars.
1701 11 10 and 1701 11 90	Cane sugar See the HS Explanatory Note to subheadings 1701 11 and 1701 12 .
1701 12 10 and 1701 12 90	Beet sugar See the HS Explanatory Note to subheadings 1701 11 <u>1701 12</u> , <u>1701 13</u> and 1701 14 <u>1701 14</u> .
<u>1701 13 10</u> and <u>1701 13 90</u>	Cane sugar specified in subheading note 2 to this chapter See the HS Explanatory Note to subheadings <u>1701 12</u> , <u>1701 13</u> and <u>1701 14</u> .
<u>1701 14 10</u> and <u>1701 14 90</u>	Other cane sugar See the HS Explanatory Note to subheadings <u>1701 12</u> , <u>1701 13</u> and <u>1701 14</u> .
1701 91 00	Containing added flavouring or colouring matter Flavoured or coloured sugars are classified in this subheading even if their sucrose content is below 99,5 % by weight.
1701 99 10	White sugar See additional note 3 to this chapter. The white sugars of this subheading are sugars, whether or not refined, which are generally white in colour because of their high sucrose content (99,5 % by weight and over). For the determination of the sucrose content of white sugar in relation to additional note 3 to Chapter 17, the polarimetric method set out in Commission Directive 79/796/EEC, Annex II, method 10, is to be applied (OJ L 239, 22.9.1979, p. 24).
1702	Other sugars, including chemically pure lactose, maltose, glucose and fructose, in solid form; sugar syrups not containing added flavouring or colouring matter; artificial honey, whether or not mixed with natural honey; caramel
1702 11 00 and 1702 19 00	Lactose and lactose syrup See the HS Explanatory Note to heading 1702, (A), (1), and (B), first paragraph.
1702 30 10	Isoglucose See additional note 5 to this chapter.
1702 30 50 and 1702 30 90	Other For the purposes of calculating the percentage weight of glucose, the expression ‘in the dry state’ is to be taken to exclude both free water and water of crystallisation.

1702 40 10	Isoglucose See additional note 5 to this chapter.
1702 60 10	Isoglucose See additional note 5 to this chapter.
1702 60 80	Inulin syrup See additional note 6 (a) to this chapter.
1702 90 30	Isoglucose See additional note 5 to this chapter.
1702 90 80	Inulin syrup See additional note 6 (b) to this chapter.
1702 90 95	Other This subheading includes: <ol style="list-style-type: none"> 1. maltose, other than chemically pure maltose; 2. invert sugar; 3. sucrose syrups (other than maple syrup), neither coloured nor flavoured; 4. the products inaccurately called 'high-test molasses' obtained by the hydrolysis and concentration of raw cane juice and used mainly as a nutritive medium in the manufacture of antibiotics and also for the manufacture of ethyl alcohol; 5. lactulose, other than chemically pure lactulose.
1703	Molasses resulting from the extraction or refining of sugar
1703 10 00	Cane molasses See the HS Explanatory Note to subheading 1703 10.
1704	Sugar confectionery (including white chocolate), not containing cocoa
1704 10 10 and <u>and</u>	Chewing gum, whether or not sugar-coated
1704 10 90	These subheadings cover sweetened chewing gum, characterised by the presence of chicle gum or other similar non-edible products, irrespective of the form in which they are put up (slabs, sugar-coated lozenges, balls, etc.), including 'bubble gum'.
1704 90 10	Liquorice extract containing more than 10 % by weight of sucrose but not containing other added substances This subheading covers only liquorice extract containing by weight more than 10 % of sucrose, without the addition of any other sugars, flavourings or other substances, whether or not put up in the form of cakes, sticks, pastilles, etc. Liquorice extract prepared as confectionery by the addition of other substances falls in subheading 1704 90 99 irrespective of the proportion of sucrose.
1704 90 30	White chocolate See the HS Explanatory Note to heading 1704, second paragraph, (vi).

1704 90 51 to 1704 90 99 Other

These subheadings cover most of the sugar preparations commonly known as 'sweets' or 'confectionery'. These preparations remain classified in these subheadings, even if they contain potable spirits or an alcohol-based liqueur.

These subheadings also include pastes for the manufacture of fondant, marzipan, nougat, etc., which are semi-manufactured products used in confectionery and generally put up as blocks or cakes. These semi-manufactures remain classified in these subheadings, even if their sugar content is later increased in the course of processing into final products, provided that they are specifically intended by their composition to be used only in manufacturing a certain type of confectionery.

These subheadings exclude:

- (a) edible ices, even where presented as bars attached to a stick in the manner of lollipops (heading 2105 00);
- (b) confectionery containing cocoa mixed in varying proportions with confectionery not containing cocoa and packaged for sale as a mixture (heading 1806).

1704 90 51**Pastes, including marzipan, in immediate packings of a net content of 1 kg or more**

See the HS Explanatory Note to heading 1704, second paragraph, (iv) and (ix).

This subheading includes sugar-coating or glazing mixes.

1704 90 55**Throat pastilles and cough drops**

See the HS Explanatory Note to heading 1704, second paragraph, (v).

1704 90 61**Sugar-coated (panned) goods**

This subheading covers sugar confectionery goods, such as sugar-coated almonds with a hard sugar coating or shell.

'Panned' sweets are obtained by putting the centre of a sweet (for example, an almond) into a pan of sugar syrup; when the pan is rotated, the centre collects sugar. On cooling, the sugar forms a distinct outer coating.

1704 90 65**Gum confectionery and jelly confectionery, including fruit pastes in the form of sugar confectionery**

Gum confectionery and jelly confectionery are products made from gelling agents (such as gum arabic, gelatine, pectin and certain starches), together with sugar and flavourings. They take various forms, for example, human or animal shapes.

1704 90 71**Boiled sweets, whether or not filled**

Boiled sweets are hard, sometimes brittle, and may be clear or opaque in appearance. They consist essentially of sugars which have been boiled and to which small quantities of other substances (except fats) have been added to achieve a large variety of flavours, consistencies and colours. Such products may also contain a central filling.

1704 90 75**Toffees, caramels and similar sweets**

Toffees, caramels and similar sweets are products which, like boiled sweets, are obtained by boiling sugar but contain added fat.

1704 90 81**Compressed tablets**

Compressed tablets are sugar confectionery presented in various forms obtained by compression, with or without a binder.

1704 90 99**Other**

This subheading covers sugar confectionery not included in previous subheadings. It includes:

1. fondants;
2. marzipan in packages for immediate consumption having a net content of less than 1 kg (marzipan in other packages: subheading 1704 90 51);
3. nougat;
4. liquorice extract put up as confectionery.

CHAPTER 20

PREPARATIONS OF VEGETABLES, FRUIT, NUTS OR OTHER PARTS OF PLANTS

General

This chapter covers snack-products ready for consumption, in the form of, for example, dried peas or peanuts which are only partially coated with dough and where the essential character of the product is consequently given by the vegetables, fruit, nuts or other parts of plants.

This chapter also covers cucumbers and gherkins that have undergone complete lactic fermentation.

However, cucumbers and gherkins which have not undergone complete lactic fermentation and which are provisionally preserved in brine are to be classified in subheading 0711 40 00 if they are not suitable for immediate consumption. In general, such products contain by weight at least 10 % of salt.

Note 4 For the determination of the dry-weight content of tomato juice, the analytical method set out in the Annex to Commission Regulation (EEC) No 1979/82 (OJ L 214, 22.7.1982, p. 12) is to be applied.

Additional note 1 In order to determine the acid content of the product, aliquot proportions of the liquid and solid parts of the goods should be homogenised.

2001 **Vegetables, fruit, nuts and other edible parts of plants, prepared or preserved by vinegar or acetic acid**
See note 3 to this chapter.

2001 90 10 **Mango chutney**
For the purposes of this subheading and subheading 2103 90 10, 'mango chutney' means a preparation of pickled mangoes to which various products such as ginger, dried grapes, pepper and sugar have been added. Whereas the mango chutney falling in this subheading contains pieces of fruit, the mango chutney falling in subheading 2103 90 10 takes the form of a completely homogenised sauce, the consistency of which varies in thickness.

2001 90 50 **Mushrooms**
This subheading does not include mushrooms which have been only provisionally preserved by the processes specified in heading 0711, for example, by a strong brine containing vinegar or acetic acid.

2002 **Tomatoes prepared or preserved otherwise than by vinegar or acetic acid**

2002 10 10 and 2002 10 90 **Tomatoes, whole or in pieces**
These subheadings include tomatoes, whole or in pieces, whether or not peeled, preserved by sterilising.

2002 90 11 to 2002 90 99 **Other**
These subheadings include tomato purée, whether or not in cake form, tomato concentrate and tomato juice, the dry-weight content of which is 7 % or more. They also include tomato powder obtained by dehydrating tomato juice; however, they do not include powder resulting from grinding the flakes obtained by drying tomatoes previously cut into slices, which falls in subheading 0712 90 30.

2004 **Other vegetables prepared or preserved otherwise than by vinegar or acetic acid, frozen, other than products of heading 2006**
See note 3 to this chapter.
This heading does not cover preparations of products of heading 0714 which are not considered to be vegetables (subheading 2001 90 40, 2006 00 38, 2006 00 99 or 2008 99 91).

- 2004 10 10** **Cooked, not otherwise prepared**
This subheading includes the products referred to in the HS Explanatory Note to heading 2004, second paragraph, (1).
- 2004 10 91** **and** **2004 10 99** **Other**
These subheadings include the products referred to in the HS Explanatory Note to heading 2004, second paragraph, (3).
- 2004 90 50** **Peas (*Pisum sativum*) and immature beans of the species *Phaseolus* spp., in pod**
For the purposes of this subheading, 'beans in pod' is to be taken to mean only beans of the genera *Phaseolus* and *Vigna* picked before maturity, the whole pod of which is edible. The pod may be of various colours such as uniform green, green with grey or blue markings, or yellow (wax beans).
- 2005** **Other vegetables prepared or preserved otherwise than by vinegar or acetic acid, not frozen, other than products of heading 2006**
The explanatory note to heading 2004 applies to this heading.
This heading covers the product known as 'papad', which is made of sheets of dried dough prepared from flour of leguminous vegetables, salt, spices, oil, raising agents and in some cases small amounts of cereal flour or rice flour.
- 2005 10 00** **Homogenised vegetables**
See subheading note 1 to this chapter.
- 2005 20 80** **Other**
This subheading includes potatoes, sliced or chipped, precooked in fat or oil, chilled and vacuum-packed.
- 2005 70 00** **Olives**
This subheading covers the olives referred to in the HS Explanatory Note to heading 2005, fourth paragraph, (1), whether or not stuffed with vegetables (for example, pimentos or sweet peppers), fruit or nuts (for example, almonds) or a mixture of vegetables and fruit or nuts.
- 2006 00** **Vegetables, fruit, nuts, fruit-peel and other parts of plants, preserved by sugar (drained, glacé or crystallised)**
- 2006 00 31** **to** **2006 00 38** **With a sugar content exceeding 13 % by weight**
See additional note 2(a) to this chapter as regards sugar content.
- 2007** **Jams, fruit jellies, marmalades, fruit or nut purée and fruit or nut pastes, obtained by cooking, whether or not containing added sugar or other sweetening matter**
See note 5 to this chapter, as regards 'obtained by cooking'.
See additional note 2(a) to this chapter, as regards 'sugar content'.
This heading does not include fruit purées obtained by sieving then brought to the boil in a vacuum, the texture and chemical composition of which have not been changed by the heat treatment (heading 2008).
- 2007 10 10** **to** **2007 10 99** **Homogenised preparations**
See subheading note 2 to this chapter.
- 2008** **Fruit, nuts and other edible parts of plants, otherwise prepared or preserved, whether or not containing added sugar or other sweetening matter or spirit, not elsewhere specified or included**
See additional note 2(a) to this chapter, as regards 'sugar content'.
See additional note 3 to this chapter, as regards 'added sugar'.
See additional note 4 to this chapter, as regards 'spirit content'.

2008 11 10~~to~~ to 2008 19 99 Nuts, groundnuts and other seeds, whether or not mixed together

These subheadings include the products referred to in the HS Explanatory Note to heading 2008, second paragraph, (1) and (2), including mixtures thereof.

These subheadings also include such products:

1. which have been flaked or crushed, used in particular in pastries; or
2. which have been ground or otherwise crushed, in the form of paste, whether or not containing other added substances.

However, these subheadings exclude pastes for making marzipan, nougat, etc. (heading 1704).

2008 19 11~~to~~ to 2008 19 99 Other, including mixtures

These subheadings cover nuts and other seeds, excluding groundnuts, and mixtures of nuts and other seeds, even those in which groundnuts predominate.

2008 30 51**Grapefruit segments, including pomelos**

For the purposes of this subheading, 'segments' means the natural sections of the fruit, whole.

The presence of small quantities of broken segments, not resulting from a deliberate process, does not affect classification in this subheading.

2008 30 71**Grapefruit segments, including pomelos**

See the explanatory note to subheading 2008 30 51.

2009**Fruit juices (including grape must) and vegetable juices, unfermented and not containing added spirit, whether or not containing added sugar or other sweetening matter**

See note 6 to this chapter, as regards 'juice, unfermented and not containing added spirit'.

See subheading note 3 to this chapter, as regards the 'Brix value'.

See additional note 5(a) to this chapter, as regards 'added sugar'.

For the purposes of additional note 5(b) to this chapter, products to which sugar has been added in such a quantity that they contain by weight less than 50 % of fruit juice are considered to have lost the original character of the fruit juices of heading 2009.

For determining whether products have lost their original character or not with regard to the addition of sugar, only additional notes 2 and 5 to this chapter are to be applied. The content of various sugars expressed as sucrose is determined in accordance with the said additional note 2. If the content of added sugar calculated in accordance with additional note 5(a) to this chapter exceeds 50 % by weight, the calculated fruit juice content is less than 50 % by weight so that the product is not to be classified under heading 2009.

Additional note 5(b) to this chapter is not to be applied to concentrated natural fruit juices.

Consequently, concentrated natural fruit juices are not excluded from heading 2009.

As regards the addition of other substances to products of heading 2009, see the HS Explanatory Note to heading 2009.

EXAMPLE

The analysis of a sample of orange juice gives the following results:

- value indicated by refractometer at a temperature of 20 °C: 65,3,
- calculated content of various sugars expressed as sucrose (additional note 2 to this chapter): 62,0 (65,3 × 0,95),
- calculated added sugar content (additional note 5 to this chapter): 49 % by weight (62,0 - 13),
- calculated fruit juice content: 51 % by weight (100 - 49).

Conclusion: the sample is considered, within the meaning of additional note 5(b) to this chapter, not to have lost its original character, because the calculated fruit juice content is not less than 50 % by weight.

2009 11 11~~to~~ to 2009 11 99 **Frozen**

See the HS Explanatory Note to subheading 2009 11.

2009 50 10~~and~~ and
2009 50 90

Tomato juice

See note 4 to this chapter and the relevant explanatory notes.

2009 69 51

Concentrated

See additional note 6 to this chapter.

2009 69 71

Concentrated

See additional note 6 to this chapter.

CHAPTER 22
BEVERAGES, SPIRITS AND VINEGAR

General

Where a distinction is made in this chapter between products in containers holding 2 litres or less and those holding more than 2 litres, the quantity to be taken into consideration is the volume of liquid contained in the containers and not the capacity of the containers.

This chapter covers — in so far as they are not medicaments — tonic preparations which, even though they are taken in small quantities, for example, by the spoonful, are suitable for direct consumption as beverages. Non-alcoholic tonic preparations which require dilution before consumption do not fall in Chapter 22 (generally, heading 2106).

Additional note 2(b) The potential alcoholic strength by volume is to be calculated by multiplying the mass of the sugars (calculated in kilograms of invert sugar) contained in 100 litres of the product in question by a factor of 0,6.

- 2201** **Waters, including natural or artificial mineral waters and aerated waters, not containing added sugar or other sweetening matter nor flavoured; ice and snow**
- 2201 10 11 to 2201 10 90** **Mineral waters and aerated waters**
These subheadings cover the products referred to in the HS Explanatory Note to heading 2201, paragraphs (B) and (C). These subheadings do not include natural mineral water in aerosol containers for use in the care of the skin (heading 3304)
- 2201 10 11 and 2201 10 19** **Natural mineral waters**
‘Natural mineral waters’ means water which complies with the relevant version of Directive 2009/54/EC of the European Parliament and of the Council (OJ L 164, 26.6.2009, p. 45).
- 2201 90 00** **Other**
This subheading includes the products referred to in the HS Explanatory Note to heading 2201, paragraphs (A) and (D). This subheading also covers water vapour and natural water, filtered, sterilised, purified or softened.
- 2202** **Waters, including mineral waters and aerated waters, containing added sugar or other sweetening matter or flavoured, and other non-alcoholic beverages, not including fruit or vegetable juices of heading 2009**
The expression ‘non-alcoholic beverages’ is defined in note 3 to this chapter.
- 2202 10 00** **Waters, including mineral waters and aerated waters, containing added sugar or other sweetening matter or flavoured**
The soft drinks referred to in the HS Explanatory Note to heading 2202, paragraph (A), are covered by this subheading. The presence of anti-oxidants, vitamins, stabilisers or quinine do not affect the classification of soft drinks. This subheading includes liquid products, composed of water, sugar and flavourings, put up in a plastic bag and intended to be made in the home into ice-lollies by freezing.
See also additional note 1 to this chapter.

- 2202 90 10** **Not containing products of headings 0401 to 0404 or fat obtained from products of headings 0401 to 0404**
This subheading includes tonic preparations as described in the explanatory note to this chapter, general, second paragraph. These non-alcoholic beverages, often referred to as food supplements, may be based on extracts from plants (including herbs) and may contain added vitamins and/or minerals. In general, these preparations should maintain general health and well-being; therefore, they differ from the flavoured or sweetened waters and other soft drinks of subheading 2202 10 00, referred to in the HS Explanatory Note to heading 2202, paragraph (A).
- 2202 90 91 to 2202 90 99** **Other, containing by weight of fat obtained from the products of headings 0401 to 0404**
These subheadings include the liquid product known commercially as 'filled milk', provided that it is a beverage ready for consumption. 'Filled milk' is a product with a basis of skimmed milk or powdered skimmed milk to which are added refined vegetable fats or oils in a quantity almost identical to the quantity of natural fat extracted from the initial whole milk. This beverage is classified in the subdivisions of these subheadings according to its milkfat content. See the explanatory note to subheading 2202 90 10.
- 2204** **Wine of fresh grapes, including fortified wines; grape must other than that of heading 2009**
See additional note 2(a) to this chapter, as regards 'actual alcoholic strength by volume'.
- 2204 10 11 to 2204 10 98** **Sparkling wine**
See subheading note 1 to this chapter.
- 2204 10 11** **Champagne**
Champagne is a sparkling wine produced in the French province of Champagne from grapes exclusively harvested in that province.
- 2204 21 06 to 2204 21 09** **Wine, other than that referred to in subheading 2204 10, in bottles with 'mushroom' stoppers held in place by ties or fastenings; wine, otherwise put up, with an excess pressure due to carbon dioxide in solution of not less than 1 bar but less than 3 bar, measured at a temperature of 20 °C**
These subheadings cover:
 1. wine, put up in bottles with 'mushroom' stoppers, which does not comply with the definition of 'sparkling wine' in subheading note 1 to this chapter;
 2. wine, put up otherwise than in bottles with 'mushroom' stoppers, with an excess pressure of not less than 1 bar but less than 3 bar at 20 °C.
Cork stoppers complying with the sketch below, and similar stoppers made of plastic materials, are considered to be 'mushroom' stoppers.

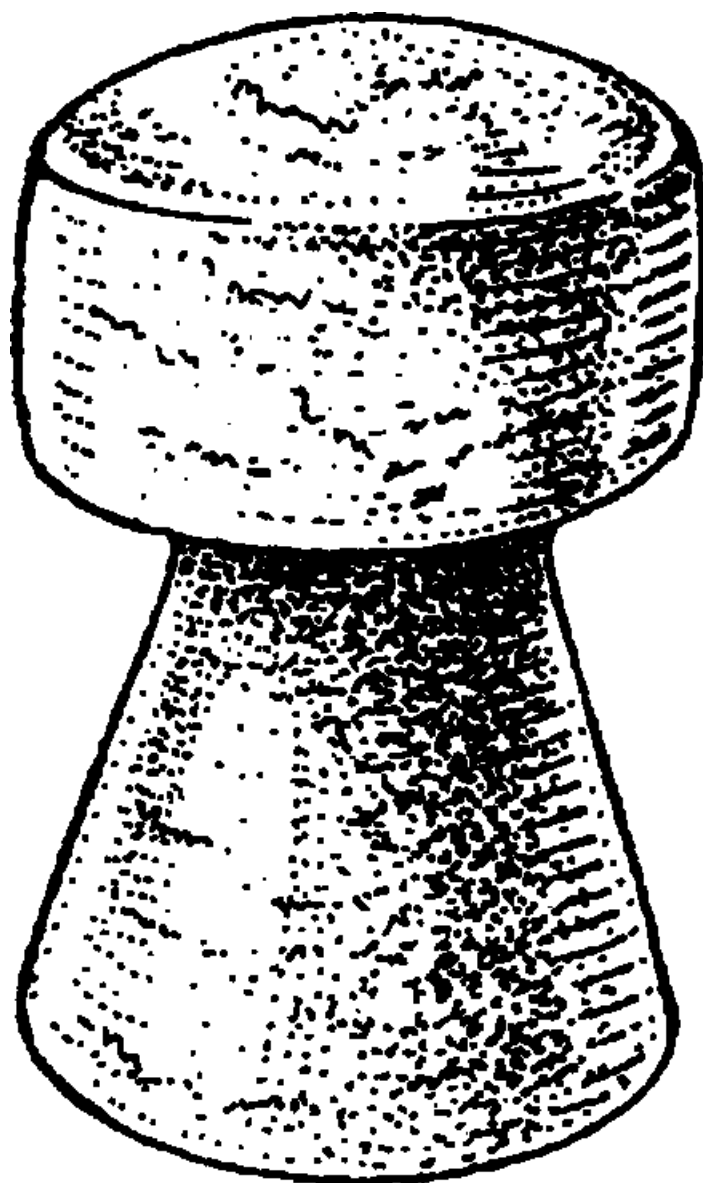

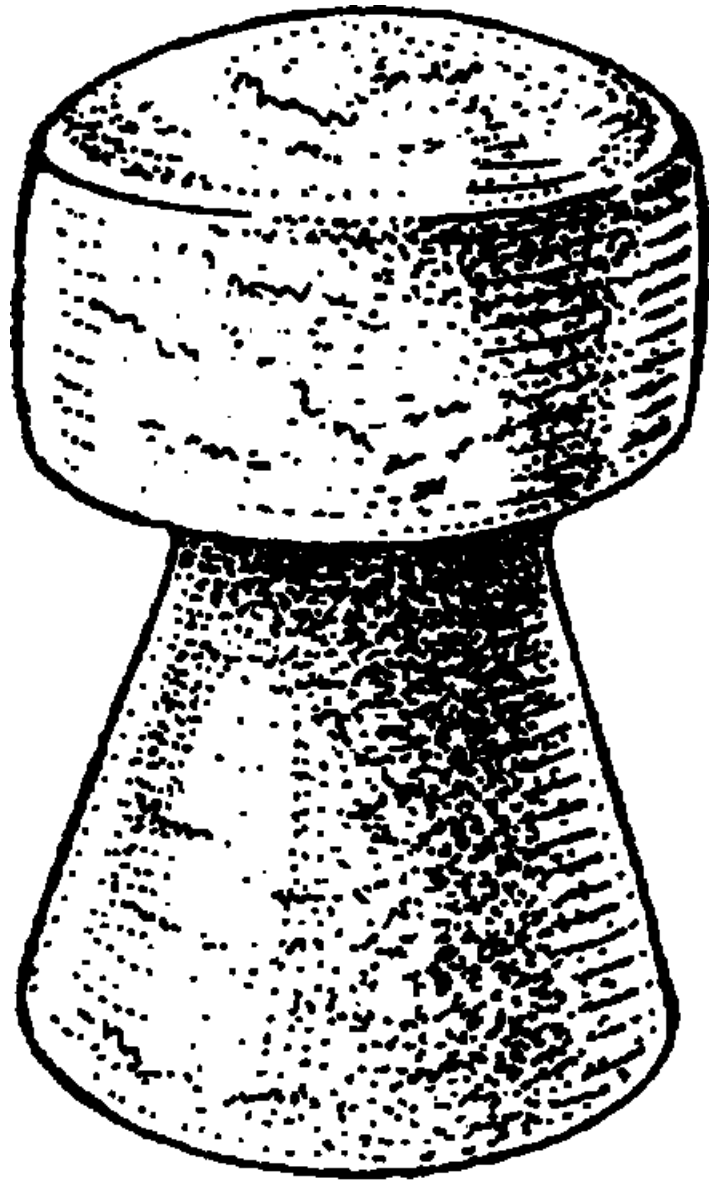

2204 21 11to 2204 21 98	Other See additional notes 4 and 5 to this chapter. The non-volatile constituents of the total dry extract within the meaning of additional note 4(A) include sugars, glycerol, tannins, tartaric acid, colouring matter and salts.
2204 21 11to 2204 21 78	Wine with a protected designation of origin (PDO) See additional note 6(a) to this chapter.
2204 21 23	Tokaj See additional note 4(B)(b) to this chapter.
2204 21 79and 2204 21 80	Wine with a protected geographical indication (PGI) See additional note 6(a) to this chapter.
2204 29 10	Wine, other than that referred to in subheading 2204 10, in bottles with ‘mushroom’ stoppers held in place by ties or fastenings; wine, otherwise put up, with an excess pressure due to carbon dioxide in solution of not less than 1 bar but less than 3 bar, measured at a temperature of 20 °C The explanatory note to subheadings 2204 21 06 to 2204 21 09 applies, <i>mutatis mutandis</i> .
2204 29 11to 2204 29 98	Other See additional notes 4 and 5 to this chapter.
2204 29 11to 2204 29 58	Wine with a protected designation of origin (PDO) See additional note 6(a) to this chapter.
2204 29 11	Tokaj See additional note 4(B)(b) to this chapter.
2204 29 79and 2204 29 80	Wine with a protected geographical indication (PGI) See additional note 6(a) to this chapter.
2204 30 10	In fermentation or with fermentation arrested otherwise than by the addition of alcohol See additional note 3 in connection with additional note 2(a), 2(b) and 2(c) to this chapter.
2204 30 92	Concentrated See additional note 7 to this chapter.
2204 30 96	Concentrated See additional note 7 to this chapter.
2205	Vermouth and other wine of fresh grapes flavoured with plants or aromatic substances Wines covered by this heading and described in the HS Explanatory Note to heading 2205 include: <ol style="list-style-type: none">1. beverages known as ‘Marsala all’uovo’, ‘Marsala alla mandorla’ and ‘Crema di Marsala all’uovo’, which are based on Marsala wine, and flavoured with egg yolks, almonds and other aromatic materials;2. wine-based beverages known as ‘Sangria’, flavoured with lemon or orange, for example. See additional note 8 to this chapter. Products having an actual alcoholic strength by volume of less than 7 % vol fall in heading 2206 00.

- 2206 00** **Other fermented beverages (for example, cider, perry, mead); mixtures of fermented beverages and mixtures of fermented beverages and non-alcoholic beverages, not elsewhere specified or included**
As regards the classification of fermented alcohol-based beverages to which distilled alcohol, water and other substances (such as syrup, various aromas and colourings, and, in some cases, a cream base) have been added, see the judgment of the Court of Justice of the European Union in Case C-150/08. In accordance with the judgment, if those additions result in losing the taste, smell and/or appearance of a beverage produced from a particular fruit or natural product, that is to say a fermented beverage of heading 2206, classification under heading 2208 takes place.
- 2206 00 10** **Piquette**
 See additional note 9 to this chapter.
- 2206 00 31 to 2206 00 89** **Other**
 These subheadings include the products described in the HS Explanatory Note to heading 2206, second paragraph, (1) to (10).
- 2206 00 31 and 2206 00 39** **Sparkling**
 See additional note 10 to this chapter as regards sparkling.
 As regards mushroom stoppers in the above additional note, see the explanatory note to subheadings 2204 21 06 to 2204 21 09, final paragraph.
- 2206 00 51 to 2206 00 89** **Still, in containers holding**
 These subheadings include beverages which are not the product of the natural fermentation of the must of fresh grapes but are produced from concentrated grape must. This must is stable and can be stored for use as required. The fermentation process is usually started with yeast. Sugar may also be added to the must before or during fermentation. The product obtained by this process may finally be sweetened, fortified or blended.
- 2207** **Undenatured ethyl alcohol of an alcoholic strength by volume of 80 % vol or higher; ethyl alcohol and other spirits, denatured, of any strength**
- 2207 10 00** **Undenatured ethyl alcohol of an alcoholic strength by volume of 80 % vol or higher**
 See the HS Explanatory Note to heading 2207, except for the fourth paragraph.
 Spirituous beverages (for example, gin, vodka) fall in subheadings 2208 20 12 to 2208 90 78, regardless of their alcoholic strength.
- 2207 20 00** **Ethyl alcohol and other spirits, denatured, of any strength**
 See the HS Explanatory Note to heading 2207, fourth paragraph.
- 2208** **Undenatured ethyl alcohol of an alcoholic strength by volume of less than 80 % vol; spirits, liqueurs and other spirituous beverages**
 Spirits, liqueurs and other spirituous beverages of heading 2208 are alcoholic liquids generally intended for human consumption and are prepared:
- either directly by distilling (with or without added flavouring) natural fermented liquids such as wine or cider, or previously fermented fruit, marc, grain or other vegetable products, or
 - by simply adding various aromatic substances, and sometimes sugar, to alcohol produced by distillation.
- The various spirituous beverages are described in the HS Explanatory Note to heading 2208, third paragraph, (1) to (18). As regards undenatured spirits, it should be noted that they remain classified in this heading even if they have an alcoholic strength of 80 % vol or higher, whether or not the product is ready for consumption as a drink.
 This heading does not cover alcoholic beverages obtained by fermentation (headings 2203 00 to 2206 00).

- 2208 30 11to 2208 30 88 Whiskies**
Whisk(e)y is a spirit distilled from a mash of cereals and marketed at an alcoholic strength by volume of 40 % vol or higher, either in bottles or in other containers.
Scotch whisky is whisky distilled and matured in Scotland.
Whiskies with added aerated water (whisky-soda) are excluded from these subheadings and fall in subheading 2208 90 69 or 2208 90 78.
- 2208 30 30 Single malt whisky**
Single malt Scotch whisky is a spirit which is produced, in pot stills at a single distillery, by distilling a fermented mash of only malted barley.
- 2208 30 41and 2208 30 49 Blended malt whisky, in containers holding**
Blended malt Scotch whisky is produced by blending two or more single malt Scotch whiskies which have been distilled/obtained at different distilleries.
- 2208 30 61and 2208 30 69 Single grain whisky and blended grain whisky, in containers holding**
Single grain Scotch whisky is a spirit, other than single malt Scotch whisky or blended malt Scotch whisky, which is produced at a single distillery by distilling a fermented mash of malted barley with or without whole grains of other cereals (predominantly, wheat or maize).
Blended grain Scotch whisky is produced by blending two or more single grain Scotch whiskies which have been distilled/obtained at different distilleries.
- 2208 30 71and 2208 30 79 Other blended whisky, in containers holding**
Other blended Scotch whisky ('Blended Scotch Whisky') is produced by blending one or more single malt Scotch whiskies with one or more single grain Scotch whiskies.
- 2208 40 11to 2208 40 99 Rum and other spirits obtained by distilling fermented sugar-cane products**
These subheadings include, for example, rum and tafia, as described in the HS Explanatory Note to heading 2208, third paragraph, (3), provided that they retain their organoleptic characteristics.
- 2208 50 11and 2208 50 19 Gin, in containers holding**
Gin is a spirituous beverage generally obtained by simple or successive distillations of rectified cereal spirits or ethyl alcohol with juniper berries and other aromatic substances (for example, coriander, angelica root, anise, ginger).
For the purposes of these subheadings, only spirituous beverages having the organoleptic characteristics of gin are regarded as gin.
The following, for example, are consequently excluded from these subheadings:
(a) Geneva (subheading 2208 50 91 or 2208 50 99);
(b) Aquavit (subheading 2208 90 56 or 2208 90 77);
(c) Kranawitter (subheading 2208 90 56 or 2208 90 77).
- 2208 60 11to 2208 60 99 Vodka**
See the HS Explanatory Note to heading 2208, third paragraph, (5).

- 2208 70 10 and 2208 70 90 Liqueurs and cordials**
See the HS Explanatory Note to heading 2208, first paragraph, (B), and third paragraph.
- 2208 90 11 and 2208 90 19 Arrack, in containers holding**
Arrack is a spirit manufactured, using a special yeast, from sugar-cane molasses or from molasses of the sweet juices of plants and of rice.
Arrack should not be confused with raki which is obtained by redistilling raisin or dry fig spirits with aniseed and falls in subheading 2208 90 56 or 2208 90 77.
- 2208 90 33 and 2208 90 38 Plum, pear or cherry spirit (excluding liqueurs), in containers holding**
Plum, pear and cherry spirits are spirituous beverages obtained exclusively by fermenting and distilling plum, pear or cherry musts.
As regards the terms 'plums' and 'cherries', see the HS Explanatory Note to heading 0809.
- 2208 90 48 Other**
For the purposes of this subheading, spirits distilled from fruit are spirituous beverages obtained exclusively by alcoholic fermentation and distillation of fruit (other than plums, pears or cherries), for example, from apricots, bilberries, raspberries, blackberries, black currants, white currants, red currants, strawberries, apples, including spirits obtained from cider. Calvados falls in subheading 2208 90 45.
- 2208 90 56 Other**
This subheading includes aniseed spirits, raki, agave spirits other than tequila (for example, mezcal), spirits distilled from aromatic herbs, 'digestive' bitters, aquavit, kranawitter, spirits distilled from roots (for example, gentian spirits), sorghum spirits.
- 2208 90 69 Other spirituous beverages**
In addition to the beverages referred to in the HS Explanatory Note to heading 2208, third paragraph, (14) to (18), the subheading also includes:
1. spirituous beverages with added aerated water (for example, whisky-soda);
 2. tea with alcohol;
 3. spirituous beverages mixed together or spirituous beverages mixed with fruit or vegetables juices (cocktails).
- 2208 90 71 Distilled from fruit**
See the explanatory note to subheading 2208 90 48. This subheading includes calvados.
- 2208 90 77 Other**
See the explanatory note to subheading 2208 90 56.
- 2208 90 78 Other spirituous beverages**
See the explanatory note to subheading 2208 90 69.
- 2208 90 91 and 2208 90 99 Undenatured ethyl alcohol of an alcoholic strength by volume of less than 80 % vol, in containers holding**
These subheadings include a liquid described as a 'malt beer base' with an alcoholic strength by volume of 14 % and obtained from brewed beer which has been clarified and then subjected to ultrafiltration, by which the concentration of ingredients such as bitter substances and proteins has been reduced (see judgment of the Court of Justice of the European Union in Case C-196/10).
- 2209 00 Vinegar and substitutes for vinegar obtained from acetic acid**
- 2209 00 11 and 2209 00 19 Wine vinegar, in containers holding**
See additional note 11 to this chapter.
See also the HS Explanatory Note to heading 2209, part (I), second paragraph, (1).
- 2209 00 91 and 2209 00 99 Other, in containers holding**
These subheadings include the products referred to in the HS Explanatory Note to heading 2209, part (I), second paragraph, (2), (3) and (4), and part (II).

CHAPTER 23

RESIDUES AND WASTE FROM THE FOOD INDUSTRIES; PREPARED ANIMAL FODDER

- Additional note 3** The potential alcoholic strength by mass is to be calculated by multiplying the mass of the sugars (calculated in kilograms of invert sugar) contained in 100 kg of the product in question by a factor of 0,47.
- 2301** **Flours, meals and pellets, of meat or meat offal, of fish or of crustaceans, molluscs or other aquatic invertebrates, unfit for human consumption; greaves**
- 2301 20 00** **Flours, meals and pellets, of fish or of crustaceans, molluscs or other aquatic invertebrates**
Flours, meals and pellets of fish of this subheading are composed of fish or fish waste which is generally cooked and then reduced to a paste, dried and ground and, in some cases, agglomerated in the form of pellets.
This subheading excludes fish flour fit for human consumption (subheading 0305 10 00).
- 2302** **Bran, sharps and other residues, whether or not in the form of pellets, derived from the sifting, milling or other working of cereals or of leguminous plants**
For the distinction between products of this heading and those of Chapter 11, see note 2(A) to Chapter 11.
Residues mentioned under HS Explanatory Note to heading 2302, (B), (1), should contain 50 % or more of cereals or leguminous plants.
For the determination of the starch content (on the product as received), the method set out in Annex III, part L, to Commission Regulation (EC) No 152/2009 (OJ L 054, 26.2.2009, p. 1) is to be applied.
- 2302 10 10 and 2302 10 90** **Of maize (corn)**
Provided that they satisfy the criteria laid down in note 2(A) to Chapter 11, broken maize grains recovered during the sifting of cleaned unhulled maize grains are excluded from these subheadings (subheading ~~1104 23 90~~1104 23 98).
- 2303** **Residues of starch manufacture and similar residues, beet-pulp, bagasse and other waste of sugar manufacture, brewing or distilling dregs and waste, whether or not in the form of pellets**
For the determination of the starch and protein content, the methods set out in Annex III, parts L and C, to Commission Regulation (EC) No 152/2009 (OJ L 054, 26.2.2009, p. 1) are to be applied.
- 2303 10 11 and 2303 10 19** **Residues from the manufacture of starch from maize (excluding concentrated steeping liquors), of a protein content, calculated on the dry product**
Products classified in these subheadings must meet the criteria laid down in additional note 1 to this chapter.
These subheadings include:
1. maize gluten (generally, in the form of a flour), which is composed mainly of the gluten of the maize grains obtained from the separation of starch; the protein content (nitrogen \times 6,25) is in excess of 40 % by weight;
 2. gluten meal, which is mainly obtained by mixing dry residue from the manufacture of starch from maize with pure gluten; such products generally contain about 40 % by weight of proteins (nitrogen \times 6,25);
 3. corn gluten feed, which generally contains at least 20 % by weight of proteins (nitrogen \times 6,25), and is composed mainly of particles of pericarp and endosperm, of maize gluten and sometimes of concentrated maize steeping liquor, all of which are by-products of the manufacture of starch from maize.
- These subheadings also include the above products agglomerated in the form of pellets.
These subheadings cover only products with a starch content not exceeding 28 % by weight on the dry product determined in accordance with the method contained in Annex III, part L, to Commission Regulation (EC) No 152/2009 (OJ L 054, 26.2.2009, p. 1), and a fat content not exceeding 4,5 % by weight on the dry product determined in accordance with the method contained in Annex III, part H, to Commission Regulation (EC) No 152/2009 (1).
Products with a higher content of starch or fat are normally classified in Chapter 11 or in subheading 2302 10 10, 2302 10 90, 2309 90 41 or 2309 90 51, as appropriate. The same applies for goods which contain products extracted from maize by a method other than the production of starch by the wet process (residues from the sifting of maize grains, ground maize grains, residues from the extraction of maize germ oil by the dry process, etc.).
Products classified in these subheadings must not contain residues from the extraction of maize germ oil by the wet process either.
Concentrated maize steeping liquors fall in subheading 2303 10 90, irrespective of their protein content.

2303 10 90**Other**

For the purposes of this subheading, residues from the manufacture of starch from manioc roots means such products with a starch content not exceeding 40 % by weight, calculated on the dry matter.

If their starch content is higher, such products, in the form of flour or meal, fall in subheading 1106 20 10 or 1106 20 90.

Products in the form of pellets fall in subheading 0714 10.

This subheading also includes:

1. sorghum gluten feed, which generally contains at least 18 % by weight of proteins, and is composed mainly of particles of the pericarp and endosperm of sorghum grains, of sorghum gluten and sometimes of concentrated sorghum steeping liquor, all of which are by-products of the manufacture of starch from sorghum.

This subheading covers only products with a starch content not exceeding 40 % by weight, calculated on the dry matter.

Products with a higher content of starch are generally classified in Chapter 11 or in heading 2302 or 2309, as appropriate;

2. residues from starch manufacture known as 'dried potato pulp'. The starch content of such residues is generally 50 % or more by weight.

For the determination of the moisture content, the method set out in Annex III, part A, to Commission Regulation (EC) No 152/2009 (OJ L 054, 26.2.2009, p. 1) is to be applied.

Concentrated maize steeping liquors are classified in this subheading, irrespective of their protein content.

2303 20 10 and 2303 20 90**Beet-pulp, bagasse and other waste of sugar manufacture**

Whey from which the lactose has been partly removed is not regarded as waste of sugar manufacture and does not fall in these subheadings (heading 0404).

These subheadings include partly or wholly desugared beet.

2303 30 00**Brewing or distilling dregs and waste**

See the HS Explanatory Note to heading 2303, first paragraph, (E)(1) to (5).

2304 00 00**Oilcake and other solid residues, whether or not ground or in the form of pellets, resulting from the extraction of soya-bean oil**

This heading does not include soya-bean flakes, whether or not ground, from which the soya-bean oil has not been extracted (heading 2308).

- 2306 Oilcake and other solid residues, whether or not ground or in the form of pellets, resulting from the extraction of vegetable fats or oils, other than those of heading 2304 or 2305**
- 2306 41 00 Of low-erucic-acid rape or colza seeds**
See subheading note 1 to this chapter and the HS Explanatory Note to subheading 2306 41.
- 2306 90 05 Of maize (corn) germ**
This subheading covers the residues from the extraction of oil of maize (corn) germs, obtained by wet or dry processing, and which conform to the criteria of additional note 2 to this chapter.
Products which do not conform to these criteria are generally classified in Chapter 11 or heading 2302 or 2309, as appropriate.
- 2306 90 11 and 2306 90 19 Oilcake and other residues resulting from the extraction of olive oil**
The expression 'residues resulting from the extraction of olive oil' means only products with a fatty matter content not exceeding 8 % by weight. Such products (except dregs) with a higher content of fatty matter are to be classified in the same subheading as the base material (subheading 0709 90 31 0709 92 10 or 0709 90 39 0709 92 90).
For the determination of the fat content, the method set out in Commission Regulation (EEC) No 2568/91, Annex XV (OJ L 248, 5.9.1991, p. 1) is to be applied.
- 2307 00 Wine lees; argol**
- 2307 00 11 Having a total alcoholic strength by mass not exceeding 7,9 % mas and a dry matter content not less than 25 % by weight**
See additional note 3 to this chapter and the relevant explanatory notes.
- 2307 00 90 Argol**
See the HS Explanatory Note to heading 2307, second paragraph.
- 2308 00 Vegetable materials and vegetable waste, vegetable residues and by-products, whether or not in the form of pellets, of a kind used in animal feeding, not elsewhere specified or included**
- 2308 00 11 Having a total alcoholic strength by mass not exceeding 4,3 % mas and a dry matter content not less than 40 % by weight**
See additional note 3 to this chapter and the relevant explanatory notes.
- 2308 00 40 Acorns and horse-chestnuts; pomace or marc of fruit, other than grapes**
Marc of fruit, other than grapes, includes 'orange cells', i.e., products consisting of parts of oranges which initially, in the course of pressing, entered the juice and after being strained off contain scarcely any constituent parts of the flesh of the fruit but consist principally of cell membrane and albedo. These products are intended for adding to diluted concentrates of orange juice and to soft drinks.
- 2308 00 90 Other**
This subheading includes the products specified in (2), (3), (4), (6), (7), (8) and (9) of the second paragraph of the HS Explanatory Note to heading 2308.
The subheading also includes soya-bean hulls, whether or not ground, from which the soya-bean oil has not been extracted.

2309**Preparations of a kind used in animal feeding**

See note 1 to this chapter.

For the determination of the starch content, the polarimetric method (also called the modified Ewers method) laid down in Annex III, part L, to Commission Regulation (EC) No 152/2009 (OJ L 054, 26.2.2009, p. 1) is to be applied.

The starch content by weight of preparations of a kind used in animal feeding within the meaning of heading 2309 is to be determined by the enzymatic analytical method laid down in the Annex to Commission Regulation (EC) No 121/2008 (OJ L 037, 12.2.2008, p. 03) in cases where the following feed materials are present in significant amounts:

- (a) (sugar) beet products such as (sugar) beet pulp, (sugar) beet molasses, (sugar) beet pulp-molassed, (sugar) beet vinasse, (beet) sugar;
- (b) citrus pulp;
- (c) linseed; linseed expeller; linseed extracted;
- (d) rape seed; rape seed expeller; rape seed extracted; rape-seed hulls;
- (e) sunflower seed; sunflower seed extracted; sunflower seed, partially decorticated, extracted;
- (f) copra expeller; copra extracted;
- (g) potato pulp;
- (h) dehydrated yeast;
- (ij) products rich in inulin (for example, chips and meal of Jerusalem artichokes);
- (k) greaves.

~~Where it is not evident whether any starch is present in a preparation of a kind used in animal feeding within the meaning of heading 2309, a qualitative microscopic method may be used to verify such presence. High-performance liquid chromatography (HPLC) should be used for the determination of glucose [Commission Regulation (EC) No 904/2008 (OJ L 249, 18.9.2008, p. 9)].~~ 2309, a qualitative microscopic method may be used to verify such presence.

As regards milk products, see additional note 4 to this chapter. The content of milk products and the content of starch are calculated on the product as received.

2309 10 11 to 2309 10 90**Dog or cat food, put up for retail sale**

These subheadings include toys to be chewed by dogs, presented in various forms, such as rings and bones, consisting of chopped-up pieces of oxhide, gelatin, glucose syrup (as binder), colouring matter, vegetable protein hydrolysate, a stabiliser and, in the case of rings, meat and bonemeal, all of which can be completely eaten.

2309 90 10**Fish or marine mammal solubles**

See the HS Explanatory Note to heading 2309, part (II), (B), last paragraph, (1).

2309 90 20**Products referred to in additional note 5 to this chapter**

The use of maize steeping liquor as a growth medium (nutrient broth) can lead to the presence in the products of residues of dead fermentation agents at a concentration generally not exceeding 2 %. These products are detectable by microscope. In addition, the products containing residues of the steeping liquor used in certain fermentation processes contain the following substances in very small quantities: amyloglucosidase, alpha-amylase, xanthan gum, lactic acid, citric acid, lysine, threonine, tryptophane.

Maize steeping liquor already contains some of these substances (for example, amino acids) in very small quantities and the increase in concentration due to fermentation is negligible.

Products with a starch or fat content exceeding the limits indicated in additional note 5 are classified in subheading 2309 90 41 or 2309 90 51, as appropriate.

The conformity of the residues from the manufacture of starch from maize imported from the USA is to be verified in accordance with Commission Regulation (EC) No 1375/2007 (OJ L 307, 24.11.2007, p. 5).

CHAPTER 24

TOBACCO AND MANUFACTURED TOBACCO SUBSTITUTES

2401

Unmanufactured tobacco; tobacco refuse

As regards tobacco in the natural or unmanufactured state, see the HS Explanatory Note to heading 2401, first paragraph, (1).

It is to be noted that:

- (a) 'flue-cured' Virginia type tobacco means tobacco which has been cured under artificial atmospheric conditions by a process of regulating the heat and ventilation, without allowing smoke and fumes to come into contact with the tobacco leaves; the colour of the cured tobacco normally ranges from lemon to very dark orange or red. Other colours and combinations of colours frequently result from variations in maturity or cultural and curing techniques;
- (b) 'light air-cured' Burley type tobacco (including Burley hybrids) means tobacco which has been cured under natural atmospheric conditions and does not carry the odour of smoke or fumes if supplemental heat or air circulation has been applied; the leaves normally range from light tan to reddish colour. Other colours and combinations of colours frequently result from variations in maturity or cultural and curing techniques;
- (c) 'light air-cured' Maryland type tobacco means tobacco which has been cured under natural atmospheric conditions and does not carry the odour of smoke or fumes if supplemental heat or air circulation has been applied; the leaves normally range from a light-yellow to deep cherry red colour. Other colours and combinations of colours frequently result from variations in maturity or cultural and curing techniques;
- (d) 'fire-cured' tobacco means tobacco, which has been cured under artificial atmospheric conditions by the use of open fires from which wood smoke has been partly absorbed by the tobacco. 'Fire-cured' tobacco leaves are normally thicker than leaves of Burley, 'flue-cured' or Maryland from the corresponding stalk position. Colours normally range from yellowish-brown to very dark brown. Other colours and combinations of colours frequently result from variations in maturity or cultural and curing techniques.

'Sun-cured' tobacco has been cured directly by the heat of the sun in the open air and in full daylight.

This heading does not include live tobacco plants (heading 0602).

2401 30 00

Tobacco refuse

In addition to the products listed in the HS Explanatory Note to heading 2401, first paragraph, (2), this subheading also includes:

1. waste resulting from the manipulation of tobacco leaves; it is known generally in the trade as 'offal' but also referred to variously in Member States as 'smalls', 'winnowings', 'sweepings', 'kirinti' or 'broquelins', etc. It generally contains impurities or foreign bodies such as dust, vegetable waste, textile fibres. Sometimes, dust has been removed from this waste by sieving;
2. waste from tobacco leaves, known in the trade as 'siftings', and obtained by sieving the refuse mentioned above;
3. waste obtained from the manufacture of cigars, described as 'cuttings', and consisting of pieces of cuttings from leaves;
4. dust obtained by sieving the refuse mentioned above.

This subheading does not include tobacco waste prepared for sale as smoking tobacco or chewing tobacco, snuff or tobacco powder, or which purports to have been treated for the purpose of being used as smoking tobacco, chewing tobacco, snuff or tobacco powder (heading 2403).

- 2402 Cigars, cheroots, cigarillos and cigarettes, of tobacco or of tobacco substitutes**
- 2402 10 00 Cigars, cheroots and cigarillos, containing tobacco**
Cigars, cheroots and cigarillos are rolls of tobacco, which can be smoked as they are, and
1. consist entirely of natural tobacco, or
 2. have an outer wrapper of natural tobacco, or
 3. have a threshed blend filler and an outer wrapper of the normal colour of a cigar covering the product in full, including where appropriate the filter but not in the case of tipped cigars, the tip, and a binder, both being of reconstituted tobacco of subheading 2403 91 00, where the unit weight, not including filter or mouth-piece, is not less than 1,2 g and where the wrapper is fitted in spiral form with an acute angle of at least 30° to the longitudinal axis of the rolls, or
 4. have a threshed blend filler and an outer wrapper of the normal colour of a cigar, of reconstituted tobacco of subheading 2403 91 00, covering the product in full, including where appropriate the filter but not, in the case of tipped cigars, the tip, where the unit weight, not including filter or mouth-piece, is not less than 2,3 g and the circumference over at least one third of the length is not less than 34 mm.
- Provided that they satisfy the above preconditions, products with a wrapper, or wrapper and binder, of reconstituted tobacco which may consist partly of substances other than tobacco are classified in this subheading.
- 2402 20 10 and 2402 20 90 Cigarettes containing tobacco**
Cigarettes are rolls of tobacco which can be smoked as they are and do not fall into the category of cigars or cigarillos (see the explanatory note to subheading 2402 10 00).
Provided that they satisfy the above preconditions, products consisting partly of substances other than tobacco are classified in these subheadings.
These subheadings do not cover products consisting wholly of substances other than tobacco (subheading 2402 90 00 or, if intended for medicinal use, Chapter 30).
- 2402 90 00 Other**
This subheading includes cigars, cheroots, cigarillos and cigarettes consisting wholly of tobacco substitutes, for example, cigarettes made from specially prepared leaves of a lettuce variety and containing neither tobacco nor nicotine.
- 2403 Other manufactured tobacco and manufactured tobacco substitutes; 'homogenised' or 'reconstituted' tobacco; tobacco extracts and essences**
- 2403 11 00 Water-pipe tobacco specified in subheading note 1 to this chapter**
See subheading note 1 to this chapter and the HS Explanatory Note to subheading 2403 11.
- ~~2403 10 10~~ 2403 19 10 and ~~2403 10 90~~ 2403 19 90 Smoking tobacco, whether or not containing tobacco substitutes in any proportion****Other**
Smoking tobacco is tobacco which has been cut or otherwise split, twisted or pressed into blocks which can be smoked without further industrial processing.
Tobacco refuse which is capable of being smoked and which is put up for retail sale is smoking tobacco if it does not meet the description of cigars, cigarillos or cigarettes (see the explanatory notes to subheadings 2402 10 00 and 2402 20 10 and 2402 20 90).
~~Products consisting in whole or in part of substances other than tobacco are also classified in these subheadings, provided that they correspond to the definition given above, the exception being products consisting wholly of substances other than tobacco and intended for medicinal use (Chapter 30).~~ Mixtures of smoking tobacco with substances other than tobacco are also classified in these subheadings, provided that they correspond to the definition given above, the exception being products intended for medicinal use (Chapter 30).
These subheadings also include water-pipe tobacco, i.e. tobacco intended for smoking in a water pipe and which consists of a mixture of tobacco and glycerol, whether or not containing aromatic oils and extracts, molasses or sugar, and whether or not flavoured with fruit. However, products that do not contain tobacco are excluded from these subheadings.
These subheadings include cut cigarette rag which is the finished mixture of tobacco for the manufacture of cigarettes.

2403 91 00**'Homogenised' or 'reconstituted' tobacco**

See the HS Explanatory Note to heading 2403, first paragraph, (6).

2403 99 10**Chewing tobacco and snuff**

Chewing tobacco is tobacco in the form of rolls, sticks, strips, cubes and blocks, which is specially prepared to be chewed but not smoked and which is put up for retail sale.

Snuff is tobacco in powder or grain form which has been specially treated so that it can be taken as snuff but not smoked. Provided that they satisfy the above preconditions, products consisting in part of substances other than tobacco are classified in this subheading.

2403 99 90**Other**

This subheading includes:

1. tobacco extracts and essences as described in the HS Explanatory Note to heading 2403, first paragraph, (7);
2. ground tobacco (tobacco powder);
3. spun, scented and fermented Brazilian tobaccos pressed in skins into a ball shape (Mangotes);
4. ~~expanded tobacco~~ expanded tobacco;
5. products for smoking (for example, 'water pipe tobacco'), consisting wholly of tobacco substitutes and substances other than tobacco.

SECTION V

MINERAL PRODUCTS

CHAPTER 25

SALT; SULPHUR; EARTHS AND STONE; PLASTERING MATERIALS, LIME AND CEMENT

- Note 1** Flotation is intended to separate the rich element of a mineral substance from the gangue by enabling it to collect at the surface of the water in which it has been immersed, while the gangue deposits at the bottom.
- 2501 00** **Salt (including table salt and denatured salt) and pure sodium chloride, whether or not in aqueous solution or containing added anti-caking or free-flowing agents; sea water**
- 2501 00 31** **For chemical transformation (separation of Na from Cl) for the manufacture of other products**
 Provided that the conditions laid down by the competent authorities are met, this subheading includes salt, whether or not denatured, intended for the manufacture of hydrochloric acid, chlorine, calcium chloride, sodium nitrate, sodium hypochlorite, sodium sulphates, sodium carbonates, sodium hydroxide, sodium chlorate, sodium perchlorate and metallic sodium.
- 2501 00 51** **Denatured or for industrial uses (including refining) other than the preservation or preparation of foodstuffs for human or animal consumption**
 Provided that the conditions laid down by the competent authorities are met, this subheading covers:
1. denatured salt, whatever its intended use, excluding the denatured salt of subheading 2501 00 31;
 2. salt for refining; 'refining' in this context means only purification by those processes in which the salt is dissolved;
 3. salt for industrial uses other than chemical transformation or the preservation or preparation of foodstuffs for human or animal consumption. 'Salt for industrial use' means salt intended for factory use as raw material or as an intermediate material in an industrial manufacturing operation (for example, in metallurgy, in dyeing, in the leather and hides industry, in soap manufacture, in refrigeration and in the ceramics industry).
- Salt, other than denatured salt used for salting roads, falls in subheading 2501 00 99.
- 2501 00 91** **Salt suitable for human consumption**
 Salt suitable for human consumption is undenatured salt suitable for direct domestic or industrial uses as a seasoning or preserving agent for foodstuffs. It generally has a high degree of purity and is uniformly white.
- 2501 00 99** **Other**
 This subheading includes undenatured salt used as a de-icing agent in winter and salt used as animal feed (for example, salt-lick).
- 2503 00** **Sulphur of all kinds, other than sublimed sulphur, precipitated sulphur and colloidal sulphur**
- 2503 00 10** **Crude or unrefined sulphur**
 This subheading includes the varieties of sulphur mentioned in the HS Explanatory Note to heading 2503, first paragraph, (1) to (4). These sulphurs are generally in the form of blocks, lumps or dust.

- 2503 00 90** **Other**
This subheading covers the varieties of sulphur mentioned in the HS Explanatory Note to heading 2503, first paragraph, (5) to (7). These sulphurs are generally in the form of sticks or small cakes (refined sulphur) or powders ('sieved sulphur', 'winnowed sulphur', 'atomised sulphur').
- 2508** **Other clays (not including expanded clays of heading 6806), andalusite, kyanite and sillimanite, whether or not calcined; mullite; chamotte or dinas earths**
- 2508 10 00** **Bentonite**
See the HS Explanatory Note to heading 2508, third paragraph, (1).
Naturally occurring bentonites normally have a pH of between 6 and 9,5 (for a 5 % aqueous suspension and after standing for 1 hour) and a sodium-carbonate content of less than 2 %; their aggregate content of exchangeable sodium and calcium does not exceed 80 meq/100 g. There are two types: low-swelling calcium and high-swelling sodium (rate of swelling less than 7 ml/g or greater than 12 ml/g).
Certain naturally occurring bentonites may have characteristics which differ from these values; where this is the case of several characteristics, the bentonite is generally considered to be activated.
Activated bentonites generally fall in subheading 3802 90 00.
- 2511** **Natural barium sulphate (barytes); natural barium carbonate (witherite), whether or not calcined, other than barium oxide of heading 2816**
- 2511 10 00** **Natural barium sulphate (barytes)**
Barytes contains variable amounts of iron oxide, alumina, sodium carbonate and silica. Since the product in its white form is most sought after, it is crushed, screened to remove the coloured elements (mostly yellowish), pulverised and then purified by levigation.
- 2511 20 00** **Natural barium carbonate (witherite)**
Witherite occurs in the form of rhomboid crystals or yellowish masses which are insoluble in water.
- 2513** **Pumice stone; emery; natural corundum, natural garnet and other natural abrasives, whether or not heat-treated**
- 2513 20 00** **Emery, natural corundum, natural garnet and other natural abrasives**
For the purposes of this subheading, other natural abrasives include the tripoli known as 'rotten stone', an ash grey product used as a mild abrasive or for polishing.
- 2516** **Granite, porphyry, basalt, sandstone and other monumental or building stone, whether or not roughly trimmed or merely cut, by sawing or otherwise, into blocks or slabs of a rectangular (including square) shape**
When squared stones do not have a uniform thickness, classification according to thickness is to be made by reference to the greatest thickness.
- 2516 11 00** **Crude or roughly trimmed**
The HS Explanatory Note to subheading 2515 11 applies, *mutatis mutandis*.
- 2516 12 00** **Merely cut, by sawing or otherwise, into blocks or slabs of a rectangular (including square) shape**
The HS Explanatory Note to subheading 2515 12 applies, *mutatis mutandis*.

- 2516 90 00** **Other monumental or building stone**
This subheading includes:
1. hard rocks like porphyry, syenite, lava, basalt, gneiss, trachyte, diabase, diorite, phonolite, liparite, gabbro, labradorite and peridotite;
 2. calcareous monumental or building stones not falling in heading 2515, i.e., with an apparent specific gravity of less than 2,5, crude, roughly trimmed or merely cut, by sawing or otherwise, into blocks or slabs of a rectangular (including square) shape of any thickness;
 3. serpentine or ophite, crude, roughly trimmed or merely cut, by sawing or otherwise, into blocks or slabs of a rectangular (including square) shape of any thickness.
- 2518** **Dolomite, whether or not calcined or sintered, including dolomite roughly trimmed or merely cut, by sawing or otherwise, into blocks or slabs of a rectangular (including square) shape; dolomite ramming mix**
- 2518 10 00** **Dolomite, not calcined or sintered**
Dolomite is a natural double carbonate of calcium and magnesium. It remains classified in this subheading, even when it has been given a light heat treatment which does not alter its chemical composition.
This subheading covers dolomite, not calcined or sintered, crude, roughly trimmed (roughly squared) or merely cut, by sawing or by splitting, into blocks or slabs of a rectangular (including square) shape.
- 2518 20 00** **Calcined or sintered dolomite**
Calcined or sintered dolomite is a dolomite which has been subjected to a high-temperature heat treatment (about 1 500 °C for dead-burned (sintered) dolomite, and about 800 °C for caustic-burned dolomite which alters its chemical composition by driving off carbon dioxide).
- 2519** **Natural magnesium carbonate (magnesite); fused magnesia; dead-burned (sintered) magnesia, whether or not containing small quantities of other oxides added before sintering; other magnesium oxide, whether or not pure**
- 2519 90 10** **Magnesium oxide, other than calcined natural magnesium carbonate**
This subheading includes:
1. magnesium oxide obtained by the calcination of either magnesium hydroxide or precipitated magnesium carbonate and used particularly in pharmacy; this substance is a white powder with a purity of not less than 98 %;
 2. magnesium oxide obtained by fusing previously calcined magnesite; magnesite is calcined at 1 400 to 1 800 °C; the magnesia obtained is then fused in an electric arc at a temperature of 2 800 to 3 000 °C, and, once cooled, it produces a crystalline product consisting almost wholly of magnesium oxide (fused magnesia); this is extremely pure (at least 95 %) and consists of glass-like crystals;
 3. magnesium oxide derived from sea water; this is obtained by calcination of magnesium hydroxide precipitated from sea water: the product is usually 91 to 98 % pure and contains more boron as its characteristic impurity than does dead-burned (sintered) magnesia (about 100 ppm as against about 40 ppm).

- 2520 Gypsum; anhydrite; plasters (consisting of calcined gypsum or calcium sulphate) whether or not coloured, with or without small quantities of accelerators or retarders**
- 2520 20 00 Plasters**
 This subheading includes building plaster.
 Building plaster is manufactured by subjecting crude gypsum (gypsum rock or other gypsum-bearing materials, for example, by-products of the chemical industry) to a special dressing and calcining process. Specific characteristics can be obtained through the introduction of additives during the manufacturing process. These take the form of floating agents (i.e., substances which affect the characteristics of the gypsum — for example, its consistency or adhesive properties — in a particular way), and retarders or accelerators.
 Building plaster is used, for example, as stucco, for plastering walls and ceilings, in the manufacture of building panels or other construction elements, or for jointing tiles.
- 2523 Portland cement, aluminous cement, slag cement, supersulphate cement and similar hydraulic cements, whether or not coloured or in the form of clinkers**
- 2523 90 00 Other hydraulic cements**
 This subheading includes:
1. blast furnace cement comprising at least 20 % by weight of Portland cement clinker, 36 % to 80 % by weight of granulated blast furnace slag and not more than 5 % by weight of other constituents of cement;
 2. pozzolanic cement composed of at least 60 % by weight Portland cement clinker, a maximum of 40 % by weight natural pozzolana or fly ash and a maximum of 5 % by weight other constituents of cement.
- For the term 'pozzolana', see the HS Explanatory Note to heading 2530, part (D), paragraph (7).
 Fly ash is a fine, light powder, obtained by extracting powder particles from the combustion gases of furnaces fired with pulverised coal. Its colour varies from grey to black.
- 2524 Asbestos**
- 2524 10 00 Crocidolite**
 See the HS Explanatory Note to heading 2524, second paragraph.
- 2526 Natural steatite, whether or not roughly trimmed or merely cut, by sawing or otherwise, into blocks or slabs of a rectangular (including square) shape; talc**
- 2526 20 00 Crushed or powdered**
 This subheading does not cover talc powder, put up in packings for retail sales, for toilet purposes (heading 3304).
- ~~2528~~2528 00 00 Natural borates and concentrates thereof (whether or not calcined), but not including borates separated from natural brine; natural boric acid containing not more than 85 % of H₃BO₃ calculated on the dry weight**
This heading includes:
1. kernite and tincal, also known as 'natural borax';
 2. pandermite and priceite, which are calcium borates;
 3. boracite, which is magnesium chloroborate;
 4. natural boric acid obtained by evaporation of the water left after the condensation of natural vapours escaping from the earth in certain regions (the Italian soffioni), or by evaporating water drawn from underground sources of those regions, provided that it does not contain more than 85 % of H₃BO₃ calculated on the dry weight. However, boric acid containing more than 85 % of H₃BO₃ is classified in heading 2810 00.
- This heading does not cover sodium borate (refined borax) obtained by chemical treatment of kernite or tincal or the sodium borates obtained by evaporating complex brines from certain salt lakes (heading 2840).
- 2528 10 00 Natural sodium borates and concentrates thereof (whether or not calcined)**
 This subheading includes kernite and tincal, also known as 'natural borax':
 This subheading does not cover sodium borate (refined borax) obtained by chemical treatment of kernite or tincal or the sodium borates obtained by evaporating complex brines from certain salt lakes (heading 2840):

2528 90 00**Other**

This subheading includes:

1. pandermite and priccite, which are calcium borates;
2. boracite, which is magnesium chloroborate;
3. natural boric acid obtained by evaporation of the water left after the condensation of natural vapours escaping from the earth in certain regions (the Italian soffioni), or by evaporating water drawn from underground sources of those regions, provided that it does not contain more than 85 % of H_3BO_3 , calculated on the dry weight. However, boric acid containing more than 85 % of H_3BO_3 is classified in heading 2810 00.

2530**Mineral substances not elsewhere specified or included****2530 10 00****Vermiculite, perlite and chlorites, unexpanded**

See the HS Explanatory Note to heading 2530, part (D), paragraph (3).

2530 90 00**Other**

See the HS Explanatory Note to heading 2530, parts (A), (B), (C) and (D) (excluding (D), paragraph (3)).

CHAPTER 26
ORES, SLAG AND ASH

- 2620** **Slag, ash and residues (other than from the manufacture of iron or steel), containing metals, arsenic or their compounds**
- 2620 11 00** **Hard zinc spelter**
Hard zinc spelter is a residue from galvanising baths and is often referred to as galvanisation matte. There are two principal kinds:
1. Mattes from heavy galvanisation which are metal products of a very variable and non-homogeneous composition, less easily melted and denser than zinc, and which settle at the bottom of the baths of liquid zinc during galvanisation of steel sheets, wire, pipes, etc. in molten zinc.

These mattes are drawn from the bath in a thick paste and are moulded in the form of sheets or slabs, which may have a rough, or even a spongy, appearance.

They contain, by weight, from 2 to 5 % of iron. Their zinc content varies from 92 to 94 % by weight. Their aluminium content is generally low and does not exceed 0,2 to 0,3 % by weight.
 2. Mattes from light galvanisation or 'surface mattes' which are metal products from continuous skimming of the galvanisation baths by the Senzimir process, not containing flux.

These mattes, which are less dense than zinc, float on the surface of the baths. When drawn from the baths in a thick paste and moulded into slabs, they have a less irregular appearance than those mentioned above.

Their iron content is very low, generally less than 0,5 % by weight. Their aluminium content is much higher: 1 to 2 % by weight. Their zinc content is of the order of 98 % by weight.

These should not be confused with zinc alloys (heading 7901), which assay by weight generally from 3 to 5 % of aluminium and can contain up to 3 % by weight of copper, but which comply with specific technical requirements, whereas the composition of zinc mattes is such that they can be usefully employed only for metallurgical or chemical transformation.
- 2620 19 00** **Other**
This subheading includes:
1. mattes from refining, which are drawn from the bottom of the baths refining crude zinc. These contain by weight from 4 to 8 % of lead and up to 6 % of iron;
 2. zinc slag and ash, consisting of zinc (from 65 to 70 % by weight) and zinc oxide with carbon and other impurities;
 3. zinc foams which consist of metallic zinc, zinc chloride and ammonium chloride, zinc oxide and iron oxide, drawn from the surface of galvanising baths or from vats remelting old zinc;
 4. zinc sludge which is a residue from certain industries using zinc as a reducing agent;
 5. zinc dross obtained as a residue from the manufacture of zinc oxide from zinc mattes; they contain at that time approximately 60 % zinc by weight, the balance consisting of iron and other impurities;
 6. zinc oxide residues, extracted from gases during the reprocessing of various metals or alloys such as brass. These residual oxides should not be confused with:
 - zinc greys (subheading 3206 49 80 3206 49 70) which are very impure zinc oxides put up in the form of powder of homogeneous colour and fineness and usable as pigments;
 - zinc powders, obtained by atomisation of molten zinc (subheading 7903 90 00), or zinc dust, containing by weight from 80 to 94 % of metallic zinc, recovered from a bed of zinc oxide (subheading 7903 10 00).

- 2620 21 00** **Leaded gasoline sludges and leaded anti-knock compound sludges**
See subheading note 1 to this chapter.
See also the HS Explanatory Note to heading 2620, second paragraph, (10).
- 2620 60 00** **Containing arsenic, mercury, thallium or their mixtures, of a kind used for the extraction of arsenic or those metals or for the manufacture of their chemical compounds**
See subheading note 2 to this chapter.
- 2620 91 00** **Containing antimony, beryllium, cadmium, chromium or their mixtures**
See the HS Explanatory Note to heading 2620, second paragraph, (13).
- 2621** **Other slag and ash, including seaweed ash (kelp); ash and residues from the incineration of municipal waste**
- 2621 10 00** **Ash and residues from the incineration of municipal waste**
See the HS Explanatory Note to heading 2621, second paragraph, (5).

CHAPTER 27

MINERAL FUELS, MINERAL OILS AND PRODUCTS OF THEIR DISTILLATION; BITUMINOUS SUBSTANCES; MINERAL WAXES

General

~~Unless otherwise indicated, the term 'ASTM method' means the methods laid down by the American Society for Testing and Materials, published in the 1976 edition of standard definitions and specifications for petroleum and lubricating products. Unless otherwise indicated, the term 'ASTM method' means the methods laid down by the American Society for Testing and Materials.~~

- Note 2** The content of aromatic constituents is to be determined by the following methods:
- ~~products with a distillation end point not exceeding 315 °C: ASTM D 1319-70 method; products with a distillation end point not exceeding 315 °C: EN 15553 method;~~
 - products with a distillation end point exceeding 315 °C: see Annex A to the explanatory notes to this chapter.

- Additional note 5**
1. It is to be noted that, except as provided in additional note 5(n), the exemption applies to the whole of the products used in the specific process.
Accordingly, where a petroleum product is subjected, for example, to alkylation or polymerisation, that part which is not effectively transformed (alkylated or polymerised) also benefits from the exemption.
 2. In cases where preliminary treatment is necessary before a 'specific process' (see final paragraph of additional note 5), two conditions must be met in order to obtain the benefit of exemption:
 - (a) the imported product must be effectively subjected to a 'specific process', for example, cracking;
 - (b) the preliminary treatment must be necessary to the 'specific process'.

The following in particular are regarded as necessary preparatory treatments for products intended for undergoing a 'specific process':

- (a) degassing;
- (b) dehydration;
- (c) removal of certain light or heavy products which might interfere with processing;
- (d) ~~removal or conversion of mercaptans (softening), of other sulphur compounds or of other compounds which might prejudice processing;~~ removal or conversion of mercaptans (softening or sweetening), of other sulphur compounds or of other compounds which might prejudice processing;
- (e) neutralisation;
- (f) decantation;
- (g) desalination.

Any products which may be obtained in the course of a preparatory treatment but which do not undergo a specific process are liable to the customs duties applicable to products 'for other purposes', according to the kind and value of the imported goods and on the basis of the net weight of the products so obtained.

- Additional note 5(a)** Vacuum distillation means distillation under a pressure not exceeding 400 mbar, measured at the head of the column.

Additional note 5(b)

Redistillation by a very thorough fractionation process means distillation (other than topping) by a continuous or batch process employed in industrial installations using distillates of subheadings ~~2710 11 11~~2710 12 11 to ~~2710 19 49~~2710 19 48, 2711 11 00, 2711 12 91 to 2711 19 00, 2711 21 00 and 2711 29 00 (other than propane of a purity of 99 % or more) to obtain:

1. isolated high-purity hydrocarbons (90 % or more in the case of olefins, and 95 % or more in the case of other hydrocarbons), mixtures of isomers having the same organic composition being regarded as isolated hydrocarbons.

Only those processes by means of which at least three different products are obtained are admissible, but this restriction does not apply in any instance where the process consists in the separation of isomers. In so far as this concerns xylenes, ethylbenzene is included with xylene isomers;

2. products of subheadings ~~2707 10 10~~2707 10 00 to ~~2707 30 90~~2707 30 00, ~~2707 50 10~~2707 50 00, ~~2707 50 90~~ and ~~2710 11 11~~2710 12 11 to ~~2710 19 49~~2710 19 48:
 - (a) ~~with no overlapping of the final boiling point of one fraction and the initial boiling point of the succeeding fraction and a difference of not more than 60 °C between the temperatures at which 5 and 90 % by volume (including losses) distil by the ASTM D 86-67 method (reapproved 1972);~~with no overlapping of the final boiling point of one fraction and the initial boiling point of the succeeding fraction and a difference of not more than 60 °C between the temperatures at which 5 and 90 % by volume (including losses) distil by the EN ISO 3405 method (equivalent to the ASTM D 86-67 method);
 - (b) ~~with an overlapping of the final boiling point of one fraction and the initial boiling point of the succeeding fraction and a difference of not more than 30 °C between the temperatures at which 5 and 90 % by volume (including losses) distil by the ASTM D 86-67 method (reapproved 1972);~~with an overlapping of the final boiling point of one fraction and the initial boiling point of the succeeding fraction and a difference of not more than 30 °C between the temperatures at which 5 and 90 % by volume (including losses) distil by the EN ISO 3405 method (equivalent to the ASTM D 86-67 method).

Additional note 5(c)

Cracking is an industrial process for modifying the chemical structure of petroleum products by breaking down the molecules by heating, with or without pressure and with or without the assistance of a catalyst, thus producing, in particular, mixtures of lighter hydrocarbons which may be liquid or gaseous at normal temperatures and pressures.

The chief cracking processes are:

1. thermal cracking;
2. catalytic cracking;
3. steam cracking to obtain gaseous hydrocarbons;
4. hydrocracking (cracking plus hydrogenation);
5. dehydrogenation;
6. dealkylation;
7. coking;
8. visbreaking.

Additional note 5(d)

Reforming is the thermal or catalytic processing of light or medium oils to increase their content of aromatics. Catalytic reforming is used, for example, to convert straight-distillation light oils into light oils with a higher octane number (with a higher content of aromatic hydrocarbons) or into a mixture of hydrocarbons containing benzene, toluene, xylenes, ethylbenzene, etc.

The principal catalytic reforming processes are those employing platinum as the catalyst.

Additional note 5(e)

~~Extraction by means of selective solvents is the process of separating groups of products with different molecular structures by means of substances having a preferential solvent effect (for example, furfural, phenol, dichloroethyl ether, sulphuric anhydride, nitrobenzene, urea and certain of its derivatives, acetone, propane, ethyl methyl ketone, isobutyl methyl ketone, glycol, morpholine).~~Extraction by means of selective solvents is the process of separating groups of products with different molecular structures by means of substances having a preferential solvent effect (for example, furfural, phenol, dichloroethyl ether, sulphuric anhydride, nitrobenzene, urea and certain of its derivatives, acetone, propane, ethyl methyl ketone, isobutyl methyl ketone, glycol, N-methyl morpholine).

Additional note 5(g)

Polymerisation is the industrial process, whether or not involving heating or the use of a catalyst, by means of which unsaturated hydrocarbons are made to form their polymers or copolymers.

Additional note 5(h)

Alkylation means any thermal or catalytic reaction in which unsaturated hydrocarbons are united with any other hydrocarbons, in particular, isoparaffins and aromatics.

- Additional note 5(ij)** Isomerisation is the reforming of the structure of the constituents of petroleum products without altering their gross composition.
- Additional note 5(l)** ~~The following are examples of deparaffining for the purposes of this additional note:~~ The following are examples of dewaxing for the purposes of this additional note:
1. ~~deparaffining by cooling (with or without solvents);~~ dewaxing by cooling (with or without solvents);
 2. microbiological treatment;
 3. ~~deparaffining by means of urea;~~ dewaxing by means of urea;
 4. molecular sieve treatment.
- Additional note 5(n)** Atmospheric distillation means distillation carried out at a pressure of about 1 013 mbar, measured at the head of the column.
- Additional Note 6**
1. 'Chemical transformation' means any operation for the molecular modification of one or more constituents of a petroleum product undergoing processing.

The mere mixing of a petroleum product with another product, whether or not also of petroleum, is not regarded as a 'chemical transformation'. The incorporation of white spirit into paint, for example, or of a base oil into printing ink, is not to be regarded as falling within the definition of 'chemical transformation'. This is also the case with all uses of petroleum products as solvents or fuels.
 2. Examples of 'chemical transformations':
 - (a) treatment with halogens or halogen compounds:
 - (i) reaction with propylene present in a gaseous petroleum fraction, in order to obtain organic derivatives (for example, to obtain propylene oxide);
 - (ii) treatment of petroleum fractions (motor spirit, kerosene, gas oil), paraffins, petroleum waxes or paraffinic residues with chlorine or chlorine compounds, in order to obtain chloroparaffins;
 - (b) treatment with bases (for example, sodium, potassium, ammonium hydroxides), in order to obtain naphthenic acids;
 - (c) treatment with sulphuric acid or its anhydride:
 - (i) to obtain sulphonates;
 - (ii) to extract or obtain isobutylene;
 - (iii) for the sulphonation of gas oils and lubricating oils.
 Oil added after sulphonation is not eligible for exemption;
 - (d) sulphochlorination;
 - (e) hydration, particularly for obtaining alcohols by modification of unsaturated hydrocarbons present in gaseous petroleum fractions;
 - (f) treatment with maleic anhydride, in particular, treatment of butadiene mixed with a gaseous petroleum fraction containing four carbon atoms, in order to obtain tetrahydrophthalic acid;
 - (g) treatment with phenol, for example, reaction of petroleum olefins with phenols in the presence of a catalyst, in order to obtain alkylphenols;
 - (h) oxidation:
 - (i) oxidation of heavy oils to obtain bitumens of subheading 2713 20 00;
 - (ii) oxidation of any petroleum product, in order to obtain more complex chemical products such as acids, aldehydes, ketones, alcohols; for example, oxidation of light fractions under heat and pressure, to obtain acetic, formic, propionic and succinic acids;
 - (ij) dehydrogenation, for example, of:
 - (i) naphthenic hydrocarbons, to obtain aromatic hydrocarbons (for example, benzole);
 - (ii) paraffinic hydrocarbons, to obtain liquid olefins as used, for example, in the manufacture of biodegradable alkylbenzenes;
 - (k) oxo synthesis;
 - (l) irreversible incorporation of heavy oils into high polymers (for example, into latex of natural or synthetic rubber, butyl rubber, polystyrene);
 - (m) manufacture of products of heading 2803;
 - (n) nitration, to obtain nitrated derivatives;
 - (o) biological treatment of certain petroleum fractions containing *n*-paraffins, to obtain proteins or other complex organic products.

- 2701 Coal; briquettes, ovoids and similar solid fuels manufactured from coal**
Those fuels known to the trade in Spain as 'black lignite' and coming from the Teruel, Mequinenza, Pirenaica and Baleares coalfields are considered to be coal of this heading.
- 2701 12 10 Coking coal**
Coking coal contains between 19 and 41 % of volatile constituents.
- 2702 Lignite, whether or not agglomerated, excluding jet**
Lignites burn with a long but cool flame, giving off pungent black smoke. Commonly distinguished types are: fibrous lignites whose fracture is reminiscent of the fibrous appearance of the original wood and which have a high moisture content (up to 50 %); common, or earthy, lignites, brown or black, containing less water than the fibrous type (approximately 15 %) and exhibiting an earthy fracture; bituminous, fat, lignites, which soften when heated and are therefore very suitable for briquetting; waxy lignites, which have a wax-like fracture and a high wax content.
This heading does not include fuels known to the trade in Spain as 'black lignite' and coming from the Teruel, Mequinenza, Pirenaica and Baleares coalfields (heading 2701).
- 2704 00 Coke and semi-coke of coal, of lignite or of peat, whether or not agglomerated; retort carbon**
- 2704 00 11 and 2704 00 19 Coke and semi-coke of coal**
Coke differs from coal in that it burns almost without flame and retains its porosity and gas permeability after combustion. It is infusible, harder, contains less sulphur and more carbon. As opposed to coke which is produced by the high-temperature (1 000 to 1 200 °C) carbonisation of coal, without air supply, semi-coke is produced by the carbonisation of coal (with a reduced air supply) at a temperature of between 450 and 700 °C.

- 2704 00 11** **For the manufacture of electrodes**
This subheading covers coke and semi-coke of coal used in the manufacture of electrodes generally intended for the production of ferro-alloys. The coke and semi-cokes of this subheading are particularly pure (very low ash content) and are generally in the form of small lumps.
- 2704 00 19** **Other**
This subheading includes gas coke (a by-product of the production of gas) and foundry coke and semi-coke specially prepared for use in the metallurgical industry (blast furnace coke) which, unlike gas coke, is a hard and tough product in the form of large lumps having a silvery appearance.
- 2704 00 30** **Coke and semi-coke of lignite**
Lignites are not suitable for the production of coke by high-temperature carbonisation. However, low-temperature carbonisation yields a semi-coke for use as a smokeless fuel which is porous, glossy, clean to handle and ignites and burns readily.
- 2704 00 90** **Other**
This subheading covers:
1. products obtained from the carbonisation of peat; they give off a strong pungent odour on burning and are used chiefly in industrial furnaces;
 2. retort carbon (see the HS Explanatory Note to heading 2704, fourth and fifth paragraphs).
- 2707** **Oils and other products of the distillation of high temperature coal tar; similar products in which the weight of the aromatic constituents exceeds that of the non-aromatic constituents**
As regards the determination of the content of aromatic constituents, see the explanatory note to note 2 to this chapter.
- ~~2707 10 10~~ **2707 10 00** ~~and~~ **Benzol (benzene)**
~~2707 10 90~~
See subheading note 3 to this chapter.
~~These subheadings cover only benzol (benzene) of a purity by weight of less than 95 %. Benzol (benzene) of a purity by weight of 95 % or more falls in subheading~~ This subheading covers only benzol (benzene) of a purity by weight of less than 95 %. Benzol (benzene) of a purity by weight of 95 % or more falls in subheading 2902 20 00.
- ~~2707 20 10~~ **2707 20 00** ~~and~~ **Toluol (toluene)**
~~2707 20 90~~
See subheading note 3 to this chapter.
~~These subheadings cover only toluol (toluene) of a purity by weight of less than 95 %. Toluol (toluene) of a purity by weight of 95 % or more falls in subheading~~ This subheading covers only toluol (toluene) of a purity by weight of less than 95 %. Toluol (toluene) of a purity by weight of 95 % or more falls in subheading 2902 30 00.
- ~~2707 30 10~~ **2707 30 00** ~~and~~ **Xylol (xylenes)**
~~2707 30 90~~
See subheading note 3 to this chapter.
~~These subheadings cover only xylol (xylenes) of a purity by weight of less than 95 % (ortho-, meta-, or para-isomers of xylol (xylenes), separately or mixed), as ascertained by gas chromatography. Xylol (xylenes) of a purity by weight of 95 % or more falls in subheadings~~ This subheading covers only xylol (xylenes) of a purity by weight of less than 95 % (ortho-, meta-, or para-isomers of xylol (xylenes), separately or mixed), as ascertained by gas chromatography. Xylol (xylenes) of a purity by weight of 95 % or more falls in subheadings 2902 41 00 to 2902 44 00.

2707 40 00**Naphthalene**

See subheading note 3 to this chapter.

This subheading covers only naphthalene the crystallising point of which, as ascertained by the method described in Annex B to the explanatory notes to this chapter, is below 79,4 °C. If the product has a crystallising point of 79,4 °C or above, it falls in subheading 2902 90 00.

This subheading does not cover naphthalene homologues (subheadings ~~2707 50 10~~2707 50 00, 2707 50 90, 2707 91 00 to 2707 99 99, 2902 90 00 or 3817 00 80).

**~~2707 50 10~~2707 50 00 and
2707 50 90****Other aromatic hydrocarbon mixtures of which 65 % or more by volume (including losses) distils at 250 °C by the ASTM D 86 method**

~~These subheadings cover hydrocarbon mixtures in which aromatics, other than benzene, toluene, xylene or naphthalene predominate and of which 65 % or more by volume (including losses) distils at up to 250 °C by the ASTM D 86-67 method (reapproved 1972). This subheading covers hydrocarbon mixtures in which aromatics, other than benzene, toluene, xylene or naphthalene predominate and of which 65 % or more by volume (including losses) distils at up to 250 °C by the EN ISO 3405 method (equivalent to the ASTM D 86 method).~~

2707 99 11 and 2707 99 19**Crude oils**

These subheadings cover:

1. the products obtained from first distillation of high-temperature coal tar.

These high-temperature coal tars are generally produced in foundry coking plants at a temperature exceeding 900 °C. The distillation products of these tars contain not only hydrocarbons with a predominance by weight of aromatic hydrocarbons but also nitrogen, oxygen and sulphur compounds and very often impurities. These products usually require further processing before use;

2. similar products in which the weight of the aromatic constituents exceeds that of the non-aromatic constituents.

‘Similar products’ means those having a composition qualitatively similar to that of the products described in item 1 above.

However, they may have a higher proportion of aliphatic and naphthenic hydrocarbons and a lower proportion of polynuclear aromatic hydrocarbons than the products described in item 1 above.

Only those products in which the weight of the aromatic constituents exceeds that of the non-aromatic constituents fall in these subheadings.

These subheadings also include oils obtained by debenzolisation after washing of the gas produced during the coking of coal.

~~2707 99 30~~2707 99 20**~~Sulphuretted toppings~~ Sulphuretted toppings; anthracene**

For the purpose of this subheading, ‘sulphuretted toppings’ means only those light products obtained in the course of first distillation of crude oils from tars, containing sulphur compounds (for example, carbon disulphide, mercaptans, thiophen) and hydrocarbons with a predominance of non-aromatic hydrocarbons, of which 90 % or more by volume distils at a temperature below 80 °C.

Anthracene of this subheading is usually in the form of a sludge or paste generally containing phenanthrene, carbazole and other aromatic constituents. The subheading covers only anthracene of a purity by weight of less than 90 %. Anthracene of a purity by weight of 90 % or more falls in subheading 2902 90 00.

2707 99 50**Basic products**

For the purposes of this subheading, basic products are aromatic and/or heterocyclic products with basic nitrogen function. The subheading covers, in particular, pyridine, quinoline, acridine and aniline bases (including mixtures thereof). These are derived principally from pyridine, quinoline, acridine and their homologues.

Among the basic products falling in this subheading are:

1. pyridine of a purity by weight of less than 95 %. Pyridine of a purity by weight of 95 % or more falls in subheading 2933 31 00;
2. methylpyridine (picoline), 5-ethyl-2-methylpyridine (5-ethyl-2-picoline), 2-vinylpyridine, of a purity by weight of less than 90 % (as ascertained by gas chromatography). If the content by weight is 90 % or more, these products fall in subheading 2933 39;
3. quinoline of a purity of less than 95 % calculated by weight on the anhydrous product (ascertained by gas chromatography). If the purity is not less than 95 %, this product falls in subheading 2933 49 90;
4. acridine of a purity of less than 95 % calculated by weight on the anhydrous product (as ascertained by gas chromatography). If the purity is not less than 95 %, this product falls in subheading 2933 99 80.

This subheading does not cover salts of any of the basic products described (heading 2933 or 3824).

2707 99 70**Anthracene**

Anthracene of this subheading is usually in the form of a sludge or paste generally containing phenanthrene, carbazole and other aromatic constituents. The subheading covers only anthracene of a purity by weight of less than 90 %. Anthracene of a purity by weight of 90 % or more falls in subheading 2902 90 00.

2707 99 80**Phenols**

See additional note 1 to this chapter.

This subheading covers:

1. phenols obtained by the distillation of high-temperature coal tar, and also similar products in which the weight of the aromatic constituents exceeds that of the non-aromatic constituents.
However, phenol salts are excluded from this subheading (generally, heading 2907 or subheading 3824 90 97);
2. cresols (single or mixed isomers) containing by weight less than 95 % of cresol, all cresol isomers being taken together (as ascertained by gas chromatography). If the content by weight is 95 % or more, these products fall in subheading 2907 12 00;
3. xylenols (single or mixed isomers) containing by weight less than 95 % of xyleneol, all xyleneol isomers being taken together (as ascertained by gas chromatography). If the content by weight is 95 % or more, these products fall in subheading 2907 19 10;
4. other phenols having one or more benzene rings with one or more hydroxyl radicals, provided they are not chemically defined phenols of heading 2907. One notable product is phenol (C₆H₅OH) of a purity by weight of less than 90 %.

2707 99 91 and 2707 99 99**Other**

These subheadings cover principally products consisting of mixtures of hydrocarbons.

These products include:

1. heavy oils (other than crude) obtained from the distillation of high-temperature coal tar or products similar to those oils, provided that:
 - (a) less than 65 % by volume distils at up to 250 °C by the ASTM D 86-67 method (reapproved 1972); and less than 65 % by volume distils at up to 250 °C by the EN ISO 3405 method (equivalent to the ASTM D 86 method); and
 - (b) they have a density exceeding 1,000 g/cm³ at 15 °C; and at 15 °C by the EN ISO 12185 method; and
 - (c) they have a needle penetration index of 400 or higher at 25 °C by the ASTM D 5 method; and they have a needle penetration index of 400 or higher at 25 °C by the EN 1426 method; and
 - (d) they have characteristics other than those of the products of heading 2715 00 00.

Products not fulfilling the conditions set out at (a) to (d) above are to be classified according to their characteristics in, for example, subheadings ~~2707 10 10~~ 2707 10 00 to ~~2707 30 90~~ 2707 30 00, ~~2707 50 10~~ 2707 50 00; ~~2707 50 90~~, heading 2708, subheadings 2710 19 31 to 2710 19 99, 2713 20 00 or heading 2715 00 00;
2. aromatic extracts not conforming to the requirements prescribed for those products in the explanatory note to subheading 2713 90 10 and 2713 90 90;
3. certain naphthalene and anthracene homologues such as ethylnaphthalenes and methylanthracenes, provided that they do not fall in heading 2902.

- 2709 00** **Petroleum oils and oils obtained from bituminous minerals, crude**
This heading covers only products which possess properties characteristic of crude oils from the various sources (for example, specific gravity, distillation curve, sulphur content, pour point, viscosity).
- 2709 00 10** **Natural gas condensates**
This subheading includes crude oils obtained from the stabilisation, immediately on extraction, of natural gas. This operation consists of extracting the condensable hydrocarbons contained in the 'wet' natural gas, mainly by cooling and depressurisation.
See also the HS Explanatory Note to heading 2709, second paragraph.
- 2710** **Petroleum oils and oils obtained from bituminous minerals, other than crude; preparations not elsewhere specified or included, containing by weight 70 % or more of petroleum oils or of oils obtained from bituminous minerals, these oils being the basic constituents of the preparations; waste oils**
See notes 2 and 3 to this chapter and the relevant explanatory notes.
- ~~2710 11 11~~ ~~2710 12 11~~ ~~to~~
2710 19 99 **Petroleum oils and oils obtained from bituminous minerals (other than crude) and preparations not elsewhere specified or included, containing by weight 70 % or more of petroleum oils or of oils obtained from bituminous minerals, these oils being the basic constituents of the preparations, other than waste oils**
Petroleum oils and oils obtained from bituminous minerals (other than crude) and preparations not elsewhere specified or included, containing by weight 70 % or more of petroleum oils or of oils obtained from bituminous minerals, these oils being the basic constituents of the preparations, other than those containing biodiesel and other than waste oils
For definitions of these products, see note 2 to this chapter and the HS Explanatory Note to heading 2710, (I).
As regards the subheadings for products intended:
— for undergoing a specific process,
— for undergoing a chemical transformation,
- see additional notes 5 and 6 to this chapter and the relevant explanatory notes.
- I. *Petroleum oils and oils obtained from bituminous minerals (other than crude)*
- This group covers mixtures of isomers (other than stereoisomers) of saturated acyclic hydrocarbons containing less than 95 % of a particular isomer or of unsaturated acyclic hydrocarbons containing less than 90 % of a particular isomer, these percentages being calculated on the weight of the anhydrous product.
- This group also covers separate isomers of the above hydrocarbons having a purity of less than 95 % and 90 %, respectively, by weight.
- This group covers only petroleum oils and oils from bituminous minerals:
1. ~~having a crystallising point, as measured by the ASTM D 938 method, below 30 °C; or having a crystallising point, as measured by the ASTM D 938 method (equivalent to the ISO 2207 method), below 30 °C; or~~
 2. having a crystallising point of 30 °C or higher and
 - (a) ~~a density of less than 0,942 g/cm³ at 70 °C and a worked cone penetration, as measured by the ASTM D 217 method, of at least 350 at 25 °C; or at 70 °C by the EN ISO 12185 method, and a worked cone penetration, as measured by the ASTM D 217 method (equivalent to the ISO 2137 method), of at least 350 at 25 °C; or~~
 - (b) ~~a minimum density of 0,942 g/cm³ at 70 °C and a needle penetration, as measured by the ASTM D 5 method, of at least 400 at 25 °C; at 70 °C by the EN ISO 12185 method, and a needle penetration, as measured by the EN 1426 method, of at least 400 at 25 °C.~~
- For the purposes of paragraph (I) above, petroleum oils and oils obtained from bituminous minerals are also to be taken to include such oils to which very small quantities of various substances have been added, for example, as additives to improve quality or odour, tracers, colouring agents.
- See also the diagram below ~~See also the diagram below: (+):~~
- Distinguishing criteria for certain petroleum products of subheadings ~~2710 11 11~~ 2710 12 11 to 2710 19 99 and of headings 2712 and 2713 (other than preparations of subheadings ~~2710 11 11~~ 2710 12 11 to 2710 19 99)**

(1) Where a product is found to be too hard for the Worked Cone Penetration test by the ASTM D 217 method, the Cone Penetration test is to be applied by the ASTM D 937 method.

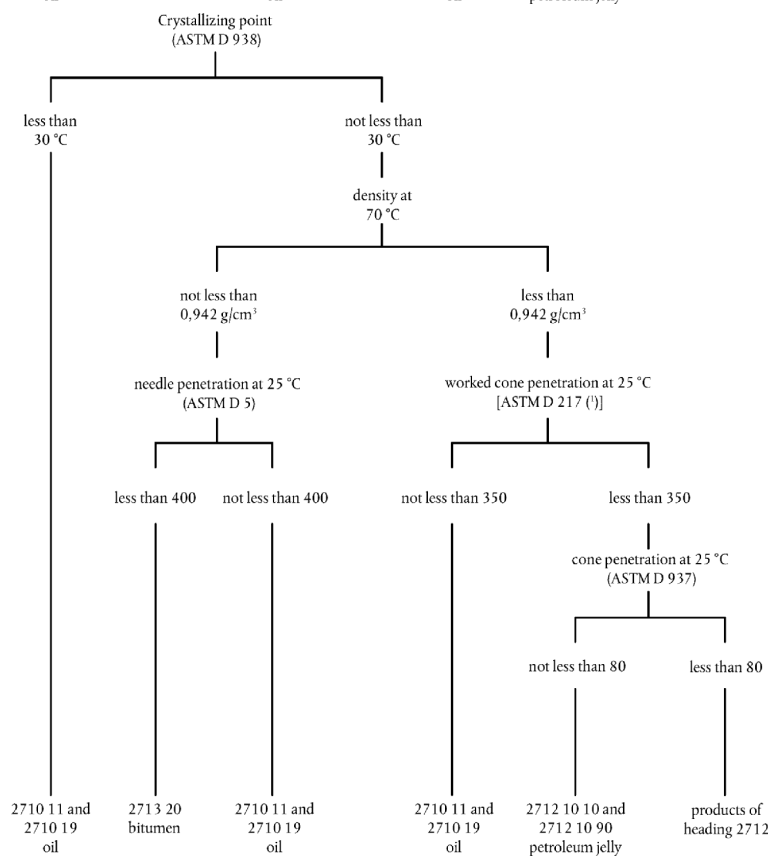
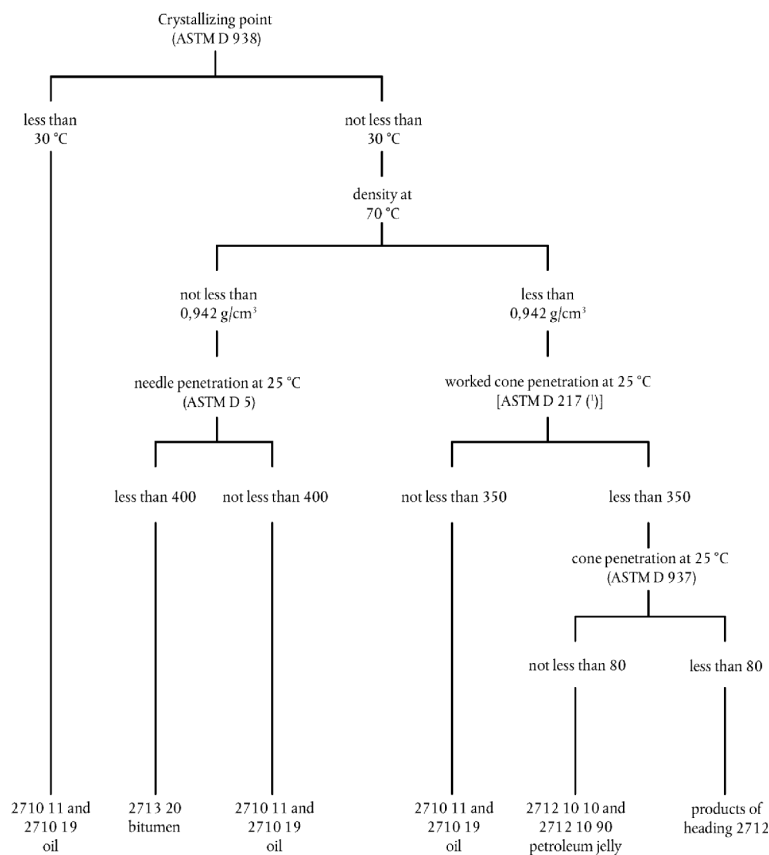

II. *Preparations not elsewhere specified or included, containing by weight 70 % or more of petroleum oils or of oils obtained from bituminous minerals, these oils being the basic constituents of the preparations* *Preparations not elsewhere specified or included, containing by weight 70 % or more of petroleum oils or of oils obtained from bituminous minerals, these oils being the basic constituents of the preparations, other than those containing biodiesel*

To be classified in these subheadings, preparations must satisfy the following conditions:

1. the proportion by weight of petroleum oils or of oils obtained from bituminous minerals, as defined in part I above, must be 70 % or more.

This proportion is that determined by analysis and not by the quantity of materials added;

2. they must be neither specified nor included elsewhere;
3. petroleum oils or oils obtained from bituminous minerals in mixtures, must be the basic constituent of the preparation, that is, the essential constituent having regard to use.

The preparations of these subheadings do not include:

- (a) paints and varnishes (headings 3208, 3209 and 3210 00);
- (b) beauty preparations and cosmetics based on mineral oils (generally, heading 3304 or 3307).
- (c) petroleum sulphonates (heading 3402 or 3824).

Petroleum sulphonates are usually in the form of suspensions in petroleum oil or oil obtained from bituminous minerals. The pure sulphonate content is usually so high as to preclude direct use as a lubricant;

- (d) preparations for polishing, preserving or otherwise treating wood, paintwork, metals, glass or other materials (mainly heading 3405);
- (e) disinfectants, insecticides, etc., however put up, consisting of solutions or dispersions of an active ingredient in petroleum oil or oil obtained from bituminous minerals (heading 3808);
- (f) prepared dressings of the kind used in the textile industry (heading 3809);
- (g) prepared additives for mineral oils (also called dopes) (heading 3811);
- (h) organic composite solvents and thinners (for example, heading 3814 00);
- (i) foundry core binders (subheading 3824 10 00);
- (k) certain anti-rust preparations, in particular:
 - (i) prepared, for example, from lanolin (approximately 20 %) in solution in white spirit (subheading 3403 19 10);
 - (ii) containing amines as active ingredients (subheading 3824 90 35).

~~2710 11 11~~ **2710 12 11**to~~2710 11 90~~ **2710 12 90****Light oils and preparations**

See subheading note 4 to this chapter.

~~2710 11 24~~ **2710 12 21**and~~2710 11 25~~ **2710 12 25****Special spirits**

See additional note 2(a) to this chapter.

~~2710 11 21~~ **2710 12 21****White spirit**

See additional note 2(b) to this chapter.

The term 'Abel-Pensky method' means method DIN (Deutsche Industrienormen) 51 755 — March 1974, published by the DNA (Deutsche Normenausschuß), Berlin 15.

2710 19 11to **2710 19 29****Medium oils**

See additional note 2(c) to this chapter.

2710 19 21**Jet fuel**

This subheading covers kerosene type jet fuel. This jet fuel complies with the provisions of additional note 2(c) to this chapter.

The gas chromatographic profile of kerosene type jet fuel, for instance the most commonly used jet fuel A-1, is characteristic of an oil obtained by no other process than distillation of a crude oil. The chain length of the alkanes varies between about 10 and 18 carbon atoms. The distillation range according to the method ASTM D 86-67 (reapproved 1972) is approximately 130 °C to 300 °C. The aromatic content may be up to 25 % by volume. Its flash point is generally above 38 °C. The gas chromatographic profile of kerosene-type jet fuel, for instance the most commonly used jet fuel A-1, is characteristic of an oil obtained by no other process than the distillation of a crude oil. The chain length of the alkanes varies between about 10 and 18 carbon atoms. The distillation range according to the EN ISO 3405 method (equivalent to the ASTM D 86 method) is approximately 130 °C to 300 °C. The aromatic content may be up to 25 % by volume. Its flash point is generally above 38 °C by the ISO 13736.

Jet fuel may contain the following additives: antioxidants, corrosion inhibitors, icing inhibitors, tracer dyes.

Gas chromatographic profile of jet fuel type A-1 (kerosene)

SIMDIS ASTM D 2887 extended **SIMDIS ASTM D 2887 extended (equivalent to the ISO 3924 method)** **2**

Sample name:

Jet fuel

Acquired on:

22.3.2007
5:51:24 PM

Processed on:

4.4.2007
12:01:26 PM

Data File:

D070322011F1101D

Vial:

1

Injection:

1

Boiling Point (°C)

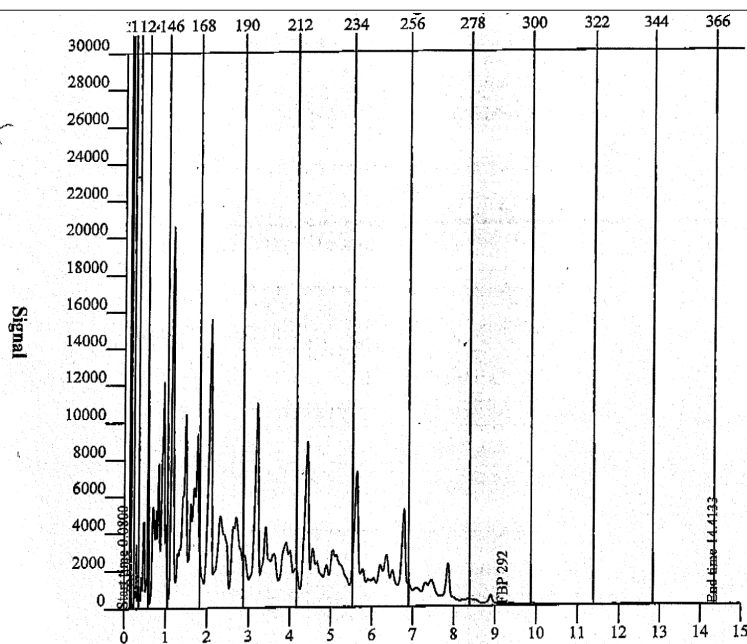

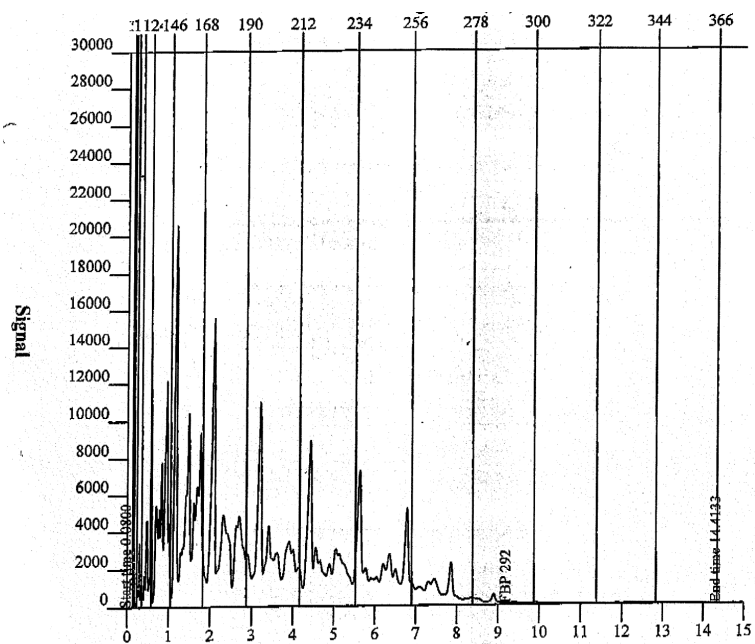

Retention Time (min)							
<u>ASTM D 86 Correlation (STP 577) - Distribution</u>							
<u>EN ISO 3405 (equivalent to the ASTM D 86 method) Correlation (STP 577) - Distribution</u>							
Recovered	PB	Re-covered	PB	Re-covered	PB	Re-covered	PB
Vol. %	°C	Vol. %	°C	Vol. %	°C	Vol. %	°C
IPB	137	20,0	163	70,0	201	FPB	267
5,0	153	30,0	176	80,0	225		
10,0	154	50,0	191	90,0	239		

2710 19 25

Other

This subheading covers kerosene other than jet fuel. The kerosene of this subheading complies with the provisions of additional note 2(c) to this chapter.

Characteristics of some of these oils are their very low aromatic and olefin content to prevent the formation of soot during combustion.

In some cases chemical markers are present.

This subheading excludes mixtures of kerosene and other mineral oils or organic solvents.

Gas chromatographic profile of low-aromatic kerosene	
SIMDIS ASTM D 2887 extended SIMDIS ASTM D 2887 extended (equivalent to the ISO 3924 method)	2
Sample name:	Kero low arom
Acquired on:	23.1.2007 10:23:54 PM
Processed on:	4.4.2007 12:30:02 PM
Data File:	D:\012007\F101.D
Vial:	6
Injection:	1
Boiling Point (°C)	

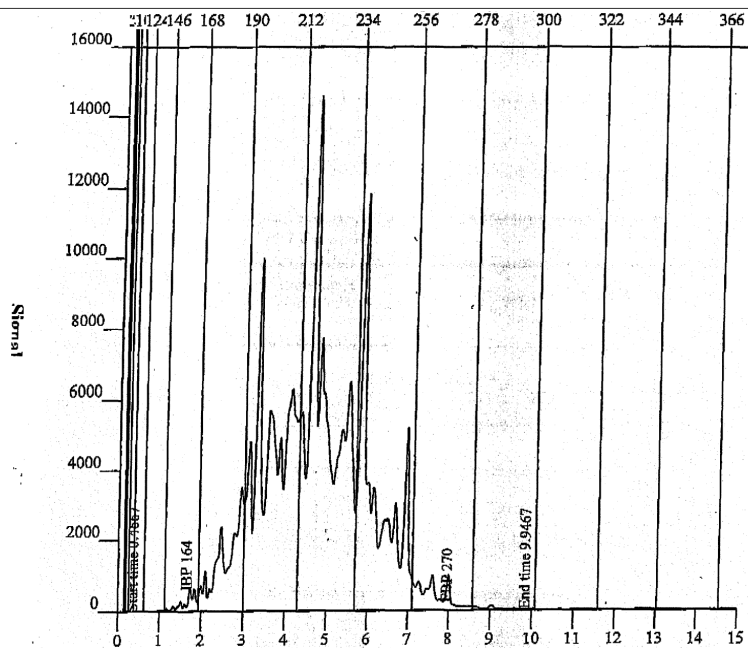

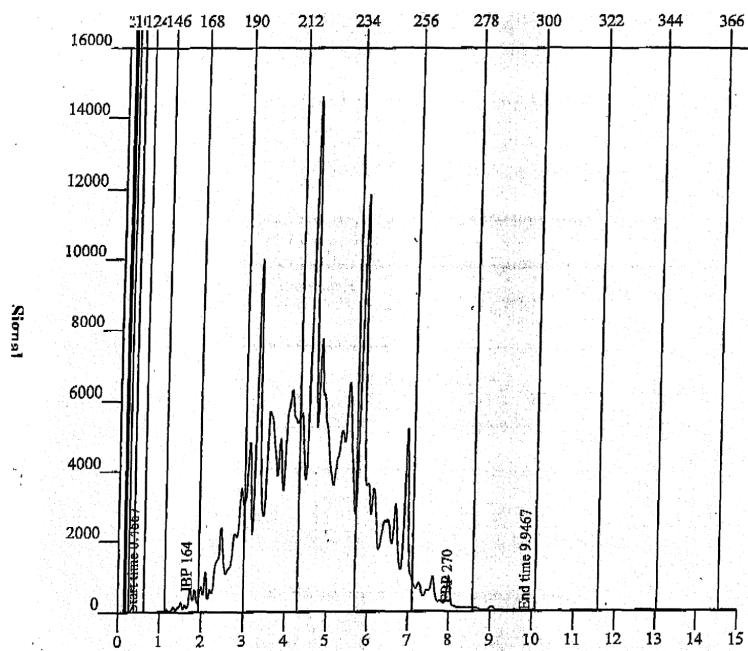

Retention Time (min)							
ASTM D 86 Correlation (STP 577) - Distribution EN ISO 3405 (equivalent to the ASTM D 86 method) Correlation (STP 577) - Distribution							
Recovered	PB	Re-covered	PB	Re-covered	PB	Re-covered	PB
Vol. %	°C	Vol. %	°C	Vol. %	°C	Vol. %	°C
IBP	194	20,0	201	70,0	201	FBP	243
5,0	208	30,0	214	80,0	224		
10,0	212	50,0	218	90,0	226		

2710 19 29

Other

This subheading covers medium oils other than kerosene of subheadings 2710 19 21 and 2710 19 25. The oils of this subheading comply with the provisions of additional note 2(c) to this chapter. An example of these oils is *n*-paraffin.

Gas chromatographic profile of <i>n</i> -paraffin	
SIMDIS ASTM D 2887 extended SIMDIS ASTM D 2887 extended (equivalent to the ISO 3924 method)	2
Sample name:	<i>n</i> -Paraffin 10-13
Acquired on:	23.1.2007 12:59:27 PM
Processed on:	4.4.2007 12:30:02 PM
Data File:	D070122\008F1301.D
Vial:	86
Injection:	1
Boiling Point (°C)	

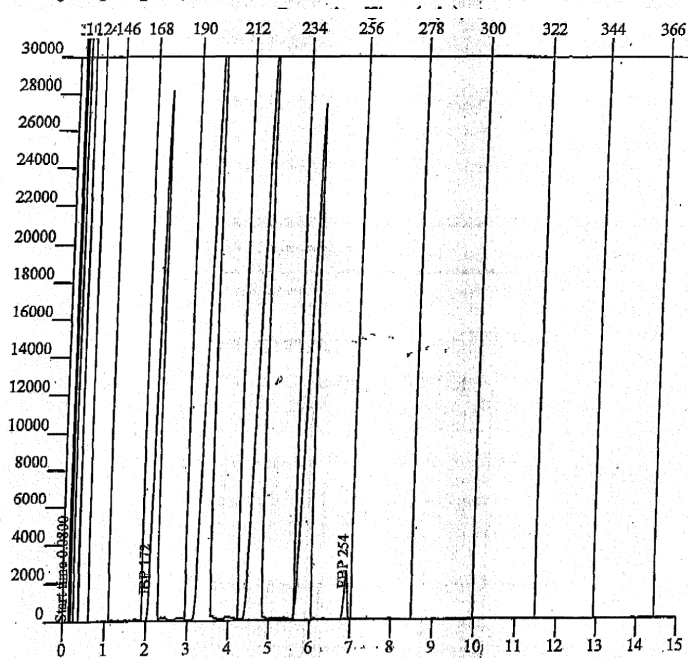
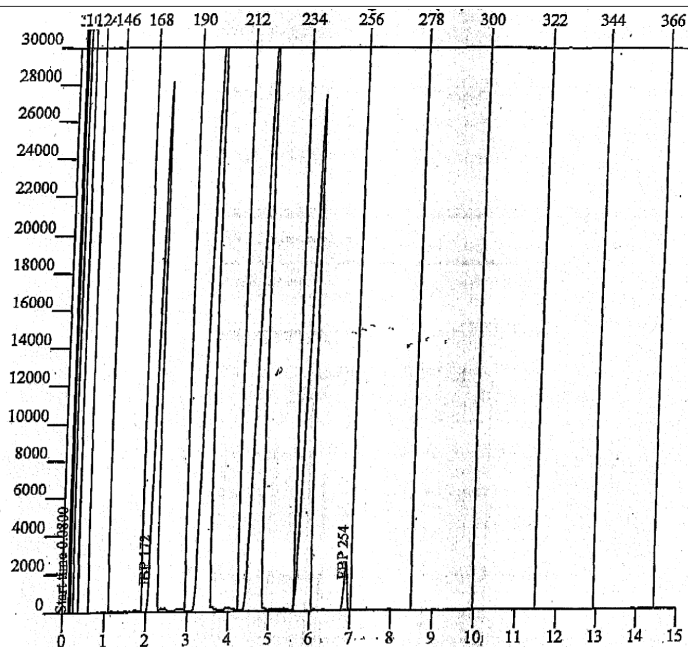

Retention Time (min)

BP Distribution table - Percent							
Recovered	PB	Recovered	PB	Recovered	PB	Recovered	PB
Mass %	°C	Mass %	°C	Mass %	°C	Mass %	°C
IBP	172,4	30,0	199,2	60,0	219,6	90,0	239,2
5,0	174,8	35,0	199,6	65,0	220,2	95,0	240,0
10,0	176,0	40,0	200,4	70,0	220,8	FBP	254,4
15,0	188,2	45,0	200,8	75,0	221,8		
20,0	197,2	50,0	217,4	80,0	237,0		
25,0	198,4	55,0	218,8	85,0	238,2		

2710 19 31to 2710 19 99

Heavy oils

See additional note 2(d) to this chapter.

2710 19 31to

~~2710 19 49~~2710 19 48

Gas oils

See additional note 2(e) to this chapter.

2710 19 51to

~~2710 19 69~~2710 19 68

Fuel oils

See additional note 2(f) to this chapter and the diagram below for the characteristics of fuel oils:

Characteristics of fuel oils

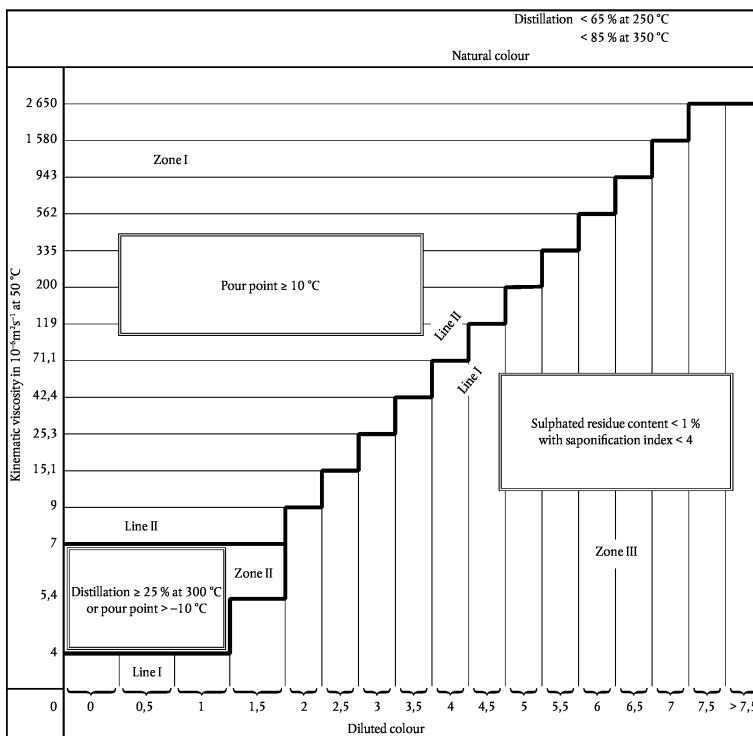

Characteristics of fuel oils

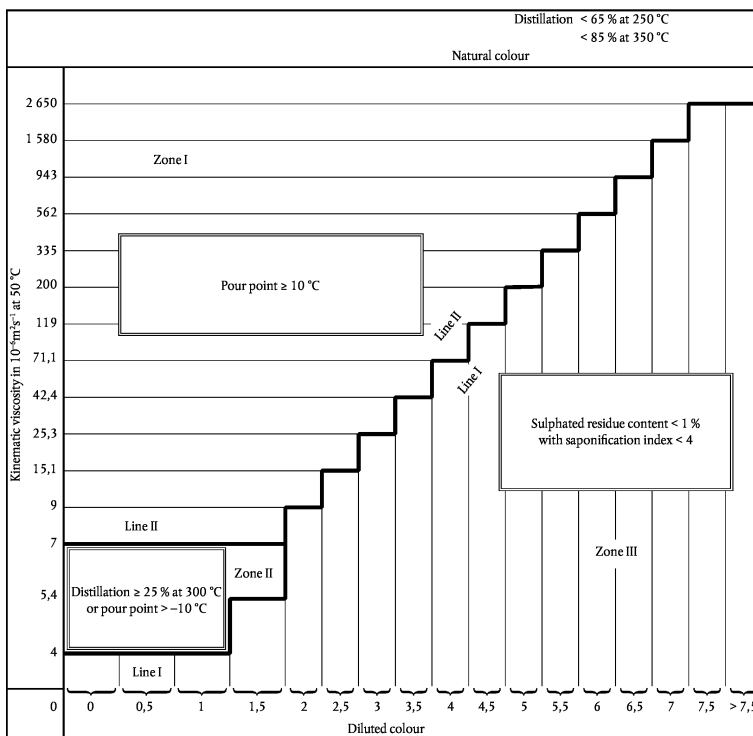

2710 19 71to 2710 19 99

Lubricating oils; other oils

These subheadings cover heavy oils as defined in additional note 2(d) to this chapter, provided that these oils do not fulfil the conditions set out in additional note 2(e) (gas oils) or 2(f) (fuel oils) to this chapter.

~~These subheadings cover heavy oils of which less than 85 % by volume, including losses, distils at 350 °C by the ASTM D 86-67 method (reapproved 1972):~~ These subheadings cover heavy oils of which less than 85 % by volume, including losses, distils at 350 °C by the EN ISO 3405 method (equivalent to the ASTM D 86 method):

1. which, for a corresponding diluted colour C, have a viscosity V:
 - (a) not exceeding that shown in line I of the concordance table set out in additional note 2(f) to this chapter, when the sulphated ash content is 1 % or more, or when the saponification index is 4 or more; or
 - (b) exceeding that shown in line II of that concordance table when the pour point is lower than 10 °C; or
 - (c) exceeding that shown in line I but not exceeding that shown in line II when less than 25 % distils at 300 °C, when the pour point is not higher than minus 10 °C. These provisions apply only to oils having a diluted colour C of less than 2;
2. for which the following cannot be determined:
 - (a) ~~the distillation percentage at 250 °C by the ASTM D 86-67 method (reapproved 1972) (zero being deemed to be a percentage); or~~ the distillation percentage at 250 °C by the EN ISO 3405 method (equivalent to the ASTM D 86 method) (zero being deemed to be a percentage); or
 - (b) ~~the kinematic viscosity at 50 °C by the ASTM D 445-74 method; or~~ the kinematic viscosity at 50 °C by the EN ISO 3104 method; or
 - (c) ~~the diluted colour C by the ASTM D 1500 method;~~ the diluted colour C by the ISO 2049 method (equivalent to the ASTM D 1500 method);
3. which are artificially coloured.

The analytical methods to be used for the purposes of item 1 above are those specified for fuel oils (see additional note 2(f) to this chapter).

See also the diagram below:

Characteristics of lubricating and other oils

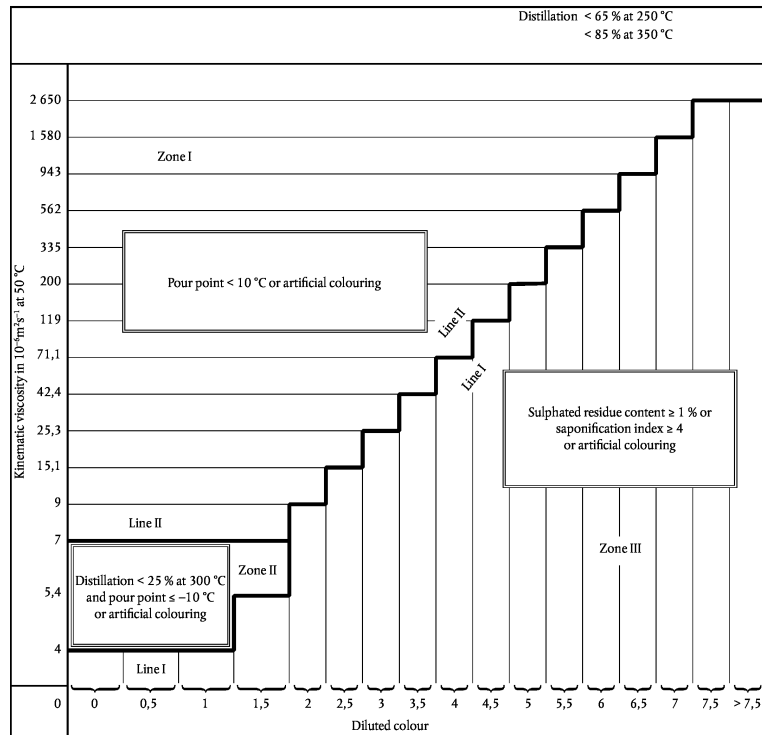

Characteristics of lubricating and other oils

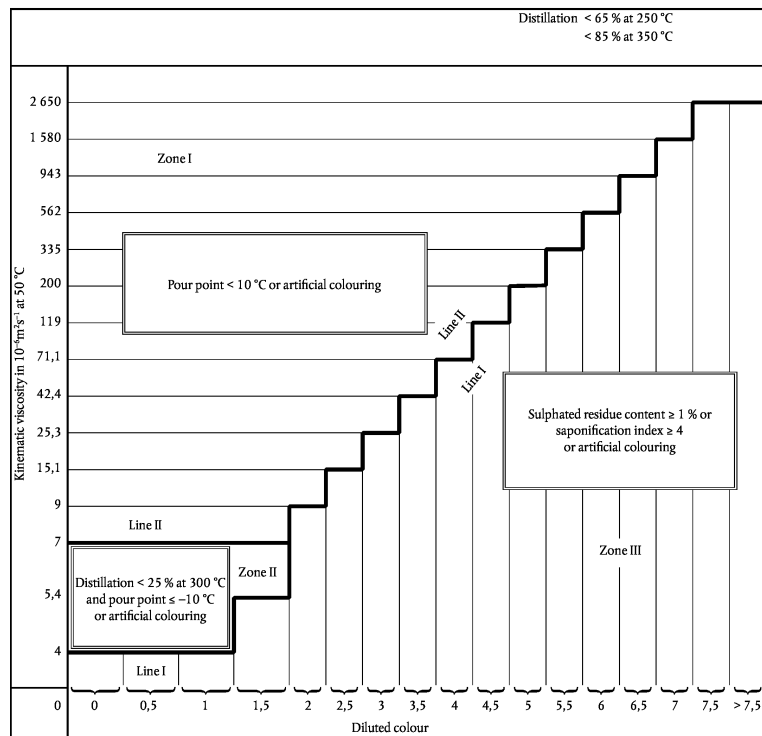

- 2710 91 00 and 2710 99 00 Waste oils**
See note 3 to this chapter and the HS Explanatory Note to heading 2710, (II).
- 2711 Petroleum gases and other gaseous hydrocarbons**
For definitions of these products, see the HS Explanatory Note to heading 2711.
As regards the subheadings for products intended:
— for undergoing a specific process,
— for undergoing chemical transformation,

see additional notes 5 and 6 to this chapter, and the relevant explanatory notes.
- 2712 Petroleum jelly; paraffin wax, microcrystalline petroleum wax, slack wax, ozokerite, lignite wax, peat wax, other mineral waxes, and similar products obtained by synthesis or by other processes, whether or not coloured**
- 2712 10 10 and 2712 10 90 Petroleum jelly**
See the HS Explanatory Note to heading 2712, part (A).
See also the diagram in the explanatory note to subheadings ~~2710 11 11~~ 2710 12 11 to 2710 19 99, part I.
- 2712 10 10 Crude**
See additional note 3 to this chapter.
- 2712 20 10 and 2712 20 90 Paraffin wax containing by weight less than 0,75 % of oil**
These subheadings cover paraffin wax described in the HS Explanatory Note to heading 2712, part (B), first and seventh paragraphs.
- 2712 90 11 and 2712 90 19 Ozokerite, lignite wax or peat wax (natural products)**
These subheadings cover the products described in the HS Explanatory Note to heading 2712, part (B), third, fourth and fifth paragraphs.
Ozokerite (natural wax) is rarely marketed at present (sources exhausted and poor financial return), the terms ozokerite and ceresin (refined ozokerite) being in practice wrongly applied to microcrystalline waxes of subheadings 2712 90 31 to 2712 90 99.
- 2712 90 31 to 2712 90 99 Other**
These subheadings cover the products described in the HS Explanatory Note to heading 2712, part (B), second, sixth and seventh paragraphs, other than synthetic paraffin of subheading 2712 20 10 or 2712 20 90.
These products show the following characteristics:
1. ~~the crystallising point, as determined by the ASTM D 938 method, is not lower than 30 °C;~~ the crystallising point, as determined by the ASTM D 938 method (equivalent to the ISO 2207 method), is not lower than 30 °C;
2. ~~the density is less than 0,942 g/cm³ at 70 °C;~~ at 70 °C by the EN ISO 12185 method;
3. ~~the worked cone penetration, as determined by the ASTM D 217 method, is less than 350 at 25 °C; and~~ the worked cone penetration, as determined by the ASTM D 217 method (equivalent to the ISO 2137 method), is less than 350 at 25 °C; and
4. ~~the cone penetration, as measured by the ASTM D 937 method, is less than 80 at 25 °C;~~ the cone penetration, as measured by the ASTM D 937 method (equivalent to the ISO 2137 method), is less than 80 at 25 °C.

If a product is found to be too hard for the worked cone penetration test by the ASTM D 217 method, the cone penetration test is to be applied by the ASTM D 937 method.

See also the diagram in the explanatory note to subheadings ~~2710 11 11~~ 2710 12 11 to 2710 19 99, part I.
- 2712 90 31 to 2712 90 39 Crude**
See additional note 4 to this chapter.
As regards the subheadings for products intended:
— for undergoing a specific process,
— for undergoing a chemical transformation,

see additional notes 5 and 6 to this chapter, and the relevant explanatory notes.

- 2713 Petroleum coke, petroleum bitumen and other residues of petroleum oils or of oils obtained from bituminous minerals**
- 2713 11 00 and 2713 12 00 Petroleum coke**
These subheadings cover petroleum coke as described in the HS Explanatory Note to heading 2713, paragraph (A).
- 2713 20 00 Petroleum bitumen**
This subheading covers petroleum bitumen as described in the HS Explanatory Note to heading 2713, paragraph (B).
This product shows the following characteristics:
- ~~the crystallising point is not below 30 °C by the ASTM D 938 method;~~the crystallising point is not below 30 °C by the ASTM D 938 method (equivalent to the ISO 2207 method);
 - the density is not less than 0,942 g/cm³ ~~at 70 °C;~~ and at 70 °C by the EN ISO 12185 method; and
 - ~~the needle penetration at 25 °C is less than 400 by the ASTM D 5 method;~~the needle penetration at 25 °C is less than 400 by the EN 1426 method.
- See also the diagram in the explanatory note to subheadings ~~2710 11 11~~2710 12 11 to 2710 19 99, part I.
- 2713 90 10 and 2713 90 90 Other residues of petroleum oils or of oils obtained from bituminous minerals**
These subheadings cover the products described in the HS Explanatory Note to heading 2713, part (C).
Aromatic extracts of these subheadings (see the HS Explanatory Note to heading 2713, part (C), paragraph (1)) generally meet the following requirements:
- content of aromatic constituents exceeds 80 % by weight by the method described in Annex A to the explanatory notes to this chapter;
 - density at 15 °C exceeds 0,950 g/cm³; ~~and, by the EN ISO 12185 method;~~ and
 - ~~not more than 20 % by volume distils at 300 °C by the ASTM D 86-67 method (reapproved 1972);~~not more than 20 % by volume distils at 300 °C by the EN ISO 3405 method (equivalent to the ASTM D 86 method).
- However, mixed alkylbenzenes and mixed alkylnaphthalenes also meeting the requirements mentioned above are classified in heading 3817.
- 2715 00 00 Bituminous mixtures based on natural asphalt, on natural bitumen, on petroleum bitumen, on mineral tar or on mineral tar pitch (for example, bituminous mastics, cut-backs)**
The composition of bituminous mixtures of this heading varies according to the intended use.
- Products used for waterproofing and protecting surfaces or for insulating purposes*
The products used for corrosion-resistant coatings, insulating electrical plant, waterproofing surfaces, filling cracks, etc. usually consist of a binder (bitumen, asphalt or tar), rigid fillers such as mineral fibres (asbestos, glass), wood sawdust and any other substance needed to give the products the properties required or to facilitate their application. The following are examples of these products:
 - bituminous sealants
with a solvent content of less than 30 % which enable coatings with a thickness of 3 to 4 mm or less to be obtained;
 - bituminous mastics
with a solvent content not exceeding 10 % which enable the following to be obtained: either coatings with a thickness ranging from 4 mm to 1 cm or caulked seams of large dimensions (2 to 8 cm);
 - other bituminous preparations
containing fillers but no solvents. These must be given heat treatment before being used. Among other applications, they are used for protecting underground or underwater pipework (pipelines).
 - Products used for surfacing roads*
Bituminous products of this heading used for surfacing roads fall into two main categories:
 - cut-backs and road-oils
Cut-backs are bitumens dissolved in fairly heavy solvents, the quantity of which can be varied according to the desired viscosity.
The trade descriptions of these preparations differ according to whether the solvents used are of petroleum or other origin; those containing the former are 'fluidified bitumens', the others are 'fluxed bitumens'.
Road-oils are like preparations based on bitumen containing heavy solvents in quantities that vary according to the desired viscosity.
Adhesives are sometimes added to render these preparations resistant to peeling.
All these bituminous preparations have the following distinctive characteristics:
 - ~~a needle penetration, as measured by the ASTM D 5 method, of not less than 400 at 25 °C;~~a needle penetration, as measured by the EN 1426 method, of not less than 400 at 25 °C.
 - ~~a distillation residue, obtained under reduced pressure by the ASTM D 1189 method, of not less than 60 % by weight with a needle penetration, as measured by the ASTM D 5 method, of less than 400 at 25 °C;~~a distillation residue, obtained under reduced pressure by the ASTM D 1189 method (withdrawn in 1979,

with no corresponding EN/ISO method in existence), of not less than 60 % by weight with a needle penetration, as measured by the EN 1426 method, of less than 400 at 25 °C.

The following diagram shows how:

- fluidified and fluxed bitumens are distinguished from bitumens of subheading 2713 20 00,
- fluidified and fluxed bitumens are distinguished from petroleum oils of subheadings ~~2710 11 11~~ 2710 12 11 to 2710 19 99.

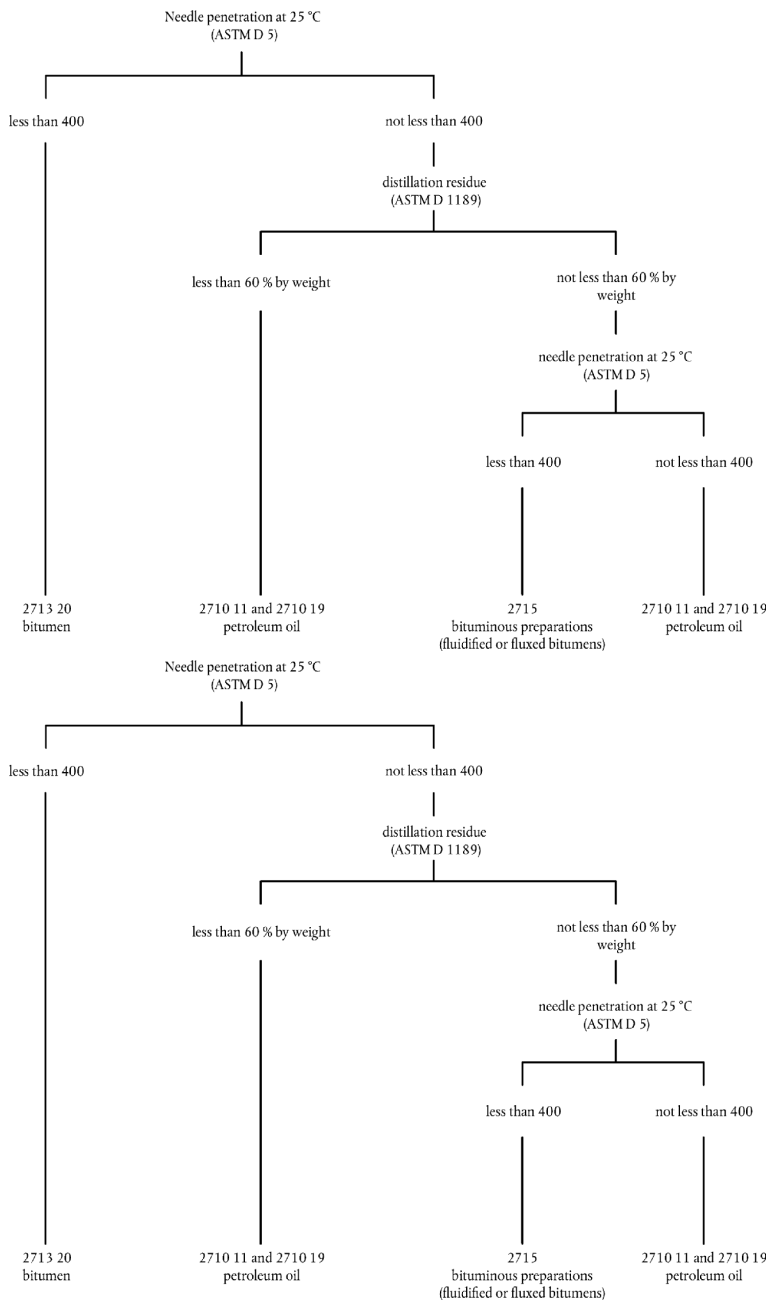

(b) aqueous emulsions

These are preparations obtained by emulsifying bitumens with water.

There are two categories:

1. anionic or 'alkaline' emulsions based on ordinary or tall oil soap;
2. cationic or 'acidic' emulsions based on an aliphatic amine or a quaternary ammonium ion.

SECTION VI

PRODUCTS OF THE CHEMICAL OR ALLIED INDUSTRIES

General

For the interpretation of section notes 1, 2 and 3, see the HS General Explanatory Note to Section VI.

CHAPTER 29
ORGANIC CHEMICALS

General

The letters 'INN', after a name appearing in the Combined Nomenclature and the explanatory notes thereto, indicate that the name is included in the list of International Nonproprietary Names for Pharmaceutical Substances published by the World Health Organisation.

The letters 'INN.M' indicate that the name is accepted by the World Health Organisation as an 'International Nonproprietary Name Modified'.

The letters 'ISO' indicate that the name appears as one of the 'common names for pest control chemicals and plant growth regulators' in recommendation R 1750 of the International Organisation for Standardisation.

A fused system is one in which there are at least two rings which have one, and only one, common bond and have two, and only two, atoms in common.

Separate chemically defined organic compounds, presented as a food supplement in capsules (except microcapsules), for example of gelatine, are excluded from this chapter because the presentation in capsules is a treatment that is not covered by note 1 to this chapter.

Note 1(a)

See the HS General Explanatory Note to this chapter, (A), first four paragraphs.

This chapter includes:

1. anthracene of a purity by weight of 90 % or more (subheading 2902 90 00);
2. benzene of a purity by weight of 95 % or more (subheading 2902 20 00);
3. naphthalene having a crystallising point of 79,4 °C or more (subheading 2902 90 00);
4. toluene of a purity by weight of 95 % or more (subheading 2902 30 00);
5. xylenes containing by weight 95 % or more of xylene (total isomers) (subheadings 2902 41 00 to 2902 44 00);
6. ethane and other saturated acyclic hydrocarbons (other than methane and propane) put up as single isomers of a purity of 95 % or more by reference to volume for gaseous products ⁽¹⁾ and to weight for non-gaseous products (subheading 2901 10 00);
7. ethylene of a purity by volume of 95 % or more (subheading 2901 21 00);
8. propene (propylene) of a purity by volume of 90 % or more (subheading 2901 22 00);
9. fatty alcohols of a purity by weight of 90 % or more, as calculated on the anhydrous product, and containing six or more carbon atoms (subheading 2905 16, 2905 17 00 or 2905 29 90);
10. cresols (single or mixed isomers) containing by weight 95 % or more of cresol, all cresol isomers being taken together (subheading 2907 12 00);
11. phenol of a purity by weight of 90 % or more (subheading 2907 11 00);
12. xylenols (single or mixed isomers) containing by weight 95 % or more of xylenol, all xylenol isomers being taken together (subheading 2907 19 10);
13. fatty acids (other than oleic acid) of a purity by weight of 90 % or more, as calculated on the anhydrous product, and containing six or more carbon atoms (headings 2915 and 2916);
14. oleic acid of a purity by weight of 85 % or more, as calculated on the anhydrous product (subheading 2916 15 00);
15. pyridine of a purity by weight of 95 % or more (subheading 2933 31 00);
16. methylpyridine (picoline), 5-ethyl-2-methylpyridine (5-ethyl-2-picoline) and 2-vinylpyridine, of a purity by weight of 90 % or more (subheading 2933 39);
17. quinoline of a purity by weight of 95 % or more, calculated on the anhydrous product (as ascertained by gas chromatography) (subheading 2933 49 90);
18. 1,2-dihydro-2,2,4-trimethylquinoline of a purity by weight exceeding 85 %, calculated on the anhydrous product (subheading 2933 49 90);
19. acridine of a purity by weight of 95 % or more, calculated on the anhydrous product (as ascertained by gas chromatography) (subheading 2933 99 80);
20. the derivatives of the fatty acids and of the fatty alcohols of items 9, 13 and 14 above (for example, salts, esters (other than those of glycerine), amines, amides, nitriles), provided that they satisfy the criteria set for the corresponding fatty acids and alcohols.

⁽¹⁾ The gaseous state is observed at 15 °C and under a pressure of 1 013 millibar.

- Note 1(b)** See the HS General Explanatory Note to this chapter, (A), final paragraph.
- Note 1(d)** The aqueous solutions permitted are only those that are true solutions, even if because of insufficient water the substance is only partly dissolved.
- Note 1(f)** As regards the addition of a stabiliser, anti-dusting agent, colouring agent or odoriferous substances, see the HS General Explanatory Note to this chapter, (A), penultimate paragraph.
- Note 1(g)** As regards the addition of a stabiliser, anti-dusting agent, colouring agent or odoriferous substances, see the HS General Explanatory Note to this chapter, (A), penultimate paragraph.
- Note 5** The provisions of this note apply only to the classification, as between headings, of the products concerned (see the HS General Explanatory Note to this chapter, (G)).
For classification as between the subheadings within a heading, the provisions of subheading note 1 to this chapter are to be applied.

I. HYDROCARBONS AND THEIR HALOGENATED, SULPHONATED, NITRATED OR NITROSATED DERIVATIVES

2902 **Cyclic hydrocarbons**

2902 19 00 **Other**

This subheading includes: azulene (bicyclo[5,3,0]decapentaene) and its alkyl derivatives such as, for example, chamazulene (7-ethyl-1,4-dimethylazulene), guaiazulene (7-isopropyl-1,4-dimethylazulene), vetiverazulene (2-isopropyl-4,8-dimethylazulene).

2903 **Halogenated derivatives of hydrocarbons**

2903 39 90 **Fluorides and iodides**

This subheading includes: 1,1-difluoroethane, carbon tetrafluoride (tetrafluoromethane), tetrafluoroethylene, trifluoroethylene, trifluoromethane.

~~2903 51 00~~ 2903 81 00 **1,2,3,4,5,6-Hexachlorocyclohexane (HCH (ISO)), including lindane (ISO, INN)**

This subheading includes lindane (ISO, INN). Lindane is the gamma-isomer of hexachlorocyclohexane (HCH (ISO)) with a purity of 99 % or more. Only this gamma-isomer of HCH has insecticidal properties. Lindane is used in agriculture and for the treatment of wood.

II. ALCOHOLS AND THEIR HALOGENATED, SULPHONATED, NITRATED OR NITROSATED DERIVATIVES

2905 **Acyclic alcohols and their halogenated, sulphonated, nitrated or nitrosated derivatives**
2905 14 90 **Other**
This subheading covers only secbutyl alcohol (butan-2-ol) and isobutyl alcohol (2-methylpropan-1-ol)

2905 19 00 **Other**
This subheading includes pentanol (amyl alcohol) or the following: *n*-amyl (pentan-1-ol), secamyl (pentan-2-ol), tertamyl (2-methylbutan-2-ol, amylene hydrate), isoamyl (3-methylbutan-1-ol), secisoamyl (3-methylbutan-2-ol), 2-methylbutan-1-ol, neopentyl (neoamyl, 2,2-dimethylpropan-1-ol), pentan-3-ol.

2905 44 11 to 2905 44 99 **D-glucitol (sorbitol)**
These subheadings cover only D-glucitol (sorbitol) complying with the provisions of note 1 to this chapter. Forms of D-glucitol (sorbitol) which do not so comply, are classified in subheadings 3824 60 11 to 3824 60 99.

2906 **Cyclic alcohols and their halogenated, sulphonated, nitrated or nitrosated derivatives**

2906 11 00 **Menthol**
This subheading covers only: (-)-paramenthol-3, ((-)-trans-1,2-cis-1,5-isopropyl-2-methyl-5-cyclohexanol), (±)-paramenthol-3, and (+)-paramenthol-3.
The subheading does not include neomenthol, isomenthol or neoisomenthol (subheading 2906 19 00).

VI. KETONE-FUNCTION COMPOUNDS AND QUINONE-FUNCTION COMPOUNDS

2914 **Ketones and quinones, whether or not with other oxygen function, and their halogenated, sulphonated, nitrated or nitrosated derivatives**

2914 50 00 **Ketone-phenols and ketones with other oxygen function**
For the purposes of this subheading, 'other oxygen function' means any of the oxygen functions specified in the preceding headings of this chapter other than the alcohol, aldehyde and phenol functions.

2914 61 00 to 2914 69 90 **Quinones**
These subheadings cover the products referred to in the HS Explanatory Note to heading 2914, parts (E) and (F). For the purposes of these subheadings, 'quinones' is to be understood in a broad sense, i.e., 'quinones whether or not with other oxygen function'; they consequently cover quinones without other oxygen function (other than the quinone function), quinone-alcohols, quinone-phenols, quinone aldehydes, and quinones with other oxygen function (other than those mentioned above).

VII. CARBOXYLIC ACIDS AND THEIR ANHYDRIDES, HALIDES, PEROXIDES AND PEROXYACIDS AND THEIR HALOGENATED, SULPHONATED, NITRATED OR NITROSATED DERIVATIVES

2915 **Saturated acyclic monocarboxylic acids and their anhydrides, halides, peroxides and peroxyacids; their halogenated, sulphonated, nitrated or nitrosated derivatives**
As regards the purity criteria for fatty acids and their derivatives, see the general explanatory note to this chapter, note 1(a), items 13 and 20.

- 2916** **Unsaturated acyclic monocarboxylic acids, cyclic monocarboxylic acids, their anhydrides, halides, peroxides and peroxyacids; their halogenated, sulphonated, nitrated or nitrosated derivatives**
As regards the purity criteria for fatty acids and their derivatives, see the general explanatory note to this chapter, note 1(a), items 13, 14 and 20.
- IX. NITROGEN-FUNCTION COMPOUNDS
- 2921** **Amine-function compounds**
- 2921 42 00** **Aniline derivatives and their salts**
See the HS Explanatory Note to subheadings 2921 42 to 2921 49.
- 2921 43 00** **Toluidines and their derivatives; salts thereof**
See the HS Explanatory Note to subheadings 2921 42 to 2921 49.
- 2921 44 00** **Diphenylamine and its derivatives; salts thereof**
See the HS Explanatory Note to subheadings 2921 42 to 2921 49.
- 2921 45 00** **1-Naphthylamine (alpha-naphthylamine), 2-naphthylamine (beta-naphthylamine) and their derivatives; salts thereof**
See the HS Explanatory Note to subheadings 2921 42 to 2921 49.
- 2921 49 00** **Other**
See the HS Explanatory Note to subheadings 2921 42 to 2921 49.
- 2923** **Quaternary ammonium salts and hydroxides; lecithins and other phosphoaminolipids, whether or not chemically defined**
- 2923 20 00** **Lecithins and other phosphoaminolipids**
See the HS Explanatory Note to heading 2923, fourth paragraph, (2).
The other phosphoaminolipids of this subheading are esters (phosphatides) similar to lecithins. These include cephalin, the nitrogenous organic bases of which are colamine and serine, and sphingomyelin, the nitrogenous bases of which are choline and sphingosine.
- 2925** **Carboxyimide-function compounds (including saccharin and its salts) and imine-function compounds**
- 2925 11 00** **Saccharin and its salts**
See the HS Explanatory Note to heading 2925, (A), first paragraph, (1).
- X. ORGANO-INORGANIC COMPOUNDS, HETEROCYCLIC COMPOUNDS, NUCLEIC ACIDS AND THEIR SALTS, AND SULPHONAMIDES
- 2930** **Organo-sulphur compounds**
Organo-sulphur compounds as defined in note 6 to this chapter are to be classified in this heading, whether or not they contain other non-metals or metals directly linked to carbon atoms.

- 2932** **Heterocyclic compounds with oxygen hetero-atom(s) only**
- ~~2932 29 10~~
~~2932 29 85~~
~~2932 20 10 to to~~
~~2932 20 90~~ **Other lactones**
Lactones
See the HS Explanatory Note to subheading 2932 29 20.
See also the HS Explanatory Note to heading 2932, first paragraph, (B), (d) to (v).
- 2933** **Heterocyclic compounds with nitrogen hetero-atom(s) only**
- 2933 11 10 and 2933 11 90** **Phenazone (antipyrin) and its derivatives**
See the HS Explanatory Note to subheadings 2933 11, 2933 21 and 2933 54.
- 2933 21 00** **Hydantoin and its derivatives**
See the HS Explanatory Note to subheadings 2933 11, 2933 21 and 2933 54.
- 2933 49 10** **Halogen derivatives of quinoline; quinolinecarboxylic acid derivatives**
See the HS Explanatory Note to heading 2933, first paragraph, (D).
For the purposes of this subheading, the term 'halogen derivatives of quinoline' covers only such derivatives of quinoline in which one or more hydrogen atom(s) of the aromatic ring system have been substituted with the corresponding number of halogen atoms.
The term 'quinolinecarboxylic acid derivatives' includes derivatives of quinolinecarboxylic acid in which one or more hydrogen atom(s) of the aromatic ring system and/or the acid function has/have been substituted.
- 2933 52 00** **Malonylurea (barbituric acid) and its salts**
See the HS Explanatory Note to subheadings 2933 11, 2933 21 and 2933 54.
- 2933 54 00** **Other derivatives of malonylurea (barbituric acid); salts thereof**
See the HS Explanatory Note to subheadings 2933 11, 2933 21 and 2933 54.
- 2933 79 00** **Other lactams**
See the HS Explanatory Note to subheading 2933 79.
See also the HS Explanatory Note to heading 2933, first paragraph, (G), (2) to (7).
- XI. PROVITAMINS, VITAMINS AND HORMONES
- 2936** **Provitamins and vitamins, natural or reproduced by synthesis (including natural concentrates), derivatives thereof used primarily as vitamins, and intermixtures of the foregoing, whether or not in any solvent**
The products of this heading may be:
— stabilised in oily form;
— stabilised by coating, for example, with gelatin, wax, fats, rubber of various kinds or derivatives of cellulose in the form of microcapsules;
— adsorbed on silicon dioxide.
- Classification in this heading is not affected by the addition of plasticisers or anti-caking agents.
Ion-exchanger adsorbates are, however, excluded from this heading and are classified according to their composition and use.
- 2936 90 00** **Other, including natural concentrates**
See the HS Explanatory Note to subheading 2936 90.

- 2937** **Hormones, prostaglandins, thromboxanes and leukotrienes, natural or reproduced by synthesis; derivatives and structural analogues thereof, including chain modified polypeptides, used primarily as hormones**
See note 8 to this chapter for the definition of the term 'hormones' and of the expression 'used primarily as hormones'. This heading covers only products satisfying the criteria given in the HS Explanatory Note to heading 2937, first paragraph, (I) to (VI), and second paragraph.
- 2937 11 00** **Somatotropin, its derivatives and structural analogues**
See the HS Explanatory Note to heading 2937, list of products which are to be classified as products of heading 2937, (A), (1).
- 2937 12 00** **Insulin and its salts**
See the HS Explanatory Note to heading 2937, list of products which are to be classified as products of heading 2937, (A), (2).
- 2937 19 00** **Other**
See the HS Explanatory Note to heading 2937, list of products which are to be classified as products of heading 2937, (A), (3) to (20).
- 2937 21 00to 2937 29 00** **Steroidal hormones, their derivatives and structural analogues**
See the HS Explanatory Note to heading 2937, list of products which are to be classified as products of heading 2937, (B).
See also, in the HS Explanatory Note to heading 2937, the 'List of steroids used primarily for their hormone function' as regards the substances listed as 'corticosteroid'.
- 2937 21 00** **Cortisone, hydrocortisone, prednisone (dehydrocortisone) and prednisolone (dehydrohydrocortisone)**
See the HS Explanatory Note to heading 2937, list of products which are to be classified as products of heading 2937, (B), (1), (a), (b), (c) and (d).
- 2937 22 00** **Halogenated derivatives of corticosteroidal hormones**
See the HS Explanatory Note to heading 2937, list of products which are to be classified as products of heading 2937, (B), (2).
- 2937 23 00** **Oestrogens and progestogens**
See the HS Explanatory Note to heading 2937, list of products which are to be classified as products of heading 2937, (B), (3).
See also, in the HS Explanatory Note to heading 2937, the 'List of steroids used primarily for their hormone function' as regards the substances listed as 'oestrogen' or 'progestogen'.
- 2937 29 00** **Other**
See the HS Explanatory Note to heading 2937, list of products which are to be classified as products of heading 2937, (B), (1), (e) and (f), and (B), (4).
- 2937 31 00and 2937 39 00** **Catecholamine hormones, their derivatives and structural analogues**
See the HS Explanatory Note to heading 2937, list of products which are to be classified as products of heading 2937, (C).
- 2937 40 00** **Amino-acid derivatives**
See the HS Explanatory Note to heading 2937, list of products which are to be classified as products of heading 2937, (D).

- 2937 50 00** **Prostaglandins, thromboxanes and leukotrienes, their derivatives and structural analogues**
See the HS Explanatory Note to heading 2937, list of products which are to be classified as products of heading 2937, (E).
- 2937 90 00** **Other**
See the HS Explanatory Note to heading 2937, list of products which are to be classified as products of heading 2937, (F).
- XII. GLYCOSIDES AND VEGETABLE ALKALOIDS, NATURAL OR REPRODUCED BY SYNTHESIS, AND THEIR SALTS, ETHERS, ESTERS AND OTHER DERIVATIVES
- 2938** **Glycosides, natural or reproduced by synthesis, and their salts, ethers, esters and other derivatives**
Glycosides of this heading are composed of a sugar part and a non-sugar part (aglycone). These parts are bonded to each other via the anomeric carbon atom of the sugar. Thus, products such as vaccinin and hamamelitannin of heading 2940 are not considered to be glycosides.
The most common naturally-occurring glycosides are the O-glycosides. However, there are also naturally occurring N-glycosides, S-glycosides and C-glycosides, in which the sugar's anomeric carbon is linked to the aglycone via a nitrogen atom, a sulphur atom or a carbon atom (for example, sinigrin, aloin, scoparin).
The following products are excluded from this heading:
(a) nucleosides and nucleotides of heading 2934 (see the HS Explanatory Note to heading 2934, third paragraph, (D), (6));
(b) alkaloids of heading 2939 (for example, tomatine);
(c) antibiotics of heading 2941 (for example, toyocamycin).
- 2938 90 10** **Digitalis glycosides**
In addition to the compounds mentioned in the HS Explanatory Note to heading 2938, third paragraph, (2), this subheading includes:
— acetyldigitoxin, acetyldigoxin, acetylgitoxin;
— desacetyllanatoside A, B, C and D;
— digifolein, diginatin, diginin, digipurpurin, *Digitalinum verum* and *germanicum*;
— gitalin, gitaloxin, gitonin, gitoxin, glucoverodoxin;
— lanafolein, lanatoside A, B, C and D;
— trigonin, verodoxin.
- 2938 90 90** **Other**
This subheading includes the compounds mentioned in the HS Explanatory Note to heading 2938, third paragraph, (4) to (9), and last two paragraphs.
- 2939** **Vegetable alkaloids, natural or reproduced by synthesis, and their salts, ethers, esters and other derivatives**
- 2939 69 00** **Other**
This subheading includes the following alkaloids of rye ergot: ergotaminine; ergosine and ergosinine; ergocristine and ergocristinine; ergocryptine and ergocryptinine; ergocornine and ergocorninine; ergobasine and ergobasinine, and their derivatives, for example, dihydroergotamine, dihydroergotoxine, methylergobasine.

XIII. OTHER ORGANIC COMPOUNDS

2941**Antibiotics****2941 10 00****Penicillins and their derivatives with a penicillanic acid structure; salts thereof**

See the HS Explanatory Note to subheading 2941 10.

Some examples of penicillins are: benzylpenicillin sodium (phenacetylpenine sodium), amylpenicillin sodium (*n*-carboxyhexenylpenine sodium), the biosynthesis penicillins and the sustained-release penicillins such as procaine penicillin and benzathine dipenicillin.

2941 20 30 and 2941 20 80**Streptomycins and their derivatives; salts thereof**

See the HS Explanatory Note to subheading 2941 20.

In addition to streptomycin, these subheadings include mannosidostreptomycin and the salts of all these products, for example, their sulphates and pantothenates.

2941 30 00**Tetracyclines and their derivatives; salts thereof**

See the HS Explanatory Note to subheading 2941 30.

This subheading includes oxytetracycline and tetracycline hydrochloride.

2941 40 00**Chloramphenicol and its derivatives; salts thereof**

See the HS Explanatory Note to subheading 2941 40.

2941 50 00**Erythromycin and its derivatives; salts thereof**

See the HS Explanatory Note to subheading 2941 50.

The salts of erythromycin include the hydrochloride, sulphate, citrate, palmitate, stearate and glucoheptonate; with acid chlorides it gives corresponding esters, and with acid anhydrides it forms monoesters such as glutarate, maleate and phthalate.

CHAPTER 30
PHARMACEUTICAL PRODUCTS

General

The description of a product as a medicament in Community legislation (other than that relating specifically to classification in the Combined Nomenclature) or in the national legislation of the Member States, or in any pharmacopoeia, is not the deciding factor in so far as its classification in this chapter is concerned.

Additional note 11. Herbal medicinal preparations are preparations based on one or more active substances, produced by subjecting a plant or parts thereof to a process such as drying, crushing, extraction or purification.

Active substance means a chemically defined substance, a chemically defined group of substances (for example, alkaloids, polyphenols, anthocyanins) or a plant extract. These active substances must have medicinal properties for the prevention or the treatment of specific diseases, ailments or their symptoms.

2. Homeopathic medicinal preparations are prepared from products, substances or compositions called homeopathic stocks (mother tinctures). The degree of dilution must be indicated (for example, D6).
3. Vitamins or mineral preparations are preparations based on vitamins of heading 2936, on minerals including trace elements and mixtures thereof. They are used to treat or prevent specific diseases, ailments or their symptoms. Such preparations contain a much higher amount of vitamins or minerals, generally at least three times higher than the recommended daily allowance (RDA).

As regards the recommended daily allowance (RDA) for certain vitamins and minerals, see, for example, the table in the Annex to Council Directive 90/496/EEC of 24 September 1990 ~~on nutrition labelling foodstuffs (on nutrition labelling for foodstuffs (OJ L 276, 6.10.1990, p. 40), reproduced below)~~, amended by Commission Directive 2008/100/EC of 28 October 2008 (OJ L 285, 29.10.2008, p. 09) reproduced below:

Vitamins and RDA
minerals

Vitamin A 800 µg

Vitamin D 5 µg

Vitamin E ~~10 mg~~ 12 mg

Vitamin K 75 µg

Vitamin C ~~60 mg~~ 80 mg

Thiamine ~~1,4 mg~~ 1,1 mg

Riboflavin ~~1,6 mg~~ 1,4 mg

Niacin ~~18 mg~~ 16 mg

Vitamin B₆ ~~2 mg~~ 1,4 mg

~~Folacin (folic acid)~~ 200 µg
Folic acid

Vitamin B₁₂ ~~1 µg~~ 2,5 µg

Biotin ~~0,15 mg~~ 50 µg

Pantothenic acid 6 mg

Potassium 2 000 mg

Chloride 800 mg

Calcium 800 mg

Phosphorus ~~800 mg~~ 700 mg

Iron	14 mg
Magnesium	300 mg 375 mg
<u>Iron</u>	<u>14 mg</u>
Zinc	15 mg <u>10 mg</u>
<u>Copper</u>	<u>1 mg</u>
<u>Managanese</u>	<u>2 mg</u>
<u>Fluoride</u>	<u>3.5 mg</u>
<u>Selenium</u>	<u>55 µg</u>
<u>Chromium</u>	<u>40 µg</u>
<u>Molybdenum</u>	<u>50 µg</u>
Iodine	150 µg

Heading 3004 ~~does not cover, does not cover, inter alia, food supplements or dietary preparations (see also note 1(a) to this chapter).~~ *inter alia*, food supplements or dietary preparations (see also note 1(a) to this chapter).

- 3001** **Glands and other organs for organo-therapeutic uses, dried, whether or not powdered; extracts of glands or other organs or of their secretions for organo-therapeutic uses; heparin and its salts; other human or animal substances prepared for therapeutic or prophylactic uses, not elsewhere specified or included**
- 3001 20 90** **Other**
This subheading includes intrinsic factor (dried purified extracts of pyloric mucous membrane of swine).
- 3001 90 20to 3001 90 98** **Other**
In addition to the glands and other organs mentioned in the HS Explanatory Note to heading 3001, (A), these subheadings include the hypophysis, the suprarenal capsules and the thyroid gland.
- 3001 90 91** **Heparin and its salts**
See the HS Explanatory Note to heading 3001, (C).
- 3002** ~~**Human blood; animal blood prepared for therapeutic, prophylactic or diagnostic uses; antisera and other blood fractions and modified immunological products, whether or not obtained by means of biotechnological processes; vaccines, toxins, cultures of micro-organisms (excluding yeasts) and similar products**~~
Human blood; animal blood prepared for therapeutic, prophylactic or diagnostic uses; antisera, other blood fractions and immunological products, whether or not modified or obtained by means of biotechnological processes; vaccines, toxins, cultures of micro-organisms (excluding yeasts) and similar products
- 3002 10 10** **Antisera**
This subheading covers the products described in the HS Explanatory Note to heading 3002, (C), (1), third paragraph. It does not include sera used as reagents to determine blood groups or blood factors (heading 3006) or 'normal' sera (subheading ~~3002 10 95~~3002 10 98 ~~or 3002 10 99~~).
- 3002 10 91** **Haemoglobin, blood globulins and serum globulins**
This subheading includes human normal immunoglobulin.
- ~~**3002 10 95**~~**3002 10 98**~~and~~
~~**3002 10 99**~~ **Other**
These subheadings include 'normal' sera, plasma, fibrinogen, fibrin and, provided that it is prepared for therapeutic or prophylactic uses, blood albumin (for example, obtained by fractionating the plasma of human blood). This subheading includes 'normal' sera, plasma, fibrinogen, fibrin and, provided that it is prepared for therapeutic or prophylactic uses, blood albumin (for example, obtained by fractionating the plasma of human blood).
Blood albumin not prepared for therapeutic or prophylactic uses is, therefore, excluded (Note 1(g) to this chapter) (heading 3502).
- 3002 20 00** **Vaccines for human medicine**
For the interpretation of the term 'vaccines', see the HS Explanatory Note to heading 3002, (D), (1).
- 3002 30 00** **Vaccines for veterinary medicine**
See the explanatory note to subheading 3002 20 00.
- 3002 90 50** **Cultures of micro-organisms**
See the HS Explanatory Note to heading 3002, (D), (3).
- 3002 90 90** **Other**
This subheading includes toxins and, in so far as they are 'similar products', the symbiotic parasites used to treat certain diseases, such as *Plasmodium* (the malarial parasite) and *Trypanosoma cruzi*.
- 3003** **Medicaments (excluding goods of heading 3002, 3005 or 3006) consisting of two or more constituents which have been mixed together for therapeutic or prophylactic uses, not put up in measured doses or in forms or packings for retail sale**
- 3003 10 00** **Containing penicillins or derivatives thereof, with a penicillanic acid structure, or streptomycins or their derivatives**
This subheading also includes combinations of penicillin and streptomycin

- 3004 Medicaments (excluding goods of heading 3002, 3005 or 3006) consisting of mixed or unmixed products for therapeutic or prophylactic uses, put up in measured doses (including those in the form of transdermal administration systems) or in forms or packings for retail sale**
See additional note 1 to this chapter.
Unlike the previous heading, this heading covers ‘unmixed products’. For the interpretation of the term ‘unmixed products’, see note 3(a) to this chapter and the HS Explanatory Note to heading 3004, fourth and fifth paragraphs.
The terms ‘in measured doses (including those in the form of transdermal administration systems)’ and ‘forms or packings for retail sale for therapeutic or prophylactic uses’ are defined in the HS Explanatory Note to heading 3004, first and second paragraphs.
Medicaments put up in packings for long-term administration or for hospitals and similar establishments are included here. In this case, a larger number of units of the product is contained and the intended long-term administration or hospital use is generally indicated on the packing.
The fact that medicaments containing, for example, antibiotics, hormones or lyophilised products, and put up in ampoules or bottles must still have added to them pyrogen-free water or another diluent before being administered, does not exclude them from this heading.
- 3005 Wadding, gauze, bandages and similar articles (for example, dressings, adhesive plasters, poultices), impregnated or coated with pharmaceutical substances or put up in forms or packings for retail sale for medical, surgical, dental or veterinary purposes**
- 3005 10 00 Adhesive dressings and other articles having an adhesive layer**
This subheading does not cover liquid dressings (subheading 3005 90 99).
- 3006 Pharmaceutical goods specified in note 4 to this chapter**
- 3006 10 10 to 3006 10 90 Sterile surgical catgut, similar sterile suture materials (including sterile absorbable surgical or dental yarns) and sterile tissue adhesives for surgical wound closure; sterile laminaria and sterile laminaria tents; sterile absorbable surgical or dental haemostatics; sterile surgical or dental adhesion barriers, whether or not absorbable**
The terms of these subheadings are to be interpreted strictly. They do not, therefore, cover sterile suture clips (heading 9018).

CHAPTER 31
FERTILISERS

- 3103** **Mineral or chemical fertilisers, phosphatic**
- 3103 10 10** ~~and~~ **and**
3103 10 90 **Superphosphates**
See the HS Explanatory Note to heading 3103, (A), (1).
- 3105** **Mineral or chemical fertilisers containing two or three of the fertilising elements nitrogen, phosphorus and potassium; other fertilisers; goods of this chapter in tablets or similar forms or in packages of a gross weight not exceeding 10 kg**
See note 6 to this chapter for the definition of 'other fertilisers' used in this heading.
- 3105 10 00** **Goods of this chapter in tablets or similar forms or in packages of a gross weight not exceeding 10 kg**
The term 'similar forms' applies to goods put up in measured quantities. Consequently, fertilisers put up in the usual, industrial forms (for example, granules) are not to be considered as 'similar forms'.
- ~~3105 20 00~~ **3105 20 10** **and**
~~3105 20 90~~ **3105 20 90** **Mineral or chemical fertilisers containing the three fertilising elements nitrogen, phosphorus and potassium**
The expression 'containing the three fertilising elements nitrogen, phosphorus and potassium' means that the elements indicated are in sufficient quantity to exercise a real fertilising action and are not simply impurities.
Nitrogen may be present in the form of nitrates, ammonium salts, urea, calcium cyanamide or other organic compounds. Phosphorus is generally present in the form of phosphates which are more or less soluble or, occasionally, in organic form. Potassium is present in the form of salts (carbonate, chloride, sulphate, nitrate, etc.).
In trade, the nitrogen, phosphorus and potassium content is expressed, respectively, as N, P₂O₅ and K₂O.
~~This subheading includes the fertilisers referred to in the HS Explanatory Note to heading~~ These subheadings include the fertilisers referred to in the HS Explanatory Note to heading 3105, (B) and (C), provided that they contain the three fertilising elements nitrogen, phosphorus and potassium. They are sometimes called 'NPK fertilisers'.
~~The double phosphates of ammonium and potassium, which are chemically defined compounds, are excluded from this subheading (subheading~~ The double phosphates of ammonium and potassium, which are chemically defined compounds, are excluded from these subheadings (subheading 2842 90 80).
- 3105 51 00** ~~and~~ **and**
3105 59 00 **Other mineral or chemical fertilisers containing the two fertilising elements nitrogen and phosphorus**
As regards the interpretation of the term 'containing the two fertilising elements nitrogen and phosphorus', the explanatory note to subheading ~~As regards the interpretation of the term 'containing the two fertilising elements nitrogen and phosphorus', the explanatory note to subheadings~~ 3105 20 00 3105 20 10 and 3105 20 90 applies, *mutatis mutandis*.
- 3105 51 00** **Containing nitrates and phosphates**
This subheading includes fertilisers containing both nitrates and phosphates of any cations, including ammonium but excluding potassium.
The product described in the HS Explanatory Note to heading 3105, (B), (2), but obtained without adding potassium salts, is an example of a fertiliser which falls in this subheading.

3105 59 00**Other**

This subheading includes:

1. mixtures of mineral salts containing phosphates of any cations (excluding potassium) and of ammonium salts other than nitrates;
2. phospho-nitrogenous fertilisers in which the nitrogen is present in a form other than nitric or ammoniacal, i.e. in the form of calcium cyanamide, urea or other organic compounds;
3. phospho-nitrogenous fertilisers of the types described in the HS Explanatory Note to heading 3105, (C), (1) and (3).

3105 60 00**Mineral or chemical fertilisers containing the two fertilising elements phosphorus and potassium**

~~As regards the interpretation of the term 'containing the two fertilising elements phosphorus and potassium', the explanatory note to subheading~~ As regards the interpretation of the term 'containing the two fertilising elements phosphorus and potassium', the explanatory note to subheadings 3105 20 00, 3105 20 10 and 3105 20 90 applies, *mutatis mutandis*.

This subheading includes fertilisers made up of the following mixtures:

- calcined natural phosphates and potassium chloride;
- superphosphates and potassium sulphate.

This subheading does not cover the chemically defined potassium phosphates of subheading 2835 24 00, even if they could be used as fertilisers.

3105 90 10 to 3105 90 99 Other

These subheadings include:

1. all fertilisers containing the two fertilising elements nitrogen and potassium. However, these subheadings do not cover chemically defined potassium nitrate, even if it is intended to be used as a fertiliser (subheading 2834 21 00);
2. fertilisers with a single fertilising element, other than those falling in headings 3102 to 3104.

CHAPTER 32

TANNING OR DYEING EXTRACTS; TANNINS AND THEIR DERIVATIVES; DYES, PIGMENTS AND OTHER COLOURING MATTER; PAINTS AND VARNISHES; PUTTY AND OTHER MASTICS; INKS

- Note 4** The term ‘solutions’ used both in this note and in note 6(a) to Chapter 39 does not apply to colloidal solutions.
- 3201 Tanning extracts of vegetable origin; tannins and their salts, ethers, esters and other derivatives**
- 3201 20 00 Wattle extract**
Wattle tanning extract is obtained from the bark of different species of acacia (in particular *Acacia decurrens*, *Acacia pycnantha*, *Acacia mollissima*).
Black cutch, an extract from *Acacia catechu*, is classified in subheading 3203 00 10.
- 3201 90 20 Sumach extract, vallonia extract, oak extract or chestnut extract**
Vallonias are the cupules (acorn cups) of certain species of oak (for example, of *Quercus valonea*).
- 3201 90 90 Other**
This subheading includes, as tanning extracts of vegetable origin:
1. extracts from the bark of pines, mangrove, eucalyptus, willow and birch;
 2. extracts from the wood of tizerah and urunday (*Astronium balansae Engl.*);
 3. extracts from the fruits of myrobolans and divi-divi; and
 4. extracts from the leaves of gambier.
- 3202 Synthetic organic tanning substances; inorganic tanning substances; tanning preparations, whether or not containing natural tanning substances; enzymatic preparations for pre-tanning**
- 3202 10 00 Synthetic organic tanning substances**
See the HS Explanatory Note to heading 3202, (I), (A).
- 3202 90 00 Other**
This subheading includes the products referred to in the HS Explanatory Note to heading 3202, (I), (B) and (II).
- 3203 00 Colouring matter of vegetable or animal origin (including dyeing extracts but excluding animal black), whether or not chemically defined; preparations as specified in note 3 to this chapter based on colouring matter of vegetable or animal origin**
- 3203 00 10 Colouring matter of vegetable origin and preparations based thereon**
Extracts of certain varieties of Persian berries are not used mainly as colouring matter and, consequently, are not included in this subheading. This applies particularly to extracts of berries of the *Rhamnus cathartica* which are used for medicinal purposes and for this reason are classified in subheading ~~4302 49 80~~ 1302 19 70.
This subheading includes black cutch (*Acacia catechu*). Black cutch is a dyeing extract obtained from the catechu, a variety of acacia.

- 3204 Synthetic organic colouring matter, whether or not chemically defined; preparations as specified in note 3 to this chapter based on synthetic organic colouring matter; synthetic organic products of a kind used as fluorescent brightening agents or as luminophores, whether or not chemically defined**
- 3204 11 00 to 3204 19 00 Synthetic organic colouring matter and preparations based thereon as specified in note 3 to this chapter**
These subheadings cover:
1. synthetic organic colouring matter, whether or not mixed together and whether or not diluted with mineral substances which have no dyeing properties, but containing only small quantities of surface-active products or other additives to encourage penetration and fixation of the dye (see the HS Explanatory Note to heading 3204, part (I), second paragraph, (A) and (B); and
 2. the preparations specified in note 3 to this chapter, namely the products described in the HS Explanatory Note to heading 3204, part (I), second paragraph, (C) to (E).
- With regard to colouring matter of subheadings 3204 11 00 to 3204 19 00 which, in view of their utilisation, may belong to two or more categories falling within different subheadings, see the HS Explanatory Note to subheadings 3204 11 to 3204 19, eleventh paragraph, to determine their classification.
- 3204 11 00 Disperse dyes and preparations based thereon**
See the HS Explanatory Note to subheadings 3204 11 to 3204 19, second paragraph.
- 3204 12 00 Acid dyes, whether or not premetallised, and preparations based thereon; mordant dyes and preparations based thereon**
See the HS Explanatory Note to subheadings 3204 11 to 3204 19, third and fourth paragraphs.
- 3204 13 00 Basic dyes and preparations based thereon**
See the HS Explanatory Note to subheadings 3204 11 to 3204 19, fifth paragraph.
- 3204 14 00 Direct dyes and preparations based thereon**
See the HS Explanatory Note to subheadings 3204 11 to 3204 19, sixth paragraph.
- 3204 15 00 Vat dyes (including those usable in that state as pigments) and preparations based thereon**
See the HS Explanatory Note to subheadings 3204 11 to 3204 19, seventh paragraph.
- 3204 16 00 Reactive dyes and preparations based thereon**
See the HS Explanatory Note to subheadings 3204 11 to 3204 19, eighth paragraph.
- 3204 17 00 Pigments and preparations based thereon**
See the HS Explanatory Note to subheadings 3204 11 to 3204 19, ninth paragraph.
- 3204 19 00 Other, including mixtures of colouring matter of two or more of the subheadings 3204 11 to 3204 19**
See the HS Explanatory Note to subheadings 3204 11 to 3204 19, tenth to twelfth paragraphs.
- 3204 20 00 Synthetic organic products of a kind used as fluorescent brightening agents**
This subheading covers the products described in the HS Explanatory Note to heading 3204, (II), (1).

- 3204 90 00** **Other**
This subheading covers synthetic organic products of a kind used as luminophores, which are described in the HS Explanatory Note to heading 3204, (II), (2), and the following three paragraphs.
- 3206** **Other colouring matter; preparations as specified in note 3 to this chapter, other than those of heading 3203, 3204 or 3205; inorganic products of a kind used as luminophores, whether or not chemically defined**
See note 5 to this chapter.
Nucleate pigments, i.e., pigments consisting of grains or inert material (generally, of silica) each of which, by means of special technical processes, has been coated with an individual layer of inorganic colouring matter, are classified in the heading appropriate to the colouring matter constituting the coating.
Thus, for example, pigments of the above type in which the coating consists of basic silico-chromate of lead are classified in subheading 3206 20 00; those in which the coating consists of copper borate or calcium plumbate are classified in subheading ~~3206 49 80~~3206 49 70.
- 3206 11 00 and 3206 19 00** **Pigments and preparations based on titanium dioxide**
See the HS Explanatory Note to heading 3206, (A), (1), and, in so far as they concern preparations of these subheadings, the four paragraphs following (13).
See also the HS Explanatory Note to subheading 3206 19.
- 3206 20 00** **Pigments and preparations based on chromium compounds**
See the HS Explanatory Note to heading 3206, (A), (2), and, in so far as they concern preparations of this subheading, the four paragraphs following (13).
This subheading includes:
1. molybdenum red, consisting of mixed crystals of lead molybdate, lead chromate and, usually, lead sulphate;
 2. mixed crystals of lead sulphate, lead chromate, barium chromate, zinc chromate or strontium chromate;
 3. pigments based on ferrous chromate ('Siderin' yellow), potassium dichromate and calcium dichromate or chrome oxide.
- 3206 41 00** **Ultramarine and preparations based thereon**
See the HS Explanatory Note to heading 3206, (A), (3), and, in so far as they concern preparations of this subheading, the four paragraphs following (13).
- 3206 42 00** **Lithopone and other pigments and preparations based on zinc sulphide**
See the HS Explanatory Note to heading 3206, (A), (4), and, in so far as they concern preparations of this subheading, the four paragraphs following (13).
- 3206 49 10** **Magnetite**
This subheading covers only finely ground magnetite.
Magnetite of which 95 % or more by weight passes through a sieve with a mesh of 0,045 mm is regarded as finely ground.
- 3206 49 30** **~~Pigments and preparations based on cadmium compounds~~**
See the HS Explanatory Note to heading 3206, (A), (5), and, in so far as they concern preparations of this subheading, the four paragraphs following (13).

~~3206 49 80~~3206 49 70**Other**

In addition to the products referred to in the HS Explanatory Note to heading 3206, (A), (6) to (13), ~~this subheading includes: (A), (5) to (13) and, in so far as they concern preparations of this subheading, the four paragraphs following point (13), this subheading includes:~~

1. manganese blue which is a pigment with a basis of barium manganate and barium sulphate;
2. artificial ochre which is a pigment obtained from artificial iron oxides; and
3. yellow pigment with a basis of nickel titanate.

In the case of pigments consisting of finely ground ores, the expression 'finely ground' is to be interpreted in the same manner as for magnetite of subheading 3206 49 10.

3206 50 00

Inorganic products of a kind used as luminophores

See the HS Explanatory Note to heading 3206, (B).

3207

Prepared pigments, prepared opacifiers and prepared colours, vitrifiable enamels and glazes, engobes (slips), liquid lustres and similar preparations, of a kind used in the ceramic, enamelling or glass industry; glass frit and other glass, in the form of powder, granules or flakes

3207 10 00

Prepared pigments, prepared opacifiers, prepared colours and similar preparations

This subheading covers the products described in the HS Explanatory Note to heading 3207, first paragraph, (1).

This subheading includes:

1. the pigment known as cobalt aluminate, consisting of a non-stoichiometric mixture of aluminium oxide and cobalt oxide;
2. the pigment known as cobalt silicate, consisting of a non-stoichiometric mixture of silica and cobalt oxide;
3. mixtures of chromium oxide and cobalt oxide;
4. mixtures of iron oxide, chromium oxide and zinc oxide;
5. mixtures of antimonates of lead and iron;
6. yellow vanadium consisting of zirconium oxide and small quantities of vanadium pentoxide;
7. vanadium blue consisting of zirconium silicate and small quantities of vanadium trioxide;
8. yellow praseodymium, consisting of zirconium silicate and praseodymium oxide;
9. iron red, consisting of zirconium silicate and ferric oxide;
10. prepared opacifiers with a basis of tin oxide, zirconium oxide, zirconium silicate, etc.

3207 20 10

Engobes (slips)

See the HS Explanatory Note to heading 3207, first paragraph, (3).

3207 20 90

Other

This subheading basically covers vitrifiable compositions. These are products which are generally in the form of powders, granules or flakes which when heated vitrify to produce a smooth homogeneous surface on ceramic or metal goods. This surface may be glossy or matt, coloured or white, transparent or opaque.

These products can be made up as follows:

1. from mixtures, reduced to powder, of glass frit of subheading 3207 40 85 with other materials such as silica, feldspar, kaolin, pigments, etc.;
2. from mixtures, reduced to powder, of silica, feldspar, kaolin, calcium carbonate, magnesium carbonate, etc. (i.e., the components of glass frit which are insoluble in water) and, possibly, of pigments.

These two types of vitrifiable compositions produce transparent coatings, either coloured or uncoloured;

3. from the products mentioned at 1 and 2 above, with the addition of opacifiers. In this case, the opaque coatings obtained are white or coloured;
4. from frits in the form of powders, granules or flakes — constituted and obtained as indicated in the explanatory note to subheadings 3207 40 40 and 3207 40 85 — but which contain, in addition, coloured pigments or opacifiers and sometimes oxides, to facilitate adhesion of the coating to metallic surfaces.

The coloured pigments used for the manufacture of products of this subheading include oxides and salts of cobalt, nickel, copper, iron, manganese, uranium and chromium.

Tin oxide, zirconium oxide and zirconium silicate, titanium oxide and arsenious anhydride may be added as opacifiers.

Nickel and cobalt oxide may be added to facilitate the adherence of the coating to metallic surfaces.

3207 30 00**Liquid lustres and similar preparations**

In addition to the products referred to in the HS Explanatory Note to heading 3207, first paragraph, (4), this subheading covers preparations with a basis of silver, dispersed in collodion or terpeneol, which are applied to mica or glass in the electrical and ceramic industries.

3207 40 40 and 3207 40 85**Glass frit and other glass, in the form of powder, granules or flakes**

These subheadings cover:

1. glass frit, i.e., the product obtained by suddenly cooling in water the liquid mass or paste resulting from the fusion of the original components of glass. These components include, for example, silica, sodium carbonate, magnesium carbonate, barium carbonate, potassium carbonate, calcium carbonate, sodium sulphate, potassium sulphate, sodium nitrate, potassium nitrate, lead oxides (litharge and red lead), kaolin, feldspar, borax and boric acid.

Glass frit of these subheadings is used principally for the preparation of vitrifiable compositions. It can be distinguished from the frits of subheadings 3207 20 10 and 3207 20 90 by the fact that it does not contain pigments, opacifiers or oxides facilitating the adherence of the coating to metallic surfaces, and that it produces, after heat vitrification, a surface more or less transparent but not uniformly opaque or coloured;

2. powder and granules of glass obtained by crushing and grinding broken and waste glassware. These products, as well as certain types of frits of paragraph 1 above, are used in the preparation of abrasive papers and cloths, are sintered to form discs, plates, tubes, etc. and employed for various laboratory purposes;
3. 'enamel glass' in the form of powder, granules, etc. which is a special glass used for the ornamentation of glass articles. Normally it melts between 540 and 600 °C in a transparent mass, generally coloured. When in bulk it falls in heading 7001 00, when in bars, rods or tubes it falls in subheading 7002 20 90 or 7002 39 00;
4. glass in flakes, whether coloured or silvered, used for decoration and obtained by crushing small spherical bubbles of blown glass;
5. vitrite, also known as foam glass, in powder or granules obtained from a white, grey or black spongy mass, depending on the impurities which it contains, and used principally for the manufacture of electrical insulators (for example, bases of electrical bulbs).

These subheadings do not cover glass-microspheres for coating cinema screens, electronic display panels, etc. (subheading 7018 20 00).

3212**Pigments (including metallic powders and flakes) dispersed in non-aqueous media, in liquid or paste form, of a kind used in the manufacture of paints (including enamels); stamping foils; dyes and other colouring matter put up in forms or packings for retail sale****3212 10 00****Stamping foils**

See note 6 to this chapter and the HS Explanatory Note to heading 3212, (B).

3212 90 00**Other**

See the HS Explanatory Note to heading 3212, parts (A) and (C).

Metallic powders and flakes, as referred to in part (A) of the HS Explanatory Note to heading 3212, include:

1. zinc powder, which is incompatible with acid binders but is an excellent rust-inhibitive pigment;
2. lamellar stainless steel and nickel powders, used in certain acid-resistant anticorrosive paints;
3. lead powder, a basic reaction pigment, used as a rust inhibitor (possibly mixed with red lead or basic lead sulphate) in oil paints or oil varnishes applied as a priming coat to large steel sections (hangar structures, bridges, viaducts, etc.);
4. copper and bronze powders whose lamellar particles 'leaf' in varnishes based on alcohol, natural or artificial resins to form decorative coatings.

CHAPTER 33

ESSENTIAL OILS AND RESINOIDS; PERFUMERY, COSMETIC OR TOILET PREPARATIONS

- 3301** **Essential oils (terpeneless or not), including concretes and absolutes; resinoids; extracted oleoresins; concentrates of essential oils in fats, in fixed oils, in waxes or the like, obtained by enfleurage or maceration; terpenic by-products of the deterpenation of essential oils; aqueous distillates and aqueous solutions of essential oils**
Some constituents of essential oils, by nature, spoil the fragrance and are preferably removed, such as terpenic hydrocarbons (for example, pinene, camphene, limonene).
Essential oils may be deterpenated by various methods according to their composition, in particular by fractional distillation in a vacuum, fractional crystallisation by cooling to a low temperature, separation by means of solvents, etc.
Essential oils which still retain their terpenic constituents and essential oils which, by their nature, do not contain terpenic constituents (for example, wintergreen oil and mustard oil) are referred to as 'not deterpenated'.
- 3301 12 10** ~~to~~ **to 3301 19 80** **Essential oils of citrus fruit**
These oils are obtained, almost entirely, from the peel of the fruit. They have a pleasant odour which is similar to that of the fruit used in their preparation. Orange-blossom oils or neroli oil are not regarded as essential oils of citrus fruit and are classified in subheading 3301 29 41 or 3301 29 91.
- 3301 90 10** **Terpenic by-products of the deterpenation of essential oils**
See the HS Explanatory Note to heading 3301, (C).
- 3301 90 90** **Other**
This subheading includes:
1. concentrates of essential oils in fats, in fixed oils, or in waxes or the like (see the HS Explanatory Note to heading 3301, (B));
2. aqueous distillates and aqueous solutions of essential oils (see the HS Explanatory Note to heading 3301, (D), first to fourth paragraphs).
- 3304** **Beauty or make-up preparations and preparations for the care of the skin (other than medicaments), including sunscreen or suntan preparations; manicure or pedicure preparations**
- 3304 30 00** **Manicure or pedicure preparations**
This subheading covers preparations used for fingernail and toenail care, cuticle and corn care or treatment. However, preparations used for the care of the skin, for example, hand creams, are excluded (generally, subheading 3304 99 00).
- 3305** **Preparations for use on the hair**
- 3305 90 00** **Other**
This subheading includes hair lotion which is a product applied to the hair, in liquid form, to produce an effect upon either the hair-shaft or the scalp. It is, generally, an aqueous or alcoholic solution.

CHAPTER 34

SOAP, ORGANIC SURFACE-ACTIVE AGENTS, WASHING PREPARATIONS, LUBRICATING PREPARATIONS, ARTIFICIAL WAXES, PREPARED WAXES, POLISHING OR SCOURING PREPARATIONS, CANDLES AND SIMILAR ARTICLES, MODELLING PASTES, 'DENTAL WAXES' AND DENTAL PREPARATIONS WITH A BASIS OF PLASTER

- 3401** Soap; organic surface-active products and preparations for use as soap, in the form of bars, cakes, moulded pieces or shapes, whether or not containing soap; organic surface-active products and preparations for washing the skin, in the form of liquid or cream and put up for retail sale, whether or not containing soap; paper, wadding, felt and nonwovens, impregnated, coated or covered with soap or detergent
- 3401 11 00** For toilet use (including medicated products)
This subheading covers the products described in the HS Explanatory Note to heading 3401, (I), seventh paragraph, (1), and those products referred to in parts (II) and (IV) which are for toilet use.
- 3401 20 90** Other
This subheading includes soap in liquid or paste form.
- 3401 30 00** Organic surface-active products and preparations for washing the skin, in the form of liquid or cream and put up for retail sale, whether or not containing soap
See the HS Explanatory Note to heading 3401, (III).
- 3403** Lubricating preparations (including cutting-oil preparations, bolt- or nut-release preparations, anti-rust or anti-corrosion preparations and mould-release preparations, based on lubricants) and preparations of a kind used for the oil or grease treatment of textile materials, leather, furskins or other materials, but excluding preparations containing, as basic constituents, 70 % or more by weight of petroleum oils or of oils obtained from bituminous minerals
- 3403 19 90** Other
This subheading includes preparations for lubricating machines, appliances and vehicles.
This subheading covers the preparations referred to in the HS Explanatory Note to heading 3403, first paragraph, (A), which contain by weight less than 70 % of petroleum oils or oils obtained from bituminous materials.
This subheading does not include such preparations containing by weight 70 % or more of petroleum oils or of oils obtained from bituminous minerals. When such oils are the basic constituent of the preparation, they fall in subheadings ~~2710 11 11~~2710 12 11 to 2710 19 99 and in other cases in subheading 3403 19 10.
- 3403 91 00 and and 3403 99 00** Other
These subheadings cover preparations of the type referred to in heading 3403 which do not contain petroleum oils or oils obtained from bituminous materials. The expression 'petroleum oils or oils obtained from bituminous materials' means the products defined in note 2 to Chapter 27.
These subheadings include:
1. lubricating preparations consisting of molybdenum disulphide and polypropylene glycol and other lubricating preparations with a basis of molybdenum disulphide, whether concentrated or in the form of pencils, rods, small plates, sheets and the like;
 2. mould-release preparations consisting of an aqueous dispersion of polyethylene wax and aminoalcohol soap;
 3. lubricating preparations with a basis of sodium soap or calcium soap and borax, intended to protect and lubricate steel wires during wire-drawing operations.
 4. preparations for lubricating machines, appliances and vehicles.

- 3405 Polishes and creams, for footwear, furniture, floors, coachwork, glass or metal, scouring pastes and powders and similar preparations (whether or not in the form of paper, wadding, felt, nonwovens, cellular plastics or cellular rubber, impregnated, coated or covered with such preparations), excluding waxes of heading 3404**
- 3405 10 00 Polishes, creams and similar preparations, for footwear or leather**
The primary materials used in the manufacture of products for footwear consist generally of waxes (animal, vegetable, mineral or artificial), volatile solvents (spirits of turpentine, white spirit, etc.), colouring material and various other substances (alcohol, borax, artificial oils, emulsifiers, etc.).
Leather dyes, particularly those for suede footwear, are not products of the nature of polishes and creams and fall in sub-heading 3212 90 00 (if they are, as is generally the case, put up in forms or in packings of a kind sold by retail). Also excluded from this subheading are whitenings for footwear, which fall in subheading 3210 00 90. Greases for footwear fall generally in subheading 3403 11 00 or 3403 91 00.
- 3405 20 00 Polishes, creams and similar preparations, for the maintenance of wooden furniture, floors or other woodwork**
Products intended for the maintenance of wood (floors, furniture, woodwork) have cleansing properties and leave on the surfaces to which they are applied a thin protective skin which, after drying and in some cases polishing, brighten their colour or give them a glossy appearance. Products of this type are generally put up in cans, bottles, pads or aerosols.
During manufacture, in addition to waxes, solvents, colouring materials and special additives going into the composition of polishes and creams for footwear, certain of the following products are frequently used: fatty acids, vegetable oils (for example, palm oil, linseed oil) or mineral oils, soaps or surface-active agents, resins (copal, rosin or colophony, etc.), silicones, perfumes (for example, essence of pine, rosemary), insecticides, etc., but not abrasives.
- 3405 30 00 Polishes and similar preparations for coachwork, other than metal polishes**
Products intended for the maintenance of vehicle bodywork generally consist of a waxy emulsion or solution containing silicones, oils, emulsifying agents and, possibly, soft abrasives.
- 3405 40 00 Scouring pastes and powders and other scouring preparations**
Scouring powders for baths, washbasins, tiles, etc. consist of very finely divided abrasive mixtures (for example, pumice-stone, sandstone) and pulverised cleansers (for example, surface-active agents with active anions, soap powder, sodium phosphate, anhydrous sodium carbonate). They are generally put up in tins or packets. Scouring pastes are scouring products made by binding the powders with, for example, a wax solution.
- 3405 90 10 Metal polishes**
Metal polishes are intended to restore, by surface treatment, the original appearance to corroded, soiled or weathered metals. This result is obtained by abrasion (a mechanical polishing action by an abrasive) and by the chemical or cleansing action of acids or alkalis on the oxides, sulphides and various tarnishes.
The primary materials used in the manufacture of metal polishes are very finely divided abrasives (for example, pumice stone, chalk, kieselguhr, tripolite, bentonite, silica), acids (for example, oxalic acid, oleic acid, phosphoric acid, sulphuric acid), volatile solvents (for example, white spirit, trichlorethylene, denatured alcohol), alkalis (for example, ammonia, soda), surface-active products such as fatty sulphonic alcohols, fats, soaps and in some cases colouring material and synthetic perfumes.
Metal polishes are presented in the form of powder, pastes, various compositions (creams or emulsions) and liquids. Depending on the type, they are presented in bottles, cans, metal tubes, tins, packets or in the form of small lumps, cones, sticks, etc.
- 3405 90 90 Other**
This subheading includes in particular:
1. polishes for glass, generally comprising water, alcohol, a small quantity of ammonia or acid (for example, oxalic, tartaric) and a soft abrasive;
 2. products for polishing, finishing and fine-grinding other materials.

CHAPTER 37

PHOTOGRAPHIC OR CINEMATOGRAPHIC GOODS

- 3702 Photographic film in rolls, sensitised, unexposed, of any material other than paper, paperboard or textiles; instant print film in rolls, sensitised, unexposed**
- 3702 32 10 Microfilm; film for the graphic arts**
 Microfilm of this subheading does not normally differ from cinematographic film but is used for the frame-by-frame reproduction of documents. It is also used for the reproduction of computer program listings, in which case it is identified by the letters COM. Microfilm is usually put up in widths of 8 mm, 16 mm and 35 mm and in lengths of approximately 30 m, 61 m, 122 m and 305 m.
 Film for the graphic arts is used in the printing industry for the photomechanical reproduction of illustrations and textual matter (for example, photolithography, heliogravure, photochromotypography, photostat reproduction).
- ~~3702 91 20~~ **Film for the graphic arts**
 See the explanatory note to subheading 3702 32 10, second paragraph.
- ~~3702 93 10~~ **3702 96 10 Microfilm; film for the graphic arts**
 See the explanatory note to subheading 3702 32 10.
- ~~3702 94 10~~ **3702 97 10 Microfilm; film for the graphic arts**
 See the explanatory note to subheading 3702 32 10.
- 3705 Photographic plates and film, exposed and developed, other than cinematographic film**
- 3705 90 10 Microfilms**
 This subheading covers reproductions, in reduced form, of documents (for example, business papers, archive documents, industrial drawings), obtained by a photographic process.
 Microfilm is film in the flat (microfiches) or in rolls consisting of a series of micro-images. Microfiches remain classified in this subheading, even if framed.
 This subheading does not cover microcopies on photographic paper, exposed and developed (in the form of microcards, books, etc.) which fall in subheading 4911 91 00.
- 3706 Cinematographic film, exposed and developed, whether or not incorporating soundtrack or consisting only of soundtrack**
Within this heading, the term 'sound films' means only those which incorporate both visual images and soundtrack on the same band. In the case of sound films in two bands, whether or not presented together, each band is classified in its appropriate subheading, i.e., film stock consisting only of soundtrack is classified in subheading 3706 10 20 or in subheading 3706 90 52 depending on its width, while film stock containing the visual images falls within one of the subheadings mentioned or in subheadings 3706 90 91 or 3706 90 99 (application of additional note 1 to this chapter).
- ~~3706 10 91 and 3706 10 99~~ **Other**
 These subheadings cover, as sound films, only those which incorporate both visual images and soundtrack on the same band. In the case of sound films in two bands, whether or not presented together, each band is classified in its appropriate subheading, i.e., film stock consisting only of soundtrack is classified in subheading 3706 10 10 or in subheading 3706 90 10 depending on its width, while film stock containing the visual images falls within one or other of the present subheadings or in subheadings 3706 90 31 to 3706 90 99 (application of additional note 1 to this chapter).

3706 10 913706 10 20**Negatives; intermediate positives** ~~Consisting only of soundtrack; negatives; intermediate positives~~

This subheading includes:

1. original film negatives;
2. intermediate positive films printed from the original negatives; in the black-and-white process they are known as 'duplicating positives', 'maroon positives', 'lavender mauve positives', 'master positives', 'masterprints', 'fine-grain masterprints', or 'lavender positives', or 'duplicating positives', whereas in the colour process they are called 'duplicating positives', 'interpositives' or 'intermediate positives'; these are put up on a base which is lightly tinted in mauve or maroon, or on a non-tinted base; these films are not normally used for projection but are intended for making duplicates of original negatives. Nevertheless, they can be used exceptionally for viewing, for editing work or post-synchronisation of a film.

Also classified as intermediate positives are the three positive black and white separations produced by means of filters (blue, green and red) from the original coloured negatives and used to obtain, by means of similar filters, a coloured internegative intended for printing positive copies;

3. duplicates of negatives printed from intermediate positive films and intended for printing positive copies; they are known as 'duplicating negatives' in black-and-white processing and 'internegatives' in colour processing ⁽¹⁾;
4. reversible internegatives which, in colour processing, are obtained directly by inversion from the original negative and from which will be printed copies intended for exhibition;
5. 'matrix films' (red, green, blue) which, in colour processing, are obtained from negatives and from which copies will be printed.

Where they are of a width of 35 mm or more, all these films — with the exception of 'matrix films' — usually have the typical perforations for negatives (barrel-shaped).

This makes it possible to distinguish intermediate positive films with an untinted backing from positive films intended for projection which have perforations typical of positives.

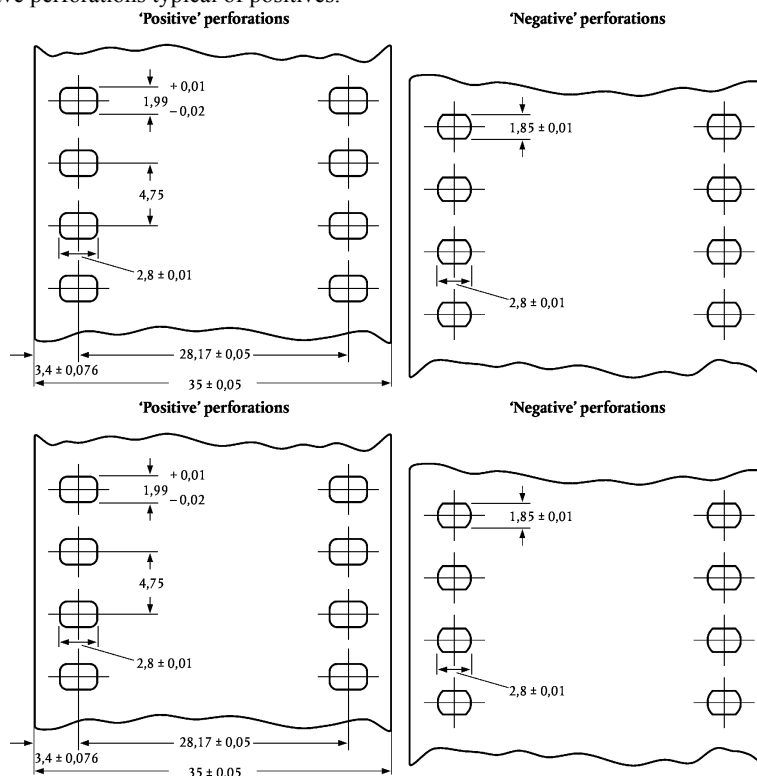

Nevertheless, it should be noted that films from certain countries (the former USSR, in particular) show a unique type of perforation (Dubray-Howell) that is very similar to normal positive perforations and is also found in original negative films, in intermediate positives and negatives and also in positive copies intended for showing or projection.

'Matrix films' have perforations typical of positives but can be recognised by their thickness (almost double that of positives), by their dominant maroon colour and the slight relief of the images.

⁽¹⁾ Corresponding terms: — Dupe negative: contretypage négatif (French) — Dup Negativ (German) — controtipi negativi (Italian) — duplicaat-negatief (Dutch); — Intermediate negative, internegative: internégatif (French) — Zwischennegativ (German) — internegativi (Italian) — internegatief (Dutch).

3706 10 99**Other positives**

This subheading covers films intended for projection.

Positive films with two or more image bands are to be classified and assessed for duty according to the width and length of the film after splitting, i.e. the width and length of the film as it will be projected.

For example, a film with a width of 35 mm (four bands of 8 mm trimmings) and a length of 100 m is to be considered as an 8 mm film of a length of 400 m.

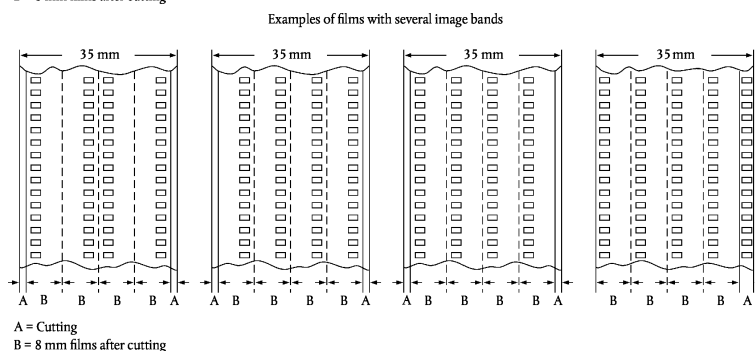
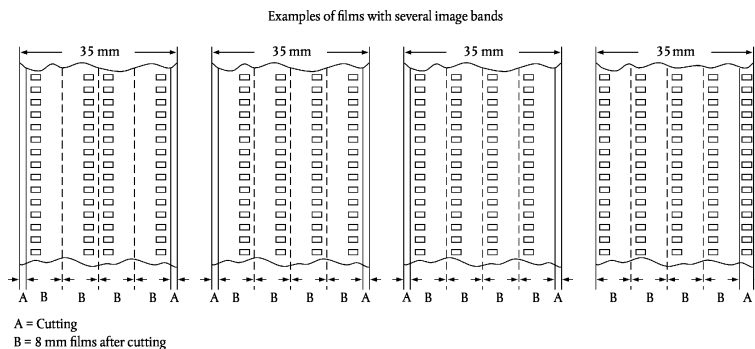
**~~3706 90 31 to 3706 90 99~~****Other**

See the explanatory notes to subheadings 3706 10 91 and 3706 10 99.

~~3706 90 31~~ 3706 90 52**~~Negatives; intermediate positives~~ Consisting only of soundtrack; negatives; intermediate positives; newsreels**

See the explanatory note to subheading 3706 40 91+3706 10 20.

For the definition of the term 'newsreels', see additional note 2 to this chapter.

~~3706 90 51~~ 3706 90 91 to and Other positives Other, of a width of**3706 90 99**

See the explanatory note to subheading 3706 10 99.

3706 90 51**Newsreels**

See additional note 2 to this chapter.

CHAPTER 38

MISCELLANEOUS CHEMICAL PRODUCTS

- 3801** **Artificial graphite; colloidal or semi-colloidal graphite; preparations based on graphite or other carbon in the form of pastes, blocks, plates or other semi-manufactures**
- 3801 10 00** **Artificial graphite**
See the HS Explanatory Note to heading 3801, (1).
- 3801 20 10** **and** **and** **3801 20 90** **Colloidal or semi-colloidal graphite**
See the HS Explanatory Note to heading 3801, (2).
- 3801 20 90** **Other**
This subheading covers colloidal graphite in aqueous suspension or in other non-oil suspension.
- 3801 30 00** **Carbonaceous pastes for electrodes and similar pastes for furnace linings**
See the HS Explanatory Note to heading 3801, (3), (b).
- 3802** **Activated carbon; activated natural mineral products; animal black, including spent animal black**
- 3802 10 00** **Activated carbon**
Activated carbon of this subheading has an iodine number of 300 or more (milligrams of iodine absorbed per gram of carbon), as determined by the ASTM D 4607-86 method.
- 3802 90 00** **Other**
Generally, activated diatomite of this subheading, calcined with sintering agents such as sodium chloride or sodium carbonate (see the HS Explanatory Note to heading 3802, part (A), third paragraph, (b), (1)), has the following characteristics:
- it is white and remains white after undergoing further calcination;
 - its pH as a 10 % suspension in water is between 7,5 and 10,5;
 - its ignition loss at 900 °C is less than 0,5 %;
 - its sodium content expressed as Na₂O is higher than 1,5 %.
- This subheading covers activated bentonites corresponding to the description of activated earth (see the HS Explanatory Note to heading 3802, part (A), third paragraph, (b) (3)). Activated bentonites falling in this subheading are differentiated from naturally occurring bentonites falling in subheading 2508 10 00 by a pH of generally less than 6 (acid bentonites), or higher than 9,5 (for an aqueous suspension and after standing for 1 hour) with a sodium carbonate content in excess of 2 % or an aggregate content of exchangeable sodium and calcium exceeding 80 meq/100 g (activated sodium bentonites). Organophylic bentonites, obtained by the addition of, for example, stearylamine, are generally covered by subheading 3824 90 97.
- Natural bentonites simply mixed with small quantities of sodium carbonate are covered by subheading 3824 90 97.

3803 00	Tall oil, whether or not refined
3803 00 10	Crude See the HS Explanatory Note to heading 3803, first two paragraphs.
3804 00 00	Residual lyes from the manufacture of wood pulp, whether or not concentrated, desugared or chemically treated, including lignin sulphonates, but excluding tall oil of heading 3803 This heading includes concentrated sulphite lye. Concentrated sulphite lye is obtained by strongly concentrating the residual lyes from the manufacture of wood pulp by the sulphite process, sometimes after suitable chemical treatment to modify its degree of acidity or alkalinity, ash content, colour and colloidal properties.
3805	Gum, wood or sulphate turpentine and other terpenic oils produced by the distillation or other treatment of coniferous woods; crude dipentene; sulphite turpentine and other crude para-cymene; pine oil containing alpha-terpineol as the main constituent
3805 10 10	Gum turpentine This subheading covers only the product obtained exclusively and directly from the distillation (by steam extraction) of the oleoresins tapped from growing coniferous trees.
3805 10 30	Wood turpentine This subheading covers the product mentioned in the HS Explanatory Note to heading 3805, second paragraph, (2), (a).
3805 10 90	Sulphate turpentine This subheading covers the product mentioned in the HS Explanatory Note to heading 3805, second paragraph, (2), (b).
3805 90 10	Pine oil This subheading covers the product mentioned in the HS Explanatory Note to heading 3805, second paragraph, (5).
3805 90 90	Other This subheading includes turpentine from which the beta-pinene has been almost entirely removed by fractional distillation followed by mixing with other fractions. This product is marketed under the description 'reconstituted spirits of turpentine'.
3806	Rosin and resin acids, and derivatives thereof; rosin spirit and rosin oils; run gums
3806 10 00	Rosin and resin acids See the HS Explanatory Note to heading 3806, part (A).
3806 20 00	Salts of rosin, of resin acids or of derivatives of rosin or resin acids, other than salts of rosin adducts See the HS Explanatory Note to heading 3806, part (B).
3806 30 00	Ester gums See the HS Explanatory Note to heading 3806, part (C).
3806 90 00	Other This subheading includes: <ol style="list-style-type: none">1. derivatives of rosin or of resin acids mentioned in the HS Explanatory Note to heading 3806, part (D), (I), as well as disproportionated (dismutated) rosin in which part of the resin acid is dehydrogenated and part is hydrogenated, technical resin amines (for example, dehydroabietylamine) and technical resin nitriles;2. rosin spirit and the rosin oils referred to in the HS Explanatory Note to heading 3806, part (D), (II);3. run gums referred to in the HS Explanatory Note to heading 3806, part (D), (III).

- 3807 00** **Wood tar; wood tar oils; wood creosote; wood naphtha; vegetable pitch; brewers' pitch and similar preparations based on rosin, resin acids or on vegetable pitch**
- 3807 00 10** **Wood tar**
See the HS Explanatory Note to heading 3807, second paragraph, (A), (1).
- 3807 00 90** **Other**
This subheading covers the products referred to in the HS Explanatory Note to heading 3807, second paragraph, (A), (2) and (3), and (B), (C) and (D).
- 3808** **Insecticides, rodenticides, fungicides, herbicides, anti-sprouting products and plant-growth regulators, disinfectants and similar products, put up in forms or packings for retail sale or as preparations or articles (for example, sulphur-treated bands, wicks and candles, and fly-papers)**
- 3808 91 10** ~~to~~ **to 3808 91 90** **Insecticides**
See the HS Explanatory Note to heading 3808, (I), after the three asterisks.
- 3808 92 10** ~~to~~ **to 3808 92 90** **Fungicides**
See the HS Explanatory Note to heading 3808, (II), after the three asterisks.
- 3808 92 10** **Preparations based on copper compounds**
This subheading includes:
1. Bordeaux mixture, made from copper sulphate and slaked lime, used in agriculture as a fungicide;
 2. preparations made from basic copper chloride and basic copper sulphate, copper oxychloride, copper silicate, copper acetoarsenite, copper oxide(s), copper hydroxide or copper carbonate, used for the same purpose;
 3. preparations based on copper naphthenate or copper phosphate used for protecting textiles and wood against fungus;
 4. chelates of organic copper salts with metallic soaps.
- The preparations of this subheading may take the form of powders, solutions or tablets, in bulk or put up for retail sale, and may contain, besides copper compounds, additional active substances such as compounds of zinc or mercury.
- 3808 93 90** **Plant-growth regulators**
This subheading covers substances which, when applied to plants, alter their physiological processes in a desired direction. They are applied to the whole plant, to parts of the plant or to the soil. Their action can influence, for example:
- (a) overall growth;
 - (b) plant height (stem lengthening or shortening);
 - (c) size or form of tubers;
 - (d) internodal length (improvement of resistance to lodging);
 - (e) fruiting and size of fruit;
 - (f) level of plant reserves (carbohydrates, proteins, fats);
 - (g) time of flowering or fruit-ripening;
 - (h) plant sterility;
 - (i) number of female flowers.
- Plant-growth regulators fall into four major categories:
1. auxins which act on root formation, stalk growth and fruit development. The most important is indol-3-ylacetic acid;
 2. gibberellins which promote, in particular, bud growth and blossoming. They are all derived from gibberellic acid;
 3. cytokinins which promote, in particular, cell division and retard ageing of the plant. The best-known are kinetin (6-furfurylamino-purine) and zeatin;
 4. growth retarders.
- This subheading does not include:
- (a) fertilisers;
 - (b) soil improvers (conditioners);
 - (c) herbicides, whether or not selective (subheadings 3808 93 11 to 3808 93 27);
 - (d) anti-sprouting products (subheading 3808 93 30).

3808 94 10~~to~~_to_3808 94 90 Disinfectants

See the HS Explanatory Note to heading 3808, (IV), after the three asterisks, first three paragraphs.

3809 Finishing agents, dye carriers to accelerate the dyeing or fixing of dyestuffs and other products and preparations (for example, dressings and mordants), of a kind used in the textile, paper, leather or like industries, not elsewhere specified or included**3809 10 10~~to~~_to_3809 10 90 With a basis of amylaceous substances**

In addition to the starch-based products and preparations described in the HS Explanatory Note to heading 3809, third paragraph, (A), (1) and (11), and (B), (1) and (2), these subheadings cover mixtures of starch with borax or with carboxymethylcellulose (used for stiffening linen) and of mixtures of soluble starch and kaolin (used in paper manufacture).

3809 91 00~~to~~_to_3809 93 00 Other

These subheadings cover the products and preparations described in the HS Explanatory Note to heading 3809, third paragraph, (A), (B) and (C), only if amylaceous substances do not form the basis of these products and preparations, in particular:

1. various dressings used in the textile industry to render fabrics crease-resistant or unshrinkable. These include urea-formaldehyde, melamine-formaldehyde and glyoxaldiurea, precondensed, provided that they do not have the characteristics either of polycondensation products within the meaning of Chapter 39 or of chemically defined compounds (Chapter 29). Furthermore, these subheadings cover aqueous compounds (for example, dimethylalurea, trimethylol-melamine) to which a perfume has been added to mask the odour of formaldehyde caused by the partial decomposition of the product;
2. dressings which, besides waterproofing fabrics, impart to them a considerable resistance to oil and dirt while leaving them permeable to air;
3. anti-static dressings, i.e., preparations which prevent the accumulation of static electricity in textile fibres or fabrics. These are generally preparations formed by precondensed water-soluble polyelectrolytes which, after a brief treatment at moderate temperature, are capable of forming on the fibre reticulated polycondensates that are sufficiently insoluble to withstand repeated washing or dry-cleaning. This category includes products formed by a basic, water-soluble, linear polyamide prepared from a dicarboxylic (for example, adipic, succinic or terephthalic) acid with polyamines containing one or more secondary amine groups (for example, diethylene-triamine, triethylenetetramine) and an alkylant (capable of reticulating the polyamide and thus rendering it insoluble by appropriate treatment under heat) consisting, for example, of particular dihalides (diiodides of polyethylene glycol of relatively low molecular weight, epichlorohydrin, etc.);
4. fire-resistant dressings which reduce the flammability of textiles and leather in particular. These are generally preparations based on ammonium salts, boric acid, chlorinated paraffins, antimony oxide, zinc oxide, other metallic oxides and certain organic compounds of nitrogen and/or phosphorus.

3811 Anti-knock preparations, oxidation inhibitors, gum inhibitors, viscosity improvers, anti-corrosive preparations and other prepared additives, for mineral oils (including gasoline) or for other liquids used for the same purposes as mineral oils

3811 11 10 Based on tetraethyl-lead
This subheading covers preparations in which tetraethyl-lead is the only anti-knock constituent.

3811 11 90 Other
This subheading includes preparations in which tetramethyl-lead or ethylmethyl-lead or a mixture of tetraethyl- and tetramethyl-lead is the sole or principal anti-knock constituent.

3815 Reaction initiators, reaction accelerators and catalytic preparations, not elsewhere specified or included

3815 11 00~~to~~ to 3815 19 90 Supported catalysts

These are catalysts of a widely used type which are deposited on a support, generally by impregnation, coprecipitation or mixing. They usually consist either of one or more active substances deposited on a support or of mixtures with a basis of active substances. The active substances are usually very finely divided metals, metallic oxides or other metallic compounds. The metals most commonly used are those belonging to group VIII of the periodic table (especially cobalt, nickel, palladium and platinum) and molybdenum, chromium, copper and zinc. The support generally consists of alumina, silica gel, fossil meal, whether or not activated, ceramic materials, etc.

They are used in industrial processes for the production of organic and inorganic compounds and in petroleum refining (for example, in ammonia synthesis, hydrogenation of fats, hydrogenation of olefins).

This category of catalysts also includes the following products:

1. certain preparations, based on compounds of transition metals, the function of which is to facilitate oxidation, and consequently elimination in the form of carbon dioxide in the course of combustion, of carbon residues (as in boilers and burners);
2. 'post-combustion' catalysts intended to be introduced into the exhaust systems of motor vehicles in order to reduce the polluting effect of the exhaust gases by converting the carbon monoxide into carbon dioxide and by converting other toxic products (for example, heterocyclic compounds) resulting from the combustion of petrol.

3815 90 10~~and~~ and 3815 90 90

Other

These subheadings cover mixtures based on compounds, the nature and proportions of which vary according to the chemical reaction to be catalysed. They are frequently used in the manufacture of plastics, often under the name of initiators, transfer agents, terminators or telomers, and reticulating (or cross-linking) agents.

They include the following:

1. *'radical' catalysts*

These are preparations, based on organic substances, which decompose slowly under reaction conditions and produce fragments that, by colliding with the initial monomers, favour the establishment of a bond and the formation of new free radicals capable of repeating the process and propagating the chain.

Amongst these are:

- (a) preparations based on organic peroxides of the type R-O-O-R' (organic solutions of peroxides such as acetyl and dibenzoyl peroxides). During the reaction, RO· and R'O· radicals are formed and act as activators;
- (b) preparations, based on azo-compounds (such as azobisisobutyronitrile), which decompose in the course of the reactions, releasing nitrogen and forming free radicals;
- (c) redox preparations (for example, a mixture of potassium peroxide and dodecylmercaptan), in which the formation of activating radicals is due to a redox reaction;

2. *ionic catalysts*

These are generally organic solutions of compounds which generate ions capable of attaching themselves to the double bond and reproducing active sites in the resulting product;

They include:

- (a) ziegler-type catalysts for the production of polyolefins (for example, a mixture of titanium and triethylaluminium);
- (b) ziegler-natta-type catalysts (stereocatalysts, orientating catalysts), such as a mixture of titanium trichloride and trialkylaluminium, for the preparation of isotactic polypropylene and ethylene-olefin block copolymers;
- (c) catalysts for the preparation of polyurethanes (for example, a mixture of triethylenediamine and tin compounds);
- (d) catalysts for the preparation of amino-plastics (for example, phosphoric acid in an organic solvent);

3. *catalysts for polycondensation reactions*

These are preparations based on various compounds (for example, a mixture of calcium acetate, antimony trioxide, titanium alcoholates, etc.).

- 3821 00 00** **Prepared culture media for the development or maintenance of micro-organisms (including viruses and the like) or of plant, human or animal cells**
This heading does not cover eggs whether or not fertilised which, although from certified pathogen-free flocks, have not been prepared for the culture of micro-organisms (heading 0407 or 0408).
- 3823** **Industrial monocarboxylic fatty acids; acid oils from refining; industrial fatty alcohols**
- 3823 11 00** **Stearic acid**
For the purposes of this subheading, stearic acid means mixtures of fatty acids which are solid at normal temperature and have a pure stearic acid content of 30 % or more but less than 90 %, calculated on the weight of the dry product.
Products of this type having a stearic acid content of 90 % by weight or more fall in subheading ~~2915 70 00~~2915 70 50.
- 3823 12 00** **Oleic acid**
For the purposes of this subheading, oleic acid means mixtures of fatty acids which are liquid at normal temperature and have a pure oleic acid content of 70 % or more but less than 85 %, calculated on the weight of the dry product.
Products having an oleic acid content of 85 % or more by weight fall in subheading 2916 15 00.
- 3823 13 00** **Tall oil fatty acids**
See the HS Explanatory Note to heading 3823, part (A), second paragraph, (3).
Products of this type containing by weight less than 90 % of fatty acids fall in heading 3803 00.
- 3823 70 00** **Industrial fatty alcohols**
See the HS Explanatory Note to heading 3823, part (B).
This subheading covers only industrial fatty alcohols (mixtures of acyclic alcohols) in which none of the alcohol components comprises 90 % or more by weight of the dry product.
Products of this type in which one of the fatty alcohol components comprises 90 % by weight or more generally fall in heading 2905.

- 3824 Prepared binders for foundry moulds or cores; chemical products and preparations of the chemical or allied industries (including those consisting of mixtures of natural products), not elsewhere specified or included**
- 3824 10 00 Prepared binders for foundry moulds or cores**
See the HS Explanatory Note to heading 3824, part (A).
- 3824 30 00 Non-agglomerated metal carbides mixed together or with metallic binders**
This subheading covers powders ready to be converted into 'hard metals' by sintering. They are composed of mixtures of different metal carbides (tungsten, titanium, tantalum and niobium carbides), with or without a metallic binder (cobalt or nickel powder), and often contain small quantities of paraffin wax (about 0,5 % by weight). Even a simple mixture of one of the above carbides with a metallic binder falls in this subheading, whereas each of these carbides, taken separately, falls in heading 2849.
- 3824 40 00 Prepared additives for cements, mortars or concretes**
See the HS Explanatory Note to heading 3824, part (B), sixth paragraph, (3).
- 3824 50 10 Concrete ready to pour**
This subheading includes concrete to which water has already been added. It is usually transported in concrete-mixer lorries.
- 3824 50 90 Other**
This subheading includes:
1. concrete not yet mixed with water;
2. mortar.
- 3824 60 11~~to~~ to 3824 60 99 Sorbitol other than that of subheading 2905 44**
These subheadings include the 'non-crystallisable' varieties of sorbitol (D-glucitol), which are generally obtained from glucose syrup containing a proportion of other oligosaccharides by hydrogenation at high pressure. Their sorbitol (D-glucitol) content ranges from 60 to 80 % of the dry matter, the remaining constituents being essentially partly hydrogenated polyalcohols and oligosaccharides. For this reason, the tendency of sorbitol (D-glucitol) to crystallise is greatly reduced (hence, the designation used: non-crystallisable sorbitol (D-glucitol)).
Sorbitol meeting the requirements of note 1 to Chapter 29 is classified in subheadings 2905 44 11 to 2905 44 99.
- 3824 71 00~~to~~ to 3824 79 00 Mixtures containing halogenated derivatives of methane, ethane or propane**
See the HS Explanatory Note to subheadings 3824 71 to 3824 79.
- 3824 90 10 Petroleum sulphonates, excluding petroleum sulphonates of alkali metals, of ammonium or of ethanolamines; thiophenated sulphonic acids of oils obtained from bituminous minerals, and their salts**
This subheading includes:
1. petroleum sulphonates of calcium or of barium, which generally have a mineral oil content of 55 to 70 % by weight. They are widely used in the manufacture of additives for mineral oils;
2. thiophenated sulphonic acids of oils obtained from bituminous minerals, prepared by dry distillation of certain bituminous shales followed by sulphuric acid treatment, intended for use in pharmacy and having a total sulphur content generally greater than 9 % by weight, as well as their salts, particularly those of calcium.

3824 90 15**Ion-exchangers**

See the HS Explanatory Note to heading 3824, part (B), sixth paragraph, (14).

This subheading includes ion-exchangers based on sulphonated carbon, as well as certain types of clay provided that they have undergone particular treatments that render them suitable for use as ion-exchangers (mainly cationic); among these is glauconite, which takes the form of a gel of alumino-silicates obtained from a sandy marl of marine origin. It is used principally for water-softening. Other products used for the same purposes are based on montmorillonite and kaolinite. This subheading also includes synthetic ion-exchangers, such as artificial zeolites and those based on aluminium oxide or silica gel.

This subheading does not cover:

- (a) pure silica gel (subheading 2811 22 00);
- (b) pure alumina, whether or not activated (subheading 2818 20 00 or 2818 30 00);
- (c) artificial zeolites, not containing binders (subheading 2842 10 00), in accordance with part B, (14), of the HS Explanatory Note to heading 3824
- (d) activated clay (subheading 3802 90 00).

3824 90 20**Getters for vacuum tubes**

This subheading covers articles known as 'getters'. These are divided into 'flash getters' and 'bulk getters'.

The first category are volatilised in the tube during its manufacture; they include: products composed both of barium and of aluminium, magnesium, tantalum, thorium, etc., in the form of wire or pellets; compositions consisting of a mixture of barium and strontium carbonates on tantalum wire.

The second category are merely heated but not volatilised and have only a contact absorption action. They are generally composed of pure metals (tantalum, tungsten, zirconium, niobium, thorium) in the form of wire, wafers, etc., and cannot therefore be classified in this subheading.

3824 90 30**Naphthenic acids, their water-insoluble salts and their esters**

Naphthenic acids are mixtures of monocarboxylic alicyclic acids recovered during the refining of crude oil of certain origins (principally, the former USSR and Romania).

This subheading also includes the water-insoluble salts of naphthenic acids (for example, the salts of aluminium, barium, lead, chromium, calcium, manganese, cobalt, zinc) and the esters of those acids.

3824 90 35**Anti-rust preparations containing amines as active constituents**

This subheading covers products containing amines or derivatives thereof as their active constituents and used for the prevention of rust, for example:

1. preparations manufactured from amines or amino-alcohols (generally, triethanolamine) and alkaline nitrites, with or without a wetting agent;
2. organic solutions of fatty or resinous amines and their derivatives (for example, phosphates and fatty diamines, fatty acid salts and fatty amine salts).

However, such preparations which are used as additives for mineral oils, for example, corrosion inhibitors for fuel oils, are classified in heading 3811.

3824 90 45**Anti-scaling and similar compounds**

This subheading covers products mentioned in the HS Explanatory Note to heading 3824, (B), sixth paragraph, (15), and preparations which dissolve calcareous deposits.

3824 90 50**Preparations for electroplating**

This subheading covers, for example, special preparations for metallising baths, polishing baths and products for electrography.

3824 90 55 Mixtures of mono-, di- and tri-, fatty acid esters of glycerol (emulsifiers for fats)

See the HS Explanatory Note to heading 3824, (B), sixth paragraph, (11).

3824 90 65 Auxiliary products for foundries (other than those of subheading 3824 10 00)

In addition to the products mentioned in the HS Explanatory Note to heading 3824, (B), sixth paragraph, (6) and (43), this subheading also includes:

1. preparations for coating foundry core boxes and pattern plates, based on calcium carbonate, waxes and a colouring agent;
2. preparations based on dextrin and sodium carbonate, intended for use, after emulsification, as coatings for steelworks moulds;
3. sand coated with a thin layer of synthetic resin, intended for the manufacture of foundry cores;
4. products for degassing steel;
5. separating agents for moulding (other than those falling in heading 3403).

3824 90 70 Fireproofing, waterproofing and similar protective preparations used in the building industry

This subheading includes:

1. products for protection against fire (for example, based on ammonium compounds which, under the influence of heat, swell and thus form an insulating layer for building sections);
2. products (generally, silicate-based) for impregnating the exterior of buildings as protection against water;
3. products added to concrete, to prevent the stopping-up of ground-water.

SECTION VII

PLASTICS AND ARTICLES THEREOF; RUBBER AND ARTICLES THEREOF

CHAPTER 39

PLASTICS AND ARTICLES THEREOF

Note 6 The term ‘solutions’, used both in this note and in note 4 to Chapter 32, does not apply to colloidal solutions.

I. PRIMARY FORMS

For the definition of the term ‘primary forms’, see note 6 to this chapter and the HS General Explanatory Note to this chapter, ‘Primary Forms’.

3901**Polymers of ethylene, in primary forms****3901 10 10** ~~and~~ **and**
3901 10 90**Polyethylene having a specific gravity of less than 0,94**

These subheadings cover only homopolymers of ethylene, i.e., polymers in which ethylene accounts for 95 % or more by weight of the total polymer content.

The specific gravity of the polyethylene must be determined by using an additive-free polymer.

Liquid polyethylene is covered, only if it meets the conditions laid down in note 3(a) to this chapter. Otherwise, it falls in subheadings ~~2710 11 11~~ 2710 12 11 to 2710 19 99.

Polyethylene waxes are classified in heading 3404.

3901 20 10 ~~and~~ **and**
3901 20 90**Polyethylene having a specific gravity of 0,94 or more**

See the explanatory note to subheadings 3901 10 10 and 3901 10 90.

3901 90 30 ~~and~~ **and**
3901 90 90**Other**

In accordance with note 4 and subheading note 1 to this chapter, these subheadings cover:

1. copolymers of ethylene and monomers other than vinyl acetate (for example, copolymers of ethylene and propylene) plus blends of polymers of similar composition in which ethylene is the predominant comonomer;
2. chemically modified polyethylene as set out in note 5 to this chapter (for example, chlorinated polyethylene and chlorosulphonated polyethylene).

3902**Polymers of propylene or of other olefins, in primary forms****3902 10 00****Polypropylene**

The explanatory note to subheadings 3901 10 10 and 3901 10 90, first paragraph, applies, *mutatis mutandis*.

This subheading does not cover liquid polypropylene which does not conform to note 3(a) to this chapter (for example, tripropylene or tetrapropylene) (subheadings ~~2710 11 11~~ 2710 12 11 to 2710 19 99).

3902 20 00**Polyisobutylene**

This subheading covers the product referred to in the HS Explanatory Note to heading 3902, third and fourth paragraphs.

This subheading does not cover liquid polyisobutylene which does not conform to note 3(a) to this chapter (for example, tri-isobutylene) (subheadings ~~2710 11 11~~2710 12 11 to 2710 19 99).

3902 30 00**Propylene copolymers**

This subheading includes a copolymer or a blend of polymers consisting of 45 % ethylene, 35 % propylene and 20 % isobutylene, by weight, since the propylene and isobutylene, the polymers of which fall in heading 3902, account for 55 % of the copolymer and, taken as a whole, they predominate over the ethylene. Furthermore, it is the propylene, the copolymers of which are expressly mentioned in this instance, which is the predominant monomer over the isobutylene (application of note 4 and of subheading note 1 to this chapter).

If, in the example given, the percentages of propylene and isobutylene are reversed, the copolymer in question falls in subheadings 3902 90 10 to 3902 90 90.

3902 90 10 to 3902 90 90 Other

These subheadings include products known commercially as poly(alpha-olefins), generally obtained by weak polymerization of dec-1-ene, followed by hydrogenation of the product formed and separation by distillation of the fractions rich in C₂₀-, C₃₀-, C₄₀-, and C₅₀-hydrocarbons. These fractions are mixed to form the different types of commercial poly(alpha-olefins).

They are liquids which do not necessarily meet the criterion set out in note 3(c) to this chapter but do correspond to the provisions of note 3(a) to the same chapter and are used as substitutes for mineral oils in the preparation of synthetic and semi-synthetic lubricating oils giving such products a higher viscosity index, a lower pour point, improved thermal stability, a higher flash-point and less volatility.

3903**Polymers of styrene, in primary forms**

This heading does not cover styrenated polyesters (heading 3907).

3903 11 00 and 3903 19 00**Polystyrene**

The explanatory note to subheadings 3901 10 10 and 3901 10 90, first paragraph, applies, *mutatis mutandis*.

3904**Polymers of vinyl chloride or of other halogenated olefins, in primary forms**

A vinyl polymer is a polymer of which the monomer shows the formula:

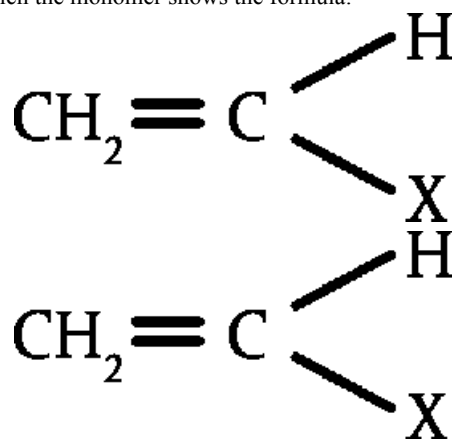

where the C-X-bond is neither a carbon-carbon nor a carbon-hydrogen bond.

3904 10 00**Poly(vinyl chloride), not mixed with any other substances**

The explanatory note to subheadings 3901 10 10 and 3901 10 90, first paragraph, applies, *mutatis mutandis*.

3904 21 00 and 3904 22 00**Other poly(vinyl chloride)**

The explanatory note to subheadings 3901 10 10 and 3901 10 90, first paragraph, applies, *mutatis mutandis*.

3904 30 00**Vinyl chloride-vinyl acetate copolymers**

This subheading covers only:

1. the copolymers of vinyl chloride in which the vinyl chloride is the predominant monomer;
2. blends of poly(vinyl chloride) and poly(vinyl acetate) in which the vinyl chloride is the predominant monomer.

3904 40 00**Other vinyl chloride copolymers**

This subheading includes the copolymers of vinyl chloride and ethylene in which the vinyl chloride is the predominant comonomer.

- 3904 61 00** **Polytetrafluoroethylene**
The explanatory note to subheadings 3901 10 10 and 3901 10 90, first paragraph, applies, *mutatis mutandis*.
- 3904 69 80** **Other**
This subheading includes poly(chlorotrifluoroethylene) and poly(vinylidene fluoride).
- 3906** **Acrylic polymers in primary forms**
- 3906 10 00** **Poly(methyl methacrylate)**
The explanatory note to subheadings 3901 10 10 and 3901 10 90, first paragraph, applies, *mutatis mutandis*.
- 3906 90 90** **Other**
This subheading includes poly(acrylonitrile).
This subheading does not include:
(a) acrylic polymers which form ion-exchangers (heading 3914 00 00);
(b) copolymers of acrylonitrile which comply with note 4 to Chapter 40 (Chapter 40).
- 3907** **Polyacetals, other polyethers and epoxide resins, in primary forms; polycarbonates, alkyd resins, polyallyl esters and other polyesters, in primary forms**
For the definition of the prefix 'poly', in the sense of this heading, see subheading note 1(a)(1) to this chapter.
- 3907 20 11 to 3907 20 99** **Other polyethers**
These subheadings also include chemically modified polyethers (other than polyacetals) (see the HS Explanatory Note to heading 3907, (2)).
- 3907 40 00** **Polycarbonates**
This subheading includes copolymers containing a component formed by a polycarbonate and a component formed by poly(ethylene terephthalate) if the polycarbonate predominates (see the HS General Explanatory Note to the subheadings of this chapter, (B), (1), sixth paragraph).
- 3907 60 20 and 3907 60 80** **Poly(ethylene terephthalate)**
The explanatory note to subheadings 3901 10 10 and 3901 10 90 applies, *mutatis mutandis*.
These subheadings include copolymers containing a component formed by a polycarbonate and a component formed by poly(ethylene terephthalate) if the poly(ethylene terephthalate) predominates (see the HS General Explanatory Note to the subheadings of this chapter, (B), (1), sixth paragraph).
- 3907 60 20** **Having a viscosity number of 78 ml/g or higher**
Poly(ethylene terephthalate) having a viscosity number of 78 ml/g or higher is generally used for the production of bottles. The viscosity number is calculated according to ISO Standard 1628-5.
- 3908** **Polyamides in primary forms**
- 3908 10 00** **Polyamide -6, -11, -12, -6,6, -6,9, -6,10 or -6,12**
The explanatory note to subheadings 3901 10 10 and 3901 10 90 applies, *mutatis mutandis*.
- 3909** **Amino-resins, phenolic resins and polyurethanes, in primary forms**
For the classification of copolymers made up of monomers of resins referred to in this heading and for the classification of their blends, see note 4 to this chapter.

- 3911** **Petroleum resins, coumarone-indene resins, polyterpenes, polysulphides, polysulphones and other products specified in note 3 to this chapter, not elsewhere specified or included, in primary forms**
- 3911 10 00** **Petroleum resins, coumarone, indene or coumarone-indene resins and polyterpenes**
The polyterpenes of this subheading are restricted to polymers and polymer blends in which one or more terpene monomers account for 95 % or more by weight of the total polymer content.
- 3911 90 11~~to~~ to 3911 90 19** **Condensation or rearrangement polymerisation products, whether or not chemically modified**
These subheadings include the products referred to in the HS Explanatory Note to heading 3911, first paragraph, (2) to (5).
- 3912** **Cellulose and its chemical derivatives, not elsewhere specified or included, in primary forms**
- 3912 11 00~~and~~ and** **Cellulose acetates**
3912 12 00 See the HS Explanatory Note to heading 3912, (B), second paragraph, (1).
- 3912 20 11~~to~~ to 3912 20 90** **Cellulose nitrates (including collodions)**
See the HS Explanatory Note to heading 3912, (B), second paragraph, (2).
- 3912 20 11** **Collodions and celloidin**
Collodion is by weight a 12 % nitrocellulose solution in a mixture of ether and alcohol. On drying, this solution leaves an elastic layer of nitrocellulose, the flexibility of which may be increased by adding castor oil. A collodion may also be obtained by dissolving nitrocellulose in acetone. Collodion is used to prepare photographic emulsions and in medicine. Celloidin is obtained from collodion by partial evaporation of the solvents. It is a solid.
- 3912 20 19** **Other**
This subheading covers non-plasticised cellulose nitrates (nitrocellulose) other than collodions and celloidin, even if for reasons of safety they are dampened — generally, with ethyl or butyl alcohol — or rendered harmless in some other manner.
- 3912 31 00~~to~~ to 3912 39 85** **Cellulose ethers**
See the HS Explanatory Note to heading 3912, (B), second paragraph, (4).
- 3912 31 00** **Carboxymethylcellulose and its salts**
Carboxymethylcellulose is obtained through the reaction of monochloroacetic acid with alkali cellulose. It is used mainly as a thickener and as a colloid protective agent.
- 3912 39 85** **Other**
This subheading includes methylcellulose, ethylcellulose, benzyl-cellulose and hydroxyethylcellulose.
- 3912 90 10** **Cellulose esters**
This subheading includes cellulose propionate and cellulose butyrate.
- 3912 90 90** **Other**
This subheading includes cellulose, not specified or included elsewhere, in primary forms.
Because of its usual commercial form, regenerated cellulose is not generally classified here. In the form of fine and transparent film, it falls in heading 3920 or 3921 and, in the form of textile fibres, in Chapter 54 or 55.
This subheading includes blends of cellulose esters and cellulose ethers (see subheading note 1 to this chapter).

- 3913** **Natural polymers (for example, alginic acid) and modified natural polymers (for example, hardened proteins, chemical derivatives of natural rubber), not elsewhere specified or included, in primary forms**
- 3913 10 00** **Alginic acid, its salts and esters**
See the HS Explanatory Note to heading 3913, first paragraph, (1)
- 3913 90 00** **Other**
See the HS Explanatory Note to heading 3913, first paragraph, (2) to (4).
II. WASTE, PARINGS AND SCRAP; SEMI-MANUFACTURES; ARTICLES
- 3915** **Waste, parings and scrap, of plastics**
The term 'plastics' is defined in note 1 to this chapter.
This heading includes:
1. waste, parings and scrap of a single thermosetting material (already hardened), converted into a primary form;
2. waste, parings and scrap of mixed plastics (thermoplastic, thermosetting (already hardened) or both), converted into a primary form.
- 3916** **Monofilament of which any cross-sectional dimension exceeds 1 mm, rods, sticks and profile shapes, whether or not surface-worked but not otherwise worked, of plastics**
- 3916 90 10** **Of condensation or rearrangement polymerisation products, whether or not chemically modified**
This subheading includes monofilaments, rods, sticks and profile shapes of polyesters, polyamides or of polyurethanes.
- 3916 90 50** **Of addition polymerisation products**
For the definition of the term 'addition polymerisation products', see the HS General Explanatory Note to this chapter, 'Polymers', second paragraph, (1).
This subheading includes monofilaments, rods, sticks and profile shapes of polymers of propylene or of styrene, or of acrylic polymers.
- 3917** **Tubes, pipes and hoses, and fittings therefor (for example, joints, elbows, flanges), of plastics**
For the definition of the term 'tubes, pipes and hoses', see note 8 to this chapter.
- 3917 29 00** **Of other plastics**
This subheading includes tubes, pipes and hoses made from condensation or rearrangement polymerisation products, whether or not chemically modified, such as phenolic resins, amino-resins, alkyd resins and other polyesters, polyamides, polyurethanes and silicones.
This subheading includes products made from addition polymerisation products, such as polytetrahaloethylenes, polyisobutylene, polymers of styrene, vinylidene chloride, vinyl acetate or other vinyl esters and acrylic polymers.
- 3918** **Floor coverings of plastics, whether or not self-adhesive, in rolls or in the form of tiles; wall or ceiling coverings of plastics, as defined in note 9 to this chapter**
This heading includes non-perforated sheeting of plastics, in rolls or in the form of tiles, of a kind used to cover, for example, tennis courts and terraces.

- 3919 Self-adhesive plates, sheets, film, foil, tape, strip and other flat shapes, of plastics, whether or not in rolls**
For the definition of the term 'self-adhesive', see the HS Explanatory Note to heading 3919, first paragraph. This heading does not cover flat shapes of plastics, which adhere only to smooth surfaces such as glass.
The goods of this heading frequently have a protective release sheet or strip of paper or plastics. This protective sheet or strip is not taken into account in determining the classification.
- 3919 10 12~~to~~ to 3919 10 80 In rolls of a width not exceeding 20 cm**
These subheadings include adhesive strips with a tab, wound on disposable dispensers which serve principally as presentation for retail sale and which are generally not reusable.
- 3919 10 12~~to~~ to 3919 10 19 Strips, the coating of which consists of unvulcanised natural or synthetic rubber**
These subheadings cover only self-adhesive strips, for example, strips recognisable as being intended for use solely or mainly as a means of sticking. Such strips are generally used for packaging goods and for similar purposes.
- 3920 Other plates, sheets, film, foil and strip, of plastics, non-cellular and not reinforced, laminated, supported or similarly combined with other materials**
See note 10 to this chapter.
This heading does not include strip of an apparent width not exceeding 5 mm (Chapter 54).
- 3920 20 80 Of a thickness exceeding 0,10 mm**
This subheading includes decorative strip, of a kind used for packaging purposes, which is coloured, silky in appearance and produced by the extrusion of polymers of propylene.
The resultant molecular orientation of the polymers of propylene causes the product to fibrillate (split) when the strip is pulled longitudinally by hand giving the erroneous impression that it is a fibre-based product.
The thickness of this strip is about 0,13 mm, it may be printed and is suitable for curling. It is generally rolled on spools or tubular reels and marketed under the name 'plastic bolducs'. It is used for the same purposes as bolducs classified in heading 5806. This decorative strip is usually knotted when used to tie packages.
This subheading includes other strip, of a kind used for packaging purposes, which is either uncoloured or coloured in the mass, and produced by the extrusion of polymers of propylene.
This decorative strip, unlike that mentioned above, is not silky in appearance, it is thicker and more rigid and is not suitable for curling. The surface may be raised or dimpled and may be printed.
This strip is placed under tension around the article to be packaged and the ends are then heat-sealed or joined by means of a metal or plastic clip.
This subheading does not include strip of polypropylene of an apparent width not exceeding 5 mm (subheading 5404 90 10).
- 3920 43 10~~and~~ and 3920 43 90 Containing by weight not less than 6 % of plasticisers**
See subheading note 2 to this chapter and the HS Explanatory Note to subheadings 3920 43 and 3920 49.
- 3920 49 10~~and~~ and 3920 49 90 Other**
See the HS Explanatory Note to subheadings 3920 43 and 3920 49.
- 3920 73 10 Film in rolls or in strips, for cinematography or photography**
This subheading covers sheets suitable for use in cinematography or photography as a support for light-sensitive materials.

- 3921** **Other plates, sheets, film, foil and strip, of plastics**
See the explanatory note to heading 3920.
- 3921 90 41** **High-pressure laminates with a decorative surface on one or both sides**
This subheading includes laminated sheets consisting of layers of fibrous sheet material (for example, paper) impregnated with thermosetting resins and bonded together by means of heat and a pressure of not less than 5 MPa; the outer layer or layers having decorative colours or designs (for example, a wood imitation).
Sheets with decorative layers on both sides are used vertically, for example, as partitions in displays or shop windows; sheets with one decorative layer are chiefly used as coatings for chipboard.
- 3923** **Articles for the conveyance or packing of goods, of plastics; stoppers, lids, caps and other closures, of plastics**
- 3923 90 00** **Other**
This subheading includes netting extruded in tubular form which is intended for packaging, is sold in indeterminate lengths and, after being cut to length, is commonly used to manufacture sacks and bags for packing certain fruit and vegetables, such as apples, oranges, potatoes and onions.
- 3924** **Tableware, kitchenware, other household articles and hygienic or toilet articles, of plastics**
- 3924 90 00** **Other**
This subheading includes sponges of regenerated cellulose cut into shapes other than rectangular (including square) as well as sponges cut into rectangles (including squares) with ground edges or otherwise worked.
This subheading does not cover:
(a) natural sponges (subheadings 0511 99 31 and 0511 99 39);
(b) sponges simply cut into rectangles (including squares) (heading 3921).
- 3925** **Builders' ware of plastics, not elsewhere specified or included**
See note 11 to this chapter.
- 3925 20 00** **Doors, windows and their frames and thresholds for doors**
See the HS Explanatory Note to subheading 3925 20.
- 3925 90 10** **Fittings and mountings intended for permanent installation in or on doors, windows, staircases, walls or other parts of buildings**
See note 11(ij) to this chapter.

SECTION VIII

RAW HIDES AND SKINS, LEATHER, FURSKINS AND ARTICLES THEREOF; SADDLERY AND HARNESS; TRAVEL GOODS, HANDBAGS AND SIMILAR CONTAINERS; ARTICLES OF ANIMAL GUT (OTHER THAN SILKWORM GUT)

CHAPTER 41

RAW HIDES AND SKINS (OTHER THAN FURSKINS) AND LEATHER

4101	Raw hides and skins of bovine (including buffalo) or equine animals (fresh, or salted, dried, limed, pickled or otherwise preserved, but not tanned, parchment-dressed or further prepared), whether or not dehaired or split
4101 20 10 <u>to</u> 4101 20 90 <u>4101 20 80</u>	Whole hides and skins, of a weight per skin not exceeding 8 kg when simply dried, 10 kg when dry-salted, or 16 kg when fresh, wet-salted or otherwise preserved Whole hides and skins, unsplit, of a weight per skin not exceeding 8 kg when simply dried, 10 kg when dry-salted, or 16 kg when fresh, wet-salted or otherwise preserved The hides and skins of these subheadings are regarded as whole whether or not the head and legs have been removed; however, they must not be split, i.e., the original thickness of the skin must not have been divided into two or more layers.
4101 20 10	Fresh This subheading covers hides and skins which have been simply removed from the animal. Chilled hides and skins are also included under this subheading.
4101 20 30	Wet-salted This subheading covers hides and skins which have been preserved from putrefaction by the simple addition of salt.
4101 20 50	Dried or dry-salted This subheading covers dried hides and skins (preserved by the simple means of drying, with or without the addition of antiseptics) and dry-salted hides and skins.
4101 20 90 <u>4101 20 80</u>	Other This subheading covers limed hides and skins (soaked in lime water or covered by a paste containing lime), pickled hides and skins (steeped in weak solutions of hydrochloric or sulphuric acid or other chemicals to which salt has been added) and hides and skins preserved by other means.
4101 50 10 <u>to</u> 4101 50 90	Whole hides and skins, of a weight exceeding 16 kg See the explanatory note to subheadings 4101 20 10 to 4101 20 90 <u>4101 20 80</u> .
4101 50 10	Fresh See the explanatory note to subheading 4101 20 10.
4101 50 30	Wet-salted See the explanatory note to subheading 4101 20 30.
4101 50 50	Dried or dry-salted See the explanatory note to subheading 4101 20 50.
4101 50 90	Other See the explanatory note to subheading 4101 20 90 <u>4101 20 80</u> .

- 4101 90 00 Other, including butts, bends and bellies**
Butts comprise the hide covering the back and hindquarters; this is the thickest, strongest, and therefore most valuable, part of the hide.
Bends are obtained by dividing the butts in two along the line of the backbone.
- 4102 Raw skins of sheep or lambs (fresh, or salted, dried, limed, pickled or otherwise preserved, but not tanned, parchment-dressed or further prepared), whether or not with wool on or split, other than those excluded by note 1(c) to this chapter**
- 4102 10 10 Of lambs**
This subheading covers skins having a maximum surface area of 0,75 m².
- 4102 10 90 Other**
This subheading covers skins having a surface area of more than 0,75 m².
- 4102 21 00 Pickled**
For pickled skins, see the explanatory note to subheading ~~4101 20 90~~4101 20 80.
- 4103 Other raw hides and skins (fresh, or salted, dried, limed, pickled or otherwise preserved, but not tanned, parchment-dressed or further prepared), whether or not dehaired or split, other than those excluded by note 1(b) or 1(c) to this chapter**
- 4103 20 00 Of reptiles**
This subheading includes the skins of pythons, boas, alligators, caymans, iguanas, gavials and lizards.
- ~~**4103 90 10 Of goats or kids**~~
Hides and skins of goats and kids are long and narrow with a long neck, whereas hides and skins of sheep and lambs are wider with a shorter neck.
See also note 1(c) to this chapter.
- 4104 Tanned or crust hides and skins of bovine (including buffalo) or equine animals, without hair on, whether or not split, but not further prepared**
See notes 2(A) and 2(B) to this chapter.
- ~~**4104 11 10 to 4104 19 90**~~ **In the wet state (including wet-blue)**
The hides and skins simply tanned are especially recognisable by their flesh side where, particularly on the edges, a certain number of original subcutaneous fibres are visible. For this reason, the flesh side has a fibrous and rough surface. Hides and skins partially tanned (pre-tanned) are classified with hides and skins not further prepared than tanned.
The processes intended to complete the tanning proper during which the products used for the tanning and any remaining water are removed from the skins (for example, washing, wringing, pressing, drying and stretching) do not change the classification of these leathers. This applies also to simple splitting of hides and skins not further prepared than tanned.
- ~~**4104 11 10 to 4104 11 90**~~ **Full grains, unsplit; grain splits**
These subheadings cover hides and skins bearing the original grain surface as exposed by removal of the epidermis, with none of the surface removed, for example, by buffing or snuffing.
These subheadings cover only hides and skins with an outer surface (hair side) of the skin.

- ~~4104 41 11 to 4104 49 90~~ **In the dry state (crust)**
See note 2(B) to this chapter and the HS General Explanatory Note to Chapter 41, (II), third paragraph.
- ~~4104 41 11 to 4104 41 90~~ **Full grains, unsplit; grain splits**
See the explanatory note to subheadings 4104 11 10 to 4104 11 90.
- ~~4104 41 11~~ **East India kip, whole, whether or not the heads and legs have been removed, each of a net weight of not more than 4,5 kg, not further prepared than vegetable tanned, whether or not having undergone certain treatments, but obviously unsuitable for immediate use for the manufacture of leather articles**
This subheading covers kip (calf) skins simply tanned using vegetable substances which may have undergone preservative treatment to facilitate their transport over long distances, for example, with vegetable oil.
These skins are characterised by a firm and compact structure and a light biscuit colour due to the vegetable tanning. The hair side of the skin is smooth and evenly glazed and the flesh side is generally well cleaned by scraping. Before they can be used in the manufacture of leather articles, skins of this type must be completely reworked (detanned, in effect) and can thus be regarded as pre-tanned.
These skins (known as Madras skins or East India (EI) skins) are imported mainly from India or Pakistan. They are usually packed, in sixes, in pressed bales wrapped in straw matting and jute sacking.
- ~~4104 49 11~~ **East India kip, whole, whether or not the heads and legs have been removed, each of a net weight of not more than 4,5 kg, not further prepared than vegetable tanned, whether or not having undergone certain treatments, but obviously unsuitable for immediate use for the manufacture of leather articles**
See the explanatory note to subheading 4104 41 11.
- ~~4105~~ **Tanned or crust skins of sheep or lambs, without wool on, whether or not split, but not further prepared**
See notes 2(A) and 2(B) to this chapter.
- ~~4105 10 10~~ **In the wet state (including wet-blue)**
See the explanatory note to subheadings 4104 11 10 to 4104 19 90.
- ~~4105 10 10~~ **Not split**
This subheading covers skins that have not been split (i.e., the original thickness has not been separated into several layers); whether or not they have been reduced to an even thickness by scraping and removal of any roughness or adhering particles on the flesh side.
- ~~4105 30 10 and 4105 30 99~~ **In the dry state (crust)**
See note 2(B) to this chapter and the HS General Explanatory Note to Chapter 41, (II), third paragraph.
- ~~4105 30 10~~ **Vegetable pre-tanned Indian hair sheep, whether or not having undergone certain treatments, but obviously unsuitable for immediate use for the manufacture of leather articles**
This subheading covers vegetable pre-tanned skins which require further tanning before finishing.
Skins simply tanned using vegetable substances may have undergone preservative treatment to facilitate their transport over long distances, for example, with vegetable oil.
These skins are characterised by a firm and compact structure and a light biscuit colour due to the vegetable tanning. These skins (known as Madras skins or East India (EI) skins) are imported mainly from India or Pakistan. They are usually packed, in sixes, in pressed bales wrapped in straw matting and jute sacking.
- ~~4105 30 91~~ **Other**
The explanatory note to subheading 4105 10 10 applies, *mutatis mutandis*.
This subheading includes skins (of sheep and lambs) which have been tanned using a mixture of salt, alum, egg-yolk and flour (alum-tanned leather). These skins are used mainly for glove-making or in the manufacture of high-quality footwear.
- ~~4105 30 99~~ **Split**
See the explanatory note to subheading 4105 30 91, second paragraph.

- 4106** **Tanned or crust hides and skins of other animals, without wool or hair on, whether or not split, but not further prepared**
See notes 2(A) and 2(B) to this chapter.
- ~~4106 21 10~~**4106 21 00****and**
~~4106 21 90~~ **In the wet state (including wet-blue)**
See the explanatory note to subheadings 4104 11 10 to 4104 19 90.
- 4106 21 10** **Not split**
The explanatory note to subheading 4105 10 10 applies, *mutatis mutandis*.
- 4106 22 10**~~and~~ **and**
4106 22 90 **In the dry state (crust)**
See note 2(B) to this chapter and the HS General Explanatory Note to Chapter 41, (II), third paragraph.
- 4106 22 10** **Vegetable pre-tanned Indian goat or kid, whether or not having undergone certain treatments, but obviously unsuitable for immediate use for the manufacture of leather articles**
The explanatory note to subheading 4105 30 10 applies, *mutatis mutandis*.
- 4106 31 00** **In the wet state (including wet-blue)**
See the explanatory note to subheadings 4104 11 10 to 4104 19 90.
- 4106 32 00** **In the dry state (crust)**
See note 2(B) to this chapter and the HS General Explanatory Note to Chapter 41, (II), third paragraph.
- 4106 40 10** **Vegetable pre-tanned**
This subheading covers vegetable pre-tanned hides and skins which require further tanning before finishing. These hides and skins are characterised by a firm and compact structure and a light biscuit colour due to the vegetable tanning.
- 4106 91 00** **In the wet state (including wet-blue)**
See the explanatory note to subheadings 4104 11 10 to 4104 19 90.
- 4106 92 00** **In the dry state (crust)**
See note 2(B) to this chapter and the HS General Explanatory Note to Chapter 41, (II), third paragraph.
- 4107** **Leather further prepared after tanning or crusting, including parchment-dressed leather, of bovine (including buffalo) or equine animals, without hair on, whether or not split, other than leather of heading 4114**
The leather covered by this heading may be further dressed (curried, dyed, grained or stamped, treated to give a suede finish, printed, glazed, satin finished, etc.), or parchment-dressed (see the HS General Explanatory Note to this chapter, (III)).
- ~~4107 11 11~~**to** **4107 11 90** **Full grains, unsplit**
These subheadings cover leather that has not been split (i.e., the original thickness has not been separated into several layers), whether or not it has been reduced to an even thickness by scraping and removal of any roughness or adhering particles on the flesh side.
- 4107 11 11** **Boxcalf**
Box-calf is calf-leather tanned by chrome or sometimes by a combination process, then coloured and polished and used for shoe uppers or certain leather goods (for example, handbags, briefcases); this skin is very soft.

- 4107 12 11** **Boxcalf**
See the explanatory note to subheading 4107 11 11.
- 4107 91 10** ~~and~~ **and** **Full grains, unsplit**
4107 91 90 See the explanatory note to subheadings 4107 11 11 to 4107 11 90.
- 4107 91 10** **Sole-leather**
Because of its use which calls for stoutness and durability, the leather known as sole-leather is not fed. The currying method used for this leather is known as water currying, as opposed to fat currying which is used for stuffed leathers. The main treatments given to this leather amount to cleaning of the leather side, exposure to air, repeated hammering and pressure rolling.
See also the HS Explanatory Note to heading 4107, third paragraph.
- 4112 00 00** **Leather further prepared after tanning or crusting, including parchment-dressed leather, of sheep or lamb, without wool on, whether or not split, other than leather of heading 4114**
The explanatory note to heading 4107 applies, *mutatis mutandis*.
- 4113** **Leather further prepared after tanning or crusting, including parchment-dressed leather, of other animals, without wool or hair on, whether or not split, other than leather of heading 4114**
The explanatory note to heading 4107 applies, *mutatis mutandis*.
- 4115** **Composition leather with a basis of leather or leather fibre, in slabs, sheets or strip, whether or not in rolls; parings and other waste of leather or of composition leather, not suitable for the manufacture of leather articles; leather dust, powder and flour**
Composition leather is made from a basis of leather or leather fibre. Feltable materials such as cellulosic, synthetic or cotton fibres are sometimes added to give the composition leather special properties. The proportion of such fibres must, however, be well under 50 % in order for the goods to be classified under heading 4115 ('slabs, sheets or strip, whether or not rolled'). The leather fibres consist of chromium crease splinters, vegetable whitenings, parings or other waste. Natural latex is the most commonly used binding agent.
The main field of application for composition leather is in the shoe industry, which uses it to make stiffenings, counters, insoles, midsoles and outsoles for slippers. Other uses are found in the leather goods industry (for example, for the backing of suitcases, school satchels, dividers for briefcases and wallets) and the technical sector (cuffs, sealing materials, etc.).

CHAPTER 42

**ARTICLES OF LEATHER; SADDLERY AND HARNESS; TRAVEL GOODS, HANDBAGS AND SIMILAR CONTAINERS;
ARTICLES OF ANIMAL GUT (OTHER THAN SILKWORM GUT)**

- 4202** **Trunks, suitcases, vanity cases, executive-cases, briefcases, school satchels, spectacle cases, binocular cases, camera cases, musical instrument cases, gun cases, holsters and similar containers; travelling-bags, insulated food or beverages bags, toilet bags, rucksacks, handbags, shopping-bags, wallets, purses, map-cases, cigarette-cases, tobacco-pouches, tool bags, sports bags, bottle-cases, jewellery boxes, powder boxes, cutlery cases and similar containers, of leather or of composition leather, of sheeting of plastics, of textile materials, of vulcanised fibre or of paperboard, or wholly or mainly covered with such materials or with paper**
For the definition of the term 'outer surface', see additional note 1 to this chapter and the HS Explanatory Note to subheadings 4202 11, 4202 21, 4202 31 and 4202 91.
This heading includes covers for rackets which envelop the entire racket, whether or not fitted with a handle or a shoulder strap.
However, this heading does not include headcovers for tennis rackets, badminton rackets, golf clubs, etc., when made from textile fabric (usually coated with plastics), whether or not they are fitted with a pocket to contain balls (heading 6307).
- 4202 11 10 and 4202 11 90** ~~**With outer surface of leather, of composition leather or of patent leather**~~ **With outer surface of leather or of composition leather**
For the definition of the terms 'patent leather' and 'composition leather', see the HS Explanatory Notes to heading For the definition of the term 'composition leather', see the HS Explanatory Note to heading 4114, (H), first paragraph, (I) and to heading 4115, (I), respectively., (I)
- 4202 12 11 and 4202 12 19** **In the form of plastic sheeting**
If a container has an outer material that is a combination of materials where the outer layer being visible to the naked eye is plastic sheeting (for example, woven fabric of textile fibres in combination with plastic sheeting), it is irrelevant for classification purposes whether the sheeting was manufactured separately before creating the combined material or whether the plastic layer is the result of applying a coating or covering of plastics to the material (for example, woven fabric of textile fibres), provided that the resultant outer layer being visible to the naked eye has the same visual appearance as an applied layer of manufactured plastic sheeting.
- 4202 22 10** **Of plastic sheeting**
See the explanatory note to subheadings 4202 12 11 and 4202 12 19.
- 4202 31 00 to 4202 39 00** **Articles of a kind normally carried in the pocket or in the handbag**
See the HS Explanatory Note to subheadings 4202 31, 4202 32 and 4202 39.
- 4202 32 10** **Of plastic sheeting**
See the explanatory note to subheadings 4202 12 11 and 4202 12 19.
- 4202 92 11 to 4202 92 19** **Of plastic sheeting**
See the explanatory note to subheadings 4202 12 11 and 4202 12 19.
- 4203** **Articles of apparel and clothing accessories, of leather or of composition leather**
- 4203 10 00** **Articles of apparel**
This subheading covers articles of apparel, including working clothes, made of leather or of composition leather, such as coats, overcoats, jackets, trousers and aprons. It also covers skins and assemblies of skins constituting incomplete or unfinished articles but recognisable nevertheless as articles of apparel.

- 4203 21 00to 4203 29 90** **Gloves, mittens and mitts**
These subheadings include gloves, mittens and mitts not further worked than cut to shape. Pieces of leather cut to a given shape and intended for the manufacture of gloves but in which the thumb and fingers have not yet been cut to shape are classified in subheading 4205 00 90.
- 4203 21 00** **Specially designed for use in sports**
See the HS Explanatory Note to subheading 4203 21.
This subheading also includes fencing-gloves, cricket gloves, baseball gloves and gloves with cut-away backs for racing cyclists.
- 4203 29 10** **Protective for all trades**
Protective gloves, mittens and mitts falling in this subheading are generally intended for the protection of the hands whilst working. For this reason, unlike fashion gloves, they are in many cases made from thick, tough leather which has normally not undergone any treatment subsequent to tanning. Protective gloves often have a rough surface; they may have cuffs which protect the wrist and forearm.
Protective gloves of which only the palm and fingerfronts are of leather are classified in this subheading.
- 4203 29 90** **Other**
This subheading also covers gloves, mittens and mitts which although used in sport do not correspond to the functional design features characteristic of gloves specially designed for use in sport given in the HS Explanatory Note to subheading 4203 21.
Gloves of the type where the palm and fingerfronts and the parts between the fingers are of leather and the back is of another material also fall in this subheading.
- 4203 30 00** **Belts and bandoliers**
This subheading includes money belts and similar belts of leather with one or more pockets with a fastening.
- 4203 40 00** **Other clothing accessories**
This subheading includes braces, wristbands, neck ties and braces for tyrolean breeches.
This subheading does not include shoelaces which are not regarded as clothing accessories and are classified in subheading 4205 00 90. Wristbands constituting 'imitation' or costume jewellery (heading 7117) and watch straps (heading 9113) are also excluded from this subheading.
- 4205 00** **Other articles of leather, or of composition leather**
- 4205 00 11** **Conveyor or transmission belts or belting**
This subheading covers the products described in the HS Explanatory Note to heading 4205, second paragraph, (1), except conveyor buckets.
- 4205 00 19** **Other**
This subheading covers conveyor buckets and the products described in the HS Explanatory Note to heading 4205, second paragraph, (2).
- 4205 00 90** **Other**
See the HS Explanatory Note to heading 4205, third paragraph.

CHAPTER 43

FURSKINS AND ARTIFICIAL FUR; MANUFACTURES THEREOF

- 4301** **Raw furskins (including heads, tails, paws and other pieces or cuttings, suitable for furriers' use), other than raw hides and skins of heading 4101, 4102 or 4103**
For the definition of the term 'raw furskins', see the HS Explanatory Note to heading 4301, penultimate paragraph.
- ~~4301 80 50~~ **Of wild felines**
This subheading includes in particular furskins of cheetah, jaguar, lynx, panther (or leopard) and puma.
- ~~4301 80 70~~ **4301 80 00** **Other furskins, whole, with or without head, tail or paws**
This subheading includes skins of seal (for example, of whitecoat pups of harp seal or of pups of hooded seal (blue-backs)), of sea otters or of nutria (coypu).
The skins of whitecoat harp seal pups are completely white.
The skins of hooded seal pups (blue-backs) are white with a broad blue-grey dorsal band extending from head to tail. Fur seal pelts are often presented incorrectly as 'sea otter'. Fur seals have a fine, silky, dense pelt which is shiny black and covers golden groundhair shading into reddish brown or orange on the neck and belly.
The fur of the sea otter is brown to black with a sprinkling of white hairs, while the groundhair is very fine but also very strong.
As the mammae are on the back, almost the only part of the nutria pelt used is the belly fur and, for this reason, when preparing the pelts and skinning the animal, the incision is made along the back. The pelt, which is blackish brown on the belly and lighter on the back and flanks, has abundant pointed coarse hairs and fine, thick, woolly groundhair.
This subheading also includes furskins of cheetah, jaguar, lynx, panther (or leopard) and puma.
- 4301 90 00** **Heads, tails, paws and other pieces or cuttings, suitable for furriers' use**
This subheading covers not only discarded parts (heads, tails and paws) but also clippings and trimming. These pieces are used to make up mats which are then used for lower-quality furs.
- 4302** **Tanned or dressed furskins (including heads, tails, paws and other pieces or cuttings), unassembled, or assembled (without the addition of other materials) other than those of heading 4303**
- ~~4302 11 00 to~~ **4302 19 95** **4302 19 99** **Whole skins, with or without head, tail or paws, not assembled**
These subheadings include hides and skins (for example, of sheep) from which not more than the head, paws and tail have been removed, whether or not straightened at the edges, not cut or otherwise worked to shape; they may be dyed and are suitable for use as rugs.
- 4302 19 41** **Of whitecoat pups of harp seal or of pups of hooded seal (blue-backs)**
See the explanatory note to subheading ~~4301 80 70~~ **4301 80 00**.
- 4302 20 00** **Heads, tails, paws and other pieces or cuttings, not assembled**
The 'pieces or cuttings' of this subheading are clippings resulting from the making-up of furs or the assembling of furskins or parts thereof into squares, rectangles, trapezia or crosses.

4302 30 10**‘Dropped’ furskins**

See the HS Explanatory Note to heading 4302, first paragraph, (2), second subparagraph.

‘Dropped’ furskins, sometimes referred to as ‘stranded’ furskins may also be obtained by:

- cutting skins diagonally into narrow strips and reassembling them in their original order,
- step-cutting skins and reassembling,

to produce a longer but narrower skin.

**~~4302 30 21~~
~~4302 30 95~~
4302 30 25 to to
4302 30 99****Other**

Subject to the condition that no other materials have been added, these subheadings include:

1. pieces or cuttings of subheading 4302 20 00 or whole skins, assembled into sacs, plates, crosses or similar semi-manufactures;
2. bodies intended for making up into fur jackets or coats, and generally consisting of three distinct assemblies of furskins, one in the form of an isosceles trapezium with a long curved base-line from which the back will be cut, and the others in rectangular shape from which the front and sleeves will be cut.

4302 30 51**Of whitecoat pups of harp seal or of pups of hooded seal (blue-backs)**

See the explanatory note to subheading ~~4301 80 70~~4301 80 00.

4303**Articles of apparel, clothing accessories and other articles of fur skin****4303 10 10 and 4303 10 90****Articles of apparel and clothing accessories**

See note 4 to this chapter.

4303 10 10**Of furskins of whitecoat pups of harp seal or of pups of hooded seal (blue-backs)**

This subheading covers articles of apparel and clothing accessories made of skins of subheading 4302 19 41 or 4302 30 51.

4303 90 00**Other**

See the HS Explanatory Note to heading 4303, third and fourth paragraphs.

SECTION IX

WOOD AND ARTICLES OF WOOD; WOOD CHARCOAL; CORK AND ARTICLES OF CORK; MANUFACTURES OF STRAW, OF ESPARTO OR OF OTHER PLAITING MATERIALS; BASKETWARE AND WICKERWORK

CHAPTER 44

WOOD AND ARTICLES OF WOOD; WOOD CHARCOAL

- 4401 Fuel wood, in logs, in billets, in twigs, in faggots or in similar forms; wood in chips or particles; sawdust and wood waste and scrap, whether or not agglomerated in logs, briquettes, pellets or similar forms**
- 4401 10 00 Fuel wood, in logs, in billets, in twigs, in faggots or in similar forms**
No limiting size has been assigned to logs and billets which are to be regarded as fuel wood. It is the condition of the wood and its mode of presentation which distinguishes it from wood falling in heading 4403 (see the HS Explanatory Note to heading 4401, exclusion (b)).
This subheading does not include sawdust, wood waste or scrap, even when these are clearly for use as fuel (subheading ~~4401 30 40~~4401 31 00, 4401 39 20, 4401 39 30 or ~~4401 30 80~~4401 39 80).
- 4401 21 00 and 4401 22 00 Wood in chips or particles**
See notes 1(a) and 1(c) to this chapter and the HS Explanatory Note to heading 4401, first paragraph, (B).
- ~~4401 30 20~~**4401 31 00 to to**
~~4401 30 80~~**4401 39 80** **Sawdust and wood waste and scrap, whether or not agglomerated in logs, briquettes, pellets or similar forms**
See notes 1(a) and 1(c) to this chapter.
~~These subheadings do not include wood flour as defined in additional note 2 to this chapter (heading 4405 00 00)~~
~~These subheadings do not include wood flour as defined in additional note 1 to this chapter (heading 4405 00 00)~~
- 4403 Wood in the rough, whether or not stripped of bark or sapwood, or roughly squared**
- 4403 10 00 Treated with paint, stains, creosote or other preservatives**
See the HS Explanatory Note to subheading 4403 10.
The injection and impregnation of wood are treatments, to preserve the wood better (for durability) or to endow it with certain special properties (for example, to make it fire-resistant or to protect it from the effects of shrinkage). The injection or impregnation treatment serves to ensure the long-term preservation for example of the poles of coniferous wood. This treatment involves either soaking for long periods in open vats of hot liquid, the poles being left in the liquid until it cools down, or treatment in an autoclave through the action of a vacuum or pressure.
Among the products used are organic products such as creosote, dinitrophenols and dinitrocresols.
Painted or varnished poles of wood also fall in this subheading.
- 4403 20 11 Sawlogs**
Sawlogs are characterised by physical properties such as:
— cylindrical and straight-grained without major bending,
— a diameter of not less than 15 cm.

They will in general be sawn (or chipped) lengthwise for the manufacture of sawnwood or railway sleepers (cross-ties) or be used for the production of sheets for veneering (mainly by peeling or slicing).

4403 20 31	Sawlogs See the explanatory note to subheading 4403 20 11.
4403 20 91	Sawlogs See the explanatory note to subheading 4403 20 11.
4403 41 00to 4403 49 95	Other, of tropical wood specified in subheading note 1 to this chapter Other, of tropical wood specified in subheading note 2 to this chapter See also the HS General Subheading Explanatory Note to this chapter for the names of certain tropical woods. See also the Annex to the HS Explanatory Notes to this chapter.
4403 49 35	Okoumé and sipo Okoumé is obtained almost exclusively from the forests of Gabon. This wood is soft and salmon-pink in colour with a fibrous texture and an irregular grain, slightly resembling mahogany but much lighter in colour. The tree yields well-formed cylindrical logs admirably suited for slicing and peeling and is chiefly used in the manufacture of veneer sheet.
4403 91 10	Sawlogs See the explanatory note to subheading 4403 20 11.
4403 92 10	Sawlogs See the explanatory note to subheading 4403 20 11.
4403 99 10	Of poplar This subheading covers all species of the genus <i>Populus</i> . Poplar wood is pale in colour, light and very soft. It is used in joinery (interiors of furniture, packing cases) and for making plywood. After the conifers, it is the principal source of cellulose for paper pulp.
4403 99 51	Sawlogs See the explanatory note to subheading 4403 20 11.
4404	Hoopwood; split poles; piles, pickets and stakes of wood, pointed but not sawn lengthwise; wooden sticks, roughly trimmed but not turned, bent or otherwise worked, suitable for the manufacture of walking sticks, umbrellas, tool handles or the like; chipwood and the like Chipwood and the like mainly differs from the veneer sheet of heading 4408 by its smaller size and the type of wood used (normally, the common softer woods).
4404 20 00	Non-coniferous This subheading includes wood shavings which resemble coiled chipwood (usually of beech or hazel) used in the manufacture of vinegar or the clarification of other liquids.
4405 00 00	Wood wool; wood flour For the definition of the term 'wood flour', see additional note 2 to this chapter. For the definition of the term 'wood flour', see additional note 1 to this chapter.
4406	Railway or tramway sleepers (cross-ties) of wood
4406 10 00	Not impregnated See the HS Explanatory Note to subheadings 4406 10 and 4406 90.
4406 90 00	Other See the HS Explanatory Note to subheadings 4406 10 and 4406 90.

- 4407** **Wood sawn or chipped lengthwise, sliced or peeled, whether or not planed, sanded or end-jointed, of a thickness exceeding 6 mm**
For the definition of the terms 'sliced' and 'peeled', see the HS Explanatory Note to heading 4408, second and third paragraphs.
- 4407 10 31 to 4407 10 38** **Planed**
These subheadings do not cover:
(a) 'hit or miss' dressed timber, i.e., timber which has been planed to remove excrescences and some of the rough saw marks (subheadings 4407 10 91 to 4407 10 98);
(b) wood sawn lengthwise, which, having regard to the peculiarities of the wood in question and of the state of development of techniques for processing that type of wood, bears no marks of having been sawn, provided that this absence of saw marks is the result of a process purely incidental to the sawing which is necessary for technical reasons and is not intended to facilitate the subsequent use of the wood by removing those traces (subheadings 4407 10 91 to 4407 10 98).
- 4407 10 91 to 4407 10 98** **Other**
These subheadings do not include complete sets of boards of sawn, sliced or peeled wood of a thickness exceeding 6 mm intended for use in making packing cases or crates. Such sets of boards fall in heading 4415, whether or not certain accessories such as corner or foot reinforcements are included. See also the explanatory notes to heading 4415.
- 4407 21 10 to 4407 29 95** ~~**Of tropical wood specified in subheading note 1 to this chapter**~~ **Of tropical wood specified in subheading note 2 to this chapter**
See the HS General Subheading Explanatory Note to this chapter for the names of certain tropical woods. See also the Annex to the HS Explanatory Notes to this chapter.
- 4407 99 96** **Of tropical wood**
~~For the purposes of this subheading, the expression 'tropical wood' means only those not specified in subheading note 1 to this chapter.~~ For the purposes of this subheading, the expression 'tropical wood' means only those not specified in subheading note 2 to this chapter.
This subheading includes the following types of tropical wood: aielé, alone, andoung, bilinga, bomanga, bubinga, ebène, ebiara, fero, kapokier, limbali, longhi, movingui, mutenye, naga, niové, tali, tchitola, wengé and zingana.
- 4408** **Sheets for veneering (including those obtained by slicing laminated wood), for plywood or for similar laminated wood and other wood, sawn lengthwise, sliced or peeled, whether or not planed, sanded, spliced or end-jointed, of a thickness not exceeding 6 mm**
- 4408 31 11 to 4408 39 95** ~~**Of tropical wood specified in subheading note 1 to this chapter**~~ **Of tropical wood specified in subheading note 2 to this chapter**
See the HS Explanatory Notes to this chapter for the names of certain tropical woods. See also the Annex to the HS Explanatory Notes to this chapter.
- 4409** **Wood (including strips and friezes for parquet flooring, not assembled) continuously shaped (tongued, grooved, rebated, chamfered, V-jointed, beaded, moulded, rounded or the like) along any of its edges, ends or faces, whether or not planed, sanded or end-jointed**
- 4409 10 11** **Mouldings for frames for paintings, photographs, mirrors or similar objects**
See the HS Explanatory Note to heading 4409, fifth paragraph, (4).
This subheading excludes moulded wood built up by superimposing a moulding on another piece of moulded or unmoulded wood (heading 4418 or 4421).

- 4409 10 18** **Other**
This subheading includes:
1. drawn woods and rounded woods for making pegs, described in the HS Explanatory Note to heading 4409, fifth paragraph, (5);
2. strips and friezes for parquet flooring, continuously shaped.
Strips and friezes which have not been worked beyond planing, sanding or end-jointing (for example, finger-jointing), fall in heading 4407 or 4408. Plywood or veneered strips and friezes fall in heading 4412.
- 4409 29 10** **Mouldings for frames for paintings, photographs, mirrors or similar objects**
See the explanatory note to subheading 4409 10 11.
- 4409 29 91 and 4409 29 99** **Other**
See the explanatory note to subheading 4409 10 18.
- 4410** **Particle board, oriented strand board (OSB) and similar board (for example, waferboard) of wood or other ligneous materials, whether or not agglomerated with resins or other organic binding substances**
- 4410 11 50** **Surface-covered with decorative laminates of plastics**
This subheading includes particle board of wood covered with high-pressure laminates of subheading 3921 90 41.
- 4410 11 90** **Other**
This subheading includes particle board covered with plastics, paint, paper, textile materials or metal, other than those referred to in subheadings 4410 11 30 and 4410 11 50.
- 4410 90 00** **Other**
Examples of ligneous materials other than wood covered by this subheading are bagasse, bamboo, cereal straw and flax or hemp shives.
- 4411** **Fibreboard of wood or other ligneous materials, whether or not bonded with resins or other organic substances**
- 4411 12 10 to 4411 14 90** **Medium density fibreboard (MDF)**
See the HS Explanatory Note to heading 4411, second paragraph, (A), first subparagraph.
- 4411 12 10** **Not mechanically worked or surface covered**
For the purposes of classification in this subheading, sanding is not to be considered as mechanical working.
- 4411 13 10** **Not mechanically worked or surface covered**
See the explanatory note to subheading 4411 12 10
- 4411 14 10** **Not mechanically worked or surface covered**
See the explanatory note to subheading 4411 12 10
- 4411 92 10 and 4411 92 90** **Of a density exceeding 0,8 g/cm³**
See the HS Explanatory Note to heading 4411, second paragraph, (B), (1).
- 4411 92 10** **Not mechanically worked or surface covered**
See the explanatory note to subheading 4411 12 10.

4411 93 10 and 4411 93 90 **Of a density exceeding 0,5 g/cm³ but not exceeding 0,8 g/cm³**
See the HS Explanatory Note to heading 4411, second paragraph, (B), (2).

4411 93 10 **Not mechanically worked or surface covered**
See the explanatory note to subheading 4411 12 10.

4411 94 10 and 4411 94 90 **Of a density not exceeding 0,5 g/cm³**
See the HS Explanatory Note to heading 4411, second paragraph, (B), (2) and (3).

4411 94 10 **Not mechanically worked or surface covered**
See the explanatory note to subheading 4411 12 10.

4412 Plywood, veneered panels and similar laminated wood

Plywood of coniferous species often has defects (for example, hollows) on the outer ply which, during the manufacturing process, are repaired by materials such as wood-inlays, plastic filler-compounds, etc. Such materials are not considered as additional substances and do not give the plywood the character of articles of other headings.

Plywood of this heading may be unsanded or further prepared by sanding. The term 'unsanded' includes 'touch-sanded'; the purpose of touch-sanding the outer ply is merely to deal with irregularities due to patching, plugging or filling.

See also the HS Explanatory Note to subheadings 4412 10, 4412 31, 4412 32 and 4412 39.

Plywood, veneered panels and similar laminated wood, used as flooring panels (see in particular the fourth paragraph of the HS Explanatory Note to this heading), only cover those panels which have a top layer of wood with a thickness of less than 2,5 mm (thin veneer).

Example of a typical three-layer product:

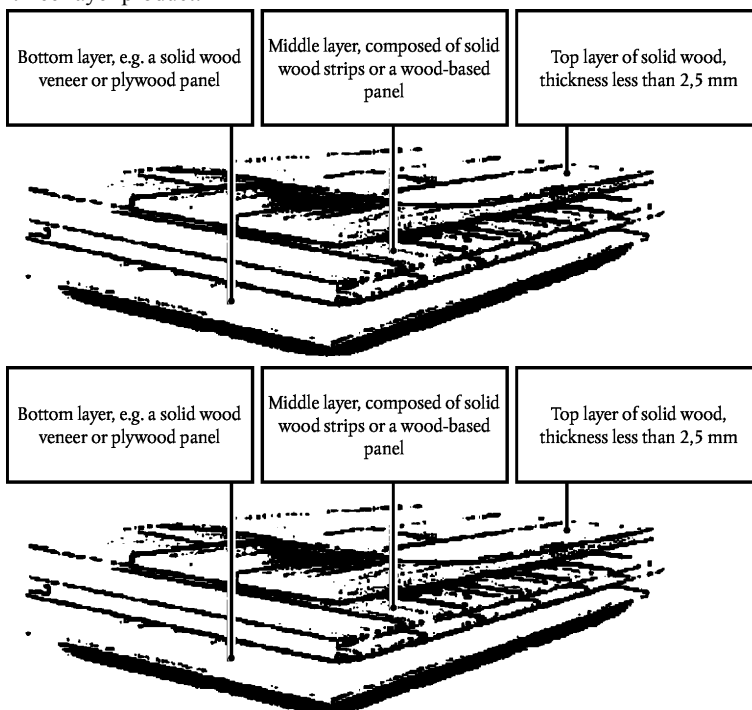

If they have a top layer of wood with a thickness of 2,5 mm or more, they are excluded from this heading (subheading 4418 71 00 or 4418 72 00).

4412 94 10 and 4412 94 90 **Blockboard, laminboard and battenboard**

For the interpretation of the terms 'blockboard, laminboard and battenboard', see the HS Explanatory Note to heading 4412, first paragraph, (3), first subparagraph.

- 4413 00 00** **Densified wood, in blocks, plates, strips or profile shapes**
The species of wood most commonly densified are beech, hornbeam, robinia and poplar.
- 4415** **Packing cases, boxes, crates, drums and similar packings, of wood; cable-drums of wood; pallets, box pallets and other load boards, of wood; pallet collars of wood**
- 4415 10 10** **Cases, boxes, crates, drums and similar packings**
This subheading includes complete sets of boards — unassembled — of wood, sawn, sliced or peeled, intended for making up into packing cases, crates, etc., presented in a single consignment, whether or not the bottoms, sides, lids and fastenings are arranged in a series.
Incomplete sets are classified as follows:
1. parts of packings, such as bottoms, lids, etc., nailed together or assembled in any other manner, made of wooden boards, sawn, sliced or peeled, fall in subheading 4421 90 98;
 2. unassembled boards are classified according to their characteristics (heading 4407 or 4408).
- See also the HS Explanatory Note to heading 4415, (I).
- 4415 10 90** **Cable-drums**
See the HS Explanatory Note to heading 4415, (II).
- 4415 20 20 and 4415 20 90** **Pallets, box pallets and other load boards; pallet collars**
See the HS Explanatory Note to heading 4415, (III) and (IV).
- 4416 00 00** **Casks, barrels, vats, tubs and other coopers' products and parts thereof, of wood, including staves**
Casks and barrels have a body which bulges in the middle and have two closed ends. Vats and tubs usually have only one closed end and may have a removable lid.
The species most commonly used are chestnut and oak.
Parts include staves and heads of barrels, and other coopers' products.
Staves are planed planks, more or less bent, pared or chamfered at one end at least, with a groove known as a 'croze', for assembly.
The heads are cut to a circular shape of the required circumference and bevelled on both sides to enable them to be inserted into the croze.
- 4417 00 00** **Tools, tool bodies, tool handles, broom or brush bodies and handles, of wood; boot- or shoe-lasts and trees, of wood**
See note 5 to this chapter.
This heading includes paint-brush and shaving-brush handles.
- 4418** **Builders' joinery and carpentry of wood, including cellular wood panels, assembled flooring panels, shingles and shakes**
- 4418 20 10 to 4418 20 80** **Doors and their frames and thresholds**
These subheadings include solid laminated wood panels with thick cores, provided that they have been further worked to an extent which identifies them exclusively for use as doors (for example, by the cutting of recesses for handles, locks or hinges).
These subheadings do not include unworked panels, sometimes known as 'solid-core doorblanks', even if their edges are veneered (heading 4412).

- 4418 40 00** **Shuttering for concrete constructional work**
Shuttering of this subheading is an assembly used for all types of concrete constructional work (for example, for foundations, walls, floors, columns, pillars, props, tunnel sections, etc.). Generally, shuttering is manufactured from resinous wood (planks, beams, etc.). However, plywood panels used as shuttering (to obtain smooth surfaces) are excluded from this subheading even if coated on one or both sides and their use as concrete shuttering is unmistakable (heading 4412).
- 4418 50 00** **Shingles and shakes**
See the HS Explanatory Note to heading 4418, seventh and eighth paragraphs.
- 4418 71 00to 4418 79 00** **Assembled flooring panels**
See the HS Explanatory Note to heading 4418, sixth paragraph.
- 4418 71 00** **For mosaic floors**
This subheading includes flooring panels consisting of a layer known as the wear-layer made of blocks, strips, friezes, etc., assembled on an appropriate backing of wood, particle board, paper, plastics, cork, etc.
See the explanatory note to heading 4412.
See also the HS Explanatory Note to subheading 4418 71.
- 4418 72 00** **Other, multilayer**
See the explanatory notes to subheading 4418 71 00.
- 4418 90 10** **Glue-laminated timber**
See the HS Explanatory Note to heading 4418, third paragraph.
- 4418 90 80** **Other**
This subheading includes the cellular wood panels described in the HS Explanatory Note to heading 4418, fourth paragraph.
- 4420** **Wood marquetry and inlaid wood; caskets and cases for jewellery or cutlery, and similar articles, of wood; statuettes and other ornaments, of wood; wooden articles of furniture not falling in Chapter 94**
- 4420 90 10** **Wood marquetry and inlaid wood**
This subheading covers panels of wood marquetry and inlaid wood.
Marquetry usually consists of thin pieces of wood or other materials (base metal, shell, ivory, etc.) glued to a wooden backboard for decorative purposes.
- 4421** **Other articles of wood**
- 4421 90 98** **Other**
This subheading includes:
1. assemblies of planks consisting of a part of wooden packing cases (lids, etc.);
 2. wooden racks (shelves), whether or not assembled, provided that they do not have the character of furniture;
 3. garden fencing, etc., made of trellis work nailed cross-wise and then stretched out (accordion system);
 4. skewers and pointed sticks of many types, used in the presentation of certain foods (rolled herrings, etc.).

SECTION X

PULP OF WOOD OR OF OTHER FIBROUS CELLULOSIC MATERIAL; RECOVERED (WASTE AND SCRAP) PAPER OR PAPERBOARD; PAPER AND PAPERBOARD AND ARTICLES THEREOF

CHAPTER 48

PAPER AND PAPERBOARD; ARTICLES OF PAPER PULP, OF PAPER OR OF PAPERBOARD

General

Rolls of paper, the outer layers of which have been partially soaked in water or otherwise damaged, remain classified in the appropriate subheading of headings 4801 to 4811.

- 4801 00 00** **Newsprint, in rolls or sheets**
See note 4 to this chapter and the HS Explanatory Note to heading 4801.
- 4802** **Uncoated paper and paperboard, of a kind used for writing, printing or other graphic purposes, and non-perforated punchcards and punch-tape paper, in rolls or rectangular (including square) sheets, of any size, other than paper of heading 4801 or 4803; handmade paper and paperboard**
See note 5 to this chapter.
- 4802 10 00** **Handmade paper and paperboard**
See the HS General Explanatory Note to this chapter, (B), and the HS Explanatory Note to heading 4802, second and third paragraphs.
- 4802 40 10 and 4802 40 90** **Wallpaper base**
Wallpaper base may be of white or coloured paper, sized, machine-finished, with a thick but flexible structure and a rough surface. This paper is suitable for coating and/or printing on one side, the other side is for the paste or other adhesive. This base paper has to stand up to the processes of wallpaper manufacture and paperhanging.
- 4803 00** **Toilet or facial tissue stock, towel or napkin stock and similar paper of a kind used for household or sanitary purposes, cellulose wadding and webs of cellulose fibres, whether or not creped, crinkled, embossed, perforated, surface-coloured, surface-decorated or printed, in rolls or sheets**
- 4803 00 10** **Cellulose wadding**
See the HS Explanatory Note to heading 4803, first paragraph, (2), second subparagraph.
The open formation of the web reveals small holes when light is shone through it.
- 4803 00 31 and 4803 00 39** **Creped paper and webs of cellulose fibres (tissues), weighing, per ply**
For the definition of the term 'creped paper', see the HS Explanatory Note to heading 4808, first paragraph, (2).
The closed formation of the web means a more compact and homogeneous structure than that of cellulose wadding.
- 4804** **Uncoated kraft paper and paperboard, in rolls or sheets, other than that of heading 4802 or 4803**
For the definition of the term 'kraft paper and paperboard', see note 6 to this chapter.
Kraft paper and kraft paperboard have great mechanical strength. They usually contain no fillers and are sized to a fairly high degree, are almost always opaque, in most cases machine-glazed (i.e., calendered on one surface only) and generally bear visible wire-marks.
Kraft paper and kraft paperboard are excellent packing and wrapping materials. They are also used as paper wrappings for electrical cables, as the flat surface sheet for corrugated paperboard, for making paper yarn and for the production of tarred, bituminised or asphalted paper or paperboard.
- 4804 11 11 to 4804 19 90** **Kraftliner**
See subheading note 1 to this chapter and the corresponding HS Subheading Explanatory Notes.

- 4804 21 10to 4804 29 90** **Sack kraft paper**
See subheading note 2 to this chapter and the corresponding HS Subheading Explanatory Notes.
- 4804 31 51** **Kraft electro-technical insulating paper**
This subheading includes capacitor paper and cable paper.
Capacitor paper is thin paper used in the dielectric of electrical capacitors. The fibres used to make this paper undergo considerable refining to reduce the porosity of the sheet to a minimum, and all foreign bodies (especially metal) are carefully removed.
Cable paper is intended for insulating electrical cables used in transformer coils or as insulators for other electrical engineering uses. It needs to have very good insulating properties and accordingly to be free from any metallic or acidic particles or other electrically conductive impurities.
- 4804 41 91** **Saturating kraft**
Paper and paperboard of this type consist mainly of wood fibres, weigh more than 185 g but less than 225 g per m² and are generally supplied in rolls in widths of more than 125 cm but less than 165 cm. They have a porosity index, measured with a Gurley porosimeter in accordance with the standard laid down by the Technical Association of the Pulp and Paper Industry (TAPPI), of less than 13 seconds per 100 cm³ air and 40 seconds per 300 cm³ air.
Saturating kraft behaves like blotting paper. It is possible to run a finger over a newly drawn line on the paper without the ink smudging.
Saturating kraft is specially designed to be impregnated with synthetic resins for the high-pressure manufacture of laminated sheets.
- 4805** **Other uncoated paper and paperboard, in rolls or sheets, not further worked or processed than as specified in note 3 to this chapter**
- 4805 11 00** **Semi-chemical fluting paper**
See subheading note 3 to this chapter.
- 4805 12 00** **Straw fluting paper**
See subheading note 4 to this chapter.
- 4805 19 10** **Wellenstoff**
See the HS Explanatory Note to subheading 4805 19.
- 4805 24 00and 4805 25 00** **Testliner (recycled liner board)**
See subheading note 5 to this chapter.
- ~~**4805 30 10**~~~~**4805 30 00and**~~
~~**4805 30 90**~~ **Sulphite wrapping paper**
See subheading note 6 to this chapter.
- 4805 40 00** **Filter paper and paperboard**
See the HS Explanatory Note to subheading 4805 40.
- 4805 50 00** **Felt paper and paperboard**
See the HS Explanatory Note to subheading 4805 50.

- 4805 91 00** **Weighing 150 g/m² or less**
This subheading includes paper and paperboard made entirely from recovered (waste and scrap) paper, without additives, and which has a burst index of 0,8 kPa or more but not exceeding 1,9 kPa.
- 4805 92 00** **Weighing more than 150 g/m² but less than 225 g/m²**
The explanatory note to subheading 4805 91 00 applies, *mutatis mutandis*.
- 4805 93 20** **Made from recovered paper**
The explanatory note to subheading 4805 91 00 applies, *mutatis mutandis*.
- 4806** **Vegetable parchment, greaseproof papers, tracing papers and glassine and other glazed transparent or translucent papers, in rolls or sheets**
- 4806 10 00** **Vegetable parchment**
See the HS Explanatory Note to heading 4806, first four paragraphs.
- 4806 20 00** **Greaseproof papers**
See the HS Explanatory Note to heading 4806, fifth to eighth paragraphs.
- 4806 30 00** **Tracing papers**
See the HS Explanatory Note to heading 4806, ninth paragraph.
- 4806 40 10 and 4806 40 90** **Glassine and other glazed transparent or translucent papers**
See the HS Explanatory Note to heading 4806, tenth and eleventh paragraphs.
- 4808** **Paper and paperboard, corrugated (with or without glued flat surface sheets), creped, crinkled, embossed or perforated, in rolls or sheets, other than paper of the kind described in heading 4803**
- 4808 10 00** **Corrugated paper and paperboard, whether or not perforated**
See the HS Explanatory Note to heading 4808, (1).
- ~~4808 20 00~~ 4808 40 00** **~~Sack kraft paper, creped or crinkled, whether or not embossed or perforated~~ Kraft paper, creped or crinkled, whether or not embossed or perforated**
See the HS Explanatory Note to heading 4808, (2), (3) and (4).
- ~~4808 30 00~~** **~~Other kraft paper, creped or crinkled, whether or not embossed or perforated~~**
See the HS Explanatory Note to heading 4808, (2), (3) and (4).
- 4808 90 00** **Other**
See the HS Explanatory Note to heading 4808, (2), (3) and (4).
- 4809** **Carbon paper, self-copy paper and other copying or transfer papers (including coated or impregnated paper for duplicator stencils or offset plates), whether or not printed, in rolls or sheets**
- 4809 20 00** **Self-copy paper**
See the HS Explanatory Note to heading 4816, (A), (2). However, the products of this subheading must satisfy the dimensional criteria in note 8 to this chapter.

- 4809 90 10** **Carbon or similar copying papers**
See the HS Explanatory Note to heading 4816, (A), (1). However, the products of this subheading must satisfy the dimensional criteria in note 8 to this chapter.
- ~~4809 90 90~~**4809 90 00** **Other**
This subheading covers other copying or transfer papers, such as heat transfer papers and coated or impregnated paper for duplicator stencils or offset plates. However, the products of this subheading must satisfy the dimensional criteria in note 8 to this chapter. This subheading covers the products mentioned in the HS Explanatory Note to heading 4816, (A), (1), and other copying or transfer papers, such as heat-transfer papers and coated or impregnated paper for duplicator stencils or offset plates. However, the products of this subheading must satisfy the dimensional criteria in note 8 to this chapter.
- 4810** **Paper and paperboard, coated on one or both sides with kaolin (China clay) or other inorganic substances, with or without a binder, and with no other coating, whether or not surface-coloured, surface-decorated or printed, in rolls or rectangular (including square) sheets, of any size**
- ~~4810 13 20~~**4810 13 00** ~~to to~~
~~4810 19 90~~**4810 19 00** **Paper and paperboard of a kind used for writing, printing or other graphic purposes, not containing fibres obtained by a mechanical or chemi-mechanical process or of which not more than 10 % by weight of the total fibre content consists of such fibres**
See the HS Explanatory Note to subheadings 4810 13, 4810 14, 4810 19, 4810 22 and 4810 29.
- ~~4810 22 10~~**4810 22 00** ~~to to~~
4810 29 80 **Paper and paperboard of a kind used for writing, printing or other graphic purposes, of which more than 10 % by weight of the total fibre content consists of fibres obtained by a mechanical or chemi-mechanical process**
See the HS Explanatory Note to subheadings 4810 13, 4810 14, 4810 19, 4810 22 and 4810 29.
- ~~4810 22 10~~**4810 22 00** ~~and~~
~~4810 22 90~~ **Lightweight coated paper**
See subheading note 7 to this chapter.
- 4810 92 10** ~~to~~ **4810 92 90** **Multi-ply**
See the HS Explanatory Note to heading 4805, second paragraph, (2).
- 4811** **Paper, paperboard, cellulose wadding and webs of cellulose fibres, coated, impregnated, covered, surface-coloured, surface-decorated or printed, in rolls or rectangular (including square) sheets, of any size, other than goods of the kind described in heading 4803, 4809 or 4810**
This heading includes certain floor coverings, not suitable as wallcoverings, on a base of paper or paperboard.
This heading excludes products suitable for use both as floor coverings and as wallcoverings (heading 4823).
- 4811 10 00** **Tarred, bituminised or asphalted paper and paperboard**
This subheading includes damp-proofing sheets consisting of two sheets of creped paper impregnated with asphalt with a thin sheet of aluminium foil sandwiched between them.
This subheading excludes roofing boards consisting of a substrate of paperboard completely enveloped in, or covered on both sides by, a layer of asphalt or similar material (heading 6807).
- 4811 51 00** ~~and~~ **4811 59 00** **Paper and paperboard, coated, impregnated or covered with plastics (excluding adhesives)**
Paper and paperboard coated or covered with plastics fall in these subheadings only if the thickness of the plastics is not more than half of the total thickness (see note 2(g) to this chapter).
- 4811 60 00** **Paper and paperboard, coated, impregnated or covered with wax, paraffin wax, stearin, oil or glycerol**
This subheading includes paraffined paper and paperboard which is intended for the manufacture of containers for milk or fruit juice or of record sleeves, etc., and which bears on one side print or illustrations relating to the goods to be contained within.

- 4811 90 00** **Other paper, paperboard, cellulose wadding and webs of cellulose fibres**
This subheading includes continuous forms. These forms consist of sheets, generally folded, or in rolls, perforated transversely at regular intervals, giving a succession of forms which can be separated at the perforations. They contain printed matter which requires completion. These articles may also have lateral guide holes permitting their use in particular in fast printers or accounting machines.
This subheading does not include continuous manifold business forms (subheading 4820 40 00).
- 4814** **Wallpaper and similar wallcoverings; window transparencies of paper**
- 4814 10 00** **‘Ingrain’ paper**
See note 9(a)(2) to this chapter and the HS Explanatory Note to heading 4814, (A), (a), (2).
- 4816** **Carbon paper, self-copy paper and other copying or transfer papers (other than those of heading 4809), duplicator stencils and offset plates, of paper, whether or not put up in boxes**
- 4816 20 00** **Self-copy paper**
See the HS Explanatory Note to heading 4816, (A), (2). Products of this subheading cannot be of the dimensions set out in note 8 to this chapter (heading 4809).
- 4816 90 00** **Other**
See the HS Explanatory Note to heading 4816, (A), (1) and (3) and (B), (1). Products of this subheading cannot be of the dimensions set out in note 8 to this chapter (heading 4809).
This subheading also includes offset plates (see the HS Explanatory Note to heading 4816, (B), (2), second sentence). These products are not subject to any dimensional conditions.
- 4818** **~~Toilet paper and similar paper, cellulose wadding or webs of cellulose fibres, of a kind used for household or sanitary purposes, in rolls of a width not exceeding 36 cm, or cut to size or shape; handkerchiefs, cleansing tissues, towels, tablecloths, serviettes, napkins for babies, tampons, bedsheets and similar household, sanitary or hospital articles, articles of apparel and clothing accessories, of paper pulp, paper, cellulose wadding or webs of cellulose fibres~~**
- 4818 40 19** **Other**
This subheading includes panty shields.
- 4818 40 99** **Other (for example, incontinence care articles)**
This subheading includes incontinence articles and invalid bed liners.
- 4819** **Cartons, boxes, cases, bags and other packing containers, of paper, paperboard, cellulose wadding or webs of cellulose fibres; box files, letter trays, and similar articles, of paper or paperboard of a kind used in offices, shops or the like**
- 4819 20 00** **Folding cartons, boxes and cases, of non-corrugated paper or paperboard**
See the HS Explanatory Note to heading 4819, (A), second paragraph.
- 4819 60 00** **Box files, letter trays, storage boxes and similar articles, of a kind used in offices, shops or the like**
See the HS Explanatory Note to heading 4819, (B).

- 4820** **Registers, account books, notebooks, order books, receipt books, letter pads, memorandum pads, diaries and similar articles, exercise books, blotting pads, binders (loose-leaf or other), folders, file covers, manifold business forms, interleaved carbon sets and other articles of stationery, of paper or paperboard; albums for samples or for collections and book covers, of paper or paperboard**
- 4820 40 00** **Manifold business forms and interleaved carbon sets**
See the HS Explanatory Note to heading 4820, first paragraph, (4) and (5).
See also the explanatory note to subheading 4811 90 00.
- 4823** **Other paper, paperboard, cellulose wadding and webs of cellulose fibres, cut to size or shape; other articles of paper pulp, paper, paperboard, cellulose wadding or webs of cellulose fibres**
- 4823 20 00** **Filter paper and paperboard**
See the HS Explanatory Note to heading 4823, second paragraph, (1).
- 4823 90 85** **Other**
See the HS Explanatory Note to heading 4823, second paragraph, (3) and (6) to (17).
This subheading includes products suitable for use both as floor coverings and as wallcoverings.
This subheading also includes condenser paper which is an electrical insulating paper used in condensers as a dielectric. It is extremely thin (generally, 0,006 to 0,02 mm), of a very regular thickness and completely without pores. It is generally made from soda or sulphate pulp, and sometimes from rag pulp. Condenser paper is chemically neutral, is free of even the smallest metallic particles and has high mechanical and dielectric strength (no dielectric losses).

SECTION XI

TEXTILES AND TEXTILE ARTICLES

General

1. As pointed out in the HS Explanatory Notes (see the HS General Explanatory Note to this section, last paragraph of the introduction), section XI is divided into two parts:
 - (a) in the first part (Chapters 50 to 55), textile products are grouped according to the textile material of which they are made, the classification of products consisting of a mixture of textile materials being governed by note 2 to this section;
 - (b) in the second part (Chapters 56 to 63), with the exception of headings 5809 00 00 and 5902, no distinction is made either at chapter or heading level between the textile materials of which the articles are made. However, many headings in Chapters 56 to 63 of the Combined Nomenclature have been subdivided on the basis of constituent textile materials. In cases of this kind, classification in these subheadings must be in accordance with the provisions of subheading note 2 to this section.
2. Subheading note 2 to this section provides the rules for determining the classification of textile products containing two or more textile materials in the headings of Chapters 56 to 63. These goods are to be classified in the subheading appropriate to goods of that one textile material which predominates in weight, account being taken, where appropriate, of the provisions of note 2(B) to this section.

In applying these rules, however, provisions (a) to (c) of subheading note 2(B) to this section must be taken into consideration.

3. Guidelines for the interpretation of note 2 to this section can be found in the HS Explanatory Notes (see, for example, part (I)(A) of the General Explanatory Note to this section).

In applying note 2, no account is to be taken of the following:

- (a) yarns contained in selvages, provided that the latter do not constitute an essential part of the finished product, as, for example, selvages of certain fabrics used for umbrellas or shawls;
 - (b) separating yarns incorporated in fabric, to indicate where it should be cut;
 - (c) yarns ('truth' yarns) contained in the ends of fabrics, if these yarns are of a textile material different from that of which the fabric itself is made.
4. See subheading notes 1(a) to 1(h) to this section, for the meaning of the terms 'unbleached', 'bleached' and 'coloured' when applied to yarn and of the terms 'unbleached', 'bleached', 'dyed', 'of yarns of different colours' and 'printed' when applied to woven fabric.
 5. For a description of the various weaves, see the Subheading Explanatory Note in part (I)(C) of the HS General Explanatory Note to this section.

CHAPTER 56

WADDING, FELT AND NONWOVENS; SPECIAL YARNS; TWINE, CORDAGE, ROPES AND CABLES AND ARTICLES THEREOF**General**

For the classification, within headings, of articles composed of two or more textile materials, see the general explanatory note to this section.

5601	Wadding of textile materials and articles thereof; textile fibres, not exceeding 5 mm in length (flock), textile dust and mill neps
5601 10 10 and 5601 10 90	Sanitary towels and tampons, napkins and napkin liners for babies and similar sanitary articles, of wadding See the HS Explanatory Note to heading 5601, (A), (2).
5601 21 10 to 5601 29 00	Wadding, other articles of wadding Wadding of textile materials and articles thereof These subheadings include 'cotton buds', sticks of wood, plastics or rolled paper having at one or both ends a 'bud' of wadding used for cleaning ears nostrils, nails, etc., for applying antiseptics or skin lotions and in beauty care. <u>These subheadings include 'cotton buds', sticks of wood, plastics or rolled paper having at one or both ends a 'bud' of wadding used for cleaning ears, nostrils, nails, etc., for applying antiseptics or skin lotions, and in beauty care.</u>
5601 21 10	Absorbent The explanatory note on the term 'absorbent' at subheading 5201 00 10 applies, <i>mutatis mutandis</i> .
5601 30 00	Textile flock and dust and mill neps See the HS Explanatory Note to heading 5601, (B) and (C).
5602	Felt, whether or not impregnated, coated, covered or laminated
5602 10 11 and 5602 10 19	Needleloom felt See the HS Explanatory Note to heading 5602, fourth paragraph.
5602 10 31 and 5602 10 38	Stitch-bonded fibre fabrics See the HS Explanatory Note to heading 5602, seventh paragraph.
5606 00	Gimped yarn, and strip and the like of heading 5404 or 5405, gimped (other than those of heading 5605 and gimped horsehair yarn); chenille yarn (including flock chenille yarn); loop wale-yarn
5606 00 91	Gimped yarn The core of a gimped yarn may consist also of an elastomeric yarn (see note 13 to this section).

CHAPTER 58

SPECIAL WOVEN FABRICS; TUFTED TEXTILE FABRICS; LACE; TAPESTRIES; TRIMMINGS; EMBROIDERY

General

For the classification, within headings, of articles composed of two or more textile materials, see the general explanatory note to this section.

- 5801** **Woven pile fabrics and chenille fabrics, other than fabrics of heading 5802 or 5806**
Without prejudice to the provisions laid down in this section concerning the classification of articles composed of two or more textile materials, it should be noted that, in the case of chenille fabrics, only the textile materials making up the pile of the chenille yarn are to be taken into consideration.
Imitations of velvet or plushes made on knitting machines fall in heading 5907 00 00 or in Chapter 60, as the case may be.
- 5801 21 00 to** **Of cotton**
~~5801 26 00~~ **5801 27 00** See the HS Explanatory Note to subheadings 5801 22 and 5801 32.
- 5804** **Tulles and other net fabrics, not including woven, knitted or crocheted fabrics; lace in the piece, in strips or in motifs, other than fabrics of headings 6002 to 6006**
- 5804 10 10 and 5804 10 90** **Tulles and other net fabrics**
See the HS Explanatory Note to heading 5804, (I).
Imitation tulle made on knitting machines (the Raschel machine, for example) falls in Chapter 60.
- 5804 10 10** **Plain**
For the purpose of this subheading, plain tulles and other net fabrics are those which have a single series of regular meshes of the same shape and size over the whole surface, with no pattern or filling-in of the meshes. In applying this definition, no account is to be taken of any minor open spaces which are inherent in the formation of the meshes.
- 5804 21 10 to 5804 29 90** **Mechanically made lace**
See the HS Explanatory Note to heading 5804, (II).
See the HS Explanatory Note to subheadings 5804 21, 5804 29 and 5804 30 for the distinction between handmade lace and mechanically made lace.
Care should be taken to ensure that knitted fabric closely resembling lace, and in fact sold as lace in the trade, is not classified in heading 5804. Such fabric is manufactured on Raschel machines and may be recognised from the fact that the openwork is formed by the intersection of meshes resembling warp knitting and not by warp threads (straights) and weft threads (slants).
For the filling of the opaque spaces of the design, the thread used is inserted in the meshes which form the sides of the small hexagons of the openwork where it is held in place by a type of chain stitch. The openwork does not therefore cease where the design begins; on the contrary, it forms the support for it (which is not always the case in mechanically made lace).
The indications given in the HS Explanatory Note to subheadings 5804 21, 5804 29 and 5804 30 which enable mechanically made lace to be recognised are also valid for Raschel 'lace': meshes or parts of meshes remain after cutting into strips, the flow of the outline threads and design threads, and the mechanical regularity of any defects, etc.
Nevertheless, for the purposes of the Combined Nomenclature, lace obtained from a Raschel machine is regarded as knitted and must therefore be classified in Chapter 60.
Fabric imitating point lace (guipure) which has been produced in the same way as chemical embroidery is not classified as mechanically made lace and falls in heading 5810.

- 5806** **Narrow woven fabrics, other than goods of heading 5807; narrow fabrics consisting of warp without weft assembled by means of an adhesive (bolducs)**
- 5806 20 00** **Other woven fabrics, containing by weight 5 % or more of elastomeric yarn or rubber thread**
See note 13 to this section, for the definition of the term 'elastomeric yarn'.
- 5806 32 10** **With real selvages**
Narrow woven fabrics with real selvages are those consisting of warp and weft, whose two longitudinal edges are formed by turning the weft thread. Since the thread is moved on without interruption, unravelling is prevented.
- 5806 40 00** **Fabrics consisting of warp without weft assembled by means of an adhesive (bolducs)**
See the HS Explanatory Note to heading 5806, (B).
- 5810** **Embroidery in the piece, in strips or in motifs**
- 5810 10 10 and 5810 10 90** **Embroidery without visible ground**
See the HS Explanatory Note to subheading 5810 10.

CHAPTER 63

OTHER MADE-UP TEXTILE ARTICLES; SETS; WORN CLOTHING AND WORN TEXTILE ARTICLES; RAGS

General

For the classification, within headings, of articles composed of two or more textile materials, see the general explanatory note to this section.

I. OTHER MADE-UP TEXTILE ARTICLES

6305**Sacks and bags, of a kind used for the packing of goods**

Some sacks and bags of textile material are classified, for example, in headings 4202 and 6307. Sacks and bags falling in heading 4819 when made of paper fall in this heading when made of woven paper yarn.

Sacks of textile material lined with paper are generally classified in this heading, while paper sacks lined with textile material fall in subheading 4819 40 00.

6305 10 10**Used**

This subheading covers only articles which have been used at least once in the transport of goods and which have retained clear traces of such use, for example, traces of the product which they contained, dirt, stains, holes, tears, repair marks, overstretched seams, traces of bindings or sewing at the opening.

6307**Other made-up articles, including dress patterns****6307 90 92****Single-use drapes made up of fabrics of heading 5603, of a kind used during surgical procedures**

This subheading includes single-use made-up surgical drapes specifically designed for use during surgical operations to prevent the transfer of potentially infectious agents (dry, wet or airborne) through direct contact from the surgical team to the patient and vice versa. Surgical drapes usually consist of multiple layers of non-wovens, and are made up by hemming. Surgical drapes are used to provide a microbiologically clean working area around the patient. Surgical drapes may be impregnated with fluorocarbons or silicon to improve repellence. They may also be partially laminated with a plastic film to provide additional strength and protection in areas likely to be exposed to bodily fluids. In addition, they may be covered with paper tissue as a comfort layer in contact with patient's skin. Drapes used on patients may have openings or windows, to facilitate access to the patient.

This subheading does not include:

—drapes which are impregnated or coated with pharmaceutical substances or put up in forms or packings for retail sale for medical, surgical, dental or veterinary purposes (heading 3005), and

—articles having the clear characteristics of toilet linen (for example, hand or face towels, facecloths) or kitchen linen such as tea towels or glass cloth (heading 6302).

6307 90 99 6307 90 98**Other**

This subheading includes:

1. headcovers for tennis rackets, badminton rackets, golf clubs etc., when made from textile fabric (usually, coated with plastics) whether or not they are fitted with a pocket to contain balls. However, covers which envelop the entire racket, whether or not fitted with a handle or a shoulder strap, are excluded (heading 4202);
2. turbans consisting of a length of fancy woven fabric (usually, cotton or a mixture of cotton and silk) between 4 and 5 m long and approximately 50 cm wide. They are hemmed on all sides, sometimes with fringed ends, and are normally presented individually folded and packaged.

SECTION XII

FOOTWEAR, HEADGEAR, UMBRELLAS, SUN UMBRELLAS, WALKING STICKS, SEAT-STICKS, WHIPS, RIDING-CROPS AND PARTS THEREOF; PREPARED FEATHERS AND ARTICLES MADE THEREWITH; ARTIFICIAL FLOWERS; ARTICLES OF HUMAN HAIR

CHAPTER 64

FOOTWEAR, GAITERS AND THE LIKE; PARTS OF SUCH ARTICLES**General**

1. For the definition of the terms 'outer soles' and 'uppers', see the HS General Explanatory Note to this chapter, parts (C) and (D).

Moreover, for 'uppers' consisting of two or more materials (note 4(a) and additional note 1 to Chapter 64), the following applies:

- (a) The 'upper' is the part of the footwear which covers the sides and top of the foot and may also cover the leg. It reaches down, and is attached, to the sole. It may even go into the sole.

The constituent materials of the upper are materials whose surface is partly or totally exposed on the outside surface of the footwear. Therefore, a lining is not an upper. The materials of the upper are attached to each other.

After removal of the accessories and reinforcements, when calculating the total surface area of the materials forming the upper, no account is to be taken of the areas which lie beneath overlapping sections where the materials have been attached to each other.

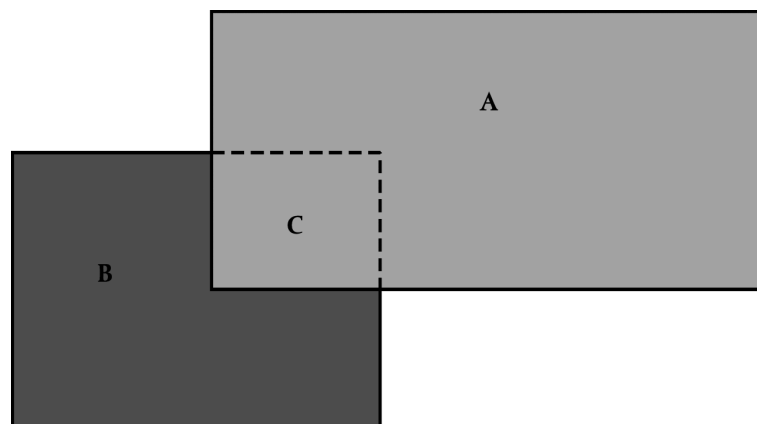

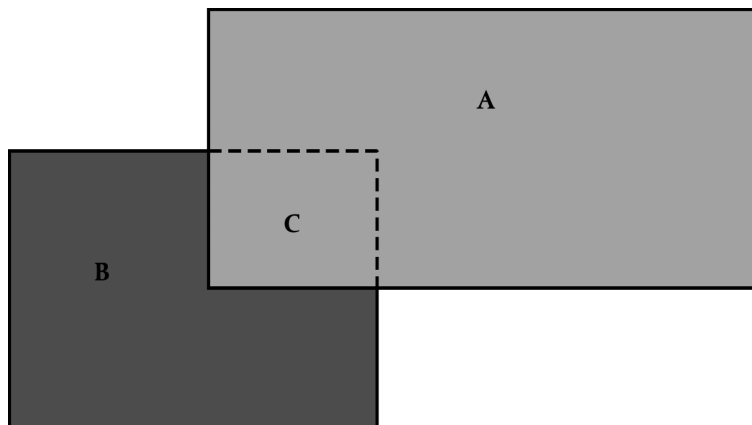

For example, leather material (A), textile material (B), the area (C) is the part of the textile material (B) that lies beneath the overlapping leather material (A). No account is to be taken of the textile area (C) when calculating the total surface area of the materials forming the upper.

No account is to be taken of any fastening systems, e.g. laces, velcro-type strap closing etc. (see the HS General Explanatory Note to this chapter, (D), last paragraph).

- (b) The 'lining' can be made of any material. It can consist of one or more materials. The lining is in contact with the foot and serves as cushioning, protection or merely as decoration. The lining is not exposed on the outside surface of the footwear, with the exception of a padding for example around the collar.
- (c) 'Accessories' and 'reinforcements' are defined in note 4(a) to Chapter 64 and in additional note 1 to Chapter 64 and in the HS General Explanatory Note to this chapter, (D), last paragraph.

Accessories generally have an ornamental function and reinforcements have a protective or strengthening function. Since reinforcements are attachments to the upper aiming to give additional strength, they are attached to the external surface of the upper and not merely to the lining. However, a section of lining may appear underneath the reinforcement, provided that its reinforcement function is not thereby reduced. Besides being attached to the upper, the reinforcement or accessory may also be attached to, or go into, the sole. A material is not considered an accessory or reinforcement, but is considered a part of the upper, provided that the method of assembling of the materials underneath is not durable (sewn seams are an example of a durable method of assembling).

Within the meaning of note 4(a), 'similar attachments' can also be e.g. logos or toe caps.

In determining the material of the 'upper', the tongue that is partly or completely covered (inner tongue) is not taken into account. See the diagram below, with the broken line indicating the inner tongue.

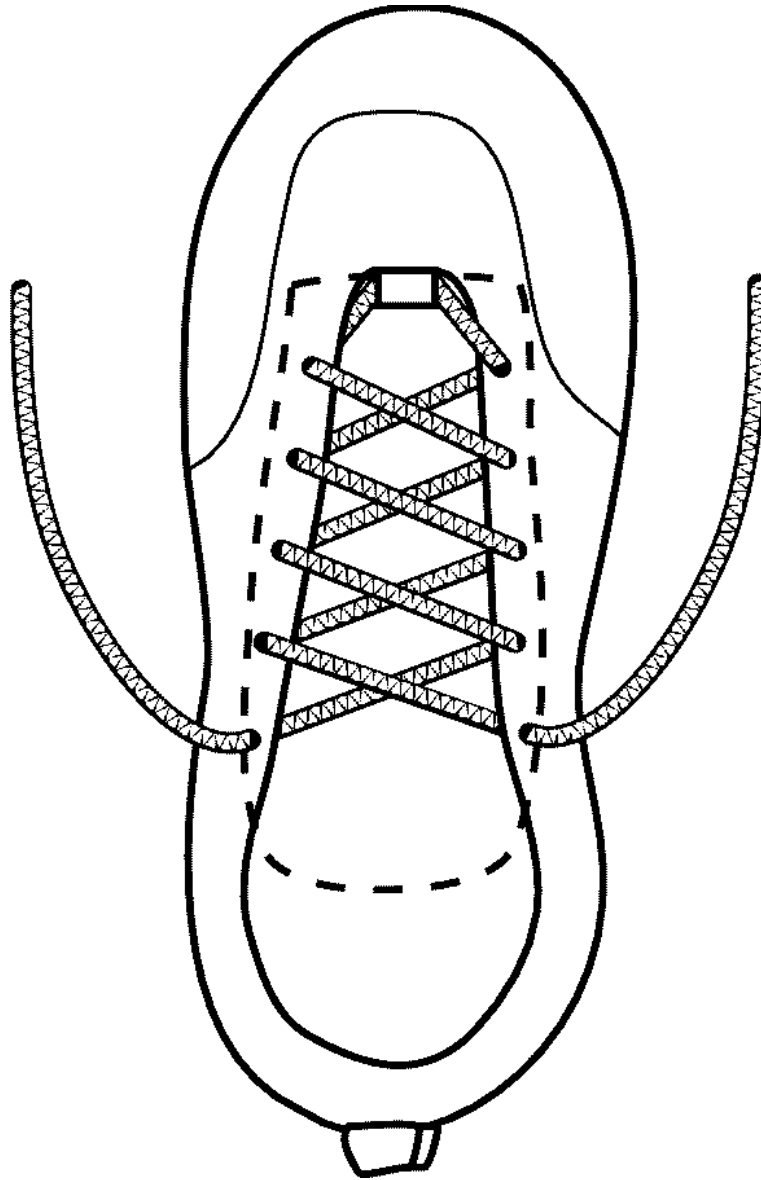

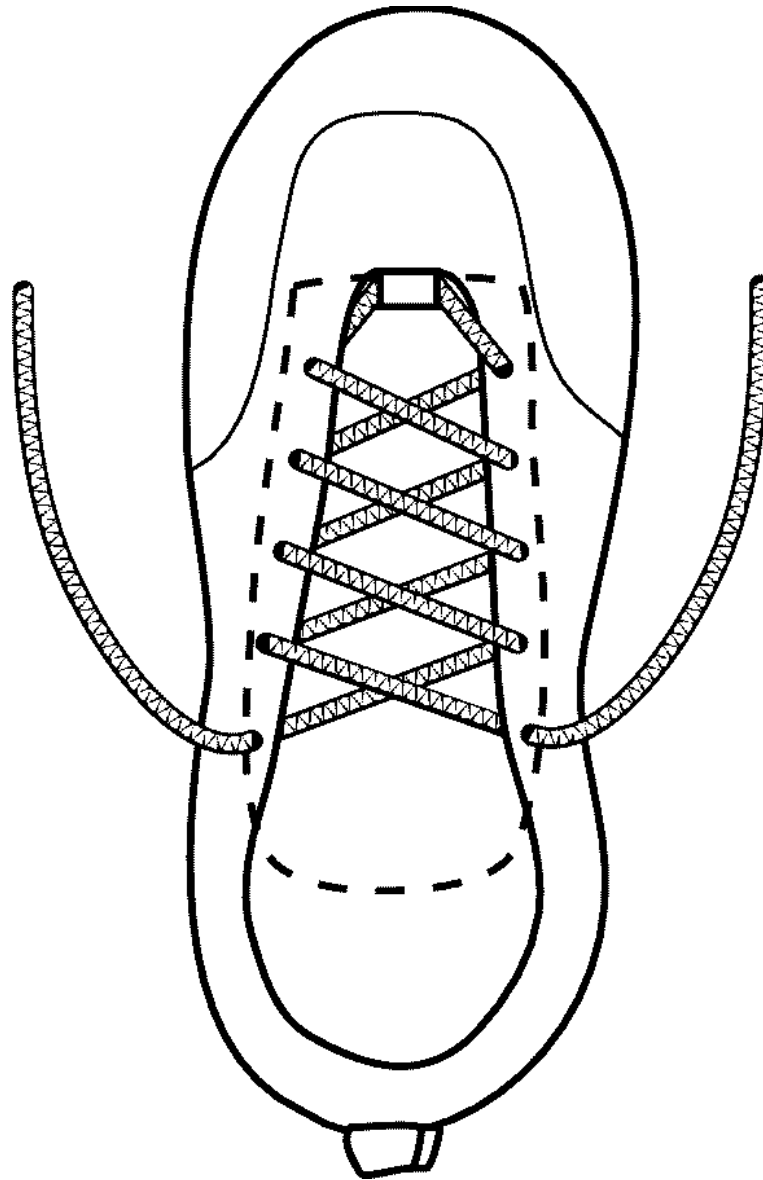

The diagrams and text below give an example of how to determine the material of the 'upper':

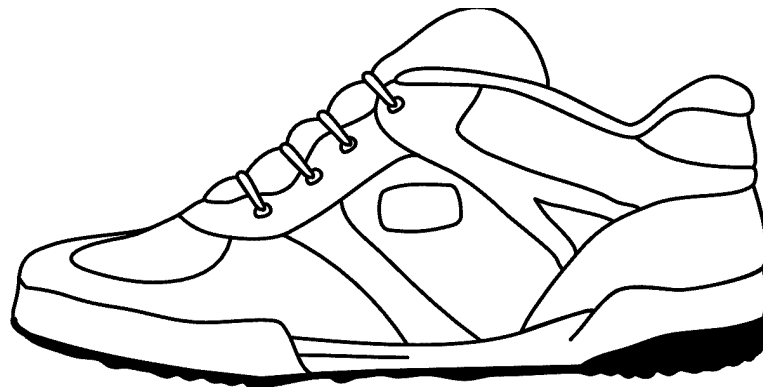

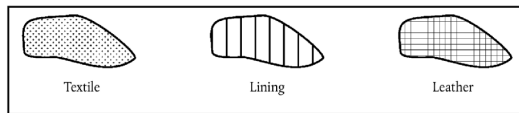
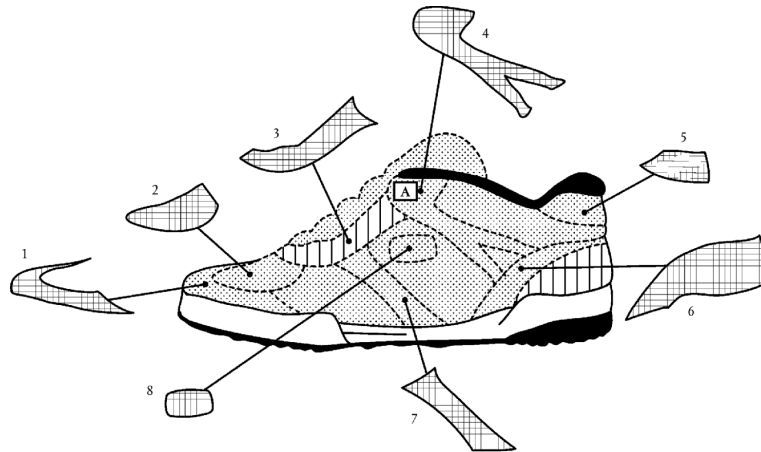
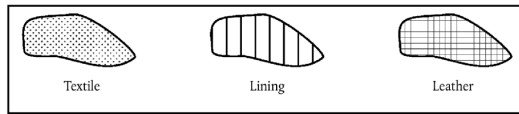
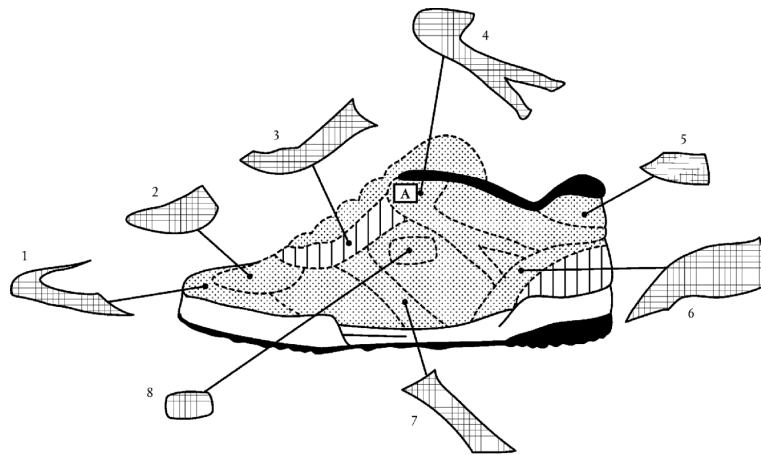

The shoe in the above diagrams is a leather-and-textile shoe. In order to determine the material of the 'upper' within the meaning of Chapter 64 and to eliminate 'accessories' and 'reinforcements', the following considerations are made:

- 1 Removing the leather toecap (1) and toe vamp (2) has revealed textile material underneath (which is not lining material). As the and leather sections 1 and 2 have a protective function, they are considered to be reinforcements. Since the textile material underneath
2. the leather sections 1 and 2 is partly exposed on the surface, the textile material has to be counted as part of the upper.
3. Removing the leather section (3) has revealed an area of textile (marked A on the diagram) and an area of lining material lying underneath section 3. As the textile does not extend all the way under section 3, and, as the lining is not considered to be an upper, and, as there is mainly lining material under the leather, the leather section does not reinforce any upper material, and, thus, has to be counted as part of the upper.
4. This leather section (4) has been sewn onto a textile section, and also overlaps (A) the leather section 3. As there is a partly exposed textile material underneath section 4 and a partly exposed leather section 3 underneath the overlap (A), and, as the leather section 4 is giving additional strength to the side of the upper, section 4 is considered to be reinforcement. Thus, leather section 3 and the textile material beneath section 4 with the exception of the textile area beneath section 3 have to be counted as parts of the upper.
5. Removing this leather section (5) has revealed partly exposed textile material underneath. As the leather section 5 is reinforcing the upper part of the heel, and, as there is partly exposed textile material underneath it, the leather is considered to be a reinforcement.
6. Removing the leather heel counter (6) has revealed an area of lining material and partly exposed textile material. As the textile does not extend all the way under the leather, the leather heel counter 6 has no reinforcing function on an upper-material and, therefore, the counter is considered to be part of the upper (and not a reinforcement).
7. Removing this leather section (7) has revealed partly exposed textile material underneath it. As the leather section 7 is giving additional strength to the side of the upper, the leather is considered to be reinforcement.
8. Removing the leather logo (8) has revealed partly exposed textile material underneath it. Therefore and as a logo is a 'similar attachment' within the meaning of note 4(a) to Chapter 64, it is not part of the upper.

Having calculated the percentages of the leather sections and the percentages of the textile areas that have been identified as parts of the upper, the textile predominates (70 % textile material). The shoe will therefore be classified as footwear with uppers of textile materials.

2. The term 'rubber' is defined in note 1 to Chapter 40 for the purpose throughout the Combined Nomenclature; note 3(a) to this chapter broadens the scope for the purpose of this chapter.
3. The term 'plastics' is defined in note 1 to Chapter 39 for the purpose throughout the Combined Nomenclature; note 3(a) to this chapter broadens the scope for the purpose of this chapter.
4. The term 'leather' is defined in note 3(b) to Chapter 64 for the purpose of this chapter.
5. The term 'textile materials' is defined in the HS General Explanatory Note to this chapter, (E) and (F). Thus, the fibres (for example, textile flock), yarns, fabrics, felts, nonwovens, twine, cordage, ropes, cables, etc., as defined in Chapters 50 to 60 are 'textile materials' within the meaning of Chapter 64. As far as the fabrics of Chapter 59 are concerned, the notes to Chapter 59 are only applicable subject to the provisions of note 3(a) to Chapter 64.

6402**Other footwear with outer soles and uppers of rubber or plastics**

This heading includes 'footwear involving special technology' and designed for sporting activity, with a single- or multi-layer moulded sole, not injected, manufactured from synthetic materials specially designed to absorb impacts due to vertical or lateral movements, and with technical features such as hermetic pads containing gas or fluid, mechanical components which absorb or neutralise impact, or special materials such as low-density polymers.

The 'technical features' listed are not to be considered as being cumulative of the 'synthetic materials', but are considered to be descriptive of the 'synthetic materials' mentioned above.

'Footwear designed for sporting activity' should be taken to mean tennis shoes, basketball shoes, gym shoes, training shoes and the like, with the exception of, for example, footwear worn mainly or exclusively for white-water canoeing, walking, trekking, hiking, mountain climbing.

Shoes which because of their size are meant to be worn by children and young people can also be 'footwear designed for sporting activity'.

In this context, the following definitions shall apply:

- (a) 'single- or multi-layer moulded soles' means preformed soles manufactured independently of the shoe by casting (for example, injection moulding or centrifugal casting), moulding (for example, compression moulding) or fusion; they are generally attached to the uppers by glueing or sewing, or by a combination of the two, but not by injection;
- 'single moulded sole' refers to shoes consisting of an upper and an outer sole,
 - 'multi-layer moulded sole' refers to shoes consisting of an upper, a mid-sole (for the full or partial length of the shoe) and an outer sole,
 - where 'moulded' refers to that part of the sole whose shape is defined by a mould,
 - 'not injected' refers to shoes whose mid or single sole (as appropriate) is manufactured separately from the upper, then subsequently attached to the upper by, for example, gluing or sewing or a combination of the two; such shoes contrast with those whose mid or single sole (as appropriate) has been attached to the upper by means of the injection of synthetic materials into a mould one part of which comprises the upper.

Except as expressly stated above, the term 'not injected' does not serve to exclude shoes whose manufacture otherwise involves the use of some injection technology;

- (b) 'mechanical components' refer to those parts of a shoe, other than the fastening device, which provide stability for the foot;
- (c) 'low-density polymers' means materials with a density of less than 0,6 g/cm³.

6402 12 10to 6402 19 00**Sports footwear**

See subheading note 1 to this chapter

6402 12 10and 6402 12 90**Ski-boots, cross-country ski footwear and snowboard boots**

These subheadings cover boots and footwear used for all types of skiing.

6402 19 00**Other**

Subheading note 1(a) to this chapter covers only footwear that is designed for a specific sporting activity and of which the fixed or removable attachments as enumerated in the subheading note make it difficult to use these shoes for any other purpose, in particular for walking on asphalt roads, because of the height or stiffness or slipperiness etc. of the attachments.

6402 20 00**Footwear with upper straps or thongs assembled to the sole by means of plugs**

For the application of this subheading, it is not necessary that the plugs are visible on the outer sole, which is in contact with the ground; they can also be attached to the inner sole and/or the midsole. Side-pieces coming up from the sole are not considered as being a part of the sole.

6402 99 31 and 6402 99 39**Footwear with a vamp made of straps or which has one or several pieces cut out**

The vamp is taken to mean that part of the upper which covers the fore-part of the foot.

6402 99 31**With sole and heel combined having a height of more than 3 cm**

For the purposes of this subheading, it is irrelevant if the heel can be distinguished from the sole or if the heel is an indistinguishable part of the sole (e.g. wedged sole, plateau sole).

The diagrams below give an example of how to measure:

A is the point where the upper begins

B > 3 cm





**6403****Footwear with outer soles of rubber, plastics, leather or composition leather and uppers of leather**

‘Leather’ is to be taken to mean only skins and hides of headings 4107 and 4112 to 4114 (see note 3(b) to this chapter). Therefore, footwear with furskin uppers or with uppers of composition leather, for example, is excluded from this heading and classified in heading 6405.

The explanatory note to heading 6402 as far as ‘footwear involving special technology’ is concerned applies, *mutatis mutandis*.

- 6403 12 00 and 6403 19 00** **Sports footwear**
See subheading note 1 to this chapter.
- 6403 12 00** **Ski-boots, cross-country ski footwear and snowboard boots**
See the explanatory note to subheadings 6402 12 10 and 6402 12 90.
- 6403 19 00** **Other**
See the explanatory note to subheading 6402 19 00.
- 6403 59 11 to 6403 59 39** **Footwear with a vamp made of straps or which has one or several pieces cut out**
See the explanatory note to subheadings 6402 99 31 and 6402 99 39.

- 6403 59 11** **With sole and heel combined having a height of more than 3 cm**
The explanatory note to subheading 6402 99 31 applies, *mutatis mutandis*.
- 6403 99 11 to 6403 99 38** **Footwear with a vamp made of straps or which has one or several pieces cut out**
See the explanatory note to subheadings 6402 99 31 and 6402 99 39.
- 6403 99 11** **With sole and heel combined having a height of more than 3 cm**
The explanatory note to subheading 6402 99 31 applies, *mutatis mutandis*.
- 6404** **Footwear with outer soles of rubber, plastics, leather or composition leather and uppers of textile materials**
This heading includes 'footwear involving special technology' and designed for sporting activity, with a single- or multi-layer moulded sole, not injected, manufactured from synthetic materials specially designed to absorb impacts due to vertical or lateral movements, and with technical features such as hermetic pads containing gas or fluid, mechanical components which absorb or neutralise impact, or special materials such as low-density polymers.
The 'technical features' listed are not to be considered as being cumulative of the 'synthetic materials', but are considered to be descriptive of the 'synthetic materials' mentioned above.
'Footwear designed for sporting activity' should be taken to mean the shoes mentioned in subheading note 1 to this chapter and tennis shoes, basketball shoes, gym shoes, training shoes and the like, with the exception of, for example, footwear worn mainly or exclusively for white-water canoeing, walking, trekking, hiking, mountain climbing.
Shoes which because of their size are meant to be worn by children and young people can also be 'footwear designed for sporting activity'.
In this context, the following definitions apply:
(a) 'single- or multi-layer moulded soles' means preformed soles manufactured independently of the shoe by casting (for example, injection moulding or centrifugal casting), moulding (for example, compression moulding) or fusion; they are generally attached to the uppers by glueing or sewing, or by a combination of the two, but not by injection;
— 'single moulded sole' refers to shoes consisting of an upper and an outer sole,
— 'multi-layer moulded sole' refers to shoes consisting of an upper, a mid-sole (for the full or partial length of the shoe) and an outer sole,
— where 'moulded' refers to that part of the sole whose shape is defined by a mould,
— 'not injected' refers to shoes whose mid or single sole (as appropriate) is manufactured separately from the upper, then subsequently attached to the upper by, for example, glueing or sewing or a combination of the two; such shoes contrast with those whose mid or single sole (as appropriate) has been attached to the upper by means of the injection of synthetic materials into a mould one part of which comprises the upper.

Except as expressly stated above, the term 'not injected' does not serve to exclude shoes whose manufacture otherwise involves the use of some injection technology;
(b) 'mechanical components' refer to those parts of a shoe, other than the fastening device, which provide stability for the foot;
(c) 'low-density polymers' means materials with a density of less than 0,6 g/cm³.
- 6404 11 00** **Sports footwear; tennis shoes, basketball shoes, gym shoes, training shoes and the like**
For the purposes of this subheading, the term 'sports footwear' is taken to mean all footwear which fulfil the conditions set out in subheading note 1 to this chapter.
Subheading note 1(a) to this chapter covers only footwear that is designed for a specific sporting activity and of which the fixed or removable attachments as enumerated in the subheading note make it difficult to use these shoes for any other purpose, in particular for walking on asphalt roads, because of the height or stiffness or slipperiness etc. of the attachments. 'Shoes similar to tennis shoes, basketball shoes, gym shoes and training shoes' of this subheading cover shoes which, by virtue of their shape, cut and look, show that they are designed for a sporting activity, for example sailing, squash, table-tennis, volleyball.
All these shoes have a non-slip outer sole and a fastening device which gives the foot stability in the shoe (e.g., laces, self-adhesive fasteners).
Minor constituents, for example, decorative strips or stitching, labels (even if sewn on), embroidery, printed or coloured laces, do not exclude classification of these shoes in this subheading.
- 6406** **Parts of footwear (including uppers whether or not attached to soles other than outer soles); removable insoles, heel cushions and similar articles; gaiters, leggings and similar articles, and parts thereof**
Most parts of footwear included in this heading are mentioned in the HS Explanatory Note to heading 6406. This heading includes wooden soles for sandals ('health sandals' and other), without uppers and without straps, laces or thongs.
See note 2 to this chapter for a list of the articles which are not to be considered as parts of footwear within the meaning of this heading.
Parts of footwear may be of any material except asbestos, and may include metal.
- ~~6406 99 30~~ 6406 90 30** **Assemblies of uppers affixed to inner soles or to other sole components, but without outer soles**
This subheading covers articles not yet constituting footwear, consisting of uppers of footwear and one or more sole components (especially the inner sole), but not yet having an outer (second) sole.

CHAPTER 65
HEADGEAR AND PARTS THEREOF

- 6504 00 00** **Hats and other headgear, plaited or made by assembling strips of any material, whether or not lined or trimmed**
The term ‘hats and other headgear, lined and trimmed’ is taken to mean those which are wholly or partly lined, whether or not those linings or trimmings are of the same material as the headgear.
The following, for example, are considered as trimmings: linings, headbands (of leather or of any other material), rim bands, hat bands, braids, buckles, buttons, cabochons, badges, feathers, ornamental stitching, artificial flowers, lace, bows of woven fabric or of ribbon, etc.
- 6505 6505 00** **Hats and other headgear, knitted or crocheted, or made up from lace, felt or other textile fabric, in the piece (but not in strips), whether or not lined or trimmed; hairnets of any material, whether or not lined or trimmed**
For the classification of turbans, see the explanatory note to subheading ~~6307 90 99~~6307 90 98.
- ~~6505 90 05~~6505 00 10** **Of fur felt or of felt of wool and fur, made from the hat bodies, hoods or plateaux of heading ~~6504 6501 00 00~~**
‘Fur felt’ means felt made from the fur of rabbit, hare, muskrat, coypu, beaver, otter or similar furs of short length.
‘Felt of wool and fur’ can be made from a close mixture of wool and fur, in any proportion, or of another combination of these two products (for example, wool felt covered with a layer of fur).
Felts of fur and felts of wool and fur can also contain other fibres (for example, synthetic or regenerated textile fibres).
- ~~6505 90 10~~6505 00 30 to ~~and~~ **Other****
~~6505 90 80~~6505 00 90 These subheadings include articles of felt of wool, whether or not other fibres are added (for example, synthetic or regenerated textile fibres), it being understood that articles made of felt of wool and fur fall in subheading ~~6505 90 05~~6505 00 10.
‘Felt of wool’ means felt made from wool or fur having a certain similarity with wool (for example, hair of vicuna, camel, calf, cow, etc.).
- 6506** **Other headgear, whether or not lined or trimmed**
- 6506 99 10** **Of fur felt or of felt of wool and fur made from the hat bodies, hoods or plateaux of heading ~~6504 6501 00 00~~**
The explanatory note to subheading ~~The explanatory note to subheading~~ ~~6505 90 05~~6505 00 10 applies, *mutatis mutandis*.
- 6506 99 90** **Other**
See the explanatory note to subheadings ~~6505 90 10~~6505 00 30 to ~~and~~ ~~6505 90 80~~6505 00 90.
- 6507 00 00** **Headbands, linings, covers, hat foundations, hat frames, peaks and chinstraps, for headgear**
This heading does not include knitted headbands of the type used by sportsmen and sportswomen to absorb perspiration (subheadings 6117 80 10 and 6117 80 80).

SECTION XIII

ARTICLES OF STONE, PLASTER, CEMENT, ASBESTOS, MICA OR SIMILAR MATERIALS; CERAMIC PRODUCTS;
GLASS AND GLASSWARE

CHAPTER 68

ARTICLES OF STONE, PLASTER, CEMENT, ASBESTOS, MICA OR SIMILAR MATERIALS

General

This chapter covers not only articles ready for use but also, under some headings, semi-manufactures which may require further processing before they can be used for the purpose intended (for example, mixtures with a basis of asbestos or with a basis of asbestos and magnesium carbonate of heading 6812).

- 6802** **Worked monumental or building stone (except slate) and articles thereof, other than goods of heading 6801; mosaic cubes and the like, of natural stone (including slate), whether or not on a backing; artificially coloured granules, chippings and powder, of natural stone (including slate)**
For the definition of the term 'worked monumental or building stone', see note 2 to this chapter.
- 6802 10 00** **Tiles, cubes and similar articles, whether or not rectangular (including square), the largest surface area of which is capable of being enclosed in a square the side of which is less than 7 cm; artificially coloured granules, chippings and powder**
For details on the articles covered by this subheading, see the HS Explanatory Note to heading 6802, seventh paragraph.
- 6802 21 00 to 6802 29 00** **Other monumental or building stone and articles thereof, simply cut or sawn, with a flat or even surface**
These subheadings cover stone and articles of stone (including unfinished articles), simply cut or sawn, which have one or more flat or even surfaces. The latter may be dressed with a chisel, pick or bush hammer.
- 6802 93 10** **Polished, decorated or otherwise worked, but not carved, of a net weight of 10 kg or more**
In addition to articles of stone of which all or part of the surface has been polished, this subheading includes:
1. articles of stone, all or part of the surface of which has been planed, sanded or ground;
 2. articles of decorated stone. These are articles of stone covered with motifs and decoration which are coloured, varnished or otherwise flat-worked, for example, where designs are produced by dressing a polished surface with a chisel;
 3. articles of encrusted stone, bearing mosaics, metal ornaments or simple chiselled inscriptions;
 4. articles of stone which have mouldings or grooves, for example, linear ornamentation, such as fillets, plinths, chamfers, mouldings and beadings;
 5. articles of turned stone as pediments, balustrades and the like.
- 6802 93 90** **Other**
This subheading includes carved granite articles covered with ornamental motifs, either sunken or in relief, such as leaves, garlands and chimeras, carried out in a more elaborate way than the decorations covered by the preceding subheadings. Statues, high-reliefs and bas-reliefs (other than original works of sculpture or statuary) are also classified in this subheading.
- 6802 99 10** **Polished, decorated or otherwise worked, but not carved, of a net weight of 10 kg or more**

See the explanatory note to subheading 6802 93 10.

6802 99 90	Other The explanatory note to subheading 6802 93 90 applies, <i>mutatis mutandis</i> .
6803 00 00 6803 00	Worked slate and articles of slate or of agglomerated slate This heading includes roofing and wall slates which may be rectangular (including square), polygonal, rounded or any other shape. They are of uniform thickness not normally exceeding 6 mm.
6803 00 10	Roofing and wall slates <u>The products of this subheading may be rectangular (including square), polygonal, rounded or any other shape. They are of uniform thickness, not normally exceeding 6 mm.</u>
6804	Millstones, grindstones, grinding wheels and the like, without frameworks, for grinding, sharpening, polishing, truing or cutting, hand sharpening or polishing stones, and parts thereof, of natural stone, of agglomerated natural or artificial abrasives, or of ceramics, with or without parts of other materials Waste and scrap of hand-polishing stones, whetstones, oilstones, hones, millstones, grindstones, grinding wheels and the like made of natural or agglomerated artificial abrasives are not covered by this heading (subheading 2530 90 00).
6804 10 00	Millstones and grindstones for milling, grinding or pulping See the HS Explanatory Note to subheading 6804 10.
6804 21 00to 6804 23 00	Other millstones, grindstones, grinding wheels and the like See the HS Explanatory Note to heading 6804, first paragraph, (2) and (3).
6804 21 00	Of agglomerated synthetic or natural diamond This subheading covers articles of synthetic or natural diamond agglomerated in some way. The process may involve mineral agglomerating agents which set hard (for example, cement) or less rigid binders (for example, rubber or plastics) or ceramic firing.
6804 22 12to 6804 22 90	Of other agglomerated abrasives or of ceramics The explanatory note to subheading 6804 21 00 applies, <i>mutatis mutandis</i> .
6804 22 12to 6804 22 50	Of artificial abrasives, with binder Examples of artificial abrasives are corundum, silicon carbide (carborundum) and boron carbide.
6804 30 00	Hand sharpening or polishing stones See the HS Explanatory Note to heading 6804, first paragraph, (4).
6806	Slag-wool, rock-wool and similar mineral wools; exfoliated vermiculite, expanded clays, foamed slag and similar expanded mineral materials; mixtures and articles of heat-insulating, sound-insulating or sound-absorbing mineral materials, other than those of heading 6811or 6812or of Chapter 69
6806 10 00	Slag-wool, rock-wool and similar mineral wools (including intermixtures thereof), in bulk, sheets or rolls See the HS Explanatory Note to heading 6806, first three paragraphs. 'Similar mineral wools' include those obtained from mixtures of rock or slag which have undergone the processes set out in the HS Explanatory Note to heading 6806, first paragraph.
6806 20 10	Expanded clays See the HS Explanatory Note to heading 6806, sixth paragraph.

6806 20 90**Other**

This subheading includes:

1. exfoliated vermiculite and similar expanded mineral products other than clays (expanded chlorite, perlite and obsidian). See the HS Explanatory Note to heading 6806, fourth and fifth paragraphs.

However, expanded chlorite and perlite are included here only if the expansion process has been stopped when hollow granules have been obtained, i.e., before the granules burst to form concave lamellae. This lamellar product is generally used as a filtering agent and not as a heat or sound insulator; it therefore falls in subheading 3802 90 00 (see the HS Explanatory Note to heading 3802);

2. slag or rock 'foams' which, when in the form of blocks, slabs and the like, are similar to multicellular glass falling in heading 7016. In such cases, they can be distinguished from multicellular glass using the criteria for distinguishing wools of subheading 6806 10 00 and wools of heading 7019;
3. granulated blast-furnace slag which has been considerably expanded by foaming and which has an apparent density in the dry state of not more than 300 kg/m³.

6806 90 00**Other**

See the HS Explanatory Note to heading 6806, text following the asterisks.

6807

Articles of asphalt or of similar material (for example, petroleum bitumen or coal tar pitch)

6807 10 00**In rolls**

The roofing and facing products included under this subheading consist of at least three layers; a middle layer of paper or paperboard or of other materials (for example, glass wool, jute fabric, aluminium foil, felt, nonwoven fabric) sandwiched between two layers of asphalt or similar materials. These covering layers may also contain or be coated with other materials (for example, sand).

6809

Articles of plaster or of compositions based on plaster

6809 11 00 and 6809 19 00

Boards, sheets, panels, tiles and similar articles, not ornamented

These subheadings cover flat products of all kinds, used mainly for partitions and ceilings.

Articles which are simply perforated or covered with a thin layer of paper or other material on one or both sides are not regarded as ornamented. They may also have a simple coating of paint or varnish. Any ornamentation, consisting, for example, of motifs either sunken or in relief or of surface decoration or decoration in the mass, entails classification of such boards, panels, etc. in subheading 6809 90 00.

These subheadings also include square panels consisting of a perforated square of plaster on the outer surface of the panel, with two rectangular cavities to the depth of the plaster filled with strips of mineral wool and backed, on the interior surface, by paper covered in aluminium foil; these panels are for covering walls and ceilings to give thermal and sound insulation.

6810

Articles of cement, of concrete or of artificial stone, whether or not reinforced

Concrete is made from a mixture of cement, aggregates (sand, gravel) and water, which becomes extremely hard as it sets. Reinforced concrete also contains metal rods (reinforcing bars) or steel mesh.

When lighter aggregates are used (for example, expanded clays, crushed pumice, vermiculite, granulated slag) 'light concrete' is obtained.

6810 11 10

Of light concrete (with a basis of crushed pumice, granulated slag, etc.)

This subheading includes building blocks and bricks of porous concrete with a density in hardened form not exceeding 1,7 kg/dm³. Light concrete is a good heat insulator but is not as strong as higher-density concrete.

- 6812** **Fabricated asbestos fibres; mixtures with a basis of asbestos or with a basis of asbestos and magnesium carbonate; articles of such mixtures or of asbestos (for example, thread, woven fabric, clothing, headgear, footwear, gaskets), whether or not reinforced, other than goods of heading 6811 or 6813**
- 6812 80 10 and 6812 80 90** **Of crocidolite**
See the HS Explanatory Note to heading 2524, second paragraph.
- 6812 80 10** **Fabricated fibres; mixtures with a basis of asbestos or with a basis of asbestos and magnesium carbonate**
For the definition of the term 'fabricated fibres', see the HS Explanatory Note to heading 6812, first paragraph. However, waste from crocidolite articles is classified in subheading 2524 10 00.
The mixtures of this subheading are described in the HS Explanatory Note to heading 6812, second paragraph.
Waste in the form of fragments or dust from articles with a basis of asbestos or asbestos and magnesium carbonate also falls in this subheading.
- 6812 80 90** **Other**
This subheading includes paper, millboard and felt made of crocidolite fibre, paper pulp and possibly a filler if they contain 35 % or more crocidolite by weight. Otherwise, they are classified in Chapter 48.
See also the HS Explanatory Note to heading 6812.
- 6812 92 00** **Paper, millboard and felt**
Paper, millboard and felt made of asbestos fibre, paper pulp and possibly a filler fall in this subheading if they contain by weight 35 % or more of asbestos. Otherwise, they are classified in Chapter 48.
See also the HS Explanatory Note to heading 6812.
- 6812 99 10** **Fabricated asbestos fibres; mixtures with a basis of asbestos or with a basis of asbestos and magnesium carbonate**
For the definition of the term 'fabricated asbestos', see the HS Explanatory Note to heading 6812, first paragraph. However, waste from asbestos articles is classified in subheading 2524 90 00.
The mixtures of this subheading are described in the HS Explanatory Note to heading 6812, second paragraph.
Waste in the form of fragments or dust from articles with a basis of asbestos or asbestos and magnesium carbonate also falls in this subheading.
- 6814** **Worked mica and articles of mica, including agglomerated or reconstituted mica, whether or not on a support of paper, paperboard or other materials**
- 6814 10 00** **Plates, sheets and strips of agglomerated or reconstituted mica, whether or not on a support**
The plates, sheets and strips of this subheading are put up in rolls of indeterminate length or may be simply cut into squares or rectangles. Articles cut to any other shape are classified in subheading 6814 90 00.
- 6814 90 00** **Other**
This subheading includes sheets or splittings of mica cut to shape for a specific use. They differ from the sheets and splittings falling in heading 2525, according to the various characteristics listed in the HS Explanatory Note to heading 2525. This subheading also includes sheets and splittings of mica, even if not cut to shape as described above, which have undergone a process excluding them from heading 2525, such as polishing or bonding to a support.

CHAPTER 70

GLASS AND GLASSWARE

General

The term 'optical glass' covers various types of special glass used in manufacturing optical instruments, especially for use, for example, in photography, astronomy, microscopy, navigation, weapons systems (telescopic sights etc.), laboratory equipment and for making certain types of ophthalmic lenses to correct defects of vision. There is a wide variety of optical glass but their usual common feature is their extreme transparency and clarity, although they are sometimes tinted so that they absorb certain frequencies of light to a small degree. They are perfectly homogenous, i.e. normally without bubbles or unevenness, and have refractive indices and scattering properties unusual in other types of glass.

Sheets of glass set in frames of wood, metal, etc., are considered to have lost the essential character of glass and fall in various headings, for example:

1. for framing pictures (headings 4414 00, 8306, etc.);
2. for machinery or vehicles (section XVI or XVII);
3. for doors, windows of buildings, etc. (headings 4418, 7610, etc.).

7001 00 Cullet and other waste and scrap of glass; glass in the mass

7001 00 10 Cullet and other waste and scrap of glass

See the HS Explanatory Note to heading 7001, first paragraph, (A).
The term 'cullet' denotes broken glass for reuse in glassmaking.

7001 00 91 and 7001 00 99 Glass in the mass

See the HS Explanatory Note to heading 7001, first paragraph, (B), and the second and third paragraphs.

7002 Glass in balls (other than microspheres of heading 7018), rods or tubes, unworked

This heading covers only semi-manufactures in the unworked state, i.e., not worked after moulding, drawing or blowing except for cutting in the case of rods and tubes or fusing/moulding of extremities to render them smooth or roughly level and make the articles less dangerous to handle, whether or not the products fashioned in this way can be used without further working.

7002 10 00 Balls

See the HS Explanatory Note to heading 7002, first paragraph, (1), and the penultimate and last paragraphs.

7002 32 00 Of other glass having a linear coefficient of expansion not exceeding 5×10^{-6} per Kelvin within a temperature range of 0 °C to 300 °C

The basic characteristics of this glass are the absence of lead, an extremely small amount of potassium and alkaline-earth oxides and a considerable amount of boric oxide. Such glass has a high thermal conductivity and remarkable elasticity, making it resistant to sudden changes in temperature; as a result, it is particularly suitable for the manufacture of kitchenware, tableware, laboratory glassware, glass for light fittings, etc.

- 7003** **Cast glass and rolled glass, in sheets or profiles, whether or not having an absorbent, reflecting or non-reflecting layer, but not otherwise worked**
This heading does not include float glass (heading 7005).
For the definition of the term ‘worked’, see note 2(a) to this chapter.
- 7003 12 10to 7003 19 90** **Non-wired sheets**
For the definition of the term ‘wired’, see the HS Explanatory Note to heading 7003, penultimate paragraph before the exclusions.
- 7003 12 10to 7003 12 99** **Coloured throughout the mass (body tinted), opacified, flashed or having an absorbent, reflecting or non-reflecting layer**
For the definition of the term ‘absorbent or reflecting layer’, see note 2(c) to this chapter. For the definition of the term ‘opacified’, see the HS Explanatory Note to heading 7003, second paragraph, (B).
Flashed glass is a translucent glass normally made of a white opaline layer and a tinted layer; the two layers are pressed against each other when still soft so that they fuse.
- 7003 20 00** **Wired sheets**
See the explanatory note to subheadings 7003 12 10 to 7003 19 90.
- 7003 30 00** **Profiles**
Glass profiles are made by a continuous process in which the glass is formed immediately on leaving the furnace and during the rest of the continuous process. The glass is subsequently cut to the desired sizes but is not further worked after manufacture.
- 7004** **Drawn glass and blown glass, in sheets, whether or not having an absorbent, reflecting or non-reflecting layer, but not otherwise worked**
For the definition of the term ‘worked’, see note 2(a) to this chapter.
- 7004 20 10to 7004 20 99** **Glass, coloured throughout the mass (body tinted), opacified, flashed or having an absorbent, reflecting or non-reflecting layer**
See the explanatory note to subheadings 7003 12 10 to 7003 12 99.
- 7005** **Float glass and surface ground or polished glass, in sheets, whether or not having an absorbent, reflecting or non-reflecting layer, but not otherwise worked**
For the definition of the term ‘worked’, see note 2(a) to this chapter.
- 7005 10 05to 7005 10 80** **Non-wired glass, having an absorbent, reflecting or non-reflecting layer**
See the explanatory notes to subheadings 7003 12 10 to 7003 19 90 and to subheadings 7003 12 10 to 7003 12 99, first paragraph, first sentence.
- 7005 21 25to 7005 21 80** **Coloured throughout the mass (body tinted), opacified, flashed or merely surface ground**
For the definition of the term ‘opacified’, see the HS Explanatory Note to heading 7003, second paragraph, (B).

- 7010** Carboys, bottles, flasks, jars, pots, phials, ampoules and other containers, of glass, of a kind used for the conveyance or packing of goods; preserving jars of glass; stoppers, lids and other closures, of glass
- 7010 90 21** **Made from tubing of glass**
These containers are of circular cross-section and have a regular, uniform wall thickness which is generally below 2 mm. They bear no embossed marks, such as numbers, logos, lines or roughening. The visual examination shows almost no optical distortion in the glass.
The volumetric capacity of these containers generally ranges from 1 to 100 millilitres.
They are used primarily for the packaging of pharmaceutical or diagnostic products.
- 7013** **Glassware of a kind used for table, kitchen, toilet, office, indoor decoration or similar purposes (other than that of heading 7010 or 7018)**
- 7013 10 00** **Of glass ceramics**
For the definition of 'glass ceramics', see the HS General Explanatory Note to this chapter, final paragraph, (2).
- 7013 22 10 and 7013 22 90** **Of lead crystal**
For the definition of the term 'lead crystal', see subheading note 1 to this chapter.
- 7013 33 11 to 7013 33 99** **Of lead crystal**
For the definition of the term 'lead crystal', see subheading note 1 to this chapter.
- 7013 41 10 and 7013 41 90** **Of lead crystal**
For the definition of the term 'lead crystal', see subheading note 1 to this chapter.
- 7013 42 00** **Of glass having a linear coefficient of expansion not exceeding 5×10^{-6} per Kelvin within a temperature range of 0 °C to 300 °C**
See the explanatory note to subheading 7002 32 00.
- 7013 91 10 and 7013 91 90** **Of lead crystal**
For the definition of the term 'lead crystal', see subheading note 1 to this chapter.
- 7015** **Clock or watch glasses and similar glasses, glasses for non-corrective or corrective spectacles, curved, bent, hollowed or the like, not optically worked; hollow glass spheres and their segments, for the manufacture of such glasses**
- 7015 10 00** **Glasses for corrective spectacles**
See the HS Explanatory Note to heading 7015, (C).
- 7015 90 00** **Other**
See the HS Explanatory Note to heading 7015, (A) and (B).

- 7016** **Paving blocks, slabs, bricks, squares, tiles and other articles of pressed or moulded glass, whether or not wired, of a kind used for building or construction purposes; glass cubes and other glass smallwares, whether or not on a backing, for mosaics or similar decorative purposes; leaded lights and the like; multicellular or foam glass in blocks, panels, plates, shells or similar forms**
Rolled glass squares (for example, opal glass or glass resembling marble) do not fall in this heading but are classified in heading 7003 or 7005 as appropriate.
- 7017** **Laboratory, hygienic or pharmaceutical glassware, whether or not graduated or calibrated**
- 7017 10 00** **Of fused quartz or other fused silica**
The products covered by this subheading have a silica content of not less than 99 % by weight. Very pure quartz sand rock crystal or compounds of volatile silicon are used as a raw material for products of this kind. Glassware made from quartz sand is opaque or at most translucent. However, glassware made from rock crystal or volatile silicon is perfectly clear and transparent.
- 7017 20 00** **Of other glass having a linear coefficient of expansion not exceeding 5×10^{-6} per Kelvin within a temperature range of 0 °C to 300 °C**
See the explanatory note to subheading 7002 32 00.
- 7018** **Glass beads, imitation pearls, imitation precious or semi-precious stones and similar glass smallwares, and articles thereof other than imitation jewellery; glass eyes other than prosthetic articles; statuettes and other ornaments of lamp-worked glass, other than imitation jewellery; glass microspheres not exceeding 1 mm in diameter**
- 7018 10 11 and 7018 10 19** **Glass beads**
These subheadings include:
1. the articles described in the HS Explanatory Note to heading 7018, second paragraph, (A);
 2. similar articles known commercially as 'glass beads', consisting of glass beads of larger sizes (up to approximately the size of a walnut). These articles, mostly intended for the manufacture of necklaces and bracelets, are put up in very varied forms (for example, spheres, hemispheres, teardrops, dice, cylinders, small tubes, cones, polyhedrons) and are also pierced right through.
- Small tubes are regarded as glass beads for the purposes of these subheadings if their external diameter and length do not exceed 4 mm and 24 mm respectively. They should not be confused with special standardised tubes of lead glass of the type used for the manufacture of incandescent lamps and tungsten lamps; tubes of this type are usually colourless and fall in heading 7002.
- The articles falling in these subheadings are normally put up in bulk, in bags, in boxes, etc.
- These subheadings also include glass beads of identical size and colour strung together without separating knots and without means of fastening, for convenience of transport and for packing purposes. Such strings are usually tied in bundles by the free ends of their threads and do not, therefore, constitute assemblies normally ready for use.
- The following are excluded from these subheadings:
- (a) strings of beads (whether or not tied in bundles) in which beads of different sizes or colour are arranged in a regular fashion (for example, by alternating the colours or sizes in a regular fashion or by stringing the beads in order of size) or in which the beads are separated by knots (heading 7117);
 - (b) strings of beads (even if containing only beads of identical size, colour or manufacture) which include fastenings or similar mechanisms or which are in short lengths suitable for wear as necklaces (heading 7117).

- 7018 10 11** **Cut and mechanically polished**
Cut and mechanically polished beads falling in this subheading are distinguished from ‘heat-polished’ beads of subheading 7018 10 19 by their perfectly smooth facets and sharp edges. Furthermore, the ends of the holes are often faceted (sometimes, also polished) and have sharp-cut edges corresponding to the adjacent facets, whereas the ends of the holes in ‘heat-polished’ beads are often rounded and do not meet the facets in a sharp edge.
It is mainly the articles referred to in the first paragraph, item 2, of the explanatory note to subheadings 7018 10 11 and 7018 10 19 which are most often cut and mechanically polished.
- 7018 10 30** **Imitation pearls**
This subheading covers the articles described in the HS Explanatory Note to heading 7018, second paragraph, (B).
As regards strings of imitation pearls, the explanatory note to subheadings 7018 10 11 and 7018 10 19 applies, *mutatis mutandis*.
- 7018 10 51 and 7018 10 59** **Imitation precious or semi-precious stones**
These subheadings cover the articles described in the HS Explanatory Note to heading 7018, second paragraph, (C).
- 7018 10 51** **Cut and mechanically polished**
The cut and mechanically polished imitation precious and semi-precious stones of this subheading are distinguished from similar ‘heat-polished’ articles of subheading 7018 10 59 by their perfectly smooth facets and sharp edges.
- 7018 10 90** **Other**
This subheading includes imitation coral, beads and cabochons (other than imitation pearls or imitation precious and semi-precious stones) for the heads of hat-pins, drops for ear-clips and small glass tubes for making up into fringes.
With regard to the distinction between the small glass tubes falling in this subheading and those regarded as glass beads for the purposes of subheadings 7018 10 11 and 7018 10 19, see the second paragraph of the explanatory note to those subheadings.
- 7018 20 00** **Glass microspheres not exceeding 1 mm in diameter**
This subheading covers the articles described in the HS Explanatory Note to heading 7018, second paragraph, (H).
- 7018 90 10** **Glass eyes; articles of glass smallware**
See the HS Explanatory Note to heading 7018, second paragraph, (E) and (F).
- 7018 90 90** **Other**
This subheading covers the objects described in the HS Explanatory Note to heading 7018, second paragraph, (G).
- 7019** **Glass fibres (including glass wool) and articles thereof (for example, yarn, woven fabrics)**
The glass fibres falling in this heading are produced from textile glass, i.e., glass products in which the filaments are largely parallel to each other. There are two types of textile glass:
— continuous glass fibre consists of a large number of continuous parallel filaments with diameters of usually between 5 and 15 µm (microns). These filaments are held together in a thread (continuous strand or roving) by a ‘sizing agent’ (usually, a plastic material); the appearance of these strands is similar to that of silk rovings),
— glass staple fibre consists of a number of filaments of varying lengths and yields a roving that is soft and hairy in appearance.
- 7019 11 00** **Chopped strands, of a length of not more than 50 mm**
See the HS Explanatory Note to subheading 7019 11.

7019 12 00	Rovings See the HS Explanatory Note to subheading 7019 12.
7019 19 90	Of staple fibres See the HS Explanatory Note to subheading 7019 19. This subheading includes yarns made from staple fibres.
7019 31 00 7019 31 10 and 7019 31 90	Mats See the HS Explanatory Note to subheading 7019 31.
7019 32 00 7019 32 10 and 7019 32 90	Thin sheets (voiles) See the HS Explanatory Note to subheading 7019 32.
7019 90 10 7019 90 00	Non-textile fibres in bulk or flocks Other <u>Bulk fibres are a mass of individual filaments of different lengths jumbled together (glass wadding and glass wool) used for heat insulation or sound-proofing and usually presented in bales or paper sacks. This subheading includes bulk fibres which are a mass of individual filaments of different lengths jumbled together (glass wadding and glass wool) and which are used for heat insulation or sound-proofing and usually presented in bales or paper sacks.</u>
7020 00	Other articles of glass
7020 00 07 and 7020 00 08	Glass inners for vacuum flasks or for other vacuum vessels See the HS Explanatory Note to heading 7020, second paragraph, (4).
7020 00 08	Finished The term 'finished' applies only to glass inners ready for cladding or being otherwise sheathed.

SECTION XIV

NATURAL OR CULTURED PEARLS, PRECIOUS OR SEMI-PRECIOUS STONES, PRECIOUS METALS, METALS CLAD WITH PRECIOUS METAL, AND ARTICLES THEREOF; IMITATION JEWELLERY; COIN

SECTION XV

BASE METALS AND ARTICLES OF BASE METAL

General

Waste or scrap from non-ferrous metals which has been melted down and cast into ingots, pigs, blocks or similar forms is classified as unwrought metal and not as waste or scrap. It is consequently classified, for example, in heading 7601 (aluminium), 7801 (lead), 7901 (zinc) or in subheading 8104 11 00 or 8104 19 00 (magnesium).

The expression 'metal' is taken to include also metal which has an amorphous (non-crystalline) structure, such as metallic glasses and powder metallurgy products.

CHAPTER 73

ARTICLES OF IRON OR STEEL

- 7301 Sheet piling of iron or steel, whether or not drilled, punched or made from assembled elements; welded angles, shapes and sections, of iron or steel**
This heading covers sheet piling and welded angles, shapes and sections which have undergone working such as drilling, twisting, etc., provided that such working has not conferred on them the character of products covered elsewhere.
- 7301 20 00 Angles, shapes and sections**
This subheading does not cover perforated angles and 'Halfen' angles, shapes and sections (heading 7308).
- 7302 Railway or tramway track construction material of iron or steel, the following: rails, check-rails and rack rails, switch blades, crossing frogs, point rods and other crossing pieces, sleepers (cross-ties), fish-plates, chairs, chair wedges, sole plates (base plates), rail clips, bedplates, ties and other material specialised for jointing or fixing rails**
- 7302 10 10 Current-conducting, with parts of non-ferrous metal**
This subheading covers only current-conducting rails, excluding running rails, the contact surface of which is of non-ferrous metal (aluminium, copper) or which are equipped with connecting pieces made of non-ferrous metals. Conductor rails falling in this subheading also commonly called 'third (or fourth) rails', have the same cross-section as a running rail or have a double T or rectangular or trapezoidal etc. cross-section, and are made of steel which is generally softer than that of running rails, because their mechanical properties can be sacrificed to the electrical qualities: the electrical resistivity, which in the steel of running rails is about $0,19 \times 10^{-6}$ ohm m, is only 0,11 ohm m for steel with a low carbon content (0,08 % approximately) and manganese content (0,20 %) and even 0,10 ohm m for Armco iron (practically pure iron: 99,9 %). Conductor rails can have an upper, lateral or lower contact and are often protected by a coating of resin which leaves uncovered the side on which the skid runs.
- ~~7302 10 21~~ ~~7302 10 22~~ ~~to~~ ~~to~~
~~7302 10 29~~ ~~7302 10 28~~
7302 10 28 Vignole rails
The Vignole rail, named after its inventor, is the type of rail commonly used for general and high-speed railway tracks or mountain railways or regional networks. They have the following shape:





7302 10 40**Grooved rails**

Grooved rails are special-purpose rails for tramways and for industrial uses such as cranes and overhead transporters. The profile of the rail is designed in such a way that the flange of the wheel fits into the hollow space of the groove. They have the following shape:

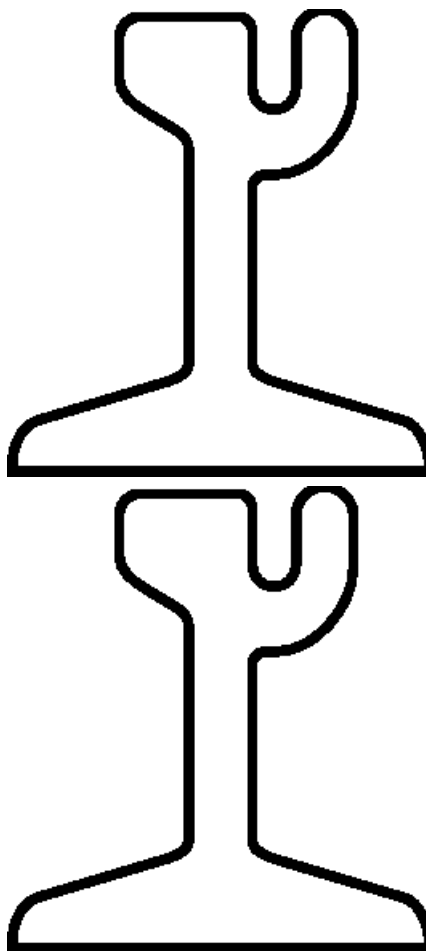
**7302 10 90****Used**

This subheading does not include used rails regarded as scrap of heading 7204, for example, twisted rails and cut-up rails of less than 1,5 m in length.

7303 00**Tubes, pipes and hollow profiles, of cast iron****7303 00 10****Tubes and pipes of a kind used in pressure systems**

This subheading includes cast-iron tubes and pipes commonly used as supply lines (often buried) for gas and water and which can withstand a pressure of at least 10,13 bar. Such tubes and pipes are manufactured almost exclusively from particularly high-strength ductile cast iron (minimum tensile strength: 420 MPa) and must possess particularly good mechanical properties (in particular plastic deformation) if they are not to fracture as a result of gradual shifts in the soil. They therefore have a yield point of at least 300 MPa.

7304**Tubes, pipes and hollow profiles, seamless, of iron (other than cast iron) or steel**

Articles of this heading, of a length which does not exceed twice the greatest external dimension of the cross-section, are not considered as tubes or pipes. They are considered to be either tube or pipe fittings (heading 7307) or washers (heading 7318).

7304 31 20**Precision tubes**

The products of this subheading are characterised by their smooth, shiny or polished internal or external surfaces and by the fact that their tolerances are stricter than those for hot-finished tubes.

Tubes meeting the requirements of ISO Standard 3304 and the related national standards are used for applications such as hydraulic or pneumatic circuits, shock absorbers, hydraulic or pneumatic screws, and generally for the fabrication of parts for motor vehicles, motors or machines.

However, tubes meeting the provisions of ISO Standards 2604 and 6759 and the relevant national standards are used as conduits in pressure vessels: boilers, superheaters, heat-exchangers and feedwater heaters for power stations, where the tolerances imposed on precision tubing are required.

- 7304 39 10** **Unworked, straight and of uniform wall-thickness, for use solely in the manufacture of tubes and pipes with other cross-sections and wall-thicknesses**
 This subheading includes seamless steel tubes, usually obtained by piercing and hot-rolling or by piercing and hot-drawing; they are usually called 'blanks'. They are intended to be transformed into tubes of other shapes and wall-thickness with more reduced dimensional tolerances.
 They are presented with the ends roughly cut off and deburred, but are otherwise unfinished. Their exterior and interior surfaces are rough and not descaled. They are not oiled, zinc-coated or painted.
- 7304 39 52 and 7304 39 58** **Threaded or threadable tubes (gas pipe)**
 These tubes are obtained by hot-rolling and calibration. They have an external diameter of 13,5 to 165,1 mm, and are delivered with smooth ends or threaded ends with sleeves. They have either an unfinished surface or a surface with a layer of zinc or other protective product, for example, plastic or bitumen.
 Hot-finishing gives them mechanical properties which enable them to be cut to the length at which they are to be used, bent and where necessary threaded *in situ*.
 They are used mainly for the distribution of steam, water or gas in buildings.
 They meet the requirements of ISO Standard 65 and the relevant national standards.
- 7304 49 10** **Unworked, straight and of uniform wall-thickness, for use solely in the manufacture of tubes and pipes with other cross-sections and wall-thicknesses**
 See the explanatory note to subheading 7304 39 10.
- 7304 51 81** **Precision tubes**
 See the explanatory note to subheading 7304 31 20.
- 7304 59 10** **Unworked, straight and of uniform wall-thickness, for use solely in the manufacture of tubes and pipes with other cross-sections and wall-thicknesses**
 See the explanatory note to subheading 7304 39 10.
- 7305** **Other tubes and pipes (for example, welded, riveted or similarly closed), having circular cross-sections, the external diameter of which exceeds 406,4 mm, of iron or steel**
 The explanatory note to heading 7304 applies, *mutatis mutandis*.
- 7306** **Other tubes, pipes and hollow profiles (for example, open seam or welded, riveted or similarly closed), of iron or steel**
 The explanatory note to heading 7304 applies, *mutatis mutandis*.
- 7306 30 11 and 7306 30 19** **Precision tubes, with a wall thickness**
 These subheadings cover both precision tubes not further worked than calibrated and precision tubes welded and cold-drawn.
1. *Tubes not further worked than calibrated*
 These tubes are generally obtained by continuous welding, without filler metal, by electrical resistance or induction welding, from coiled flat-rolled products, hot-rolled or cold-rolled, after cold forming in the longitudinal direction.
 For the most part, their surfaces are free of scale and oiled, as a result of lubrication during forming, welding and calibrating. There is no external weld seam, this having been ground down immediately after welding. In some cases, the weld seam is also removed from the internal surface of the product.
 Following cold working and calibration, these products are delivered in the work-hardened state, unless heat treatment for the regeneration of the structure is not required.
 They are mainly used for the manufacture of parts of motor vehicles or machines, metal furniture, bicycle frames, perambulators, gates and balustrades.
 They meet the requirements of ISO Standard 3306 and the relevant national standards.
 2. *Welded, drawn tubes*
 These tubes can be distinguished from welded precision tubes not further worked than calibrated, by the fact that no trace of a weld seam exists on either the external or the internal surface of the tube and that their dimensional tolerances are stricter.
 Their uses are the same as those in subheadings 7304 31 20 and 7304 51 81.
 They meet the requirements of ISO Standard 3305, or those of ISO Standards 2604 and 6758 if they are used for pressure vessels.

7306 30 41 and 7306 30 49 Threaded or threadable tubes (gas pipe)

These tubes are made by the weld-forging process after hot working. For the other characteristics and uses, see the explanatory note to subheadings 7304 39 52 and 7304 39 58.

7306 50 20 Precision tubes

See the explanatory note to subheadings 7306 30 11 and 7306 30 19.

7307 Tube or pipe fittings (for example, couplings, elbows, sleeves), of iron or steel**7307 11 10 and 7307 11 90 Of non-malleable cast iron**

The expression 'non-malleable' includes lamellar graphite cast iron.

These subheadings cover cast-iron fittings, such as elbows, bends, sleeves, ties, collars and tees. They are connected to tubes or pipes of cast iron or steel by screwing, contact or by mechanical assembly.

7307 19 10 Of malleable cast iron

Malleable cast iron is an intermediate product between lamellar graphite iron (grey iron) and cast steel. It can be easily cast and becomes tough and malleable after suitable heat treatment. During the heat treatment, the carbon partly disappears or changes its make-up; it finally deposits in the form of nodules which do not impair metallic cohesion to such an extent as the graphite flakes in grey cast iron.

Where the carbon content is 2 % or less by weight, the products are regarded as being of cast steel and fall in subheading 7307 19 90 (see note 1 to this chapter).

The expression 'malleable' includes spheroidal graphite cast iron.

See also the explanatory note to subheadings 7307 11 10 and 7307 11 90, second paragraph.

7307 23 10**Elbows and bends**

This subheading includes elbows and bends of constant thickness throughout their generating lines, as described in ISO Standard 3419-1981 and in the relevant national standards.

Their ends are cut square and, in products with thicker walls, are chamfered to facilitate welding to the tubes.

The fittings are presented with either 45° or 90° bends (known as elbows) or with 180° bends (known as bends).

This subheading also covers elbows and bends the thickness of which is not constant.

7307 23 90**Other**

This subheading covers mainly tees and crosses, sleeves, plugs and concentric or eccentric reducers described in ISO Standard 3419-1981 and in the relevant national standards.

With respect to the finishing of the ends, see the explanatory note to subheading 7307 23 10.

7307 93 11**Elbows and bends**

See the explanatory note to subheading 7307 23 10.

7307 93 19**Other**

See the explanatory note to subheading 7307 23 90.

7307 93 91**Elbows and bends**

See the explanatory note to subheading 7307 23 10.

7307 93 99**Other**

See the explanatory note to subheading 7307 23 90.

7308**Structures (excluding prefabricated buildings of heading 9406) and parts of structures (for example, bridges and bridge-sections, lock-gates, towers, lattice masts, roofs, roofing frameworks, doors and windows and their frames and thresholds for doors, shutters, balustrades, pillars and columns), of iron or steel; plates, rods, angles, shapes, sections, tubes and the like, prepared for use in structures, of iron or steel**

In addition to the products mentioned in the HS Explanatory Note to heading 7308, this heading includes:

1. perforated angles ('handy angles' or 'Dexion slotted angles') prepared for use in the assembly of metal structures such as racks, sets of shelves, furniture, stairs, scaffolding, roofing frameworks, presented separately or in sets;
2. 'Halfen' angles, shapes and sections of approximately omega cross-section with slits at irregular intervals along the back, slightly humped to permit insertion of an anchor strip, intended for embedding in concrete floors, ceilings or walls, for the purpose of securing by means of special bolts various types of equipment (machines, railway track, conveyor track, monorails, mobile cranes, piping, etc.).

7308 90 59**Other**

This subheading includes panels with an insulating core between a wall of profiled (ribbed) sheet as classified in subheading 7216 91 10 and a wall of sheet other than profiled (ribbed).

- 7310 Tanks, casks, drums, cans, boxes and similar containers, for any material (other than compressed or liquefied gas), of iron or steel, of a capacity not exceeding 300 l, whether or not lined or heat-insulated, but not fitted with mechanical or thermal equipment**
- 7310 21 11 Cans of a kind used for preserving food**
This subheading covers cans having the following characteristics:
- the body of the can
 - is either printed with the name of the food, or
 - is delivered blank and is later provided with a label;
 - the top of the can is always opened completely, and can have for example a ring which allows the opening of the top.
- The top may, however, be supplied separately.
- 7310 21 19 Cans of a kind used for preserving drink**
This subheading covers cans having the following characteristics:
- the body of the can is always printed with the name of the drink,
 - the top is always opened partially, and can have for example a ring pushing or pulling a latch.
- The top may, however, be supplied separately.
- 7311 00 Containers for compressed or liquefied gas, of iron or steel**
This heading does not cover portable tyre inflators comprising, in addition to a compressed-air reservoir, a pressure gauge, a filling tube, an adapter nozzle and air inlet and outlet valves, and in which the pressure gauge is used for measuring the pressure of the tyre and not the pressure inside the reservoir (subheading 9026 20 40 or 9026 20 80).
- 7312 Stranded wire, ropes, cables, plaited bands, slings and the like, of iron or steel, not electrically insulated**
- 7312 10 61to 7312 10 69 Stranded wire**
Stranded wire consists of circular cross-section wires twisted in one or more layers around a core. Stranded wire may be round-strand, flat-strand or triangular strand, depending on the cross-section.
- 7312 10 81to 7312 10 98 Ropes and cables (including locked coil ropes)**
Ropes generally consist of a number of strands twisted in one or more layers around a core. Locked coil ropes have one or more outer layers consisting wholly or partly of interlocking wires, thus providing a surface impervious to water or foreign bodies. They always have a circular cross-sectional shape.

7318 **Screws, bolts, nuts, coach screws, screw hooks, rivets, cotters, cotter-pins, washers (including spring washers) and similar articles, of iron or steel**

7318 11 00

Coach screws

Coach screws are a special kind of wood screw which differs from the latter because they have a hexagonal head or a square head and may have a fixed cap.

There are two types of coach screws:

- screws used to secure railway lines to sleepers of wood which are, in principle, large wood screws with a hexagonal or square unslotted head (see example A);
- screws used for assembling rafters and for similar heavy woodwork which, in view of their use, have a diameter of the shank which is more than 5 mm (see example B).



Example A



Example B

7318 14 91

Spaced-thread screws

This subheading covers hardened screws with head and fixing thread (V-thread) for driving into sheet metal. The thread, which is not metric, extends from the shank end to the head. The shank end is pointed or a journal. They typically have the following appearance:

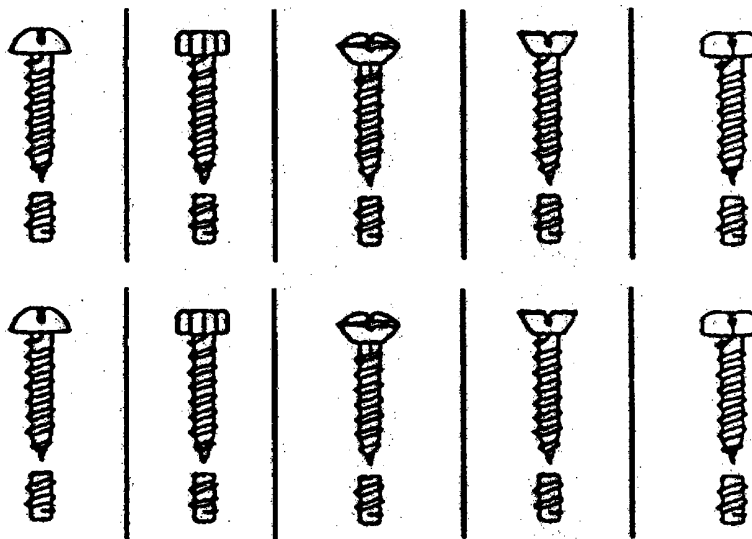

7318 15 10

Screws, turned from bars, rods, profiles or wire, of solid section, of a shank thickness not exceeding 6 mm Turned from bars, rods, profiles or wire, of solid section, of a shank thickness not exceeding 6 mm

'Screw-machine produced' articles are considered to be those turned on a screw machine from bars, sections or wire, with their complete cross-section. These articles do not necessarily have to have been turned throughout the whole of their length.

In addition to having been turned, they may have undergone other metal-removing operations, for example, milling, drilling, boring, or planing. They may also have slots or grooves. Surface working which does not alter their form and which is carried out after turning may also be permitted, provided that the articles are still identifiable as having been obtained by turning.

7318 15 20

For fixing railway track construction material

This subheading includes:

1. hook bolts which generally have a square or trapezoidal head, with or without a square neck, and which are used for metal sleepers;
2. fish bolts which generally have a square or round head and oval neck, and which are used to join rails to one another;
3. other bolts for fixing railway track construction material, which are generally supplied with nuts attached and which have a shank thickness not less than 18 mm.

7318 15 30to 7318 15 49

Without heads

These subheadings include goods which typically have the following appearance:

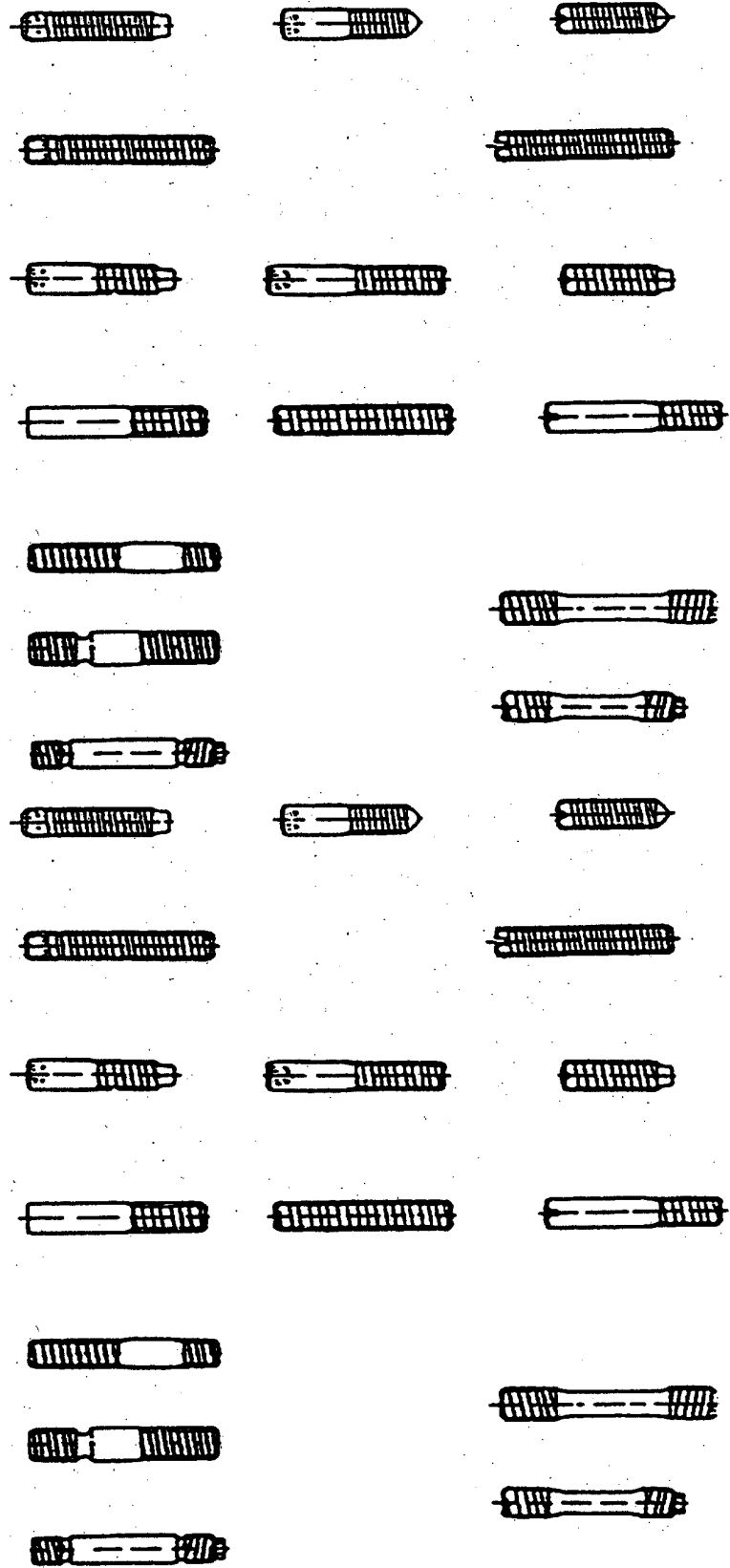

7318 15 90

Other

This subheading includes screws and bolts with square socket heads or square, octagonal or triangular heads,

wing screws:



knurled screws:



flat leaf screws:



wing screws:



knurled screws:



flat leaf screws:



round-headed screws and bolts of various types, for example:

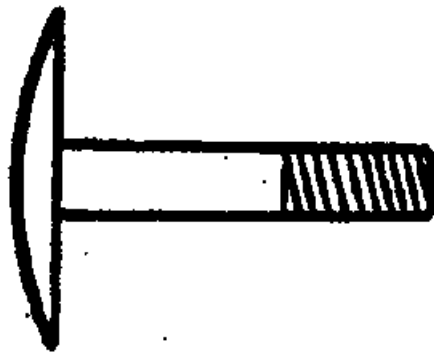

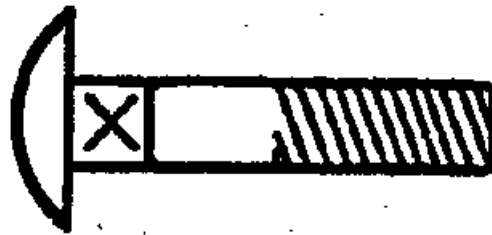
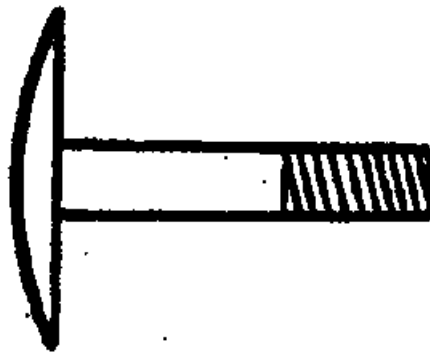

7318 16 10

Turned from bars, rods, profiles or wire, of solid section, of a hole diameter not exceeding 6 mm
See the explanatory note to subheading 7318 15 10.

7318 16 91 and 7318 16 99

Other, with an inside diameter

The inside diameter must be measured at the root of the thread. The diameter of bolts, on the other hand, must be measured at the crest of the thread.

7320

Springs and leaves for springs, of iron or steel

7320 10 11

Laminated springs and leaves therefor

Laminated springs are hot-worked leaf-springs with a cross-section tapering from the mid-point to either end.

7320 20 81

Coil compression springs

Coil compression springs are designed to react to pressure and are, therefore, open-coiled.

7320 20 85

Coil tension springs

Coil tension springs are designed to react to tension and are, therefore, close-coiled.

7320 20 89

Other

This subheading includes coil torsion springs and volute springs. Coil torsion springs typically have the following appearance:

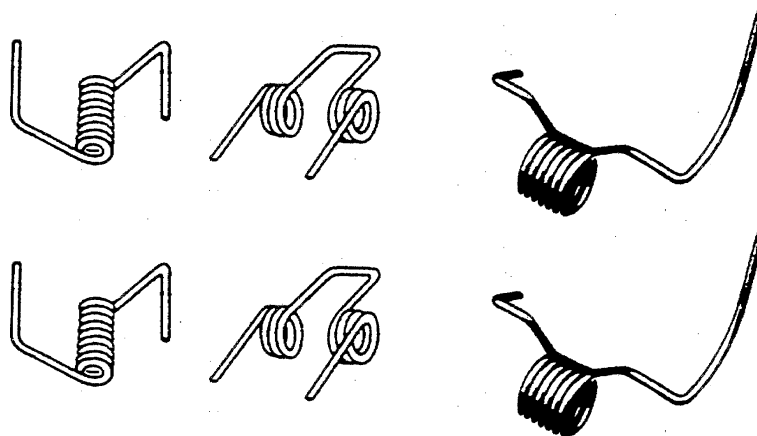

Volute springs typically have the following appearance:

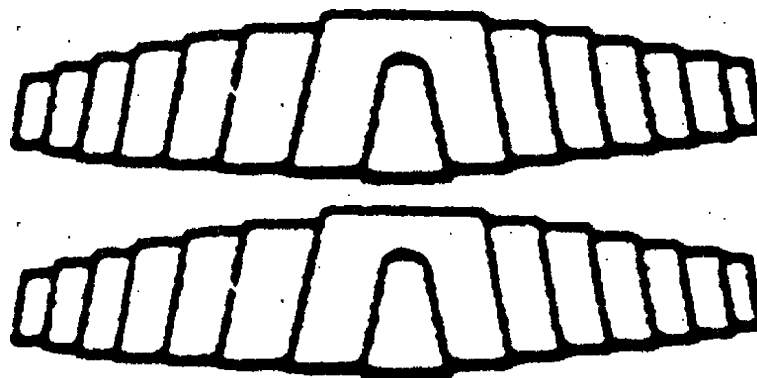

7320 90 30

Disc springs

Disc springs typically have the following appearance:

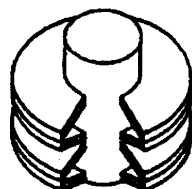

Disc spring column
(cutaway)

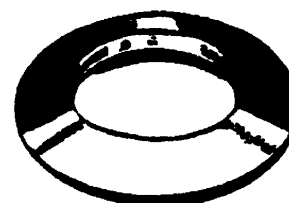

Single disc spring

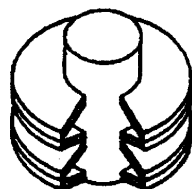

Disc spring column
(cutaway)

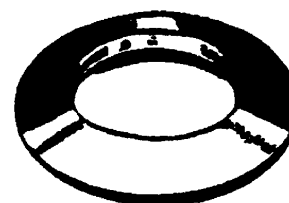

Single disc spring

7324

Sanitary ware and parts thereof, of iron or steel

7324 10 00

Sinks and washbasins, of stainless steel

Stainless steel is defined in note 1(e) to Chapter 72. The articles of this subheading are usually made of stainless steel of the austenitic type containing approximately 18 % chromium and 8 % nickel.

They are produced either by the deep drawing of a sheet of stainless steel to give a one-piece sink or by the joining of one or more sink units with one or two smooth or channelled draining boards.

7326

Other articles of iron or steel

7326 20 807326 20 00

Other Articles of iron or steel wire

This subheading includes products consisting of one or more steel wires sandwiched between two strips of paper or plastic, not cut to length. These goods are generally supplied on spools for use with automatic bag-closing machines. When cut into short lengths (suitable for sealing bags, sachets, etc.), these products are classified in heading 8309 (see the HS Explanatory Note to heading 8309, second paragraph, (9)).

CHAPTER 76
ALUMINIUM AND ARTICLES THEREOF

- 7601** **Unwrought aluminium**
This heading covers aluminium in the forms described in the HS Explanatory Note to heading 7601. It also covers pieces resulting from cutting or breaking these products.
- ~~7601 20 91 and 7601 20 99~~ **Secondary**
Secondary aluminium is obtained by remelting aluminium waste or scrap.
- 7602 00** **Aluminium waste and scrap**
This heading does not cover unwrought waste and scrap which has been remelted (heading 7601).
- 7602 00 11** **Turnings, shavings, chips, milling waste, sawdust and filings; waste of coloured, coated or bonded sheets and foil, of a thickness (excluding any backing) not exceeding 0,2 mm**
This subheading covers turnings, shavings, chips or sawdust, milling waste and filings which constitute the waste from products which have been worked on by lathe, milling machine, plane, drill, saw, grinding machine or file.
This subheading also covers waste of coloured, coated or bonded sheets and foil, of a thickness (excluding any backing) not exceeding 0,2 mm.
This waste must undergo a special treatment, before recovery of the metal, for the removal of foreign substances (grease, oil, coatings, paper, etc.)
- 7602 00 19** **Other (including factory rejects)**
This subheading covers all aluminium waste not covered by subheading 7602 00 11.
‘Factory rejects’ is to be taken to mean new articles, finished or unfinished, which because of a manufacturing fault (for example, a defect in the metal structure or a defect resulting from processing) can be used only for the recovery of the metal.
- 7602 00 90** **Scrap**
Aluminium scrap is to be taken to mean old aluminium articles which have become unfit for their original use because they have been broken, cut or become worn, together with scrap from these articles.
- 7603** **Aluminium powders and flakes**
- 7603 20 00** **Powders of lamellar structure; flakes**
See the explanatory note to subheading 7406 20 00.
- 7608** **Aluminium tubes and pipes**
The explanatory note to heading 7304 applies, *mutatis mutandis*.

SECTION XVI

MACHINERY AND MECHANICAL APPLIANCES; ELECTRICAL EQUIPMENT; PARTS THEREOF; SOUND RECORDERS AND REPRODUCERS, TELEVISION IMAGE AND SOUND RECORDERS AND REPRODUCERS, AND PARTS AND ACCESSORIES OF SUCH ARTICLES

Note 4 Unless otherwise indicated, transmission can also be made by means of devices (whether or not built into the individual components) which use infra-red rays, radio waves or laser beams etc. over short distances.

Additional note 1**A. Tools for the assembly or maintenance of machines**

To be classified with the appropriate machines, assembly or maintenance tools must satisfy the following three conditions concerning their nature, intended use and presentation:

1. they must be tools, i.e., hand tools of heading 4417 00 00 or 8205 or, for example, tools falling in subheading 8203 20 00, 8203 30 00, 8203 40 00, 8204 11 00, 8204 12 00, 9603 29 80, 9603 30 90, 9603 40 10, 9603 40 90, 9603 90 91 or 9603 90 99.

Measuring and checking instruments of Chapter 90 are excluded in all cases;

2. they must be intended for the assembly or maintenance of the appropriate machine. Where the tools are identical, only those which must be used simultaneously are to be classified with their machines. Where they are different, only one of each kind of tool is allowed;
3. they must be presented for customs clearance at the same time as the appropriate machines.

B. Interchangeable tools

To be classified with the appropriate machines, interchangeable tools must fulfil three conditions:

1. they must be tools, i.e., tools falling in heading 8207 or, for example, tools falling in headings 4016, 5911 and 6909 or in subheading 4205 00 11, 4205 00 19, 6804 10 00, 6804 21 00, 6804 22 12, 6804 22 18, 6804 22 30, 6804 22 50, 6804 22 90, 6804 23 00 or 9603 50 00.

Moulds (heading 8480) and accessories, including accessory apparatus (of, for example, heading 8466), are not considered as tools and consequently do not qualify under this additional note;

2. they must form part of the normal equipment of the appropriate machines.

The following are considered part of the normal equipment of a machine:

- (a) any number of identical tools which can be accommodated on the machine simultaneously;
- (b) one of each kind of tool if the tools are different;

3. they must normally be sold with the appropriate machine and be presented for customs clearance with it.

Additional note 3

A machine in a disassembled or unassembled state may be imported in several consignments over a period of time, if this is necessary for convenience of trade or transport.

In order to be able to declare the different constituent parts under the same tariff heading or subheading as the assembled machine, the declarant must make a request in writing to the customs post not later than the first consignment and attach:

- (a) a diagram or, if necessary several diagrams, of the machine showing the serial numbers of the most important constituent parts;

- (b) a general inventory containing an indication of the characteristics and approximate weights of the different parts and the serial numbers of the principal parts referred to above.

The application may be accepted only in fulfilment of a contract for the supply of a machine which can be regarded as complete for the purposes of the Combined Nomenclature.

All the constituent parts must be imported through the same entry point within the allowed time. However, in special cases, the competent authorities may authorise importation through several points of entry. This time limit may not be exceeded unless a reasoned and justified request for an extension is made to the competent authorities.

Upon each partial importation, a list of the parts making up the consignment with references to the aforementioned general inventory must be provided. The customs declaration for each consignment must contain descriptions of both the part or parts making up the consignment and the complete machine.

CHAPTER 84

NUCLEAR REACTORS, BOILERS, MACHINERY AND MECHANICAL APPLIANCES; PARTS THEREOF

General

For the purposes of subheadings 8407 34 10, 8407 90 50 and 8408 20 10, 'for the industrial assembly' applies only to the series-assembly of new vehicles in factories which manufacture or assemble motor vehicles (including subcontractors).

These subheadings can be applied only to engines actually used in the production of new vehicles of the kinds referred to in the subheadings. Consequently, they do not cover similar engines used as spare parts.

- 8402** **Steam or other vapour generating boilers (other than central heating hot water boilers capable also of producing low pressure steam); superheated water boilers**
- 8402 19 90** **Other**
This subheading includes hybrid firetube water-tube boilers and also special tank-boiler variants, such as electrically heated steam boilers equipped with electric-heating cartridges instead of firing plant.
- 8405** **Producer gas or water gas generators, with or without their purifiers; acetylene gas generators and similar water process gas generators, with or without their purifiers**
- 8405 10 00** **Producer gas or water gas generators, with or without their purifiers; acetylene gas generators and similar water process gas generators, with or without their purifiers**
This subheading does not include:
(a) town gas generators (coking ovens), as used in gasworks (heading 8417);
(b) electrolytic gas generators (for example, for the generation of nitrogen dioxide, hydrogen sulphide or prussic acid, depending upon the electrolyte used) are to be classified in heading 8543.
- 8407** **Spark-ignition reciprocating or rotary internal combustion piston engines**
- 8407 21 10 to 8407 29 00** **Marine propulsion engines**
These subheadings do not cover engines used on board water craft for purposes other than propulsion.
- 8408** **Compression-ignition internal combustion piston engines (diesel or semi-diesel engines)**
- 8408 10 11 to 8408 10 99** **Marine propulsion engines**
See the explanatory note to subheadings 8407 21 10 to 8407 29 00.

- 8409** **Parts suitable for use solely or principally with the engines of heading 8407 or 8408**
In addition to the exclusions referred to in the HS Explanatory Note to heading 8409, the following are also excluded from this heading:
- (a) piping and tubing, of unhardened vulcanised rubber (heading 4009);
 - (b) flexible tubing and piping, of base metal (heading 8307);
 - (c) gaskets and similar joints (generally, classified according to their constituent material or in heading 8484).
- 8409 99 00** **Other**
This subheading does not include exhaust-gas turbochargers used to compress the atmospheric air needed for combustion in order to boost the power of internal-combustion piston engines. As turbine-driven air compressors driven by an exhaust-gas turbine, they fall in heading 8414.
- 8411** **Turbojets, turbopropellers and other gas turbines**
- 8411 11 00 to 8411 12 80** **Turbojets**
These subheadings do not cover so-called after-burning auxiliary appliances, presented separately (subheading 8411 91 00).
- 8411 99 00** **Other**
This subheading includes rotor (fan) blades for gas turbines, whether or not the gas turbine functions as a prime mover in combination with an electric generator.
- 8412** **Other engines and motors**
- 8412 21 20 to 8412 29 89** **Hydraulic power engines and motors**
These subheadings include motors for hydraulic transmission.
- 8412 21 20 and 8412 21 80** **Linear acting (cylinders)**
These subheadings cover hydraulic positioning and locking actuators used to adjust the position of seats for the crew of aircraft.
- 8413** **Pumps for liquids, whether or not fitted with a measuring device; liquid elevators**
- 8413 50 20** **Hydraulic units**
See the HS Explanatory Note to heading 8412, (B), (6).
- 8413 60 20** **Hydraulic units**
See the HS Explanatory Note to heading 8412, (B), (6).
- 8413 70 51 to 8413 70 75** **Radial flow pumps**
In radial flow pumps, the liquid is propelled at right angles to the axis of the impeller.
- 8413 70 81 and 8413 70 89** **Other centrifugal pumps**
These subheadings include, in particular, axial-flow centrifugal pumps in which the liquid is propelled along the axis of the impeller. They also include hybrid types of radial-flow and axial-flow pumps (for example, radial intake and axial outflow or axial intake and radial outflow).

- 8413 81 00 and 8413 82 00** **Other pumps; liquid elevators**
These subheadings do not cover:
- (a) so-called medical suction pumps for drawing off secretions, which, in addition to the pump, also consist of a suction device and are used in operating theatres or emergency accident ambulances (mobile operating theatres) (heading 9018);
 - (b) medical pumps which are to be worn, carried or implanted in the body, fitted with a supply reservoir and acting as medicine dispensers incorporating an energy source to drive the pump, in a common housing (heading 9021).
- 8414** **Air or vacuum pumps, air or other gas compressors and fans; ventilating or recycling hoods incorporating a fan, whether or not fitted with filters**
For the purposes of this heading, pumps and compressors also include motor pumps, turbopumps, motor compressors and turbo-compressors.
- 8414 10 89** **Other**
This subheading includes liquid-ring vacuum pumps and membrane vacuum pumps.
- 8414 20 20 and 8414 20 80** **Hand- or foot-operated air pumps**
Only those pumps which are hand- or foot-operated, i.e., operated solely by human effort, as described in the HS Explanatory Note to heading 8414, (A), fall in these subheadings. They must be designed, in particular, for the inflation of pneumatic tyres (for example, for cycles, motor vehicles, etc.) and similar goods, for example, air mattresses, air cushions and inflatable boats.
- 8414 51 00 to 8414 59 80** **Fans**
Only those goods displaying the characteristics described in the HS Explanatory Note to heading 8414, (B), and complying with the following conditions are considered to be fans for the purposes of these subheadings:
1. the air or gas pressure must not exceed 2 bar;
 2. they must incorporate only one rotating surface (one stage).
- Air compressors not satisfying the above conditions are classified in subheadings 8414 80 11 to 8414 80 80.
- 8414 59 40** **Centrifugal fans**
Centrifugal fans are those in which air or other gas to be moved is taken in axially and discharged radially.
- 8414 80 11 and 8414 80 19** **Turbo-compressors**
In a turbo-compressor, the vane wheel shaft is driven by an external motor and the air or the other gas to be pumped is set in motion by the vane wheel. Turbo-compressors may be single-stage or multi-stage, axial or radial. Simple two-stage compressors are used, for example, in vacuum cleaners.
- 8414 80 11** **Single-stage**
This subheading also includes exhaust-gas turbochargers for internal-combustion piston engines, where they are used to compress the atmospheric air needed for combustion in order to increase power output. They are single-stage air turbo-compressors (blowers) used to generate an overpressure of more than 2 bar and are driven by an exhaust-gas turbine installed adjacent to the compressor casing. The exhaust-gas turbine is supplied with exhaust gases from the internal-combustion piston engine on which it is mounted.
- 8414 90 00** **Parts**
This subheading also includes parts of exhaust-gas turbochargers for internal combustion engines. However, parts of the exhaust-gas turbine used with exhaust-gas turbochargers are classified in heading 8411 as parts of a gas turbine without combustion chamber.

8418 Refrigerators, freezers and other refrigerating or freezing equipment, electric or other; heat pumps other than air-conditioning machines of heading 8415

8418 69 00

Other

This subheading includes 'chill dryers' which are devices used to dry the air in swimming-pool buildings and other damp premises. Basically, they consist of a refrigerating unit and a motor-driven fan. The fan ingests the moist air, which is then ducted to the refrigerator-unit evaporator, where it is condensed on the cold walls. The resultant condensate water is caught in a trough. The dried air is led for reheating across the heated refrigerator-unit condenser and fed back into the room. In the case of the chill dryers used to dry compressed air in the compressed-air systems also covered by this subheading, the dried compressed air is normally reheated by means of an additionally installed air-air heat exchanger. This heat exchanger conducts the heat from the damp compressed air entering on the input side of the chill dryer via walls to the dried, compressed air.

These appliances are not provided with devices for adjusting the temperature of the air.

However, this subheading does not cover devices producing dry ices (slab ice) by means of the rapid reduction of the pressure of high-pressure carbon dioxide with resultant supercooling (heading 8479).

8419 Machinery, plant or laboratory equipment, whether or not electrically heated (excluding furnaces, ovens and other equipment of heading 8514), for the treatment of materials by a process involving a change of temperature such as heating, cooking, roasting, distilling, rectifying, sterilising, pasteurising, steaming, drying, evaporating, vaporising, condensing or cooling, other than machinery or plant of a kind used for domestic purposes; instantaneous or storage water heaters, non-electric

8419 20 00

Medical, surgical or laboratory sterilisers

The apparatus covered by this subheading, intended as equipment for clinics, operating theatres, medical centres, etc., consists of receptacles in which medical and surgical instruments as well as cotton wool, absorbent lint and other dressings are subjected to a temperature of 100 °C or more in order to destroy the micro-organisms they may be carrying.

They are usually in the form of a parallelepiped or a cylinder standing on a pedestal and containing removable grids. Generally, the container is of steel or aluminium and lined with insulating material. The door may be glazed to allow the instruments placed in the interior to be seen. Some appliances are in the form of cabinets or other furniture. In this case, a steriliser proper may incorporate a rack for storing instruments or other articles to be sterilised; this will not affect its classification in this subheading.

These appliances are heated by spirit, petroleum, gas or electricity and sterilisation is effected by boiling water (vats), steam under pressure (autoclaves) or hot dry air (ovens), depending on the design of the appliance.

8419 50 00

Heat-exchange units

Heat-exchange units are used:

1. to bring about a change of temperature in fluids or gases without changing their state, this change of temperature being in some cases sufficient to cause sterilisation or pasteurisation;
2. to vaporise or condense fluids.

This subheading includes:

1. condensers for nitrogen and other gases;
2. devices called 'freezers', for the cooling and condensing of solvents used mainly in dyeing and dry-cleaning;
3. cooling apparatus for liquids, vapour or gas, used in various industries (for example, dairies, breweries);
4. continuous pasteurisation apparatus, used notably in dairies (plate pasteurisers).

This subheading does not cover:

- (a) instantaneous or storage water heaters of subheading 8419 11 00 or 8419 19 00;
- (b) apparatus in which:

- the thermal exchange is used to transform a liquid or gaseous substance into a solid state (for example, spray drying);
- the thermal exchange between the two fluids does not take place through a wall (for example, a free air-flow tower).

Such apparatus is generally classified in subheading 8419 89 10 or 8419 89 98.

- 8419 89 10** **Cooling towers and similar plant for direct cooling (without a separating wall) by means of recirculated water**
This subheading covers cooling towers in which the water to be cooled releases its heat directly into the air by means of evaporation. The heated water is pumped up, then trickles down freely inside the cooling tower and in so doing is cooled by the rising air (chimney effect).
- 8419 89 98** **Other**
This subheading covers apparatus for smoking raw sausages, even when the sausage undergoes thermal treatment during smoking which results in the partial or total cooking of the sausage. The apparatus consists of a large chamber heated by steam coils; hot or cold smoke is blown into the chamber from outside by a fan. It is also equipped with a humidifier and with coils containing cold water for cooling. The raw sausages are conveyed into the chamber, suspended on moving frames.
Items of equipment known as ‘tableware dispensers’ for the holding and dispensing of tableware to diners in canteens or self-service restaurants are excluded from this subheading, even where they are equipped with an electrical heating device or water-bath heating for warming the tableware (heading 9403).
- 8421** **Centrifuges, including centrifugal dryers; filtering or purifying machinery and apparatus, for liquids or gases**
- 8421 39 60** **By a catalytic process**
This subheading includes catalytic exhaust gas purifiers for fitting in the exhaust systems of motor vehicles or in flue gas lines of industrial plant, to remove the nitrogen oxide and, possibly, other pollutants (for example, carbon monoxide and hydrocarbons) from the exhaust or flue gases by means of a chemical reaction in order to reduce air pollution. Catalytic converters fitted in motor vehicles consist of a housing containing a ceramic honeycomb (monolithic support) composed of channels coated with activated catalytic material. In industrial plant, flue gas purifiers consist of a support frame containing a large number of catalytic components. Monolithic supports and catalytic components presented separately, however, are classified as catalysts in heading 3815.
- 8421 39 80** **Other**
In addition to apparatus operating by an electrostatic and thermic process, this subheading includes gas-purifying apparatus which separates the gas mixture into its individual components by a retaining process.

- 8422 Dishwashing machines; machinery for cleaning or drying bottles or other containers; machinery for filling, closing, sealing or labelling bottles, cans, boxes, bags or other containers; machinery for capsuling bottles, jars, tubes and similar containers; other packing or wrapping machinery (including heat-shrink wrapping machinery); machinery for aerating beverages**
- 8422 90 10 Of dishwashing machines**
Programmed time switches for dishwashing machines presented separately are classified according to their characteristics (for example, heading 9107 00 00).
- 8423 Weighing machinery (excluding balances of a sensitivity of 5 cg or better), including weight-operated counting or checking machines; weighing-machine weights of all kinds**
- 8423 20 00 Scales for continuous weighing of goods on conveyors**
This subheading includes electromechanical scales for conveyors. The design and method of operation of such scales correspond to those of electromechanical scales described in the explanatory note to subheadings 8423 81 10 to 8423 89 00.
- 8423 30 00 Constant weight scales and scales for discharging a predetermined weight of material into a bag or container, including hopper scales**
This subheading includes electromechanical scales of the type described above. The design and method of operation of these scales correspond to those of the electromechanical scales described in the explanatory note to subheadings 8423 81 10 to 8423 89 00.
- 8423 81 10 to 8423 89 00 Other weighing machinery**
These subheadings include electromechanical scales in which the weight of objects is converted into an electrical signal (current) by means of a transducer fitted into the scales, the current then being measured by a measuring device incorporated in the scales. As a rule the measuring transducers in such scales consist of load cells or bars with strain gauges (electrical resistances) connected to form an electrical bridge. The force exerted by the mass to be weighed deforms the load cells, causing a change in the length of the strain gauge (contraction or elongation) and thus a change of resistance which is proportional to the mass to be weighed and which is passed in the form of a change of current to the measuring device on the scale by the resistance-measuring bridge.
In addition to the measuring instrument, known as a weighing-out unit, scale display or weighing indicator, which is normally contained in a single casing, electromechanical scales can also have other units which are wired up together (for example, keyboard, memory unit, printer, VDU, controller and card reader for controlling access to the scales). In weighing systems of this kind, several scales may be connected to a common measuring instrument (also known as 'remote weighing terminals').
The above scales may also be equipped with an interface through which the scales can be connected to an automatic data-processing unit.
Electromechanical scales are considered to be 'electronic scales' if microprocessors are built into the scales' measuring instrument, for example, in order to calculate the cost of the amount weighed using the unit price (for example, price per kilogram) entered into the scale.
- 8424 Mechanical appliances (whether or not hand-operated) for projecting, dispersing or spraying liquids or powders; fire extinguishers, whether or not charged; spray guns and similar appliances; steam or sandblasting machines and similar jet projecting machines**
- 8424 30 10 Compressed air operated**
This subheading includes sand-blasting machines incorporating an air compressor used for cleaning sparking plugs or trimming monolithic electrical condensers.
Trimming denotes the removal of the conductive condenser material by applying a jet of sand to attain the desired capacitance in the condenser.

8424 89 00**Other**

This subheading includes 'washing machines' for cleaning motor vehicles, metal parts or other articles by the spraying of water, petrol or other fluids; they are fitted with a pump, hoses with nozzles as well as, where appropriate, a feed device, heating apparatus etc., to form a complete unit.

However, this subheading does not include high-pressure water cleaning appliances (subheadings 8424 30 01 and 8424 30 08).

8426**Ships' derricks; cranes, including cable cranes; mobile lifting frames, straddle carriers and works trucks fitted with a crane****8426 41 00 and 8426 49 00****Other machinery, self-propelled**

See the HS Explanatory Note to heading 8426, 'self-propelled and other "mobile" machines', (b), (2).

In order to distinguish between the self-propelled machinery of these subheadings, on the one hand, and powered vehicles for special purposes of heading 8705, on the other hand, the self-propelled machines falling in these subheadings generally have the following characteristics:

1. they are propelled by an engine forming part of the lifting device;
2. they have a maximum speed of 20 km per hour;
3. they have a single cabin forming part of the lifting device;
4. they do not usually move when laden or, if they do, only when the movement is limited and incidental to their lifting function.

8428**Other lifting, handling, loading or unloading machinery (for example, lifts, escalators, conveyors, teleferics)**

This heading does not include caterpillar lifts with caterpillar track systems used to move wheelchairs with their occupants up or downstairs, these fall in heading 8714 as accessories for wheelchairs.

8428 90 90**Other**

This subheading includes:

1. roller tables or roller conveyors, power-driven or not, intended for feeding the stock into the rolling stand and removing it therefrom or for transporting the stock from one stand to another;
2. pinch rolls with an analogous function to the above machines, consisting of two series of rollers between which the stock passes;
3. roller cooling beds which are situated at the end of the rolling-mill lines on which the stock (for example, bars and wire) is conveyed slowly while being allowed to cool in the ambient air;
4. lifting or tilting tables for rolling-mills with several superimposed sets of rolls (three high and double two high stands). Such apparatus comprises a table tilting on an axis situated at the furthest extremity of the rolling-mill. The tables are fitted with power-driven rollers. After passing through one set of rollers, the stock arrives on the table which then tilts and aligns with the next set of rolls between which the stock is pushed by means of power-driven rollers;
5. transfers used in parallel-stand rolling-mills for transferring, for example, bars from the roller table of the first stand to that of the second stand;
6. tilting and turn-over devices;
7. machinery designed for the remote handling of highly radioactive substances.

This subheading does not include automatic ingot manipulators and machinery (for example, cranes and overhead travelling cranes), which, although used for feeding rolling-mills, does not participate directly in the work of the latter (subheading 8426 12 00, 8426 41 00, 8426 49 00 or 8426 99 00).

- 8429 Self-propelled bulldozers, angledozers, graders, levellers, scrapers, mechanical shovels, excavators, shovel loaders, tamping machines and roadrollers**
- 8429 30 00 Scrapers**
See the HS Explanatory Note to heading 8429, second paragraph, (C).
This subheading does not cover combination scrapers, which consist of a tractor (even with only a single axle) and a scraper proper. Each element must, by application of note 2 to Chapter 87, be classified in its own appropriate heading (heading 8701 for the tractor and subheading 8430 69 00 for the scraper).
- 8432 Agricultural, horticultural or forestry machinery for soil preparation or cultivation; lawn or sports-ground rollers**
- 8432 30 11 Central driven precision spacing seeders**
This subheading covers machines which place the seed or individual grains in the soil in rows with controlled uniform spacing. These machines can also place seeds simultaneously in several rows.
- 8433 Harvesting or threshing machinery, including straw or fodder balers; grass or hay mowers; machines for cleaning, sorting or grading eggs, fruit or other agricultural produce, other than machinery of heading 8437**
- 8433 11 10to 8433 19 90 Mowers for lawns, parks or sports grounds**
See the HS Explanatory Note to heading 8433, part (A), penultimate paragraph, with reference to riding lawnmowers.
- 8438 Machinery, not specified or included elsewhere in this chapter, for the industrial preparation or manufacture of food or drink, other than machinery for the extraction or preparation of animal or fixed vegetable fats or oils**
- 8438 80 10 For the preparation of tea or coffee**
This subheading includes machines for blending various teas and coffee-grinding machines.
This subheading does not include machines for the industrial preparation of ready-made tea or coffee (subheading 8419 81 20), coffee-roasting machines (subheading 8419 89 98), machines for manufacturing coffee powder (instant coffee) (subheading 8419 39 00).
- 8439 Machinery for making pulp of fibrous cellulosic material or for making or finishing paper or paperboard**
- 8439 30 00 Machinery for finishing paper or paperboard**
In addition to the machinery referred to in the HS Explanatory Note to heading 8439, part III, this subheading also covers machines giving a parchment finish.
This subheading does not cover:
- (a) machines which having analogous functions to those referred to above, operate not on the paper or paperboard sheets, but on products of these materials. For example, machines for waxing paper cups and containers, etc., by immersion (subheading 8479 89 97). Machines which make paper or paperboard products such as paper cups, boxes, containers, etc., fall in heading 8441;
 - (b) machines which, while operating on paper or paperboard in sheets, make products which are no longer paper or paperboard for the purposes of the Combined Nomenclature. This is the case, for example, with machines for coating paper with abrasives or for applying photosensitive emulsions (subheading 8479 89 97).

- 8441** **Other machinery for making up paper pulp, paper or paperboard, including cutting machines of all kinds**
- 8441 10 20** **Other slitting and cross-cutting machines**
This subheading covers machines which produce sheets of a specific format from continuous webs of paper either by cross-cutting only or by slitting and cross-cutting simultaneously.
- 8441 10 30** **Guillotines**
This subheading covers machines which cut piles of paper with a single blade, while a beam placed above the cutting table holds the paper firmly in place along the cut.
This subheading also covers machines with a single knife and a revolving cutting table for trimming book blocks, whereby the book blocks are turned 90° after the first and second cuts.
- 8441 10 70** **Other**
This subheading includes machines with three knives set at 90° to each other which are used for trimming book blocks. Two knives simultaneously trim the top and bottom edges of the book blocks and then the third knife trims the fore-edge or vice versa.
This subheading also includes hand- or pedal-operated machines.
- 8442** **Machinery, apparatus and equipment (other than the machine tools of headings 8456 to 8465) for preparing or making plates, cylinders or other printing components; plates, cylinders and other printing components; plates, cylinders and lithographic stones, prepared for printing purposes (for example, planed, grained or polished)**
- 8442 30 10** **Phototypesetting and composing machines**
This subheading covers phototypesetting and composing machines, which compose by successively photographing characters mounted on revolving discs or the face of special matrices or the characters created on a cathode-ray tube by a matrix of very small overlapping dots. This subheading also includes composing machines using a laser beam projected onto photographic film.
This subheading does not, however, cover:
- (a) general-purpose automatic data-processing machines which are used for photocomposition in addition to having bookkeeping and payroll accounting functions, for example, and for this purpose are connected by cable (on-line) to a phototypesetting and composing machine in order to control it and supply it with type-setting data (heading 8471 — see note 5(A) to this chapter);
 - (b) stand-alone telegraphic transmitter and receiver apparatus (heading 8517).

8442 30 91

For typefounding and typesetting (for example, linotypes, monotypes, intertypes), with or without founding device
Type-founding may be a hand operation, or may be done mechanically by means of more or less complex machines. The apparatus and machines covered include:

1. matrices, small plates, usually of copper or nickel, impressed by means of a punch. They are used for casting separate printing types;
2. tables for levelling, by hand planing, the face of printing type. These consist essentially of a perfectly smooth table slit down the centre and fitted with a clamping device which holds the type in place;
3. automatic typefounders. In these, the printing type is made letter by letter, but is not set. They usually consist of an electrically heated crucible containing the molten metal, of a mould cooling device to accelerate the hardening, and of mechanisms for planing and levelling the type;
4. typecasting machines for rules, spacing material (furniture), etc., operating by extrusion;
5. composing sticks (or setting sticks) used to start the composition, and on which one or more lines of type are set by hand. They consist mainly of a small well planed wooden or metal plate, with flanges on two adjacent sides and often with a mobile clamping slide. The heading includes galleys, similar, but larger, which hold the type for a whole page;
6. chases, cast iron or steel frames to hold several pages for printing. One, two or four pages are held in place in the chase by means of metal quoins (special metal wedges) or by mechanical wedging devices (nut or screw type, etc.) which also fall in this heading.

In addition to the above typefounding and typesetting machines and apparatus, there is a whole group of other machines which mechanically cast the type and also set it. This is done either as two distinct operations on two different but complementary machines (the first machine produces a perforated paper band which controls the second machine whose function is to cast the type either separately or in line blocks), or as one operation on the same machine. These machines, often very complex, include:

1. casting and setting machines for separate types (monotype) which, operating from a band previously perforated on a precomposing machine, select, by means of pneumatic relays, special matrices contained within the machine which produces the individual type characters and sets them in a galley (itself incorporated in the machine).

These machines are used in conjunction with a precomposing machine having a keyboard perforator which produces the precomposition on a paper tape. These precomposing machines are also classified here.

2. keyboard machines for casting and setting separate types, all operations being carried out on the same machine (Rototype, etc.);
3. typefounders for lineset type. The matrices, after being set in lines by hand, are incorporated in the machine which casts the type and delivers it in the form of a line of type (slug);
4. machines for setting and founding lines of type. These are complex keyboard machines of various types (Intertype, Linograph, etc.) which both set and cast the type in the form of lines on the same machine. Some of these machines are fitted with a device to enable them to operate from paper bands previously perforated on a separate machine which is also covered by this heading.

- 8442 30 99** **Other**
 This subheading covers the machinery, apparatus and equipment for preparing or making plates, cylinders or other printing components described in the HS Explanatory Note to heading 8442, (A), (1) to (3).
- 8442 50 20 and 8442 50 80** **Plates, cylinders and other printing components; plates, cylinders and lithographic stones, prepared for printing purposes (for example, planed, grained or polished)**
 Natural lithographic stone consists of a kind of limestone with fine homogeneous grains. Artificial lithographic stone is usually made from cement and calcium carbonate which has been ground and compressed.
 Lithographic stones of these subheadings are:
 — covered with illustrations, either hand drawn or photographically transferred; or
 — planed or grained so as to be rendered suitable, without further treatment, for drawings or writing.
- Limestone (known as 'lithographic stone') in the crude state is excluded from these subheadings and falls in subheading 2530 90 00.
- 8443** **Printing machinery used for printing by means of plates, cylinders and other printing components of heading 8442; other printers, copying machines and facsimile machines, whether or not combined; parts and accessories thereof**
- 8443 31 10** **Machines performing the functions of copying and facsimile transmission, whether or not with a printing function, with a copying speed not exceeding 12 monochrome pages per minute**
 To determine the copy speed, the maximum speed for pages with text only at the lowest resolution (dpi) is to be taken into account.
- 8443 31 91** **Machines performing a copying function by scanning the original and printing the copies by means of an electrostatic print engine**
 See the HS Explanatory Note to heading 8443, part (II), (A), (1).
 The scanning process can be performed by either a digital or an optical system.
 An electrostatic print engine operates in the same way as an electrostatic printer.
 In addition to the copying function, the machines of this subheading perform the function of facsimile transmission or printing.
 This subheading excludes machines that print the copies by means of an inkjet or thermal print engine (subheading 8443 31 99).

- 8443 32 30** **Facsimile machines**
See the HS Explanatory Note to heading 8443, part (II), (C).
- 8443 39 10** ~~**Machines performing a copying function by scanning the original and printing the copies by means of an electrostatic print engine**~~
See the explanatory note to subheading 8443 31 91.
- 8443 39 31** **Incorporating an optical system**
Machines of this subheading incorporate an optical system (comprising mainly a light source, a condenser, lenses, mirrors, prisms or an array of optical fibres or similar devices) for the scanning of the original.
- 8443 39 39** **Other**
This subheading includes blueprinters and diazocopiers which are used for copying translucent originals onto photosensitive paper. As a result of light passing through the translucent original, the diazo compound or the photosensitive iron salts in the copying paper are broken down in the illuminated areas. The non-illuminated areas are rendered visible by developing. This apparatus normally provides bluish copies, in which the individual lines are not quite as sharp as the original. ~~This subheading also includes contact type machines and thermo-copying apparatus. This subheading also includes contact type machines and thermocopying apparatus.~~
- 8443 39 90** **Other**
This subheading includes non-impact printers, provided that they are not capable of connecting to an automatic data-processing machine or to a network, such as:
1. thermal printers, in which an electrically heated thermal print head produces the desired characters on heat-sensitive paper by means of a dot matrix;
 2. electrostatic printers, in which the moving, statically charged metal tips of the write head produce invisible characters made up of small electrostatically charged dots on electrographic paper. Toner fluid is used to ink the charged dots and produce visible characters.
- The printers listed above are controlled by data media (for example, CD ROM, diskettes, magnetic tapes or semiconductor media) or by machines other than automatic data-processing machines (for example, digital cameras, video camera recorders or telephones for cellular networks).
- 8443 91 10 to 8443 99 90** **Parts and accessories**
In addition to the parts and accessories mentioned in the HS Explanatory Note to heading 8443, these subheadings include:
1. automatic feeders for feeding tinplate printing machines;
 2. tensioning systems, usually pneumatic, for maintaining the tension of the paper drawn from the reel holders;
 3. anti-offsetting devices, other than those of the spray type;
 4. print chains, pin-heads, type heads and daisy wheels.

8443 99 10**Electronic assemblies**

Electronic assemblies consist of one or more printed circuits fitted with electronic integrated circuits of heading 8542. They may also contain discrete active elements, discrete passive elements, articles of heading 8536 or other electrical or electromechanical devices, provided that they do not lose their character as electronic assemblies.

This subheading does not include:

- (a) mechanisms (without electronic components);
- (b) modules (composed of mechanisms and electronic assemblies), such as cassette, compact disc or DVD drives for data, video or audio reproduction consisting of mechanisms and electronic control and signal processing assemblies.

8445**Machines for preparing textile fibres; spinning, doubling or twisting machines and other machinery for producing textile yarns; textile reeling or winding (including weft-winding) machines and machines for preparing textile yarns for use on the machines of heading 8446 or 8447****8445 90 00****Other**

In addition to the machines described in the HS Explanatory Note to heading 8445, (E), this subheading also includes machines for assembling warp yarn on the beam from warper drums, machines for interlacing and supplying the thread during weaving and threading machines for embroidery. 'Hand knotters', on the other hand, which are small tools held in the hand for knotting broken threads, fall in heading 8205.

8446**Weaving machines (looms)**

This heading covers the weaving machines described in the HS Explanatory Note to heading 8446, including Axminster carpet looms, chenille looms, pile fabric looms, terry fabric looms, crepe looms, linen looms, sail looms, transmission belt looms and strap looms.

8447**Knitting machines, stitch-bonding machines and machines for making gimped yarn, tulle, lace, embroidery, trimmings, braid or net and machines for tufting****8447 20 20 and 8447 20 80****Flat knitting machines; stitch-bonding machines**

These subheadings include crochet machines which are, in fact, chain knitting machines used for making ornamental trimmings, fringes, curtains, net, lace, etc. (such as galloon braiding looms, lace frames, curtain machines and ribbon looms).

8447 90 00**Other**

In addition to the machines described in the HS Explanatory Note to heading 8447, (C), this subheading includes:

1. hand embroidery machines (embroidery machines with pantograph shuttles), automatic shuttle embroidery machines, equipped with jacquard or similar mechanisms, embroidery machines with a number of needles, and multi-head automatic embroidery machines (with several machine heads on one table and equipped with a jacquard or similar mechanism);
2. bobbin lace machines, which produce lace consisting of one or several threads (bobbin lace) using bobbins;
3. braiding and spindle machines, which, by interlacing threads by means of feeders (spindles) equipped with bobbins of thread and making circular and sinusoidal trajectories, produce articles in the piece (for example, flat or round braids) or in shapes (piping, braids, rovings, tubular braids, piping for garments), or cover buttons, wooden articles, fluting, etc., with threads (for example, round braid looms, tubular plait looms, packing braid looms).

However, special braiding machines intended for covering cable wire or other electrical conductors or which braid or twist flexible wire conductors, fall in heading 8479;

4. machines for making trimmings (other than the braid-making machines referred to in 3 above), including:
 - (a) machines for making pompons and chenille;
 - (b) machines for making round and fancy chenille and machines for making chenille garlands for Christmas trees;
 - (c) fringe twisting and cutting machines.

However, balancing machines, i.e., weaving machines for making ribbons or trimmings, fall in heading 8446 and crochet machines for making trimmings fall in subheading 8447 20 20 or 8447 20 80.

- 8448** **Auxiliary machinery for use with machines of heading 8444, 8445, 8446or 8447(for example, dobbies, jacquards, automatic stop motions, shuttle changing mechanisms); parts and accessories suitable for use solely or principally with the machines of this heading or of heading 8444, 8445, 8446or 8447(for example, spindles and spindle flyers, card clothing, combs, extruding nipples, shuttles, healds and heald-frames, hosiery needles)**
- 8448 11 00and 8448 19 00** **Auxiliary machinery for machines of heading 8444, 8445, 8446or 8447**
These subheadings do not include:
- (a) machines for removing the remaining threads from the quills of weaving machines and blade cleaners (subheading 8479 89 97);
 - (b) equipment for checking the regularity of threads by rolling onto a drum or board (subheading 9017 80 90);
 - (c) thread cleaners using electronic processes — photoelectric cells, for example (subheading 9031 80 34 or 9031 80 38).
- 8450** **Household or laundry-type washing machines, including machines which both wash and dry**
- 8450 11 11to 8450 19 00** **Machines, each of a dry linen capacity not exceeding 10 kg**
These subheadings include: tub-type washing machines with paddles, agitators, pulsators, etc., or with a spraying system; drum-type washing machines, including those in which the washing drum acts also as a spin-drier; combination washing machines in which a drum or tub-type washing appliance is combined in the one housing with a spin-drier of heading 8421. These washing machines are considered to have a dry-linen capacity of not more than 10 kg if the loading volume of the drum or tub is:
1. 120 litres (120 dm³) or less, in the case of drum-type machines;
 2. 150 litres (150 dm³) or less, in the case of tub-type machines with agitators or paddles;
 3. 200 litres (200 dm³) or less, in the case of tub-type machines with pulsators;
 4. 250 litres (250 dm³) or less, in the case of tub-type machines with a spraying system.
- In determining the volume, it should be noted that:
1. in the case of drum-type machines the ribs on the drum and any special deformations present are not to be taken into account;
 2. in the case of tub-type machines, it is not the full depth of the tub (measured to the top rim) that is to be taken as the basis but the height to the water-level mark, the full depth of the tub less 10 cm.

8451 Machinery (other than machines of heading 8450) for washing, cleaning, wringing, drying, ironing, pressing (including fusing presses), bleaching, dyeing, dressing, finishing, coating or impregnating textile yarns, fabrics or made-up textile articles and machines for applying the paste to the base fabric or other support used in the manufacture of floor coverings such as linoleum; machines for reeling, unreeling, folding, cutting or pinking textile fabrics

8451 90 00

Parts

This subheading does not include:

- (a) special cones and bobbins for dyeing machinery and apparatus (classified according to their constituent material, see note 1(c) to Section XVI);
- (b) blades and cutters for cropping machines (heading 8208);
- (c) electrostatic devices for flocking machines (heading 8543).

8452 Sewing machines, other than book-sewing machines of heading 8440; furniture, bases and covers specially designed for sewing machines; sewing machine needles

8452 10 11 and 8452 10 19 Sewing machines (lock-stitch only), with heads of a weight not exceeding 16 kg without motor or 17 kg including the motor; sewing machine heads (lock-stitch only), of a weight not exceeding 16 kg without motor or 17 kg including the motor

1. These subheadings cover sewing machines and sewing machine heads having both the following characteristics:
 - (a) they must be lock-stitch only (running-stitch, zig-zag stitch, decorative stitch), i.e., operate with two threads, one inserted on the needle and one carried underneath by a shuttle;
 - (b) the head must not exceed 16 kg in weight without motor or 17 kg, including the motor (in the case of an incomplete head to be classified as complete in accordance with general interpretative rule 2(a) of the Combined Nomenclature, it is the weight in the complete state which counts).
2. The sewing machine head comprises the working unit of the machine (including, where relevant, the motor incorporated in or mounted on the head) and consists essentially of an arm containing the needle-driving mechanism and a base containing the shuttle mechanism and possibly a device for lifting the presser foot. The frame, table, cover and other furniture (including the pedal board) do not form part of the head.
3. It should be noted, however, that on some portable sewing machines the base is designed to serve also as a stand. In this case, it is regarded as a sewing machine and not as a sewing machine head.

8452 30 10**With single flat shank**

These needles are used in household sewing machines. They have the following appearance:

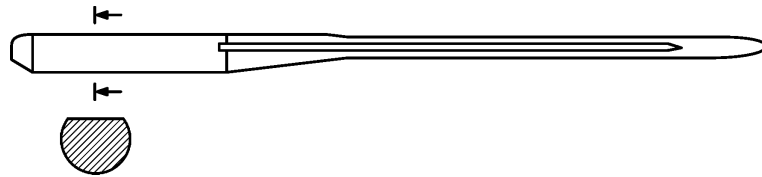
**8456**

Machine tools for working any material by removal of material, by laser or other light or photon beam, ultrasonic, electrodischarge, electrochemical, electron beam, ionic-beam or plasma arc processes
Machine tools for working any material by removal of material, by laser or other light or photon beam, ultrasonic, electrodischarge, electrochemical, electron beam, ionic-beam or plasma arc processes; water-jet cutting machines

8456 10 00**Operated by laser or other light or photon beam processes**

In addition to the machines referred to in the HS Explanatory Note to heading 8456, (A), this subheading also includes machines for trimming electrical resistors in printed circuits using a laser beam. The conductive material which constitutes the resistors on the insulating substrate of the printed circuits is removed by means of a laser beam until the desired resistance is attained.

8456 30 11**Wire-cut**

These machines are equipped with an electrode which consists of a small diameter wire which is wound between two spools set on opposite sides of the workpiece. ~~These machines are equipped with an electrode which consists of a small-diameter wire which is wound between two spools set on opposite sides of the workpiece.~~

8457

Machining centres, unit construction machines (single station) and multi-station transfer machines, for working metal

8457 10 10**Horizontal**

This subheading covers machining centres where the tooling is set exclusively in a horizontal spindle and cuts the workpiece from the side.

8457 10 90**Other**

This subheading includes machining centres where the tooling is applied to the workpiece from above (vertical spindle machining centres), those using both vertical and horizontal spindles (combined machining centres) or those working through the use of a pivoting head (universal machining centres).

- 8458 Lathes (including turning centres) for removing metal**
 This heading covers lathes specially designed for working metals and which operate by removing the material with the help of turning tools. In general, the article to be shaped is driven in a rotary movement around its own axis. However, lathes in which the tool itself or the tool and the article are rotated are also covered by this heading.
 In addition to the lathes referred to in the HS Explanatory Note to heading 8458, third paragraph, this heading includes special relieving lathes for axles, bark-stripping lathes and spindle or axle turning machines, as well as universal lathes. These universal lathes resemble slide lathes but are differentiated by a particular mechanism which enables them to perform other functions such as drilling, milling and cutting into lengths, in addition to turning.
- 8459 Machine tools (including way-type unit head machines) for drilling, boring, milling, threading or tapping by removing metal, other than lathes (including turning centres) of heading 8458**
- 8459 10 00 Way-type unit head machines**
 See the HS Explanatory Note to heading 8459, third paragraph, (1).
- 8459 31 00and 8459 39 00 Other boring-milling machines**
 See the HS Explanatory Note to heading 8459, third paragraph, (3), third subparagraph.
- 8460 Machine tools for deburring, sharpening, grinding, honing, lapping, polishing or otherwise finishing metal or cermet by means of grinding stones, abrasives or polishing products, other than gear cutting, gear grinding or gear finishing machines of heading 8461**
- 8460 11 00and 8460 19 00 Flat-surface grinding machines, in which the positioning in any one axis can be set up to an accuracy of at least 0,01 mm**
 These subheadings include the flat-surface grinding machines referred to in the HS Explanatory Note to heading 8460, third paragraph, (3).
 These machines are equipped with measuring or setting devices. These devices include:
1. direct reading linear instruments, for example, slide rules and verniers, on which the space between two successive graduations corresponds to a movement of an element of the machine not exceeding 1/100th mm (0,01 mm);
 2. profile projectors for checking work in progress. These projectors consist of a graduated ground-glass screen on which a greatly enlarged image of the article and tool is projected so that any travel of the article or tool, as well as the progress of the working process, can be assessed by reference to the graduations on the screen. The work can also be checked by placing on the screen a drawing of the article to be obtained traced on a transparent sheet on a scale corresponding to the magnification factor of the profile projectors; in this case, the machine operator's task is to make the image on the article coincide with the drawing seen on the screen;
 3. devices limiting the travel of the tool holder or workpiece holder by means of an adjustable device whose positioning is controlled by means of a slip gauge;
 4. electronic checking and control devices for honing and lapping machines which are adjusted by means of a graduated scale on the actual final dimensions of the article and which allow the tool to be slowed down and stopped when the dimensions of the article approach and attain the previously determined dimensions.

- 8460 21 11to 8460 29 90** **Other grinding machines, in which the positioning in any one axis can be set up to an accuracy of at least 0,01 mm**
See the explanatory note to subheadings 8460 11 00 and 8460 19 00.
- 8460 21 11** **Internal cylindrical grinding machines**
Internal cylindrical grinding machines are used for grinding internal diameters of hollow workpieces (for example, the bore). The workpiece is held in a chuck and worked with a grinding wheel small enough to enter the hollow bore of the workpiece.
- 8460 21 15** **Centreless grinding machines**
Centreless grinding machines are used for grinding the external diameters of workpieces. In the centreless process, the workpiece is not fixed but rests on a rail between the rotating grinding disc and a guide disc (also driven). The diameter required is determined by the distance between the grinding disc and the guide disc.
- 8460 21 19** **Other**
This subheading includes universal grinding machines. These are a combination of external and internal grinding machines and can therefore work simultaneously on both the external and internal diameters of a workpiece.
- 8460 29 10** **For cylindrical surfaces**
For internal cylindrical grinding machines, the explanatory note to subheading 8460 21 11 applies, *mutatis mutandis*.
For centreless grinding machines and universal grinding machines, the explanatory notes to subheading 8460 21 15 and to subheading 8460 21 19 apply, *mutatis mutandis*.
- 8461** **Machine tools for planing, shaping, slotting, broaching, gear cutting, gear grinding or gear finishing, sawing, cutting-off and other machine tools working by removing metal or cermets, not elsewhere specified or included**
- 8461 30 10and 8461 30 90** **Broaching machines**
These subheadings cover broaching machines (see the HS Explanatory Note to heading 8461, third paragraph, (4)); these are machine tools consisting of a multiple-toothed cutting tool, called a broach, used for working the interior or exterior surfaces of an article. In these machines, the article is fixed and the broach, secured to the slide, is pulled or pushed across the work piece in an even, linear cutting motion.
The internal broach works and calibrates the internal surfaces of a rough or pre-worked article traversed by the tool. The external broach produces plane or profile surfaces.
- 8461 40 11and 8461 40 19** **For cutting cylindrical gears**
Only gears which are obtained from cylindrical blanks and which retain that form after cutting are considered as cylindrical gears for the purposes of these subheadings.
These subheadings include machines for making straight-toothed gear wheels, worm gear wheels, worm gears, ratchet wheels and sprocket wheels.

- 8461 40 31 and 8461 40 39 For cutting other gears**
These subheadings include machines for making racks, helical gears and worm gears other than cylindrical gears.
- 8461 40 71 and 8461 40 79 Fitted with a micrometric adjusting system, in which the positioning in any one axis can be set up to an accuracy of at least 0,01 mm**
See the explanatory note to subheadings 8460 11 00 and 8460 19 00 for measuring and setting devices.
- 8470 Calculating machines and pocket-size data-recording, reproducing and displaying machines with calculating functions; accounting machines, postage-franking machines, ticket-issuing machines and similar machines, incorporating a calculating device; cash registers**
- 8470 10 00 Electronic calculators capable of operation without an external source of electric power and pocket-size data-recording, reproducing and displaying machines with calculating functions**
This subheading includes, for example:
1. electronic calculators incorporating a time-and-date display and an alarm or, for example, in addition, a stopwatch device, timer or musical keys;
 2. pocket-sized, battery-powered electronic machines which, in addition to performing arithmetical operations, have a memory that can store data for a telephone directory, scheduler, memo pad, calendar, etc. (sometimes known as 'digital diaries');
 3. small, pocket-sized, electronic devices (also called 'minicomputers'), which can be used to form words and sentences which are translated into a chosen foreign language, depending on the memory modules used with these devices; they can also perform simple calculations. They have an alphanumeric keyboard and a rectangular display.
- This subheading does not cover:
- (a) wrist watches and pocket watches incorporating a small electronic calculator (heading 9101 or 9102);
 - (b) cigarette lighters incorporating a small electronic calculator and also possibly an electronic timepiece (heading 9613).
 - (c) similar devices without calculating functions (heading 8543).
- 8470 30 00 Other calculating machines**
This subheading includes non-electronic calculating machines mentioned in the HS Explanatory Note to heading 8470, part (A), which for the purposes of calculation employ mechanical devices, generally rack gearing, irrespective of whether they are operated by hand, motor or electromagnetically.
- 8470 90 00 Other**
In addition to the machines listed in the HS Explanatory Note to heading 8470, parts (B) and (D), this subheading includes machines for issuing labels showing the selling price calculated from the weight and unit price, and machines used for issuing motorway toll tickets which at the same time total the amounts involved.
This subheading does not include separately presented printers (heading 8443).

- 8471 Automatic data-processing machines and units thereof; magnetic or optical readers, machines for transcribing data onto data media in coded form and machines for processing such data, not elsewhere specified or included**
- 8471 70 30 Optical, including magneto-optical**
See additional note 2 to this chapter.
- 8472 Other office machines (for example, hectograph or stencil duplicating machines, addressing machines, automatic banknote dispensers, coin-sorting machines, coin-counting or -wrapping machines, pencil-sharpening machines, perforating or stapling machines)**
This heading does not include typewriters fitted with a special device for typing address plates in stencil (heading 8469).
- 8472 90 70 Other**
In addition to the machines described in the HS Explanatory Note to heading 8472, fifth paragraph, (2), (3), (5), (7) to (11), and (16) to (22), this subheading includes:
1. machines for the double-sided coating (facing) of contracts, data sheets, plans, identity cards or other documents with transparent film, in order to protect these documents from aging, falsification, soiling or crumpling;

However, similar machines not used in offices (so-called heat-seal presses), which employ heat and pressure for the purpose of applying thermoplastic transparent film made of synthetic material to the surface or reverse side of pictures, photographs, art prints or other printed products, are excluded from this subheading and fall in heading 8477;
 2. electric engraving machines as used, for example, in drawing offices.
- This subheading does not include:
- (a) printers of heading 8443;
 - (b) pocket-sized, battery-powered electronic machines which, in addition to performing arithmetical operations, have a memory that can store data for a telephone directory, scheduler, memo pad, calendar, etc. (sometimes known as 'digital diaries') (subheading 8470 10 00).
- 8473 Parts and accessories (other than covers, carrying cases and the like) suitable for use solely or principally with machines of headings 8469 to 8472**
In addition to the parts, assemblies and accessories mentioned in the HS Explanatory Note to heading 8473, this heading includes:
1. magnetic heads in Winchester or thin-film technology for peripheral magnetic disk storage units, whether or not incorporated on support arms or in housings;
 2. data-storage assemblies (so-called Head/Disk/Assemblies (HDAs)) designed for permanent installation in disk storage units and consisting of several magnetic disks rigidly mounted on a support spindle, of data-head arms with read/write heads, of control, access and positioning mechanisms, incorporated in a single hermetically sealed housing;
 3. print and write cassettes, made up in the form of clearly interchangeable accessories and containing, in a special housing, both ribbons and correction tapes.

- 8473 10 11and 8473 10 19** **Electronic assemblies**
See the explanatory note to subheading 8443 99 10.
- 8473 21 10** **Electronic assemblies**
See the explanatory note to subheading 8443 99 10.
- 8473 29 10** **Electronic assemblies**
See the explanatory note to subheading 8443 99 10.
- 8473 30 20and 8473 30 80** **Parts and accessories of the machines of heading 8471**
These subheadings do not cover keyboards for automatic data-processing machines, in their own housing (subheading 8471 60 60).
- 8473 30 20** **Electronic assemblies**
See the explanatory note to subheading 8443 99 10.
- 8473 40 11and 8473 40 18** **Electronic assemblies**
See the explanatory note to subheading 8443 99 10.
- 8473 40 80** **Other**
The types of address plates covered by this subheading are those that are used in addressing machines and that contain the addresses to be duplicated, namely by embossing, typing or stamping. Consequently, the plates in question may be made of metal or synthetic material or may take the form of small mounted plates (cards, stencils) made of paperboard, etc.
This subheading also covers address plates that have not yet been embossed, typed on or stamped, provided that they are recognizable as address plates for addressing machines. However, goods of this type made of paper or paperboard, i.e., small stencils which are mounted in paperboard frames and which can therefore be inserted in the addressing machines, are covered by heading 4816.
- 8473 50 20** **Electronic assemblies**
See the explanatory note to subheadings 8443 99 10.
- 8477** **Machinery for working rubber or plastics or for the manufacture of products from these materials, not specified or included elsewhere in this chapter**
In addition to the machines mentioned in the HS Explanatory Note to heading 8477, this heading includes:
1. machines for removing rubber soles and rubber heels, which, although used in the shoe industry, are not intended for working leather, skins or hides;
 2. machines for cutting blocks of foam plastic, foam rubber, latex foam and similar materials, using a band knife or saw blade.

8479 Machines and mechanical appliances having individual functions, not specified or included elsewhere in this chapter**8479 40 00****Rope- or cable-making machines**

This subheading includes:

1. machines and appliances for making string, cord, rope or cable from textile fibre, such as:
 - (a) stranding machines, which make strands by twisting two or more single threads (cable yarn);
 - (b) rope or cable twisting machines, which twist two or more strands to make large-diameter rope or cable;
 - (c) combined stranding and rope or cable twisting machines, chiefly used for making heavier cord and smaller-diameter rope or cable;
2. machines and appliances for making wire ropes and cables, other than electric cables, working on the same principle as the machines and appliances described in item 1 above;
3. machines and appliances for cabling or braiding electric wires and machines for making coaxial cables.

The subheading does not include machines carrying out operations prior to stranding, for example, combing, spreading, doubling, successive drawing or spinning, or twisting frames of a type used in spinning mills; some machines of this type can also be used for making fine cord by twisting rope yarn (heading 8445).

8479 89 97**Other**

This subheading includes:

1. garage door opening systems, which are mechanical devices for automatically opening and closing up-and-over garage doors by radio remote control. They are fitted to the garage ceiling and consist chiefly of an electric servomotor with drive spindle, a connecting rail with power-transmitting device and an operating arm fixed to the garage door. The servomotor is connected by a cable to the radio RC receiver, which switches on the power supply to the servomotor when it receives control signals from the radio RC transmitter in the vehicle. The radio transmitters and receivers necessary for the remote control of these systems are, however, excluded from this subheading and are classified in heading 8526 in accordance with their own characteristics;
2. certain machines and appliances for the manufacture of printed circuit boards (by machining and cutting larger sheets of paper-base laminate, glass-fibre fabric, ceramic or other insulating material), such as:
 - (a) brushing machines and ultrasonic washing machines for cleaning the sheets of insulating material;
 - (b) rolling or pouring machines for applying photoresist, bonding agent or adhesive to the sheets of insulating material;
3. printed circuit board assembly machines for mounting active, passive or connecting components on printed circuits (pick-and-place machines). These components are automatically fed to the machine on tapes (belts). The machines position the components exactly at the intended locations and mount them on the printed circuit. After the components have been mounted, they are fixed to the printed circuit by, for example, soldering, contact bonding. Apart from the assembly of semiconductor devices, these machines are also able to pick and place other components on substrates.

This subheading does not include machines and apparatus of a kind used solely or principally for the manufacture of semiconductor boules or wafers, semiconductor devices, electronic integrated circuits or flat panel displays (heading 8486).

8481 Taps, cocks, valves and similar appliances for pipes, boiler shells, tanks, vats or the like, including pressure-reducing valves and thermostatically controlled valves

8481 10 05 Combined with filters or lubricators

This subheading covers articles consisting of different components which perform the functions needed to regulate compressed-air systems: air filtration (to remove impurities, for example, water, rust, dirt, etc.), regulation to the correct working pressure, lubrication (to ensure smooth operation of the pneumatic components).

They typically have the following appearance:

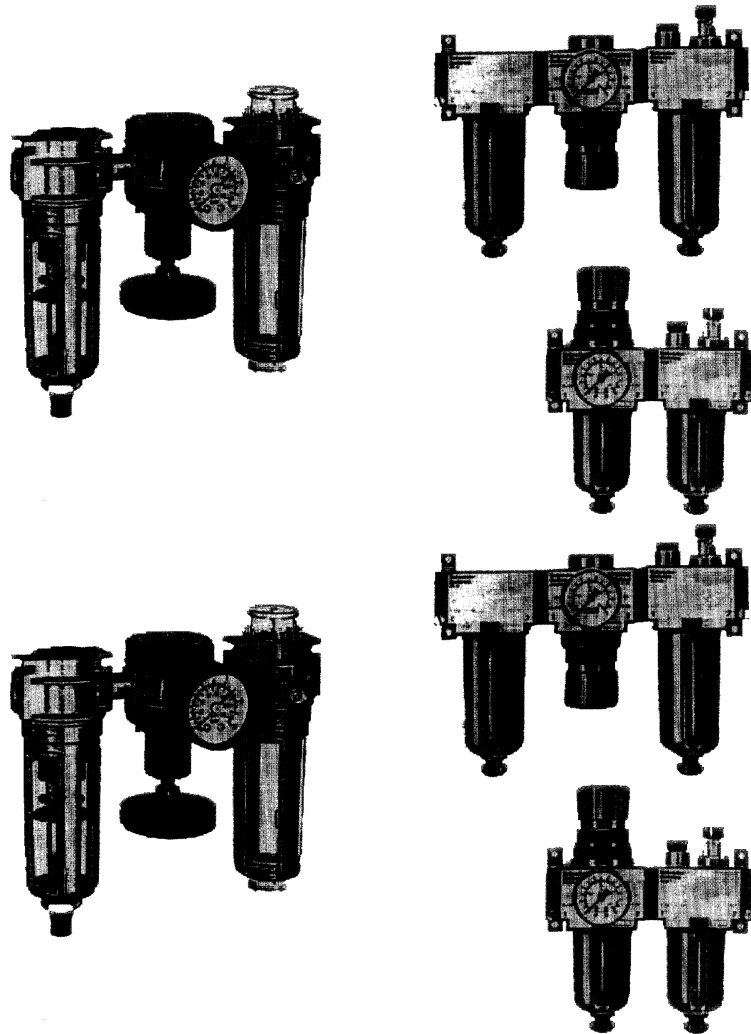

8486 Machines and apparatus of a kind used solely or principally for the manufacture of semiconductor boules or wafers, semiconductor devices, electronic integrated circuits or flat panel displays; machines and apparatus specified in note 9(C) to this chapter; parts and accessories

This heading excludes, inter alia:

- (a) machines and appliances for the manufacture of printed circuit boards as defined in note 5 to Chapter 85;
- (b) electrical machines and devices for testing wafers or integrated circuits by electrical measurement and for detecting and locating defects, including those equipped with a device for defect marking or a sorting device for assigning the products tested to specific storage containers (Chapter 90).

8486 20 10 Machine-tools operated by ultrasonic processes

See the HS Explanatory Note to heading 8456, second paragraph.

8486 20 90**Other**

In addition to the machines mentioned in the HS Explanatory Note to heading 8486, part (B), this subheading includes:

1. machine tools for scribing or scoring semiconductor wafers;
2. apparatus for rapid heating of semiconductor wafers;
3. machine tools for working any material, whereby the removal of material is by means of laser or other light- or photon-beam processes;
4. appliances for drying printed or washed insulating substrate and continuous dryers for wafers.

8486 40 00**Machines and apparatus specified in note 9(C) to this chapter**

In addition to the machines mentioned in the HS Explanatory Note to heading 8486, part (D), this subheading includes:

1. die attach apparatus and tape automated bonders for the assembly of semiconductor devices or electronic integrated circuits;
2. photographic cameras, being pattern-generating apparatus of a kind used for producing masks or reticles from photoresist-coated substrates;
3. marking-out instruments, being pattern-generating apparatus of a kind used for producing masks or reticles from photoresist-coated substrates;
4. certain machines and appliances for the manufacture of hybrid integrated circuits (by machining and cutting larger sheets of ceramic or other insulating material), such as:
 - (a) brushing machines and ultrasonic washing machines for cleaning the sheets of insulating material;
 - (b) rolling or pouring machines for applying photoresist, bonding agent or adhesive to the sheets of insulating material.

CHAPTER 85

ELECTRICAL MACHINERY AND EQUIPMENT AND PARTS THEREOF; SOUND RECORDERS AND REPRODUCERS, TELEVISION IMAGE AND SOUND RECORDERS AND REPRODUCERS, AND PARTS AND ACCESSORIES OF SUCH ARTICLES

- 8501** **Electric motors and generators (excluding generating sets)**
This heading includes rotary electric windscreen-wiper motors, without arms or wiper blades but with appropriate transmission mechanisms (spur gear and oscillating connecting rod) which convert the rotary motion into an oscillating one.
- 8502** **Electric generating sets and rotary converters**
In addition to the electrical machinery described in the HS Explanatory Note to heading 8502, parts (I) and (II), this heading includes cascade converters, Ward-Leonard sets and rotary dephasers.
- 8502 39 20** **Turbo-generators**
Turbo-generators are driven directly by gas or steam turbines. They have a solid cylindrical rotor with longitudinal grooves in which the induction windings are mounted. The rotor may be in one piece or consist of a number of solid sections. Turbo-generators are generally air-cooled, but high-capacity types are hydrogen-cooled.
- 8503 00** **Parts suitable for use solely or principally with the machines of heading 8501 or 8502**
This heading does not include branch circuit plates for electric motors (heading 8536).
- 8504** **Electrical transformers, static converters (for example, rectifiers) and inductors**
In addition to the products referred to in the HS Explanatory Note to heading 8504, this heading includes:
1. adjustable transformers (for example, cursor transformers) and variable ratio transformers;
 2. field dispersion transformers for fluorescent tubes;
 3. special transformers for communications;
 4. compensation coils;
 5. output coils;
 6. smoothing inductors;
 7. moving core coils for modifying inductance;
 8. ballasts (chokes) for electrical discharge lamps and tubes;
 9. Pupin coils;
 10. Godefroy coils;
 11. stabilised power packs (rectifier with a regulator).
- This heading also includes selenium rectifying elements, whether single (selenium plates, in particular) or multiple. However, this heading does not include silicon or germanium single-crystal rectifiers constituting discrete components (for example, rectifier diodes) or rectifiers constituting integrated circuits, especially microcircuits, whether or not equipped with cooling or insulating devices, etc. Note 8 to this chapter assigns such components to heading 8541 or to heading 8542 (see also note 2 to this chapter).
Furthermore, this heading does not include:
- (a) commutators for multiple-point transformers (heading 8536);
 - (b) rectifying lamps, tubes and valves such as phanotrons, thyratrons, ignitrons and high-voltage rectifying tubes for X-ray equipment (subheading 8540 89 00);
 - (c) voltage regulators of heading 9032.

8504 40 30**Of a kind used with telecommunication apparatus, automatic data-processing machines and units thereof**

This subheading includes static converters for telecommunication apparatus or for automatic data-processing machines and units thereof, which:

- generally, have stabilising circuits;
- have a typical output voltage of, for example, 3,3, 5, 12, 24, 48 or 60 V.

Static converters for telecommunication apparatus or for automatic data-processing machines and units thereof serve to convert the alternating current (AC) drawn from the mains supply into the requisite direct current (DC).

Used with automatic data-processing machines, a so-called Uninterruptible Power Supply (UPS) ensures a 'back-up' of energy (with a 'power good' signal) in the event of a power failure, thus preventing data loss.

8504 90 05**Electronic assemblies of machines of subheading 8504 50 20**

For the definition of the expression 'electronic assemblies', see the explanatory note to subheading 8443 99 10

8504 90 91**Electronic assemblies of machines of subheading 8504 40 30**

For the definition of the expression 'electronic assemblies', see the explanatory note to subheading 8443 99 10

8505**Electromagnets; permanent magnets and articles intended to become permanent magnets after magnetisation; electromagnetic or permanent magnet chucks, clamps and similar holding devices; electromagnetic couplings, clutches and brakes; electromagnetic lifting heads****8505 90 20****Electromagnets; electromagnetic or permanent magnet chucks, clamps and similar holding devices**

This subheading includes electric operating magnets fitted to the doors of private cars and forming part of a central door-locking system. Such systems are connected to the vehicle power supply and are actuated by control signals from an electrical control device belonging to the system. If one of the doors is opened or closed manually, the other vehicle doors will be simultaneously locked or unlocked electromagnetically.

However, this subheading does not include solenoid-operated injection valves for spark-ignition or compression-ignition internal combustion piston engines, the valve bodies and valve needles of which are equipped with a magnet winding and magnet keeper respectively (subheading 8409 91 00 or 8409 99 00).

8506

Primary cells and primary batteries

8506 10 11

Cylindrical cells

Cylindrical cells have a circular cross-section. Positive and negative poles are at opposite ends. The length of cylindrical cells is greater than their diameter:

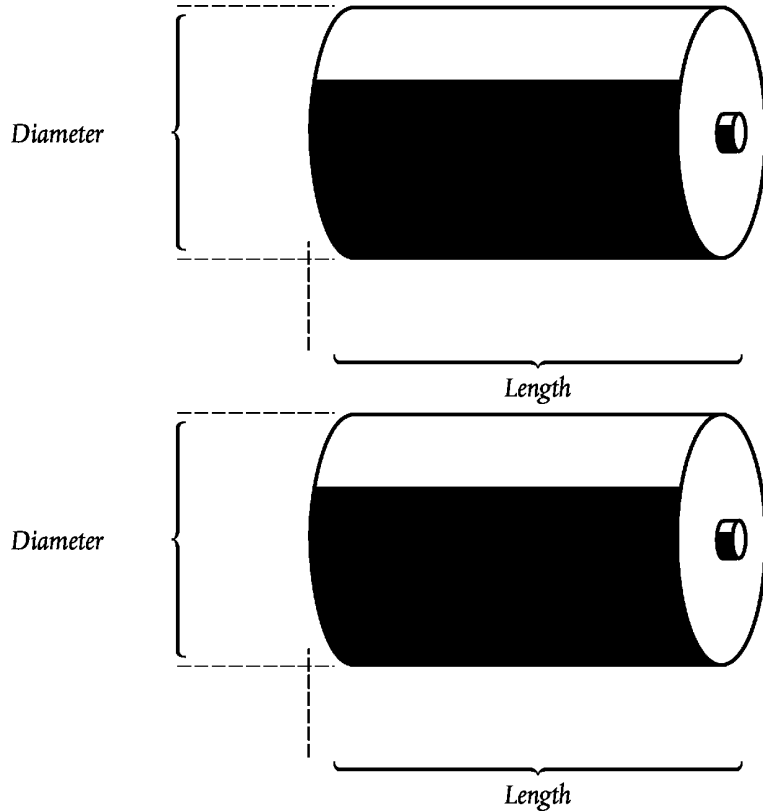

8506 10 91

Cylindrical cells

See the explanatory note to subheading 8506 10 11.

8506 50 10

Cylindrical cells

See the explanatory note to subheading 8506 10 11.

8506 50 30

Button cells

The height of button cells is less than or equal to the diameter:

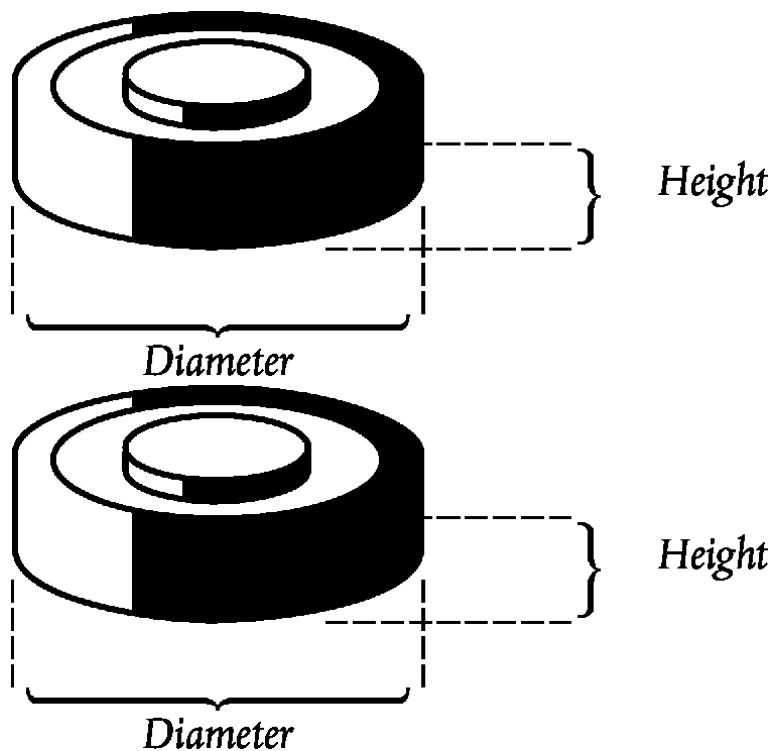

8507 Electric accumulators, including separators therefor, whether or not rectangular (including square)**8507 20 20 and 8507 20 80 Other lead-acid accumulators**

With the exception of accumulators of a kind used for starting piston engines (see subheadings 8507 10 20 and 8507 10 80), these subheadings cover the electric lead-acid accumulators mentioned in the HS Explanatory Note to heading 8507, third paragraph, (1).

These accumulators are used, for example, for driving electric vehicles and for supplying power to telecommunication installations.

8507 30 20 and 8507 30 80 Nickel-cadmium

The accumulators of these subheadings are used particularly in safety lamps for miners and often as replacements for dry batteries in equipment such as portable radios, television sets, electric razors and other electrical equipment.

8507 80 20 8507 80 80	Other accumulators These subheadings include silver-zinc and silver-cadmium accumulators. <u>This subheading includes silver-zinc and silver-cadmium accumulators.</u>
8507 90 30 and 8507 90 80	Parts These subheadings do not include connecting parts of accumulator elements (subheading 8536 90 85).
8509	Electromechanical domestic appliances, with self-contained electric motor, other than vacuum cleaners of heading 8508
8509 80 00	Other appliances This subheading includes electrical manicure and pedicure sets with self-contained electric motor, connected via a cable to the power-supply unit (mains unit) belonging to the appliance.
8510	Shavers, hair clippers and hair-removing appliances, with self-contained electric motor
8510 10 00	Shavers Shavers incorporating hair clippers fall in this subheading.
8511	Electrical ignition or starting equipment of a kind used for spark-ignition or compression-ignition internal combustion engines (for example, ignition magnetos, magneto-dynamos, ignition coils, sparking plugs and glow plugs, starter motors); generators (for example, dynamos, alternators) and cut-outs of a kind used in conjunction with such engines
8511 40 00	Starter motors and dual purpose starter-generators The equipment of this subheading usually operates on 6, 12 or 24 V and has special devices for attachment to motors. This subheading includes: <ol style="list-style-type: none">1. starter motors with sliding armature, starter motors with sliding feeder, starter motors with a helicoidal motion, and starter motors with a sliding pinion and a helicoidal motion;2. equipment which is the result of combining in one unit a starter motor and a generator.
8512	Electrical lighting or signalling equipment (excluding articles of heading 8539), windscreen wipers, defrosters and demisters, of a kind used for cycles or motor vehicles
8512 30 10	Burglar alarms of a kind used for motor vehicles See the HS Explanatory Note to heading 8512, second paragraph, (11).
8512 90 90	Other This subheading includes frames and reflectors for headlights, and wiper arms, with or without wiper blades, for electric windscreen wipers. However, the subheading does not include lamp holders (subheading 8536 61 10 or 8536 61 90).

- 8514 Industrial or laboratory electric furnaces and ovens (including those functioning by induction or dielectric loss); other industrial or laboratory equipment for the heat treatment of materials by induction or dielectric loss**
- 8514 20 80 Dielectric furnaces and ovens**
 Microwave ovens of a type designed to be used in restaurants, canteens, etc., differ from domestic appliances of heading 8516 in their power output and oven capacity. Such ovens having a power output of more than 1 000 W or an oven capacity of more than 34 litres are considered to be for industrial use. For microwave ovens combined in a single housing with a grill or another type of oven, the aforementioned power output applies only to the microwave. The classification of such a combination is not influenced by the oven capacity criterion.
 Microwave ovens having a power output of not more than 1 000 W and an oven capacity of not more than 34 litres are considered to be for domestic use (heading 8516).
- 8516 Electric instantaneous or storage water heaters and immersion heaters; electric space-heating apparatus and soil-heating apparatus; electrothermic hairdressing apparatus (for example, hairdryers, hair curlers, curling tong heaters) and hand dryers; electric smoothing irons; other electrothermic appliances of a kind used for domestic purposes; electric heating resistors, other than those of heading 8545**
- 8516 10 11 and 8516 10 80 Electric instantaneous or storage water heaters and immersion heaters**
 These subheadings include:
 1. water heaters operating both as instantaneous water heaters and water storage heaters;
 2. electric boilers which produce only hot water, or hot water and low-pressure steam simultaneously.
 These subheadings do not include electrically heated steam boilers and 'superheated water' boilers (heading 8402) and electrically heated electric boilers for central heating (heading 8403).
- 8516 21 00 to 8516 29 99 Electric space-heating apparatus and electric soil-heating apparatus**
 These subheadings include:
 1. electric heating equipment for saunas;
 2. battery-operated heating devices for warming and defrosting iced-up door locks on motor vehicles by the presence of a heating element in the lock. These small portable devices may incorporate a lamp of the type falling in heading 8513 to illuminate the working area.
- 8516 50 00 Microwave ovens**
 See the explanatory note to subheading 8514 20 80.
- 8516 60 10 Cookers (incorporating at least an oven and a hob)**
 Cookers consist of at least a hob and an oven (which may also include a microwave unit or grill).
- 8516 79 70 Other**
 In addition to the appliances described in the HS Explanatory Note to heading 8516, part (E), (5) to (20), this subheading includes:
 1. saunas with infra-red radiators (individual cubicles);
 2. foot-heating plates;
 3. electrically heated shoe trees;
 4. devices for cleaning contact lenses, consisting of two small electrically heated compartments with screw-on lids to hold the contact lenses and heat up the cleansing fluid.

8516 80 20 and 8516 80 80 Electric heating resistors

These subheadings include wire, cables, tapes and the like, which are insulated and provide heat for heating ceilings, walls, pipes, containers, etc.

However, these subheadings do not include heating resistors connected to parts of equipment, for example, base plates for smoothing irons and plates for electric cookers (subheading 8516 90 00).

8517 Telephone sets, including telephones for cellular networks or for other wireless networks; other apparatus for the transmission or reception of voice, images or other data, including apparatus for communication in a wired or wireless network (such as a local- or wide-area network), other than transmission or reception apparatus of heading 8443, 8525, 8527 or 8528**8517 12 00 Telephones for cellular networks or for other wireless networks**

See the HS Explanatory Note to heading 8517, part (I), (B).

This subheading includes telephones for cellular networks, so called 'mobile phones'.

'Mobile phones' have the following characteristics:

- they are 'pocket-sized', i.e. they are of dimensions that do not exceed 170 mm × 100 mm × 45 mm, when measured in their most compact form,
- they are capable of operating without an external source of electric power,
- they have both a microphone, and an earphone and/or a loudspeaker, either in the same unit or in the form of a detachable headset presented together with the 'mobile phone', for the transmission and reception of voice enabling voice communication,
- they incorporate other components such as an amplifier and an antenna for telephony, which provide for dual-way short-range transmission of voice within a network consisting of base stations of subheading 8517 61 and using mobile telephony frequency bands,
- they are able to do telephony communication using cellular networks when equipped with a SIM (Subscriber Identity Module) of various types (physical or software) that has been activated. They may provide that emergency calls may be made without the SIM.

'Mobile phones' may also have other features such as sending and receiving SMS (Short Message Service) and MMS (Multimedia Messaging Service) messages; emails; packet switching for access to the Internet; sending and receiving positioning signals; navigating, routing, maps, instant messaging, VOIP (voice over Internet Protocol); PDA (Personal Digital Assistant); gaming; receiving radio or television signals; capturing, recording and reproducing sound and images. Irrespective of such additional features, the mobile telephony function is generally the principal function of mobile phones that meet all of the above listed characteristics. This is the case, for example, when the telephony function takes precedence over all other functions, including when incoming calls are normally notified to the user regardless of secondary functions used.

8517 18 00 Other

In addition to the telephone sets described in the HS Explanatory Note to heading 8517, part (I), (A), this subheading includes push-button, telephone sets incorporating a magnetic card reader, a data display, an electronic circuit-board with micro-processor, several data stores, a clock and a modulator-demodulator (modem). These appliances can be used not only as telephone sets but also (for example, in supermarkets) as data terminals, for example, for verifying magnetic credit cards or cheques or for the transmission of sales data over telephone lines to automatic data-processing machines.

8517 62 00**Machines for the reception, conversion and transmission or regeneration of voice, images or other data, including switching and routing apparatus**

This subheading covers two groups of machines:

1. machines for the reception, conversion and transmission of voice, images or other data;
2. machines for the regeneration of voice, images or other data.

These machines include:

1. network interface cards;
2. modems;
3. repeaters;
4. hubs;
5. bridges (including switches);
6. routers.

This subheading includes apparatus consisting of all the elements required for transmission and reception, in one cabinet or housing. Such is the case, for example, with walkie-talkies, which contain the batteries or accumulators required for their operation, or with transmitter-receiver apparatus, the power supply unit of which would be separate and connected to the apparatus by cable only.

This subheading also includes units in which the transmitter and receiver elements are located in different furniture units or housings, provided that they constitute a functional unit. In order to be regarded as constituting a functional unit, transmitter-receiver apparatus must be installed near each other (for example, in the same building or on the same vehicle) and have certain elements in common, such as the aerial.

This subheading also includes so-called 'wireless headsets' designed to be used solely or principally with telephones for cellular networks (mobile phones), intended to be hung on the ear to provide a hands-free option. They enable the user to control telephone functions, such as answering, ending and dialling (for example, redialling the last call), within approximately 10 m from the mobile phone and have means for adjusting the earphone sound volume. These headsets incorporate a radio transmitter/receiver to communicate with a mobile phone by means of wireless technology, for example, 'Bluetooth'

8517 69 10**Videophones**

See the HS Explanatory Note to heading 8517, part (II), (C).

This subheading also includes closed-circuit television systems consisting of one camera, a panel with several call buttons, and one or more monitors connected to a communication post, and coaxial cables for linking the different elements, presented in the form of a set put up for retail sale.

Products of this subheading may also be combined with an electrical door opener, a signalling device or a light source.

8517 69 39**Other**

This subheading includes:

1. fixed reception apparatus (including those used mainly in large installations), and special devices such as secrecy devices (for example, spectrum inverters); certain receivers, termed 'diversity receivers', employ multiple receiver technique to overcome fading;
2. radiotelephony receivers for motor vehicles, ships, aircraft, trains, etc.;
3. receivers for radiotelegraphic staff location systems;
4. radio receivers for simultaneous interpretation at multilingual conferences;
5. special receivers for distress signals from ships, aircraft, etc.;
6. telemetric signal receivers;
7. 'facsimile' radiotelegraphic apparatus for receiving, on sensitised paper, copies of documents, newspapers, plans, messages, etc.

8517 69 90**Other**

This subheading includes:

1. fixed transmitters. Certain types, used mainly in large installations, include special devices such as secrecy devices (for example spectrum inverters) and multiplex devices (used for sending more than two messages simultaneously);
2. radiotelephony transmitters for motor vehicles, ships, aircraft, trains, etc.;
3. transmitters used in radiotelegraphic staff location systems;
4. radio transmitters for simultaneous interpretation at multilingual conferences;
5. automatic transmitters for distress signals from ships, aircraft, etc.;
6. 'facsimile' radiotelegraphic apparatus for transmitting copies of documents, newspapers, plans, messages, etc.;
7. transmitters of telemetric signals.

8518**Microphones and stands therefor; loudspeakers, whether or not mounted in their enclosures; headphones and earphones, whether or not combined with a microphone, and sets consisting of a microphone and one or more loudspeakers; audio-frequency electric amplifiers; electric sound amplifier sets**

This heading includes separately presented wireless microphones, headphones, earphones and loudspeakers, whether or not combined.

This heading does not include:

1. separately presented cordless handsets for line telephone sets (see the HS Explanatory Note to subheading 8517 62);
2. separately presented wireless headsets (combination of a headphone and a microphone) with dialling capability (see the explanatory note to subheading 8517 62 00).

8519**Sound recording or reproducing apparatus****8519 81 15****Pocket-size cassette-players**

For the determination of the measurements of such apparatus, subheading note 1 to Chapter 85 applies, and the dimensions of the cabinet are to be taken into account; protuberances, such as control buttons, closing devices and securing clips, are to be ignored.

- 8519 81 35** **Other**
This subheading does not include sound reproducing apparatus, so-called 'MP3 players', using optical media and incorporating devices which can be subsequently activated for the reception of radio-broadcast signals by means of software (heading 8527).
- 8519 81 45** **Other**
The explanatory note to subheading 8519 81 35 applies, *mutatis mutandis*.
- 8519 81 65** **Pocket-size recorders**
The explanatory note to subheading 8519 81 15 applies, *mutatis mutandis*.
- 8519 81 95** **Other**
The explanatory note to subheading 8519 81 35 applies, *mutatis mutandis*.
- ~~**8521**~~ ~~**Video recording or reproducing apparatus, whether or not incorporating a video tuner**~~
- ~~**8521 90 00**~~ ~~**Other**~~
~~This subheading includes apparatus without a screen capable of receiving television signals, so-called 'set-top boxes', which incorporate a device performing a recording or reproducing function (for example, a hard disk or DVD drive).~~
- 8522** **Parts and accessories suitable for use solely or principally with the apparatus of headings 8519 to 8521**
- 8522 90 41 and 8522 90 49** **Electronic assemblies**
See the explanatory note to subheading 8443 99 10
- 8523** **Discs, tapes, solid-state non-volatile storage devices, 'smart cards' and other media for the recording of sound or of other phenomena, whether or not recorded, including matrices and masters for the production of discs, but excluding products of Chapter 37**
If media of this heading are presented together with other articles, the following classification principles should be applied:
1. if the media and the other articles make up a set put up for retail sale under general interpretative rule 3(b), the set should be classified by application of that rule, or
 2. if the media and the other articles do not make up a set put up for retail sale under general interpretative rule 3(b), then the media should be classified in the appropriate subheading.
- 8523 21 00** **Cards incorporating a magnetic stripe**
This subheading also includes printed matter, such as travel tickets and boarding passes, that incorporate one or more magnetic stripes.
- 8523 29 15** **Unrecorded**
This subheading also covers tapes which have to be cut to size before use.

8523 40 118523 41 10**Discs for laser reading systems of a recording capacity not exceeding 900 megabytes, other than erasable**

This subheading covers recordable compact discs (CD-Rs).

CD-Rs are usually made of colourless transparent polycarbonate with a thickness of 1,2 mm. The top side is coated with a reflective layer of golden or silver colour and can be printed. The underside is covered with a layer of dye and a protective layer. They have a diameter of 8 or 12 cm, or can have the form of a card.

Their recording capacity can be checked with reading/writing machines and corresponding recording software.

Although recording on such discs can be done in one or several steps, the recorded information cannot be erased.

8523 40 138523 41 30**Discs for laser reading systems of a recording capacity exceeding 900 megabytes but not exceeding 18 gigabytes, other than erasable**

This subheading covers recordable digital versatile discs (DVD-/+Rs).

In contrast to the CD-Rs of subheading ~~8523 40 118523 41 10~~, DVD-/+Rs consist of two 0,6 mm-thick polycarbonate layers glued together. This physical difference can be identified by examining the outside edge of the disc. They have a diameter of 8 or 12 cm.

Their recording capacity can be checked with reading/writing machines and corresponding recording software.

Although recording on such discs can be done in one or several steps, the recorded information cannot be erased.

8523 40 198523 41 90**Other**

This subheading includes:

1. optical discs on which the recorded information can be erased and new data can be recorded ('rewritable compact discs' (CD-RWs) and 'rewritable digital versatile discs' (DVD-/+RWs)). They can be identified by the disc recording software of an automatic data-processing machine;
2. rewritable DVD-RAMs and 'MiniDiscs' which are both housed in cartridges.

8523 52 10 and 8523 52 90**'Smart cards'**

See the HS Explanatory Note to heading 8523, (C), (2).

These subheadings also include electronic proximity cards/tags usually consisting of a coil which is activated by a signal from a reader and produces a voltage to power a microcircuit, a code generator which on receiving a signal from the coil generates data, and a signal transmission antenna.

8525**Transmission apparatus for radio-broadcasting or television, whether or not incorporating reception apparatus or sound recording or reproducing apparatus; television cameras, digital cameras and video camera recorders**

This heading includes thermal-imaging cameras with infra-red imagers which capture heat-radiation and convert it into images that represent the temperatures of individual surfaces or objects in different shades of grey or in different colours but which cannot measure temperatures or represent the measured values in figures.

8523 60 00**Transmission apparatus incorporating reception apparatus**

This subheading also includes units in which the transmitter and receiver elements are located in different furniture units or housings, provided that they constitute a functional unit. In order to be regarded as constituting a functional unit, transmitter-receiver apparatus must be installed near each other (for example, in the same building or on the same vehicle) and have certain elements in common, such as the aerial.

8525 80 11 to 8525 80 99**Television cameras, digital cameras and video camera recorders**

See the HS Explanatory Note to heading 8525, (B).

These subheadings do not cover electronic reading devices for the visually handicapped (see the explanatory note to subheading 8543 70 90).

8525 80 30**Digital cameras**

Digital cameras of this subheading are always capable of still-image recording, whether on an internal storage medium or on interchangeable media.

Most cameras of this subheading have the design of a traditional photographic camera and do not have a foldable viewfinder.

These cameras may also have video-capture capability to record sequences of video.

Cameras remain classified in this subheading unless they are capable, using the maximum storage capacity, of recording, in a quality of 800 × 600 pixels (or higher) at 23 frames per second (or higher) at least 30 minutes in a single sequence of video.

Compared to the video camera recorders of subheadings 8525 80 91 and 8525 80 99, many digital cameras (when functioning as video cameras) do not offer an optical zoom function during video recording. Unaffected by the storage capacity, some cameras automatically terminate the recording of video after a certain period of time.

8525 80 91 and 8525 80 99**Video camera recorders**

Video camera recorders of these subheadings are always capable of recording sequences of video, whether on an internal storage medium or on interchangeable media.

In general, the digital video camera recorders of these subheadings have the design which differs from digital cameras of subheading 8525 80 30. They often have a foldable viewfinder and are frequently presented together with a remote control. They always offer an optical zoom function during video recording.

These digital video camera recorders may also have still image recording capability.

Digital cameras are excluded from these subheadings if they are not capable, using the maximum storage capacity, of recording, in a quality of 800 × 600 pixels (or higher) at 23 frames per second (or higher) at least 30 minutes in a single sequence of video.

8525 80 99**Other**

This subheading covers video camera recorders (so-called 'camcorders') for the recording not only of sound and images taken by the camera but also of signals from external sources, for example, DVD-players, automatic data-processing machines or television receivers. The images thus recorded can be reproduced by means of an external television receiver or monitor.

This subheading also includes 'camcorders' in which the video input is obstructed by a plate or in another way, or in which the video interface can be subsequently activated as video input by means of software. The apparatus is nevertheless designed to record television programmes or other externally incoming signals.

However, 'camcorders' with which only the images taken by the camera can be recorded and reproduced by means of an external television receiver or monitor fall in subheading 8525 80 91.

- 8527** **Reception apparatus for radio broadcasting, whether or not combined, in the same housing, with sound recording or reproducing apparatus or a clock**
For transmission apparatus incorporating reception apparatus, see the explanatory note to subheading 8525 60 00.
- 8527 12 10 and 8527 12 90** **Pocket-size radio cassette players**
See the explanatory note to subheading 8519 81 15.
- 8527 13 10** **With laser reading system**
This subheading includes radio-broadcast receivers, combined with a sound recording or reproducing apparatus with a laser reading system, whether or not combined with other sound recording or reproducing apparatus (for example of the cassette-type) or a clock.
This subheading also includes sound reproducing apparatus, so-called 'MP3 players', using optical media and incorporating devices which can be subsequently activated for the reception of radio-broadcast signals by means of software.
- 8527 13 99** **Other**
The explanatory note to subheading 8527 13 10 applies, *mutatis mutandis*.
- 8527 21 20** **With laser reading system**
The explanatory note to subheading 8527 13 10 applies, *mutatis mutandis*.
- 8527 21 70** **With laser reading system**
The explanatory note to subheading 8527 13 10 applies, *mutatis mutandis*.
- 8527 91 11 to 8527 91 99** **Combined with sound recording or reproducing apparatus**
Stereo systems (hi-fi systems) containing a radio receiver, put up in sets for retail sale, consisting of modular units in their own separate housings, for example, in combination with a CD player, a cassette recorder, an amplifier with equalizer, always fall in these subheadings as the radio receiver gives them their essential character.
- 8527 91 11 and 8527 91 19** **Within the same housing one or more loudspeakers**
These subheadings cover apparatus from which the loudspeakers are inseparable.
However, these subheadings do not cover apparatus with detachable loudspeakers, even if the loudspeakers can be attached with fastening devices (subheading 8527 91 35, 8527 91 91 or 8527 91 99).
- 8527 91 35 to 8527 91 99** **Other**
If loudspeakers for stereo systems (hi-fi systems) are specially designed for and packed together with other components of the sets, they are included in these subheadings.
- 8527 91 35** **With laser reading system**
The explanatory note to subheading 8527 13 10 applies, *mutatis mutandis*.

- 8528** **Monitors and projectors, not incorporating television reception apparatus; reception apparatus for television, whether or not incorporating radio-broadcast receivers or sound or video recording or reproducing apparatus**
According to general rule 3(c) for the interpretation of the Combined Nomenclature, video surveillance systems, consisting of a limited number of television cameras and one monitor, fall within this heading when put up in a set for retail sale. The components of such video surveillance systems are to be classified separately when the system is not put up in a set for retail sale (see the HS General Explanatory Note to Section XVI, (VII)).
This heading does not cover electronic reading devices for the visually handicapped (see the explanatory note to subheading 8543 70 90).
- 8528 61 00to 8528 69 99** **Projectors**
These subheadings do not include products comprising a projector and a screen in the same housing (subheadings 8528 51 00 to 8528 59 80 or, when incorporating reception apparatus for television, subheading 8528 72 10).
- 8528 69 10** **Operating by means of flat panel display (for example, a liquid crystal device), capable of displaying digital information generated by an automatic data-processing machine**
Besides apparatus operating by means of a liquid crystal device (LCD), this subheading also includes apparatus operating by means of digital light processing technology. It works by means of a semiconductor-controlled mechanical micro-mirror device.
- 8528 71 11to 8528 71 19** **Video tuners**
These subheadings include apparatus incorporating a video tuner which converts high-frequency television signals into signals usable by video recording or reproducing apparatus or monitors.
The apparatus incorporates selector circuits, which permit tuning to a special channel or carrier frequency, and demodulation circuits. The apparatus may also be equipped with a decoding device (colour) or with separator circuitry for synchronisation. It is generally designed to operate with an individual aerial or a shared aerial (high-frequency cable distribution).
The output signal can be used as an input signal for monitors or for recording or reproducing apparatus. It consists of the original camera signal (i.e., not modulated for transmission purposes).
Analogue video tuners within the meaning of these subheadings may be in the form of modules comprising, at least, the radio frequency circuits (RF block), intermediate frequency circuits (IF block) and demodulation circuits (DEM block) where the output is a separate audio and composite video baseband signal (CVBS).
Digital video tuners within the meaning of these subheadings may be in the form of modules comprising, at least, the RF block, IF block, DEM block and an MPEG decoder for digital television where the output is a separate audio and digital video signal.
Modules incorporating both an analogue and a digital video tuner component fall under these subheadings when one of the components is to be classified as a complete or finished video tuner by application of general rule 2(a) for the interpretation of the Combined Nomenclature.
A module not fulfilling the above conditions is to be classified as a 'part' under heading 8529.
- 8528 71 11** **Electronic assemblies for incorporation into automatic data-processing machines**
For the definition of the expression 'electronic assemblies', see the explanatory note to subheading 8443 99 10.

8528 71 13**Apparatus with a microprocessor-based device incorporating a modem for gaining access to the Internet, and having a function of interactive information exchange, capable of receiving television signals ('set-top boxes with communication function')**

This subheading covers apparatus without a screen, so-called 'set-top boxes with communication function', consisting of the following main components:

- a microprocessor;
- a video tuner.

The presence of an RF connector is an indicator that a video tuner may be present,

- a modem:

Modems modulate and demodulate outgoing as well as incoming data signals. This enables bidirectional communication for the purposes of gaining access to the Internet. Examples of such modems are: V.34, V.90, V.92, DSL- or cable modems. An indication of the presence of such a modem is an RJ 11 connector.

Devices performing a similar function to that of a modem but which do not modulate and demodulate signals are not considered to be modems. Examples of such apparatus are ISDN-, WLAN- or Ethernet devices. An indication of the presence of such a device is an RJ 45 connector.

The modem must be built into the set-top box. Set-top boxes which do not have a built-in modem but use an external modem are excluded from this subheading (e.g. a set consisting of a set-top box and an external modem).

The Transmission Control Protocol/Internet Protocol (TCP/IP) must be present as firmware in the set-top box. Set-top boxes of this subheading must enable the user of the apparatus to access the Internet. The apparatus must also be able to run Internet applications in an 'interactive information exchange' mode such as an e-mail client or a messaging application using UDP or TCP/IP sockets.

Set-top boxes which incorporate a device performing a recording or reproducing function (for example, a hard disk or DVD drive) are excluded from this subheading (subheading 8521 90 00).

8528 71 19**Other**

See the last paragraph of the explanatory note to subheading 8528 71 13.

8528 71 90**Other**

This subheading includes products without a screen which are reception apparatus for television but which do not incorporate a video tuner (for example, so-called 'IP-streaming boxes').

See also the last paragraph of the explanatory note to subheading 8528 71 13.

8528 72 10**Television projection equipment**

This subheading includes projection equipment incorporating reception apparatus for television. Such equipment projects the image via an optical system onto a screen. It may be based on cathode-ray-tube or flat-panel (for example, DMD, LCD, plasma) technology.

The projection screen may be either incorporated in the same housing as the television receiver or may be separate.

- 8528 72 30** **With integral tube**
This subheading includes apparatus combining tuner and monitor functions in the same housing, with possible simultaneous use of certain elements of each. Domestic television receivers generally belong to this category. The diagonal measurement of the screen means the active part of the picture tube measured in a straight line.
- 8529** **Parts suitable for use solely or principally with the apparatus of headings 8525 to 8528**
This heading does not include tripods for use with cameras of heading 8525 or Chapter 90 (classification according to their constituent material).
- 8529 90 20 to 8529 90 97** **Other**
These subheadings include:
1. dials;
 2. tuning blocks;
 3. diaphragms for television cameras;
 4. so-called PAL-Secam adapters. These are decoder boards (printed circuit boards mounted with electrical components) for subsequent incorporation in television receivers designed for the reception of PAL signals, so as to make these sets suitable for the dual reception of PAL/Secam signals.
- These subheadings do not include waveguides (classification of the tubes according to their constituent material).
- 8529 90 65** **Electronic assemblies**
See the explanatory note to subheadings 8443 99 10.
- 8529 90 92** **For television cameras of subheadings 8525 80 11 and 8525 80 19 and apparatus of headings 8527 and 8528**
This subheading includes so-called 'LCD modules' consisting of a thin-film transistor (TFT) liquid-crystal layer sandwiched between two sheets or plates of glass or plastic, not combined with touch-screen facilities, used in the manufacture of monitors and/or reception apparatus for television of heading 8528.
The modules are equipped with one or more printed or integrated circuits, with control electronics for pixel-addressing only. They are not equipped with electronics (such as a video converter or a scaler) for video processing.
The modules can be equipped with a backlight unit and/or inverters.
This subheading does not include liquid-crystal devices consisting of a liquid-crystal layer sandwiched between two sheets or plates of glass or plastics, whether or not fitted with electrical connections (i.e. for the supply of power), presented in the piece or cut to special shapes (subheading 9013 80 20).
- 8531** **Electric sound or visual signalling apparatus (for example, bells, sirens, indicator panels, burglar or fire alarms), other than those of heading 8512 or 8530**
- 8531 10 30 and 8531 10 95** **Burglar and fire alarms and similar apparatus**
See the HS Explanatory Note to heading 8531, second paragraph, (E).
These subheadings do not include burglar alarms of a kind used for motor vehicles (subheading 8512 30 10).
- 8531 20 20 to 8531 20 95** **Indicator panels incorporating liquid crystal devices (LCD) or light-emitting diodes (LED)**
These subheadings include variable electroluminescent diode readouts used principally as numerical and/or alphanumeric signals or display panels, for example, made up of cells or various light-emitting diodes. Each sign contains a certain number of light-emitting diodes in the form of components which are either discrete or attached to a single microchip. These devices are mounted on a printed circuit with a driver/decoder. Each digit or assembly of digits is covered by translucent material which amplifies the intensity of the light points produced by the diodes in order to produce figures or letters as a function of the pulse applied to the circuit by an input signal.

8531 90 85**Other**

This subheading includes anti-theft tags (such as those consisting of a diode and an antenna, so-called 'microwave tags', or those consisting of a microchip-resonant circuit, so-called 'frequency division' tags) attached to goods which, when they come within the signal field of a burglar alarm system installed at a shop exit, of a type falling in subheading 8531 10, influence the receiving electronics of the system and trigger off an alarm.

This subheading also includes tags which combine two different technologies, such as acousto-magnetic with microwave or acousto-magnetic with radio frequency.

However, this subheading does not include:

- tags consisting of a wire, strip or combination of two strips, so-called 'magnetic tags' or 'acousto-magnetic tags', of magnetic materials intended to be used within the control zone of an Electronic Article Surveillance (EAS) system (heading 8505),
- tags which have embedded in them one or more electronic integrated circuits in the form of chips and an antenna but with no other active or passive circuit elements ('smart cards'), so-called 'Radio Frequency Identification' tags (RFID) (subheading 8523 52),
- tags containing one or more electronic integrated circuits in the form of chips with an embedded antenna and one or more capacitors but no other active or passive circuit elements (subheading 8523 59),
- tags in the form of a printed circuit (see note 5 to Chapter 85), so-called 'radio frequency tags' (heading 8534 00).

8534 00**Printed circuits**

This heading includes paper tags in the form of a printed circuit, to prevent the theft of, for example, library books. This heading includes:

1. paper tags in the form of a printed circuit, to prevent the theft of, for example, library books;
2. flexible electric conductors in the form of printed circuits.

8536

Electrical apparatus for switching or protecting electrical circuits, or for making connections to or in electrical circuits (for example, switches, relays, fuses, surge suppressors, plugs, sockets, lamp holders and other connectors, junction boxes), for a voltage not exceeding 1 000 V; connectors for optical fibres, optical-fibre bundles or cables

In addition to the apparatus described in the HS Explanatory Note to heading 8536, this heading includes:

1. distribution frames for telephone exchanges;
2. intersection or junction plates for overhead tram cables;
3. junction plates for electric motors;
4. commutators for multiple point transformers;
5. connecting parts for accumulator elements;
6. so-called inductive proximity switches, i.e., electronic switches incorporating a free-radiating induction coil for the contactless actuation (closure) of the switch when a metal object comes within the stray field of the induction coil. Such switches are used, for example, in machine tools, conveyor machinery and weighing balances instead of mechanically operated electrical terminal switches;
7. on-off switches housed alongside an intensity modulation device (dimmer) in a single housing. By means of this equipment, it is possible not only to switch mains-operated lamps on and off, but also to vary their intensity continuously;
8. so-called contact pads for connecting electrical circuits. These consist of two superposed resilient films of plastics in which are embedded, at regular intervals, a large number of electrically conductive contact points of silicone rubber. These contact pads are incorporated, for example, under the keys of telephone sets. Each time a key is pressed the appropriate contact points on the two films touch, and electrical contact is established;
9. electronic switches which operate by contactless means, using semiconductor components (for example, transistors, thyristors, integrated circuits).

However, this heading does not include:

- (a) insulation and sheathing for electric lines (generally, heading 7326);
- (b) control equipment for railways and other communication routes (heading 8530).

8536 50 11**Push-button switches**

This subheading does not cover touch-sensitive switches (subheading 8536 50 19).

8536 69 10to 8536 69 90**Other**

These subheadings include electromechanical plugs and sockets which permit multi-way connection, for example, between appliances, cables and connector boards, simply by plugging the attached plugs into the attached sockets with no assembly work required.

The connectors may have a plug or socket on either side or a plug or socket on one side and another contact device on the other (for example, crimp, clamp, soldered or screw-type).

These subheadings also include plug-in couplings comprising a plug and socket pair (two pieces). The plug and the socket pieces each have one socket and one other contact device.

These subheadings do not include connection or contact elements with which an electrical connection is established by other means (for example, crimp, screw-type, soldered or clamp terminals). These are covered by subheading 8536 90.

8536 69 10**For coaxial cables**

This subheading covers only plugs and sockets used for coaxial connections, where coaxial cables can be permanently attached to the contacts at the other ends (see the examples in figures 1 to 4).

Figure 1
Coaxial plug

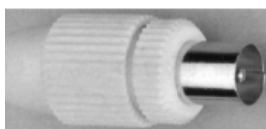

Figure 2
Coaxial socket

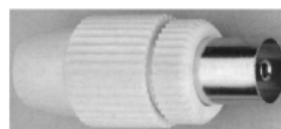

Figure 3
Coaxial plug

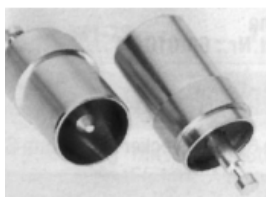

Figure 4
Coaxial socket

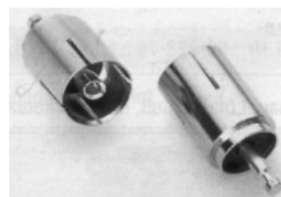

Figure 1
Coaxial plug

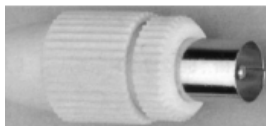

Figure 2
Coaxial socket

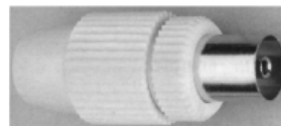
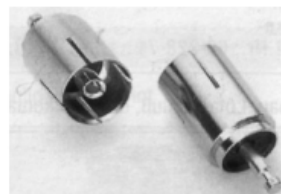

Figure 3
Coaxial plug



Figure 4
Coaxial socket



8536 69 30

For printed circuits

This subheading covers all plug-and-socket connectors to which printed circuits can be directly connected on one or both sides (direct connectors; see the examples in figures 5 to 9).

1. Plug-and-socket connectors for direct vertical mounting of printed circuits:

Figure 5
Connector

Figure 6
Printed circuit

Figure 7
Connector with mounted
circuit board

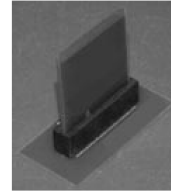
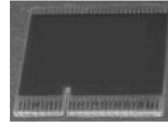
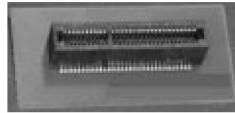
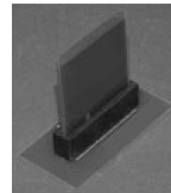
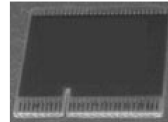
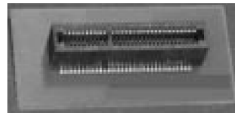

Figure 5
Connector

Figure 6
Printed circuit

Figure 7
Connector with mounted
circuit board



2. Single and double-sided plug-and-socket connectors for mounting printed circuits horizontally:

Figure 8
Single-sided connector for direct connection to circuit board

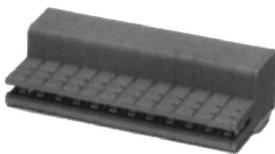

Figure 8
Single-sided connector for direct connection to circuit board

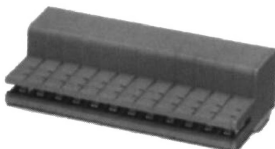

Figure 9
Double-sided connector for mounting two circuit boards

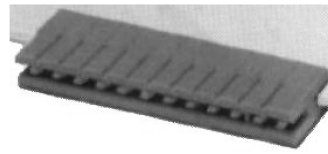
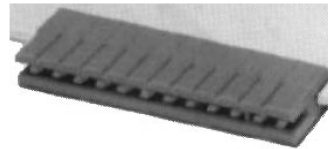

Figure 9
Double-sided connector for mounting two circuit boards



This subheading does not include male and female components of a plug-and-socket connection (for example, pin or socket terminal strips) which are attached permanently to the circuit board and can be plugged into or onto the connector (subheading 8536 69 90).

8536 69 90

Other

This subheading covers all other plug-and-socket connectors and connections illustrated below:

Figure 10

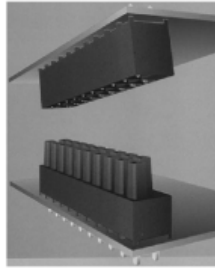

Figure 11

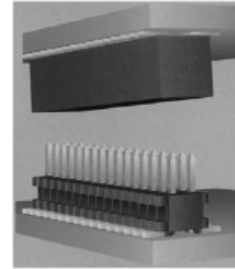

Figure 12

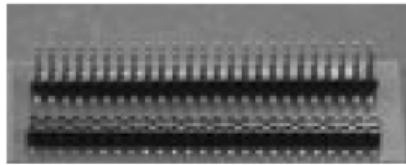

Figure 13



RJ45 Receptacle and Plug'

Figure 11

Figure 10

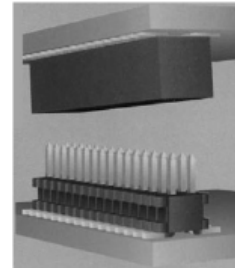
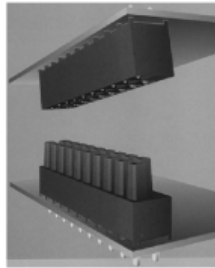

Figure 12

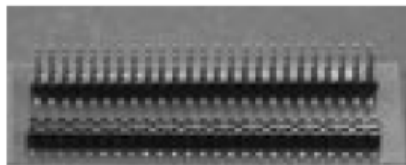

Figure 13



RJ45 Receptacle and Plug'

8536 70 00

Connectors for optical fibres, optical-fibre bundles or cables

See note 6 to this chapter.

See the HS Explanatory Note to heading 8536, (IV).

8536 90 01

Prefabricated elements for electrical circuits

This subheading includes ready-to-mount elements for the transmission of electricity. Such elements provide a degree of spatial flexibility in the power supply for lamps and electrically powered machines and equipment. The contact points across which the current is delivered are of the clamp or sliding variety. Typical applications are shown in the diagrams below:

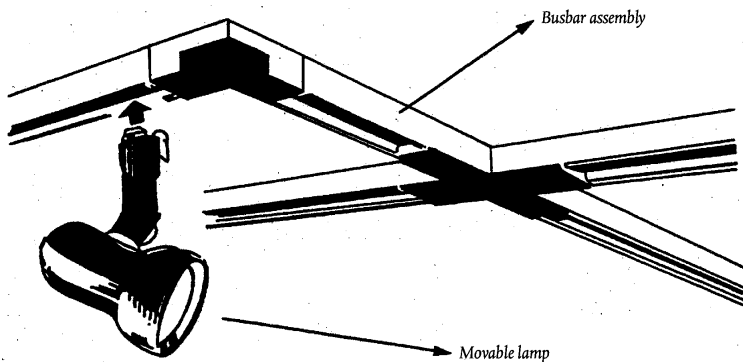
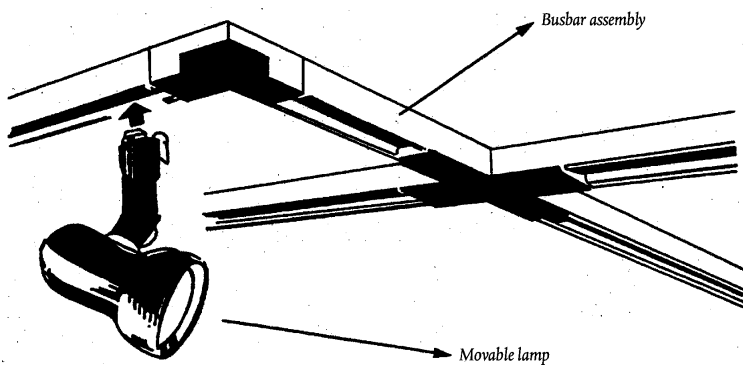
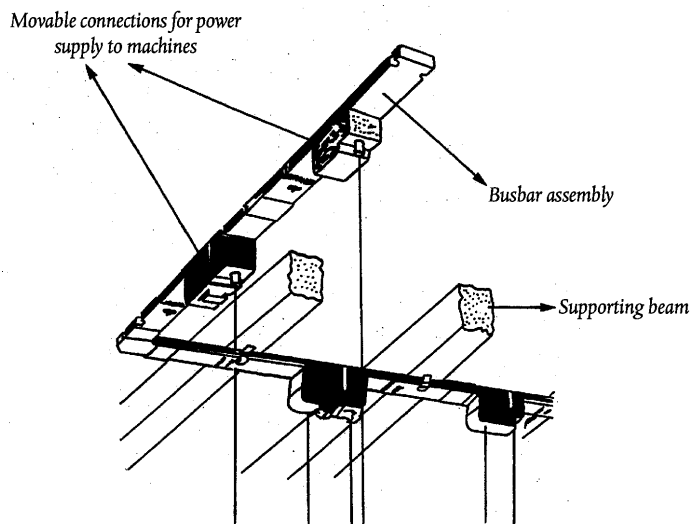
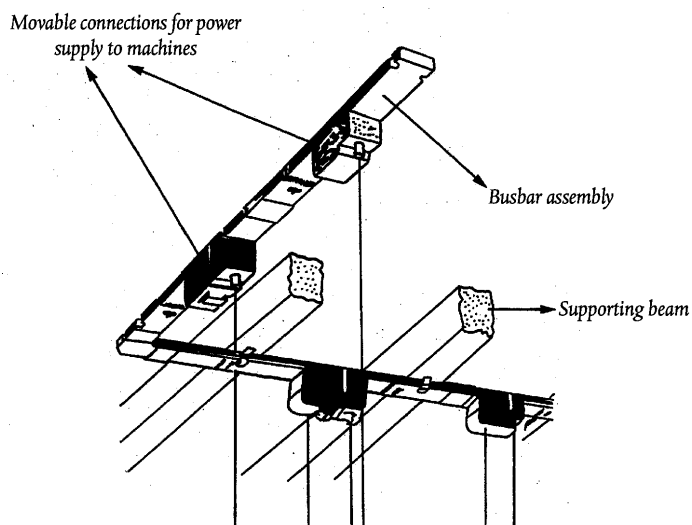

This subheading covers all terminal devices fitted to the ends of wires or cables for establishing an electrical connection by means other than plugging (for example, crimp, screw-type, soldered or clamp terminals).

8537 **Boards, panels, consoles, desks, cabinets and other bases, equipped with two or more apparatus of heading 8535 or 8536, for electric control or the distribution of electricity, including those incorporating instruments or apparatus of Chapter 90, and numerical control apparatus, other than switching apparatus of heading 8517**

This heading includes assemblies on a support (for example, panel, box) of identical items of equipment to those of heading 8536 (for example, light switches).

8537 10 91 **Programmable memory controllers**

This subheading includes panel cabinets incorporating application memory for the electrical control of machines. They are fitted not only with equipment of heading 8535 or 8536 (for example, relays) but also, for example, with transistors or triacs of heading 8541 as switching devices and which, in addition to these switching elements, also include microprocessors (for example, for logic processing and the management of inputs and outputs), interfaces and a power supply unit (power pack).

8537 10 99 **Other**

This subheading includes:

1. remote cable control units for video recorders. These are electrical control pads (with push-button switches and other electrical components mounted on a board) which are used to execute, via a connecting cable, all the functions of the linked-up video recorder;
2. electrical control devices for automatic vending machines. These consist of a control pad incorporating, in addition to relays and electrical switches, triacs and integrated circuits.

This subheading does not include:

- (a) electrical control devices known as 'joysticks' within the meaning of note 5(C) to Chapter 84 (heading 8471);
- (b) cordless infra-red devices for the remote control of television receivers, video recorders or other electrical equipment (heading 8543).

8538 **Parts suitable for use solely or principally with the apparatus of heading 8535, 8536 or 8537**

8538 90 11**Electronic assemblies**

See the explanatory note to subheading 8443 99 10.

8538 90 91**Electronic assemblies**

See the explanatory note to subheading 8443 99 10.

8539**Electric filament or discharge lamps, including sealed-beam lamp units and ultraviolet or infra-red lamps; arc lamps**

With the exception of certain arc lamps (see the explanatory note to subheadings 8539 41 00 and 8539 49 00) which are specially equipped or mounted, only lamps and tubes as such and parts thereof which are identifiable in accordance with note 2(b) to section XVI, fall in this heading.

Apparatus fitted with such lamps (consisting, for example, of a simple reflector with a support or base) is classified in its appropriate heading, as lighting equipment (heading 9405), heating equipment (heading 7321, for example) or medical equipment (heading 9018), etc.

- 8539 21 30to 8539 29 98** **Other filament lamps, excluding ultraviolet or infra-red lamps**
 These subheadings do not include:
 (a) resistance lamps with carbon filaments and variable resistance lamps with iron filaments in hydrogen (heading 8533);
 (b) electric lamp sets of a specific length comprising a fixed number of fancy lights, mainly used for decorating Christmas trees (heading 9405).
- 8539 31 10to 8539 39 00** **Discharge lamps, other than ultraviolet lamps**
 These subheadings include:
 1. xenon tubes;
 2. spectral discharge lamps;
 3. glow discharge lamps;
 4. alphanumeric tubes.
- 8539 41 00and 8539 49 00** **Ultraviolet or infra-red lamps; arc lamps**
 These subheadings include:
 1. ultraviolet tubes and lamps. In addition to the uses referred to in the HS Explanatory Note to heading 8539, part (D), first paragraph, the following may be mentioned:
 (a) actino-chemical printing;
 (b) vitaminisation;
 (c) sterilisation;
 (d) photochemistry;
 (e) production of ozone.
 2. infra-red lamps and tubes. In addition to the uses referred to in the HS Explanatory Note to heading 8539, part (D), second paragraph, the following may be mentioned:
 (a) space heating;
 (b) equipment for infra-red emitters (for example, in anti-theft apparatus);
 (c) scientific research (for example, spectral analysis).
 3. arc lamps described in the HS Explanatory Note to heading 8539, part (E).
 Carbon-electrode arc lamps are installed, for example, in cinematographic projection equipment of heading 9007 or used in document-reproducing equipment.
 Subheading 8539 41 00 includes electric arc lamps equipped with special supports as well as guidable light equipment consisting of one or more arc lamps mounted on a mobile support, intended for use particularly in photographic or cinematographic studios.
 These subheadings do not include:
 (a) luminescent diodes (heading 8541);
 (b) electroluminescent devices, generally in strips, plates or panels, and based on electroluminescent substances (for example, zinc sulphide) placed between two layers of conductive material (heading 8543).
- 8539 90 10and 8539 90 90** **Parts**
 These subheadings include:
 1. bases for incandescent and discharge electric lamps and bulbs;
 2. tungsten filaments, spiral, cut to length and ready for mounting;
 3. metal electrodes for discharge lamps and tubes;
 4. glass parts (excluding insulating parts of subheading 8547 90 00) intended for mounting inside lamps or tubes;
 5. supporting brackets for filaments.
- 8540** **Thermionic, cold cathode or photocathode valves and tubes (for example, vacuum or vapour or gas-filled valves and tubes, mercury arc rectifying valves and tubes, cathode ray tubes, television camera tubes)**
- 8540 11 00** **Colour**
 This subheading covers the cathode ray tubes described in the HS Explanatory Note to heading 8540, fourth paragraph, (2), and which comply with the conditions set out below:
 1. slit mask;
 2. gap between two lines of the same colour at the centre of the screen not less than 0,4 mm.
 For the diagonal measurement of the screen, see the explanatory note to subheading 8528 72 30.

- 8540 60 00** **Other cathode ray tubes**
This subheading covers the cathode ray tubes described in the HS Explanatory Note to heading 8540, fourth paragraph, (2), (d), other than those covered by subheadings 8540 11 and 8540 12.
- 8540 71 00**~~to~~ **and 8540 79 00** **Microwave tubes (for example, magnetrons, klystrons, travelling wave tubes, carcinotrons), excluding grid-controlled tubes**
These subheadings cover the tubes described in the HS Explanatory Note to heading 8540, fourth paragraph, (4).
These subheadings do not include Geiger-Müller counter tubes (subheading 9030 90 85).
- 8540 81 00** **and 8540 89 00** **Other valves and tubes**
In addition to the lamps, tubes and valves for rectifying electric current referred to in the HS Explanatory Note to heading 8540, fourth paragraph, (1), these subheadings include phanotrons, thyratrons, ignitrons and high-voltage rectifying tubes for X-ray apparatus.
- 8541** **Diodes, transistors and similar semiconductor devices; photosensitive semiconductor devices, including photovoltaic cells whether or not assembled in modules or made up into panels; light-emitting diodes; mounted piezoelectric crystals**
- 8541 40 90** **Other**
This subheading includes photovoltaic cells assembled in modules or made up into panels incorporating bypass diodes (but no blocking diodes). The bypass diodes are not elements which supply the power directly to, for example, a motor (see the HS Explanatory Notes to headings 8501 and 8541).

8541 90 00**Parts**

In addition to the parts mentioned in the HS Explanatory Note to heading 8541, this subheading includes:

1. supports and housings for piezoelectric crystals;
2. housings of metal, steatite, etc., for mounted semiconductors.

This subheading does not include:

- (a) electrical connectors for conducting current between pins (or contacts) and electrodes (heading 8536);
- (b) graphite parts (subheading 8545 90 90).

8542**Electronic integrated circuits**

This heading includes interchangeable pre-programmed memory modules in the form of a monolithic integrated circuit for electronic translation devices falling in subheadings 8470 10 00 and 8543 70 10.

This heading does not include discs (sometimes referred to as wafers) which, for the purposes of their applications in the field of electronics, consist of doped chemical elements, whether or not polished and whether or not epitaxially coated, provided that they have not been selectively doped or diffused to create discrete regions (heading 3818 00).

8542 31 10 and 8542 31 90**Processors and controllers, whether or not combined with memories, converters, logic circuits, amplifiers, clock and timing circuits, or other circuits**

These subheadings include:

1. microprocessors, also called micro processing units (MPUs), which are integrated circuits that can be defined as devices that perform the primary instruction, execution and system control functions. They consist of the following main parts:
 - the arithmetic logic unit (ALU);
 - the instruction decoder and programme counter;
 - the control unit;
 - the input/output (I/O) unit, for communications with other devices.

A microprocessor can operate only if, apart from the internal memory, an external memory or other device is being used.

They may have one or more micro-program-memories (RAM or ROM) for loading or storing micro-instructions, thereby increasing the number of primary instructions in the control unit.

The micro-programmed ROM that a microprocessor may contain is dedicated to storing binary basic-instructions and is not to be considered as a real program memory storing the instructions to be executed.

These products may contain an instruction cache memory or micro-peripheral functions.

Microprocessors entirely processed for a specific application, based on 'full custom', 'gate array' or 'standard cell' designs, are included.

The processing capacity of microprocessors means the length of each word which the accumulator of the arithmetic and logic unit can process in a single micro-instruction cycle.

2. microcontrollers and microcomputers which are integrated circuits, consisting of at least the following main parts:
 - a microprocessor, also called micro processing unit (MPU);
 - a program memory (for example, RAM, ROM, PROM, EPROM, E²ROM, flash E²PROM) linked to the instruction decoder and containing a program defining an instruction sequence;
 - a data memory (for example, RAM or E²PROM), not accessible from outside the chip contrary to microprocessors;
 - an external bus (for data, addresses or instructions).

Microcontrollers are programmed, or further programmable, to perform specific functions and only for certain use (for example, for television receivers, video recording or reproducing apparatus or microwave ovens).

Microcomputers are capable of operating independently (stand alone) and for general use (for example, mainframes, minicomputers and personal computers). Microcomputers are freely programmable in accordance with the requirements of the user.

Microcontrollers, entirely processed for a specific application, based on 'full custom', 'gate array' or 'standard cell' designs, are included.

The processing capacity of microcontrollers or microcomputers means the length of each word which the accumulator of the arithmetic logic unit can process in a single micro-instruction cycle.

3. control circuits which are integrated circuits used to influence a process or the performance of a machine (for example, an automatic data-processing machine). Control circuits (for example, for disk storage units, memories, electric motors or cathode ray tubes) are generally capable of interpreting signals and, in accordance with the interpretation, determining the timing and sequence of certain functions (for example, input, processing, storage and output in an automatic data-processing system).

8542 31 10**Goods specified in note 8(b)(3) to this chapter**

See the HS Explanatory Note to heading 8542, (III).

8542 32 10**Goods specified in note 8(b)(3) to this chapter**

See the HS Explanatory Note to heading 8542, (III).

8542 32 45**Static random-access memories (S-RAMs), including cache random-access memories (cache-RAMs)**

Cache random-access memories (cache-RAMs) are static random-access memories with an access time faster than the main memory. Cache-RAMs are generally used as temporary buffer memories to accommodate the speed differential between a central processing unit and the main memory.

8542 32 61 to 8542 32 75**Electrically erasable, programmable, read only memories (E²PROMs), including flash E²PROMs**

E²PROMs are in general byte-erasable memories.

Flash E²PROMs are memories also called 'flash Memories', 'flash EPROMs' or 'flash EEPROMs'.

Flash memories may be based on EPROM or E²PROM-technology and are electrically erasable, either totally (bulk-wise) or by sector (page- or block-wise).

Programming, reading and erasure of these memories can be accomplished at a dual power supply or at a single power supply.

Flash memories based on EPROM technology have an array structure composed of one transistor cell.

Flash memories based on E²PROM technology have an array structure composed of two or more transistor cells or of one transistor cell combined with another transistor per sector (page or block). The latter type further differentiates from EPROM-technology based memories because they contain a number of characteristic E²PROM elements (for example, an E²PROM command-set).

8542 32 90**Other memories**

This subheading includes content addressable memories (CAMs) and ferroelectric memories.

Content addressable memories (CAMs) are content associative storage devices. Storage locations of these devices are identified by their contents or by part of their contents, rather than by their names or positions (addresses).

Ferroelectric memories are non-volatile memories obtained by combining ferroelectric and semiconductor material. The ferroelectric material is able to retain electric polarisation in the absence of an applied electric field.

These devices are both electrically programmable and erasable.

8542 39 10 and 8542 39 90**Other**

These subheadings include:

1. full custom logic circuits which are defined by and produced for a single user. The manufacturing process involves routing and placement of cells (logic gates), using fully customised diffusion masks. Full custom logic circuits are designed to perform application-specific functions. They are known as application-specific integrated circuits, so called ASICs;
2. gate arrays which are integrated logic circuits, consisting of a fixed and regular arrangement of uncommitted logic elements (transistor cells of, for example, AND-, NAND-, OR- or NOR- gates). Gate arrays are programmed in accordance with user-specific interconnection of these logic elements by one or more metallisation patterns;
3. standard cells which are integrated logic circuits, consisting of a user-specific arrangement of predefined subcircuits and fixed subcircuits. These subcircuits may contain any integrated function (for example, a logic function or a memory function);
4. programmable logic circuits which are integrated circuits, consisting of fixed logic elements. The eventual function of these circuits is determined by the user by blowing fusible links or by electrically programming the interconnections between the logic elements;
5. standard logic circuits which are integrated logic circuits consisting of less than 150 logic gates (for example, AND, NAND, OR, NOR). These devices may integrate several functions or sets of identical and independent functions;
6. interface circuits which are integrated circuits which perform a link function (for example, by code conversion, by conversion between bit-serial and bit-parallel or by synchronization) to interconnect programs, integrated circuits, peripherals or systems with different characteristics;
7. microperipherals which are integrated circuits performing specific functions to complement microprocessors, micro-controllers or microcomputers and improve their external communication, control and interface features.

Technical specifications of a microperipheral clearly express its relationship with and dedication to a microprocessor, microcontroller or microcomputer.

Communications, control and interface features may consist of bus controllers, memory controllers (DRAM controllers, memory management units (MMUs), direct memory access controllers) or peripheral interface controllers (graphic controllers, local area network controllers, universal asynchronous receiver/transmitter controllers, keyboard controllers, mass storage controllers);

8. smartpower circuits which are integrated analogue circuits which combine digital and analogue circuitry (power transistors) to control logic output signals and power output signals. These devices are able to provide, for example, internal power dissipation protection, fault management or diagnostic capabilities.

These subheadings do not include programmable read only memories (PROMs) (subheading 8542 32 90).

8542 39 10

Goods specified in note 8(b)(3) to this chapter

See the HS Explanatory Note to heading 8542, (III).

8543

Electrical machines and apparatus, having individual functions, not specified or included elsewhere in this chapter

8543 70 90**Other**

This subheading includes:

1. electrostatic devices (for example, for flocking machines);
2. electroluminescent devices, generally in the form of strips, plates or panels;
3. thermo-electric generators consisting of a thermopile comprising a variable number of thermocouples and a heat source (for example, butane gas), producing direct current by the Seebeck effect;
4. static electricity eliminator devices;
5. demagnetising equipment;
6. shock-wave generators;
7. digital flight-data recorders (flight recorders) in the form of a fire-proof, crash-proof electronic apparatus for the continuous in-flight recording of specific flight data;
8. cordless infra-red devices for the remote control of television receivers, video recorders or other electrical equipment;
9. electronic sound-effect devices used as peripherals for electric guitars for the production of various effects (for example, sound duplication, sound distortion, echoing). These devices are not housed in the guitar casing but are wired between the guitar and the power amplifier;
10. electronic reading devices for the visually handicapped. These devices comprise, in a single housing, a camera, which scans the original text (for example, newspaper or book) and a monitor which reproduces the text in magnified form.

This subheading also covers small electronic devices not mounted on a base-plate (including so-called 'minicomputers'), which can be used to form words and sentences which are translated into a chosen foreign language depending on the memory modules used with these devices. They have an alphanumeric keyboard and a rectangular display. However, this subheading does not cover similar devices with calculating functions (heading 8470).

This subheading does not include:

- (a) electrostatic filters and electromagnetic water purifiers (heading 8421);
- (b) ultraviolet irradiation equipment for treating milk (heading 8434);
- (c) equipment for cleaning various articles ultrasonically (metal parts, in particular) and ultrasonic generators (heading 8479);
- (d) ultrasonic welding equipment (heading 8515);
- (e) ultraviolet irradiation equipment for medical purposes, even if a practitioner is not needed to use them (heading 9018);
- (f) electric regulators for regulating electric or non-electric variables, falling in heading 9032.

8544

Insulated (including enamelled or anodised) wire, cable (including coaxial cable) and other insulated electric conductors, whether or not fitted with connectors; optical-fibre cables, made up of individually sheathed fibres, whether or not assembled with electric conductors or fitted with connectors

This heading does not include separately presented connectors and adapters for cables. Connectors and adapters for electric conductors are to be classified in heading ~~This heading does not include: 8535 or 8536.~~

Connectors for optical-fibre cables are to be classified in subheading 8536 70 00.

- (a) flexible electric conductors in the form of printed circuits (heading 8534 00);
- (b) separately presented connectors and adapters for cables or other electric conductors (heading 8535 or 8536);
- (c) connectors for optical-fibre cables (subheading 8536 70 00).

8544 42 10**Of a kind used for telecommunication**

See the HS Explanatory Note to heading 8544.

For the purpose of this subheading, the expression 'of a kind used for telecommunication' also includes electric conductors fitted with connectors used in telecommunication networks, for example, to connect an automatic data-processing (ADP) machine with a modem.

However, this subheading does not include:

- (a) electric conductors fitted with connectors to be used for connecting different apparatus (for example, a DVD player with a monitor or an ADP machine with a monitor, a printer, a keyboard, a projector, etc.);
- (b) electric conductors designed to be inserted into machines, for example, an ADP machine or a unit thereof, to connect different internal parts of the machine;
- (c) electric conductors which serve only to supply power, for example, power cables.

8544 49 20**Of a kind used for telecommunication, for a voltage not exceeding 80 V**

The explanatory note to subheading 8544 42 10 applies, *mutatis mutandis*.

8544 70 00**Optical-fibre cables**

This subheading also includes optical-fibre cables, designed for example for telecommunication use, made up of optical fibres individually coated with a dual layer of acrylate polymer placed in a protective casing. The coating consists of an inner sheath of soft acrylate and an outer sheath of hard acrylate, the latter being coated by a layer of various colours. The coating of the individual optical fibres provides protection and structural integrity, for example by protecting the individual fibres against fracture.

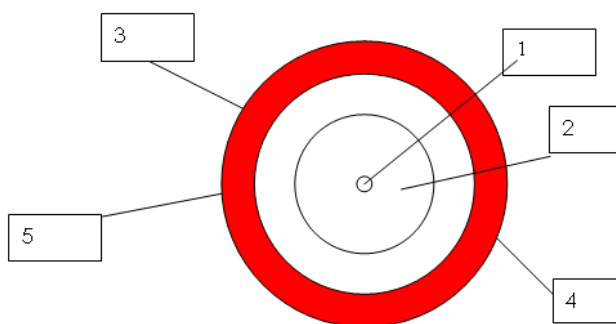
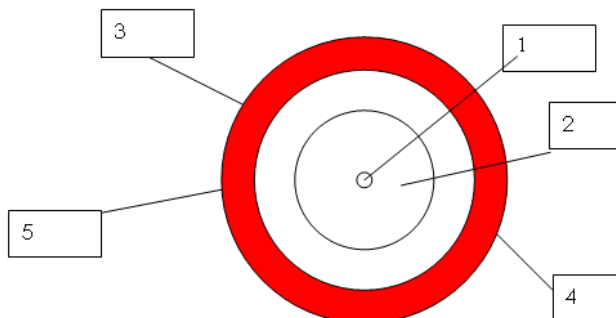

1. optical-fibre core (glass-fibre core);
2. optical-fibre cladding (glass);
3. inner sheath of soft acrylate coating;
4. colour coding (ColourLock) identification;
5. outer sheath of hard acrylate coating.

8545 Carbon electrodes, carbon brushes, lamp carbons, battery carbons and other articles of graphite or other carbon, with or without metal, of a kind used for electrical purposes

8545 90 90

Other

This subheading includes:

1. carbons for lightning arresters;
2. contacts for electrical control equipment or for rheostats.

This subheading does not include compositions of paste for electrodes with a basis of carbonised material (heading 3824).

8547

Insulating fittings for electrical machines, appliances or equipment, being fittings wholly of insulating material apart from any minor components of metal (for example, threaded sockets) incorporated during moulding solely for purposes of assembly, other than insulators of heading 8546; electrical conduit tubing and joints therefor, of base metal lined with insulating material

8547 20 00

Insulating fittings of plastics

This subheading includes insulating parts obtained by compressing glass fibres steeped in resin or by superimposing or compressing layers of paper or woven materials previously impregnated with artificial resins, provided that the products in question are hard and rigid (see the HS General Explanatory Note to Chapter 39, 'Combinations of plastics and materials other than textiles', (d)).

8547 90 00

Other

This subheading includes insulating fittings of paper or paperboard, asbestos cement and mica, as well as the conduit tubing and joints therefor referred to in the HS Explanatory Note to heading 8547, (B).

8548

Waste and scrap of primary cells, primary batteries and electric accumulators; spent primary cells, spent primary batteries and spent electric accumulators; electrical parts of machinery or apparatus, not specified or included elsewhere in this chapter

8548 90 90

Other

This subheading includes:

1. electric coils without magnetic cores which are equally suitable for use in machines or apparatus falling in different headings, for example, for transformers of heading 8504 and for electromagnets of heading 8505 (application of note 2(c) to Section XVI);
2. delay lines used, for example, in automatic data-processing machines or television receivers;
3. electronic filters used for the selective transmission of different frequencies of electromagnetic, electromechanical or electro-acoustic vibrations;
4. elements of ferrite or other ceramics (for example, those used in circulators for ultra-high-frequency transmission apparatus or as a high-frequency filter in electrical cables), which are electrical parts, equally suitable for use in machines or apparatus falling within different headings of this chapter.

SECTION XVII

VEHICLES, AIRCRAFT, VESSELS AND ASSOCIATED TRANSPORT EQUIPMENT

Additional note 2 The explanatory note to additional note 3 to section XVI applies, *mutatis mutandis*.

CHAPTER 87

VEHICLES OTHER THAN RAILWAY OR TRAMWAY ROLLING STOCK, AND PARTS AND ACCESSORIES THEREOF

General

1. Throughout the Combined Nomenclature, 'new vehicles' means vehicles which have never been registered.
2. Throughout the Combined Nomenclature, 'used vehicles' means vehicles which have been registered at least once.

8701 Tractors (other than tractors of heading 8709)**8701 10 00 Pedestrian-controlled tractors**

This subheading covers the items of equipment described in the HS Explanatory Note to heading 8701, sixth and seventh paragraphs, including tracked pedestrian-controlled tractors. Tractors of this type are used mainly in horticulture. Interchangeable implements intended for use with pedestrian-controlled tractors (harrows, ploughs, etc.) are still classified separately, even if they are mounted on a pedestrian-controlled tractor.

However, if the implements or tools are permanently attached to a chassis with an engine and, together with the latter, form a single mechanical unit, that unit is classified in the heading which covers the working unit. This applies to motorised ploughs and motorised cultivators (heading 8432).

8701 30 00 Track-laying tractors

This subheading includes tractor-type vehicles with extra wide tracks for levelling and smoothing the snow on ski slopes etc.

Machines and working tools designed for fitting to this type of vehicle, as interchangeable equipment (pusher-blades, rotary snow-ploughs, etc.) remain classified in their respective headings (headings 8430, 8479, etc.) even if presented with the vehicle, and whether or not mounted on it.

8701 90 11 to 8701 90 90 Other

These subheadings include so-called 'all-terrain vehicles', designed to be used as tractors, with the following characteristics:

- a single seat, accommodating the driver only; the vehicle is not designed to carry other persons,
- a handlebar with two grips incorporating the controls for steering the vehicle; the steering is achieved by turning the two front wheels and is based on a motor-car-type steering system (Ackerman principle),
- brakes on all wheels,
- an automatic clutch and a reverse gear,
- an engine specially designed for use in difficult terrain and capable in low ratio of delivering sufficient power to tow attached equipment,
- power transmission to the wheels by shafts and not with a chain,
- tyres having a deep tread design suitable for rough terrain,
- a coupling device of any kind, for example a towing hitch, designed to enable the vehicle to pull or push at least twice its dry weight,
- a towing capacity of a non-braked trailer of twice its dry weight or more.

If they meet all of the above characteristics and are in accordance with the explanatory note to subheadings 8701 90 11 to 8701 90 50, the vehicles are to be classified as agricultural or forestry tractors. Otherwise, they fall under subheading 8701 90 90.

If they do not meet the above characteristics, the so-called 'all-terrain vehicles' are to be classified in heading 8703.

These subheadings also exclude so-called 'Quads' (heading 8703 or subheading 9503 00 10 (see the explanatory note to that subheading)).

8701 90 11 to 8701 90 50**Agricultural tractors (excluding pedestrian-controlled tractors) and forestry tractors, wheeled**

These subheadings cover agricultural or forestry tractors having at least three wheels and obviously intended, given their construction and equipment, to be used for agricultural, horticultural or forestry purposes.

Vehicles of this type normally have a maximum speed of 45 km/h.

Their engines are capable of delivering maximum pulling force, for example when using a locking differential.

Their tyres have a deep tread design suitable for agricultural, horticultural or forestry purposes.

Agricultural tractors are generally equipped with a hydraulic device enabling agricultural machinery (harrows, ploughs, etc.) to be raised or lowered, a power take-off enabling the power from the engine to be used to operate other machines or implements, and a coupling device for trailers. They may also be fitted with a hydraulic device intended to operate handling equipment (hay loaders, manure loaders, etc.) when these may be considered to be accessories.

These subheadings also include specially built agricultural tractors, such as raised-chassis tractors (straddle tractors) used in vineyards and nurseries, and hill tractors and tool-carrying tractors.

Even if mounted on the tractor at the time of presentation, interchangeable agricultural equipment remains classified in its respective heading (heading 8432, 8433, etc.).

A particular feature of forestry tractors is the presence of a permanently attached winch enabling timber to be hauled.

In accordance with note 2 to this chapter, tractors falling in these subheadings may also incorporate certain characteristics enabling them, in line with their main purpose, to carry agricultural or forestry machinery, tools, fertilisers, seeds, etc.

These subheadings do not include lawnmowers (referred to as ride-on lawnmowers or garden tractors), fitted with a permanent cutting device and no more than one power take-off solely for the purpose of driving the cutting equipment (see the explanatory note to subheadings 8433 11 10 to 8433 19 90).

8701 90 90**Other**

This subheading includes:

1. public works tractors;
2. single-axled tractors for articulated motor vehicles.

- 8703** **Motor cars and other motor vehicles principally designed for the transport of persons (other than those of heading 8702), including station wagons and racing cars**
This heading includes 'multipurpose vehicles', such as motor vehicles which can transport both persons and goods:
1. Of the pick-up type:
This type of vehicle usually has more than one row of seats and is formed by two separate areas, namely a closed cabin for the transport of persons and an open or covered area for the transport of goods.
However, such vehicles are to be classified in heading 8704, if the maximum inner length at the floor of the area for the transport of the goods is more than 50 % of the length of the wheelbase of the vehicle or if they have more than two axles.
 2. Of the van-type:
The van-type vehicle with more than one row of seats must fulfil the indications given in the HS Explanatory Note to heading 8703.
However, van-type vehicles with one row of seats, and no presence of permanent anchor points and fittings for installing seats and safety equipment in the rear part of the vehicle, whether or not they have a permanent panel or barrier between the area for persons and the load area or windows in the side panels, are to be classified in heading 8704.
- 8703 21 10to 8703 24 90** **Other vehicles, with spark-ignition internal combustion reciprocating piston engine**
For the definition of cylinder capacity, see the HS Explanatory Note to subheadings 8407 31, 8407 32, 8407 33 and 8407 34.
These subheadings include 'station wagons' and 'multipurpose vehicles' referred to in the HS Explanatory Note to heading 8703, fifth and sixth paragraphs.
These subheadings also include small racing cars (called 'skelters' or 'go-carts') without a body, fitted with a spark-ignition internal combustion reciprocating piston engine and capable of reaching relatively high speeds.
- 8703 31 10to 8703 33 90** **Other vehicles, with compression-ignition internal combustion piston engine (diesel or semi-diesel)**
These subheadings include 'station wagons' and 'multipurpose vehicles' referred to in the HS Explanatory Note to heading 8703, fifth and sixth paragraphs.
- 8704** **Motor vehicles for the transport of goods**
The explanatory note to heading 8703 applies, *mutatis mutandis*.
For the definition of cylinder capacity, see the HS Explanatory Note to subheadings 8407 31, 8407 32, 8407 33 and 8407 34.
This heading includes four-wheel drive, articulated chassis, all-terrain vehicles in which the front section houses a diesel engine and a cab fitted with controls. The rear section consists of a two-wheeled chassis, without equipment, but designed to be fitted with a variety of equipment.
This heading does not, however, include such vehicles when fitted with agricultural or other special purpose equipment (heading 8705).

8704 10 10 and 8704 10 90 Dumpers designed for off-highway use

1. These subheadings mainly cover vehicles fitted with a front or rear tipping body or a bottom-opening body that have been specially designed to transport sand, gravel, earth, stones, etc., and are intended for use in quarries, mines, or on building sites, at roadworks, airports and ports. Examples illustrating various types of dumper are given at the end of this note.
2. These subheadings also cover smaller vehicles of the type used on construction sites for carrying earth, rubble, fresh cement and concrete, etc. These have a fixed or articulated chassis and two- or four-wheel drive, the dumper hopper being located above one axle and the driver's seat above the other. The driver's seat is not usually inside a cab.

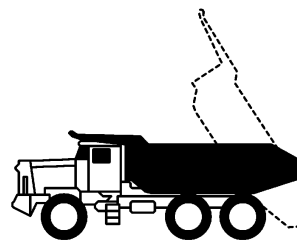
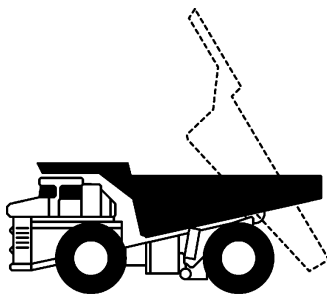

Typical dumpers

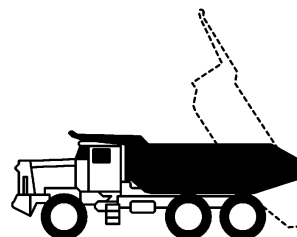
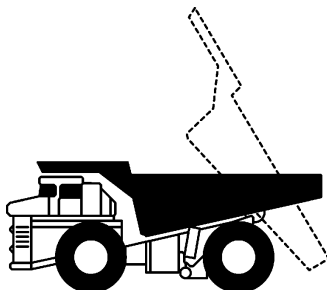

Typical dumpers

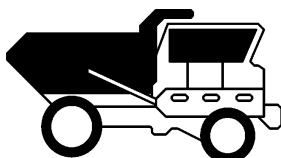

Dumper with two-way seat and two sets of controls

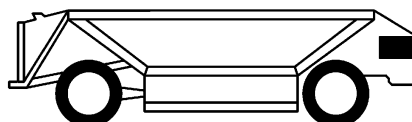

Dumper with bottom-opening body

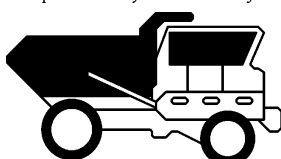

Dumper with two-way seat and two sets of controls

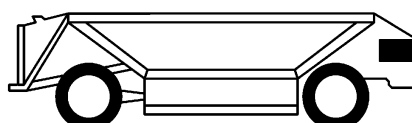

Dumper with bottom-opening body

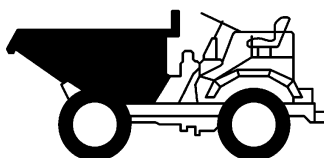

Dumper for construction sites

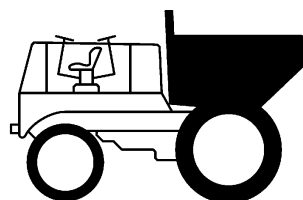

Dumper with two-way seat and two sets of controls

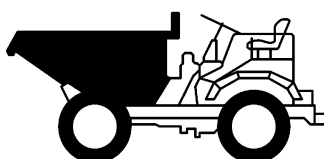

Dumper for construction sites

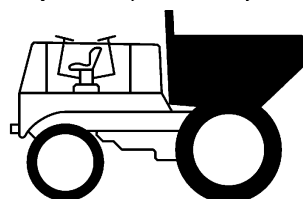

Dumper with two-way seat and two sets of controls

8704 21 10

Specially designed for the transport of highly radioactive materials (Euratom)
 The explanatory note to subheading 8606 91 10 applies, *mutatis mutandis*.

- 8704 21 31to 8704 21 99** **Other**
These subheadings include ‘multipurpose vehicles’ referred to in the HS Explanatory Note to heading 8704, second paragraph.
- 8704 22 10** **Specially designed for the transport of highly radioactive materials (*Euratom*)**
The explanatory note to subheading 8606 91 10 applies, *mutatis mutandis*.
- 8704 23 10** **Specially designed for the transport of highly radioactive materials (*Euratom*)**
The explanatory note to subheading 8606 91 10 applies, *mutatis mutandis*.
- 8704 31 10** **Specially designed for the transport of highly radioactive materials (*Euratom*)**
The explanatory note to subheading 8606 91 10 applies, *mutatis mutandis*.
- 8704 31 31to 8704 31 99** **Other**
These subheadings include the ‘multipurpose vehicles’ referred to in the HS Explanatory Notes to heading 8704, second paragraph.
- 8704 32 10** **Specially designed for the transport of highly radioactive materials (*Euratom*)**
The explanatory note to subheading 8606 91 10 applies, *mutatis mutandis*.
- 8707** **Bodies (including cabs), for the motor vehicles of headings 8701to 8705**
- 8707 10 10** **For industrial assembly purposes**
For the purposes of this subheading, the expression ‘for industrial assembly’ applies only to bodies used in a motor-vehicle assembly or manufacturing plant (or bodies used by subcontractors in subassemblies) for the production of new vehicles. This subheading can be applied only to bodies actually used in the production of new vehicles covered by the subheading itself. Consequently, it does not apply to similar bodies for use as spare parts.
- 8707 90 10** **For the industrial assembly of: Pedestrian-controlled tractors of subheading 8701 10; Vehicles of heading 8704with either a compression-ignition internal combustion piston engine (diesel or semi-diesel) of a cylinder capacity not exceeding 2 500 cm³ or with spark-ignition internal combustion piston engine of a cylinder capacity not exceeding 2 800 cm³; Special purpose motor vehicles of heading 8705**
See the explanatory note to subheading 8707 10 10.
For the definition of ‘cylinder capacity’, see the HS Explanatory Note to subheadings 8407 31, 8407 32, 8407 33 and 8407 34.
- 8708** **Parts and accessories of the motor vehicles of headings 8701to 8705**
The explanatory note to subheading 8707 10 10 applies, *mutatis mutandis*, to parts and accessories intended for industrial assembly.

8708 70 91

Wheel centres in star form, cast in one piece, of iron or steel

The wheel centres of this subheading are generally used on motor buses or on vehicles for the transport of goods. They are star-shaped, usually with five or six branches, and are designed for use with detachable rims.

8708 70 99

Other

In addition to the parts and accessories referred to in the HS Explanatory Note to heading 8708, second paragraph, (K), this subheading includes wheel-balance weights.

8708 80 55

Anti-roll bars; other torsion bars

Anti-roll bars are springs for vehicles for transmitting suspension forces from one side of the vehicle to the other. They consist mostly of steel bars of circular cross-section, generally bent to form an approximate U shape. They typically have the following appearance:

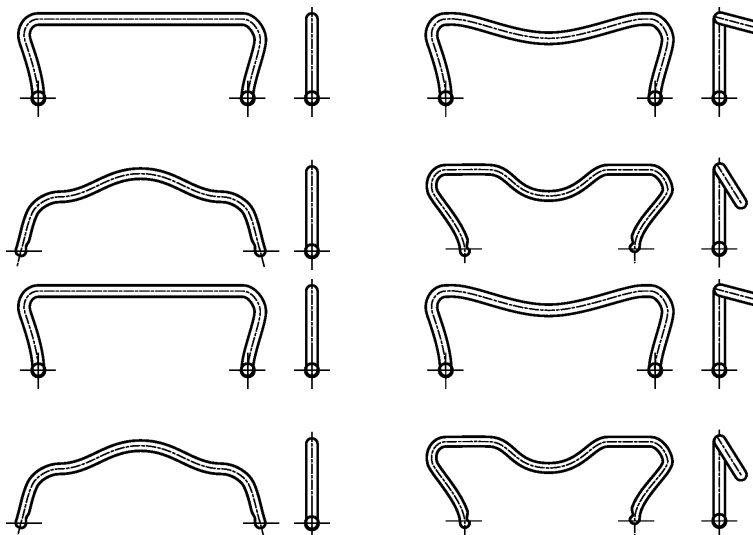

Torsion bars are steel bars which are generally round, but may sometimes be square or bundles of a number of rectangular bars.

Torsion bars are linear, i.e. the torque applied at one end of the bar is proportional to the angle of torsion it produces. They typically have the following appearance:

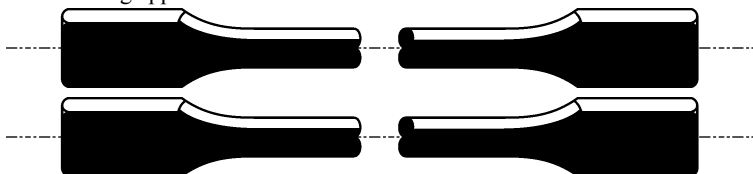

8708 99 10to 8708 99 97

Other

These subheadings do not include:

- (a) chassis of motor vehicles of headings 8702 to 8704, not fitted with an engine, but fitted with a cab (heading 8702, 8703 or 8704);
- (b) headrests for motor car seats (heading 9401 or 9404).

- 8709 Works trucks, self-propelled, not fitted with lifting or handling equipment, of the type used in factories, warehouses, dock areas or airports for short-distance transport of goods; tractors of the type used on railway station platforms; parts of the foregoing vehicles**
- 8709 11 10 Specially designed for the transport of highly radioactive materials (*Euratom*)**
The explanatory note to subheading 8606 91 10 applies, *mutatis mutandis*.
- 8709 19 10 Specially designed for the transport of highly radioactive materials (*Euratom*)**
The explanatory note to subheading 8606 91 10 applies, *mutatis mutandis*.
- 8712 00 Bicycles and other cycles (including delivery tricycles), not motorised**
This heading includes incomplete bicycles that have the essential characteristics of complete bicycles (general rule 2(a) for the interpretation of the Combined Nomenclature).
An incomplete bicycle, whether or not assembled, is to be classified under heading 8712 if it consists of the frame, the fork and at least two of the following components:
- a set of wheels;
 - a crank-gear (see the explanatory note to subheading 8714 96 30);
 - a steering unit (including handlebar and handlebar stems);
 - a brake system.
- ~~8712 00-10~~8712 00 70 ~~Without ball bearings~~Other**
~~This subheading covers only bicycles and other cycles without any ball bearings. This subheading includes bicycles and other cycles without any ball bearings.~~
- 8713 Carriages for disabled persons, whether or not motorised or otherwise mechanically propelled**
- 8713 90 00 Other**
Motorised vehicles specifically designed for disabled persons are distinguishable from vehicles of heading 8703, mainly because they have:
- a maximum speed of 10 km per hour, i.e. a fast walking pace;
 - a maximum width of 80 cm;
 - two sets of wheels touching the ground;
 - special features to alleviate the disability (for example, footrests for stabilising the legs).
- Such vehicles may have:
- an additional set of wheels (anti-tips);
 - steering and other controls (for example, a joystick) that are easy to manipulate; such controls are usually attached to one of the armrests; they are never in the form of a separate, adjustable steering column.
- This subheading includes electrically-driven vehicles similar to wheelchairs which are only for the transport of disabled people. They can have the following appearance:





However, motor-driven scooters (mobility scooters) fitted with a separate, adjustable steering column are excluded from this subheading. They can have the following appearance and are classified in heading 8703:



8714

Parts and accessories of vehicles of headings 8711 to 8713

8714 91 10 to 8714 99 90

Other

These subheadings include parts and accessories intended for the manufacture, equipping or repair of:

1. side-cars for motorcycles and bicycles;
2. cycles fitted with an auxiliary motor, i.e., cycles which may be propelled by means of pedals and which are fitted with an auxiliary motor (having a cylinder capacity not exceeding 50 cm³);
3. other cycles (including delivery tricycles) not fitted with a motor.

8714 94 108714 94 20**Coaster braking hubs and hub brakes**

This subheading includes coaster braking hubs and hub brakes.

Braking hubs are generally of the back-pedal type.

However, in drum hub brakes, the braking action is produced manually, via a cable or a rod.

They typically have the following appearance:

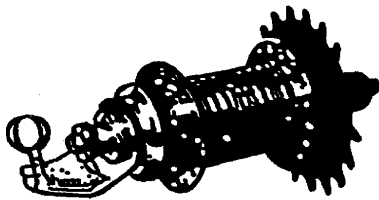

Braking hub of the back-pedal type

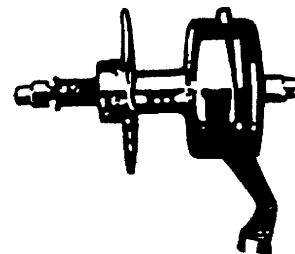

Drum hub brake

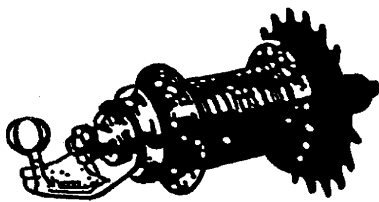

Braking hub of the back-pedal type

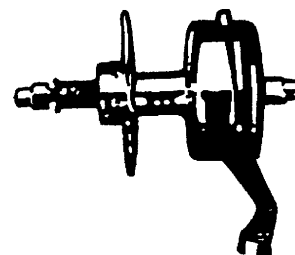

Drum hub brake

8714 94 90**Parts**

This subheading includes brake levers.

However, this subheading does not include rubber brake blocks (subheading 4016 99 97) or brake guides (generally, subheading 8307 10 00 or 8307 90 00).

8714 96 30**Crank-gear**

A crank gear normally consists of:

- a bracket-bearing axle (see image 1),
- one or several gearings (also referred to as sprockets, chain-rings or chain-wheels) usually attached to the right crank/pedal arm (see image 2), and
- a left crank/pedal arm (see image 3).

By application of general rule 2(a) for the interpretation of the Combined Nomenclature, an article remains classified as an incomplete article, whether or not assembled, under this subheading, for example, when it consists of:

- one or several gearings usually attached to the right crank/pedal arm,
- one or several gearings usually attached to the right crank/pedal arm and the left crank/pedal arm, or
- one or several gearings usually attached to the right crank/pedal arm and the bracket-bearing axle.

Image 1





Image 2



Image 3



8714 99 50**Derailleur gears**

Derailleur gears of this subheading are mechanisms that enable the chain of a bicycle to be moved on the front sprockets or on the rear sprockets. A complete derailleur gear set usually consists of at least one derailleur (front or rear, see images) and a shift lever attached to the derailleur by a cable. When a rider operates the lever while pedalling, the change in cable tension moves the derailleur from side to side, 'derailing' the chain onto different sprockets.

This subheading also covers front or rear derailleurs presented separately, as well as sets consisting of these derailleurs with cables or shift levers unassembled. However, presented separately, shift levers and cables are to be classified in subheading 8714 99 90 as parts.

Front derailleur

Rear derailleur

8716**Trailers and semi-trailers; other vehicles, not mechanically propelled; parts thereof****~~8716 10 91~~ ~~8716 10 92~~ ~~to~~ ~~and~~ ~~Other, of a weight~~ **Trailers and semi-trailers of the caravan type, for housing or camping******~~8716 10 99~~ ~~8716 10 98~~**

'Weight' is to be taken to mean the weight of the vehicle with all permanent fixtures and fittings. In the descriptions, the term 'weight' is to be taken to mean the weight of the vehicle with all of the permanent fixtures and fittings.

8716 39 10**Specially designed for the transport of highly radioactive materials (*Euratom*)**

The explanatory note to subheading 8606 91 10 applies, *mutatis mutandis*.

SECTION XVIII

OPTICAL, PHOTOGRAPHIC, CINEMATOGRAPHIC, MEASURING, CHECKING, PRECISION, MEDICAL OR SURGICAL INSTRUMENTS AND APPARATUS; CLOCKS AND WATCHES; MUSICAL INSTRUMENTS; PARTS AND ACCESSORIES THEREOF*CHAPTER 90***OPTICAL, PHOTOGRAPHIC, CINEMATOGRAPHIC, MEASURING, CHECKING, PRECISION, MEDICAL OR SURGICAL INSTRUMENTS AND APPARATUS; PARTS AND ACCESSORIES THEREOF****General**

This chapter includes only those tripods which are solely or principally for use with apparatus of this chapter (see the HS General Explanatory Note to this chapter, (H)).

Tripods for use with cameras of this chapter and heading 8525 are to be classified according to their constituent material.

Parts of tripods of this chapter are to be classified according to their constituent material.

- 9001** ~~Optical fibres and optical fibre bundles; optical fibre cables other than those of heading 8544; sheets and plates of polarising material; lenses (including contact lenses), prisms, mirrors and other optical elements, of any material, unmounted, other than such elements of glass not optically worked~~
 This heading includes articles used with visible light and articles used with the invisible part of the spectrum (infra-red and ultraviolet).
 The heading does not include, however, electronic 'optical' elements, for example, electrostatic lenses, electromagnetic lenses and so-called field lenses (generally, Chapter 85).
- 9001 10 10 and 9001 10 90** ~~Optical fibres, optical fibre bundles and cables~~
 These subheadings do not include connectors and adapters for connecting optical fibres, optical fibre bundles and optical fibre cables.
 See also the explanatory note to subheading 8536 70 00.
- 9001 20 00** ~~Sheets and plates of polarising material~~
 This subheading includes foils of polarising material in rolls, for example, for use in the manufacture of LCD modules.

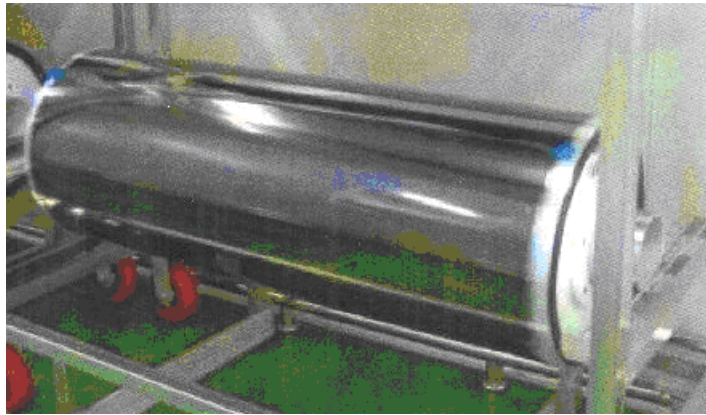

- 9001-90-00** **Other**
This subheading includes:
1. rubies and other optical elements for lasers;
 2. Fresnel lenses of plastics, intended for use, for example, after fitting with a mounting, as magnifying screens for television receivers.
- 9005** **Binoculars, monoculars, other optical telescopes, and mountings therefor; other astronomical instruments and mountings therefor, but not including instruments for radio astronomy**
This heading includes apparatus using image intensifiers for night vision.
- 9006** **Photographic (other than cinematographic) cameras; photographic flashlight apparatus and flashbulbs other than discharge lamps of heading 8539**
- 9006-10-00** **Cameras of a kind used for preparing printing plates or cylinders**
See the HS Explanatory Note to heading 9006, part (I), third paragraph, (17).
- 9010** **Apparatus and equipment for photographic (including cinematographic) laboratories, not specified or included elsewhere in this chapter; negatoscopes; projection screens**
- 9010-50-00** **Other apparatus and equipment for photographic (including cinematographic) laboratories; negatoscopes**
This subheading includes printed circuit board exposure apparatus which copies photographic negatives of the circuit patterns of printed circuits by exposure onto boards of insulating material from which printed circuit boards are made. The apparatus basically comprises an exposure chamber fitted with ultraviolet lamps, into which the photographic negative and the board of insulating material are placed and in which the board is exposed in contact with the negative in a vacuum.
- 9013** **Liquid crystal devices not constituting articles provided for more specifically in other headings; lasers, other than laser diodes; other optical appliances and instruments, not specified or included elsewhere in this chapter**
- 9013-80-90** **Other**
This subheading includes magnifying screens for television sets, consisting of an optical element (Fresnel lens) of plastics, a frame and a system of metal rods specially designed to fix the screen in front of the television set.
- 9017** **Drawing, marking-out or mathematical calculating instruments (for example, drafting machines, pantographs, protractors, drawing sets, slide rules, disc calculators); instruments for measuring length, for use in the hand (for example, measuring rods and tapes, micrometers, callipers), not specified or included elsewhere in this chapter**
- 9017-10-90** **Other**
This subheading includes drafting tables equipped with pantographs or the like.

9017 20 05 to 9017 20 90

Other drawing, marking-out or mathematical calculating instruments

These subheadings include:

1. coordinatographs not designed for photogrammetry;
2. lettering stencils clearly identifiable as being specialised as drawing or marking-out instruments.

9018

Instruments and appliances used in medical, surgical, dental or veterinary sciences, including scintigraphic apparatus, other electromedical apparatus and sight-testing instruments

9018 50 10

Non-optical

In addition to ultrasonic diagnostic equipment for general use, this subheading includes special appliances for ultrasonic examination of the eyes (such as those for determining the thickness of the cornea and eye lens or the length of the eyeball).

9018 90 84

Other

This subheading includes:

1. electrical defibrillators for delivering current pulses to restore the natural heart function. With these instruments, which are equipped with a pulse generator and two defibrillation electrodes, the patient's electrocardiogram (ECG) signal coming from the electrodes is displayed on a screen or printed out on a built-in printer;
2. medical appliances for blowing gases into the human abdominal cavity in order to make it possible to examine various organs with an endoscope. Attached to these appliances, which are provided with measuring instruments and displays, are two hoses which are connected at their ends to a stopcock and a long needle;
3. medical suction pumps for pumping out secretions, comprising the pump and a suction device and used in operating theatres or in ambulances;
4. contraceptive appliances known as 'intra-uterine devices (IUDs)', made of plastics together with copper wire, copper in colloidal form or a hormone insert.

9021

Orthopaedic appliances, including crutches, surgical belts and trusses; splints and other fracture appliances; artificial parts of the body; hearing aids and other appliances which are worn or carried, or implanted in the body, to compensate for a defect or disability

For the purposes of this heading, the expression 'to compensate for a defect or disability' means only appliances which actually take over or substitute for the function of the defective or disabled part of the body.

This heading does not include appliances, which simply alleviate the effects of the defect or disability.

This heading also excludes appliances identifiable for ostomy use (subheading 3006 91 00).

9021 39 90

Other

This subheading includes:

1. plates which remain permanently in the body, for example, to replace part or the whole of a bone);
2. woven strips of man-made fibre, which are implanted in the knee joint to replace the ligaments in the case of chronic knee-joint ligament instabilities.

9021 40 00

Hearing aids, excluding parts and accessories

This subheading includes the appliances covered by the HS Explanatory Note to heading 9021, part (IV), even if in the form of spectacles.

9021 50 00**Pacemakers for stimulating heart muscles, excluding parts and accessories**

This subheading includes only cardiac pacemakers proper. Subject to notes 1 and 2 to this chapter, parts and accessories for such pacemakers, such as casings, casing halves, casing covers and electrodes fall in subheading 9021 90 90.

Separately presented primary batteries and electric accumulators for pacemakers are classified in heading 8506 or 8507. Chargers with a transformer primary for charging the accumulator in the implanted pacemaker by inducing a current in the secondary in the pacemaker fall in heading 8504.

9021 90 90**Other**

This subheading includes the following appliances which compensate for a defect or a disability:

1. appliances implanted in the human body as medicament dispensers and accommodating in a common housing a 'medicinal pump', the power source for the pump and the reservoir for the medicament;
2. 'annular prostheses', i.e., stainless steel rings covered with two layers of plastics and a man-made fibre fabric. These are surgically attached to the heart valve in order to restore the heart valve's ability to close, for example, in the case of mitral insufficiency;
3. 'umbrella' filters for implanting in the cardiac vein (vena cava inferior) in order to prevent thromboses and embolisms from migrating to the heart. They consist of a very small, umbrella-shaped frame made of a stainless steel alloy, which is covered with a thin layer of synthetic elastic material and opens like an umbrella in the vein;
4. permanent ureter dilators of plastics. These barbed, rod-shaped appliances are inserted into the ureter to permit urine to flow.

9022**Apparatus based on the use of X-rays or of alpha, beta or gamma radiation, whether or not for medical, surgical, dental or veterinary uses, including radiography or radiotherapy apparatus, X-ray tubes and other X-ray generators, high-tension generators, control panels and desks, screens, examination or treatment tables, chairs and the like****9022 12 00****Computed tomography apparatus**

See the HS Explanatory Note to subheading 9022 12.

However, video recording systems, which are not incorporated in X-ray apparatus and which digitise, edit and store analogue video signals supplied by an external video camera fall in heading 8543. They essentially comprise an analogue-to-digital converter, a process computer, monitors and a magnetic tape or disk memory.

9022 90 00**Other, including parts and accessories**

This subheading includes beryllium windows for X-ray tubes.

9025**Hydrometers and similar floating instruments, thermometers, pyrometers, barometers, hygrometers and psychrometers, recording or not, and any combination of these instruments****9025 11 20 and 9025 11 80****Liquid-filled, for direct reading**

Thermometers 'for direct reading' are of a kind in which the temperature is indicated on a scale by the level of the fluid in the thermometer.

- 9026** **Instruments and apparatus for measuring or checking the flow, level, pressure or other variables of liquids or gases (for example, flow meters, level gauges, manometers, heat meters), excluding instruments and apparatus of heading 9014, 9015, 9028 or 9032**
- 9026 20 20 to 9026 20 80** **For measuring or checking pressure**
These subheadings include tyre inflators incorporating a pressure gauge and are regarded as pressure gauges even if they are not designed to be connected to an external supply source but incorporate their own compressed-air reservoir.
- 9027** **Instruments and apparatus for physical or chemical analysis (for example, polarimeters, refractometers, spectrometers, gas or smoke analysis apparatus); instruments and apparatus for measuring or checking viscosity, porosity, expansion, surface tension or the like; instruments and apparatus for measuring or checking quantities of heat, sound or light (including exposure meters); microtomes**
- 9027 10 10** **Electronic**
This subheading includes laser air-particle counters. These are electronic devices which determine or monitor the dust content of filtered air, for example, in industrial plants or in the medical field. The dust particles contained in the air sample cause a laser beam to produce scattered light in the measurement chamber of the device which, after being concentrated into a beam by a lens system, is picked up by a photodiode and converted into an electrical signal. With the aid of pre-programmed reference data, the proportion of dust particles is determined and the measurement result is shown on the instrument's digital display or printed out on an external tape printer. Via an interface, the measurement result in the form of an electrical signal can also be sent by cable to an automatic data-processing machine.
- 9027 30 00** **Spectrometers, spectrophotometers and spectrographs using optical radiation (UV, visible, IR)**
This subheading includes microprocessor-controlled electronic devices (multichannel optical analysers) for measuring and analysing the wavelengths of optical signals for spectral analyses. The wavelengths of the optical signals, measured by detectors, are converted into digital electrical signals and compared with reference values (analysed). The result of the comparison is evaluated by computer and displayed on external monitors which can be connected up to the equipment.
- 9027 50 00** **Other instruments and apparatus using optical radiation (UV, visible, IR)**
This subheading includes electronic devices used in hospital chemical laboratories for the fully automatic analysis of blood sera. They consist essentially of the analyser proper (with sample preparation device, reagent metering mechanism and photometric measurement system using a halogen lamp as the light source and photodiodes as the detectors), a control and evaluation device (with microprocessors and screen for displaying the measurement results) and a printer for recording the results. All three devices are interconnected by electric cables.
- 9027 80 99** **Other**
This subheading includes climatic testing cupboards equipped with a pressure chamber, an electric heater, an air humidifier and an electric unit, in which electronic components are exposed to specific pressure, temperature and humidity conditions, simulating the influences and environmental conditions occurring in their subsequent use, in order to test their service life, insulation, etc.

- 9030** **Oscilloscopes, spectrum analysers and other instruments and apparatus for measuring or checking electrical quantities, excluding meters of heading 9028; instruments and apparatus for measuring or detecting alpha, beta, gamma, X-ray, cosmic or other ionising radiation**
In accordance with general rule 3(b) for the interpretation of the Combined Nomenclature, instruments and apparatus which can be used for measuring or checking both electrical and non-electrical quantities still fall in heading 9030 if their nature determines that they are mainly used for measuring or checking electrical quantities. This is the case, for example, with cathode ray oscilloscopes and oscillographs and light-beam and UV-beam oscillographs (subheadings 9030 20 10 to 9030 20 99).
However, instruments and apparatus whose essential character cannot be determined because they are used for measuring or checking both electrical and non-electrical quantities to the same extent do not fall in this heading. Accordingly, in accordance with general rule 3(c) for the interpretation of the Combined Nomenclature, instruments for testing motor vehicle engines and ignition systems by measuring electrical quantities such as voltage and resistance and non-electrical quantities such as speed of rotation, contact angle and state of contact breaker points fall in heading 9031.
- 9030 20 30** **Other, with recording device**
This subheading includes light-beam and UV-beam oscillographs for measuring and recording rapid variations of electrical quantities. These instruments also known as light-beam recorders, UV recorders or loop oscillographs, record the signals produced by the periodic phenomenon under study by means of a light or UV beam on photosensitive paper.
- 9030 39 00** **Other, with a recording device**
This subheading includes electrical testing devices or systems which determine the serviceability of printed circuits or other electronic components and display any defects such as short circuits or breaks by measuring or checking electrical quantities like capacitance, inductance, impedance, resistance and voltage.
These devices or systems usually comprise a measuring and checking unit (with input keyboard, program memory and CRT terminal), which carries out the measurements and compares the results with reference values and displays them, a control unit (with automatic data-processing machine or microprocessors), an output printer for printing out the test results and a device for sorting the tested components according to specific actual values and separates out defective ones.
The subheading does not, however, include electrical devices for checking whether the packages of electronic components are hermetically sealed (heading 9031).
- 9030 82 00** **For measuring or checking semiconductor wafers or devices**
This subheading covers electrical testing devices or systems which measure or check electrical quantities such as voltage, frequency, etc., to determine the serviceability of wafers, chips and other semiconductor devices and to display any defects such as deviations from previously set values.
The devices or systems usually comprise a measuring and checking unit (with input keyboard, program memory and CRT terminal), which carries out the measurement and compares the results with reference values and displays them, a control unit (with automatic data-processing machine or microprocessors), an output printer for printing out the test results and a device for sorting the tested components according to specific actual values and separates out defective ones.
The subheading does not, however, include electrical devices for checking whether the packages of integrated circuits or other electronic components are hermetically sealed (heading 9031).

- 9031** **Measuring or checking instruments, appliances and machines, not specified or included elsewhere in this chapter; profile projectors**
- 9031 20 00** **Test benches**
Test benches for checking fuel-injection pumps of diesel engines have, as essential components which are all fixed to the same stand, an electric motor and a device comprising injectors and graduated glass tubes for checking the output of the injection pump elements; they may additionally be fitted with an auxiliary appliance (a stroboscope) for checking the exact timing of fuel injections.
- 9031 80 32 and 9031 80 34** **For measuring or checking geometrical quantities**
Examples of geometrical quantities are: length, distance, diameter, radius, curvature, angle, tilt, volume, and surface roughness.
These subheadings do not include interferometers for checking plane surfaces, used in laboratories (subheading 9027 50 00).
- 9031 80 91** **For measuring or checking geometrical quantities**
See the explanatory note to subheadings 9031 80 32 and 9031 80 34.
This subheading also includes spirit levels.
- 9001** **Optical fibres and optical-fibre bundles; optical-fibre cables other than those of heading 8544; sheets and plates of polarising material; lenses (including contact lenses), prisms, mirrors and other optical elements, of any material, unmounted, other than such elements of glass not optically worked**
This heading includes articles used with visible light and articles used with the invisible part of the spectrum (infra-red and ultraviolet).
The heading does not include, however, electronic 'optical' elements, for example, electrostatic lenses, electromagnetic lenses and so-called field lenses (generally, Chapter 85).
- 9001 10 10 and 9001 10 90** **Optical fibres, optical-fibre bundles and cables**
These subheadings do not include connectors and adapters for connecting optical fibres, optical-fibre bundles and optical-fibre cables.
See also the explanatory note to subheading 8536 70 00.
- 9001 20 00** **Sheets and plates of polarising material**
This subheading includes foils of polarising material in rolls, for example, for use in the manufacture of LCD modules.

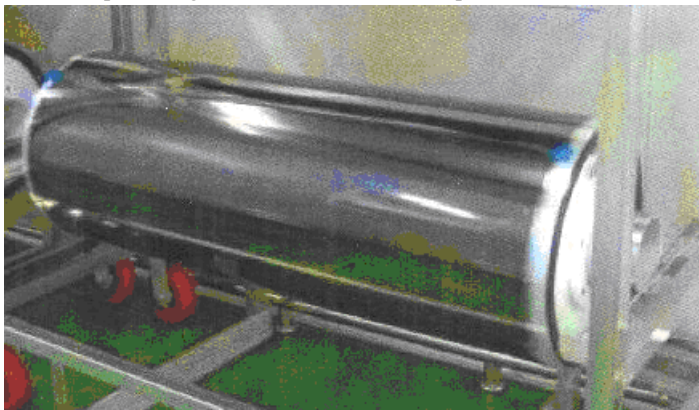

9001 90 00**Other**

This subheading includes:

1. rubies and other optical elements for lasers;
2. Fresnel lenses of plastics, intended for use, for example, after fitting with a mounting, as magnifying screens for television receivers.

9005**Binoculars, monoculars, other optical telescopes, and mountings therefor; other astronomical instruments and mountings therefor, but not including instruments for radio astronomy**

This heading includes apparatus using image intensifiers for night vision.

9006**Photographic (other than cinematographic) cameras; photographic flashlight apparatus and flashbulbs other than discharge lamps of heading 8539****9006 10 00****Cameras of a kind used for preparing printing plates or cylinders**

See the HS Explanatory Note to heading 9006, part (I), third paragraph, (17).

9010**Apparatus and equipment for photographic (including cinematographic) laboratories, not specified or included elsewhere in this chapter; negatoscopes; projection screens****9010 50 00****Other apparatus and equipment for photographic (including cinematographic) laboratories; negatoscopes**

This subheading includes printed circuit board exposure apparatus which copies photographic negatives of the circuit patterns of printed circuits by exposure onto boards of insulating material from which printed circuit boards are made. The apparatus basically comprises an exposure chamber fitted with ultraviolet lamps, into which the photographic negative and the board of insulating material are placed and in which the board is exposed in contact with the negative in a vacuum.

9013**Liquid crystal devices not constituting articles provided for more specifically in other headings; lasers, other than laser diodes; other optical appliances and instruments, not specified or included elsewhere in this chapter****9013 80 90****Other**

This subheading includes magnifying screens for television sets, consisting of an optical element (Fresnel lens) of plastics, a frame and a system of metal rods specially designed to fix the screen in front of the television set.

9017**Drawing, marking-out or mathematical calculating instruments (for example, drafting machines, pantographs, protractors, drawing sets, slide rules, disc calculators); instruments for measuring length, for use in the hand (for example, measuring rods and tapes, micrometers, callipers), not specified or included elsewhere in this chapter****9017 10 90****Other**

This subheading includes drafting tables equipped with pantographs or the like.

9017 20 05 to 9017 20 90**Other drawing, marking-out or mathematical calculating instruments**

These subheadings include:

1. coordinatographs not designed for photogrammetry;
2. lettering stencils clearly identifiable as being specialised as drawing or marking-out instruments.

9018**Instruments and appliances used in medical, surgical, dental or veterinary sciences, including scintigraphic apparatus, other electromedical apparatus and sight-testing instruments****9018 50 10****Non-optical**

In addition to ultrasonic diagnostic equipment for general use, this subheading includes special appliances for ultrasonic examination of the eyes (such as those for determining the thickness of the cornea and eye lens or the length of the eyeball).

9018 90 84**Other**

This subheading includes:

1. electrical defibrillators for delivering current pulses to restore the natural heart function. With these instruments, which are equipped with a pulse generator and two defibrillation electrodes, the patient's electrocardiogram (ECG) signal coming from the electrodes is displayed on a screen or printed out on a built-in printer;
2. medical appliances for blowing gases into the human abdominal cavity in order to make it possible to examine various organs with an endoscope. Attached to these appliances, which are provided with measuring instruments and displays, are two hoses which are connected at their ends to a stopcock and a long needle;
3. medical suction pumps for pumping out secretions, comprising the pump and a suction device and used in operating theatres or in ambulances;
4. contraceptive appliances known as 'intra-uterine devices (IUDs)', made of plastics together with copper wire, copper in colloidal form or a hormone insert.

9021**Orthopaedic appliances, including crutches, surgical belts and trusses; splints and other fracture appliances; artificial parts of the body; hearing aids and other appliances which are worn or carried, or implanted in the body, to compensate for a defect or disability**

For the purposes of this heading, the expression 'to compensate for a defect or disability' means only appliances which actually take over or substitute for the function of the defective or disabled part of the body.

This heading does not include appliances, which simply alleviate the effects of the defect or disability.

This heading also excludes appliances identifiable for ostomy use (subheading 3006 91 00).

9021 39 90**Other**

This subheading includes:

1. plates which remain permanently in the body, for example, to replace part or the whole of a bone);
2. woven strips of man-made fibre, which are implanted in the knee joint to replace the ligaments in the case of chronic knee-joint ligament instabilities.

9021 40 00**Hearing aids, excluding parts and accessories**

This subheading includes the appliances covered by the HS Explanatory Note to heading 9021, part (IV), even if in the form of spectacles.

9021 50 00**Pacemakers for stimulating heart muscles, excluding parts and accessories**

This subheading includes only cardiac pacemakers proper. Subject to notes 1 and 2 to this chapter, parts and accessories for such pacemakers, such as casings, casing halves, casing covers and electrodes fall in subheading 9021 90 90. Separately presented primary batteries and electric accumulators for pacemakers are classified in heading 8506 or 8507. Chargers with a transformer primary for charging the accumulator in the implanted pacemaker by inducing a current in the secondary in the pacemaker fall in heading 8504.

9021 90 90**Other**

This subheading includes the following appliances which compensate for a defect or a disability:

1. appliances implanted in the human body as medicament dispensers and accommodating in a common housing a 'medicinal pump', the power source for the pump and the reservoir for the medicament;
2. 'annular prostheses', i.e., stainless steel rings covered with two layers of plastics and a man-made fibre fabric. These are surgically attached to the heart valve in order to restore the heart valve's ability to close, for example, in the case of mitral insufficiency;
3. 'umbrella' filters for implanting in the cardiac vein (vena cava inferior) in order to prevent thromboses and embolisms from migrating to the heart. They consist of a very small, umbrella-shaped frame made of a stainless steel alloy, which is covered with a thin layer of synthetic elastic material and opens like an umbrella in the vein;
4. permanent ureter dilators of plastics. These barbed, rod-shaped appliances are inserted into the ureter to permit urine to flow.

9022**Apparatus based on the use of X-rays or of alpha, beta or gamma radiation, whether or not for medical, surgical, dental or veterinary uses, including radiography or radiotherapy apparatus, X-ray tubes and other X-ray generators, high-tension generators, control panels and desks, screens, examination or treatment tables, chairs and the like****9022 12 00****Computed tomography apparatus**

See the HS Explanatory Note to subheading 9022 12.

However, video recording systems, which are not incorporated in X-ray apparatus and which digitise, edit and store analogue video signals supplied by an external video camera fall in heading 8543. They essentially comprise an analogue-to-digital converter, a process computer, monitors and a magnetic tape or disk memory.

9022 90 00**Other, including parts and accessories**

This subheading includes beryllium windows for X-ray tubes.

9025**Hydrometers and similar floating instruments, thermometers, pyrometers, barometers, hygrometers and psychrometers, recording or not, and any combination of these instruments****9025 11 20 and 9025 11 80****Liquid-filled, for direct reading**

Thermometers 'for direct reading' are of a kind in which the temperature is indicated on a scale by the level of the fluid in the thermometer.

- 9026** **Instruments and apparatus for measuring or checking the flow, level, pressure or other variables of liquids or gases (for example, flow meters, level gauges, manometers, heat meters), excluding instruments and apparatus of heading 9014, 9015, 9028 or 9032**
- 9026 20 20 to 9026 20 80** **For measuring or checking pressure**
These subheadings include tyre inflators incorporating a pressure gauge and are regarded as pressure gauges even if they are not designed to be connected to an external supply source but incorporate their own compressed-air reservoir.
- 9027** **Instruments and apparatus for physical or chemical analysis (for example, polarimeters, refractometers, spectrometers, gas or smoke analysis apparatus); instruments and apparatus for measuring or checking viscosity, porosity, expansion, surface tension or the like; instruments and apparatus for measuring or checking quantities of heat, sound or light (including exposure meters); microtomes**
- 9027 10 10** **Electronic**
This subheading includes laser air-particle counters. These are electronic devices which determine or monitor the dust content of filtered air, for example, in industrial plants or in the medical field. The dust particles contained in the air sample cause a laser beam to produce scattered light in the measurement chamber of the device which, after being concentrated into a beam by a lens system, is picked up by a photodiode and converted into an electrical signal. With the aid of pre-programmed reference data, the proportion of dust particles is determined and the measurement result is shown on the instrument's digital display or printed out on an external tape printer. Via an interface, the measurement result in the form of an electrical signal can also be sent by cable to an automatic data-processing machine.
- 9027 30 00** **Spectrometers, spectrophotometers and spectrographs using optical radiation (UV, visible, IR)**
This subheading includes microprocessor-controlled electronic devices (multichannel optical analysers) for measuring and analysing the wavelengths of optical signals for spectral analyses. The wavelengths of the optical signals, measured by detectors, are converted into digital electrical signals and compared with reference values (analysed). The result of the comparison is evaluated by computer and displayed on external monitors which can be connected up to the equipment.
- 9027 50 00** **Other instruments and apparatus using optical radiation (UV, visible, IR)**
This subheading includes electronic devices used in hospital chemical laboratories for the fully automatic analysis of blood sera. They consist essentially of the analyser proper (with sample preparation device, reagent metering mechanism and photometric measurement system using a halogen lamp as the light source and photodiodes as the detectors), a control and evaluation device (with microprocessors and screen for displaying the measurement results) and a printer for recording the results. All three devices are interconnected by electric cables.
- 9027 80 99** **Other**
This subheading includes climatic testing cupboards equipped with a pressure chamber, an electric heater, an air humidifier and an electric unit, in which electronic components are exposed to specific pressure, temperature and humidity conditions, simulating the influences and environmental conditions occurring in their subsequent use, in order to test their service life, insulation, etc.

- 9030** **Oscilloscopes, spectrum analysers and other instruments and apparatus for measuring or checking electrical quantities, excluding meters of heading 9028; instruments and apparatus for measuring or detecting alpha, beta, gamma, X-ray, cosmic or other ionising radiation**
In accordance with general rule 3(b) for the interpretation of the Combined Nomenclature, instruments and apparatus which can be used for measuring or checking both electrical and non-electrical quantities still fall in heading 9030 if their nature determines that they are mainly used for measuring or checking electrical quantities. This is the case, for example, with cathode ray oscilloscopes and oscillographs and light-beam and UV-beam oscillographs (subheadings 9030 20 10 to 9030 20 99).
However, instruments and apparatus whose essential character cannot be determined because they are used for measuring or checking both electrical and non-electrical quantities to the same extent do not fall in this heading. Accordingly, in accordance with general rule 3(c) for the interpretation of the Combined Nomenclature, instruments for testing motor vehicle engines and ignition systems by measuring electrical quantities such as voltage and resistance and non-electrical quantities such as speed of rotation, contact angle and state of contact breaker points fall in heading 9031.
- 9030 20 30** **Other, with recording device**
This subheading includes light-beam and UV-beam oscillographs for measuring and recording rapid variations of electrical quantities. These instruments also known as light-beam recorders, UV recorders or loop oscillographs, record the signals produced by the periodic phenomenon under study by means of a light or UV beam on photosensitive paper.
- 9030 39 00** **Other, with a recording device**
This subheading includes electrical testing devices or systems which determine the serviceability of printed circuits or other electronic components and display any defects such as short circuits or breaks by measuring or checking electrical quantities like capacitance, inductance, impedance, resistance and voltage.
These devices or systems usually comprise a measuring and checking unit (with input keyboard, program memory and CRT terminal), which carries out the measurements and compares the results with reference values and displays them, a control unit (with automatic data-processing machine or microprocessors), an output printer for printing out the test results and a device for sorting the tested components according to specific actual values and separates out defective ones.
The subheading does not, however, include electrical devices for checking whether the packages of electronic components are hermetically sealed (heading 9031).
- 9030 82 00** **For measuring or checking semiconductor wafers or devices**
This subheading covers electrical testing devices or systems which measure or check electrical quantities such as voltage, frequency, etc., to determine the serviceability of wafers, chips and other semiconductor devices and to display any defects such as deviations from previously set values.
The devices or systems usually comprise a measuring and checking unit (with input keyboard, program memory and CRT terminal), which carries out the measurement and compares the results with reference values and displays them, a control unit (with automatic data-processing machine or microprocessors), an output printer for printing out the test results and a device for sorting the tested components according to specific actual values and separates out defective ones.
The subheading does not, however, include electrical devices for checking whether the packages of integrated circuits or other electronic components are hermetically sealed (heading 9031).

9031 **Measuring or checking instruments, appliances and machines, not specified or included elsewhere in this chapter: profile projectors**

9031 20 00 **Test benches**

Test benches for checking fuel-injection pumps of diesel engines have, as essential components which are all fixed to the same stand, an electric motor and a device comprising injectors and graduated glass tubes for checking the output of the injection pump elements; they may additionally be fitted with an auxiliary appliance (a stroboscope) for checking the exact timing of fuel injections.

9031 80 32 and 9031 80 34 **For measuring or checking geometrical quantities**

Examples of geometrical quantities are: length, distance, diameter, radius, curvature, angle, tilt, volume, and surface roughness.

These subheadings do not include interferometers for checking plane surfaces, used in laboratories (subheading 9027 50 00).

9031 80 91 **For measuring or checking geometrical quantities**

See the explanatory note to subheadings 9031 80 32 and 9031 80 34.

This subheading also includes spirit levels.

SECTION XIX

ARMS AND AMMUNITION; PARTS AND ACCESSORIES THEREOF

SECTION XX

MISCELLANEOUS MANUFACTURED ARTICLES

CHAPTER 96

MISCELLANEOUS MANUFACTURED ARTICLES

- 9601** **Worked ivory, bone, tortoiseshell, horn, antlers, coral, mother-of-pearl and other animal carving material, and articles of these materials (including articles obtained by moulding)**
For the definition of the term 'worked', see the HS Explanatory Note to heading 9601, second paragraph.
- 9602 00 00** **Worked vegetable or mineral carving material and articles of these materials; moulded or carved articles of wax, of stearin, of natural gums or natural resins or of modelling pastes, and other moulded or carved articles, not elsewhere specified or included; worked, unhardened gelatin (except gelatin of heading 3503) and articles of unhardened gelatin**
For the definition of the term 'worked', see the HS Explanatory Note to heading 9601, second paragraph, which applies, *mutatis mutandis*.
Agglomerated meerschaum and agglomerated amber presented in the form of plates, rods, sticks and similar forms, not further worked than simply moulded, fall in heading 2530.
- 9603** **Brooms, brushes (including brushes constituting parts of machines, appliances or vehicles), hand-operated mechanical floor sweepers, not motorised, mops and feather dusters; prepared knots and tufts for broom or brush making; paint pads and rollers; squeegees (other than roller squeegees)**
- 9603 10 00** **Brooms and brushes, consisting of twigs or other vegetable materials bound together, with or without handles**
See the HS Explanatory Note to heading 9603, (A).
- 9603 21 00to 9603 29 80** **Toothbrushes, shaving-brushes, hairbrushes, nail brushes, eyelash brushes and other toilet brushes for use on the person, including such brushes constituting parts of appliances**
Eyelash brushes generally consist of several tufts of hair mounted at right angles to the handle.
Clothes brushes and shoe brushes are not included in these subheadings (subheading 9603 90 91).
- 9603 40 90** **Paint pads and rollers**
See the HS Explanatory Note to heading 9603, (F), first two paragraphs.
- 9603 90 10** **Hand-operated mechanical floor sweepers, not motorised**
See the HS Explanatory Note to heading 9603, (C).
- 9606** **Buttons, press-fasteners, snap-fasteners and press studs, button moulds and other parts of these articles; button blanks**
- 9606 30 00** **Button moulds and other parts of buttons; button blanks**
See the HS Explanatory Note to heading 9606, fourth paragraph, (1), (2) and (3).

9608	Ballpoint pens; felt-tipped and other porous-tipped pens and markers; fountain pens, stylograph pens and other pens; duplicating stylos; propelling or sliding pencils; pen-holders, pencil-holders and similar holders; parts (including caps and clips) of the foregoing articles, other than those of heading 9609
9608 10 10 to 9608 10 99	Ballpoint pens See the HS Explanatory Note to heading 9608, (1). Articles falling in these subheadings may incorporate an electronic timepiece (usually, with a digital display).
9608 31 00 9608 39 90 9608 30 00 to	Fountain pens, stylograph pens and other pens See the HS Explanatory Note to heading 9608, (3).
9608 40 00	Propelling or sliding pencils See the HS Explanatory Note to heading 9608, (5).
9608 91 00	Pen nibs and nib points This subheading also covers heads for special pens used with stencils.
9608 99 00	Other This subheading includes balls for ballpoint pens; they are usually made of tungsten carbide but also of other metals (excluding those of steel, heading 7326 or 8482) and range from 0,6 to 1,25 mm in diameter. However, balls for pen nibs and nib points fall in subheading 9608 91 00, irrespective of their material (see the HS Explanatory Note to heading 9608, parts).
9609	Pencils (other than pencils of heading 9608), crayons, pencil leads, pastels, drawing charcoals, writing or drawing chalks and tailors' chalks
9609 10 10 and 9609 10 90	Pencils and crayons, with leads encased in a rigid sheath See the HS Explanatory Note to heading 9609, first paragraph, (B).
9609 20 00	Pencil leads, black or coloured See the HS Explanatory Note to heading 9609, third paragraph, (7).
9612	Typewriter or similar ribbons, inked or otherwise prepared for giving impressions, whether or not on spools or in cartridges; ink-pads, whether or not inked, with or without boxes
9612 10 10 to 9612 10 80	Ribbons See the HS Explanatory Note to heading 9612, first paragraph, (1).
9612 20 00	Ink-pads See the HS Explanatory Note to heading 9612, first paragraph, (2).
9613	Cigarette lighters and other lighters, whether or not mechanical or electrical, and parts thereof other than flints and wicks This heading includes lighters incorporating an electronic mini-calculator and/or an electronic timepiece.
9614 00	Smoking pipes (including pipe bowls) and cigar or cigarette holders, and parts thereof
9614 00 10	Roughly shaped blocks of wood or root, for the manufacture of pipes See the HS Explanatory Note to heading 9614, first paragraph, (4).
9619 00	<u>Sanitary towels (pads) and tampons, napkins and napkin liners for babies, and similar articles, of any material</u>
9619 00 19	<u>Other</u> <u>This subheading includes panty shields.</u>
9619 00 29	<u>Other (for example, incontinence care articles)</u> <u>This subheading includes incontinence articles and invalid-bed liners.</u>
9619 00 31 and 9619 00 39	<u>Of wadding of textile materials</u> <u>These subheadings include sanitary towels and tampons, napkins and napkin liners for babies, and similar sanitary articles, consisting of wadding with knitted or loosely woven open-work covering.</u>

SECTION XXI

WORKS OF ART, COLLECTORS' PIECES AND ANTIQUES