



Fungal Planet description sheets: 400–468

P.W. Crous^{1,2}, M.J. Wingfield³, D.M. Richardson⁴, J.J. Le Roux⁴, D. Strasberg⁵, J. Edwards⁶, F. Roets⁷, V. Hubka⁸, P.W.J. Taylor⁹, M. Heykoop¹⁰, M.P. Martín¹¹, G. Moreno¹⁰, D.A. Sutton¹², N.P. Wiederhold¹², C.W. Barnes¹³, J.R. Carlavilla¹⁰, J. Gené¹⁴, A. Giraldo^{1,2}, V. Guarnaccia¹, J. Guarro¹⁴, M. Hernández-Restrepo^{1,2}, M. Kolařík¹⁵, J.L. Manjón¹⁰, I.G. Pascoe⁶, E.S. Popov¹⁶, M. Sandoval-Denis¹⁴, J.H.C. Woudenberg¹, K. Acharya¹⁷, A.V. Alexandrova¹⁸, P. Alvarado¹⁹, R.N. Barbosa²⁰, I.G. Baseia²¹, R.A. Blanchette²², T. Boekhout³, T.I. Burgess²³, J.F. Cano-Lira¹⁴, A. Čmoková⁸, R.A. Dimitrov²⁴, M.Yu. Dyakov¹⁸, M. Dueñas¹¹, A.K. Dutta¹⁷, F. Esteve-Raventós¹⁰, A.G. Fedosova¹⁶, J. Fournier²⁵, P. Gamboa²⁶, D.E. Gouliamova²⁷, T. Grebenc²⁸, M. Groenewald¹, B. Hanse²⁹, G.E.St.J. Hardy²³, B.W. Held²², Ž. Jurjević³⁰, T. Kaewgrajang³¹, K.P.D. Latha³², L. Lombard¹, J.J. Luangsa-ard³³, P. Lysková³⁴, N. Mallátová³⁵, P. Manimohan³², A.N. Miller³⁶, M. Mirabolfathy³⁷, O.V. Morozova¹⁶, M. Obodai³⁸, N.T. Oliveira²⁰, M.E. Ordóñez³⁹, E.C. Otto²², S. Paloi¹⁷, S.W. Peterson⁴⁰, C. Phosri⁴¹, J. Roux³, W.A. Salazar³⁹, A. Sánchez¹⁰, G.A. Sarria⁴², H.-D. Shin⁴³, B.D.B. Silva²¹, G.A. Silva²⁰, M.Th. Smith¹, C.M. Souza-Motta⁴⁴, A.M. Stchigel¹⁴, M.M. Stoilova-Disheva²⁷, M.A. Sulzbacher⁴⁵, M.T. Telleria¹¹, C. Toapanta⁴⁶, J.M. Traba⁴⁷, N. Valenzuela-Lopez^{14,48}, R. Watling⁴⁹, J.Z. Groenewald¹

Key words

ITS DNA barcodes
LSU
novel fungal species
systematics

Abstract Novel species of fungi described in the present study include the following from Australia: *Vermiculariopsisella eucalypti*, *Mulderomyces natalis* (incl. *Mulderomyces* gen. nov.), *Fusicladium paraamoenum*, *Neotrimmatostroma paraexcentricum*, and *Pseudophloeospora eucalyptorum* on leaves of *Eucalyptus* spp., *Anungitea grevilleae* (on leaves of *Grevillea* sp.), *Pyrenochaeta acaciae* (on leaves of *Acacia* sp.), and *Brunneocarpos banksiae* (incl. *Brunneocarpos* gen. nov.) on cones of *Banksia attenuata*. Novel foliicolous taxa from South Africa include *Neosulcatisspora strelitziae* (on *Strelitzia nicolai*), *Colletotrichum ledebouriae* (on *Ledebouria floridunda*), *Cylindrosymptodioides brabejum* (incl. *Cylindrosymptodioides* gen. nov.) on *Brabejum stellatifolium*, *Sclerostagonospora ericae* (on *Erica* sp.), *Setophoma cyperi* (on *Cyperus sphaerocephala*), and *Phaeosphaeria breonadiae* (on *Breonadia microcephala*). Novelities described from Robben Island (South Africa) include *Wojnowiciella cissampeli* and *Diaporthe cissampeli* (both on *Cissampelos capensis*), *Phaeotheca salicorniae* (on *Salicornia meyeriana*), *Paracylindrocarpon aloicola* (incl. *Paracylindrocarpon* gen. nov.) on *Aloe* sp., and *Libertasomyces myopori* (incl. *Libertasomyces* gen. nov.) on *Myoporum serratum*. Several novelities are recorded from La Réunion (France), namely *Phaeosphaeriopsis agapanthi* (on *Agapanthus* sp.), *Roussolla solani* (on *Solanum mauritanium*), *Vermiculariopsisella acaciae* (on *Acacia heterophylla*), *Dothiorella acacicola* (on *Acacia mearnsii*), *Chalara clidemiae* (on *Clidemia hirta*), *Cytospora tibouchinae* (on *Tibouchina semidecandra*), *Diaporthe ocoteae* (on *Ocotea obtusata*), *Castanediella eucalypticola*, *Phaeophloeospora eucalypticola* and *Fusicladium eucalypticola* (on *Eucalyptus robusta*), *Lareunionomyces syzygii* (incl. *Lareunionomyces* gen. nov.) and *Parawiesneriomyces syzygii* (incl. *Parawiesneriomyces* gen. nov.) on leaves of *Syzygium jambos*. Novel taxa from the USA include *Meristemomyces arctostaphylos* (on *Arctostaphylos patula*), *Ochroconis dracaenae* (on *Dracaena reflexa*), *Rasamsonia columbiensis* (air of a hotel conference room), *Paecilomyces tabacinus* (on *Nicotiana tabacum*), *Toxicocladosporium hominis* (from human bronchoalveolar lavage fluid), *Nothophoma macrospora* (from respiratory secretion of a patient with pneumonia), and *Penidiellopsis radicularis* (incl. *Penidiellopsis* gen. nov.) from a human nail. Novel taxa described from Malaysia include *Prosopidicola albizziae* (on *Albizia falcataria*), *Proxipyricularia asari* (on *Asarum* sp.), *Diaporthe passifloricola* (on *Passiflora foetida*), *Paramycoleptodiscus albizziae* (incl. *Paramycoleptodiscus* gen. nov.) on *Albizia falcataria*, and *Malaysiasca phaii* (incl. *Malaysiasca* gen. nov.) on *Phaius reflexipetalus*. Two species are newly described from human patients in the Czech Republic, namely *Microascus longicollis* (from toenails of patient with suspected onychomycosis), and *Chrysosporium echinulatum* (from sole skin of patient). Furthermore, *Alternaria quercicola* is described on leaves of *Quercus brantii* (Iran), *Stemphylium beticola* on leaves of *Beta vulgaris* (The Netherlands), *Scleroderma capeverdeanum* on soil (Cape Verde Islands), *Scleroderma dunensis* on soil, and *Blastobotrys meliponae* from bee honey (Brazil), *Ganoderma mbrekobenum* on angiosperms (Ghana), *Geoglossum raitviii* and *Entoloma kruticianum* on soil (Russia), *Priceomyces vitoshaensis* on *Pterostichus melas* (*Carabidae*) (Bulgaria) is the only one for which the family is listed, *Ganoderma ecuadoriense* on decaying wood (Ecuador), *Thyrostroma cornicola* on *Cornus officinalis* (Korea), *Cercophora vinosa* on decorticated branch of *Salix* sp. (France), *Coprinus pinetorum*, *Coprinus littoralis* and *Xerocomellus poederi* on soil (Spain). Two new genera from Colombia include *Helminthosporiella* and *Uwemyces* on leaves of *Elaeis oleifera*. Two species are described from India, namely *Russula intervenosa* (ectomycorrhizal with *Shorea robusta*), and *Crinipellis odorata* (on bark of *Mytragyna parviflora*). Novelities from Thailand include *Cyphellophora gamsii* (on leaf litter), *Pisolithus aureosericeus* and *Corynascus citrinus* (on soil). Two species are newly described from *Citrus* in Italy, namely *Dendryphiella paravinosa* on *Citrus sinensis*, and *Ramularia citricola* on *Citrus floridana*. Morphological and culture characteristics along with ITS nrDNA barcodes are provided for all taxa.

Article info Received: 1 March 2016; Accepted: 15 May 2016; Published: 4 July 2016.

Acknowledgements Financial support was provided to María P. Martín, Margarita Dueñas and M. Teresa Tellería by Plan Nacional I+D+I projects No. CGL2009-07231 and CGL2012-35559. They also acknowledge Marian Glenn (Seton Hall University, USA) for her revision of the English text. Anna G. Fedosova and Eugene S. Popov acknowledge financial support from the Russian Foundation for Basic Research (project 15-29-02622). Gabriel Moreno, Juan Ramón Carlavilla, Michel Heykoop and José Luis Manjón wish to express their gratitude to Miguel Martín Calvo (Sociedad Micológica de Madrid) and Manuel Castro-Marcote for sending them fungal collections; to Dr L. Monje and Mr A. Pueblas of the Department of Drawing and Scientific Photography at the University of Alcalá for their help in the digital preparation of the photographs; to Dr J. Rejos, curator of the AH herbarium, for his assistance with the specimens examined in the present study. Olga V. Morozova and Eugene S. Popov are grateful to the Russian Foundation for Basic Research (project 15-04-04645a) for financial support. Alina V. Alexandrova and Maxim Yu. Dyakov acknowledge financial support from the Russian Science Foundation (project N 14-50-00029). K.P.D. Latha acknowledges support from the Kerala State Council for Science, Technology and Environment (KSCSTE) in the form of a PhD fellowship (Grant No. 001/FSHP/2011/CSTE) and is thankful to the Principal Chief Conservator of forests, Kerala State, for granting permission (No. WL10-4937/2012, dated 03-10-2013) to collect agarics from the forests of Kerala. The research of Vit Hubka, Miroslav Kolařík and Adéla Čmoková was supported through a grant from the Charles University Grant Agency (GAUK 8615) and by the

project 'BIOCEV–Biotechnology and Biomedicine Centre of the Academy of Sciences and Charles University' (CZ.1.05/1.1.00/02.0109) from the European Regional Development Fund. Dilnora E. Gouliamova, Margarita M. Stoilova-Disheva and Roumen A. Dimitrov acknowledge support from the Bulgarian Science Fund (D002-TK-176) and EU FP6 Research and Infrastructure Synthesis grant. They are also grateful to Dr Borislav Guéorguiev for the identification of insects. Margarita Hernández-Restrepo and Pedro W. Crous thank Prof. Uwe Braun (Martin-Luther Univ. Halle, Germany) for his comments on the fungi described as *Helminthosporiella* and *Uwemyces*. Mention of trade names or commercial products in this publication is solely for the purpose of providing specific information and does not imply recommendation or endorsement by the U.S. Department of Agriculture. USDA is an equal opportunity provider and employer. Johannes J. le Roux and David M. Richardson acknowledge funding from the DST-NRF Centre of Excellence for Invasion Biology. J. Jennifer Luangsa-ard, Alejandra Giraldo and Pedro W. Crous have received funding from the European Union's Horizon 2020 research innovation and staff exchange programme (RISE) under the Marie Skłodowska-Curie grant agreement No. 645701. Francois Roets and Pedro W. Crous thank the management board of Robben Island Museum, the Western Cape Nature Conservation board and Sabelo Madlala for permission to undertake research on Robben Island. Josepa Gené acknowledges financial support from the Spanish Ministerio de Economía y Competitividad grant CGL 2011-27185. Maria E. Ordóñez and colleagues acknowledge financial support from Secretaría de Educación Superior, Ciencia, Tecnología e Innovación del Ecuador (SENESCYT, Arca de Noé Initiative).

- 1 CBS-KNAW Fungal Biodiversity Centre, P.O. Box 85167, 3508 AD Utrecht, The Netherlands; corresponding author e-mail: p.crous@cbs.knaw.nl.
- 2 Department of Microbiology and Plant Pathology, Forestry and Agricultural Biotechnology Institute (FABI), University of Pretoria, P. Bag X20, Pretoria 0028, South Africa.
- 3 Forestry and Agricultural Biotechnology Institute (FABI), University of Pretoria, Pretoria 0002, South Africa.
- 4 Centre for Invasion Biology, Department of Botany & Zoology, Stellenbosch University, Matieland 7602, South Africa.
- 5 Université de La Réunion, UMR PVBMT, Peuplements Végétaux et Bio-agresseurs en Milieu Tropical, 15 avenue René Cassin, CS 93002, 97 744 Saint-Denis Messag. Cedex 9, La Réunion, France.
- 6 AgriBio, Centre for AgriBiosciences, Department of Economic Development, Jobs, Transport and Resources, 5 Ring Road, La Trobe University, Bundoora, Victoria 3083, Australia.
- 7 Department of Conservation Ecology and Entomology, Stellenbosch University, South Africa.
- 8 Department of Botany, Faculty of Science, Charles University in Prague, Benátská 2, 12801 Prague 2, Czech Republic.
- 9 Faculty of Veterinary and Agricultural Sciences, The University of Melbourne, Australia.
- 10 Departamento de Ciencias de la Vida (Área de Botánica), Universidad de Alcalá, E-28805 Alcalá de Henares, Madrid, Spain.
- 11 Departamento de Micología, Real Jardín Botánico-CSIC, Plaza de Murillo 2, 28014 Madrid, Spain.
- 12 Fungus Testing Laboratory, Department of Pathology, University of Texas Health Science Center, 7703 Floyd Curl Dr., San Antonio, Texas 78229-3900, USA.
- 13 Departamento Nacional de Protección Vegetal, Estación Experimental Santa Catalina, Instituto Nacional de Investigaciones Agropecuarias, Panamericana Sur Km. 1 vía Tambillo, Cantón Mejía, Provincia de Pichincha, Quito, Ecuador.
- 14 Mycology Unit, Medical School and IISPV, Universitat Rovira i Virgili (URV), Sant Llorenç 21, 43201 Reus, Tarragona, Spain.
- 15 Laboratory of Fungal Genetics and Metabolism, Institute of Microbiology of the AS CR, v.v.i, Vídeňská 1083, 142 20 Prague 4, Czech Republic.
- 16 Laboratory of Systematics and Geography of Fungi, Komarov Botanical Institute of the Russian Academy of Sciences, 197376, 2 Prof. Popov Str., Saint Petersburg, Russia.
- 17 Molecular and Applied Mycology and Plant Pathology Laboratory, Department of Botany, University of Calcutta, 35, Ballygunge Circular Road, Kolkata-700019, West Bengal, India.
- 18 Lomonosov Moscow State University (MSU), Faculty of Biology, 119234, 1, 12 Leninskie Gory Str., Moscow, Russia.
- 19 ALVALAB, La Rochela nº 47, E-39012, Santander, Spain.
- 20 Departamento de Micología Prof. Chaves Batista, Universidade Federal de Pernambuco, Recife, Brazil.
- 21 Departamento de Botânica e Zoologia, Universidade Federal do Rio Grande do Norte, Natal, Rio Grande do Norte, Brazil.
- 22 Department of Plant Pathology, University of Minnesota, 495 Borlaug Hall, 1991 Upper Buford Circle, St. Paul, MN 55108, USA.

- 23 Centre for Phytophthora Science and Management, Murdoch University, 90 South Street, Murdoch, WA 6150, Australia.
- 24 Sofia University "St. Kliment Ohridski", 5 James Bourchier Blvd., Sofia 1164, Bulgaria.
- 25 Las Muros, 09420 Rimont, France.
- 26 Universidad Central del Ecuador, Facultad de Medicina, Carrera de Ciencias Biológicas y Ambientales, Av. América, Quito, Ecuador.
- 27 The Stephan Angeloff Institute of Microbiology, Bulgarian Academy of Sciences, Acad. G. Bonchev 26, Sofia 1113, Bulgaria.
- 28 Slovenian Forestry Institute Vecna pot 2, Ljubljana, Slovenia.
- 29 IRS, P.O. Box 32, 4600 AA Bergen op Zoom, The Netherlands.
- 30 EMSL Analytical, Inc., 200 Route 130 North, Cinnaminson, NJ 08077, USA.
- 31 Department of Forest Biology, Faculty of Forestry, Kasetsart University, 50 Ngamwongwan Rd, Latyao, Chatuchak, Bangkok 10900, Thailand.
- 32 Department of Botany, Institute of Microbiology, Kerala, 673 635, India.
- 33 Microbe Interaction Laboratory, BIOTEC, Thailand Science Park, Khlong Nueng, Klong Luang Pathum Thani 12120, Thailand.
- 34 Laboratory of Medical Mycology, Department of Parasitology, Mycology and Mycobacteriology Prague, Public Health Institute in Usti nad Labem, Sokolovská 60, 186 00 Prague 8, Czech Republic.
- 35 Laboratory of Mycology and Parasitology, Hospital České Budějovice, B. Němcové 585/54, 370 01 České Budějovice, Czech Republic.
- 36 University of Illinois Urbana-Champaign, Illinois Natural History Survey, 1816 South Oak Street, Champaign, IL, 61820, USA.
- 37 Iranian Research Institute of Plant Protection, Tehran, Iran.
- 38 CSIR-Food Research Institute, P.O. Box M20, Accra, Ghana.
- 39 Escuela de Ciencias Biológicas, Pontificia Universidad Católica del Ecuador, Av. 12 de octubre 1076 y Roca, Quito, Ecuador.
- 40 Mycotoxin Prevention and Applied Microbiology Research Unit, Agricultural Research Service, U.S. Department of Agriculture, 1815 North University Street, Peoria, IL 61604, USA.
- 41 Faculty of Science, Nakhon Phanom University, 214, Moo 12, Nittayo Road, Nong Yart Sub-district, Muang District, Nakhon Phanom, 48000, Thailand.
- 42 Corporación Centro de Investigación en Palma de Aceite (CENIPALMA), Colombia.
- 43 Division of Environmental Science and Ecological Engineering, Korea University, Seoul 02841, Korea.
- 44 URM Culture Collection, Recife, Brazil.
- 45 Departamento de Solos, Universidade Federal de Santa Maria, CCR, Campus Universitário, 971050-900, Santa Maria, Rio Grande do Sul, Brazil.
- 46 Escuela de Ciencias Biológicas, Pontificia Universidad Católica del Ecuador, Av. 12 de octubre 1076 y Roca, Quito, Ecuador.
- 47 Plaza de España 1, E 15001 A Coruña, Spain.
- 48 Microbiology Unit, Medical Technology Department, Faculty of Health Science, University of Antofagasta, Av. Universidad de Antofagasta s/n, 02800 Antofagasta, Chile.
- 49 Caledonian Mycological Enterprises, Vrelah, 26 Blinkbonny Avenue, Edinburgh, EH4 3HU, Scotland, UK.

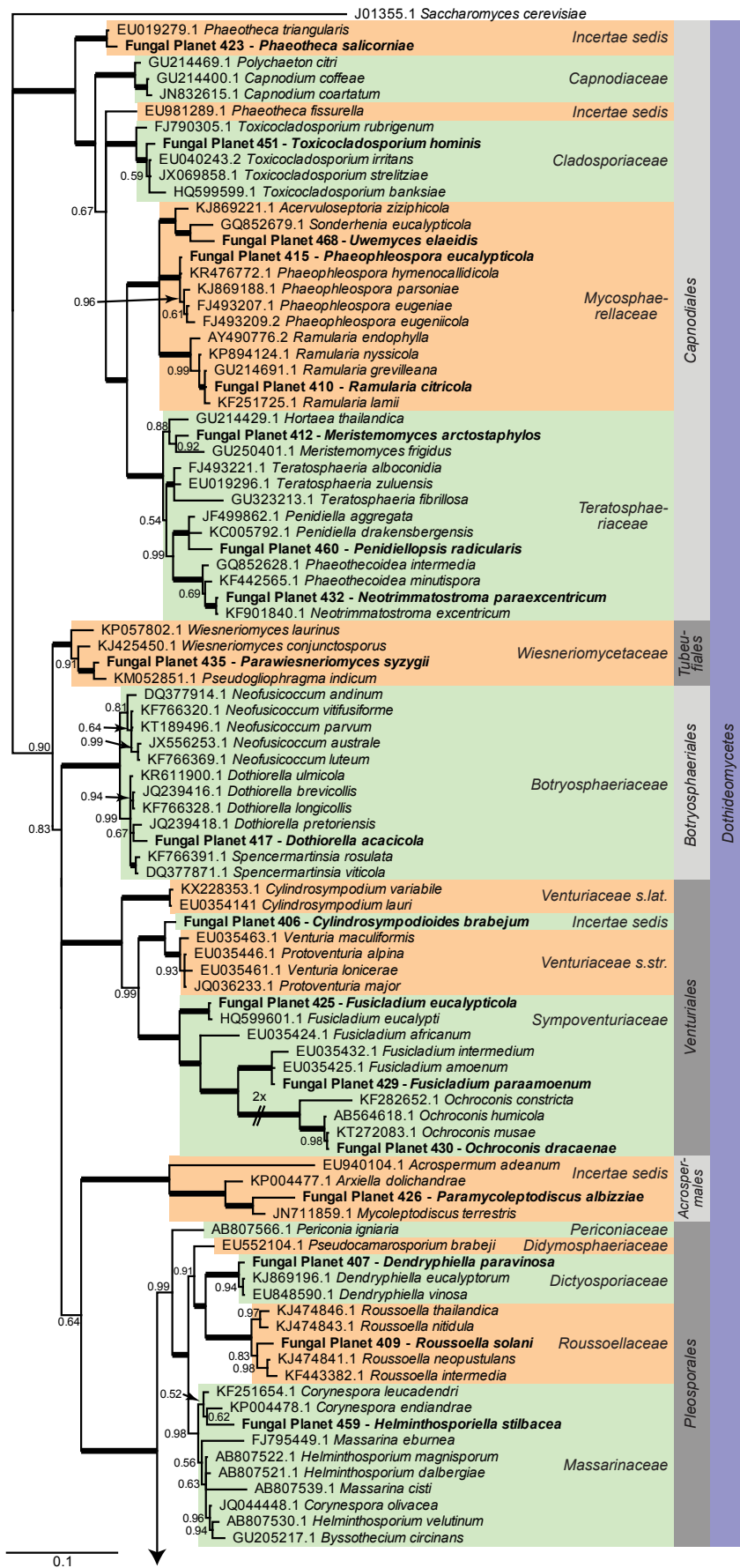

Overview *Dothideomycetes* phylogeny

Consensus phylogenetic tree (50% majority rule) of 42 902 trees resulting from a Bayesian analysis of the LSU sequence alignment (173 taxa including outgroup; 743 aligned positions; 375 unique site patterns) using MrBayes v. 3.2.5 (Ronquist et al. 2012). Bayesian posterior probabilities (PP) are shown at the nodes and thickened lines represent nodes with PP = 1.00. The scale bar represents the expected changes per site. Families, orders and classes are indicated with coloured blocks to the right of the tree. GenBank accession numbers are indicated in front of the species names. The tree was rooted to *Saccharomyces cerevisiae* (GenBank J01355.1) and the novel species described in this study for which LSU sequence data were available are indicated in bold face. The alignment and tree were deposited in TreeBASE (Submission ID 19280).

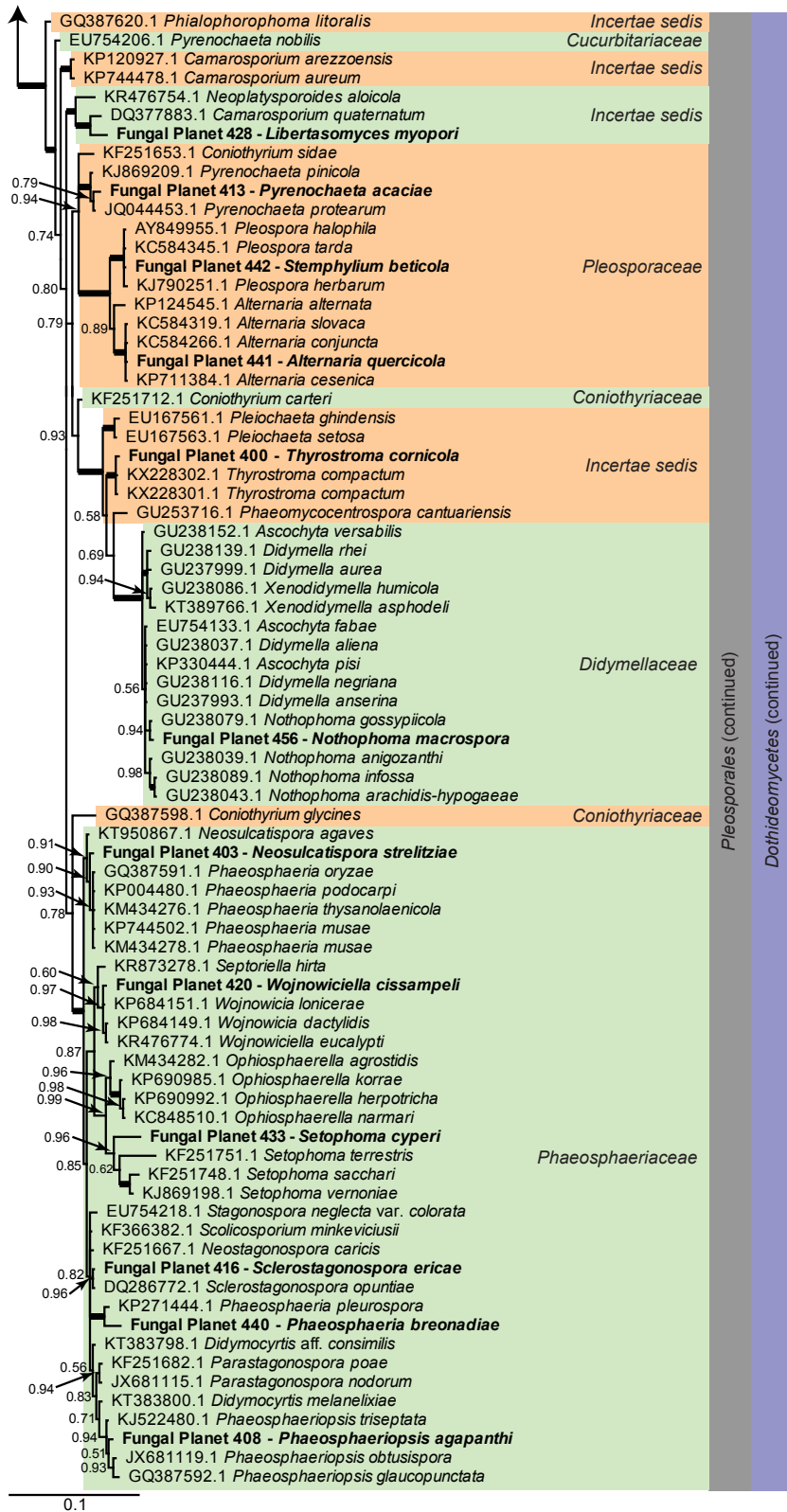
Overview *Dothideomycetes* phylogeny (cont.)

Overview Eurotiomycetes, Geoglossomycetes, Lecanoromycetes and Leotiomycetes phylogeny

Consensus phylogram (50 % majority rule) of 9 452 trees resulting from a Bayesian analysis of the LSU sequence alignment (46 taxa including out-group; 751 aligned positions; 348 unique site patterns) using MrBayes v. 3.2.5 (Ronquist et al. 2012). Bayesian posterior probabilities (PP) are shown at the nodes and thickened lines represent nodes with PP = 1.00. The scale bar represents the expected changes per site. Families, orders and classes are indicated with coloured blocks to the right of the tree. GenBank accession numbers are indicated in front of the species names. The tree was rooted to *Saccharomyces cerevisiae* (GenBank J01355.1) and the novel species described in this study for which LSU sequence data were available are indicated in **bold** face. The alignment and tree were deposited in TreeBASE (Submission ID 19280).

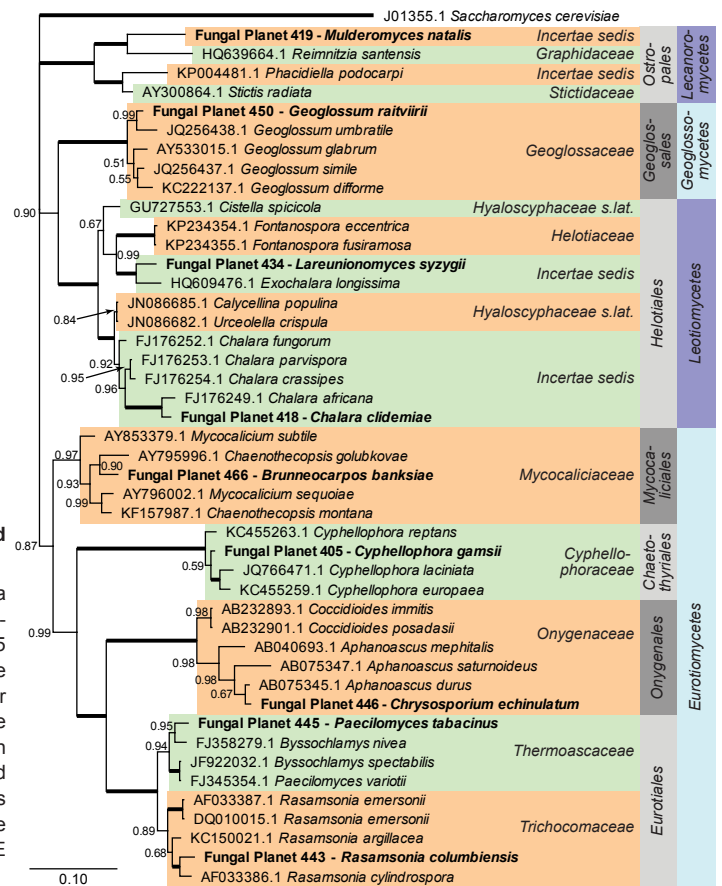

Overview Saccharomycotina and Agaricomycotina phylogeny

Consensus phylogram (50 % majority rule) of 4 352 trees resulting from a Bayesian analysis of the LSU sequence alignment (42 taxa including out-group; 769 aligned positions; 421 unique site patterns) using MrBayes v. 3.2.5 (Ronquist et al. 2012). Bayesian posterior probabilities (PP) are shown at the nodes and thickened lines represent nodes with PP = 1.00. The scale bar represents the expected changes per site. Families, orders and classes are indicated with coloured blocks to the right of the tree. GenBank accession numbers are indicated in front of the species names. The tree was rooted to *Diaporthe eres* (GenBank AF362565.1) and the novel species described in this study for which LSU sequence data were available are indicated in **bold** face. The alignment and tree were deposited in TreeBASE (Submission ID 19280).

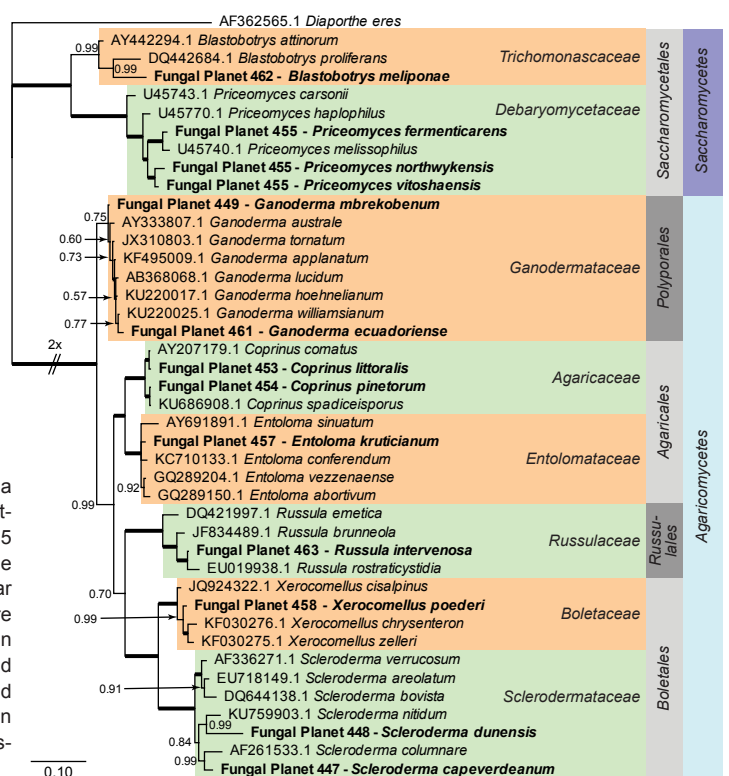

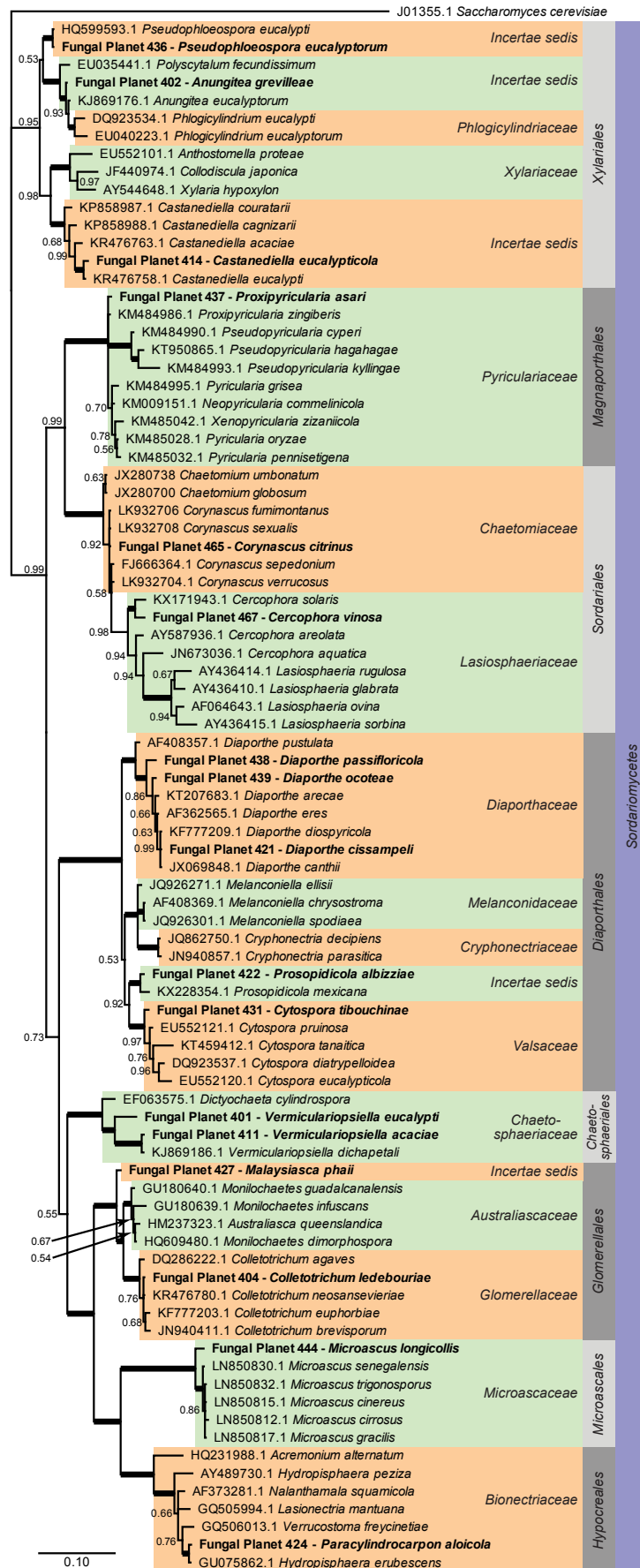

Overview Sordariomycetes phylogeny

Consensus phylogram (50 % majority rule) of 21 302 trees resulting from a Bayesian analysis of the LSU sequence alignment (88 taxa including outgroup; 740 aligned positions; 299 unique site patterns) using MrBayes v. 3.2.5 (Ronquist et al. 2012). Bayesian posterior probabilities (PP) are shown at the nodes and thickened lines represent nodes with PP = 1.00. The scale bar represents the expected changes per site. Families, orders and classes are indicated with coloured blocks to the right of the tree. GenBank accession numbers are indicated in front of the species names. The tree was rooted to *Saccharomyces cerevisiae* (GenBank J01355.1) and the novel species described in this study for which LSU sequence data were available are indicated in bold face. The alignment and tree were deposited in TreeBASE (Submission ID 19280).



Fungal Planet 400 – 4 July 2016

Thyrostroma cornicola Crous & H.D. Shin, *sp. nov.*

Etymology. Name refers to *Cornus*, the plant genus from which this fungus was collected.

Classification — *Incertae sedis*, *Pleosporales*, *Dothideomycetes*.

Sporodochia dark brown, punctiform, to 300 µm diam. *Stromata* immersed to superficial, brown, 100–150 µm diam. *Conidiophores* brown, finely roughened, subcylindrical, 1–3-septate, 10–50 × 7–10 µm. *Conidiogenous cells* brown, subcylindrical, finely roughened, 7–20 × 7–10 µm, proliferating percurrently at apex. *Conidia* clavate, ellipsoid to fusoid, medium brown, with (1–)3 transverse septa, and 0–3 oblique or longitudinal septa, apex broadly obtuse, base truncate, 5–6 µm diam, (25–)30–36(–40) × (12–)14–17(–26) µm.

Culture characteristics — Colonies covering dish after 2 wk at 25 °C, with fluffy aerial mycelium. On MEA surface pale mouse-grey to mouse-grey, reverse dark mouse-grey. On PDA and OA surface mouse-grey, reverse dark mouse-grey.

Typus. KOREA, Incheon, Namdong-gu, Incheon Arboretum, N37°27'37.1" E126°45'22.6", on leaves of *Cornus officinalis* (*Cornaceae*), 28 Oct. 2014, P.W. Crous & H.D. Shin (holotype CBS H-22589, culture ex-type CPC 25427 = CBS 141280; ITS sequence GenBank KX228248.1, LSU sequence GenBank KX228300.1, *tef1* sequence GenBank KX228372.1, MycoBank MB816999).

Notes — The genus *Thyrostroma* is based on the description of *T. compactum* (CBS 700.70, ITS, LSU sequences GenBank KX228250.1, KX228302.1), the ITS of which is 99 % (539/542) similar to the present collection. However, *T. compactum* is associated with *Thyrostroma* canker of *Ulmus* spp. in Europe and the USA (Ellis 1971), while the present collection is associated with leaf spots on *Cornus officinalis* in Korea. Conidia of *T. compactum* are 28–64 × 18–25 µm, with 2–4 transverse, and 1 to several, longitudinal to oblique septa (Ellis 1971), thus with conidia appearing somewhat larger than those observed in the present collection.

Although *Thyrostroma* was linked to *Dothidotthia* by Phillips et al. (2008), this treatment shows that the type of the genus clusters in the *Pleosporales*, suggesting that the asexual morph of *Dothidotthia* is thyrostroma-like, but that the two genera are not congeneric.

Colour illustrations. Symptomatic leaves of *Cornus officinalis*; sporodochia on PNA, sporulation on PNA, conidiophores and conidia. Scale bars = 10 µm.



Fungal Planet 401 – 4 July 2016

Vermiculariopsiella eucalypti Crous, Jacq. Edwards & P.W.J. Taylor, *sp. nov.*

Etymology. Name refers to *Eucalyptus*, the plant genus from which this fungus was collected.

Classification — *Chaetosphaeriaceae*, *Chaetosphaeriales*, *Sordariomycetes*.

Colonies sporulating profusely throughout on SNA. *Setae* erect, brown, cylindrical, straight to flexuous, 120–220 × 4–5 µm, thick-walled, finely roughened, 8–15-septate, tapering towards apex, developing a head of lateral coiled to whip-like branches (constricted at base where attached to setae), that are brown, septate, tapering, containing coiled, septate lateral branches that could again contain coiled, lateral, branched, mostly aseptate branches. *Conidiophores* arranged in a whorl around base of setae, pale brown, smooth, subcylindrical, branched or not, 0–6-septate, containing conidiogenous cells that are arranged laterally along its length or at times reduced to conidiogenous cells, 20–50 × 3–5 µm. *Conidiogenous cells* solitary, monophialidic, discrete, ampulliform to subulate, pale brown, 15–25 × 3–5 µm, apex 1–1.5 µm diam, with minute collarette (1–2 µm long), at times with percurrent proliferation at apex. *Conidia* asymmetrical, fusoid to subfusoid or oblong, attenuated, base bluntly rounded to somewhat inflated, aseptate, smooth, finely granular, (5–)7–9(–10) × (2–)2.5(–3) µm.

Culture characteristics — Colonies spreading, with sparse aerial mycelium, and even, lobate margins, reaching 30 mm diam after 2 wk at 25 °C. On MEA surface pale mouse-grey, reverse dark mouse-grey. On PDA surface and reverse pale mouse-grey. On OA surface mouse-grey.

Typus. AUSTRALIA, Victoria, Toolangi State Forest, S37°33'25.3" E145°31'55.9", on leaves of *Eucalyptus regnans* (*Myrtaceae*), 9 Nov. 2014, P.W. Crous, J. Edwards & P.W.J. Taylor (holotype CBS H-22590, culture ex-type CPC 25525 = CBS 141281; ITS sequence GenBank KX228251.1, LSU sequence GenBank KX228303.1, MycoBank MB817000).

Notes — The setose conidiomata with brown, branched setae and basally arranged phialides with periclinal thickening are typical characteristics of the genus *Vermiculariopsiella*. On ITS *V. eucalypti* is 95 % (487/511) similar to *V. pediculata* (FMR 12187; GenBank HF678527.1), followed by *V. dichapetali* (Crous et al. 2014a; CPC 22463; GenBank KJ869129.1; 488/555 (88 %)). *Vermiculariopsiella pediculata* has smaller conidiogenous cells (14–15 × 3–4 µm), and narrower conidia (5–9 × 2 µm) (Hernandez-Restrepo et al. 2012). The closest hits using a megablast search of the LSU sequence were 96 % (792/827) similar to *Dictyochaeta cylindrospora* (GenBank EF063575.1; *Chaetosphaeriaceae*, *Chaetosphaeriales*), 96 % (777/813) to *Vermiculariopsiella dichapetali* (GenBank KJ869186.1; *incertae sedis*, *Microascales*), 94 % (780/827) to *Pseudobotrytis terrestris* (GenBank KF771875.1; *incertae sedis*) and 94 % (781/830) to *Barbatosphaeria fimbriata* (GenBank KM492867.1; *incertae sedis*).

Colour illustrations. Toolangi State Forest; conidiophores with setae on PNA, conidiogenous cells and conidia. Scale bars = 10 µm.

Pedro W. Crous & Johannes Z. Groenewald, CBS-KNAW Fungal Biodiversity Centre, P.O. Box 85167, 3508 AD Utrecht, The Netherlands;
e-mail: p.crous@cbs.knaw.nl & e.groenewald@cbs.knaw.nl
Jacqueline Edwards, AgriBio, Centre for AgriBiosciences, Department of Economic Development, Jobs, Transport and Resources,
5 Ring Road, La Trobe University, Bundoora, Victoria 3083, Australia;
e-mail: jacky.edwards@ecodev.vic.gov.au
Paul W.J. Taylor, Faculty of Veterinary and Agricultural Sciences, The University of Melbourne, Australia;
e-mail: paulwtj@unimelb.edu.au

Anungitea grevilleae



Fungal Planet 402 – 4 July 2016

Anungitea grevilleae Crous & Jacq. Edwards, *sp. nov.*

Etymology. Name refers to *Grevillea*, the plant genus from which this fungus was collected.

Classification — *Incertae sedis*, *Xylariales*, *Sordariomycetes*.

Mycelium of pale brown, smooth, septate, branched, 1.5–2.5 µm hyphae. *Setae* intermingled among conidiophores, flexuous, subcylindrical with taper to acutely rounded apices, multiseptate, brown, smooth, base bulbous, 4–5 µm diam, up to 500 µm tall, 2.5–3.5 µm wide. *Conidiophores* erect, flexuous, dark brown, thick-walled, 1–4-septate, 15–70 × 2.5–3.5 µm, with several sympodial, flat-tipped apical loci, 1–1.5 µm diam, not thickened. *Ramoconidia* giving rise to branched chains of cylindrical conidia, hyaline to pale brown, smooth, subcylindrical, 0–1-septate, 15–20 × 2–3 µm, with 1–3 flat-tipped apical scars, 1.5–2 µm diam. *Conidia* hyaline, rarely pale olivaceous, cylindrical, 0–1-septate, guttulate, ends truncate, (10–)13–16(–22) × (2–)2.5–3 µm.

Culture characteristics — Colonies reaching up to 40 mm diam after 2 wk at 25 °C, with spreading, flat surface; margins smooth, even, and sparse to moderate aerial mycelium. On MEA surface umber with patches of ochreous, reverse chestnut. On OA surface umber with patches of honey. On PDA surface and reverse umber.

Typus. AUSTRALIA, Victoria, Royal Botanic Gardens Cranbourne, S38°7' 49.6" E145°16'9", on leaves of *Grevillea* sp. (*Proteaceae*), 7 Nov. 2014, *P.W. Crous & J. Edwards* (holotype CBS H-22591, culture ex-type CPC 25576 = CBS 141282; ITS sequence GenBank KX228252.1, LSU sequence GenBank KX228304.1, MycoBank MB817001).

Notes — On ITS *Anungitea grevilleae* is 98 % (553/566) similar to *A. eucalyptorum* (CPC 17207 = CBS 137967; GenBank KJ869118.1). Morphologically, the two species are distinct in that *A. eucalyptorum* has shorter ramoconidia (12–17 × 2–3 µm), and somewhat larger conidia ((10–)13–16(–22) × (2–)2.5–3 µm). The most obvious difference lies in the dimorphic conidiophores observed in *A. eucalyptorum*, where microconidiophores can be reduced to conidiogenous cells, and macroconidiophores are up to 180 µm tall (Crous et al. 2014a).

Colour illustrations. Leaves of *Grevillea* sp.; conidiophores sporulating on PNA, seta, conidiophores and conidia. Scale bars = 10 µm.

Pedro W. Crous & Johannes Z. Groenewald, CBS-KNAW Fungal Biodiversity Centre, P.O. Box 85167, 3508 AD Utrecht, The Netherlands;
e-mail: p.crous@cbs.knaw.nl & e.groenewald@cbs.knaw.nl
Jacqueline Edwards, AgriBio, Centre for AgriBiosciences, Department of Economic Development, Jobs, Transport and Resources,
5 Ring Road, La Trobe University, Bundoora, Victoria 3083, Australia;
e-mail: jacky.edwards@ecodev.vic.gov.au

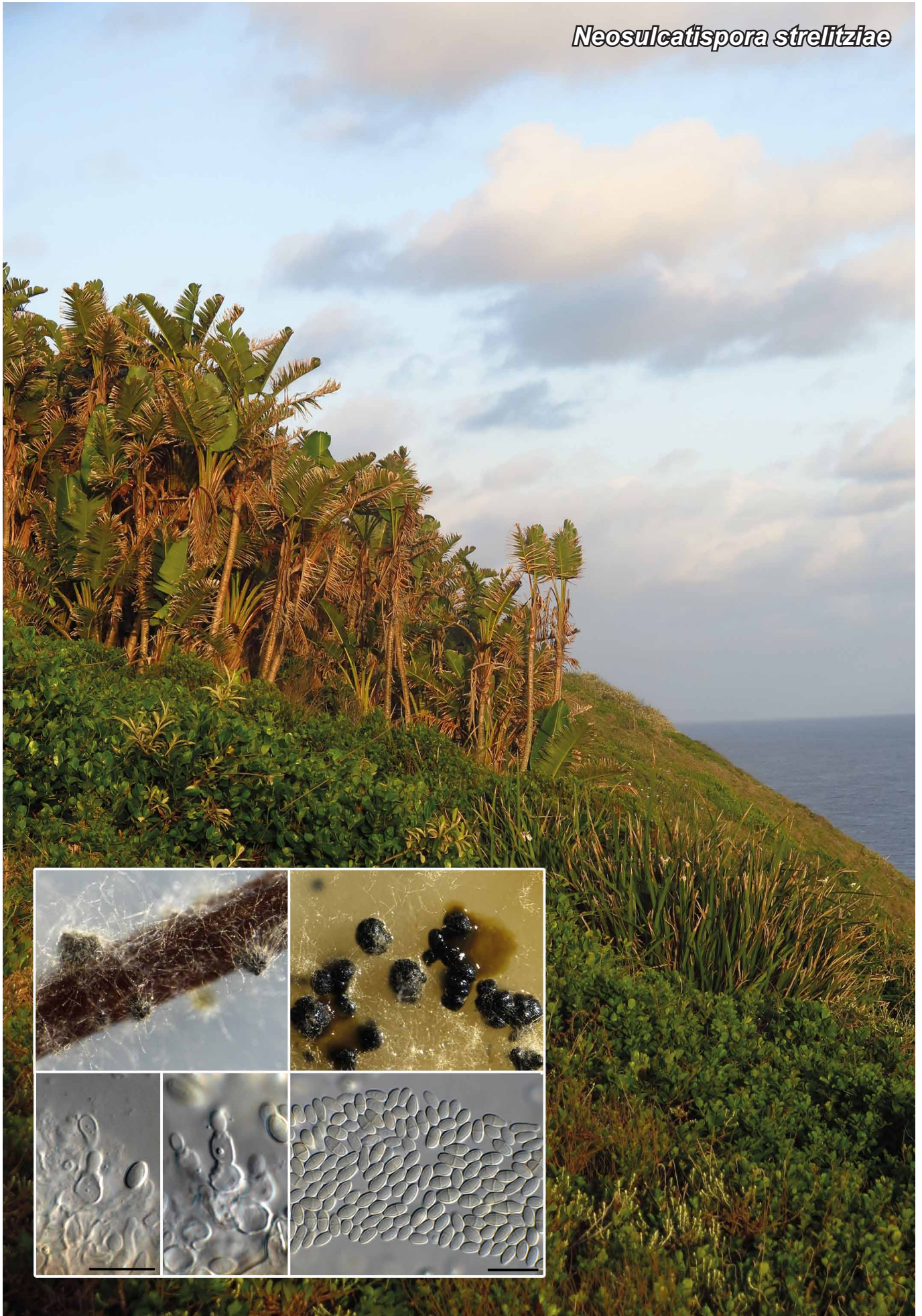
Neosulcatispora strelitziae

Fungal Planet 403 – 4 July 2016

Neosulcatispora strelitziae Crous & M.J. Wingf., *sp. nov.*

Etymology. Name refers to *Strelitzia*, the plant genus from which this fungus was collected.

Classification — *Phaeosphaeriaceae*, *Pleosporales*, *Dothi-deomycetes*.

Leaf spots amphigenous, subcircular to irregular, grey-brown with dark brown margin, 3–8 mm diam. *Conidiomata* erumpent, globose, dark brown to black, to 350 µm diam with central ostiole (to 40 µm diam), exuding a pale olivaceous conidial mass; wall of 3–4 layers of brown *textura angularis*. *Conidiophores* reduced to conidiogenous cells, or with a supporting cell, lining the inner cavity, hyaline, smooth, ampulliform, 4–6 × 3–4 µm, phialidic, with periclinal thickening or tightly aggregated percurrent proliferations. *Conidia* solitary, golden-brown, smooth, ellipsoid, 0–1-septate, (4–)5–7(–8) × (2.5–)3 µm.

Culture characteristics — Colonies flat, spreading, with moderate aerial mycelium, and smooth lobate margins, reaching 50 mm diam after 2 wk at 25 °C. On MEA surface mouse-grey, reverse greyish sepia. On OA surface honey with black conidiomata. On PDA surface and reverse pale mouse-grey.

Typus. SOUTH AFRICA, Eastern Cape Province, Haga Haga, on leaves of *Strelitzia nicolai* (*Strelitziaceae*), Dec. 2014, *M.J. Wingfield* (holotype CBS H-22592, culture ex-type CPC 25657 = CBS 141283; ITS sequence GenBank KX228253.1, LSU sequence GenBank KX228305.1, *tub2* sequence GenBank KX228380.1, MycoBank MB817002).

Notes — The ITS, LSU and *tub2* sequences of the present collection are 410/470 (87 %), 835/837 (99 %) and 440/533 (83 %) similar to *Neosulcatispora agaves* (CBS 140661; KT-950853.1, KT950867.1, KT950883.1, respectively), which was recently described from leaves of *Agave vera-cruz* growing in La Réunion (Crous et al. 2015b). Morphologically, *N. strelitziae* differs from *N. agaves* in that its conidiophores are reduced to conidiogenous cells, and its conidia are smooth, whereas they are larger ((7–)9–11(–12) × (3.5–)4(–4.5) µm), and prominently striate in *N. agaves* (Crous et al. 2015b).

Colour illustrations. *Strelitzia nicolai* plants; conidiomata sporulating on PNA, conidiogenous cells and conidia. Scale bars = 10 µm.

Colletotrichum ledebouriae



Fungal Planet 404 – 4 July 2016

Colletotrichum ledebouriae Crous & M.J. Wingf., *sp. nov.*

Etymology. Name refers to *Ledebouria*, the plant genus from which this fungus was collected.

Classification — *Glomerellaceae*, *Glomerellales*, *Sordariomycetes*.

Leaf spots circular, amphigenous, pale brown with raised dark brown border, 10–20 mm diam. *Conidiomata* (on pine needle agar; PNA) acervular, to 350 µm diam, conidiophores and setae on a cushion of pale brown stroma. *Setae* dark brown, smooth-walled, 2–4-septate, 80–120 × 5–7 µm, tapering to subacute apex. *Conidiophores* hyaline to pale brown, smooth-walled, septate, branched, to 50 µm tall, 4–5 µm wide. *Conidiogenous cells* hyaline to pale brown, smooth-walled, 15–23 × 3.5–4.5 µm. *Conidia* hyaline, smooth-walled, guttulate, aseptate, straight, subcylindrical, apex obtuse, base truncate with hilum 1–1.5 µm diam, (15–)17–21(–22) × (5–)6 µm.

Culture characteristics — Colonies covering dish after 1 mo at 25 °C, with moderate to woolly aerial mycelium. On MEA surface grey olivaceous, reverse dark brick. On OA surface smoke grey. On PDA surface and reverse grey olivaceous.

Typus. SOUTH AFRICA, Eastern Cape Province, Haga Haga, on leaves of *Ledebouria floridunda* (*Hyacinthaceae*), Dec. 2014, M.J. Wingfield (holotype CBS H-22593, culture ex-type CPC 25671 = CBS 141284; ITS sequence GenBank KX228254.1, LSU sequence GenBank KX228306.1, *actA* sequence GenBank KX228357.1, *his3* sequence GenBank KX228365.1, MycoBank MB817003).

Notes — *Ledebouria* is a genus of deciduous or weakly evergreen bulb plants that occur in Sub-Saharan Africa, but almost nothing is known regarding fungal diseases of these plants (Crous et al. 2000). As far as we could establish, this is the first record of anthracnose disease on *Ledebouria*. On ITS *C. ledebouriae* is 98 % (563/572) similar to *C. sansevieriae* (MAFF239721; GenBank KC790947.1). The most similar sequences based on *actA* and *his3* are 94 % (242/257) and 93 % (346/372) to *C. neosansevieriae* (GenBank KR476790.1 and KR476792.1), and 90 % (230/255) and 92 % (343/371) to *C. euphorbiae* (GenBank KF777125.1 and KF777134.1). Conidia of *C. sansevieriae* are larger (12.5–(18.4)–32.5 × 2.8–(6.4)–8.8 µm; Nakamura et al. 2006) than those of *C. ledebouriae*, but overlap with those of *C. neosansevieriae* ((16–)18–22(–25) × (4–)5–6 µm; Crous et al. 2015a).

Colour illustrations. Coastline at Haga Haga in the Eastern Cape Province; conidiomata sporulating on OA and PNA, setae and conidia. Scale bars = 10 µm.

Pedro W. Crous & Johannes Z. Groenewald, CBS-KNAW Fungal Biodiversity Centre, P.O. Box 85167, 3508 AD Utrecht, The Netherlands; e-mail: p.crous@cbs.knaw.nl & e.groenewald@cbs.knaw.nl
Michael J. Wingfield, Forestry and Agricultural Biotechnology Institute (FABI), University of Pretoria, Pretoria 0002, South Africa; e-mail: mike.wingfield@up.ac.za



Fungal Planet 405 – 4 July 2016

Cyphellophora gamsii Crous, *sp. nov.*

Etymology. Named for Walter Gams, who collected and isolated this fungus.

Classification — *Cyphellophoraceae*, *Chaetothyriales*, *Eurotiomycetes*.

Mycelium consisting of smooth, pale brown, branched, septate, 1.5–2 µm diam hyphae. *Conidiophores* reduced to conidiogenous cells on hyphae, erect, straight, cylindrical, 2–6 × 1.5–2 µm; apex with flared collarette, 1–2 µm long. *Conidia* solitary, granular, hyaline, smooth, curved, falcate to flexuous, tapering from middle to subacutely rounded apex with mucoid cap, and towards truncate hilum, 0.5 µm diam, (0–)3-septate, (22–)30–40(–50) × (1.5–)2 µm; microcyclic conidiation observed in culture.

Culture characteristics — Colonies reaching up to 20 mm diam after 2 wk at 25 °C, with spreading, flat surface; margins smooth, lobate, and moderate aerial mycelium. On MEA and PDA surface mouse-grey, reverse dark mouse-grey. On OA surface dark mouse-grey.

Typus. THAILAND, Chiang Mai, Mushroom Research Centre, on leaf litter, Aug. 2014, *W. Gams* (holotype MFLU 16-1139, culture ex-type CPC 25867; ITS sequence GenBank KX228255.1, LSU sequence GenBank KX228307.1, *tub2* sequence GenBank KX228381.1, MycoBank MB817005).

Notes — The genus *Cyphellophora* includes species that are associated with plant litter, as well as human and animal skin and nails (Gao et al. 2015). *Cyphellophora gamsii* is a typical species in the genus, being 99 % (812/821) similar on LSU to other known species. On ITS *C. gamsii* is 99 % (531/537) similar to *Cyphellophora* sp. (CBS 112.94; GenBank JQ766437.1) and 95 % (582/615) to *C. laciniata* (CBS 190.61; GenBank EU035416.1). No highly similar *tub2* sequences were found. Morphologically, *C. gamsii* is quite distinct from other species in the genus by having large, 3-septate conidia (Decock et al. 2003, Gao et al. 2015).

Colour illustrations. Mountain stream at Chiang Mai; hyphae with fertile conidiogenous loci and conidia on PNA. Scale bars = 10 µm.

Cylindrosympodioides brabejum

Fungal Planet 406 – 4 July 2016

***Cylindrosympodioides* Crous & M.J. Wingf., gen. nov.**

Etymology. Name refers to the morphological similarity with the genus *Cylindrosympodium*.

Classification — *Incertae sedis*, *Venturiales*, *Dothideomycetes*.

Mycelium consisting of smooth, pale brown, branched, septate, hyphae. *Conidiophores* erect, medium brown, cylindrical, septate. *Conidiogenous cells* terminal, subcylindrical, pale brown, proliferating sympodially, scars unthickened, slightly darkened, flat. *Conidia* solitary, hyaline, acicular, straight to slightly curved, guttulate, multiseptate, apex subobtusely rounded,

base prominently truncate, unthickened but slightly darkened. Fusicladium-like synasexual morph developing on SNA, intermixed on hyphae with *Cylindrosympodioides* morph. *Conidiophores* reduced to conidiogenous cells, brown, ampulliform to fusoid-ellipsoid, proliferating sympodially, scars somewhat darkened. *Conidia* solitary, brown, verruculose, guttulate, thick-walled, fusoid-ellipsoid, septate, widest at median septum, apex subobtusely rounded, base truncate.

Type species. *Cylindrosympodioides brabejum* Crous & M.J. Wingf. MycoBank MB817076.

***Cylindrosympodioides brabejum* Crous & M.J. Wingf., sp. nov.**

Etymology. Name refers to *Brabejum*, the plant genus from which this fungus was collected.

Mycelium consisting of smooth, pale brown, branched, septate, 1.5–2 µm diam hyphae. *Conidiophores* erect, medium brown, cylindrical, 0–2-septate, 10–25 × 2.5–3.5 µm. *Conidiogenous cells* terminal, subcylindrical, pale brown, 7–15 × 2.5–3 µm, proliferating sympodially, scars unthickened, slightly darkened, flat, 1.5–2 µm diam. *Conidia* solitary, hyaline, acicular, straight to slightly curved, guttulate, multiseptate, apex subobtusely rounded, base prominently truncate, 2 µm diam, unthickened but slightly darkened, (55–)100–110(–120) × (1.5–)2(–2.5) µm. Fusicladium-like synasexual morph developing on SNA, intermixed on hyphae with *Cylindrosympodioides* morph. *Conidiophores* reduced to conidiogenous cells, brown, ampulliform to fusoid-ellipsoid, 5–7 × 3–4 µm, proliferating sympodially, scars somewhat darkened, 0.5 µm diam. *Conidia* solitary, brown, verruculose, guttulate, thick-walled, fusoid-ellipsoid, 1(–3)-septate, widest at median septum, apex subobtusely rounded, base truncate, 1 µm diam, (12–)15–17(–20) × (2.5–)3(–3.5) µm.

Culture characteristics — Colonies reaching up to 15 mm diam after 2 wk at 25 °C, with spreading, flat surface; margins smooth, lobate, and moderate aerial mycelium. On MEA surface isabelline, reverse sepia. On OA surface dark brick. On PDA surface isabelline, reverse sepia.

Typus. SOUTH AFRICA, Western Cape Province, Franschhoek, on leaves of *Brabejum stellatifolium* (*Proteaceae*), 17 Jan. 2015, P.W. Crous & M.J. Wingfield (holotype CBS H-22594, culture ex-type CPC 25934 = CBS 141285; ITS sequence GenBank KX228256.1, LSU sequence GenBank KX228308.1, MycoBank MB817008).

Notes — The genus *Cylindrosympodium* (based on *C. variabile*) is characterised by its solitary, septate, cylindrical to subacicular, hyaline conidia with truncate bases, somewhat darkened hila, and brown conidiogenous structures with sympodial proliferation (Crous et al. 2007d). *Cylindrosympodioides*, which shares a similar morphology with species of *Cylindrosympodium*, is distinct in that it has acicular conidia with slightly thickened hila, and a fusicladium-like synasexual morph, which has conidiophores that are reduced to conidiogenous cells. *Cylindrosympodioides* is phylogenetically also closer to *Venturia*, whereas *Cylindrosympodium* forms a distinct sister lineage basal in the *Venturiaceae*.

Colour illustrations. Symptomatic leaves of *Brabejum stellatifolium*; conidiogenous cells with *Fusicladium* conidia, colony on SNA, conidiophores and conidia of *Cylindrosympodioides* morph. Scale bars = 10 µm.

Dendryphiella paravinosa

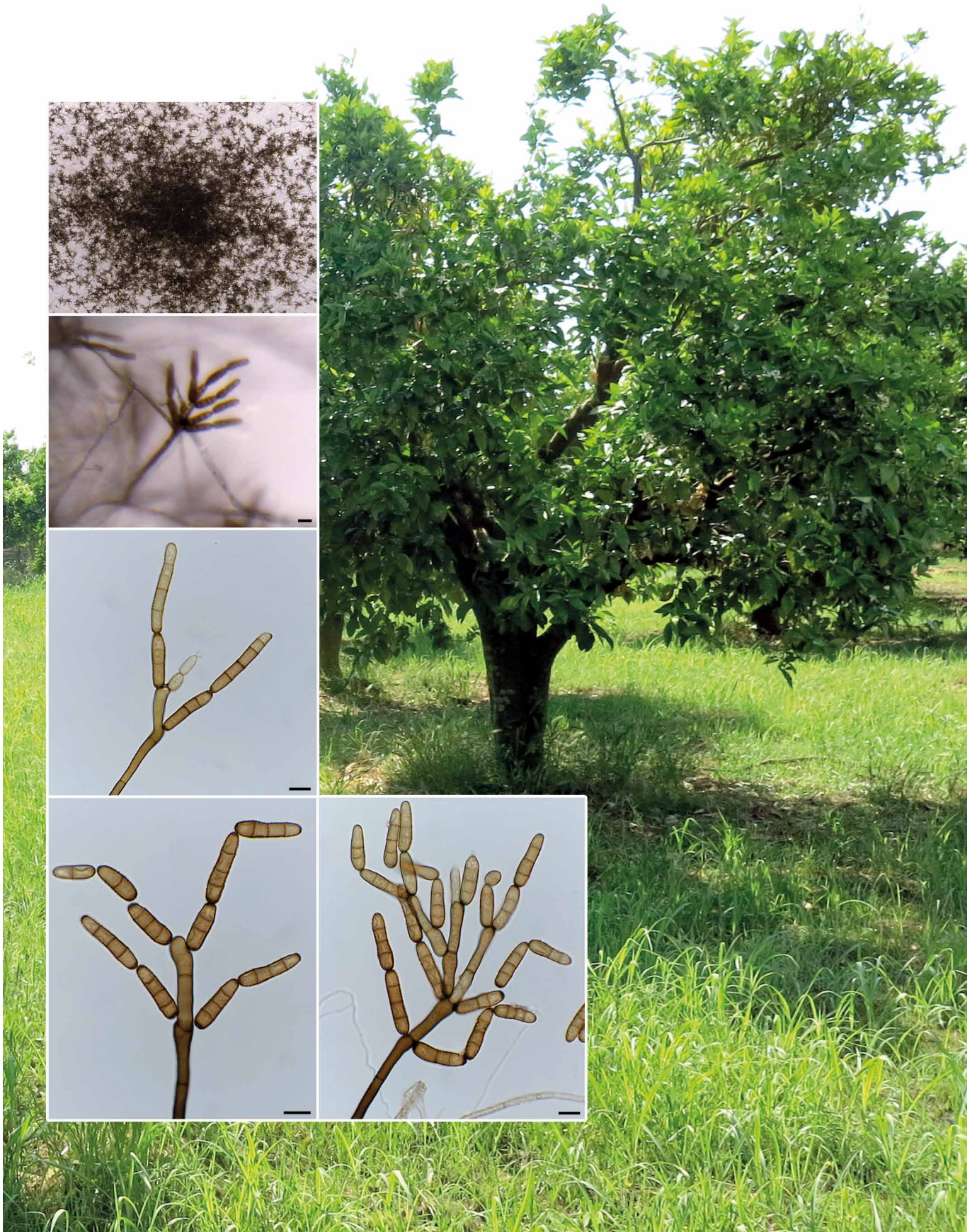

Fungal Planet 407 – 4 July 2016

***Dendryphiella paravinosa* Crous & Guarnaccia, sp. nov.**

Etymology. Name reflects the morphological similarity to *Dendryphiella vinosa*.

Classification — *Dictyosporiaceae*, *Pleosporales*, *Dothideo-mycetes*.

Mycelium consisting of hyaline to pale brown, smooth to verruculose 2–3 µm diam hyphae. *Conidiophores* solitary, erect, dark brown, subcylindrical, verruculose, branched above and below, to 150 µm long, 10–20 × 6–7 µm, 5–7-septate. *Conidiogenous cells* integrated, terminal and intercalary, clavate, with several loci arranged at the apex, 2–3 µm diam; loci thickened, darkened, refractive, 2–3 µm diam, with central pore. *Conidia* subcylindrical, apex obtuse, base bluntly rounded, medium brown, verruculose, (1–)3-septate, occurring in short chains (10–)24–27(–33) × (6–)7(–7.5) µm; hila thickened, darkened, refractive, 2–3 µm diam.

Culture characteristics — Colonies reaching up to 40 mm diam after 2 wk at 25 °C, with spreading, flat surface; margins smooth, lobate, and moderate aerial mycelium. On MEA surface honey to ochreous, reverse umber. On OA surface chestnut. On PDA surface umber to ochreous, reverse umber.

Typus. ITALY, Sicily, Scordia (CT), on leaves of *Citrus sinensis* (*Rutaceae*), Mar. 2015, V. Guarnaccia (holotype CBS H-22595, culture ex-type CPC 26176 = CBS 141286; ITS sequence GenBank KX228257.1, LSU sequence GenBank KX228309.1, MycoBank MB817009); Sicily, Scordia (CT), on leaves of *Citrus limon*, Mar. 2015, V. Guarnaccia, CPC 26182 (ITS sequence GenBank KX228258.1).

Notes — The genus *Dendryphiella* is characterised by branched to unbranched conidiophores, with polytretic conidiogenous cells, darkened, thickened scars, and brown, septate, catenulate conidia (Crous et al. 2014a). Conidia of *D. paravinosa* resemble those of *D. vinosa* (13–39 × 4–8 µm; Ellis 1971, described from Congo bean in Cuba), but are smaller. *Dendryphiella paravinosa* CPC 26176 = CBS 141286 is identical to CPC 26182, and they are 90 % (424/472) related to *D. vinosa* (NBRC 32669; GenBank DQ307316.1), 88 % (374/427) to *Dictyosporium toruloides* (FMR 11942; GenBank HF677181.1) and 90 % (526/582) to *Dendryphiella eucalyptorum* (CPC 22927 = CBS 137987; GenBank KJ869139.1).

Colour illustrations. *Citrus sinensis* orchard; colony sporulating on PNA, conidiophores and chains of conidia. Scale bars = 10 µm.

Phaeosphaeriopsis agapanthi



Fungal Planet 408 – 4 July 2016

***Phaeosphaeriopsis agapanthi* Crous & M.J. Wingf., sp. nov.**

Etymology. Name refers to *Agapanthus*, the host plant from which this fungus was collected.

Classification — *Phaeosphaeriaceae*, *Pleosporales*, *Dothi-deomycetes*.

Conidiomata erumpent, globose, black, to 250 µm diam with central ostiole; wall of 2–3 layers of black *textura angularis*. *Conidiophores* reduced to conidiogenous cells lining the inner cavity, ampulliform to doliiform, hyaline, phialidic, with periclinal thickening, or percurrent proliferation, 5–7 × 5–6 µm. *Conidia* solitary, aseptate, golden-brown, verruculose, subcylindrical, apex obtuse, base bluntly rounded to truncate, (6–)7–8(–9) × 3(–3.5) µm.

Culture characteristics — Colonies reaching up to 40 mm diam after 2 wk at 25 °C, with spreading, flat surface; margins smooth, lobate (feathery on PDA), and sparse to moderate aerial mycelium. On MEA surface pale luteous, reverse luteous. On OA and PDA surface and reverse pale luteous.

Typus. FRANCE, La Réunion, S21°3'39.5" E55°32'10.6", on leaves of *Agapanthus precox* (*Amaryllidaceae*), 8 Mar. 2015, P.W. Crous & M.J. Wingfield (holotype CBS H-22596, culture ex-type CPC 26303 = CBS 141287; ITS sequence GenBank KX228260.1, LSU sequence GenBank KX228311.1, MycoBank MB817012); *ibid.*, CPC 26301 = CBS 141316 (ITS sequence GenBank KX228259.1, LSU sequence GenBank KX228310.1).

Notes — The genus *Phaeosphaeriopsis* (based on *P. glaucopunctata*) is characterised by immersed, globose to subglobose to pyriform ascomata, cylindrical asci and septate, verrucose ascospores with coniothyrium-like or *Phaeostagonospora* asexual morphs (Câmara et al. 2003). The genus was recently revised by Thambugala et al. (2014), who accepted seven species. The aseptate conidia of *P. agapanthi* suggest that it should be compared to *P. obtusispora*, but, based on ITS, phylogenetically it is closest 98 % (558/568) to *P. triseptata* (MFLUCC 13-0347; GenBank KJ522476.1), and only 93 % (525/563) to *P. obtusispora* (GenBank AF250822.1). Of the two isolates studied, CPC 26301 is identical on its DNA sequence (ITS) to CPC 26303.

Colour illustrations. Symptomatic leaves of *Agapanthus precox*; conidiomata sporulating on PNA and OA, conidiogenous cells and conidia. Scale bars = 10 µm.

Pedro W. Crous, CBS-KNAW Fungal Biodiversity Centre, P.O. Box 85167, 3508 AD Utrecht, The Netherlands; e-mail: p.crous@cbs.knaw.nl
Michael J. Wingfield, Forestry and Agricultural Biotechnology Institute (FABI), University of Pretoria, Pretoria 0002, South Africa; e-mail: mike.wingfield@up.ac.za
Johannes J. Le Roux & David M. Richardson, Centre for Invasion Biology, Department of Botany & Zoology, Stellenbosch University, Matieland 7602, South Africa; e-mail: jleroux@sun.ac.za & rich@sun.ac.za
Dominique Strasberg, Université de La Réunion, UMR PVBMT, Peuplements Végétaux et Bioagresseurs en Milieu Tropical, 15 avenue René Cassin, CS 93002, 97 744 Saint-Denis Messag. Cedex 9, La Réunion, France; e-mail: dominique.strasberg@univ-reunion.fr

Roussoella solani

Fungal Planet 409 – 4 July 2016

Roussoella solani Crous & M.J. Wingf., *sp. nov.*

Etymology. Name refers to *Solanum*, the plant genus from which this fungus was collected.

Classification — *Roussoellaceae*, *Pleosporales*, *Dothideo-myces*.

Conidiomata immersed to erumpent, solitary, globose, brown, to 150 µm diam with central ostiole, exuding a grey-brown conidial mass; wall of 3–4 layers of brown *textura angularis*. *Conidiophores* reduced to conidiogenous cells lining the inner cavity, hyaline, smooth, ampulliform to doliiform, 4–6 × 3–4 µm, phialides with visible periclinal thickening. *Conidia* solitary, aseptate, smooth, pale brown, subcylindrical, apex obtuse, base bluntly rounded to truncate, (4–)4.5–5(–7) × 2(–3) µm.

Culture characteristics — Colonies reaching up to 40 mm diam after 2 wk at 25 °C, with spreading, erumpent surface; margins smooth to feathery, lobate, and moderate aerial mycelium. On MEA surface pale luteous with patches of scarlet, reverse luteous with patches of umber. On OA surface sienna with patches of umber and scarlet. On PDA surface pale vinaceous with diffuse scarlet pigment in agar, reverse isabelline in centre, scarlet at margin.

Typus. FRANCE, La Réunion, on stems of *Solanum mauritianum* (*Solana-ceae*), 13 Mar. 2015, P.W. Crous & M.J. Wingfield (holotype CBS H-22597, culture ex-type CPC 26331 = CBS 141288; ITS sequence GenBank KX-228261.1, LSU sequence GenBank KX228312.1, MycoBank MB817016).

Notes — Based on the LSU sequence, *Roussoella solani* is accommodated in the *Roussoellaceae* (e.g. 98 % (787/803) similarity to *R. thailandica* GenBank KJ474846.1), but on ITS data it is phylogenetically distinct from other known taxa within the genus, showing less than 90 % similarity. Unfortunately, *R. solani* is known only from its asexual morph and hence a full morphological comparison with other species known in the genus is presently not possible. Recent studies have shown that several species of *Roussoella* occur on woody plants (Crous et al. 2014b, 2015b), and are not only restricted to mono-cotyledons.

Colour illustrations. Valley in La Réunion; conidiomata sporulating on PNA, conidiogenous cells and conidia. Scale bars = 10 µm.

Pedro W. Crous, CBS-KNAW Fungal Biodiversity Centre, P.O. Box 85167, 3508 AD Utrecht, The Netherlands; e-mail: p.crous@cbs.knaw.nl
Michael J. Wingfield, Forestry and Agricultural Biotechnology Institute (FABI), University of Pretoria, Pretoria 0002, South Africa; e-mail: mike.wingfield@up.ac.za
Johannes J. Le Roux & David M. Richardson, Centre for Invasion Biology, Department of Botany & Zoology, Stellenbosch University, Matieland 7602, South Africa; e-mail: jleroux@sun.ac.za & rich@sun.ac.za
Dominique Strasberg, Université de La Réunion, UMR PVBMT, Peuplements Végétaux et Bioagresseurs en Milieu Tropical, 15 avenue René Cassin, CS 93002, 97 744 Saint-Denis Messag. Cedex 9, La Réunion, France; e-mail: dominique.strasberg@univ-reunion.fr

Ramularia citricola



Fungal Planet 410 – 4 July 2016

Ramularia citricola Crous & Guarnaccia, *sp. nov.*

Etymology. Name refers to *Citrus*, the plant genus from which this fungus was collected.

Classification — *Mycosphaerellaceae*, *Capnodiales*, *Dothideomycetes*.

Mycelium consisting of septate, branched, hyaline, smooth, 2–2.5 µm diam hyphae. *Conidiophores* solitary, arising from hyphae as lateral branches, or terminal in loose fascicles, straight to geniculate-sinuous, erect, hyaline, smooth, subcylindrical, reduced to conidiogenous loci on hyphae, or 0–1-septate, erect, 2–20 × 2–2.5 µm. *Conidiogenous cells* hyaline, smooth, subcylindrical, 2–16 × 2–2.5 µm; loci terminal, thickened, darkened and refractive, 1 µm diam. *Primary ramoconidia* hyaline, smooth to finely roughened, subcylindrical, 0–1-septate, 22–33 × 2.5–3 µm. *Secondary ramoconidia* subcylindrical, 0–1-septate, finely roughened, guttulate, 8–22 × 2–2.5 µm. *Intermediary conidia* subcylindrical-fusiform, 0(–1)-septate, 7–9 × 2 µm. *Conidia* in branched chains, ellipsoid-fusoid, smooth to finely roughened, (3–)6–8(–9) × 2 µm; loci thickened, darkened and refractive, 0.5 µm diam.

Culture characteristics — Colonies reaching up to 15 mm diam after 2 wk at 25 °C, with spreading, erumpent, folded surface; margins smooth, lobate, and sparse aerial mycelium. On MEA surface luteous, reverse ochreous. On OA surface mouse-grey. On PDA surface pale mouse-grey to mouse-grey, reverse mouse-grey.

Typus. ITALY, Sicily, Messina, on twigs of *Citrus floridana* (*Rutaceae*), Mar. 2015, V. Guarnaccia (holotype CBS H-22598, culture ex-type CPC 26192 = CBS 141449; ITS sequence GenBank KX228262.1, LSU sequence GenBank KX228313.1, *actA* sequence GenBank KX228358.1, *rpb2* sequence GenBank KX228369.1, *tef1* sequence GenBank KX228373.1, MycoBank MB817020).

Notes — On ITS *Ramularia citricola* is 99 % (524/531) similar to *R. grevilleana* (CPC 4903; GenBank GU214691.1) and 98 % (523/531) *R. grevilleana* (isolate s208; GenBank GU939181.1). None of the sequences from the protein coding genes resulted in similarities higher than 92 %. *Ramularia grevilleana* can be distinguished from *R. citricola* by having larger conidia that are ellipsoid-ovoid, subcylindrical-fusoid, (8–)15–45(–55) × (1.5–)2.5–4.5(–5) µm, 0–2(–3)-septate (Braun 1998). Two species of *Ramularia* have been described from *Citrus*, namely *R. citri* and *R. citrifolia*. *Ramularia citri* (on *Citrus aurantium*, Italy) was described from fallen, dry leaves (asymptomatic), with catenate conidia, oblong, 8–14 × 3.5–4 µm, 0–2-septate. Type material of the latter species could not be traced, and its generic affinity remains unclear (Braun 1998). *Ramularia citrifolia* (hyperparasitic on *Meliola butleri* on *Citrus tankan*, Taiwan) was allocated to *Eriomycopsis* by Braun (1993).

Colour illustrations. Glasshouse with *Citrus floridana* trees; conidiophores sporulating on PNA, conidiophores and conidia. Scale bars = 10 µm.

Pedro W. Crous, Johannes Z. Groenewald & Vadimiro Guarnaccia, CBS-KNAW Fungal Biodiversity Centre, P.O. Box 85167, 3508 AD Utrecht, The Netherlands;
e-mail: p.crous@cbs.knaw.nl, e.groenewald@cbs.knaw.nl & v.guarnaccia@cbs.knaw.nl

Vermiculariopsisella acaciae

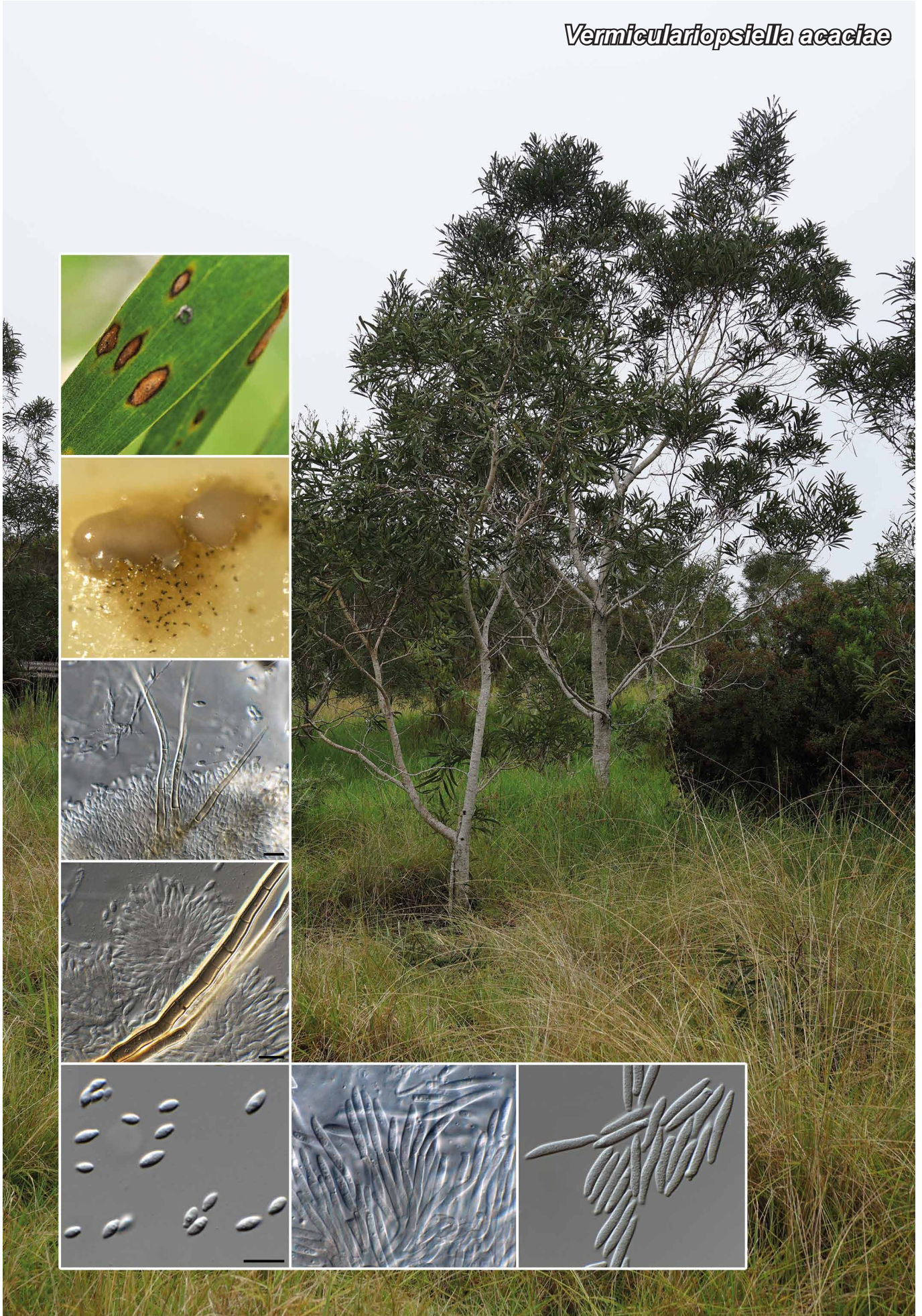

Fungal Planet 411 – 4 July 2016

***Vermiculariopsiella acaciae* Crous, M.J. Wingf., sp. nov.**

Etymology. Name refers to *Acacia*, the plant genus from which this fungus was collected.

Classification — *Chaetosphaeriaceae*, *Chaetosphaeriales*, *Sordariomycetes*.

Sporodochia on SNA and OA erumpent, crystalline, to 450 µm diam, with brown, erect setae distributed throughout conidoma, thick-walled, roughened, flexuous, 180–250 × 4–5 µm, 5–7-septate, tapering to an obtuse apex. *Conidiophores* aggregated in stroma, subcylindrical, 1–2-septate, branched or not, 25–40 × 3–4 µm. *Conidiogenous cells* terminal, subcylindrical, pale brown to hyaline, smooth to verruculose, at times curved at the apex, 15–27 × 2.5–3 µm, apex 1.5 µm diam, collarete flaring, 1–2 µm long. *Conidia* dimorphic. On OA solitary, hyaline, guttulate, aseptate, straight to slightly curved, inequilateral with inner plane straight, outer plane convex, apex subobtusely rounded, base truncate with excentric hilum, 0.5–1 µm diam, (14–)18–22(–25) × 3(–3.5) µm. On SNA forming ellipsoid, straight, hyaline, smooth, guttulate conidia, apex subobtusely rounded, base truncate, 4–7 × 2–2.5 µm.

Culture characteristics — Colonies reaching up to 40 mm diam after 2 wk at 25 °C, with spreading, flat surface; margins smooth, lobate, and sparse aerial mycelium. On MEA surface pale luteous, reverse luteous. On OA surface dirty white to pale luteous. On PDA surface and reverse dirty white.

Typus. FRANCE, La Réunion, S21°5'45.7" E55°33'3.6", on leaves of *Acacia heterophylla* (*Fabaceae*), 7 Mar. 2015, P.W. Crous & M.J. Wingfield (holotype CBS H-22599, culture ex-type CPC 26291 = CBS 141289; ITS sequence GenBank KX228263.1, LSU sequence GenBank KX228314.1, MycoBank MB817023).

Notes — Based on ITS DNA sequence data *Vermiculariopsiella acaciae* is 97 % (539/557) similar to *V. dichapetali* (CPC 22463; GenBank KJ869129.1; from leaves of *Dichapetalum rhodesicum*, Botswana) and 89 % (489/548) similar to *V. eucalypti* described elsewhere in the present study. Morphologically, the latter two species can be distinguished from *V. dichapetali* in having much larger conidiogenous cells (20–40 × 2.5–3 µm), setae (100–300 × 6–10 µm, 6–12-septate), and lacking dimorphic conidia (Crous et al. 2014a). The closest hits using a megablast search of the LSU DNA sequence data are 99 % (816/819) similar to *Vermiculariopsiella dichapetali* (GenBank KJ869186.1; *incertae sedis*, *Microascales*), 96 % (820/857) to *Dictyochoeta cylindrospora* (GenBank EF063575.1; *Chaetosphaeriaceae*, *Chaetosphaeriales*), 94 % (793/841) to *Dactylaria parvispora* (GenBank EU107296.1; *Orbiliaceae*, *Orbiliales*) and 94 % (808/858) to *Cryptadelphia groenendalensis* (GenBank EU528007.1; *incertae sedis*).

Colour illustrations. Leaf spots on *Acacia heterophylla*; sporodochia sporulating on OA, conidiophores, setae and dimorphic conidia. Scale bars = 10 µm.

Pedro W. Crous, CBS-KNAW Fungal Biodiversity Centre, P.O. Box 85167, 3508 AD Utrecht, The Netherlands; e-mail: p.crous@cbs.knaw.nl
 Michael J. Wingfield, Forestry and Agricultural Biotechnology Institute (FABI), University of Pretoria, Pretoria 0002, South Africa; e-mail: mike.wingfield@up.ac.za
 Johannes J. Le Roux & David M. Richardson, Centre for Invasion Biology, Department of Botany & Zoology, Stellenbosch University, Matieland 7602, South Africa; e-mail: jleroux@sun.ac.za & rich@sun.ac.za
 Dominique Strasberg, Université de La Réunion, UMR PVBMT, Peuplements Végétaux et Bioagresseurs en Milieu Tropical, 15 avenue René Cassin, CS 93002, 97 744 Saint-Denis Messag. Cedex 9, La Réunion, France; e-mail: dominique.strasberg@univ-reunion.fr

Meristemomyces arctostaphylos

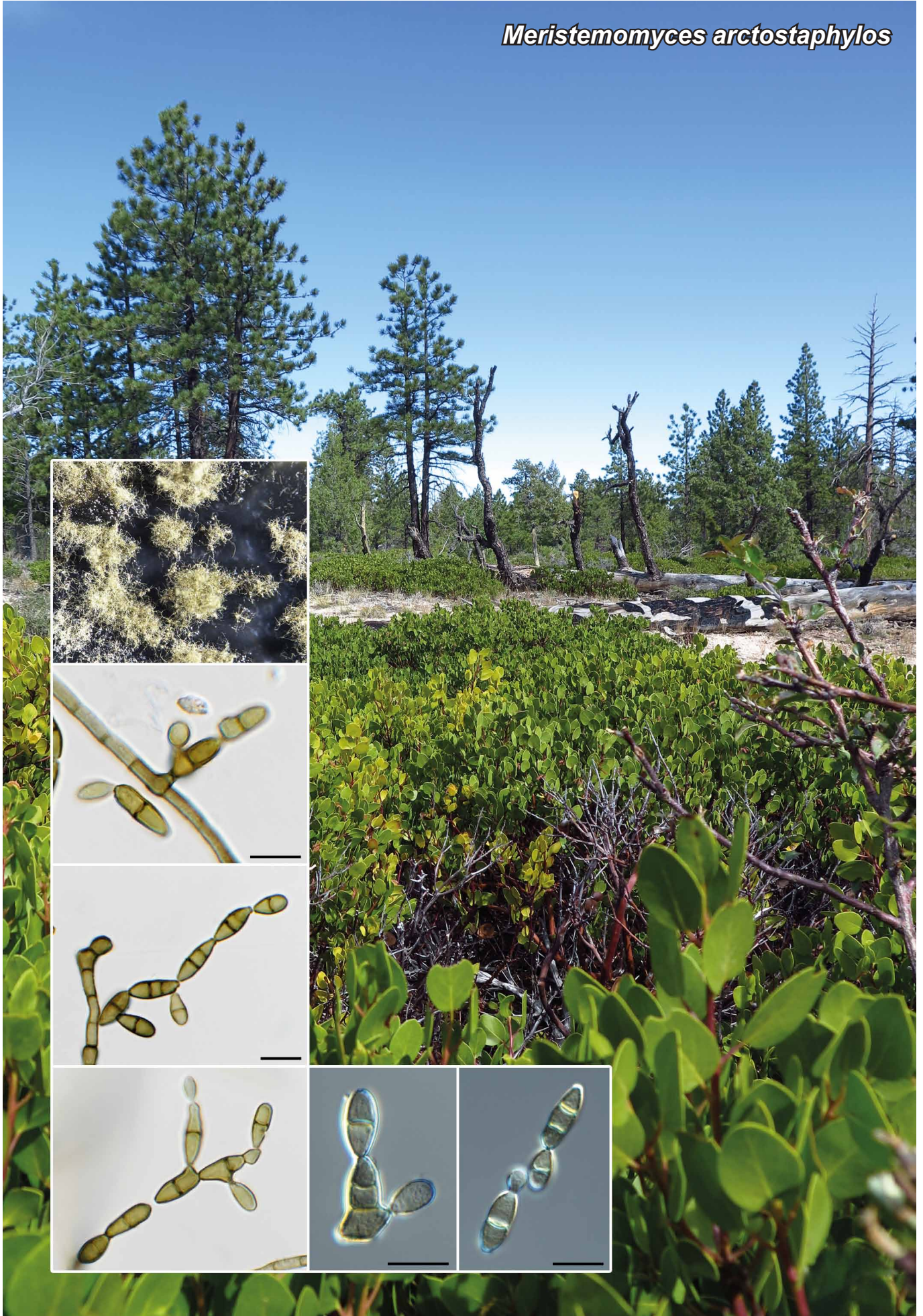

Fungal Planet 412 – 4 July 2016

Meristemomyces arctostaphylos Crous & M.J. Wingf., *sp. nov.*

Etymology. Name refers to *Arctostaphylos*, the plant genus from which this fungus was collected.

Classification — *Teratosphaeriaceae*, *Capnodiales*, *Dothideomycetes*.

Mycelium consisting of brown, thick-walled, verruculose, branched, septate, 2.5–4 µm hyphae, frequently encased in a mucoid sheath. *Conidiophores* solitary, brown, verruculose, terminal or lateral on hyphae, multiseptate, flexuous, subcylindrical, up to 150 µm long, 3–5 µm diam, or reduced to conidiogenous loci on hyphae. *Conidiogenous cells* brown, verruculose, thick-walled, subcylindrical to irregular, 3–10 × 3–6 µm, with 1–3 terminal flat-tipped loci, 1.5–2 µm diam. *Conidia* in branched chains, brown, thick-walled, verruculose. *Secondary ramoconidia* fusoid-ellipsoid to subcylindrical, 1–3-septate, 15–20 × 5–9 µm, with 1–3 flat-tipped unthickened, not darkened loci, 1.5–2 µm diam. *Conidia* brown, verruculose, thick-walled, 1(–3)-septate, fusoid-ellipsoid, (9–)10–12(–13) × (4–)5(–6) µm; loci not thickened nor darkened, 1.5–2 µm diam, frequently with minute marginal frill.

Culture characteristics — Colonies reaching up to 15 mm diam after 2 wk at 25 °C, with spreading, erumpent, folded surface; margins smooth, lobate, and sparse aerial mycelium. On MEA surface iron-grey, reverse olivaceous grey. On OA, PDA and MEA surface dark mouse-grey to greenish black, reverse greenish black.

Typus. USA, Utah, near Long Valley, on leaves of *Arctostaphylos patula* (*Ericaceae*), Oct. 2014, *M.J. Wingfield* (holotype CBS H-22600, culture ex-type CPC 25574 = CBS 141290; ITS sequence GenBank KX228264.1, LSU sequence GenBank KX228315.1, MycoBank MB817026).

Notes — The genus *Meristemomyces* is monotypic, based on *M. frigidus*, isolated from rocks in the Himalayas (Egidi et al. 2014). Based on ITS sequence data, *M. arctostaphylos* is 91 % (404/443) similar to the type culture of *M. frigidus* (CBS 136109 = CCFEE 5508; GenBank KF309961.1) and 99 % (458/460) to *Xenomeris raetica* (CBS 485.61; GenBank EF114690.1). Morphologically, *M. arctostaphylos* is quite distinct from *M. frigidus*, as the latter species produces arthroconidia by disarticulation, while *M. arctostaphylos* has well-defined conidiophores giving rise to a series of secondary ramoconidia, and septate conidia.

Xenomeris raetica was described on leaf litter of *Arctostaphylos uva-ursi* in Switzerland. The fungus is known only by its sexual morph. The present collection was obtained on the same host genus, but from the USA. Although only the asexual morph was found, based on DNA data, it appears to be 99 % similar to a strain identified as *Xenomeris raetica* (CBS 485.61), suggesting that this could be the same fungus. However, CBS 485.61 is not an ex-type strain, and *M. arctostaphylos* is a common hyphomycete on leaves of *Arctostaphylos*. Furthermore, the genus *Xenomeris* is regarded as a member of *Venturiaceae*, not *Teratosphaeriaceae*, thus the possible synonymy of *Meristemomyces* under the older *Xenomeris* can only be resolved once fresh collections of *Xenomeris raetica* have been obtained.

Colour illustrations. *Arctostaphylos patula* plants in the USA; colonies sporulating on PDA, conidiophores and chains of conidia. Scale bars = 10 µm.

Pyrenochaeta acaciae



Fungal Planet 413 – 4 July 2016

Pyrenochaeta acaciae Crous, Jacq. Edwards & Pascoe, *sp. nov.*

Etymology. Name refers to *Acacia*, the plant genus from which this fungus was collected.

Classification — *Cucurbitariaceae*, *Pleosporales*, *Dothideomycetes*.

Conidiomata immersed to erumpent, solitary, globose, brown, to 150 µm diam, with central ostiole to 35 µm diam, exuding a caramel coloured conidial mass; wall of 2–3 layers of brown *textura angularis*; ostiolar area with several cylindrical, brown, thick-walled, septate setae, with obtuse ends to 70 µm long. *Conidiophores* 0–3-septate, but mostly reduced to conidiogenous cells lining the inner cavity, hyaline, smooth, ampulliform to subcylindrical, 4–8 × 2.5–3.5 µm, phialidic with periclinal thickening. *Conidia* solitary, hyaline (pale olivaceous in mass), smooth, aseptate, allantoid with obtuse ends, (3–)4–4.5(–5) × (1.5–)2 µm.

Culture characteristics — Colonies reaching up to 40 mm diam after 2 wk at 25 °C, with spreading, flat surface; margins smooth, lobate, and sparse aerial mycelium. On MEA surface folded, sepia with patches of isabelline and buff, reverse isabelline. On OA surface isabelline. On PDA surface and reverse isabelline.

Typus. AUSTRALIA, Victoria, roadside bushland opposite 125 Gurdies-St. Helier road, The Gurdies, S38°22'49" E145°34'14", on leaves of *Acacia* sp. (*Fabaceae*), 7 Nov. 2014, P.W. Crous, J. Edwards & I.G. Pascoe (holotype CBS H-22601, culture ex-type CPC 25527 = CBS 141291; ITS sequence GenBank KX228265.1, LSU sequence GenBank KX228316.1, MycoBank MB817028).

Notes — Based on ITS *Pyrenochaeta acaciae* is 98 % (409/416) similar to *P. protearum* (CBS 131315; GenBank JQ044434.1) and 98 % (425/433) to *P. pinicola* (CPC 23455; GenBank KJ869152.1). *Pyrenochaeta protearum* can be distinguished from *P. acaciae* by having setae surrounding its conidiomatal ostiole that are longer (up to 100 µm tall), and conidia that are wider ((3–)4–5(–6) × (2–)2.5(–3) µm) (Crous et al. 2011). *Pyrenochaeta pinicola* is distinct by having larger conidia, (4–)4.5–5.5(–6) × 2(–2.5) µm, and longer setae (up to 150 µm tall) (Crous et al. 2014a).

Colour illustrations. Symptomatic leaves of *Acacia* sp.; conidiomata sporulating on PDA, conidiogenous cells and conidia. Scale bars: conidioma = 100 µm, others = 10 µm.

Pedro W. Crous & Johannes Z. Groenewald, CBS-KNAW Fungal Biodiversity Centre, P.O. Box 85167, 3508 AD Utrecht, The Netherlands; e-mail: p.crous@cbs.knaw.nl & e.groenewald@cbs.knaw.nl

Ian G. Pascoe & Jacqueline Edwards, AgriBio, Centre for AgriBiosciences, Department of Economic Development, Jobs, Transport and Resources, 5 Ring Road, La Trobe University, Bundoora, Victoria 3083 Australia; e-mail: pascoeig@bigpond.net.au & jacky.edwards@ecodev.vic.gov.au

Castanediella eucalypticola
& *Phaeophleospora eucalypticola*



Fungal Planet 414 & 415 – 4 July 2016

***Castanediella eucalypticola* Crous & M.J. Wingf., sp. nov.**

Etymology. Name refers to *Eucalyptus*, the plant genus from which this fungus was collected.

Classification — *Incertae sedis*, *Xylariales*, *Sordariomycetes*.

Mycelium consisting of pale brown, branched, septate hyphae, 2–5 µm diam, frequently in hyphal strands, and forming hyphal coils. *Conidiophores* erect, solitary, unbranched, 0–2-septate, subcylindrical, medium brown, smooth, 5–30 × 3–5 µm. *Conidiogenous cells* terminal and intercalary, subcylindrical to ampulliform or lanceolate, pale brown, smooth, polyblastic, terminating in a swollen apex, 1.5–3 µm diam, with several scars, 5–20 × 3–3.5 µm. *Conidia* solitary, hyaline, smooth, falcate, straight to curved, widest in the middle, apex subobtusely rounded, base truncate, 0.5 µm diam, (15–)20–26(–30) × (2.5–)3 µm.

Culture characteristics — Colonies reaching up to 30 mm diam after 2 wk at 25 °C, with spreading, erumpent surface; margins smooth, lobate, and sparse aerial mycelium. On MEA surface sepia, reverse isabelline. On OA surface cinnamon. On PDA surface honey, reverse isabelline.

Typus. FRANCE, La Réunion, on leaves of *Eucalyptus robusta* (*Myrtaceae*), 9 Mar. 2015, P.W. Crous & M.J. Wingfield (holotype CBS H-22604, culture ex-type CPC 26539 = CBS 141317; ITS sequence GenBank KX228266.1, LSU sequence GenBank KX228317.1, *tub2* sequence GenBank KX228382.1, MycoBank MB817029).

Notes — On ITS *Castanediella eucalypticola* is 98 % (547/556) similar to *C. eucalypti* (CPC 24746; GenBank KR476723.1), and 95 % (523/552) to *C. couratarii* (CBS 579.71; GenBank KP859050.1) (Crous et al. 2015a). *Castanediella eucalypticola* can be distinguished from *C. eucalypti*, by the fact that the latter has smaller conidia, (15–)18–21(–23) × 2–3 µm, and branched conidiophores (Crous et al. 2015a).

***Phaeophleospora eucalypticola* Crous & M.J. Wingf., sp. nov.**

Etymology. Name refers to *Eucalyptus*, the plant genus from which this fungus was collected.

Classification — *Mycosphaerellaceae*, *Capnodiales*, *Dothideomycetes*.

Conidiomata (on pine needle agar; PNA) pycnidial, erumpent, solitary, brown, globose, to 300 µm diam, with central ostiole, to 20 µm diam; wall of 2–3 layers of brown *textura angularis*. *Conidiophores* lining the inner cavity, hyaline, smooth, reduced to conidiogenous cells, or with a supporting cell, branched at base or not, ampulliform to subcylindrical, 5–10 × 2.5–3.5 µm, proliferating inconspicuously percurrently at apex, 1 µm diam. *Conidia* hyaline, smooth, solitary, aseptate, guttulate, ellipsoid to obovoid, base truncate, 0.5 µm diam, (3.5–)4.5–6(–7) × (1.5–)2(–2.5) µm.

Culture characteristics — Colonies reaching up to 15 mm diam after 2 wk at 25 °C, with spreading, erumpent surface; margins smooth, lobate, and moderate aerial mycelium. On MEA, PDA and OA, surface and reverse mouse-grey.

Typus. FRANCE, La Réunion, Le Tampon, on leaves of *Eucalyptus robusta* (*Myrtaceae*), 9 Mar. 2015, P.W. Crous & M.J. Wingfield (holotype CBS H-22605, culture ex-type CPC 26523 = CBS 141294; ITS sequence GenBank KX228267.1, LSU sequence GenBank KX228318.1, *tef1* sequence GenBank KX228374.1, MycoBank MB817030).

Notes — *Phaeophleospora* (based on *P. eugeniae*; Crous et al. 1997) is a genus in the *Mycosphaerellaceae*, which is distinct from *Teratosphaeria* and its various asexual morphs (Quaedvlieg et al. 2014). Based on LSU DNA sequence data *Phaeophleospora eucalypticola* is identical (100 %) (818/818) to *P. hymenocallidicola* (CPC 25014; GenBank KR476772.1) and 99 % (846/849) similar to *P. eugeniae* (CPC 15159; GenBank FJ493207.1) (Crous et al. 2015a). Based on ITS sequence data it is 94 % (453/482) similar to *P. pteridivora* (COAD 1182; GenBank KT037547.1), though the latter species has conidia that are subcylindrical, curved to sinuous, 70–107 × 2–3 µm, 6–9-septate (Guatimosim et al. 2016). The ITS sequence of *P. eucalypticola* is similar to numerous sequences in GenBank labelled as '*Mycosphaerella* sp. AA-2012' which emerged from an unpublished study on endophytic fungi from leaves of an *Eucalyptus grandis* × *E. camaldulensis* clone in South Africa.

Colour illustrations. *Eucalyptus* trees growing on La Réunion; *Phaeophleospora eucalypticola* (left column): colonies sporulating on OA, conidiogenous cells and conidia; *Castanediella eucalypticola* (right column): colony sporulating on OA, conidiophores and conidia. Scale bars = 10 µm.

Pedro W. Crous, CBS-KNAW Fungal Biodiversity Centre, P.O. Box 85167, 3508 AD Utrecht, The Netherlands; e-mail: p.crous@cbs.knaw.nl
 Michael J. Wingfield, Forestry and Agricultural Biotechnology Institute (FABI), University of Pretoria, Pretoria 0002, South Africa; e-mail: mike.wingfield@up.ac.za
 Johannes J. Le Roux & David M. Richardson, Centre for Invasion Biology, Department of Botany & Zoology, Stellenbosch University, Matieland 7602, South Africa; e-mail: jleroux@sun.ac.za & rich@sun.ac.za
 Dominique Strasberg, Université de La Réunion, UMR PVBMT, Peuplements Végétaux et Bioagresseurs en Milieu Tropical, 15 avenue René Cassin, CS 93002, 97 744 Saint-Denis Messag. Cedex 9, La Réunion, France; e-mail: dominique.strasberg@univ-reunion.fr

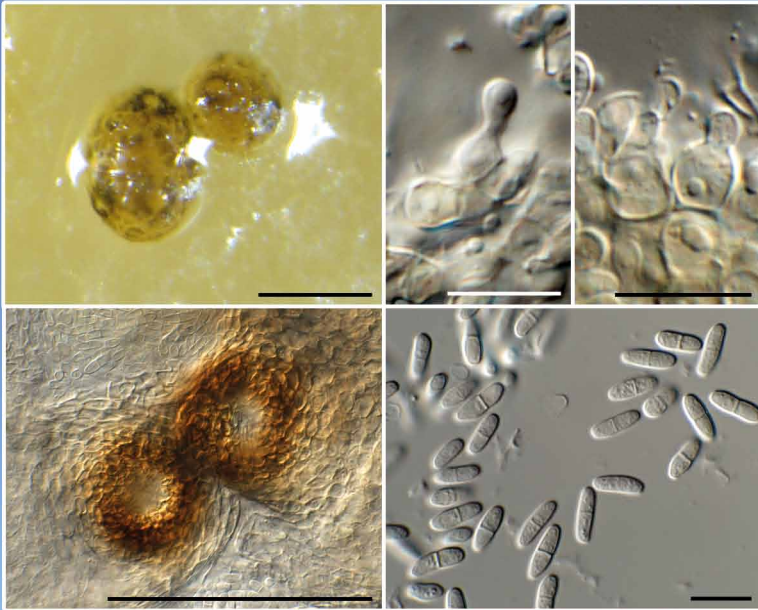
Sclerostagonospora ericae

Fungal Planet 416 – 4 July 2016

Sclerostagonospora ericae Crous & M.J. Wingf., *sp. nov.*

Etymology. Name refers to *Erica*, the plant genus from which this fungus was collected.

Classification — *Phaeosphaeriaceae*, *Pleosporales*, *Dothi-deomycetes*.

Conidiomata (on pine needle agar; PNA) pycnidial, solitary or in small clusters, immersed or semi-erumpent, to 200 µm diam, globose, pale brown, with 1–3 dark brown, semi-papillate ostioles, to 40 µm diam; wall of 3–4 layers of pale brown *textura angularis*. *Conidiophores* reduced to conidiogenous cells lining the inner cavity, hyaline, smooth, ampulliform to doliiform, 4–5 × 3–5 µm, proliferating inconspicuously percurrently at apex. *Conidia* solitary, pale brown, smooth, subcylindrical, guttulate, 1(–3)-septate, constricted at median septum, (7–)8–10(–11) × (2.5–)3 µm.

Culture characteristics — Colonies reaching up to 60 mm diam after 2 wk at 25 °C, with spreading, flat surface; margins smooth, lobate, and moderate aerial mycelium. On MEA surface dirty white to buff, reverse sepia. On OA surface buff. On PDA surface buff, reverse cinnamon.

Typus. SOUTH AFRICA, Western Cape Province, Franschhoek, on leaves of *Erica* sp. (*Ericaceae*), Nov. 2014, *M.J. Wingfield* (holotype CBS H-22606, culture ex-type CPC 25927 = CBS 141318; ITS sequence GenBank KX228268.1, LSU sequence GenBank KX228319.1, *tef1* sequence GenBank KX228375.1, *tub2* sequence GenBank KX228383.1, MycoBank MB817031).

Notes — Based on LSU sequences, *Sclerostagonospora ericae* is identical (813/813) to *S. opuntiae* (GenBank DQ-286772.1; Huhndorf 1992). However, the genus *Sclerostagonospora* is based on *S. heraclei*, and the latter is presently not known from DNA or culture, hence the concept of *Sclerostagonospora* remains unsettled. On ITS *S. ericae* is 98 % (550/560) similar to *S. opuntiae* (GenBank DQ286768.1) and 94 % (541/574) similar to *Stagonospora foliicola* (GenBank KF251256.1).

Colour illustrations. *Erica* sp. in Franschhoek; conidiomata sporulating on OA, conidiogenous cells, ostiolar region and conidia. Scale bars: conidiomata and ostioles = 200 µm, all others = 10 µm.

Dothiorella acacicola



Fungal Planet 417 – 4 July 2016

Dothiorella acacicola Crous & M.J. Wingf., *sp. nov.*

Etymology. Name refers to *Acacia*, the plant genus from which this fungus was collected.

Classification — *Botryosphaeriaceae*, *Botryosphaeriales*, *Dothideomycetes*.

Conidiomata (on pine needle agar; PNA) pycnidial, solitary, black, erumpent, globose, to 400 µm diam, with central ostiole; wall of 2–3 layers of brown *textura angularis*. *Conidiophores* reduced to conidiogenous cells, or with a supporting cell, lining the inner cavity, hyaline, smooth, subcylindrical to doliiform, straight to geniculous-sinuuous, 7–20 × 5–11 µm; proliferating percurrently at apex. *Conidia* solitary, initially hyaline, becoming pigmented while attached to conidiogenous cells, golden-brown to brown, granular to guttulate, surface roughened (at times with hyaline outer sheath), obovoid, medianly 1-septate, slightly constricted at septum, apex obtuse, base truncate, 3–5 µm diam, (22–)24–27(–32) × (9–)10(–11) µm.

Culture characteristics — Colonies covering dish after 2 wk at 25 °C, with spreading, flat surface; margins smooth, lobate, and moderate aerial mycelium. On MEA, PDA and OA surface and reverse dark mouse-grey.

Typus. FRANCE, La Réunion, S21°12'47.6" E55°36'48.7", on leaves of *Acacia mearnsii* (*Fabaceae*), 8 Mar. 2015, P.W. Crous & M.J. Wingfield (holotype CBS H-22607, culture ex-type CPC 26349 = CBS 141295; ITS sequence GenBank KX228269.1, LSU sequence GenBank KX228320.1, *tef1* sequence GenBank KX228376.1, MycoBank MB817032).

Notes — Based on LSU sequence data *Dothiorella acacicola* is 99 % similar to several *Dothiorella* spp. (e.g. 791/801 with *D. ulmicola* GenBank KR611900.1). Based on ITS sequence data *Dothiorella acacicola* is 97 % (523/538) similar to *D. longicollis* (CBS 122068; GenBank KF766162.1). The two species can be distinguished from each other by the fact that conidia of *D. longicollis* are smaller, (17–)19–22(–23) × (7–)8.5–9.5(–10) µm (Phillips et al. 2013).

Colour illustrations. *Acacia mearnsii* trees growing in La Réunion; conidiomata sporulating on PNA, conidiogenous cells and conidia. Scale bars = 10 µm.

Pedro W. Crous, CBS-KNAW Fungal Biodiversity Centre, P.O. Box 85167, 3508 AD Utrecht, The Netherlands; e-mail: p.crous@cbs.knaw.nl
 Michael J. Wingfield, Forestry and Agricultural Biotechnology Institute (FABI), University of Pretoria, Pretoria 0002, South Africa; e-mail: mike.wingfield@up.ac.za
 Johannes J. Le Roux & David M. Richardson, Centre for Invasion Biology, Department of Botany & Zoology, Stellenbosch University, Matieland 7602, South Africa; e-mail: jleroux@sun.ac.za & rich@sun.ac.za
 Dominique Strasberg, Université de La Réunion, UMR PVBMT, Peuplements Végétaux et Bioagresseurs en Milieu Tropical, 15 avenue René Cassin, CS 93002, 97 744 Saint-Denis Messag. Cedex 9, La Réunion, France; e-mail: dominique.strasberg@univ-reunion.fr

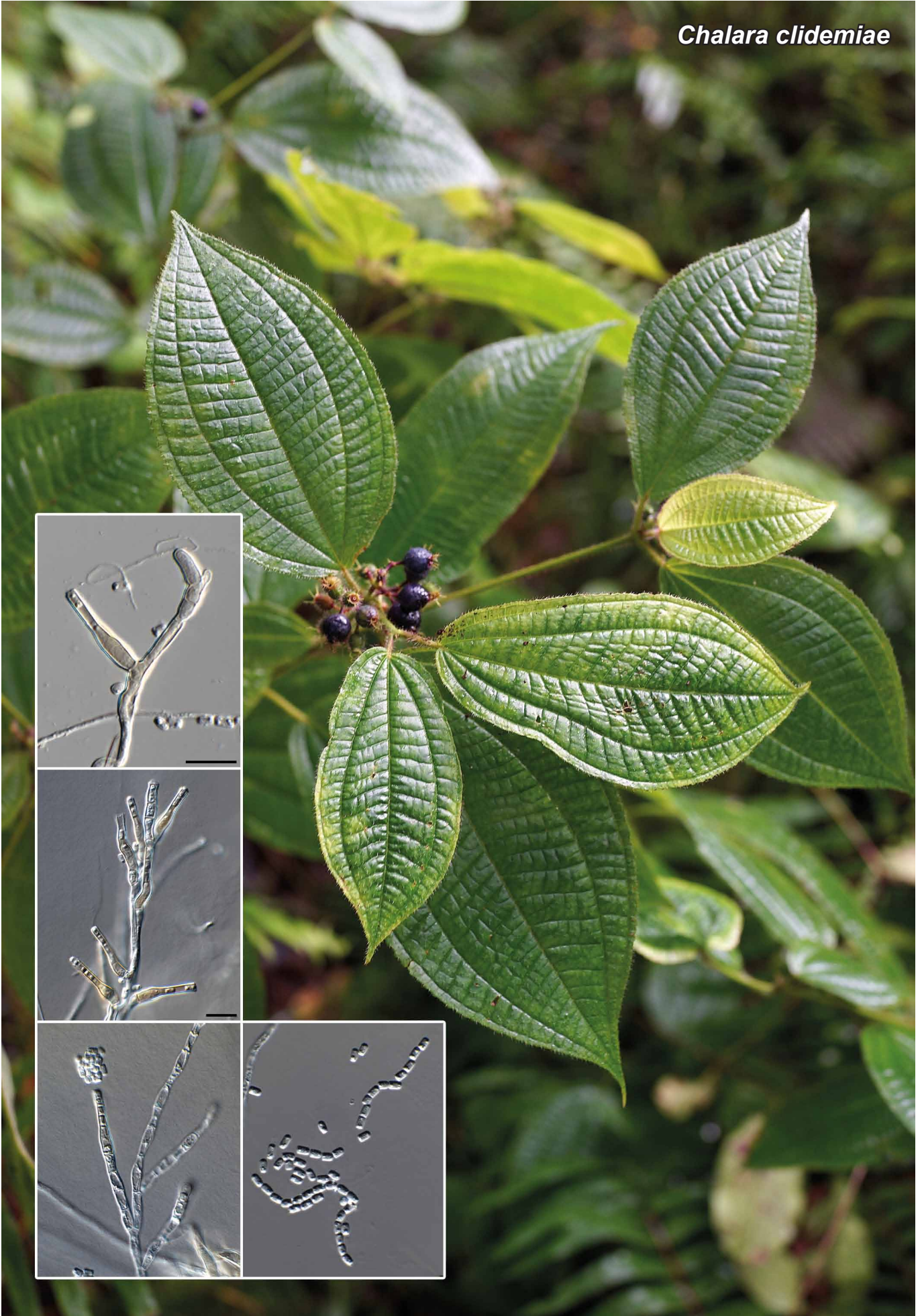
Chalara clidemiae

Fungal Planet 418 – 4 July 2016

Chalara clidemiae Crous & M.J. Wingf., *sp. nov.*

Etymology. Name refers to *Clidemia*, the plant genus from which this fungus was collected.

Classification — *Incertae sedis*, *Helotiales*, *Leotiomyces*.

Mycelium consisting of hyaline, smooth, branched, septate, 1.5–2.5 µm diam hyphae. *Conidiophores* arranged in terminal clusters on hyphae, 25–30 × 3–4 µm, 1–5-septate, subcylindrical, smooth, hyaline in bottom half, but upper two cells medium brown. *Conidiogenous cells* terminal, swollen in bottom third, venter cylindrical, brown, smooth, phialidic, 15–25 × 3.5–4 µm. *Conidia* hyaline, smooth, guttulate, subcylindrical, apex obtuse, base truncate, (3–)4(–5) × (2–)2.5 µm, forming long, curvy chains or slimy masses on older phialides.

Culture characteristics — Colonies reaching up to 30 mm diam after 2 wk at 25 °C, with spreading, flat surface; margins smooth, lobate, and sparse to moderate aerial mycelium. On MEA surface dirty white, reverse buff. On OA surface ochreous. On PDA surface luteous, reverse ochreous.

Typus. FRANCE, La Réunion, on twigs of *Clidemia hirta* (*Melastomataceae*), 6 Mar. 2015, P.W. Crous & M.J. Wingfield (holotype CBS H-22608, culture ex-type CPC 26423 = CBS 141319; ITS sequence GenBank KX228270.1, LSU sequence GenBank KX228321.1, MycoBank MB817033).

Notes — The genus *Chalara* is paraphyletic, with species occupying different positions within *Helotiales* (Cai et al. 2009). Based on ITS sequence data *Chalara clidemiae* is 91 % (492/538) similar to *Chalara pseudoaffinis* (CCF 3979; GenBank FR667224.1). On LSU it is 98 % (841/855) similar to *Chalara africana* (OC0018; GenBank FJ176249.1) and 96 % (821/854) to *Chalara parvispora* (CBS 385.94; GenBank FJ176253.1).

Colour illustrations. *Clidemia hirta* on La Réunion; conidiophores sporulating on PNA, phialides and conidia. Scale bars = 10 µm.

Pedro W. Crous, CBS-KNAW Fungal Biodiversity Centre, P.O. Box 85167, 3508 AD Utrecht, The Netherlands; e-mail: p.crous@cbs.knaw.nl
Michael J. Wingfield, Forestry and Agricultural Biotechnology Institute (FABI), University of Pretoria, Pretoria 0002, South Africa; e-mail: mike.wingfield@up.ac.za
Johannes J. Le Roux & David M. Richardson, Centre for Invasion Biology, Department of Botany & Zoology, Stellenbosch University, Matieland 7602, South Africa; e-mail: jleroux@sun.ac.za & rich@sun.ac.za
Dominique Strasberg, Université de La Réunion, UMR PVBMT, Peuplements Végétaux et Bioagresseurs en Milieu Tropical, 15 avenue René Cassin, CS 93002, 97 744 Saint-Denis Messag. Cedex 9, La Réunion, France; e-mail: dominique.strasberg@univ-reunion.fr

Mulderomyces natalis

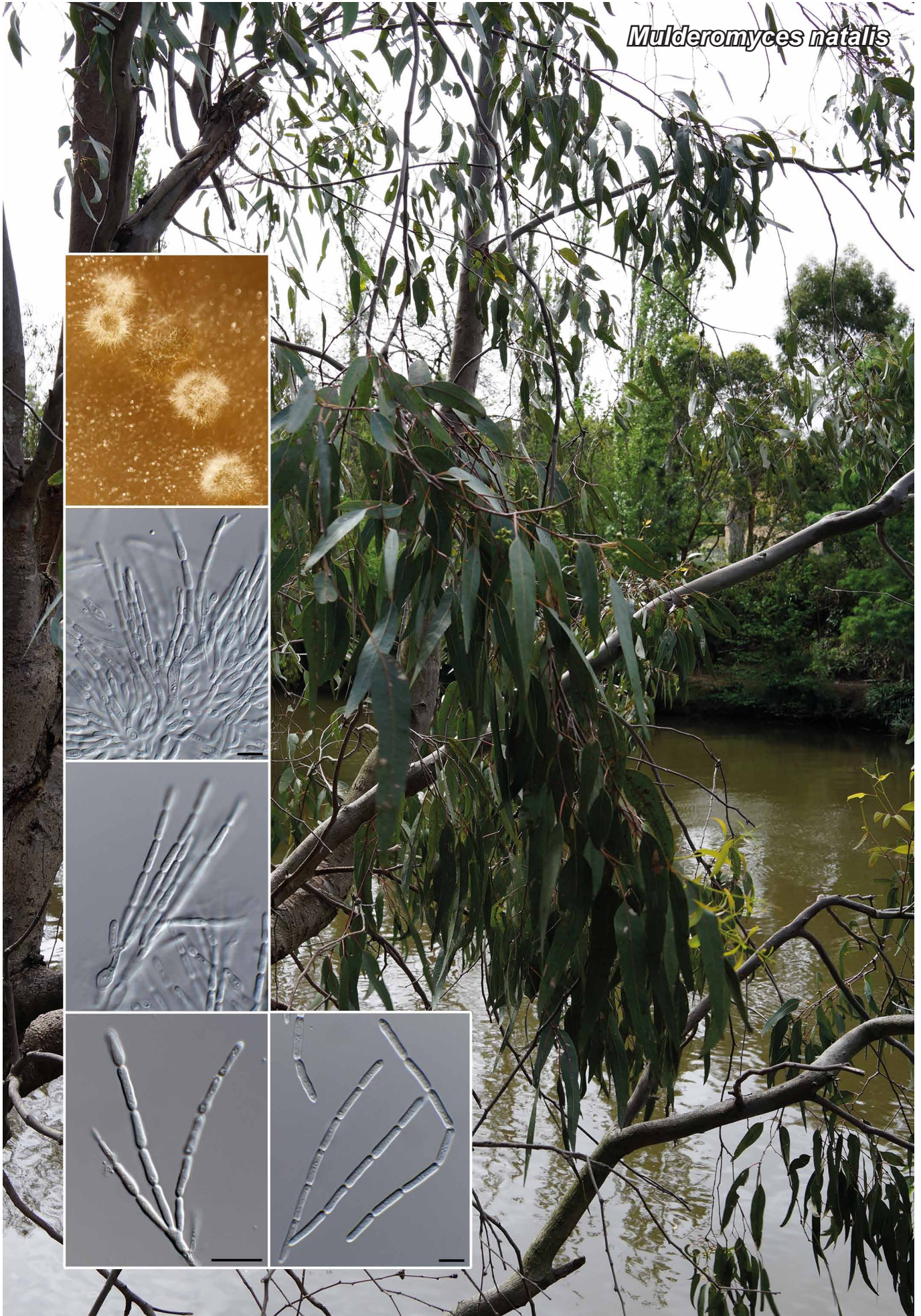

Fungal Planet 419 – 4 July 2016

Mulderomyces Crous, Jacq. Edwards & P.W.J. Taylor, *gen. nov.*

Etymology. Named after Prof. dr. Theo W. Mulder, the scientific director of the institutes of the Royal Dutch Academy of Arts and Sciences (KNAW), on the occasion of his farewell symposium, 20 June 2016.

Classification — *Incertae sedis*, *Ostropales*, *Lecanoromycetes*.

Conidiomata pycnidial, solitary, pale brown, erumpent, globose, with central ostiole; wall of 6–8 layers of subhyaline to pale brown *textura angularis*. *Conidiophores* lining the inner cavity, hyaline, smooth, subcylindrical, septate, branched. *Conidiog-*

enous cells hyaline, smooth, subcylindrical, terminal and lateral; proliferating sympodially, scars inconspicuous. *Conidia* cylindrical, hyaline, smooth, guttulate, straight with subobtuse ends, 2–6-septate, prominently constricted at septa (cells linked by a narrow isthmus), with mature conidia breaking into phragmospores.

Type species. *Mulderomyces natalis* Crous, Jacq. Edwards & P.W.J. Taylor. MycoBank MB817034.

Mulderomyces natalis Crous, Jacq. Edwards & P.W.J. Taylor, *sp. nov.*

Etymology. *Natalis* (Latin genitive noun), refers to the birth date of the first author, on which day this fungus was collected.

Conidiomata (on pine needle agar; PNA) pycnidial, solitary, pale brown, erumpent, globose, to 200 µm diam, with central ostiole; wall of 6–8 layers of subhyaline to pale brown *textura angularis*. *Conidiophores* lining the inner cavity, hyaline, smooth, subcylindrical, 1–4-septate, branched, 10–30 × 3–5 µm. *Conidiog-enous cells* hyaline, smooth, subcylindrical, terminal and lateral, 8–15 × 3–5 µm; proliferating sympodially, scars inconspicuous. *Conidia* cylindrical, hyaline, smooth, guttulate, straight with subobtuse ends, 2–6-septate, prominently constricted at septa (cells linked by a narrow isthmus), with mature conidia breaking into phragmospores, (22–)50–75(–90) × (2–)3 µm.

Culture characteristics — Colonies reaching up to 20 mm diam after 2 wk at 25 °C, with spreading, flat surface; margins smooth, lobate, and sparse aerial mycelium. On MEA surface cinnamon, reverse brick. On OA surface rosy buff. On PDA surface rosy buff, reverse cinnamon.

Typus. AUSTRALIA, Victoria, Melbourne, Moonee Ponds Creek, on leaves of *Eucalyptus* sp. (*Myrtaceae*), 2 Nov. 2014, P.W. Crous, J. Edwards & P.W.J. Taylor (holotype CBS H-22609, culture ex-type CPC 25519 = CBS 141296; ITS sequence GenBank KX228271.1, LSU sequence GenBank KX228322.1, MycoBank MB817035).

Notes — The LSU sequence of *Mulderomyces natalis* is 91 % similar to species of *Xylographa* (lichenised ascomycetes; e.g. 738/810 to *X. opegraphella* GenBank KJ462366.1) and 92 % (746/812) similar to *Furcasporea eucalypti* (GenBank EF110613; Crous et al. 2007c). Phylogenetically, it appears quite distinct from all taxa presently available in GenBank, both on LSU and ITS. Morphologically, *Mulderomyces* resembles species of *Phacidiella*, except that the nature of its conidia is different with cells not linked by a narrow isthmus, and its conidiomata become cupulate with age (Sutton 1980).

Colour illustrations. *Eucalyptus* tree growing along river at Moonee Ponds Creek; conidiomata sporulating on OA, conidiophores and conidia. Scale bars = 10 µm.

Pedro W. Crous & Johannes Z. Groenewald, CBS-KNAW Fungal Biodiversity Centre, P.O. Box 85167, 3508 AD Utrecht, The Netherlands; e-mail: p.crous@cbs.knaw.nl & e.groenewald@cbs.knaw.nl
 Jacqueline Edwards, AgriBio, Centre for AgriBiosciences, Department of Economic Development, Jobs, Transport and Resources, 5 Ring Road, La Trobe University, Bundoora, Victoria 3083, Australia; e-mail: jacky.edwards@ecodev.vic.gov.au
 Paul W.J. Taylor, Faculty of Veterinary and Agricultural Sciences, The University of Melbourne, Australia; e-mail: paulwjt@unimelb.edu.au

Wojnowiciella cissampeli
& *Diaporthe cissampeli*



Fungal Planet 420 & 421 – 4 July 2016

***Wojnowiciella cissampeli* Crous & Roets, sp. nov.**

Etymology. Name refers to *Cissampelos*, the plant genus from which this fungus was collected.

Classification — *Phaeosphaeriaceae*, *Pleosporales*, *Dothi-deomycetes*.

Conidiomata (on pine needle agar; PNA) pycnidial, solitary, black, erumpent, or immersed in agar, globose, to 300 µm diam, non-papillate, with a central ostiole; pycnidial wall of 3–6 layers of brown *textura angularis*. *Conidiophores* reduced to conidiogenous cells. *Conidiogenous cells* lining the inner cavity, hyaline, smooth, ampulliform to doliform, phialidic, 3–6 × 4–5 µm. *Conidia* subcylindrical, straight to curved, apex subobtuse, base truncate, widest in middle, (0–)3–7-septate, rarely with 1–2 oblique septa, thick-walled, verruculose, guttulate, golden-brown, (20–)22–25(–27) × (4.5–)5(–6) µm.

Culture characteristics — Colonies reaching up to 20 mm diam after 2 wk at 25 °C, with spreading, flat surface; margins smooth, lobate, and moderate aerial mycelium. On MEA surface mouse-grey to greyish sepia, reverse greyish sepia. On OA surface pale mouse-grey in centre, sienna in outer region. On PDA surface pale mouse-grey, reverse greyish sepia.

Typus. SOUTH AFRICA, Western Cape Province, Robben Island, on leaves and twigs of *Cissampelos capensis* (*Menispermaceae*), May 2015, P.W. Crous & F. Roets (holotype CBS H-22610, culture ex-type CPC 27455 = CBS 141297; ITS sequence GenBank KX228272.1, LSU sequence GenBank KX228323.1, MycoBank MB817036).

Notes — On ITS *Wojnowiciella cissampeli* is 98 % (565/577) similar to *W. eucalypti* (CPC 25024; GenBank KR476741.1), and 99 % (546/552) to *Wojnowicia lonicerae* (MFLUCC 13-0737; GenBank KP744471.1). Morphologically, conidia of *W. cissampeli* are smaller than those of *W. eucalypti*, (10–)28–30(–33) × (4–)6–7 µm (Crous et al. 2015a), and *Wojnowicia lonicerae* (38–(42)–49 × 5–(5.5)–6 µm) (Liu et al. 2015).

***Diaporthe cissampeli* Crous & Roets, sp. nov.**

Etymology. Name refers to *Cissampelos*, the plant genus from which this fungus was collected.

Classification — *Diaporthaceae*, *Diaporthales*, *Sordariomycetes*.

Conidiomata (on pine needle agar; PNA) pycnidial, solitary, black, erumpent, globose, to 200 µm diam, exuding creamy droplets from central ostioles; walls consisting of 3–6 layers of medium brown *textura angularis*. *Conidiophores* hyaline, smooth, 1–2-septate, branched, densely aggregated, subcylindrical, straight to sinuous, 12–20 × 3–5 µm. *Conidiogenous cells* 7–10 × 2–3 µm, phialidic, cylindrical, terminal and lateral with slight taper towards apex, 1–1.5 µm diam, with visible periclinal thickening; collarette not observed. *Paraphyses* not observed. *Alpha conidia* aseptate, hyaline, smooth, guttulate, subcylindrical, tapering towards both ends, apex subobtuse, base subtruncate, (7.5–)9–11(–12) × (2–)2.5(–3) µm. *Gamma conidia* not observed. *Beta conidia* not observed.

Culture characteristics — Colonies covering dish after 2 wk at 25 °C, with smooth, even margins, and moderate aerial mycelium. On MEA surface dirty white with patches of pale mouse-grey, reverse luteous. On OA and PDA surface and reverse dirty white.

Typus. SOUTH AFRICA, Western Cape Province, Robben Island, on leaves and twigs of *Cissampelos capensis* (*Menispermaceae*), May 2015, P.W. Crous & F. Roets (holotype CBS H-22628, culture ex-type CPC 27302 = CBS 141331; ITS sequence GenBank KX228273.1, LSU sequence GenBank KX228324.1, *his3* sequence GenBank KX228366.1, *tub2* sequence GenBank KX228384.1, MycoBank MB817059).

Notes — Based on ITS *Diaporthe cissampeli* is 98 % (561/575) similar to *D. neotheicola* (ICMP 10076; GenBank KC-145914.1; Gomes et al. 2013). No high similarity (> 99 %) hits were obtained when the protein coding sequences were blasted against NCBI's GenBank nucleotide database. No other species of *Diaporthe* are known from *Cissampelos* (Crous et al. 2000) and hence *D. cissampeli* is herewith introduced as new.

Colour illustrations. *Cissampelos capensis* growing on Robben Island; *Wojnowiciella cissampeli* (left column): conidiomata sporulating on OA (scale bar = 300 µm), conidiogenous cells and conidia; *Diaporthe cissampeli* (right column): conidiomata sporulating on PNA (scale bar = 200 µm), conidiogenous cells and conidia. Scale bars = 10 µm.

Prosopidicola albizziae

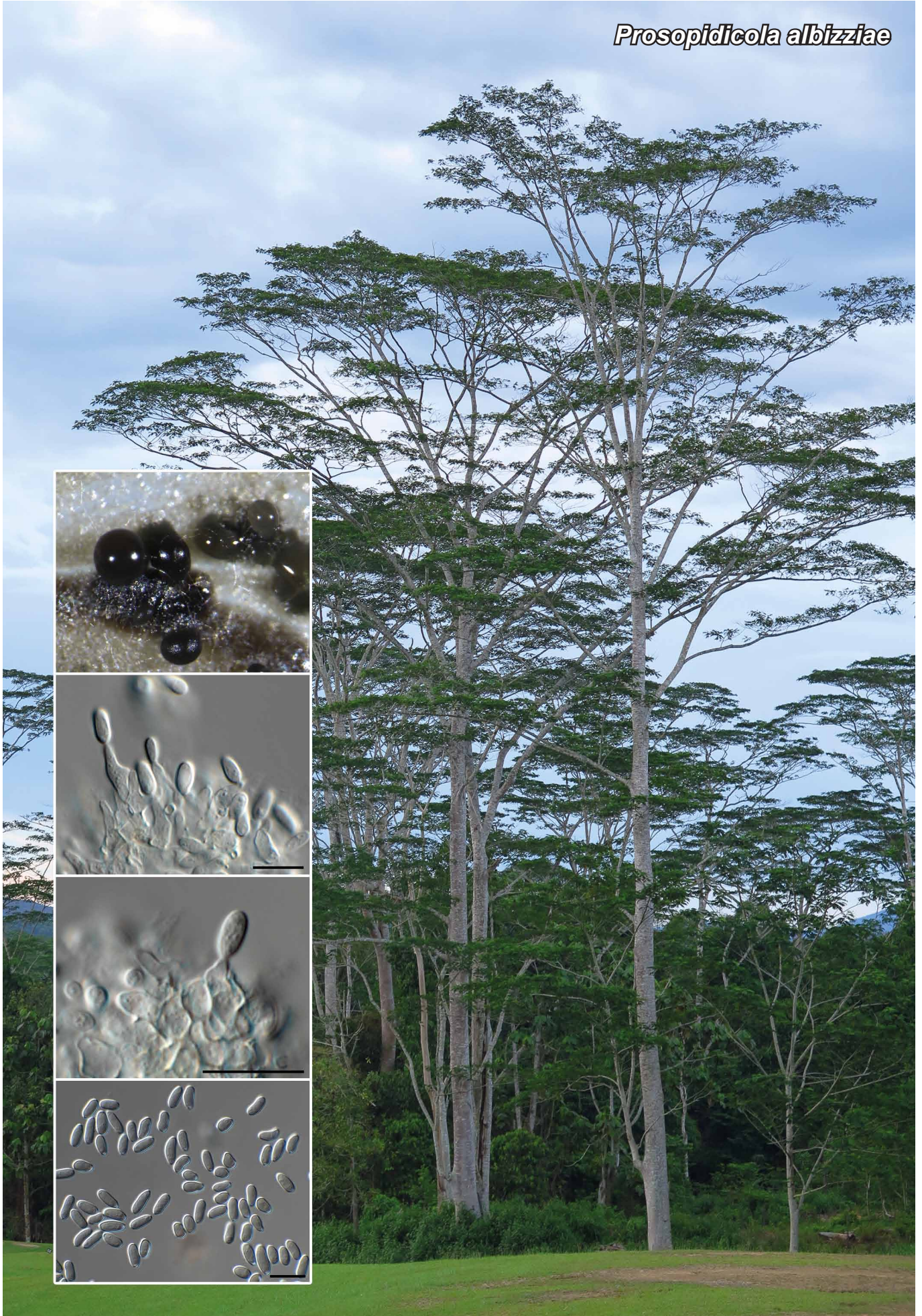

Fungal Planet 422 – 4 July 2016

Prosopidicola albizziae Crous & M.J. Wingf., *sp. nov.*

Etymology. Name refers to *Albizzia*, the host genus from which this fungus was collected.

Classification — *Incertae sedis*, *Diaporthales*, *Sordariomycetes*.

Conidiomata (on pine needle agar; PNA) pycnidial, separate or aggregated in an eustromatic stroma with one to several ostioles, mouse-grey, erumpent, to 300 µm diam; wall up to 10 layers of grey-brown *textura angularis*. *Conidiophores* reduced to conidiogenous cells. *Conidiogenous cells* tightly aggregated, hyaline, smooth, ampulliform, 5–12 × 3–4 µm, mono- to polyphialidic, with 1–2 apical loci with visible periclinal thickening, at times with percurrent proliferation. *Conidia* solitary, subhyaline to grey-brown, smooth, guttulate, straight to variously curved, ellipsoid to fusoid-ellipsoid, apex obtuse, base truncate to bluntly rounded, 1–1.5 µm diam, (5–)7–9(–11) × (2.5–)3–3.5(–4) µm.

Culture characteristics — Colonies reaching up to 20–30 mm diam after 2 wk at 25 °C, with spreading, flat surface; margins uneven, feathery, and sparse to moderate aerial mycelium. On MEA, PDA and OA surface and reverse pale mouse-grey.

Typus. MALAYSIA, Sabah, Tawau, on leaves of *Albizzia falcataria* (*Fabaceae*), May 2015, M.J. Wingfield (holotype CBS H-22611, culture ex-type CPC 27478 = CBS 141298; ITS sequence GenBank KX228274.1, LSU sequence GenBank KX228325.1, MycoBank MB817037); *ibid.*, associated with stem cankers on *Albizzia falcataria*, CPC 27484 (ITS sequence GenBank KX228275.1, LSU sequence GenBank KX228326.1, *tub2* sequence GenBank KX228385.1).

Notes — Phylogenetically, CPC 27478 is identical to CPC 27484. Based on LSU sequence data, *Prosopidicola albizziae* is 99 % (807/815) similar to *P. mexicana*, which was regarded as a potential biocontrol agent of *Prosopis glandulosa*, causing a pod disease of this host in Mexico and the USA (Texas) (Lennox et al. 2004). However, on ITS the two species are only 84 % (512/607) similar. Morphologically, *P. albizziae* has smaller conidia than those of *P. mexicana*, (8–)10–13(–20) × (3.5–)4.5–5.5(–6) µm. *Prosopidicola* was noted to have conidiogenous cells that vary from being phialidic with periclinal thickening, or with prominent percurrent proliferation, becoming darkened at the apex (Lennox et al. 2004).

Colour illustrations. *Albizzia falcataria* trees; conidiomata sporulating on PNA, conidiogenous cells and conidia. Scale bars = 10 µm.

Pedro W. Crous & Johannes Z. Groenewald, CBS-KNAW Fungal Biodiversity Centre, P.O. Box 85167, 3508 AD Utrecht, The Netherlands; e-mail: p.crous@cbs.knaw.nl & e.groenewald@cbs.knaw.nl
Michael J. Wingfield, Forestry and Agricultural Biotechnology Institute (FABI), University of Pretoria, Pretoria 0002, South Africa; e-mail: mike.wingfield@up.ac.za

Phaeotheca salicorniae

Fungal Planet 423 – 4 July 2016

Phaeotheca salicorniae Crous & Roets, *sp. nov.*

Etymology. Name refers to *Salicornia*, the plant genus from which this fungus was collected.

Classification — *Incertae sedis*, *Capnodiales*, *Dothideomycetes*.

Mycelium consisting of hyaline, smooth, septate, branched, 3–5 µm diam hyphae, that swell in areas up to 20 µm diam, terminal or intercalary, and develop numerous endoconidia, brown, verruculose, globose to obovoid, muriformly septate, 5–8 µm diam, bursting open to release several endoconidia that are red-brown, verruculose, aseptate, ellipsoid to subglobose or irregularly, 3–6 × 3–5 µm.

Culture characteristics — Colonies reaching up to 10 mm diam after 2 wk at 25 °C, with spreading, flat surface; margins smooth, lobate, and lacking aerial mycelium. On MEA, PDA and OA surface and reverse black.

Typus. SOUTH AFRICA, Western Cape Province, Robben Island, on leaves and twigs of *Salicornia meyeriana* (*Amaranthaceae*), May 2015, P.W. Crous & F. Roets (holotype CBS H-22612, culture ex-type CPC 27406 = CBS 141299; ITS sequence GenBank KX228276.1, LSU sequence GenBank KX228327.1, MycoBank MB817038).

Notes — Based on the LSU sequence data, *Phaeotheca salicorniae* is 99 % (828/834) similar to *Phaeotheca triangularis* (CBS 471.90; GenBank EU019279.1). On ITS the two species are 99 % (828/834) similar. The genus *Phaeotheca* presently includes three species, with *P. triangularis* (isolated from an air-conditioning system in Belgium) being characterised by ellipsoid to subglobose to triangular endoconidia. In *P. salicorniae* the endoconidia differ in shape and are slightly larger, 5.5–7 × 4.5–5.5 µm (De Hoog et al. 1997), and hyphal swellings up are to 70 µm diam. The genus *Phaeotheca* is polyphyletic, and its taxonomy will be revised in a separate study (J. Bezerra et al. in prep).

Colour illustrations. *Salicornia* sp.; hyphae with endoconidia on PNA. Scale bars = 10 µm.

Paracylindrocarpon aloicola

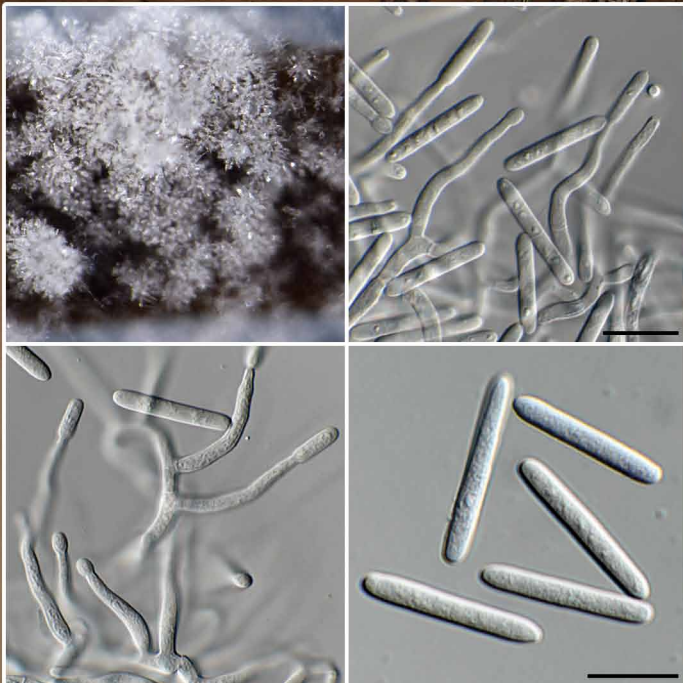

Fungal Planet 424 – 4 July 2016

***Paracylindrocarpon* Crous, Roets & L. Lombard, gen. nov.**

Etymology. Name reflects a morphological similarity to the genus *Cylindrocarpon*.

Classification — *Bionectriaceae*, *Hypocreales*, *Sordariomycetes*.

Mycelium consisting of hyaline, smooth, branched, septate hyphae, forming hyphal coils. *Conidiophores* solitary, hyaline, smooth, erect, straight to geniculate-sinuous, arising from superficial hyphae, unbranched or branched, septate. *Conidi-*

ogenous cells hyaline, smooth, subcylindrical with slight apical taper, straight to slightly irregularly curved, terminal or lateral on conidiophores, apex with minute periclinal thickening. *Conidia* hyaline, smooth, granular, cylindrical, apex obtuse, base truncate, (0–)3-septate.

Type species. *Paracylindrocarpon aloicola* Crous, Roets & L. Lombard. MycoBank MB817039.

***Paracylindrocarpon aloicola* Crous, Roets & L. Lombard, sp. nov.**

Etymology. Name refers to *Aloe*, the plant genus from which this fungus was collected.

Mycelium consisting of hyaline, smooth, branched, septate, 3–4 µm diam hyphae, forming hyphal coils. *Conidiophores* solitary, hyaline, smooth, erect, straight to geniculate-sinuous, arising from superficial hyphae, unbranched or branched, 1–4-septate, 20–50 × 3–4 µm. *Conidiogenous cells* hyaline, smooth, subcylindrical with slight apical taper, straight to slightly irregularly curved, terminal or lateral on conidiophores, 20–30 × 2.5–3 µm, apex with minute periclinal thickening, 1.5–2 µm diam. *Conidia* hyaline, smooth, granular, cylindrical, apex obtuse, base truncate, 1 µm diam, (0–)3-septate, (17–)20–24(–27) × (2.5–)3 µm.

Culture characteristics — Colonies reaching up to 30 mm diam on PDA and OA, 15 mm diam on MEA after 2 wk at 25 °C, with spreading, flat surface; margins smooth, lobate, and sparse to moderate aerial mycelium. On MEA surface pale luteous with patches of saffron, and diffuse scarlet pigment in agar, reverse amber. On PDA and OA surface and reverse pale luteous.

Typus. SOUTH AFRICA, Western Cape Province, Robben Island, on leaves and twigs of *Aloe* sp. (*Xanthorrhoeaceae*), May 2015, *P.W. Crous & F. Roets* (holotype CBS H-22613, culture ex-type CPC 27362 = CBS 141300; ITS sequence GenBank KX228277.1, LSU sequence GenBank KX228328.1, *tub2* sequence GenBank KX228386.1, MycoBank MB817040).

Notes — Based on LSU *Paracylindrocarpon aloicola* has 99 % (791/794) similarity to *Hydropisphaera erubescens* (ATCC 36093; GenBank AF193230.1). Likewise, ITS is 99 % (559/567) similar to *Hydropisphaera erubescens* (GenBank FJ969800.1) and 94 % (536/572) to *Fusariella sinensis* (OUCMBI110131; GenBank KP269041.1). The genus *Hydropisphaera* is based on *H. peziza*, which has an *Acremonium* asexual morph (Samuels 1976). *Hydropisphaera erubescens* has a cylindrocarpon-like asexual morph with 1–3-septate conidia (Samuels 1978), showing some resemblance to the present collection, suggesting that some members of *Hydropisphaera* would be better accommodated in *Paracylindrocarpon* once the genus has been revised. The genus *Cylindrocarpon* (*Nectriaceae*) has recently been revised, and shown to be polyphyletic (Halleen et al. 2004, Chaverri et al. 2011, Lombard et al. 2014), with *Paracylindrocarpon* (*Bionectriaceae*) representing yet an additional genus in this complex.

Colour illustrations. Symptomatic leaves of *Aloe* sp. growing on top of old gun turret on Robben Island; colony sporulating on PNA, conidiophores and conidia. Scale bars = 10 µm.

Pedro W. Crous, Johannes Z. Groenewald & Lorenzo Lombard, CBS-KNAW Fungal Biodiversity Centre, P.O. Box 85167, 3508 AD Utrecht, The Netherlands;

e-mail: p.crous@cbs.knaw.nl, e.groenewald@cbs.knaw.nl & l.lombard@cbs.knaw.nl

Francois Roets, Department of Conservation Ecology and Entomology, Stellenbosch University, South Africa; e-mail: fr@sun.ac.za



Fungal Planet 425 – 4 July 2016

Fusicladium eucalypticola Crous & M.J. Wingf., *sp. nov.*

Etymology. Name refers to *Eucalyptus*, the plant genus from which this fungus was collected.

Classification — *Symptoventuriaceae*, *Venturiales*, *Dothideo-mycetes*.

Mycelium consisting of pale brown, smooth, branched, septate, 1.5–3 µm diam hyphae. *Conidiophores* reduced to conidiogenous cells, or with basal supporting cell. *Conidiogenous cells* erect, brown, smooth, subcylindrical, straight, 5–20 × 2.5–3 µm, with a single terminal locus, thickened and darkened, 1–2 µm diam. *Primary ramoconidia* brown, smooth, subcylindrical, 0–2-septate, 15–25 × 3 µm, with 1–2 apical loci. *Secondary ramoconidia* brown, smooth, subcylindrical to fusoid-ellipsoid, 15–20 × 3–5 µm, 1–3-septate; loci thickened, darkened, 0.5–1 µm diam. *Conidia* occurring in branched chains of up to 15 conidia, fusoid-ellipsoid, pale brown, smooth, guttulate, aseptate, (5–)7–10(–12) × (2.5–)3(–4) µm; hila thickened, darkened, 0.5 µm diam.

Culture characteristics — Colonies reaching up to 15 mm diam after 2 wk at 25 °C, with spreading, flat surface; margins smooth, lobate, and moderate aerial mycelium. On MEA, PDA and OA surface and reverse sienna.

Typus. FRANCE, La Réunion, on leaves of *Eucalyptus robusta* (*Myrtaceae*), 8 Mar. 2015, P.W. Crous & M.J. Wingfield (holotype CBS H-22614, culture ex-type CPC 27238 = CBS 141301; ITS sequence GenBank KX228278.1, LSU sequence GenBank KX228329.1, MycoBank MB817041).

Notes — The LSU sequence of *Fusicladium eucalypticola* is 99 % (868/871) similar to *F. eucalypti* (CBS 128216; GenBank HQ599601.1) and 94 % (824/872) to *F. africanum* (CPC 12829; GenBank EU035424.1). Based on ITS DNA sequence data *F. eucalypticola* is 99 % (532/539) similar to *F. eucalypti* (CBS 128216; GenBank HQ599600.1) and 86 % (319/371) to *F. convolvularum* (CPC 3884; GenBank AY251082.1). *Fusicladium eucalypti* (on *Eucalyptus* sp., Queensland, Australia) has smaller secondary ramoconidia, being 0–1-septate, (10–)12–13(–15) × (2–)2.5–3 µm, and narrower conidia, (7–)8–9(–10) × (2–)2.5(–3) µm (Crous et al. 2010a).

Colour illustrations. Forest undergrowth on La Réunion Island; conidiophores and conidia on PNA. Scale bars = 10 µm.

Pedro W. Crous, CBS-KNAW Fungal Biodiversity Centre, P.O. Box 85167, 3508 AD Utrecht, The Netherlands; e-mail: p.crous@cbs.knaw.nl
Michael J. Wingfield, Forestry and Agricultural Biotechnology Institute (FABI), University of Pretoria, Pretoria 0002, South Africa; e-mail: mike.wingfield@up.ac.za
Johannes J. Le Roux & David M. Richardson, Centre for Invasion Biology, Department of Botany & Zoology, Stellenbosch University, Matieland 7602, South Africa; e-mail: jleroux@sun.ac.za & rich@sun.ac.za
Dominique Strasberg, Université de La Réunion, UMR PVBMT, Peuplements Végétaux et Bioagresseurs en Milieu Tropical, 15 avenue René Cassin, CS 93002, 97 744 Saint-Denis Messag. Cedex 9, La Réunion, France; e-mail: dominique.strasberg@univ-reunion.fr

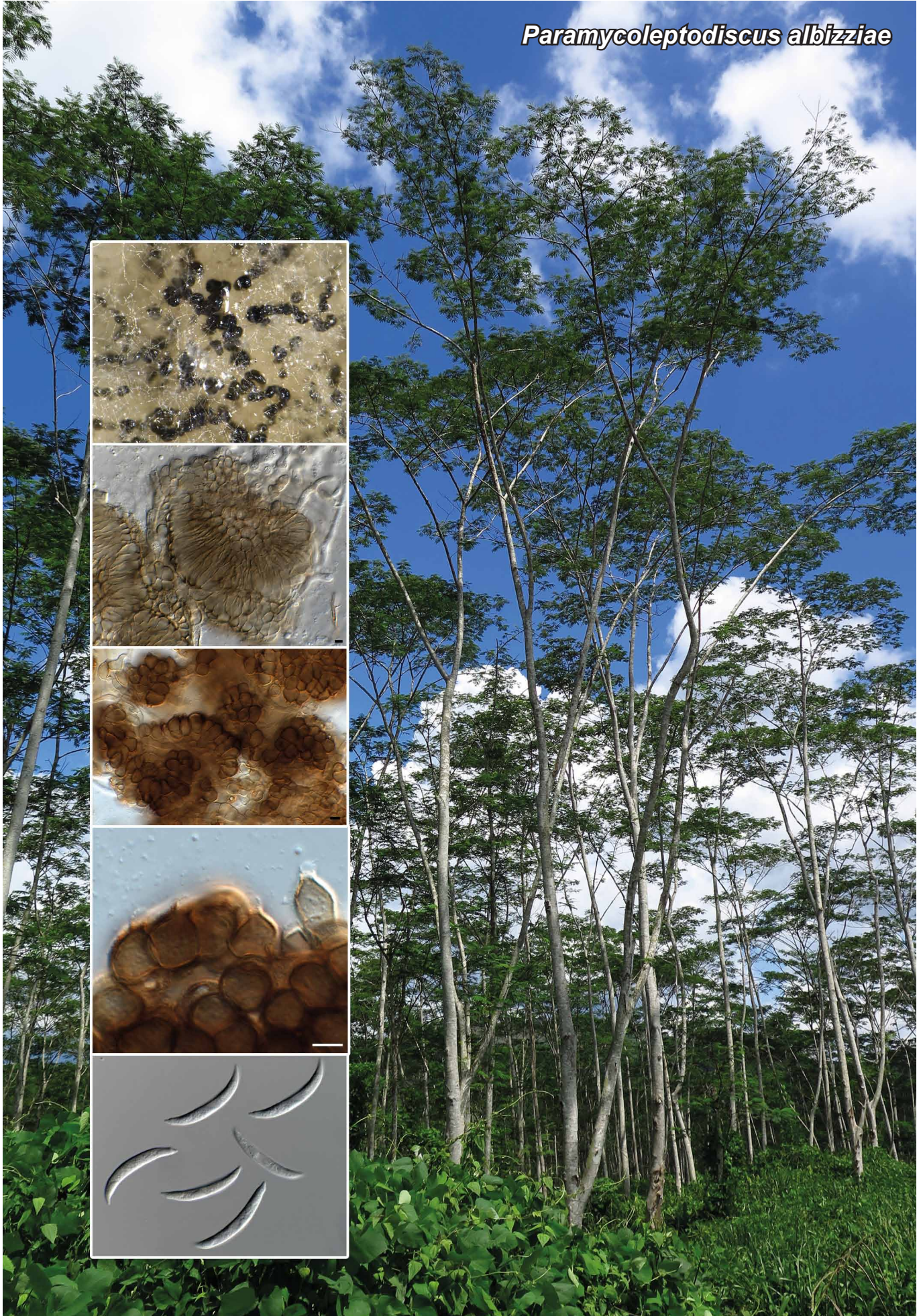
Paramycoleptodiscus albizziae

Fungal Planet 426 – 4 July 2016

***Paramycoleptodiscus* Crous & M.J. Wingf., gen. nov.**

Etymology. Name reflects a morphological similarity with the genus *Mycoleptodiscus*.

Classification — *Incertae sedis*, *Acrospermales*, *Dothideo-mycetes*.

Mycelium consisting of hyaline, branched, septate hyphae that become brown, constricted at septa, forming a cluster of globose, brown, chlamydospore-like cells that form a stroma; stroma brown, solitary, globose, but with age joining along the length of hyphae to become strands of radiating stromata;

stroma forming a sporodochium of densely aggregated, dark brown, finely roughened conidiogenous cells, subglobose to slightly ampulliform, containing a single, central phialidic locus, slightly papillate, with cylindrical collarete. *Conidia* solitary, aseptate, hyaline, smooth, granular, falcate, slightly curved, widest in middle, apex subobtusely rounded, base with well-defined fusarium-like foot cell.

Type species. *Paramycoleptodiscus albizziae* Crous & M.J. Wingf. MycoBank MB817042.

***Paramycoleptodiscus albizziae* Crous & M.J. Wingf., sp. nov.**

Etymology. Name refers to *Albizzia*, the plant genus from which this fungus was collected.

Mycelium consisting of hyaline, branched, septate, 2–3 µm diam hyphae that become brown, constricted at septa, up to 6 µm diam, forming a cluster of globose, brown, chlamydospore-like cells up to 8 µm diam, that form a stroma; stroma brown, up to 100 µm diam, solitary, globose, but with age joining along the length of hyphae to become strands of radiating stromata; stroma forming a sporodochium of densely aggregated, dark brown, finely roughened *conidiogenous cells*, subglobose to slightly ampulliform, 7–12 × 5–12 µm, containing a single, central phialidic locus, slightly papillate, 2–3.5 µm diam, with cylindrical collarete, 2–3 µm long. *Conidia* solitary, aseptate, hyaline, smooth, granular, falcate, slightly curved, widest in middle, apex subobtusely rounded, base with well-defined fusarium-like foot cell, (23–)26–32(–37) × (3–)4 µm (including foot cell), 1–3 × 1–1.5 µm.

Culture characteristics — Colonies reaching up to 15 mm diam after 2 wk at 25 °C, with spreading, erumpent surface; margins smooth, lobate, and sparse to moderate aerial mycelium. On MEA surface and reverse mouse-grey. On OA surface mouse-grey. On PDA surface mouse-grey, reverse dark mouse-grey.

Typus. MALAYSIA, Sabah, Tawau, on leaves of *Albizzia falcataria* (*Fabaceae*), May 2015, *M.J. Wingfield* (holotype CBS H-22615, culture ex-type CPC 27552 = CBS 141320; ITS sequence GenBank KX228279.1, LSU sequence GenBank KX228330.1, MycoBank MB817043).

Notes — The LSU sequence of *Paramycoleptodiscus albizziae* is 95 % (544/572) similar to *Mycoleptodiscus terrestris* (type of *Mycoleptodiscus*; CBS 231.53; GenBank JN711859) and 94 % (754/800) to *Arxiella dolichandrae* (CBS 138853; GenBank KP004477.1). No highly similar sequences were obtained with the ITS sequence. *Paramycoleptodiscus* is distinct from *Mycoleptodiscus* (Sutton 1973) in that the latter has septate conidia with apical appendages, whereas in *Paramycoleptodiscus* the conidia are aseptate, and have a basal appendage in the form of a foot cell.

Colour illustrations. Stand of *Albizzia falcataria* trees; conidiomata sporulating on OA, sporodochia, conidiogenous cells and conidia. Scale bar = 10 µm.

Malaysiasca phaii



Fungal Planet 427 – 4 July 2016

***Malaysiasca* Crous & M.J. Wingf., gen. nov.**

Etymology. Name refers to Malaysia, the country where it was collected.

Classification — *Incertae sedis*, *Glomerellales*, *Sordariomycetes*.

Stroma brown, globose, erumpent, giving rise to a fascicle of conidiophores. *Conidiophores* subcylindrical, unbranched, erect, flexuous, basal cell slightly swollen; thick-walled, finely roughened, granular to slightly guttulate, septate, grey-brown, becoming somewhat pale brown towards slightly tapered apex, rejuvenating percurrently, with apical conidiogenous cells. *Conidiogenous cells* integrated, pale brown, subcylindrical, phialidic, with periclinal thickening and minute collarette. *Conidia* solitary, aggregating in a slimy mass, ellipsoidal to cylindrical-ellipsoid to somewhat clavate, prominently guttulate, frequently with large

central guttule, apex obtuse, base truncate, scar slightly thickened and darkened, frequently excentric. *Ascomata* perithecial, base immersed in substrate, obpyriform, papillate, dark brown with setae around base of perithecialium, pale brown; wall of 3–5 layers of pale brown *textura prismatica*. *Paraphyses* persistent, hyaline, branched, septate, longer than asci. *Asci* unitunicate, cylindrical-clavate, short-stipitate, apex truncate with shallow annulus, 8-spored. *Ascospores* biseriata in ascus, ellipsoid to oblong, apiculate at ends, with one end having minute mucoid cap, hyaline, smooth, frequently with large central guttule, becoming 1-septate and pale brown after discharge.

Type species. *Malaysiasca phaii* Crous & M.J. Wingf.
Mycobank MB817044.

***Malaysiasca phaii* Crous & M.J. Wingf., sp. nov.**

Etymology. Name refers to *Phaius*, the plant genus from which this fungus was collected.

Stroma brown, globose, erumpent, to 150 µm diam, giving rise to a fascicle of 2–10 conidiophores. *Conidiophores* subcylindrical, unbranched, erect, flexuous, basal cell slightly swollen, 7–12 µm diam; thick-walled, finely roughened, granular to slightly guttulate, 5–8-septate, grey-brown, becoming somewhat pale brown towards slightly tapered apex, rejuvenating percurrently, 150–220 × 5–7 µm, with apical conidiogenous cell. *Conidiogenous cells* integrated, pale brown, subcylindrical, 55–80 × 6 µm, phialidic, with periclinal thickening and minute collarette, apex 4–5 µm diam. *Conidia* solitary, aggregating in a slimy mass, ellipsoidal to cylindrical-ellipsoid to somewhat clavate, prominently guttulate, frequently with large central guttule, apex obtuse, base truncate, scar slightly thickened and darkened, frequently excentric, 3–4 µm diam, (16–)18–20(–24) × (8–)9–10(–11) µm. On PNA developing a sexual morph after 4 wk, and essentially dissolving the cellolytic tissue of the pine needle in the process. *Ascomata* perithecial, base immersed in pine needles, to 250 µm wide, 400 µm tall, obpyriform, papillate, dark brown with setae around base of perithecialium, pale brown; wall of 3–5 layers of pale brown *textura prismatica*. *Paraphyses* persistent, hyaline, branched, septate, longer than asci, 2.5–4 µm diam. *Asci* 55–80 × 9–12 µm, unitunicate, cylindrical-clavate, short-stipitate, apex truncate with shallow annulus, 8-spored. *Ascospores* biseriata in ascus, ellipsoid to oblong, apiculate at ends, with one end having minute mucoid cap, hyaline, smooth, frequently with large central guttule, becoming 1-septate and pale brown after discharge, (22–)24–27(–30) × (6–)7(–8) µm.

Culture characteristics — Colonies reaching up to 25 mm diam after 2 wk at 25 °C, with spreading, flat surface; margins feathery, lobate, and sparse aerial mycelium. On MEA surface and reverse pale luteous. On OA surface dark mouse-grey. On PDA surface and reverse mouse-grey.

Typus. MALAYSIA, Sabah, Tawau, on leaves of *Phaius reflexipetalus* (*Orchidaceae*), 30 May 2015, M.J. Wingfield (holotype CBS H-22616, culture ex-type CPC 27548 = CBS 141321; ITS sequence GenBank KX228280.1, LSU sequence GenBank KX228331.1, *actA* sequence GenBank KX228359.1, Mycobank MB817045).

Notes — The LSU sequence of *Malaysiasca phaii* is 98 % (784/797) similar to that of *Monilochaetes dimorphospora* (MUCL 40959; GenBank HQ609480.1), 98 % (783/797) to *Monilochaetes guadalcanalensis* (CBS 346.76; GenBank GU180640.1) and 98 % (782/797) to *Australiasca queenslandica* (BRIP 24334c; GenBank HM237323.1). Morphologically, *Malaysiasca* resembles the genus *Australiasca* (Réblová et al. 2011), but is distinct in that it forms a stroma that gives rise to fascicles of conidiophores, whereas stromata are absent in *Australiasca*. In general the asexual morph is similar to species of *Monilochaetes*, and would be difficult to distinguish without the aid of molecular data.

Colour illustrations. Forest undergrowth in Malaysia; ascomata, ascospores and asci; stroma giving rise to conidiophores, conidiogenous cells and conidia. Scale bars: ascomata = 250 µm, all others = 10 µm.

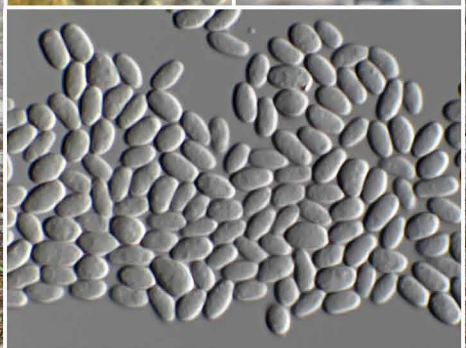
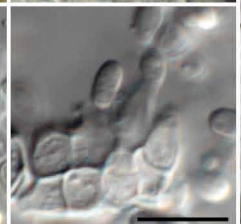
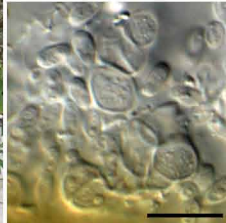
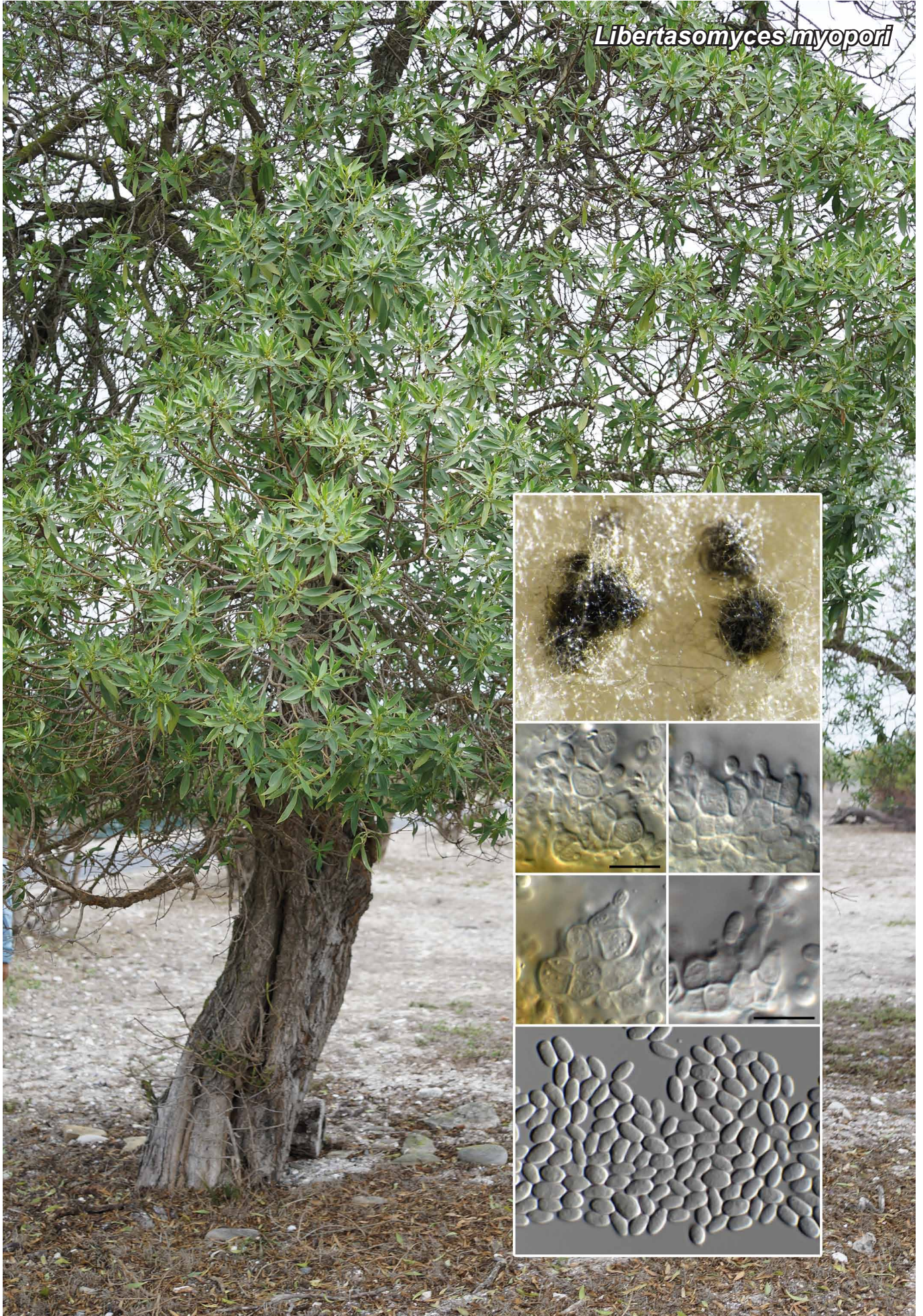

Fungal Planet 428 – 4 July 2016

***Libertasomyces* Crous & Roets, gen. nov.**

Etymology. This fungus was collected on Robben Island off the west coast of Cape Town, South Africa. The word *robbe* is Dutch for 'seal', and thus 'seal island' is where Nelson Mandela, the first democratically elected President of South Africa, was imprisoned for 18 of the 27 years he served behind bars before the fall of apartheid. *Libertas* (Latin) for freedom.

Classification — *Incertae sedis*, *Pleosporales*, *Dothideomycetes*.

Conidiomata pycnidial, solitary, dark brown, erumpent, globose, with central ostiole; wall of 3–6 layers of brown *textura angularis*. *Conidiophores* reduced to conidiogenous cells. *Conidiogenous cells* lining the inner cavity, hyaline, smooth, ampulliform to doliiform, phialidic with prominent periclinal thickening. *Conidia* solitary, hyaline, smooth, granular, thin-walled, ellipsoid, widest in middle, apex obtuse, base truncate to bluntly rounded, aseptate.

Type species. *Libertasomyces myopori* Crous & Roets.
Mycobank MB817046.

***Libertasomyces myopori* Crous & Roets, sp. nov.**

Etymology. Name refers to *Myoporum*, the plant genus from which this fungus was collected.

Conidiomata (on pine needle agar; PNA) pycnidial, solitary, dark brown, erumpent, globose, to 300 µm diam, with central ostiole; wall of 3–6 layers of brown *textura angularis*. *Conidiophores* reduced to conidiogenous cells. *Conidiogenous cells* lining the inner cavity, hyaline, smooth, ampulliform to doliiform, phialidic with prominent periclinal thickening, 3–6 × 3–4 µm. *Conidia* solitary, hyaline, smooth, granular, thin-walled, ellipsoid, widest in middle, apex obtuse, base truncate to bluntly rounded, aseptate, (4–)4.5–5(–6) × (2–)2.5–3(–3.5) µm.

Culture characteristics — Colonies reaching up to 30 mm diam after 2 wk at 25 °C, with spreading, erumpent surface; margins smooth, lobate, and moderate aerial mycelium. On MEA surface dirty white, reverse luteous. On OA surface honey. On PDA surface buff with patches of isabelline, reverse isabelline to buff.

Typus. SOUTH AFRICA, Western Cape Province, Robben Island, on twigs of *Myoporum serratum* (*Myoporaceae*), May 2015, P.W. Crous & F. Roets (holotype CBS H-22617, culture ex-type CPC 27354 = CBS 141302; ITS sequence GenBank KX228281.1, LSU sequence GenBank KX228332.1, MycoBank MB817047).

Notes — On LSU *Libertasomyces myopori* is 98 % (792/808) similar to *Camarosporium quaternatum* (CBS 134.97; GenBank DQ377883.1), 98 % (791/808) to *Leptosphaeria rubefaciens* (CBS 387.80; GenBank JF740311.1), 97 % (787/809) to *Plenodomus visci* (CBS 122783; GenBank EU754195.1) and 97 % (786/808) to *Neoplatysporoides aloicola* (CPC 24435; GenBank KR476754.1), and represents another genus being phoma-like in morphology. *Neoplatysporoides aloicola* (CPC 24435; GenBank KR476719.1) also represents the most similar ITS sequence at 92 % (534/580). *Libertasomyces* is morphologically quite distinct from *Neoplatysporoides* in that conidia remain hyaline and aseptate, in contrast to those of *Neoplatysporoides* that are 0–1-septate, golden brown, and with longitudinal striations (Crous et al. 2015a).

Colour illustrations. *Myoporum serratum* growing on Robben Island; conidiomata sporulating on OA, conidiogenous cells and conidia. Scale bars = 10 µm.



Fungal Planet 429 – 4 July 2016

Fusicladium paraamoenum Crous, Jacq. Edwards & P.W.J. Taylor, *sp. nov.*

Etymology. Name reflects morphological similarity to *Fusicladium amoenum*.

Classification — *Sympoventuriaceae*, *Venturiales*, *Dothideo-mycetes*.

Mycelium consisting of pale brown, smooth, branched, septate, 2.5–3.5 µm diam hyphae. *Conidiophores* erect, solitary, subcylindrical, dark brown, thick-walled, smooth, rarely branched below, 25–120 × 3–4 µm, 1–7-septate. *Conidiogenous cells* integrated, terminal, rarely lateral, 10–30 × 3–4 µm, brown, smooth, with several sympodial denticle-like loci, 1–1.5 µm diam, thickened and darkened. *Conidia* occurring in short chains, subcylindrical, pale brown, smooth, guttulate, (0–)1(–3)-septate, ends obtusely rounded, hila thickened and darkened, 1.5–2 µm diam, (13–)15–20(–28) × (3–)3.5(–4) µm.

Culture characteristics — Colonies reaching up to 10 mm diam after 2 wk at 25 °C, with spreading, erumpent surface; margins smooth, lobate, and moderate aerial mycelium. On MEA and PDA surface umber, reverse chestnut. On OA surface umber with chestnut outer margin.

Typus. AUSTRALIA, Victoria, Toolangi State Forest, S37°33'25.3" E145°31'55.9", on leaves of *Eucalyptus regnans* (*Myrtaceae*), 9 Nov. 2014, P.W. Crous, J. Edwards & P.W.J. Taylor (holotype CBS H-22618, culture ex-type CPC 25596 = CBS 141322; ITS sequence GenBank KX228282.1, LSU sequence GenBank KX228333.1, MycoBank MB817048).

Notes — On ITS *Fusicladium paraamoenum* is 98 % (560/574) similar to *F. amoenum* (CBS 254.95; GenBank EU035425.1) and 97 % (527/545) to *F. intermedium* (CBS 110746; GenBank EU035432.1). The LSU sequence is 99 % (907/909) similar to *F. amoenum* (CBS 254.95; GenBank EU035425.1) and 99 % (897/909) to *F. intermedium* (CBS 110746; GenBank EU035432.1). Conidia of *F. paraamoenum* are larger than those of *F. amoenum* (6–)10.5–12.8(–17.3) × (1.5–)2.4–3(–3.8) µm (Ho et al. 1999).

Colour illustrations. *Eucalyptus regnans* trees at Toolangi State Forest; conidiophores and conidia on SNA. Scale bars = 10 µm.

Pedro W. Crous & Johannes Z. Groenewald, CBS-KNAW Fungal Biodiversity Centre, P.O. Box 85167, 3508 AD Utrecht, The Netherlands; e-mail: p.crous@cbs.knaw.nl & e.groenewald@cbs.knaw.nl
Jacqueline Edwards, AgriBio, Centre for AgriBiosciences, Department of Economic Development, Jobs, Transport and Resources, 5 Ring Road, La Trobe University, Bundoora, Victoria 3083, Australia; e-mail: jacky.edwards@ecodev.vic.gov.au
Paul W.J. Taylor, Faculty of Veterinary and Agricultural Sciences, The University of Melbourne, Australia; e-mail: paulwjt@unimelb.edu.au



Fungal Planet 430 – 4 July 2016

Ochroconis dracaenae Crous, sp. nov.

Etymology. Name refers to *Dracaena*, the plant genus from which this fungus was collected.

Classification — *Symptoventuriaceae*, *Venturiales*, *Dothideo-mycetes*.

Mycelium consisting of smooth, pale brown, septate, branched, 1.5–3 µm diam hyphae. *Conidiophores* solitary, erect, brown, smooth, arising from superficial hyphae, subcylindrical, straight to geniculous-sinuuous, branched below or not, 1–6-septate, 10–30 × 2–3 µm. *Conidiogenous cells* brown, smooth, terminal and lateral on conidiophores, 5–15 × 2.5–3 µm, containing several apical, cylindrical denticles, 1–1.5 × 1 µm. *Conidia* solitary, subcylindrical, ends obtuse, pale brown, verruculose, medianly 1-septate, hilum thickened and darkened, 1 µm diam, (6.5–)7–9(–10) × (3–)3.5(–4) µm.

Culture characteristics — Colonies reaching up to 20 mm diam after 2 wk at 25 °C, with spreading erumpent surface; margins smooth, lobate, and moderate aerial mycelium. On MEA surface isabelline, reverse brown-vinaceous. On OA surface brown-vinaceous. On PDA surface and reverse isabelline.

Typus. USA, Texas, Austin, on leaf spots of *Dracaena reflexa* (*Asparagaceae*), Aug. 2013, *P.W. Crous* (holotype CBS H-22619, culture ex-type CPC 26115 = CBS 141323; ITS sequence GenBank KX228283.1, LSU sequence GenBank KX228334.1, *rpb2* sequence GenBank KX228370.1, *tef1* sequence GenBank KX228377.1, MycoBank MB817049).

Notes — On ITS *Ochroconis dracaenae* is 96 % (691/719) similar to *O. humicola* (UZ1582_14; GenBank KP326578.1) and 97 % (626/647) to *O. musae* (CBS 121963; GenBank HQ-667535.1). No better matches were obtained with the protein coding sequences. *Ochroconis dracaenae* has smaller conidia than *O. humicola* (8–20 × 3–5 µm) and *O. musae* (9.0–13.5 × 4.8–6.7 µm) (Crous et al. 2014a, Samerpitak et al. 2015).

Colour illustrations. Forest path along walkway in Austin, Texas; conidiogenous cells and conidia on SNA. Scale bars = 10 µm.

Cytospora tibouchinae

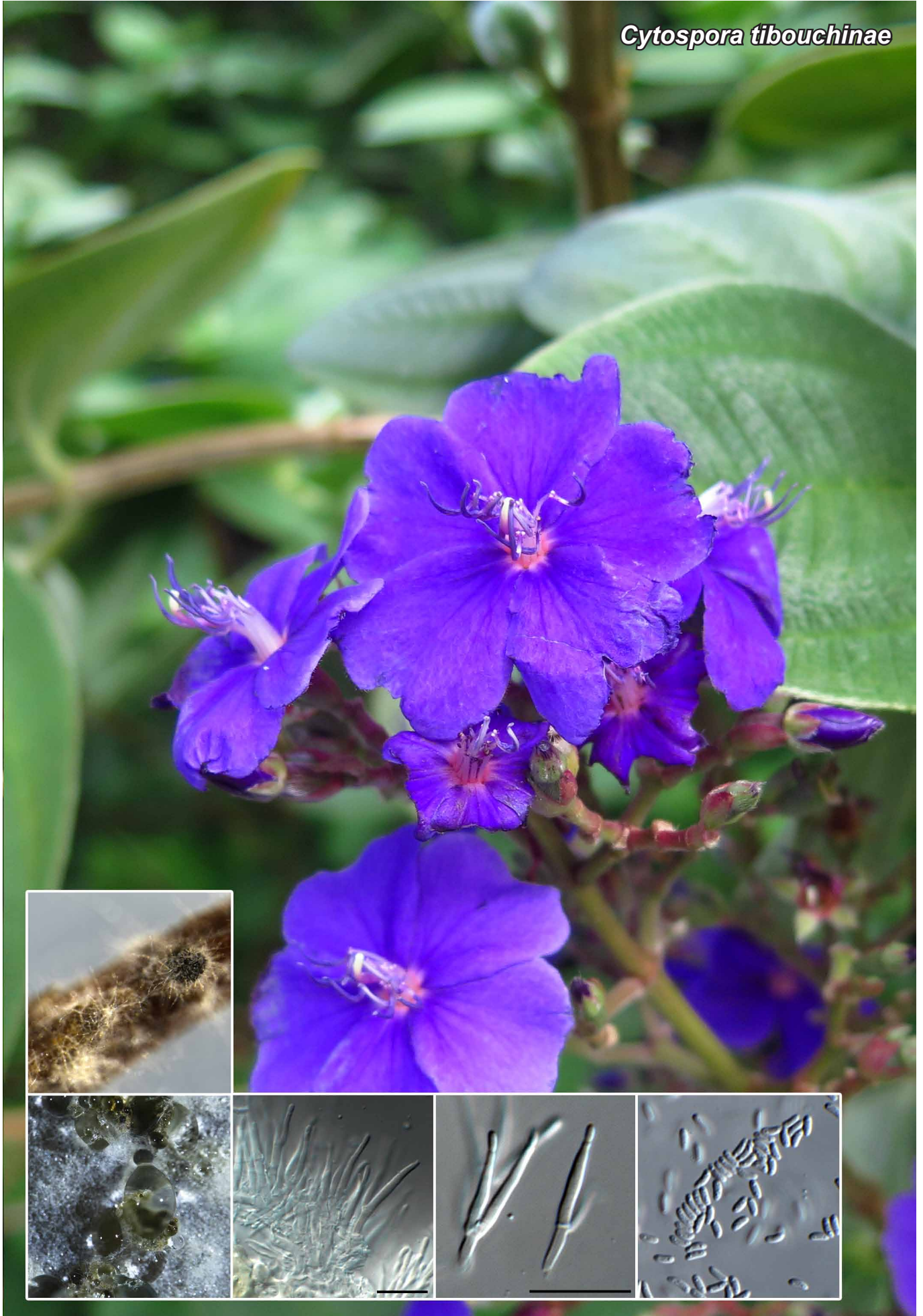

Fungal Planet 431 – 4 July 2016

Cytospora tibouchinae Crous & M.J. Wingf., *sp. nov.*

Etymology. Name refers to *Tibouchina*, the plant genus from which this fungus was collected.

Classification — *Valsaceae*, *Diaporthales*, *Sordariomycetes*.

Conidiomatal (on pine needle agar; PNA) stromata up to 500 µm diam, rosette cytosporoid, subdivided by invaginations, up to six radially arranged. *Conidiophores* hyaline, smooth, branched, 0–3-septate, 15–25 × 2–3 µm, embedded in a gelatinous layer. *Conidiogenous cells* phialidic, with periclinal thickening, tapering towards apices, collarettes minute, 8–14 × 1.5–2 µm. *Conidia* hyaline, smooth, guttulate, allantoid, aseptate, (3–) 3.5(–4) × 1(–1.5) µm.

Culture characteristics — Colonies covering dish after 2 wk at 25 °C, with spreading, flat surface; margins smooth, and with moderate aerial mycelium. On MEA surface grey-olivaceous, reverse greyish sepia. On OA surface olivaceous grey. On PDA surface smoke grey with patches of honey, reverse grey olivaceous.

Typus. FRANCE, La Réunion, on stems of *Tibouchina semidecandra* (*Melastomataceae*), 12 Mar. 2015, P.W. Crous & M.J. Wingfield (holotype CBS H-22620, culture ex-type CPC 26333 = CBS 141324; ITS sequence GenBank KX228284.1, LSU sequence GenBank KX228335.1, MycoBank MB817050).

Notes — Based on ITS sequence data *Cytospora tibouchinae* is 98 % (561/575) similar to *Cytospora myrtagena* (CMW4046; GenBank AY347380.1) (Adams et al. 2005, Rossman et al. 2015). Morphologically, *Cytospora tibouchinae* has conidia of similar dimensions, 3–3.5(–4) × 1 µm, but the two species can be distinguished in that *C. myrtagena* has unbranched conidiophores, and shorter conidiogenous cells, 5–7 × 1 µm (Adams et al. 2005).

Colour illustrations. *Tibouchina semidecandra* on La Réunion Island; conidiomata sporulating on PNA, conidiophores and conidia. Scale bars = 10 µm.

Pedro W. Crous, CBS-KNAW Fungal Biodiversity Centre, P.O. Box 85167, 3508 AD Utrecht, The Netherlands; e-mail: p.crous@cbs.knaw.nl
Michael J. Wingfield, Forestry and Agricultural Biotechnology Institute (FABI), University of Pretoria, Pretoria 0002, South Africa; e-mail: mike.wingfield@up.ac.za
Johannes J. Le Roux & David M. Richardson, Centre for Invasion Biology, Department of Botany & Zoology, Stellenbosch University, Matieland 7602, South Africa; e-mail: jleroux@sun.ac.za & rich@sun.ac.za
Dominique Strasberg, Université de La Réunion, UMR PVBMT, Peuplements Végétaux et Bioagresseurs en Milieu Tropical, 15 avenue René Cassin, CS 93002, 97 744 Saint-Denis Messag. Cedex 9, La Réunion, France; e-mail: dominique.strasberg@univ-reunion.fr

Neotrimmatostroma paraexcentricum

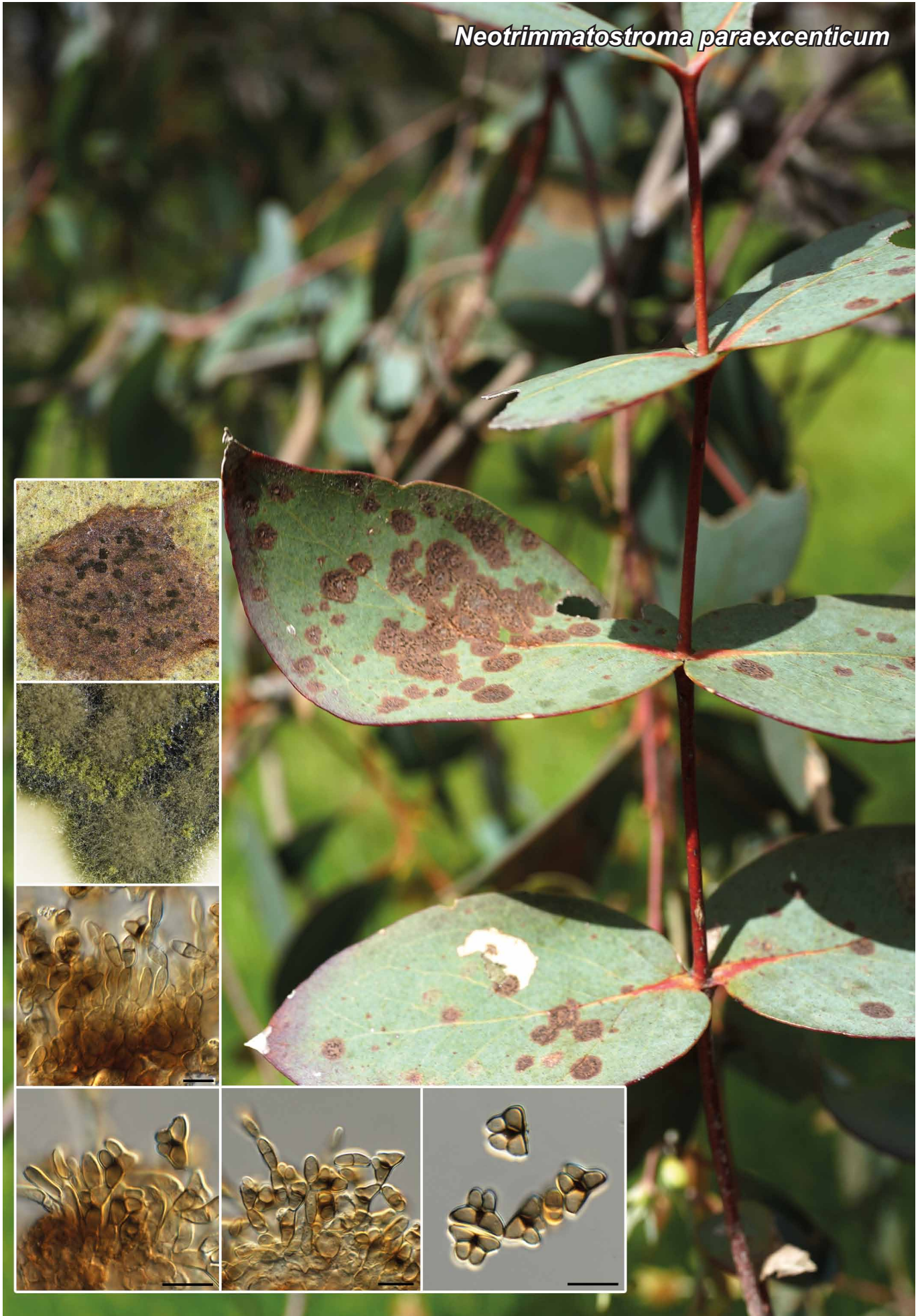

Fungal Planet 432 – 4 July 2016

Neotrimmatostroma paraexcentricum Crous, Jacq. Edwards & Pascoe, *sp. nov.*

Etymology. Name reflects a morphological similarity to *Neotrimmatostroma excentricum*.

Classification — *Teratosphaeriaceae*, *Capnodiales*, *Dothideomycetes*.

Leaf spots separate, coalescing with age, medium brown, sub-circular with indistinct margins, 2–7 mm diam, amphigenous, but more prominent on epiphyllous surface. *Mycelium* immersed, consisting of pale brown, septate, branched, 2–3 µm diam hyphae. *Conidiomata* sporodochial, chiefly epiphyllous, concentrically arranged, dark brown, dry powdery, discrete, to 400 µm diam. *Conidiophores* micronematous, branched, septate, medium brown, smooth, densely aggregated, with differential thickening of periclinal wall, one side thinner than the other, to 30 µm tall, 3–4 µm diam. *Conidiogenous cells* holothallic, integrated, terminal, doliiiform to subcylindrical, 7–10 × 3–4 µm. *Conidia* in sparsely branched chains, smooth, pale brown, 4-celled, consisting of upper and lower cells with truncate ends, separated by a thick, dark brown transverse septum, each primary cell with a smaller, lateral, globose secondary cell on either side of the primary septum. The two primary cells together are 9–11 µm diam, the secondary cells 4–5 µm diam.

Culture characteristics — Colonies reaching up to 7 mm diam after 2 wk at 25 °C, with margins smooth, lobate, and sparse aerial mycelium. On MEA, PDA and OA surface and reverse iron-grey.

Typus. AUSTRALIA, Victoria, Phillip Island, Oswin Roberts Reserve, on leaves of *Eucalyptus* sp. (*Myrtaceae*), 8 Nov. 2014, P.W. Crous, J. Edwards & I.G. Pascoe (holotype CBS H-22621, culture ex-type CPC 25594 = CBS 141325; ITS sequence GenBank KX228285.1, LSU sequence GenBank KX228336.1, *tef1* sequence GenBank KX228378.1, MycoBank MB817051).

Notes — On ITS *Neotrimmatostroma paraexcentricum* is 98 % (467/476) similar to *N. excentricum* (CBS 121102; GenBank KF901518.1) and on *tef1* it is 89 % (331/372) similar to the same isolate (GenBank KF903123.1). Although morphologically similar, the two species can be distinguished in that the secondary conidium cells of *N. excentricum* are 2.5–4.5 µm diam, thus smaller than those of *N. paraexcentricum* (Sutton & Ganapathi 1978, Quaedvlieg et al. 2014).

Colour illustrations. Symptomatic leaves of *Eucalyptus* sp.; conidiomata sporulating on leaf spot, colony on OA, conidiophores and conidia. Scale bars = 10 µm.

Pedro W. Crous & Johannes Z. Groenewald, CBS-KNAW Fungal Biodiversity Centre, P.O. Box 85167, 3508 AD Utrecht, The Netherlands; e-mail: p.crous@cbs.knaw.nl & e.groenewald@cbs.knaw.nl

Ian G. Pascoe & Jacqueline Edwards, AgriBio, Centre for AgriBiosciences, Department of Economic Development, Jobs, Transport and Resources, 5 Ring Road, La Trobe University, Bundoora, Victoria 3083 Australia; e-mail: pascoeig@bigpond.net.au & jacky.edwards@ecodev.vic.gov.au

Setophoma cyperi



Fungal Planet 433 – 4 July 2016

Setophoma cyperi Crous & M.J. Wingf., *sp. nov.*

Etymology. Name refers to *Cyperus*, the plant genus from which this fungus was collected.

Classification — *Phaeosphaeriaceae*, *Pleosporales*, *Dothi-deomycetes*.

Associated with leaf scorch symptoms on *Cyperus*. *Ascomata* immersed on host, erumpent in culture, black, globose, to 200 µm diam, with central ostiole; wall of 3–4 layers of dark brown *textura angularis*. *Pseudoparaphyses* intermingled among asci, hyaline, septate, branched prominently, constricted at septa, 2–4 µm diam. *Asci* bitunicate with apical chamber, sub-cylindrical, hyaline, smooth, fasciculate, stipitate, 8-spored, 65–80 × 11–13 µm. *Ascospores* tri- to multiseriate, fusoid with subobtusely rounded ends, finely verruculose, red-brown, guttulate, 2-septate, slightly constricted at septa, with central cell somewhat swollen, (26–)27–29(–31) × (3.5–)4(–4.5) µm.

Culture characteristics — Colonies reaching up to 30 mm diam on MEA and OA, 10 mm diam on PDA, after 2 wk at 25 °C, with spreading, erumpent surface; margins feathery, and moderate aerial mycelium. On MEA, PDA and OA surface dirty white, reverse dirty white to luteous.

Typus. SOUTH AFRICA, Eastern Cape Province, Haga Haga, on leaves of *Cyperus sphaerocephala* (*Cyperaceae*), Dec. 2014, M.J. Wingfield (holotype CBS H-22622, culture ex-type CPC 25702 = CBS 141450; ITS sequence GenBank KX228286.1, LSU sequence GenBank KX228337.1, MycoBank MB817052).

Notes — On LSU *Setophoma cyperi* is 98 % similar to several genera in *Phaeosphaeriaceae*, including *Setophoma* (e.g. 825/844 to *S. sacchari* CBS 333.39, GenBank GQ387586.1). De Gruyter et al. (2010) introduced the genus *Setophoma* to accommodate *Pyrenochaeta sacchari*, and Phookamsak et al. (2014) recently reported a sexual morph for the genus in *Phaeosphaeriaceae*.

Colour illustrations. Leaves of *Cyperus sphaerocephala*; pseudoparaphyses, asci and ascospores. Scale bars = 10 µm.

Pedro W. Crous & Johannes Z. Groenewald, CBS-KNAW Fungal Biodiversity Centre, P.O. Box 85167, 3508 AD Utrecht, The Netherlands; e-mail: p.crous@cbs.knaw.nl & e.groenewald@cbs.knaw.nl
Michael J. Wingfield, Forestry and Agricultural Biotechnology Institute (FABI), University of Pretoria, Pretoria 0002, South Africa; e-mail: mike.wingfield@up.ac.za

Lareunionomyces syzygii



Fungal Planet 434 – 4 July 2016

***Lareunionomyces* Crous & M.J. Wingf., gen. nov.**

Etymology. Named after the island where this fungus was collected, La Réunion.

Classification — *Incertae sedis*, *Helotiales*, *Leotiomyces*.

Mycelium consisting of hyaline, smooth, branched hyphae. *Conidiophores* solitary, erect, unbranched, subcylindrical, dark brown, smooth, septate, thick-walled, basal cell slightly swollen, lacking rhizoids. *Penicillate conidiogenous apparatus* pale brown, smooth; primary branches brown, smooth, subcylindrical

to clavate, giving rise to up to several secondary branches, pale brown, subcylindrical to clavate; tertiary branches pale brown, giving rise to several phialides. *Phialides* subulate, pale brown, flexuous, venter cylindrical, with prominent collarete. *Conidia* hyaline, smooth, guttulate, subcylindrical, aseptate, apex bluntly rounded, base truncate, in short chains that form slimy spore masses.

Type species. *Lareunionomyces syzygii* Crous & M.J. Wingf.
Mycobank MB817053.

***Lareunionomyces syzygii* Crous & M.J. Wingf., sp. nov.**

Etymology. Name refers to *Syzygium*, the plant genus from which this fungus was collected.

Mycelium consisting of hyaline, smooth, branched, 2–3 µm diam hyphae. *Conidiophores* solitary, erect, unbranched, subcylindrical, dark brown, smooth, 3–7-septate, 50–100 × 5–8 µm, thick-walled, basal cell slightly swollen, to 10 µm diam, lacking rhizoids. *Penicillate conidiogenous apparatus* pale brown, smooth; primary branches brown, smooth, subcylindrical to clavate, 8–15 × 4–6 µm, giving rise to up to 8 secondary branches, pale brown, subcylindrical to clavate, 4–10 × 4–5 µm; tertiary branches pale brown, 4–7 × 3–4 µm, giving rise to several phialides. *Phialides* subulate, pale brown, flexuous, 9–12 × 2–2.5 µm, venter cylindrical, with prominent collarete, 4–6 µm long, apex 1.5–2 µm diam. *Conidia* hyaline, smooth, guttulate, subcylindrical, aseptate, apex bluntly rounded, base truncate, (3.5–)4(–5) × (1.5–)2 µm, in short chains that form slimy spore masses.

Culture characteristics — Colonies reaching up to 8 mm diam after 2 wk at 25 °C, with spreading, erumpent surface; margins smooth, lobate, and sparse aerial mycelium. On MEA surface pale luteous, reverse umber. On PDA and OA surface and reverse umber.

Typus. FRANCE, La Réunion, on leaves of *Syzygium jambos* (*Myrtaceae*), 12 Mar. 2015, P.W. Crous & M.J. Wingfield (holotype CBS H-22623, culture ex-type CPC 26531 = CBS 141326; ITS sequence GenBank KX228287.1, LSU sequence GenBank KX228338.1, MycoBank MB817054).

Notes — Based on its mode of conidiogenesis, Wingfield et al. (1987) regarded *Sporendocladia* as separate from *Phialocephala* and Jacobs et al. (2003) showed that this complex is paraphyletic. Based on identification in the MycoBank nucleotide database the LSU sequence of the present collection is 98.4 % similar to an isolate identified as *Sporendocladia foliicola* (CBS 201.95) and it is possible that these two species could be congeneric. The type of *Sporendocladia* (*S. castanaea*) is regarded as synonym of *S. fumosa* (Wingfield et al. 1987, Crous & Wingfield 1994) but the culture, CBS 518.93, is not congeneric with the present collection, and hence a new genus is introduced here to accommodate the present collection. Morphologically, *Sporendocladia* is similar to *Lareunionomyces*, except that the latter genus has a more intricate conidiogenous apparatus, with numerous tightly aggregated branches and phialides.

Colour illustrations. Branch of *Syzygium jambos*; colony on OA, conidiophores and conidia. Scale bars = 10 µm.

Pedro W. Crous, CBS-KNAW Fungal Biodiversity Centre, P.O. Box 85167, 3508 AD Utrecht, The Netherlands; e-mail: p.crous@cbs.knaw.nl
Michael J. Wingfield, Forestry and Agricultural Biotechnology Institute (FABI), University of Pretoria, Pretoria 0002, South Africa; e-mail: mike.wingfield@up.ac.za
Johannes J. Le Roux & David M. Richardson, Centre for Invasion Biology, Department of Botany & Zoology, Stellenbosch University, Matieland 7602, South Africa; e-mail: jleroux@sun.ac.za & rich@sun.ac.za
Dominique Strasberg, Université de La Réunion, UMR PVBMT, Peuplements Végétaux et Bioagresseurs en Milieu Tropical, 15 avenue René Cassin, CS 93002, 97 744 Saint-Denis Messag. Cedex 9, La Réunion, France; e-mail: dominique.strasberg@univ-reunion.fr

Parawiesneriomyces syzygii



Fungal Planet 435 – 4 July 2016

***Parawiesneriomyces* Crous & M.J. Wingf., gen. nov.**

Etymology. Name reflects a morphological similarity to the genus *Wiesneriomyces*.

Classification — *Wiesneriomycetaceae*, *Tubeufiales*, *Dothideomycetes*.

Mycelium consisting of brown, finely verruculose, branched, septate hyphae, giving rise to hyphopodia-like structures, with several lateral branches, creating a cauliflower-like appearance. Setae loosely associated with sporodochia, erect, flexuous, base bulbous, lacking rhizoids, apex acute, thick-walled, smooth, granular, dark brown, septate. *Conidiomata* sporodochial, solitary, becoming somewhat gregarious in older cultures, hyaline, becoming pale luteous with age; arising from

a basal stroma of loosely aggregated brown hyphae that give rise to densely aggregated, hyaline, penicillate conidiophores. *Conidiophores* hyaline, smooth, penicillate, septate (constricted at septa), branched, with several series of branches. *Conidiogenous cells* terminal, clavate, hyaline, smooth, straight to gently curved, polyblastic, with several flat-tipped apical loci. *Conidia* solitary, aggregated in mucoid mass, hyaline, smooth, granular, prominently guttulate, subcylindrical, widest in middle with taper towards both ends that are obtusely rounded, septate, prominently constricted at septa, joined by a narrow isthmus.

Type species. *Parawiesneriomyces syzygii* Crous & M.J. Wingf.
Mycobank MB817060.

***Parawiesneriomyces syzygii* Crous & M.J. Wingf., sp. nov.**

Etymology. Name refers to *Syzygium*, the plant genus from which this fungus was collected.

Mycelium (on SNA, OA and PNA) consisting of brown, finely verruculose, branched, septate, 3–5 µm diam hyphae, giving rise to hyphopodia-like structures, up to 25 µm tall, with several lateral branches (5–15 µm diam), creating a cauliflower-like appearance. Setae loosely associated with sporodochia, erect, flexuous, base bulbous (7–15 µm diam), lacking rhizoids, apex acute, thick-walled, smooth, granular, dark brown, 8–12-septate (at times minutely constricted at some septa), 180–300 µm tall. *Conidiomata* sporodochial, 80–300 µm diam, solitary, becoming somewhat gregarious in older cultures, hyaline, becoming pale luteous with age; arising from a basal stroma of loosely aggregated brown hyphae that give rise to densely aggregated, hyaline, penicillate conidiophores. *Conidiophores* hyaline, smooth, penicillate, septate (constricted at septa), branched, 40–80 × 3–4 µm, with up to three series of branches. *Conidiogenous cells* terminal, clavate, hyaline, smooth, straight to gently curved, 5–8 × 3–4 µm, polyblastic, with several flat-tipped apical loci, 0.5–1 µm diam. *Conidia* solitary, aggregated in mucoid mass, hyaline, smooth, granular, prominently guttulate, subcylindrical, widest in middle with taper towards both ends that are obtusely rounded, (4–)6–7-septate, prominently constricted at septa, joined by a narrow isthmus, (41–)65–75(–80) × 2(–3.5) µm, median cells 9–12 µm long, terminal cells 8–10 × 2–3 µm.

Culture characteristics — Colonies reaching up to 60 mm diam after 3 wk at 25 °C, with spreading, flat surface; margins smooth, even, and moderate aerial mycelium. On MEA, OA and PDA surface and reverse mouse-grey with patches of dark mouse-grey.

Colour illustrations. Conidiomata sporulating on PNA, seta, cauliflower-like lateral branch, conidiogenous apparatus and conidia. Scale bars: seta = 300 µm, all others = 10 µm.

Typus. FRANCE, La Réunion, on leaves of *Syzygium jambos* (*Myrtaceae*), 12 Mar. 2015, P.W. Crous & M.J. Wingfield (holotype CBS H-22630, culture ex-type CPC 26528 = CBS 141333; ITS sequence GenBank KX228288.1, LSU sequence GenBank KX228339.1, MycoBank MB817061).

Notes — *Wiesneriomycetaceae* accommodates two genera, namely *Wiesneriomyces* and *Pseudogliophragma* (Suetrong et al. 2014, Pratibha et al. 2015). Based on LSU sequence data, the present isolate is more closely related to *Pseudogliophragma indicum* (815/825 (99 %); MTCC 11985; GenBank KM052851.1) than to *Wiesneriomyces conjunctosporus* (798/823 (97 %); BCC18525; GenBank KJ425450.1). Morphologically, *Parawiesneriomyces* closely resembles the genus *Wiesneriomyces*, but can be distinguished in that sporodochia are not elevated by a dark pseudoparenchymatous stalk, but arise flat on the agar surface, and the setae are not directly linked to sporodochia, but also occur in the absence of sporodochia. *Parawiesneriomyces syzygii* differs from *W. conjunctosporus* (setae up to 650 µm tall, conidia 230–360 µm long) by having shorter setae and conidia (Kuthubutheen & Nawawi 1988). Incidentally, both Kuthubutheen & Nawawi (1988) and Suetrong et al. (2014) regarded the conidial propagules as defined here as chains of individual conidia, whereas we regard this as a single, multiseptate conidium. This is also based on the difference in morphology between the median and end cells of the propagule, and that fact that the conidium does not readily break into smaller 'conidia' with age. Pratibha et al. (2015) were in agreement with this interpretation and referred to these propagules as phragmoconidia.

Pedro W. Crous, CBS-KNAW Fungal Biodiversity Centre, P.O. Box 85167, 3508 AD Utrecht, The Netherlands; e-mail: p.crous@cbs.knaw.nl
Michael J. Wingfield, Forestry and Agricultural Biotechnology Institute (FABI), University of Pretoria, Pretoria 0002, South Africa; e-mail: mike.wingfield@up.ac.za
Johannes J. Le Roux & David M. Richardson, Centre for Invasion Biology, Department of Botany & Zoology, Stellenbosch University, Matieland 7602, South Africa; e-mail: jleroux@sun.ac.za & rich@sun.ac.za
Dominique Strasberg, Université de La Réunion, UMR PVBMT, Peuplements Végétaux et Bioagresseurs en Milieu Tropical, 15 avenue René Cassin, CS 93002, 97 744 Saint-Denis Messag. Cedex 9, La Réunion, France; e-mail: dominique.strasberg@univ-reunion.fr

Pseudophloeospora eucalyptorum

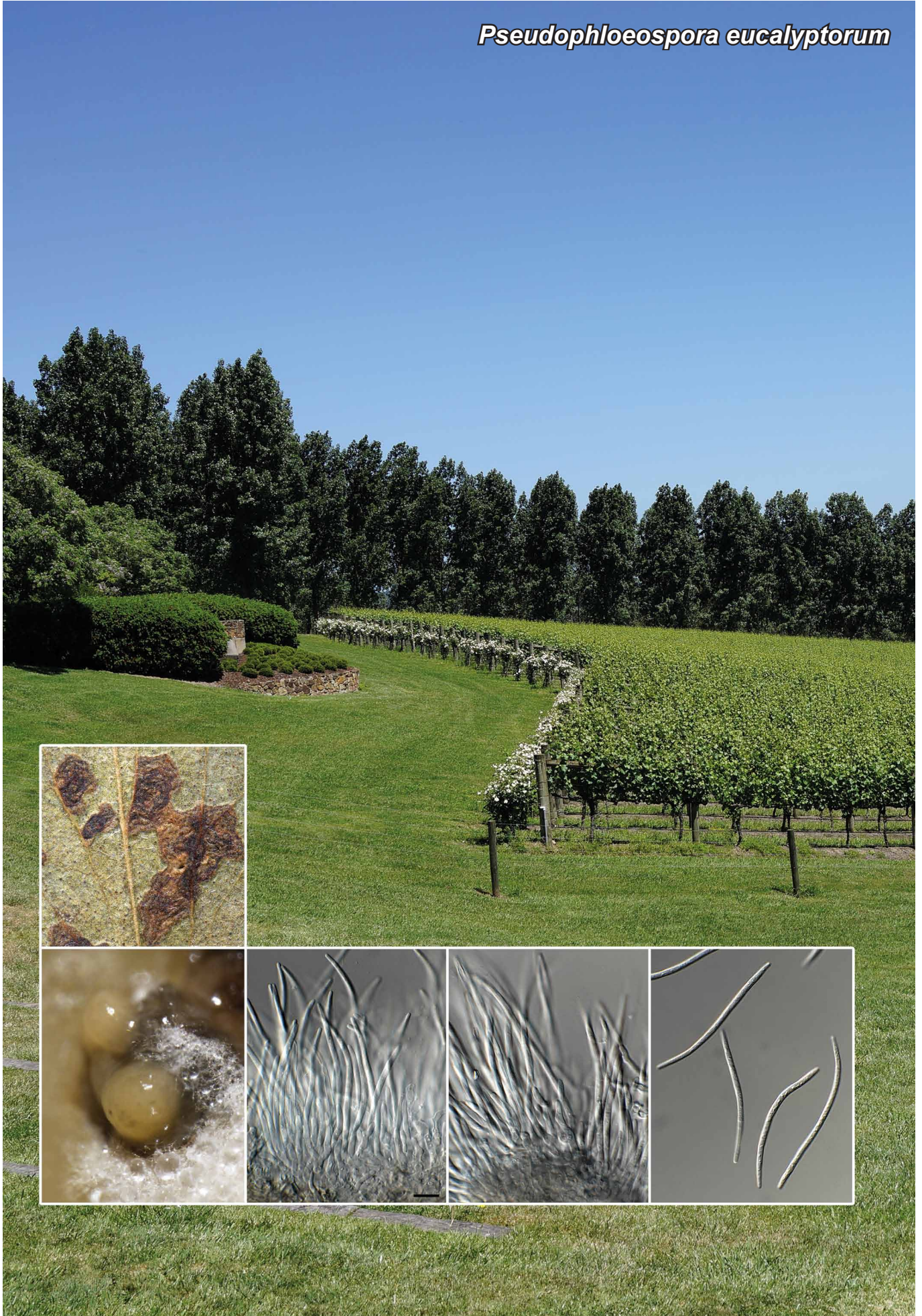

Fungal Planet 436 – 4 July 2016

Pseudophloeospora eucalyptorum Crous, Jacq. Edwards & Pascoe, *sp. nov.*

Etymology. Name refers to *Eucalyptus*, the plant genus from which this fungus was collected.

Classification — *Incertae sedis*, *Xylariales*, *Sordariomycetes*.

Leaf spots amphigenous, angular to irregular, medium to dark brown, 2–7 µm diam with raised border. *Conidiomata* pycnidial on host, in culture appearing more acervular to even sporodochial, brown, to 250 µm diam; wall of 3–6 layers of pale brown *textura angularis*. *Conidiophores* lining inner cavity, hyaline, smooth, subcylindrical, branched, 1–5-septate, 15–60 × 2.5–3.5 µm. *Conidiogenous cells* terminal and lateral, hyaline, smooth, tapering towards truncate apex, proliferating sympodially as well as inconspicuously percurrently at apex, 5–15 × 2–2.5 µm. *Conidia* hyaline, smooth, filiform, guttulate, flexuous, subcylindrical, widest in lower third, tapering to an acutely rounded apex, and truncate base, 1.5 µm diam, 3-septate, (30–)50–67(–75) × 2.5(–3) µm.

Culture characteristics — Colonies reaching up to 30 mm diam after 2 wk at 25 °C, with spreading, erumpent, folded surface; margins feathery, lobate, and moderate aerial mycelium. On MEA surface dirty white, with patches of pale mouse grey, reverse sienna with patches of luteous. On OA surface dirty white. On PDA surface sienna to luteous, reverse ochreous.

Typus. AUSTRALIA, Victoria, near Gurdies Winery, Gurdies-St. Helier Road, The Gurdies, S38°22'49.8" E145°34'23.4", on leaves of *Eucalyptus* sp. (*Myrtaceae*), 7 Nov. 2014, P.W. Crous, J. Edwards & I.G. Pascoe (holotype CBS H-22624, culture ex-type CPC 25600 = CBS 141327; ITS sequence GenBank KX228289.1, LSU sequence GenBank KX228340.1, MycoBank MB817055).

Notes — On ITS *Pseudophloeospora eucalyptorum* is 98 % (612/625) similar to *Pseudophloeospora eucalypti* (CBS 128212; GenBank HQ599592). Morphologically, the two species can be distinguished in that on average the conidia of *P. eucalypti* are larger, (60–)65–75(–80) × (1.5–)2(–2.5) µm (Crous et al. 2010b).

Colour illustrations. Australian winery; symptomatic *Eucalyptus* leaf, colony sporulating on OA, conidiophores and conidia. Scale bar = 10 µm.

Pedro W. Crous & Johannes Z. Groenewald, CBS-KNAW Fungal Biodiversity Centre, P.O. Box 85167, 3508 AD Utrecht, The Netherlands;

e-mail: p.crous@cbs.knaw.nl & e.groenewald@cbs.knaw.nl

Ian G. Pascoe & Jacqueline Edwards, AgriBio Centre for AgriBiosciences, Department of Economic Development, Jobs, Transport and Resources,

5 Ring Road, LaTrobe University, Bundoora, Victoria 3083 Australia;

e-mail: pascoeig@bigpond.net.au & jacky.edwards@ecodev.vic.gov.au

Proxipyricularia asari



Fungal Planet 437 – 4 July 2016

Proxipyricularia asari Crous & M.J. Wingf., *sp. nov.*

Etymology. Name refers to *Asarum*, the plant genus from which this fungus was collected.

Classification — *Pyriculariaceae*, *Magnaporthales*, *Sordariomycetes*.

Ascomata separate, immersed, globose, brown, to 200 µm diam, with central papillate ostiole; wall of 2–4 layers of brown *textura angularis*. *Hamathecium* dissolving upon maturity, with some cells remaining among asci. *Asci* unitunicate, hyaline, smooth, 8-spored, subcylindrical, stipitate, apical mechanism refractive, but not straining in Meltzer's, 50–75 × 10–12 µm. *Ascospores* biseriate, fusoid-ellipsoid, widest in middle, with taper towards subobtusely rounded ends, slightly curved to straight, 3-septate, pale brown, guttulate, (16–)18–20(–22) × (4–)5 µm. *Conidiophores* solitary, erect, straight to flexuous, unbranched, subcylindrical, brown, smooth, 1–8-septate, 55–200 × 3.5–5 µm. *Conidiogenous cells* integrated, terminal, apex somewhat swollen with numerous denticle-like loci, 1–1.5 µm tall and in diam, slightly thickened and darkened, 25–60 × 3.5–5 µm. *Conidia* solitary, pyriform, brown, finely verruculose, guttulate, granular, apex subobtusely rounded, with or without mucoid cap, base truncate, hilum 1.5 µm diam, darkened, thickened, 2-septate, (20–)22–24(–26) × (6.5–)7–8 µm.

Culture characteristics — Colonies covering dish after 2 wk at 25 °C, with moderate aerial mycelium and smooth, even margins. On MEA surface pale mouse-grey with patches of dirty white, reverse isabelline with patches of pale luteous. On OA surface honey with patches of pale mouse grey. On PDA surface honey, reverse isabelline to honey.

Typus. MALAYSIA, Sabah, on leaves and stems of *Asarum* sp. (*Aristolochiaceae*), May 2015, M.J. Wingfield (holotype CBS H-22625, culture ex-type CPC 27444 = CBS 141328; ITS sequence GenBank KX228291.1, LSU sequence GenBank KX228342.1, *actA* sequence GenBank KX228361.1, *rpb1* sequence GenBank KX228368.1, MycoBank MB817056); *ibid.*, CPC 27442 (ITS sequence GenBank KX228290.1, LSU sequence GenBank KX228341.1, *actA* sequence GenBank KX228360.1).

Notes — On LSU *Proxipyricularia asari* is 99 % (736/740) similar to species of *Proxipyricularia*, *Neopyricularia* and *Pyricularia*. The *rpb1* sequence is 92 % (900/978) similar to *Pyricularia ctenantheicola* (GR0001; GenBank KM485098.1) and 89 % (868/975) to *Proxipyricularia zingiberis* (HYZiM201-0-1; GenBank KM485091.1), suggesting that this may even represent yet another genus in this complex (Klaubauf et al. 2014).

Colour illustrations. Forest undergrowth in Malaysia; ascomata on stem of *Asarum* sp., ascoma, asci, conidiophores and conidia. Scale bars: ascoma = 200 µm, all others = 10 µm.

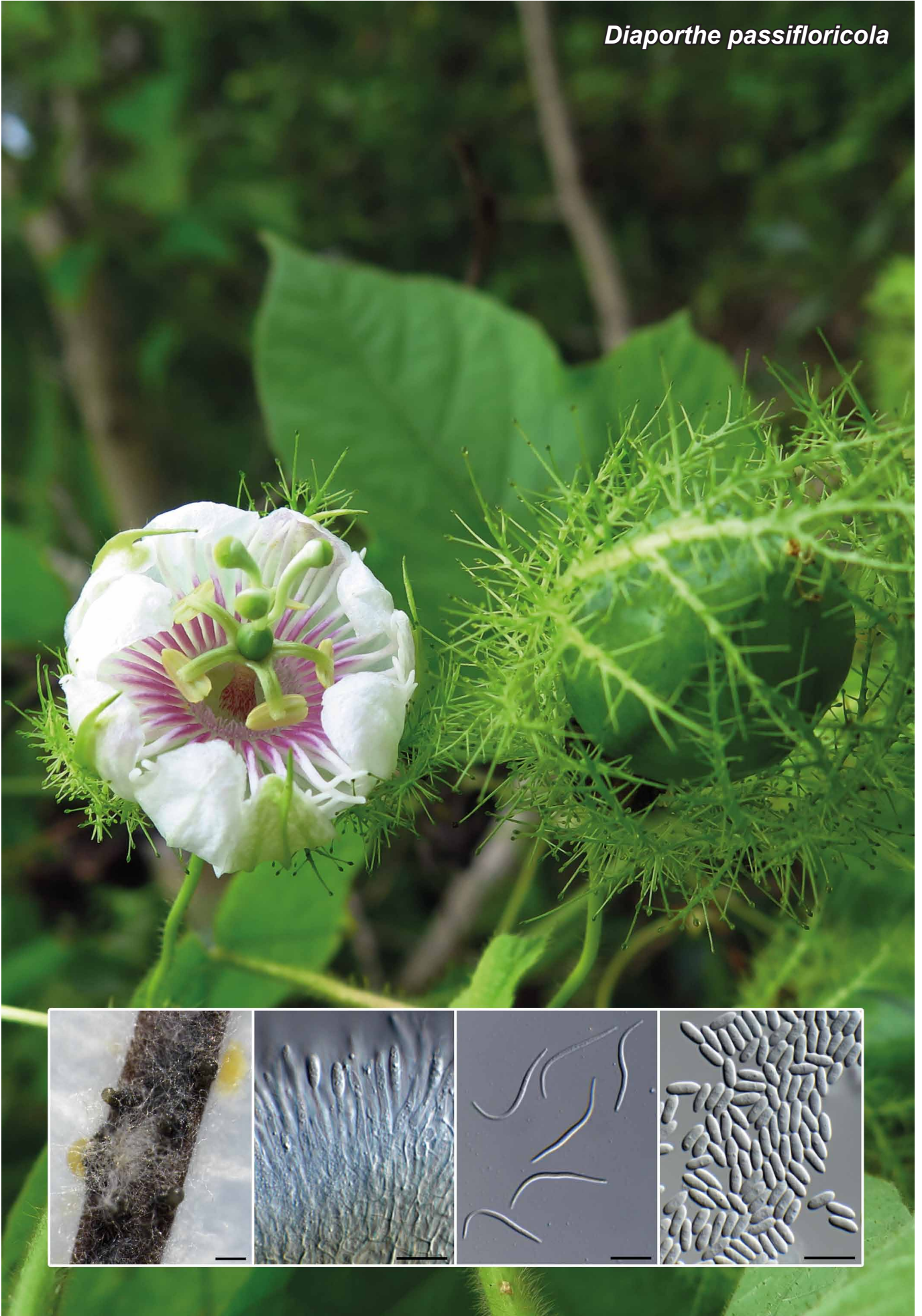
Diaporthe passifloricola

Fungal Planet 438 – 4 July 2016

***Diaporthe passifloricola* Crous & M.J. Wingf., sp. nov.**

Etymology. Name refers to *Passiflora*, the plant genus from which this fungus was collected.

Classification — *Diaporthaceae*, *Diaporthales*, *Sordariomycetes*.

Conidiomata (on pine needle agar; PNA) pycnidial, solitary, black, erumpent, globose, to 250 µm diam, with short black neck, exuding creamy droplets from central ostioles; walls consisting of 3–6 layers of medium brown *textura angularis*. *Conidiophores* hyaline, smooth, 2–3-septate, branched, densely aggregated, cylindrical, straight to sinuous, 20–50 × 3–4 µm. *Conidiogenous cells* 7–20 × 1.5–2.5 µm, phialidic, cylindrical, terminal and lateral with slight taper towards apex, 1–1.5 µm diam, with visible periclinal thickening; collarette not observed. *Paraphyses* not observed. *Alpha conidia* aseptate, hyaline, smooth, guttulate, fusoid-ellipsoid, tapering towards both ends, apex subobtuse, base subtruncate, (5–)6–7(–9) × 2.5(–3) µm. *Gamma conidia* not observed. *Beta conidia* spindle-shaped, aseptate, smooth, hyaline, apex acutely rounded, base truncate, tapering from lower third towards apex, curved, (20–)22–25(–27) × 1.5(–2) µm.

Culture characteristics — Colonies covering dish after 2 wk at 25 °C, with even, smooth margins, and fluffy aerial mycelium. On MEA surface dirty white, reverse luteous to ochreous. On OA surface dirty white. On PDA surface dirty white, reverse saffron.

Typus. MALAYSIA, Kota Kinabalu, on leaf spots of *Passiflora foetida* (*Passifloraceae*), May 2015, M.J. Wingfield (holotype CBS H-22626, culture ex-type CPC 27480 = CBS 141329; ITS sequence GenBank KX228292.1, LSU sequence GenBank KX228343.1, *his3* sequence GenBank KX228367.1, *tub2* sequence GenBank KX228387.1, MycoBank MB817057).

Notes — On ITS *Diaporthe passifloricola* is 98 % (556/567) similar to *D. miriciae* (BRIP 56918a; GenBank KJ197284.1) and 90 % (466/519)–93 % (402/430) similar to five sequences of '*Phomopsis*' *tersa* deposited on GenBank (e.g. KF516000.1 and JQ585648.1). The *his3* sequence is 100 % (380/380) identical to *D. absenteum* (LC3564; GenBank KP293559.1) and 99 % (378/380) to the sterile *Diaporthe* 'sp. 1 RG-2013' (LGMF947; GenBank KC343687.1), whereas the *tub2* sequence is 99 % (513/517) to the sterile *Diaporthe* 'sp. 1 RG-2013' (LGMF947; GenBank KC344171.1) and 99 % (589/595) to *D. miriciae* (BRIP 56918a; GenBank KJ197264.1). Although alpha conidia of *D. miriciae* are similar in size ((6–)7.5(–9) × 2–2.5(–3) µm), beta conidia are larger (20–35 × 1.0–1.5 µm) and conidiophores are shorter (10–20 × 1.5–3 µm) (Thompson et al. 2015). Other species previously reported from *Passiflora* include *D. passiflorae* (conidia 14–20 × 1.5–2 µm; Crous et al. 2012a) and '*Phomopsis*' *tersa* (conidia 6.5–7.5 × 2.5 µm) (Sutton 1980). '*Phomopsis*' *tersa* has alpha conidia of similar dimensions, but has much larger conidiomata (to 650 µm diam), shorter conidiophores (to 15 µm long) and lacks beta conidia (Sutton 1980).

Colour illustrations. Flower of *Passiflora foetida*; conidiomata sporulating on PNA, conidiophores, beta and alpha conidia. Scale bars: conidiomata = 250 µm, all others = 10 µm.



Fungal Planet 439 – 4 July 2016

Diaporthe ocoteae Crous & M.J. Wingf., *sp. nov.*

Etymology. Name refers to *Ocotea*, the plant genus from which this fungus was collected.

Classification — *Diaporthaceae*, *Diaporthales*, *Sordariomycetes*.

Conidiomata (on pine needle agar; PNA) pycnidial, solitary, black, erumpent, globose, to 300 µm diam, exuding creamy droplets from central ostioles; walls consisting of 3–6 layers of medium brown *textura angularis*. *Conidiophores* hyaline, smooth, 2–3-septate, branched, densely aggregated, cylindrical, straight to sinuous, 15–35 × 2.5–4 µm. *Conidiogenous cells* 7–15 × 2–3 µm, phialidic, cylindrical, terminal and lateral with slight taper towards apex, 1.5 µm diam, with visible periclinal thickening; collarette not flared, up to 1 µm long when present. *Paraphyses* cylindrical, hyaline, smooth, 1–6-septate, 30–80 × 2–3 µm. *Alpha conidia* aseptate, hyaline, smooth, guttulate, fusoid, tapering towards both ends, apex subobtuse, base subtruncate, (8–)9–10(–13) × (2–)2.5–3 µm. *Gamma conidia* not observed. *Beta conidia* not observed.

Culture characteristics — Colonies covering dish after 2 wk at 25 °C, with sparse to moderate aerial mycelium. On MEA surface dirty white with patches of pale mouse grey, reverse umber with patches of luteous. On OA surface pale luteous with patches of umber. On PDA surface and reverse pale luteous with patches of pale mouse-grey.

Typus. FRANCE, La Réunion, on leaves of *Ocotea obtusata* (*Lauraceae*), 6 Mar. 2015, P.W. Crous & M.J. Wingfield (holotype CBS H-22627, culture ex-type CPC 26217 = CBS 141330; ITS sequence GenBank KX228293.1, LSU sequence GenBank KX228344.1, *tub2* sequence GenBank KX228388.1, MycoBank MB817058).

Notes — Based on LSU sequence data *Diaporthe ocoteae* is 99 % similar to species of *Diaporthe* and *Phaeocystostroma* (Lamprecht et al. 2011, Rossman et al. 2015) and based on ITS < 95 % and *tub2* < 90 % similar to presently known species of *Diaporthe*. As far as we could establish, no *Diaporthe* sp. has thus far been described from *Ocotea* and hence *Diaporthe ocoteae* is introduced as a new species.

Colour illustrations. Forest on La Réunion; conidiomata sporulating on PNA, conidiophores and conidia. Scale bar = 10 µm.

Pedro W. Crous, CBS-KNAW Fungal Biodiversity Centre, P.O. Box 85167, 3508 AD Utrecht, The Netherlands; e-mail: p.crous@cbs.knaw.nl
Michael J. Wingfield, Forestry and Agricultural Biotechnology Institute (FABI), University of Pretoria, Pretoria 0002, South Africa; e-mail: mike.wingfield@up.ac.za
Johannes J. Le Roux & David M. Richardson, Centre for Invasion Biology, Department of Botany & Zoology, Stellenbosch University, Matieland 7602, South Africa; e-mail: jleroux@sun.ac.za & rich@sun.ac.za
Dominique Strasberg, Université de La Réunion, UMR PVBMT, Peuplements Végétaux et Bioagresseurs en Milieu Tropical, 15 avenue René Cassin, CS 93002, 97 744 Saint-Denis Messag. Cedex 9, La Réunion, France; e-mail: dominique.strasberg@univ-reunion.fr

Phaeosphaeria breonadiae

Fungal Planet 440 – 4 July 2016

Phaeosphaeria breonadiae Crous & Jol. Roux, *sp. nov.*

Etymology. Name refers to *Breonadia*, the plant genus from which this fungus was collected.

Classification — *Phaeosphaeriaceae*, *Pleosporales*, *Dothi-deomycetes*.

Leaf spots prominent on hypophyllous leaf surface, subcircular, medium brown, erumpent, with raised margin, 3–7 mm diam, with immersed black pseudothecia; upper leaf surface with pale green spot, lacking any ascomata. *Ascomata* globose to papillate, dark brown with central darker brown ostiole, up to 30 µm diam, solitary, but commonly aggregated in a cluster, joined by stromatic tissue, up to 250 µm diam; wall of several layers of brown *textura angularis*. *Asci* short stipitate, bitunicate, cylindrical-ellipsoid, with obtuse apex and small apical chamber, 35–60 × 8–11 µm, 8-spored, straight to irregularly curved. *Pseudoparaphyses* intermingled among asci, hyaline, septate, anastomosing, hyphae-like, 2.5–3.5 µm diam. *Ascospores* bi- to triseriate in asci, fusoid-ellipsoidal with obtuse ends, 3-septate, constricted at median septum, second cell from apex swollen, medium brown, smooth, guttulate to granular, (16–)18–20(–21) × (3.5–)4–5 µm; ascospores are homothallic and produce the sexual morph in culture; ascospores distorting somewhat at germination, brown, finely roughened, with germ tubes growing parallel to the long axis of the spore.

Culture characteristics — Colonies reaching up to 40 mm diam after 2 wk at 25 °C, with spreading, flat surface; margins uneven, feathery; aerial mycelium absent to sparse. On MEA surface dirty white to pale luteous, reverse luteous. On OA surface luteous. On PDA surface luteous, reverse saffron.

Typus. SOUTH AFRICA, Limpopo Province, Wolkberg, on leaves of *Breonadia microcephala* (*Rubiaceae*), Jan. 2015, J. Roux (holotype CBS H-22631, culture ex-type CPC 25944 = CBS 141334; ITS sequence GenBank KX228294.1, LSU sequence GenBank KX228345.1, *tef1* sequence GenBank KX228379.1, MycoBank MB817062).

Notes — At least three species are present on these lesions. One of these resembled *Teratosphaeria*, another having aseptate ascospores and the third being the *Phaeosphaeria* ascomycete described here. LSU sequence data places *Phaeosphaeria breonadiae* with 98 % identity in *Phaeosphaeria*. Based on ITS, it is 99 % (564/566) similar to '*Phoma* sp. 2' TMS-2011 voucher SC12d10p12-12 (GenBank HQ631048.1), an isolate obtained from decaying sugarcane in the USA (Shrestha et al. 2011). The isolate did not produce the asexual morph in culture, but based on its DNA sequence, it appears to be the same, or closely related species to the USA isolate (Shrestha et al. 2011). The *tef1* sequence did not yield results showing high similarity to other fungi.

Colour illustrations. Wolkberg in Limpopo Province; leaf spot, ascomata on OA, asci and germinating ascospores. Scale bars = 10 µm.

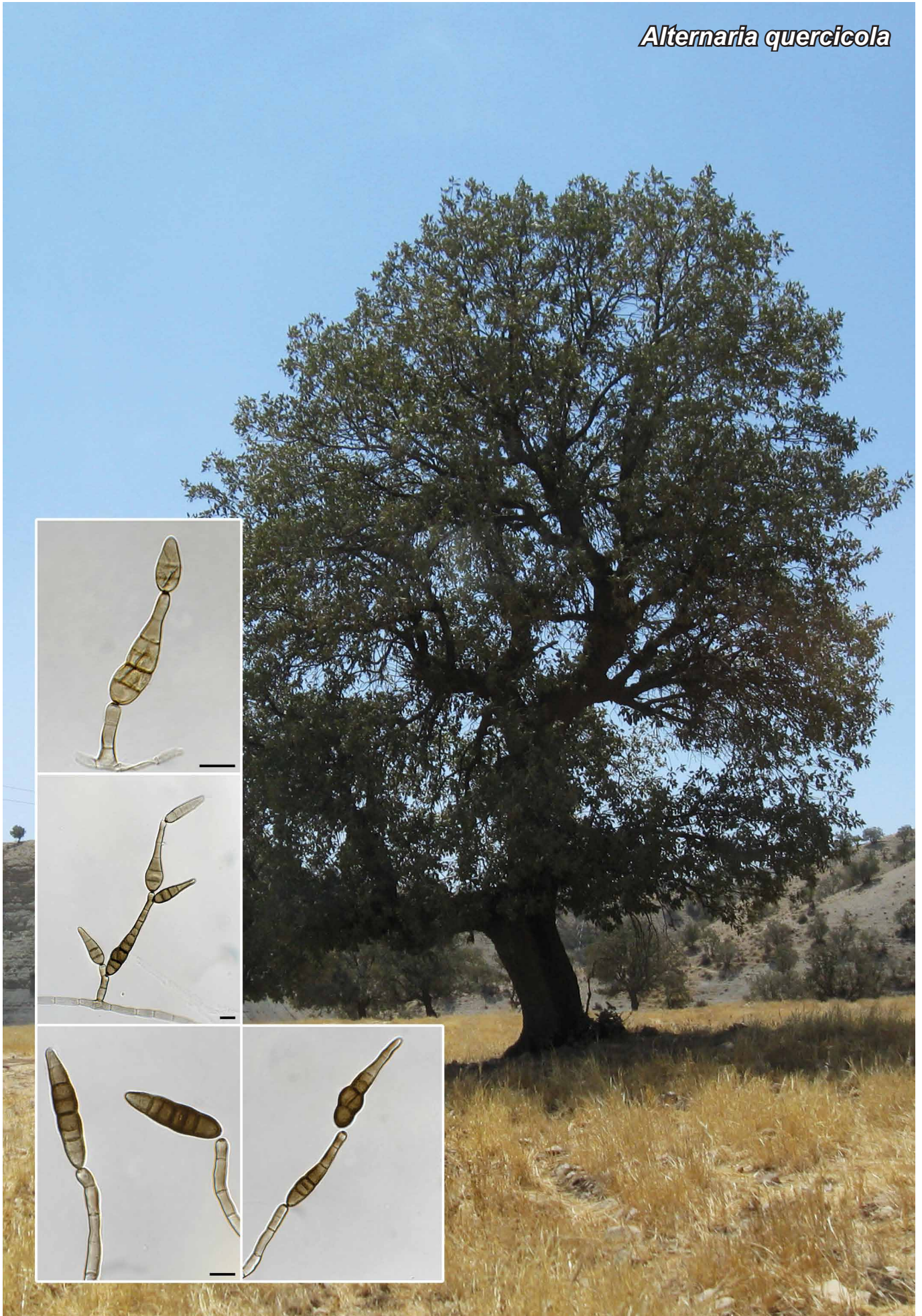
Alternaria quercicola

Fungal Planet 441 – 4 July 2016

Alternaria quercicola Woudenb. & Mirab., *sp. nov.*

Etymology. Named after the plant genus from which it was isolated, *Quercus*.

Classification — *Pleosporaceae*, *Pleosporales*, *Dothideo-mycetes*

Associated with shothole disease symptoms on leaves. Infected tissues die and cannot expand as the leaf continues to grow, eventually tearing out, creating the typical disease symptoms. *Primary conidiophores* solitary, smooth, straight to slightly curved, septate, pale brown with a hyaline tip, (16–)21–37(–48) × 3–4(–5) μm, bearing 0–1 geniculate conidiogenous extensions with darkened conidiogenous loci. *Conidia* solitary or in short chains, simple or branched, pale olive-brown, (narrowly) ovoid to obpyriform, primary conidia (25–)31–51(–57) × (6–)8–11(–12) μm, with 3–8 *transverse septa* and occasionally 1 oblique or *longitudinal septa*, rough walled at the lower sections and smooth walled at the top sections. The conidial body sometimes constricted near thickened and darkened transverse septa. Conidia can form an apical *secondary conidiophore*, which can again form a geniculate conidiogenous extension. *Sexual morph* not observed.

Culture characteristics — After 7 d cultures on SNA flat, fimbriate, colourless, aerial mycelium sparse, colonies reaching 50 mm diam; cultures on PCA flat, entire, colourless, aerial mycelium sparse, colonies reaching 60 mm diam.

Typus. IRAN, Fars province, on leaves of *Quercus brantii* (*Fagaceae*), 3 May 2013, *M. Mirabolfathy* (holotype CBS H-22640, culture ex-type CPC 26163 = CBS 141466; ITS sequence GenBank KX228295.1, LSU sequence GenBank KX228346.1, *gapdh* sequence GenBank KX228362.1, MycoBank MB817068); *ibid.*, CPC 26164, CPC 26165 (ITS, LSU, *gapdh* sequences GenBank KX228296.1–KX228297.1, KX228347.1–KX228348.1, KX228363.1–KX228364.1).

Notes — Species of *Alternaria* are commonly associated with leaf spot, postharvest and other diseases of various crops. Recent molecular studies have revealed that species of the genus cluster in several distinct species clades, now referred to as sections, which places *A. quercicola* within section *Infectoria* (Woudenberg et al. 2013, 2014, 2015). Based on the gene loci sequenced, *A. quercicola* is clearly distinct from other taxa in the *Infectoria* complex. *Alternaria querci* represents a potentially similar species occurring on *Fagaceae* in China (Zhang et al. 1999). Unfortunately, no culture was available for study, and the description was insufficient to make a good comparison.

Colour illustrations. Iran, *Quercus brantii* (Persian oak) tree; conidiophores, with conidiogenous cells and conidia. Scale bars = 10 μm.

Joyce H.C. Woudenberg, Pedro W. Crous & Johannes Z. Groenewald, CBS-KNAW Fungal Biodiversity Centre, P.O. Box 85167, 3508 AD Utrecht, The Netherlands;
e-mail: j.woudenberg@cbs.knaw.nl, p.crous@cbs.knaw.nl & e.groenewald@cbs.knaw.nl
Mansoureh Mirabolfathy, Iranian Research Institute of Plant Protection, Tehran, Iran;
e-mail: mmirab2000@yahoo.com

Stemphylium beticola



Fungal Planet 442 – 4 July 2016

Stemphylium beticola Woudenb. & Hanse, *sp. nov.*

Etymology. Named after the plant genus from which it was collected, *Beta*.

Classification — *Pleosporaceae*, *Pleosporales*, *Dothideo-mycetes*.

Conidiophores solitary, straight to flexuous, occasionally branched, septate, smooth, pale brown, (41–)45–72(–88) × 4–5 µm, bearing 1–3 darkened percurrent rejuvenation sites. *Conidiogenous cells* swollen at the apex, darkened, 5–6 µm wide. *Conidia* solitary, conidium body pale olive-brown, verrucose, ellipsoid to cylindrical, (21–)22–26(–30) × (13–)14–16(–18) µm, L/W = 1.6, with 2–4 *transverse septa* and 1–3 *longitudinal* and 0–2 *oblique septa* per transverse sector. Constricted at 1–2 darkened transverse septa. Occasionally with an apical *secondary conidiophore*. Immature ascomata of *sexual morph* observed on agar, pseudothecia globose, ellipsoid or irregular, single or aggregated, ranging from 100–300 µm tall.

Culture characteristics — After 7 d cultures on SNA flat, fimbriate, colourless with abundant black ascomatal initials in the agar, aerial mycelium is sparse, white, colonies reaching 45–55 mm diam; cultures on PCA flat, entire to undulate, colourless with abundant black ascomata in the agar, aerial mycelium sparse, floccose, (greenish) olivaceous; colonies reaching 50–60 mm diam.

Typus. NETHERLANDS, Noord-Brabant, Langenboom, on leaves of *Beta vulgaris* (*Amaranthaceae*), 17 Aug. 2011, *P. Wilting* (holotype CBS H-22486, culture ex-type GV11-265a = CBS 141024; ITS sequence GenBank KU850520, LSU sequence GenBank KX228349.1, *gapdh* sequence GenBank KU850667, MycoBank MB815876).

Additional specimens examined. NETHERLANDS, Drenthe, Eerste Exloërmond, on leaves of *Beta vulgaris*, 11 Sept. 2012, *B. Hanse*, GV12-474a1 = CBS 141026; ITS sequence GenBank KU850522, *gapdh* sequence GenBank KU850669; Groningen, Nieuwe Pekela, on leaves of *Beta vulgaris*, 17 July 2012, *J. Lingbeek*, GV12-288-2 = CBS 141025; ITS sequence GenBank KU850521.1, *gapdh* sequence GenBank KU850668.1.

Colour illustrations. The Netherlands, *Beta vulgaris* field; yellow leaf spots on *Beta vulgaris*; ascomata; conidiophores with conidiogenous cells and conidia. Scale bars: ascomata = 100 µm, others = 10 µm.

Notes — In 2007 a new leaf spot disease was first discovered on sugar beet (*Beta vulgaris*) in the Netherlands, which spread rapidly throughout the country in the following years (Hanse 2013). Currently, the disease has been detected in Belgium, Denmark, Germany, Poland, Slovakia, Sweden and the UK (unpubl. data). The disease manifests in June–August and starts with small, irregular, yellow spots on the leaves of sugar beet. The yellow spots become necrotic from the centre of the lesion outwards with tissue turning brown. The spots spread over all the leaves of the plant, and in case of severe infestation, heavily infected leaves will die. Due to this loss of leaves the canopy, and thus sugar yield, declines. A *Stemphylium* sp. was detected as the causative agent and additional field trials showed that the fungus is hard to control with the current registered fungicides in the Netherlands (Hanse et al. 2015). Host range tests under climate room conditions showed that the fungus was not restricted to sugar beet, but could also infect potato (*Solanum tuberosum*), white mustard (*Sinapsis alba*), red beet (*Beta vulgaris*), spinach (*Spinacia oleracea*) and fat hen (*Chenopodium album*) (Hanse et al. 2015). Blast searches of the ITS and *gapdh* gene sequences give high similarity hits with isolates CBS 116599 (P107), CBS 135690 (P212) and CBS 133892 (P221), which were regarded a new *Stemphylium* species by Inderbitzin et al. (2009). Here we describe the species as *Stemphylium beticola*.

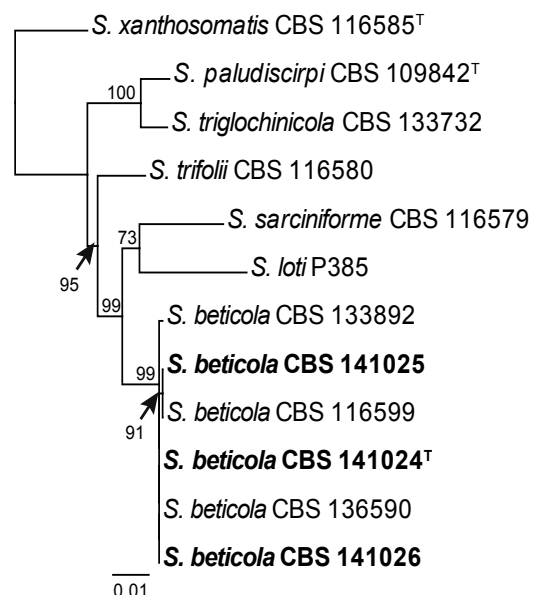

Maximum likelihood tree based on a multiple sequence alignment of the ITS and *gapdh* sequences containing 1 083 characters in total. The analysis was run with RAxML v. 7.2.6 (Stamatakis & Alachiotis 2010) using the GTR+CAT model and included 500 bootstrap replicates. The tree was rooted to *S. xanthosomatis*. Bootstrap support values are indicated at the nodes.

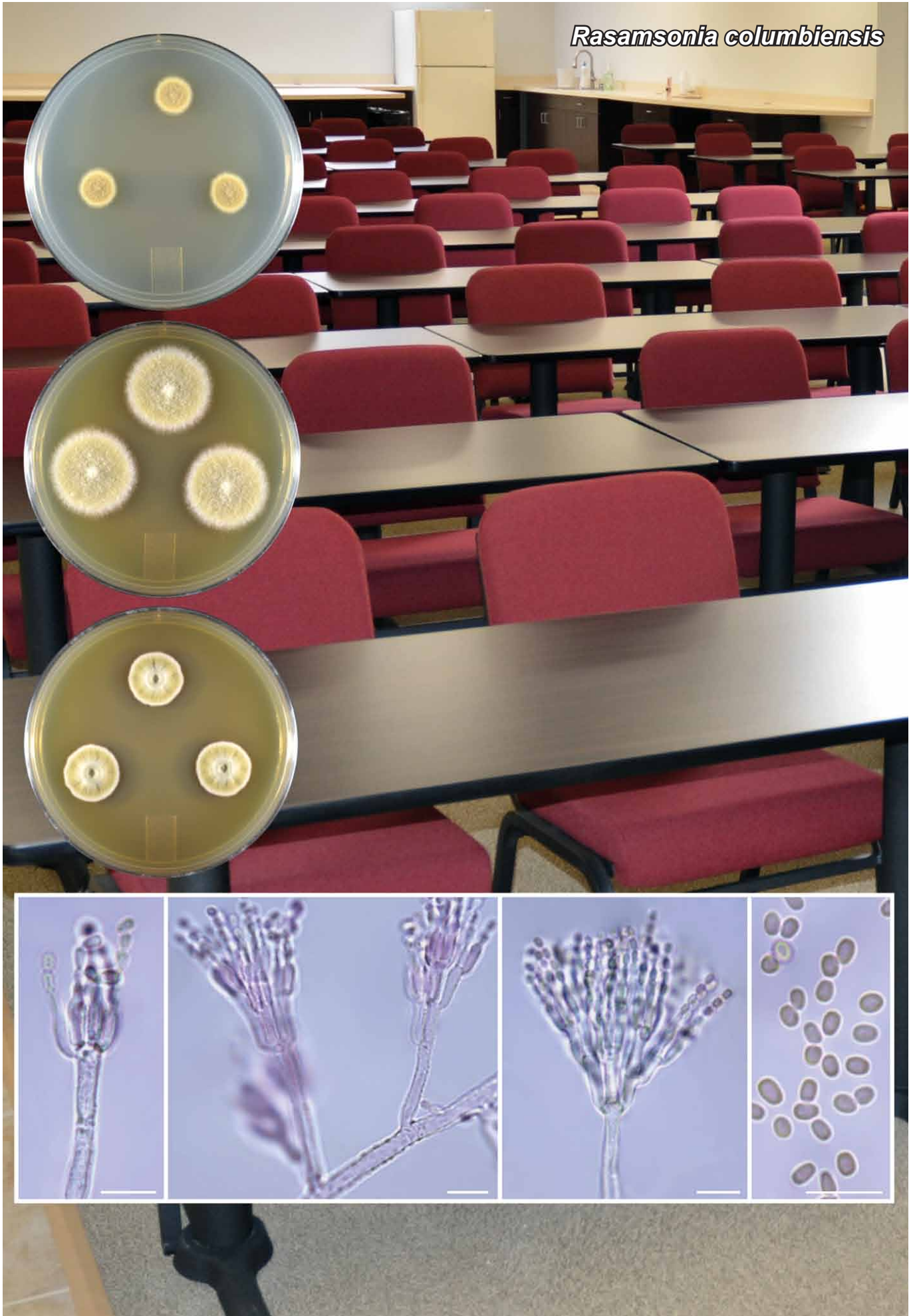
Rasamsonia columbiensis

Fungal Planet 443 – 4 July 2016

Rasamsonia columbiensis Jurjević, Hubka & S.W. Peterson, *sp. nov.*

Etymology. The species is named for the type locality, District of Columbia, USA.

Classification — *Trichocomaceae*, *Eurotiales*, *Eurotiomycetes*.

On MEA: *Stipes* predominantly arising from aerial hyphae, verrucose, (50–)100–250(–300) × 2.5–4 µm, terminating in appressed biverticillate structures, occasionally monoverticillate or tertverticillate, branches on subterminal and intercalary positions, appearing as separate stipes, short 5–50(–75) × 2.5–4 µm; *metulae* in terminal whorls of 2–5, verrucose, 8–12(–17) × 2.5–4.5 µm; *phialides* with long tapering collula, acerose, occasionally rough (8–)9–12(–16) × 2.5–3.5(–5) µm; *conidia* smooth walled, cylindrical to ovoid, (2.5–)3–4(–7) × 2.5–4.5 µm diam.

Culture characteristics — (in darkness, 25 °C after 7 d): Colonies on malt extract agar (MEA) 30–31 mm diam, colony texture velutinous to slightly floccose, mycelium white, sporulation abundant, cream-buff (R30; Ridgway 1912), exudate clear, small droplets predominate, soluble pigments absent, reverse cream-buff to chamois (R30). Colonies on Czapek yeast autolysate agar (CYA) 14–15 mm diam, colony texture velutinous to slightly floccose, mycelium white, at margins c. 2–3 mm broad zone of submerged growth, sporulation abundant, conidia *en masse* cream-buff to chamois (R30), exudate absent, soluble pigments absent, reverse cream-buff (R30). Colonies on potato dextrose agar (PDA) 29–30 mm diam, colony texture velutinous to slightly floccose, mycelium white, sporulation abundant, cream-buff (R30), exudate clear, small droplets are predominant, soluble pigments absent, reverse cream-buff (R30). Colonies on oatmeal agar (OA) 19–20 mm diam, colony texture slightly floccose, mycelium white, at margins c. 4–5 mm broad zone of submerged growth, sporulation abundant, conidia *en masse* cream-buff to chamois (R30), exudate, sparse, no soluble pigments. Colonies on Czapek yeast agar with 20 % sucrose (CY20S) 14–15 mm diam, colony texture velutinous, mycelium white, sporulation good, conidia *en masse* cream-buff (R30), no exudate or soluble pigments, reverse uncoloured to cream-buff (R30). Colonies on dichloran glycerol agar (DG18) 8–9 mm diam, colony texture velutinous

Best scoring maximum likelihood tree (T92+G substitution model) based on sequences of the ITS rDNA showing relationships of *Rasamsonia columbiensis* to other *Rasamsonia* species. The tree was constructed with the IQ-TREE v. 1.4.0 (Nguyen et al. 2015). Dataset contained 21 taxa and a total of 697 characters with 169 characters variable and 125 parsimony-informative. Support values at branches were obtained from 1 000 bootstrap replicates. Only bootstrap support ≥ 70 % are shown on the branches; ex-type strains are designated by a superscript †.

Colour illustrations. USA; 7-d-old cultures of *Rasamsonia columbiensis* on CYA (25 °C - top) and MEA (25 °C - middle and 41 °C - bottom), conidiophores and conidia on MEA. Scale bars = 10 µm.

to slightly floccose, mycelium white, at margins c. 3 mm broad zone of submerged growth sporulation abundant, conidia *en masse* cream-buff to chamois (R30), exudate absent, soluble pigments absent, reverse cartridge buff (R30), cream-buff (R30) to chamois centrally (R30). Colonies on Czapek yeast autolysate agar with 5 % NaCl 2–3 mm diam, sporulation absent. Colonies on creatine sucrose agar (CREA) 19–20 mm diam, moderate to good growth, no acid production, mycelium white, predominantly submerged, sporulation good at the centre of the colony. Growth rates at different temperatures: colonies on CYA/MEA (in mm) 20 °C 9–10/19–20; 30 °C 16–17/43–45; 35 °C 15–17/38–39; 37 °C 15–16/30–31; 41 °C 9–10/19–20; 45 °C no growth. Colonies on MEA at 41 °C radially moderate deep sulcate, no exudate, reverse chamois to Isabella colour (R30); on CYA at 41 °C, very poor sporulation, mycelium white, colony texture funiculose to lightly floccose, exudate absent, soluble pigments absent.

Typus. USA, Washington DC, air of a hotel conference room, 18 June 2015, Ž. Jurjević (holotype BPI 910043, cultures ex-type CBS 141097 = CCF 5289, ITS and partial LSU sequence GenBank LT548281, β-tubulin sequence GenBank LT548285, MycoBank MB816869).

Notes — BLAST analysis of the ITS and β-tubulin sequences of *Rasamsonia columbiensis* with reference sequences (Houbraken et al. 2013, Tanney & Seifert 2013) gave the closest match with the ex-type strain of *R. brevistipitata* CBS 128785[†]: ITS 96 %, β-tubulin 87 %.

Rasamsonia columbiensis fails to grow at 45 °C, while closely related *R. brevistipitata* grows. Also *R. columbiensis* has larger spores ((2.5–)3–4(–7) × 2.5–4.5 µm) than *R. brevistipitata* ((2–)2.5–3(–3.5) × 1.7–2.1 µm).

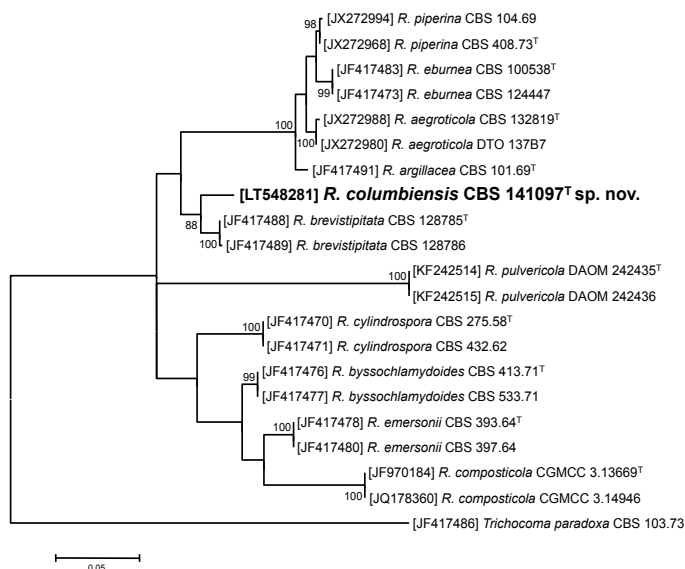

Željko Jurjević, EMSL Analytical, Inc., 200 Route 130 North, Cinnaminson, NJ 08077, USA; e-mail: zjurjevic@emsl.com
Vit Hubka, Department of Botany, Faculty of Science, Charles University in Prague, Benátská 2, 12801 Prague 2, Czech Republic;
e-mail: hubka@biomed.cas.cz

Stephen W. Peterson, Mycotoxin Prevention and Applied Microbiology Research Unit, Agricultural Research Service, U.S. Department of Agriculture, 1815 North University Street, Peoria, IL 61604, USA; e-mail: stephen.peterson@ars.usda.gov

Microascus longicollis

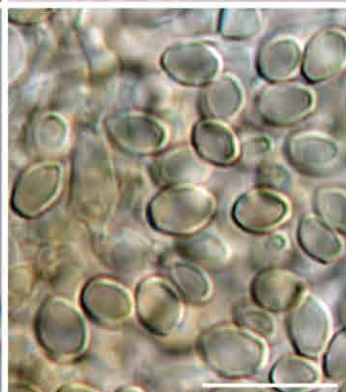

Fungal Planet 444 – 4 July 2016

Microascus longicollis Hubka, Lysková, Cmokova & M. Kolařík, *sp. nov.**Etymology.* Refers to the long annellate zone.Classification — *Microasaceae*, *Microascales*, *Sordariomycetes*.

Ascomata immersed, less commonly superficial, predominantly formed in the colony centre, globose or subglobose, (60–)80–230 µm diam, without ostiolar neck, black, glabrous, ripening after 2–3 weeks of cultivation on OA, ascomata are absent or develop tardily on other media (3–6 weeks on MEA and PDA), peridium with a *textura angularis*. *Asci* globose, subglobose, ellipsoidal or pyriform, 10–15(–17.5) × 9–13.5 µm. *Ascospores* lemon-shaped, pale brown, 4.5–5.5 × 3–4 µm. *Conidiophores* represented by individual conidiogenous cells (annellides) on the hyphae, sometimes supported by a basal cell of 3.5–5 × 2–3 µm, bearing 1–4 annellides. *Annellides* with a swollen base, 4.5–7(–9) × 2.5–3.5(–4.5) µm, tapering to a cylindrical annellated zone, up to 30 µm long and 1.5–2.5 µm wide. *Conidia* 1-celled, thick-walled, hyaline to pale brown, brown in mass, ovate, pyriform or ellipsoidal, with a rounded or pointed apex and truncate base, smooth, 3.5–5(–6) × 2.5–3.5 µm. *Chlamydospores* globose to ellipsoidal, 5–10 × 5–6.5 µm.

Culture characteristics — (in the dark, 25 °C after 14 d): Colonies on OA attained 25–27 mm diam, flat, predominantly submerged, greyish brown in the centre (ISCC-NBS No. 61) due to production of black ascomata, reverse greyish brown (No. 61) in the colony centre. Colonies on PCA attained 24–28 mm diam, flat, predominantly submerged except of granular central part, dark greyish yellow (No. 91) to pale yellowish green (No. 121), reverse pale yellowish green (No. 121) to greyish yellowish green (No. 122) in the colony centre. Colonies on PDA attained 23–27 mm diam, downy, centrally raised, slightly radially furrowed, surrounded by 5 mm broad submerged zone, light greyish olive (No. 109) to greyish yellowish green (No. 122), reverse light greyish olive. Colonies on MEA attained 14–24 mm diam, downy, centrally raised, radially furrowed, light greyish olive (No. 109) to greyish yellowish green (No. 122), surrounded by 5 mm broad submerged zone, reverse dark greyish yellow (No. 91) to greyish brown (No. 61). Colonies on MEA after 7 d at 37 °C and 40 °C attained 12–15 and 4–6 mm diam, respectively.

Typus. CZECH REPUBLIC, Prague, ex toenails of 48-yr-old female with suspected onychomycosis, 20 Dec. 2013, P. Lysková (holotype PRM 935209, isotype PRM 935210, culture ex-type CCF 5317 = CBS 141177; ITS and LSU sequence GenBank LT548275, β-tubulin sequence GenBank LT548282, TEF1-α sequence GenBank LT548287, MycoBank MB816867).

Notes — The ability of this species to grow at 40 °C, ascomata without ostiolar neck, lemon-shaped ascospores and annellides with annellate zone up to 30 µm long make *M. longicollis* well distinguishable from all species accepted to date (Sandoval-Denis et al. 2016, Jagielski et al. 2016).

Colour illustrations. Czech Republic, toenail with suspected onychomycosis; Colonies, top to bottom: 21-d-old colonies of *Microascus longicollis* growing on OA, MEA and PDA at 25 °C; micromorphology, left to right: annellides, conidia (top row), ascospores (bottom row), ascomata, asci. Scale bars = 10 µm, scale bar of the subfigure with ascomata = 100 µm.

Microascus longicollis was associated with a case of suspected onychomycosis of the great toenail of a 48-yr-old female living in the Czech Republic. The fungus was isolated in pure culture from the nail scrapings collected during the first visit and the direct microscopic examination was positive for hyphae. The etiological significance of the isolate could not be confirmed because the second mycological examination (negative) was performed several months after initiation of the treatment at the time of significant clinical improvement (naftifine hydrochloride: 2 mo, without effect; changed to cyclopirox olamine: effective). Repeated isolation of the same non-dermatophyte fungus in pure culture is required for confirmation of its etiological role (Summerbell et al. 2005).

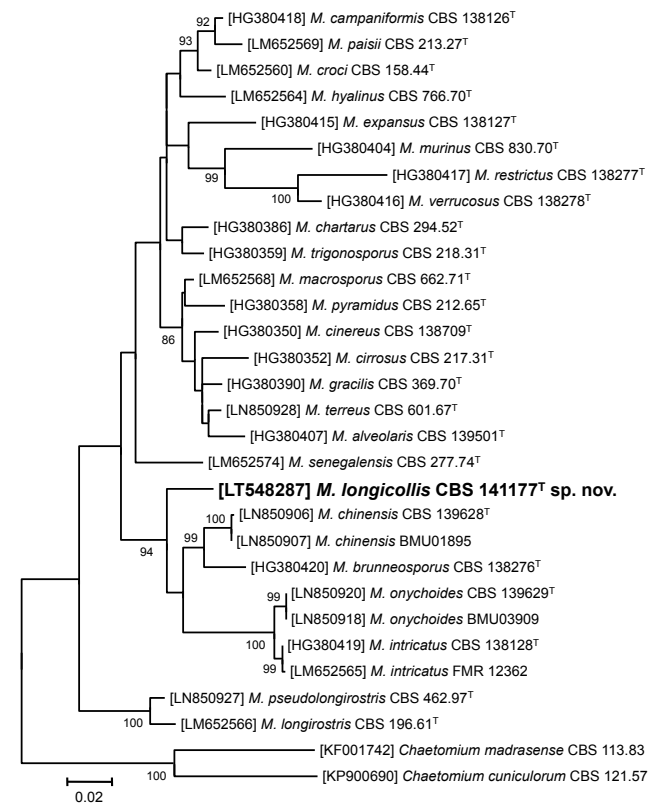

Best scoring maximum likelihood tree (GTR+G+I substitution model) based on sequences of the *TEF1-α* showing the relationship of *M. longicollis* to other *Microascus* species. The tree was constructed with IQ-TREE v. 1.4.0 (Nguyen et al. 2015). Dataset contained 30 taxa and a total of 812 characters of which 226 were variable and 166 parsimony-informative. Support values at branches were obtained from 1 000 bootstrap replicates. Only bootstrap support $\geq 70\%$ are shown on the branches; ex-type strains are designated by a superscript T.

Vít Hubka & Adéla Čmoková, Department of Botany, Faculty of Science, Charles University in Prague, Benátská 2, 128 01 Prague 2, Czech Republic; e-mail: hubka@biomed.cas.cz & cmokova@gmail.com

Pavína Lysková, Laboratory of Medical Mycology, Department of Parasitology, Mycology and Mycobacteriology Prague, Public Health Institute in Usti nad Labem, Sokolovská 60, 186 00 Prague 8, Czech Republic; e-mail: Pavlina.Lyskova@zuusti.cz

Miroslav Kolařík, Laboratory of Fungal Genetics and Metabolism, Institute of Microbiology of the AS CR, v.v.i, Vídeňská 1083, 142 20 Prague 4, Czech Republic; e-mail: mkolarik@biomed.cas.cz

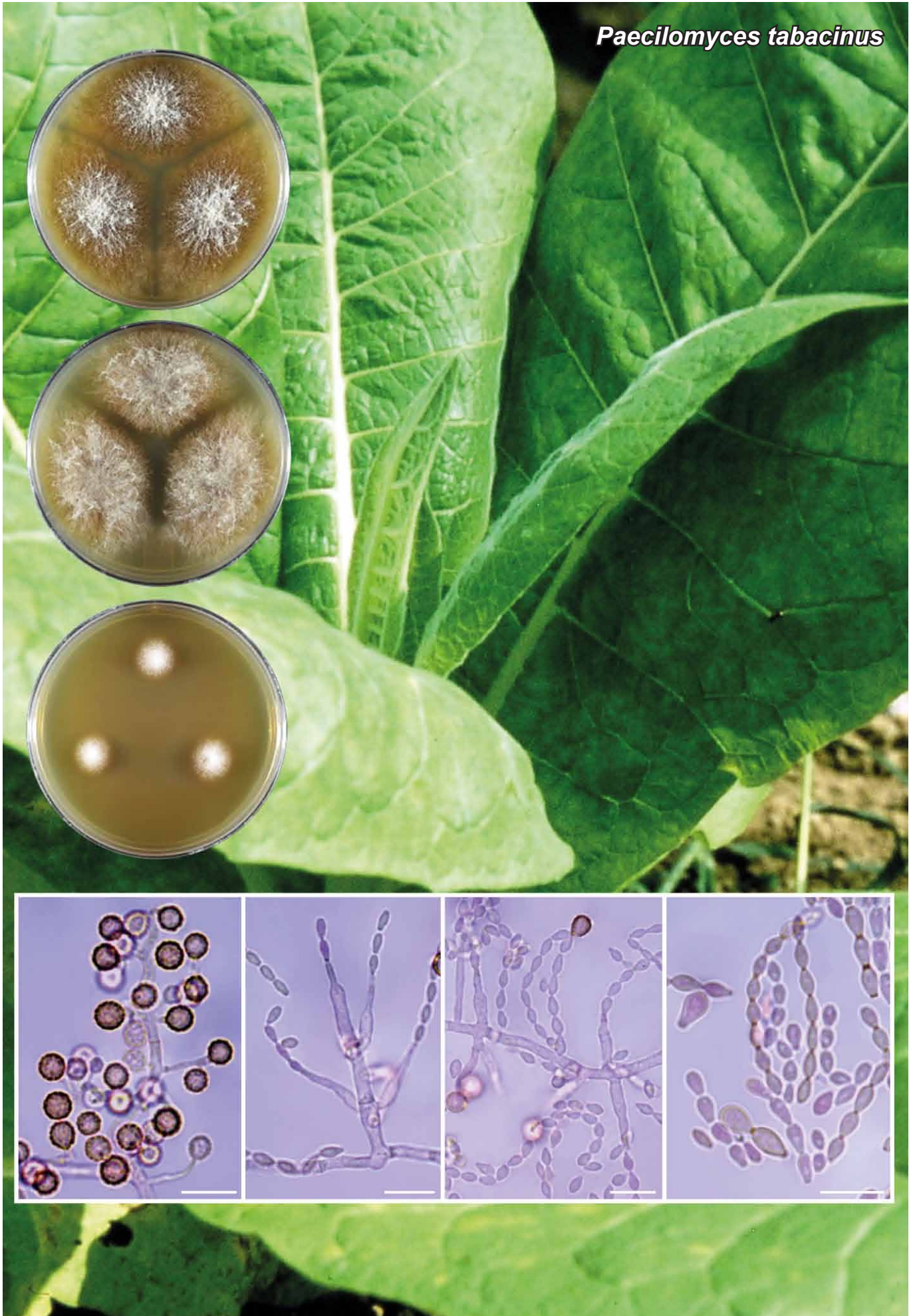
Paecilomyces tabacinus

Fungal Planet 445 – 4 July 2016

Paecilomyces tabacinus Jurjević, Hubka & S.W. Peterson, *sp. nov.*

Etymology. Named after the host from which it was isolated, Tobacco.

Classification — *Thermoascaceae*, *Eurotiales*, *Eurotiomycetes*.

On MEA: *Stipes* short, smooth, rarely finely roughened, 5–30(–50) × (2.5–)3–4(–4.5) µm diam; *branches* irregularly verticillate; *phialides* 2–5 per branch, cylindrical, 9–14(–28) × 2.5–3.5(–5) µm diam, tapering abruptly toward a long cylindrical collula, up to 7 µm long and 1–2 µm diam, occasionally finely roughened, solitary phialides common, often forming directly on hyphae; *conidia* ellipsoidal, fusiform, pyriform (tear-shaped), rarely subglobose (small conidia), (2.5–)3–7(–11) × 2.5–7 µm diam, large pyriform conidia are with broad attachment point up to 3 µm diam, chlamydospores thick walled, abundant, single or in bunch of grapes, yellow-ochre to Dresden-brown (R15; Ridgway 1912), globose to subglobose, occasionally nearly pyriform, finely roughened in early stages, later becoming very rough to spiny, (4–)5–8(–10) µm diam. No sexual morph observed after prolonged cultivation (4 wk) on media listed below.

Culture characteristics — (in darkness, 25 °C after 7 d): Colonies on malt extract agar (MEA) 74–88 mm diam, colony texture floccose, mycelium white to sayal-brown (R29), sporulation very good, conidia *en masse* light-buff to warm-buff (R15), exudate absent, soluble pigments absent, reverse buckthorn-brown to Dresden-brown (R15). Colonies on Czapek yeast autolysate agar (CYA) 38–40 mm diam, colony texture floccose, mycelium white, sporulation good, conidia *en masse* light buff to antimony-yellow (R15), exudate absent, soluble pigments absent, reverse light buff to antimony-yellow (R15). Colonies on potato dextrose agar (PDA) 75–78 mm diam, colony texture floccose, mycelium white to sayal-brown (R29), sporulation very good, conidia *en masse* light-buff to warm-buff (R15), exudate absent,

soluble pigments absent, reverse Isabella colour to brownish olive (R30). Colonies on Czapek yeast agar with 20 % sucrose (CY20S) 9–11 mm diam, sporulation very poor, mycelium white, submerged, reverse uncoloured. Colonies on Dichloran glycerol agar (DG18) 8–10 mm diam, sporulation very poor, mycelium white, submerged, reverse uncoloured. No growth on CYA with 5 % NaCl. Colonies on Oatmeal agar (OA) 37–39 mm diam, colony texture floccose, mycelium white, sporulation very good, conidia *en masse* light-buff to warm-buff (R15), exudate absent, soluble pigments absent. Colonies on creatine sucrose agar (CREA) 40–42 mm diam, poor to moderate growth, no acid production, mycelium white, colony texture floccose to submerged into the agar, sporulation poor to good. On MEA (colony diam in mm) at 30 °C > 90; 35 °C > 90; 37 °C 68–71; 41 °C 18–19; no growth at 45 °C.

Typus. USA, North Carolina, Durham, tobacco leaves, greenhouse, 5 June 2015. Ž. Jurjević (holotype BPI 910044, cultures ex-type CBS 141098 = CCF 5290, ITS and LSU sequence GenBank LT548280, β-tubulin sequence GenBank LT548286, calmodulin sequence GenBank LT548288, MycoBank MB816870).

Notes — BLAST searches of the sequences of *P. tabacinus* showed highest degree of similarity with *Byssoschlamys zollerniae* CBS 374.70^T: ITS 97 %, β-tubulin 94 %, calmodulin 95 %. Another strain with an identical ITS sequence (GenBank GU-934506) originated from roots of *Salix*, Canada (Corredor et al. 2012).

Paecilomyces tabacinus is distinguished by production of ellipsoidal or fusiform conidia and numerous coarsely roughened chlamydospores (smooth, finely roughened or absent in the majority of species). Closely related *B. zollerniae* also produces warted chlamydospores but can be differentiated by the production of sexual state in culture and by having smaller conidia.

Best scoring maximum likelihood tree (T92+G substitution model) based on sequences of the ITS rDNA region showing relationship of *P. tabacinus* to *Paecilomyces* and *Byssoschlamys* species belonging to *Eurotiales* (Samson et al. 2009). The tree was constructed with IQ-TREE v. 1.4.0 (Nguyen et al. 2015). Dataset contained 19 taxa and a total of 588 characters with 138 characters variable and 79 parsimony-informative. Support values at branches were obtained from 1 000 bootstrap replicates. Only bootstrap support ≥ 70 % are shown on the branches; ex-type strains are designated by a superscript ^T.

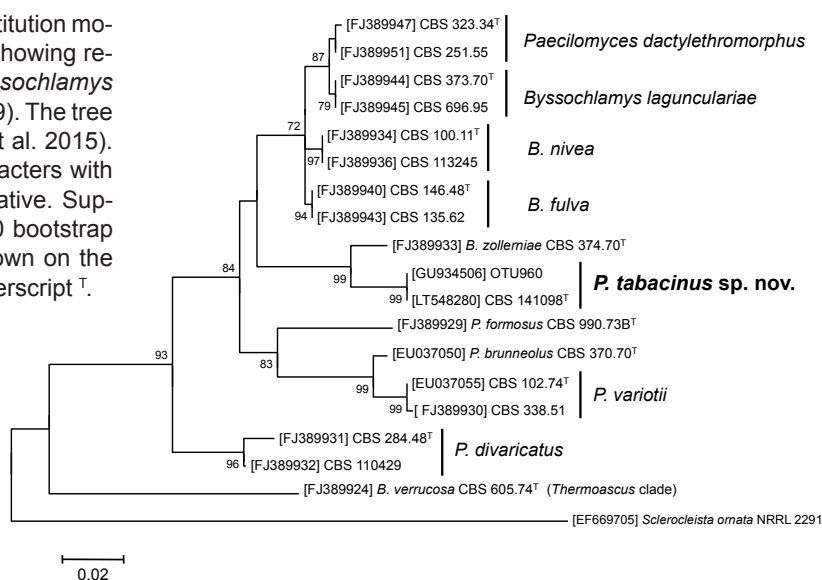

Colour illustrations. Tobacco plant; 7-d-old cultures of *Paecilomyces tabacinus* on MEA (25 °C - top, 37 °C - middle, 41 °C - bottom), chlamydospores, conidia and conidiophores on MEA. Scale bars = 10 µm.

Željko Jurjević, EMSL Analytical, Inc., 200 Route 130 North, Cinnaminson, NJ 08077, USA; e-mail: zjurjevic@emsl.com
 Vit Hubka, Department of Botany, Faculty of Science, Charles University in Prague, Benátská 2, 12801 Prague 2, Czech Republic;
 e-mail: hubka@biomed.cas.cz
 Stephen W. Peterson, Mycotoxin Prevention and Applied Microbiology Research Unit, Agricultural Research Service, U.S. Department of Agriculture,
 1815 North University Street, Peoria, IL 61604, USA; e-mail: stephen.peterson@ars.usda.gov

Chrysosporium echinulatum

Fungal Planet 446 – 4 July 2016

Chrysosporium echinulatum Hubka, Mallátová, Cmokova & M. Kolařík, *sp. nov.*

Etymology. Refers to the surface ornamentation of conidia.

Classification — *Onygenaceae*, *Onygenales*, *Eurotiomycetes*.

Hyphae hyaline, septate, smooth-walled, 1.5–5 µm wide, straight, sparsely branched. *Conidia* hyaline, yellowish in mass, terminal and lateral conidia sessile or on short right-angled side protrusions (occasionally swollen) of variable length, solitary or in chains, initially smooth-walled, nearly all becoming echinulate at maturity, obovoid to clavate, 1-celled, 4.5–7 × 2.5–4 µm. Intercalary conidia solitary or in short chains, smooth-walled, barrel-shaped to ellipsoid. *Chlamydospores* absent. *Racquet hyphae* present. *Sexual morph* not observed.

Culture characteristics — (in the dark, 25 °C after 14 d): Colonies on potato dextrose agar (PDA) attained 28–45 mm diam, floccose, flat or with slightly elevated centre, white with light yellow (NBS-ISCC No. 86) to pale orange yellow (No. 73) colony centre, reverse moderate orange yellow (No. 71). Colonies on malt extract agar (MEA) attained 33–36 mm diam, morphology similar to PDA with more pronounced submerged growth at the colony margins. Colonies on phytone yeast extract agar (PYE) attained 28–37 mm diam, morphology similar to PDA. Colonies on oatmeal agar (OA) attained 35–45 mm diam, flat, downy, pale yellowish pink (No. 31), reverse uncoloured. No growth at 35 °C.

Typus. CZECH REPUBLIC, České Budějovice, ex skin scales from the sole of the foot of a 35-yr-old woman, 21 Aug. 2012, *N. Mallátová* (holotype PRM 935095, isotype PRM 935096, culture ex-type CCF 4652 = UAMH 11824 = CBS 141178; ITS and LSU sequence GenBank LT548276, MycoBank MB816868).

Notes — BLAST analysis with the ITS rDNA region sequence gave closest hits to *C. pannicola* CBS 116.63 (98 %, 526/539 bp, GenBank AJ005368), *C. fluviale* IMI 378764^T (92 %, 498/540 bp, GenBank AJ005367) and *C. minutisporosum* CBS 101577^T (91 %, 468/515 bp, GenBank AJ131689). LSU rDNA showed 99 % similarity (548/555 bp) to *Aphanoascus durus* CBS 118.85 (GenBank AB075345) and *A. terreus* CBS 342.64^T (556/564 bp, GenBank KC989709); other species showed 95 % or lower similarity.

Chrysosporium echinulatum resembles *C. pannicola* (= *C. evoluceanni*) and can be distinguished by the inability to grow at 35 °C and smaller conidia. *Chrysosporium echinulatum* was associated with a case of suspected tinea pedis in a 35-yr-old woman living in the Czech Republic. The fungus was isolated in pure culture from the skin scales collected during the first visit and the direct microscopic examination was positive for hyphae. The mycological examination was not repeated and the etiological significance of the fungus is unclear. We believe that the infection was in fact caused by a dermatophyte, which was not isolated or overgrown by the *Chrysosporium* isolate.

Colour illustrations. Czech Republic; sole of the foot with suspected tinea pedis. Micromorphology: left to right: conidia sessile or on the short side protrusions of the hyphae, conidia sometimes forming short chains, conidia smooth when young, later echinulate. Macromorphology: colony after 14 d on PDA (28 mm diam). Scale bars = 10 µm.

Vít Hubka & Adéla Čmoková, Department of Botany, Faculty of Science, Charles University in Prague, Benátská 2, 128 01 Prague 2, Czech Republic; e-mail: hubka@biomed.cas.cz & cmokova@gmail.com

Naďa Mallátová, Laboratory of Mycology and Parasitology, Hospital České Budějovice, B. Němcové 585/54, 370 01 České Budějovice, Czech Republic; e-mail: mallatova@nemcb.cz

Miroslav Kolařík, Laboratory of Fungal Genetics and Metabolism, Institute of Microbiology of the AS CR, v.v.i, Vídeňská 1083, 142 20 Prague 4, Czech Republic; e-mail: mkolarik@biomed.cas.cz

Scleroderma capeverdeanum

Fungal Planet 447 – 4 July 2016

***Scleroderma capeverdeanum* M.P. Martín, M. Dueñas & Telleria, sp. nov.**

Etymology. The name refers to the country where the holotype was collected.

Classification — *Sclerodermataceae*, *Boletales*, *Agaricomycetes*.

Macroscopic characteristics — *Basidiomes* epigeous, depressed globose to subglobose, 0.8–20 mm diam, sessile (all the sizes from dry specimens); the base attached to the substrate by a tuft of mycelium and rhizomorphs. *Peridium* thin (up to 1 mm thick), 2-layered: external layer pale yellowish to yellowish brown (colour 250; Séguéy 1936) covered by dark brown scales (colour 701), very thin in young specimens, leaving the surface finely areolated; internal layer whitish. *Dehiscence* by an irregular and lacerate apical pore. *Gleba* compact when young, becoming powdery when old, blue greyish (colour 493) to grey-violet (colour 660).

Microscopic characteristics — *Basidiospores* globose, 8.5–9.5(–10.5) µm diam, including ornamentation, densely echinulate (ornamentation 0.5–1 µm high), dark brown in 5 % KOH. Outer layer of peridium composed of interwoven hyphae, hyaline to yellowish, 3.5–4 µm diam; the inner layer composed of interwoven hyphae, hyaline, 3–5 µm diam, with clamp-connections.

Typus. CAPE VERDE, Santiago Island, Parque Natural Serra de Malagueta, Concejo Sta. Catarina, alt. 907 m, N15°10'28" W28°40'37", on a slope under *Furcraea foetida* and *Lantana camara*, 20 Sept. 2010, M.P. Martín MPM3238 (holotype MA-Fungi 87406, ITS sequence GenBank KU747111, LSU sequence GenBank KU747110, MycoBank MB816518).

Additional material examined of *Scleroderma bovista*. CAPE VERDE, Santiago Island, Parque Natural Serra de Malagueta, Concejo Sta. Catarina, alt. 914 m, N15°10'28" W28°40'37", on a slope, 20 Sept. 2010, M.P. Martín MPM3241 (MA-Fungi 87407, ITS sequence GenBank KX017590).

Strict consensus tree of 100 equally most parsimonious trees was obtained after heuristic search (PAUP v. 4.0a147) of ITS nrDNA sequences. The two new *Scleroderma* species described in this issue are marked with rectangles: *S. capeverdeanum* and *S. dunensis* (see Fungal Planet 448). New sequences of *S. bovista* from Cape Verde, and *S. nitidium* from Brazil are marked in **bold**. The accession number from EMBL/GenBank or UNITE databases are indicated. Bootstrap values greater than 50 % are indicated on the branches. As in our preliminary studies (Phosri et al. 2009, Rusevska et al. 2014), *Pisolithus arhizus* was included as outgroup.

Colour illustrations. Cape Verde, Parque Natural Serra de Malagueta, where the species was collected (M.T. Telleria); basidiome (holotype MA-Fungi 87406), echinulate spores (holotype MA-Fungi 87406). Scale bars: basidiomata = 0.5 cm; spores = 1 µm.

Notes — Mature basidiomes of *Scleroderma capeverdeanum* show a peridium with brown squamules, similar to *Scleroderma verrucosum*, a species widely distributed in Azores, Canaria Islands, Madeira and Morocco (Kreisel 2001), also with echinulate spores; however, in young specimens, the peridium is finely areolated as in *Scleroderma bovista*, but this species has reticulate spores. Specimens of *S. capeverdeanum* were found in the same locality as collection MA-Fungi 87407 of *Scleroderma bovista*, as indicated in the additional material examined. Based on a megablast search of NCBI's GenBank nucleotide database, the closest hits using ITS sequences of *S. capeverdeanum* were two sequences of Chinese specimens collected under *Eucalyptus grandis* (GenBank HM237173 and HM237174), and misidentified as *S. polyrhizum* and *S. aurantium*, respectively. In the ITS analyses *S. capeverdeanum* cluster with these two sequences from China, as a sister group of *S. dunensis*, a new species described from Brazil (this issue). Until now, no species of *Scleroderma* were reported from Cape Verde.

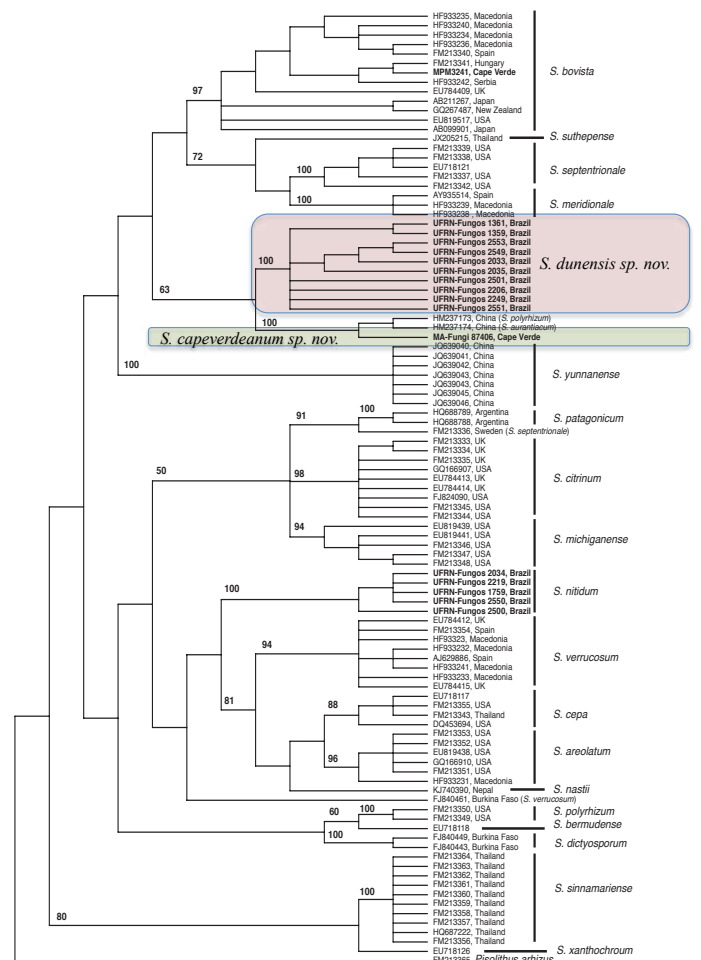

Scleroderma dunensis



Fungal Planet 448 – 4 July 2016

Scleroderma dunensis B.D.B. Silva, Sulzbacher, Grebenc, Baseia & M.P. Martín, *sp. nov.*

Etymology. The name refers to the type locality, Parque Estadual Dunas do Natal.

Classification — *Sclerodermataceae*, *Boletales*, *Agaricomycetes*.

Macroscopic characteristics — *Basidiomes* epigeous, depressed subglobose to subglobose, 12–17 mm diam, sessile or shortly pseudostipitate, up to 2 mm (all the sizes from dry specimens), the base attached to the substrate by a tuft of mycelium and rhizomorphs. *Peridium* composed of two layers, thin, up to 2 mm thick, pale yellowish to yellowish brown (colour 4A2, 4B4; Kornerup & Wanscher 1978), surface partially smooth towards the base and covered by small and thin scales on top, dark brown (colour 5D4, 5E4). *Dehiscence* by an irregular and lacerate apical pore. *Gleba* compact when young, becoming powdery when old, greyish (colour 5E4) to brownish (colour KW5C4).

Microscopic characteristics — *Basidiospores* globose to subglobose, 8.3–10.7 × 8.0–10.8 µm diam, including ornamentation, echinulate, composed by dense narrow pyramidal warts, 0.9–1.3 µm high, dark brown in 5 % KOH. Outer layer of peridium composed of interwoven hyphae, hyaline to yellowish, 2.5–4.0 (–5.0) µm diam; the inner layer composed of interwoven hyphae, hyaline, 3.0–5.5 µm diam, with clamp-connections.

Typus. BRAZIL, Rio Grande do Norte, Natal, Parque Estadual Dunas do Natal, alt. 73 m, S06°22'47" W35°01'40", on soil close to *Coccoloba* sp., 14 May 2010, B.D.B. Silva & A.G. Leite (holotype UFRN-Fungos 2033, isotype MA-Fungi 47736, ITS sequence GenBank KU747112, LSU sequence GenBank KU747105, MycoBank MB814792).

Colour illustrations. Brazil, Parque Estadual Dunas do Natal, *Coccoloba* sp. growing next to the locality where the type species was collected; a. peridium (holotype UFRN-Fungos 2033), details of the scales on top; b. basidiome (UFRN-Fungos 2033); c. cross section showing gleba (UFRN-Fungos 2033); d. echinulate spores (UFRN-Fungos 2035). Scale bars: a = 1 mm; b–c = 2 mm; d = 2 µm.

Additional material examined. BRAZIL, Rio Grande do Norte, Baía Formosa, Reserva Particular do Patrimônio Natural Mata Estrela, alt. 52 m, S06°22'79" W35°01'23" on soil close to *Coccoloba* sp., 12 June 2010, B.D.B. Silva et al. (UFRN-Fungos 1359, ITS sequence GenBank KU747113, LSU sequence GenBank KU747106); *ibid.*, (UFRN-Fungos 1361, ITS sequence GenBank KU747114, LSU sequence GenBank KU747107); *ibid.*, 19 June 2010, B.D.B. Silva et al. (UFRN-Fungos 2035, ITS sequence GenBank KU747117); *ibid.*, (UFRN-Fungos 2549, ITS sequence GenBank KU747115, LSU sequence GenBank KU747108); *ibid.*, 14 July 2010, B.D.B. Silva et al. (UFRN-Fungos 2553, ITS sequence GenBank KU747118); Natal, Parque Estadual Dunas do Natal, alt. 73 m, S06°22'47" W35°01'40" on soil close to *Coccoloba* sp., 9 July 2013, M.A. Sulzbacher, T. Grebenc (UFRN-Fungos 2501, ITS sequence GenBank KU747119); *ibid.*, (UFRN-Fungos 2499, ITS sequence GenBank KU747120); Paraíba, Reserva Biológica Guaribas, alt. 198 m, S06°44'50" W35°08'40" on soil close to *Coccoloba* sp., 27 July 2012, B.D.B. Silva et al. (UFRN-Fungos 2551, ITS sequence GenBank KU747116, LSU sequence GenBank KU747109); *ibid.*, 30 June 2013, M.A. Sulzbacher (UFRN-Fungos 2206, ITS sequence GenBank KU747121).

Additional material examined of Scleroderma nitidum. BRAZIL, Rio Grande do Norte, Natal, Parque Estadual Dunas do Natal, alt. 73 m, S06°22'47" W35°01'40" on sandy soil, 16 June 2010, B.D.B. Silva, D.S. Alfredo, I.G. Baseia (UFRN-Fungos 2034, ITS sequence GenBank KU759904, LSU sequence GenBank KU759903); *ibid.*, 14 May 2010, B.D.B. Silva, A.G. Leite (UFRN-Fungos 2550, ITS sequence GenBank KU759906, LSU sequence GenBank KU759905); *ibid.*, 24 June 2013, M.A. Sulzbacher (UFRN-Fungos 2219, ITS sequence GenBank KU759908); *ibid.*, 9 July 2013, M.A. Sulzbacher, T. Grebenc (UFRN-Fungos 2500, ITS sequence GenBank KU759909); Paraíba, João Pessoa, Campus universitário da Paraíba, 13 July 2012, M.A. Sulzbacher ECM-Sulzbacher-400 (UFRN-Fungos 1759, ITS sequence GenBank KU759907).

Notes — *Scleroderma dunensis* is one of the most common species occurring on sand dunes from the Parque Estadual Dunas do Natal, growing usually close to *Coccoloba* spp. Several previous reports for this locality consider this species to be *S. nitidum* (Gurgel et al. 2008, Sulzbacher et al. 2013). *Scleroderma dunensis* resembles *S. areolatum*, *S. nitidum* and *S. verrucosum*, mainly by echinulate basidiospores and peridium opening by irregular dehiscence, differing fundamentally by larger basidiomes and spores in *S. areolatum* (15–30 mm diam; 10–15 µm), *S. nitidum* (20–25 mm diam; 7–11 µm) and *S. verrucosum* (25–30 mm diam; 9–12 µm) (Guzmán et al. 2013). However, the ITS nrDNA and LSU sequences of *S. dunensis* show greater similarity with a species from Cape Verde (see tree figure in *Scleroderma capeverdeanum* (= Fungal Planet 447)) instead of *S. areolatum*, *S. nitidum* or *S. verrucosum*.

Bianca D.B. Silva & Iuri G. Baseia, Departamento de Botânica e Zoologia, Universidade Federal do Rio Grande do Norte, Natal, Rio Grande do Norte, Brazil;

e-mail: biancadeni@yahoo.com.br & iuri.baseia@gmail.com

Marcelo A. Sulzbacher, Departamento de Solos, Universidade Federal de Santa Maria, CCR, Campus Universitário, 971050-900, Santa Maria, Rio Grande do Sul, Brazil;

e-mail: marcelo_sulzbacher@yahoo.com.br

Tine Grebenc, Slovenian Forestry Institute Vecna pot 2, Ljubljana, Slovenia;

e-mail: tine.grebenc@gozdis.si

María P. Martín, Departamento de Micología, Real Jardín Botánico-CSIC, Plaza de Murillo 2, 28014 Madrid, Spain;

e-mail: maripaz@rjb.csic.es

Ganoderma mbrekobenum

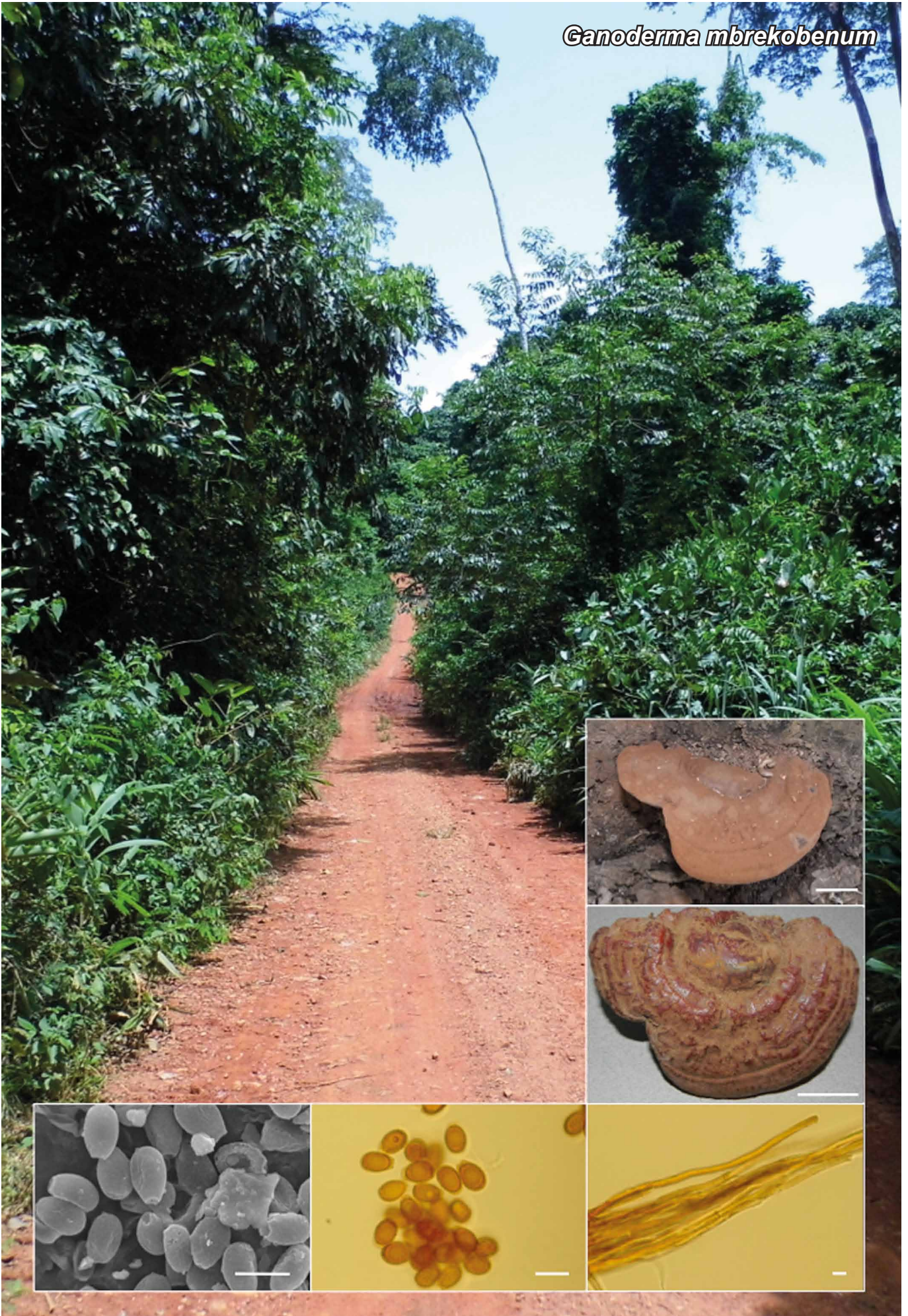

Fungal Planet 449 – 4 July 2016

Ganoderma mbrekobenum E.C. Otto, Blanchette, Held, C.W. Barnes & Obodai, *sp. nov.*

Etymology. Named after the Ghanaian Twi word 'mbrekoben', which translates to reddish brown mushroom.

Classification — *Ganodermataceae*, *Polyporales*, *Agaricomycetes*.

Mature *basidiomata* annual, pileate, stipitate, dimidiate, applanate, woody to corky when dried, homogenous context structure, pileus maroon to liver brown when dry, surface hard and glabrous, margin rounded, thickened, maroon to liver brown when dry. *Stipe* substipe (> 5 cm), lateral, columnar, with one solitary column, maroon; borders with hymenophore thickened. *Pore surface* smooth, creamy to snuff brown when dry, pores 4–6 per mm, round to somewhat irregular and slightly elongated, 105–247 × 76–207 µm (av. 167.2 × 123.8 µm; SD 32, 26; n = 100), dissepiments 44–152 µm (av. 83.6 µm; SD 23; n = 100); tubes 0.1–0.7 mm long, dark brown. *Hyphal system* dimitic; generative hyphae slightly inconspicuous, branched, thin-walled and hyaline; skeletal hyphae most prevalent in the basidiocarp, occasionally branched, pale to dark brown, 2.5–7 µm thick, tapering towards the end. *Basidia* not observed. *Basidiospores* brown, ovoid to broadly ellipsoid with a truncate base, bitunicate, verruculose, 8–11.5 × 6–8 µm (av. 10.4 × 7.1 µm; SD 0.7, 0.4; n = 100), perisporium thin, smooth; exosporium with intermediate thick inter-walled pillars; endosporium thick, dark brown. *Chlamydospores* not observed.

Culture characteristics — No live culture obtained.

Typus. GHANA, Brong Ahafo and Greater Accra Regions, on angiosperms, June 2015, *M. Obodai* (holotype MIN 850481, paratype MIN 850482, holotype ITS sequence GenBank KX000896, LSU sequence GenBank KX000897; paratype ITS sequence GenBank KX000898, LSU sequence GenBank KX000899, holotype MycoBank MB816172).

The phylogenetic tree with *G. mbrekobenum* was constructed using the Maximum Likelihood plugin PHYML in Geneious R9 (<http://www.geneious.com>, Kearse et al. 2012), and the substitution model determined by jModelTest (Posada 2008) according to Corrected Akaike Information Criterion (AICc). *Ganoderma enigmatica* (GenBank KR183855 and KR150678) is the outgroup. Bootstrap support values ≥ 50 % are given above branches. The phylogenetic position of *G. mbrekobenum* is indicated in **bold**. The *Ganoderma* species is followed by the sample ID and the three letter United Nations country code, in order of appearance ZAF: South Africa, GHA: Ghana, EGY: Egypt, IND: India, MYS: Malaysia, CHN: China, USA: United States.

Colour illustrations. Ghana, Brong Ahafo Region, native tree species along the road of the Ayum forest (background); basidiocarp in the field with basidiospores covering the pileus, basidiocarp in lab with basidiospores cleaned off; skeletal hyphae, basidiospores by light microscopy and SEM. Scale bars = 3 cm (basidiocarps), 10 µm (microscopic structures).

Notes — *Ganoderma mbrekobenum* causes decay in the roots and trunks of angiosperm trees in the southern regions of Ghana. Sequences were downloaded from GenBank for phylogenetic analysis with *G. mbrekobenum* sequences using the program Geneious R9 (<http://www.geneious.com>, Kearse et al. 2012). The complete ITS sequence of the *G. mbrekobenum* holotype was used for the Blastn search. The results gave the highest score to an isolate *Ganoderma* sp. (EGDA, GenBank LN774971) from Egypt, with a single nucleotide difference. The next 14 Blastn hits were to *Ganoderma* sp. sequences from a single institution in India. The analysis included only the top three of these sequences, having four to six differences from the *G. mbrekobenum* holotype. A few isolated sequences with various *Ganoderma* species names had relatively high Blastn scores, but were excluded from the analysis because they did not align with their respective species and are likely *G. mbrekobenum*, or closely related. The closest legitimate *Ganoderma* species were *G. applanatum* and *G. fornicatum*, both with 94 % identity. Additional sequences of other recently described *Ganoderma* species from Africa (Coetzee et al. 2015, Crous et al. 2015b) were included in the analysis. The final alignment was edited by hand for alignment errors.

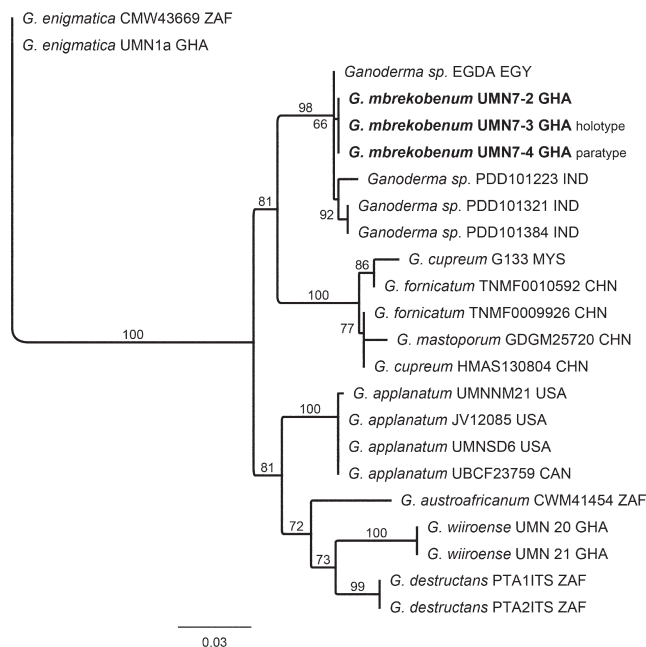

Eric C. Otto, Robert A. Blanchette & Benjamin W. Held, Department of Plant Pathology, University of Minnesota, 495 Borlaug Hall, 1991 Upper Buford Circle, St. Paul, MN 55108, USA; e-mail: ottox136@umn.edu, robertb@umn.edu & bheld@umn.edu

Charles W. Barnes, Departamento Nacional de Protección Vegetal, Estación Experimental Santa Catalina, Instituto Nacional de Investigaciones Agropecuarias, Panamericana Sur Km. 1 vía Tambillo, Cantón Mejía, Provincia de Pichincha, Quito, Ecuador; e-mail: cbarnes333b@gmail.com

Mary Obodai, CSIR-Food Research Institute, P.O. Box M20, Accra, Ghana; obodaime@yahoo.com

Geoglossum raitviirii



Fungal Planet 450 – 4 July 2016

Geoglossum raitviirii Fedosova & E.S. Popov, *sp. nov.*

Etymology. Named after the Estonian mycologist Ain Raitviir, in recognition of his contribution to the study of the *Geoglossaceae* from the Russian Far East.

Classification — *Geoglossaceae*, *Geoglossales*, *Geoglossomycetes*.

Ascocarps scattered to gregarious, clavate, stipitate, 2.2–4.5 cm tall, dark brown. *Ascigerous part* clavate, broadly clavate, 1/4–1/2 of the total ascocarp length, 0.5–1.8 cm long, black to dark brown, darker than the stipe, compressed, dumbbell-shaped or oval in cross section, sharply delimited from the stipe in fresh condition, in herbarium material smooth, ceraceous-pubescent due to prominent paraphyses tips extending from the hymenium. *Stipe* terete, compressed, brown, in fresh conditions lighter than the ascigerous part, dark brown and concolorous in herbarium material, rough, squamous. *Asci* clavate to broadly clavate, (161.5–)172.5–176.5(–191.5) × (21–)24.5–26.5(–31) μm (measured in KOH), Q = (5.5–)6.5–7(–8), 8-spored, with euamyloid apical ring and inamyloid wall in MLZ and IKI. *Ascospores* elongate-clavate, subfusiform to fusiform, narrowed to basal end, sometimes slightly curved, (49–)76.5–81.5(–93.5) × (5.5–)6–6.5(–9.5) μm (in KOH), Q = (7.5–)12.5(–15), brown, sometimes hyaline with pigmented septae and poles, predominantly 7-septate, rarely with 3–6(–11) septa, with one or several large oil drops in each cell. *Paraphyses* straight, sometimes branched, sparsely or moderately septate, non-agglutinated, (2–)3(–5) μm diam, apically straight, declinate, circinate or coiled, pale brown. *Apical cells of paraphyses* swollen at tips, pyriform, globose, hockey stick-like, hook-like, cylindrical, sometimes proliferating, (12.5–)32.5–38.5(–97) × (4.5–)8.5–9.5(–13.5) μm, pale brown, incrustated. *Hyphae of the stipe surface* straight, moderately septate, formed by chains of several pale brown cells, apical cells clavate.

Habit, Habitat & Distribution — In small groups on soil in broadleaf forests. The species is known only from two localities in Primorye, Russia.

Typus. RUSSIA, Primorsky Krai, Terneysky District, Sikhote-Alin Nature Reserve, right side of the Zabolochennaya River, the road from Maysa ranger station to Ust-Shanduy ranger station, N45°14'19" E136°30'40", broadleaf forest (with *Quercus mongolica*, *Tilia* sp., *Acer mono*, *Aralia elata*, *Betula* sp., *Eleutherococcus senticosus*, *Corylus mandshurica*), on sandy soil, 22 Aug. 2013, A. Fedosova (holotype LE303983, ITS sequence GenBank KT936308, LSU sequence GenBank KU986891, MycoBank MB814833).

Additional specimen examined. RUSSIA, Primorsky Krai, Khasansky District, Kedrovaya Pad Nature Reserve, valley of the Kedrovaya River, vicinity of the main reserve station, broadleaf forest, on soil along a brook, 19 Aug. 2005, E. Popov (LE291814, ITS sequence GenBank KT936309).

Notes — *Geoglossum raitviirii* is characterised by medium sized brown ascocarps with squamous or granulose stipes, which are normally lighter than the ascigerous part, relatively short and broad, 8-spored asci, predominantly 7-septate asco-

Colour illustrations. Primorsky Krai, Terneysky District, Sikhote-Alin Nature Reserve; spores, apical cells of paraphyses, amyloid reaction of the ascus apical ring, asci, hyphae of the stipe surface, ascocarps (all from holotype), type locality. Scale bars = 1 cm (ascocarps), 10 μm (microscopic structures).

spores, and long, swollen apical cells of the paraphyses. Among other species of *Geoglossum* with 7-septate ascospores it is most similar to *G. chamaecyparinum*, *G. variabilisporum*, and *G. lineare*. *Geoglossum chamaecyparinum* (Arauzo & Iglesias 2014) shares similar morphology with *G. raitviirii*, but differs in more narrow and long asci ((164.5–)181.5–196(–217) × (16–)19.5–23(–25.5) μm) and more narrow ascospores ((50–)72–82(–90) × (5–)6(–6.5) μm). *Geoglossum variabilisporum* can be recognised by smaller ascocarps (0.6–1.9 cm), narrower and shorter asci ((124–)145.5–169(–187) × (15.5–)18.5–21(–24) μm) and by presence of the considerable number of ascospores with more than 7 septa (Arauzo & Iglesias 2014). *Geoglossum chamaecyparinum* and *G. variabilisporum* are known from Spain, where they were found on sandy soil under *Chamaecyparis lawsoniana*. *Geoglossum lineare* described from pasture land in Sweden can be separated from *G. raitviirii* by the smooth viscid stipe of ascocarps, stout straight paraphyses, smaller asci (140–155 × 13–16 μm) and 3–7-septate ascospores (45–65 × 4.5–5.5 μm) (Hakeliev 1967).

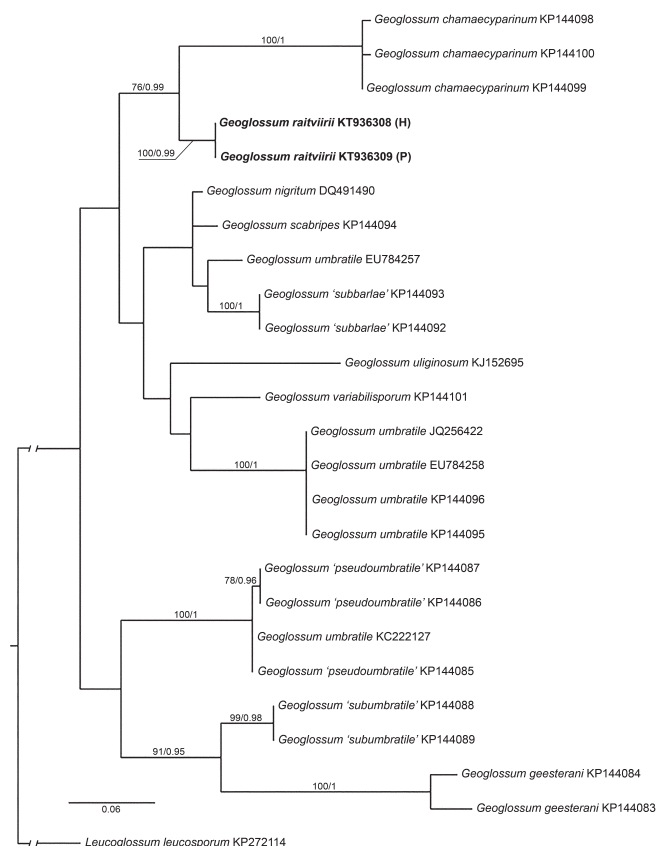

Maximum likelihood tree (RAxML web server) was obtained from the nrITS dataset sequences of *Geoglossum raitviirii* (H: holotype; P: paratype) and closely related species (TreeBASE submission ID S19197). The Bayesian analysis (MrBayes v. 3.2.5) was performed under a GTG+G+I model for 1 M generations. Numbers at branches indicate Maximum likelihood bootstrap values ≥ 75 % and Bayesian posterior probabilities ≥ 0.95. The scale bar represents the number of nucleotide changes per site.

Toxicocladosporium hominis

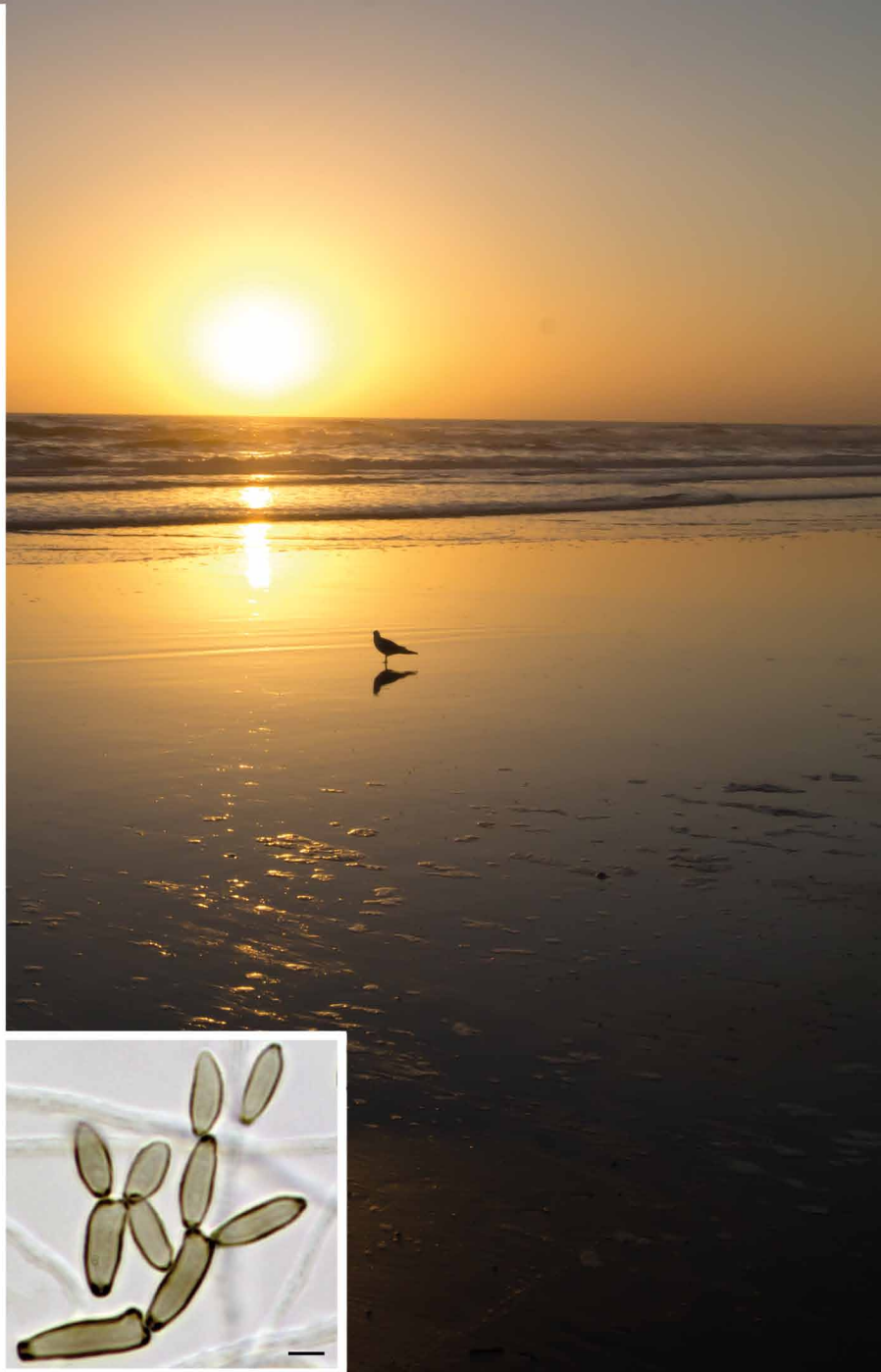
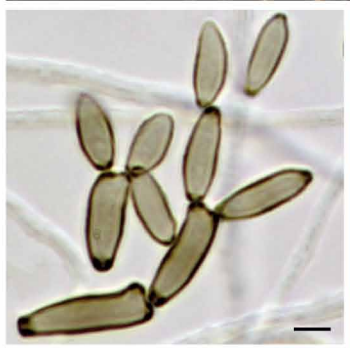
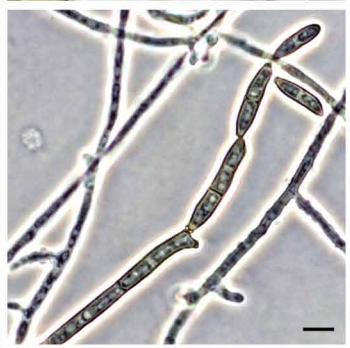

Fungal Planet 451 – 4 July 2016

Toxicocladosporium hominis Sandoval-Denis, Gené & Deanna A. Sutton, *sp. nov.*

Etymology. Referring to the isolation source of the ex-type strain.

Classification — *Cladosporiaceae*, *Capnodiales*, *Dothideomycetes*.

Colonies sporulating on synthetic nutrient-poor agar. *Mycelium* branched, septate, smooth, subhyaline to pale brown, hyphae 1.5–3 µm wide. *Conidiophores* simple or branched, subcylindrical, erect, thickening toward the apex, dark brown, smooth and thick-walled, 70–113 × 3–3.5 µm. *Conidiogenous cells* integrated, polyblastic, terminal, geniculate, dark brown, 13–30 × 3–4 µm; scars truncate, thickened and darkened, 1.5–2 µm wide. *Primary ramoconidia* cylindrical, dark brown, smooth and thick-walled, 15–32 × 2–4 µm, 0–2-septate. *Secondary ramoconidia* subcylindrical to cylindrical, pale to dark brown, smooth- and thick-walled, 11–15 × 2.5–4 µm, 0–1-septate, sometimes constricted at the septum, giving rise to branched conidial chains; scars darkened, thickened, 0.5–1.5 µm diam. *Intercalary conidia* subcylindrical, brown, smooth- and thick-walled, 9–16 × 3–4 µm, 0–1-septate, usually constricted at the septum. *Small terminal conidia* ellipsoidal to clavate, brown, smooth-walled, 5.5–8 × 2.5–3.5 µm.

Culture characteristics — Colonies on PDA at 25 °C attaining 13–18 mm diam after 14 d, deep green to dark green (30D3/F8) (Kornerup & Wanscher 1978), erumpent and folded, velvety; reverse olive-brown (4D4/4D6). On SNA at 25 °C attaining 8–10 mm diam after 14 d, olive-brown (4E5/E8), flat to slightly umbonate, velvety to dusty; reverse olive-brown (4F6). On OA at 25 °C attaining 9–12 mm diam after 14 d, olive-brown (4E4/4D3), flat, velvety to dusty; reverse olive-brown (4E4/4D3).

Typus. USA, Florida, Daytona Beach, from human bronchoalveolar lavage fluid, D.A. Sutton (holotype FMR H-13297, isotype deposited at CBS, cultures ex-type FMR 13297 = UTHSCSA DI-13-172 = CBS 140694, ITS sequence GenBank LN834444, LSU sequence GenBank LN834448, MycoBank MB814942).

Colour illustrations. USA, Florida, view of Daytona Beach (image credit: *First Glow* by Kaitlynn-Rae Landry); colony on PDA after 14 d at 25 °C, conidiophores, conidiogenous cell bearing conidia, ramoconidia, intercalary and terminal conidia. Scale bars = 5 µm.

Notes — The genus *Toxicocladosporium*, typified by *T. irritans*, currently includes 12 species. Segregated from *Cladosporium*, *Toxicocladosporium* differs in the presence of conspicuous, dark septa in the conidiophores and conidia, and by having flat, thickened and refractive conidiogenous scars in contrast to the coronate scars of *Cladosporium* (Crous et al. 2007b). *Toxicocladosporium hominis* is phylogenetically related and morphologically similar to *T. strelitziae* (Crous et al. 2012b), from which it differs in the production of larger conidiogenous cells (13–30 × 3–4 µm) and intercalary conidia (9–16 × 3–4 µm) vs 10–15 × 2.5–3.5 µm and 10–12 × 2–2.5 µm, respectively, in *T. strelitziae*. In addition, the latter species has smooth to verruculose ramoconidia, secondary ramoconidia and intercalary conidia, without constrictions in the medial portion or at the septum.

Based on a megablast search of NCBI's GenBank nucleotide database, the closest hit using the ITS sequence is *T. strelitziae* CBS 132535 (GenBank KM816684; Identities = 513/522 (98 %), Gaps = 2/522 (0 %)), followed by *T. irritans* CBS 185.58 (GenBank EU040243; Identities = 510/526 (97 %), Gaps = 4/526 (0 %)) and *T. pini* CPC 23639 (GenBank KJ869160; Identities = 505/527 (96 %), Gaps = 6/527 (1 %)). Closest hits using the LSU sequence were to *T. strelitziae* CBS 132535 (GenBank NG042687; Identities = 542/547 (99 %), Gaps = 2/547 (0 %)), *T. irritans* CBS 185.58 (GenBank EU040243; Identities = 542/547 (99 %), Gaps = 2/547 (0 %)) and *Cladosporium* sp. ATCC 28310 (GenBank KP780464; Identities = 539/547 (99 %), Gaps = 2/547 (0 %)).

Marcelo Sandoval-Denis, Josepa Gené & Josep Guarro, Mycology Unit, Medical School and IISPV, Universitat Rovira i Virgili (URV), Sant Llorenç 21, 43201 Reus, Tarragona, Spain; e-mail: msandovaldenis@gmail.com, josepa.gene@urv.cat & josep.guarro@urv.cat
Deanna A. Sutton & Nathan P. Wiederhold, Fungus Testing Laboratory, Department of Pathology, University of Texas Health Science Center, 7703 Floyd Curl Dr., San Antonio, Texas 78229-3900, USA; e-mail: suttnd@uthscsa.edu & wiederholdn@uthscsa.edu

Pisolithus aureosericeus

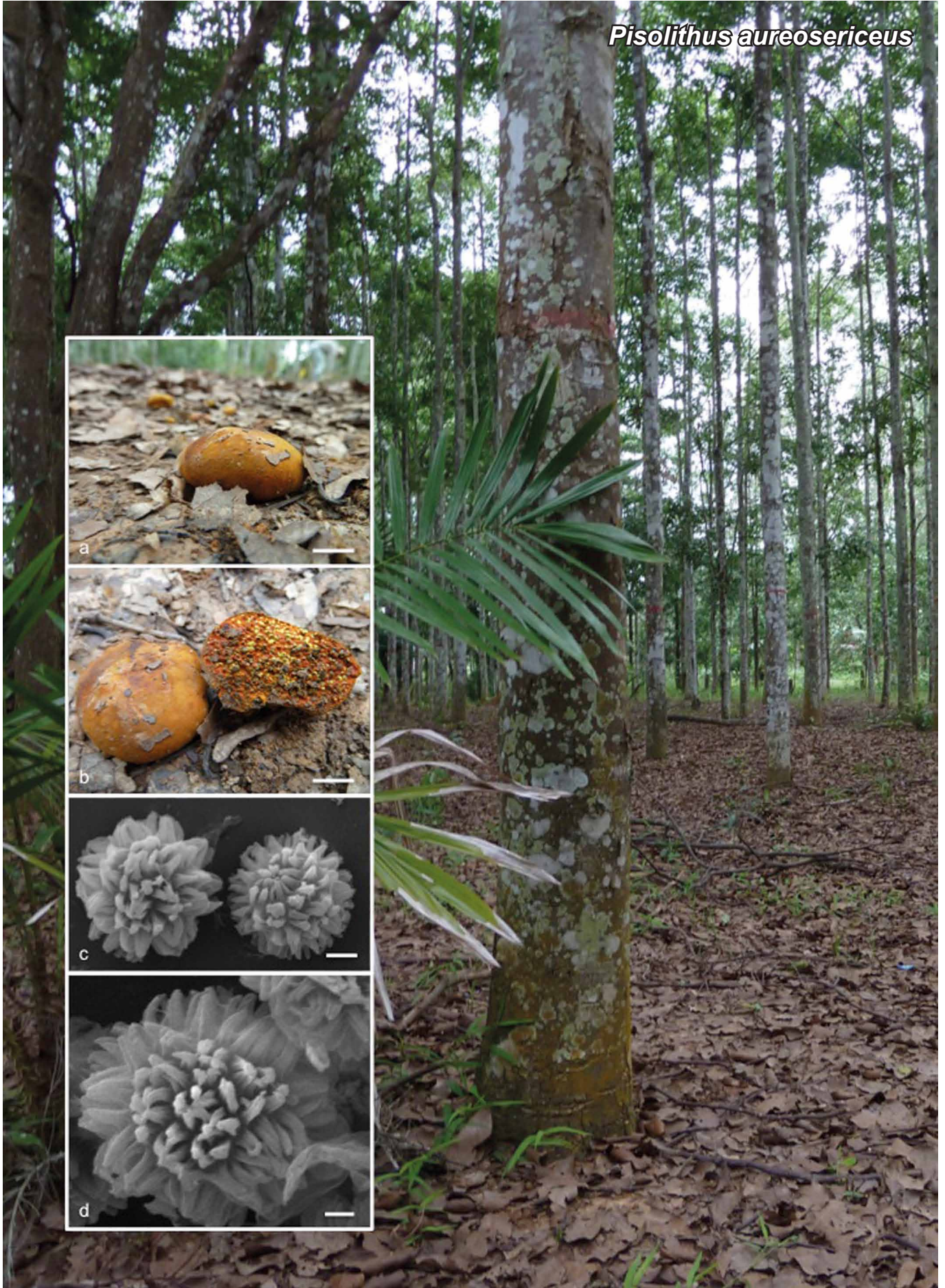

Fungal Planet 452 – 4 July 2016

***Pisolithus aureosericeus* M.P. Martín, Kaewgrajang, Phosri & Watling, sp. nov.**

Etymology. From Latin *aureus* and *sericeus*, referring to the colour and texture of the peridium.

Classification — *Sclerodermataceae*, *Boletales*, *Agaricomycetes*.

Macroscopic characteristics — *Basidiomes* subglobose to broadly ellipsoid, gasterocarp, 10–50 mm, sessile. *Peridium* surface slightly velvety, golden yellow at first, later buff to snuff brown. *Rhizomorphs* at the base, small, 0.8–1.3 mm high × 0.3–0.5 diam. *Gleba* orange-brown become ferruginous powdery mass at maturity by the breakdown of the peridioles. *Peridioles* subglobose to broadly ellipsoid, 0.2–0.8 × 1.0–1.2 mm diam, thin-walled, surface smooth, bright yellow or greenish yellow, later a snuff-brown powdery mass when they mature.

Microscopic characteristics — *Constituent hyphae* intertwined, cream to ochraceous, thin-walled, 2–3.5 mm broad, septate without encrustation, clamp-connections present. *Basidia* not seen. *Spores* globose to subglobose, 8.5–10 × 8–11 µm excluding ornamentation, pale brown, densely ornamented with pyramidal spines (0.5–0.8 µm long).

Typus. THAILAND, Nakhon Ratchasima, alt. 470 m, N14°29'59" E101°56'22", on clay loam soil, under *Hopea odorata* trees, 8 Aug. 2012, T. Kaewgrajang KUFF001 (holotype Herbarium Kasetsart University, ITS sequence GenBank KU351837, MycoBank MB851695).

Additional materials examined. THAILAND, Nakhon Ratchasima, alt. 470 m, N14°29'59" E101°56'22", on clay loam soil, under *Hopea odorata* trees, 8 Aug. 2012, T. Kaewgrajang KUFF002 (Herbarium Kasetsart University, ITS sequences GenBank KU351835, KU351836); *ibid.*, T. Kaewgrajang KUFF003 (Herbarium Kasetsart University, ITS sequences GenBank KU351838, KU351839, KU351840).

Notes — The genus *Pisolithus* has for a long time been considered a genus of species with mainly a xerophytic life-strategy, being found in shrub-land, woodland-clearings, even wasteland, and all generally on highly mineral soils (Pilát 1958). For many years the dark coloured, elongated, narrow stemmed *Pisolithus kisslingii* was perhaps the only species linked to tropical areas being described from the rain forest in Sumatra (Fischer 1906); although, specimens of this genus had been located amongst the dried collections of the late John H. Corner now housed in the herbarium of the Royal Botanic Garden, Edinburgh. However, after intensive work in the last few years in more tropical plant-communities has demonstrated a wealth of species of *Pisolithus* present certainly in South-East Asia. The present study delimits a further species, similar in colour to *P. aurantioscabrosus*, but differing markedly in the smoother and slightly velvety outer surface of the exoperidium in contrast to the erect squamules of the former. Phylogenetic analyses (parsimony), based on three collections (six specimens/six sequences) of *P. aureosericeus*, and previously published data, mainly from Martín et al. (2002), Phosri et al. (2012), Martín et al.

Colour illustrations. Thailand, Nakhon Ratchasima (T. Kaewgrajang); a. basidiome (KUFF001); b. basidiomes (KUFF001) detail to shown the peridioles; c, d. spores (KUFF001). Scale bars = 10 mm (basidiomes), 1 µm (spores).

(2013) clearly grouped the new sequences with species of *P. aurantioscabrosus* from Malaysia collected under *Shorea macropera*. However, the specimens of *P. aureosericeus* form a cluster together as a group of their own, and were collected under *Hopea odorata*. Moreover, the peridium surface is slightly velvety and golden yellow, and the basidiospores are strongly ornamented with wedge-shaped extensions giving a very rough appearance; although *Pisolithus* spores are ornamented this present feature is rather uncommon in the genus and helps to delimit this new taxon under the microscope.

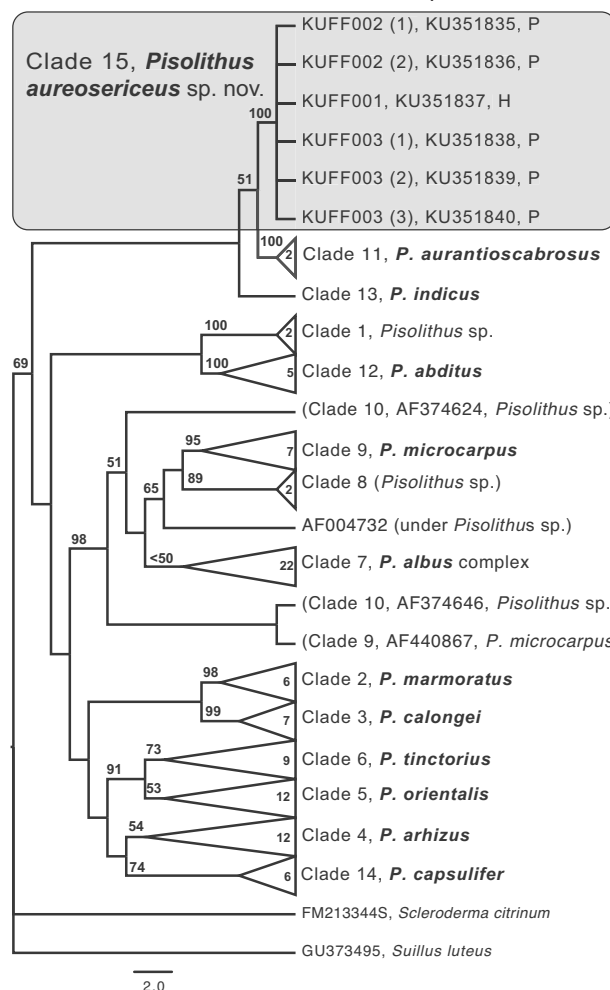

One of the 100 equally most parsimony trees obtained after a heuristic search of the ITS sequence alignment (PAUP v. 4.0b10). Following Phosri et al. (2012) and Martín et al. (2013), sequences of *Suillus luteus* and *Scleroderma citrinum* were included as outgroup. *Pisolithus* sequences were distributed in 15 main clades, clade number after Martín et al. (2002); percentage of bootstrap values (> 50 %) are indicated on the branches. The *P. aureosericeus* clade is marked with a grey square (H: Holotype; P: Paratypes); the accession number from EMBL/GenBank or UNITE databases are indicated to the rest of terminals.

María P. Martín, Departamento de Micología, Real Jardín Botánico-CSIC, Plaza de Murillo 2, 28014 Madrid, Spain; e-mail: maripaz@rjb.csic.es
 Tharnrat Kaewgrajang, Department of Forest Biology, Faculty of Forestry, Kasetsart University, 50 Ngamwongwan Rd, Latyao, Chatuchak, Bangkok 10900, Thailand; e-mail: tarn_67@hotmail.com
 Cherdchai Phosri, Faculty of Science, Nakhon Phanom University, 214, Moo 12, Nittayo Road, Nong Yart Sub-district, Muang District, Nakhon Phanom, 48000, Thailand; e-mail: cherd_phosri@yahoo.co.uk
 Roy Watling, Caledonian Mycological Enterprises, Vrelah, 26 Blinkbonny Avenue, Edinburgh, EH4 3HU, Scotland, UK; e-mail: caledonianmyc@blueyonder.co.uk

Coprinus littoralis

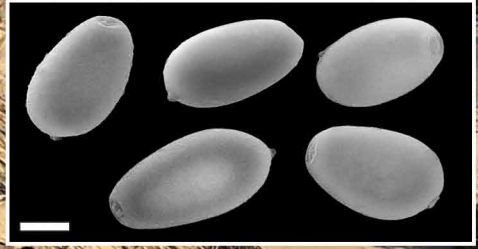
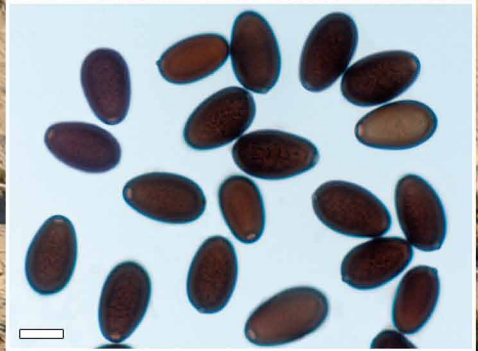
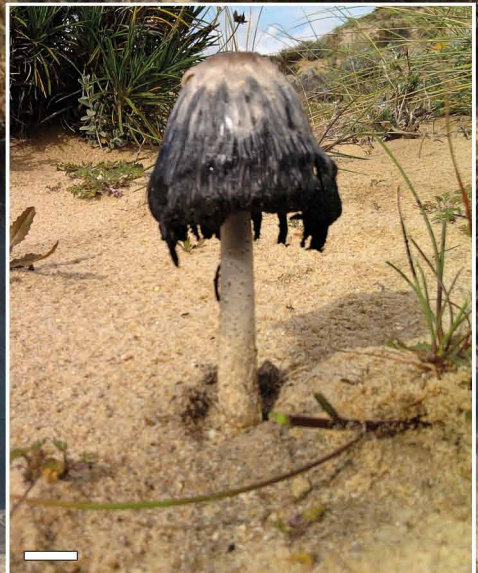

Fungal Planet 453 – 4 July 2016

Coprinus littoralis G. Moreno, Carlavilla, Heykoop, Manjón, A. Sánchez, *sp. nov.*

Etymology. Name reflects the habitat, littoral dunes, from which this fungus was collected.

Classification — Agaricaceae, Agaricales, Agaricomycetes.

Cap up to 45 × 25 mm (measured on dried herbarium specimens), ovoid to broadly ellipsoid, becoming revolute at margin when mature and strongly deliquescent, first whitish, later with pinkish tinges, veil thick, ochraceous, persistent at centre, star-shaped, not deliquescent, recalling that of *Coprinus vosoustii*. *Gills* crowded, first white, then pinkish, later black, strongly deliquescent; gill-edge could not be observed due to deliquescence. *Stem* 55–65 × 3–6 mm, whitish, with whitish ephemeral ring; base up to 13 mm wide and bulbous to napiform, strongly rooting, 20–35 mm in length; hollow, with central strand. *Spores* 13–20 × 8–12 µm av. 15.5–17.5 × 9.5–10.6 µm (3 collections), Q_{av} = 1.60–1.72, ellipsoid, smooth, sometimes slightly broadened base, dark black, germ pore central to slightly eccentric toward the abaxial spore side, up to 2.5–3 µm diam. *Basidia* and *pseudoparaphyses* could not be observed due to deliquescence. *Pleurocystidia* not observed. *Cheilocystidia* probably present in young specimens but the material studied was always very mature, with the gill-edge completely deliquesced. *Clamp-connections* absent, only *pseudoclamps* present. *Elements of veil* 45–200 × 5–30 µm, consisting of cylindrical septate hyphae, rarely branched, densely packed, very variable in size and shape.

Habit, Habitat & Distribution — Growing solitary on sand in littoral dunes with psammophilous vegetation. Very rare in the studied area.

Typus. SPAIN, Huelva, Playa Coto de Doñana, National Park of Doñana, psammophilous in dunes, 5 Apr. 2013, A. Sánchez (holotype AH 45819, ITS sequence GenBank KU686920, LSU sequence GenBank KU686903, MycoBank MB815823).

Additional specimens examined. ***Coprinus littoralis***: SPAIN, Huelva, Playa de Doñana, National Park of Doñana, psammophilous in dunes, 6 Apr. 2013, A. Sánchez, paratype AH 45860 (ITS, LSU sequences GenBank, KU686921, KU686904), idem, 7 Apr. 2013, AH 45859 (ITS, LSU sequences GenBank, KU686922, KU686905). ***Coprinus comatus***: SPAIN, Alcalá de Henares, Campus universitario, Facultad de Biología, in a garden, 15 Nov. 2008, J. Rejos & G. Moreno, AH 44095 (ITS, LSU sequences GenBank, KU686915, KU686898); Madrid, Valdemorillo, in open area in a forest of *Quercus ilex* subsp. *ballota*, 10 Apr. 2010, M. Hinojosa & J.C. Campos, AH 45823 (ITS, LSU sequences GenBank, KU686913, KU686896); Madrid, Canillejas, in parking of the Capricho Park, 23 Mar. 2014, J.L. Domingo, AH 44089 (ITS, LSU sequences GenBank, KU686914, KU686897); Madrid, Las Matas, on side of a path, 8 May 2014, J. Morales, AH 45796 (ITS, LSU sequences GenBank, KU686916, KU686899); Guadalajara, in a garden, 6 Dec. 2014, J.R. Carlavilla, AH 45795 (ITS, LSU sequences GenBank, KU686911, KU686894); Alcalá de Henares, Campus universitario, Residencia Crusa, in a garden, 28 Oct. 2015, P. Rosario, AH 45832 (ITS, LSU sequences GenBank, KU686912, KU686895); idem, 4 Nov. 2015, AH 45831 (ITS, LSU sequences GenBank, KU686918, KU686901); Alcalá de

Henares, Campus universitario, Escuela Politécnica, in a garden, 6 Nov. 2015, A. López-Villalba, J.R. Carlavilla & G. Moreno, AH 45830 (ITS, LSU sequences GenBank, KU686917, KU686900). ***Coprinus pinetorum***: SPAIN, Madrid, Rivas Vaciamadrid, in humus of *Pinus halepensis*, 18 Nov. 2011, M. Martín, L. Rubio-Casas, L. Rubio-Roldán & G. Moreno, holotype AH 44094 (ITS, LSU sequences GenBank, KU686924, KU686907); Madrid, Rivas Vaciamadrid, in humus of *Pinus halepensis*, 18 Nov. 2011, M. Martín, L. Rubio-Casas, L. Rubio-Roldán & G. Moreno, AH 45797 (ITS, LSU sequences GenBank, KU686925, KU686908); idem, 22 Nov. 2014, M. Martín, AH 45798 (ITS, LSU sequences GenBank, KU686926, KU686909); Almería, Sierra de los Filabres, in humus of *Pinus halepensis*, 30 Nov. 2002, G. Moreno & R. Galán, AH 45815 (ITS, LSU sequences GenBank, KU686927, KU686910). ***Coprinus vosoustii***: SPAIN, Madrid, Ciudad Universitaria, Facultad de Farmacia and Medicina, in a garden, 13 May 1976, K. Tabba, AH 1284 (ITS, LSU sequences GenBank, KU686919, KU686902); idem, 8 May 1977, G. Moreno, AH 556 (ITS, LSU sequences GenBank, KU686923, KU686906).

Notes — *Coprinus littoralis* is characterised by its medium size sporocarp (as compared with *Coprinus comatus*), its large spores (13–20 × 8–12 µm) with slightly eccentric germ pore and by growing in littoral dunes.

In our ITS phylogeny (MycoBank supplementary data) *Coprinus littoralis* is significantly related to *C. comatus*, *C. sterquilinus*, *C. vosoustii* and *C. pinetorum*. They all belong to subsect. *Coprinus* s. Uljé (the *C. comatus* group). *Coprinus comatus* differs from *C. littoralis* by its more robust habit, smaller spores (9–12.5 × 7–9 µm) and by fruiting on strongly nitrified sites (gardens, roadsides and paths or on lawns). *Coprinus sterquilinus* differs from *C. littoralis* by its larger spores (17–26 × 10–15 µm) and the habitat on dung. *Coprinus vosoustii*, considered by Moreno & Heykoop (1998) as a synonym of *C. calyptratus*, resembles *C. littoralis* because of the thick and persistent star-shaped ochraceous veil on the cap as well as by the large spores. Nevertheless, *Coprinus littoralis* differs from *C. vosoustii* by the strict psammophilous habitat and the absence of a napiform rooting stipe. *Coprinus pinetorum* differs from *C. littoralis* by its fibrillose flocculose veil, smaller spores (8–11 × 5.5–8 µm) and by fruiting among needles of *Pinus halepensis*.

Macroscopically, *Coprinus spadiceisporus*, a very rare species described from the State of Washington by Van de Bogart (1976), is also a *C. comatus*-like fungus. Nevertheless, it differs from *C. littoralis* by fruiting on dung and by its veil with small somewhat appressed scales (Van de Bogart 1976). Uljé et al. (1998) revised the type of *C. spadiceisporus* and synonymised it with *C. roseistipitatus*, which also was described fruiting on dung of rabbit and deer. *Coprinus spadiceisporus* has been collected in Spain (Lleida) by Tabarés & Rocabruna (2002) fruiting on dung of rabbit. Another *C. comatus*-like fungus which resembles *Coprinus littoralis* is *C. levisticolens*. However, *Coprinus levisticolens* differs from *C. pinetorum* by its scaly cap, smaller spores (11–14.5 × 7–8 µm) and by fruiting on sandy soil under *Populus alba* and *Crataegus* spp. (Ludwig & Roux 1995).

Colour illustrations. Spain, Playa Coto de Doñana, National Park of Doñana, littoral dunes with psammophilous vegetation, where the holotype was collected; basidiomata, cylindrical septate hyphae of veil, spores under LM, smooth spores with eccentric germ pore under SEM (from the holotype). Scale bars = 1 cm (basidiomata), 50 µm (veil), 10 µm (spores under LM), 5 µm (spores under SEM).



Fungal Planet 454 – 4 July 2016

Coprinus pinetorum G. Moreno, Carlavilla, Heykoop & Manjón, *sp. nov.*

Etymology. Name reflects the habitat, humus of *Pinus halepensis*, from which this fungus was collected.

Classification — Agaricaceae, Agaricales, Agaricomycetes.

Cap 35–45 × 25–35 mm when still closed, ellipsoid to subcylindrical, becoming revolute at margin when mature, first whitish, later with pinkish tinges, veil first fibrillose to flocculose, then breaking up into small and fragile whitish upturned scales, except at centre, that stays smooth and becomes creamy to strawish creamy. *Gills* crowded, first white, and then pinkish to black, the gill-edge whitish, probably due to the presence of numerous cheilocystidia, strongly deliquescent when mature. *Stem* 60–120 × 10–17 mm, whitish, with movable fragile ring on lower part, upperside strawish whitish, underside greyish flesh coloured, with up to 22 mm wide bulbous to subbulbous base, hollow, with central strand. *Spores* 8–11 × (5–)5.5–8 µm av. 8.1–10.6 × 5.9–6.9 µm (4 collections), Q_{av} = 1.38–1.62, smooth, ellipsoid, sometimes slightly broadened base, dark black, germ pore central, up to 1–1.5 µm diam. *Basidia* 14–35 × 10–13 µm (excl. sterigmata), sterigmata up to 4 µm in length, 4-spored, hyaline, sometimes with brownish vacuolar pigment toward the base, surrounded by 6–8 pseudoparaphyses. *Cheilocystidia* probably present in young specimens but the material studied was always very mature, with the gill-edge completely deliquesced. *Pleurocystidia* not observed. *Clamp-connections* absent, only *pseudoclamps* present. *Elements of veil* 35–220 × 9–35 µm, consisting of cylindrical branched hyphae, septate, densely packed and very variable in size and shape.

Habit, Habitat & Distribution — Growing gregarious on basic soil under *Pinus halepensis*. Rare in the studied area.

Typus. SPAIN, Madrid, Rivas Vaciamadrid, in humus of *Pinus halepensis*, 18 Nov. 2011, M. Martín, L. Rubio-Casas, L. Rubio-Roldán & G. Moreno (holotype AH 44094, ITS sequence GenBank KU686924, LSU sequence GenBank KU686907, MycoBank MB815824).

Additional specimens examined. ***Coprinus pinetorum***: SPAIN, Madrid, Rivas Vaciamadrid, in humus of *Pinus halepensis*, 18 Nov. 2011, M. Martín, L. Rubio-Casas, L. Rubio-Roldán & G. Moreno, paratype AH 45797 (ITS, LSU sequences GenBank, KU686925, KU686908); idem, 22 Nov. 2014, M. Martín, paratype AH 45798 (ITS, LSU sequences GenBank, KU686926, KU686909); Almería, Sierra de los Filabres, in humus of *Pinus halepensis*, 30 Nov. 2002, G. Moreno & R. Galán, paratype AH 45815 (ITS, LSU sequences GenBank, KU686927, KU686910). ***Coprinus comatus***: SPAIN, Alcalá de Henares, Campus universitario, Facultad de Biología, in a garden, 15 Nov. 2008, J. Rejos & G. Moreno, AH 44095 (ITS, LSU sequences GenBank, KU686915, KU686898); Madrid, Valdemorillo, in open area in a forest of *Quercus ilex* subsp. *ballota*, 10 Apr. 2010, M. Hinojosa & J.C. Campos, AH 45823 (ITS, LSU sequences GenBank, KU686913, KU686896); Madrid, Canillejas, in parking of the Capricho Park, 23 Mar. 2014, J.L. Domingo, AH 44089 (ITS, LSU sequences GenBank, KU686914, KU686897); Madrid, Las Matas, on

side of a path, 8 May 2014, I. Morales, AH 45796 (ITS, LSU sequences GenBank, KU686916, KU686899); Guadalajara, in a garden, 6 Dec. 2014, J.R. Carlavilla, AH 45795 (ITS, LSU sequences GenBank, KU686911, KU686894); Alcalá de Henares, Campus universitario, Residencia Crusa, in a garden, 28 Oct. 2015, P. Rosario, AH 45832 (ITS, LSU sequences GenBank, KU686912, KU686895); idem, 4 Nov. 2015, AH 45831 (ITS, LSU sequences GenBank, KU686918, KU686901); Alcalá de Henares, Campus universitario, Escuela Politécnica, in a garden, 6 Nov. 2015, A. López-Villalba, J.R. Carlavilla & G. Moreno, AH 45830 (ITS, LSU sequences GenBank, KU686917, KU686900). ***Coprinus littoralis***: SPAIN, Huelva, Playa Coto de Doñana, National Park of Doñana, psammophilous in dunes, 5 Apr. 2013, A. Sánchez, holotype AH 45819 (ITS, LSU sequences GenBank, KU686920, KU686903); Huelva, Playa de Doñana, National Park of Doñana, psammophilous in dunes, 6 Apr. 2013, A. Sánchez, AH 45860 (ITS, LSU sequences GenBank, KU686921, KU686904), idem, 7 Apr. 2013, AH 45859 (ITS, LSU sequences GenBank, KU686922, KU686905). ***Coprinus vosoustii***: SPAIN, Madrid, Ciudad Universitaria, Facultad de Farmacia y Medicina, in a garden, 13 May 1976, K. Tabba, AH 1284 (ITS, LSU sequences GenBank, KU686919, KU686902); idem, 8 May 1977, G. Moreno, AH 556 (ITS, LSU sequences GenBank, KU686923, KU686906).

Notes — *Coprinus pinetorum* is characterised by its small size (as compared with *C. comatus*), its spores with slightly broadened base (8–11 × 5.5–8 µm) and by fruiting among needles of *Pinus halepensis*.

In our ITS phylogeny (MycoBank supplementary data) *Coprinus pinetorum* is significantly related to *C. comatus*, *C. sterquilinus*, *C. vosoustii* and *C. littoralis*. They all belong to subsect. *Coprinus* s. Uljé (the *C. comatus* group). *Coprinus comatus* differs from *C. pinetorum* by its more robust habit and by fruiting on strongly nitrified sites (gardens, roadsides and paths or on lawns). *Coprinus sterquilinus* differs from *C. pinetorum* by its solitary basidiocarps, very large spores (17–26 × 10–15 µm) and the habitat on dung. *Coprinus vosoustii* differs from *C. pinetorum* by its ovoid cap, thick ochraceous and persistent veil forming a star-shaped layer at centre, and much larger spores (17–20 × 10–12 µm). *Coprinus littoralis* differs from *C. pinetorum* by its larger basidiocarps, larger spores (13–20 × 8–12 µm) with slightly eccentric germ pore and the psammophilous habitat in littoral dunes.

Macroscopically, *C. spadiceisporus*, a very rare species described from the State of Washington by Van de Bogart (1976), is also a *C. comatus*-like fungus. Nevertheless, it differs from *C. pinetorum* by fruiting on dung and by its spores with eccentric germ pore (Van de Bogart 1976). Another *C. comatus*-like fungus which resembles *Coprinus pinetorum* is *C. levisticolens*. However, *C. levisticolens* differs from *C. pinetorum* by its scaly cap, larger spores (11–14.5 × 7–8 µm) with eccentric germ pore and by fruiting on sandy soil under *Populus alba* and *Crataegus* spp. (Ludwig & Roux 1995).

Colour illustrations. Spain, Rivas Vaciamadrid, humus of *Pinus halepensis*, where the holotype was collected; basidiomata and fruit body section, cylindrical hyphae of veil, 4-spored basidia, spores under LM, smooth spores with central germ pore under SEM (from the holotype). Scale bars = 1 cm (basidiomata), 10 µm (veil, basidia, spores under LM), 2 µm (spores under SEM).

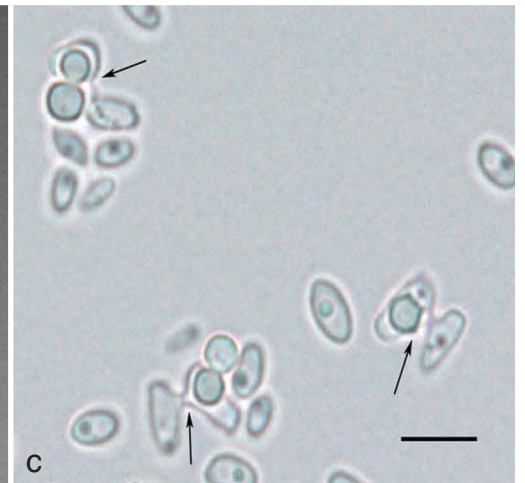
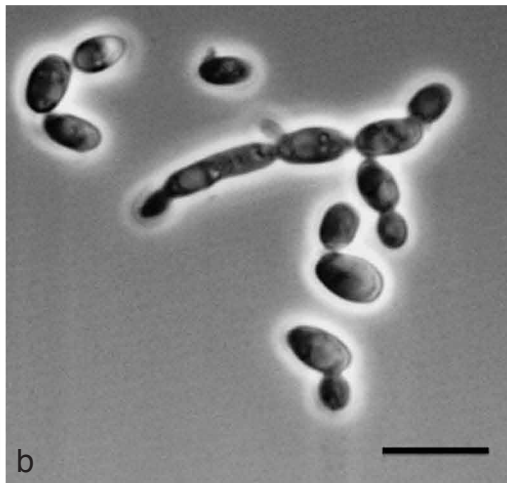

Fungal Planet 455 – 4 July 2016

Priceomyces vitoshaensis Gouliamova, Dimitrov, M.T. Sm., M.M. Stoilova-Disheva & M. Groenew., *sp. nov.*

Etymology. The specific epithet '*vitoshaensis*' was derived from the locality Vitosha Nature Park where insect hosts of the ex-type strain were collected.

Classification — *Debaryomycetaceae*, *Saccharomycetales*, *Saccharomycetes*.

After 7 d growth at 25 °C on 5 % glucose broth, cells are globose, ovoid, oblong, 2–5 × 3–7 µm, occurring singly, in pairs, in small clusters or in small chains, and proliferating by multi-lateral budding. Dalmat plate culture after 10 d on morphology (Wickerham 1951) and potato-dextrose agar (PDA) at 20–25 °C did not show pseudohyphae. After 3 d of incubation on yeast extract, malt extract, pepton, glucose agar (YM), the single strains formed asci after conjugation of independent cells. The asci were lytic, releasing 1–2 round and smooth ascospores. For physiological characteristics see MycoBank MB802453.

Typus. BULGARIA, Sofia, Nature Park Vitosha, in birch forest, above village Bistritsa, N42°35'10" E23°21'36", from *Pterostichus melas* (*Carabidae*) 19 July 2009, *D. Gouliamova* (holotype metabolically inactive strain CBS 12457; ITS sequence GenBank HM627157.2, LSU sequence GenBank HM627053, MycoBank MB802453); Additional strain 3R = CBS 1243 was isolated from the same beetle species collected in Nature Park 'Zlatni Pyasatsi', N43°17'0" E28°2'0", on oak meadow, 24 Apr. 2009, ITS, LSU sequences GenBank KC810955, KC810946.

Notes — The most similar sequence in GenBank is *C. northwykensis* (98 % identity in both LSU and ITS sequences). Phylogenetic analyses, using an alignment of concatenated LSU and ITS sequences of known species present in the *Priceomyces* clade and the new yeast strains, placed the latter with *C. northwykensis* in a separate subclade (100 % support). Pairwise comparison of sequences from multiple alignment data showed that the new strains have 97 % identity with *C. northwykensis*

(1 121 identical nt., 14 subst. in ITS and 11 subst., 1 gap in LSU), 93 % with *C. fermenticarenis* (1 080 identical nt., 44 subst., 10 gaps in ITS and 23 subst., 3 gaps in LSU) and 91 % identity with *P. melissophilus* (1 054 nt., 47 subst., 10 gaps in ITS and 24 subst., 2 gaps in LSU). Nine physiological characteristics distinguish the new strains from *C. northwykensis*. They can assimilate cellobiose, salicin, ribitol, succinate, methyl α-glucoside and nitrite. They cannot assimilate ethanol and they do not grow in 0.01 % cycloheximide and at 35 °C. Thus, we assign these strains to the newly proposed species, *Priceomyces vitoshaensis*.

New combinations in the genus Priceomyces.

Based on the results of phylogenetic analysis of combined LSU and ITS rDNA we propose new combinations in the genus *Priceomyces* for the following species that previously belonged to the genus *Candida*.

Priceomyces fermenticarenis (Van der Walt & Baker) Gouliamova, Dimitrov, M.T. Sm., M.M. Stoilova-Disheva & M. Groenew., *comb. nov.* — MycoBank MB310255

Basionym. *Candida fermenticarenis*, Van der Walt & Baker, *Bothalia* 12: 561. 1978.

Priceomyces northwykensis (Ravella et al.) Gouliamova, Dimitrov, M.T. Sm., M.M. Stoilova-Disheva & M. Groenew., *comb. nov.* — MycoBank MB560189

Basionym. *Candida northwykensis*, Ravella et al., *Curr. Microbiol.* 63: 115. 2011.

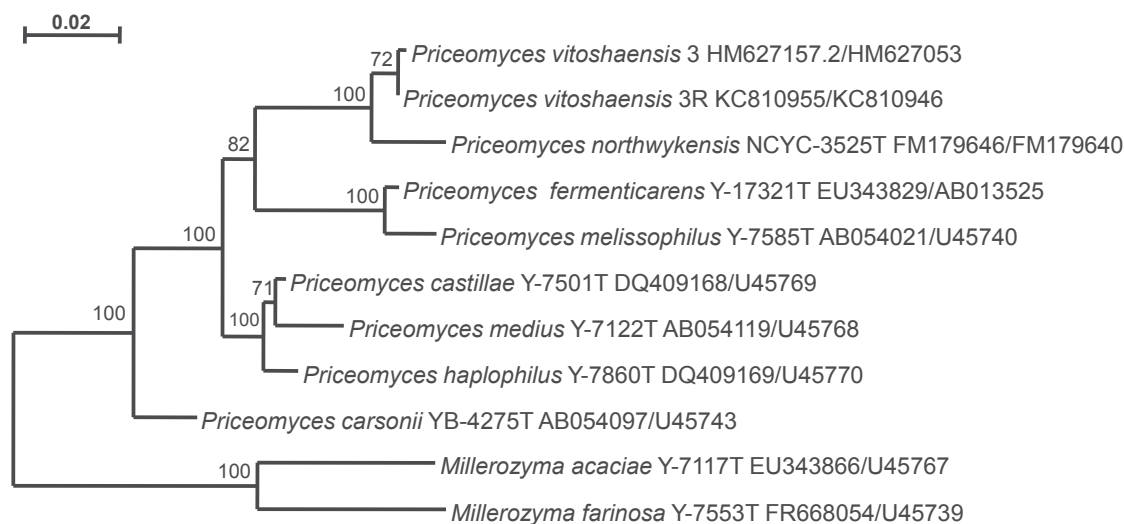

Colour illustrations. Bulgaria, Vitosha Mountain, large stone river Zlatnite Mostove (Golden Bridges) (Photo: Alexandra Toneva); a. *Pterostichus melas* (*Carabidae*, www.zin.ru/Animalia/Coleoptera); b. morphology of cells of *Priceomyces vitoshaensis* 3^T in 5 % glucose broth; c. arrows indicating the conjugated asci with ascospores. Scale bars = 10 µm (cells), 5 µm (asci with ascospores).

Phylogenetic analysis of the alignment of the ITS1+2 region, and the LSU (D1/D2 domains) rRNA gene using a maximum likelihood analysis (MEGA v. 6) for *Priceomyces vitoshaensis* 3^T and related species.

Dilnora E. Gouliamova & Margarita M. Stoilova-Disheva, The Stephan Angeloff Institute of Microbiology, Bulgarian Academy of Sciences, Acad. G. Bonchev 26, Sofia 1113, Bulgaria; e-mail: dilnorag@gmail.com & margid@microbio.bas.bg
Roumen A. Dimitrov, Sofia University "St. Kliment Ohridski", 5 James Bourchier Blvd., Sofia 1164, Bulgaria; e-mail: dimitrov@phys.uni-sofia.bg
Maudy Th. Smith & Marizeth Groenewald, CBS-KNAW Fungal Biodiversity Centre, Box 85167, 3508 AD Utrecht, The Netherlands; e-mail: m.smith@cbs.knaw.nl & m.groenewald@cbs.knaw.nl

Nothophoma macrospora

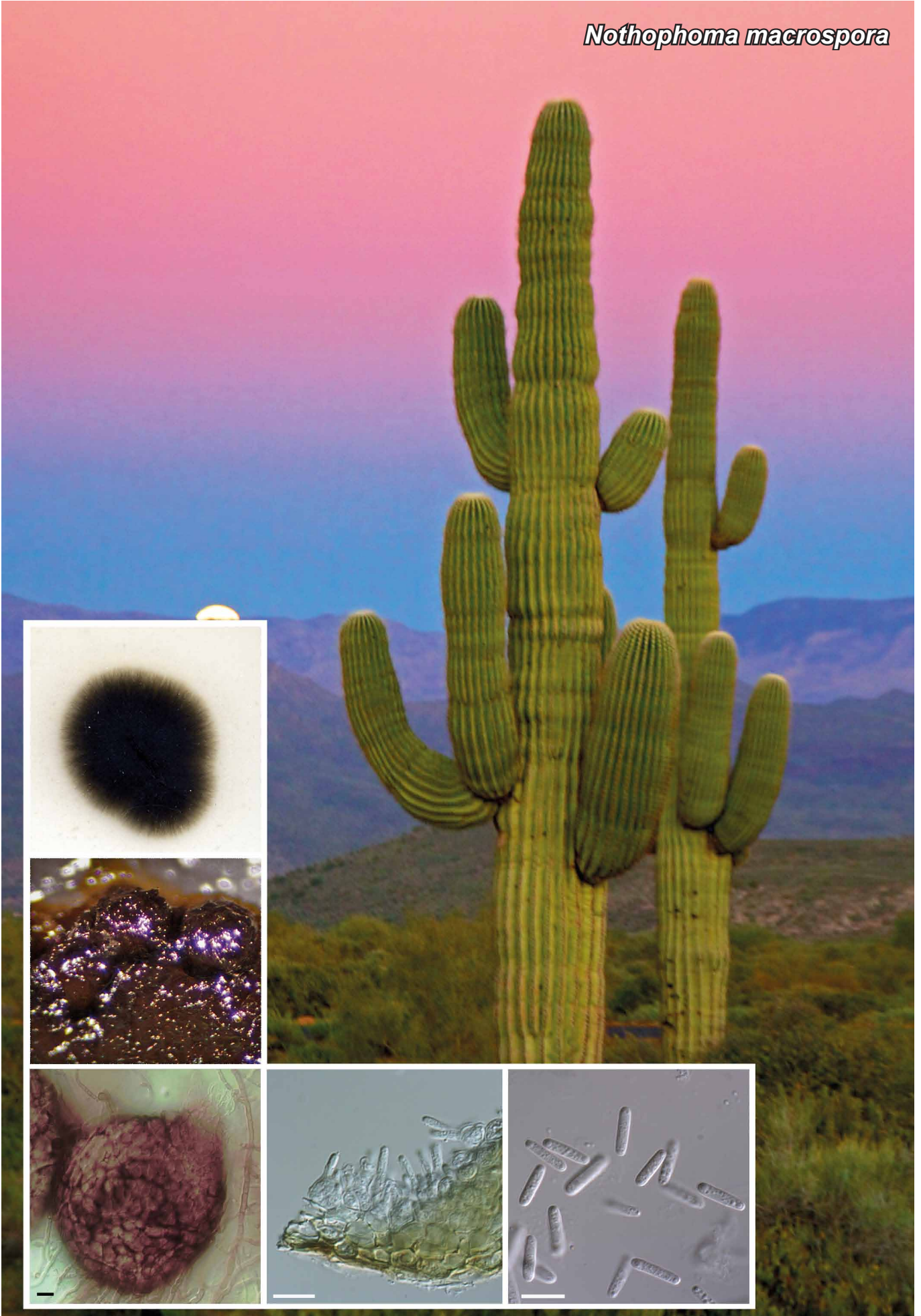

Fungal Planet 456 – 4 July 2016

Nothophoma macrospora Valenzuela-Lopez, Stchigel, Cano & Deanna A. Sutton, sp. nov.

Etymology. *G. μακρό-*, large, and *-σπορά*, spore, referring to the big size of the conidia.

Classification — *Didymellaceae*, *Pleosporales*, *Dothideo-mycetes*.

Hyphae pale to dark brown, 3–10 µm wide, thin- to thick-walled, smooth to granulose due to the production of dark granules, septate, anastomosing. *Conidiomata* pycnidial dark brown, pyriform to heart-shaped by the occasional production of 2–3(–4) necks, rarely globose, 100–300 × 100–300 µm; peridium 3–5-layered, 15–25 µm thick, peridial cells globose to polygonal, pale to dark brown, 5–10 µm diam, thick-walled; neck usually present, paler than the peridial wall, cylindrical to conical, (50–)90–150 × (50–)80–110 µm, papillate, ornamented with a crown of short, subhyaline, conical to digitiform projections around the ostium, ostium of late opening; exuded conidial masses not observed; conidiogenous cells enteroblastic, phialidic, globose to flask-shaped, hyaline, thin-walled, 5–10 µm diam; conidia (9–)10–15 × 2.5–3(–3.5) µm, hyaline, cylindrical to slightly clavate at one or both ends, 0(–2)-septate, narrowing slightly at the septa, guttulate, sometimes producing a similar conidia on a lateral bulge, then forming irregular chains. *Chlamydospores* absent, but some hyphae cells become darker, thicker and barrel-shaped.

Culture characteristics — Colonies on OA reaching 30 mm diam in 7 d at 25 °C, olive brown (M.4F3), flattened, granulose due to the production of numerous pycnidia; reverse concolorous. Colonies on MEA attaining 37–41 mm in 7 d at 25 °C, yellowish white (M.4A2) to light brown (M.6D8), flattened, compact, reverse concolorous. NaOH spot test: negative. Crystals absent.

Typus. USA, Arizona, Phoenix, from respiratory secretion of a patient with pneumonia, 1 Apr. 2009, *D.A. Sutton* (holotype CBS H-22377, cultures ex-type UTHSC DI09-853 = FMR 13767 = CBS 140674, ITS sequence GenBank LN880536, LSU sequence GenBank LN880537, *actA* sequence GenBank LN880538, *tub2* sequence GenBank LN880539, MycoBank MB815051).

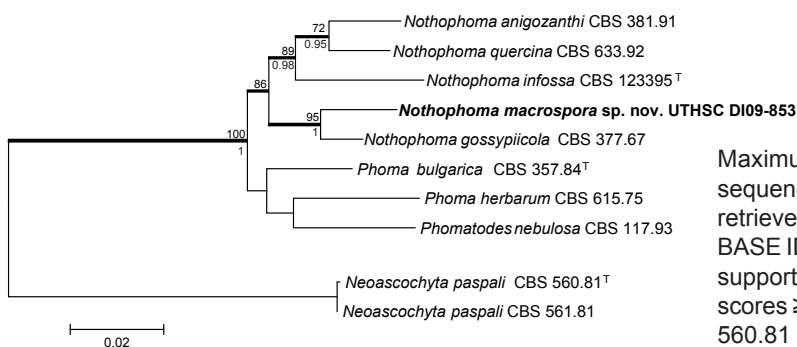

Colour illustrations. USA, Arizona, Phoenix, McDowell mountain park (image credit: Hector Lopez and Brenda, www.hmlopezphoto.com); colony on OA after 7 d at 25 °C, conidiomata under stereomicroscope, pycnidia, conidiogenous cells, conidia. Scale bars = 10 µm.

Notes — This fungus was isolated from a human clinical specimen. Morphologically, *Nothophoma macrospora* resembles the species previously classified into *Phoma* section *Macrospora* (Boerema et al. 2004), i.e. *Phoma andropogonivora*, *P. boeremae*, *P. chenopodii*, *P. commelinicola*, *P. gossypicola*, *P. necator*, *P. rabiei*, *P. xanthina* and *P. zae-maydis*. These species produce the largest conidia of the genus. Based on a megablast search of NCBI's GenBank nucleotide database, the closest hits using the LSU sequence are *Peyronellaea combreti* (GenBank KJ869191; Identities = 887/889 (99 %), no gaps) and *Peyronellaea prosopidis* (GenBank KF777232; Identities = 887/889 (99 %), no gaps). Closest hits using ITS sequence are *Leptosphaerulina australis* (GenBank KF293970; Identities = 493/497 (99 %), gaps 1/497 (0 %)), *Didymella glomerata* (GenBank AB369471; Identities = 493/497 (99 %), gaps 1/497 (0 %)) and *Nothophoma quercina* (GenBank AB369461; Identities = 493/497 (99 %), gaps 1/497 (0 %)). In a similar search in the Q-Bank fungal nucleotide database (www.q-bank.eu), the closest hit is *Nothophoma anigozanthi* CBS 381.91 (Identities = 468/473 (99 %), gaps = 1/473 (0 %)). The closest hit using the beta-tubulin (*tub2*) sequence is *Nothophoma gossypicola* (GenBank GU237611; Identities = 323/335 (99 %), no gaps), as well as using the actin (*actA*) sequence against Q-Bank (*Nothophoma gossypicola* CBS 377.67; Identities = 214/224 (96 %), no gaps). Our phylogenetic tree, built by using the ITS, LSU, *tub2* and *actA* sequences, corroborated that our fungus represents a new species of the genus *Nothophoma*, *N. gossypicola* being the most phylogenetically and morphologically related species. *Nothophoma macrospora* differs from *N. gossypicola* by its lower growing rate on OA, the shape (pyriform to heart-shaped vs globose), the number of necks (up to 4 vs 0–1) and the ornamentation (papillate vs non-papillate) of the pycnidia, and the presence of conidial septa (up to 2 vs non-septate).

Maximum likelihood tree obtained from the combined DNA sequences dataset from four loci of our isolate and sequences retrieved from the GenBank and the Q-Bank databases (TreeBASE ID 18137). Above the nodes are presented the bootstrap support values ≥ 70 %, and the Bayesian posterior probability scores ≥ 0.95 are indicated below. *Neoscochyta paspali* (CBS 560.81 & CBS 561.81) was used as outgroup. Ex-type strains of the different species are indicated with †. The new species proposed in this study is indicated in **bold**. The alignment was performed by MEGA v. 6.06 (Tamura et al. 2013), and the tree building by MEGA v. 6.06 and by MrBayes v. 3.2.4 (Huelsenbeck & Ronquist 2001).

Nicomedes Valenzuela-Lopez, Mycology Unit, Medical School and IISPV, Universitat Rovira i Virgili (URV), Sant Llorenç 21, 43201 Reus, Tarragona, Spain; Microbiology Unit, Medical Technology Department, Faculty of Health Science, University of Antofagasta, Av. Universidad de Antofagasta s/n, 02800 Antofagasta, Chile; e-mail: nicomedes.vl@gmail.com
 Alberto M. Stchigel & José F. Cano-Lira, Mycology Unit, Medical School and IISPV, Universitat Rovira i Virgili (URV), Sant Llorenç 21, 43201 Reus, Tarragona, Spain; e-mail: alberto.stchigel@urv.cat; jose.cano@urv.cat & josep.guarro@urv.cat
 Deanna A. Sutton & Nathan P. Wiederhold, Fungus Testing Laboratory, Department of Pathology, University of Texas Health Science Center, 7703 Floyd Curl Dr., San Antonio, Texas 78229-3900, USA; e-mail: suttond@uthscsa.edu

Entoloma kruticianum



Fungal Planet 457 – 4 July 2016

Entoloma kruticianum O.V. Morozova, M.Yu. Dyakov, E.S. Popov & A.V. Alexandrova, *sp. nov.*

Etymology. The epithet refers to the type locality – Krutitsy Village in the Tver Region of Russia.

Classification — *Entolomataceae*, *Agaricales*, *Agaricomycetes*.

Basidiomata small-sized, mycenoid. *Pileus* 5–12 mm diam, hemispherical to convex, not hygrophanous, not translucently striate, with appendiculate margin, radially fibrillose to slightly squamulose in the centre, deep violet (15E7–8; Kornerup & Wanscher 1978), darker in the centre (15F6–8). *Lamellae* moderately distant, adnate-emarginate or almost free, ventricose, reddish lilac (14C3–4, 14D3–4), becoming greyish pink, with paler entire edge. *Stipe* 20–70 × 1–2 mm, cylindrical, longitudinally fibrillose-striate, deep blue to deep violet (19D8–E8, 18D8–E8), clearly different from the pileus, white tomentose at base. *Context* concolorous with the surface. *Smell* indistinct, taste not reported. *Spores* (7.5–)8.5(–10.5) × (5.5–)6(–7) μm, Q = (1.3–)1.5(–1.8), heterodiametrical, with 5–7 angles in side-view. *Basidia* 22–25 × 8–12.5 μm, 4-spored, narrowly clavate to clavate, clamped. *Lamellae* edge fertile or heterogeneous. *Cheilocystidia* 24.5–37.5 × 4.5–9.5 μm, cylindrical, lageniform or irregularly shaped, intermixed with basidia, in some basidiomata rare or absent. *Pileipellis* a plagiotrichoderm to trichoderm in the centre, of cylindrical to slightly inflated hyphae 10–20 μm wide with swollen terminal elements and bluish-violetaceous intracellular pigment. *Clamp-connections* present.

Habit, Habitat & Distribution — In a small group among *Sphagnum* in *Picea abies* forest. Known from European Russia.

Typus. RUSSIA, Tver Region, Staritsa District, vicinities of the Krutitsy Village, N56°18'35.2" E34°52'07.7", 13 Sept. 2015, M. Dyakov, O. Morozova, E. Popov & A. Alexandrova (holotype LE 311767, ITS sequence GenBank KU666558, LSU sequence GenBank KU710222, MycoBank MB815745).

Notes — *Entoloma kruticianum* represents a species of the subgenus *Leptonia* due to the presence of clamp-connections, absence of brilliant granules and plagiotrichoderm to trichoderm pileipellis. It resembles *E. lepidissimum* by its small-sized mycenoid basidiomata with deep blue and violet colours, including coloured lamellae. Microscopically, the scattered cheilocystidia also make them similar. However, *E. kruticianum* can be recognized by the colour of the pileus, which is clearly different from the stipe, the presence of the reddish lilac tint in the lamellae, as well as smaller spores with pronounced angles and attenuate hilum. The ITS1-5.8S-ITS2 region of the newly described species has been compared with those of the other *Leptonia* species (mostly derived from the type material, data from Morozova et al. 2014). Molecular data support their differences (p-distance from the closest species *E. lepidissimum* – 8%). The similar dark blue species distinguish (except for the colour of the pileus): *E. coelestinum* – by the white lamellae, smaller

Colour illustrations. Russia, Tver' Region, Staritsa District, vicinities of the Krutitsy Village, type locality; pileipellis, spores, cheilocystidia, basidiomata (all from holotype). Scale bars = 1 cm (basidiomata), 10 μm (spores, cheilocystidia and pileipellis).

spores and more conical pileus, *E. chytrophilum* possesses white lamellae, nodulose spores and more applanate pileus. Both varieties of *E. callichroum* are characterized by the similar coloration of the basidiomata, but their spores are larger and cheilocystidia (if present) are broadly clavate, never lageniform. One more species with coloured lamellae – *E. euchroum* – usually is more robust and possesses larger spores with rather blunt angles.

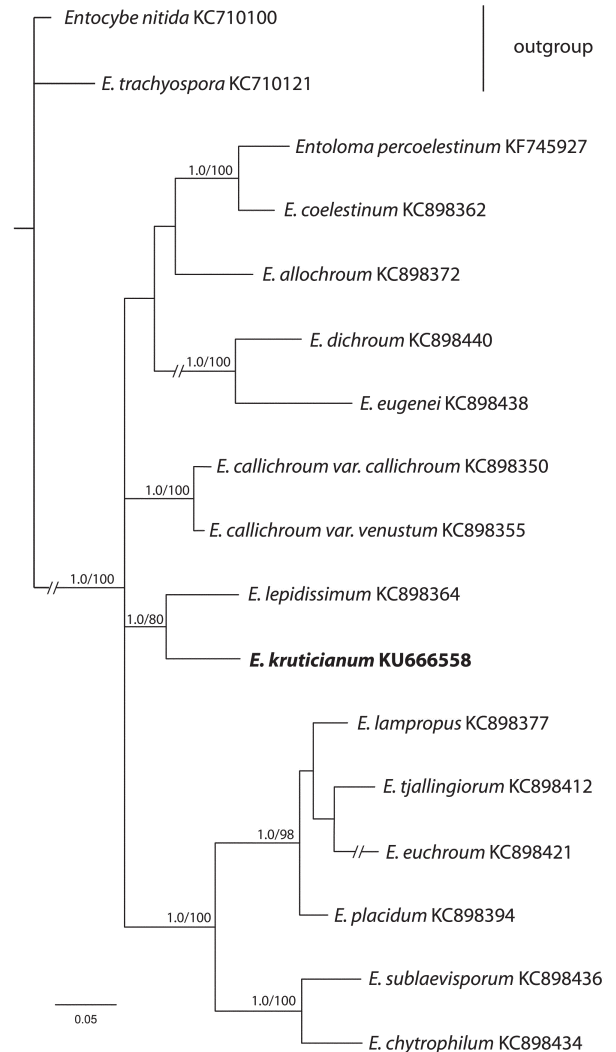

Phylogenetic tree derived from Bayesian analysis, based on nrITS1-5.8S-ITS2 data. Analysis was performed under GTR model, for 3 M generations, using MrBayes v. 3.2.1 (Ronquist et al. 2012). The ML analysis was run in the RAXML server (<http://phylobench.vital-it.ch/raxml-bb/index.php> (Stamatakis et al. 2008)). Posterior probability (PP > 0.95) values from the Bayesian analysis followed by bootstrap values from the Maximum Likelihood (BS > 70%) analysis are added to the left of a node (PP/BS).

Olga V. Morozova & Eugene S. Popov, Laboratory of Systematics and Geography of Fungi, Komarov Botanical Institute of the Russian Academy of Sciences, 197376, 2 Prof. Popov Str., Saint Petersburg, Russia; e-mail: OMorozova@binran.ru & EPopov@binran.ru
Alina V. Alexandrova & Maxim Yu. Dyakov, Lomonosov Moscow State University (MSU), Faculty of Biology, 119234, 1, 12 Leninskie Gory Str., Moscow, Russia; e-mail: alina-alex2011@yandex.ru & max_fungi@mail.ru



Fungal Planet 458 – 4 July 2016

Xerocomellus poederi G. Moreno, Heykoop, Esteve-Rav., P. Alvarado & Traba, sp. nov.

Etymology. Named after Reinhold Pöder, Austrian mycologist and specialist in *Boletales*, who passed away in August 2015.

Classification — *Boletaceae*, *Boletales*, *Agaricomycetes*.

Cap 1.2–5.5 cm broad, convex becoming applanate convex, sometimes depressed at centre, pale brown (Mu 7.5YR 6/3, 6/4), brown pinkish (Mu 5YR 6/3, 6/4) to dark brown when mature (Mu 5YR 3/1, 3/2, 3/3), becoming darker in herbarium specimen; surface dry, smooth, the epicutis cracking in age with reddish tinges in the cracks on the upper part (Mu 10R 4/6, 4/8); *context* in cap whitish, reddish under the epicutis, staining slightly bluish when bruised or cut. Margin irregular, concolorous to slightly paler, not hygrophanous nor striate. *Tubes* up to 0.8 mm in length, depressed around the stipe, ventricose, narrower towards the margin, whitish to pale yellowish when young (Mu 2.5Y 8/3, 8/4) then yellowish (Mu 2.5Y 7/4, 7/6), turning slightly bluish when bruised or cut. *Stem* 2.5–6 × 0.3–0.6 cm, cylindrical, solid, tapered downward, often curved, fragile, dark reddish (Mu 10R 3/4, 3/6), yellowish at the apex (Mu 2.5Y 8/4, 8/6), surface slightly granulose; *context* in stem whitish at the apex, dark red in the lower half or lower two thirds, turning slightly bluish when bruised or cut. Odour and taste not distinctive. *Spore-print* olive brown (Mu 2.5Y 5/3, 5/4). *Spores* (10.5–)11–16(–17) × 4–5.5(–6) µm, av. 11.9–14.6 × 4.4–5 µm (8 collections), Q_{av} = 2.56–3.17, fusiform, smooth with obtuse apex, with a distinct suprahilar depression, not amyloid nor dextrinoid, containing 1–3 lipidic globose drops or one ellipsoid drop filling almost the entire spore volume; under the SEM spores lack any ornamentation. *Basidia* 4-spored, 33–45 × 9–13 µm, sterigmata up to 5 µm in height, clavate, hyaline. *Pleurocystidia* numerous, fusiform, with obtuse apex, 33–55 × 8–12 µm, hyaline, sometimes with yellowish content. *Cheilocystidia* similar to pleurocystidia. *Caulohymenium* throughout the stem consisting of basidia, basidioles and cystidia similar to those present in the hymenium. *Pileipellis* a trichodermium consisting of septate hyphae, the cylindrical cells of the hyphae with thick walls, terminal cells very variable in shape, cylindrical (narrower than lower cells) to lageniform, 30–40 × 9–11 µm, with abundant yellowish pigment forming patches or strips. *Clamp-connections* not seen.

Habit, Habitat & Distribution — Growing solitary to gregarious on acid soil under *Quercus robur*. Very abundant in the studied area.

Typus. SPAIN, Lugo, Parque Río Rato, Concello de Lugo, in humus of *Quercus robur*, 1 Nov. 2013, G. Moreno & J.M. Traba (holotype AH 44050, ITS sequence GenBank KU355475, LSU sequence GenBank KU355488, MycoBank MB815475).

Additional specimens examined. *Xerocomellus poederi*: SPAIN, Lugo, Parque Río Rato, Concello de Lugo, in humus of *Quercus robur*, 1 Nov. 2013, G. Moreno & J.M. Traba, paratype AH 44051 (ITS, LSU sequences GenBank, KU355476, KU355489); idem, paratype AH 44052 (ITS, LSU

Colour illustrations. Spain, Parque Río Rato, *Quercus robur* forest, where the holotype was collected; basidiomata and fruit body section, trichodermium showing its variability, 4-spored basidium, hymenial cystidia, basidiospores, smooth spores under SEM (holotype AH 44050). Scale bars = 1 cm (basidiomata), 10 µm (pileipellis, basidium, pleurocystidia, spores under LM), 2 µm (spores under SEM).

sequences GenBank, KU355477, KU355490); idem, paratype AH 44053; idem, paratype AH 45804 (ITS, LSU sequences GenBank, KU355478, KU355491); Lugo, Concello de O Corgo, Finca O Fia, in humus of *Quercus robur*, 2 Nov. 2013, G. Moreno, J.M. Traba & J.M. Castro-Marcote, paratype AH 45855; A Coruña, Vimianzo, in humus of *Quercus robur*, *Corylus avellana* and *Laurus nobilis*, 29 Aug. 2015, J.M. Castro-Marcote, paratype AH 45803 (ITS, LSU sequences GenBank, KU355480, KU355491); Orense, Leiro, in humus of *Quercus robur*, 23 Nov. 2013, J.M. Castro-Marcote, paratype AH 45805 (ITS, LSU sequences GenBank, KU355479, KU355492). *Xerocomellus chrysenderon*: SPAIN, Madrid, La Barranca, Navacerrada, in humus of *Pinus sylvestris*, 29 Oct. 2013, V. Córdoba, AH 44023 (ITS, LSU sequences GenBank, KU355474, KU355487); Segovia, Ermita de Hontanares, Riaza, in humus of *Quercus pyrenaica*, 20 June 2010, D. Saavedra, Y. Fernández & L. Rubio-Casas, AH38968 (ITS, LSU sequences GenBank, KU355473, KU355486). *Xerocomellus porosporus*: SPAIN, Segovia, Ermita de Hontanares, Riaza, in humus of *Quercus pyrenaica*, 12 June 2010, L. Rubio-Roldán & L. Rubio-Casas, AH 38964 (ITS, LSU sequences GenBank, KU355481, KU355493). *Xerocomellus ripariellus*: SPAIN, Madrid, Veilla de San Antonio, in humus of *Populus alba*, 3 July 2010, M. Martín, AH38971 (ITS, LSU sequences GenBank, KU355482, KU355494). *Xerocomus submentosus*: SPAIN, Ávila, El Tiemblo, in humus of *Castanea sativa* and *Quercus pyrenaica*, 27 June 2010, J.A. Rodea, AH38974 (ITS sequence GenBank, KU355483); Toledo, Real de San Vicente, in humus of *Quercus ilex* ssp. *ballota*, 23 Nov. 2013, R. Losada, AH 44076 (ITS, LSU sequences GenBank, KU355484, KU355495); Segovia, Fresno de Cantespino, in humus of *Quercus pyrenaica* and *Q. ilex* ssp. *ballota*, 6 Sept. 2013, J.M. Barrasa, AH45790 (ITS, LSU sequences GenBank, KU355485, KU355496).

Notes — *Xerocomellus poederi* is morphologically characterised by its small size, the reddish cylindrical fusiform long stem in relation to the cap diameter, the dark reddish context in the lower part of the stipe and by fruiting isolated to gregarious on acid soil under *Quercus robur*.

In our ITS phylogeny (MycoBank supplementary data) *Xerocomellus poederi* is closely related to *X. chrysenderon*, *X. porosporus* and *X. sarnarii*, and to a lesser degree to *X. dryophilus*, all of them belonging to the difficult *X. chrysenderon* complex (Peintner et al. 2003). The whole genus is strikingly different from *Xerocomus* and other taxa. *Xerocomellus chrysenderon* differs from *X. poederi* because of its more robust habit and its differently coloured stem context, with greenish to yellowish green tinges in the base, never dark reddish, and also because of its association with conifers or *Fagus* in Southern Europe. *Xerocomellus porosporus* differs from *X. poederi* because of the dark brownish colours lacking dark reddish tinges in the context at the base of the stem, as well as its apically truncate spores with a distinct germ pore. *Xerocomellus dryophilus*, a species described by Thiers (1975) from California, resembles *X. poederi* because of the dark reddish context at the base of the stem, a feature which led many authors to confuse both taxa (Simonini 1994, Pérez de Gregorio 1995, Ladurner & Simonini 2003); however, it differs from *X. poederi* because of its larger habit, the short stem in relation with the cap diameter, and a strict association to *Quercus agrifolia* (coast Live Oak) (Bessette et al. 2000, Desjardin et al. 2015). *Xerocomellus sarnarii*, a species described recently by Ariyawansa et al. (2015) from Italy, is macroscopically similar to *X. poederi*; however, it differs from *X. poederi* because of its spores which have a small truncature at the apex and a strict association with Mediterranean sclerophilous forests of *Quercus ilex* and *Q. suber*.

For the description of the colours the Munsell soil colour charts were used (Munsell 1994).

Helminthosporiella stilbacea



Fungal Planet 459 – 4 July 2016

Helminthosporiella Hern.-Restr., G.A. Sarria & Crous, *gen. nov.**Etymology.* Similar to the genus *Helminthosporium*.Classification — *Massarinaceae*, *Pleosporales*, *Dothideomycetes*.*Mycelium* superficial and immersed, hyphae hyaline to pale brown, smooth, branched, septate. *Conidiophores* erect, brown to red-brown, synnematos, septate, compacted. *Conidiogenous cells* polytretic, sympodial, integrated, determinate, ter-minal, cylindrical. *Conidia* catenate in easily disarticulating chains, obclavate, subcylindrical, occasionally bifurcate, brown, distoseptate, hilum darkened, thickened and refractive. *Sexual morph* unknown.*Type species.* *Helminthosporiella stilbacea* (Moreau) Hern.-Restr., G.A. Sarria & Crous.

Mycobank MB816988.

Helminthosporiella stilbacea (Moreau) Hern.-Restr., G.A. Sarria & Crous, *comb. & stat. nov.**Basionym.* *Cercospora palmicola* f. *stilbacea* Moreau, Rev. Mycol. 12: 38. 1947.= *Helminthosporium stilbaceum* (Moreau) S. Hughes, Mycol. Pap. 48: 38. 1952.= *Exosporium stilbaceum* var. *stilbaceum* (Moreau) M.B. Ellis, Mycol. Pap. 82: 38. 1961.= *Exosporium stilbaceum* var. *macrosporum* Subramon. & V.G. Rao, Journal of the Annamalai University, part B, Sciences 29: 404. 1971.*Mycelium* superficial and immersed, hyphae hyaline to pale brown, smooth, branched, septate. *Conidiophores* erect, brown to red-brown, synnematos, septate, compacted, 620–1400 × 19–54 µm, individual hyphae 3–4 µm wide. *Conidiogenous cells* mono- or polytretic, integrated, determinate, terminal, cylindrical, 31–67 × 4.5–7 µm, straight or curved at the apex. *Conidia* catenate in easily disarticulating chains, obclavate, subcylindrical, occasionally bifurcate, medium brown, 26–83 × 7–10 µm, (1–)3–5(–6)-distoseptate, striate-wall, hilum darkened, thickened and refractive.

Culture characteristics — Colonies on OA, reaching 9–12 mm diam after 1 wk at 25 °C in the dark. Velvety, with concentric rings and some black spots in the agar, olivaceous to green olivaceous, margin entire, white; reverse grey olivaceous. Colonies on MEA, reaching 20–27 mm diam after 1 wk at 25 °C in the dark. Velvety, elevate, dark brick, margin irregular, reverse vinaceous buff.

Specimen examined. COLOMBIA, Barrancabermeja, CENIPALMA, on leaves of *Elaeis oleifera*, May 2013, G. Andrea Sarria (culture CPHmZC-01, ITS sequence GenBank KX228298.1, LSU sequence GenBank KX228355.1, MycoBank MB816989).*Colour illustrations.* Nursery of *Elaeis oleifera* in CENIPALMA, Colombia; *Helminthosporiella stilbaceae*: synnemata, conidiogenous cells and conidia. Scale bars = 10 µm.Notes — This species was initially introduced as *Cercospora palmicola* f. *stilbacea* by Moreau (1947) as a 'form', different from *C. palmicola* due to the presence of a 'coremium'. Later it was transferred to *Exosporium* (Ellis 1961). Nevertheless, the generic placement of this species is doubtful in *Cercospora* or *Exosporium* and was tentatively accepted in *Helminthosporium* (Braun et al. 2014). *Helminthosporium* as well as *Helminthosporiella* are asexual genera in *Massarinaceae* with polytretic conidiogenous cells and distoseptate conidia. However, they are molecular and morphologically different. *Helminthosporiella* shows terminal conidiogenous cells and catenate conidia and species of *Helminthosporium* have both terminal and intercalary conidiogenous cells and solitary conidia. Another genus morphologically similar is *Corynespora*. But *Helminthosporiella* differs from *Corynespora* in having polytretic and sympodial, instead of monotretic and percurrent conidiogenous cells. Unfortunately, it was not possible to propose a formal epi- or neotypification, since the geographical origin of the specimen examined was not the same as described in the protologue (Democratic Republic of the Congo).*ITS.* Based on a megablast search of NCBI's GenBank nucleotide database, the closest hits using the ITS sequences are *Helminthosporium velutinum* (GenBank JN198435; Identities = 446/480 (93 %), Gaps = 5/480 (1 %)), *Helminthosporium* sp. (GenBank KJ877647; Identities = 447/480 (93 %), Gaps = 9/480 (1 %)) and *Helminthosporium* sp. (GenBank JN662484, Identities = 496/552 (90 %), Gaps = 16/552 (2 %)).*LSU.* Based on a megablast search of NCBI's GenBank nucleotide database, the closest hits using the LSU sequences are *Corynespora leucadendri* (GenBank KF251654, Identities = 820/840 (98 %), Gaps = 7/840 (0 %)), *Corynespora olivacea* (GenBank JQ044448, Identities = 831/858 (97 %), Gaps = 6/858 (0 %)) and *Byssothecium circinans* (GenBank AY016357; Identities = 830/858 (97 %), Gaps = 7/858 (0 %)) (Mycobank supplementary data).

Penidiellopsis radicularis

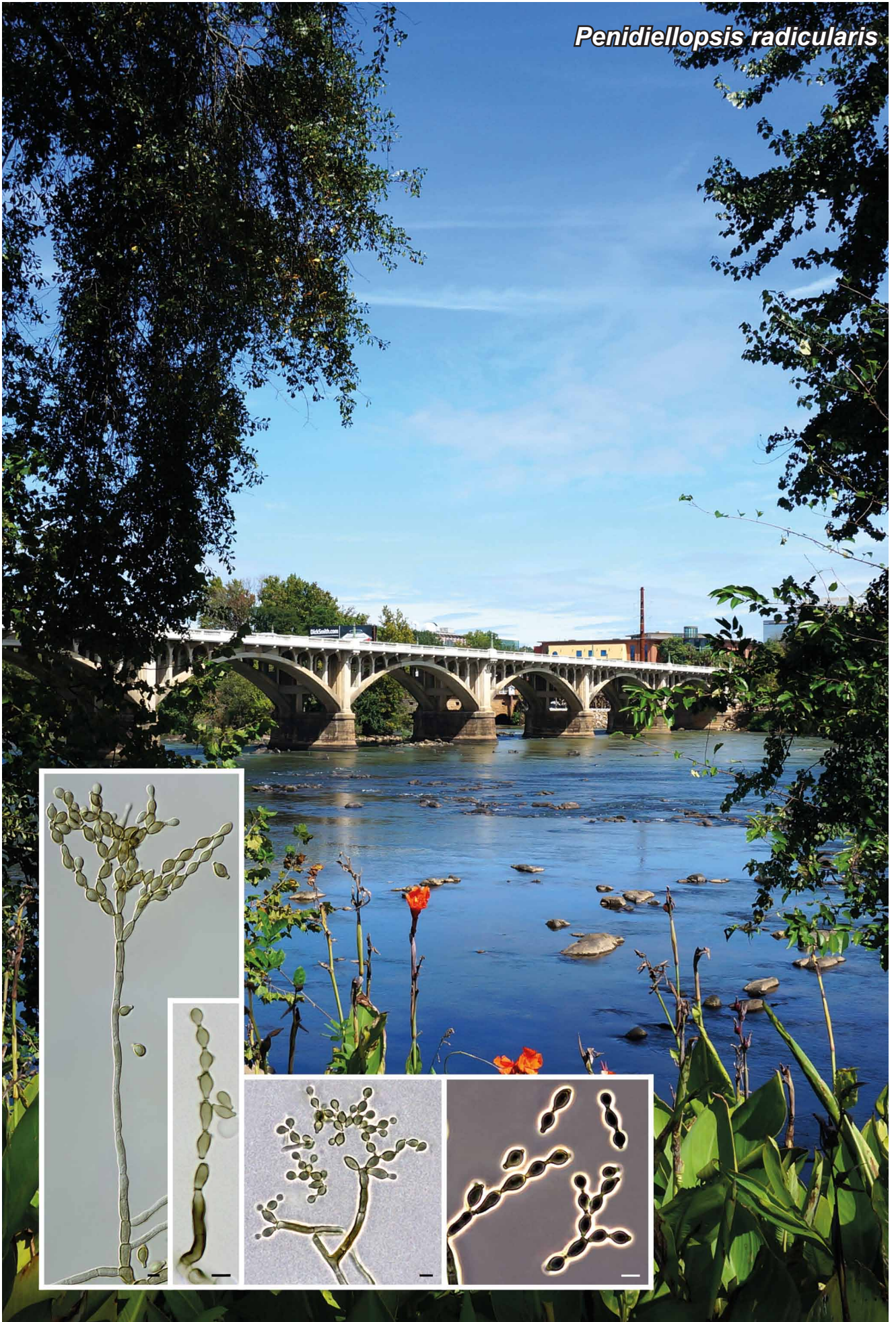

Fungal Planet 460 – 4 July 2016

Penidiellopsis Sandoval-Denis, Gené, Deanna A. Sutton & Guarro, *gen. nov.*

Etymology. Named after its morphological resemblance to the genus *Penidiella*.

Classification — *Teratosphaeriaceae*, *Capnodiales*, *Dothideomycetes*.

Conidiophores differentiated, solitary, erect, straight to geniculate-sinuous, rarely branched, pale to medium brown, smooth and thick-walled. *Conidiogenous cells* integrated, terminal or intercalary, pale to medium brown, smooth, mono- and polyblastic, giving rise to one or more sets of ramoconidia, scars truncate, slightly darkened, unthickened and not refractive. *Ramoconidia* 0–1-septate, obovoid, ellipsoid or slightly

clavate, pale to medium brown, smooth- and thick-walled, apical part with denticle-like loci, basal scar flattened, slightly darkened, unthickened and not refractive. *Conidia* in branched acropetal chains, 0-septate, obovoid, ellipsoid or limoniform, pale to medium brown, smooth, thick-walled, with conidial scars truncate or protuberant, somewhat darkened, unthickened and not refractive.

Type species. *Penidiellopsis radicularis* Sandoval-Denis, Gené, Deanna A. Sutton & Guarro.

Mycobank MB815361.

Penidiellopsis radicularis Sandoval-Denis, Gené, Deanna A. Sutton & Guarro, *sp. nov.*

Etymology. Named after its root-like growth pattern in culture media.

Mycelium superficial and immersed, composed of septate, branched, pale brown, smooth to finely verruculose and thin-walled hyphae, 1.5–4.5 µm wide. *Conidiophores* straight or geniculate, septate, slightly constricted at the septum, 40–150 × 3.5–5 µm, pale to medium-brown, usually darkening at the medial portion, smooth-, thick-walled. *Conidiogenous cells* terminal or intercalary, 12–18 × 4–5 µm, with one or several conidiogenous loci, 1–2.5 µm wide. *Ramoconidia* 0(–1)-septate, ellipsoid, obovoid or somewhat clavate, 7–11 × 3–4 µm, pale to medium brown, smooth and thick-walled. *Conidia* 0-septate, obovoid or limoniform, 5–9 × 3–4 µm, pale brown, smooth and thick-walled, with protuberant conidial scars.

Culture characteristics — (in the dark, 25 °C after 14 d), colonies on PDA attaining 6–7 mm diam, dark green (30F3/F8) (Kornerup & Wanscher 1978), erumpent and folded, velvety; reverse dark green (30F3) to black. On SNA attaining 4–8 mm diam, olive grey to olive (3F2/F8), flat, velvety; reverse olive (3F7/F8). On OA attaining 6–8 mm diam, dark green (30F8) to black, flat, velvety; reverse dark green (30F8).

Typus. USA, South Carolina, West Columbia, from human nail, date unknown, D.A. Sutton (holotype CBS H-22389, culture ex-type CBS 140695 = UTHSC DI-13-256 = FMR 13369; ITS sequence GenBank LN834441, LSU sequence GenBank LN834445, MycoBank MB815362).

Notes — The genus *Penidiellopsis* (*Ps.*) is similar to *Penidiella* (*Pa.*), however, both genera are clearly differentiated genetically and morphologically. While *Penidiella* produces penicillate branched conidiophores, those of *Penidiellopsis* are mostly unbranched, although its conidial chains exhibit a continuous bi- or trifurcating elongation pattern (Crous et al. 2007a). The monotypic genus *Xenopenidiella* exhibits also similar morphological features, however, is genetically distinct and produces dimorphic conidiophores with loosely branched apices (Quaedvlieg et al. 2014).

Our phylogenetic results showed that *Ps. radicularis* is closely related to *Pa. aggregata* and *Pa. drakensbergensis*, two species not included in *Penidiella* s.str. (sensu Quaedvlieg et al. 2014) (for phylogenetic tree, see MycoBank). However, the new genus *Penidiellopsis* is genetically well-delimited, and also differs from the latter two species by its shorter ramoconidia (vs 8–15 µm and 10–15 µm long in *Pa. aggregata* and *Pa. drakensbergensis*, respectively) and its wider, aseptate intermediate and terminal conidia.

Based on a megablast search of NCBI's GenBank nucleotide database, the closest hit using the ITS sequence is *Pa. aggregata* CBS 128772 (GenBank JF499842; Identities= 466/508 (92 %), Gaps = 11/508 (2 %)), followed by *Pa. drakensbergensis* CPC 19778 (GenBank NR_111821; Identities = 469/519 (90 %), Gaps = 23/519 (4 %)) and *Teratosphaeria agapanthi* CBS 129064 (GenBank JF770456; Identities = 435/509 (89 %), Gaps= 18/509 (3 %)). Closest hits using the LSU sequence were to *Pa. aggregata* CBS 128772 (GenBank JF499862; Identities = 539/551 (98 %), Gaps = 0/551 (0 %)), *Pa. drakensbergensis* CPC 19778 (GenBank KC005792; Identities = 536/551 (97 %), Gaps = 0/551 (0 %)) and *Teratosphaeria macowanii* CPC 1872 (GenBank EU019254; Identities = 534/551 (97 %), Gaps = 0/551 (0 %)).

Colour illustrations. USA, South Carolina, view of the Gervais Street Bridge (image credit: Wikimedia commons); conidiophores, conidiogenous cell bearing conidia in branched chains. Scale bars = 5 µm.

Marcelo Sandoval-Denis, Josepa Gené & Josep Guarro, Mycology Unit, Medical School and IISPV, Universitat Rovira i Virgili (URV), Sant Llorenç 21, 43201 Reus, Tarragona, Spain; e-mail: msandovaldenis@gmail.com, josepa.gene@urv.cat & josep.guarro@urv.cat.
Deanna A. Sutton & Nathan P. Wiederhold, Fungus Testing Laboratory, Department of Pathology, University of Texas Health Science Center, 7703 Floyd Curl Dr., San Antonio, Texas 78229-3900, USA; e-mail: sutttond@uthscsa.edu & wiederholdn@uthscsa.edu

Ganoderma ecuadoriense



Fungal Planet 461 – 4 July 2016

***Ganoderma ecuadoriense* W.A. Salazar, C.W. Barnes & Ordóñez, sp. nov.**

Etymology. Name reflects the geographical origin from which the fungus was collected.

Classification — *Ganodermataceae*, *Polyporales*, *Agaricomycetes*.

Basidiomata annual, flabelliform, pileate, pileus 21.6 × 21.8 mm, surface glabrous, woody, reddish brown, laccate, upper surface covered by cinnamon coloured powder of deposited basidiospores. *Basidiospore* surface smooth, white when fresh and dark brown when dry, pores 5–7 per mm, round, thick walls. *Stipe* missing from sample, but lateral. *Hyphal system* dimitic, skeletal hyphae yellow to pale brown, 3.5–5.5 µm wide, end in ramifications, generative hyphae thin-walled, hyaline to pale yellow, 1–2.5 µm wide. *Hyphae* faintly amyloid when dispersed and slightly dextrinoid when in masses with Melzer. *Cuticle cells* club-like, slight amyloid reaction to 5 % KOH and Melzer. Resin deposits between the trama and cuticle. *Basidia* not observed. *Basidiospores* hyaline to pale yellow, truncated, 8–10.5 × 4.5–7 µm, no reaction to 5 % KOH or Melzer.

Typus. ECUADOR, Orellana Province, Yasuní Research Station, on decaying wood, Mar. 2013, A. Salazar (holotype QCAM3430, ITS sequence GenBank KU128524, LSU sequence GenBank KX228350, TreeBASE Submission ID 18454, MycoBank MB816866).

Notes — Morphological identification using the Neotropical *Polyporaceae* key (Ryvarden 2004), revealed *G. ecuadoriense* to be very similar to *G. perzonatum*. However, based on a Blastn ITS sequence comparison, after trimming the 18S and 28S sequences (Schoch et al. 2014), the highest similarities were obtained with *G. orbiforme* from Brazil, and *G. cupreum*, *G. mastoporum* and *G. fornicatum* from China. The sequence of *Ganoderma* sp. VPB202 from Brazil is actually identical, but has a low query score due to the discrepancy in sequence length, missing roughly 25 bases at the 3' end of ITS2. There were seven consistent differences, three in ITS1 and four in ITS2, between *G. ecuadoriense*, collected in the North-western Amazon basin in Ecuador, and *G. orbiforme*, collected in the South-eastern Amazon in Brazil. Twenty sequences, 16 for *G. ecuadoriense* and four for *G. orbiforme* were used in the DNA alignment analysis. The *Ganoderma* sp. VPB202 sequence suggests *G. ecuadoriense* occurs throughout the Amazon basin, but due to the missing bases of the ITS2 sequence, this is somewhat speculative.

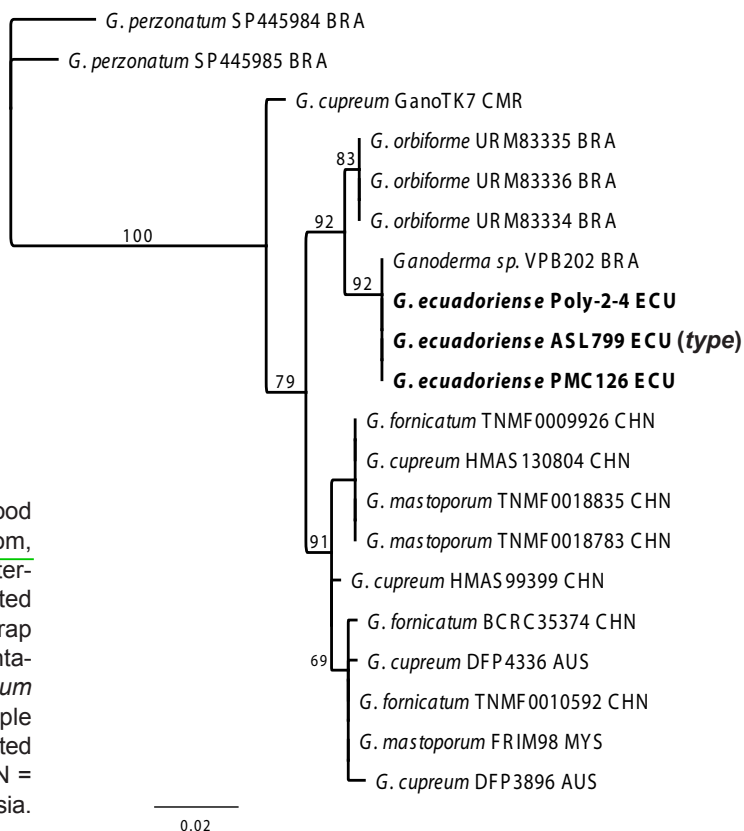

Phylogenetic analysis was done using the Maximum Likelihood plugin PHYML in Geneious v. 7.1 (<http://www.geneious.com>, Kearse et al. 2012), and the substitution model HKY85 determined by jModelTest (Posada 2008) according to Corrected Akaike Information Criterion (AICc). One hundred bootstrap replicates were used. Included in the analysis were representative species found in the Blastn search, plus *G. perzonatum* sequences because of its morphological similarity. Sample nomenclature: species name, isolate number, three letter United Nations country code: AUS = Australia, BRA = Brazil, CHN = China, CMR = Camaroon, ECU = Ecuador and MYS = Malaysia.

Colour illustrations. Ecuador, Yasuni National Park rain forest; basidiocarps, skeletal and generative hyphae, basidiospores. Scale bars = 10 µm.

Washington A. Salazar, Maria E. Ordóñez, & Cristina Toapanta, Escuela de Ciencias Biológicas, Pontificia Universidad Católica del Ecuador, Av. 12 de octubre 1076 y Roca, Quito, Ecuador;
 e-mail: andres_salazar89@hotmail.com, meordonez@puce.edu.ec & ceta_333@hotmail.com
 Charles W. Barnes, Instituto Nacional Autónomo de Investigaciones Agropecuarias, Estación Experimental Santa Catalina, Panamericana Sur Km 1, Sector Cutuglahua, Pichincha, Ecuador;
 e-mail: cbarnes333b@gmail.com
 Paul Gamboa, Universidad Central del Ecuador, Facultad de Medicina, Carrera de Ciencias Biológicas y Ambientales, Av. América, Quito, Ecuador;
 e-mail: paulgamboati@hotmail.com



Fungal Planet 462 – 4 July 2016

Blastobotrys meliponae R.N. Barbosa, Boekhout, G.A. Silva, Souza-Motta & N. Oliveira, *sp. nov.*

Etymology. me.li,po'nae. N.L. gen. n. *meliponae*, of the bee genus *Melipona*.

Classification — *Trichomonascaceae*, *Saccharomycetales*, *Saccharomycetes*.

Hyphae thin, 1–1.5 µm wide, septate, branched, hyaline. *Chlamydospores* globose or subglobose, terminal or intercalary, up to 5.5 µm diam. *Conidiophores* erect, sympodially branched, 130–260 µm long or more, 2.0–2.6 µm wide, simple or branched, tapering upwards, producing 1–2 joint conidiogenous cells. *Conidiogenous cells* are discrete, shortly pedicellate, globose to subglobose, (1.6–)2.5–3(–4) µm, with one seta. The conidiogenous cells separate easily from the conidiophores and are densely covered with conidia (up to 15 conidia, but mostly 6–13). *Setae* straight, sometimes slightly curved, narrowing towards the apex, 1-septate, not deciduous, 55–124 µm long or more (260 µm after 18 d of growth). *Conidia* holoblastic, globose, smooth, sessile, 1–1.5 (can be up to 2) µm diam; may form directly on 1–2 µm diam hyphae and below the tip of conidiophores. In yeast-like colonies, growth with budding observed on hyphae. Glucose, galactose and sucrose are fermented, and maltose, raffinose and xylose are not fermented. L-Arabinose, D-xylose, acetate, glucuronate, erythritol, D-galactose, D-glucose, lactose, D-maltose, L-sorbose and L-rhamnose are assimilated. D-glucosamine, glycerol, raffinose, and mellibiose are not assimilated. Nitrate and citrate are not assimilated. Does not hydrolyse urea.

Culture characteristics — Colonies on 5 % malt extract agar (5 % ME) at 25 °C grow slowly, white with irregular margins, delicately downy, cerebriform, opaque, with light brownish reverse; 8 mm after 7 d. Colonies on yeast malt agar (YM) similar to those on 5 % ME but with light yellowish reverse; 11 mm in 7 d. Colonies on restricted growth agar (RG) similar to those on 5 % ME, but differ by plane colonies, and a colourless reverse; 5 mm in 7 d. Colonies at 27 °C, 28 °C, 30 °C and 37 °C were similar to colonies at 25 °C. At 10 °C no growth was observed.

Typus. BRAZIL, Recife, Pernambuco, isolated from honey of the bee *Melipona scutellaris* collected in Atlantic Forest (S8°7'30" W34°52'30") (metabolically inactive culture, holotype URM 7224, isotype CBS 14100, ITS sequences GenBank KT448719, KT448720, KT448721, LSU sequences GenBank KR779215, KR779216, KR779217, MycoBank MB812601).

Colour illustrations. Bees and pot honey in the nest of *Melipona scutellaris*; chlamydospores, hyaline conidia on hyphae and conidiophores on YM agar for 7 d at 28 °C. Scale bars = 10 µm.

Notes — Based on phylogenetic analyses using only sequences of the D1/D2 domains, the three isolates formed a clade with *B. proliferans*, but the sequences showed only 91 % identity with the LSU sequences of that species in a BLASTn analysis, indicating that these isolates represented a new yeast species of *Blastobotrys*. Members of *Blastobotrys* with a high similarity of the LSU rDNA D1/D2 domains to the new species were: *B. attinorum* (GenBank GU373758; 92 %), *B. proliferans* (GenBank EF584541; 91 %) and *B. nivea* (GenBank DQ442690; 90 %). *Blastobotrys meliponae* differs from *B. nivea* in having sympodially branched conidiophores, lacking budding cells and chlamydospores, but with lateral conidia forming directly on the hyphae. The species can be distinguished from *B. aristata* by the size of the conidiogenous cells (3–8 × 4.5–9 µm), conidiophore branching, number and size (100 µm) of setae, absence of lateral conidia formed directly on the hyphae, absence of chlamydospores and growth at 37 °C. *Blastobotrys proliferans* has a different branching of the conidiophores, conidiogenous cell size (3–4.5 × 4.5–7 µm), setae with a spatulate apex in older cultures and presence of distinct refraction bodies in the conidiogenous cells.

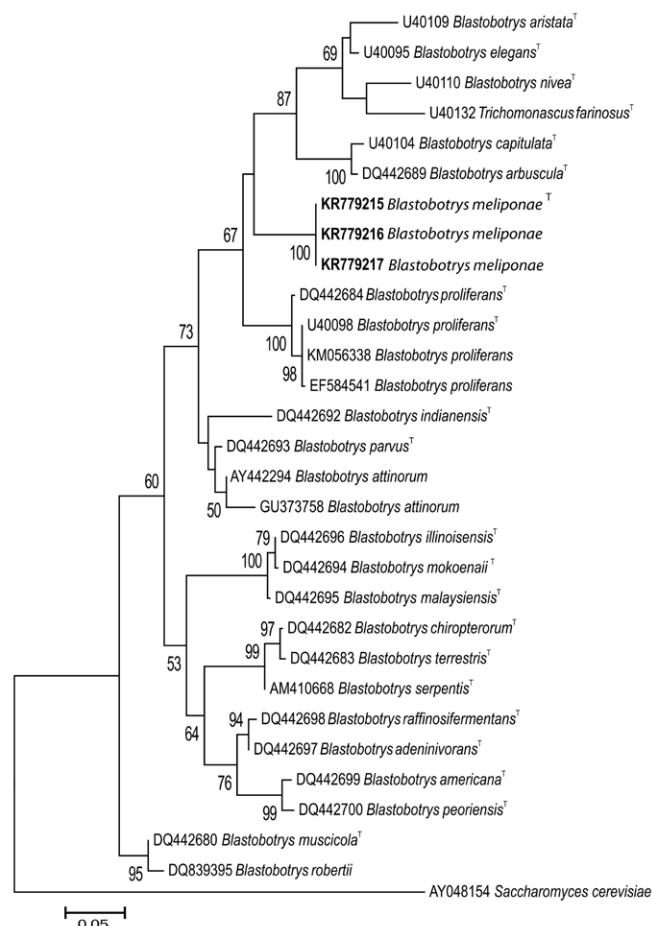

Renan N. Barbosa, Gladstone A. Silva & Neiva T. Oliveira, Departamento de Micologia Prof. Chaves Batista, Universidade Federal de Pernambuco, Recife, Brazil; e-mail: renan.mb@gmail.com, gladstonesilva@yahoo.com, netinti@hotmail.com
Cristina M. Souza-Motta, URM Culture Collection, Recife, Brazil; e-mail: cristina.motta@ufpe.br
Teun Boekhout, CBS-KNAW Fungal Biodiversity Centre; Utrecht, The Netherlands; e-mail: t.boekhout@cbs.knaw.nl

Russula intervenosa



Fungal Planet 463 – 4 July 2016

***Russula intervenosa* S. Paloi, A.K. Dutta & K. Acharya, sp. nov.**

Etymology. 'Intervenosa' is the Latin transliteration of 'intervenose', referring to the pattern of lamellae.

Classification — *Russulaceae*, *Russulales*, *Agaricomycetes*.

Pileus 26–49 mm diam, convex to broadly convex when young, becoming infundibuliform to applanate with a central depression in age, surface smooth when young, becoming cracked at maturity, semi moist, dark red (10C8) to brownish red (10D8) at center, pastel red (10A5) to dull red (10B4) towards margin, unchanging with NH_4OH and FeSO_4 , pale orange (5A3) to light orange (5A4) with KOH, red (9B8) to brownish red (9C8) with sulfovanillin (SV), red (9A7) with guaiacol; margin translucent striate; context very thin (< 1 mm), white (1A1), no colour change when exposed, turns whitish yellow (8A2) to pale yellow (8A3) with FeSO_4 , reddish brown (9D8) with SV. *Lamellae* adnexed, 4–5 mm broad, regular, with intervenose to reticulate like appearance, lamellulae none, dull yellow (3B3), edge even, concolorous, light yellow (4A4) to yellowish orange (4A6) with FeSO_4 , pale yellow (3A3) with KOH, reddish brown (9D-E8) with SV, light brown (5D4) to yellowish brown (5E4) with 10 % phenol. *Stipe* central, 8–15 × 4–6 mm, tapered toward the base, smooth, semi moist, greyish red (10C5) to brownish red (10D6), white (1A1) towards extreme base, unchanging on brushing, light brown (7D7) to brown (7E7) with 10 % phenol and SV, red (9A6) to brownish red (9C7) with guaiacol; context hollow, white (1A1), unchanging after brushing. *Odour* and *taste* mild. *Spore print* cream. *Basidiospores* (6.5–)7–7.5–8.0(–9) × (6–)6.5–6.7–7(–7.5) μm , $Q = 1.07–1.12–1.19$, subglobose, hyaline, ornamentation amyloid, composed of high (0.6–0.9 μm) and low (0.1–0.4 μm) ridges with irregularly interrupted margin that are aligned or connected to give nearly complete or partial reticulum to reticulate-winged fashion; suprahilar plage amyloid, up to 2 μm long. *Basidia* (28–)30–40(–43) × 10.5–12(–14) μm , 4-spored, clavate to subclavate, thin-walled, oil droplets present when viewed with KOH; sterigmata 3.5–4.5 × 1 μm . *Subhymenium* pseudoparenchymatous. *Lamellar trama* composed of sphaerocytes and hyphal cells, sphaerocytes measuring c. 22–39 × 18–29 μm . *Hymenial cystidia* c. (26–)32–39(–43) × (4.5–)5.5–7(–9) μm near gill edge, cylindrical with pointed towards apex, filled with cytoplasmic contents; on gill sides c. 29–34(–39) × 10–12.5(–14.5) μm , appendiculate to fusiform, thin-walled, oil droplets present when viewed with KOH. *Pileipellis* orthochromatic in cresyl blue, sharply delimited from the underlying sphaerocytes of the context, distinctly divided into a 43–50 μm deep subpellis composed of loosely arranged, less gelatinized, measuring 2.5–4.5 μm diam, hyaline, thin-walled hyphae and less gelatinized, c. 47–64 μm deep suprapellis composed of interwoven, measuring c. 36–64 × 2.5–4 μm , erect to suberect, thin-walled, hyaline hyphae of subulate to pointed hyphal apex and up to five round cells,

measuring 39–47 × 2.5–4.5 μm at base; pileocystidia absent. *Stipitipellis* up to 42–51 μm thick, composed of loosely arranged subulate hyphae with pointed apex, up to 2.5–4.5 μm broad, often branched, hyaline, thin-walled and caulocystidia measuring 26–32 × 5.5–6.5 μm , subcylindrical to subclavate to with pointed to moniliform apex, filled with cytoplasmic contents. *Stipe trama* composed of sphaerocytes.

Typus. INDIA, West Bengal, Paschim Midnapur, Lodhasuli forest, ectomycorrhizal with *Shorea robusta* (*Dipterocarpaceae*), 13 July 2014, S. Paloi (holotype CAL-1272, ITS sequence GenBank KT824241, LSU sequence GenBank KU928135, MycoBank MB814593).

Notes — The combination of macro- and micromorphological characters undoubtedly place *R. intervenosa* in the subgenus *Amoenula* (Sarnari 1998, Das & Sharma 2005).

Based on a megablast search of NCBI's GenBank nucleotide database, the closest hits using the ITS1-5.8S-ITS2 sequence had highest similarity with *R. violeipes* (GenBank KF361797; Identities 512/548 (93 %), Gaps = 12/548 (2 %)) and *R. mariae* (GenBank EU819426; Identities 481/529 (91 %), Gaps = 15/529 (2 %)). However, *R. violeipes* differs from the newly described species by its more variegated pileus colours, much longer stipe (up to 70 mm) and differently sized basidiospores (6–8 × 6.5–9 μm ; Quélet 1898). *Russula mariae* has a more fleshy pileus with wider cap (up to 5 mm), with flushed pink or purplish surface that does not react with SV and slowly turns blue green with guaiacol (Peck 1872, Bills & Miller 1984). (MycoBank supplementary data.)

Considering the overall size and ornamentation of the basidiospores and nature of pileipellis, our species is related to *R. amoena* and *R. amoenicolor*. However, *R. amoena*, the type species of the subgenus, can be distinguished from the present species in having a pileus coloured shades of purple or violet with velvety cuticle, context that turns violet with phenol, much longer and pruinose stipe (up to 50 mm), dichotomous split of lamellae, presence of a sweetish taste and fragrance like fruit (Quélet 1880, Romagnesi 1967, Sarnari 1998). *Russula amoenicolor*, originally described from Europe, has much larger (up to 80 mm diam) and velvety pileus coloured purplish brown or purple, and much longer stipe (up to 70 mm; Romagnesi 1967). Among the New Zealand taxa, species with similar shape, colouration of pileus with smaller stipe: *R. miniata* differs by the presence of white coloured lamellae, larger basidiospores (9.5–11.5 × 8–10 μm), absence of caulocystidia and habitat under *Nothofagus* sp.; *R. pudorina* has a white coloured spore print, larger basidiospores (8–10.5 × 7–9 μm), bitter taste and habitat under *Leptospermum* spp. (McNabb 1973). Within the same subgenus *Amoenula*, previous described species from the moist deciduous to mixed subtropical forests of India include *R. mukteshwarica*. But, *R. mukteshwarica* is more robust (6.5–13 cm) and has a purple coloured pileus with light to brilliant or very greenish yellow centre, white coloured spore print and basidiospores are somewhat larger (7.5–9.5 × 7.5–8 μm ; Das et al. 2005).

Colour illustrations. India, West Bengal, vegetation cover of the collection site (background). Left column: field photograph of the basidiocarp, fresh basidiocarp showing lamellae, basidia, SEM microphotograph of the basidiospores; right column: cheilocystidia, pleurocystidia (all from holotype). Scale bars = 10 mm (basidiocarps), 20 μm (microscopic structures), 1 μm (basidiospore).

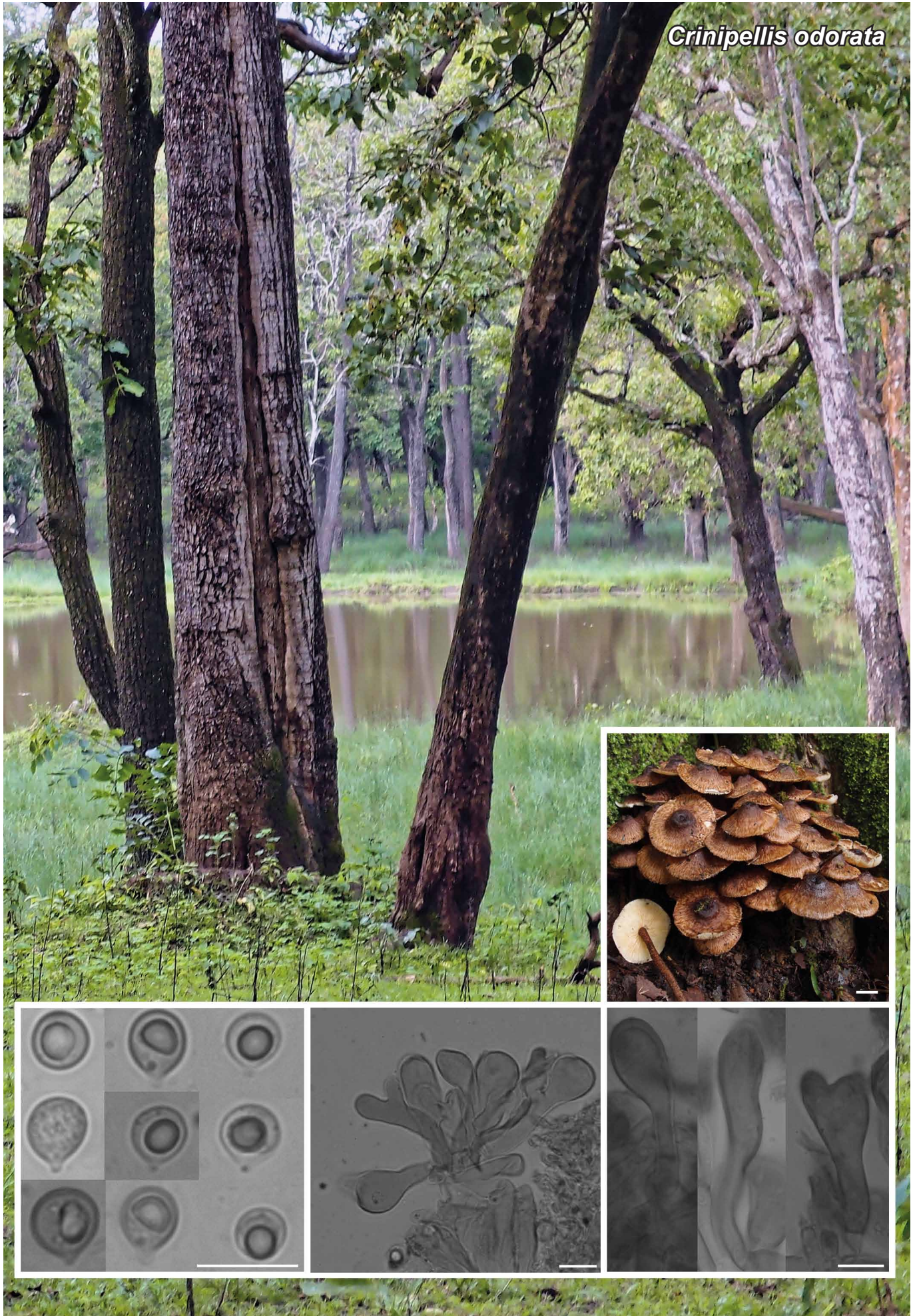

Fungal Planet 464 – 4 July 2016

***Crinipellis odorata* K.P.D. Latha & Manim., sp. nov.**

Etymology. The name refers to the odoriferous basidiomata of this species.

Classification — *Marasmiaceae*, *Agaricales*, *Agaricomycetes*.

Basidiomata small to medium-sized, marasmioid, often in dense tufts. *Pileus* 6–31 mm diam, truncately conical or conico-convex with a small central depression when very young, becoming campanulate to broadly campanulate, still with a small central depression; surface dark brown (8F4, 8F5/OAC635) or reddish brown (8F7/OAC636) at the centre and on the squamules and brownish orange (6C5/OAC652) or light brown (6D5/OAC659) elsewhere, not hygrophanous, not striate, appressed- to slightly recurved-squamulose all over; margin initially incurved, becoming decurved to almost reflexed with age, finely appendiculate, crenate or somewhat wavy. *Lamellae* adnexed, crowded, yellowish white (4A2/OAC815) when very young, becoming greyish yellow (4B4/OAC806), up to 2 mm wide, with lamellulae of 3 lengths; edge crenate, concolorous with the sides. *Stipe* 39–120 × 2–4 mm, central, terete, or slightly compressed, tapering towards the base, hollow, slightly flexuous towards the base, insititious; surface concolorous with the pileus, appressed- to slightly recurved-squamulose all over, densely so towards the apex; base deeply rooted. *Rhizomorphs* absent. *Context* up to 2 mm thick, yellowish brown. *Odour* strong, unpleasant. *Taste* not distinctive. *Basidiospores* 5–8 × 5–7 (6.5 ± 0.77 × 5.9 ± 0.61) µm, Q = 0.86–1.3, Qm = 1.11, subglobose to almost globose, smooth, thin-walled, inamyloid. *Basidia* 23–33 × 6–9 µm, sparse clavate, hyaline, thin-walled, 4-spored; sterigmata up to 4 µm long. *Basidioles* 28–48 × 6–12 µm, abundant, fusoid or clavate, thin-walled, hyaline. Lamella edge sterile with copious cheilocystidia. *Cheilocystidia* 22–65 × 7–19 µm, versiform: oblong, clavate, cylindrical, cylindrical with a median constriction, flexuous, nodulose-diverticulate, sometimes capitate, thin- to slightly thick-walled, hyaline or pale yellow. *Pleurocystidia* absent. *Lamellar trama* subregular; hyphae 3–12 µm wide, thin-walled, hyaline or pale yellow, inamyloid. *Pileus trama* subregular to interwoven; hyphae 6–15 µm wide, thick-walled (up to 2 µm thick), with a pale yellow wall pigment, dextrinoid. *Pileipellis* composed of tufts of fasciculate hairs arising from a hypotrachium; hypotrachial hyphae 8–18 µm wide, thick-walled (up to 1.5 µm thick), with pale yellow wall and dense, spiral encrusting pigments; pileal hairs 500–1200 × 5–7.5 µm or more, unbranched, cylindrical or sinuous-cylindrical with an obtuse apex, thick-walled (up to 2 µm thick), with a yellowish brown wall pigment, dextrinoid, yellowish brown in KOH. *Stipitipellis* composed of clusters of hairs arising from a hypotrachium with flaring-out cystidioid terminal cells; hypotrachial hyphae 3–7 µm wide, thick-walled (up to 1 µm thick), with pale yellow wall and minutely, encrusting pigments; stipitipellis hairs 47.5–452.5 × 7.5–12.5 µm, sinuous-cylindrical, thick-walled (up to 3 µm thick), with a pale brown or yellowish brown wall pigment, dextrinoid, pale yellowish brown in KOH; terminal cells cystidioid 32–95 × 10–16 µm, clavate, cylindrical-clavate or irregular in outline,

Colour illustrations. India, Kerala State, Wayanad District, Wayanad Wildlife Sanctuary, type locality; basidiomata, basidiospores, cheilocystidia, terminal elements of stipitipellis. Scale bars = 10 mm (basidiomata), 10 µm (microscopic structures).

dextrinoid, thick-walled (up to 2 µm thick), with a pale yellowish brown wall pigment. *Caulocystidia* absent. *Clamp-connections* observed on all hyphae except at the base of basidia.

Habit, Habitat & Distribution — In dense caespitose clusters or in small groups, attached to the bark at the base of a living *Mytragyna parviflora* tree as well as deeply rooted in the nearby soil. Known only from the type locality in Kerala State, India.

Typus. INDIA, Kerala State, Wayanad District, Tholpetty, Wayanad Wildlife Sanctuary, 6 July 2013, K.P. Deepna Latha (holotype CAL 1240, ITS sequence GenBank KT952521, MycoBank MB814919).

Notes — Characters such as a brown pileus not reacting with KOH, a long, central stipe, long, thick-walled, dextrinoid hairs on both the pileipellis and the stipitipellis and subglobose basidiospores indicate that the present species belongs to *Crinipellis* sect. *Crinipellis* subsect. *Macrosphaerigerae* (Singer 1976, 1986). The key to the species of *Crinipellis* by Singer (1953) leads *C. odorata* into *C. macrosphaerigera*, a Brazilian species, as both species have somewhat similar pileus surfaces, adnexed lamellae, subglobose basidiospores, versiform cheilocystidia and association with living trees. However, *C. macrosphaerigera* has smaller basidiomata with a straw-coloured pileus and stipe, distant lamellae, larger basidiospores (12.5–14 × 9.5–11.5 µm), a heterogeneous lamella edge and an indistinct odour. *Crinipellis podocarp*, a species originally described from Argentina (Singer 1976) and subsequently from Mexico (Bandala et al. 2012) and belonging to sect. *Crinipellis* of subsect. *Stipitarinae*, seems to be somewhat close to *C. odorata* in having basidiospores of almost similar size and shape. However, *C. podocarp* differs in all other macro- and microscopic characters. Comparison of the ITS sequence (CAL 1240: 754 bp) generated from *C. odorata* with the nucleotide sequences of taxa available in GenBank suggest that *C. odorata* has a distinct ITS sequence. In a megablast search of the GenBank database using ITS sequence of the species, the closest hit was *C. floccosa* (GenBank KJ698642; Identities = 685/762 (90 %), Gaps = 32/762 (4 %)) followed by *C. zonata* (GenBank FJ167659; Identities = 662/741 (89 %), Gaps = 35/741 (4 %)). *Crinipellis floccosa*, a species recently described from China (Xia et al. 2015), shares a few features such as a reddish brown, squamulose pileus, somewhat similarly-coloured lamellae, similar-sized basidiospores ((5.5–)6–8 × 4–4.5(–5)), somewhat similar-sized cheilocystidia, the absence of pleurocystidia and a similar pileipellis structure with *C. odorata*. *Crinipellis floccosa* is distinguished, however, by its smaller basidiomata, free lamellae with a denticulate margin, a differently-coloured, equal, tomentose-pilose stipe, ellipsoid to broadly ellipsoid or somewhat amygdaliform basidiospores, scattered cheilocystidia, the hairs of both the pileus and stipe exhibit greenish yellow in KOH and a non-distinctive odour. *Crinipellis zonata*, a species reported from North America (Redhead 1989), Europe (Antonín & Noordeloos 1997, 2010) and the Republic of Korea (Antonín et al. 2009), has similar looking basidiomata with almost similar colour, crowded lamellae, somewhat similar morphology of cheilocystidia, lamellae devoid of pleurocystidia, similar pileipellis and stipitipellis structure and clamped hyphae. However, *C. zonata* has smaller basidiomata, a tomentose pileus with an inflexed margin, differently attached, pale cream lamellae, a hairy stipe, much narrower (3–4 µm) and cylindrical-ellipsoid basidiospores, smaller pileipellis hairs and an indistinct odour. (Mycobank supplementary data.)

Corynascus citrinus

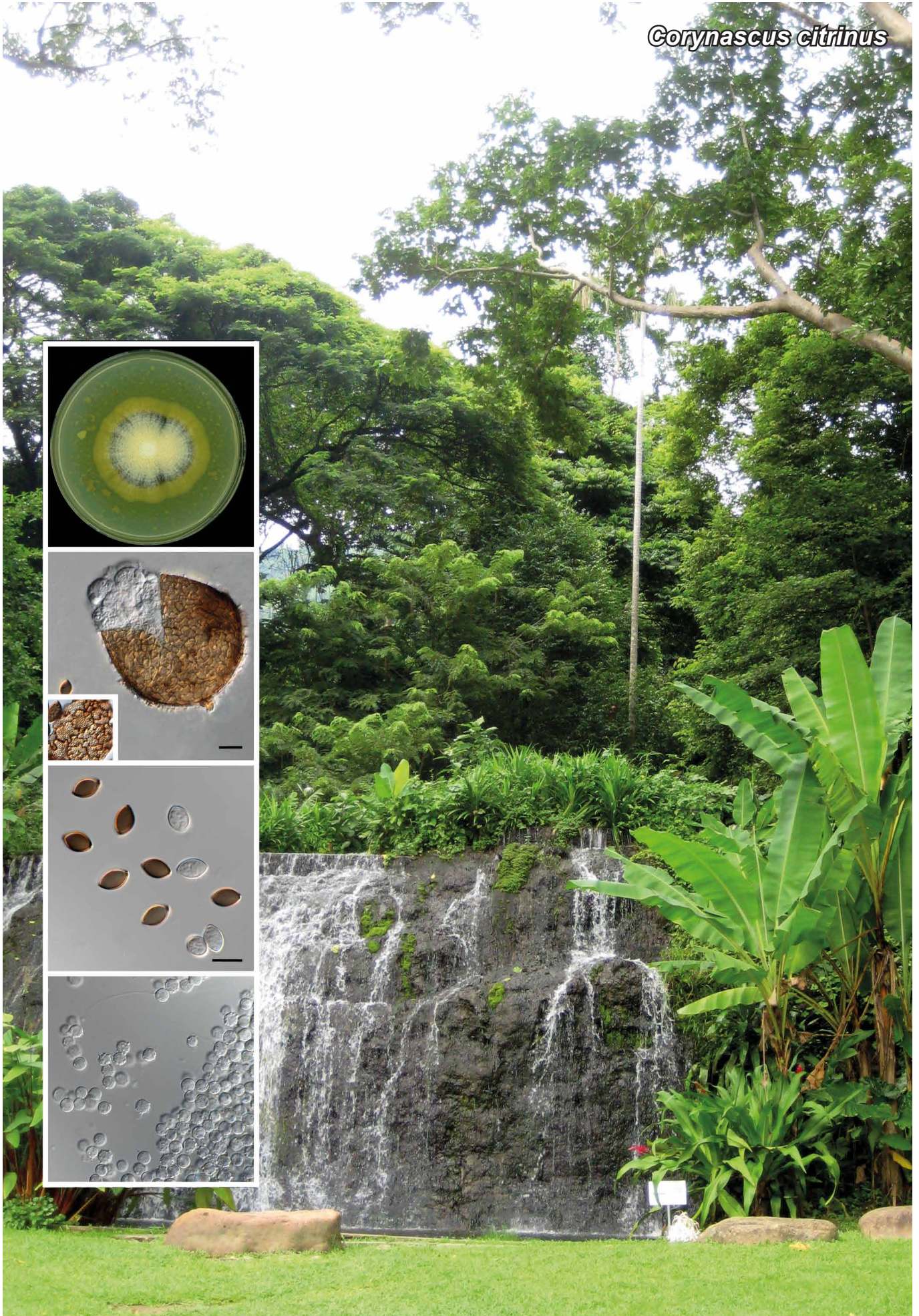

Fungal Planet 465 – 4 July 2016

Corynascus citrinus Giraldo & Crous, *sp. nov.*

Etymology. From Latin *citrinus*, citrine or lemon-yellow, referring to the yellow pigment produced in vitro.

Classification — *Chaetomiaceae*, *Sordariales*, *Sordariomycetes*.

Ascomata cleistothecial, submerged or embedded in the aerial mycelium, spherical, brown, 44–83 µm diam, surface of *textura epidermoidea*, striated. *Paraphyses* absent. *Asci* evanescent, subglobose, unitunicate, thin-walled. *Ascospores* unicellular, broadly fusiform, thick- and smooth-walled, with germ pores at both ends, 9–12 × 6–8 µm, hyaline becoming brown when mature. *Conidiophores* absent or poorly differentiated. *Conidia* growing directly on undifferentiated hyphae, lateral, sessile, occasionally on short stalk, globose, 5–7 µm diam, hyaline, thick-walled, tuberculate.

Culture characteristics — Colonies on PDA reaching 41–42 mm diam after 21 d at 25 °C, surface straw at centre and fuscous black at periphery, reverse fuscous black (Rayner 1970), flat, floccose. On OA and MEA attaining 54–55 and 55–56 mm diam, respectively after 21 d at 25 °C, surface straw, flat, granulose. Diffusible pure yellow pigment in all media tested.

Maximum likelihood (ML) tree based on partial sequences of ITS, *tef1* and *rpb2* regions from reference and type strains of *Corynascus* species. The alignment included 1 604 bp and was generated with ClustalW under MEGA v. 6.06 (Tamura et al. 2013). Tamura-Nei with Gamma distribution was used as the best nucleotide substitution model. *Myceliophthora lutea* (*Chaetomiaceae*, *Sordariales*) was used as outgroup taxon. The new species is highlighted in **bold face**. Bootstrap support values above 70 % are shown at the nodes. † Ex-type strain. Accession numbers of ITS, *tef1* and *rpb2* sequences retrieved from GenBank are in parentheses.

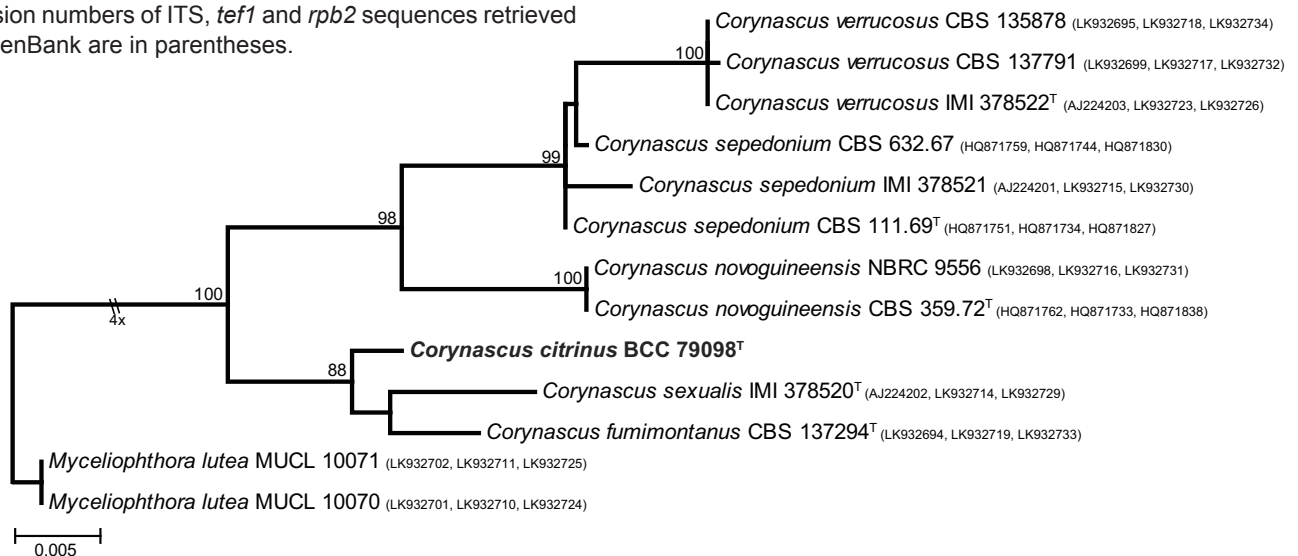

Colour illustrations. Thailand, Wang Takhrai waterfall, Mueang Nakhon Nayok district, Nakhon Nayok province (photo: A. Giraldo); colony on PDA after 21 d at 25 °C, ascoma with asci, detail of the peridium wall, immature and mature ascospores, conidia. Scale bars = 10 µm.

Typus. THAILAND, Nakhon Nayok province, Mueang Nakhon Nayok district, Wang Takhrai waterfall, N14.330023° E101.307168°, 64 m above sea level, from soil, 22 July 2015, A. Giraldo (holotype metabolically inactive culture BCC 79098, ITS sequence GenBank KX262667, LSU sequence GenBank KX228351.1, *rpb2* sequence GenBank KX262668, *tef1* sequence GenBank KX262669, MycoBank MB816971).

Notes — The genus *Corynascus* (*Chaetomiaceae*, *Sordariales*), previously considered as synonym of *Myceliophthora* (Van den Brink et al. 2012), was recently resurrected by Marin-Felix et al. (2015). Currently, *Corynascus* contains five species apart from *C. citrinus*, which are commonly isolated from soil and characterised by their mesophilic habitat, ascomata cleistothecial of *textura epidermoidea*, ascospores with a germ pore at each end, and a myceliophthora-like asexual morph (Guarro et al. 2012). *Corynascus citrinus* is phylogenetically closely related to *C. sexualis* and *C. fumimontanus* but can be morphologically distinguished from the former species by the presence of the asexual morph in culture, and from the latter species by its smaller ascomata (50–110 µm), ascospores (13–17 × 7–9 µm) and conidia (6–10 µm) (Marin-Felix et al. 2015).

Alejandra Giraldo & Pedro W. Crous, CBS-KNAW Fungal Biodiversity Centre, P.O. Box 85167, 3508 AD Utrecht, The Netherlands; e-mail: a.giraldo@cbs.knaw.nl & p.crous@cbs.knaw.nl

J. Jennifer Luangsa-ard, Microbe Interaction Laboratory, BIOTEC, Thailand Science Park, Khlong Nueng, Khlong Luang Pathum Thani 12120, Thailand; jajen@biotec.or.th

Brunneocarpus banksiae

Fungal Planet 466 – 4 July 2016

***Brunneocarpus* Giraldo & Crous, gen. nov.**

Etymology. Brunneus (Latin) = brown, and carpos (Greek) = fruit.

Classification — *Mycocaliciaceae*, *Mycocaliciales*, *Eurotiomycetes*.

Ascomata apothecial, stipitate, growing intermingled among the floral bracts on *Banksia* cones. *Stipe* straight or flexuous, mostly branched. *Capitulum* brown, globose to subglobose. *Paraphyses* not observed. *Asci* 8-spored, cylindrical, unitunicate.

Ascospores uniseriate, ellipsoidal to slightly fusiform, clavate, 1-celled, brown, smooth-walled. *Mycelium* consisting of septate, hyaline, smooth- and thin-walled hyphae. *Asexual morph* producing dictyochlamydospores in chains, subhyaline, thick-walled, lateral or terminal.

Type species. *Brunneocarpus banksiae* Giraldo & Crous.
Mycobank MB816972.

***Brunneocarpus banksiae* Giraldo & Crous, sp. nov.**

Etymology. Name reflects the host genus *Banksia*, from which the species was isolated.

Ascomata apothecial, stipitate, growing intermingled among the floral bracts on *Banksia attenuata* cones. *Stipe* dark brown, shiny, flexuous, mostly branched two or three times at the apex, 1–2 mm long, 50–85 µm wide. *Capitulum* dark brown, globose to subglobose with a funnel-shaped base, covered by hyaline mycelium when older, 150–285 × 125–206 µm. *Paraphyses* not observed. *Asci* 8-spored, cylindrical, unitunicate, 30–34 × 4–5 µm. *Ascospores* uniseriate, ellipsoidal to slightly fusiform, clavate, 1-celled, brown, thick- and smooth-walled, 4.5–7 × 2–3.5 µm. *Mycelium* consisting of septate, hyaline, smooth- and thin-walled hyphae, 1.5–2 µm diam. *Conidiophores* absent or poorly differentiated. *Dictyochlamydospores* in chains, sessile or with short subconical stalk, subhyaline to pale brown, thick- and smooth-walled, lateral or terminal, 26–60 µm long.

Culture characteristics — Colonies on MEA reaching 3–3.3 cm diam after 2 mo at 25 °C, vinaceous buff (Rayner 1970), depressed at centre, floccose.

Typus. AUSTRALIA, Western Australia, S34°22'19.4" E118°1'33.6", on *Banksia attenuata* (*Proteaceae*), 23 Sept. 2015, P.W. Crous (holotype CBS H-22633, cultures ex-type CPC 29841 = CBS 141465, ITS sequence GenBank KX262670, LSU sequence GenBank KX228352.1, MycoBank MB816973); CPC 29070, CPC 29072, CPC 29435.

Notes — According to LSU and ITS analyses *Brunneocarpus banksiae* belongs to *Mycocaliciaceae* (*Mycocaliciales*) where four genera are currently accepted; *Chaenothecopsis*, *Phaeocalicium*, *Mycocalicium* and *Stenocybe*. All produce apothecioid ascomata, usually with a tiny stalk and brown ascospores (Tuovila et al. 2011). These genera harbour resinicolous species, growing directly on exudate and/or on exudate-impregnated wood of different hosts, including *Acer* (*Sapindaceae*), *Mangifera* (*Anacardiaceae*), *Khaya* (*Meliaceae*), *Abies* (*Pinaceae*), *Picea*, *Tsuga* and *Tilia* (*Malvaceae*) (Rikkinen 2003, Tuovila et al. 2011) and known species are lignicolous, algicolous or lichenicolous (Tuovila et al. 2014). So far no species from these genera have been reported growing on *Banksia*. Species growing in axenic culture produce a phialophora-like (*Chaenothecopsis shefferae*) or coelomycetous asexual morph (Tibell 1991, Tibell & Vinuesa 2005), and in some cases, a hyphomycetous asexual morph with ramoconidia in acropetal chains (*C. haematopus*) (Tibell & Constantinescu 1991). This morphological character differs from the new taxon proposed here, which produces a chlamydospore-like asexual morph in culture.

Colour illustrations. Australia, Western Australia, cones of *Banksia attenuata* (photo: P.W. Crous); stipitated apothecium, detail of the capitulum, asci, ascospores, dictyochlamydospore. Scale bar = 10 µm.

Alejandra Giraldo & Pedro W. Crous, CBS-KNAW Fungal Biodiversity Centre, P.O. Box 85167, 3508 AD Utrecht, The Netherlands; e-mail: a.giraldo@cbs.knaw.nl & p.crous@cbs.knaw.nl
Michael J. Wingfield, Forestry and Agricultural Biotechnology Institute (FABI), University of Pretoria, Pretoria 0002, South Africa; e-mail: mike.wingfield@up.ac.za
Treena I. Burgess & Giles E.St.J. Hardy, Centre for Phytophthora Science and Management, Murdoch University, 90 South Street, Murdoch, WA 6150, Australia; e-mail: tburgess@murdoch.edu.au & g-hardy@murdoch.edu.au



Fungal Planet 467 – 4 July 2016

***Cercophora vinosa* A.N. Mill. & J. Fourn., sp. nov.**

Etymology. The specific epithet refers to the purple colour in the outermost layer of the ascomal wall.

Classification — *Lasiosphaeriaceae*, *Sordariales*, *Sordariomycetes*.

Ascomata subglobose to broadly obpyriform with a stout conical to hemispherical neck, 420–670 µm diam × 420–650 µm high, erumpent through a thick, felty yellowish grey subiculum spreading widely over the substrate, gregarious to loosely clustered, more rarely in contact; underlying wood discoloured greyish brown or unaltered, not stained purple; subiculum encrusted with sand particles, composed of pale brown, septate hyphae 1.5–3.5 µm wide, thin- to moderately thick-walled; neck papillate, broadly conical to rounded, sometimes undifferentiated, 80–170 µm high, ostiolate, black, roughened or obscurely sulcate. *Ascomatal wall* 34–56 µm thick on sides and at base in longitudinal section, slightly thicker at apex, roughened, dark purple gradually turning blackish, pseudoparenchymatous, leathery, 3-layered: outermost layer 10–15 µm thick, present on upper half of ascomata, fugacious, composed of several rows of thin-walled, hyaline, angular cells containing a purple substance that slightly fades in 10 % KOH and dissolves in chloral-lactophenol; middle layer 20–30 µm thick, composed of independent clusters of subcarbonaceous opaque cells, breaking into small angular plaques upon pressure but lacking a network of hyphae connecting the plaques as in cephalothecoid walls; inner layer 14–22 µm thick, composed of flattened, thin-walled subhyaline cells. *Ascomatal apex* periphysate. *Centrum* hyaline to yellowish. *Paraphyses* filiform, 4.5–8 µm wide at base and occasionally slightly moniliform, tapering to 2–2.5 µm wide above asci, hyaline, thin-walled, abundant, septate, unbranched, persistent. *Asci* unitunicate, cylindrical, 320–380 × 19–23 µm, spore-bearing part fusoid-ventricose, apex rounded, long-stipitate, stipe 100–160 µm long, often slightly sinuous, with eight bi- to triseriate ascospores, apical ring double, refractive, 2.7–3 µm wide × 1–1.2 µm high, inamyloid, staining in blue Waterman ink, subapical globule absent. *Ascospores* cylindrical, (54.5–)60.5–73.5(–79.5) × (3–)4–6(–7) µm (66.7 × 5 µm), straight to slightly sigmoid, geniculate in lower quarter, hyaline, aseptate, densely guttulate; bipolar appendages (27–)35–56 µm long, lash-like, 3–4 µm wide at base, centrally attached on ascospores ends, readily staining in blue Waterman ink and in aqueous nigrosin, sometimes granular at base, persistent; ascospore becoming differentiated into an apical swollen head and a basal tail while inside the ascus; head ellipsoid, 15.5–19 × 8–9 µm, usually 1-septate, remaining hyaline, rarely pigmented; tail 41–50 × 4–5 µm, obscurely 2–4-septate, hyaline, the lower end swelling upon germination; germinating from upper and

lower ends, more rarely laterally before being released. *Asexual morph*: Hyphae largely undifferentiated, 1.5–5 µm wide, thin-walled, hyaline to pale brown. *Conidiogenous cells* phialides, commonly produced from pale brown hyphae as single terminal or several lateral phialides, delimited by a basal septum, monophialidic or polyphialidic, cylindrical to obpyriform, 9–18 × 2.5–4 µm at widest part, mostly pale brown, constricted below the collarete, 1–1.5 µm just below the collarete; collarete short, slightly flaring, inconspicuous, same colour as phialide. *Conidia* subglobose to pyriform, truncate at base, 2.5–4.5 × 1.5–2.5 µm (3.3 × 2.2 µm), hyaline.

Culture characteristics — Colonies (of holotype) slow-growing on all media, covering the PDA plates in 8 wk, 25–30 mm diam after 8 wk on the WA and CMA plates, downy to silky on WA and CMA, subfelty on PDA, hyaline on WA, hyaline to greyish yellow (4B3) on CMA, brown (5F8) and becoming greyish red (7B5) at plug on PDA; margin even or wavy, appressed, hyaline on WA and CMA, becoming olive brown (4F8) on PDA; reverse same as the mat.

Typus. FRANCE, Ariège, Castelnau-Durban, Artillac stream, down-stream from the marble quarry, c. 410 m elev., on decorticated branch of *Salix* sp., 8 cm diam, partly submerged, 22 July 2014, J. Fournier, JF 14067 (holotype ILLS 79802, cultures ex-type ANM Acc#840-1, -2, -3, -4, -5, deposited in CBS, ITS-LSU sequence GenBank KX171944, beta-tubulin sequence GenBank KX171942, MycoBank MB816935).

Other material examined. FRANCE, Ariège, Montségur, Le Lasset stream flowing at the village, 880–890 m elev., on submerged decorticated wood of *Populus* sp., soc. *Amniculicola lignicola*, 16 Nov. 2014, J. Fournier (JF 14156); Illier, Laramade, Vicdessos stream, 630 m elev., on submerged wood of *Fraxinus excelsior*, 25 Nov. 2014, J. Fournier (JF 14163); Rimont, Paletès, Peyrau brook, c. 400 m elev., on submerged wood of *Alnus glutinosa*, 4 Dec. 2014, J. Fournier (JF 14170).

Notes — *Cercophora vinosa* is distinguished by its ascomata that possess a distinct purplish colour in the outermost wall layer, asci with a double ring but lack a subapical globule, long ascospores with lash-like appendages and aquatic habitat. Only two other species of *Cercophora* are known to have violet-coloured ascomata, *C. septentrionalis* and *C. caerulea*. Although these species also possess asci with a double ring but no subapical globule and ascospores with long, lash-like appendages, both have shorter ascospores (38–43 µm and 43–48 µm, respectively) and occur on dung. The ascomata in *C. septentrionalis* are covered by brown, flexuous hairs, whereas a distinct dark purple to blackish blue subiculum surrounds the ascomata in *C. caerulea* (Lundqvist 1972). *Cercophora vinosa* occurs in a well-supported clade with *C. solaris* in which it shares only a cephalothecoid-like ascomal wall and lack of a subapical globule (Catania et al. 2011).

For phylogenetic tree, see MycoBank.

Colour illustrations. France, background photo of Artillac stream in the Ariège region of south-western France; ascomata and ascomal section, ascomal wall, ascus, ascospores, phialides, colony on CMA. Scale bars = 100 µm (ascomata and ascomal section), 10 µm (ascomal wall, ascus, ascospores and phialides), 10 mm (colony on CMA plate). (Photos: Jacques Fournier).



Fungal Planet 468 – 4 July 2016

Uwemyces* Hern.-Restr., G.A. Sarria & Crous, *gen. nov.

Etymology. Named for Prof. Uwe Braun, who greatly contributed to our knowledge of dematiaceous hyphomycetous fungi.

Classification — *Mycosphaerellaceae*, *Capnodiales*, *Dothideomycetes*.

Mycelium immersed and superficial, hyphae branched, septate, hyaline and brown, smooth-walled. *Conidiophores* fasciculate, simple, dark brown at the base and subhyaline at the apex.

Conidiogenous cells cylindrical, sympodial, polytretic, with dark scars, terminal and intercalary, brown. *Conidia* straight or curved, cylindrical to obclavate, pale brown to brown, apex subhyaline, verruculose-walled, with a thick, dark brown, truncate scar at the base, septate. *Sexual morph* unknown.

Type species. *Uwemyces elaeidis* Hern.-Restr., G.A. Sarria & Crous. MycoBank MB816986.

Uwemyces elaeidis* (Steyaert) Hern.-Restr., G.A. Sarria & Crous, *comb. nov.

Basionym. *Cercospora elaeidis* Steyaert, Bull. Soc. Roy. Bot. Belgique 80: 35. 1948; as '*elaedis*'.

= *Pseudospiropes elaeidis* (Steyaert) Deighton, Trans. Brit. Mycol. Soc. 85, 4: 739. 1985.

Mycelium immersed and superficial, hyphae branched, septate, hyaline and brown, smooth-walled. *Conidiophores* fasciculate, simple, dark brown at the base and subhyaline at the apex, 96.5–188 × 6–9 µm. *Conidiogenous cells* cylindrical, sympodial, with dark brown scars, terminal and intercalary, brown, 28–70 × 5–9 µm. *Conidia* cylindrical to obclavate, straight or curved, pale brown to brown, apex subhyaline, 2–3.5 µm wide, wall verruculose, 82–133 × 6–8.5 µm, 4–8-septate, with a thick, dark brown, truncate scar at the base, 2–3.5 µm wide. *Sexual morph* unknown.

Culture characteristics — Colonies on OA, reaching 10 mm diam after 4 wk at 25 °C in the dark. Convex, cottony, vinaceous buff in the centre and velvety, olivaceous black towards the periphery, margin fimbriate; reverse black. On MEA, reaching 7 mm diam after 4 wk at 25 °C in the dark. Convex with papillate surface, centre vinaceous buff, periphery olivaceous black, margin lobed; reverse black.

Specimen examined. COLOMBIA, Barrancabermeja, CENIPALMA, on leaves of *Elaeis oleifera*, May 2013, coll. G.A. Sarria (culture CPUwZC-01, ITS sequence GenBank KX228299.1, LSU sequence GenBank KX228356.1, *rpb2* sequence GenBank KX228371.1, MycoBank MB816987).

Notes — The generic affinity of this species has been recently discussed by Braun et al. (2014). It was excluded from *Cercospora* and it is not congeneric with *Pseudospiropes* where it was tentatively placed (Steyaert 1948, Deighton 1985). Our molecular result suggests that *Uwemyces elaeidis* is related to members of *Mycosphaerellaceae*, and represents a different genus in this family. This species has wide distribution and seems to be restricted to *Elaeis guineensis*, *Arecaceae* (Braun et al. 2014). Unfortunately, it was not possible to propose a formal neotypification, since the geographical origin of the specimen examined was not the same as described in the protologue (Democratic Republic of the Congo, Kodoro).

ITS. Based on a megablast search of NCBI's GenBank nucleotide database, the closest hits using the ITS sequences are *Pseudocercospora cladrastidis* (GenBank AB694922; Identities = 463/508 (91 %), Gaps = 22/508 (4 %). GenBank AB694923; Identities = 462/507 (91 %), Gaps = 20/507 (3 %). GenBank AB694921; Identities = 462/507 (91 %), Gaps = 20/507 (3 %)), *Cercospora dolichandrae* (GenBank KJ869140; Identities = 496/546 (91 %), Gaps = 12/546 (2 %) and *Pseudocercospora ocimicola* (GenBank GU214678; Identities = 497/548 (91 %), Gaps = 10/548 (1 %)).

LSU. Based on a megablast search of NCBI's GenBank nucleotide database, the closest hits using the LSU sequences are *Mycosphaerella swartii* (GenBank DQ923536; Identities = 828/860 (96 %), Gaps = 8/860 (0 %)), *Mycosphaerella walkeri* (GenBank DQ267574; Identities = 828/860 (96 %), Gaps = 8/860 (0 %)) and *Acervuloseptoria ziziphicola* (GenBank KJ869221; Identities = 796/828 (96 %), Gaps = 8/828 (0 %)).

rpb2. Based on a megablast search of NCBI's GenBank nucleotide database, the closest hits using the *rpb2* sequences are *Pseudocercospora norchiensis* (GenBank JQ739865; Identities = 192/229 (84 %), Gaps = 4/229 (1 %), GenBank KF902320; Identities = 200/239 (84 %), Gaps = 4/239 (1 %), GenBank JX902017; Identities = 200/239 (84 %), Gaps = 4/239 (1 %)) and *Pseudocercospora atromarginalis* (GenBank JX902006; Identities = 205/245 (84 %), Gaps = 4/245 (1 %)).

Colour illustrations. *Elaeis oleifera* palm tree in CENIPALMA Colombia; leaf spots, conidiophores, conidiogenous cells and conidia in natural substrate and in culture. Scale bars = 10 µm.

REFERENCES

- Adams GC, Wingfield MJ, Common R, et al. 2005. Phylogenetic relationships and morphology of *Cytospora* species and related teleomorphs (Ascomycota, Diaporthales, Valsaceae) from *Eucalyptus*. *Studies in Mycology* 52: 1–144.
- Antonín V, Noordeloos ME. 1997. A monograph of Marasmius, Collybia and related genera in Europe. Part 2: Collybia, Gymnopus, Rhodocollybia, Crinipellis, Chaetocalathus, and additions to Marasmiellus. *Libri Botanici* 17: 1–256.
- Antonín V, Noordeloos ME. 2010. A monograph of marasmioid and collybioid fungi in Europe. IHW-Verlag, Eching.
- Antonín V, Ryoo R, Shin HD. 2009. Marasmioid and gymnopoid fungi of the Republic of Korea. 1. Three interesting species of *Crinipellis* (Basidiomycota, Marasmiaceae). *Mycotaxon* 108: 429–440.
- Arauzo S, Iglesias P. 2014. La familia Geoglossaceae s.str. en la península Ibérica y la Macaronesia. *Errotari* 11: 166–259.
- Ariyawansa HA, Hyde KD, Jayasiri SC, et al. 2015. Fungal diversity notes 111–252: taxonomic and phylogenetic contributions to fungal taxa. *Fungal Diversity* 75: 27–274.
- Bandala VM, Ryoo R, Montoya L, et al. 2012. New species and new records of *Crinipellis* from tropical and subtropical forests of the east coast of Mexico. *Mycologia* 104: 733–745.
- Bessette AE, Roody WC, Bessette AR. 2000. North American boletes: A color guide to the fleshy pored mushrooms. Syracuse University Press, Syracuse, NY.
- Bills GF, Miller Jr OK. 1984. Southern Appalachian russulas. I. *Mycologia* 76: 975–1002.
- Boerema GH, De Gruyter J, Noordeloos ME, et al. 2004. Phoma identification manual. Differentiation of specific and infra-specific taxa in culture. CABI Publishing, Wallingford, UK.
- Braun U. 1993. Studies on *Ramularia* and allied genera (VI). *Nova Hedwigia* 56: 423–454.
- Braun U. 1998. A monograph of *Cercospora*, *Ramularia* and allied genera (phytopathogenic hyphomycetes). Vol. 2. IHW-Verlag, Eching, Munich, Germany.
- Braun U, Crous PW, Nakashima C. 2014. Cercosporoid fungi (Mycosphaerellaceae) 2. Species on monocots (Acoraceae to Xyridaceae, excluding Poaceae). *IMA Fungus* 5: 203–390.
- Cai L, Wu WP, Hyde KD. 2009. Phylogenetic relationships of *Chalara* and allied species inferred from ribosomal DNA sequences. *Mycological Progress* 8: 133–143.
- Câmara PS, Ramaley AW, Castlebury LA, et al. 2003. Neophaeosphaeria and Phaeosphaeriopsis, segregates of Paraphaeosphaeria. *Mycological Research* 107: 516–522.
- Catania MV, Romero AI, Huhndorf SM, et al. 2011. A new species and new records of *Cercophora* from Argentina. *Mycologia* 103: 1372–1383.
- Chaverri P, Salgado C, Hirooka Y, et al. 2011. Delimitation of *Neonectria* and *Cylindrocarpon* (Nectriaceae, Hypocreales, Ascomycota) and related genera with *Cylindrocarpon*-like anamorphs. *Studies in Mycology* 68: 57–78.
- Coetzee MPA, Marinowitz S, Muthelo VG, et al. 2015. *Ganoderma* species, including new taxa associated with root rot of the iconic *Jacaranda mimosifolia* in Pretoria, South Africa. *IMA Fungus* 6: 249–256.
- Corredor AH, Van Rees K, Vujanovic V. 2012. Changes in root-associated fungal assemblages within newly established clonal biomass plantations of *Salix* spp. *Forest Ecology and Management* 282: 105–114.
- Crous PW, Braun U, Groenewald JZ. 2007a. *Mycosphaerella* is polyphyletic. *Studies in Mycology* 58: 1–32.
- Crous PW, Braun U, Schubert K, et al. 2007b. Delimiting *Cladosporium* from morphologically similar genera. *Studies in Mycology* 58: 33–56.
- Crous PW, Ferreira FA, Sutton BC. 1997. A comparison of the fungal genera *Phaeophloeospora* and *Kirramyces* (coelomycetes). *South African Journal of Botany* 63: 111–115.
- Crous PW, Groenewald JZ, Shivas RG. 2010a. *Fusicladium eucalypti*. *Fungal Planet* 64. *Persoonia* 25: 148–149.
- Crous PW, Groenewald JZ, Shivas RG. 2010b. *Pseudophloeospora eucalypti*. *Fungal Planet* 60. *Persoonia* 25: 140–141.
- Crous PW, Mohammed C, Glen M, et al. 2007c. *Eucalyptus* microfungi known from culture. 3. *Eucasphaeria* and *Symptoventuria* genera nova, and new species of *Furcaspora*, *Harknessia*, *Heteroconium* and *Phacidiella*. *Fungal Diversity* 25: 19–36.
- Crous PW, Phillips AJL, Baxter AP. 2000. Phytopathogenic fungi from South Africa. University of Stellenbosch Printers, Department of Plant Pathology Press.
- Crous PW, Schubert K, Braun U, et al. 2007d. Opportunistic, human-pathogenic species in the *Herpotrichiellaceae* are phenotypically similar to saprobic or phytopathogenic species in the *Venturiaceae*. *Studies in Mycology* 58: 185–217.
- Crous PW, Shivas RG, Quaedvlieg W, et al. 2014a. *Fungal Planet* description sheets: 214–280. *Persoonia* 32: 184–306.
- Crous PW, Shivas RG, Wingfield MJ, et al. 2012a. *Fungal Planet* description sheets: 128–153. *Persoonia* 29: 146–201.
- Crous PW, Summerell BA, Shivas RG, et al. 2011. *Fungal Planet* description sheets: 92–106. *Persoonia* 27: 130–162.
- Crous PW, Summerell BA, Shivas RG, et al. 2012b. *Fungal Planet* description sheets: 107–127. *Persoonia* 28: 138–182.
- Crous PW, Wingfield MJ. 1994. *Sporendocladia fumosa* and *Lauriomyces bellulus* sp. nov. from *Castanea cupules* in Switzerland. *Sydowia* 46: 193–203.
- Crous PW, Wingfield MJ, Guarro J, et al. 2015a. *Fungal Planet* description sheets: 320–370. *Persoonia* 34: 167–266.
- Crous PW, Wingfield MJ, Le Roux JJ, et al. 2015b. *Fungal Planet* description sheets: 371–399. *Persoonia* 35: 264–327.
- Crous PW, Wingfield MJ, Schumacher RK, et al. 2014b. *Fungal Planet* description sheets 281–319. *Persoonia* 33: 212–289.
- Das K, Miller SL, Sharma JR, et al. 2005. *Russula* in Himalaya 1: A new species of subgenus *Amoenula*. *Mycotaxon* 94: 85–88.
- Das K, Sharma JR. 2005. *Russulaceae* of Kumaon Himalaya. Kolkata, Botanical Survey of India, Ministry of Environment and Forests.
- De Gruyter J, Woudenberg JHC, Aveskamp MM, et al. 2010. Systematic reappraisal of species in *Phoma* section *Paraphoma*, *Pyrenochaeta* and *Pleurophoma*. *Mycologia* 102: 1066–1081.
- De Hoog GS, Beguin H, Batenburg-van de Vegte WH. 1997. *Phaeotheca triangularis*, a new meristematic black yeast from a humidifier. *Antonie van Leeuwenhoek* 71: 289–295.
- Decock C, Delgado-Rodríguez G, Buchet S, et al. 2003. A new species and three new combinations in *Cyphellophora*, with a note on the taxonomic affinities of the genus, and its relation to *Kumbhamaya* and *Pseudomicrodochium*. *Antonie van Leeuwenhoek* 84: 209–216.
- Deighton FC. 1985. Three leaf-spotting hyphomycetes on palms. *Transactions of the British Mycological Society* 85: 739–742.
- Desjardin DE, Wood MG, Stevens FA. 2015. *California mushrooms: The comprehensive identification guide*. Timber Press, Portland, OR.
- Egidi E, De Hoog GS, Isola D, et al. 2014. Phylogeny and taxonomy of meristematic rock-inhabiting black fungi in the *Dothidemyces* based on multi-locus phylogenies. *Fungal Diversity* 65: 127–165.
- Ellis MB. 1961. *Dematiaceous Hyphomycetes*. III. *Mycological Papers* 82: 1–55.
- Ellis MB. 1971. *Dematiaceous Hyphomycetes*. Commonwealth Mycological Institute, Kew Surrey, England.
- Fischer E. 1906. Ueber einige von Herrn Prof. E. Kissling in Sumatra gesammelte Pilze. *Mitteilungen der Naturforschenden Gesellschaft in Bern*, issues 1609–1628: 109–123.
- Gao L, Ma Y, Zhao W, et al. 2015. Three new species of *Cyphellophora* (Chaetothyriales) associated with Sooty Blotch and Flyspeck. *PLoS ONE* 10, 9: e0136857.
- Gomes RR, Glienke C, Videira CIR, et al. 2013. *Diaporthe*: a genus of endophytic, saprobic and plant pathogenic fungi. *Persoonia* 31: 1–41.
- Guarro J, Gené J, Stchigel AM, et al. 2012. *Atlas of soil ascomycetes*. CBS Biodiversity Series 10. CBS-KNAW Fungal Biodiversity Centre, Utrecht, The Netherlands.
- Guatimosim E, Schwartsburd PB, Barreto RW, et al. 2016. Novel fungi from an old niche: cercosporoid and related sexual morphs on ferns. *Persoonia* 37: 106–141.
- Gurgel FE, Silva BDB, Baseia IG. 2008. New records of *Scleroderma* from Northeastern Brazil. *Mycotaxon* 105: 399–405.
- Guzmán G, Cortés-Pérez A, Guzmán-Dávalos L, et al. 2013. An emendation of *Scleroderma*, new records, and review of the known species in Mexico. *Revista Mexicana de Biodiversidad* S173–S191.
- Hakelien N. 1967. Three new Swedish species of *Geoglossum*. *Svensk Botanisk Tidskrift* 61: 419–424.
- Halleen F, Schroers H-J, Groenewald JZ, et al. 2004. Novel species of *Cylindrocarpon* (*Neonectria*) and *Campylocarpon* gen. nov. associated with black foot disease of grapevines (*Vitis* spp.). *Studies in Mycology* 50: 431–455.
- Hanse B. 2013. Research on *Stemphylium* spp. the causal agent of the yellow leaf spot disease in sugar beet in 2012. IRS, Bergen op Zoom, The Netherlands.
- Hanse B, Raaijmakers EEM, Schoone AHL, et al. 2015. *Stemphylium* sp., the cause of yellow leaf spot disease in sugar beet (*Beta vulgaris* L.) in the Netherlands. *European Journal of Plant Pathology* 141: 1–12.
- Hernández-Restrepo M, Castañeda-Ruiz RF, Gené J, et al. 2012. *Microfungi* from Portugal: *Minimelanolocus manifestus* sp. nov. and *Vermiculariopsiella pediculata* comb. nov. *Mycotaxon* 122: 135–143.

- Ho MH-M, Castañeda RF, Dugan FM, et al. 1999. Cladosporium and Cladophialophora in culture: description and an expanded key. *Mycotaxon* 72: 115–157.
- Houbraken J, Giraud S, Meijer M, et al. 2013. Taxonomy and antifungal susceptibility of clinically important *Rasamsonia* species. *Journal of Clinical Microbiology* 51: 22–30.
- Huelsenbeck JP, Ronquist F. 2001. MrBayes: Bayesian inference of phylogenetic trees. *Bioinformatics* 17: 754–755.
- Huhndorf SM. 1992. Studies in Leptosphaeria. Transfer of Leptosphaeria opuntiae to Montagnula (Ascomycetes). *Brittonia* 44, 2: 208–212.
- Inderbitzin P, Mehta YR, Berbee ML. 2009. Pleospora species with Stemphylium anamorphs: a four locus phylogeny resolves new lineages yet does not distinguish among species in the Pleospora herbarum clade. *Mycologia* 101: 329–339.
- Jacobs A, Coetzee MPA, Jacobs K, et al. 2003. Phylogenetic relationships among Phialocephala species and other ascomycetes. *Mycologia* 95: 637–645.
- Jagielski T, Sandoval-Denis M, Yu J, et al. 2016. Molecular taxonomy of scopulariopsis-like fungi with description of new clinical and environmental species. *Fungal Biology* 120: 586–602.
- Kearse M, Moir R, Wilson A, et al. 2012. Geneious basic: an integrated and extendable desktop software platform for the organization and analysis of sequence data. *Bioinformatics* 28: 1647–1649.
- Klaubauf S, Tharreau D, Fournier E, et al. 2014. Resolving the polyphyletic nature of Pyricularia (Pyriculariaceae). *Studies in Mycology* 79: 85–120.
- Kornerup A, Wanscher JH. 1978. *Methuen handbook of colour*. 3rd ed. Eyre Methuen, London.
- Kreisel, H. 2001. Checklist of the gasteral and secotioid Basidiomycetes of Europe, Africa, and the Middle East. *Österreichische Zeitschrift für Pilzkunde* 10: 213–313.
- Kuthubutheen AJ, Nawawi A. 1988. A new species of Wiesneriomyces (Hyphomycetes) from submerged decaying leaves. *Transactions of the British Mycological Society* 90: 619–625.
- Ladurner H, Simonini G. 2003. *Xerocomus* s.l. *Fungi Europaei* 8: 1–527. Edizioni Candusso, Alassio.
- Lamprecht SC, Crous PW, Groenewald JZ, et al. 2011. Diaporthaceae associated with root rot of maize. *IMA Fungus* 2: 13–24.
- Lennox CL, Serdani M, Groenewald JZ, et al. 2004. *Prosopidicola mexicana* gen. et. sp. nov., causing a new pod disease of *Prosopis* species. *Studies in Mycology* 50: 187–194.
- Liu JK, Hyde KD, Jones EBG, et al. 2015. Fungal diversity notes 1–110: taxonomic and phylogenetic contributions to fungal species. *Fungal Diversity* 72: 1–197.
- Lombard L, Van der Merwe N, Groenewald JZ, et al. 2014. Lineages in Nectriaceae: re-evaluating the generic status of *Ilyonectria* and allied genera. *Phytopathologia Mediterranea* 53: 340–357.
- Ludwig E, Roux P. 1995. *Coprinus leviscolens* und *Coprinus citrinovelatus* zwei neue, leicht kenntliche Tintlinge. *Zeitschrift für Mykologie* 6: 29–37.
- Lundqvist N. 1972. Nordic Sordariaceae s. lat. *Symbolae Botanicae Upsalienses* 20: 1–374.
- Marin-Felix Y, Stchigel AM, Miller AN, et al. 2015. A re-evaluation of the genus *Myceliophthora* (Sordariales, Ascomycota): its segregation into four genera and description of *Corynascus fumimontanus* sp. nov. *Mycologia* 107: 619–632.
- Martin F, Díez J, Dell B, et al. 2002. Phylogeography of the ectomycorrhizal *Pisolithus* species as inferred from nuclear ribosomal ITS sequences. *New Phytologist* 153: 345–357.
- Martín MP, Durán F, Phosri C, et al. 2013. A new species of *Pisolithus* from Spain. *Mycotaxon* 124: 149–154.
- McNabb RFR. 1973. Russulaceae of New Zealand 2. *Russula* Pers. ex S.F. Gray. *New Zealand Journal of Botany* 11: 673–730.
- Moreau C. 1947. Un *Cercospora* parasite des feuilles du palmier a hule au Moyen Congo. *Revue Mycologie* 12: 37–38.
- Moreno G, Heykoop M. 1998. Type studies in the genus *Coprinus* (Coprinaceae, Agaricales) *Coprinus xerophilus* a new record in Europe. *Persoonia* 17: 97–111.
- Morozova OV, Noordeloos ME, Vila J. 2014. *Entoloma* subgenus *Leptonia* in boreal-temperate Eurasia: towards a phylogenetic species concept. *Persoonia* 32: 141–169.
- Munsell. 1994. Soil color charts (rev. ed.). Macbeth Division of Kollmorgen Instruments Corporation, New Windsor, NY.
- Nakamura M, Ohzono M, Iwai H, et al. 2006. Anthracnose of *Sansevieria trifasciata* caused by *Colletotrichum sansevieriae* sp. nov. *Journal of General Plant Pathology* 72: 253–256.
- Nguyen LT, Schmidt HA, Von Haeseler A, et al. 2015. IQ-TREE: A fast and effective stochastic algorithm for estimating maximum-likelihood phylogenies. *Molecular Biology and Evolution* 32: 268–274.
- Peck CH. 1872. Report of the Botanist (1870). Annual report on the New York State Museum of Natural History 24: 41–108.
- Peintner U, Ladurner H, Simonini G. 2003. *Xerocomus cisalpinus* sp. nov., and the delimitation of species in the *X. chrysenron* complex based on morphology and rDNA-LSU sequences. *Mycological Research* 107: 659–679.
- Pérez de Gregorio MA. 1995. Aportació al coneixement dels macromicets de l'illa de Mallorca. II. *Revista de la Societat Catalana de Micologia* 18: 9–17.
- Phillips AJL, Alves A, Abdollahzadeh J, et al. 2013. The Botryosphaeriaceae: genera and species known from culture. *Studies in Mycology* 76: 51–167.
- Phillips AJL, Alves A, Pennycook SR, et al. 2008. Resolving the phylogenetic and taxonomic status of dark-spored teleomorph genera in the Botryosphaeriaceae. *Persoonia* 21: 29–55.
- Phookamsak R, Liu J-K, Manamgoda DS, et al. 2014. The sexual state of *Setophoma*. *Phytotaxa* 176: 260–269.
- Phosri C, Martín MP, Suwannasai N, et al. 2012. *Pisolithus*: a new species from southeast Asia and a new combination. *Mycotaxon* 120: 195–208.
- Phosri C, Martín MP, Watling R, et al. 2009. Molecular phylogeny and re-assessment of some *Scleroderma* spp. (Gasteromycetes). *Anales del Jardín Botánico de Madrid* 66S1: 83–91.
- Pilát A. 1958. Pisolithaceae. In: *Flora CSR – Gasteromycetes*. Nakladatelství Československé Akademie Ved, Prague. [In Czech.]
- Posada D. 2008. jModelTest: Phylogenetic Model Averaging. *Molecular Biology and Evolution* 25: 1253–1256.
- Pratibha J, Nguyen HDT, Mel'nik VA, et al. 2015. Lectotypification, epitypification, and molecular phylogeny of the synnematosus hyphomycete *Pseudoglyphragma indicum*, the second genus in the *Wiesneriomycetaceae*. *Mycoscience* 56: 387–395.
- Quaedvlieg W, Binder M, Groenewald JZ, et al. 2014. Introducing the Consolidated Species Concept to resolve species in the *Teratosphaeriaceae*. *Persoonia* 33: 1–40.
- Quélet L. 1880. Quelques espèces critiques ou nouvelles de la Flore Mycologique de France. *Comptes Rendus de l'Association Française pour l'Avancement des Sciences* 9: 661–675.
- Quélet L. 1898. Quelques espèces critiques ou nouvelles de la Flore Mycologique de France. *Comptes Rendus de l'Association Française pour l'Avancement des Sciences* 26: 446–452.
- Rayner RW. 1970. A mycological colour chart. Commonwealth Mycological Institute and British Mycological Society, Kew.
- Réblová M, Gams W, Seifert KA. 2011. *Monilochaetes* and allied genera of the Glomerellales, and a reconsideration of families in the Microascales. *Studies in Mycology* 68: 163–191.
- Redhead SA. 1989. The presence of *Crinipellis maxima* (Tricholomataceae) in Canada. *Memoirs of the New York Botanical Garden* 49: 187–191.
- Ridgway R. 1912. Color standards and color nomenclature. Ridgway, Washington DC.
- Rikkinen J. 2003. *Chaenothecopsis nigripunctata*, a remarkable new species of resinicolous Mycocaliciaceae from western North America. *Mycologia* 95: 98–103.
- Romagnesi H. 1967. *Les Russules d'Europe et d'Afrique du Nord*. Bordas, Paris.
- Ronquist F, Teslenko M, Van der Mark P, et al. 2012. MrBayes 3.2: efficient Bayesian phylogenetic inference and model choice across a large model space. *Systematic Biology* 61: 539–542.
- Rossmann AY, Adams GC, Cannon PF, et al. 2015. Recommendations of generic names in Diaporthales competing for protection or use. *IMA Fungus* 6: 145–154.
- Rusevska K, Karadelev M, Phosri C, et al. 2014. Rechecking of the genus *Scleroderma* (Gasteromycetes) from Macedonia using barcoding approach. *Turkish Journal of Botany* 38: 375–385.
- Ryvarden L. 2004. Neotropical Polypores, part 1. *Synopsis Fungorum* 19: 69–102.
- Samerpitak K, Gerrits van den Ende AHG, Menken SBJ, et al. 2015. Three new species of the genus *Ochroconis*. *Mycopathologia* 180: 7–17.
- Samson RA, Houbraken J, Varga J, et al. 2009. Polyphasic taxonomy of the heat resistant ascomycete genus *Byssosclamyces* and its *Paecilomyces* anamorphs. *Persoonia* 22: 14–27.
- Samuels GJ. 1976. Perfect states of *Acremonium*. The genera *Nectria*, *Actinopiopsis*, *Ijuhya*, *Neohenningsia*, *Ophiodictyon*, and *Peristomialis*. *New Zealand Journal of Botany* 14: 231–260.
- Samuels GJ. 1978. Some species of *Nectria* having *Cylindrocarpon* imperfect states. *New Zealand Journal of Botany* 16: 73–82.
- Sandoval-Denis M, Gené J, Sutton DA, et al. 2016. Redefining *Microascus*, *Scopulariopsis* and allied genera. *Persoonia* 36: 1–36.
- Sarnari M. 1998. *Monografia illustrate del genere Russula in Europa*. Italy, Trovo Primo.
- Schoch CL, Robbertse B, Robert V, et al. 2014. Finding needles in haystacks: linking scientific names, reference specimens and molecular data for Fungi. *Database* 2014: 1–21.

- Séguy E. 1936. XXX Code Universel des couleurs. Edt. P. Lechevalier, 51 pl. Paris.
- Shrestha P, Szaro TM, Bruns TD, et al. 2011. Systematic search for cultivable fungi that best deconstruct cell walls of *Miscanthus* and sugarcane in the field. *Applied and Environmental Microbiology* 77: 5490–5504.
- Simonini G. 1994. *Boletus dryophilus* Thiers, specie nuova per l'Europa. *Rivista di Micologia* 37: 205–219.
- Singer R. 1953. Type studies on Basidiomycetes. VI. *Lilloa* 26: 57–159.
- Singer R. 1976. Marasmieae (Basidiomycetes – Tricholomataceae). *Flora Neotropica* 17: 1–348.
- Singer R. 1986. The Agaricales in modern taxonomy, 4th ed. Koenigstein, Koeltz Scientific Books.
- Stamatakis A, Alachiotis N. 2010. Time and memory efficient likelihood-based tree searches on phylogenomic alignments with missing data. *Bioinformatics* 26: i132–i139.
- Stamatakis A, Hoover P, Rougemont J. 2008. A rapid bootstrap algorithm for the RAxML web-servers. *Systematic Biology* 75: 758–771.
- Steyaert RL. 1948. Contribution a l'étude des parasites des végétaux du Congo Belge. *Bulletin de la Société Royale de Botanique de Belgique* 80: 11–58.
- Suetrong S, Rungjindamai N, Sommai S, et al. 2014. *Wiesneriomyces* a new lineage of Dothideomycetes (Ascomycota) basal to Tubeufiales. *Phytotaxa* 176: 283–297.
- Sulzbacher MA, Giachini AJ, Grebenc T, et al. 2013. A survey of an ectotrophic sand dune forest in the northeast Brazil. *Mycosphere* 4: 1106–1116.
- Summerbell RC, Cooper E, Bunn U, et al. 2005. Onychomycosis: a critical study of techniques and criteria for confirming the etiologic significance of nondermatophytes. *Medical Mycology* 43: 39–59.
- Sutton BC. 1973. *Pucciniopsis*, *Mycoleptodiscus* and *Amerodiscosiella*. *Transactions of the British Mycological Society* 60: 525–536.
- Sutton BC. 1980. The Coelomycetes: fungi imperfecti with pycnidia, acervuli, and stromata. Kew, Commonwealth Mycological Institute.
- Sutton BC, Ganapathi A. 1978. *Trimmatostroma excentricum* sp. nov. on *Eucalyptus* from New-Zealand and Fiji. *New Zealand Journal of Botany* 16: 529–533.
- Tabarés M, Rocabrana A. 2002. *Coprinus spadiceisporus* Bogart, en Catalunya. *Revista Catalana de Micologia* 24: 57–60.
- Tamura K, Stecher G, Peterson D, et al. 2013. MEGA 6: Molecular Evolutionary Genetics Analysis version 6.0. *Molecular Biology and Evolution* 30: 2725–2729.
- Tanney JB, Seifert KA. 2013. *Rasamsonia pulvericola* sp. nov., isolated from house dust. *IMA Fungus* 4: 205–212.
- Thambugala KM, Camporesi E, Ariyawansa HA, et al. 2014. Phylogeny and morphology of *Phaeosphaeriopsis triseptata* sp. nov., and *Phaeosphaeriopsis glaucopunctata*. *Phytotaxa* 176: 238–250.
- Thiers HD. 1975. California mushrooms – a field guide to the Boletes. Hafner Press, New York, NY.
- Thompson SM, Tan YP, Shivas RG. 2015. Green and brown bridges between weeds and crops reveal novel *Diaporthe* species in Australia. *Persoonia* 35: 39–49.
- Tibell L. 1991. The *Asterophoma* anamorph of *Chaenothecopsis savonica* and its hyphomycetous synanamorph. *Canadian Journal of Botany* 69: 2427–2433.
- Tibell L, Constantinescu O. 1991. *Catenomyces rosea* gen. et sp. nov. (Hyphomycetes), anamorph of *Chaenothecopsis haematopus*. *Mycological Research* 95: 556–560.
- Tibell L, Vinuesa M. 2005. *Chaenothecopsis* in a molecular phylogeny based on nuclear rDNA ITS and LSU sequences. *Taxon* 54: 427–442.
- Tuovila H, Cobbinah J, Rikkinen J. 2011. *Chaenothecopsis khayensis*, a new resinicolous calicioid fungus on African mahogany. *Mycologia* 103: 610–615.
- Tuovila H, Davey ML, Yan L, et al. 2014. New resinicolous *Chaenothecopsis* species from China. *Mycologia* 106: 989–1003.
- Uljé CB, Gennari A, Doveri F, et al. 1998. First report of *Coprinus spadiceisporus* in Europe. *Persoonia* 16: 537–540.
- Van de Bogart F. 1976. The genus *Coprinus* in Western North America, part I: section *Coprinus*. *Mycotaxon* 4: 233–275.
- Van den Brink J, Samson RA, Hagen F, et al. 2012. Phylogeny of the industrial relevant, thermophilic genera *Myceliophthora* and *Corynascus*. *Fungal Diversity* 52: 197–207.
- Wickerham LJ. 1951. Taxonomy of yeasts. Technical Bulletin No. 1029. U.S. Department of Agriculture, Washington DC.
- Wingfield MJ, Van Wyk PS, Wingfield BD. 1987. Reclassification of *Phialocephala* based on conidial development. *Transactions of the British Mycological Society* 89: 509–520.
- Woudenberg JHC, Groenewald JZ, Binder M, et al. 2013. *Alternaria* re-defined. *Studies in Mycology* 75: 171–212.
- Woudenberg JHC, Seidl MF, Groenewald JZ, et al. 2015. *Alternaria* section *Alternaria*: Species, formae speciales or pathotypes? *Studies in Mycology* 82: 1–21.
- Woudenberg JHC, Truter M, Groenewald JZ, et al. 2014. Large-spored *Alternaria* pathogens in section *Porri* disentangled. *Studies in Mycology* 79: 1–47.
- Xia YW, Li TH, Deng WQ, et al. 2015. A new *Crinipellis* species with floccose squamules from China. *Mycoscience* 56: 476–480.
- Zhang T-Y, Zhang J-Z, Chen W-Q, et al. 1999. Taxonomic studies of *Alternaria* from China VII. New taxa on Fagaceae, Magnoliaceae, Meliaceae, and Moraceae. *Mycotaxon* 72: 433–441.