Agaricales of the Hawaiian Islands. 8. Agaricaceae: *Coprinus* and *Podaxis*; Psathyrellaceae: *Coprinopsis*, *Coprinellus* and *Parasola*

M.R. Keirle¹, D.E. Hemmes² and D.E. Desjardin^{1*}

¹Department of Biology, San Francisco State University, 1600 Holloway Ave., San Francisco, California 94132 USA

²Department of Biology, University of Hawai`i, 200 W. Kawili Street, Hilo, Hawai`i 96720 USA

Keirle, M.R., Hemmes, D.E. and Desjardin, D.E. (2004). Agaricales of the Hawaiian Islands. 8. Agaricaceae: *Coprinus* and *Podaxis*; Psathyrellaceae: *Coprinopsis*, *Coprinellus* and *Parasola*. *Fungal Diversity* 15: 33-124.

Twenty-nine species belonging to the genera *Coprinus* and *Podaxis* (Agaricaceae) and *Coprinopsis*, *Coprinellus*, and *Parasola* (Psathyrellaceae) are reported from the Hawaiian Islands. These species represent a polyphyletic assemblage of dark-spored, saprotrophic taxa comprising the traditional genus *Coprinus* and the genus *Podaxis* which is considered a secotioid ally of *Coprinus*. The collections were obtained from a variety of habitats ranging from sandy soils to woodchip piles, lawns and pastures, ungulate dung, herbaceous debris, and fallen logs in alien and native mesic forests. *Coprinopsis urticicola* var. *hawaiiensis* is described as new, *Coprinus candidolanatus* is transferred to *Coprinopsis*, and two additional species are provisionally described in *Coprinopsis*. Multiple specimens representing the *Coprinus cordisporus* complex were analyzed using morphological and ITS sequence datasets to investigate relationships within the group. All taxa are described, illustrated, and compared with phenetically similar taxa. An artificial dichotomous key to aid in determining Hawaiian coprinoid species is presented.

Key words: coprinoid fungi, coprophilous fungi, fungal taxonomy, ITS sequences, systematics

Introduction

This research represents the eighth installment of ongoing studies of the Agaricales of the Hawaiian Islands. Prior to this study, there were no validly published reports of coprini from the Hawaiian Archipelago. Twenty-nine species belonging to the genera *Coprinus* and *Podaxis* (Agaricaceae) and *Coprinopsis*, *Coprinellus*, and *Parasola* (Psathyrellaceae) are reported herein. Eleven of these species are illustrated with color photographs in the recently published fieldguide, *Mushrooms of Hawai`i* (Hemmes and Desjardin, 2002).

*Corresponding author: D.E. Desjardin; e-mail: ded@sfsu.edu

The majority of Hawaiian coprini probably represent recent introductions to the Hawaiian Islands (cf. Ko *et al.*, 2001). Data from more than 150 specimens are included in this work. Specimens were collected on the islands of Hawai'i, Maui, Kaua'i, Lana'i, and Oahu during the years 1992-2003. A wide variety of habitats were sampled including lawns and pastures, composts piles and woodchips, arid leeward coastal habitats, mesic montane native forests, and coastal *Casuarina* habitats.

Most collections were obtained from agricultural and horticultural land or in other disturbed areas and appear to be cosmopolitan wood and dung decomposers. Three species were collected in native Hawaiian forest, but these represent species common to Europe and North America. There are several other Hawaiian taxa, however, that do not match north temperate coprini, and they probably represent introductions to Hawai'i from tropical regions including parts of Asia or Australia.

The nomenclature employed is based on the circumscription of the genus *Coprinus sensu lato* as published by Redhead *et al.* (2001). The traditional generic concept for *Coprinus* Pers. has existed for over 200 years. Members of the genus were recognized by a suite of characters that included: the presence of brachybasidia (pavement cells), darkly pigmented basidiospores, saprotrophic nutrition, fragile flesh, parallel to subparallel lamellae with inaequihymeniferous development, deliquescent to subdeliquescent lamellae, and a pileus with a plicate margin. A segregate genus, *Pseudocoprinus*, was erected by Kühner in 1928 to accommodate the non-deliquescent members of the genus, but Kühner (1980) later synonymized *Pseudocoprinus* with *Coprinus*. There have been numerous infrageneric delimitations within *Coprinus sensu lato*. A comparison of five contemporary classifications of *Coprinus* is presented in Table 1.

Recent molecular studies and new interpretations of morphological features have revealed the genus *Coprinus sensu lato* to be polyphyletic. As a result, the type species for *Coprinus*, *C. comatus* (O.F. Mull.: Fr.) Pers., is more closely allied with the genera *Agaricus* and *Lepiota* than with most of the other coprini which are allied with members of the genus *Psathyrella*. Consequently, most coprini have been reassigned to three newly defined genera included in the family Psathyrellaceae: viz., *Coprinopsis*, *Coprinellus*, and *Parasola* (Redhead *et al.* 2001). Many of the features used traditionally to recognize members of the genus *Coprinus*, including deliquescence, appear to be homoplastic. *Podaxis*, although superficially resembling *Coprinus comatus*, appears not to be closely allied. It is unclear which taxa are the closest relatives

Table 1. Comparison of Sectional organization of the coprini by different authors

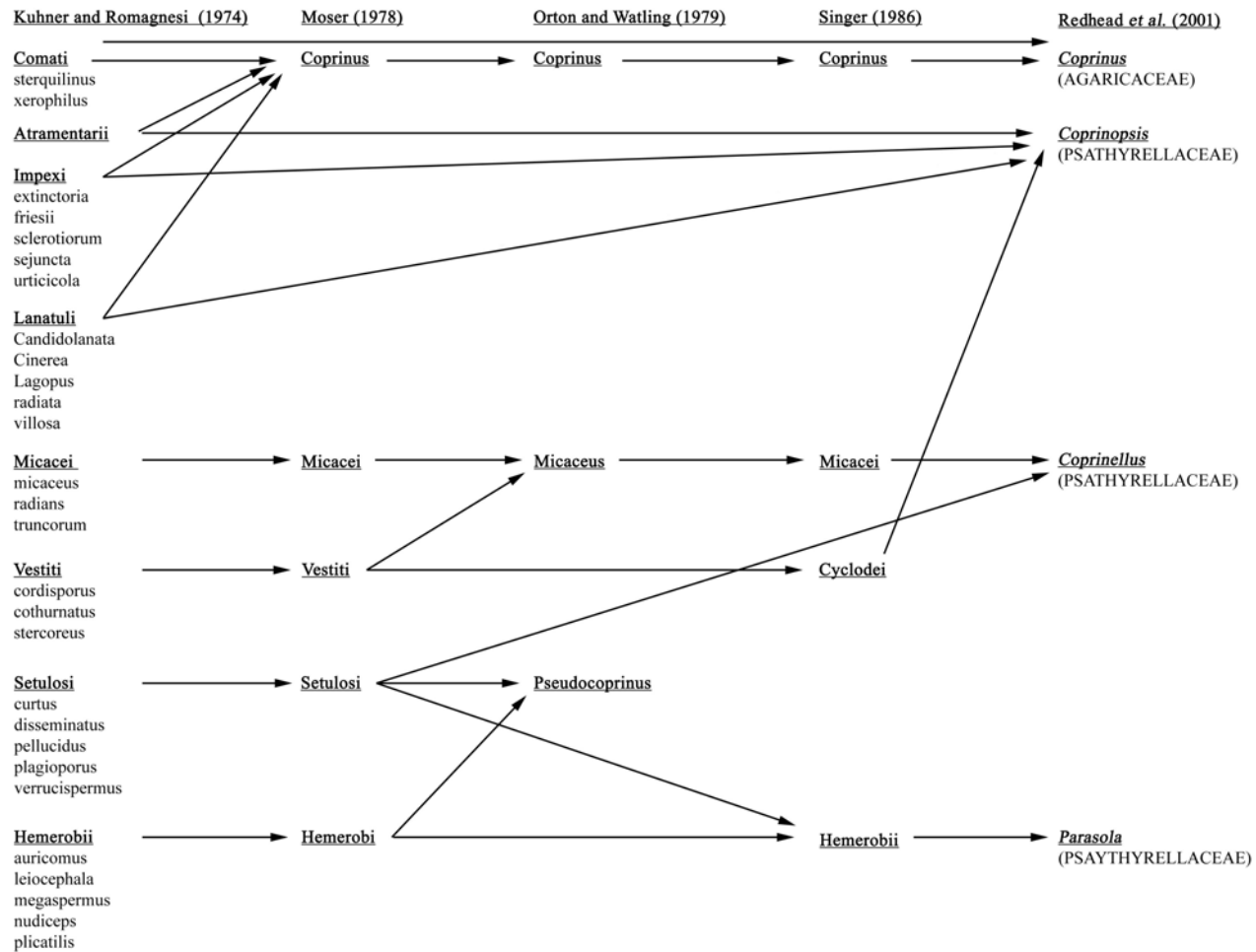

Table 2. Morphological features used to distinguish the newly redefined coprinoid genera supported by molecular sequence data (Redhead *et al.*, 2001; Moncalvo *et al.*, 2002).

Genus	<i>Coprinus</i>	<i>Montagnea</i> and <i>Xerocoprinus</i>	<i>Podaxis</i>	<i>Coprinopsis</i>	<i>Parasola</i>	<i>Coprinellus</i>
representative species	<i>Comatus</i> <i>Sterquilinus</i> <i>Xerophilus</i>	<i>Arenaria</i>	<i>pistillaris</i>	<i>candidolanatus</i> <i>cinerea</i> <i>cothurnata</i> <i>extinctoria</i> <i>friesii</i> <i>lagopus</i> <i>radiata</i> <i>sclerotiorum</i> <i>sejuncta</i> <i>stercorea</i> <i>urticicola</i> <i>villosa</i>	auricoma <i>leiocephala</i> <i>megasperma</i> <i>nudiceps</i> <i>plicatilis</i>	<i>curtus</i> <i>disseminatus</i> <i>micaceus</i> <i>pellucidus</i> <i>plagioporus</i> <i>radians</i> <i>truncorum</i> <i>verrucispermus</i>
Family	Agaricaceae	Agaricaceae	Agaricaceae	Psathyrellaceae	Psathyrellaceae	Psathyrellaceae
agaricoid–secotioid	agaricoid	Secotioid	secotioid	agaricoid	agaricoid	agaricoid
immature lamellae pinkish	yes	Yes	yes	no	no	no
pileipellis	inflated cells	Inflated cells	inflated cells	cutis	smooth hymeniform palisade	hymeniderm or cystoderm
pileocystidia	absent	Absent	absent	absent	absent or with non- secretory setae	often round-tipped secretory pileocystidia
veil tissue	floccose scales, cottony annulus and pseudovolva	Floccose scales, cottony annulus and pseudovolva	floccose scales, cottony annulus and pseudovolva	usually floccose leaving shaggy scales	completely absent	usually of globular cells forming granules
deliquescence	always	Always	always	always	fully, partially, or non- deliquescent	fully, partially, or non- deliquescent
central stipe strand	present	Present	present	absent	absent	absent
basidia	consistently dimorphic	Consistently dimorphic	consistently dimorphic	dimorphic	irregularly dimorphic to trimorphic	dimorphic, trimorphic or tetramorphic
pleurocystidia	always absent	Always absent	always absent	usually present	always present	present or absent
ozonium	absent	Absent	absent	absent	absent	present or absent

Traditionally recognized coprinoid features: inaequihymeniiferous lamellar development, brachybasidia present, spores darkly pigmented, saprotrophic, flesh fragile, lamellae parallel to sub-parallel, deliquescent to sub-deliquescent, pileus often with plicate margin

of *Podaxis*, but *Podaxis* does appear to be in the same general *Agaricus/Lepiota* clade with *C. comatus*. It has been included in this work based on its traditional taxonomic association with *C. comatus* and allies. A list of the morphological features currently used to delimit coprinoid genera is presented in Table 2.

An interesting taxonomic problem arose in the *Coprinus cordisporus* complex that was addressed in this work using molecular sequence data. A phylogenetic analysis of molecular ITS sequence data was used in an attempt to delimit species within this highly variable group. While the molecular data appear to suggest as many as four distinct clades within the complex, these clades are not readily identifiable based on non-molecular characters. It was decided to tentatively treat all 22 Hawaiian collections as *C. cordisporus* and consider *C. cardiasporus* to be a taxonomic synonym based on overlapping morphology and ecology. Although our data are equivocal concerning the proper generic placement of *Coprinus cordisporus*, they clearly support a sister relationship between the *C. cordisporus* complex and the genus *Coprinellus*. Because *C. cordisporus* does not belong in *Coprinus sensu stricto*, and because its proper generic placement is equivocal, we refer to this taxon as “*Coprinus*” *cordisporus* throughout this monograph.

Materials and Methods

All descriptions are based on material collected from the Hawaiian Islands. Plant communities cited in habitat descriptions are those designated by Gagné and Cuddihy (1990) and flowering plant names are those given by Wagner *et al.* (1990). Color terms and notations in parentheses are those of Kornerup and Wanscher (1978). Taxon author abbreviations are those of Kirk and Ansell (1992).

Identification of the Hawaiian collections was made using macroscopic and microscopic features, habit, and ecology. Many of the coprophilous collections were obtained using moist chamber techniques to fruit coprini from cow, horse, and goat dung. Wood-rotting coprini were collected from wood chip piles and fallen logs in alien and native mesic forests. Other coprini were collected from monocot debris including banana, *Heliconia* stumps, coconut fronds and infructescences, grass and sandy soil.

Macroscopic features including pileus and stipe dimensions, form and color, lamellar spacing, color, and attachment, substrate and habit were observed and recorded from fresh material.

All observations and measurements reported for microscopic features were obtained from dried material rehydrated in 100% ethanol followed by 3%

KOH followed by Congo Red Solution then returned to 3% KOH. Only normally pigmented basidiospores were measured to insure maturity. Basidiospore statistics presented include: \bar{x} the arithmetic mean of the basidiospore length by basidiospore width (\pm SD) for n basidiospores measured in a single sample (specimen); \bar{x}_r , the range of the basidiospore means and \bar{x}_m , the mean of basidiospore means (\pm SD) where more than one specimen was available; Q, the quotient of basidiospore length and basidiospore width in any one basidiospore, indicated as a range of variation in n basidiospores measured; \bar{Q} the mean of Q values in a single sample; \bar{Q}_r , the range of Q values and \bar{Q}_m , the mean of Q values where more than one specimen was available. Because of the ephemeral and deliquescent nature of many of these taxa, cystidia, basidia, brachybasidia, pileipellis, and universal veil features were observed mainly in primordia or immature basidiomes. Throughout this work, the term “veil” refers to the universal veil. If a partial veil is present, it is termed an annulus.

Sixteen collections representing the diverse ecological and morphological features of the members of the *C. cordisporus*/*C. cardiasporus* complex in Hawaii were selected for molecular sequencing. One collection each of *C. cordisporus* and *C. cardiasporus* from Europe were also sequenced and included in the analysis. In addition, ITS sequences from 10 Hawaiian collections representing the genus *Coprinellus* (*C. curtus*, *C. disseminatus*, and *C. radians*), and the genus *Coprinopsis* (section Vestiti – *C. cothurnata* and *C. stercorea*; sect. Lanatuli – *C. cinerea*) were included. ITS sequences obtained from GenBank for the following five taxa were also included: *Coprinellus micaceus*, *C. radians*, *Psathyrella candolleana*, *P. velutina*, and *Hypholoma fasciculare*. Few coprinoid sequences were used from GenBank because few complete ITS1–5.8S–ITS2 sequences currently exist for this group. A total of 18 sequences representing the *C. cordisporus*/*C. cardiasporus* complex, 12 other coprinoid taxa, and three non-coprinoid taxa are represented in this study.

DNA extractions were performed using the E.Z.N.A. EaZy Nucleic Acid Isolation Omega Bio-tek Forensic DNA Kit (D3591–01). This extraction protocol was chosen because many of the collections contained very little material due to the diminutive nature of the basidiomes of *C. cordisporus*. A tiny amount of material was placed in a 1.5ml epindorph tube, 100 μ l of Buffer STL was added and the material was ground thoroughly with a micropestel. Another 100 μ l of Buffer STL was added, rinsing each pestle so as to release any material adhering to the surface. All pestels were discarded after a single use.

Tubes were incubated at 55°C for a total of 15 minutes with vortexing every 2 minutes. 25 μ l of OB protease solution was added to each tube and the

tubes were allowed to incubate for an additional 45 minutes at 60°C with occasional vortexing. 225µl of Buffer BL was added to each tube and the tubes were incubated an additional 10 minutes at 60°C. The tubes were centrifuged at V_{\max} for 1 minute. The supernatant was transferred to new 1.5ml tubes and 225µl of 100% EtOH was added to each tube and vortexed to mix thoroughly.

HiBind DNA mini columns were assembled on 2ml collecting tubes. The liquid from each extraction was transferred into a mini column and the columns were centrifuged at $V_{11,000 \text{ rpm}}$ for 1 minute. The collection tube and liquid were discarded and the columns were placed in new 2ml tubes. 750µl of Wash Buffer diluted with ethanol was added to each column and the columns were again centrifuged at $V_{11,000 \text{ rpm}}$ for 1 minute. Columns were transferred to new tubes, an additional 750µl of Wash Buffer diluted with ethanol was added to each column and the columns were again centrifuged at $V_{11,000 \text{ rpm}}$ for 1 minute. The flow through liquid was discarded from these final collecting tubes and the columns were centrifuged an additional 2 minutes at V_{\max} in order to dry the filters. Collecting tubes were discarded and the columns were transferred back into new 1.5ml tubes.

Elution Buffer was heated to 70°C. 50µl of Elution Buffer was added directly to the column filter. The columns were covered and allowed to stand for 30 minutes after which they were centrifuged at V_{\max} for 1 minute. The same elution buffer was then removed from the tube and reapplied to the filter with an additional 5µl of elution buffer to make up for evaporated liquid, let stand for 3 minutes, and centrifuged at V_{\max} for 1 additional minute. The columns were discarded and the tubes labeled. For each DNA extraction, 1:10 and 1:100 dilutions were prepared.

PCR was performed by preparing a stock tube that contained the following reagents for each PCR reaction: 15µl distilled water, 2.5µl 10× PCR Buffer, 0.5µl dNTP mix, 1.25µl ITS1F Primer, 1.25µl ITS4 Primer, 0.125 *Taq* DNA Polymerase (5U/µl). 20µl of the stock solution were added to each PCR reaction tube along with 5µl of each DNA sample for a total volume of 25µl.

PCR tubes were placed in an MJ Research PTC-200 DNA Engine Thermocycler with the following program settings: 2 minutes 95°C (initial denaturation); 30 second 94°C (denaturation); 30 second 45°C (annealing); 1 minute 72°C (extension); go to step 2, repeat 39 cycles; end. Following the PCR reaction, each sample was tested using agarose gel electrophoresis to check for the presence of DNA.

The PCR products were transferred to 1.5ml tubes and cleaned. 75µl of cold NaI was added to each tube and tubes were vortexed. 5µl of glassmilk was added, vortexed, and then allowed to bind to the DNA for 5 minutes. Tubes were centrifuged for 5 seconds at V_{\max} and the supernatant was removed and

discarded. The DNA/glassmilk pellet was washed twice with 500 μ l NewWash using the tip of the pipet to help dissolve the pellet completely each time and centrifuged for 5 seconds at V_{max} after each wash. Each time the supernatant was discarded. The pellets were then dissolved in 35 μ l of distilled water, let stand for 15 minutes, and centrifuged at V_{max} for 30 seconds. The cleaned PCR product (supernatant) was transferred to new 1.5ml tubes.

Cycle sequencing was performed by preparing a stock tube that contained the following reagents for each cycle sequence reaction: 2 μ l BigDye ready reaction mix, 5 μ l distilled water, 0.6 μ l pellet paint. 7.6 μ l of the stock solution was added to each cycle sequence reaction tube along with 2.5 μ l of PCR product and either 2.5 μ l of ITS1F primer or 2.5 μ l of ITS4 primer. Two cycle sequence reactions were performed for each PCR product, each using only one of the two ITS primers. This produced separate DNA strands replicated from opposite ends of the ITS region.

Cycle sequencing was performed with the following Thermocycler program settings: 1 minute 96 $^{\circ}$ C (initial denaturation); 15 seconds 94 $^{\circ}$ C (denaturation); 10 seconds 50 $^{\circ}$ C (annealing); 4 minutes 60 $^{\circ}$ C (extension); go to step 2, repeat 35 cycles; end.

Cycle sequence products were transferred to 1.5ml tubes and purified. 80 μ l of 60% EtOH was added to each tube and the tubes were vortexed. Tubes were left at -18 $^{\circ}$ C for 15 minutes to precipitate. The tubes were centrifuged at V_{max} for 20 minutes and the supernatants removed immediately and discarded. The pellets were washed by adding 250 μ l of 70% EtOH, centrifuging the tubes at V_{max} for 5 minutes, and removing the supernatants. The pellets were then allowed to air dry for 20 minutes.

For sequencing, 2 μ l of loading dye was added to each of the purified cycle sequence pellets. The samples were denatured by submersing them in a 95 $^{\circ}$ C water bath for two minutes and then transferring them immediately to ice.

Sequencing was performed in an ABI 377-XL Automated Sequencer. The gel file sequences were edited using Sequencher 3.1.1 and aligned using Clustal \times 1.83 software. Further manual alignment was carried out using MacClade 4.0 PPC.

Phylogenetic analyses were conducted by performing a heuristic search using a random stepwise addition method in PAUP 4.0b. The 655 equally most parsimonious trees (MPTs) were saved, a consensus tree was generated, and a bootstrap analysis was executed. A Maximum Likelihood analysis of hierarchical substitution models was performed to test the JC69, F81, HKY85, HKY85 + Γ (shape parameter of the gamma distribution estimated with 10 rate categories) models. The HKY85 + Γ model proved statistically better than the

other likelihood models. Likelihood scores were computed for each of the 655 MPTs using the HKY85 + Γ to enhance comparison between individual trees.

The phylogenetic reconstructions were used to examine potential affinities between *C. cordisporus* and other coprinoid taxa in order to determine its correct generic placement. In addition, the morphological and ecological characters of the Hawaiian *C. cordisporus* collections were mapped on the molecular phylogenies in order to investigate the usefulness of individual characters in delimiting species within the complex.

All specimens are deposited in SFSU unless specified otherwise. In the descriptions that follow, frequently cited collectors are abbreviated as: D.E. Desjardin (DED), D.E. Hemmes (DEH), and M. Keirle (MRK).

Synopsis of Taxa

In the alphabetical list of species presented below, sectional names are those used within *Coprinus* according to Kühner and Romagnesi (1974), while Stirps names are those used within *Coprinus* based on Orton and Watling (1979). Because current molecular data (Hopple and Vilgalys, 1999; Moncalvo *et al.*, 2002) indicate that these infrageneric taxa may not be monophyletic, formal transfers of these Sections and Stirps into the genera *Coprinopsis*, *Coprinellus*, and *Parasola* will not be proposed. Until further molecular data become available from a larger selection of species to aid in illuminating infrageneric delimitations, the species reported in this regional monograph will not be accepted formally in the infrageneric taxa used by other contemporary *Coprinus* researchers.

Coprinellus [Psathyrellaceae]

[*Coprinus* sect. Micacei]

[*Coprinus* stirps Domesticus]

17. *Coprinellus radians* (Desm.) Vilgalys, Hopple & Jac. Johnson

[*Coprinus* stirps Micaceus]

18. *Coprinellus micaceus* (Bull.: Fr.) Vilgalys, Hopple & Jac. Johnson

19. *Coprinellus truncorum* (Scop.: Fr.) Redhead, Vilgalys & Moncalvo

[*Coprinus* sect. Setulosi]

[*Coprinus* stirps Disseminatus]

24. *Coprinellus curtus* (Kalchbr.) Vilgalys, Hopple & Jac. Johnson

23. *Coprinellus disseminatus* (Pers.: Fr.) J.E. Lange
 21. *Coprinellus verrucispermus* (Joss. & Enderle)
 Redhead, Vilgalys & Moncalvo
 [*Coprinus* stirps Ephemerus]
 20. *Coprinellus pellucidus* (P. Karst.) Redhead, Vilgalys
 & Moncalvo
 [*Coprinus* stirps Hiascens]
 22. *Coprinellus plagioporus* (Romagn.) Redhead,
 Vilgalys & Moncalvo

Coprinopsis [Psathyrellaceae]

[*Coprinus* sect. Impexi]

[*Coprinus* stirps Friesii]

6. *Coprinopsis urticicola* var. *hawaiiensis* Keirle,
 Hemmes & Desjardin

[*Coprinus* stirps Picaceus]

7. *Coprinopsis extinctoria* (Fr.) Redhead, Vilgalys &
 Moncalvo

8. *Coprinopsis sejuncta* nom. prov.

4. *Coprinopsis sclerotiorum* (Horvers & de Cock)
 Redhead, Vilgalys & Moncalvo

[*Coprinus* stirps Tigrinellus]

5. *Coprinopsis friesii* (Quél.) P. Karst.

[*Coprinus* sect. Lanatuli]

9. *Coprinopsis candidolanata* (Doveri & Uljé) Keirle,
 Hemmes & Desjardin

10. *Coprinopsis villosa* nom. prov.

[*Coprinus* stirps Lagopus]

13. *Coprinopsis cinerea* (Schaeff.: Fr.) Redhead,
 Vilgalys & Moncalvo

12. *Coprinopsis lagopus* (Fr.: Fr.) Redhead, Vilgalys &
 Moncalvo

11. *Coprinopsis radiata* (Bolton) Redhead, Vilgalys &
 Moncalvo

[*Coprinus* sect. Vestiti pro parte]

[*Coprinus* stirps Narcoticus]

14. *Coprinopsis stercorea* (Fr.) Redhead, Vilgalys &
 Moncalvo

[*Coprinus* stirps Niveus pro parte]

15. *Coprinopsis cothurnata* (Godey) Redhead, Vilgalys & Moncalvo

Coprinus [Agaricaceae]

[*Coprinus* sect. Comati]

[*Coprinus* stirps Comatus]

2. *Coprinus sterquilinus* (Fr.: Fr.) Fr.

3. *Coprinus xerophilus* Bogart

Parasola [Psathyrellaceae]

[*Coprinus* sect. Hemerobii]

[*Coprinus* stirps Auricomus]

25. *Parasola auricoma* (Pat.) Redhead, Vilgalys & Hopple

[*Coprinus* stirps Hemerobius]

26. *Parasola leiocephala* (P.D. Orton) Redhead, Vilgalys & Hopple

27. *Parasola megasperma* (P.D. Orton) Redhead, Vilgalys & Hopple

28. *Parasola nudiceps* (P.D. Orton) Redhead, Vilgalys & Hopple

29. *Parasola plicatilis* (Curtis: Fr.) Redhead, Vilgalys & Hopple

Podaxis [Agaricaceae]

1. *Podaxis pistillaris* (L.: Pers.) Morse

Taxon of Uncertain Generic Placement

[*Coprinus* sect. Vestiti pro parte]

[*Coprinus* stirps Niveus pro parte]

16. "*Coprinus*" *cordisporus* Gibbs

Artificial Key to Hawaiian Coprinoid Fungi

1. Basidiomes secotioid; lamellae not well-defined; hymenophore of interwoven skeletal and generative hyphae bearing basidia and basidioles; common in arid regions on the leeward sides of the islands 1. *Podaxis pistillaris*
- 1*. Basidiomes not secotioid; well-developed lamellae present; habitat variable 2
2. Pileipellis a cutis of radially arranged, elongated to somewhat inflated hyphae (see Fig. 15: 7); veil always present; setules on pileus always absent 3
- 2*. Pileipellis cellular forming a cystoderm of globose cells with or without pileus setules (see Figs 19: 7 and 23: 7); or forming a distinct hymeniform layer (see Fig. 27: 5); veil present or absent 17
3. Veil composed of tenacious, floccose remnants that do not easily wash away from the pileus surface; annulus present; pleurocystidia absent; sterigmata plugged with gold-colored material *Coprinus* 4
- 3*. Veil composed of floccose to granular remnants that readily slough off from the pileus; annulus absent; pleurocystidia present; sterigmata not plugged *Coprinopsis* and “*Coprinus*” *cordisporus* 5
4. Basidiomes on dung; base of stipe not bulbous; germ pore central to slightly eccentric 2. *Coprinus sterquilinus*
- 4*. Basidiomes in sand; base of stipe distinctly bulbous; germ pore distinctly eccentric 3. *Coprinus xerophilus*
5. Veil composed of cylindrical to inflated cells, typically lacking globose elements (see Figs 5: 2 and 11: 5); (sects. *Impexi* and *Lanatuli sensu auct.*) 6
- 5*. Veil of globose elements with subtending cylindrical hyphae (see Figs 14: 7a and 7b); (sect. *Vestiti sensu auct.*) 15
6. Veil composed of narrow, cylindrical, branched, often diverticulate hyphae (see Figs 7: 2 and 8: 2) (sect. *Impexi sensu auct.*) 7
- 6*. Veil composed of tapering chains of broad, inflated cells or a mixture of chains of broad cells and narrow coralloid elements (see Fig. 11: 5) (sect. *Lanatuli sensu auct.*) 11
7. Basidiomes on dung; basidiospores mitriform in face view 4. *Coprinopsis sclerotiorum*
- 7*. Basidiomes not on dung; basidiospores ellipsoid to irregularly shaped 8
8. Basidiospores irregularly shaped to rhomboid in side and face views; basidiomes on grass 5. *Coprinopsis friesii*
- 8*. Basidiospores ellipsoid in side and face views; basidiomes on wood, sand, or monocot debris 9
9. Basidiomes on herbaceous monocot debris including banana, *Heliconia* stumps, and coconut fronds and infructescences 6. *Coprinopsis urticicola* var. *hawaiiensis*
- 9*. Basidiomes on wood or in sand 10

Fungal Diversity

10. Veil composed of diverticulate hyphae, incrustated with brownish pigment, about 25% thick-walled; on wood, found only in native forest **7. *Coprinopsis extinctoria***
- 10*. Veil composed of diverticulate hyphae lacking incrustations and brownish pigments, all thin-walled; in sand; known only from Midway Island **8. *Coprinopsis sejuncta***
11. Pileus < 5 mm diam. at maturity; basidiomes on dung **12**
- 11*. Pileus > 5 mm diam. at maturity; substratum variable **13**
12. Veil floccose to shaggy, veil elements up to 70 × 30 μm, with some diverticulate or stellate hyphae; mean basidiospore length < 10 μm **9. *Coprinopsis candidolanata***
- 12*. Veil fibrous to silky, veil elements up to 120 × 50 μm, diverticulate and stellate hyphae absent; mean basidiospore length > 10 μm **10. *Coprinopsis villosa***
13. Basidiomes small, 5-16 mm diam. at maturity; on dung; often with reddish, fibrillose veil remnants **11. *Coprinopsis radiata***
- 13*. Basidiomes larger, 20-50 mm diam. at maturity; on woodchip piles; fibrillose veil whitish to beige, lacking reddish tones **14**
14. Mature basidiomes with stipe length seldom exceeding 80 mm, stipe never radicating; often appearing late in succession on woodchip piles **12. *Coprinopsis lagopus***
- 14*. Mature basidiomes typically having a stipe length from 120-150 mm, stipe frequently radicating; often appearing early in succession on woodchip piles **13. *Coprinopsis cinerea***
15. Globose veil elements with verrucose ornamentation (see Fig. 14: 7b); remnants of a perisporial sac sometimes visible on basidiospores **14. *Coprinopsis stercorea***
- 15*. Globose veil elements smooth or incrustated, not verrucose; perisporial sac absent **16**
16. Basidiomes medium sized (pileus 15-30 mm diam. at maturity); veil typically appearing powdery or chalky; basidiospores rounded-amygdaliform in face view, typically more than 11 μm in length **15. *Coprinopsis cothurnata***
- 16*. Basidiomes small to very small (pileus 5-15 mm diam. at maturity); veil typically appearing granular or crystalline; basidiospores flask-shaped to heart-shaped in face view, typically less than 9 μm in length **16. "*Coprinus*" *cordisporus***
17. Pileipellis composed of an epithelium layer of globose cells, i.e. a cystoderm (see Figs. 17: 7 and 23: 7); pileus setules present or absent; veil present or absent; lamellae adnate to sub-free ***Coprinellus* 18**
- 17*. Pileipellis composed of a hymeniform layer of discretely arranged, clavate cells, commonly lacking pileus setules or seldom with long, thick-walled, golden setae (see Figs. 25: 7 and 27:5); veil absent; lamellae free, with a distinctive clear zone around the stipe apex on the underside of the pileus ***Parasola* 25**
18. Pileus setules lacking; basidiomes always on wood **(sect. *Micacei sensu auct.*) 19**
- 18*. Pileus setules present; basidiomes on wood chips, in soil, or on dung **(sect. *Setulosi sensu auct.*) 21**

19.	Veil with pigmented elements; orange ozonium present around the base of the stipe.....	17. <i>Coprinellus radians</i>
19*.	Veil lacking pigmented elements; ozonium absent.....	20
20.	Distal end of basidiospores somewhat truncate	18. <i>Coprinellus micaceus</i>
20*.	Distal end of basidiospores rounded, not truncate	19. <i>Coprinellus truncorum</i>
21.	Basidiomes on dung or in soil.....	22
21*.	Basidiomes on wood chips	24
22.	Basidiomes in dung.....	20. <i>Coprinellus pellucidus</i>
22*.	Basidiomes in soil.....	23
23.	Basidiospores with a prominent perisporial sac.....	21. <i>Coprinellus verrucispermus</i>
23*.	Basidiospores lacking a perisporial sac	22. <i>Coprinellus plagioporus</i>
24.	Pileus setules mostly lageniform, but occasionally subcapitate; pileus disc lacking fox-brown tones.....	23. <i>Coprinellus disseminatus</i>
24*.	Pileus setules distinctly capitate; pileus disc with fox-brown tones	24. <i>Coprinellus curtus</i>
25.	Pileipellis with long, thick-walled, golden setae.....	25. <i>Parasola auricoma</i>
25*.	Pileipellis lacking setae.....	26
26.	Basidiomes in soil or in sand under <i>Casuarina</i>	27
26*.	Basidiomes in grass	28
27.	Basidiomes in soil; basidiospores apple-shaped in face view, typically less than 10 μm in length	26. <i>Parasola leiocephala</i>
27*.	Basidiomes in sand under <i>Casuarina</i> ; basidiospores subglobose to nearly globose, typically more than 14 μm in length	27. <i>Parasola megasperma</i>
28.	Fresh basidiomes typically with orange tones on pileus disc; basidiospores broadly ellipsoid to amygdaliform in side view, typically more than 12 μm in length.....	28. <i>Parasola nudiceps</i>
28*.	Fresh basidiomes lacking orange tones on pileus disc; basidiospores narrowly ellipsoid, flattened in side view, typically less than 12 μm in length	29. <i>Parasola plicatilis</i>

Taxonomy

Podaxis Desvaux, J. Bot. 2:97. 1809.

Type: *P. senegalensis* Desvaux

1. *Podaxis pistillaris* (L.: Pers.) Morse, Mycologia 25: 27. 1933. (Fig. 1)

= *Lycoperdon pistillare* L., Mant. Pl. 313. 1771.

= *Scleroderma pistillare* (L.) Pers., Syn. Meth. Fung. 150. 1801.

= *Podaxon pistillaris* (L.: Fr.) Fr., Syst. Mycol. 3: 63. 1829.

Reported synonyms:

= *Lycoperdon carcinomale* L., Fil. Suppl. 453. 1781.

= *Scleroderma carcinomale* (L.) Pers., Syn. Meth. Fung. 150. 1801.

= *Podaxon carcinomalis* (L.: Pers.) Fr., Syst. Mycol. 3: 62. 1829.

= *Podaxis carcinomalis* (L.: Pers.) Dodge, Compt. Morph. Fungi. 495. 1928.

= *Podaxis senegalensis* Desv., J. Bot. (Desvaux) 2: 97. 1809.

= *Podaxis indicus* Spreng., Syst. Veg. 5: 518. 1828.

= *Podaxon calyptratus* Fr., Syst. Mycol. 3: 62. 1829.

= *Podaxon aegypticus* Mont., Ann. Sci. Nat. Ser. II 20: 69. 1843.

= *Podaxon loandensis* Welw. & Curr., Trans. Linn. Soc. London 26: 288. 1850.

= *Podaxon elatus* Welw. & Curr., Trans. Linn. Soc. London 26: 288. 1850.

= *Podaxon mossamadensis* Welw. & Curr., Trans. Linn. Soc. London 26: 288. 1850.

= *Podaxon arabicus* Pat., Bull. Soc. Mycol. France 3: 122, 123. 1887.

= *Podaxon schweinfurthii* Pat., Bull. Soc. Mycol. France 6: 165. 1890.

= *Podaxon deflersii* Pat., Bull. Soc. Mycol. France 6: 165. 1890.

= *Lycoperdon axatum* Bosc, Actes Soc. Hist. Nat. Paris 1: 47. 1792.

= *Podaxis axata* (Bosc) Masee, J. Bot. 28: 75. 1890.

= *Podaxis farlowii* Masee, J. Bot. 28: 77. 1890.

= *Podaxis emerici* Berk. ex Masee, J. Bot. 28: 75. 1890.

= *Chainoderma drummondii* Masee ex Cooke, Grevillea, 19: 46. 1890.

= *Podaxon squamosus* Pat., Bull. Soc. Mycol. France 7: 210. 1891.

= *Podaxon mexicanum* Ellis, J. Mycol. 7: 274. 1893.

= *Podaxon perraldieri* Pat., Cat. Pl. Cell. Tunisiae 68. 1897.

= *Podaxon glaziovii* Henn., Hedwigia 36: 210. 1897.

= *Podaxon ghattasensis* Henn., Hedwigia 37: 287. 1898.

= *Podaxon gollanii* Henn., Hedwigia 40: 338. 1901.

= *Podaxon algericus* Pat., Bull. Soc. Mycol. France 20: 53. 1904.

= *Podaxon muelleri* Henn., Hedwigia 43: 187. 1904.

= *Podaxon macrosporus* Speg., Anales Mus. Nac. Hist. Nat. Buenos Aires 16: 27. 1906.

= *Podaxon termitophilus* Jumelle & Perrier, Compt. Rend. Hebd. Séances Acad. Sci. 145: 274. 1907.

= *Podaxon anomalum* Lloyd, Mycol. Writ. 6, Mycol. Notes 64: 992. 1920.

Selected descriptions and icones: Hemmes and Desjardin (2002: 95); Grgurinovic (1997: 429–430, pl. 283.); Liu (1984: 193–195); Cunningham (1979: 197–198); Dennis (1970: 8); Bottomley (1948: 628–630); Masee (1890: 33–39, 69–77).

Pileus 30–40 (–55) mm diam. × 60–100 (–150) mm in height at maturity, narrowly ellipsoid to paraboloid or obtusely conical throughout development, white to pale cream with patches or yellow or brown, dry, shiny, brittle, veil persistent on pileus surface, base of pileus remaining adhered to the stipe, pileus breaking apart into fibrous scales to release basidiospores. – *Odor* not distinctive. – *Lamellae* absent, basidiospore-producing tissue stringy-powdery, yellowish ochre-brown to dark brown to nearly black. – *Stipe* 60–80 (–100) × 6–10 mm at maturity, cylindrical with a basal bulb, dry, hard and woody, fibrous, striate, white to yellowish brown sometimes staining bright red. – *Annulus* and *volva* absent.

Basidiospores (9.2–) 10.0–12.8 (–13.6) × (8.0–) 8.8–11.2 (–12.0) μm , [\bar{x}_r = 10.9–12.4 × 9.5–10.6 μm , \bar{x}_m = 11.6 ± 0.6 × 10.0 ± 0.4 μm , Q = 1.0–1.4, \bar{Q}_r = 1.1–1.2, \bar{Q}_m = 1.2 ± 0.1, n = 20 basidiospores per 6 collections], broadly ellipsoid to ovoid, nearly globose, rarely narrowly ellipsoid or submitriform, smooth, cell wall thick occupying up to 70% of the total basidiospore volume, basidiospore wall brittle and cracking easily if basidiospores are pressed under cover slide, central germ pore prominent, yellowish earth brown, in a given collection as many as half of the basidiospores unpigmented but of approximately equal size as the pigmented basidiospores [the percentage of pigmented basidiospores correlates to the overall tone of the basidiospore print from pale yellowish to olivaceous, ochre brown or nearly chocolate brown, but individual basidiospores are always yellowish brown with yellowish brown pigment soluble in KOH]. – Mature *basidia*, *cheilocystidia*, and *pleurocystidia* not observed. – *Basidiospore-producing tissue* (hymenophore) composed of interwoven, hyaline, thin-walled generative and/or skeletal-like hyphae, 300⁺ × 4–20 μm , giving rise to large clusters of brachybasidia or basidioles, 10 × 5 μm . – *Pileipellis* a cutis of elongated, tightly interwoven, repent hyphae with undulating margins, sometimes almost branching; hyphae 40–120 × 4– μm . – *Universal veil* comprised of chains of ellipsoid to nearly globose, thin-walled, hyaline cells; hyphae 10–40 × 5–20 μm . – *Clamp connections* not observed.

Habit, habitat, and distribution in the Hawaiian Islands: Scattered in sand or hard-packed soil after floods associated with coastal fountain grass (*Pennisetum setaceum* (Forssk.) Chiov.) and kiawe (*Prosopis pallida* (Hump. & Bonpl.: Willd.) Kunth.) on arid, leeward coasts. Hawai'i, Lana'i, and Maui.

Worldwide distribution: Australia, India, China, Africa, North America, South America, Hawai'i.

Specimens examined: USA. HAWAII: Hawai'i, Mauna Kea Beach Hotel, 16 Sep. 1992, DEH 116; Hawai'i, Spencer Beach Park, 18 Nov. 2000, DEH 2037; same location, 2 Mar. 2001, DEH 2261; same location, 2 Jan. 2001, MRK 41; Lana'i, Shipwreck Beach, 4 Jan. 2002, DEH 2218; Maui, Kihei, 14 Jan. 1996, DED 6452.

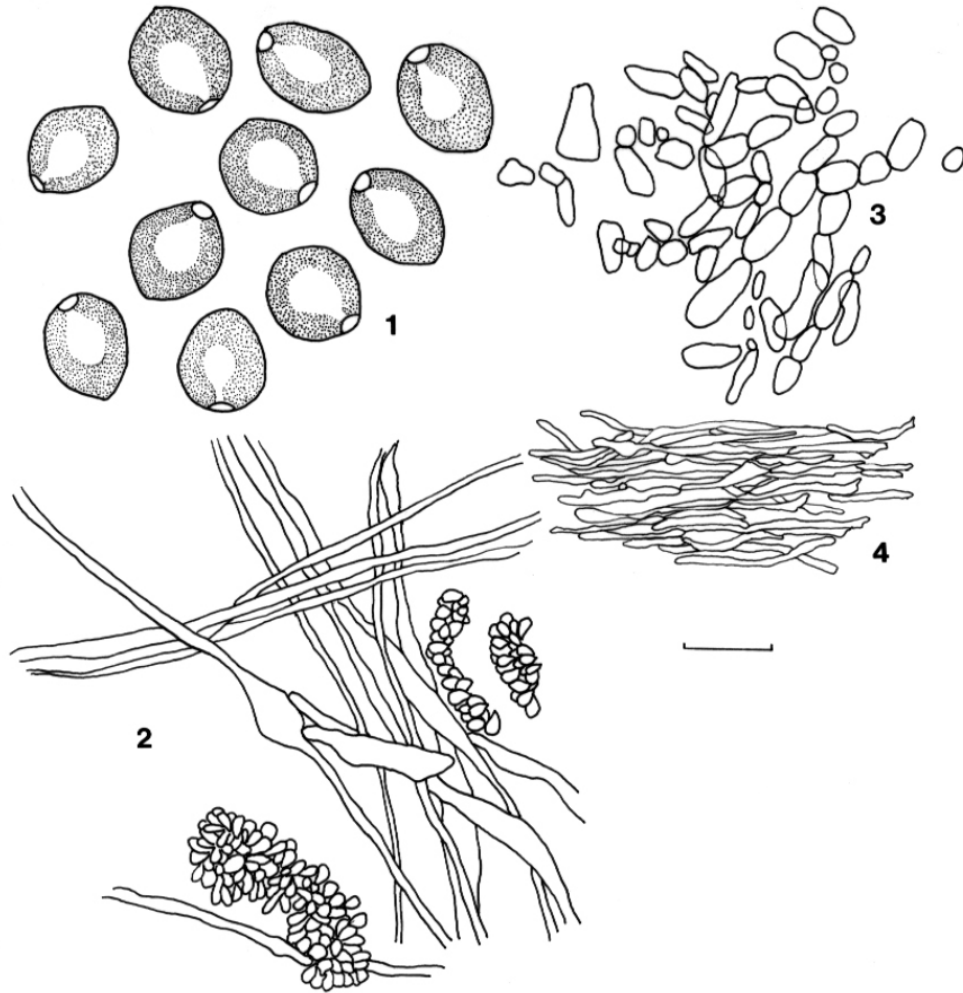

Fig. 1. *Podaxis pistillaris* (MRK 41). **1.** Basidiospores. **2.** Generative and skeletal-like hyphae with brachybasidioles. **3.** Universal veil elements. **4.** Pileipellis. Bars: 1 = 10 μm , 2–4 = 50 μm .

Notes: *Podaxis pistillaris* represents the only secotioid taxon treated in this work. It has been included because of its traditional association with *Coprinus comatus*. Recent molecular studies (Moncalvo *et al.*, 2002) have failed to indicate a sister relationship between *Podaxis* and *C. comatus*. *Podaxis* appears on a lone branch in the *Agaricus/Lepiota* clade – the same general clade where *C. comatus* occurs. It is uncertain which taxa are most

closely allied with *Podaxis*, but it appears unlikely that it is closely allied with *C. comatus* despite their similarity in overall appearance.

Podaxis pistillaris has been collected on three different islands in Hawai'i, always in the sandy soil of arid leeward regions. The basidiospores of *P. pistillaris* have an exceptionally thick wall, the lamellae are contorted, and the pileus does not fully open. These special ontological adaptations enable it to flourish in xeric habitats. It is common in desert regions throughout the world, which has apparently led to it being described by many authors, several of whom have described it as a new species several times. This has created many superfluous names for what appears to be a single, widely dispersed entity.

Coprinus Pers., Tent. Disp. Meth. Fung. 62. 1797.

Type: *C. comatus* (O.F. Müll.: Fr.) Pers.

2. *Coprinus sterquilinus* (Fr.) Fr., Epicr. Syst. Mycol. p. 242. 1838. (Fig. 2)

= *Agaricus sterquilinus* Fr., Syst. Mycol. I: 308. 1821.

Reported synonyms:

= *Coprinus oblectus* (Bolton) Fr., Epicr. Syst. Mycol. p. 243. 1838.

= *Coprinus grandisporus* Henn., Hedwigia 34: 331. 1895.

Selected descriptions and icones: Uljé (2003); Grgurinovic (1997: 467–469, pl. 308); Orton and Watling (1979: 30–31, pls. 38 and 44); Moser (1978: 256); Pegler (1977: 389–390, pl. 86:1); Kühner and Romagnesi (1974: 389, pl. 544).

Pileus 18–32 mm diam. × 27–30 mm in height at maturity, ovoid becoming campanulate, brownish at disc, white on margins, plicate, covered with upturned, squamulose scales, rapidly deliquescing, context 0.1 mm thick, concolorous with pileus surface. – *Lamellae* medium-close with 3 series of lamellulae, adnexed, 3 mm broad, gray when young becoming black. – *Stipe* at maturity 35–70 × 7–8 mm, equal, smooth, white. – *Annulus* membranous, occurring just above the stipe base. – *Volva* absent.

Basidiospores 18.0–23.6 × 11.2–15.2 μm, [\bar{x} = 21.2 ± 1.6 × 12.9 ± 1.1 μm, Q = 1.6–1.9, \bar{Q} = 1.7, n = 20 basidiospores per 1 collection], ellipsoid to somewhat amygdaliform, smooth, sometimes slightly truncate, apiculus visible, germ pore central to slightly eccentric, dark chestnut brown. – *Basidia* 40–45 × 20–25 μm, clavate to ellipsoid, 4-spored, sterigmata plugged with golden contents at tips. – *Brachybasidia* 20–30 × 12–20 μm, clavate to subglobose. – *Cheilocystidia* and *pleurocystidia* not observed. – *Pileipellis* a cutis of narrowly cylindrical hyphae, tightly appressed; hyphae 20–40 (–60) × 2–4 μm. – *Universal veil* composed of chains of thin-walled, hyaline, inflated,

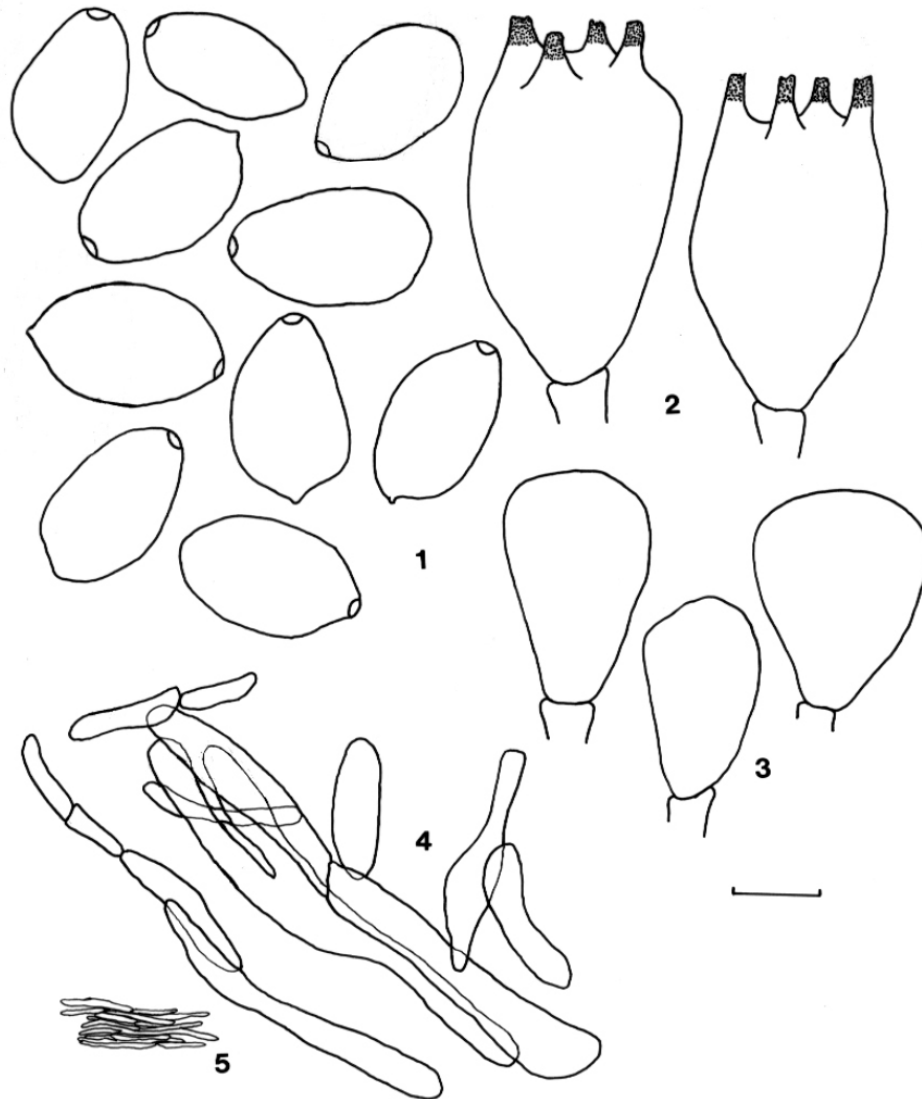

Fig. 2. *Coprinus sterquilinus* (DEH 1362). 1. Basidiospores. 2. Basidia. 3. Brachybasidia. 4. Universal veil elements. 5. Pileipellis. Bars: 1–3 = 10 μm , 4–5 = 50 μm .

sausage-like cells with rounded apices, arranged in parallel to somewhat interwoven; hyphae 60–200 \times 10–35 μm . – *Clamp connections* not observed.

Habit, habitat, and distribution in the Hawaiian Islands: Horse dung in alien wet forest. Hawai'i.

Worldwide distribution: East Africa, Australia, Japan, and Hawai'i.

Specimens examined: USA. HAWAII: Hawai'i, Waipio Valley, 10 Nov. 1996, DEH 1362.

Notes: *Coprinus sterquilinus* has been collected only once in Hawai'i. It is one of only two taxa found in Hawai'i that belong to the genus *Coprinus*, allied with the well known Lawyer's Wig or Shaggy Mane, *C. comatus*. Superficially, *C. sterquilinus* resembles *C. comatus*, but is considerably smaller in stature. It is easily distinguished from *C. comatus* by its much larger basidiospores with slightly eccentric germ pore and its dung substratum. *Coprinus comatus* is terrestrial, typically growing in grass or soil, and interestingly, has not yet been reported from the Hawaiian archipelago.

In Hawai'i, *C. sterquilinus* would most likely be confused with the other *C. comatus* ally, *C. xerophilus*. *Coprinus xerophilus* grows in sand (which may or may not be associated with dung), whereas *C. sterquilinus* grows exclusively in dung. In addition, the average basidiospore size for *C. sterquilinus* is slightly larger than that for *C. xerophilus* and the germ pore in *C. xerophilus* is markedly more eccentric than that of *C. sterquilinus*. Perhaps most distinctive, the stipe base of *C. sterquilinus* is not bulbous, whereas that of *C. xerophilus* is quite bulbous with the stipe base usually measuring double the diameter of the upper stipe region.

3. *Coprinus xerophilus* Bogart, Mycotaxon 4: 255–256. 1976. (Fig. 3)

Selected descriptions and icones: Moreno & Heykoop (1998: 104–111, pls. 25–53); Bogart (1976: 255–259, pl. 6).

Pileus 12–15 mm diam. in primordia becoming up to 52 mm diam. at maturity, subglobose becoming campanulate, then planar with revolute to inrolled margins, covered in white scurfy scales that break apart forming an overlapping, imbricate pattern at the pileus disc, rapidly deliquescing. – *Odor* not distinctive. – *Lamellae* medium-close, adnexed, becoming black. – *Stipe* at maturity up to 95 mm in length and 6 mm diam. at the apex to 12 mm diam. at the base, tapering upwards with significantly bulbous base, glabrous, white. – *Annulus* not observed, probably rather ephemeral. – *Volva* absent but bulbous stipe base appearing almost to form a pseudovolva.

Basidiospores (13.2–) 16.4–22.5 × 9.6–12.5 (–15.0) μm [$\bar{x}_r = 16.0\text{--}20.3 \times 10.8\text{--}12.3$ μm, $\bar{x}_m = 18.2 \pm 3.0 \times 11.5 \pm 1.0$ μm, Q = 1.3–1.9, $\bar{Q}_r = 1.5\text{--}1.7$, $\bar{Q}_m = 1.6 \pm 0.1$, n = 20 basidiospores per 2 collections], ellipsoid to narrowly ellipsoid in all views, smooth, apiculus often visible, with a broad, eccentric, abaxial germ pore, more rarely appearing somewhat less eccentric and more central, yellowish earth brown to dark chestnut brown. – *Basidia* 30–40 × 12–20 μm, clavate to ellipsoid, 4-spored, sterigmata plugged with golden contents at tips. – *Brachybasidia* 15–25 μm diam., subvesiculose. – *Cheilocystidia* and

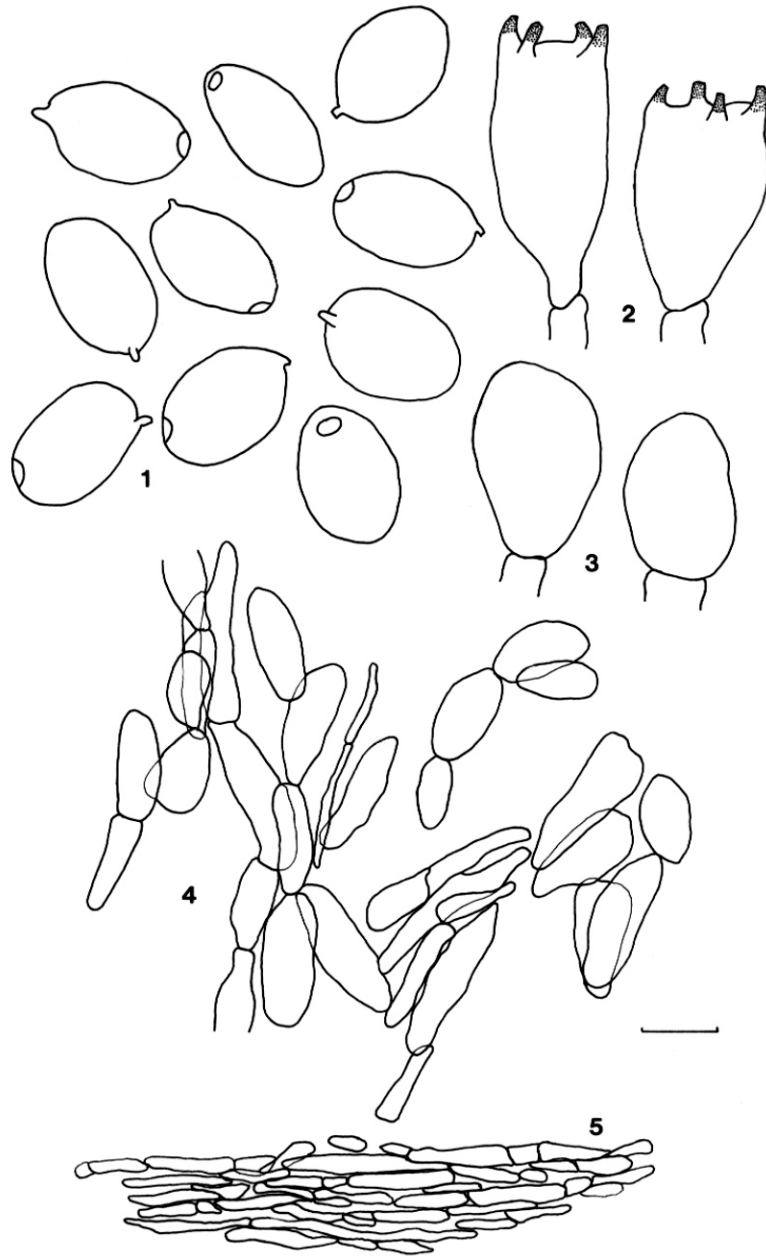

Fig. 3. *Coprinus xerophilus* (DEH 2219). **1.** Basidiospores. **2.** Basidia. **3.** Brachybasidia. **4.** Universal veil elements. **5.** Pileipellis. Bars: 1–3 = 10 μm , 4–5 = 50 μm .

pleurocystidia not observed. – *Pileipellis* a cutis of narrowly cylindrical hyphae, tightly appressed; hyphae 20–80 × 5–12 µm. – *Universal veil* composed of thin-walled, hyaline, inflated cells in chains, sausage-like, 30–80 × 5–25 µm. – *Clamp connections* present.

Habit, habitat, and distribution in the Hawaiian Islands: Solitary in coastal sand and duff under kiawe (*Prosopis pallida* (Hump. & Bonpl.: Willd.) Kunth.), sometimes associated with axis deer dung. Lana'i.

Worldwide distribution: North America, Spain, Tunisia, and Hawai'i.

Specimens examined: USA. HAWAII: Lana'i, Shipwreck Beach, 25 Jan. 1997, DEH 1467; same location, 4 Jan. 2001, DEH 2219.

Notes: *Coprinus xerophilus* has been collected only at one site from sandy soil associated with axis deer dung on the island of Lana'i. In a recent study (Moreno and Heykoop 1998), *C. calyptratus*, *C. vosoustii*, *C. asterophorus*, and *C. asterophoroides* were determined to be conspecific, with the correct name of the taxon being *C. calyptratus*. In the same study, *C. xerophilus* was shown to be a distinct taxon closely related to *C. calyptratus*. *Coprinus xerophilus* was determined to be distinct based primarily on characteristics of the veil that cause it to consistently form an imbricate pattern on the pileus during maturation. The veil of *C. calyptratus* forms a distinctly stellate pattern. In other respects the taxa are very similar and are most likely closely allied.

Coprinopsis P. Karst., Acta Soc. Fauna Fl. Fenn. 2(1): 27. 1881.

Type: *C. friesii* (Quél.) P. Karst.

4. *Coprinopsis sclerotiorum* (Horvers & de Cock) Redhead, Vilgalys & Moncalvo, Taxon 50: 231. 2001. (Fig. 4)

≡ *Coprinus sclerotiorum* Horvers & de Cock, Uljé and Noordeloos, Persoonia 16: 283. 1997.

Selected descriptions and icones: Hemmes and Desjardin (2002: 55, ut *Coprinus* aff. *picaceus*); Uljé (2003); Uljé and Noordeloos (1997: 283).

Pileus 14 mm diam. × 20 mm height at maturity, ovoid, pileus covered in large, light brown (6D5) plaques of veil tissue up to 5 mm broad, pileus surface brownish gray (7E2) becoming grayish brown (7F3) in age, veil breaking up into dispersed patches that readily slough off, deliquescing; context 0.1 mm thick, concolorous with surface. – *Odor* somewhat fishy. – *Lamellae* close, adnexed, 3 mm broad, becoming black in age. – *Stipe* at maturity 35 × 5 mm, equal to tapering upwards, smooth, white, sometimes subbulbous or often abruptly bulbous. – *Annulus* and *volva* absent.

Basidiospores in face view (13.7–) 15–16 (–17.3) × 11.2–12.8 µm [\bar{x} = 15.7 ± 1.0 × 12.1 ± 0.6 µm, Q = 1.2–1.5 \bar{Q} = 1.3, n = 14 basidiospores per 1

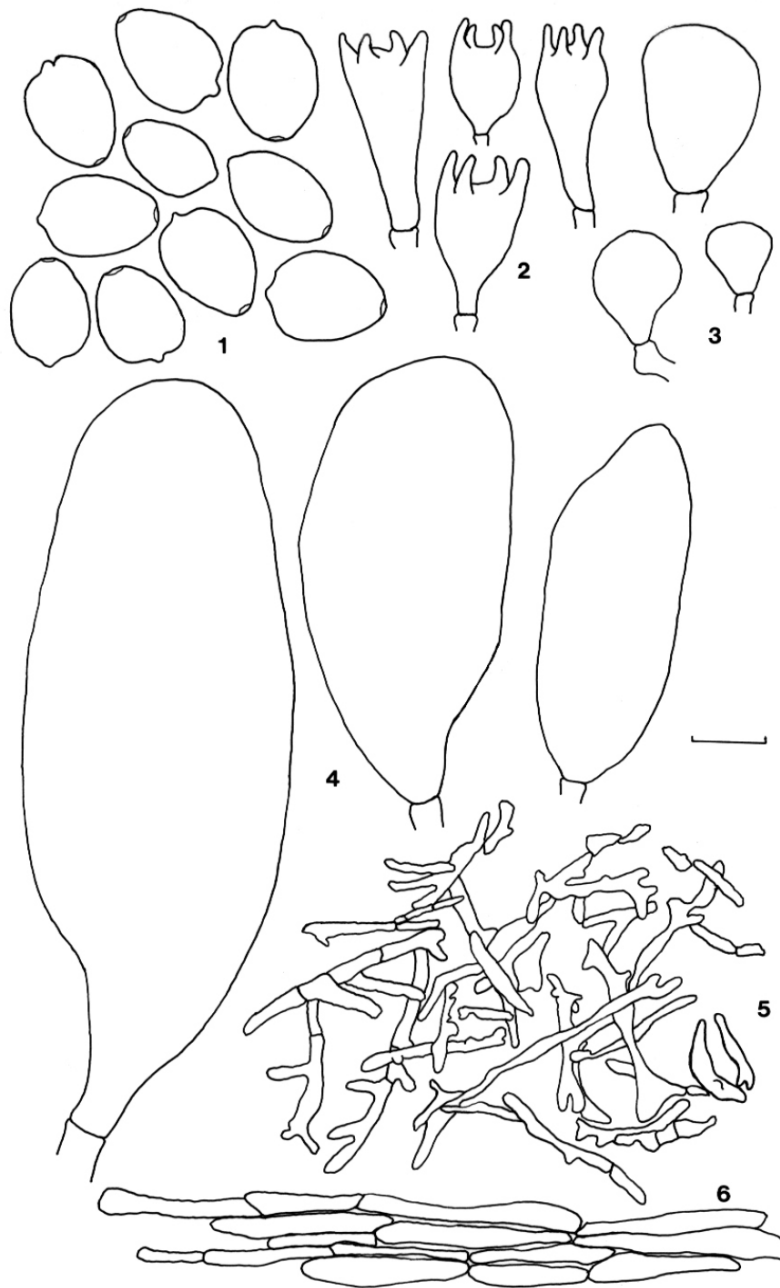

Fig. 4. *Coprinopsis sclerotiorum* (DEH 1363). 1. Basidiospores. 2. Basidia. 3. Brachybasidia. 4. Pleurocystidia. 5. Universal veil elements. 6. Pileipellis. Bars: 1–4 = 10 μ m, 5–6 = 20 μ m.

collection], in side view $14.5\text{--}17 \times 9.3\text{--}11.2 \mu\text{m}$ [$\bar{x} = 15.5 \pm 0.8 \times 9.8 \pm 0.7 \mu\text{m}$, $Q = 1.5\text{--}1.7$ $\bar{Q} = 1.6$, $n = 6$ basidiospores per 1 collection], mitriform in face view, lentiform to ellipsoid in side view, apiculus visible, with a central germ pore, smooth, black. – *Basidia* $15\text{--}25 \times 8\text{--}12 \mu\text{m}$, subglobose to clavate, 4-spored. – *Brachybasidia* $7\text{--}15 \mu\text{m}$ diam., subglobose to clavate. – *Cheilocystidia* not observed. – *Pleurocystidia* $45\text{--}75 \times 15\text{--}40 \mu\text{m}$, clavate to elongate-vesiculose or ellipsoid. – *Pileipellis* a cutis of somewhat inflated, regularly septate hyphae, $20\text{--}55 \times 3\text{--}8 \mu\text{m}$. – *Universal veil* composed of tightly interwoven, thin-walled, hyaline to pale yellow, branching to nodulose or diverticulate, sometimes irregular cells $10\text{--}90 \times 2\text{--}5 \mu\text{m}$, regularly septate. – *Clamp connections* not observed.

Habit, habitat, and distribution in the Hawaiian Islands: Rare, scattered in horse dung in alien wet forest. Hawai'i.

Worldwide distribution: Hawai'i.

Specimens examined: USA. HAWAII: Hawai'i, Waipio Valley, 10 Dec. 1996, DEH 1363.

Notes: *Coprinopsis sclerotiorum* has been collected only a single time in Hawai'i. It was described from Europe in 1997 and was only known from the type locality until this report. Unfortunately, the Hawaiian collection does not include any of the sclerotia mentioned in the European description, but in most other aspects it matches almost exactly. It should be noted that cheilocystidia appear absent in the Hawaiian collection and the pleurocystidia seem smaller than in the European description.

This taxon displays a mixture of characteristics from two better known taxa reported mostly from Europe, viz., *C. picacea* and *C. episcopalis*. The thin-walled branching veil elements and the large basidiospore size of *C. sclerotiorum* are more like *C. picacea* than *C. episcopalis* which has some thick-walled and incrustated velar elements and basidiospores that are barely half as large as those of *C. picacea* and *C. sclerotiorum*. However, *C. sclerotiorum* has basidiospores that are distinctly angular-ovoid to mitriform as does *C. episcopalis*, whereas *C. picacea* has ellipsoid basidiospores. Additionally, the overall basidiome size of *C. sclerotiorum* is quite small for *C. picacea*, but is similar to that of *C. episcopalis*. The Hawaiian specimen was collected from horse dung (the type for *C. sclerotiorum* was collected from cow dung). The dung substratum fails to match either *C. picacea* or *C. episcopalis* which are both associated with leaf litter and buried wood. Hemmes and Desjardin (2002) included a color photograph of this species determined as *Coprinus* aff. *picaceus* (Bull.: Fr.) S.F. Gray.

5. *Coprinopsis friesii* (Quél.) P. Karst., Acta Soc. Fauna Fl. Fenn. 2(1): 27. 1881. (Fig. 5)

= *Coprinus friesii* Quél., Mém. Soc. Émul. Montéliard, ser. II (5): 129. 1872.

Reported synonym:

= *Coprinus rhombisporus* P.D. Orton, Notes from the Royal Botanic Garden, Edinburgh. 32: 145. 1972.

Selected descriptions and icones: Uljé (2003); Uljé and Noordeloos (1997: 318, Fig. 28); Orton and Watling (1979: 45–46, pl. 83); Moser (1978: 260); Kühner and Romagnesi (1974: 386–387, pl. 540).

Pileus 5–16 mm diam. × 0.5–7 mm in height at maturity, conical then convex, becoming planar and revolute, margin splitting in age, plicate, shiny, almost crystalline-like with white patches of cottony veil remnants, pileus surface grayish beige. – *Odor* not distinctive. – *Lamellae* close with 2 series of lamellulae, adnexed, 0.5 mm broad, gray becoming black in age. – *Stipe* at maturity 25–53 × 0.25–1.5 mm, equal to tapering upwards, subbulbous, glabrous, white. – *Annulus* and *volva* absent.

Basidiospores (9.5–) 11.6–12.8 (–13.6) × (8.0–) 8.8–10.4 (–11.2) μm [\bar{x}_r = 11.7–12.6 × 9.2–9.7 μm, \bar{x}_m = 12.1 ± 0.6 × 9.5 ± 0.3 μm, Q = 1.1–1.5, \bar{Q}_r = 1.3, \bar{Q}_m = 1.3 ± 0, n = 20 basidiospores per 2 collections], ellipsoid to amygdaliform, pear-shaped or irregular and “lumpy” or “knobby” from all views, apiculus visible, with a central germ pore, smooth, dark earth to chocolate brown or nearly black. – *Basidia* 4-spored. – *Brachybasidia* and *cheilocystidia* not observed. – *Pleurocystidia* 15–20 × 3–8 μm, lageniform, only observed in young basidiomes. – *Pileipellis* a cutis of elongated, repent hyphae. – *Universal veil* composed of a combination of thin-walled and thick-walled cells; cells narrow, hyaline, diverticulate, knobby, and regularly septate. – *Clamp connections* present, scattered on veil elements.

Habit, habitat, and distribution in the Hawaiian Islands: Common, scattered to clustered in grass. Hawai’i.

Worldwide distribution: Europe, Japan, Venezuela, and Hawai’i.

Specimens examined: USA. HAWAII: Hawai’i, Hilo, University Heights Park, 30 Apr. 2002, DEH 2263; Hawai’i, Hilo, Ah Fook Chinen Stadium, 3 May 2002, DEH 2268.

Notes: *Coprinopsis friesii* is common on lawns in Hawai’i. It is easily recognized from other lawn-inhabiting coprini by its thick-walled diverticulate veil elements and relatively large ellipsoid to rhomboid basidiospores. It matches European descriptions of *C. friesii* in habitat and basidiospore shape. However, compared to the European *C. friesii*, the Hawaiian specimens have basidiospores that are much longer (11.6–12.8 μm instead of 7–9 μm *sensu* Orton and Watling, 1979; 6.2–9.5 μm *sensu* Uljé and Noordeloos, 1997). Although this spore size difference may be taxonomically significant, until further specimens from Hawai’i are collected to evaluate spore size range variability, we are reluctant to describe the Hawaiian material as a new taxon.

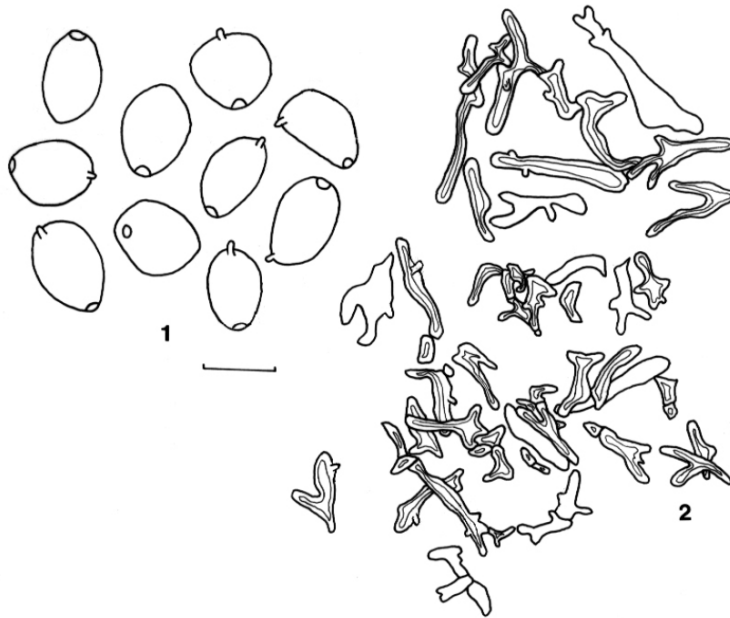

Fig. 5. *Coprinopsis friesii*. 1. Basidiospores (DEH 2263). 2. Universal veil elements (DEH 2268). Bars: 1 = 10 µm, 2 = 20 µm.

A taxon that is morphologically quite similar to the Hawaiian *C. friesii* is common in California, however, the California specimens have a basidiospore size range that more closely matches the size range of the European collections than do the Hawaiian collections. In other respects, the California *C. friesii* closely matches the Hawaiian taxon. Some authors (Uljé and Noordeloos, 1997) consider *C. rhombisporus* a synonym of *C. friesii*.

The taxon in Hawai'i, that would be most likely confused with *C. friesii* is *C. urticicola* var. *hawaiiensis*. However, *C. urticicola* var. *hawaiiensis* occurs on banana, coconut or *Heliconia* debris, not on grass, has much smaller basidiospores that are not rhomboid, has consistently thin-walled veil elements, and has a more robust stature.

6. *Coprinopsis urticicola* var. *hawaiiensis* Keirle, Hemmes & Desjardin, var. nov. (Fig. 6)

Differt a typo magnis basidiosporarum et habitatio tropicalis in Hawaii. Holotypus varietatis hic designatus D.E. Hemmes 1960 (SFSU).

Pileus 2–5 mm diam. × 3–6 mm height in primordia, white with touches of grayish brown (7D3), floccose to shaggy, ovoid to paraboloid, becoming

conical to campanulate or broadly convex and often truncated at the pileus apex, 3–20 (–40) mm diam. \times 3–10 (–15) mm in height at maturity, gradually becoming planar, veil breaking up into dispersed patches that readily slough off, veil patches remaining whitish to slightly tinged grayish brown, often powdery near pileus margin; pileus brownish gray (7D–E2–3) or light brown (5D7), blond (4C4), or golden brown (5D7) especially near disc, becoming pale orange (5A3) and gray (8E1) towards the margin, plicate, rapidly deliquescing, margins revolute and splitting in age. – *Odor* not distinctive. – *Lamellae* close with 0–4 series of lamellulae, somewhat adnate to narrowly adnexed to almost free, 0.1–2.0 mm broad, white becoming black in age. – *Stipe* at maturity 15–45 (–60) \times 1–2 mm, equal to tapering upwards, translucent to white, with fine longitudinal striations, glabrous or with a few scattered veil remnant hairs, often with bulbous substrate attachment and densely tomentose to shaggy or cottony at stipe base. – *Annulus* and *volva* absent.

Basidiospores (5–) 7–10 (–12) \times (4.4–) 5–7 (–9.2) μm [$\bar{x}_r = 6.1\text{--}9.9 \times 4.9\text{--}7.8 \mu\text{m}$, $\bar{x}_m = 8.5 \pm 1.1 \times 6.5 \pm 0.8 \mu\text{m}$, $Q = 1.0\text{--}1.8$, $\bar{Q}_r = 1.2\text{--}1.4$, $\bar{Q}_m = 1.3 \pm 0.1$, $n = 20$ basidiospores per 16 collections], ellipsoid to amygdaliform or almost subglobose, somewhat truncate, basidiospore wall sometimes appearing rather thick, apiculus often visible, with a central germ pore, often with a single large lipid droplet per basidiospore, smooth, pale brown to chestnut brown to yellowish or olivaceous brown or nearly black. – *Basidia* 15–25 \times 10–20 μm , subglobose to clavate, 4-spored. – *Brachybasidia* 10–20 (–30) \times 8–16 μm , subglobose to clavate. – *Cheilocystidia* not observed. – *Pleurocystidia* (15–) 30–65 \times 10–15 (–20) μm , narrowly ellipsoid to lageniform or almost cylindrical, usually tapering somewhat towards base or towards apex, often abundant. – *Pileipellis* a cutis of compressed, elongated hyphae; hyphae 5–50 (–80) \times 3–12 μm . – *Universal veil* composed of thin-walled, hyaline, branching to nodulose or diverticulate, interwoven, cylindrical to irregular cells 5–50 (–75) \times 3–5 (–15) μm , regularly septate. – *Clamp connections* not observed.

Habit, habitat, and distribution in the Hawaiian Islands: Common on herbaceous monocot debris, including banana and *Heliconia* stumps, palm fronds and infructescences. Hawai'i.

Worldwide distribution: Hawai'i.

Specimens examined: USA. HAWAII: Hawai'i, Hilo, UHH Campus, 7 Nov. 1994, DEH 633; same location, 29 Mar. 1995, DEH 761; same location, 15 Aug. 1995, DEH 862; same location, 7 Jul. 1996, DEH 1156; same location, 24 May 1999, DEH 1823; same location, 8 Jul. 1999, DEH 1824; Hawai'i, Hilo, UH Agriculture Farm, 3 Sep. 1999, DEH 1833; same location, 17 Jul. 2000, DEH 1960 (Holotype SFSU; Isotype BISH); same location, 13 Feb.

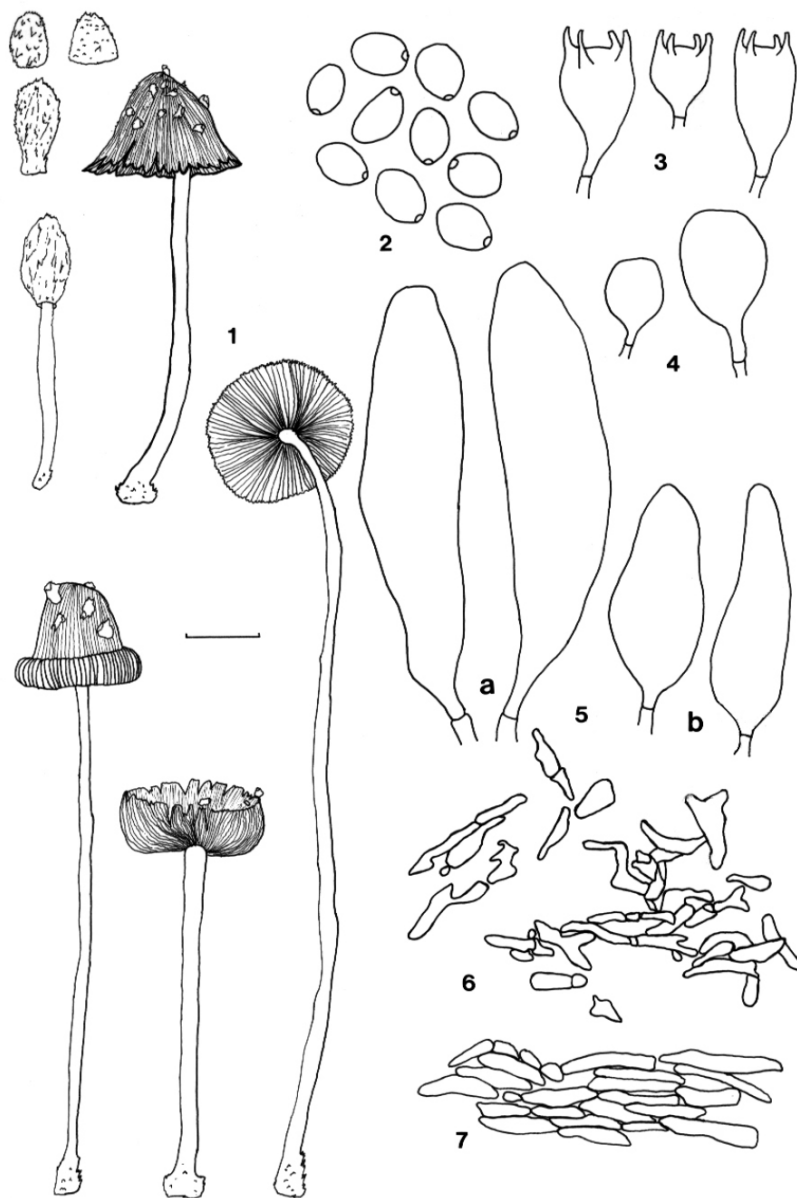

Fig. 6. *Coprinopsis urticicola* var. *hawaiiensis*. **1.** Basidiomata (MRK 22 and MRK 24). **2.** Basidiospores (DEH 1833). **3.** Basidia (DEH 1824). **4.** Brachybasidia (DEH 1824). **5.** Pleurocystidia. **a.** (DEH 1824) **b.** (DEH 1833). **6.** Universal veil elements (DEH 1833). **7.** Pileipellis (DEH 1833). Bars: 1 = 4 mm, 2–5 = 10 μ m, 6–7 = 20 μ m.

2001, DEH 2066; same location, 12 Jul. 2001, MRK 19; Hawai'i, Hilo, Bayfront, 23 Sep. 1999, DEH 1836; same location, 23 Sep. 1999, DEH 1838; Hawai'i, Hilo, 3 May 2002, DEH 2269; Hawai'i, Mountain View, 12 Jul. 2001, MRK 20; same location, plant matter collected 12 Jul. 2001, fruited 14 Jul. 2001, MRK 22; Hawai'i, MacKenzie Park, 14 Jul. 2001, MRK 24.

Notes: *Coprinopsis urticicola* var. *hawaiiensis* is easily recognized in Hawai'i by its thin-walled diverticulate veil elements and its monocot substrate. Only one other Hawaiian coprinoid taxon with diverticulate hyphae grows on herbaceous material, viz., *C. friesii*, and it is characterized by larger basidiospores, a thinner, more fragile basidiome, thick-walled veil elements, and a growth habit exclusively on grass. Morphologically, the Hawaiian *C. urticicola* var. *hawaiiensis* matches European descriptions of *C. urticicola* var. *urticicola* in most respects. According to Uljé and Noordeloos (1997), who studied the type specimen of *C. urticicola*, *C. urticicola* var. *urticicola* has basidiospores that are slightly smaller ($5.3\text{--}8.9 \times 4.3\text{--}6.7 \mu\text{m}$) than the Hawaiian specimens and has a substrate listed as "grasses or herbs." The overall basidiome size, cystidial, and veil characters of *C. urticicola* var. *hawaiiensis* and *C. urticicola* var. *urticicola* match quite well. We have decided to describe the Hawaiian taxon as a new variety of *C. urticicola* due to its tropical monocot substratum specificity and the slightly larger basidiospore size.

7. *Coprinopsis extingtoria* (Fr.) Redhead, Vilgalys & Moncalvo, Taxon 50: 228. 2001. (Fig. 7)

≡ *Coprinus extingtorius* Fr., Epicr. Syst. Mycol. 245. 1838.

Selected descriptions and icones: Orton and Watling (1979: 39, pl. 48); Moser (1978: 260); Kühner and Romagnesi (1974: 387, pl. 544).

Pileus 13–15 mm diam. \times 9–13 mm in height at maturity, conical becoming convex, splitting at margin, with whitish veil breaking up into segments, brownish near center to translucent near margins, rapidly deliquescing. – *Odor* not distinctive. – *Lamellae* close, adnexed, 2.0 mm broad, becoming black in age. – *Stipe* at maturity 22–31 \times 2–3 mm, tapering upwards, white. – *Annulus* and *volva* absent.

Basidiospores $8.0\text{--}10.5 \times 4.8\text{--}7.2 \mu\text{m}$ [$\bar{x}_r = 9.0\text{--}9.1 \times 5.0\text{--}5.7 \mu\text{m}$, $\bar{x}_m = 9.0 \pm 0.1 \times 5.4 \pm 0.6 \mu\text{m}$, $Q = 1.4\text{--}2.0$, $\bar{Q}_r = 1.6\text{--}1.8$, $\bar{Q}_m = 1.7 \pm 0.2$, $n = 20$ basidiospores per 2 collections], ellipsoid in all views to somewhat phaseoliform in side view, truncate, apiculus visible, with a broad, central germ pore, smooth, dark chestnut brown to nearly black. – *Basidia*, *brachybasidia*, *cheilocystidia* and *pleurocystidia* not observed [only mature specimens studied]. – *Pileipellis* a cutis of elongated repent hyphae. – *Universal veil*

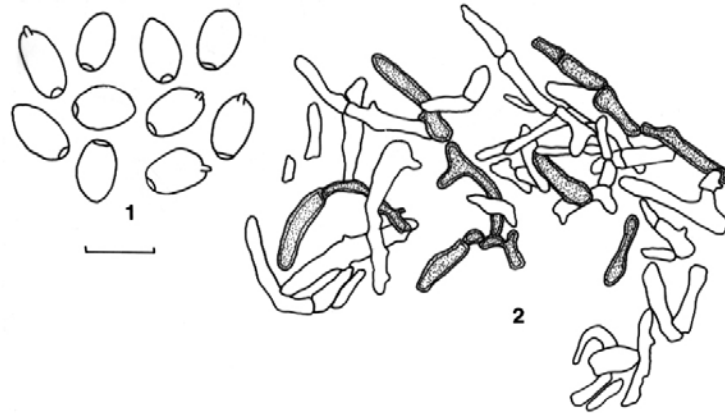

Fig. 7. *Coprinopsis extinctoria* (MRK 42). 1. Basidiospores. 2. Universal veil elements. Bars: 1 = 10 μm , 2 = 20 μm .

composed of interwoven, regularly branched, diverticulate hyphae, 5–40 \times 3–5 μm , sometimes narrowing at septa, about 75% thin-walled, hyaline, and about 25% thick-walled and incrustated with golden brown pigmentation, walls appearing finely granular. – *Clamp connections* present but rare.

Habit, habitat, and distribution in the Hawaiian Islands: Rare, solitary on fallen logs and branches of Olopua (*Nestegis sandwicensis* A. Gray; Oleaceae) in dry Ohi'a lehua (*Metrosideros polymorpha* Gaud.) Forest. Hawai'i.

Worldwide distribution: Australia, Europe, and Hawai'i.

Specimens examined: USA. HAWAII: Hawai'i, Manuka National Area Reserve, 16 May 2002, DEH 2284; same location, 27 Jan. 2002, MRK 42.

Notes: *Coprinopsis extinctoria* has been collected only twice from the same location in Hawai'i, growing on wood in native forest. We are tentatively determining the two Hawaiian specimens to be *C. extinctoria*. The Hawaiian material grows on the endemic tree Olopua (*Nestegis sandwicensis* (A. Gray) Degener, I. Degener & L. Johnson; Oleaceae) in native dry Ohi'a forest. It differs from European material (*sensu* Orton and Watling, 1979), which is reported from stumps of broad-leaved trees, only in its obvious tropical, dry habitat. Until more material from the Hawaiian Islands is collected for comparison with European material, we accept the epithet *C. extinctoria* for our specimens.

Coprinopsis extinctoria is most similar in Hawai'i to *C. sejuncta* but is readily distinguished by the veil that contains some pigmented, thick-walled elements, much less conspicuous clamp connections, and by its growth on

wood. *Coprinopsis sejuncta* has thin-walled veil elements, large conspicuous clamp connections on nearly every septum, occurs in sand, and has been collected only from the Midway Atoll.

8. *Coprinopsis sejuncta* nom. prov. (Fig. 8)

Etymology: *sejuncta* (Latin) – isolated, referring to the single collection from the remote Midway Atoll.

Pileus 10–15 mm diam. at maturity, covered with large plaques of whitish veil patches, brownish gray when dried. – *Lamellae* crowded, adnate. – *Stipe* at maturity -55×-3 mm, equal, drying pale to dark brown. – *Annulus* and *volva* absent. [This description is based on dried specimens from the only collection of this taxon. No field notes were taken by the collector. Fresh basidiomes are likely larger with paler colors.]

Basidiospores $6.4\text{--}8.4 \times 5.2\text{--}6.4 \mu\text{m}$, [$\bar{x} = 7.8 \pm 0.5 \times 5.6 \pm 0.3 \mu\text{m}$, $Q = 1.1\text{--}1.5$, $\bar{Q} = 1.4$, $n = 20$ basidiospores per 1 collection], ellipsoid in all views to slightly amygdaliform in side view, truncate, apiculus visible, with a broad, central germ pore, smooth, earth brown. – *Basidia*, *brachybasidia*, *cheilocystidia* and *pleurocystidia* not observed (material too old). – *Pileipellis* a cutis of elongated, repent hyphae. – *Universal veil* of cylindrical, thin-walled, hyaline, smooth or rarely diverticulate hyphae, $15\text{--}40$ (-80) $\times 3\text{--}10 \mu\text{m}$, highly branched. – *Clamp connections* prominent, at nearly every septum in universal veil tissue.

Habit, habitat, and distribution in the Hawaiian Islands: In sand. Midway Atoll.

Worldwide distribution: Midway Atoll, Hawai'i.

Specimens examined: USA. HAWAII: Midway Atoll, West Beach Trail, 5 Jun 1999, MRK 31.

Notes: *Coprinopsis sejuncta* has been collected only once in Hawai'i growing in sand on the remote Midway Atoll. The single specimen was collected by a person not associated with this project and no field notes were generated. *Coprinopsis sejuncta* is similar to *C. extinctoria* but is readily distinguished by the consistently thin-walled, hyaline veil elements with prominent clamps. It is also distinct in that it was collected from sand whereas *C. extinctoria* grows only on wood. *Coprinopsis sejuncta* shows some similarities to *Coprinus ammophilae* Courtec., another sand-inhabiting species, but the latter species differs in forming unbranched veil hyphae (in sect. Lanatuli) and has much larger basidiospores measuring $10\text{--}12 \times 6.5\text{--}7.5 \mu\text{m}$ (Courtecuisse, 1988).

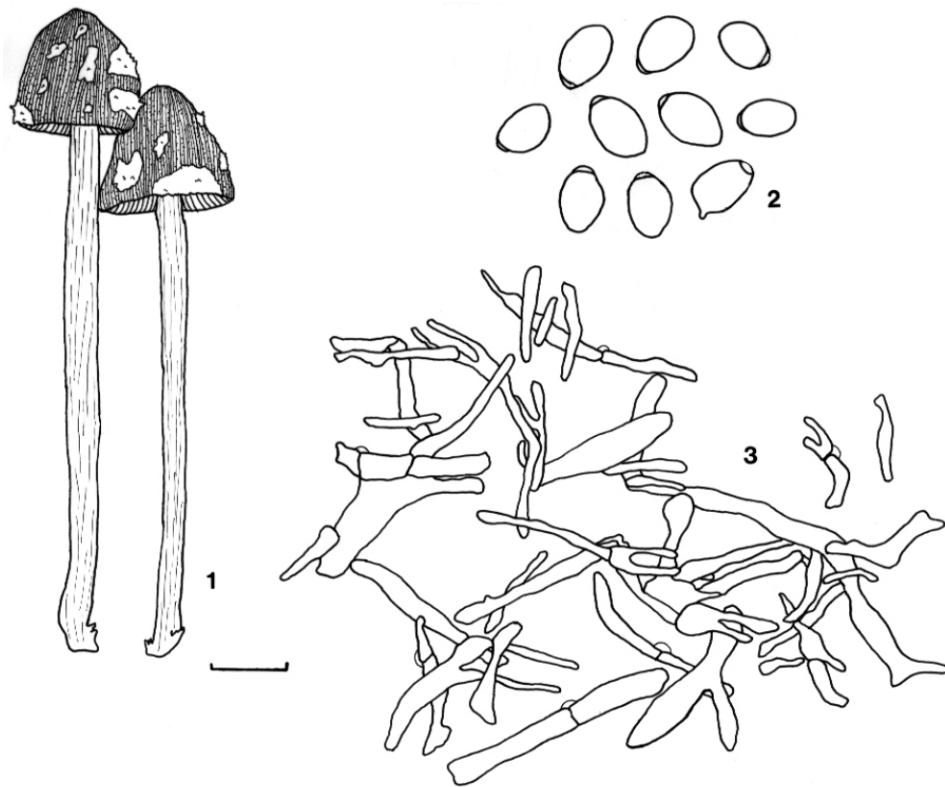

Fig. 8. *Coprinopsis sejuncta* (MRK 31). 1. Basidiomata. 2. Basidiospores. 3. Universal veil elements. Bars: 1 = 10 mm, 2 = 10 μ m, 3 = 20 μ m.

Until more material of this interesting species is collected from which adequate macromorphological data may be obtained, the proposed epithet will remain provisional.

9. *Coprinopsis candidolanata* (Doveri and Uljé) Keirle, Hemmes & Desjardin, *comb. nov.* (Fig. 9)

Basionym: *Coprinus candidolanatus* Doveri & Uljé in Uljé, Doveri and Noordeloos, *Persoonia* 17: 465. 2000.

Selected descriptions and icones: Uljé *et al.* (2000: 465); Uljé (2003).

Pileus 0.1–0.25 mm diam. in primordia, 0.5–1 mm diam. \times 1–1.5 mm in height at maturity, spathuliform to ovoid when young becoming conical to narrowly campanulate at maturity, finely plicate, primordia finely tomentose

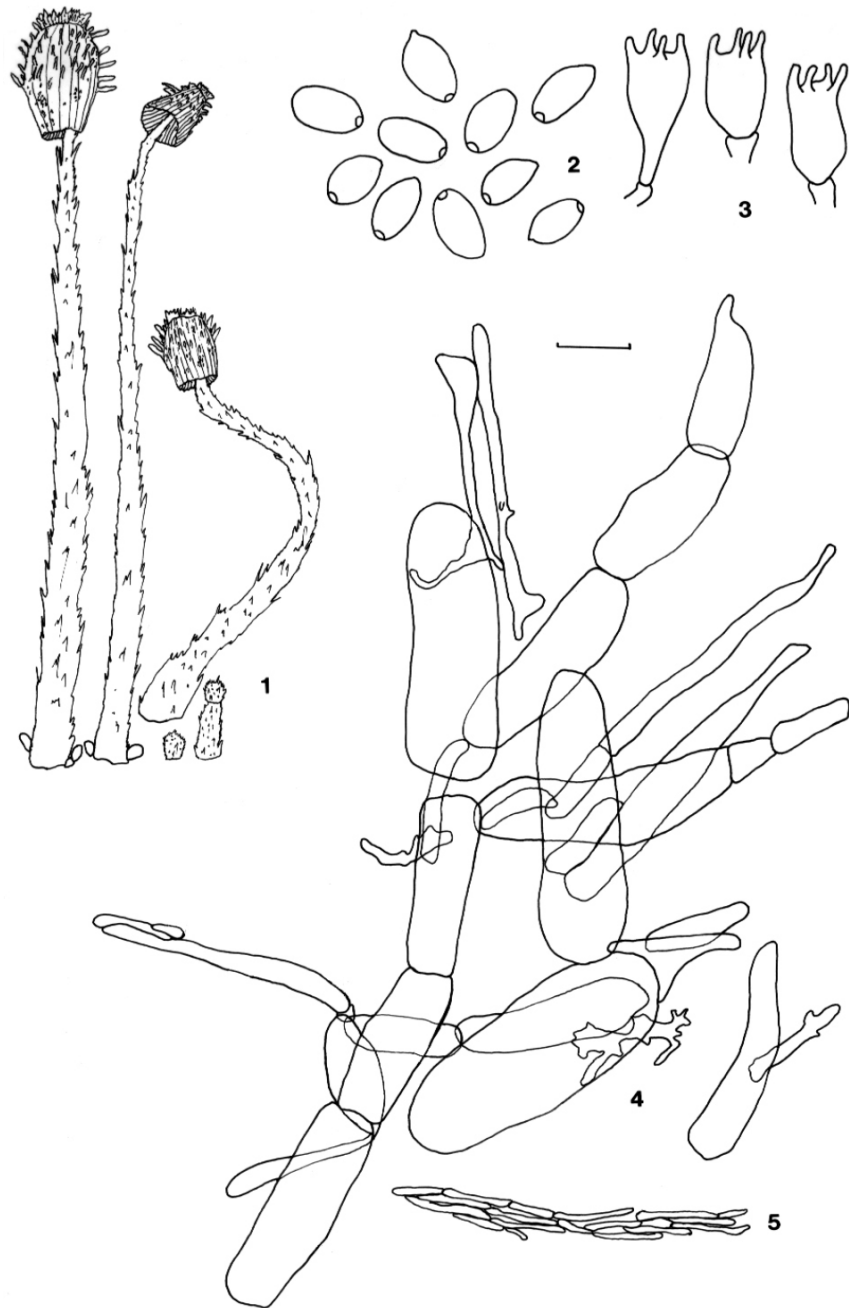

Fig. 9. *Coprinopsis candidolanata* (MRK 25). 1. Basidiomata. 2. Basidiospores. 3. Basidia. 4. Universal veil elements. 5. Pileipellis. Bars: 1 = 1 mm, 2–3 = 10 μ m, 4–5 = 20 μ m.

with dense radial tufts that persist especially at the disc forming a crown of tufts on mature specimens with more sparse, radially arranged tufts on the margins, becoming nearly glabrous at pileus margin in age, pure white throughout. – *Odor* not distinctive. – *Lamellae* subdistant, adnate, white becoming black in age. – *Stipe* 0.2–0.75 × 0.1–0.2 mm in primordia, 6–9 × 0.3–0.5 mm at maturity, tapering upwards, snow white, floccose to tomentose with velar remnants along entire stipe persisting throughout maturity. – *Annulus* and *volva* absent.

Basidiospores (8.0–) 8.8–10 (–11.2) × (4.8–) 5.6–6 (–6.8) μm [\bar{x} = 9.3 ± 0.8 × 5.8 ± 0.4 μm , Q = 1.4–1.9, \bar{Q} = 1.6, n = 20 basidiospores per 1 collection], ellipsoid to oblong with a prominent apiculus and central germ pore, smooth, dark chestnut brown. – *Basidia* 12–22 × 6–8 μm , clavate to subclavate to nearly vesicular, 4-spored. – *Brachybasidia*, *cheilocystidia* and *pleurocystidia* not observed. – *Pileipellis* a cutis of compressed elongated hyphae 8–25 × 1–3 μm . – *Universal veil* elements thin-walled, hyaline, composed of a mixture of three types of hyphae: 1) chains of cylindrical to somewhat inflated cells, 35–80 × 10–30 μm ; 2) narrowly cylindrical hyphae, often diverticulate, 20–100 × 5–10 μm ; and 3) irregular, highly branched or knobby elements, up to 30 μm in length. – *Clamp connections* absent.

Habit, habitat, and distribution in the Hawaiian Islands: Gregarious on goat dung. Hawai'i.

Worldwide distribution: Europe and Hawai'i.

Specimens examined: USA. HAWAII: Hawai'i, Agriculture Farm, from goat dung collected 9 Jul. 2001, basidiomes fruited in lab on 16 Jul. 2001, MRK 25.

Notes: *Coprinopsis candidolanata* has been found only on goat dung in Hawai'i. *Coprinopsis candidolanata* is similar to *C. utrifer* (Watling) Redhead, Vilgalys & Moncalvo, another goat or sheep dung-inhabiting species with veil tissue composed of a mixture of hyphal types. *Coprinopsis utrifer* differs, however, in forming larger basidiomes with smaller basidiospores (7.5–9 × 4.5–5.5 μm , *sensu* Orton and Watling, 1979; 6–7.7 × 4.2–5 μm , *sensu* Uljé and Noordeloos, 1993), has globose veil elements, and forms clamp connections. In Hawai'i, *C. candidolanata* may be confused with *C. villosa* nom. prov., but the latter species lacks diverticulate elements in the veil and has uniformly larger velar elements and basidiospores. *Coprinopsis villosa* has also been collected only once in Hawai'i but from horse dung, not goat dung. Other species in Hawai'i that are macromorphologically similar to *C. candidolanata* are *C. stercorea* and *C. cordisporus*. They are easily distinguished by their primarily globose veil elements. Moreover, *Coprinopsis stercorea* has verrucose ornamentation on the veil cells and almost cylindrical basidiospores, while *C. cordisporus* has distinctly heart-shaped to rhomboid, not ellipsoid, basidiospores.

10. *Coprinopsis villosa* nom. prov. (Fig. 10)

Pileus 1–1.5 mm diam. in primordia, 1.5–5 mm diam. × 2–2.5 mm in height at maturity, spathuliform, paraboloid, becoming convex to broadly convex, and then planar in age, finely tomentose with long silky hairs covering the entire pileus, white often with brownish or reddish tones near the disc. – *Odor* not distinctive. – *Lamellae* adnate. – *Stipe* up to 3 × 1 mm in primordia, up to 45 × 0.5 mm at maturity, equal, white, floccose to tomentose with silky velar remnants along entire stipe that persist throughout maturity. – *Annulus* and *volva* absent.

Basidiospores 7.6–14.4 × 4.8–9.2 μm [\bar{x} = 10.2 ± 1.5 × 6.0 ± 0.9 μm, Q = 1.5–1.9, \bar{Q} = 1.7, n = 20 basidiospores per 1 collection], ellipsoid, prominent apiculus and central germ pore, smooth, dark chestnut brown. [In less mature specimens, basidiospore wall pigment develops first in longitudinal ridges that give the basidiospores a cog-wheel appearance in end view. The pigment fills in the area between the ridges as the basidiospore matures such that mature basidiospores appear darker and evenly pigmented.] – *Basidia* 15–20 × 6–8 μm, clavate, 4-spored. – *Brachybasidia*, *cheilocystidia* and *pleurocystidia* not observed. – *Pileipellis* a cutis of radially arranged, somewhat inflated hyphae; hyphae 20–55 × 5–10 μm. – *Universal veil* composed of chains of cylindrical to irregularly-shaped, inflated cells, thin-walled, hyaline; hyphae 35–100 × 12–50 μm. – *Clamp connections* present, conspicuous.

Habit, habitat, and distribution in the Hawaiian Islands: Scattered on horse dung. Hawai'i.

Worldwide distribution: Hawai'i.

Specimens examined: USA. HAWAII: Hawai'i, Agriculture Farm, fruited in moist chamber, 10 Feb. 2001, DEH 2061.

Notes: *Coprinopsis villosa* has been collected only once in Hawai'i. *Pileipellis* and veil anatomy clearly indicate the taxon is allied with members of *Coprinus* s.l. sect. *Lanatuli*. Macroscopically it is similar to *C. stercorea*. However, *C. villosa* has much larger basidiospores than *C. stercorea* and the veil is composed of chains of large inflated cells altogether distinct from the much smaller, globose and verrucose veil elements of *C. stercorea*. *Coprinopsis villosa* is closely allied with *C. candidolanata*, which so far has only been found on goat dung in Hawai'i. The latter species differs, however, in having smaller, more narrowly ellipsoid basidiospores, and velar remnants often containing diverticulate to coralloid elements. The Hawaiian taxon, only provisionally named herein because of the paucity of available material, does

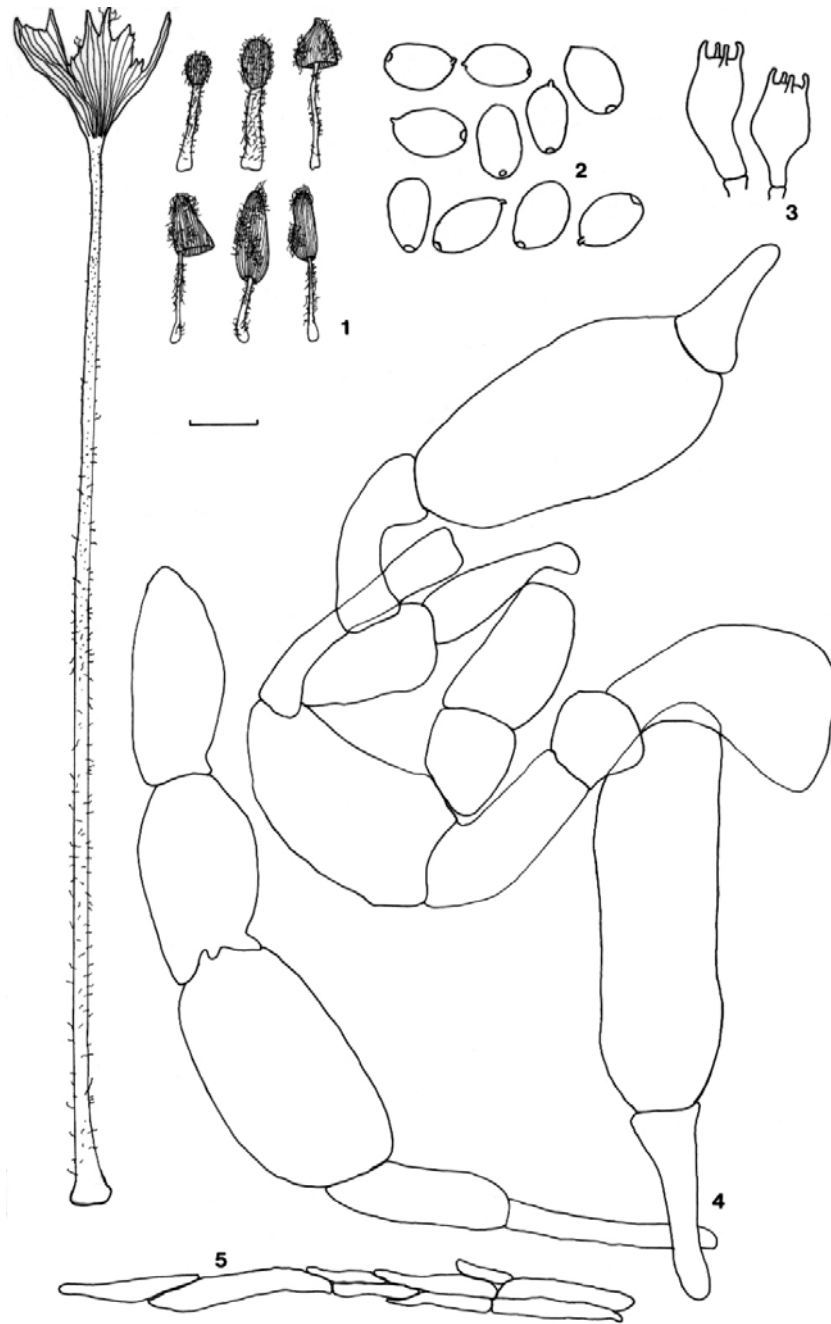

Fig. 10. *Coprinopsis villosa* (DEH 2061). **1.** Basidiomata. **2.** Basidiospores. **3.** Basidia. **4.** Universal veil elements. **5.** Pileipellis. Bars: 1 = 2.5 mm, 2–3 = 10 μ m, 4–5 = 20 μ m.

not key to any species in a revised key to members of *Coprinus* subsect. Lanatuli by Uljé *et al.* (2000).

11. *Coprinopsis radiata* (Bolton: Fr.) Redhead, Vilgalys & Moncalvo, Taxon 50: 230. 2001. (Fig. 11)

≡ *Agaricus radiatus* Bolton, An History of Fungusses, growing about Halifax, vol. 1: 39. 1788.

≡ *Agaricus radiatus* Bolton: Fr., Syst. Mycol. I: 313. 1821.

≡ *Coprinus radiatus* (Bolton: Fr.) S.F. Gray, Nat. Arr. British Pl. I: 635. 1821.

Reported synonym:

= *Coprinus fimetarius* (L.) Fr., Epicr. Syst. Mycol. 245. 1838 pro parte.

Misapplied names:

Coprinus lagopus (Fr.) Fr. *sensu* Buller, Researches on Fungi 2: 86. 1922 et seq.

Selected descriptions and icones: Uljé (2003); Uljé and Noordeloos (1999: 174–177, Fig. 5); Breitenbach and Kränzlin (1995: 248, pl. 299); Orton and Watling (1979: 43–44, pls. 65, 67, & 75); Moser (1978: 258); Kühner and Romagnesi (1974: 388, pls. 549 & 550).

Pileus 1–7 mm diam. × 3–13 mm height in primordia, subglobose becoming ellipsoid then paraboloid to oblong, becoming 7–16 mm diam. at maturity, gradually becoming obtusely conical then campanulate and finally with revolute margins, splitting in age, finely plicate; primordia shaggy with dense radial tufts of veil fibrils; fibrils white near margin to grayish orange (6B5), light brown (6D7), brown (6E6) or reddish brown near the disc; veil readily sloughing off, pileus rapidly deliquescing; pileus surface under veil pale gray becoming black. – *Odor* not distinctive. – *Lamellae* narrowly adnexed to almost free. – *Stipe* 2–14 × 1.5–2 mm in primordia to 17–80 × 1–3 mm at maturity, equal to tapering upwards with slightly bulbous base, white, floccose to tomentose with velar fibrils somewhat appressed to the stipe surface, gradually becoming only finely pubescent in age. – *Annulus* and *volva* absent.

Basidiospores (8–) 8.8–11.6 (–13.6) × 5.2–7.6 (–8.4) μm [$\bar{x}_r = 9.0–12.3 \times 5.7–7.3 \mu\text{m}$, $\bar{x}_m = 10.8 \pm 1.3 \times 6.4 \pm 0.6 \mu\text{m}$, $Q = 1.3–2.1$, $\bar{Q}_r = 1.6–1.8$, $\bar{Q}_m = 1.7 \pm 0.1$, $n = 20$ basidiospores per 5 collections], narrowly ellipsoid to ellipsoid and somewhat phaseoliform or amygdaliform in side view, not truncate, with visible apiculus and a broad, central germ pore, smooth, rarely pale earth brown, more commonly dark chestnut brown or nearly black. – *Basidia* clavate, 20–25 × 5–8 μm, 4-spored. – *Brachybasidia* and *cheilocystidia* not observed. – *Pleurocystidia* 25–75 × 10–30 μm, voluminous, ellipsoid to almost cylindrical, often extending between lamellae. – *Pileipellis* a cutis of elongated hyphae, 20–90 × 5–10 μm, radially arranged. – *Universal veil* composed of relatively large, long tapering chains of regular, inflated cells; hyphae 50–175 × 10–50 μm. – *Clamp connections* not observed.

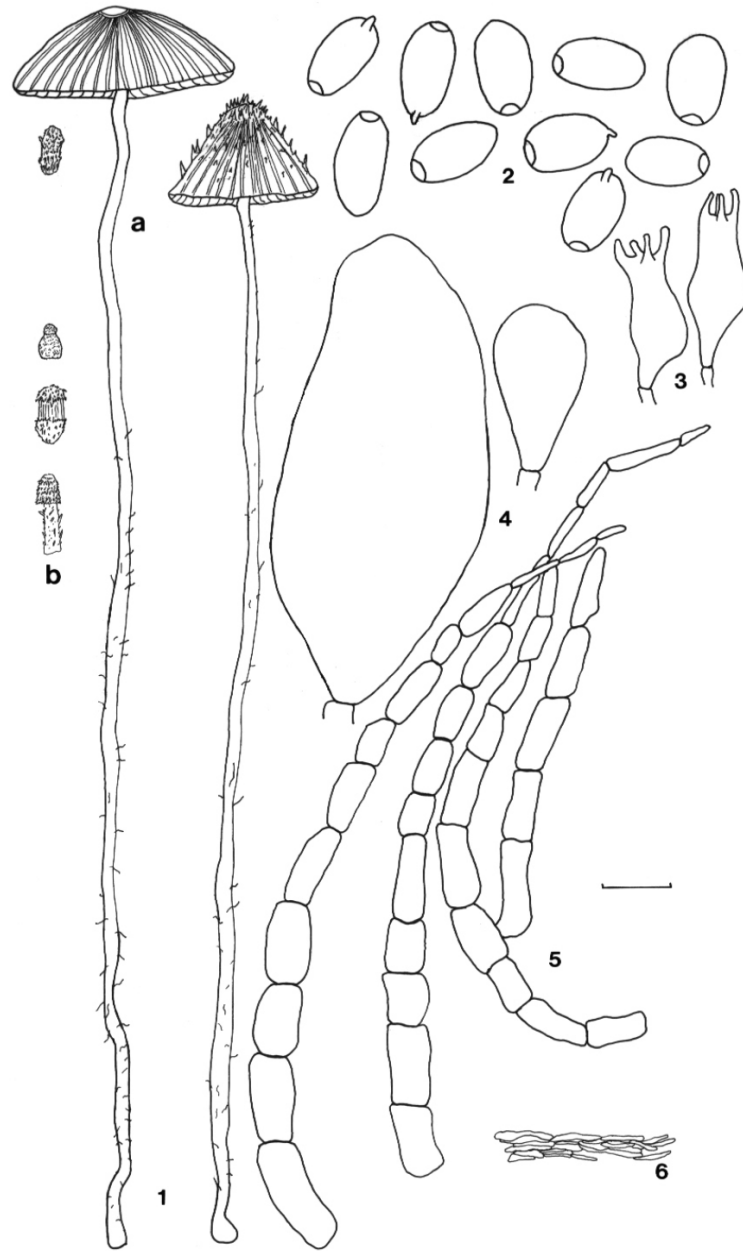

Fig. 11. *Coprinopsis radiata*. **1.** Basidiomata. **a.** (MRK 3) **b.** (MRK 14) **2.** Basidiospores (DEH 2080). **3.** Basidia. **4.** Pleurocystidia. **5.** Universal veil elements. **6.** Pileipellis (Figs. 3–6, DEH 2072). Bars: 1 = 4 mm, 2–4 = 10 μ m, 5–6 = 100 μ m.

Habit, habitat, and distribution in the Hawaiian Islands: Scattered on horse dung. Hawai'i.

Worldwide distribution: Europe, North America, Hawai'i.

Specimens examined: USA. HAWAII: Hawai'i, UHH Agriculture Farm, 5 Mar. 2001, DEH 2072; same location, dung collected 21 Feb. 2001, fruited 9 Mar. 2001, DEH 2079; same location, dung collected 21 Feb. 2001, fruited 9 Mar. 2001, DEH 2080; Hawai'i, Panewa Race Track, dung collected 7 Feb. 2001, fruited 19 Feb. 2001, DEH 2082; same location, dung collected 6 Jun. 2001, fruited 7 Jul. 2001, MRK 03; same location, dung collected 6 Jun. 2001, fruited 11 Jul. 2001, MRK 14.

Notes: *Coprinopsis radiata* is recognized easily in Hawai'i by its growth on dung and shaggy veil. It is much smaller overall than *C. lagopus* and *C. cinerea* which also have a shaggy veil but are found on woodchips, not dung. Of the other small coprophilous coprini, *C. stercorea* has verrucose, globose veil elements, *C. candidolanata* and *C. villosa* have considerably smaller basidiospores and smaller basidiomes, and *C. pellucidus* lacks a veil. The average basidiospore size of the Hawaiian *C. radiata* collections matches the Breitenbach and Kränzlin (1995) basidiospore sizes for *C. radiata* ($9.8\text{--}12.3 \times 6.5\text{--}7.5 \mu\text{m}$) quite well. Uljé and Noordeloos (1999), Orton and Watling (1979), and Kühner and Romagnesi (1974) distinguish a morphologically similar taxon, *C. pseudoradiata*, as having basidiospores in a significantly smaller range ($7\text{--}9.7 \times 4\text{--}5.5 \mu\text{m}$) than *C. radiata* ($11\text{--}15.2 \times 6\text{--}8.5 \mu\text{m}$). While Hawaiian collections exhibit basidiospore size ranges that are between those cited by these authors for *C. radiata* and *C. pseudoradiata*, they do not appear to be as small as required to be considered conspecific with *C. pseudoradiata*.

12. *Coprinopsis lagopus* (Fr.: Fr.) Redhead, Vilgalys & Moncalvo, Taxon 50: 229. 2001. (Fig. 12)

≡ *Agaricus lagopus* Fr., Syst. Mycol. I: 312. 1821.

≡ *Coprinus lagopus* (Fr.) Fr., Epicr. Syst. Mycol. 250. 1838.

Selected descriptions and icones: Hemmes and Desjardin (2002: 32); Uljé (2003 [as *Coprinus lagopus* var. *lagopus*]); Uljé and Noordeloos (1999: 181–183, Fig. 8); Breitenbach and Kränzlin (1995: 240, pl. 288); Orton and Watling (1979: 40–41, pls. 61 and 70); Moser (1978: 259); Kühner and Romagnesi (1974: 389, pls. 552 and 553).

Pileus 2–8 mm diam. \times 3–12 mm height in primordia, 22–42 mm diam. \times 4–12 mm height at maturity, paraboloid to spathuliform or ovoid when young becoming broadly conical to campanulate then planar at maturity, margins revolute and splitting in age, fragile, strongly plicate, primordia tomentose with dense radial tufts of hairs concentrated at disc and becoming more sparse near margin, tufts golden brown (5D–F7) to orangish gray (6B2),

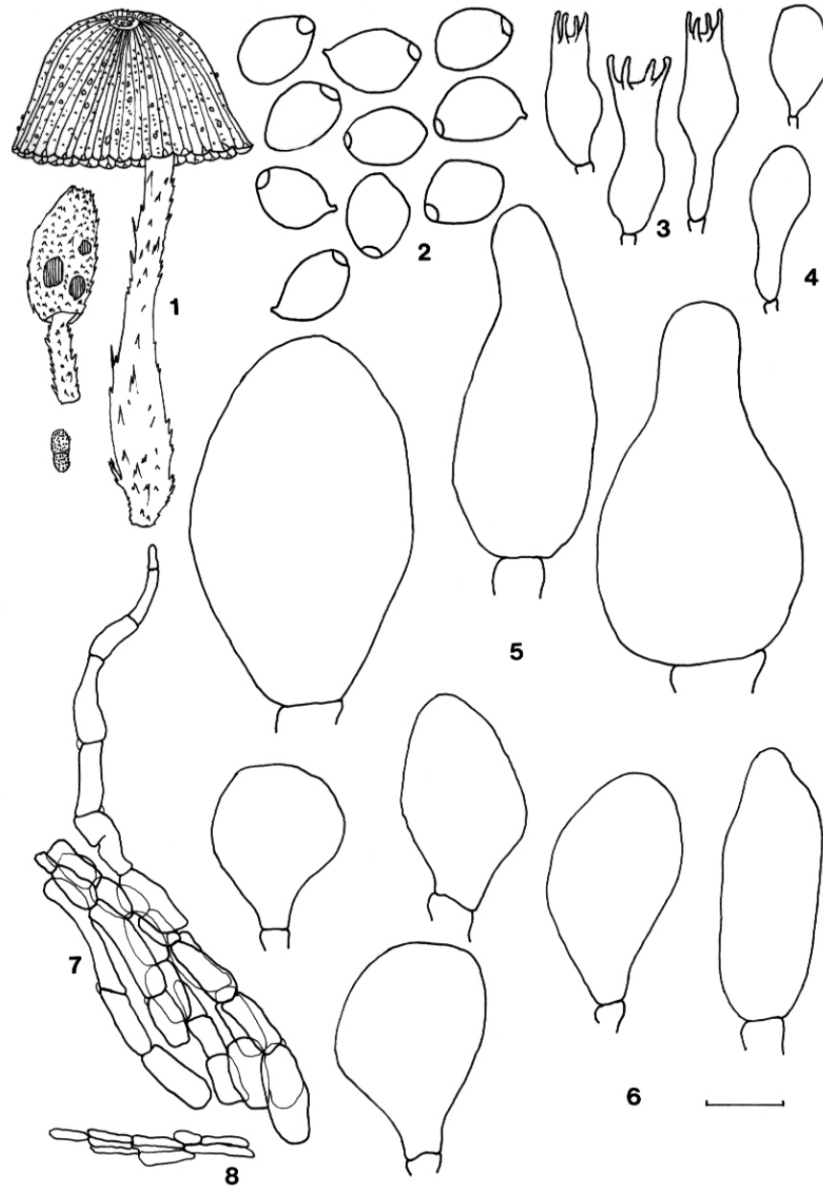

Fig. 12. *Coprinopsis lagopus*. 1. Basidiomata (MRK 21). 2. Basidiospores (DEH 1739). 3. Basidia. 4. Brachybasidia. 5. Pleurocystidia. 6. Cheilocystidia (Figs. 3–6, DEH 1801). 7. Universal veil elements (MRK 21). 8. Pileipellis (DEH 1801). Bars: 1 = 8 mm, 2–6 = 10 μ m, 7–8 = 50 μ m.

light brown (6D4), or dark brown (6–7F4–8), sloughing off pileus surface with rain, but always with some tenacious remnants adhering to the pileus surface leaving tightly attached scurfy scales, pileus yellowish white (4A2) at disc to brownish gray (6E2), grayish brown (7D3), or gray (7E–F1–2) becoming violet gray (18C2) near margin, deliquescing; context 0.1–0.25 mm thick, color same as surface color. – *Odor* typically not distinctive, but sometimes acrid. – *Lamellae* close to subdistant, with 2–4 series of lamellulae, narrowly adnexed to almost free forming a clear zone surrounding the point of stipe attachment, 0.5–1.5 mm broad, white becoming black in age first along margins then on lamellar faces. – *Stipe* 2–8 × 2–5 mm in primordia, 50–80 × 1.5–5 mm at maturity, equal to tapering upwards, white, fragile, finely tomentose to densely tomentose, shaggy, or woolly, sometimes becoming glabrous with age, particularly cottony near stipe base, never radicating, sometimes slightly bulbous. – *Annulus* and *volva* absent.

Basidiospores (8.4–) 9.6–12 (–15) × (6–) 6.4–8.8 (–10) μm [$\bar{x}_r = 10.3\text{--}11.5 \times 7.2\text{--}7.9 \mu\text{m}$, $\bar{x}_m = 10.8 \pm 0.4 \times 7.7 \pm 0.2 \mu\text{m}$, $Q = 1.2\text{--}1.7$, $Q_r = 1.3\text{--}1.5$, $Q_m = 1.4 \pm 0.1$, $n = 20$ basidiospores per 9 collections], ellipsoid to amygdaliform or ovoid or lemoniform, sometimes appearing slightly truncate, apiculus visible, with a central germ pore, smooth, dark chestnut brown. – *Basidia* 20–30 × 3–8 μm , clavate, 4-spored. – *Brachybasidia* 12–20 × 3–8 μm , clavate. – *Cheilocystidia* 20–35 × 12–20 μm , vesiculose to spathuliform or ellipsoid. – *Pleurocystidia*, 50 × 15–30 μm , ellipsoid to bowling pin-shaped, broad at base and narrowing slightly towards apex. – *Pileipellis* a cutis of compressed elongated hyphae; 25–45 × 3–8 μm . – *Universal veil* composed of chains of cylindrical to somewhat inflated cells 25–75 × 5–25 μm , often tapering near the tips of the chains, chains of hyphae lying parallel to one another, some brown pigmentation on veil cells. – *Clamp connections* present.

Habit, habitat, and distribution in the Hawaiian Islands: Densely gregarious on older woodchip piles. Hawai'i.

Worldwide distribution: Europe, Lesser Antilles, North America Venezuela, Japan, Hawai'i.

Specimens examined: USA. HAWAII: Hawai'i, Hilo, Prince Kuhio Mall, 29 Oct. 1994, DEH 631; Hawai'i, Hilo, UH Hilo, 13 Aug. 1995, DEH 828; Hawai'i, Hilo, American Savings Bank, 4 Aug. 1996, DEH 1189; Hawai'i, Hilo, Bayfront, 15 Dec. 1998, DEH 1739; same location, 27 Jan. 1999, DEH 1801; same location, 23 Feb. 1999, DEH 1817; same location, 7 Sep. 2001, DEH 2132; same location, 7 Sep. 2001, DEH 2133; same location, 12 Jul. 2001, MRK 21.

Notes: *Coprinopsis lagopus* fruits typically on old woodchip piles often following the morphologically similar *C. cinerea*. *Coprinopsis lagopus* has a shorter stipe, more brown tones in the pileus and veil, and never has a

radicating stipe. *Coprinopsis cinerea* has a longer stipe, typically more gray tones in the pileus and a whiter veil, and frequently forms a radicating stipe.

13. *Coprinopsis cinerea* (Schaeff.: Fr.) Redhead, Vilgalys & Moncalvo, Taxon 50: 227. 2001. (Fig. 13)

≡ *Agaricus cinereus* Schaeff., Fungorum qui in Bavaria et Palatinato circa Ratisbonam nascentur 4: 43. 1774.

≡ *Agaricus cinereus* Schaeff.: Fr., Syst. Mycol. I: 310. 1821.

≡ *Coprinus cinereus* (Schaeff.: Fr.) S.F. Gray, Nat. Arr. British Pl. I: 634. 1821.

Reported synonym:

= *Coprinus fimetarius* (L.) Fr., Epicr. Syst. Mycol. 245. 1838 pro parte.

= *Coprinus macrorhizus* (Pers.: Fr.) Rea, British Basidiomycetae 503. 1922.

= *Coprinus delicatulus* Apinis, Trans. Brit. Myc. Soc. 48: 653. 1965.

Selected descriptions and icones: Hemmes and Desjardin (2002: 33); Uljé (2003); Uljé and Noordeloos (1999: 174, Fig. 4); Breitenbach and Kränzlin (1995: 228, pl. 269); Orton and Watling (1979: 42, pls. 63, 68, 71–73); Bogart (1979: 287–291; 284–287 [as *C. macrorhizus* and its varieties]; 281–284 [as *C. fimetarius*]); Moser (1978: 258); Kühner and Romagnesi (1974: 388, pl. 548 [as *C. macrorhizus*]).

Pileus 12 mm diam. × 25 mm height in primordia, 50 mm diam. × 20 mm in height at maturity, paraboloid to spathuliform or ovoid when young becoming hemispherical to obtusely conical at maturity, finely plicate, primordia finely tomentose with dense radial tufts of white, downward-pointing, downy fibrils that readily slough off, brownish beige (6E3) to dark brown (7F4) at disc gradating to white at pileus margin, becoming dark gray during maturation, mature pileus ovoid-convex, plicate except at disc, grayish brown (7E3) to dark brown (7F4) on disc, gradating to gray (7E1–7F1) to nearly black at margins, rapidly deliquescing, margins revolute and splitting in age; context 0.2–1 mm thick, color same as surface color. – *Odor* sweet or musty. – *Lamellae* close with 3 or more series of lamellulae, narrowly adnexed to almost free, 3–5 mm broad, white becoming black in age. – *Stipe* 40–48 × 10 mm in primordia, 85–150 × 4–11 mm at maturity, equal to tapering downwards, longitudinally-sulcate, white, some specimens with an additional 40–45 mm rooting portion, tapering downwards or with bulbous substrate attachment, densely tomentose at stipe base. – *Annulus* and *volva* absent.

Basidiospores (6–) 7–12 (–13.2) × (4.5–) 5–8 (–9.6) μm [$\bar{x}_r = 7.8–12.1 \times 5.6–7.6 \mu\text{m}$, $\bar{x}_m = 10.2 \pm 1.3 \times 6.8 \pm 0.7 \mu\text{m}$, $Q = 1.0–1.9$, $\bar{Q}_r = 1.3–1.5$, $\bar{Q}_m = 1.5 \pm 0.1$, $n = 20$ basidiospores per 8 collections], ellipsoid to somewhat oblong in face view to amygdaliform in side view, with a prominent apiculus and central germ pore, smooth, dark chocolate to chestnut brown sometimes with olivaceous tones. – *Basidia* 15–22 × 8–12 μm, clavate, 4-spored. – *Brachybasidia* 15–20 × 8–10 μm, clavate. – *Cheilocystidia* not observed. –

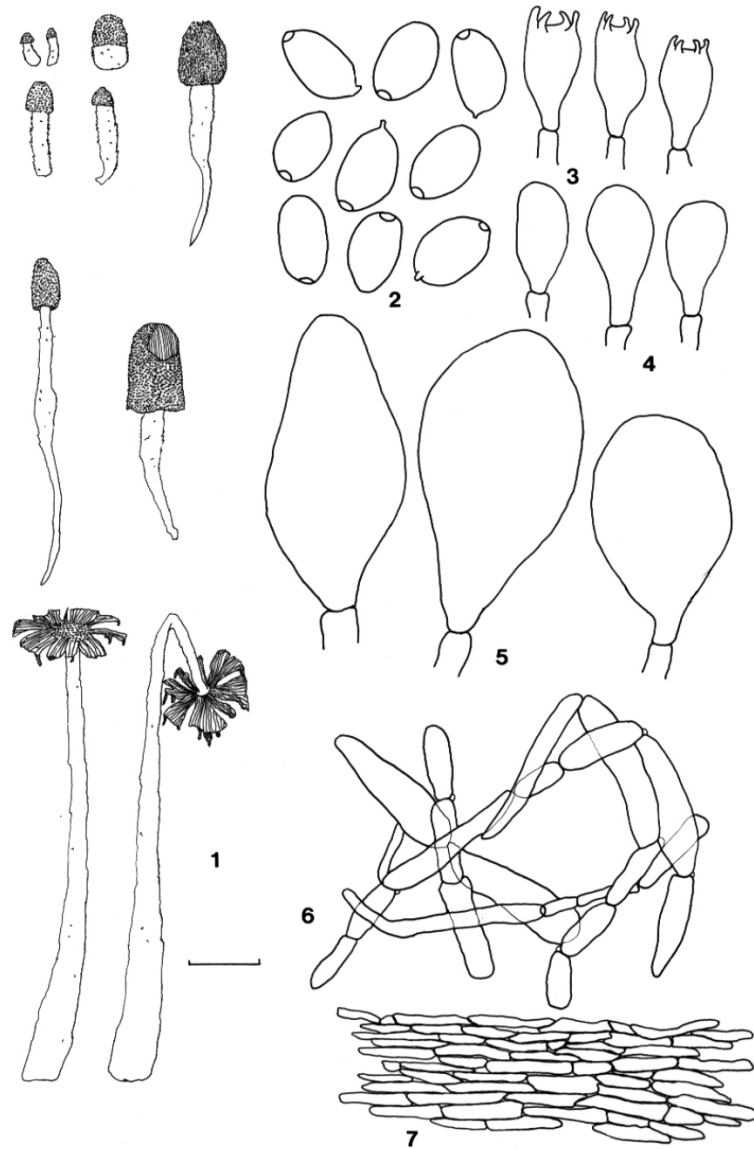

Fig. 13. *Coprinopsis cinerea*. 1. Basidiomata (MRK 38). 2. Basidiospores (DEH 2126). 3. Basidia. 4. Brachybasidia. 5. Pleurocystidia (Figs. 3–5, DEH 1839). 6. Universal veil elements (MRK 38). 7. Pileipellis (MRK 38). Bars: 1 = 20 mm, 2–5 = 10 μ m, 6–7 = 50 μ m.

Pleurocystidia 30–45 \times 20–30 μ m, ellipsoid to almost cylindrical often extending between lamellae. – *Pileipellis* a cutis of compressed elongated

hyphae 25–70 × 6–15 µm. – *Universal veil* composed of chains of cylindrical to somewhat inflated cells 25–150 × 6–30 µm, often tapering near the tips of the chains. – *Clamp connections* present.

Habit, habitat, and distribution in the Hawaiian Islands: Densely gregarious on fresh woodchip piles. Hawai'i and Oahu.

Worldwide distribution: Cosmopolitan.

Specimens examined: USA. HAWAII: Hawai'i, Hilo, Bayfront, 1 Jul. 1996, DEH 1136; Hawai'i, Hilo, Liliokalani Park, 15 Dec. 1998, DEH 1738; Hawai'i, Hilo, Bayfront, 27 Jan. 1999, DEH 1800; Hawai'i, Hilo, American Savings Bank, 23 Sep. 1999, DEH 1839; Hawai'i, Hilo, Bayfront, 13 Feb. 2001, DEH 2065; Hawai'i, Hilo, Komohana Agriculture Complex, 4 Sep. 2001, DEH 2126; Hawai'i, Hilo, St. Joseph's Field, 21 Jan. 2002, MRK 38; Oahu, Hoomalahia Botanical Garden, 27 Mar. 2002, DEH 2255.

Notes: *Coprinopsis cinerea* is one of two woodchip-decomposing species with a shaggy veil that represent *Coprinus* s.l. section *Lanatuli* in Hawai'i. It typically fruits on woodchip piles where it is often succeeded by *C. lagopus*. The overall stature of *C. lagopus* is considerably more diminutive than that of *C. cinerea*, and the former forms a shorter stipe that is never radicating. Hawaiian *C. cinerea* basidiomes exhibit both radicating and non-radicating stipe morphologies. Although *C. cinerea* has been reported in the literature to occur only associated with manured areas, all Hawaiian collections have been made in woodchip piles devoid of manure. Interestingly, in California, populations of *C. cinerea* are associated both with dung and with woodchips (pers. obs.).

14. *Coprinopsis stercorea* (Fr.) Redhead, Vilgalys & Moncalvo, *Taxon* 50: 231. 2001. (Fig. 14)

≡ *Coprinus stercoreus* Fr., *Epicr. Syst. Mycol.* 251. 1838.

Reported synonyms:

= *Agaricus stercorarius* Bull.: *St Amans, Flore Agenaise*, 569. 1821. [non *A. stercorarius* Schum: *Fr., Syst. Mycol. I:* 291. 1821.]

≡ *C. stercorarius* (Bull.: *St. Amans*) J.E. Lange, *Ansk Bot. Ark.* 2: 44. 1915.

= *C. sclerotianus* Cleland & Cheel, *Proc. Linn. Soc. New South Wales* 41: 854. 1916.

Misapplied names:

C. velox Godey apud Gillet, *sensu van Waveren*, *Persoonia* 5: 154. 1968.

Selected descriptions and icones: Hemmes and Desjardin (2002: 55); Uljé (2003); Breitenbach and Kränzlin (1995: 250, pl. 303); Orton and Watling (1979: 78–80, pls. 144, 145, 146.); Moser (1978: 263); Kühner and Romagnesi (1974: 385. [as *C. stercorarius*]).

Pileus 0.5–2.5 mm diam. × 0.5–3 mm height in primordia, paraboloid to ellipsoid, becoming obtusely conical to campanulate or planar with revolute margins in age, up to 4 (–7 in culture) mm diam. × 0.5–5 mm in height at maturity, finely plicate; primordia tomentose especially near pileus margins with lustrous sugar-like granules covering primordial pileus, sometimes

forming large clumps, persisting throughout maturation especially on or between pileus ridges, white (1B1) to pale gray or gray (1D1) to orange white (6A2), grayish orange (6B8), bluish gray (20D2) or blackish blue (20F4), deliquescent, margins splitting in age. – *Odor* not noticeable. – *Lamellae* distant to subdistant, without lamellulae, adnate to adnexed, white becoming black in age. – *Stipe* 0.75–5 × 0.5–1 mm in primordia, 10–45 × 0.1–0.5 mm at maturity, equal to tapering upwards, translucent or white, pubescent to tomentose throughout with filamentous veil remains especially near stipe base. – *Annulus* and *volva* absent.

Basidiospores (5.2–) 6.4–8.8 (–10.8) × (2.8–) 3.2–4.8 (–6.4) μm [$\bar{x}_r = 6.0\text{--}8.9 \times 3.2\text{--}5.3 \mu\text{m}$, $\bar{x}_m = 7.6 \pm 1.0 \times 4.1 \pm 0.7 \mu\text{m}$, $Q = 1.3\text{--}2.5$, $\bar{Q}_r = 1.7\text{--}2.1$, $\bar{Q}_m = 1.9 \pm 0.1$, $n = 20$ basidiospores per 8 collections], phaseoliform to ellipsoid, fusoid or cylindrical in all views, slightly truncated, apiculus usually visible, with a central to slightly eccentric germ pore, remnants of perispore sac sparse and often absent, smooth, pale to dark earth brown, cigar or chestnut brown rarely with uneven pigmentation appearing almost as banding. – *Basidia* 10–15 × 5–7 μm , clavate, 4-spored. – *Brachybasidia* 5–7 × 3–5 μm , clavate. – *Cheilocystidia* 15–40 × 8–15 μm , variable, globose to subglobose, clavate, ellipsoid or lageniform. – *Pleurocystidia* 15–30 × 10–15 μm , subglobose to clavate or ellipsoid. – *Pileipellis* a cutis of compressed elongated hyphae up to 50 × 3–5 μm . – *Universal veil* composed of branching cylindrical elements and globose to subglobose elements with varying degrees of verrucose ornamentation, cylindrical elements up to 120 × 4–10 μm , globose elements 10–50 μm diam., floccose elements covering stipe comprised of cylindrical branching hyphae similar in size and form to those found in the veil, but lacking ornamentation. – *Clamp connections* absent.

Habit, habitat, and distribution in the Hawaiian Islands: Common on horse and cow dung, rarely on goat dung. Cultured and fruited artificially on MEA medium. Hawai'i.

Worldwide distribution: Europe, Australia, and Hawai'i.

Specimens examined: USA. HAWAII: Hawai'i, Saddle Pine Grove, 30 Nov. 1993, DEH 328; Hawai'i, UH Agriculture Farm, 10 Feb. 2001, DEH 2063; same location, 8 Mar. 2001, DEH 2074A; same location, 30 Mar. 2001, DEH 2084; same location, 30 Mar. 2001, DEH 2085; same location, dung collected 20 Jun. 2001, fruited 6 Jul. 2001, MRK 02; same location, dung collected 20 Jun. 2001, fruited 9 Jul. 2001, MRK 09; same location, dung collected 9 Jul. 2001, fruited 11 Jul. 2001, MRK 17; same location, dung collected 9 Jul. 2001, fruited 17 Jul. 2001, MRK 28; same location, fruited on MEA medium 17 Jan. 2002, MRK 37; same location, dung collected 16 Jan. 2002, fruited 24 Jan. 2002, MRK 40.

Notes: *Coprinopsis stercorea* is recognized easily in Hawai'i by its sugar-like universal veil, small stature, dung habit, verrucose veil ornamentation, and small, cylindrical to ellipsoid basidiospores. It is one of Hawai'i's most common coprophiles. In addition, it grows easily and fruits

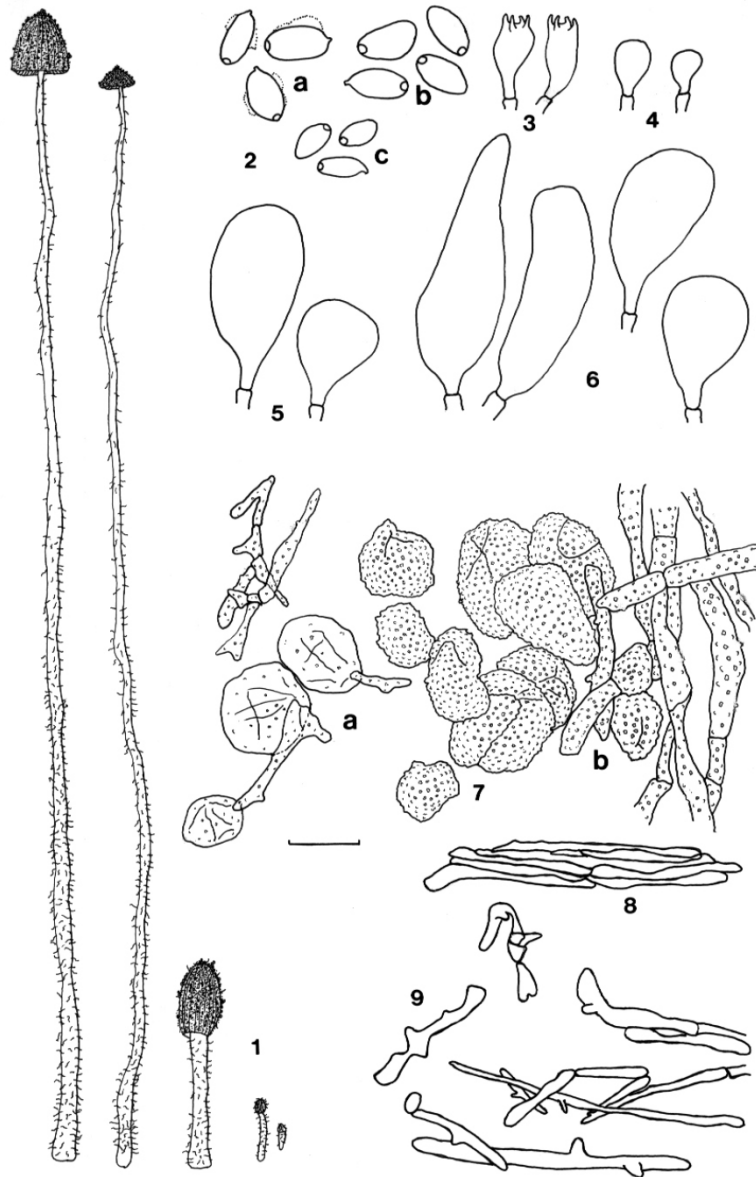

Fig. 14. *Coprinopsis stercorea*. **1.** Basidiomata (MRK 28). **2.** Basidiospores. **a.** (DEH 328). **b.** (MRK 28). **c.** (DEH 2084). **3.** Basidia. **4.** Brachybasidia. **5.** Pleurocystidia (Figs. 3–5, DEH 2084). **6.** Cheilocystidia (DEH 2085). **7.** Universal veil elements. **a.** (MRK 17). **b.** (DEH 2085). **8.** Pileipellis (DEH 2074A). **9.** Veil elements remaining on stipe (DEH 2074A). Bars: 1 = 3 mm, 2–6 = 10 μ m, 7–9 = 20 μ m.

prolifically in culture. Macroscopically, it could be confused with *C. cordisporus*, but *C. cordisporus* has smooth or somewhat incrustated (never verrucose) velar elements and heart-shaped basidiospores. *Coprinopsis villosa* is also quite similar macromorphologically, but has larger basidiospores and velar elements that consist of chains of inflated cylindrical hyphae devoid of globose cells. Other similar, small dung coprini such as *C. candidolanata* and *C. radiata* also have cylindrical velar elements without globose cells, while *C. pellucidus* has pileus setules and lacks a universal veil.

15. *Coprinopsis cothurnata* (Godey) Redhead, Vilgalys & Moncalvo, Taxon 50: 227. 2001. (Fig. 15)

≡ *Coprinus cothurnatus* Godey in Gillet, Les Hyménomycètes, ou description de tous les champignons (fungi) qui croissent en France 605. 1878.

Selected descriptions and icones: Hemmes and Desjardin (2002: 54); Uljé (2003); Uljé and Noordeloos (1993: 271, Fig. 3); Orton and Watling (1979: 66, pls. 127 and 136); Moser (1978: 262).

Pileus up to 13 mm diam. × 17 mm height in primordia, narrowly spathuliform, brownish orange (7C3), covered in web-like, stringy white hairs, becoming paraboloid to convex in age, 15–30 mm diam. × 11–25 mm in height at maturity, smooth, grayish brown (6D3) at disc gradating to reddish golden or brownish orange (6C3), with fine radial striations, covered in a fine mealy powder that is easily brushed off, powdery veil remnants drying pale clay color, with pileus color gradating to brownish gray (6D2) at margin, becoming brownish gray (7E2) overall in age, deliquescing. – *Odor* unpleasant, of strong musty straw or mousy. – *Lamellae* adnexed, subdistant with 3–4 series of lamellulae, 0.1–0.75 mm broad, black in young and old basidiomes. – *Stipe* in primordia up to 8 mm in length, equal, 55–65 mm in length × 2–5 mm diam. when young to 120–130 mm in length × 3–6 mm diam. at maturity, equal to tapering slightly upwards, elongating slightly near the base in age, white, smooth with fine white flakes near base or shaggy when young becoming glabrous in age. – *Annulus* and *volva* absent.

Basidiospores in face view (11–) 13–14 (–16) × (8–) 12–14 μm [$\bar{x}_r = 12.9\text{--}13.9 \times 9.3\text{--}11.6 \mu\text{m}$, $\bar{x}_m = 13.3 \pm 0.5 \times 10.6 \pm 0.8 \mu\text{m}$, $Q = 0.9\text{--}1.6$, $\bar{Q}_r = 1.2\text{--}1.4$, $\bar{Q}_m = 1.3 \pm 0.1$, $n = 14$ basidiospores per 6 collections], in side view (11–) 13–14 (–16) × (6–) 7–9 (–10) μm [$\bar{x}_r = 12.3\text{--}14 \times 7.3\text{--}8.8 \mu\text{m}$, $\bar{x}_m = 13.2 \pm 0.6 \times 8.0 \pm 0.6 \mu\text{m}$, $Q = 1.3\text{--}2.0$, $\bar{Q}_r = 1.6\text{--}1.8$, $\bar{Q}_m = 1.7 \pm 0.1$, $n = 6$ basidiospores per 8 collections], broadly ellipsoid to nearly globose-angular, hexagonal, rounded amygdaliform or mitriform in face view, to ellipsoid or limoniform in side view; with a prominent apiculus and central germ pore, smooth, olivaceous brown to dark brown to nearly black. – *Basidia* 16–28 × 6–14 μm, clavate to subglobose with prominent sterigmata, 4-spored. –

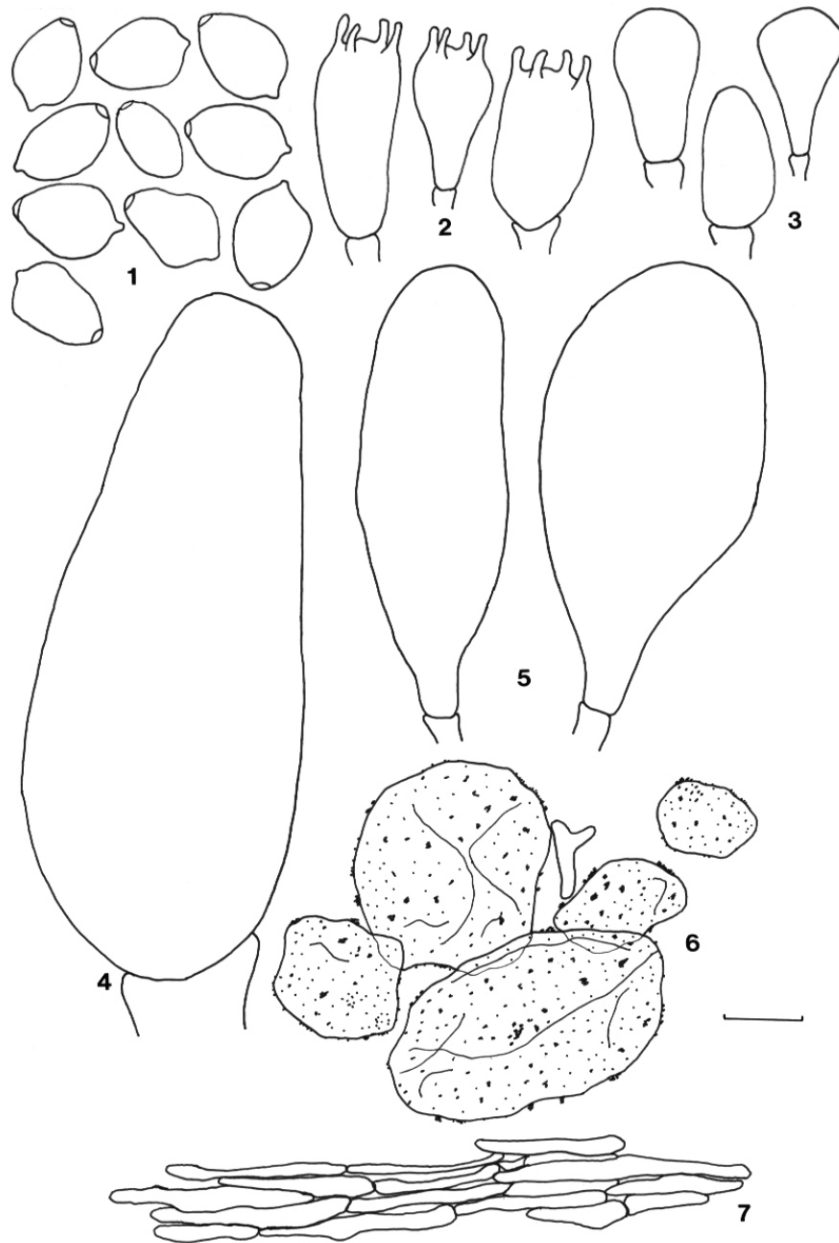

Fig. 15. *Coprinopsis cothurnata* (DEH 556). **1.** Basidiospores. **2.** Basidia. **3.** Brachybasidia. **4.** Pleurocystidium. **5.** Cheilocystidia. **6.** Universal veil elements. **7.** Pileipellis. Bars: 1–5 = 10 μ m, 6–7 = 20 μ m.

Brachybasidia 18–20 × 12–20 µm, clavate to ellipsoid or nearly globose. – *Cheilocystidia* up to 60 × 20–30 µm, ellipsoid to broadly clavate or vesiculose, thin-walled. – *Pleurocystidia* 40–100 × 16–40 µm, ellipsoid to vesicular. – *Pileocystidia* absent. – *Pileipellis* a cutis of somewhat inflated cylindrical cells; hyphae up to 10 µm diam. and up to 50 µm in length. – *Universal veil* of scattered globose to subglobose cells 20–48(–60) µm diam., smooth or more commonly with pale yellowish brown granular incrustations overall, thin to slightly thick-walled; also with filamentous hyphae 3.5–8 µm diam., smooth or incrustated. – *Clamp connections* rare on universal veil hyphae.

Habit, habitat, and distribution in the Hawaiian Islands: In pastures on cow dung, rare. Hawai'i.

Worldwide distribution: Hawai'i, Europe.

Specimens examined: USA. HAWAII: Hawai'i, Saddle, Parker Ranch, 10 Sep. 1994, DEH 548; same location, 10 Sep. 1994, DEH 556; same location, 29 Aug. 1995, DEH 877; same location, 3 Oct. 1995, DEH 889; same location, 29 Oct. 1996, DEH 1274; same location, 23 Mar. 1999, DEH 1820.

Notes: *Coprinopsis cothurnatus* is distinctive among the Hawaiian coprini found on dung. It has been collected only in one general area in the Saddle between Mauna Loa and Mauna Kea at an elevation approximately 6000 feet above sea level. It has also been found only in association with cow dung. Its powdery, clay-colored veil and relatively large basidiome size easily distinguish it from other Hawaiian coprophiles.

16. "*Coprinus*" *cordisporus* Gibbs, Yorkshire Naturalist: 100. 1898.

(Figs. 16A–G; Tables 3–4)

= *Coprinus cardiasporus* Bender in Enderle, Krieglsteiner & Bender, Z. Mykol. 52: 102. 1986.

Reported synonyms:

= *Coprinus volvaceominimus* Crossland, The Naturalist, London: 372. 1892.

= *Coprinus patouillardii* ssp. *isabellinus* Locq., Bull. Oc. Mycol. Fr. 63: 83. 1947 (invalid, no Latin description).

Misapplied names:

Coprinus patouillardii Quél. sensu Jossierand, Ann. Soc. Linn. Lyon 77: 104. 1933.

Selected descriptions and icones: Uljé (2003 [as *C. cardiasporus* and *C. cordisporus*]); Uljé and Noordeloos (1993: 286–292, Figs. 12 & 14 [as *C. cardiasporus* and *C. cordisporus*]); Orton and Watling (1979: 66, pls. 126, 134, 137); Moser (1978: 262 [as *C. patouillardii*]).

Pileus 1–2.5 mm diam. × 2–5 mm height in primordia, cylindrical to broadly conical, paraboloid or ovoid, disc often with relatively large brownish bumps, always with mealy or sugar-like granules; veil elements grayish (8C1), light yellow (2A5), pale orange (53A), brownish orange (5B6, 5D5), grayish orange (6A–C2–3), brownish gray (7E2–5), light brown (7D3) or dark brown;

pileus translucent to white, grayish or dull violet (18E3), often reflecting the degree of basidiospore maturation in a given basidiome, becoming conical to convex, broadly convex or campanulate with age, 3–15 mm diam. × 4–8 mm in height, eventually becoming planar with inrolled margins, sometimes splitting before inrolling, 5–15 (–20) mm diam. × 2–3 mm in height at maturity, distinctly plicate to pleated, with coarse sugary granules persisting on the pileus surface especially at the disc and on ridges of pileus pleats, not noticeably deliquescent. – *Odor* not distinctive. – *Lamellae* adnate to narrowly adnexed, free at maturity, close, with 0–3 series of lamellulae, 0.1–1 mm broad, white becoming black with maturation, first along lamellar edges and proceeding up lamellar faces. – *Stipe* in primordia 2–10 (–21) mm in length, sometimes finely tomentose, equal, 35–50 (–75) × 0.5–2 mm at maturity, equal to tapering slightly upwards, translucent to gray (8C1), white to yellowish (4–5A–B3–4), or distinctly brown (5A–C1–7) or (7–8B–F5–7) in some collections, often with these colors in various combinations at different points along the stipe at different stages of development, sometimes with delicate flakes but usually glabrous, smooth, and with a white, shaggy, cupulate, slightly bulbous, volva-like (pseudovolva) base. – *Annulus* absent; *pseudovolva* present.

Basidiospores in face view (5.6–) 6.4–8.8 (–10.4) × (4–) 5.2–7.6 (–9.6) μm [$\bar{x}_r = 6.4\text{--}9.1 \times 5.4\text{--}8 \mu\text{m}$, $\bar{x}_m = 7.4 \pm 0.7 \times 6.4 \pm 0.8 \mu\text{m}$, $Q = 0.9\text{--}1.8$, $\bar{Q}_r = 1.0\text{--}1.3$, $\bar{Q}_m = 1.2 \pm 0.1$, $n = 20$ basidiospores per 19 collections and 15 basidiospores per 3 collections], in side view 6.4–8.8 × (3.6–) 4.4–5.2 μm [$\bar{x}_r = 7\text{--}8.1 \times 4\text{--}4.8 \mu\text{m}$, $\bar{x}_m = 7.5 \pm 0.4 \times 4.5 \pm 0.4 \mu\text{m}$, $Q = 1.3\text{--}2.1$, $\bar{Q}_r = 1.6\text{--}2.0$, $\bar{Q}_m = 1.7 \pm 0.2$, $n = 5$ basidiospores per 3 collections], angular-subglobose to pentagonal, heart-shaped, apple-shaped or pear-shaped with a variable neck leading from the basidiospore body to the germ pore creating a somewhat truncate, flask-shape basidiospore in face view, narrowly ellipsoid in side view; rarely with prominent apiculus, with a central germ pore, smooth, pale to grayish earth brown, dark chestnut brown or chocolate brown, with or without reddish tones. – *Basidia* 7–15 × 4–8 μm , narrowly clavate to clavate or subglobose, with prominent sterigmata, 4-spored. – *Brachybasidia* clavate to ellipsoid or nearly globose, similar in size range to basidia. – *Cheilocystidia* 20–40 × 5–20 μm , ellipsoid to cylindrical, bowling-pin-shaped, lageniform or narrowly tapering, highly variable, thin-walled. – *Pleurocystidia* cylindrical to ellipsoid or vesicular, typically not lageniform, thin-walled, similar in size range to cheilocystidia. – *Pileocystidia* absent. – *Pileipellis* a cutis of somewhat inflated to cylindrical, radially arranged hyphae up to 10 μm diam. and up to 45 μm long. – *Universal veil* of scattered globose to subglobose cells 10–40 (–50) μm diam., smooth, thin-walled, some elements hyaline and others with

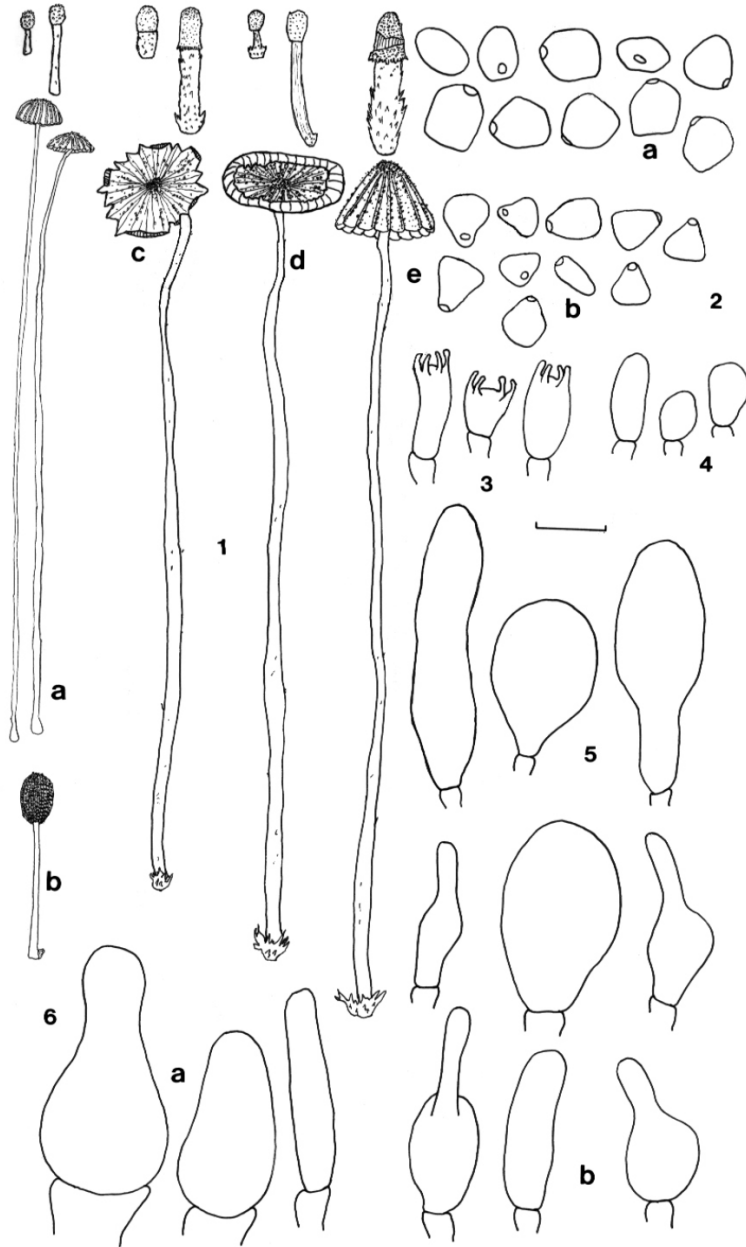

Fig. 16A. *“Coprinus” cordisporus*. **1.** Basidiomata. **a.** (MRK 10). **b.** (MRK 27). **c.** (MRK 8). **d.** (MRK 15). **e.** (MRK 16). **2.** Basidiospores. **a.** (DEH 1829). **b.** (DEH 2071). **3.** Basidia (DEH 2071). **4.** Brachybasidia (DEH 2071). **5.** Pleurocystidia (DEH 2081). **6.** Cheilocystidia. **a.** (DEH 2071). **b.** (DEH 2073). Bars: 1 = 4 mm, 2–6 = 10 μ m.

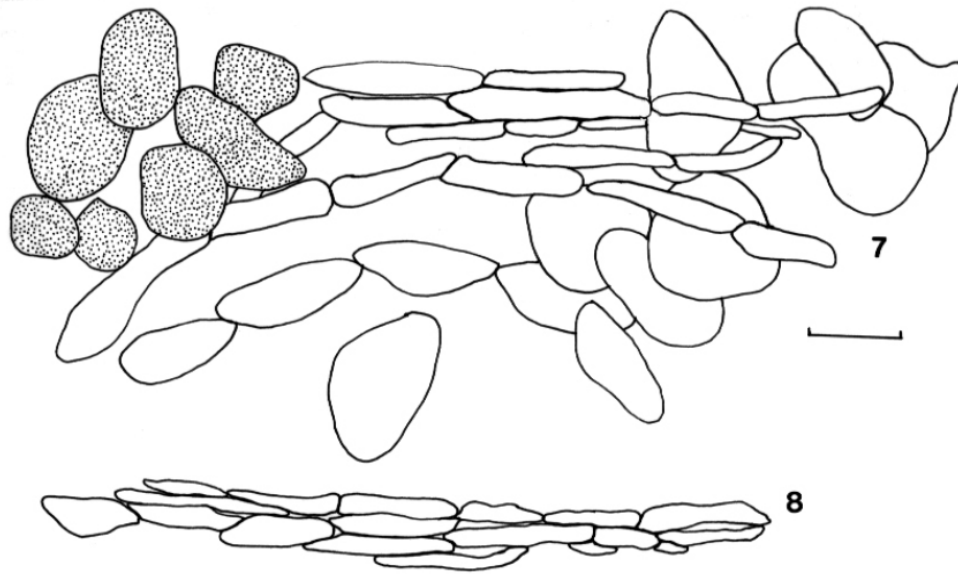

Fig. 16B. “*Coprinus*” *cordisporus*. 7. Universal veil elements (MRK 04). 8. Pileipellis (DEH 1837). Bar = 20 μ m.

brown parietal pigmentation, not incrustated; also with filamentous hyphae in chains, 4–8 μ m diam., smooth, hyaline. – *Clamp connections* not observed.

Habit, habitat, and distribution in the Hawaiian Islands: Common in horse and cow dung, or associated with woodchips, or on soil near woodchips. Hawai’i.

Worldwide distribution: Hawai’i, Europe, possibly Japan and East Africa [as *C. patouillardii*].

Specimens examined: USA. HAWAII: Hawai’i, DEH 000; Hawai’i, UH Agriculture Farm, 28 Mar. 1996, DEH 1084; same location, 24 Jul. 1998, DEH 1702; same location, 10 Feb. 1999, DEH 1813; same location, 12 Feb. 1999, DEH 1815; same location, 19 Aug. 1999, DEH 1829; same location, 29 Feb 2000, DEH 2071; same location 7 Jul. 2001, DEH 2073; same location, 8 Mar. 2001, DEH 2074B; same location, dung collected 21 Feb. 2001, fruited 9 Mar. 2001, DEH 2081; same location, dung collected 14 Feb. 2001, fruited 6 Jul. 2001, MRK 01; same location, dung collected 6 Jun. 2001, fruited 7 Jul. 2001, MRK 04; same location, dung collected 6 Jun. 2001, fruited 9 Jul. 2001, MRK 07; same location, dung collected 6 Jun. 2001, fruited 9 Jul. 2001, MRK 10; same location, dung collected 6 Jun. 2001, fruited 11 Jul. 2001, MRK 16; Hawai’i, Hilo, Bayfront, 23 Sep. 1999, DEH 1837; Hawai’i, Komohana Agriculture Station, 4 Sep. 2001, DEH 2128B; Hawai’i, Saddle, Parker Ranch, dung collected 6 Jun. 2001, fruited 7 Jul. 2001, MRK 06; same location, dung collected 6 Jun. 2001, fruited 9

Jul. 2001, MRK 08; same location, dung collected 6 Jun. 2001, fruited 11 Jul. 2001, MRK 15; Hawai'i, Waipio Valley, 16 Jul. 2001, MRK 27; Oahu, Nature Center, 3 Jan 2001, DEH 2046.

Notes: “*Coprinus*” *cordisporus* is one of the more common coprini in Hawai'i. The variation in overall size of the basidiomes, basidiospore shape and size, cheilocystidia shape, and substrate specificity found among members of this group in Hawai'i clearly indicate that *C. cordisporus* represents a complex of closely allied taxa. There are, however, a combination of characters that can be used to easily identify specimens as belonging to the complex. Of the small coprini found on dung, members of the *C. cordisporus* complex are recognized by their granular, sugar-like veil, and flattened, heart-shaped to pear-shaped or flask-shaped basidiospores. Other small coprophiles lack a veil and have pileus setules (e.g., *Coprinellus pellucidus*), or have a floccose, non-granular veil (e.g., *Coprinopsis radiata*, *C. villosa* nom. prov.). The only small coprinoid taxon that could be confused with *C. cordisporus* macroscopically is *Coprinopsis stercorea*. The latter species is easily distinguished microscopically by the verrucose ornamentation on its veil cells and its ellipsoid rather than heart-shaped basidiospores. It is also possible to recognize *C. stercorea* in the field by its somewhat shaggy-granular rather than purely granular veil. The *C. cordisporus* complex members have fibrillose veil elements only near the edges of the mature pileus, whereas *C. stercorea* has fibrillose veil elements covering the pileus and stipe throughout development. The “*Coprinus*” *cordisporus* complex contains the only coprinoid taxa with a granular veil lacking pileus setules that occur on woodchips in Hawai'i.

Coprinus cordisporus is described as forming relatively large basidiomes, relatively large and darkly pigmented basidiospores that are apple- or lemon-shaped, distinctly lageniform cheilocystidia, and grows only on dung (Uljé and Noordeloos 1993). *Coprinus cardiasporus* is distinguished by a smaller basidiome, smaller, paler and more flask-shaped basidiospores, a lack of lageniform cheilocystidia, and a habitat that includes dung mixed with woodchips or compost, or grows strictly on wood (Uljé and Noordeloos, 1993). These ecological and morphological features used to distinguish *C. cordisporus* from *C. cardiasporus* appear to be inconsistent and overlapping among the 22 Hawaiian collections in this group. Hawaiian collections show mixtures of the above characters such that a given collection represents certain features of *C. cordisporus* and certain features of *C. cardiasporus* (Table 3).

An attempt was made to separate members of this complex into the closely allied European taxa *C. cordisporus* and *C. cardiasporus* using molecular data (ITS sequences). A total of 18 sequences representing the *C. cordisporus*/*C. cardiasporus* complex, 12 other coprinoid taxa, and three non-coprinoid taxa were used in the analysis (Table 4). The phylogenetic analyses of ITS sequence data resulted in 655 equally most parsimonious trees (MPTs).

Table 3. Morphological features and substrate specificities of collections within the *C. cordisporus*-*C. cardiasporus* complex.

Collection	Pileus diameter (mm)	Substrate	Spore Size (µm)	Spore Shape (face view)	Cheilocystidia
<i>C. cordisporus</i> (O&W)	5-10	fresh dung	(6-)6.5-8.5(-9) x 4-5 x 5.5-7	subglobose-triangular or ± pentagonal	cylindric-ovoid or broadly lageniform
<i>C. cordisporus</i> (U&N)	up to 25	dung	7.3-11.6 x 6.5-10.1	rectangular lemon-shaped, lentiform	utriform, subglobose to ellipsoid or subcylindric mixed with lageniform
<i>C. cardiasporus</i> (U&N)	up to 10	compost/horse dung mixed with wood chips	5.5-8.5 x 4.8-6.5 x 3.7-4.5	cordiform, lentiform	subglobose, ellipsoid or utriform
DEH 000	up to 5	dung	6.4-7.2 x 5.2-6.8	more apple shaped	subglobose, ellipsoid or utriform
DEH 1084	up to 19	wood chips	7.2-9.6 x 6.4-8.4	more apple-shaped	not observed
DEH 1702	up to 20	wood chips	8.0-10.4 x 7.2-9.6	more apple-shaped	not observed
DEH 1813	up to 15	cow dung	7.6-9.2 x 6.8-8.0	more apple-shaped	not observed
DEH 1815	up to 10	cow dung	6.4-8.0 x 6.0-7.6 x 4.4-5.2	more apple-shaped	not observed
DEH 1829	up to 7 (X)	cow dung	6.8-8.0 x 6.4-8.0 x 3.6-4.4	more apple-shaped	utriform, subglobose to ellipsoid or subcylindric mixed with lageniform
DEH 1837	up to 13	woodchips	6.8-9.6 x 5.2-7.6	more apple-shaped	subglobose, ellipsoid or utriform
DEH 2046	up to 12	fertilized soil	6.6-7.6 x 6.0-6.8	more apple-shaped	not observed
DEH 2071	up to 15	horse dung	5.6-7.6 x 4.8-6.0 x 4.4-4.8	more flask-shaped	utriform, subglobose to ellipsoid or subcylindric mixed with lageniform
DEH 2073	up to 15	horse dung	7.2-9.6 x 6.8-8.4	more apple-shaped	utriform, subglobose to ellipsoid or subcylindric mixed with lageniform
DEH 2074 B	4	horse dung	6.4-8 x 5.2-6.8	more flask-shaped	subglobose, ellipsoid or utriform
DEH 2081	up to 10	dung	6.4-7.6 x 5.6-6.8	more apple-shaped	utriform, subglobose to ellipsoid or subcylindric mixed with lageniform
DEH 2128 B	up to 12	woodchips	7.6-8.8 x 6.8-7.6	more apple-shaped	not observed
MRK 1	up to 10	horse dung	6-8 x 5-8	more apple-shaped	not observed
MRK 4	5	horse dung	6.0-8.8 x 5.2-6.8	more flask-shaped	not observed
MRK 6	4	horse dung	6.4-8.8 x 5.2-6.8	more flask-shaped	not observed
MRK 7	up to 7	horse dung	6.4-7.2 x 4.8-6.8	more flask-shaped	not observed
MRK 8	up to 8	horse dung	6-7.5 x 5.5-6 x 4-4.5	more flask-shaped	utriform, subglobose to ellipsoid or subcylindric mixed with lageniform
MRK 10	up to 3	horse dung	6.0-8.4 x 4.8-6.4	more flask-shaped	not observed
MRK 15	up to 5+	horse dung	5.6-8.0 x 4.8-6.8	more flask-shaped	utriform, subglobose to ellipsoid or subcylindric mixed with lageniform
MRK 16	up to 4+	horse dung	6.0-8.0 x 5.2-6.0	more flask-shaped	not observed
MRK 27	up to 8	horse dung	7.2-8.0 x 5.6-6.8	more apple shaped	subglobose, ellipsoid or utriform

Dark-shaded boxes represent *C. cardiasporus*-like features, whereas unshaded boxes represent *C. cordisporus*-like features sensu Uljé and Noordeloos (1993: 286-292). O&W = Orton and Watling (1979). U&N = Uljé and Noordeloos (1993).

Table 4. List of the *Coprinus cordisporus* / *cardiasporus* complex members and outgroup taxa included in the analysis of ITS sequence data including available GenBank accession numbers.

Species	Collection	Geographic Location	Gen Bank Acc. No.
<i>Coprinellus curtus</i>	DEH 630	Hawai'i	AY461834
<i>Coprinellus curtus</i>	DEH 2064	Hawai'i	AY461824
<i>Coprinellus disseminatus</i>	MRK 18	Hawai'i	AY461838
<i>Coprinellus micaceus</i>	DEH 351	Hawai'i	AY461832
<i>Coprinellus micaceus</i>	KACC 500403	Korea	AF345808
<i>Coprinellus radians</i>	DEH 1026	Hawai'i	AY461815
<i>Coprinellus radians</i>	DEH 1765	Hawai'i	AY461818
<i>Coprinellus radians</i>	KACC 49348	Korea	AF345822
<i>Coprinopsis cinerea</i>	DEH 2065	Hawai'i	AY461825
<i>Coprinopsis cothurnata</i>	DEH 548	Hawai'i	AY461833
<i>Coprinopsis stercorea</i>	DEH 2074A	Hawai'i	AY461828
<i>Coprinopsis stercorea</i>	MRK 37	Hawai'i	AY461839
<i>Coprinus cardiasporus</i>	Uljé 1100	Netherlands	AY461841
<i>Coprinus cordisporus</i>	Uljé 1058	Netherlands	AY461840
<i>Coprinus cordisporus</i> complex	DEH 000	Hawai'i	AY461814
<i>Coprinus cordisporus</i> complex	DEH 1084	Hawai'i	AY461816
<i>Coprinus cordisporus</i> complex	DEH 1702	Hawai'i	AY461817
<i>Coprinus cordisporus</i> complex	DEH 1813	Hawai'i	AY461819
<i>Coprinus cordisporus</i> complex	DEH 1815	Hawai'i	AY461820
<i>Coprinus cordisporus</i> complex	DEH 1829	Hawai'i	AY461821
<i>Coprinus cordisporus</i> complex	DEH 1837	Hawai'i	AY461822
<i>Coprinus cordisporus</i> complex	DEH 2046	Hawai'i	AY461823
<i>Coprinus cordisporus</i> complex	DEH 2071	Hawai'i	AY461826
<i>Coprinus cordisporus</i> complex	DEH 2073	Hawai'i	AY461827
<i>Coprinus cordisporus</i> complex	DEH 2074B	Hawai'i	AY461829
<i>Coprinus cordisporus</i> complex	DEH 2081	Hawai'i	AY461830
<i>Coprinus cordisporus</i> complex	DEH 2128B	Hawai'i	AY461831
<i>Coprinus cordisporus</i> complex	MRK 04	Hawai'i	AY461835
<i>Coprinus cordisporus</i> complex	MRK 06	Hawai'i	AY461836
<i>Coprinus cordisporus</i> complex	MRK 16	Hawai'i	AY461837
<i>Hypholoma fasciculare</i>	CFB 739	Spain	AY004235
<i>Psathyrella candolleana</i>	KACC 500091	Korea	AF345810
<i>Psathyrella velutina</i>	KACC 500079	Korea	AF345811

The strict consensus of those trees with corresponding bootstrap values is presented in Figure 16C.

A Maximum Likelihood (ML) analysis of hierarchical substitution models resulted in the following data that were used for pairwise comparison of likelihood models:

Pairwise Comparison of Likelihood Models	$-\ln L_0$	$-\ln L_1$	$-2\ln\Delta$	df	Critical Value	H_0
JC69 vs. F81	4839.56990	4817.51151	44.17	3	7.8	rejected
F81 vs. HKY85	4817.51151	4765.18610	104.7	1	3.8	rejected
HKY85 vs. HKY85 + Γ	4765.18610	4531.03579	468.3	1	3.8	rejected

Based on these data, the HKY85 + Γ model is clearly statistically better than the other likelihood models in evaluating this data set. Therefore, likelihood scores were computed for each of the 655 MPTs using the Shimodara-Hasegawa test set to incorporate the parameters of the HKY85 + Γ likelihood model. The 655 likelihood scores obtained indicate that no one of the 655 MPTs is statistically worse than the best of the 655 trees (ML score of the best tree = 4530.79948; ML score of the worst tree = 4539.39839).

The European *C. cordisporus* and *C. cardiasporus* specimens and all of the Hawaiian specimens determined as belonging to this complex based on morphology, belong to a single monophyletic clade with 100% bootstrap support (Fig. 16C). One of the 655 trees has been selected (Fig. 16D) which shows a clade containing all 4 of the woodchip inhabiting *C. cordisporus* collections from Hawai'i and the non-dung-inhabiting European *C. cardiasporus* collection (see also Fig. 16Eb). This substrate-specific clade represents the only pattern that has emerged. The *C. cordisporus* clade of the selected tree has been mapped to show the distribution of the five morphological and ecological characters outlined in Table 3 and is presented in Figures 16E–G. None of the basidiome, basidiospore, or cystidial characters traditionally used to distinguish *C. cordisporus* from *C. cardiasporus* appears to be useful in differentiating these two species, or in understanding relationships within the molecular-based phylogeny.

While the ITS sequence data fail to provide a straightforward way to separate members of the *C. cordisporus*/*C. cardiasporus* complex, the data do support the notion that there exist multiple discrete groups within the complex and that those groups may, in fact, represent as many as four distinct taxa. The morphological and ecological features that could be used to define these taxa are unclear, but there does seem to be an alliance between the woodchip-inhabiting individuals suggesting that substrate specificity may be an important taxonomic tool. Based on the molecular, morphological, and ecological data

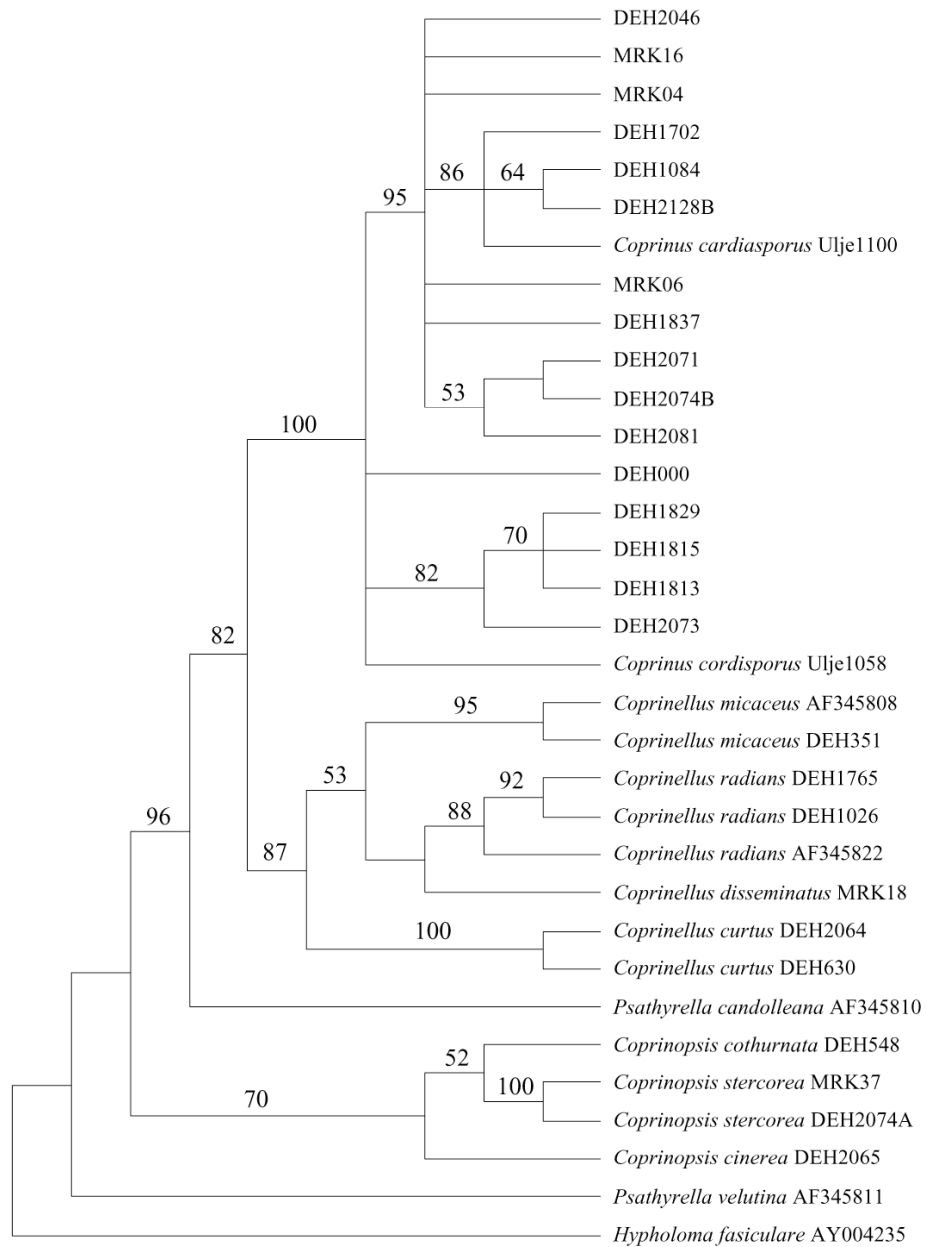

Fig. 16C. Strict consensus of 655 MPTs generated from ITS1–5.8S–ITS2 sequence data. Bootstrap values after 100 replicates are indicated above branches. Taxa with only collection numbers represent the Hawaiian *C. cordisporus* complex members. Refer to Table 4 for distribution data and GenBank accession numbers.

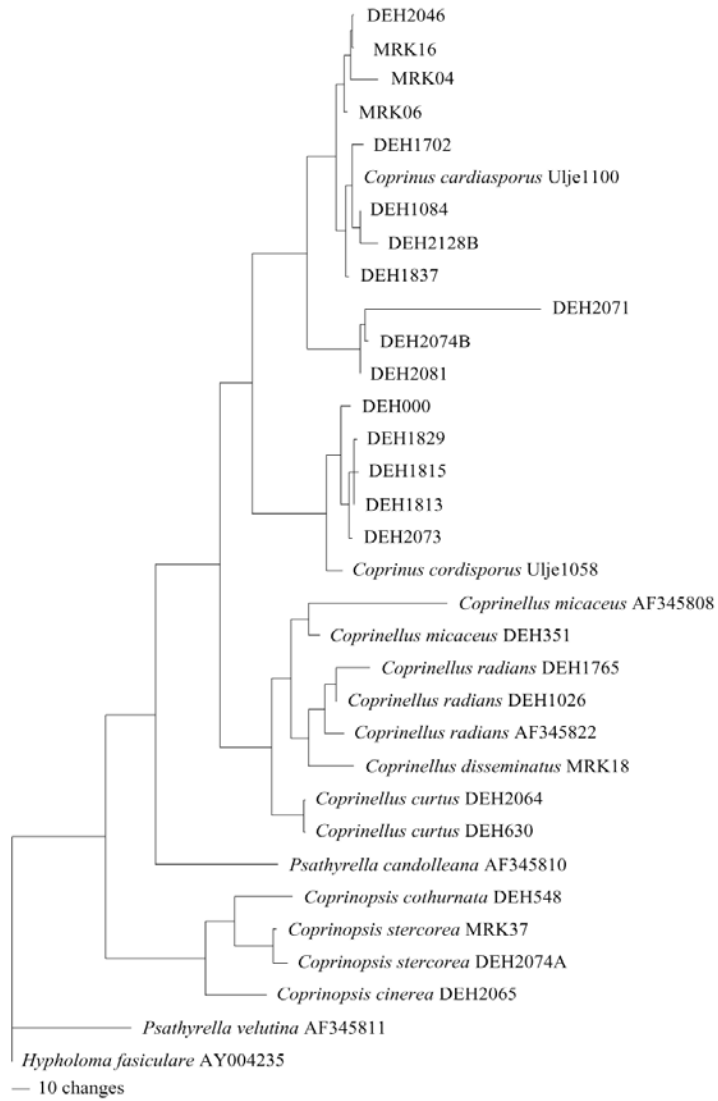

Fig. 16D. One of 655 MPTs of length = 809, generated from ITS1–5.8S–ITS2 sequence data. Taxa with only collection numbers represent the Hawaiian *C. cordisporus* complex members. Refer to Table 4 for distribution data and GenBank accession numbers.

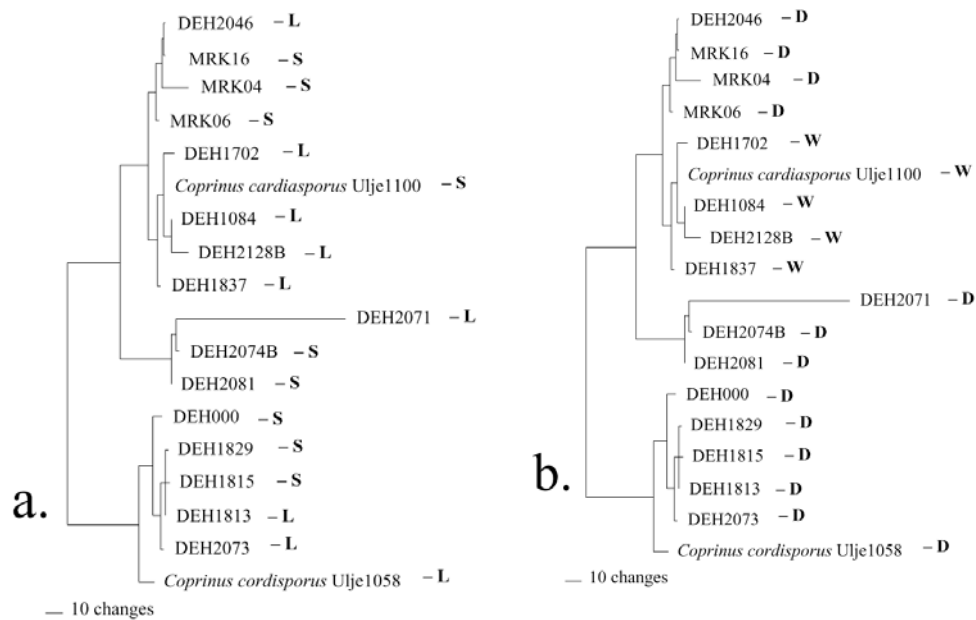

Fig. 16E. a. *C. cordisporus* complex phylogram with the distribution of pileus diameter size mapped; small pileus (-S; up to 10 mm diam.); large pileus (-L; 11–20 mm diam.). Note: differences in pileus size appear dispersed across multiple clades. **b.** *C. cordisporus* complex phylogram with the distribution of substrate mapped; dung (-D); woodchips (-W). Note: substrate type appears to be clade specific.

available at this time, the decision was made to treat all 22 Hawaiian collections as *C. cordisporus*, the oldest available epithet, and consider *C. cardisporus* to be a taxonomic synonym.

In addition, there has existed confusion regarding the taxonomic placement of *C. cordisporus* at the generic level. *Coprinus cordisporus* has been traditionally classified in *Coprinus* section *Vestiti* based on the presence of globose veil cells and a radially filamentous pileipellis. Molecular

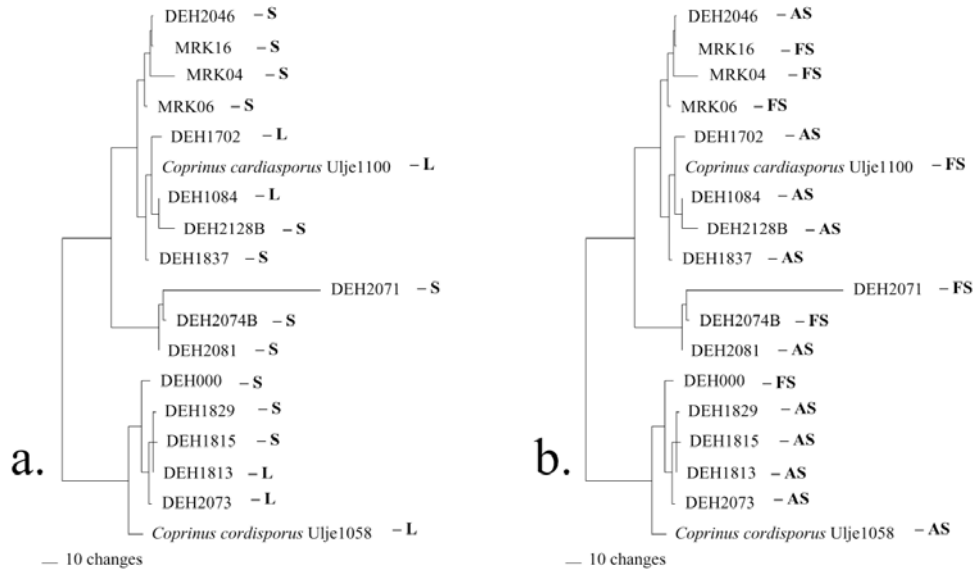

Fig. 16F. a. *C. cordisporus* complex phylogram with the distribution of basidiospore size range mapped; small basidiospore size range (-S; $5.6\text{--}9.6 \times 4.8\text{--}7.6 \mu\text{m}$); large basidiospore size range (-L; $7.2\text{--}10.4 \times 5.6\text{--}9.6 \mu\text{m}$). Note: differences in basidiospore size appear dispersed across multiple clades. **b.** *C. cordisporus* complex phylogram with the distribution of basidiospore shape mapped; apple-shaped (-AS; see Fig. 16: 2a); flask-shaped (-FS; see Fig. 16: 2b). Note: differences in basidiospore shape appear dispersed across multiple clades.

phylogenies of the coprini using sequence data from the nLSU-rDNA region have placed other members of section Vestiti in the *Coprinopsis* clade (Hopple & Vilgalys, 1999; Moncalvo *et al.*, 2002). In these publications, however, *C. cordisporus* appears as either sister to *Coprinellus curtus* (Hopple & Vilgalys, 1999) or on a separate branch but still distinctly within a *Coprinellus/Psathyrella* pro parte clade (Moncalvo *et al.*, 2002). Our ITS data place the *C. cordisporus/C. cardiasporus* complex as sister to a *Coprinellus* clade with 82% bootstrap support. This creates an anatomical anomaly between *C. cordisporus* and its apparent *Coprinellus* allies. All known *Coprinellus* species have a cellular pileipellis, whereas the *C. cordisporus* clade members have a cutis-type pileipellis. Redhead *et al.* (2001) chose to not transfer *C. cordisporus* to *Coprinopsis* (where other members of the section Vestiti were transferred) or to the genus *Coprinellus* because of the discrepancy between

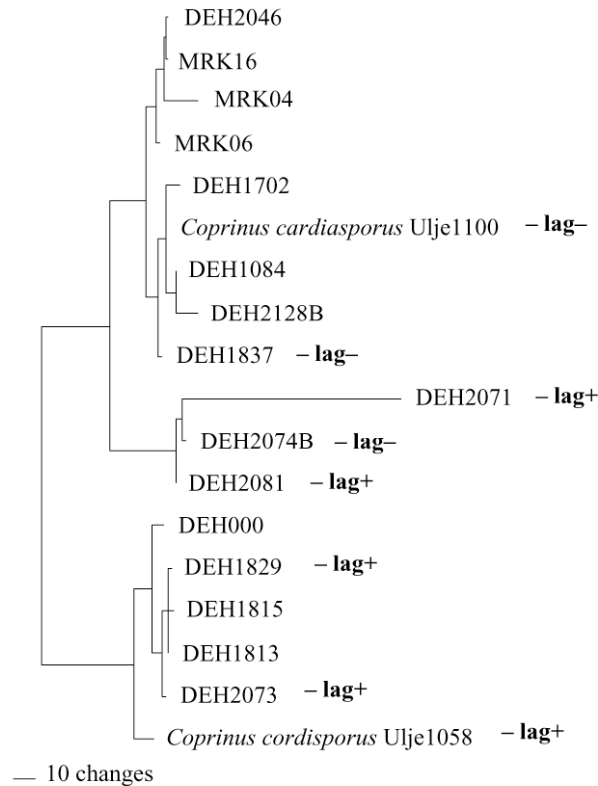

Fig. 16G. *C. cordisporus* complex phylogram with the distribution of cheilocystidia type mapped; subglobose, ellipsoid or utriform without lageniform (**-lag-**); subglobose ellipsoid or utriform mixed with lageniform (**-lag+**). Cystidial characters were observable only in certain collections. Note: differences in cheilocystidia shape appear dispersed across multiple clades.

morphological and molecular data. In addition, Redhead *et al.* (2001) report *Psathyrella candolleana* as nested between *Coprinellus* and *C. cordisporus* based on Moncalvo *et al.* (2002; unpublished when reported). ITS data in our study support *Psathyrella candolleana* as sister to a clade containing *Coprinellus* species plus the *C. cordisporus* complex with 96% bootstrap support (Fig. 16C). However, because of morphological discrepancies, wherein the *C. cordisporus* complex is more similar to *Coprinopsis* than to *Coprinellus*, we are hesitant to formally transfer *C. cordisporus* to the genus *Coprinellus*. In addition, the *C. cordisporus* clade in our study is sister to multiple species of

Coprinellus, and not nested amongst them. These data suggest that *C. cordisporus* and its allies may represent a distinct coprinoid lineage worthy of generic recognition.

Coprinellus P. Karst., *Bidrag Kännedom Finlands Natur Folk* 32: 542. 1879.

Type: *C. deliquescens* (Bull.: Fr.) P. Karst.

17. *Coprinellus radians* (Desm.) Vilgalys, Hoppole & Jac. Johnson, *Taxon* 50: 234. 2001. (Fig. 17)

≡ *Agaricus radians* Desm., *Ann. Sci. Nat. (Paris)* 13: 214, tab. 10, fig. 1. 1828.

≡ *Coprinus radians* (Desm.) Fr., *Epicr. Syst. Mycol.* 248. 1838.

Reported synonyms:

= *Coprinus similis* Berk. & Broome, *Ann. Mag. Nat. His. Ser. 3*, 15: 317. 1865.

= *Coprinus horotum* Métrod, *Rev. Mycol.* 5: 80. 1940.

Selected descriptions and icones: Uljé (2003); Orton and Watling (1979: 59, pls. 105, 114); Moser (1978: 261); Kühner and Romagnesi (1974: 383, pl. 529).

Pileus 10–27 (–32) mm diam. × 15–20 mm height at maturity, at first cylindrical to paraboloid or ovoid, becoming conical to campanulate, striate to plicate to disc, covered with dark reddish brown (8F4) floccose squamules or conical tufts near disc and white mica-like flecks throughout; pileus surface when young pinkish white to brownish orange (6C3) becoming grayish orange (5B3) to dark brown (6F8) or pastel red (8A4) at disc, gradating to light brown (7D5) at margin or dark brown (6F8) to gray with age, rapidly deliquescing; context 0.1–2 mm thick, buff-colored or same as surface color. – *Odor* and taste not distinctive. – *Lamellae* medium close to close with up to 5 or 6 series of lamellulae, adnexed to almost free, 1–5 mm broad, white becoming black in age. – *Stipe* 30–60 × 2–4 (–9) mm at maturity, equal to tapering upwards, glabrous, smooth or finely longitudinally sulcate, white, with sheathed or ridged bulbous base, almost volva-like. – *Annulus* absent. – Dark orange to reddish-golden *ozonium* present around the stipe base often covering a large area on the substrate.

Basidiospores (6–) 6.4–10.2 (–12.2) × (3.2–) 3.6–5.1 (–6.0) μm [$\bar{x}_r = 7.0\text{--}9.8 \times 3.6\text{--}5.1$ μm, $\bar{x}_m = 7.8 \pm 1.2 \times 4.2 \pm 0.6$ μm, Q = 1.4–2.3, $\bar{Q}_r = 1.7\text{--}2.0$, $\bar{Q}_m = 1.8 \pm 0.1$, n = 20 basidiospores per 5 collections], ellipsoid to elongate in face view, to phaseoliform in side view, smooth, apiculus not visible, with a broad central germ pore often appearing truncate, pale to dark gray or earth brown. – *Basidia* 15–20 × 5–8 μm, clavate, 4-spored. – *Brachybasidia* 6–12 × 7–10 μm, subglobose. – *Cheilocystidia* 16–45 μm diam., broadly clavate, globose to sphaeropedunculate, thin-walled, hyaline. –

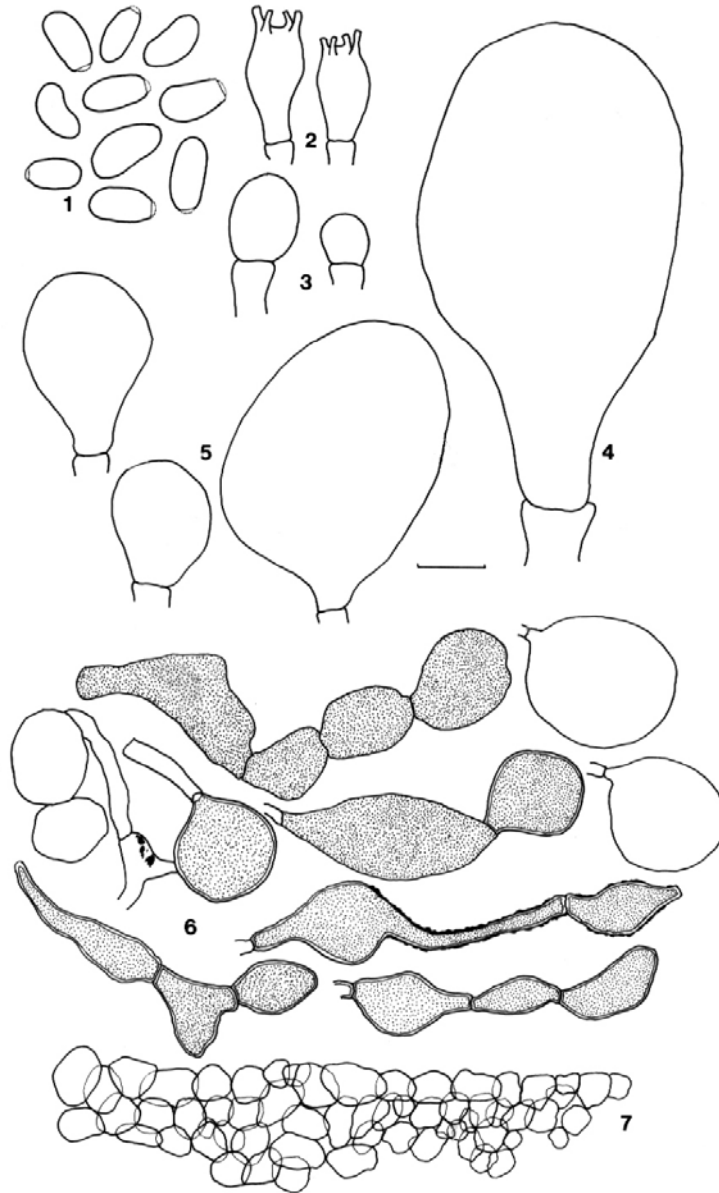

Fig. 17. *Coprinellus radians* (DEH 1765). 1. Basidiospores. 2. Basidia. 3. Brachybasidia. 4. Pleurocystidium. 5. Cheilocystidia. 6. Universal veil. 7. Pileipellis. Bars: 1–6 = 10 μ m, 7 = 20 μ m.

Pleurocystidia 32–62 (–75) μm diam., voluminous, ellipsoid-pedicellate to vesiculose, otherwise like cheilocystidia. – *Pileipellis* an epithellium of loosely arranged globose cells 5–20 μm diam. – *Universal veil* elements ranging from globose to ovoid or fusoid, as terminal cells on narrow hyphae or as chains of cells, thin- to thick-walled, mostly brown and roughened, pigment intraparietal and incrusting, some nearly hyaline and smooth, 16–40 μm diam. – *Clamp connections* absent. – *Ozonium* hyphae 12–50 \times 1–3 μm , associated with base of stipe cylindrical, tightly appressed.

Habit, habitat, and distribution in the Hawaiian Islands: Solitary to clustered on fallen branches and logs of naio (*Myoporum sandwicense* A. Gray) in Mamane-Naio Native Forest; and on branches or stumps of monkey pod (*Samanea saman* (Jacq.) Merr.) or gunpowder tree (*Trema orientalis* (L.) Blume) in Alien Wet Forest. Hawai'i.

Worldwide distribution: Europe, North America, Australia, Japan, Hawai'i.

Specimens examined: USA. HAWAII: Hawai'i, Pu'u La'au, 30 Jan. 1996, DEH 1026; Hawai'i, Waipio Valley, 10 Dec. 1996, DEH 1361; same location, 5 Jan. 1997, DEH 1410; Hawai'i, windward side of Mauna Kea between Parker Ranch and Military, 2 Dec. 1998, DEH 1765; Hawai'i, Hilo, UHH campus, 25 Jul. 1999, DEH 1826.

Notes: *Coprinellus radians* is conspicuous among the Hawaiian coprini by its distinctive rust-colored ozonium and a veil of dark brown tufts and white mica-like flecks. It has been collected from fallen naio branches in dry montane forests on the windward side of Mauna Loa making it one of only three coprini that have been found in native Hawaiian forest habitats. It has also been found in alien wet forests.

18. *Coprinellus micaceus* (Bull.: Fr.) Vilgalys, Hopple & Jac. Johnson, *Taxon* 50: 234. 2001. (Fig. 18)

≡ *Agaricus micaceus* Bull., *Herb. France* pl. 246 [text on plate]. 1786.

≡ *Agaricus micaceus* Bull.: Fr., *Syst. Mycol.* I: 309. 1821.

≡ *Coprinus micaceus* (Bull.: Fr.) Fr., *Epicr. Syst. Mycol.* 247. 1838.

Selected descriptions and icones: Hemmes and Desjardin (2002: 127); Uljé (2003); Breitenbach and Kränzlin (1995: 244, pl. 294); Orton and Watling (1979: 54, pls. 100, 106, 112); Moser (1978: 261); Kühner and Romagnesi (1974: 382).

Pileus 10–24 mm diam. \times 10–20 mm height, obtusely cylindrical when young, expanding to convex, campanulate or planar-convex in age, striate to the disc; surface covered by small, white, mica-like flecks or granules, these in clusters at first then diffuse in age, detersile, becoming glabrous at maturity, moist; at first light brown (6–7D4–6) overall, disc remaining so through maturity, margin fading to tan or cream buff, as basidiospores mature and

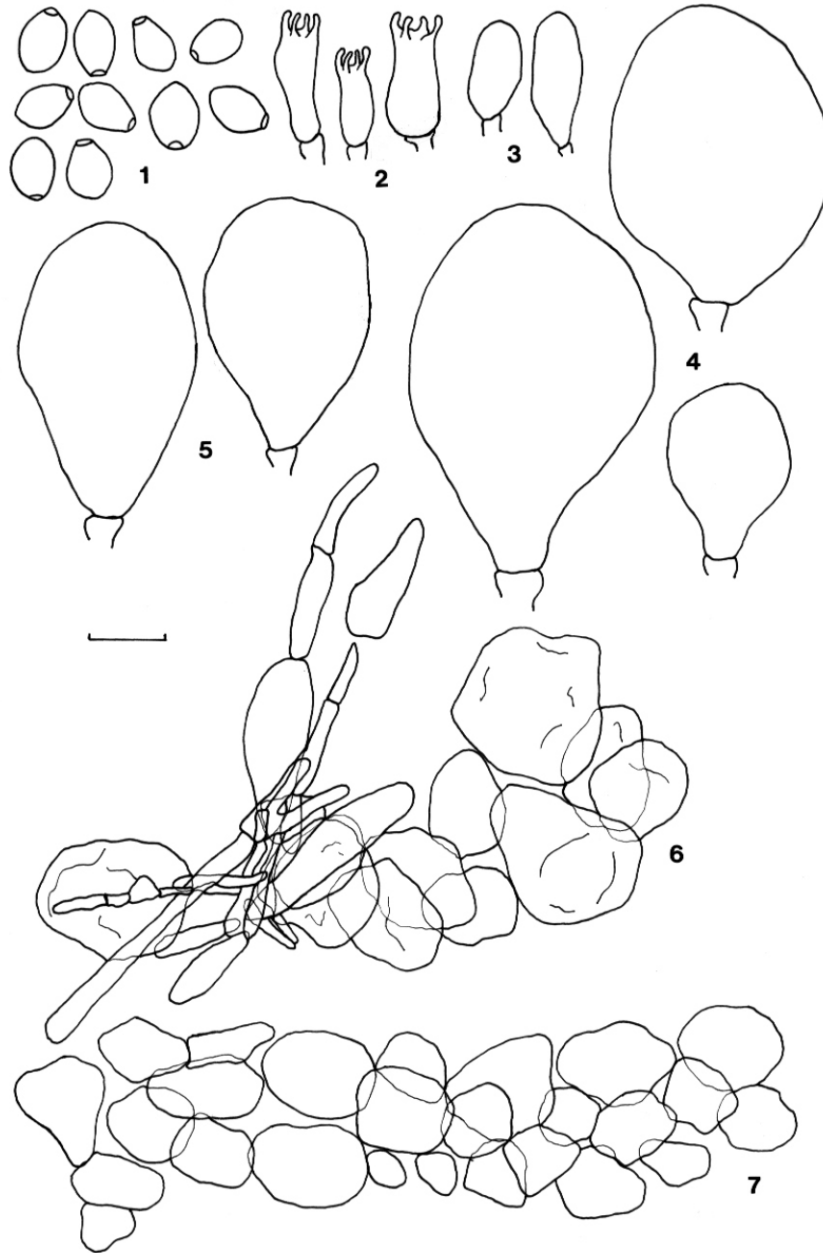

Fig 18. *Coprinellus micaceus* (DED 6373). 1. Basidiospores. 2. Basidia. 3. Brachybasidia. 4. Pleurocystidia. 5. Cheilocystidia. 6. Universal veil elements. 7. Pileipellis. Bars: 1–5 = 10 μm , 6–7 = 20 μm .

pileus deliquesces, color darkens to dark brown or black, pileus context 1–1.5 mm thick, same color as surface. – *Odor* mild or not distinctive. – *Lamellae* ascending, free, close to crowded, broad (2–4 mm), white becoming black. – *Stipe* 28–55 × 2–3 mm, tomentose to smooth, equal or narrowed upwards, white overall, base bruising pale grayish brown. – *Annulus* and *volva* absent.

Basidiospores (6.8–) 7.2–9.2 (–10.4) × (4.8–) 5.2–6 (–6.5) μm [$\bar{x}_r = 8.0\text{--}8.8 \times 5.4\text{--}5.7 \mu\text{m}$, $\bar{x}_m = 8.4 \pm 0.4 \times 5.6 \pm 0.1 \mu\text{m}$, $Q = 1.3\text{--}1.9$, $Q_r = 1.5$, $Q_m = 1.5 \pm 0$, $n = 20$ basidiospores per 3 collections], ellipsoid to amygdaliform in side view, lacrimiform to submitriform in face view, often slightly conical towards base, apiculus sometimes visible, with a prominent, large, central germ pore, slightly truncate, smooth, pale to dark gray or yellowish brown. – *Basidia* 10–15 × 4–7 μm , clavate, 4-spored. – *Brachybasidia* 10–17 × 5–8 μm , clavate. – *Cheilocystidia* 30–40 × 20–25 μm , vesiculose. – *Pleurocystidia* 20–50 × 15–30 μm , broadly clavate to vesiculose, voluminous, readily collapsing. – *Pileipellis* an epithelium of loosely arranged globose cells 10–50 (–60) μm diam. – *Universal veil* composed of chains of cylindrical to somewhat inflated cells 15–70 × 5–15 μm , often tapering near the tips of the chains, interspersed with globose cells 10–50 μm diam. – *Caulocystidia* scattered, often rare, 60–100 × 5–10 μm , cylindrical to fusoid or narrowly lageniform with a long neck, thin-walled. – *Clamp connections* not observed.

Habit, habitat, and distribution in the Hawaiian Islands: Clustered on fallen alien logs including *Widdingtonia* (Chinese Fir), decayed wood fragments and bark of koa under karakanut (*Corynocarpus laevigatus* J.R. & G. Forst.), ohia (*Meterosideros polymorpha* Gaud.) and koa (*Acacia koa* Gray) in Montane Wet Ohia Forest with scattered alien plants. Kauai.

Worldwide distribution: Europe, Australia, East Africa, North America, South America, Japan, Hawaii.

Specimens examined: USA. HAWAII: Kauai, Kokee, 5 Jan. 1994, DEH 351; Kauai, Kuia Natural Area Reserve, Nualolo Trail, 4 Jan. 1995, DEH 685; same location, 8 Jan. 1996, DED 6373.

Notes: *Coprinellus micaceus* is one of three species in *Coprinus* s.l. section Micacei found on fallen logs in Hawaii. It is distinguished easily from *C. radians*, because the latter has pigmented veil elements and is associated with a rust-colored ozonium. *Coprinellus micaceus* is, however, very similar to *C. truncorum* which actually might represent a synonym of *C. micaceus* (see below). *Coprinellus micaceus* is distinguished morphologically from *C. truncorum* by the presence of caulocystidia (which may be sparse or almost non-existent in some individuals), and by submitriform-subtruncate basidiospores. In contrast, *C. truncorum* lacks caulocystidia and has ellipsoid and non-truncate basidiospores. Additionally, we have noticed that *C. micaceus* typically has more brown tones in the disc and a more clustered

growth habit, while *C. truncorum* has more gray tones in the disc and a more dispersed growth habit. It should be noted that collections numbered DEH 6373 (herein determined as *C. micaceus*), DEH 627 and DEH 953 (both herein determined as *C. truncorum*) had identical ITS1-5.8S-ITS2 sequences (Ko *et al.*, 2001), indicating that there is no genetic variation between these morphologically distinct specimens at loci that are traditionally used to distinguish species or populations within species. Until further molecular data become available from numerous geographically distinct populations from which the potential conspecificity of these two taxa can be evaluated, we will accept the epithets as representing two distinct morphological species.

19. *Coprinellus truncorum* (Scop.: Fr.) Redhead, Vilgalys & Moncalvo, Taxon 50: 235. 2001. (Fig. 19)

≡ *Agaricus truncorum* Scop., Flora Carniolica (ed. 2) 2: 426. 1772.

≡ *Coprinus truncorum* (Scop.) Fr., Epicr. Syst. Mycol. 248. 1838.

Misapplied name:

Coprinus micaceus sensu Cleland, Trans. Roy. Soc. South Australia 47: 63.1923; *ibid.* 48: 243. 1924.

Selected descriptions and icones: Hemmes and Desjardin (2002: 127); Uljé (2003); Orton and Watling (1979: 55–56, pl. 101); Moser (1978: 260); Kühner and Romagnesi (1974: 382).

Pileus convex, flattened at disc, 14 mm diam. × 14 mm height in primordia, 25–35 mm diam. × 15–18 mm in height at maturity, broadly convex at maturity, finely plicate, covered with clusters of mica-like flecks or sugar-like granules that slough off mature specimens, grayish orange (5B3) to light brown (6D5), becoming brown (6E6–7) to brownish orange (6C5) at the disc, gradating to grayish orange (5B3) or brownish orange (6C3) and then brownish gray (6E2) at the edges, finally becoming dark brown (6F7) to black; context 0.5 mm thick, buff-color, same as surface color. – *Odor* none, *taste* mild. – *Lamellae* close with 1–4 series of lamellulae, narrowly adnexed to almost free, 2–3 mm broad, white becoming black in age. – *Stipe* 23–70 × 3–7 mm at maturity, even or tapering upwards, white, satiny, smooth, glabrous, thickening at stipe base. – *Annulus* and *volva* absent.

Basidiospores (7–) 8.6–9.2 (–9.6) × (5–) 5.6–6 (–6.5) μm [$\bar{x}_r = 8.5–8.7$ × 5.7–5.9 μm, $\bar{x}_m = 8.6 ± 0.1$ × 5.8 ± 0.1 μm, Q = 1.3–1.6, $\bar{Q}_r = 1.4–1.5$, $\bar{Q}_m = 1.5 ± 0$, n = 20 basidiospores per 3 collections], ellipsoid in all views, not distinctly lentiform, with very broad central to slightly eccentric germ pore, broadly rounded apex, not truncate, smooth, dark gray to gray brown or black. – *Basidia* 12–18 × 5–8 μm, clavate, 4-spored. – *Brachybasidia* 8–12 × 5–7 μm, clavate to ellipsoid. – *Cheilocystidia* 25–40 × 25–30 μm, abundant,

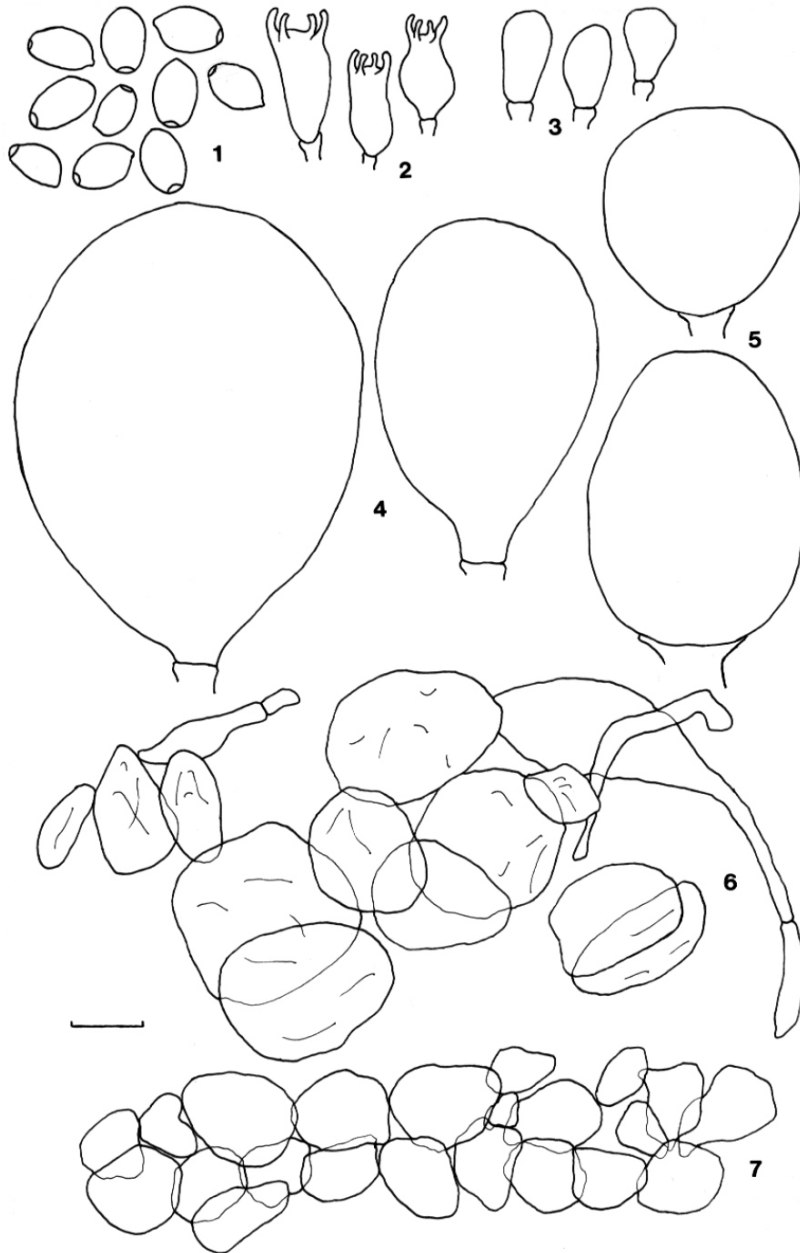

Fig. 19. *Coprinellus truncorum* (DEH 627). 1. Basidiospores. 2. Basidia. 3. Brachybasidia. 4. Pleurocystidia. 5. Cheilocystidia. 6. Universal veil elements. 7. Pileipellis. Bars: 1–5 = 10 μ m, 6–7 = 20 μ m.

Voluminous-vesiculose, to globose or ellipsoid, hyaline, readily collapsing. – *Pleurocystidia* 45–65 × 30–50 µm, similar. – *Pileipellis* an epithelium of loosely arranged globose to subglobose or broadly clavate, hyaline, thin-walled cells 10–55 (–65) µm diam. – *Universal veil* composed of thin-walled globose elements 15–50 µm diam., with scattered chains of cylindrical to somewhat inflated cells 10–100 × 5–25 µm, often tapering near the tips of the chains. – *Clamp connections* absent.

Habit, habitat, and distribution in the Hawaiian Islands: Clustered on fallen manele (*Sapindus saponaria* L.) logs in native Mesic-Montane Forest or on karakanut (*Corynocarpus laevigatus* J.R. & G. Forst.) and koa (*Acacia koa* Gray). Hawai'i and Kaua'i.

Worldwide distribution: Europe, Australia, East Africa, North America, South America, Hawai'i.

Specimens examined: USA. HAWAII: Hawai'i, 12 Sep. 1993, DEH 303; Hawai'i, Kipuka Puauulu, 25 Oct. 1994, DEH 627; Kaua'i, Koke'e, Nualolo Trail, 8 Jan. 1996, DEH 953.

Notes: *Coprinellus truncorum* is similar morphologically to *C. micaceus* but the former species can be distinguished in Hawai'i by having more grayish tones in the pileus, a more dispersed growth habit, and basidiospores that are not truncate but have a rounded apex. While *C. truncorum* from Europe is reported to lack caulocystidia, there are some Hawaiian collections which possess a few scattered stipe setules.

20. *Coprinellus pellucidus* (P. Karst.) Redhead, Vilgalys & Moncalvo, *Taxon* 50: 234. 2001. (Fig. 20)

≡ *Coprinus pellucidus* P. Karst., *Bidrag Kännedom Finlands Natur Folk* 37: 236. 1882.

Selected descriptions and icones: Uljé (2003); Uljé and Bas (1991: 325, Fig. 27); Orton and Watling (1979: 89–90, pl. 198); Moser (1978: 265); Kühner and Romagnesi (1974: 379).

Pileus 0.5–2 mm diam. × 1–3 mm height in primordia, 2–7 mm diam. × 3–10 mm in height at maturity, hemispherical to ovoid becoming paraboloid then acutely conical, margins eventually becoming revolute and splitting in age, finely plicate to the disc; primordia finely pubescent or pruinose with numerous setules dispersed over the entire pileus surface, veil remnants completely absent, dark orange (5B4) to brown (6E7) or dark brown (6F7–8) at disc, to pale orange (5A3), grayish orange (6B3) or cream-colored at the margin. – *Odor* not distinctive. – *Lamellae* subdistant to close, adnate to adnexed, white or pale gray becoming black in age. – *Stipe* 3–8 × 0.5–1 mm in primordia, 7–45 × 0.2–0.5 mm at maturity, even to somewhat tapered, longitudinally striate, translucent to white, grayish white, or brownish near base at maturity, finely pubescent to pruinose, similar to pileus, becoming

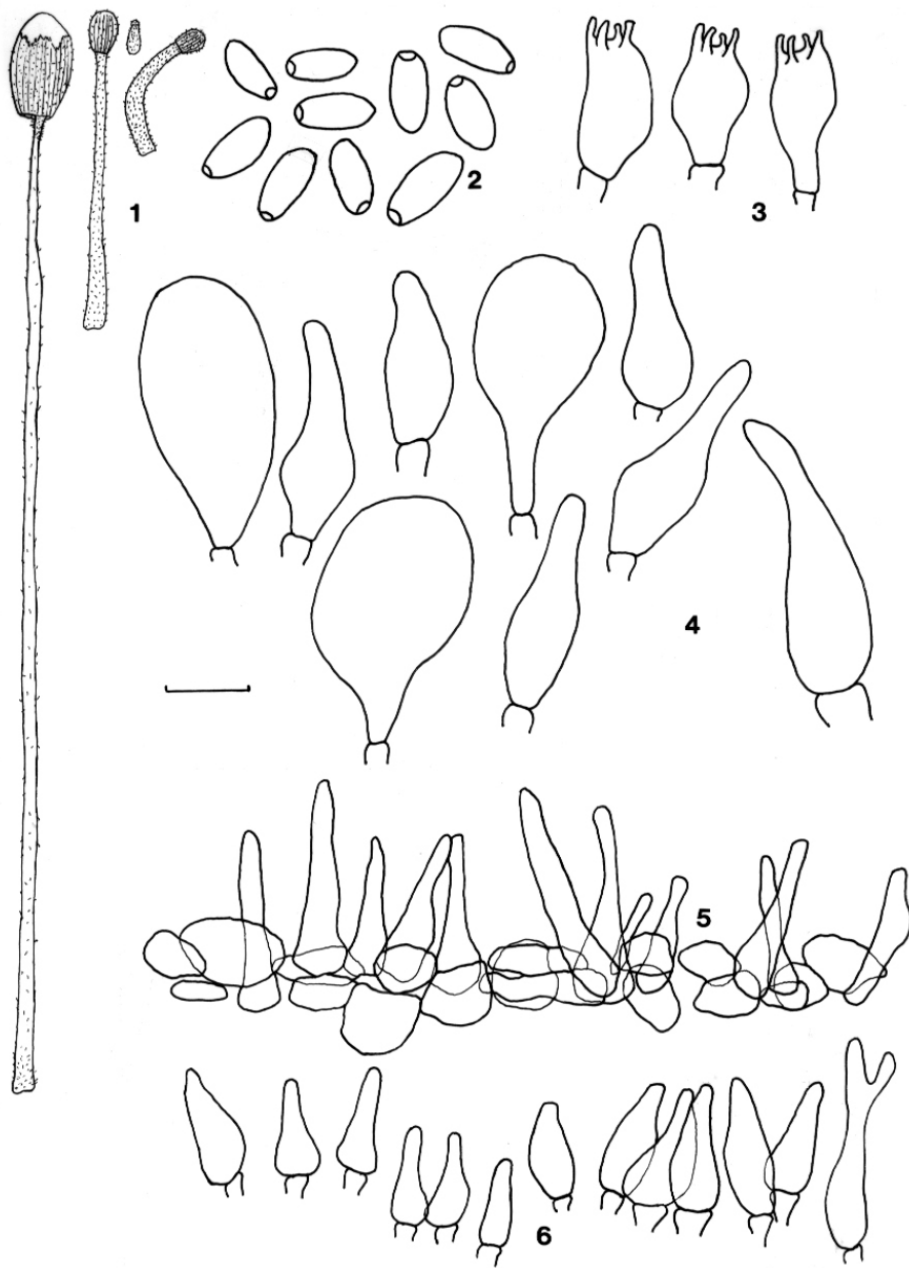

Fig. 20. *Coprinellus pellucidus*. 1. Basidiomata. 2. Basidiospores. 3. Basidia. 4. Cheilocystidia (Figs. 1–4, MRK 29). 5. Pileocystidia and pileipellis. 6. Caulocystidia (Figs. 5–6, DEH 2062). Bars: 1 = 5 mm, 2–4 = 10 μ m, 5–6 = 20 μ m.

glabrous in age except near stipe apex and base which remain pubescent. – *Annulus* and *volva* absent.

Basidiospores (6–) 7.6–10.4 (–11.6) × (3.2–) 3.6–5.2 (–6.0) μm [$\bar{x}_r = 8.0\text{--}9.8 \times 3.8\text{--}5.0$ μm, $\bar{x}_m = 9.3 \pm 0.9 \times 4.7 \pm 0.6$ μm, $Q = 1.7\text{--}2.5$, $\bar{Q}_r = 1.9\text{--}2.1$, $\bar{Q}_m = 2.1 \pm 0.1$, $n = 20$ basidiospores per 4 collections], narrowly ellipsoid to oblong or more often cylindrical in all views, truncate, apiculus not visible, with a broad central germ pore, smooth, pale gray to earth brown or cigar brown. – *Basidia* 15–20 × 7–10 μm, clavate, 4-spored. – *Brachybasidia* not observed. – *Cheilocystidia* 20–35 × 4–20 μm, numerous, globose or lageniform often intermingled or clustered and in roughly equal numbers of each form. – *Pleurocystidia* not observed. – *Pileipellis* a nearly hymeniform layer in young basidiomes becoming more an epithelium of loosely arranged subglobose cells 5–25 μm diam.; in more mature individuals, interspersed with numerous, crowded, thin-walled, hyaline, oblong to fusiform or cylindrical pileus setules (20–) 30–55 × 5–12 μm, setules with a slightly bulbous base. – *Universal veil* absent. – *Caulocystidia* 18–35 (–50) × 6–30 μm, similar to pileus setules, but somewhat smaller and less numerous in mature basidiomes, rarely bifurcating.

Habit, habitat, and distribution in the Hawaiian Islands: Common on cow and horse dung. Hawai'i.

Worldwide distribution: Europe, Australia, and Hawai'i.

Specimens examined: USA. HAWAII: Hawai'i, UHH Agriculture Farm, 10 Feb. 1999, DEH 1812; same location, 12 Feb. 1999, DEH 1814; same location, 10 Feb. 2001, DEH 2062; Hawai'i, Kalopa State Park, 4 Jul. 2002, DEH 2302; Hawai'i, Panewa Equestrian Center, dung collected 6 Jun. 2001, fruited 7 Jul. 2001, MRK 05; Hawai'i, Parker Ranch, dung collected 15 Jul. 2001, fruited 18 Jul. 2001, MRK 29.

Notes: *Coprinellus pellucidus* is distinctive because of its small stature, growth on dung, and abundant pileus setules. There are no other Hawaiian coprini found on dung that form pileus setules. The setules of *C. pellucidus* are seen easily with a hand lens making it one of only a few dung coprini in Hawai'i that can be confidently identified in the field. Its cream colored pileus devoid of any veil and the numerous cystidia on both the pileus and stipe are unmistakable.

21. *Coprinellus verrucispermus* (Joss. & Enderle) Redhead, Vilgalys & Moncalvo, *Taxon* 50: 235. 2001. (Fig. 21)

≡ *Coprinus verrucispermus* Joss., *Bull. Soc. Mycol. France* 60: 9. 1944 (invalid, no Latin description).

≡ *Coprinus verrucispermus* Joss. & Enderle in Bender & Enderle, *Z. Mykol.* 54: 67. 1988.

Selected descriptions and icones: Uljé (2003); Uljé and Bas (1991: 337–338, Fig. 35); Bender & Enderle (1988: 66–67); Bender *et al.* (1984: 31–32); Moser (1978: 264); Kühner and Romagnesi (1974: 381).

Pileus 20–35 mm diam. × 3–10 mm in height at maturity, campanulate to planar or depressed with revolute margins in age, pleated to the disc, reddish brown (8E5) at disc gradating to gray (8F1) at margin, rapidly deliquescing. – *Odor* not distinctive. – *Lamellae* medium-close with 3 series of lamellulae, narrowly adnexed to almost free, intervenose creating an undulating appearance observable through the pileus surface, 1 mm in breadth, becoming black in age. – *Stipe* up to 25–70 × 1.5–3 mm at maturity, even, glabrous, white. – *Annulus* and *volva* absent.

Basidiospores (8.8–) 11.2–14.4 (–16.0) × (6.4–) 7.2–8.8 μm , [\bar{x} = 13.3 ± 2.0 × 7.9 ± 0.7 μm , Q = 1.4–1.9, \bar{Q} = 1.7, n = 20 basidiospores per 1 collection (measurements do not include perisporial sac which may add another 0.5–3 μm to a given dimension)], ellipsoid to slightly amygdaliform, apiculus slight, with a central germ pore, often erupting through the perisporial sac adding an extra 2 μm to the length of the basidiospore, smooth, chestnut brown with hyaline to somewhat pigmented, elaborate perisporial sac causing each basidiospore to appear encased in bubble-wrap. – *Basidia*, *brachybasidia*, *cheilocystidia* and *pleurocystidia* not observed. – *Pileipellis* a cellular to hymeniform layer of globose cells 7–15 μm diam. arising vertically from subtending hyphae interspersed with thin-walled, hyaline, tapering pileus setules 35–75 in length × 5–10 (–15) μm diam., often with a bulbous base, sublageniform. – *Universal veil* absent. – *Caulocystidia* with a long tapering-neck and bulbous base, distinctly lageniform, often geniculating, 45–100 μm in length, 2–7 μm in width of neck, 14–20 μm in width of base.

Habit, habitat, and distribution in the Hawaiian Islands: Scattered on soil near woodchips in urban park. Hawai'i.

Worldwide distribution: Europe and Hawai'i.

Specimens examined: USA. HAWAII: Hawai'i, Hilo, Liliokalani Park, 28 Apr. 2000, DEH 1943.

Notes: *Coprinellus verrucispermus* is perhaps the most distinctive of all the coprini in Hawai'i when examined microscopically. Although there are two other taxa that occur on soil that superficially resemble *C. verrucispermus*, viz., *C. plagioporus* and *P. leiocephala*, there are none that have the incredibly elaborate perisporial sac with an erupting germ pore present in the basidiospores of *C. verrucispermus*. Uljé and Bas (1991) mention only two members of the genus *Coprinellus* (traditionally in *Coprinus* s.l. section *Setulosi*) with “warty” basidiospores, viz., *C. silvaticus* and *C. verrucispermus*. A perisporial sac is commonly formed by some members of the genus *Coprinopsis* (in *Coprinus* s.l. section *Vestiti*), but the numerous pileocystidia and caulocystidia as well as the clearly cellular pileipellis of *C. silvaticus* and *C. verrucispermus* place these two taxa in the genus *Coprinellus*. *Coprinellus*

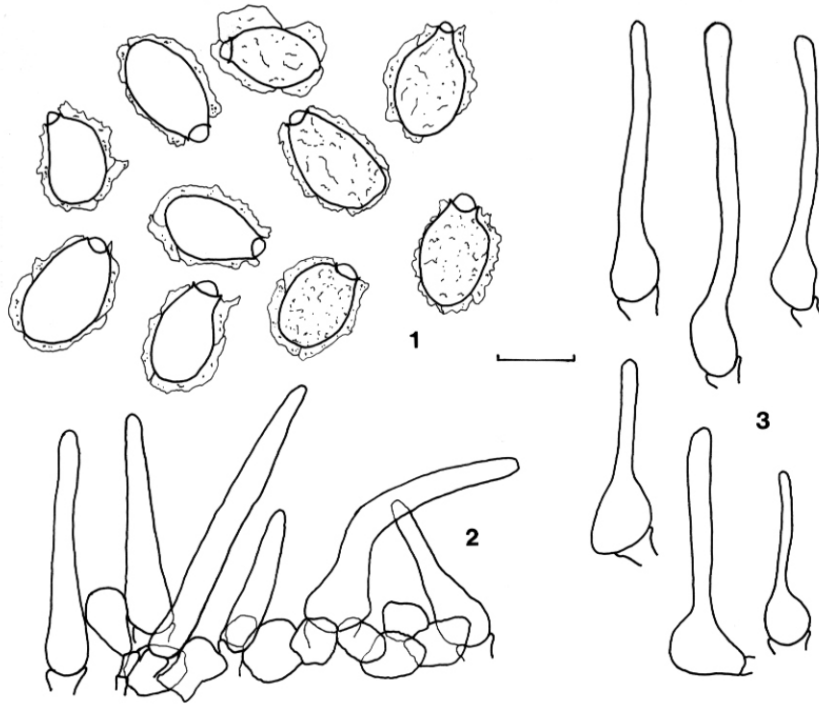

Fig. 21. *Coprinellus verrucispermus* (DEH 1943). **1.** Basidiospores. **2.** Pileocystidia and pileipellis. **3.** Caulocystidia. Bars: 1 = 10 μm , 2–3 = 20 μm .

verrucispermus is the only Hawaiian coprinoid taxon with pileus setules and basidiospores with a perispore.

22. *Coprinellus plagioporus* (Romagn.) Redhead, Vilgalys & Moncalvo, *Taxon* 50: 234. 2001. (Fig. 22)

= *Coprinus plagioporus* Romagn., *Rev. Mycol. (Paris)* 6: 121–124. 1941.

Reported synonyms:

= *C. fallax* M. Lange & A.H. Sm., *Mycologia* 45: 765. 1953.

= *C. ephemerus* f. *saturatus* J.E. Lange, *Fl. Agar. Danica* 4: 117. 1939 (nom. inval.).

Selected descriptions and icones: Uljé (2003); Uljé and Bas (1991: 307–310, Fig. 17); Orton and Watling (1979: 95–96, pl. 206); Moser (1978: 265); Kühner and Romagnesi (1974: 380, pl. 521).

Pileus up to 23 mm diam. \times 3–10 mm in height at maturity, conical to broadly convex becoming planar, strongly plicate to the disc, brown (7E7) to dark brown (8F4) at the disc, light brown (7D2) or brownish gray (8F2) on the

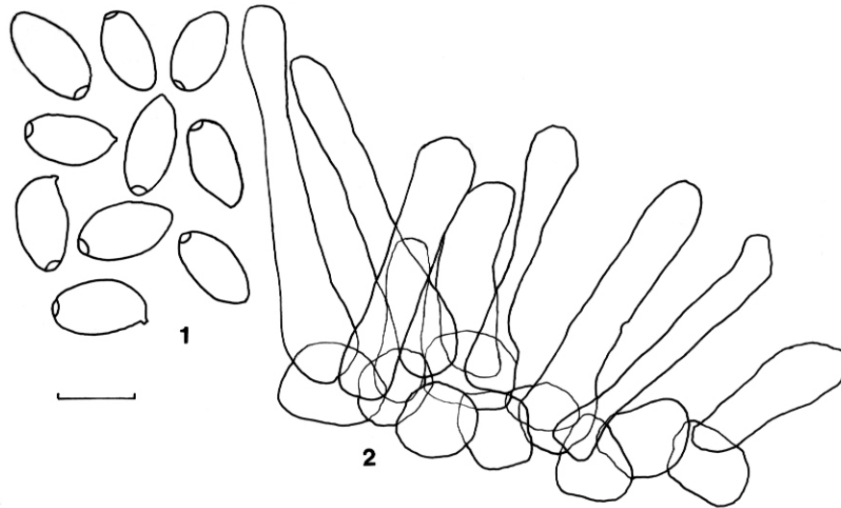

Fig. 22. *Coprinellus plagioporus*. 1. Basidiospores (DEH 1945A). 2. Pileocystidia and pileipellis (DEH 1946). Bars: 1 = 10 μm , 2 = 20 μm .

margin, glabrous, veil remnants absent, not deliquescing. – *Odor* not distinctive. – *Lamellae* subdistant with 2–3 series of lamellulae, adnate to adnexed, seceding in age, 1.5 mm broad, becoming black in age. – *Stipe* up to 55 \times 1.5–2 mm at maturity, even with slight basal swelling, white. – *Annulus* and *volva* absent.

Basidiospores (8.8–) 10.8–12.4 (–13.6) \times (5.6–) 6–6.8 (–7.2) μm [$\bar{x}_r = 10.6\text{--}12.1 \times 6.4\text{--}6.5 \mu\text{m}$, $\bar{x}_m = 11.5 \pm 0.8 \times 6.5 \pm 0.1 \mu\text{m}$, $Q = 1.4\text{--}2.0$, $\bar{Q}_r = 1.7\text{--}1.9$, $\bar{Q}_m = 1.8 \pm 0.1$, $n = 20$ basidiospores per 3 collections], subcylindrical to slightly lacrimiform or ellipsoid with a slight shoulder, somewhat amygdaliform in side view, slightly truncate, apiculus visible, with a central to somewhat eccentric germ pore, smooth, grayish earth brown to cigar brown. – *Basidia*, *brachybasidia*, *cheilocystidia* and *pleurocystidia* not observed. – *Pileipellis* an epithelium of loosely arranged globose to subglobose cells 10–25 μm diam. interspersed with numerous, crowded, thin-walled, hyaline, cylindrical pileus setules 30–100 \times 8–16 μm with slightly bulbous bases, equal to somewhat subcapitate, never acute near apex. – *Universal veil* absent.

Habit, habitat, and distribution in the Hawaiian Islands: Widely scattered in grass or in soil sometimes mixed with woodchips, in parks. Hawai'i.

Worldwide distribution: Europe and Hawai'i.

Specimens examined: USA. HAWAII: Hawai'i, Hilo, UHH Campus, 22 Sep. 1999, DEH 1835; Hawai'i, Hilo, Liliokalani Park, 28 Apr. 2000, DEH 1945A; same location, 28 Apr. 2000, DEH 1946.

Notes: *Coprinellus plagioporus* is uncommon in Hawai'i. It can be recognized by the broad, non-tapering to somewhat subcapitate pileus setules, a habit of growing in soil or grass in parks, and rather large basidiospores with a slightly eccentric germ pore. It has been speculated that there are several morphologically similar taxa in *Coprinus* s.l. stirps *Hiascens* that might be confused with *C. plagioporus* (Uljé and Bas, 1991). Interfertility studies have indicated that there exist at least two discrete taxa within the complex (Lange, 1952: 44). Hawaiian specimens of *C. plagioporus* have pileus setules with a somewhat less bulbous base and are less capitate than European descriptions, however, there is some variability in these characters (Orton and Watling, 1979; Uljé and Bas, 1991). In any case, the pileus setules of the Hawaiian collections are not “attenuated towards the apex or tapering” as they are in most other members of the stirps *Hiascens*.

23. *Coprinellus disseminatus* (Pers.: Fr.) J.E. Lange, Dansk Bot. Ark. 9(6): 93. 1938. (ut “*disseminata*”) (Fig. 23)

≡ *Agaricus disseminatus* Pers., Syn. Meth.: 403. 1801.

≡ *Agaricus disseminatus* Pers.: Fr., Syst. Mycol. I: 305. 1821.

≡ *Coprinus disseminatus* (Pers.: Fr.) S.F. Gray, Nat. Arr. British Pl. I: 634. 1821.

≡ *Coprinarius disseminatus* (Pers.: Fr.) P. Kumm., Führ. Pilzk.: 68. 1871.

≡ *Psathyrella disseminata* (Pers.: Fr.) Quél., Mém. Soc. Emul. Montbéliard XI, 5: 153, t. 8/5. 1872.

≡ *Pseudocoprinus disseminatus* (Pers.: Fr.) Kühner, Le Bot. 20: 155. 1928.

Reported synonyms:

= *Agaricus achnous* Berk. & Broome, J. Linn. Soc., Bot. 2: 557. 1871.

≡ *Psathyrella achnoa* (Berk. & Broome) Sacc., Syll. Fung. 5: 1135. 1887.

= *Agaricus ctenodes* Berk. & Broome, J. Linn. Soc., Bot. 2: 558. 1871.

≡ *Psathyrella ctenodes* (Berk. & Broome) Sacc., Syll. Fung. 5: 1136. 1887.

≡ *Psathyra ctenodes* (Berk. & Broome) Petch, Ann. Roy. Bot. Gard., Peradeniya 4: 397. 1910.

= *Agaricus leptomeres* Berk. & Broome, J. Linn. Soc., Bot. 2: 559. 1871.

≡ *Psathyrella leptomeres* (Berk. & Broome) Sacc., Syll. Fung. 5: 1136. 1887.

= *Agaricus pygmaeus* Bull.: Fr. *sensu* Berk. & Broome, J. Linn. Soc., Bot. 2: 554. 1871. (non *A. pygmaeus* Bull.: Fr., Syst. Mycol. 263. 1821).

= *Agaricus argutus* Kalchbr., Grevillea 10: 52. 1881.

≡ *Mycena arguta* (Kalchbr.) Sacc., Syll. Fung. 5: 304. 1887.

= *Psathyrella minutula* Sacc., Fl. Ital. Crypt. 1: 868. 1916.

Selected descriptions and icones: Hemmes and Desjardin (2002: 61); Uljé (2003); Uljé and Bas (1991: 290, Fig. 6); Breitenbach and Kränzlin (1995: 230, pl. 272); Orton and Watling (1979: 82, pls. 169, 178, 179, 182); Moser (1978: 264); Kühner and Romagnesi (1974: 381).

Pileus 7–15 mm diam. × 6–10 mm in height, convex to obtusely conical or conic-cylindrical when young, expanding with maturity to broadly conical, striate to sulcate to the disc, often with a shallow umbilicus; surface finely granulose, with sparse, micaceous-glistening, hyaline to pale brownish orange granules when young, these detersile and surface becoming glabrous in age, surface also finely pruinose when young becoming less pruinose in age, fragile, crumbly, moist to dry, hygrophanous disc brown (6E6–8) to grayish orange (5B6) and margin grayish orange (5B4) to orangish white (5A2) when young, disc remaining so or fading to grayish orange in age, margin becoming grayish white to gray (5E1) with darker striae, not deliquescing; context 1 mm thick, color same as surface color. – *Odor* mildly fungal. – *Lamellae*, subdistant to close, with 0–2 series of lamellulae, ascending-free to ascending-adnate or subdecurrent, 2–4 mm broad, white becoming black in age. – *Stipe* 10–35 × 0.5–2 mm, central, terete, cylindrical, equal or with a slightly enlarged base or slightly tapering upwards, hollow, brittle, glabrous to minutely pruinose above, base pubescent, dull to shiny, dry, at first pale orangish white, becoming white in age. – *Annulus* and *volva* absent.

Basidiospores (6–) 6.8–9.2 (–10) × (3.2–) 4.4–5.2 (–6.0) μm [$\bar{x}_r = 7.0\text{--}8.5 \times 4.0\text{--}5.2 \mu\text{m}$, $\bar{x}_m = 7.8 \pm 0.5 \times 4.6 \pm 0.3 \mu\text{m}$, $Q = 1.3\text{--}2.1$, $\bar{Q}_r = 1.6\text{--}1.8$, $\bar{Q}_m = 1.7 \pm 0.1$, $n = 20$ basidiospores per 12 collections], ellipsoid or utriform in face view to phaseoliform or amygdaliform or narrowly amygdaliform in side view, mildly to broadly truncate, apiculus visible, with a central germ pore, smooth, pale to dark earth brown sometimes with yellowish or chestnut tones. – *Basidia* 15–30 × 5–8 μm , clavate, 4-spored. – *Brachybasidia* 8–15 × 5–7 μm , globose to subglobose or clavate. – *Cheilocystidia* cylindrical to narrowly ellipsoid, numerous, 50–70 × 8–15 μm . – *Pleurocystidia* not observed. – *Pileipellis* an epithelium of primarily globose cells 8–15 μm diam. arising in vertical chains, with numerous lageniform, rarely subcapitate, pileus setules 25–60 × 10–22 μm , often with golden brown incrustations especially near the apices. – *Universal veil* ephemeral, rare even in primordia, consisting of globose elements up to 25 μm diam. interspersed with narrow branching hyphae 10–40 × 3–8 μm , often with golden brown incrustations on the globose elements similar to those on the pileus setules. – *Clamp connections* not observed.

Habit, habitat, and distribution in the Hawaiian Islands: Densely gregarious to subcespitate on rotting sticks of hau (*Hibiscus*) in riparian habitat, on bark and wood of dead karakanut (*Corynocarpus laevigatus* J.R. & G. Forst.), ohī'a (*Meterosideros polymorpha* Gaud.) and koa (*Acacia koa* Gray) in Montane Wet Ohī'a Forest with scattered alien plants, clustered on hala (*Pandanus tectorius* S. Parkinson ex Z) branches under coastal casuarina

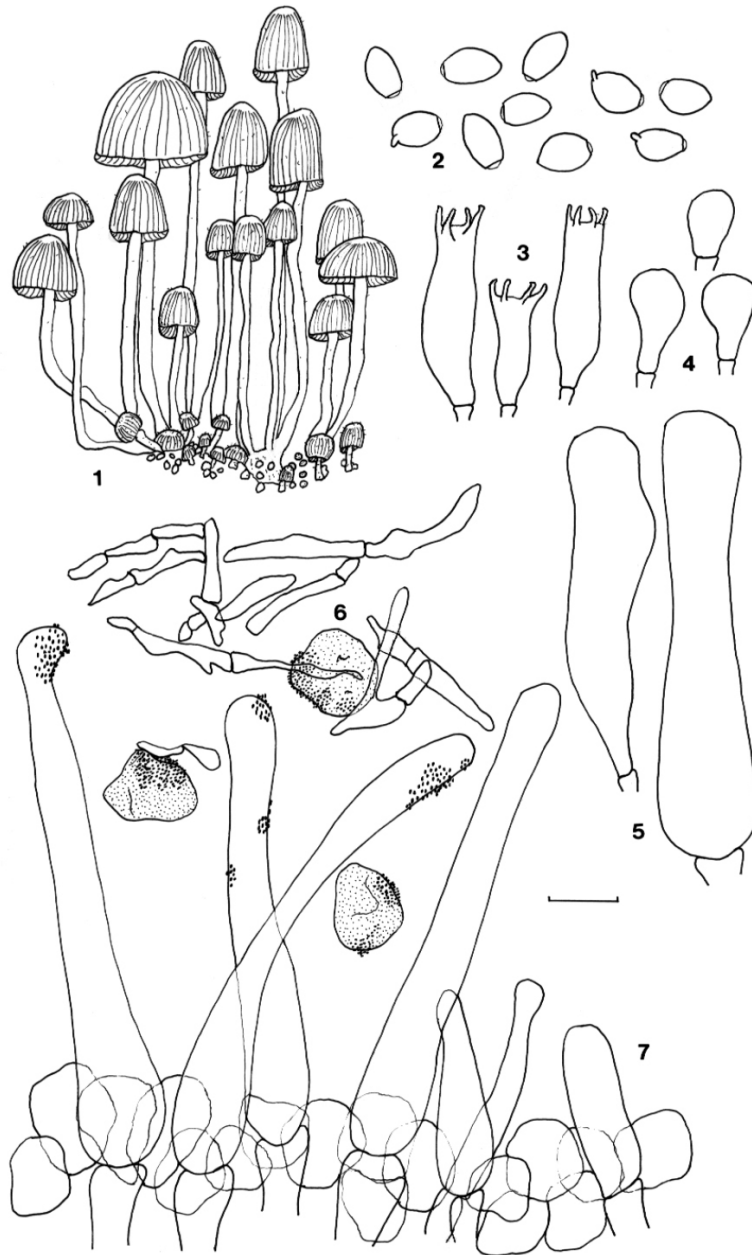

Fig. 23. *Coprinellus disseminatus*. **1.** Basidiomata (MRK 18). **2.** Basidiospores (DEH 2165). **3.** Basidia. **4.** Brachybasidia. **5.** Cheilocystidia (Figs. 3–5, DEH 1312). **6.** Granular universal veil elements. **7.** Pileocystidia and pileipellis (Figs. 6–7, DEH 2134). Bars: 1 = 5 mm, 2–5 = 10 μ m, 6–7 = 20 μ m.

(*Casuarina equisetifolia* L.), wiliwili (*Erythrina sandwicensis* Degener) woodchip piles, and woodchips under monkeypod (*Samanea saman* (Jacq.) Merr.), and on old vines of *Monstera deliciosa*. Hawai'i and Kaua'i.

Worldwide distribution: Europe, East Africa, North America, South America, Japan, Australia, Sri Lanka, Hawai'i.

Specimens examined: USA. HAWAII: Hawai'i, Hilo, American Savings Bank, 11 Nov. 1996, DEH 1312; Hawai'i, Hilo, UHH campus, 30 Aug. 1999, DEH 1832; Hawai'i, Hilo, Bayfront, 7 Sep. 2001, DEH 2134; same location, 7 Sep. 2001, DEH 2135; same location, 12 Jul. 2001, MRK 18; Hawai'i, Hilo, King's Landing, 20 Oct. 2001, DEH 2165; same location, 13 May 2002, DEH 2286; same location, 13 May 2002, DEH 2287; Hawai'i, Mountain View, Mike Au Farm, 11 Jul. 2001, MRK 11; Hawai'i, Waipio Valley, 16 Jul. 2001, MRK 26; Kaua'i, Wailua, Keahua Arboretum, 4 Jan. 1994, DED 5969; Kaua'i, Kuia Natural Area Reserve, Nualolo Trail, 8 Jan. 1996, DED 6374.

Notes: *Coprinellus disseminatus* is a common wood and woodchip decomposer in Hawai'i. It has an interesting taxonomic history reflecting in large part its non-deliquestent nature. This lack of deliquescence caused several authors to place it in alternative genera, such as *Psathyrella* and *Pseudocoprinus*, but molecular studies place *C. disseminatus* in a well-supported clade with many highly deliquescent taxa including *C. micaceus* and its allies (Hopple and Vilgalys, 1999). In Hawai'i, *C. disseminatus* is most likely to be confused with the similar but less common *C. curtus*. Both have fragile, crumbly basidiomes that occur on wood in troops of dozens, hundreds, or even thousands of basidiomes. *Coprinellus curtus*, however, has foxy, reddish brown tones on the pileus disc that are not present in *C. disseminatus*. The pileocystidia of *C. curtus* are also consistently capitate whereas those of *C. disseminatus*, while sometimes subcapitate, are more often tapered to the apex.

24. *Coprinellus curtus* (Kalchbr.) Vilgalys, Hopple & Jac. Johnson, *Taxon* 50: 233. 2001. (Fig. 24)

≡ *Coprinus curtus* Kalchbr. in Thümen, *Flora* 59: 424. 1876.

Reported synonyms:

= *Coprinus plicatiloides* Buller, *Trans. Brit. Mycol. Soc.* 6: 364. 1920.

Selected descriptions and icones: Hemmes and Desjardin (2002: 34); Uljé (2003); Uljé and Bas (1991: 284, Fig. 2); Orton and Watling (1979: 85–86, pl. 175); Moser (1978: 264); Kühner and Romagnesi (1974: 378, pl. 517).

Pileus 1–3 mm diam. × 1–2 mm height in primordia, 8–22 mm diam. × 4–5 mm in height at maturity, ovoid when young becoming convex to hemispherical or campanulate and eventually planar-uplifted at maturity, strongly plicate, primordia covered with foxy red to dark reddish brown (8D7), amorphous, sugar-like granules, these persisting throughout development especially near disc; pileus under veil brown (6E8) to light brown (7D5) with gray running along pileus ridges, becoming gray (7E1) to brownish gray (7E2)

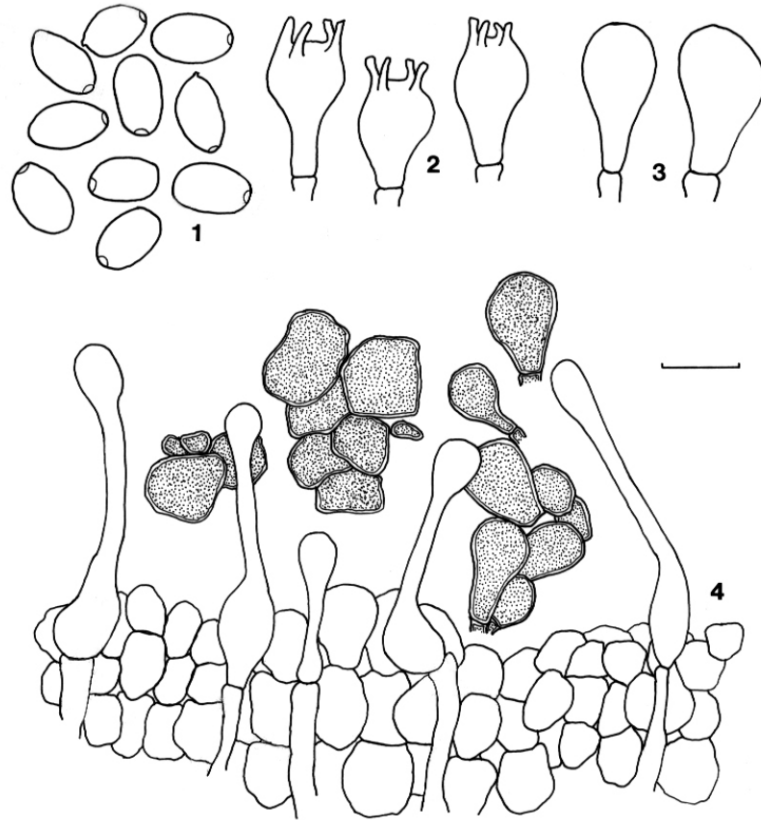

Fig. 24. *Coprinellus curtus* (DEH 630). 1. Basidiospores. 2. Basidia. 3. Brachybasidia. 4. Granular universal veil elements with pileocystidia and pileipellis. Bars: 1–3 = 10 μm , 4 = 20 μm .

or remaining light brown (7D6) at maturity, not deliquescing; context 0.1 mm thick, color same as surface color. – *Odor* not distinctive. – *Lamellae* medium-close with 2–3 series of lamellulae, narrowly adnexed to almost free, 1–2 mm broad, white becoming gray or black in age. – *Stipe* 1–4 mm in length in primordia, 8–27 \times 0.5–1.75 mm at maturity, equal to tapering upwards, glabrous, white. – *Annulus* and *volva* absent.

Basidiospores (7.2–) 8–10 (–10.5) \times (4.8–) 5.6–6.8 (–7.6) μm [$\bar{x}_r = 8.7$ –9.7 \times 5.5–6.4 μm , $\bar{x}_m = 9.1 \pm 0.4 \times 6.0 \pm 0.4 \mu\text{m}$, $Q = 1.2$ –1.8, $\bar{Q}_r = 1.4$ –1.6, $\bar{Q}_m = 1.5 \pm 0.1$, $n = 20$ basidiospores per 5 collections], ellipsoid to ovoid in face view, narrowly ellipsoid or phaseoliform in side view, apiculus often not visible, with a distinct central to slightly eccentric, small to somewhat broad

germ pore, not truncate, smooth, chestnut brown to black. – *Basidia* 15–22 × 5–10 µm, clavate, 4-spored. – *Brachybasidia* 15–20 × 8–10 µm, clavate. – *Cheilocystidia* 30 µm in length × 7–8 µm in width near the base, extremely rare, bottle-shaped, lageniform. – *Pleurocystidia* not observed. – *Pileipellis* an epithelium of globose, hyaline, thin-walled cells 16–30 µm diam. arising vertically as a cystoderm layer, interspersed with bulbous-based, capitate to subcapitate, hyaline, thin-walled pileus setules 76–88 × 11–18 (base) × 4–5.5 (neck) × 8.5–13 (capitulum) µm. – *Universal veil* composed of granules formed from clusters of golden brown, thick-walled, broadly clavate to pyriform to sphaeropedunculate cells, 12–20 µm diam. – *Clamp connections* absent.

Habit, habitat, and distribution in the Hawaiian Islands: Clustered on woodchip piles or rarely scattered in mud associated with axis deer dung under coastal kiawe (*Prosopis pallida* (Hump. & Bonpl.: Willd.) Kunth.). Hawai'i and Lana'i.

Worldwide distribution: Europe, Australia, Hawai'i.

Specimens examined: USA. HAWAII: Hawai'i, Hilo, Prince Kuhio Mall, 29 Oct. 1994, DEH 630; Hawai'i, Hilo, UH Agriculture Farm, 28 Feb. 1996, DEH 1083; Hawai'i, Hilo, Bayfront, 13 Feb. 2001, DEH 2064; Hawai'i, Komohana Agriculture Station, 15 Sep. 2001, DEH 2128A; Lana'i, Shipwreck Beach, 4 Jan. 2001, DEH 2223.

Notes: *Coprinellus curtus* is a close ally of the more common *C. disseminatus*. It is distinguished from other coprini in *Coprinus* s.l. section *Setulosi* by its foxy reddish brown disc with capitate pileus setules. As with at least three other Hawaiian coprini, *C. curtus* has a substrate preference that is different from that cited in the literature. In Hawai'i, *C. curtus* is most commonly collected from woodchip piles and once was found in mud associated with axis deer dung. European authors report *C. curtus* only from horse dung.

Parasola Redhead, Vilgalys & Hoppole, *Taxon* 50: 235. 2001.

Type: *P. plicatilis* (Curtis: Fr.) Redhead, Vilgalys & Hoppole

25. *Parasola auricoma* (Pat.) Redhead, Vilgalys & Hoppole, *Taxon* 50: 235. 2001. (Fig. 25)

≡ *Coprinus auricomus* Pat., *Tabulae Analyticae Fungorum* 5: 200. 1886.

Reported synonyms:

= *Agaricus subtilirugatus* Secr., *Mycographie Suisse* I: 423. 1883 (invalid name).

= *Coprinus hansenii* J. Lange, *Dansk Bot. Ark.* 2(3): 48. 1915.

Misapplied names:

Coprinus hemerobius Fr., *Epicr. Syst. Mycol.* 253. 1838; *sensu* many authors.

Selected descriptions and icones: Uljé (2003); Breitenbach and Kränzlin (1995: 226, pl. 266); Uljé and Bas (1988: 435–436, Fig. 1 & 12); Orton and

Watling (1979: 98–99, pls. 230–231); Moser (1978: 267); Kühner and Romagnesi (1974: 376, pl. 514).

Pileus 3–5 mm diam. × 4–6 mm height in primordia, 13–38 mm diam. × 7–10 (–20) mm in height at maturity, paraboloid to ovoid or oblong to ellipsoid when young, becoming conical to campanulate, sometimes with an acute umbo, then becoming broadly convex and often umbonate to nearly planar and depressed in age, plicate to disc; primordium pileus finely pruinose with setae, becoming glabrous in age, the disc initially colored brown (7E7) to dark brown (7F6–8) or reddish brown (8E8, 8F4–5), becoming pale orange to light orange (5A3–5), grayish orange (5B3–6), brown (6D–E4–6) or dark brown (7F8) through development, the margin colored brownish orange (5C6) to yellowish brown (5E4), grayish brown (6–7D–F3) or dark brown (7F5); mature pileus colored grayish brown (6F3) or brown (6E8) on the disc, and reddish brown or dark brown (8E–F5–8) near the margins, hygrophanous, fading to light brown (6D6) on the disc and brown (7E6) on the margin with moisture loss; not deliquescing, context 0.1–1 mm thick, white to concolorous with surface. – *Odor* not distinctive. – *Lamellae* subdistant to close with 0–4 series of lamellulae, free, with a distinctive clear zone around the stipe apex, 2–3 mm broad, pale cream or gray becoming black in age. – *Stipe* 5–10 × 0.5–1 mm in primordia, 45–90 × 1–3 mm at maturity, equal to tapering upwards slightly, glabrous or rarely with a few scattered hairs, white to off-white, light yellow (4A4) or grayish orange (5A2, 5–6B3–4) near base, with brownish orange (6C8) tomentum often surrounding stipe base. – *Annulus* and *volva* absent.

Basidiospores (8.4–) 9.2–11.6 (–13.2) × (6.0–) 7.6–8.8 (–10.8) μm , [$\bar{x}_r = 9.9–11.8 \times 7.2–8.3 \mu\text{m}$, $\bar{x}_m = 10.8 \pm 0.6 \times 7.7 \pm 0.4 \mu\text{m}$, $Q = 1.1–1.9$, $\bar{Q}_r = 1.3–1.5$, $\bar{Q}_m = 1.4 \pm 0.1$, $n = 20$ basidiospores per 9 collections], broadly ellipsoid to lacrimiform, submitriform or cordiform to nearly triangular in face view, amygdaliform or somewhat narrowly ellipsoid in side view, apiculus visible, with a central to slightly eccentric germ pore, smooth, chestnut brown to dark chocolate brown. – *Basidia* 18–24 × 8–10 μm , clavate, 4-spored. – *Brachybasidia* 20–24 × 5–8 μm , clavate. – *Cheilocystidia* 12–50 × 10–22 μm , vesicular to subglobose, ellipsoid or narrowly ellipsoid, abundant. *Pleurocystidia* 40–70 × 8–14 μm , ellipsoid, subpedicellate. – *Pileipellis* a single hymeniform layer of clavate cells 25–35 × 10–15 μm interspersed with long thick-walled, gold-colored, lageniform setae (50–) 100–300 (–400) × 3–16 μm with bulbous base and typically tapering to an acute apex. – *Universal veil* absent.

Habit, habitat, and distribution in the Hawaiian Islands: Scattered to gregarious or clustered on woodchips, common. Hawai'i.

Worldwide distribution: Europe, North America, Hawai'i.

Specimens examined: USA. HAWAII: Hawai'i, Komohana Agriculture Station,

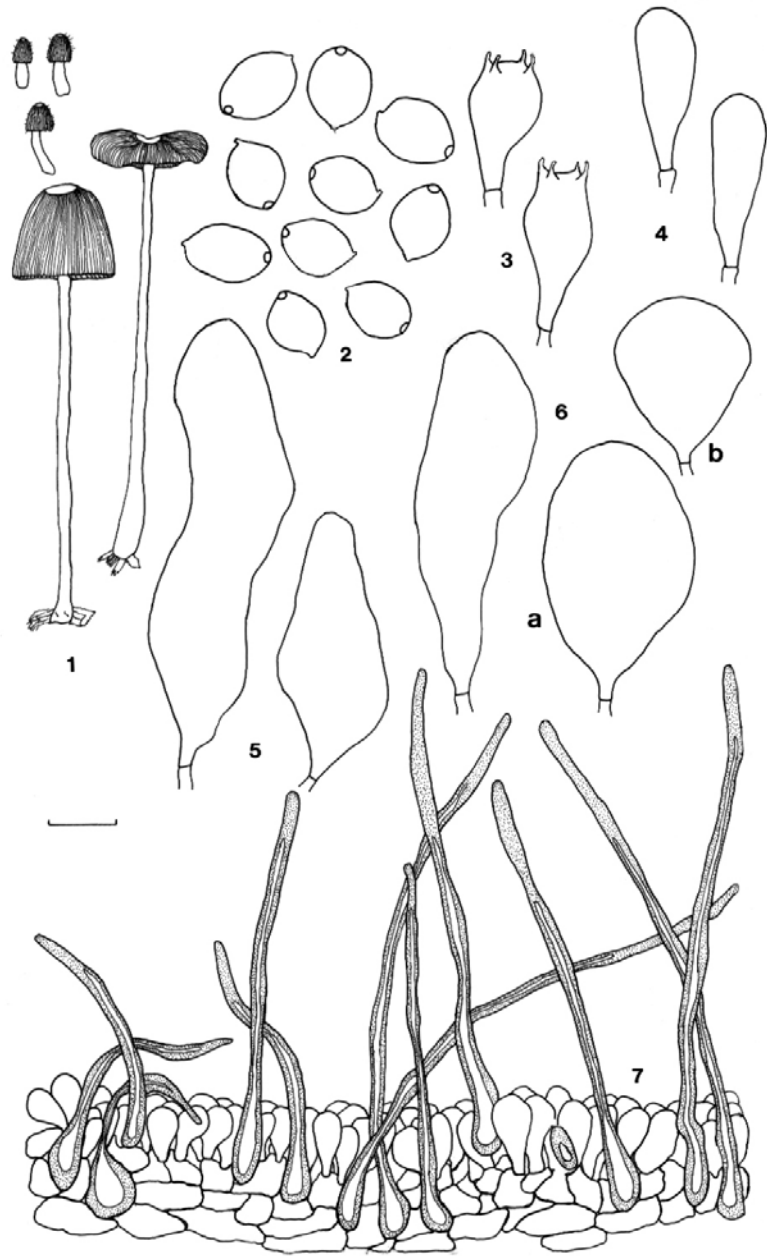

Fig. 25. *Parasola auricoma*. 1. Basidiomata. 2. Basidiospores. 3. Basidia. 4. Brachybasidia. 5. Pleurocystidia (Figs. 1–5, MRK 36). 6. Cheilocystidia. a. (DEH 2131). b. (MRK 23). 7. Pileipellis with setae (MRK 36). Bars: 1 = 10 mm, 2–6 = 10 μ m, 7 = 20 μ m.

1 Aug. 2001, DEH 2107; same location, 5 Sep. 2001, DEH 2129; Hawai'i, Hilo, Bayfront, 4 Sep. 2001, DEH 2127; same location, 7 Sep. 2001, DEH 2131; same location, 5 Oct. 2001, DEH 2140A; same location, 5 Oct. 2001, DEH 2140B; same location, 14 Jul. 2001, MRK 23; Hawai'i, Hilo, Keaukoha, 9 Nov. 2001, DEH 2176; Hawai'i, Mountain View, 11 Jul. 2001, MRK 12; Hawai'i, Hilo, James Kealoha Park, 16, Jan. 2002, MRK 36.

Notes: *Parasola auricoma* is exceedingly common on woodchips in Hawai'i. It is distinguished from other woodchip coprini in being non-deliquestent, by lacking a veil, and by long, gold-pigmented, thick-walled setae that adorn the pileus. It often fruits in large numbers. It has a distinctly plicate margin indicating that it is allied with the coprini and not with the genus *Psathyrella*, although it should be mentioned that some *Psathyrella* species are extremely similar in morphology and habit to *P. auricoma*.

It has been reported that in some specimens, the setae can be difficult to observe depending upon the type of mount and preparation used (Uljé and Bas, 1988). In most Hawaiian collections, however, the setae are numerous and easy to observe making this a readily identifiable species.

26. *Parasola leiocephala* (P.D. Orton) Redhead, Vilgalys & Hopple, *Taxon* 50: 236. 2001. (Fig. 26)

= *Coprinus leiocephalus* P.D. Orton, *Notes Roy. Bot. Gard. Edinburgh* 29: 88–90. 1969.

Reported synonyms:

= *Coprinus plicatilis* var. *microsporus* Kühner, *Bull. Soc. Mycol France*, 50: 57. 1934.

= *Pseudocoprinus brunneolus* McKnight & Allison, *Morris Arbor. Bull.* 20: 73. 1969.

Misapplied names:

= *Coprinus plicatilis* (Curtis: Fr.) Fr. *sensu* many authors.

= *Coprinus superiusculus* Britzelm., *Derm. et Mel.*: 183. 1883.

= *Coprinus rapidus* Fr. *sensu* Quél., *Flora Mycol. France*, 1888.

= *Pseudocoprinus lacteus* A.H. Sm., *J. Elisha Mitchell Sci. Soc.* 62: 191. 1946.

= *Coprinus galericuliformis* Watling *sensu* auct. p.p., Breitenbach and Kränzlin, *Fungi of Switzerland* 4: 242. 1995.

Selected descriptions and icones: Uljé (2003); Breitenbach and Kränzlin (1995: 242, pl. 290); Uljé and Bas (1988: 440–441, Fig. 10); Orton and Watling (1979: 102–103, pl. 219); Moser (1978: 267).

Pileus 10–22 mm diam. at maturity, convex to broadly convex or plano-convex, strongly pleated to disc, dark brown (8F–E4–7) at disc to brownish gray (7–8D–F2) at margin, not deliquescent. – *Odor* not distinctive. – *Lamellae* free, with a distinctive clear zone around the stipe apex, white becoming black. – *Stipe* up to 42–55 × 1–2 mm at maturity, equal to tapering upwards, glabrous, white. – *Annulus* and *volva* absent.

Basidiospores (7.2–) 8.0–9.2 (–10.0) × (6.4–) 6.8–8.0 (–8.4) μm, [\bar{x}_r = 8.3–8.7 × 7.1–7.6 μm, \bar{x}_m = 10.5 ± 0.3 × 7.4 ± 0.3 μm, Q = 1.0–1.5, \bar{Q}_r = 1.1–1.2, \bar{Q}_m = 1.2 ± 0.1, n = 20 basidiospores per 2 collections], pentagonal to apple-shaped in face view, angular-ellipsoid in end view, amygdaliform in side

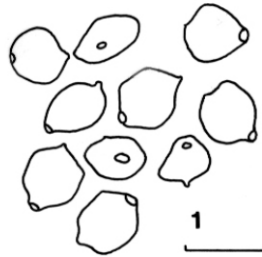

Fig. 26. *Parasola leiocephala* (DEH 1945B). 1. Basidiospores. Bar: 1 = 10 μ m.

view, apiculus visible, with a central germ pore, smooth, dark chestnut brown. – *Basidia*, *brachybasidia*, *cheilocystidia* and *pleurocystidia* not observed. *Pileipellis* not observable in mature basidiomes. – *Universal veil* absent.

Habit, habitat, and distribution in the Hawaiian Islands: Scattered on soil near woodchips in urban park and zoo. Hawai'i.

Worldwide distribution: Europe, Japan, Hawai'i.

Specimens examined: USA. HAWAII: Hawai'i, Hilo, Liliokalani Park, 28 Apr. 2000, DEH 1945B; Hawai'i, Hilo, Panewa Zoo, 29 Oct. 2001, DEH 2343.

Notes: *Parasola leiocephala* closely resembles *P. plicatilis*, but is readily distinguished by forming significantly smaller basidiospores that exhibit a more consistently central germ pore, and by basidiome production in soil associated with woodchips. *Parasola plicatilis* in Hawai'i is always found in grass. Breitenbach and Kränzlin (1995) expressed concern that *P. plicatilis*, *P. kuehneri*, *P. galericuliformis* and *P. leiocephala* might not be discrete taxa because the characters used to distinguish them are overlapping. However, in Hawai'i, *P. plicatilis* (in grass) and *P. leiocephala* (in soil with woodchips) appear to have discrete, non-overlapping basidiospore size ranges that clearly distinguish them.

27. *Parasola megasperma* (P.D. Orton) Redhead, Vilgalys & Hopple, *Taxon* 50: 236. 2001. (Fig. 27)

≡ *Coprinus megaspermus* P.D. Orton, *Notes Roy. Bot. Gard. Edinburgh* 32: 141. 1972.

Selected descriptions and icones: Uljé (2003); Uljé and Bas (1988: 442); Orton and Watling (1979: 100, pl. 220).

Pileus 5–7 mm diam. × 5–9 mm in height in primordia, 20–27 mm diam. × 2–7 mm at maturity, ovoid becoming convex to broadly convex or plano-convex, umbilicate, strongly pleated to disc, reddish brown (8E5) to dark brown (8F5) when young, remaining dark brown (6–7F5–7) to reddish brown (8E5) at disc, with brownish gray (8F2) on margin, not deliquescing; context

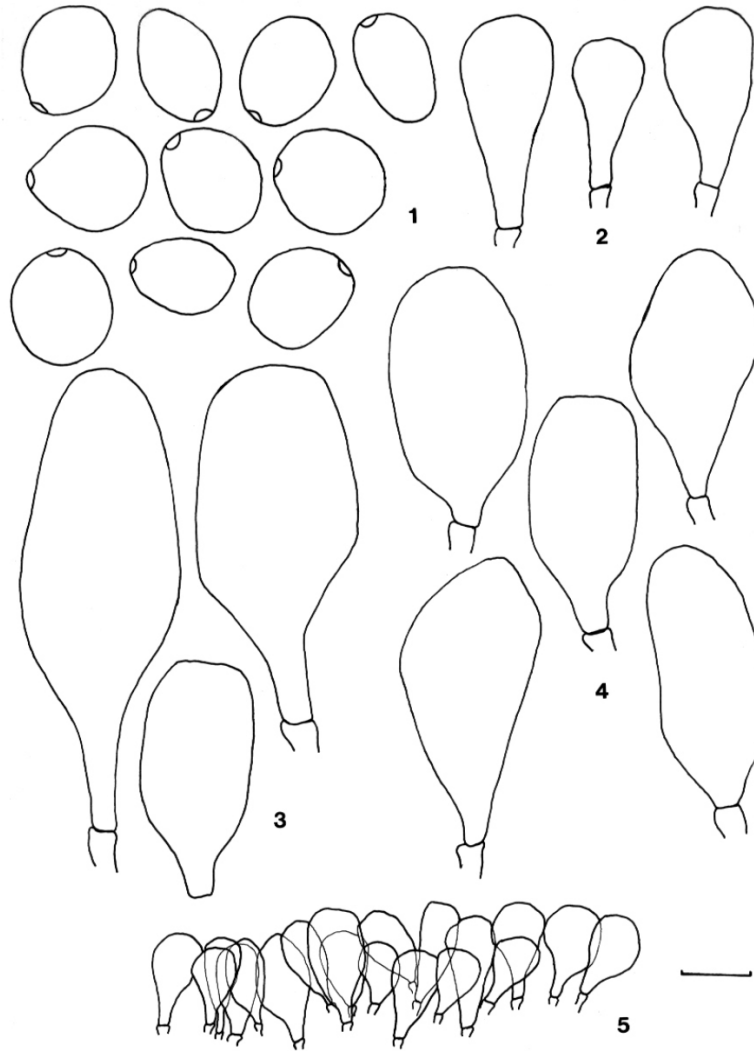

Fig. 27. *Parasola megasperma* (DEH 2307). 1. Basidiospores. 2. Basidioles 3. Pleurocystidia. 4. Cheilocystidia. 5. Pileipellis. Bars: 1–4 = 10 μ m, 5 = 20 μ m.

0.1 mm thick, color same as surface color. – *Odor* not distinctive. – *Lamellae* subdistant, with 2–3 series of lamellulae, 1–3 mm broad, free, with a distinctive clear zone around the stipe apex, white becoming black. – *Stipe* 9–16 \times 2 mm in primordia, 40–80 \times 2–3 mm at maturity, equal, cylindrical, glabrous, white to golden-tan near apex, subbulbous. – *Annulus* and *volva* absent.

Basidiospores (13.6–) 15.2–17.2 (–18.6) × (9.6–) 11.2–14.4 (–15.2) μm, [$\bar{x}_r = 16.1\text{--}16.3 \times 12.2\text{--}13.8$ μm, $\bar{x}_m = 16.2 \pm 0.1 \times 13.0 \pm 1.1$ μm, Q = 0.9–1.5, $\bar{Q}_r = 1.2\text{--}1.3$, $\bar{Q}_m = 1.3 \pm 0.3$, n = 20 basidiospores per 2 collections], ellipsoid to slightly amygdaliform in side view, somewhat mitriform to angular-subglobose or nearly globose, apiculus not visible, with a central germ pore, smooth, dark chocolate or chestnut brown to nearly black. – *Basidia* and *brachybasidia* 20–30 × 5–14 μm, clavate to narrowly clavate, only in immature specimens, not distinctive from one another. – *Cheilocystidia* 30–40 × 5–20 μm, ellipsoid to narrowly ellipsoid, pedicellate, thin-walled, hyaline. – *Pleurocystidia* 30–70 × 5–25 μm, similar to cheilocystidia but larger. – *Pileipellis* a hymeniform layer of clavate cells 15–30 × 5–17 μm arising vertically, almost indistinguishable from the hymenium. – *Universal veil* absent. – *Clamp connections* not observed.

Habit, habitat, and distribution in the Hawaiian Islands: In sand and duff under coastal ironwood (*Casuarina equisetifolia* L.). Hawai'i.

Worldwide distribution: Europe and Hawai'i.

Specimens examined: USA. HAWAII: Hawai'i, Waipio Valley, 5 Jan. 1997, DEH 1403; Hawai'i, MacKenzie Park, 31 Aug. 2002, DEH 2307.

Notes: In Hawai'i, *Parasola megasperma* is found consistently associated with coastal *Casuarina*. It is easily recognized as a *Parasola* by its glabrous, plicate pileus and the distinctive clear zone surrounding the stipe apex. Its large basidiomes and large basidiospores readily distinguish it from all other *Parasola* in Hawai'i.

28. *Parasola nudiceps* (P.D. Orton) Redhead, Vilgalys & Hopple, *Taxon* 50: 236. 2001. (Fig. 28)

≡ *Coprinus nudiceps* P.D. Orton, *Notes Roy. Bot. Gard. Edinburgh* 32: 142–144. 1972.

Selected descriptions and icones. Uljé and Bas (1988: 443–444, Fig. 11); Orton and Watling (1979: 103–104, pls. 222 & 227).

Pileus 14–20 mm diam. × 5–7 mm height at maturity, paraboloid becoming convex to broadly convex or plano-convex, strongly pleated to disc, glabrous, brownish orange (6C4) to brown (6–7E6–7) at disc, becoming brownish gray (6C2) to reddish gray (7B2) at margin, not deliquescing. – *Odor* not distinctive. – *Lamellae* subdistant with 2 series of lamellulae, free, with a distinctive clear zone around the stipe apex, 0.75 mm broad, white becoming black. – *Stipe* 57–65 × 0.75–1.25 mm at maturity, equal to tapering upwards, glabrous, white. – *Annulus* and *volva* absent.

Basidiospores (12.4–) 13.6–14.8 (–15.6) × (8.8–) 10.8–12.4 (–13.6) μm [$\bar{x}_r = 13.9\text{--}14.2 \times 11.3\text{--}11.8$ μm, $\bar{x}_m = 14.1 \pm 0.2 \times 11.5 \pm 0.4$ μm, Q = 1.0–1.5, $\bar{Q}_r = 1.2\text{--}1.3$, $\bar{Q}_m = 1.2 \pm 0.1$, n = 20 basidiospores per 2 collections], heart-shaped to nearly triangular with rounded corners in face view, ellipsoid

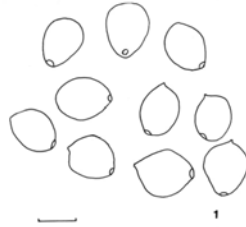

Fig. 28. *Parasola nudiceps* (DEH 1157). **1.** Basidiospores. Bar: 1 = 10 μ m.

to somewhat amygdaliform in side view, apiculus visible, with a central to slightly eccentric germ pore, smooth, dark earth brown to dark chestnut brown. – *Basidia*, *brachybasidia*, *cheilocystidia* and *pleurocystidia* not observed. – *Pileipellis* not observable in mature basidiomes. – *Universal veil* completely absent.

Habit, habitat, and distribution in the Hawaiian Islands: Scattered on lawns. Hawai'i.

Worldwide distribution: Europe, Hawai'i.

Specimens examined: USA. HAWAII: Hawai'i, Hilo, UH Agriculture Farm, 19 Mar. 1996, DEH 1069; Hawai'i, Hilo, Richardson's Ocean Park, 7 Jul. 1996, DEH 1157.

Notes: *Parasola nudiceps* is common on lawns in Hawai'i, though not as common as the very similar *P. plicatilis*. While the two are distinguished microscopically by basidiospore size and shape, in the field they are separated by minor differences in overall pileus color. *Parasola nudiceps* has more reddish or rusty undertones while *P. plicatilis* is more grayish brown. Other taxa that might be confused with *P. nudiceps* in Hawai'i include: *P. leiocephala* which occurs in soil, not grass, and has much smaller basidiospores; *P. auricoma* which is found typically on woodchips and has long, golden pileal setae; *P. megasperma* which occurs under *Casuarina* in duff and sand and has much larger, more globose basidiospores; and *C. friesii* which also occurs scattered in grass, but has patches of universal veil tissue dispersed on the pileus surface.

Although the Hawaiian specimens match *P. nudiceps* in terms of macro- and micromorphological features, Orton and Watling (1979) cite the substrate for *P. nudiceps* as "old cow and horse dung," not grass. Uljé and Bas (1988) expand the possible substrates for *P. nudiceps* to include "dung or terrestrial." Because several other Hawaiian coprinoid taxa occur on substrates different from those cited by European authors, it is more reliable to stress morphology rather than substrate specificity for identification purposes.

Uljé and Bender (1997) studied the type of *Parasola schroeteri* (P. Karst.) Redhead, Vilgalys, & Hopple (ut *Coprinus schroeteri* P. Karst.), another dung-inhabiting species, and determined the material to be identical to *P. nudiceps* except for the size of the basidiomes. Accordingly, Uljé and Bender (1997) chose to accept *P. nudiceps* as a synonym of the older epithet *P. schroeteri*. *Parasola schroeteri* was described as forming very small basidiomes with pilei up to 10 mm diam. at maturity and stipes 10–20 mm long. The Hawaiian specimens formed expanded pilei measuring 14–20 mm diam. and mature stipes that were 57–65 mm in length, within the size range of the more robust *P. nudiceps* as reported by contemporary authors (pileus 10–24 mm diam.; stipe 30–60 mm long). Until further European specimens are studied to evaluate the taxonomic significance of basidiome size in these taxa, we accept the epithet *P. nudiceps* for the Hawaiian taxon.

29. *Parasola plicatilis* (Curtis: Fr.) Redhead, Vilgalys & Hopple, Taxon 50: 235. 2001. (Fig. 29)

≡ *Agaricus plicatilis* Curtis, Flora Londinensis, tab 200. 1778.

≡ *Agaricus plicatilis* Curtis: Fr., Syst. Mycol. I: 312. 1821.

≡ *Coprinus plicatilis* (Curtis: Fr.) Fr., Epicr. Syst. Mycol. 252. 1838.

Misapplied names:

Coprinus hemerobius Fr. *sensu* Ricken, Die Blatterpilze 65. 1915.

Selected descriptions and icones: Hemmes and Desjardin (2002: 25); Uljé (2003); Breitenbach and Kränzlin (1995: 248, pl. 298); Uljé and Bas (1988: 441–442, Fig. 13); Orton and Watling (1979: 101–102, pls. 218, 228, 229); Moser (1978: 267); Kühner and Romagnesi (1974: 376, pls. 515 & 516).

Pileus 9–24 mm diam. × (2–) 4–8 mm height at maturity, paraboloid to convex or hemispherical, strongly pleated to disc, glabrous, dark brown (7F7) to reddish brown (8E7–8) or dark reddish brown (9F5) at disc, becoming pale orange (5A3) and then gradating to orangish white (5A2), grayish brown (6E3), gray (8D1), or brownish gray (8E2) at margin, not deliquescing; context 0.1 mm thick, color same as surface color. – *Odor* not distinctive. – *Lamellae* subdistant to medium close with 1–3 series of lamellulae, free, with a distinctive clear zone around the stipe apex, 1–2 mm broad, gray becoming black in age. – *Stipe* 35–45(–65) × 0.5–1.2 mm at maturity, almost equal or tapering upwards, base sometimes subbulbous, even, smooth, glabrous, off-white to light brown (6D5) near base. – *Annulus* and *volva* absent.

Basidiospores in face view (–7.2) 8–11.2 (–12.4) × (6.0–) 8–10.4 (–13.6) μm [$\bar{x}_r = 8.8\text{--}11.3 \times 8.0\text{--}9.4$ μm, $\bar{x}_m = 9.9 \pm 1.0 \times 9.1 \pm 0.5$ μm, Q = 0.8–1.5, $\bar{Q}_r = 1.0\text{--}1.2$, $\bar{Q}_m = 1.1 \pm 0.1$, n = 18 basidiospores per 6 collections], in side view 8.4–11.6 × 5.6–8.4 μm [$\bar{x}_r = 9.1\text{--}10.8 \times 6.4\text{--}7.3$ μm, $\bar{x}_m = 10.0 \pm 0.8 \times 6.9 \pm 0.5$ μm, Q = 1.3–1.6, $\bar{Q}_r = 1.4\text{--}1.5$, $\bar{Q}_m = 1.5 \pm 0.0$, n = 5 basidiospores

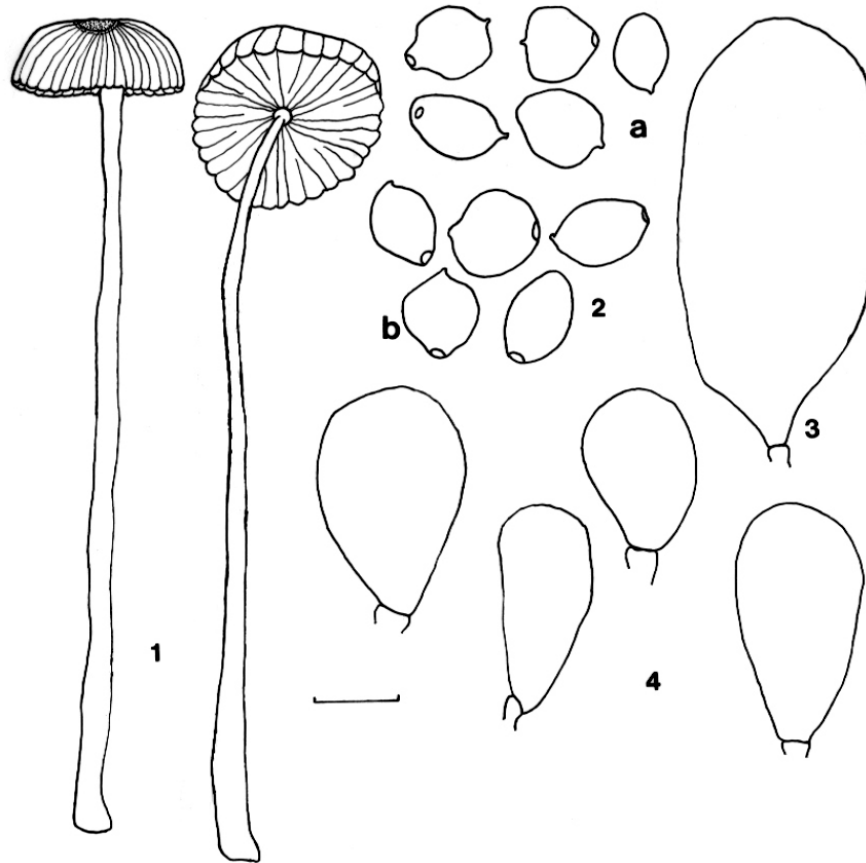

Fig. 29. *Parasola plicatilis*. 1. Basidiomata (MRK 30). 2. Basidiospores. a. (DEH 1654). b. (DEH 760). 3. Pleurocystidium (MRK 30). 4. Cheilocystidia (DEH 1658). Bars: 1 = 4 mm, 2–4 = 10 μ m.

per 3 collections], subglobose to mitriform, hexagonal with rounded corners, apple-shaped or heart-shaped in front view, obliquely amygdaliform to ellipsoid, narrowly ellipsoid or oblong in side view, apiculus visible, with an eccentric germ pore that sometimes appears almost central, smooth, pale ash brown to cigar brown, chestnut brown, or dark reddish brown. – *Basidia* and *brachybasidia* not observed. – *Cheilocystidia* 18–30 \times 12–18 μ m, subglobose to ellipsoid or narrowly ellipsoid–*Pleurocystidia* 55 \times 25 μ m, ellipsoid. – *Pileipellis* not observed. – *Universal veil* absent.

Habit, habitat, and distribution in the Hawaiian Islands: Scattered on lawns. Hawai'i.

Worldwide distribution: Cosmopolitan.

Specimens examined: USA. HAWAII: Hawai'i, Hilo, UHH Campus, 29 Mar. 1995, DEH 760; same location, 31 Mar. 1998, DEH 1654; same location, 2 Apr. 1998, DEH 1658; Hawai'i, Hilo, United Methodist Church, 28 Apr. 2002, DEH 2262; Hawai'i, Hilo, Ah Fook Chinen, 3 May 2002, DEH 2267; Hawai'i, Hilo, Kalili Street Park, 18 Jul. 2002, MRK 30.

Notes: *Parasola plicatilis* is the most common of the Hawaiian coprini found in grass on lawns. No collections of young basidiomes have been made in Hawai'i most likely because primordia are difficult to find scattered in grass. Consequently, pileipellis anatomy has not been documented because it is not observable in mature specimens. In Hawai'i, there is only one other coprinoid taxon that completely lacks a universal veil and is found on lawns, viz., *P. nudiceps*. *Parasola plicatilis* can be distinguished from *P. nudiceps* by its much smaller basidiospores, and in the field by a pileus that is devoid of rusty or red tones.

Acknowledgments

We thank the following people for facilitating access to collecting permits: G. Wong (Dept. of Botany, University of Hawai'i at Manoa); E. Misaki, P. Higashino and G. Hughes (The Nature Conservancy of Hawai'i); B. Gagné (Natural Area Reserves); R. Nagata (Koke'e State Park); D. Foote (Volcanoes National Park); and L. Loope (Haleakala National Park). Keirle is thankful for financial support provided by a USDOE-GAANN Fellowship, a NSF-GK12 Teaching Fellowship, a CSU-UC California Pre-Doctoral Fellowship, and scholarships from the Mycological Society of San Francisco and the Sonoma County Mycological Association. We thank K. Uljé for providing comparative European *Coprinus* specimens for study and for sharing his expertise on coprinoid fungi. We are most grateful to D. Hibbett and his laboratory personnel at Clark University for providing their expertise and resources to aid in generating the molecular sequence data. This research was funded in part by NSF grant #'s DED-9300874 and DEB-0118776 to Desjardin.

References

- Bender, H. and Enderle, M. (1988). Studien zur Gattung *Coprinus* (Pers.: Fr.) S.F. Gray in der Bundesrepublik Deutschland. IV. Zeitschrift für Mykologie 54: 45–68.
- Bender, H., Enderle, M. and Krieglsteiner, G.J. (1984). Studien zur Gattung *Coprinus* (Pers.: Fr.) S.F. Gray in der Bundesrepublik Deutschland. II. Zeitschrift für Mykologie 50: 17–40.
- Bogart, F. van de (1976). The genus *Coprinus* in Western North America, Part 1 (sect. *Coprinus*). Mycotaxon 4: 233–275.
- Bogart, F. van de (1979). The genus *Coprinus* in Western North America, Part 2: (sect. *Lanatuli*). Mycotaxon 8: 243–291.
- Bottomley, A.M. (1948). Gasteromycetes of South Africa. Bothalia 4(3): 474–810.

- Breitenbach, J. and Kranzlin F. (1995). *Fungi of Switzerland, Volume 4*. Edition Mykologia Lucerne, Lucerne, Switzerland.
- Courtecuisse, R. (1988). Macromycetes Interessants, Rares ou Nouveaux V – Coprinaceae. Documents Mycologiques 18: 73–84.
- Cunningham, G.H. (1979). *The Gasteromycetes of Australia and New Zealand*. John McIndoe, Printer, New Zealand.
- Dennis, R.W.G. (1970). Fungus flora of Venezuela and adjacent countries. Kew Bulletin Additional Series 3: 1–531.
- Gagné, W.C. and Cuddihy, L.W. (1990). – In: W.L. Wagner, D.R. Herbst, and S.H. Somer (eds.). Manual of the flowering plants of Hawai'i. University of Hawai'i Press and Bishop Museum Press, Honolulu, Hawai'i: 45-114.
- Grgurinovic, C.A. (1997). *Larger Fungi of South Australia*. The Botanical Gardens of Adelaide and State Herbarium, Adelaide, Australia.
- Hemmes, D.E. and Desjardin, D.E. (2002). *Mushrooms of Hawai'i*. Ten Speed Press, Berkeley, California.
- Hopple, J.S. Jr. and Vilgalys, R. (1999). Phylogenetic relationships in the mushroom Genus *Coprinus* and the dark-spored allies based on sequence data from the nuclear gene coding for the large ribosomal subunit RNA: divergent domains, outgroups, and monophyly. Molecular Phylogenetics and Evolution. 13: 1–19.
- Kirk, P.M. and Ansell, A.E. (1992). Authors of fungal names. Index of Fungi Supplement. International Mycological Institute, CAB International, UK.
- Ko, K.S., Lim, Y.W., Kim, Y.H. and Jung, H.S. (2001). Phylogeographic divergences of nuclear ITS sequences in *Coprinus* species *sensu lato*. Mycological Research 105: 1519–1526.
- Kornerup, A. and Wanscher, J.H. (1978). *Methuen Handbook of Colour, Third Edition*. Eyre Methuen, London.
- Kühner, R. (1980). *Les Hyménomycètes agaricoïdes*. Numéro spécial du Bulletin de la Société Linnéenne de Lyon, 49 Anné, Imprimerie Terreaux Freres.
- Kühner, R. and Romagnesi, H. (1974). *Flore Analytique des Champignons Supérieurs*. Masson et C^{IE}, Paris.
- Lange, M. (1952). Species concept in the genus *Coprinus*. Dansk botanisk arkiv udgivet af Dansk botanisk forening 14(6): 1–164.
- Liu, B. (1984). *The Gasteromycetes of China*. Beihefte Nova Hedwigia 76: 1-235.
- Massee, G.A. (1890). Monograph of the genus *Podaxis*. Journal of Botany 28: 33–39; 69–77.
- Moncalvo, J.-M., Vilgalys, R., Redhead S.A., Johnson, J.E., James, T.Y., Aime, M.C., Hofstetter, V., Verduin, S.J.W., Larsson, E., Baroni, T.J., Thorn, R.G., Jacobsson, S., Clémenton, H. and Miller, O.K. Jr. (2002). One hundred and seventeen clades of euagarics. Molecular Phylogenetics and Evolution 23: 357–400.
- Moreno, G. and Heykoop, M. (1998). Type Studies in the Genus *Coprinus* – *Coprinus xerophilus* a new record in Europe. Persoonia 17: 97–111.
- Moser, M. (1978). *Keys to Agarics and Boleti*. Roger Phillips.
- Orton, P.D. and Watling, R. (1979). *British Fungus Flora. Agarics and Boleti. 2/Coprinaceae. Part 1: Coprinus*. Her Majesty's Stationery Office, Edinburgh.
- Pegler, D.N. (1977). A Preliminary Agaric Flora of East Africa. Kew Bulletin Additional Series 6: 1–615.
- Redhead, S., Vilgalys, R., Moncalvo, J.-M., Johnson, J. and Hopple, J.S. Jr. (2001). *Coprinus* Pers. and the disposition of *Coprinus* species *sensu lato*. Taxon 50: 203–275.
- Uljé, C.B. (2003). Web site: <http://www.homepages.hetnet.nl/~idakees/>

- Uljé, C.B. and Bas, C. (1988). Studies in *Coprinus*-I. Subsections *Auricomi* and *Glabri* of *Coprinus* section *Pseudocoprinus*. *Persoonia* 13: 433–448.
- Uljé, C.B. and Bas, C. (1991). Studies in *Coprinus*-II. Subsection *Setulosi* of section *Pseudocoprinus*. *Persoonia* 14: 275–339.
- Uljé, C.B. and Bender, H. (1997). Additional studies in *Coprinus* subsection *Glabri*. *Persoonia* 16: 373–381.
- Uljé, C.B., Doveri, F. and Noordeloos, M.E. (2000). Additions to *Coprinus* subsection *Lanatuli*. *Persoonia* 17: 465–471.
- Uljé, C.B. and Noordeloos, M.E. (1993). Studies in *Coprinus*-III. *Coprinus* section *Veliformes*. Subsection and revision of subsection *Nivei* emend. *Persoonia* 15: 257–301.
- Uljé, C.B. and Noordeloos, M.E. (1997). Studies in *Coprinus*-IV. *Coprinus* section *Coprinus*. Subsection and revision of subsection *Alachuani*. *Persoonia* 16: 265–333.
- Uljé, C.B. and Noordeloos, M.E. (1999). Studies in *Coprinus* V -- *Coprinus* Section *Coprinus*, Revision of subsection *Lanatuli* Sing. *Persoonia* 17: 165–199.
- Wagner, W.L., Herbst, D.R. and Sohmer, S.H. (1990). *Manual of the flowering plants of Hawai'i*. Vols. 1 & 2. University of Hawai'i Press and Bishop Museum Press, Honolulu, Hawai'i.

(Received 17 June 2003; accepted 3 December 2003)