



Device Manual

SmartPLC DataLine with EtherCAT slave interface

AC1433

AC1434

Master profile: M4

Firmware: 4.3.1 or higher

English

Contents

1	Preliminary note	5
1.1	Legal and copyright information	5
1.2	Purpose of the document	5
1.3	Explanation of Symbols	6
1.4	Overview: User documentation for AC1433/34	7
1.5	Modification history	7
2	Safety instructions	8
2.1	General safety instructions	8
2.2	Required background knowledge	8
2.3	Tampering with the unit	8
3	System description	9
3.1	Intended use	10
3.1.1	Permitted use	10
3.1.2	Prohibited use	10
3.2	Information concerning the device	11
3.2.1	Overview	11
3.2.2	Operating elements	12
3.2.3	Display elements	12
3.2.4	CODESYS PLC	12
3.2.5	Interfaces	13
3.2.6	Required accessories	13
4	Operation	14
4.1	Control of the graphical user interface	14
4.1.1	Function keys	15
4.1.2	Arrow keys	15
4.2	Menu view	16
4.2.1	Menu navigation	16
4.2.2	Navigation aids	17
4.3	Page view	19
4.3.1	Navigate on a page	19
4.3.2	Use navigation aids	19
4.3.3	Description of the control elements	20
4.4	Remote access	32
4.4.1	General	32
4.4.2	Recommended browsers	32
4.4.3	Operating instructions	33
5	Menu	36
5.1	Start screen	36
5.2	Menu functions	37
5.2.1	Additional functions	37
5.3	Quick setup	38
5.3.1	Quick setup: Project AS-i networks	39
5.3.2	Quick setup: Configure the operating mode of the AS-i masters	40
5.3.3	Quick setup: Configure the output access	41
5.3.4	Quick setup: Access the device via QR code	41
5.3.5	Quick setup: Configure the EtherCAT interface	41
5.3.6	Quick setup: Set the Configuration interface 1	43
5.3.7	Quick setup: Set the configuration interface 2	45

5.3.8	Quick setup: Address the AS-i slaves connected to AS-i Master 1	46
5.3.9	Quick setup: Address the AS-i slaves connected to AS-i Master 2	47
5.4	AS-i 1 / AS-i 2.....	48
5.4.1	AS-i 1 / AS-i 2: Master setup	49
5.4.2	AS-i 1 / AS-i 2: Diagnosis	52
5.4.3	AS-i 1 / AS-i 2: AS-i slaves	54
5.5	System	60
5.5.1	System: Programmable Logic Controller (PLC).....	61
5.5.2	System: Information	67
5.5.3	System: Setup	68
5.5.4	System: Diagnosis.....	81
5.6	Interfaces	82
5.6.1	Interfaces: Configuration interface 1.....	83
5.6.2	Interfaces: Configuration interface 2.....	86
5.6.3	Interfaces: EtherCAT interface	87
5.7	ifm system solutions.....	92
5.7.1	Notes on ifm system solutions.....	93
5.7.2	Show information about installed ifm apps	94
5.7.3	Install single/basic app	95
5.7.4	Install multi app	96
5.7.5	Update ifm apps	97
5.7.6	Uninstall ifm apps	97
6	Setup	98
6.1	Connect the device to the periphery	98
6.1.1	EtherCAT interface	98
6.1.2	Ethernet configuration interfaces.....	98
6.2	Start screen 'Basic settings'	99
6.2.1	Change the basic settings of the device.....	99
6.3	Update the firmware of the device	101
6.3.1	Behaviour of the settings upon firmware update	101
6.3.2	Firmware update from SD card	102
6.3.3	Firmware update via the web interface.....	103
6.4	Connect and address AS-i slaves.....	105
6.5	Configure EtherCAT interface.....	105
6.6	Set Ethernet configuration interfaces.....	105
6.7	Exchange AS-i slave.....	105
7	Troubleshooting	107
7.1	Status LED	107
7.1.1	Status LED: Basic device	107
7.1.2	Status LED: Fieldbus EtherCAT	107
7.1.3	Status LED: Configuration interface 2 (X8).....	108
7.2	Start screen: Status LEDs.....	109
7.2.1	Status of the web interface	109
7.2.2	Operating mode of the AS-i master	109
7.2.3	Control instance of the AS-i outputs	109
7.2.4	EtherCAT: fieldbus status.....	109
7.2.5	EtherCAT: Error status	110
7.3	Online diagnosis function	111
7.3.1	Message types	111
7.3.2	Locate error sources	111
7.4	Online Support Center (OSC)	112
7.4.1	OSC: View current error messages.....	113
7.4.2	OSC: Show message history.....	114

8	Appendix	115
8.1	Approval tests / certifications	115
8.2	Technical data	116
8.2.1	Housing	116
8.2.2	Display elements	116
8.2.3	Operation	116
8.2.4	Power supply connections	116
8.2.5	Interface	117
8.2.6	Programmable Logic Controller (PLC)	117
8.3	Address assignment in Ethernet networks	118
8.4	Configuration interfaces: Connection concepts	119
8.4.1	Direct connection	119
8.4.2	Connection via Ethernet network	120
8.5	AS-i master	121
8.5.1	Operating modes of the AS-i master	122
8.5.2	Master flags	124
8.6	AS-i slaves	125
8.6.1	Profiles of AS-i slaves	126
8.7	Fieldbus EtherCAT	135
8.7.1	Parameter data	136
8.7.2	Cyclic data	138
8.7.3	Acyclic data	151
8.7.4	EtherCAT projection software: Programmers' notes	156
8.8	OSC messages	164
8.8.1	OSC messages: System	164
8.8.2	OSC messages: AS-i 1 / AS-i 2	165
9	Index	166

1 Preliminary note

Content

Legal and copyright information	5
Purpose of the document	5
Explanation of Symbols	6
Overview: User documentation for AC1433/34	7
Modification history	7

33203

1.1 Legal and copyright information

33117

© All rights reserved by ifm electronic gmbh. No part of this manual may be reproduced and used without the consent of ifm electronic gmbh.

All product names, pictures, companies or other brands used on our pages are the property of the respective rights owners:

- AS-i is the property of the AS-International Association, (→ www.as-interface.net)
- CAN is the property of the CiA (CAN in Automation e.V.), Germany (→ www.can-cia.org)
- CODESYS™ is the property of the 3S – Smart Software Solutions GmbH, Germany (→ www.codesys.com)
- DeviceNet™ is the property of the ODVA™ (Open DeviceNet Vendor Association), USA (→ www.odva.org)
- EtherNet/IP® is the property of the → ODVA™
- EtherCAT® is a registered trade mark and patented technology, licensed by Beckhoff Automation GmbH, Germany
- IO-Link® (→ www.io-link.com) is the property of the → PROFIBUS Nutzerorganisation e.V., Germany
- ISOBUS is the property of the AEF – Agricultural Industry Electronics Foundation e.V., Deutschland (→ www.aef-online.org)
- Microsoft® is the property of the Microsoft Corporation, USA (→ www.microsoft.com)
- PROFIBUS® is the property of the PROFIBUS Nutzerorganisation e.V., Germany (→ www.profibus.com)
- PROFINET® is the property of the → PROFIBUS Nutzerorganisation e.V., Germany
- Windows® is the property of the → Microsoft Corporation, USA

1.2 Purpose of the document

41760

This document applies to devices of the type "SmartPLC DataLine with EtherCAT slave interface (art. no.: AC1433/34)

It is part of the device and contains information about the correct handling of the product.

- ▶ Read this document before using the device.
- ▶ Keep this document during the service life of the device.

1.3 Explanation of Symbols

34171



WARNING!

Death or serious irreversible injuries may result.



CAUTION!

Slight reversible injuries may result.

NOTICE!

Property damage is to be expected or may result.



Important note

Non-compliance can result in malfunction or interference



Information

Supplementary note



Request for action



Reaction, result



"see"

abc

Cross-reference

123

Decimal number

0x123

Hexadecimal number

0b010

Binary number

[...]

Designation of pushbuttons, buttons or indications

1.4 Overview: User documentation for AC1433/34

41793

ifm electronic provides the following user documentation for the models of the device class "SmartPLC DataLine mit EtherCAT-Slave-Schnittstelle":

Document	Content / Description
Data sheet	Technical data of the device as a table
Operating instructions *	<ul style="list-style-type: none"> ▪ Notes on mounting and electrical installation of the device ▪ Set-up, description of the operating and display elements, maintenance information, scale drawing
Device manual	<ul style="list-style-type: none"> ▪ Notes on operation of the device via GUI and web interface ▪ Error elimination ▪ Description of the fieldbus data
Supplement device manual	<ul style="list-style-type: none"> ▪ Description of the acyclic data sets and the command interface
Programming manual	<ul style="list-style-type: none"> ▪ Creation of a project with the device using CODESYS ▪ Configuration of the device using CODESYS ▪ Programming of the PLC of the device ▪ Description of the device-specific CODESYS function libraries

*... The operating instructions are supplied with the device.



The user can download all documents from the ifm website.

1.5 Modification history

34492

Version	Topic	Date
00	New creation of document	xx/201x
01		05 / 2018
02	<ul style="list-style-type: none"> ▪ Update to firmware 4.3.1 ▪ Changed: Restrore device configuration 	09 / 2018

2 Safety instructions

Content

General safety instructions	8
Required background knowledge	8
Tampering with the unit	8

28333

2.1 General safety instructions

41415

Read this document before setting up the product and keep it during the entire service life.

Only use the product for its intended purpose.

If the operating instructions or the technical data are not adhered to, personal injury and/or damage to property may occur.

Improper or non-intended use may lead to malfunctions of the device, to unwanted effects in the application or to a loss of the warranty claims.

The manufacturer assumes no liability for any consequences caused by tampering with the device or incorrect use by the operator.

- ▶ Observe these operating instructions.
- ▶ Adhere to the warning notes on the product.

2.2 Required background knowledge

41648

This document is intended for specialists. Specialists are people who, based on their relevant training and experience, are capable of identifying risks and avoiding potential hazards that may be caused during operation or maintenance of the product.

For programming these people should also have knowledge of control technology experience in PLC programming to IEC 61131-3.

The document contains information about the correct handling of the product.

2.3 Tampering with the unit

33190



WARNING!

Tampering with the unit.

- > In case of non-compliance:
 - Possible affects on safety of operators and machinery
 - Expiration of liability and warranty
- ▶ Do not open the devices!
- ▶ Do not insert any objects into the devices!
- ▶ Prevent metal foreign bodies from penetrating!

3 System description

Content	
Intended use	10
Information concerning the device	11

28392

3.1 Intended use

Content

Permitted use	10
Prohibited use.....	10

36928

3.1.1 Permitted use

36762

The device is designed for operation in the control cabinet.

The device may only be used for the following purposes:

- as AS-i master in 1 or 2 AS-i networks to control the data exchange to the sensor/actuator level
- as gateway between the AS-i network and a higher-level controller (EtherCAT-Controller = Host; e.g. PLC) via the fieldbus interface
- as Programmable Logic Controller (PLC) for program-based parameter setting, control and regulation of the AS-i slaves connected to the device
- as EtherCAT master (software extension)
- as fieldbus slave (software extension)

3.1.2 Prohibited use

34228

The device may not be used beyond the limits of the technical data (→ **Technical data** (→ S. [116](#)))!

3.2 Information concerning the device

Content

Overview.....	11
Operating elements.....	12
Display elements.....	12
CODESYS PLC.....	12
Interfaces.....	13
Required accessories.....	13

36905

3.2.1 Overview

36757

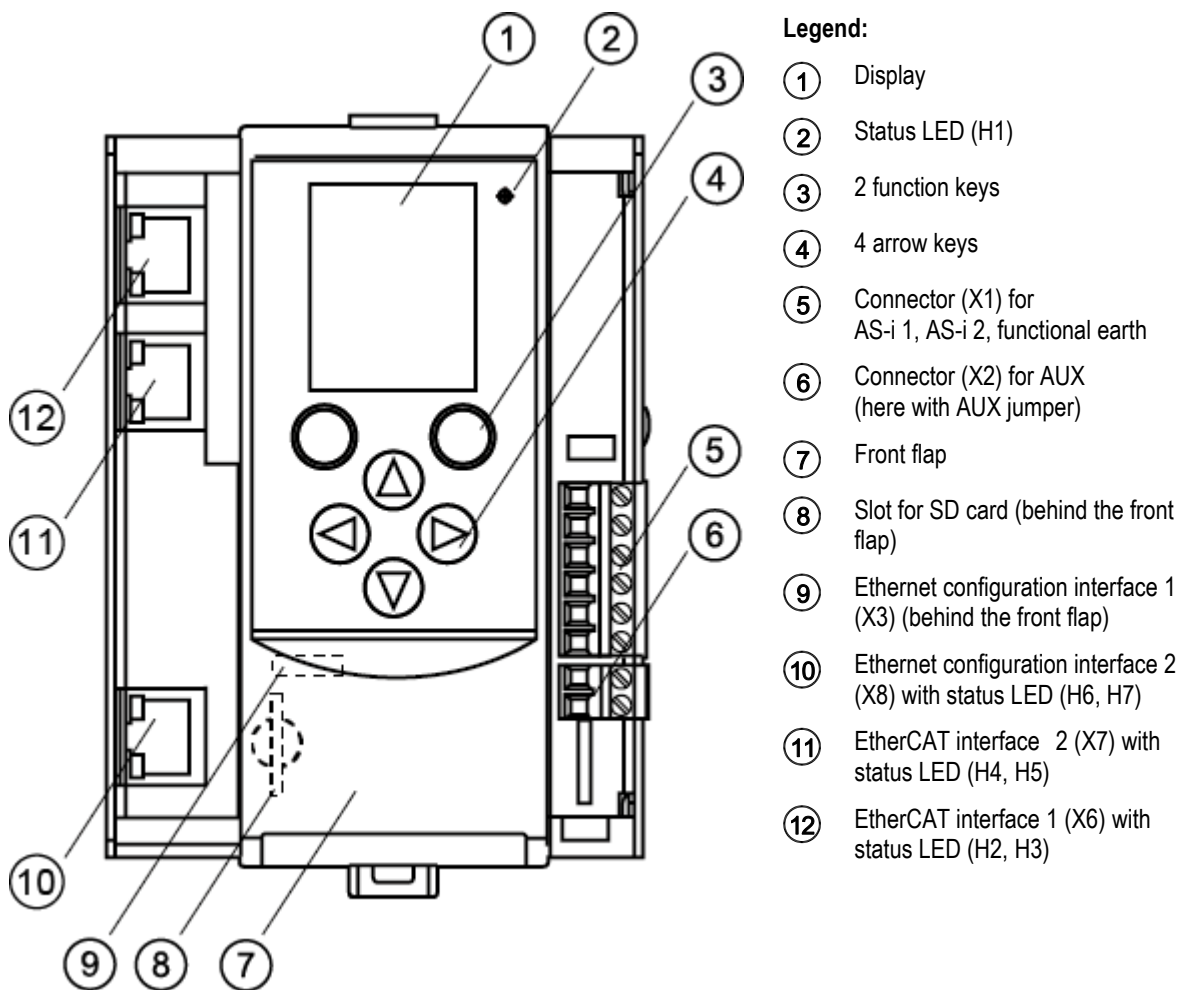

3.2.2 Operating elements

36790

The device provides the following operating elements.

Arrow and function keys

36959

Below the display is the key panel with two function keys and four arrow keys. The operator controls the Graphical User Interface (GUI) of the device with the keys.

Operating notes: → **Operation** (→ S. [14](#))

3.2.3 Display elements

36917

The device provides the following display elements:

Display

36894

The display is used to display the Graphical User Interface (GUI) of the device.

Operating notes: → **Operation** (→ S. [14](#))

Technical data: → **Technical data** (→ S. [116](#))

Status LEDs

36784

The device features the following status LEDs which display the current status of system components.

Meaning of the LED colours and flashing frequencies: → **Status LED** (→ S. [107](#))

3.2.4 CODESYS PLC

36953

The device features a Programmable Logic Controller (PLC). The PLC can run the following application types:

- Applications that have been created with the IEC 61131-3 compliant programming software "CODESYS Development System" (from version 3.5 SP9 Patch 7 Hotfix 3)
- System solutions that have been provided by ifm electronic

Technical data: → **Programmable Logic Controller (PLC)** (→ S. [117](#))



For information about the programming of the device-internal PLC with CODESYS, please refer to the programming manual:

→ www.ifm.com > product page > [Downloads]

3.2.5 Interfaces

36927

The device provides the following interfaces:

Ethernet configuration interfaces

36913

The configuration interface 1 (X3) is behind the front flap of the device.

The configuration interface 2 (X8) is underneath the EtherCAT interface (X6/X7).

The user can access the following functions via both interfaces:

- web interface for device configuration and diagnostics
- Programming of the device-internal PLC and the fail-safe PLC with CODESYS
- Operation as additional fieldbus interface

Possible network topologies: → **Configuration interfaces: Connection concepts** (→ S. [119](#))

Technical data: → **Technical data** (→ S. [116](#))

EtherCAT fieldbus interface

36925

The device communicates with the higher-level control instance of the EtherCAT network via the EtherCAT interface (X6/X7).

- Notes regarding connection concepts: → **Configuration interfaces: Connection concepts** (→ S. [119](#))
- Technical data: → **Technical data** (→ S. [116](#))

SD card slot

36761

The SD card slot (X5) is located behind the front flap of the device. The following actions can be performed with an SD card:

- update the firmware of the device
- save/restore the device configuration

Technical data: → **Technical data** (→ S. [116](#))

3.2.6 Required accessories

36764

To be able to operate the device in a sensible way you need the following accessories (not supplied with the device):

- Depending on the selected voltage supply (→ Operating instructions) you need:
 - a power supply for the 24 V power supply (e.g. art. no. DN3011)
 - for each AS-i master one AS-i power supply each (e.g. art. no. AC1236)
 - a data decoupling module AC1250 (accessory, optional)
- AS-i slaves.

4 Operation

Content

Control of the graphical user interface	14
Menu view.....	16
Page view	19
Remote access.....	32

41713

4.1 Control of the graphical user interface

41568

Below the display is the key panel with six membrane keys. The operator controls the graphical user interface of the device with these keys. The key panel is closely linked to the navigation status bar.

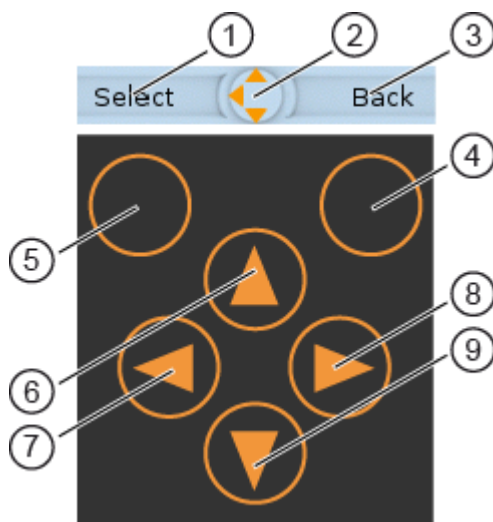

Legend:

- ① Label left function key
- ② Navigation compass
- ③ Label right function key
- ④ Right function key
- ⑤ Left function key
- ⑥ [▲] arrow key
- ⑦ [▼] arrow key
- ⑧ [▶] arrow key
- ⑨ [◀] arrow key

4.1.1 Function keys

41476

The two **function keys** allow the operator to trigger specified actions (e.g. tick a checkbox). The function of the function keys changes depending on the context.

The two **text fields in the navigation status bar** are associated with the function keys located directly below the display. They indicate the action that will be triggered if the function key is pressed in the current work step. If the function key is not labelled, it means that it has no function in the present situation.

Example (→ figure):

- ▶ The left function key triggers the action [Select].
- ▶ The right function key triggers the action [Back].

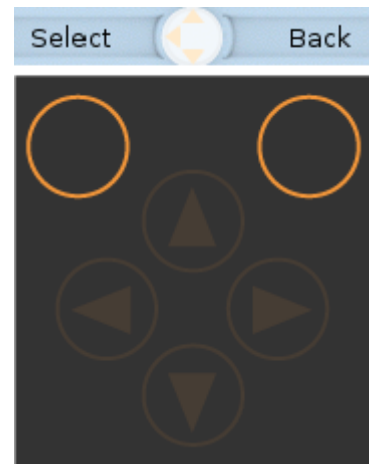

4.1.2 Arrow keys

7091

The four **arrow keys** [▲], [▶], [▼] and [◀] can be used for navigation and selection.

The **navigation compass** shows which of the four arrow keys can be used in the respective work step.

Examples:



All arrow keys are active and will trigger a device response when pressed.



Only the arrow keys [▶] and [▼] are active and will trigger a device response when pressed.

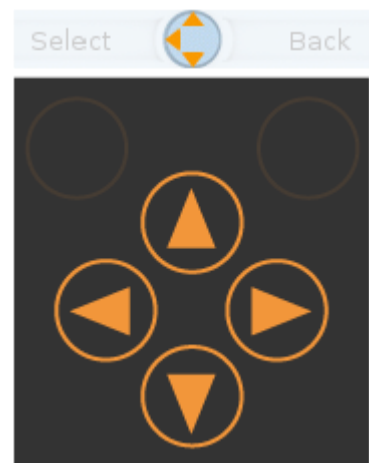

4.2 Menu view

The menu view allows the user to select the menu page with the required control or display function.

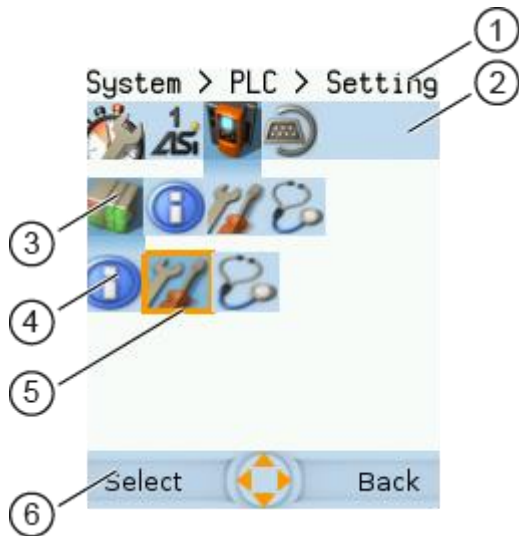

Legend:

- ① Info bar
- ② Main navigation bar
- ③ Subnavigation bar 1
- ④ Subnavigation bar 2
- ⑤ Selected menu item (focus)
- ⑥ Navigation status bar with
 - labelling of the function keys
 - navigation compass



Long texts are displayed as scrolling text in the info bar.

4.2.1 Menu navigation

The central operating elements in the menu view are the three **navigation bars**. They reflect the menu structure of the device software. Each navigation bar represents a menu level. The symbols in a navigation bar represent the submenus and menu items.

Rules for menu navigation:

- ▶ Use [◀] / [▶] to navigate within a menu level.
- > The selected symbol has the **focus** (= orange frame).
- > If the selected symbol has a submenu, the corresponding **subnavigation bar** will automatically appear.
- ▶ Use [▼] to go one menu level down.
- ▶ Use [▲] to go one menu level up.

At the lowest menu level:

- ▶ Press [Select] function key to go to the page of the selected menu item (→ **Page view** (→ S. [19](#))).

In the main navigation bar:

- ▶ Press [Back] function key to return to the start screen (→ **Start screen** (→ S. [36](#))).

4.2.2 Navigation aids

41748

The following screen elements help you navigate through the menu:

- > The **info bar** shows the navigation path of the selected menu symbol.
- > The **navigation compass** shows which navigation steps are possible from the current position.

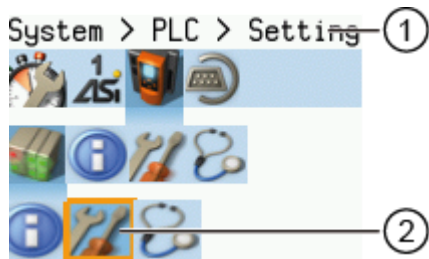

Legend:

- ① Info bar

Navigation path to the focused menu element:
[System] > [PLC] > [Setup]

- ② Menu element with focus

Navigation path to the focused menu element:



Example

41499

To access the menu page containing the setting options for the device-internal PLC:

1. > Initial position when accessing the menu screen
2. ► Use [▶] to select the [System] menu symbol.
 - > The focus is on the [System] menu symbol.
 - > The first subnavigation bar appears.
3. ► Use [▼] to change to the first subnavigation barh.
 - > The focus is on the [Diagnosis] menu symbol.
4. ► Use [◀] to select the [PLC] menu symbol.
 - > The focus is on the [PLC] menu symbol.
 - > The second subnavigation bar appears.
5. ► Use [▼] to change to the second subnavigation bar.
 - > The focus is on the [Information] menu symbol.



6.
 - ▶ Use [▶] to select the [Settings] menu symbol.
 - > The focus is on the [Settings] menu symbol.
 - ▶ Press the [Select] function key to go to the page view of the [Settings] menu item.
 - > The page shows the setting options for the device-internal PLC.

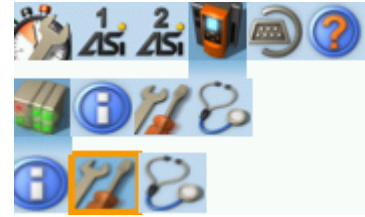

4.3 Page view

41786

The page view allows the user to select and execute a requested function.

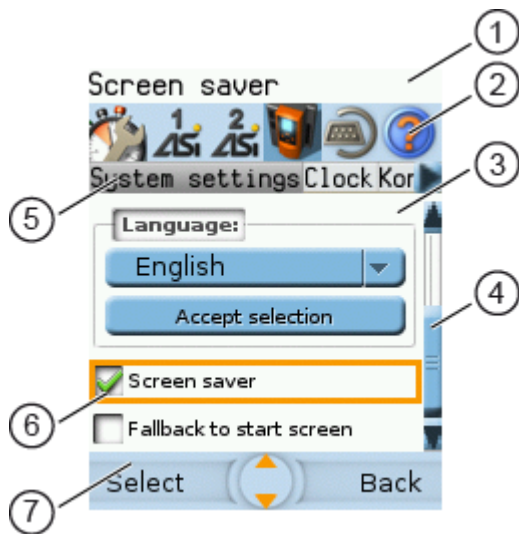

Legend:

- ① Info bar
- ② Main navigation bar
- ③ Page
- ④ Scroll bar
- ⑤ Tab menu
- ⑥ Page element with focus
- ⑦ Navigation status bar with
 - labelling of function keys
 - navigation compass

4.3.1 Navigate on a page

41749

The page contains elements, that allow the operator to control the device or access information.

For page navigation, the following basic rules apply:

- ▶ Use the arrow keys [▼] / [▲] to change between the different page elements.
- > The selected element is marked (= orange frame).
- ▶ Use the [Back] function key to return to the tab menu / menu view.



Rules for using the different control elements: → **Description of the control elements** (→ S. [20](#))

4.3.2 Use navigation aids

41678

The following aids offer navigation users additional orientation:

- > The **info bar** shows detailed information about the selected element (focus).



Long texts are displayed as scrolling text in the info bar.

- > The active menu symbol in the **main navigation bar** has a dark background.
- > A **scroll bar** appears on the right side of the screen if the elements do not fit on the page.
- > The **navigation compass** shows the navigation options in the active work step.
- > The **text fields in the navigation status bar** show the current assignment of the function keys.

4.3.3 Description of the control elements

Content	
Tab menu/Tab	21
Button	22
Checkbox.....	22
List	23
Slave selector	24
Confirmation message.....	29
Numerical field	30
Binary field	31

41586

A page consists of different control elements.

Tab menu/Tab

A tab menu groups together the different functions of a menu page. A tab menu consists of at least two tabs. A tab combines related functions.

Example:

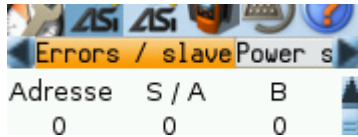

- > The focused tab has an orange background
- > The info bar displays the name of the active tab (in this example: Errors / slave).
- > The symbols ◀ and ▶ indicate that there are more tabs on the left and right sides of the visible tab.
- > The page shows the control elements that belong to the currently selected tab.

Tabs can have the following background colours:

Version = Tab has the focus

Version = Tab is active

Version = Tab is inactive

Use:

1 Select the menu item

- ▶ Go to the menu item with the tab menu.
- > The tab menu appears.
- > The focus is on the left-hand tab.

2 Select a tab

- ▶ Use [◀] / [▶] arrow key to select the desired tab.
- > The focus (orange background) moves to the selected tab: **Version**
- > The page shows the functions of the selected tab.

3 Activate the menu page

- ▶ Press [Select] arrow key to go to the page that belongs to the active tab.
- > When going to the page, the tab menu remains visible.
- > The background colour of the active tab turns grey. **Version**

4 Carry out the desired functions

- ▶ Use [▼] to select and execute the desired function.

5 Change to tab menu

- ▶ Press [Back] function key to change to the tab menu.
- > The focus (orange background) moves to the active tab.

Button

41536

A button allows the operator to carry out a specified action once. The caption on the button describes the action.

Example:



Use:

1 Select a button

- ▶ Use the arrow keys [▲] / [▼] to select a button.
- > The selected button gets an orange frame:

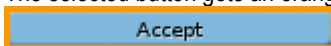

2 Activate the button

- ▶ Use [Select] function key to activate the selected button.
- > The function is executed.

Checkbox

41600

A checkbox permits the user to activate/deactivate a parameter. A checkbox control element consists of a checkbox and a caption.

Example:

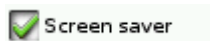

Use:

1 Select a checkbox

- ▶ Use [▲] / [▼] arrow key to select the checkbox
- > The focus (orange frame) moves to the selected checkbox

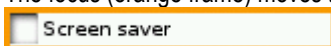

OR:



2 Check/uncheck a checkbox

- ▶ Use [Select] function key to check/uncheck the selected checkbox.
- > The status change is indicated:
 - = checkbox is checked
 - OR:
 - = checkbox is unchecked



The setting or clearing of a checkbox is not always immediately effective. Often the change must be confirmed by clicking a button (e.g. [\[Accept selection\]](#))!

List

A list provides a set of defined values. The operator can select precisely one value from this set (= 1 of n selection).

Examples:



= list without caption



= list with caption

Use:

1 Select a list

- ▶ Use [▲] / [▼] arrow key to select the list.
- > The focus (orange frame) moves to the selected list.

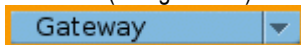

- > The list shows the active value: (in this example Gateway).

2 Activate the list

- ▶ Use [Select] function key to open the list.
- > The opened list shows the selectable values.

3 Select a value

- ▶ Use [▲] / [▼] arrow key to select the desired value from the list.
- > The background colour of the selected value turns orange.

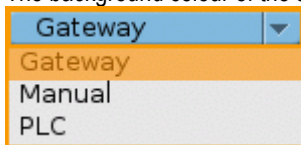

4 Apply the selected value

- ▶ Use [Select] function key to apply the selected value.
OR:
Use [Back] function key to quit and close the list.
- > The list shows the selected value.



The set value will not always become effective immediately. Often the change must be confirmed by clicking a button (e.g. **[Accept selection]**)!

Slave selector

Content

Overview of slave states.....	25
Overview of free slave addresses	27

41653

The slave selector is used to select an AS-i slave or an AS-i address.

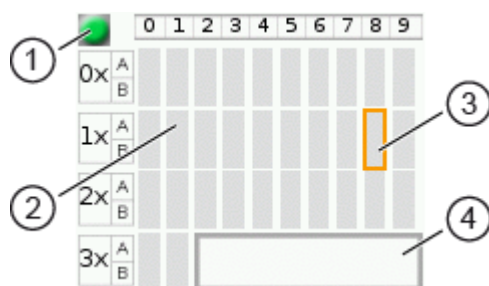

Legend:

- ① Indicator of AS-i master operating mode
- ② AS-i address symbol
- ③ Highlighted AS-i address (focus)
- ④ Status message of highlighted AS-i address

- > The **status LED** indicates the active operating mode of the AS-i master:
 - = AS-i master in protected mode
 - = AS-i master in projection mode
- > Every field represents an **AS-i address**. An AS-i address can be occupied by:
 - a single slave symbol
 - an A/B slave pair symbol
- > The row and column headers help to locate the AS-i address.

Example: address of the field selected in the picture

- row header: 1x (= tens digit of the AS-i address)
- column header: 8 (= units digit of the AS-i address)
- type of slave: single slave (= symbol fully occupies the address field)
- resulting AS-i address: 18

- > The symbol of the A/B slave pair appears when an A or B slave is used on this address.

The slave selector is used in the following overviews:

- Overview of slave states (→ **Overview of slave states** (→ S. [25](#)))
- Overview of free slave addresses (→ **Overview of free slave addresses** (→ S. [27](#)))

Overview of slave states

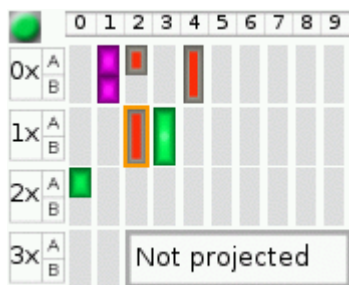

- > The slave selector shows an overview of the slaves in the selected AS-i network.
- > The symbol colour signals the slave status. Meaning of symbols and colours:
→ **Slave status: colour code + symbols** (→ S. 26)
- > The text field displays the status of the selected AS-i slave.
Possible status messages:
 - Slave active
 - Not projected (= configuration error)
 - Double address (= double address error)
 - Periphery (= periphery fault)

Use:

1 Select an AS-i slave













- ▶ Use the arrow keys [▲], [▶], [▼] and [◀] to select the desired AS-i slave.
- > The focus (= orange frame) is on the selected AS-i slave.
- > The info bar shows the address of the selected AS-i slave.
- > The text field shows a status message about the selected AS-i slave.

2 Activate the selected AS-i slave

- ▶ Use [Select] function key to activate the selected AS-i slave and go to the next menu page.
OR:
Use [Back] function key to cancel and leave the slave selector.



Slave status: colour code + symbols

41652

Single slave	A/B slave	Colour	Meaning
		grey	No slave found: slave address is neither in the LPS nor in the LDS
		green	Slave is activated (in LAS)
		red	Configuration error type 1: slave is projected (in LPS) but was not found (in LDS)
		yellow	Slave signals a peripheral fault
		pink	Several slaves have the same address (double address error)
		grey red	Configuration error type 2: <ul style="list-style-type: none"> the found slave (in LDS) is not projected (in LPS) the found slave has another profile than projected

Meaning of the colour combinations (example: configuration error type 2)

41741

Symbol	Colour	Meaning
	grey red grey	Configuration error type 2: <ul style="list-style-type: none"> Single slave is projected (in LPS) but was not found (in LDS). Instead, a new A slave with the same address was installed.
	grey grey red	Configuration error type 2: <ul style="list-style-type: none"> Single slave is projected (in LPS) but was not found (in LDS). Instead, a new B slave with the same address was installed.
	grey red	Configuration error type 2: <ul style="list-style-type: none"> A or B slave is projected (in LPS) but was not found (in LDS). Instead, a new single slave with the same address was installed.

Overview of free slave addresses

In this overview, the slave selector shows the free and occupied AS-i addresses.



- > The symbol colour indicates the state of the AS-i address.
Meaning of symbols and colours:
→ **Free slave addresses: colour code + symbols** (→ S. 28)
- > The text field displays the status of the selected AS-i slave.
Possible status messages:
 - Free
 - Missing slave

Use:

1 Select the AS-i address







- ▶ Use the arrow keys [▲], [▶], [▼] and [◀] to select the desired AS-i address.
- > The focus (= orange frame) is on the selected AS-i address.
- > The info bar displays the selected AS-i address.
- > The text field shows a status message for the selected AS-i address.

2 Activate the selected AS-i address

- ▶ Press [Select] function key to activate the selected AS-i address and go to the next menu page.
OR:
Press [Back] function key to cancel and leave the slave selector.









Free slave addresses: colour code + symbols

41493

Single slave	A/B slave	Colour	Meaning	Prio.
		grey	Slave address is already used.	--
		turquoise	Address is free according to LDS (= no slave found), however: address already belongs to a stored projection (= application profile).	1
		blue	Address is free according to LDS (= no slave found). Address is not used in a stored projection (= application profile).	2

Meaning of the colour combinations

41736

Symbol	Colour	Meaning
	blue blue	Slave to be addressed is an A/B slave: A and B addresses are free.
	blue grey	Slave to be addressed is an A/B slave: – A address is free. – B address is used.
	grey blue	Slave to be addressed is an A/B slave: – A address is used. – B address is free.
	turquoise turquoise	Slave to be addressed is an A/B slave: A and B addresses are free, but already used in a stored projection.
	turquoise grey	Slave to be addressed is an A/B slave: – A address is free, but already used in a stored projection. – B address is used.
	grey turquoise	Slave to be addressed is an A/B slave: – A address is used. – B address is free, but already used in a stored projection.
	turquoise blue	Slave to be addressed is an A/B slave: – A address is free, but already used in a stored projection. – B address is free.
	blue turquoise	Slave to be addressed is an A/B slave: – A address is free – B address is free, but already used in a stored projection.

Confirmation message

The confirmation message is a security prompt. It appears when important changes are made to the system settings. The confirmation message shows the changes made. For the changes to become effective, they first need to be acknowledged by the operator.

Example:



- > Action: Change AS-i slave address from 1a to 1b
- > Confirmation message shows:
 - Action (= Change AS-i address)
 - Slave address prior to change
 - Slave address after change
- > The operator has the following input options:
 - [Select] function key
 - [Back] function key

Use:

1 Change the settings





- ▶ Change the system settings.
- > The confirmation message appears.

2 Confirm the message

- ▶ Press [Select] function key to confirm the changes and apply the new value.
OR:
Press [Back] function key to reject the changes and continue to use the old value.
- > The page displays the valid settings.

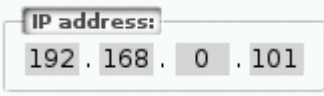
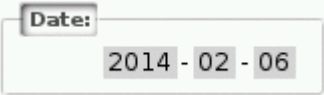
Numerical field

The numerical field allows the operator to enter integer values. The value range is context-specific. Numerical fields are part of the following GUI elements:

Control element	Example	Meaning
IP address		Entry of an IP address (IPv4) in [w.x.y.z] format <ul style="list-style-type: none"> ▪ w x y z = network segments (value range: 0... 255)
Date		Date entry in [yyyy-mm-ss] format <ul style="list-style-type: none"> ▪ yyyy = year (value range: 0000 ... 9999) ▪ mm = month (value range: 01 ... 12) ▪ dd = day (value range: 01 ... 31)
Time		Time entry in [hh:mm:ss] format <ul style="list-style-type: none"> ▪ hh = hours (value range: 00 ... 12) ▪ mm = minutes (value range: 00 ... 59) ▪ ss = seconds (value range: 00 ... 59) <p> The numerical field for seconds (ss) cannot be edited!</p>
Analogue value		Entry of an analogue output value Value range (per numerical field): 0 ... 9

Use (using the example of the numerical date field):

1 Select a numerical field

- ▶ Use [▲]/[▼] arrow key to select the date control element.
- > The focus (= orange frame) is on the selected date control element.



- > The date control element displays the current date

2 Activate the editing mode

- ▶ Press [Select] function key to enter the editing mode.
- > The focus (orange frame) is on the right element



3 Set the desired value

- ▶ Use [▲]/[▼] arrow key to increment the desired value.
- > The segment displays the new value.



Press and hold the arrow key [▲]/[▼] to rapidly move through larger value ranges.

4 Select the next segment

- ▶ Use the arrow key [◀]/[▶] to mark the segment to be edited.
- > The focus (orange frame) moves to the marked segment



- ▶ Optional: Repeat steps 3 and 4 until all segments have the desired values.

5 Adopt the set values

- ▶ Use [Select] function key to confirm the set values and to leave the edit mode.
OR:
Use [Back] function key to reset the set values and to leave the edit mode.
- > The date control element displays the valid date



The set value will not always become effective immediately. Often the change must be confirmed by clicking a button (e.g. [\[Accept selection\]](#))!



Binary field

41531

The binary field allows the operator to change a digital value bit-wise.

Example:



- > Display of the 4-bit digital value:
 - Binary representation
 -  = bit is on (= 1).
 -  = bit is off (= 0).
 - Hexadecimal representation:
0xf = 1111

Use:

1 Select the binary field

- ▶ Use [▲] / [▼] arrow key to select the binary field.
- > The focus (orange frame) is on the selected binary field.



- > The control element shows the current value (digital and hexadecimal).

2 Activate the editing mode

- ▶ Press [Select] function key to enter the editing mode.
- > The focus (orange frame) is on the right element.



3 Set the desired value

- ▶ Use [▲] / [▼] arrow key to set the desired value.
- > The control element shows the new value in digital and hexadecimal format.

4 Select the next segment

- ▶ Use [◀] / [▶] arrow key to mark the segment to be edited.
- > The focus (orange frame) is on the selected segment.



- ▶ Optional: Repeat steps 3 and 4 until all segments have the desired values.

5 Apply the set values

- ▶ Use [Select] function key to confirm the set values and to leave the edit mode.
OR:
Use [Back] function key to reset the set values and to leave the edit mode.
- > The binary field displays the current value (binary and hexadecimal).

4.4 Remote access

Content

General.....	32
Recommended browsers.....	32
Operating instructions.....	33

41775

The device has an integrated web server. It generates a web interface which allows remote access to all device functions via an web browser. The web-interface allows the operator to easily configure, parameterise and monitor the device in permanent operation via an ethernet-based network.

4.4.1 General

41475

The operating concept of the web interface follows the same philosophy as the operating concept of the local display. The web interface uses the same menu items, the same menu structure and the same symbols as the graphic user interface of the local display.



Observe notes regarding the additional functionality of the web interface: → **Additional functions** (→ S. [37](#))

4.4.2 Recommended browsers

41777

Use one of the following Internet browsers to correctly display the HTML pages of the web interface:

- Microsoft Internet Explorer (from version 8.0)
- Mozilla Firefox (from version 3.5)

4.4.3 Operating instructions

41723

Web interface: Access

41681

- ▶ PC / Laptop / mobile device: Start Internet browser.
- ▶ Internet browser: Enter IP address of the device in the address line (e.g. 192.168.82.2)
- > Internet browser displays the start page of the web interface.

Web interface: Navigation

41680

In the web interface, the pointing device (e.g. mouse, touchpad) is used instead of the following key functions:

- Navigation functions of the arrow keys [▼], [▲], [▶], [◀]
- Selecting functions of the function keys [Select] and [Back]

Example:

To select  > :

- ▶ Place the cursor on symbol [AS-i 1] in the main navigation bar.
- > Symbol [AS-i 1] has the focus.
- > Subnavigation bar appears.
- > Navigation trail shows actual position in the menu tree:
AS-i 1
- ▶ Place the cursor on symbol [Diagnostics] in the subnavigation bar.
- > Symbol [Diagnostics] has the focus.
- > Navigation trail shows actual position in the menu tree:
AS-i 1 > Diagnostics
- ▶ Click on symbol [Diagnostics]
- > Web browser shows menu page [Diagnostics]



Web interface: Password protection

41679

The web server has a basic password protection to prevent unwanted or unauthorised changes to the device settings via the web interface.

When the web interface is accessed, a status bar at the top shows if the user is logged in or logged out:

 Status: logged in

User is logged in:

- Full access to device settings
- Full access to diagnostics and information data

 Status: logged out

User is logged out:

- No access to device settings
- Access to diagnostics and information data





The password is: CAFE

The password protection cannot be deactivated! The password cannot be changed!

Web interface login

41676

- ▶ Go to the web interface (→ **Operating instructions** (→ S. 33)).
- > At the top of the web interface, the status bar displays the following status message:
 -  Status: logged out
- ▶ Enter the fixed password in the [Password:] field.
- ▶ Click [Login] to log in to the web interface.
- > The status bar displays the changed status:
 -  Status: logged in
- > The operator has unlimited access to all menus and functions of the web interface.



The operator remains logged in if one of the following actions is carried out:

- the web browser is closed and reopened
- the PC/laptop is restarted
- AC1433/34 is restarted

To prevent unauthorised access to the device settings:

- ▶ Manually log off before you leave the web interface! (→ **Disconnect from web interface** (→ S. 35))
- ▶ Remember to turn off the "Save password" function of your web browser before accessing the web interface!
- ▶ If the "Save password" function of your web browser is not turned off: delete the stored passwords in your browser settings!

Disconnect from web interface

41457

To log out of the web interface:

- ▶ Start web interface
- > Status line with status message is displayed at the top of the web interface:
 - 🔒 Status: logged in
- ▶ Log out of the web interface by clicking [Logout]
- > Status bar shows changed status
 - 🔓 Status: logged out
- > User can only access menus in the web interface containing diagnostic and information data.
- > An error message is displayed when a user in the web interface accesses a menu with device settings.



The user stays logged into the web interface even when the web browser is closed and then restarted.

To prevent unauthorised access to the device settings:

- ▶ After finishing the access via the web browser manually log out of the device web interface!
- ▶ When password memory function of the web browser is not deactivated: Delete all saved passwords in the browser settings!

5 Menu

Content

Start screen	36
Menu functions	37
Quick setup.....	38
AS-i 1 / AS-i 2	48
System.....	60
Interfaces.....	82
ifm system solutions	92

41740

This chapter describes the menu functions of the device's graphical user interface.

5.1 Start screen

42111

When starting the device, the start screen of the graphical user interface appears (special case: system start after initial commissioning or firmware update: → **Start screen 'Basic settings'** (→ S. 99)). The start screen displays the status information of important system components. The start screen is also the starting point for access to the menu functions of the AC1433/34.

Please press a button

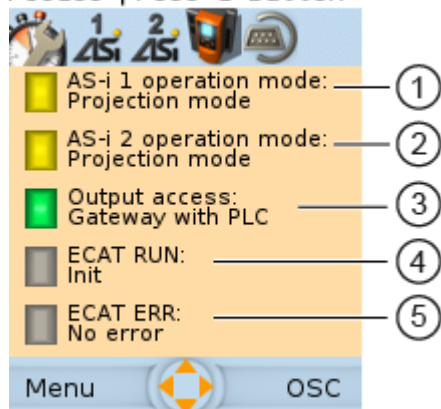

- ① AS-i Master 1 operation mode
→ **Operating mode of the AS-i master** (→ S. 109)
- ② Operating mode of the AS-i Master 2
→ **Operating mode of the AS-i master** (→ S. 109)
(only available for devices with 2 AS-i masters)
- ③ Control instance of the AS-i slave outputs
→ **Control instance of the AS-i outputs** (→ S. 109)
- ④ State of the EtherCAT connection
→ **EtherCAT: fieldbus status** (→ S. 109)
- ⑤ Error status of the field bus
→ **EtherCAT: Error status** (→ S. 110)







► Change to the menu with [Menu] function key (→ **Menu functions** (→ S. 37)).

OR:

► Display the online support centre with [OSC] function key (→ **Online Support Center (OSC)** (→ S. 112)).

5.2 Menu functions

The main navigation bar of the AC1433/34 provides access to the following menus:

Symbol	Description
	Access to the most important device functions → System (→ S. 60)
	Configuration and diagnostics of the AS-i 1 network (AS-i master, AS-i slaves) → AS-i 1 / AS-i 2 (→ S. 48)
	Configuration and diagnostics of the AS-i 2 network (AS-i master, AS-i slaves)* → AS-i 1 / AS-i 2 (→ S. 48)
	Configuration and diagnostics of the device, control of the device-internal PLC → System (→ S. 60)
	Configuration and diagnostics of the interfaces (EtherCAT, Configuration interface) → Interfaces (→ S. 82)
	Online Support Centre** → Online Support Center (OSC) (→ S. 112)
	Control and administration of the ifm system solutions (ifm apps)** → ifm system solutions (→ S. 92)

* ... only available for devices with 2 AS-i masters

** ... only available via the web interface of the device

5.2.1 Additional functions

Compared to the user interface of the display, the web interface offers the following additional functions:

- Download device description file
(→ **Download ESI file** (→ S. [89](#)))
- Adopt date and time of a PC/laptop
(→ **Adopt the system time of the PC** (→ S. [76](#)))
- Store diagnostic protocol
(→ **Store diagnostic protocol** (→ S. [80](#)))
- Use ifm system solutions
(→ **ifm system solutions** (→ S. [92](#)))
- Diagnostics display
(→ **Start screen: Status LEDs** (→ S. [109](#)))

5.3 Quick setup

42973

The [Quick-Setup] menu provides fast access to the most important device functions.

Navigation path	Functions
	<ul style="list-style-type: none"> → Quick setup: Project AS-i networks (→ S. 39) → Quick setup: Configure the operating mode of the AS-i masters (→ S. 40) → Quick setup: Configure the output access (→ S. 41) → Quick setup: Access the device via QR code (→ S. 41) → Quick setup: Configure the EtherCAT interface (→ S. 41) → Quick setup: Set the Configuration interface 1 (→ S. 43) → Quick setup: Set the configuration interface 2 (→ S. 45) → Quick setup: Address the AS-i slaves connected to AS-i Master 1 (→ S. 46) → Quick setup: Address the AS-i slaves connected to AS-i Master 2 (→ S. 47)

5.3.1 Quick setup: Project AS-i networks

During projection adaptation, the AS-i master carries out the following actions:

- The configuration data of all detected AS-i slaves (LDS) is saved
- The detected AS-i slaves are added to the list of projected slaves (LPS)



During a project a projection adaptation all output parameters of the unconnected AS-i slaves are reset to their default value in the AS-i master (single /A slaves = 0xF, B slaves = 0x7).

To carry out the projection adaptation on AS-i master 1 and/or AS-i master 2:

1 Select menu page



- ▶ Select tab **Project all!**

2 Select the AS-i master for projection adaptation

- ▶ Set the following parameters as required:

Parameter	Description	Possible values	
[AS-i Master 1]	Select AS-i Master 1 for projection adaptation	<input type="checkbox"/>	Exclude AS-i Master 1 from projection adaptation
		<input checked="" type="checkbox"/>	Include AS-i Master 1 in projection adaptation
[AS-i Master 2]	Select AS-i Master 2 for projection adaptation (only available for devices with 2 AS-i masters)	<input type="checkbox"/>	Exclude AS-i Master 2 from projection adaptation
		<input checked="" type="checkbox"/>	Include AS-i Master 2 in projection adaptation

3 Start the projection adaptation

- ▶ Activate the button **Start projection process**.
- > The selected AS-i masters go into the "projection mode".
- > A projection adaptation is carried out on the selected AS-i masters.
- > After projection adaptation, the selected AS-i masters go into the "protected mode".

5.3.2 Quick setup: Configure the operating mode of the AS-i masters

41778



Information regarding the operating modes of an AS-i master: → **Operating modes of the AS-i master** (→ S. [122](#))

To configure the operating modes of the AS-i masters:

1 Select the menu page



- ▶ Select **[Operation modes]** tab.

2 Configure the operating mode of AS-i master 1 and the behaviour of the connected AS-i slaves

- > In group [AS-i master 1], set the following parameters as required:

Parameter	Description	Possible values	
[Projection mode]	Active operating mode of the AS-i master	<input type="checkbox"/>	Projection mode inactive: AS-i network runs in protected mode (normal mode)
		<input checked="" type="checkbox"/>	Projection mode active: AS-i network can be projected. (→ Quick setup: Address the AS-i slaves connected to AS-i Master 1 (→ S. 46) or → Quick setup: Address the AS-i slaves connected to AS-i Master 2 (→ S. 47))
[No slave reset]	Behaviour of the AS-i slaves when changing the operating mode	<input type="checkbox"/>	Slave is reset when changing the operating mode: When changing the operating mode, the AS-i slaves will be reset for a short moment (reset or offline phase).
		<input checked="" type="checkbox"/>	Slave is not reset when changing the operating mode: When changing the operating mode, the AS-i slaves continue to operate without interruption.

- > Selected values are applied.

3 Optional: set the operating mode of AS-i master 2 and the behaviour of the AS-i slaves

- ▶ Repeat step 2 for the group [AS-i master 2].

5.3.3 Quick setup: Configure the output access

41783

Only one control instance at a time can have write access to the outputs of the connected AS-i slaves. The operator configures the control instance with the parameter [Output access].

To configure the control instance of the AS-i slave outputs:

1 Select the menu page



- ▶ Select [Operation modes] tab.

2 Set the control instance for the outputs of the AS-i slaves

- ▶ From the list [Output access], select the desired value:

Parameter	Description	Possible values	
[Output access]	Control instance of the AS-i slave outputs	[Gateway]	A higher-level PLC controls the outputs of the AS-i slaves.
		[Manual]	The operator controls the outputs of the AS-i slaves via the graphical user interface.
		[PLC]	The device-internal PLC controls the outputs of the AS-i slaves.

3 Save the changes

- ▶ Press [Accept selection] to save the changes.
- > The selected instance controls the outputs of the AS-i slaves.

5.3.4 Quick setup: Access the device via QR code

41765

The QR code (Quick Response Code) allows the operator to access the web interface of the device from a smartphone or tablet PC.

Requirements:

- The AS-i device must be connected to a wireless LAN router with switch functionality. (→ **Connection via Ethernet network** (→ S. 120))
- The smartphone/tablet PC is connected to the wireless LAN router.
- The smartphone/tablet PC provides a camera function.
- The smartphone/tablet PC has a QR-code reader installed.

1 Select menu page



- ▶ Select the [QR-Code] tab.
- > The display shows the QR code.

2 Read the QR code

- ▶ Start the QR code reading app and scan the QR code.
- > The smartphone displays the web interface of the device (→ **Remote access** (→ S. 32)).

5.3.5 Quick setup: Configure the EtherCAT interface

42934

To configure the EtherCAT interface:

1 Select menu page

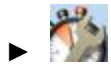

▶ Select tab **EtherCAT**.

2 Set the EtherCAT address of the device

▶ Set the following parameters as required:

Parameter	Description	Possible values	
[ID]	EtherCAT address of the device	1 ... 65535	EtherCAT address 1 ... EtherCAT address 65535

▶ Click on **Übernehmen** to save the changes.

5.3.6 Quick setup: Set the Configuration interface 1

41781

The device provides the following options for configuration of the Ethernet Configuration interface 1:

- Manual = The operator sets the interface parameters (IP address, network mask, gateway address) manually.
- Automatic = The interface parameters are set automatically. The operator can choose between these protocols:
 - Dynamic Host Configuration Protocol (DHCP)
 - Zero Configuration Networking (Zeroconf)



The device must be connected to a DHCP server to automatically receive the interface parameters via DHCP.

- ▶ Connect the configuration interface (X3) to a DHCP server.

To configure the IP parameters of the configuration interface:

1 Select the menu page



- ▶ Select **[Config. interface X3]** tab.

2 Show the active settings

- > The parameters below show the active settings:

Parameter	Description	Possible values	
[Obtain IP address autom.]	Active method for the configuration of the interface parameters	<input type="checkbox"/>	Manual assignment of the interface parameters through the operator
		<input checked="" type="checkbox"/>	Automatic assignment of the interface parameters
[IP status]	Configuration protocol used	[Static]	The operator sets the IP parameters manually.
		[DHCP]	The IP parameters are set by a DHCP server.
		[Zeroconf]	The IP parameters are set automatically with the Zeroconf protocol.
[IP address]	IP address of the interface	e.g. 192.168.0.100	
[Subnet mask]	Network mask of the network segment	e.g. 255.255.255.0	
[Gateway address]	IP address of the network gateway	e.g. 192.168.0.1	

- ▶ Take one of the following actions:
 - Configure the IP parameters manually: continue with → step 3
 - Configure the IP parameters automatically: continue with → step 4

3 Configure the IP parameters manually

- ▶ Uncheck [Obtain IP address autom].
- ▶ Set the following parameters as required:
 - [IP address]
 - [Subnet mask]
 - [Gateway address]
- ▶ Press **[Accept]** to save the changes.
- ▶ Continue with → step 5

4 Configure the IP parameters automatically

- ▶ Check [Obtain IP address autom].
- ▶ Press [Accept] to save the changes.
- > The device tries to obtain IP parameters from a DHCP server.
- > If the IP parameter configuration via DHCP server fails, the device will generate the IP parameters by means of the Zeroconf protocol.



The automatic configuration of the interface takes approx. 10 seconds.

5 Show the current settings

- > The parameters (→ step 2) show the active IP settings of the Configuration interface 1.

5.3.7 Quick setup: Set the configuration interface 2

42159



Configuration interface 2 (X8) has the same configuration options as configuration interface 1 (X3).

→ **Quick setup: Set the Configuration interface 1** (→ S. [43](#))

To configure configuration interface 2 (X8):

1 Select menu page



- ▶ Select tab **Config interface X8**.

2 Configure interface

- ▶ Set the interface as required.

5.3.8 Quick setup: Address the AS-i slaves connected to AS-i Master 1

To change the address of an AS-i slave connected to AS-i Master 1:

1 Select the menu page



- ▶ Select **[Addressing AS-i 1]** tab.

2 Select the AS-i slave

- > The page provides an overview of the current addressing and status of the AS-i slaves on the selected AS-i master (→ figure)
Notes on colour codes: → **Overview of slave states** (→ S. 25)
- ▶ Select the AS-i slave of which want to change the address.
- ▶ Use [Select] to activate the selected AS-i slave.

	0	1	2	3	4	5	6	7	8	9
0x	A	B	Green	Green	Green	Green	Green	Green	Green	Green
1x	A	B	Green	Green	Green	Green	Green	Green	Green	Green
2x	A	B	Green	Green	Green	Green	Green	Green	Green	Green
3x	A	B	Slave active							

3 Select a new AS-i address

- > The page provides an overview of the free AS-i addresses (→ figure)
Notes on colour codes: → **Overview of free slave addresses** (→ S. 27)
- ▶ Select the address to be assigned to the AS-i slave.
- ▶ Assign the selected address with [Select].
- > The confirmation prompt appears.
- ▶ Confirm the message with [OK].
- > The AS-i slave has new address.
- > The page provides an overview of the current addressing and configuration errors (→ figure)

	0	1	2	3	4	5	6	7	8	9
0x	A	B	Blue	Blue	Blue	Blue	Blue	Blue	Blue	Blue
1x	A	B	Blue	Blue	Blue	Blue	Blue	Blue	Blue	Blue
2x	A	B	Blue	Blue	Blue	Blue	Blue	Blue	Blue	Blue
3x	A	B	Free							

	0	1	2	3	4	5	6	7	8	9
0x	A	B	Green	Green	Green	Green	Green	Green	Green	Green
1x	A	B	Red	Green	Green	Green	Green	Green	Green	Green
2x	A	B	Green	Green	Green	Green	Green	Green	Green	Green
3x	A	B	Not projected							

4 Address additional AS-i slaves (optional)

- ▶ Repeat steps 2 and 3 to address additional AS-i slaves.



After the address change, the present configuration no longer corresponds to the stored configuration.

- > The slave status indicates a configuration error.

To eliminate the configuration error:

- ▶ Start a projection adaptation (→ **Quick setup: Project AS-i networks** (→ S. 39)).

5.3.9 Quick setup: Address the AS-i slaves connected to AS-i Master 2

41763



The procedure for addressing the AS-i slaves connected to AS-i Master 2 is the same as for addressing the AS-i slaves connected to AS-i Master 1 (→ **Quick setup: Address the AS-i slaves connected to AS-i Master 1** (→ S. [46](#))).

To change the address of an AS-i slave connected to AS-i Master 2

1 Select the menu page



- ▶ Select **Addressing AS-i 2** tab.

2 Change the AS-i slave address







- ▶ Address AS-i slaves.

5.4 AS-i 1 / AS-i 2

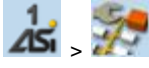
The [AS-i 1] and [AS-i 2] menus provide access to configuration functions of the AS-i networks.



The [AS-i 2] menu is only available for devices with two AS-i masters!

Navigation path	Content
 	AS-i master settings → Set the operating mode of the AS-i master (→ S. 49) → Carry out a projection adaptation (→ S. 50) → Set the monitoring functions of the AS-i master (→ S. 51)
 	AS-i network diagnosis → Display and reset the error counters (→ S. 52) → Display the error statistics of the AS-i slaves (→ S. 52) → Display the voltage supply analysis (→ S. 53) → Display and reset performance data (→ S. 53)
 	AS-i slave settings → Display the input/output data of the AS-i slave (→ S. 54) → Change the digital output values manually (→ S. 56) → Change the analogue output values manually (→ S. 57) → Show AS-i slave information (→ S. 57) → Change an AS-i slave address (→ S. 58) → Change an AS-i slave parameter output (→ S. 58) → Change the Extended ID1 of the AS-i slave (→ S. 59)

5.4.1 AS-i 1 / AS-i 2: Master setup

41537

The menu item [Master setup] provides access to the configuration options of the selected AS-i master.

Set the operating mode of the AS-i master

41640



More information on the operating modes of the AS-i master: → **Operating modes of the AS-i master** (→ S. [122](#))

To set the operating mode of the AS-i master:

1 Select the menu page

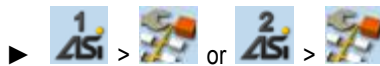

2 Set the operating mode of AS-i master 1 and the behaviour of the connected AS-i slaves

> Set the following parameters as required:

Parameter	Description	Possible values	
[Projection mode]	Active operating mode of the AS-i master	<input type="checkbox"/>	Projection mode inactive: AS-i network operates in protected mode (normal mode)
		<input checked="" type="checkbox"/>	Projection mode active: AS-i network can be projected.
[No slave reset]	Behaviour of the AS-i slaves when changing the operating mode	<input type="checkbox"/>	Slave is reset when changing the operating mode: When changing the operating mode, the AS-i slaves will be reset for a short moment (reset or offline phase).
		<input checked="" type="checkbox"/>	Slave is not reset when changing the operating mode: When changing the operating mode, the AS-i slaves continue to operate without interruption.

> Selected values are applied.

Carry out a projection adaptation

During projection adaptation, the AS-i master stores the configuration of all AS-i slaves currently found on the AS-i network in its memory and assigns a valid AS-i address to each of them.



The projection adaptation can only be carried out in projection mode:

- ▶ [Projection mode] must be checked (→ **Set the operating mode of the AS-i master** (→ S. 49)).
- ▶ During a Projection process all output parameter of not connected AS- slaves in the AS-i master will be reset to their default values (single / A slaves = 0xF, B slaves = 0x7).

To launch the projection adaptation:

1 Select the menu page

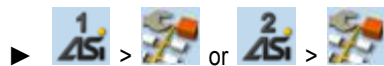

2 Carry out a projection adaptation

- ▶ Press **Start projection process** button.
- > The projection adaptation is carried out.

If successful:

- > All slaves on the AS-i master are projected.

If not successful:

- > The Online Support Center displays an error message.
- ▶ Remove the error and repeat the process.

Set the monitoring functions of the AS-i master

To set the monitoring functions of the selected AS-i master:

1 Select the menu page



2 Set the monitoring functions of the AS-i master

▶ Set the following parameters as required:

Parameter	Description	Possible values	
[Automatic addressing]	Behaviour if AS-i slave is replaced (→ Protected mode (→ S. 122))	<input type="checkbox"/>	Automatic addressing disabled
		<input checked="" type="checkbox"/>	Automatic addressing enabled
[Earth fault detection]	Detection of earth faults	<input type="checkbox"/>	Do not detect earth faults in the AS-i system
		<input checked="" type="checkbox"/>	Detect earth faults in the AS-i system
[Double address detection]	Double address detection	<input type="checkbox"/>	Do not detect AS-i slaves with the same address
		<input checked="" type="checkbox"/>	Detect AS-i slaves with the same address

> Selected values are applied.

5.4.2 AS-i 1 / AS-i 2: Diagnosis

41538

The [Diagnosis] menu provides access to the diagnostic data of the selected AS-i network.

Display and reset the error counters

41445

To display and reset the AS-i error counters:

1 Select the menu page



- ▶ Select [Error counters] tab.

2 Display the error counters

- > Page shows the following information:

Name	Description
[Telegrams]	Number of message errors that occurred
[Configuration]	Number of configuration errors that occurred
[Voltage < 22.5V]	Number of voltage errors < 22.5 V
[Voltage < 19.0V]	Number of voltage errors < 19.0 V
[Earth fault]	Number of detected earth faults

3 Optional: reset the error counters

- ▶ Press [Reset] button.
- > All error counters are reset to 0.

Display the error statistics of the AS-i slaves

41437

To display the error messages of the AS-i slaves on the selected AS-i master:

1 Select the menu page



- ▶ Select [Errors / slave] tab.

2 Display the error statistics of the AS-i slaves

- > Page shows the following information:

Column header	Description
[Address]	Address of the AS-i slave
[S/A]	Number of errors of the single or A slave at this address
[B]	Number of errors of the B slave at this address

- ▶ Use [▲] / [▼] to scroll through the table.

Display the voltage supply analysis

41502

To display the voltage supply analysis:





1 Select the menu page



- ▶ Select **[Power supply]** tab.

2 Display the voltage supply analysis

- > Page shows the following information:

Name	Description	Possible values	
[Power supply]	Method of voltage supply	[Aux]	Voltage is supplied separately by the AS-i network and AUX 24 V.
		[AS-i]	Voltage is only supplied by the AS-i network.
		[Power24]	Voltage is supplied by data decoupling module.
[AS-i voltage]	AS-i voltage measured (in [V])	e.g. 30.3 V	
[DC earth fault]	Evaluation of the network symmetry		AS-i network is symmetrical
			AS-i network is asymmetrical
			AS-i network has earth fault
		Graphical representation of the network symmetry: 	

Display and reset performance data

41460

To display the performance statistics of the selected AS-i master:

1 Select the menu page



- ▶ Select **[Performance]** tab.

2 Display performance data

- > Page shows the following information:

Designation	Description
[Activated slaves]	Number of active AS-i slaves on the AS-i network
[AS-i cycle time [ms]]	AS-i cycle time (value in [ms])
▪ [minimum]	shortest cycle time
▪ [maximum]	longest cycle time
▪ [current]	current cycle time

3 Optional: reset the performance data

- ▶ Press **[Reset]** button.

- > The saved statistic data for minimum and maximum cycle times are deleted.

5.4.3 AS-i 1 / AS-i 2: AS-i slaves

41539

The [AS-i Slaves] menu provides access to information and configuration options of the AS-i slaves.



The scope of configuration options shown ([Data] and [Setup] tab) varies according to the status of the selected AS-i slaves.

Display the input/output data of the AS-i slave

41438

To display the input/output data or the parameter output of the selected AS-i slaves:

1 Select the menu page



- ▶ Select an AS-i slave (→ **Slave selector** (→ S. 24)).
- ▶ Select **[Data]** tab.

2 Display input/output data

- > Depending on the profile of the selected AS-i slave, the page displays the following data:

Digital input

41464

Name	Description	Example / Possible values
[Inputs]	Current values of the digital inputs (binary and hexadecimal representation)	
		<input type="checkbox"/> Data bit is switched off (0 / OFF)
		<input checked="" type="checkbox"/> Data bit is switched on (1 / ON)

Analogue input

41528

Name	Description	Example / Possible values
[Inputs]	Current values of the analogue input channels and information about their status	
▪ [Valid]	The Valid bit indicates whether the displayed value is valid.	<input type="checkbox"/> Invalid value <input checked="" type="checkbox"/> Valid value
▪ [Overflow]	The Overflow bit indicates whether the displayed value is within the value range.	<input type="checkbox"/> Value within valid value range <input checked="" type="checkbox"/> Valid value range exceeded

Digital output

41465

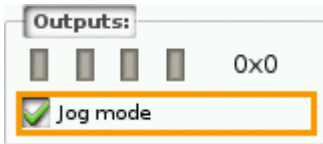
Designation	Description	Example / Possible values
[Outputs]	Current values of the digital outputs (binary and hexadecimal representation)	
		<input type="checkbox"/> Data bit is switched off (0 / OFF)
		<input checked="" type="checkbox"/> Data bit is switched on (1 / ON)
▪ [Jog mode]	The parameter controls the behaviour of the outputs in the event of a changed output value.	<input type="checkbox"/> Jog mode disabled ("switch mode") > The changes do not affect the output until you quit the editing mode.
		<input checked="" type="checkbox"/> Jog mode enabled ("momentary switch mode") > The changes immediately affect the output.

Analogue output

41521

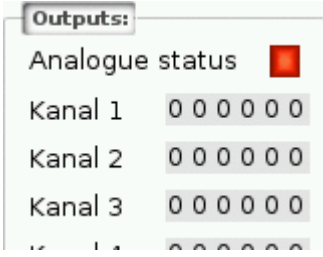
Name	Description	Example / Possible values
[Outputs]	Current values of the analogue output channels and information about their status	
▪ [Analogue status]	Current status of the analogue outputs	<input checked="" type="checkbox"/> Not O.K. <input checked="" type="checkbox"/> O.K.
▪ [Channel x]	Current value of the analogue output channel x (x = 1...n; n = number of channels per AS-i slave)	per digit: 0 ... 9

Parameter input

41787

Name	Description	Example / Possible values
[Parameter input]	Current value of the parameter input (binary and hexadecimal representation)	
		<input type="checkbox"/> Data bit is switched off (0 / OFF)
		<input checked="" type="checkbox"/> Data bit is switched on (1 / ON)

Change the digital output values manually



WARNING!

The manual change of digital output values may cause undesired consequences to the control process.

- > Risk of personal injury!
- > Risk of material damage to the machine/plant!

The operator is responsible for any consequences caused by the manual change of the digital output values!

- ▶ Secure the concerned area.
- ▶ Only trained personnel is allowed to set outputs manually.

If the jog mode is deactivated: After changing the slave outputs the output values remain on the changed values.

- ▶ Change the inverted outputs again immediately to the original values after the end of the test!

To change the digital output values of an AS-i slave manually:

1 Enable manual access to the outputs

- ▶ Set [Output access] parameter = Manual (→ **Set the output access** (→ S. 68)).

2 Select the menu page



- ▶ Select an AS-i slave (→ **Slave selector** (→ S. 24)).
- ▶ Select **[Data]** tab.

3 Set the digital output values manually

- > The group [Outputs] displays the current value of the digital output (binary and hexadecimal representation).
- ▶ Set [Jog mode] as required. (→ **Digital output** (→ S. 55))
- ▶ Change the desired output value bit by bit.
- > Selected value is applied.

Change the analogue output values manually

To change the analogue output values of an AS-i slave manually:

1 Enable manual access to the outputs

- ▶ Set [Output access] parameter = Manual (→ **Set the output access** (→ S. 68)).

2 Select the menu page



- ▶ Select an AS-i slave (→ **Slave selector** (→ S. 24)).
- ▶ Select **[Data]** tab.

3 Set the analogue output values manually

- > [Outputs] group shows the current value of the analogue output.
- ▶ Change the value of the requested channel one digit at a time (→ **Numerical field** (→ S. 30)).
- > Selected value is applied.
- ▶ Optional: repeat step 3 to change further channels.

Show AS-i slave information

To display information about an AS-i slave:

1 Select the menu page



- ▶ Select an AS-i slave (→ **Slave selector** (→ S. 24)).
- ▶ Select **[Information]** tab.

2 Display information about the AS-i slave

- > Page shows the following information:

Name	Description	Possible values										
[AS-i slave address]	Current address of the AS-i slave	e.g. 13B										
[Slave status]	Current status of the AS-i slave	<table border="1"> <tr> <td></td> <td>AS-i slave is active</td> </tr> <tr> <td></td> <td>AS-i slave is missing</td> </tr> <tr> <td></td> <td>Not projected</td> </tr> <tr> <td></td> <td>Double address error</td> </tr> <tr> <td></td> <td>Periphery fault</td> </tr> </table>		AS-i slave is active		AS-i slave is missing		Not projected		Double address error		Periphery fault
	AS-i slave is active											
	AS-i slave is missing											
	Not projected											
	Double address error											
	Periphery fault											
[AS-i slave profile]	Current (= Current) and expected (= Preset) slave profile (IO, ID, ID2, ID1) in hexadecimal format	<div style="border: 1px solid grey; padding: 5px;"> <p>AS-i slave profile:</p> <p style="border: 2px solid orange; display: inline-block; padding: 2px;">IO ID ID2 (ID1)</p></div> <p>Current: 3 f f (f)</p> <p>Preset: 3 f f (f)</p>										

- ▶ Use [▲]/[▼] for page navigation.

Change an AS-i slave address

To change the address of an AS-i slave:

1 Select the menu page



- ▶ Select an AS-i slave (→ **Slave selector** (→ S. 24)).
- ▶ Select **[Setup]** tab.

2 Change the address of the AS-i slave

- ▶ Press the **[Change slave address]** button.
 - > The page displays an overview of the free AS-i addresses (→ **Overview of free slave addresses** (→ S. 27)).
- ▶ Select the address to be assigned to the AS-i slave and confirm with [Select] function key.
 - > Security prompt appears.
- ▶ Press [OK] to confirm the security prompt.
 - > The AS-i slave has a new address.
 - > The page displays an overview of the AS-i slave states (→ **Overview of slave states** (→ S. 25)).

3 Optional: change further AS-i addresses.

- ▶ Repeat step 2 to change further AS-i slave addresses.



After the address change, the present configuration (LDS) no longer corresponds to the stored configuration (LPS).

- > The OSC displays a configuration error.

To remove the configuration error:

- ▶ start a projection adaptation (→ **Carry out a projection adaptation** (→ S. 50)).

Change an AS-i slave parameter output

To change the parameter output of an AS-i slave:

1 Enable manual access to the outputs

- ▶ Set [Output access] parameter = Manual (→ **Set the output access** (→ S. 68))

2 Select the menu page



- ▶ Select an AS-i slave (→ **Slave selector** (→ S. 24)).
- ▶ Select **[Setup]** tab.

3 Change the parameter output of the AS-i slave

- > The [Parameter output] group displays the current assignment of the parameter output (binary and hexadecimal representation).
- ▶ Adjust the desired output value one position at a time.
- > Selected value is applied.

Change the Extended ID1 of the AS-i slave

To set the Extended ID1 of an AS-i slave:

1 Select the menu page



- ▶ Select an AS-i slave (→ **Slave selector** (→ S. [24](#))).
- ▶ Select **[Setup]** tab.

2 Set the Extended ID1

- > The [ID1] list displays the current Extended ID1 value (hexadecimal format).
- ▶ Select the desired value for Extended ID1 from the [ID1] list.
- > Selected value is applied.











After changing the Extended ID1, the existing configuration no longer corresponds to the stored configuration:

- > An error message appears (configuration error).
- ▶ Start a projection adaptation (→ **Carry out a projection adaptation** (→ S. [50](#))).

5.5 System



The [System] menu provides access to functions that allow configuration of the system and the device-internal PLC.

Navigation path	Functions
 > 	Device-internal PLC → System: Programmable Logic Controller (PLC) (→ S. 61)
 > 	System information → Show version information (→ S. 67)
 > 	System settings → Set the output access (→ S. 68) → Enable/Disable the device-internal PLC (→ S. 69) → Set the device cycle (→ S. 70) → Switch the menu language (→ S. 71) → Set the behaviour of the display (→ S. 72) → Set the system time manually (→ S. 74) → Synchronise the system time with an NTP server (→ S. 75) → Adopt the system time of the PC (→ S. 76) → Export device configuration (→ S. 78) → Import device configuration (→ S. 79) → System reset (→ S. 80) → Store diagnostic protocol (→ S. 80)
 > 	System diagnostics → Display diagnostic data (→ S. 81)

5.5.1 System: Programmable Logic Controller (PLC)

41671

The [PLC] menu provides access to the device-internal PLC.

Navigation path	Functions
	PLC information: → Display the status of the CODESYS PLC (→ S. 62) → Display information about PLC projects (→ S. 62)
	PLC settings → Control a single PLC application (→ S. 63) → Control PLC applications (→ S. 64) → Show target visualisation (→ S. 65)
	PLC diagnosis → Show memory used (→ S. 66)



For information about the programming of the device-internal PLC with CODESYS, please refer to the programming manual:

→ www.ifm.com > product page > [Downloads]

PLC: Information

41796

The [Information] menu item provides access to the PLC status and project information.

Display the status of the CODESYS PLC

41467

To display information about the current status of the device-internal PLC:

1 Select the menu page



▶ Select **Status** tab.

2 Display the status of the CODESYS PLC

> Page shows the following information:

Name	Description	Possible values	
Status LED	Status of the device-internal PLC		The CODESYS PLC is disabled.
			The CODESYS PLC is enabled.
[Version]	CODESYS version	e.g. 3.5.3.60	
[Node name]	Name of device in CODESYS project	e.g. ifm_SmartPLC_DataLine	

Display information about PLC projects

41440

To obtain information about the CODESYS project stored on the device-internal PLC:

1 Select the menu page



▶ Select **Project** tab.

2 Display information about PLC projects

> Page shows the following information:

Name	Description
[Project]	Name of the CODESYS project file
[Title]	Name of the CODESYS project
[Version]	Version number of the CODESYS project
[Author]	Author of the CODESYS project

PLC: Settings

41801

The [Settings] menu item provides access to the PLC applications (apps) on the device.

Control a single PLC application

41576

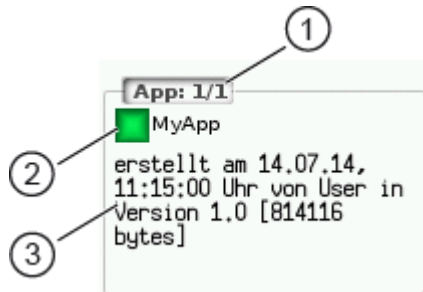

- ① [App x/y]
 – x ... number of the app displayed
 – y ... total number of apps stored
- ② Status and name of the application
 ■ = application has been stopped
 ■ = application has been started
- ③ Information concerning the application
 – date and time of creation
 – author
 – version of application
 – size

To control a single PLC application stored on the device:

1 Select the menu page



- ▶ Select [Applications] tab.

2 Select an application

- ▶ Use [▼] to select the message field.
- > The focus (orange frame) is on the message field.
- ▶ Use [▼] / [▲] to select the requested application.
- ▶ Perform one of the following actions:
 - Launch a single PLC application: continue with → step 3
 - Stop a single PLC application: continue with → step 4

3 Launch a single PLC application

- ▶ Press [Start] to launch the selected PLC application.
- > The confirmation prompt appears.
- ▶ Press [OK] to confirm the prompt.
- > The PLC application is started.
- ▶ Continue with → step 5

4 Stop a single PLC application

- ▶ Press [Stop] to stop the selected application.
- > The confirmation prompt appears.
- ▶ Press [OK] to confirm the prompt.
- > The application is stopped.

5 Display information about the PLC application

- > The status display of the PLC application is updated

Control PLC applications

To control all PLC applications stored on the device:

1 Select the menu page



- ▶ Select **[All applications]** tab.

2 Display status information about the PLC applications

- > Page shows the following information:

Designation	Meaning
[Total]	Number of applications stored on the device
[Started]	Number of applications running

- ▶ Perform one of the following actions:
 - Launch all PLC applications: continue with → step 3
 - Stop all PLC applications: continue with → step 4
 - Reset all PLC applications: continue with → step 5

3 Launch all PLC applications

- ▶ Press **[Starten]** button.
- > The confirmation prompt appears.
- ▶ Press [OK] to confirm the prompt.
- > All PLC applications are started.
- ▶ Continue with → step 6

4 Stop all PLC applications

- ▶ Press **[Stop]** button.
- > The confirmation prompt appears
- ▶ Press [OK] to confirm the prompt.
- > All PLC applications are stopped.
- ▶ Continue with → step 6

5 Reset all PLC applications

- ▶ Press **[Reset]** button.
- > The confirmation prompt appears.
- ▶ Press [OK] to confirm the prompt.
- > All PLC applications are reset and stopped.

6 Display the status of the PLC applications

- > The page shows updated information about the stored PLC applications.
- > The status of the **[Start]**, **[Stop]** and **[Reset]** buttons is updated.

Show target visualisation

41662

Using the CODESYS programming system, the user can optionally program a target visualisation to create an application-specific user interface for the display of AC1433/34. The target visualisation is loaded onto the device together with the CODESYS project, but it must be activated manually.



If no valid target visualisation is stored on the device, a green screen appears after activating the **[Activate Target-Visu]** button

To exit the target visualisation and return to the menu page:

- ▶ Press [**◀**] and [**▶**] simultaneously.

If the device does not react when entering [**◀**] + [**▶**], the key combination is deactivated.

- ▶ Activate the key combination using the system command "Show target visualisation" (→ Device Manual Supplement, **Command 0x0110 – Display target visualisation!**)

To activate the target visualisation:

1 Select menu page



- ▶ Select the **[Activate TargetVisu]** tab.

2 Start the target visualisation

- ▶ Press **[Activate Target-Visu]** button.
- > The confirmation message appears.
- ▶ Press **[OK]** button to confirm the message.
- > The display shows the target visualisation.

PLC: Diagnosis

41797

The [Diagnosis] menu item provides access to diagnostic data of the device-internal PLC.

Show memory used

41663

To display information about the memory capacity currently used:

1 Select the menu page



- ▶ Select [Memory] tab.

2 Show memory used

- > Page shows the following information:

Name	Description
[CODESYS]	Memory capacity occupied by CODESYS data (in Kbytes)
[free]	Free memory (in Kbytes)



The current usage of memory space is read out once when calling up the menu page. These values are not refreshed while the menu page is displayed. Any changes regarding the memory capacity (e.g. through download of a new CODESYS project) will therefore not be reflected in the displayed values.

To update the displayed values:

- ▶ Quit the [Diagnosis] menu page.
- ▶ Access the [Diagnosis] menu page again.
- > The menu page displays the current memory usage of device.

5.5.2 System: Information

41672

The [Information] menu item provides access to the version information about the system components.

Show version information

41661

To display information about the hardware and software components of the device:

1 Select the menu page

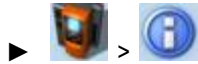

▶ Select **Version** tab.

2 Show version information

> Page shows the following information:

Name	Description	Possible values
[Modell]	Article number of the device	e.g. AC1433/34
[SN]	Serial number of the device	e.g. 000000113034
[Build]	Version number of the installed firmware	e.g. 4.3.1
[HW version]	Version number of the device main board	e.g. AA

5.5.3 System: Setup

41670

The [Setup] menu item provides access to the configuration options of the system.

Set the output access

41645

To set the control instance for the outputs of the AS-i slaves:

1 Select the menu page

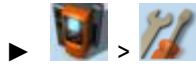

- ▶ Select [System settings] tab.

2 Configure the control instance for the outputs of the AS-i slaves

- ▶ Set the following parameters as required:

Name	Description	Possible values	
[Output access]	Control instance of the AS-i slave outputs	[Gateway]	A higher-level PLC controls the outputs of the AS-i slaves.
		[Manual]	The operator controls the outputs of the AS-i slaves via the graphical user interface.
		[PLC]	The device-internal PLC controls the outputs of the AS-i slaves.

3 Save the changes

- ▶ Press [Accept selection] to save the changes.
- > The selected instance controls the outputs of the AS-i slaves.



If the value PLC is selected, the system will automatically enable the device-internal PLC (→ **Enable/Disable the device-internal PLC** (→ S. [69](#))).

Enable/Disable the device-internal PLC

NOTICE!

When disabling the device-internal PLC, all running PLC applications will be stopped. This could have undesirable effects on the controlled process if the PLC figures as the control unit for the AS-i slave outputs.

Risk of material damage to the machine/plant!

- ▶ The PLC application should be terminated in a controlled manner before disabling the device-internal PLC!
(→ **Control PLC applications** (→ S. 64))

- ▶ Implement a safe state when programming the PLC applications!

When activating the device-internal PLC, PLC applications stored on the device are started automatically.

- ▶ Implement a safe start state when programming the PLC applications!

To set the internal Programmable Logic Controller (PLC):

1 Select the menu page



- ▶ Select **[System settings]** tab.

2 Enable/Disable the device-internal PLC

- > Set the following parameters as required:

Parameter	Description	Possible values	
[Use PLC]	State of the device-internal CODESYS PLC	<input type="checkbox"/>	Device-internal PLC is disabled.
		<input checked="" type="checkbox"/>	Device-internal PLC is enabled.

- > Selected value is applied.

Set the device cycle

NOTICE!

A device cycle that is too short can have undesirable effects on the correct transmission of the process and control data between the PLC and peripheral devices (higher-level PLC, AS-i slaves).

- > Risk of material damage to the machine/plant!
- ▶ Ensure a sufficiently long cycle time!



If the PLC is disabled, the device operates with a fixed cycle time of 0.7 ms.

To set the device cycle:

1 Select the menu page

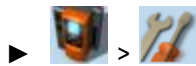

- ▶ Select **[System settings]** tab.

2 Set the device cycle

- ▶ Set the following parameters as required:

Parameter	Description	Possible values	
[Device cycle]	Active → device cycle	[1.5 ms]	1.5 milliseconds
		[2.0 ms]	2.0 milliseconds
		[2.5 ms]	2.5 milliseconds
		[3.0 ms]	3.0 milliseconds

3 Save the changes

- ▶ Press **[Accept selection]** button.
- > Selected value is applied.

Switch the menu language

41701

To select the language of the GUI texts:

1 Select the menu page

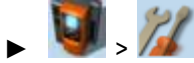

- ▶ Select **System settings** tab.

2 Select the menu language

- > The [Language] list shows the active language in which the GUI texts are displayed.
- ▶ Set the following parameters as required:

Parameter	Description	Possible values	
[Language]	Language in which the GUI texts are displayed	[Deutsch]	German
		[English]	English
		[Français]	French
		[Español]	Spanish
		[Italiano]	Italian
		[Português]	Portuguese

3 Save the changes

- ▶ Press **Accept selection** button.
- > GUI elements are displayed in the requested language.

Optional: switch the language with a key combination

41731

The languages available on the device are saved in an ordered list:

- German
- English
- French
- Spanish
- Italian
- Portuguese

To switch the language with a key combination (from the active language):

- ▶ Press [▶] + [▲] to select the previous language in the list.

OR:

- ▶ Press [▶] + [▼] to select the next language in the list.
- > GUI elements are displayed in the requested language.



The key combination allows you to change the language from any menu page.

Set the behaviour of the display

To set the display behaviour (screen saver, behaviour in case of inactivity):

1 Select the menu page

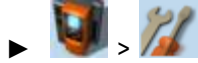

- ▶ Select **System settings** tab.

2 Set the behaviour of the display

- ▶ Set the following parameters as required:

Parameter	Description	Possible values	
[Screen saver]	Status of the screen saver	<input type="checkbox"/>	Screen saver is inactive: Display remains permanently switched on.
		<input checked="" type="checkbox"/>	Screen saver is active: Display is switched off after 10 minutes of inactivity.
[Return to start screen]	Display behaviour in case of extended period of user inactivity	<input type="checkbox"/>	The currently selected menu page stays on the screen.
		<input checked="" type="checkbox"/>	When the set time has elapsed, the display automatically changes to the start screen.

- > Selected values are applied.

>

Set the system time

41412

The system time consists of date and time. The device provides the following options for setting the system time:

- **Manual:** The operator sets the date and time manually.
- **Via NTP server:** The device has an NTP client. The system time can be synchronised with an NTP server.
- **Apply the system time of a PC/laptop:** The device adopts the system time of a PC/laptop (only available via the web interface of the device)

To set the system time:

1 Select the menu page



- ▶ Select **Clock** tab.

2 Display the current system time settings

- > The following parameters display the current system time settings:

Parameter	Description	Possible values	
[Activate NTP]	Activate the NTP client of the device	<input type="checkbox"/>	NTP client is deactivated: Device adopts the manually set values for [Time] and [Date].
		<input checked="" type="checkbox"/>	NTP client is not active: From an NTP server, the device adopts the values for [Time] and [Date].
Status LED	Status of NTP client and synchronisation with NTP server	[NTP not active]	NTP client is deactivated: Applicable are the manually set values for [Time] and [Date].
		[NTP waiting]	NTP client is active: Device waits for messages from NTP server.
		[NTP successful]	NTP client is active: Time synchronisation with NTP server was successful.
[Time]	System time (format [hh:mm:ss])	e.g. 12:23:56	
[Date]	System date (format [yyyy-mm-dd])	e.g. 2014-04-23	

3 Select the configuration method

- ▶ Select one of the following:
 - **Set the system time manually** (→ S. [74](#))
 - **Synchronise the system time with an NTP server** (→ S. [75](#))
 - **Adopt the system time of the PC** (→ S. [76](#))

Set the system time manually

To set the system time manually:

1 Select the menu page

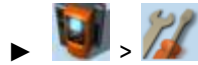

- ▶ Select **[Clock]** tab.

2 Deactivate the NTP client of the device

- ▶ Uncheck [Activate NTP] (→ **Set the system time** (→ S. [73](#))).
- ▶ Press **[Accept selection]** button.
- > The changes become effective.
- > NTP status: [NTP not active

3 Set the system time manually

- ▶ Set [Time] and [Date] (Operating notes: → **Numerical field** (→ S. [30](#)))
- > Selected values are applied.



Seconds cannot be changed manually. When leaving the edit mode, the seconds will be automatically set to 0.

Synchronise the system time with an NTP server

To synchronise the system time with an NTP server:



To synchronise the system time and date via Network Time Protocol (NTP), connect the configuration interface of the device to an NTP server directly or over a network.

1 Select the menu page



- ▶ Select **[Clock]** tab.

2 Deactivate the NTP client

- ▶ Uncheck [Activate NTP] (→ **Set the system time** (→ S. 73)).
- > The IP address field and the [NTP-Offset] list can be edited.

3 Set the IP address of the NTP server and NTP offset

- ▶ Set the following parameters as required:

Parameter	Description	Possible values	
IP address field	IP address of the NTP server	e.g. 192.168.0.100	
[NTP-Offset] (optional)	Time zone of the NTP server in UTC (Universal Coordinated Time).	[no offset]	System time is taken from NTP server without offset
		[UTC -12:00 ... UTC +12:00]	Adopt time zones according to UTC division (displayed number of hours will be added/subtracted)

- ▶ Press **[Accept selection]** button.
- ▶ The device tries to synchronise the system time with the NTP server.
- > NTP status: [NTP waiting 

In case of a successful synchronisation:

- > NTP status: [NTP successful 
- > [Time] and [Date] show the synchronised values.

In case of a failed synchronisation:

- ▶ Check the settings of the IP parameters of the configuration interface.
- ▶ Check the IP address of the NTP server.
- ▶ Repeat the process.

Adopt the system time of the PC

To adopt the date and time of a PC/laptop:



This function is only available via the web-interface of the device (→ **Remote access** (→ S. [32](#))).

Requirements:

- ▶ Connect the device with PC/laptop (→ **Configuration interfaces: Connection concepts** (→ S. [119](#))).
- ▶ Start the web browser and open the web interface of the device (→ **Recommended browsers** (→ S. [32](#))).



This function can only be executed via the web interface of the device.

1 Select the menu page



- ▶ Select the **Clock** tab.

2 Adopt the system time of the PC/laptop

- ▶ Uncheck [Activate NTP] (→ **Set the system time** (→ S. [73](#))).
- ▶ In group [Apply Time and Date from the PC]: Press [OK] button.
 - > The device applies the date and time of the PC/laptop.
 - > [Date] and [Time] display the system time.

Clone device configuration

41593



This function is only available via the local user interface of the device!

The device makes it possible to create an image of the current device configuration, to transfer it to another device and activate it there (clone). The export and import of the configuration file takes place via an SD card.

A device configuration consists of the following settings:

- System settings
- AS-i 1/AS-i 2 settings
- EtherCAT settings
- PLC applications (incl. PLC task configuration, variables and data)



Cloning a device configuration is only possible if the following conditions are met.

- The firmware versions of the source device and the target device are compatible (compatible = versions are identical in the major release and minor release, e.g. V3.2. is compatible with V3.2.2, but: V3.2.1 is incompatible with V3.3.1).
- Source and target device have the same article number.

Export device configuration

NOTICE!

During the export the control functions of the device are not available.

- > Risk of undesired system behaviour
- ▶ Do not export the device configuration during operation of the plant!

NOTICE!

An interruption of the export can lead to a faulty export file.

- > Risk of data loss
- ▶ Do not disconnect the device during the export.
- ▶ Only start the export after the boot application has been successfully generated.
- ▶ Do not remove the SD card from the device before the export is completed.



The SD card has to be formatted with the FAT32 file system. SD cards with other file systems are not recognised by the AC1433/34.

To allow identification of the saved configuration the export file is saved using the following name convention:

`ifm_DevID_XXXXXXXXXX_YYYYMMDDhhmmss.icnf`

- DevID Article number of the device
- XXXXXXXXXXXX Serial number of the device
- YYYYMMDDhhmmss Timestamp of the saved file
(YYYY = year, MM = month, DD = day, hh = hours, mm = minutes, ss = seconds)

To save the current device configuration on an SD card:

1 Select menu page



- ▶ Select **[Configuration]** tab.

2 Save the device configuration

- ▶ Insert an empty, formatted SD card in the SD card slot of the device.
- ▶ Activate the **[Export configuration]** button.
- > The device saves the current configuration on the SD card. The device stores the current configuration on the SD card.

Import device configuration

NOTICE!

During the import the control functions of the device are not available. During the import the device reboots.

- > Risk of undesired system behaviour
- ▶ Do not import the device configuration during operation of the plant!

NOTICE!

An interruption of the import can lead to a faulty device configuration.

- > Risk of data loss
- ▶ Do not disconnect the device during the import.
- ▶ Do not remove the SD card from the device before the import is completed.



To avoid that a wrong device configuration is restored:

- ▶ Check before the import if the required device configuration is saved on the SD card (identification of the saved device configuration: → **Export device configuration** (→ S. [78](#))).
- ▶ Save only the device configuration to be imported in the root directory of the SD card.

To transfer a stored device configuration to the device:

1 Reboot the device

- ▶ Insert the SD card containing the stored device configuration into the SD card slot.
- ▶ Disconnect and the device from the power supply and reconnect it to the power supply.
- > Device reboots.

2 Select menu page

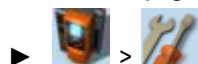

- ▶ Select **[Configuration]** tab.

3 Restore the device configuration

- ▶ Activate the **[Import configuration]** button.
- > A warning appears.
- ▶ Confirm prompt with [OK].
- > The device configuration is loaded and saved onto the device.
- > The device reboots.

System reset

41704

To reset the device:

1 Select the menu page

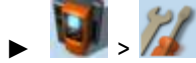

- ▶ Select **Reset** tab.

2 Carry out a system reset

- ▶ Press **Restart** button.
- > A safety query is displayed..
- ▶ Press [OK] to confirm the security prompt.
- > The device reboots.

Store diagnostic protocol

41710

Using the diagnostic protocol, the user can archive the current device configuration or provide all relevant information to the service staff via the device settings.

The diagnostic protocol contains the following information in the selected user language:

- AS-i configuration
- EtherCAT configuration
- System settings
- CODESYS information
- OSC history



This function is only available via the web-interface of the device (→ **Remote access** (→ S. [32](#))).

Requirements:

- ▶ Connect the device with PC/laptop (→ **Configuration interfaces: Connection concepts** (→ S. [119](#))).
- ▶ Start the web browser and open the web interface of the device (→ **Recommended browsers** (→ S. [32](#))).

1 Select menu page



- ▶ Select the [Diagnostic protocol] tab.

2 Store diagnostic protocol

- ▶ Press the [Generate diagnostic protocol] button.
- > AC1433/34 generates diagnostic protocol.
- > The progress bar indicates the status of the process.
- > A dialogue window appears.
- ▶ Select file name and memory location and press [OK] to confirm.
- > The diagnostic protocol is stored as an HTML file at the selected location.

5.5.4 System: Diagnosis

9053:

The [Diagnosis] menu item provides access to the diagnostic data of the device.

Display diagnostic data

41435

To display the diagnostic data of the device:

1 Select menu page



2 Display diagnostic data

> Page shows the following information:

Name	Description	Possible values	
[Betriebszeit [JJ-TTT SS:MM]]	Operating time of system and components	All times indicated in [JJ-TTT-SS-MM] format: YY = years DD = days hh = hours mm = minutes	
▪ [gesamt]	Operating time of device		
▪ [aktuell]	Operating time of device since last system start		
▪ [LCD]	Operating time of LCD		
▪ [PLC]	Operating time of controller		
[Temperatur]	Current device temperature	Indications in [°C] (→ Note)	
[Versorgt durch]	Voltage supply of device	[Aux]	Voltage is supplied separately by AS-i network and AUX 24 V.
		[AS-i]	Voltage is only supplied by the AS-i network.
		[Power Modul]	Voltage is supplied by data decoupling module.



The temperature monitoring continuously checks the system temperature of the device. The following temperature ranges apply:

- Normal range: < 79.9 °C
- Limit range: 80 °C ... 84.9 °C
- Critical range: >= 85 °C

If the system temperature reaches the critical zone, a warning is displayed in the → **Online Support Center (OSC)** (→ S. [112](#)). The warning only disappears when the device temperature is again in the normal range.

5.6 Interfaces

The [Schnittstellen] menu provides access to the configuration options of the device's interfaces.

Navigation path	Functions
	Configuration interface 1 → Configure the IP parameters manually (→ S. 84) → Configure the IP parameters automatically (→ S. 84) → Show Ethernet information (→ S. 85)
	Configuration interface 2 → Interfaces: Configuration interface 2 (→ S. 86)
	EtherCAT interface → Interfaces: EtherCAT interface (→ S. 87)

5.6.1 Interfaces: Configuration interface 1

41481

The [Configuration interface 1] menu provides access to the settings of the Ethernet Configuration interface 1 (port X3).

Notes on IP settings

41751

The device provides the following options for configuration of the Ethernet Configuration interface 1:

- Manual = The operator sets the interface parameters (IP address, network mask, gateway address) manually.
- Automatic = The interface parameters are set automatically. The operator can choose between these protocols:
 - Dynamic Host Configuration Protocol (DHCP)
 - Zero Configuration Networking (Zeroconf)

To display the current configuration method and the active IP parameters of the configuration interface:

1 Select the menu page



- ▶ Select **[IP setup]** tab.

2 Show the active settings

- > The parameters below show the active settings:

Parameter	Meaning	Possible values	
[Obtain IP address autom.]	Active method for the configuration of the interface parameters	<input type="checkbox"/>	Manual assignment of interface parameters through operator
		<input checked="" type="checkbox"/>	Automatic assignment of interface parameters
[IP status]	Configuration protocol used	[Static]	The operator sets the IP parameters manually.
		[DHCP]	The IP parameters are set by a DHCP server.
		[Zeroconf]	The IP parameters are set automatically with the Zeroconf protocol.
[IP address]	IP address of the interface	e.g. 192.168.0.100	
[Subnet mask]	Network mask of the network segment	e.g. 255.255.255.0	
[Gateway address]	IP address of the network gateway	e.g. 192.168.0.1	

- ▶ Select one of the following options:
 - **Configure the IP parameters manually** (→ S. [84](#))
 - **Configure the IP parameters automatically** (→ S. [84](#))

Configure the IP parameters manually

To configure the IP parameters of the configuration interface manually:

1 Select the menu page



- ▶ Select [IP setup] tab.

2 Deactivate the NTP client

- ▶ Uncheck [Obtain IP address autom.] (→ **Notes on IP settings** (→ S. 83)).
- > The IP address fields [IP address], [Subnet mask] and [Gateway address] can be edited.

3 Configure the IP parameters

- ▶ Configure the following parameters as required (→ **Notes on IP settings** (→ S. 83)):
 - [IP address]
 - [Subnet mask]
 - [Gateway address]

4 Save the changes

- ▶ Press [Accept] button.
- > Selected values are applied.
- > [IP status] displays the active configuration method: [Static]

Configure the IP parameters automatically



The device must be connected to a DHCP server to automatically receive the interface parameters via DHCP.

- ▶ Connect the configuration interface (X3) to a DHCP server.

To configure the IP parameters of the configuration interface automatically:

1 Select the menu page



- ▶ Select [IP setup] tab.

2 Enable the NTP client

- ▶ Activate the [Obtain IP address autom.] (→ **Notes on IP settings** (→ S. 83))

3 Save the changes

- ▶ Press [Accept] button.
- > The device tries to obtain the IP parameters from a DHCP server.
- > If the configuration of IP parameters via DHCP server fails, the device will generate the IP parameters with the Zeroconf protocol.
- > [IP address], [Subnet mask] and [Gateway address] display the set IP parameters.
- > Selected values are applied.
- > [IP status] displays the active configuration method: DHCP or Zeroconf.



The automatic configuration of the IP parameters takes approx. 10 seconds.

Show Ethernet information

41660

To show Ethernet information regarding the configuration interface:

1 Select the menu page



- ▶ Select **Ethernet information** tab.

2 Show Ethernet information

- > Page shows the following information:

Name	Description
[MAC ID]	MAC identification number of the interface

5.6.2 Interfaces: Configuration interface 2

42105

The [Configuration interface 2] menu provides access to the settings of the Ethernet configuration interface 2 (port X2).





The Ethernet configuration interfaces 1 (X3) and 2 (X8) must not be participants of the same EtherNet subnet. Non-compliance may lead to connection problems under CODESYS.

- ▶ Configure IP settings so that interfaces X3 and X8 are part of different Ethernet subnets.



The menu functions correspond to the functions of the menu [Configuration interface 1].



For information regarding the menu functions: → **Interfaces: Configuration interface 1** (→ S. [83](#))

- ▶ For the selection of the menu page replace the symbol  by  !

5.6.3 Interfaces: EtherCAT interface

42888

The [EtherCAT] menu provides access to information, settings and diagnostic data regarding the EtherCAT interface.

Navigation path	Functions
	EtherCAT information → Show information (→ S. 88) → Display EtherCAT parameters (→ S. 88) → Display the module configuration (→ S. 89) → Download ESI file (→ S. 89)
	EtherCAT settings → Configure the EtherCAT interface (→ S. 90)
	EtherCAT diagnostics → Display diagnostic data (→ S. 91)

EtherCAT: Information

41553

The menu item [Information] provides access to information regarding the EtherCAT interface.

Show information

42930

To display information about the EtherCAT module AC1433/34:

1 Select menu page



- ▶ Select tab **[ID object]**

2 Show information

- > Page shows the following information:

Name	Description	Possible values
[Device type]	EtherCAT ID of the device type	5001
[Device name]	Article number of the device	AC1433/34
[Device revision]	Hardware version of the device	e.g. AA
[Software revision]	Software version of the device	e.g. 4.2.2
[Vendor ID]	Manufacturer ID	0x0622
[Product code]	Product code of the device	e.g. 0xAC432
[Revisions-Nr.]	Revision number of the device	e.g. 0x0001
[S. no.]	Serial number of the device	e.g. 4206659

Display EtherCAT parameters

42147

To display the current settings of the EtherCAT parameters

1 Select menu page



- ▶ Select tab **[EtherCAT data]**

2 Display EtherCAT parameters

- > Page displays current settings of the following EtherCAT parameters (→ **Device-specific parameters** (→ S. [136](#))):
 - [Failsafe value]
 - [Parameter Download]

Display the module configuration

41434

To display the current module configuration:

1 Select the menu page



- ▶ Select **[Module configuration]** tab.

2 Display the module configuration

- > The page shows the active module configuration of the EtherCAT slots. (→ **Profibus modules**)



The fieldbus slots can only be configured in the EtherCAT projection software.

Download ESI file

42971



This function is only available via the web interface of the device (→ **Remote access** (→ S. [32](#))).

To download the ESI file:

Requirements:

- ▶ Connect the device to the PC/laptop (→ **Configuration interfaces: Connection concepts** (→ S. [119](#))).
- ▶ Start web browser and activate device web interface (→ **Recommended browsers** (→ S. [32](#))).

1 Select menu page



- ▶ Select tab [Datei-Download].
- > Menu screen [Datei-Download] appears.

2 Download ESI file

- ▶ Click on [Download ESI-Datei] to download the device description.

EtherCAT: Setup

41552

The [Setup] menu item provides access to the configuration options of the EtherCAT interface.

Configure the EtherCAT interface

42965

To configure the EtherCAT interface:

1 Select menu page



- ▶ Select tab **EtherCAT settings**.

2 Set the EtherCAT address of the device

- ▶ Set the following parameters as required:

Parameter	Description	Possible values	
[ID]	EtherCAT address of the device	1 ... 65535	EtherCAT address 1 ... EtherCAT address 65535

- ▶ Click on **Accept** to save the changes.

EtherCAT: Diagnosis

41554

The menu item [Diagnosis] provides access to the diagnostic data of the EtherCAT interface:

Display diagnostic data

42944





















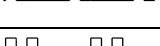

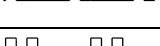

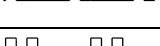

To display the diagnostic EtherCAT data:

1 Select menu page



2 Display diagnostic data

> Page shows the following information:

Parameter	Description	Possible values									
[EtherCAT RUN]	status of the EtherCAT state machine		<table border="1"> <tr> <td>OFF</td> <td>INIT</td> </tr> <tr> <td></td> <td>PRE-OPERATIONAL</td> </tr> <tr> <td></td> <td>SAFE-OPERATIONAL</td> </tr> <tr> <td>EIN</td> <td>OPERATIONAL</td> </tr> </table>	OFF	INIT		PRE-OPERATIONAL		SAFE-OPERATIONAL	EIN	OPERATIONAL
OFF	INIT										
	PRE-OPERATIONAL										
	SAFE-OPERATIONAL										
EIN	OPERATIONAL										
[EtherCAT ERR]	Error status		<table border="1"> <tr> <td>OFF</td> <td>no error</td> </tr> <tr> <td></td> <td>invalid configuration</td> </tr> <tr> <td></td> <td>local error / unexpected state of change</td> </tr> <tr> <td></td> <td>watchdog error</td> </tr> </table>	OFF	no error		invalid configuration		local error / unexpected state of change		watchdog error
OFF	no error										
	invalid configuration										
	local error / unexpected state of change										
	watchdog error										
[Status X6]	connection status port X6	<table border="1"> <tr> <td></td> <td>no connection to the EtherCAT controller</td> </tr> <tr> <td></td> <td>connection to fieldbus controller established</td> </tr> </table>		no connection to the EtherCAT controller		connection to fieldbus controller established					
	no connection to the EtherCAT controller										
	connection to fieldbus controller established										
[Status X7]	connection status port X7	<table border="1"> <tr> <td></td> <td>no connection to the EtherCAT controller</td> </tr> <tr> <td></td> <td>connection to fieldbus controller established</td> </tr> </table>		no connection to the EtherCAT controller		connection to fieldbus controller established					
	no connection to the EtherCAT controller										
	connection to fieldbus controller established										

5.7 ifm system solutions

41480



This menu is only available via the web interface of AC1433/34.
→ **Remote access** (→ S. [32](#))

The [ifm system solutions] menu provides access to information and installation options for ifm system solutions.

Navigation path	Functions
	ifm system solutions: → Show information about installed ifm apps (→ S. 94) → Install single/basic app (→ S. 95) → Install multi app (→ S. 96) → Update ifm apps (→ S. 97) → Uninstall ifm apps (→ S. 97)

5.7.1 Notes on ifm system solutions

41753

With the AC1433/34, ifm electronic offers different system solutions for the simple implementation of typical applications. System solutions consist of applications which are processed by the device-internal CODESYS PLC.



ifm system solutions and user-created applications must not be stored and run simultaneously on the AC1433/34!

- ▶ Delete all CODESYS system solutions stored on the device before installing new ifm system solutions or user applications!

ifm system solutions can only be installed and run if the device-internal PLC is activated.

- ▶ Activate the PLC of the AC1433/34 (→ **Enable/Disable the device-internal PLC** (→ S. 69))!



Users can download the available ifm system solutions from ifm's website.

Types of ifm system solutions

41684

There are 2 types of ifm system solutions:

- **Single apps**
Single apps provide the user with a CODESYS-based solution. Single apps directly access the I/O mechanisms of the CODESYS PLC. Only one single app must be stored and executed on the device.
- **Basic app + multi apps**
Multi apps provide the user with the possibility to execute different CODESYS-based solutions in parallel. The multi apps use the services of the basic app in order to be able to access the inputs and outputs of AC1433/34 at the same time. They operate as a pure communication layer between the I/O mechanisms of the CODESYS PLC and the connected multi apps. Maximum 5 multi apps at a time can be stored and executed in parallel on the device.

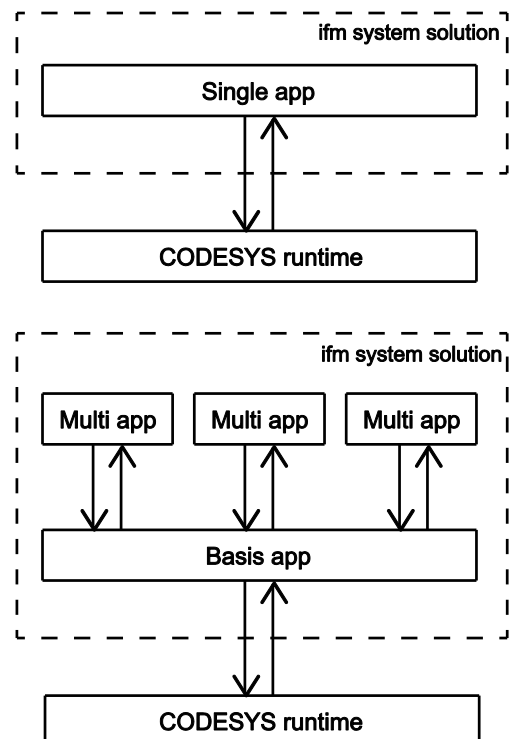

5.7.2 Show information about installed ifm apps

41658

In order to display information about the ifm system solutions installed on the device:

1 Select menu page



- ▶ Select the [Information] tab.

2 Show information about installed ifm apps

- > The browser window displays an overview of the installed ifm apps. The following information is displayed for each ifm app:

Information	Meaning
[Name]	Designation of the ifm system solution app
[Version]	Version number of the ifm system solution app
[Type]	Type of ifm app (single, basic, multi)
[Description]	Description of the functionality of the ifm system solution app
[Licence information]	Licence information about the ifm system solution in the selected user language
[Link to the ifm system solution app]	Hyperlink for web visualisation of the ifm system solution app

5.7.3 Install single/basic app



Only one single app, basic app or CODESYS PLC application must be stored on the device. When installing a single/basic app, all ifm system solutions and CODESYS PLC applications stored on the device are deleted.

To install a single or basic app on the device:

1 Select menu page



- ▶ Select the [Installation] tab.

2 Select single/basic app

- ▶ Activate the [Search] button.
- > A dialogue window appears.
- ▶ Select the requested single/basic app (*.ifmapp) and click [Open] to load it.
- > The file name of the selected single/basic app is displayed.

3 Transfer the single/basic app to the device

- ▶ Click on [Transfer file] button to transfer the selected single/basic app to the device.
- > The progress bar indicates the status of the process.
- > After successful transfer: The window shows information about the copied single/basic app.
- ▶ Optional: Click on [Cancel] to stop the download process.

4 Install the single/basic app

- ▶ Activate the [Start installation] button.
- > CODESYS PLC is stopped.
- > All ifm system solutions and CODESYS PLC applications on the device are deleted.
- > The selected single/basic app is installed.
- > The progress bar indicates the status of the installation process.
- > CODESYS PLC is started.
- > The installed single/basic app is automatically started (RUN state).

5.7.4 Install multi app



Maximum 5 multi apps must be stored on the device simultaneously.

To install a multi app on the device:

Requirements:

- > The basic app is installed and started (RUN state) (→ **Install single/basic app** (→ S. [95](#)))

1 Select menu page



- ▶ Select the [Installation] tab.

2 Select multi app

- ▶ Activate the [Search] button.
- > A dialogue window appears.
- ▶ Select the requested multi app (*.ifmapp) and click the [Open] button to load it.
- > The file name of the selected multi app is displayed.

3 Transfer the multi app onto the device

- ▶ Click on [Transfer file] to transfer the selected multi app onto the device.
- > The progress bar indicates the status of the process.
- > After successful transfer: The window shows information about the copied multi app.
- ▶ Optional: Click on [Cancel] to stop the download process.

4 Install multi app

- ▶ Activate the [Start installation] button.
- > CODESYS PLC is stopped.
- > The selected multi app is installed.
- > The progress bar indicates the status of the installation process.
- > CODESYS PLC is started.
- > The installed multi app is automatically started (RUN state).
- ▶ Optional: Repeat steps 2 to 4 to install further multi apps.

5.7.5 Update ifm apps

41682

The user can update an ifm system solution installed on the device by overwriting it with the new version of the ifm system solution.

Naming convention for ifm apps:

AppName_x.y.z.ifmapp

AppName =	name of the ifm app
x.y.z =	version number of the ifm app
ifmapp =	file extension of an ifm app

To update an ifm system solution:

Requirements:

- > The name of the new ifm app and the installed ifm app must be identical.
- > The version number of the ifm app must be greater than that of the installed ifm app.



To determine the version of the installed ifm app: → **Show information about installed ifm apps** (→ S. [94](#))

1 Download new ifm app

- ▶ Download new version of the ifm system solution (→ **Notes on ifm system solutions** (→ S. [93](#))).

2 Update the installed ifm app

- ▶ Install the new ifm system solution
 - Single/basic app: → **Install single/basic app** (→ S. [95](#))
 - multi app: → **Install multi app** (→ S. [96](#))

5.7.6 Uninstall ifm apps

41683



When a basic app is uninstalled, all dependent multi apps are uninstalled, too.

Before uninstalling an ifm app, the CODESYS PLC of AC1433/34 is stopped. After successful uninstallation, the CODESYS PLC is started again.

To uninstall an ifm system solution installed on the device:

1 Display installed ifm apps

- ▶ **Show information about installed ifm apps** (→ S. [94](#))

2 Uninstall ifm app

- ▶ In the section of the respective ifm app:
 - Activate the [Uninstall app] button.
- > CODESYS PLC is stopped.
- > The selected ifm app is uninstalled.
- > CODESYS PLC is started.

6 Setup

Content

Connect the device to the periphery.....	98
Start screen 'Basic settings'.....	99
Update the firmware of the device.....	101
Connect and address AS-i slaves	105
Configure EtherCAT interface	105
Set Ethernet configuration interfaces	105
Exchange AS-i slave	105

41644

This section provides information for setting up the device following mounting, electrical installation and connection to AS-i network components.



Observe the notes on mounting and electrical connection of the device!
→ Operating instructions (supplied with the device)

6.1 Connect the device to the periphery

41574

6.1.1 EtherCAT interface

42951

If AC1433/34 is to be operated as EtherCAT slave:

- ▶ Connect EtherCAT IN (X7) to the EtherCAT master or the previous EtherCAT slave
- ▶ Optional: Connect EtherCAT OUT (X6) with the next EtherCAT slave.

6.1.2 Ethernet configuration interfaces

42952

To access the web interface or the programming interface of the device-internal PLC of the device:

- ▶ Connect the device to the Ethernet network or the PC/laptop via the configuration interface 1 (X3) or 2 (X8)
(→ **Configuration interfaces: Connection concepts** (→ S. [119](#))).

If AC1433/34 is to be operated as EtherCAT master:

- ▶ Connect the device to the EtherCAT network via the configuration interfac

- ▶ e 1 (X3) or 2 (X8).

6.2 Start screen 'Basic settings'

41689

The 'Basic settings' start screen appears after the following actions/events:

- initial setup
- firmware update
- data loss due to battery failure

The basic settings provide access to the GUI texts, system time, etc.



The same operating notes as for the page view apply for the 'Basic settings' start screen (→ **Page view** (→ S. [19](#))).

6.2.1 Change the basic settings of the device

41597

To change the basic settings of the device:

1 Start the device

- ▶ Connect the device to a circuit.
- > The device starts.
- > The display shows the start screen "Basic settings" (screenshot).

2 Set the language of the GUI texts

- ▶ List shows the active language.
- ▶ Use [▼] / [▲] to mark the list.
- > The focus (= orange frame) is on the marked list.
- ▶ Open the list with the left function key [Select].
- ▶ Use [▼] / [▲] to mark the desired language and press [Select] to activate it.
- > The GUI texts appear in the selected language.
- ▶ Go to the next page with **[Next]**.

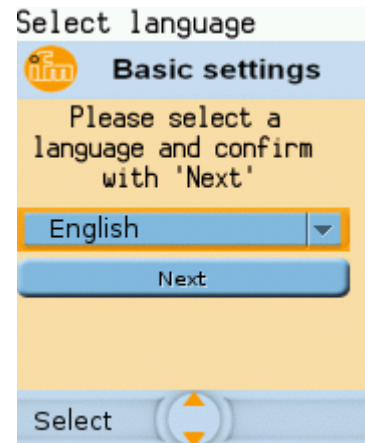

3 Set the system time

Option 1: Set the system time manually

- ▶ [Uhrzeit] and [Datum] indicate the current system time.
- ▶ Deactivate the checkbox [NT aktivieren].
- > Status LED =
- ▶ In the group [Uhrzeit], set the desired clock time one position at a time.
- ▶ In the group [Datum], set the desired date one position at a time.
- ▶ Save the changes with **[Finish]** and go to the standard start screen.

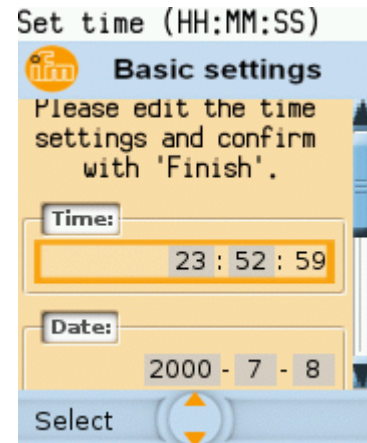

Option 2. Synchronise the system time with an NTP server

- ▶ Activate the checkbox [NTP aktivieren].
- > Status LED =
- ▶ Enter the IP address of the NTP server in the IP address field.
- ▶ Pick the time zone of the NTP server from the list (UTC format).
- > The NTP client of the device synchronises the system time with the selected NTP server.
- ▶ Wait until status LED =
- > [Datum] and [Uhrzeit] show the synchronised values.
- ▶ Save the changes with **[Finish]** and go to the standard start screen.

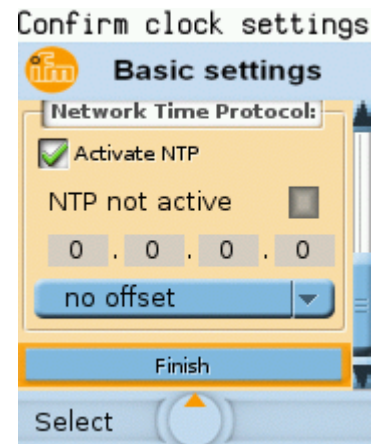

6.3 Update the firmware of the device

NOTICE!

Interrupting a firmware update leads to a loss of the current system and fieldbus settings.

- > Risk of data loss!
- ▶ Secure the device settings before carrying out a firmware update! (→ **Export device configuration** (→ S. [78](#)))
- ▶ Ensure an uninterrupted voltage supply during the firmware update!

To update the firmware of the device:

- ▶ Select one of the following options:
 - **Firmware update from SD card** (→ S. [102](#))
 - **Firmware update via the web interface** (→ S. [103](#))

6.3.1 Behaviour of the settings upon firmware update

The following settings/data records remain valid upon a firmware update:

Setting / data record	Path to the menu page
User language of the GUI	[System] > [Setup] > [System settings]
Display settings (screen saver, return)	[System] > [Setup] > [System settings]
System time (date/time)	[System] > [Setup] > [Clock]
NTP settings	[System] > [Setup] > [Clock]
Operating hours counter	[System] > [Diagnosis]
AS-i master settings and configuration data	[AS-i 1] / [AS-i 2] > [Master setup]
IP parameters of the configuration interface	[Interfaces] > [Configuration interface] > [IP-Setup]
Fieldbus settings	[Interfaces] > [EtherCAT] > [Setup]

The following settings/data records are reinitialised with their default values upon firmware update:

Setting / data record	Reset value	Path to the menu page
Control of the outputs	Gateway	[System] > [Setup] > [System settings]
Activate CODESYS PLC	deactivated	[System] > [Setup] > [System settings]
Device cycle	0.7 ms	[System] > [Setup] > [System settings]
OSC	Delete system messages	Start page > [OSC]
Retain variables	0x00	--

6.3.2 Firmware update from SD card



Pay attention to notes on memory behaviour (→ **Behaviour of the settings upon firmware update** (→ S. [101](#)))!

1 Preparations

- ▶ Download the new firmware file from the **ifm** website.
- ▶ Copy the firmware file into the root directory of an SD card.
- ▶ Insert the SD card containing the firmware file in the SD card slot (→ **SD card slot** (→ S. [13](#))).

2 Start the recovery mode

- ▶ Separate the device from the circuit.
- ▶ Perform the following actions simultaneously:
 - Press the left function key and the arrow keys [**▲**] and [**▼**] simultaneously and keep them pressed (→ picture).
 - Connect the device to a circuit.
- ▶ Keep the keys pressed until the screen [ifm Recovery] appears (approx. 10 s).



3 Update the firmware

- ▶ Use the arrow keys [**▲**] / [**▼**] to select the menu item [Install from SD] (→ picture).
- ▶ Press [OK] using the left function key.
- > The updating process starts.
- > The display shows the progress of the firmware update.
- > A status message appears once the firmware has been updated successfully.

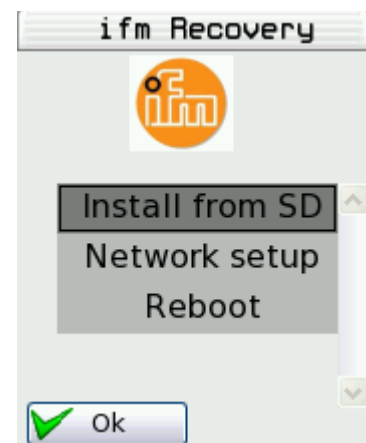

4 Reboot the device

- ▶ Use the arrow keys [**▲**] / [**▼**] to select the [Reboot] button.
- ▶ Press [OK] to reboot the device.
- > The device reboots with the current firmware.
- > The start screen "Basic settings" appears (→ **Start screen 'Basic settings'** (→ S. [99](#))).

6.3.3 Firmware update via the web interface



Pay attention to notes on memory behaviour (→ **Behaviour of the settings upon firmware update** (→ S. [101](#)))!

1 Preparations

- ▶ Download the new firmware file from the **ifm** website.
- ▶ Connect the PC/laptop to the configuration interface (X3) of the device.
(→ **Configuration interfaces: Connection concepts** (→ S. [119](#)))

2 Start the recovery mode

- ▶ Separate the device from the circuit.
- ▶ Perform the following actions simultaneously:
 - Press the left function key and the arrow keys [▲] and [▼] simultaneously and keep them pressed (→ picture).
 - Connect the device to a circuit.
- ▶ Keep the keys pressed until the screen [ifm Recovery] appears (approx. 10 s).



3 Optional: adjust the IP parameters

- ▶ Use the arrow keys [▲] / [▼] to select the menu item [Network Setup].
- ▶ Press [OK] to go to the network setup.
- > The display shows the page [Network Setup] (→ picture).
- > The page shows the current IP address of the device.

Option 1: obtain the IP parameters from a DHCP server

- ▶ Connect the configuration interface to the DHCP server.
- ▶ Use the arrow keys [▲] / [▼] to select the menu item [DHCP].
- ▶ Press [OK] to activate the DHCP client of the device.
- > The device obtains the IP parameters from the DHCP server.
- > If not successful, the device will create the IP parameters by means of the Zeroconf protocol.
- > The display shows the [Network Setup] page with the new IP address.
- ▶ Leave the network setup with [Back].
- > The display shows the [ifm Recovery] page.

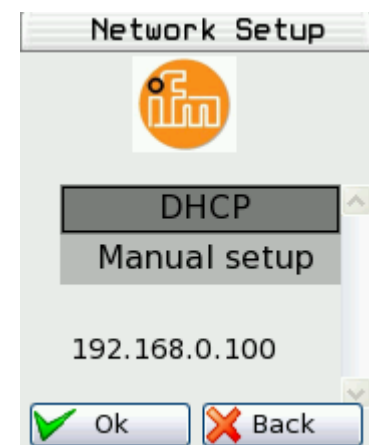

Option 2: configure the IP parameters manually

- ▶ Use the arrow keys [▲] / [▼] to select the menu item [Manual Setup].
- ▶ Activate the manual setup with [OK].
- > The display shows the [Static IP setup] page (→ picture)
- ▶ Use the arrow keys [▲] / [▼] to select the following menu items one after the other and set them as required:
 - [IP Address]
 - [Network Mask]
 - [Default gateway]
- ▶ Press [Apply] to save the set values.
- > The display shows the [Network Setup] page with the new IP address.
- ▶ Leave the network setup with [Back].
- > The display shows the [ifm Recovery] page.

**4 Update the firmware**

- ▶ Access the web interface of the device.
- > The web interface of the recovery mode appears:



- ▶ Press the [Search ...] button.
- > The file explorer appears.
- ▶ Select the firmware file and press [Open].
- > The field [Select image to upload] shows the file path and name of the firmware file.
- ▶ Press [send] to start the updating process.
- > The display and web interface show the progress of the firmware update.
- > A status message appears once the firmware has been updated successfully.

5 Reboot the device

- ▶ Click on the tab [Reboot]
- > The device reboots with the current firmware.
- > The start screen "Basic settings" appears (→ **Start screen 'Basic settings'** (→ S. 99)).

6.4 Connect and address AS-i slaves

41575

To integrate AS-i slaves into an AS-i network that is controlled by one of the AS-i masters of the device:

1 Connect and address the AS-i slave

- ▶ Connect ONE AS-i slave to be addressed to the requested AS-i network (AS-i 1 or AS-i 2) as described in the corresponding installation instructions.
- ▶ Assign the desired address to the AS-i slave
(→ **Quick setup: Address the AS-i slaves connected to AS-i Master 1** (→ S. [46](#)) or → **Quick setup: Address the AS-i slaves connected to AS-i Master 2** (→ S. [47](#))).
- ▶ Optional: Repeat step 1 to connect and address further AS-i slaves.

2 Project the AS-i network

- ▶ Carry out a projection adaptation on the AS-i master with the newly addressed AS-i slaves
(→ **Quick setup: Project AS-i networks** (→ S. [39](#))).
- > The AS-i master adds the detected slaves (LDS) to the list of the projected slaves (LPS).
- > The AS-i slaves have a valid address and are integrated in the AS-i network.

6.5 Configure EtherCAT interface

42165

If AC1433/34 is to be operated as EtherCAT slave:

- ▶ Set device ID (→ **Configure the EtherCAT interface** (→ S. [90](#)))
- ▶ In the EtherCAT projection software:
 1. Integrate the AC1433/34 into the EtherCAT project.
 2. Optional: AC1433/34 is added to a hot-connect group.
 3. Configure EtherCAT slots of the AC1433/34 (→ **Cyclic data** (→ S. [138](#))).



If the AC1433/34 is to be operated as EtherCAT master:



- ▶ Add and configure EtherCAT master stack (→ Programming manual)

6.6 Set Ethernet configuration interfaces



42937

To configure the Ethernet configuration interfaces 1 (X3) and 2 (X8):

- Ethernet configuration interface 1 (X3):

- ▶  > 
- ▶ Select **[IP setup]**.
- ▶ Set interface parameters (→ **Notes on IP settings** (→ S. [83](#))).

- Ethernet configuration interface 2 (X8):

- ▶  > 
- ▶ Select **[IP setup]**.
- ▶ Set interface parameters (→ **Notes on IP settings** (→ S. [83](#))).

6.7 Exchange AS-i slave

41506

AC1433/34 makes it possible to replace an AS-i slave by a new AS-i slave in the operating mode "protected mode".

Requirements:

- > The new and the old AS-i slave have the same device profile (→ **Profiles of AS-i slaves** (→ S. [126](#))).
- > The new AS-i slave has the address 0.
- > Parameter [Automat. addressing] is activated (→ **Set the monitoring functions of the AS-i master** (→ S. [51](#))).

1 Remove old AS-i slave

- ▶ Disconnect the AS-i slave to be replaced from the AS-i network
- > AC1433/34 detects a configuration error and generates a corresponding OSC message.

2 Install new AS-i slave

- ▶ Connect the new AS-i slave to the AS-i network.
- > AC1433/34 detects the new AS-i slave and automatically assigns the address of the old AS-i slave.
- > The OSC error message disappears.
- > The new AS-i slave is operational.

7 Troubleshooting

Content

Status LED	107
Start screen: Status LEDs	109
Online diagnosis function	111
Online Support Center (OSC)	112

41667

This chapter offers information regarding fault detection and troubleshooting.

7.1 Status LED

41692

The status LEDs of the device provide information about the current state of system components.



Position of the status LED on device: → [Overview](#) (→ S. [11](#))

7.1.1 Status LED: Basic device

41691

Status LED			Description
H1	green	on	Device has started, warnings or error messages.
	yellow	flashes 0.5 Hz	There is a warning but not an error message.
	red	flashes 2 Hz	There is an error message.

7.1.2 Status LED: Fieldbus EtherCAT

41708

Status LED			Description
H2	yellow	off	no data transmission
		flashes	Reception of data
H3	green	off	no physical connection
		on	Physical connection OK
H4	yellow	off	no data transmission
		flashes	Reception of data
H5	green	off	no physical connection
		on	Physical connection OK

7.1.3 Status LED: Configuration interface 2 (X8)

42115

Status LED			Description
H6	yellow	off	no data transmission
		flashes	Reception of data
H7	green	off	no physical connection
		on	Physical connection OK

7.2 Start screen: Status LEDs

41688

The start screen of the graphic user interface provides the following status information (→ **Start screen** (→ S. [36](#))):

7.2.1 Status of the web interface

41707

Status LED			Description
Web interface status	red	on	offline
	green	on	online



This function is only available via the web interface of the device (→ **Remote access** (→ S. [32](#))).

7.2.2 Operating mode of the AS-i master

41722

Status LED			Description
AS-i 1 2 operating mode	yellow	on	projection mode
	green	on	protected mode



7.2.3 Control instance of the AS-i outputs

41569

Status LED			Description
Output control	yellow	on	manually manually via PLC
	green	on	gateway gateway with PLC
	blue	on	PLC



7.2.4 EtherCAT: fieldbus status

42914

Status LED			Description
ECAT RUN	green	off	INIT
		flashes (200 ms on, 200 ms off) 	PRE-OPERATIONAL
		flashes (200 ms on, 1000 ms off) 	SAFE-OPERATIONAL
		on	OPERATIONAL

7.2.5 EtherCAT: Error status

42915

Status LED		Description	
ECAT ERR	red	off	no error
		flashes (200 ms on, 200 ms off) 	invalid configuration
		flashes (200 ms on, 1000 ms off) 	local error / unexpected change of status
		flashes (200 ms on, 200 ms off, 200 ms on, 1000 ms off) 	watchdog error

7.3 Online diagnosis function



41719

The device offers an online diagnosis function. It helps the user to find and eliminate the source of occurring failures and errors.

7.3.1 Message types

41754

The online diagnostic function of AC1433/34 distinguishes 3 types of messages:

Symbol	Message type	Meaning
	Error	<ul style="list-style-type: none"> An error occurred; proper operation of the device is disturbed. User action absolutely required
	Warning	<ul style="list-style-type: none"> An irregularity has occurred User action required
	Event	<ul style="list-style-type: none"> An uncritical event has occurred No user action required

7.3.2 Locate error sources

41743

The online diagnosis function helps the operator to locate the source of occurring warning and error messages. The menu symbols of the navigation path leading to the menu page, which generates a message, are overlain by a warning / error symbol. Thus, the operator can easily locate the error source.

Example:



- > The following menu symbols are overlain by an error symbol:
 - Main navigation bar: [AS-i 1]
 - Sub navigation bar: [Slaves]
- > Error source on menu page [AS-i 1] > [Slaves]



If a function unit of the device causes a warning and an error message at the same time, then the error symbol is displayed.

7.4 Online Support Center (OSC)

41718

The Online Support Center (OSC) displays detailed information about occurring events, failures and errors.

The OSC has the following appearance:

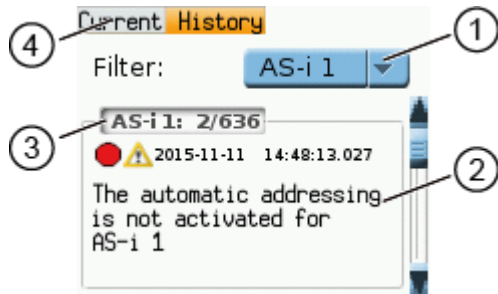

- ① List to select a filter and name of the selected filter
- ② Message
An message consists of error symbol, timestamp and detailed information about the errors
- ③ Number of the message displayed and total number of messages
- ④ Tabs to select a view
[Current]: → **OSC: View current error messages**
(→ S. [113](#))
[History]: → **OSC: Show message history** (→ S. [114](#))

7.4.1 OSC: View current error messages

The [Current] tab lists all current messages. The messages are in chronological order. All messages regarding warnings and errors are displayed.



Information about the different types of messages: → **Message types** (→ S. [111](#))
 Overview of possible OSC messages of the device: → **OSC messages** (→ S. [164](#))

To view the error messages that are currently active:

1 Select the menu page

- ▶ On the start screen: Select [OSC]
- ▶ Select **[Current]** tab.

2 Show current messages

- > The page shows the error messages that are currently active.
- ▶ Press [▼] to select the message field.
- > The focus (orange frame) is on the message field.
- ▶ Use [▲]/[▼] to go through the error messages.

3 Optional: filter messages

- ▶ Set the following parameters as required:

Parameter	Description	Possible values	
[Filter]	System component the message was created in	[All]	Display all messages in chronological order of their occurrence (= preset).
		[AS-i 1]	Display messages that were created in AS-i master 1.
		[AS-i 2]	Display messages that were created in AS-i master 2 (only selectable for devices with 2 AS-i masters).
		[System]	Display messages that were created in the system.

- > Page shows filtered messages.

7.4.2 OSC: Show message history

The [History] tab lists all messages which occurred during the operating time of the device. The messages are shown in chronological order. The device displays messages regarding events, warnings and errors.



The messages are stored in a ring buffer. The ring buffer can store 2000 messages. If full, the device overwrites the oldest message(s) (time stamp).

There is a message pair for each failure (warning, error). It indicates the time of occurrence of the failure and the time at which the cause of the failure was rectified. The symbols of the messages are correspondingly marked.

Example: Error message



Time at which the error occurred



Time at which the cause of the fault was rectified.

To display the history of messages created so far again:

1 Select menu page

- ▶ On the start screen: Select [OSC].
- ▶ Select [History] tab.

2 Display all messages

- > The page shows all previously generated error messages.
- ▶ Press [▼] to select the message field.
- > The focus (orange frame) is on the message field.
- ▶ Use [▲]/[▼] to go through the error messages.

3 Optional: Filter messages

- ▶ Set the following parameters as required:

Parameter	Description	Possible values	
[Filter]	System component the message was created in	[All]	Display all messages in chronological order of their occurrence (= preset).
		[AS-i 1]	Display messages that were created in AS-i master 1.
		[AS-i 2]	Display messages that were created in AS-i master 2 (only selectable for devices with 2 AS-i masters).
		[System]	Display messages that were created in the system.

- > Page shows filtered messages.

8 Appendix

Content

Approval tests / certifications	115
Technical data	116
Address assignment in Ethernet networks	118
Configuration interfaces: Connection concepts	119
AS-i master	121
AS-i slaves	125
Fieldbus EtherCAT	135
OSC messages	164

33879

8.1 Approval tests / certifications

42185

Software-relevant certifications:

- AS-i master profile M4 according to AS-i specification 3.0
- Fieldbus certification: compliant with EtherCat specification



8.2 Technical data

Content

Housing.....	116
Display elements	116
Operation	116
Power supply connections.....	116
Interface.....	117
Programmable Logic Controller (PLC)	117

34188

8.2.1 Housing

41477

Housing	
Degrees of protection	IP20
Material	Aluminium, steel sheet, Makrolon
Dimensions (W x H x D) [mm]	93 x 128,2 x 106,2

8.2.2 Display elements

41442

Display	
Technology	LCD, colour
Size	35 x 28 mm (1.8")
Resolution	220 x 176 pixels
Colour depth	18 bits (= 262 144 possible colours)

LED	
Possible colours	red, green, yellow

8.2.3 Operation

41714

Membrane keys	
Function keys	2x
Navigation keys / arrow keys	4x

8.2.4 Power supply connections

41800

Power supply connections	
AS-i 1, AS-i 2, FE	plug-in, 6 poles, Combicon
24 V Power supply	plug-in, 2 poles, Combicon

8.2.5 Interface

42139

Ethernet configuration interface	
Connection	2x RJ45
Transfer	10/100 Mbits/s
Protocol	HTTP, FTP, Telnet

42139

EtherCAT interface	
Connection	2x RJ45
Protocol	EtherCAT slave
Transfer	10/100 Mbits/s

42139

SD card slot	
Media	SD memory cards (max. 32 Gbytes)
Format	SDHC format is supported
Supported file formats	FAT32

8.2.6 Programmable Logic Controller (PLC)

41770

Programmable Logic Controller (PLC)	
Type	CODESYS Control Runtime System (incl. CODESYS WebVisu)
Programming system	CODESYS Development System (version 3.5 SP9 Patch 7 Hotfix 3 or higher)
Programming languages	FBD, SFC, CFC, IL, LD, ST
Available memory for PLC applications / RETAIN variables	approx. 10 MB / 4072 bytes

8.3 Address assignment in Ethernet networks

39571



In the Ethernet network every IP address **MUST** be unique.

The following IP addresses are reserved for network-internal purposes and are therefore not allowed as an address for participants: nnn.nnn.nnn.0 | nnn.nnn.nnn.255.

Only network participants whose subnet mask is identical and whose IP addresses are identical with respect to the subnet mask can communicate with each other.

Rule:

If part of the subnet mask = 255, the corresponding IP address parts must be identical.

If part of the subnet mask = 0, the corresponding IP address parts must be different.

If the subnet mask = 255.255.255.0, 254 participants communicating with each other are possible in the network.

If the subnet mask = 255.255.0.0, 256x254 = 65 024 participants communicating with each other are possible in the network.

In the same physical network different subnet masks of the participants are allowed. They form different groups of participants which cannot communicate with groups of participants having other subnet masks.



In case of doubt or problems please contact your system administrator.

Examples:

Participant A IP address	Participant A Subnet mask	Participant B IP address	Participant B Subnet mask	Communication of participants possible?
192.168.82.247	255.255.255.0	192.168.82.10	255.255.255.0	Yes, 254 participants possible
192.168.82. 247	255.255.255.0	192.168.82. 247	255.255.255.0	No (same IP address)
192.168.82.247	255.255. 255 .0	192.168.82.10	255.255. 0 .0	No (different subnet mask)
192.168. 82 .247	255.255.255.0	192.168. 116 .10	255.255.255.0	No (different IP address range: 82 vs. 116)
192.168.222.213	255.255.0.0	192.168.222.123	255.255.0.0	Yes, 65 024 participants possible
192.168.111.213	255.255.0.0	192.168.222.123	255.255.0.0	Yes, 65 024 participants possible
192.168.82.247	255.255.255.0	192.168.82. 0	255.255.255.0	No; the whole network is disturbed because the IP address xxx.xxx.xxx.0 is not allowed

8.4 Configuration interfaces: Connection concepts

Content

Direct connection	119
Connection via Ethernet network	120

42146

The device has 2 configuration interfaces X3 and X8 (→ **Ethernet configuration interfaces** (→ S. [13](#))).

To use the interface functions configuration interface X3 or X8 has to be connected to the necessary IT infrastructure. The device supports the following connection types:

- **Direct connection** (→ S. [119](#))
- **Connection via Ethernet network** (→ S. [120](#))

8.4.1 Direct connection

42925

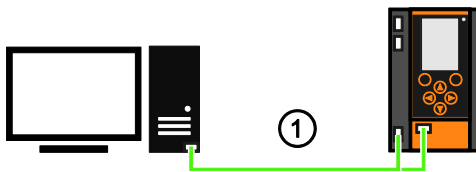

- ①
- ▶ Connect either configuration interface 1 (X3) or 2 (X8) to the PC/laptop via Ethernet cable.
 - ▶ Set the IP parameters of the configuration interface according to the requirements. (→ **Address assignment in Ethernet networks** (→ S. [118](#)))
 - > User can access the web interface and/or programming interface of the device.



The selected configuration interface must not be used as EtherCAT master!

8.4.2 Connection via Ethernet network

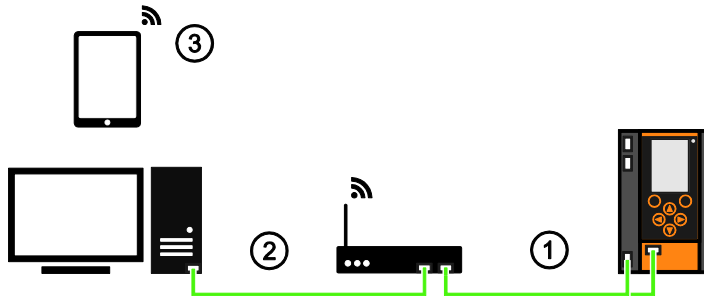

- ①
 - ▶ Connect either configuration interface 1 (X3) or 2 (X8) to switch / WiFi router via Ethernet cable.
 - ▶ Set IP parameters of the configuration interface and the switch / WiFi router so that the data exchange between both devices is ensured. (→ **Address assignment in Ethernet networks** (→ S. [118](#)))
- ②
 - ▶ Connect the PC/laptop to the switch using an Ethernet cable.
 - > User can access the web interface and/or programming interface of the device.
 OR:
- ③
 - ▶ Establish wireless connection of PC/laptop/mobile device to the WiFi router.
 - > User can access the web interface and/or programming interface of the device.



The selected configuration interface must not be used as EtherCAT master!

8.5 AS-i master

Content

Operating modes of the AS-i master	122
Master flags	124

41540

Master = Handles the complete organisation on the bus. The master decides on the bus access time and polls the →slaves cyclically.

8.5.1 Operating modes of the AS-i master

Content

Protected mode	122
Projection mode.....	122
Switch operating modes	123

41721

The AS-i master can be operated in one of the following operating modes:

Protected mode

41761

In the operating mode "Protected mode" (= normal mode), the AS-i master only communicates with AS-i slaves that are entered in the list of projected slaves (LPS) and where current and target configuration match.

The AS-i master automatically detects the following actions and signals a configuration error:

- an AS-i slave is added to the AS-i network (error message: Slave not projected)
- an AS-i slave is removed from the AS-i network (error message: Slave not present)

Optionally, the operator can activate/deactivate the following monitoring functions (→ **Set the monitoring functions of the AS-i master** (→ S. [51](#))):

• Automatic addressing:	When a defective slave is replaced, the AS-i master controls the addressing. The new AS-i slave obtains the same address as the old AS-i slave if the following conditions are met: <ul style="list-style-type: none"> ▪ The new AS-i slave has the address 0. ▪ Both AS-i slaves have the same device profile.
• Double address recognition:	The AS-i master recognises whether one or several AS-i slaves have the same address (error message: Double address error).
• Earth-fault detection:	The AS-i master detects any earth faults.

In the operating mode "Protected mode", the operator can control the PLC applications stored on the device (start, stop, reset).

Projection mode

41762

In the operating mode "Projection mode", the AS-i master communicates with all AS-i slaves that are connected to the AS-i line and do not have the address 0. Missing AS-i slaves are not detected by the AS-i master.

In projection mode a projection adaptation can be carried out. The AS-i master reads the configuration data of all detected AS-i slaves and saves it permanently.

Switch operating modes

41702

The operator / programmer can switch the operating modes of the AS-i master as follows:

- per GUI / web interface (→ **Set the operating mode of the AS-i master** (→ S. [49](#)))
- per function block Set_Mode (→ programming manual: **Set_Mode**)



If an AS-i slave with the address 0 is connected, then the AS-i master cannot switch from "projection mode" into "protected mode" !

- ▶ Address the AS-i slave correctly.
- ▶ Switch the operating mode.

8.5.2 Master flags

41738

The master flags contain information about the status of the AS-i master and the fieldbus host.

The master flags are transmitted along with the input data of the digital AS-i slaves in the acyclic data set DS2 (→ Device Manual Supplement - Acyclic datasets and command interface).

8.6 AS-i slaves

Content

Profiles of AS-i slaves.....	126
------------------------------	-----

41533

Slave = Passive participant on the bus, only replies on request of the →master. Slaves have a clearly defined and unique →address in the bus.

8.6.1 Profiles of AS-i slaves

Content

Configuration data (CDI) of the slaves (slave profiles).....	127
Slave profiles for slaves with combined transaction.....	133
Combined transaction – Use of analogue channels in the gateway depending on the slave profile ...	133

41771

Configuration data (CDI) of the slaves (slave profiles)

Content

Structure of the slave profile.....	127
Description of the IO code for digital slaves	128
Description of the ID code (selection)	128
Description of the extended ID code 1	129
Description of the extended ID code 2	129
Valid combinations IO code / ID code / extended ID code 2.....	130

41591

The configuration data CDI (= **C**onfiguration **D**ata **I**mage) for single, A and B slaves is stored in a data word. The structure is shown below and is the same for all slaves.

Structure of the slave profile

41709

The slave profile has the following structure: S-[IO code].[ID code].[ext. ID code2]

Bits 15...12	Bits 11...8	Bits 7...4	Bits 3...0
XID2 extended ID code 2 3rd figure in the slave profile (AS-i slave v2.0 = 0xF *)	XID1 extended ID code 1 is <u>no</u> part of the slave profile can be changed by the user (AS-i slave v2.0 = 0xF *)	ID code ID code 2nd figure in the slave profile	IO code I/O configuration 1st figure in the slave profile
Example:	AC2255 4 digital inputs, 2 digital outputs AS-i profile = S-7.A.E This results in the following configuration data of the slave:		
0b1110 = 0xE	(e.g.) 0b0111 = 0x7	0b1010 = 0xA	0b0111 = 0x7
The corresponding CDI data word is: 11100111 10100111 = 0xE7A7			

*) AS-i slaves according to the AS-i specification 2.0 and older do not support the extended ID codes 1 and 2. In the master 0xF is stored for this configuration data.

Description of the IO code for digital slaves

41588

Structure slave profile = S-[IO-Code].x.x

IO code [hex]	IO code (bits 3...0)	Function of the periphery bit			
		D3	D2	D1	D0
0	0000	input	input	input	input
1	0001	output	input	input	input
2	0010	input / output	input	input	input
3	0011	output	output	input	input
4	0100	input / output	input / output	input	input
5	0101	output	output	output	input
6	0110	input / output	input / output	input / output	input
7	0111	input / output	input / output	input / output	input / output
8	1000	output	output	output	output
9	1001	input	output	output	output
A	1010	input / output	output	output	output
B	1011	input	input	output	output
C	1100	input / output	input / output	output	output
D	1101	input	input	input	output
E	1110	input / output	input / output	input / output	output
F	1111	not allowed			

Description of the ID code (selection)

41589

Structure slave profile = S-x.[ID-Code].x

ID code [hex]	ID code (Bits 3...0)	Description
0	0000	4 I/O connections for binary sensors and/or actuators with 1 signal each
1	0001	2 dual-signal I/O connections for binary sensors and/or actuators with 2 signals each
A	1010	slave operates in the extended addressing mode (B slave or A/B slave)
B	1011	slave corresponds to Safety-at-Work
F	1111	manufacturer-specific device (cannot be replaced with products from other manufacturers)

Description of the extended ID code 1

41585

Can be changed by the user, however not a part of the slave profile.

Default value:

0xF for single slaves

0x7 for A/B slaves

The value is evaluated and checked by the master. The user can make an additional distinction between slaves which do not differ in the AS-i system, e.g. slaves with different ranges for current, voltage or frequency. This prevents damage when replacing slaves with a wrong performance range.

Description of the extended ID code 2

41590

Extended ID code 2 for analogue slaves with profile 7.3.x

41514

The extended ID code 2 is used to specify complex slaves.

Structure slave profile = S-7.3.[ext.ID code2]

Bit 3	Bit 2	Bit 1	Bit 0	Description
		0	0	1-channel slave
		0	1	2-channel slave
		1	0	4-channel slave
		1	1	4-channel slave (if slave has no extended ID code)
	0			transparent data exchange = binary bits
	1			analogue value transmission
0				output slave
1				input slave

The ID code 2 results from a combination of the options stated above.

Extended ID code 2 for analogue slaves with profile 7.4.x

41513

The extended ID code 2 is used to specify complex slaves.

Structure slave profile = S-7.3.[ext. ID code2]

Bit 3	Bit 2	Bit 1	Bit 0	Description
		0	0	1-channel slave
		0	1	2-channel slave
		1	0	4-channel slave
		1	1	4-channel slave (if slave has no extended ID code)
0	0	0	0	4 binary inputs + 4 binary outputs
0				output slave
1				input slave

The ID code 2 results from a combination of the options stated above.

Valid combinations IO code / ID code / extended ID code 2

41677

Structure slave profile = S-[IO code].[ID code].[ext. ID code2]

IO code [hex]	ID code [hex]	Ext. ID code 2 [hex]	Meaning
0...E not: 9, B, D	0	x	binary I/O connections for sensors and actuators
0, 3, 8	1	x	1 or 2 binary sensors or actuators with 2 signals each (dual-signal devices)
0	1	x	4 binary inputs for 2 dual-signal sensors
0...E not: 2A	A	x	slave operates in the "extended addressing mode" (B slave or A/B slave)
0	A	E	slave with extended address function: 4 binary inputs for 2 dual-signal sensors (e.g. I/O module AC2250)
0	B	x	slave corresponds to Safety-at-Work
0...E	F	x	manufacturer-specific device (cannot be replaced by other products)
1	1	x	single sensor with remote setting: 3 binary inputs + 1 binary output (e.g. sensor OC5226)
3	1	x	2 binary inputs for 1 dual-signal sensor AND 2 binary outputs for 1 dual-signal actuator
3	A	x	slave with extended address function
3	A	1	slave with extended address function: 2 binary inputs + 1 binary output
3	A	2	slave with extended address function: 4 binary inputs
6	0	x	quick combined transaction type 5 of 8, 12 or 16 data bits by using 2, 3 or 4 slave addresses in a slave
7	0	F	motor starter 2I + 2O (e.g. ZB0032)
7	0	E	4 binary inputs + 4 binary outputs (e.g. I/O module AC2251)
7	1	x	interface for the transmission of 6...18-bit signals; analogue profile for combined transaction type 1; was replaced by S-7.3
7	2	x	extended slave profile for the transmission of 6...18-bit signals; extended analogue profile for combined transaction type 1; was replaced by S-7.4
7	3	x	slave profile for 16-bit transmission with integrated support in the master; integrated analogue profile for combined transaction type 1 (→ Extended ID code 2 for analogue slaves with profile 7.3.x (→ S. 129))
7	3	5	2 analogue outputs of 16 bits each (e.g. I/O module AC2618)
7	3	6	4 analogue outputs of 16 bits each (e.g. I/O module AC2518)
7	3	C	1 analogue input of 16 bits (e.g. sensor PPA020)
7	3	D	2 analogue inputs of 16 bits each (e.g. I/O module AC2616)
7	3	E	4 analogue inputs of 16 bits each (e.g. I/O module AC2516)
7	4	x	extended slave profile for 16-bit transmission with integrated support in the master; integrated extended analogue profile for combined transaction type 1 (→ Extended ID code 2 for analogue slaves with profile 7.4.x (→ S. 129))
7	4	C	RFID identification system for writing and reading RFID tags 15-bit data + 1-bit messages (e.g. DTA100)
7	A	x	slave operates in the "extended addressing mode" (B slave or A/B slave)

IO code [hex]	ID code [hex]	Ext. ID code 2 [hex]	Meaning
7	A	5	slave operates in the "extended addressing mode" (B slave or A/B slave) combined slave; supports combined transaction type 2
7	A	7	slave operates in the "extended addressing mode" (B slave or A/B slave) 4 binary inputs + 4 binary outputs
7	A	8	slave operates in the "extended addressing mode" (B slave or A/B slave) 1 channel for combined transaction type 4
7	A	9	slave operates in the "extended addressing mode" (B slave or A/B slave) dual channel for combined transaction type 4
7	A	A	slave operates in the "extended addressing mode" (B slave or A/B slave) 8 binary inputs + 8 binary outputs
7	A	E	slave operates in the "extended addressing mode" (B slave or A/B slave); dual sensor with actuator interface (e.g. sensor AC2317); 2 binary inputs + 2 binary outputs
7	B	x	safety slave with non-safe outputs
7	B	0	safety slave with non-safe outputs; 2 safe binary inputs (e.g. I/O module AC005S)
7	B	E	safety sensor with non-safe outputs; 2 safe binary inputs AND 2 safe binary outputs AND 2 non-safe (relay) outputs (e.g. I/O module AC009S)
7	D	x	device for motor control (electromechanical)
7	D	0	electromechanical motor control with open sub-profile
7	D	1	electromechanical direct starter
7	D	2	electromechanical reverser
7	D	3	electromechanical direct starter with brake
7	D	4	electromechanical reverser with brake
7	D	5	electromechanical direct starter with accessories
7	D	6	electromechanical reverser with accessories
7	E	x	device for motor control (electronic)
7	E	0	electronic motor control with open sub-profile
7	E	1	electronic direct starter
7	E	2	electronic reverser
7	E	3	electronic direct starter with brake
7	E	4	electronic reverser with brake
7	E	5	electronic direct starter with accessories
7	E	6	electronic reverser with accessories
8	1	x	4 binary outputs for 2 dual-signal actuators
B	1	x	dual-signal actuator with feedback: 2 binary outputs + 2 binary inputs
B	A	5	slave operates in the "extended addressing mode" (B slave or A/B slave); supports combined transaction type 2
B	A	E	slave operates in the "extended addressing mode" (B slave or A/B slave); 2 binary outputs + 2 binary inputs (e.g. AC2086 module)
D	1	x	single actuator with monitoring: 1 binary output + 3 binary inputs

x = any value (0...F)

Devices with M4 master profile enable connection of slaves with more than 4 digital inputs/outputs. The transmission is combined: Part of the data transmission is carried out via the digital bits D0...D3, another part via the "analogue" channels.



The more data is transmitted, the longer it takes until all data of a slave has been transmitted.

Cycle time single slave = 5 ms

Cycle time A/B slave (if address is only assigned to A or B slave) = 5 ms

Cycle time A/B slave (if address is assigned to A and B slave) = 10 ms

The cycle time for CTT transmission is a multiple of these values for individual data.

CTT = Combined Transaction Type



Slave profiles for slaves with combined transaction

41654

Structure slave profile = S-[IO-Code].[ID-Code].[ext.ID-Code2]

Slave profile	Master profile	Assignment analogue channels in the device		Bits D0...D3	Additional acyclic string data transaction	Combined transaction CTT
		Number of channels	Use analogue / digital			
S-6.0	M4	1 I and 1 O	2/3/4 x 4 binary inputs and 2/3/4 x 4 binary outputs	—	no	type 5
S-7.3	M3	1/2/4 I or 1/2/4 O	1/2/4 analogue inputs or 1/2/4 binary outputs	—	no	type 1
S-7.4	M3	1/2/4 I or 1/2/4 O	1/2/4 analogue inputs or 1/2/4 binary outputs	4 inputs or 4 outputs	yes	type 1
S-7.5.5	M4	0...4 I and 0...4 O	0...4 analogue inputs or < 65 binary inputs and 0...4 analogue outputs or < 65 binary outputs	2 inputs and 2 outputs	yes	type 2
S-7.A.5	M4	0...2 I and 0...2 O	0...2 analogue inputs or < 33 binary inputs and 0...2 analogue outputs or < 33 binary outputs	2 inputs and 1 output	yes	type 2
S-7.A.7	M4	—	—	4 inputs and 4 outputs	no	type 3
S-7.A.8	M4	1 I	1 analogue input or < 17 binary inputs	1 output	no	type 4
S-7.A.9	M4	2 I	2 analogue inputs or < 33 binary inputs	—	no	type 4
S-7.A.A	M4	1 I and 1 O	8 binary inputs and 8 binary outputs	—	no	type 3
S-B.A.5	M4	0...2 I and 0...2 O	0...2 analogue inputs or < 33 binary inputs and 0...2 analogue outputs or < 33 binary outputs	—	yes	type 2

Legend colour pattern:

 binary inputs	 binary outputs	 analogue inputs	 analogue outputs
---	--	---	--

Combined transaction – Use of analogue channels in the gateway depending on the slave profile

41592

Transaction	Slave profile	Slave type	Number channels	Analogue input channels					Analogue output channels								
				CH3	CH2	CH1	CH0	Trans.	CH3	CH2	CH1	CH0	Trans.				
CTT5	6.0.x	S	1	-	-	-	b	-	-	-	-	b	-				
CTT1	7.3.C	S	1	-	-	-	a	-	-	-	-	-	-				
	7.3.D	S	2	-	-	a	a	-	-	-	-	-	-				
	7.3.E	S	4	a	a	a	a	-	-	-	-	-	-				
	7.3.4	S	1	-	-	-	-	-	-	-	-	a	-				
	7.3.5	S	2	-	-	-	-	-	-	-	a	a	-				
	7.3.6	S	4	-	-	-	-	-	a	a	a	a	-				
	7.3.C	S	1	-	-	-	a	-	-	-	-	-	-				
	7.3.D	S	2	-	-	a	a	-	-	-	-	-	-				
	7.3.E	S	4	a	a	a	a	-	-	-	-	-	-				
	7.3.4	S	1	-	-	-	-	-	-	-	-	a	-				
	7.3.5	S	2	-	-	-	-	-	-	-	a	a	-				
7.3.6	S	4	-	-	-	-	-	-	a	a	a	a	-				
CTT1	7.4.4	S	1	-	-	-	-	-	-	-	-	a	X				
	7.4.5	S	2	-	-	-	-	-	-	-	a	a	X				
	7.4.6	S	4	-	-	-	-	-	-	a	a	a	a	X			
	7.4.C	S	1	-	-	-	a	X	-	-	-	-	-				
	7.4.D	S	2	-	-	a	a	X	-	-	-	-	-				
	7.4.E	S	4	a	a	a	a	X	-	-	-	-	-				
CTT2	7.5.5	S	0..4	a	b	a	b	a	b	a	b	a	b	X			
CTT2	7.A.5	A	0..2	-	-	a	b	a	b	X	-	-	a	b	a	b	X
	7.A.5	B	0..2	a	b	a	b	-	-	X	a	b	a	b	-	-	X
CTT3	7.A.7	A	-	only binary					-	only binary					-		
		B	-						-						-		
CTT4	7.A.8	A	1	-	-	-	a	b	-	-	-	-	-	-			
		B	1	-	a	b	-	-	-	-	-	-	-	-			
CTT4	7.A.9	A	2	-	-	a	b	a	b	-	-	-	-	-			
		B	2	a	b	a	b	-	-	-	-	-	-	-			
CTT3	7.A.A	A	1	-	-	-	b	-	-	-	-	-	b	-			
		B	1	-	b	-	-	-	-	-	b	-	-	-			
CTT2	B.A.5	A	0..2	-	-	a	b	a	b	X	-	-	a	b	a	b	X
	B.A.5	B	0..2	a	b	a	b	-	-	X	a	b	a	b	-	-	X

CHn = channel
Trans. = transparent mode
S = single slave
A = A slave
B = B slave
a = analogue inputs/outputs (word)
b = binary inputs/outputs (bits)
- = not used
X = additional acyclic transaction of strings for device, parameters, diagnosis

Legend colour pattern:

binary inputs	binary outputs	analogue inputs	analogue outputs
---------------	----------------	-----------------	------------------

8.7 Fieldbus EtherCAT

Content

Parameter data	136
Cyclic data	138
Acyclic data	151
EtherCAT projection software: Programmers' notes	156

42131

8.7.1 Parameter data

Content

Fieldbus parameters	136
Device-specific parameters	136
ESI file	137

34170

Fieldbus parameters

42136

The fieldbus parameters provide information for the integration of the device into the EtherCAT network.

Name	Description	Possible values
[ID]	"Explicit Device ID" of the device	0...65535

Device-specific parameters

42903

The device-specific parameters allow you to make individual adjustments to the system.



The device only supports the top down configuration via the EtherCAT projection software.

Parameter	Description	Values	
Failsafe state	Behaviour of the slave outputs if an interrupted fieldbus connection is detected	Clear outputs* =	All AS-i outputs are switched off in case of an interrupted EtherCAT connection (value = 0).
		Hold outputs =	The outputs are held in the last valid state that existed before the interrupted connection was detected.
AS-i param. download	Transmission of the slave parameters when downloading a configuration from the EtherCAT projection software.	Disable* =	The following slave parameter data are NOT downloaded to the device. The parameters set in the device apply.
		Enable =	Each time the EtherCAT connection is established, the following slave parameter data are downloaded to the device, activated in the AS-i slaves, and stored non-volatilely.
Param. slave 1(A) AS-i master 1 ... Param. slave 31(A) AS-i master 1 Param. slave 1B AS-i master 1 ... Param. slave 31B AS-i master 1 Param. slave 1(A) AS-i master 2 ... Param. slave 31(A) AS-i master 2 Param. slave 1B AS-i master 2 ... Param. slave 31B AS-i master 2	Parameter data of the AS-i slaves. The set values are only activated when the parameter "AS-i param. download" is set to the value "Enable".	P3..P0 = P3..P0 = ... P3..P0** = ... P3..P0* =	2#0000 / 16#0 2#0001 / 16#1 ... 2#0111 / 16#7 ... 2#1111 / 16#F

ESI file

42188

To represent the AC1433/34 in a field bus projection software ifm electronic provides an ESI file.

The ESI file is saved in the device. It can be downloaded to the PC with the EtherCAT projection software via the web interface (→ **Download ESI file** (→ S. [89](#))). In the ESI file, all parameters, process data and their valid value ranges are defined.

8.7.2 Cyclic data

Content

Overview: EtherCAT modules	138
Slot 1 – Digital inputs/outputs of the single/A slaves to AS-i Master 1	139
Slot 2 – Digital inputs/outputs of the single/A slaves to AS-i Master 2	139
Slot 3 – Digital inputs/outputs of the B slaves to AS-i Master 1	140
Slot 4 – Digital inputs/outputs of the B slaves to AS-i Master 2	140
Slot 5 ... 66 – Analogue slaves to AS-i Master 1 and AS-i Master 2	142
Slot 67 – Inputs of AC14 PLC	143
Slot 68 – Outputs to AC14 PLC	144
Slot 69 – Diagnostic data	145

33814

Overview: EtherCAT modules

42166

The following tables show the available EtherCAT modules.

Slot location	Description	Detailed information
1	Digital inputs/outputs of single or A slaves, connected to <AS-i1>	Slot 1 – Digital inputs/outputs of the single/A slaves to AS-i Master 1 (→ S. 139)
2	Digital inputs/outputs of single or A slaves, connected to <AS-i2>	Slot 2 – Digital inputs/outputs of the single/A slaves to AS-i Master 2 (→ S. 139)
3	Digital inputs/outputs of the B slaves, connected to AS-i Master 1	Slot 3 – Digital inputs/outputs of the B slaves to AS-i Master 1 (→ S. 140)
4	Digital inputs/outputs of the B slaves, connected to AS-i Master 2	Slot 4 – Digital inputs/outputs of the B slaves to AS-i Master 2 (→ S. 140)
5...66	Analogue inputs/outputs of the AS-i slaves, connected to AS-i Master 1 and 2	Slot 5 ... 66 – Analogue slaves to AS-i Master 1 and AS-i Master 2 (→ S. 142)
67	Data from the device-internal PLC to the EtherCAT PLC	Slot 67 – Inputs of AC14 PLC (→ S. 143)
68	Data from the EtherCAT PLC to the device-internal PLC	Slot 68 – Outputs to AC14 PLC (→ S. 144)
69	Diagnostic data sent to the EtherCAT master	Slot 69 – Diagnostic data (→ S. 145)

Slot 1 – Digital inputs/outputs of the single/A slaves to AS-i Master 1

42179

Slot location	Description	Value range	Length [Bytes]
1	Digital inputs/outputs of single or A slaves, connected to <AS-i1>	Empty module = module is deactivated	0
		all S/A slaves AS-i 1 = all S/A slaves of AS-i Master 1	16

→ Mapping: digital input / output data (TxPDO/RxPDO) (→ S. [141](#))

Slot 2 – Digital inputs/outputs of the single/A slaves to AS-i Master 2

42187

Slot location	Description	Value range	Length [Bytes]
2	Digital inputs/outputs of single or A slaves, connected to <AS-i2>	Empty module = module is deactivated	0
		all S/A slaves AS-i 2 = all S/A slaves of AS-i Master 2	16

→ Mapping: digital input / output data (TxPDO/RxPDO) (→ S. [141](#))

Slot 3 – Digital inputs/outputs of the B slaves to AS-i Master 1

42171

Slot location	Description	Value range	Length [Bytes]
3	Digital inputs/outputs of the B slaves, connected to AS-i Master 1	Empty module = module is deactivated	0
		all B slaves AS-i 1 = all B slaves of AS-i Master 1	16

→ **Mapping: digital input / output data (TxPDO/RxPDO)** (→ S. [141](#))

Slot 4 – Digital inputs/outputs of the B slaves to AS-i Master 2

42167

Slot location	Description	Value range	Length [Bytes]
4	Digital inputs/outputs of the B slaves, connected to AS-i Master 2	Empty module = module is deactivated	0
		all B slaves AS-i 2 = all B slaves of AS-i Master 2	16

→ **Mapping: digital input / output data (TxPDO/RxPDO)** (→ S. [141](#))

Mapping: digital input / output data (TxPDO/RxPDO)

42112

TxPDO:

Byte	Bit							
	7	6	5	4	3	2	1	0
1	slave 1(A) or 1B: DI3...DI0				master flags (→ S. 141) or reserved*			
2	slave 3(A) or 3B: DI3...DI0				slave 2(A) or 2B: DI3...DI0			
3	slave 5(A) or 5B: DI3...DI0				slave 4(A) or 4B: DI3...DI0			
...			
15	slave 29(A) or 29B: DI3...DI0				slave 28(A) or 28B: DI3...DI0			
16	slave 31(A) or 31B: DI3...DI0				slave 30(A) or 30B: DI3...DI0			

* ... Master flags are only transferred in slots 1 and 2, in slots 3 and 4 bits 0...4 of the 1st byte remain empty.

RxPDO:

Byte	Bit							
	7	6	5	4	3	2	1	0
1	slave 1(A) or 1B: DO3...DO0				reserved			
2	slave 3(A) or 3B: DO3...DO0				slave 2(A) or 2B: DO3...DO0			
3	slave 5(A) or 5B: DO3...DO0				slave 4(A) or 4B: DO3...DO0			
...			
15	slave 29(A) or 29B: DO3...DO0				slave 28(A) or 28B: DO3...DO0			
16	slave 31(A) or 31B: DO3...DO0				slave 30(A) or 30B: DO3...DO0			

master flags

42954

The master flags are transferred together with the digital input data of the single/A slaves (→ **Mapping: digital input / output data (TxPDO/RxPDO)** (→ S. [141](#))). They provide information about the operating status of the AS-i master.

Bit 3	Bit 2	Bit 1	Bit 0
AS-i power fail (19 V)	Configuration error in the AS-i circuit	AS-i master is offline	Peripheral fault

Slot 5 ... 66 – Analogue slaves to AS-i Master 1 and AS-i Master 2

Slot location	Description	Value range	Length [Word]
5...66	Input and output values of the analogue slaves connected to an AS-i Master 1 and AS-i Master 2	Empty module = module is deactivated	0
		IN 1 word A or S = 1-word input data, single or A slave	1
		IN 1 word B = 1-word input data, B slave	1
		IN 2 word A or S = 2-word input data, single or A slave	2
		IN 2 word B = 2-word input data, B slave	2
		IN 4 word A+B or S = 4-word input data, A and B slaves or single slave	4
		IN/OUT 1 word A or S = 1-word input and output data, single or A slave	1
		IN/OUT 1 word B = 1-word input and output data, B slave	1
		IN/OUT 2 word A or S = 2-word input and output data, single or A slave	2
		IN/OUT 2-word B = 2-word input and output data, B slave	2
		IN/OUT 4-word A+B or S = 4-word input and output data, A and B slave or single slave	4
		OUT 1-word A or S = 1-word output data, single or A slave	1
		OUT 1-word B = 1-word output data, B slave	1
		OUT 2-word A or S = 2-word output data, single or A slave	2
		OUT 2-word B = 2-word output data, B slave	2
OUT 4-word A+B or S = 4-word output data, A and B slave or single slave	4		

Slot 67 – Inputs of AC14 PLC

42178

Slot location	Description	Value range	Length [Worte]
67	Data from the device-internal PLC to the EtherCAT PLC	Empty module = module is deactivated	0
		PLC IN, 004 words = 4 words AC1433/34 PLC >> fieldbus PLC	4
		PLC IN, 008 words = 8 words AC1433/34 PLC >> fieldbus PLC	8
		PLC IN, 012 words = 12 words AC1433/34 PLC >> fieldbus PLC	12
		PLC IN, 016 words = 16 words AC1433/34 PLC >> fieldbus PLC	16
		PLC IN, 020 words = 20 words AC1433/34 PLC >> fieldbus PLC	20
		PLC IN, 024 words = 24 words AC1433/34 PLC >> fieldbus PLC	24
		PLC IN, 028 words = 28 words AC1433/34 PLC >> fieldbus PLC	28
		PLC IN, 032 words = 32 words AC1433/34 PLC >> fieldbus PLC	32
		PLC IN, 036 words = 36 words AC1433/34 PLC >> fieldbus PLC	36
		PLC IN, 040 words = 40 words AC1433/34 PLC >> fieldbus PLC	40
		PLC IN, 044 words = 44 words AC1433/34 PLC >> fieldbus PLC	44
		PLC IN, 048 words = 48 words AC1433/34 PLC >> fieldbus PLC	48
		PLC IN, 052 words = 52 words AC1433/34 PLC >> fieldbus PLC	52
		PLC IN, 056 words = 56 words AC1433/34 PLC >> fieldbus PLC	56
		PLC IN, 060 words = 60 words AC1433/34 PLC >> fieldbus PLC	60
		PLC IN, 076 words = 76 words AC1433/34 PLC >> fieldbus PLC	76
PLC IN, 092 words = 92 words AC1433/34 PLC >> fieldbus PLC	92		
PLC IN, 108 words = 108 words AC1433/34 PLC >> fieldbus PLC	108		
PLC IN, 120 words = 120 words AC1433/34 PLC >> fieldbus PLC	120		

Slot 68 – Outputs to AC14 PLC

Slot location	Description	Value range	Length [Worte]
68	Data from the EtherCAT PLC to the device-internal PLC	Empty module = module is deactivated	0
		PLC OUT, 004 words = 4 words fieldbus PLC >> AC1433/34 PLC	4
		PLC OUT, 008 words = 8 words fieldbus PLC >> AC1433/34 PLC	8
		PLC OUT, 012 words = 12 words fieldbus PLC >> AC1433/34 PLC	12
		PLC OUT, 016 words = 16 words fieldbus PLC >> AC1433/34 PLC	16
		PLC OUT, 020 words = 20 words fieldbus PLC >> AC1433/34 PLC	20
		PLC OUT, 024 words = 24 words fieldbus PLC >> AC1433/34 PLC	24
		PLC OUT, 028 words = 28 words fieldbus PLC >> AC1433/34 PLC	28
		PLC OUT, 032 words = 32 words fieldbus PLC >> AC1433/34 PLC	32
		PLC OUT, 036 words = 36 words fieldbus PLC >> AC1433/34 PLC	36
		PLC OUT, 040 words = 40 words fieldbus PLC >> AC1433/34 PLC	40
		PLC OUT, 044 words = 44 words fieldbus PLC >> AC1433/34 PLC	44
		PLC OUT, 048 words = 48 words fieldbus PLC >> AC1433/34 PLC	48
		PLC OUT, 052 words = 52 words fieldbus PLC >> AC1433/34 PLC	52
		PLC OUT, 056 words = 56 words fieldbus PLC >> AC1433/34 PLC	56
		PLC OUT, 060 words = 60 words fieldbus PLC >> AC1433/34 PLC	60
		PLC OUT, 076 words = 76 words fieldbus PLC >> AC1433/34 PLC	76
		PLC OUT, 092 words = 92 words fieldbus PLC >> AC1433/34 PLC	92
PLC OUT, 108 words = 108 words fieldbus PLC >> AC1433/34 PLC	108		
PLC OUT, 120 words = 120 words fieldbus PLC >> AC1433/34 PLC	120		

Slot 69 – Diagnostic data

42956

The diagnostic data comprise max. 9 words.

Slot location	Description	Value range	Data length [Worte]
69	Diagnostic data sent to the EtherCAT master	Empty module	0
		AC1433 (→ Module: AC1433 diagnostics (→ S. 145))	25
		AC1434 (→ Module: AC1434 diagnostics (→ S. 146))	49

Module: AC1433 diagnostics

42933

Word	Description	Details
1	System diagnostics	→ Diagnosis - System diagnosis (→ S. 146)
2...5	AS-i Master 1: AS-i diagnostics	→ Diagnosis - AS-i diagnosis (→ S. 147)
6...9	AS-i Master 1: List of missing slaves	→ Diagnosis - List of missing slaves (LCMES) (→ S. 148)
10...13	AS-i Master 1: List of non-projected slaves	→ Diagnosis - List of non-projected slaves (LCAES) (→ S. 148)
14...17	AS-i Master 1: List of slaves with wrong slave profile	→ Diagnosis - List of slaves with wrong slave profile (LCE) (→ S. 149)
18...21	AS-i Master 1: List of peripheral faults	→ Diagnosis - List of peripheral faults (LPF) (→ S. 149)
22...25	AS-i Master 1: List of slaves addressed several times	→ Diagnosis - List of double addressed slaves (LDAS) (→ S. 150)

Module: AC1434 diagnostics

42932

Word	Description	Details
1	System diagnostics	→ Diagnosis - System diagnosis (→ S. 146)
2...5	AS-i Master 1: AS-i diagnostics	→ Diagnosis - AS-i diagnosis (→ S. 147)
6...9	AS-i Master 1: List of missing slaves	→ Diagnosis - List of missing slaves (LCMES) (→ S. 148)
10...13	AS-i Master 1: List of non-projected slaves	→ Diagnosis - List of non-projected slaves (LCAES) (→ S. 148)
14...17	AS-i Master 1: List of slaves with wrong slave profile	→ Diagnosis - List of slaves with wrong slave profile (LCE) (→ S. 149)
18...21	AS-i Master 1: List of peripheral faults	→ Diagnosis - List of peripheral faults (LPF) (→ S. 149)
22...25	AS-i Master 1: List of slaves addressed several times	→ Diagnosis - List of double addressed slaves (LDAS) (→ S. 150)
26...29	AS-i Master 2: AS-i diagnostics	→ Diagnosis - AS-i diagnosis (→ S. 147)
30...33	AS-i Master 2: List of missing slaves	→ Diagnosis - List of missing slaves (LCMES) (→ S. 148)
34...37	AS-i Master 2: List of non-projected slaves	→ Diagnosis - List of non-projected slaves (LCAES) (→ S. 148)
38...41	AS-i Master 2: List of slaves with wrong slave profile	→ Diagnosis - List of slaves with wrong slave profile (LCE) (→ S. 149)
42...45	AS-i Master 2: List of peripheral faults	→ Diagnosis - List of peripheral faults (LPF) (→ S. 149)
46...49	AS-i Master 2: List of slaves addressed several times	→ Diagnosis - List of double addressed slaves (LDAS) (→ S. 150)

Diagnosis - System diagnosis

41448

Offset Word no.	Bit															
	15	14	13	12	11	10	9	8	7	6	5	4	3	2	1	0
n	-	-	-	-	-	-	-	-	-	-	-	-	PS	GI	OT	ISE

Legend:

Flag	Description
ISE	Internal System Error Interner Systemfehler
OT	over temperature: temperature inside the device has exceeded the permissible max. temperature value
GI	gateway inactive: the gateway mode was deactivated
PS	PLC stop: The controller was stopped

Diagnosis - AS-i diagnosis

41466

Offset Word no.	bit															
	15	14	13	12	11	10	9	8	7	6	5	4	3	2	1	0
n	-	-	PF19	PF22.5	EF	S0	PM	IME	-	-	-	DAE	PE	CEIP	CEAS	CEMS
n+1	Voltage AS-i+ to AS-i- in mV															
n+2	Voltage FE to AS-i- in mV															
n+3	Symmetry in % (-100% ... +100%)															

Legend:

Flag	Description
IME	internal master error: Internal system error of an AS-i master
PM	projection mode: AS-i master was set to the projection mode.
S0	slave 0 detected: New slave 0 was detected.
EF	earth fault: Earth fault was detected
PF22.5	22.5V AS-i Power-Fail (classic AS-i Power) was detected.
PF19	19 AS-i Power-Fail (Power24) was detected.
CEMS	Configuration Error – Missing Slave: AS-i configuration error, one or several slaves are projected, but not available.
CEAS	Configuration Error – Additional Slave: AS-i configuration error, one or several slaves are available, but not projected.
CEIP	Configuration Error – Invalid Profile: AS-i configuration error, the slave profiles of one or several slaves differ from the projected slave profiles.
PE	periphery error: One or several AS-i slaves have a periphery error.
DAE	duplicate address error: One or several multiple-addressing faults occurred.

Diagnosis - List of detected slaves (LDS)

41452

Offset Word no.	Bit															
	15	14	13	12	11	10	9	8	7	6	5	4	3	2	1	0
n	15(A)	14(A)	13(A)	12(A)	11(A)	10(A)	9(A)	8(A)	7(A)	6(A)	5(A)	4(A)	3(A)	2(A)	1(A)	0
n+1	31(A)	30(A)	29(A)	28(A)	27(A)	26(A)	25(A)	24(A)	23(A)	22(A)	21(A)	20(A)	19(A)	18(A)	17(A)	16(A)
n+2	15B	14B	13B	12B	11B	10B	9B	8B	7B	6B	5B	4B	3B	2B	1B	n.a.
n+3	31B	30B	29B	28B	27B	26B	25B	24B	23B	22B	21B	20B	19B	18B	17B	16B

Possible value of slave fields:

0 ... no slave detected

1.... slave detected

Diagnosis - List of missing slaves (LCMES)

41453

Offset Word no.	Bit															
	15	14	13	12	11	10	9	8	7	6	5	4	3	2	1	0
n	15(A)	14(A)	13(A)	12(A)	11(A)	10(A)	9(A)	8(A)	7(A)	6(A)	5(A)	4(A)	3(A)	2(A)	1(A)	0
n+1	31(A)	30(A)	29(A)	28(A)	27(A)	26(A)	25(A)	24(A)	23(A)	22(A)	21(A)	20(A)	19(A)	18(A)	17(A)	16(A)
n+2	15B	14B	13B	12B	11B	10B	9B	8B	7B	6B	5B	4B	3B	2B	1B	n.a.
n+3	31B	30B	29B	28B	27B	26B	25B	24B	23B	22B	21B	20B	19B	18B	17B	16B

Possible values of slave fields:

0 ... no error

1.... slave is projected, but is missing



If at least 1 bit is set in this list, the bit for CEMS is also set.
 (→ **Diagnosis - AS-i diagnosis** (→ S. [147](#)))

Diagnosis - List of non-projected slaves (LCAES)

41455

Offset Word no.	Bit															
	15	14	13	12	11	10	9	8	7	6	5	4	3	2	1	0
n	15(A)	14(A)	13(A)	12(A)	11(A)	10(A)	9(A)	8(A)	7(A)	6(A)	5(A)	4(A)	3(A)	2(A)	1(A)	0
n+1	31(A)	30(A)	29(A)	28(A)	27(A)	26(A)	25(A)	24(A)	23(A)	22(A)	21(A)	20(A)	19(A)	18(A)	17(A)	16(A)
n+2	15B	14B	13B	12B	11B	10B	9B	8B	7B	6B	5B	4B	3B	2B	1B	n.a.
n+3	31B	30B	29B	28B	27B	26B	25B	24B	23B	22B	21B	20B	19B	18B	17B	16B

Possible values of slave fields:

0 ... no error

1.... slave is detected, but not yet projected



If at least 1 bit is set in this list, the bit for CEAS is also set.
 (→ **Diagnosis - AS-i diagnosis** (→ S. [147](#)))

Diagnosis - List of slaves with wrong slave profile (LCE)

41447

Offset Word no.	Bit															
	15	14	13	12	11	10	9	8	7	6	5	4	3	2	1	0
n	15(A)	14(A)	13(A)	12(A)	11(A)	10(A)	9(A)	8(A)	7(A)	6(A)	5(A)	4(A)	3(A)	2(A)	1(A)	0
n+1	31(A)	30(A)	29(A)	28(A)	27(A)	26(A)	25(A)	24(A)	23(A)	22(A)	21(A)	20(A)	19(A)	18(A)	17(A)	16(A)
n+2	15B	14B	13B	12B	11B	10B	9B	8B	7B	6B	5B	4B	3B	2B	1B	n.a.
n+3	31B	30B	29B	28B	27B	26B	25B	24B	23B	22B	21B	20B	19B	18B	17B	16B

Possible values of slave fields:

0 ... no error

1.... Slave is detected, but has wrong profile



If at least 1 bit is set in this list, the bit for CEIP is also set.
 (→ **Diagnosis - AS-i diagnosis** (→ S. [147](#)))

Diagnosis - List of peripheral faults (LPF)

41454

Offset Word no.	Bit															
	15	14	13	12	11	10	9	8	7	6	5	4	3	2	1	0
n	15(A)	14(A)	13(A)	12(A)	11(A)	10(A)	9(A)	8(A)	7(A)	6(A)	5(A)	4(A)	3(A)	2(A)	1(A)	0
n+1	31(A)	30(A)	29(A)	28(A)	27(A)	26(A)	25(A)	24(A)	23(A)	22(A)	21(A)	20(A)	19(A)	18(A)	17(A)	16(A)
n+2	15B	14B	13B	12B	11B	10B	9B	8B	7B	6B	5B	4B	3B	2B	1B	n.a.
n+3	31B	30B	29B	28B	27B	26B	25B	24B	23B	22B	21B	20B	19B	18B	17B	16B

Possible values of slave fields:

0 ... no error

1.... peripheral fault at the slave



If at least 1 bit is set in this list, the bit for PE is also set.
 (→ **Diagnosis - AS-i diagnosis** (→ S. [147](#)))

Diagnosis - List of double addressed slaves (LDAS)

41451

Offset Word no.	Bit															
	15	14	13	12	11	10	9	8	7	6	5	4	3	2	1	0
n	15(A)	14(A)	13(A)	12(A)	11(A)	10(A)	9(A)	8(A)	7(A)	6(A)	5(A)	4(A)	3(A)	2(A)	1(A)	0
n+1	31(A)	30(A)	29(A)	28(A)	27(A)	26(A)	25(A)	24(A)	23(A)	22(A)	21(A)	20(A)	19(A)	18(A)	17(A)	16(A)
n+2	15B	14B	13B	12B	11B	10B	9B	8B	7B	6B	5B	4B	3B	2B	1B	n.a.
n+3	31B	30B	29B	28B	27B	26B	25B	24B	23B	22B	21B	20B	19B	18B	17B	16B

Possible values of slave fields:

0 ... no error

1.... Double address error detected



If at least 1 bit is set in this list, the bit for DAE is also set.
 (→ **Diagnosis - AS-i diagnosis** (→ S. [147](#))).

8.7.3 Acyclic data

Content

Fieldbus objects.....	151
Overview: acyclic data sets (DSx).....	152
Overview: System commands.....	153
Overview: AS-i master commands.....	154

41545

Fieldbus objects

42140

The device uses the following fieldbus objects for acyclic communication:

- Access to the command channels:

Command channel	Fieldbus object		Description
	Index	Subindex	
System	0x2010	01	request channel for system commands
		03	response channel for system commands
AS-i Master 1	0x2011	01	request channel for AS-i Master 1 commands
		03	response channel for AS-i Master 1 commands
AS-i Master 2	0x2012	01	request channel for AS-i Master 2 commands
		03	response channel for AS-i Master 2 commands

- Access to acyclic data sets (DS)

Command	Fieldbus object		Description
	Index	Subindex	
Read / write calls	0x2013	xx	acyclic read or write call for a data set (DSxx)

xx ... number of the requested data set (DSxx)

Overview: acyclic data sets (DSx)

Data record	Content	Access r = read w = write	Words
DS1	System information	r	26
DS2	Digital inputs of slaves 1(A)...31(A) and 1B...31B and master flags (Status AS-i master and exec.-ctl. flags and host flags)	r	36
DS3	Analogue inputs of slaves 1(A)...15(B)	r	75
DS4	Analogue inputs of slaves 16(A)...31(B)	r	80
DS5	Digital outputs of slaves 1(A)...31(A) and 1B...31B	r/w	32
DS6	Analogue outputs of slaves 1(A)...15(B)	r/w	60
DS7	Analogue outputs of slaves 16(A)...31(B)	r/w	64
DS8	Statusflags of analogue output data of slaves 1(A)...31(A) and 1B...31B	r	32
DS9	Slave lists LAS, LDS, LPF, LCE	r	16
DS10	Slave list LPS	r	4
DS11	Actual Configuration data (CDI)	r	64
DS12	Projected Configuration data (PCD)	r	64
DS13	Image of input parameter	r	32
DS14	Image of output parameter	r/w	32
DS15	Slave error counter, configuration error counter, AS-i cycle counter	r	72
DS16	n.a.	–	–
DS17	AS-i master: Error lists LCEMS, LCEAS, LDAE	r	12
DS18	Fieldbus information (only available via CODESYS)	r	19
DS19	n.a.	–	–
DS20	n.a.	–	–



Detailed information about the acyclic data sets and the command interface is given in the supplement to the device manual of the SmartPLC DataLine mit EtherCAT-Slave-Schnittstelle (→ **Overview: User documentation for AC1433/34** (→ S. [7](#))).

Overview: System commands

41794

Comm. no. [hex]	Comm. no. [dec]	Description
0101	257	Quick setup AS-i Master 1/2
0103	259	Change the user language
0104	260	Change the display settings
0105	261	Set output control
0106	262	Set the PLC operating mode
0109	265	Set the date / time
010A	266	Configure the NTP server settings
010B	267	Read date / time / NTP settings
010C	268	Reboot the system
010D	269	Read fieldbus information (can only be executed in CODESYS!)
010F	271	Read text of an OSC entry
0110	272	Display target visualisation



Detailed information about the acyclic data sets and the command interface is given in the supplement to the device manual of the SmartPLC DataLine mit EtherCAT-Slave-Schnittstelle (→ **Overview: User documentation for AC1433/34** (→ S. [7](#))).

Overview: AS-i master commands

Comm. no. [hex]	Comm. no. [dec]	Description	Note
0001	1	Write parameters to a connected AS-i slave	
0003	3	Adopt and save currently connected AS-i slaves in the configuration  With this command the fieldbus connection is reset. The device must be rebooted!	ConfDataInp Slave → Projected Configuration Data and LDS → LPS
0004	4	Change the list of projected AS-i slaves (LPS)	
0005	5	set the operating mode of the AS-i master	
0006	6	readdress a connected AS-i slave	
0007	7	set the auto addressing mode of the AS-i master	
0009	9	change the extended ID code 1 in the connected AS-i slave	
000A	10	change PCD	
000D	13	AS-i master supply voltage, symmetry, earth fault	
0015	21	read ID string of an AS-i slave with profile S-7.4	slave profile S-7.4
001A	26	read AS-i master info	
001C	28	deactivation of the slave reset when changing to the protected mode	
0021	33	read diagnostic string of an AS-i slave with profile S-7.4	slave profile S-7.4
0022	34	read parameter string of an AS-i slave with profile S-7.4	slave profile S-7.4
0023	35	write parameter string of an AS-i slave with profile S-7.4	slave profile S-7.4
0024	36	CTT2 standard read: acyclic standard read call of an AS-i slave with CTT2 profile	CTT2 slave profile *)
0025	37	CTT2 standard write: acyclic standard write call of an AS-i slave with CTT2 profile	CTT2 slave profile *)
0026	38	CTT2 vendor specific read: acyclic manufacturer-specific read call of an AS-i slave with CTT2 profile	CTT2 slave profile *)
0027	39	CTT2 vendor specific write: acyclic manufacturer-specific write call of an AS-i slave with CTT2 profile	CTT2 slave profile *)
0040	64	CTT2 device group read: acyclic manufacturer-specific read call of an AS-i slave with CTT2 profile	CTT2 slave profile *)
0041	65	CTT2 device group write: acyclic device group write call of an AS-i slave with CTT2 profile	CTT2 slave profile *)
0042	66	CTT2 vendor specific selective read from buffer: selective standard read call of an AS-i slave with CTT2 profile	CTT2 slave profile *)
0043	67	CTT2 vendor specific selective write from buffer: selective standard write call of an AS-i slave with CTT2 profile	CTT2 slave profile *)
0044	68	CTT2 vendor specific selective read: selective manufacturer-specific read call of an AS-i slave with CTT2 profile	CTT2 slave profile *)
0045	69	CTT2 vendor specific selective write: selective manufacturer-specific write call of an AS-i slave with CTT2 profile	CTT2 slave profile *)
0046	70	CTT2 device group selective read: selective device group read call of an AS-i slave with CTT2 profile	CTT2 slave profile *)
0047	71	CTT2 device group selective write: selective device group write call of an AS-i slave with CTT2 profile	CTT2 slave profile *)
0049	73	CTT2 vendor specific exchange: manufacturer-specific data exchange with an AS-i slave with CTT2 profile	CTT2 slave profile *)

Comm. no. [hex]	Comm. no. [dec]	Description	Note
004A	74	CTT2 device group exchange: device group data exchange with an AS-i slave with CTT2 profile	CTT2 slave profile *)
004B	75	CTT2 device group selective read from buffer: manufacturer-specific read / write call of an AS-i slave with CTT2 profile	CTT2 slave profile *)
004C	76	CTT2 device group selective write from buffer: device group read / write call of an AS-i slave with CTT2 profile	CTT2 slave profile *)
0050	80	set AS-i master settings	
0051	81	Reset the error counters	

Legend:

*) ... CTT2 profiles = S-7.5.5, S-7.A.5 or S-B.A.5

CTT → **Combined transaction – Use of analogue channels in the gateway depending on the slave profile** (→ S. [133](#))



Detailed information about the acyclic data sets and the command interface is given in the supplement to the device manual of the SmartPLC DataLine mit EtherCAT-Slave-Schnittstelle (→ **Overview: User documentation for AC1433/34** (→ S. [7](#))).

8.7.4 EtherCAT projection software: Programmers' notes

Content

Integrate the device into a TwinCAT project	156
Read cyclical data	157
Use acyclic services	157

41549

Integrate the device into a TwinCAT project

42135

To integrate the device into a TwinCAT project:

1 Integrate ESI file

- ▶ Download device ESI file of the device (→ **Download ESI file** (→ S. [89](#))).
- ▶ Copy downloaded file to the following subdirectory of the TwinCAT installation directory:
.. \3.1\Config\Io\EtherCAT
- ▶ Start TwinCAT.
- > TwinCAT loads the device description to the device catalogue.

2 Integrate the device into the TwinCat project

- ▶ Open a project or create a new project.
- ▶ Add device as sub-device to the requested EtherCAT master.
- ▶ Set EtherCAT address of the device (→ **Configure the EtherCAT interface** (→ S. [90](#))).
- ▶ Optional: Add the device to a hot connect group.

3 Configure cyclical data

- ▶ Configure fieldbus slots (→ **Read cyclical data** (→ S. [157](#))).
- ▶ Load the configuration to the device.

Read cyclical data

42940

To access the cyclical process data of the device the user has to configure the fieldbus slots of the device.

- ▶ In the Solutions Explorer: Double click on the device icon.
- > The editor window shows the configuration options of the device.
- ▶ Select the tab [Slots].
- > Table shows device slots and available fieldbus modules.
- ▶ Configure slots as requested.
- ▶ Optional: Map the configured cyclical data to variables.
- ▶ Save the project to apply changes.
- ▶ Download device configuration to activate the changes.

Use acyclic services

42128

To access acyclic services from a TwinCAT application the user can use the following function blocks:

- FB_EcCoESdoRead: read SDO of an EtherCAT slave
- FB_EcCoESdoWrite: write SDO of an EtherCAT slave



To use both function blocks the function library `Tc2_EtherCAT.library` has to be added to the project.

Description of the function blocks: → Help function of TwinCAT

Read acyclic data records

To access acyclic data sets of the device the user can use the TwinCAT function block FB_EcCoESdoRead. The function block is part of the TwinCAT library Tc2_EtherCAT.lib (→ TwinCAT documentation).

The user has to configure the parameters of the function block:

Input	Description	Possible values
sNetId	AMS net ID of the device	depends on the project, e.g. 172.16.2.131.2.1
nSlaveAddr	EtherCAT address of the device	depends on the project, e.g. 1006
nIndex	index of the field bus object	0x2013 read/write an acyclic data set
nSubIndex	subindex of the fieldbus object	xx number of the data set DSxx (→ Overview: acyclic data sets (DSx) (→ S. 152))
pDstBuf	pointer to the structure variable (e.g. arRxData) to which the read data set DSxx is written	address of the structure variable, e.g. ADR(arTxData)
cbBufLen	maximum size of the data buffer (number of the words)	depending on the command, e.g. 8

Example: Read list of projected slaves (LPS)**Task:** Read list of projected AS-i slaves on AS-i master 2**Solution:** Read acyclic data set DS10 of the device**Preparations**

- ▶ Create empty array for return values of the data set (e.g. arRxData):

Word	Value	Description
1	blank	user ID (UID)
2	blank	reflected command number
3	blank	command status
4	blank	command error code
5	blank	List of projected slaves (LPS): → Details of the slave lists
6	blank	
7	blank	
8	blank	



The words 1..4 contain the administration information of the command. The user data is stored as from the 5th word in the array. (→ Principle of the command channels)

1 Read data set

- ▶ Execute function block FB_EcCoESdoRead with the following input values:

Input	Value	Description
nNetId	depends on the project	AMS network ID of the EtherCAT master
nSlaveAddr	depends on the project	EtherCAT address of the device
nSubIndex	0x0A	subindex of the fieldbus object (number of the data set)
nIndex	0x2013	Index of the field bus object (read/write an acyclic data set)
pSrcBuf	ADR(arTxData)	address of the buffer storage for return values
cbBufLen	SIZEOF(arTxData)	Number of words to be transferred

2 Evaluate return values

- ▶ After faultless function block processing: Evaluate the command status (word 3) and command error code (word 4) in the buffer storage.
- > If successful: Words 5..8 of the buffer storage contain the list of projected slaves (LPS).

Use acyclic commands

Since request and response are paired, the following partial steps always have to be executed sequentially in the program code:

1. Send command to the device (write)
2. Check if command was successfully executed (read)
3. If successful receive the reply data (read)

To access the device command interface in reading or writing the user has to define the following inputs of the TwinCAT function blocks:

Input	Description	Possible values	
sNetId	AMS net ID of the EtherCAT master to which the device is connected	depends on the project e.g. 172.16.2.131.2.1	
nSlaveAddr	EtherCAT address of the device	depends on the project e.g. 1006	
nIndex	index of the field bus object	0x2010	System command
		0x2011	AS-i Master 1 command
		0x2012	AS-i Master 2 command
nSubIndex	subindex of the fieldbus object	0x01	command request
		0x02	status of the command execution
		0x03	command response
pDstBuf	pointer to the array to be sent/received	e.g. ADR(arTxData) (= address of the transmit buffer arTxData)	
cbBufLen	maximum size of the data buffer (number of the words)	depending on the command e.g. 8	

Example: Set the operating mode of AS-i master 2 to "Projection mode"**Task:** Set the operating mode of AS-i master 2 to "Projection mode"**Solution:** Execute command 0x0005**Preparations**

- ▶ Create data structure for values to be transferred to the device (arTxData):

Word	Value	Description
1	UID	User ID (value between 0 and 65535 to mark the request)
2	0x0005	Command number → Command 0x0005 – Change the operating mode of the AS-i master
3	0x0001	0x01 = projection mode

- ▶ Create empty data structure for status message of the command processing (bRxStatus)

Byte	Value	Description
1	blank	Status message of command processing (index 0x02)

- ▶ Create empty data structure for values of the command response (arRxData):

Word	Value	Description
1	blank	UID value between 0 and 65535 to mark the request
2	blank	reflected command number
3	blank	MSB = reserved, LSB = command status
4	blank	Command error code

1 Send command request to the device

- ▶ Execute function block FB_EcCoESdoWrite with the following input values:

Input	Value	Description
nNetId	depends on the project	AMS network ID of the EtherCAT master
nSlaveAddr	depends on the project	EtherCAT address of the device
nSubIndex	0x01	subindex of the fieldbus object (command request)
nIndex	0x2012	Index of the fieldbus object (AS-i Master 2 command)
pSrcBuf	ADR(arTxData)	address of the buffer storage with the data to be transmitted
cbBufLen	SIZEOF(arTxData)	Number of words to be transferred

2 Evaluate command status

- ▶ Execute function block FB_EcCoESdoRead with the following input values:

Input	Value	Description
nNetId	depends on the project	AMS network ID of the EtherCAT master
nSlaveAddr	depends on the project	EtherCAT address of the device
nSubIndex	0x02	subindex of the fieldbus object (status message)
nIndex	0x2012	Index of the fieldbus object (AS-i Master 2 command)
pSrcBuf	ADR(bRxStatus)	Buffer storage for data to be transmitted
cbBufLen	SIZEOF(bRxStatus)	Number of words to be transferred

- ▶ Evaluate the status of the command processing (bRxStatus).

3 Receive command response from the device

- ▶ After faultless function block processing: Execute function block FB_EcCoESdoRead with the following input values:

Input	Value	Description
nNetId	depends on the project	AMS network ID of the EtherCAT master
nSlaveAddr	depends on the project	EtherCAT address of the device
nSubIndex	0x03	subindex of the fieldbus object (command response)
nIndex	0x2012	Index of the fieldbus object (AS-i Master 2 command)
pSrcBuf	ADR(arRxData)	Buffer storage for data to be transmitted
cbBufLen	SIZEOF(arRxData)	Number of words to be transferred

- ▶ Evaluate the command status (word 3) and command error code (word 4) in the buffer storage.
- > If successful: AS-i Master 2 is in the projection mode.

Example: Read date / time / NTP settings

42891

Task: Read date / time / NTP settings of the device

Solution: Execute command 0x010B

Preparations

- ▶ Create data structure for values to be transferred to the device (arTxData):

Word	Value	Description
1	UID	User ID (value between 0 and 65535 to mark the request)
2	0x010B	Command number → Command 0x010B – Read date / time / NTP settings
3	0x4F42	Boot sequence 1 (0x4F = O, 0x42 = B)
4	0x544F	Boot sequence 2 (0x54 = T, 0x4F = O)

- ▶ Create empty data structure for status message of the command processing (bRxStatus)

Byte	Value	Description
1	blank	Status message of command processing (index 0x02)

- ▶ Create empty data structure for values of the command response (arRxData):

Word	Value	Description
1	blank	UID value between 0 and 65535 to mark the request
2	blank	reflected command number
3	blank	MSB = reserved, LSB = command status
4	blank	Command error code
5	blank	Date / time / NTP settings → Command 0x010B – Read date / time / NTP settings
...	...	
11	blank	

1 Send command request to the device

- ▶ Execute function block FB_EcCoESdoWrite with the following input values:

Input	Value	Description
nNetId	depends on the project	AMS network ID of the EtherCAT master
nSlaveAddr	depends on the project	EtherCAT address of the device
nSubIndex	0x01	subindex of the fieldbus object (command request)
nIndex	0x2010	Index of the fieldbus object (system command)
pSrcBuf	ADR(arTxData)	address of the buffer storage with the data to be transmitted
cbBufLen	SIZEOF(arTxData)	Number of words to be transferred

2 Evaluate command status

- ▶ Execute function block FB_EcCoESdoRead with the following input values:

Input	Value	Description
nNetId	depends on the project	AMS network ID of the EtherCAT master
nSlaveAddr	depends on the project	EtherCAT address of the device
nSubIndex	0x02	subindex of the fieldbus object (status message)
nIndex	0x2010	Index of the fieldbus object (system command)
pSrcBuf	ADR(bRxStatus)	Buffer storage for data to be transmitted
cbBufLen	SIZEOF(bRxStatus)	Number of words to be transferred

- ▶ Evaluate the status of the command processing (bRxStatus).

3 Command response received from the device

- ▶ After faultless command processing: Execute FB_EcCoESdoRead with the following input values:

Input	Value	Description
nNetId	depends on the project	AMS network ID of the EtherCAT master
nSlaveAddr	depends on the project	EtherCAT address of the device
nSubIndex	0x03	subindex of the fieldbus object (command response)
nIndex	0x2010	Index of the fieldbus object (system command)
pSrcBuf	ADR(arRxData)	Buffer storage for data to be transmitted
cbBufLen	SIZEOF(arRxData)	Number of words to be transferred

- ▶ Evaluate the command status (word 3) and command error code (word 4).
- > If successful: words 5...11 contain the date / time / NTP settings.

8.8 OSC messages

Content

OSC messages: System	164
OSC messages: AS-i 1 / AS-i 2.....	165

41730

This section contains information about the messages for events, warnings and faults of the AC1433/34.

8.8.1 OSC messages: System

41734

Message	Type	Corrective measures
An internal device error was detected <Fehlernummer>	Error	► Note the message and contact the ifm service center
Permitted temperature limit value inside the device was exceeded (<xxx.x> °C)	Warning	► Check thermal conditions of the system environment
First operation after delivery	Event	not necessary
The output control was set to <Gateway,manuell,PLC>	Event	not necessary
System power-up completed, <SW-Version>	Event	not necessary
A system reset was requested manually	Event	not necessary
The user-specific message history was deleted.	Event	not necessary
The device was reset to factory settings via <HMI, Feldbus>.	Event	not necessary
PLC used for more than 10 hours.	Event	not necessary
The project <Name> was loaded.	Event	not necessary
The PLC was set to the operating mode <Projektierungsmodus, geschützter Betrieb>.	Event	not necessary
The firmware was updated from <FW-Version> to version <FW-Version>.	Event	not necessary
The settings of the fieldbus interface were modified	Event	not necessary
The fieldbus connection was established	Event	not necessary
The fieldbus connection was aborted	Event	not necessary
The IP settings of the configuration interface were changed	Event	not necessary

8.8.2 OSC messages: AS-i 1 / AS-i 2

41735

Message	Type	Corrective measures
System errors: AS-i master <1,2>	Error	<ul style="list-style-type: none"> ▶ Reboot the device If the error occurs again: ▶ Note the message and contact the ifm service center!
Earth fault: AS-i <1,2>	Error	<ul style="list-style-type: none"> ▶ Check for earth fault of AC1433/34
Incorrect profile: AS-i <1,2>, slave <1(A)..31(A), 1B..31B> with profile <S-x.x.x> expected, but <S-y.y.y> found.	Error	<ul style="list-style-type: none"> ▶ Check profile of the AS-i slave
Config error: AS-i <1,2>, slave <1(A)..31(A), 1B..31B> with the profile <S-x.x.x> missing	Error	<ul style="list-style-type: none"> ▶ Check connections of the AS-i slave ▶ Reconnect AS-i slave
Config error: AS-i <1,2>, slave <1(A)..31(A), 1B..31B> with the profile <S-x.x.x> is available but not projected	Error	<ul style="list-style-type: none"> ▶ Carry out projection process ([Quick setup] > [Project all])
Protocol error: AS-i <1, 2>, slave <1(A)..31(A), 1B..31B> no data transmission	Error	<ul style="list-style-type: none"> ▶ Improve the transmission quality on the AS-i line
Double address detected: AS-i <1, 2>, slave <1(A)..31(A), 1B..31B>	Error	<ul style="list-style-type: none"> ▶ Remove an AS-i slave with a double address from the AS-i network ▶ Readdress the remaining AS-i slave ▶ Reconnect removed AS-i slave to the AS-i network
The automatic addressing is not activated for AS-i <1,2>.	Warning	<ul style="list-style-type: none"> ▶ Activate automatic addressing ([AS-i1]/[AS-i2] > [Master setup])
A voltage drop of 19.0 V was detected on AS-i master <1,2>	Warning	<ul style="list-style-type: none"> ▶ Check voltage supply of the device and replace if necessary
A voltage drop of 22.5 V was detected on AS-i master <1,2>	Warning	<ul style="list-style-type: none"> ▶ Check voltage supply of the device and replace if necessary
Increased message error rate: AS-i <1, 2>, slave <1(A)..31(A), 1B..31B>	Warning	<ul style="list-style-type: none"> ▶ Improve the transmission quality on the AS-i line
Peripheral fault: AS-i <1, 2>, slave <1(A)..31(A), 1B..31B>	Warning	<ul style="list-style-type: none"> ▶ Check displayed AS-i slave
AS-i slave with address 0 cannot be automatically readdressed (wrong profile)	Warning	<ul style="list-style-type: none"> ▶ Activate automatic addressing ([AS-i1]/[AS-i2] > [Master setup])
Manual output change: AS-i <1, 2>, slave <1(A)..31(A), 1B..31B>, value: <0..F, 0..32768>	Event	not necessary
Manual parameter change: AS-i <1, 2>, slave <1(A)..31(A), 1B..31B>, value: <0..F, 0..32768>	Event	not necessary
AS-i master <1,2> was switched to the <geschützten Betrieb, Projektierungsmodus>	Event	not necessary
AS-i projection process was carried out.	Event	not necessary
AS-i slave with the address 0 was detected	Event	not necessary

9 Index

A

Acyclic data.....	152
Additional functions.....	37
Address assignment in Ethernet networks.....	118
Adopt the system time of the PC.....	76
Analogue input.....	54
Analogue output.....	55
Appendix.....	115
Approval tests / certifications.....	115
Arrow and function keys.....	12
Arrow keys.....	15
AS-i 1 / AS-i 2.....	48
AS-i slaves.....	54
Diagnosis.....	52
Master setup.....	49
AS-i master.....	121
AS-i slaves.....	125

B

Behaviour of the settings upon firmware update.....	101
Binary field.....	31
Button.....	22

C

Carry out a projection adaptation.....	50
Change an AS-i slave address.....	58
Change an AS-i slave parameter output.....	58
Change the analogue output values manually.....	57
Change the basic settings of the device.....	99
Change the digital output values manually.....	56
Change the Extended ID1 of the AS-i slave.....	59
Checkbox.....	22
Clone device configuration.....	77
CODESYS PLC.....	12
Combined transaction – Use of analogue channels in the gateway depending on the slave profile.....	134
Configuration data (CDI) of the slaves (slave profiles).....	127
Configuration interfaces.....	
Connection concepts.....	119
Configure EtherCAT interface.....	105
Configure the EtherCAT interface.....	90
Configure the IP parameters automatically.....	84
Configure the IP parameters manually.....	84
Confirmation message.....	29
Connect and address AS-i slaves.....	105
Connect the device to the periphery.....	98
Connection via Ethernet network.....	120
Control a single PLC application.....	63
Control instance of the AS-i outputs.....	109
Control of the graphical user interface.....	14
Control PLC applications.....	64
Cyclic data.....	139

D

Description of the control elements.....	20
Description of the extended ID code 1.....	129
Description of the extended ID code 2.....	129

Description of the ID code (selection).....	128
Description of the IO code for digital slaves.....	128
Device-specific parameters.....	137
Diagnosis - AS-i diagnosis.....	148
Diagnosis - List of detected slaves (LDS).....	148
Diagnosis - List of double addressed slaves (LDAS).....	151
Diagnosis - List of missing slaves (LCMES).....	149
Diagnosis - List of non-projected slaves (LCAES).....	149
Diagnosis - List of peripheral faults (LPF).....	150
Diagnosis - List of slaves with wrong slave profile (LCE).....	150
Diagnosis - System diagnosis.....	147
Digital input.....	54
Digital output.....	55
Direct connection.....	119
Disconnect from web interface.....	35
Display.....	12
Display and reset performance data.....	53
Display and reset the error counters.....	52
Display diagnostic data.....	81, 91
Display elements.....	12, 116
Display EtherCAT parameters.....	88
Display information about PLC projects.....	62
Display the error statistics of the AS-i slaves.....	52
Display the input/output data of the AS-i slave.....	54
Display the module configuration.....	89
Display the status of the CODESYS PLC.....	62
Display the voltage supply analysis.....	53
Download ESI file.....	89

E

Enable/Disable the device-internal PLC.....	69
ESI file.....	138
EtherCAT.....	
Diagnosis.....	91
Error status.....	110
fieldbus status.....	109
Information.....	88
Setup.....	90
EtherCAT fieldbus interface.....	13
EtherCAT interface.....	98
EtherCAT projection software.....	
Programmers' notes.....	157
Ethernet configuration interfaces.....	13, 98
Example.....	17
Read date / time / NTP settings.....	163
Read list of projected slaves (LPS).....	160
Set the operating mode of AS-i master 2 to.....	162
Exchange AS-i slave.....	105
Explanation of Symbols.....	6
Export device configuration.....	78
Extended ID code 2 for analogue slaves with profile 7.3.x.....	129
Extended ID code 2 for analogue slaves with profile 7.4.x.....	129

F

Fieldbus EtherCAT.....	136
Fieldbus objects.....	152
Fieldbus parameters.....	137
Firmware update from SD card.....	102
Firmware update via the web interface.....	103
Free slave addresses.....	
colour code + symbols.....	28

Function keys.....	15	Operation	14, 116
G		Optional	
General.....	32	adjust the IP parameters.....	103
General safety instructions.....	8	switch the language with a key combination	71
H		OSC	
Housing.....	116	Show message history.....	114
I		View current error messages.....	113
ifm system solutions	92	OSC messages.....	165
Import device configuration	79	AS-i 1 / AS-i 2.....	166
Information concerning the device	11	System.....	165
Install multi app.....	96	Overview.....	11
Install single/basic app	95	acyclic data sets (DSx).....	153
Integrate the device into a TwinCAT project	157	AS-i master commands.....	155
Intended use.....	10	EtherCAT modules.....	139
Interface.....	117	System commands.....	154
Interfaces.....	13, 82	User documentation for AC1433/34	7
Configuration interface 1.....	83	Overview of free slave addresses	27
Configuration interface 2.....	86	Overview of slave states.....	25
EtherCAT interface.....	87	P	
L		Page view	19
Legal and copyright information	5	Parameter data.....	137
List	23	Parameter input.....	55
Locate error sources.....	111	Permitted use.....	10
M		PLC	
Mapping		Diagnosis.....	66
digital input / output data (TxPDO/RxPDO).....	142	Information.....	62
master flags	142	Settings.....	63
Master flags	124	Power supply connections.....	116
Meaning of the colour combinations.....	28	Preliminary note.....	5
Meaning of the colour combinations (example		Preparations	102, 103
configuration error type 2).....	26	Profiles of AS-i slaves.....	126
Menu.....	36	Programmable Logic Controller (PLC).....	117
Menu functions	37	Prohibited use.....	10
Menu navigation	16	Projection mode.....	122
Menu view.....	16	Protected mode	122
Message types.....	111	Purpose of the document	5
Modification history.....	7	Q	
Module		Quick setup.....	38
AC1433 diagnostics	146	Access the device via QR code	41
AC1434 diagnostics	147	Address the AS-i slaves connected to AS-i Master 1.....	46
N		Address the AS-i slaves connected to AS-i Master 2.....	47
Navigate on a page.....	19	Configure the EtherCAT interface.....	41
Navigation aids	17	Configure the operating mode of the AS-i masters.....	40
Notes on ifm system solutions.....	93	Configure the output access	41
Notes on IP settings.....	83	Project AS-i networks.....	39
Numerical field	30	Set the Configuration interface 1	43
O		Set the configuration interface 2	45
Online diagnosis function	111	R	
Online Support Center (OSC).....	112	Read acyclic data records.....	159
Operating elements	12	Read cyclical data.....	158
Operating instructions.....	33	Reboot the device.....	102, 104
Operating mode of the AS-i master.....	109	Recommended browsers.....	32
Operating modes of the AS-i master.....	122	Remote access.....	32
		Required accessories.....	13
		Required background knowledge.....	8
		S	
		Safety instructions	8
		SD card slot	13

Set Ethernet configuration interfaces	105	Update the firmware	102, 104
Set the behaviour of the display	72	Update the firmware of the device.....	101
Set the device cycle.....	70	Use acyclic commands.....	161
Set the monitoring functions of the AS-i master.....	51	Use acyclic services	158
Set the operating mode of the AS-i master	49	Use navigation aids	19
Set the output access	68	V	
Set the system time	73	Valid combinations IO code / ID code / extended ID code 2.....	130
Set the system time manually.....	74	W	
Setup.....	98	Web interface	
Show AS-i slave information.....	57	Access	33
Show Ethernet information	85	Navigation.....	33
Show information	88	Password protection	34
Show information about installed ifm apps.....	94	Web interface login.....	34
Show memory used.....	66		
Show target visualisation	65		
Show version information	67		
Slave profiles for slaves with combined transaction	133		
Slave selector	24		
Slave status			
colour code + symbols	26		
Slot 1 – Digital inputs/outputs of the single/A slaves to AS-i Master	1140		
Slot 2 – Digital inputs/outputs of the single/A slaves to AS-i Master	2140		
Slot 3 – Digital inputs/outputs of the B slaves to AS-i Master 1	141		
Slot 4 – Digital inputs/outputs of the B slaves to AS-i Master 2.....	141		
Slot 5 ... 66 – Analogue slaves to AS-i Master 1 and AS-i Master 2..	143		
Slot 67 – Inputs of AC14 PLC.....	144		
Slot 68 – Outputs to AC14 PLC.....	145		
Slot 69 – Diagnostic data.....	146		
Start screen	36		
Status LEDs.....	109		
Start screen 'Basic settings'.....	99		
Start the recovery mode	102, 103		
Status LED.....	107		
Basic device	107		
Configuration interface 2 (X8).....	108		
Fieldbus EtherCAT	107		
Status LEDs.....	12		
Status of the web interface	109		
Store diagnostic protocol	80		
Structure of the slave profile.....	127		
Switch operating modes	123		
Switch the menu language	71		
Synchronise the system time with an NTP server.....	75		
System.....	60		
Diagnosis.....	81		
Information.....	67		
Programmable Logic Controller (PLC)	61		
Setup	68		
System description	9		
System reset.....	80		
T			
Tab menu/Tab	21		
Tampering with the unit.....	8		
Technical data	116		
Troubleshooting	107		
Types of ifm system solutions	93		
U			
Uninstall ifm apps	97		
Update ifm apps.....	97		