



OLYMPIA, WASHINGTON

REQUEST FOR BIDS
BUS STOP PAD CONSTRUCTION AND IMPROVEMENTS
PROJECT #2003C

REQUEST FOR BIDS (RFB) RELEASE DATE:

July 13, 2020

**DEADLINE FOR REQUEST FOR CLARIFICATIONS
OR APPROVED EQUALS:**

Date: July 23, 2020

Time: 11:00 a.m. (PST)

BID OPENING:

Date: July 30, 2020

Time: 11:00 a.m. (PST)

Location: 526 Pattison Street, SE
Olympia, WA 98501

CONTACT PERSON:

Tammy Ferris, Procurement Coordinator
(360) 705-5818

tferris@intercitytransit.com

NOTICE TO BIDDERS
REQUEST FOR BIDS (RFB)
BUS STOP PAD CONSTRUCTION AND IMPROVEMENTS
PROJECT #2003C

Intercity Transit, the public transportation provider in Thurston County, Washington, is requesting bids for the Bus Stop Pad Construction and Improvements Project #2003C. This Contract provides for the construction of fourteen (14) bus stop pads located at various sites throughout the City of Lacey and Thurston County. The project consists of, but is not limited to, excavation and removal items, installation of curb and gutter, sidewalk, concrete bus stop pads, traffic control, erosion control measures, construction survey, and all other work described in the Plans and Specifications.

The Engineer's Estimate is \$60,000 to \$80,000. This project does not have Federal funding.

Contract documents and planholder's list are available through Builders Exchange of Washington, Inc. at <http://www.bxwa.com>.

Submittal Time/Date/Location: Sealed bids are due prior to 11:00 a.m., (PST) on July 30, 2020. Enclose the Bid Submittal in a sealed envelope or container labeled as follows:

- **Mail in and received prior to 11:00 a.m. July 30, 2020:**

Intercity Transit
Attn: Tammy Ferris
526 Pattison Street, SE
Olympia, WA 98501

BID – DO NOT OPEN
Bus Stop Pad Construction and Improvements–Project #2003C

- **Hand-deliver only between the hours of 9:00 a.m. and prior to 11:00 a.m., July 30, 2020:**

Intercity Transit
Attn: Tammy Ferris
526 Pattison Street, SE
Olympia, WA 98501

BID – DO NOT OPEN
Bus Stop Pad Construction and Improvements–Project #2003C

The sealed bids will be publicly opened and read at 11:00 a.m., on July 30, 2020, outside and under the covered canopy of Intercity Transit's Administration Building to allow for safe social distancing.

Please contact Tammy Ferris, Procurement Coordinator, by phone at (360) 705-5818 or email at tferris@intercitytransit.com with any questions regarding this solicitation.

PUBLISHED IN: The Olympian
 Daily Journal of Commerce
 Builder's Exchange of Washington (BXWA)
 Office of Minority and Women's Business Enterprises (OMWBE)

Project Engineer Certification

For Construction of:

**Bus Stop Pad Construction and Improvements
Project #2003C**

As the Engineer in direct responsible charge of developing these contract provisions, I certify these provisions have been developed or incorporated into this project under my supervision.



Brad Shea, P.E.
Project Engineer

TABLE OF CONTENTS

SECTION 1 – GENERAL INFORMATION.....	5
1.1 PURPOSE.....	5
1.2 SCOPE OF WORK.....	5
1.3 DELIVERABLES.....	5
1.4 AWARD.....	5
1.5 CONTACT INFORMATION.....	5
1.6 PROCUREMENT SCHEDULE.....	5
1.7 EXAMINATION OF DOCUMENTS.....	6
1.8 BIDDER QUESTIONS AND REQUESTS FOR CLARIFICATIONS.....	6
1.9 ORAL AGREEMENTS.....	6
1.10 REQUEST FOR APPROVED EQUALS.....	6
1.11 WAGES AND LABOR PROVISIONS.....	7
1.12 RETAINAGE.....	7
1.13 PERMITS AND LICENSES.....	7
1.14 GUARANTEE OF WORK.....	8
1.15 SOLICITATION STANDARDS.....	8
1.16 CONTRACT TERMS.....	8
1.17 INCORPORATION OF DOCUMENTS INTO CONTRACT.....	8
1.18 PROTECTION OF PROPERTY.....	8
1.19 LIENS PROHIBITED.....	9
SECTION 2 – BID SUBMITTAL.....	10
2.1 BID SUBMITTAL REQUIREMENTS.....	10
2.2 SUBMITTAL INSTRUCTIONS.....	12
2.3 LATE BIDS.....	13
2.4 BID OPENING.....	13
2.5 PROGRESS AND COMPLETION.....	13
2.6 BIDDER RESPONSIVENESS.....	13
2.7 BID EVALUATION AND AWARD.....	13
SECTION 4 – SPECIAL PROVISIONS.....	15
APPENDIX A BID SUBMITTAL DOCUMENT.....	71
APPENDIX B SOLICITATION STANDARDS.....	84
APPENDIX C SAMPLE CONTRACT.....	91
APPENDIX D PAYMENT BOND.....	108
APPENDIX E PERFORMANCE BOND.....	111
APPENDIX F CONTRACTOR’S REQUIREMENTS FOR WORKING IN THE ROW.....	113
ATTACHMENT A WAGE RATES.....	118
ATTACHMENT B PLANS.....	

SECTION 1 – GENERAL INFORMATION

1.1 PURPOSE

Intercity Transit (Transit), the public transportation provider in Thurston County, Washington, is requesting bids for the Bus Stop Pad Construction and Improvements Project #2003C.

1.2 SCOPE OF WORK

This Contract provides for the construction of fourteen (14) bus stop pads located at various sites throughout the City of Lacey. The project consists of, but is not limited to, excavation and removal items, installation of curb and gutter, sidewalk, concrete bus stop pads, traffic control, erosion control measures, construction survey, and all other work described in the Plans and Specifications.

The Engineer’s Estimate is \$60,000 to \$80,000.

1.3 DELIVERABLES

All deliverables provided by the awarded Contractor as a result of this solicitation are subject to Transit’s approval and acceptance.

1.4 AWARD

Transit intends to award a firm-fixed Contract to the responsive responsible Bidder whose Bid meets all RFB requirements and is determined the most advantageous to Transit.

Transit does not represent or guarantee any minimum purchase. This Solicitation does not obligate Transit to contract for the goods and/or services specified herein. Transit reserves the right to add, remove, or otherwise modify requirements to meet the operational and strategic objectives of the agency.

1.5 CONTACT INFORMATION

Until a Contract is awarded, the Bid submittal documents and any other communications concerning the project or the Request for Bids (RFB) must be addressed to:

Procurement Coordinator: Tammy Ferris
Email Address: tferris@intercitytransit.com
Address: Intercity Transit
526 Pattison Street, SE
Olympia, WA 98501

1.6 PROCUREMENT SCHEDULE

The schedule below outlines key action dates and times (if applicable). Transit reserves the right to change the schedule.

RFB #2003C Schedule	Date and Time (Pacific Time)
RFB Release	July 13, 2020
Request for Clarifications or Approved Equals Due	July 23, 2020 @ 11:00 a.m.
Bid Opening	July 30, 2020 @ 11:00 a.m.

1.7 EXAMINATION OF DOCUMENTS

Bidders must thoroughly examine and be familiar with the bid documents, including but not limited to, the Solicitation, Technical Specifications, Contract, Drawings, Addenda (if any), and any other material referenced or incorporated herein. Submission of a bid constitutes acknowledgment upon which Transit may rely that the Bidder has thoroughly examined and is familiar with the Bid Documents.

Bidder's failure or neglect to receive or examine any of the Contract Documents, statutes, ordinances, regulations and permits will in no way relieve the Bidder from any obligations with respect to the Bid or any resulting Contract.

Transit will reject claims for additional compensation based upon a lack of knowledge or misunderstanding of any of the Contract Documents, referenced materials, statutes, ordinances, regulations, permit requirements, or other materials referenced or incorporated in this RFB.

1.8 BIDDER QUESTIONS AND REQUESTS FOR CLARIFICATIONS

Bidder questions and/or requests for clarification shall be submitted in writing via email to the Procurement Coordinator. Bidders shall submit questions or requests for clarifications by the deadline listed in the Procurement Schedule.

Transit will respond to all requests for clarifications and questions in writing. If necessary, Transit will issue an Addendum to the solicitation which identifies any changes to the Contract Document. Transit reserves the right to accept or reject any request for changes.

Bidders shall not rely on any oral statements or conversations, whether at the Pre-Bid meeting or otherwise, with Transit representatives for questions or clarifications regarding this RFB. Verbal responses to questions and/or clarifications will be considered unofficial and non-binding. Only written responses posted to BXWA in the form of an addendum will be considered official and binding. All such Addenda will become part of the Solicitation and any awarded Contract.

If no requests for clarifications are received, Transit will construe that the Bidder intends to comply with the document in its entirety.

1.9 ORAL AGREEMENTS

No oral agreement or conversation with any officer, agent, or employee of Transit, either before or after execution of the contract, shall affect or modify any of the terms or obligations contained in any of the documents comprising the contract. Such oral agreement or conversation shall be considered as unofficial information and in no way binding upon Transit, unless subsequently put in writing and signed by the Transit.

1.10 REQUEST FOR APPROVED EQUALS

Bidders shall submit any and all Requests for Approved Equals no later than the time and date identified in the Procurement Schedule. All Requests for Approved Equals shall be submitted in writing via email to the Procurement Coordinator.

Transit shall review all requests for approved equals and if necessary, shall issue Addenda to the solicitation which identifies all approved or disapproved requests. Bidders shall provide adequate technical information for any request for approved equal to allow Transit to make a technical decision of whether to accept or deny. Failure to do so may allow

Transit to deny requests. It is Transit's sole discretion to accept or reject any request for approved equals. Bidders shall not rely upon any oral statements or conversations, whether at the pre-bid conference or otherwise, they may have with representatives of Transit regarding approved equals or deviations or Contract Documents.

If no request for approved equal or deviation is received in a timely manner, it shall be construed to mean that the Bidder intends to fully comply with all Scope of Work and Specifications listed herein.

1.11 WAGES AND LABOR PROVISIONS

This Contract is subject to Chapters 39.12 RCW, and amendments and regulations issued thereunder, relating to state of Washington prevailing wages, benefits, and other requirements. The Contractor, each Subcontractor and other person doing any work under this Contract shall pay laborers, workmen or mechanics not less than the prevailing rate of wage for an hours work in the same trade or occupation in the locality within the state of Washington where such labor is performed.

The Contractor must comply with State or applicable Federal determinations. In the event of a discrepancy between Federal and State rates and requirements, the Contractor, each Subcontractor and other person, as applicable, will comply with the higher rates and more stringent requirements. The cost of such compliance shall be deemed included in the Contract Price. No claim for additional compensation due to lack of knowledge, misinterpretation of requirements, or failure to include adequate wage increases in Bid pricing will be allowed.

The Contractor is responsible to ensure proper wages are paid and the appropriate documentation is submitted to Transit. Wages and benefits higher than the minimums required by law may be paid. In the event wage rates and benefits change during the Contract term, the Contractor will bear the cost of changes and will not have any claim against Transit on account of such changes.

Contractor, each subcontractor, and other person required to pay the prevailing rate of wage shall post in a location(s) readily visible to workers at the job site: (1) a copy of the statement of intent to pay prevailing wages approved by the industrial statistician of the Department of Labor and Industries under RCW 39.12.040; and (2) the address and telephone number of the industrial statistician of the Department of Labor and Industries where a complaint or inquiry concerning prevailing rates may be made.

Wage Rates are included in Attachment A.

1.12 RETAINAGE

In accordance with RCW 60.28.011, Transit will retain five (5) percent of each invoice or pay request. Unless the Contractor pre-arranges otherwise, retained amounts will be remitted to the Contractor upon receipt of a certified copy of Affidavits of Wages Paid for the Contractor and each subcontractor, final acceptance by Transit of work performed, receipt of all necessary releases, and after any other requirements are met.

1.13 PERMITS AND LICENSES

In order to perform work on these sites, the Contractor must comply with the requirements of the applicable permitting agency as it relates to bonding, insurance, and business licensing. These requirements are set forth by the City of Lacey and City of Olympia. The Contractor will be responsible for City of Olympia Bonding requirements for work in the

ROW. The City of Olympia's Contractor Requirements for Working in the Right-of-Way is included in Appendix F. Transit will pay all permit/building fees.

It is the Contractor's responsibility to obtain, or retain in good standing, all required trade and business licenses and documentation throughout the duration of the project.

1.14 GUARANTEE OF WORK

The Contractor warrants and guarantees to Transit that all work for this project shall be in accordance with the Contract Documents and will not be defective. The warranty shall survive termination of this Contract. Conducting of tests and inspections, review of specifications or plans, payment of goods or services, or acceptance by Transit does not constitute waiver, modification or exclusion of any express or implied warranty or any right under this Contract or law.

Transit will give notice of all defects to the Contractor for correction. The Contractor shall, at its sole cost and expense, remedy any defects in the work performed in execution of the Contract. The Contractor shall guarantee against failure due to defective materials or workmanship for a period of one (1) year from the date of Final Acceptance of the work completed for this project unless a longer period is specified elsewhere. The Contractor shall defend, hold harmless and indemnify Transit for any claims made as well as claims paid pertaining to defects in workmanship and material.

1.15 SOLICITATION STANDARDS

The Solicitation Standards document has been included in [Appendix B](#).

This document contains important information for Bidders applicable to this Solicitation. The terms and conditions provided in the Solicitation Standards document apply directly to, and are incorporated by reference, into this Solicitation and the Contract resulting from this Solicitation. As such, Bidders do not need to attach this document with their Bid. It is the Bidder's responsibility to read and fully understand the details of all items contained herein prior to Bid submittal.

1.16 CONTRACT TERMS

A Sample Contract is included in [Appendix C](#). Transit expects the final Contract signed by the successful Bidder to be substantially the same as the Sample Contract. Bidder's submission of a response to this Solicitation constitutes general acceptance of these Contract requirements.

The foregoing should not be interpreted to prohibit either party from proposing additional Contract terms and conditions during negotiation of the final Contract.

1.17 INCORPORATION OF DOCUMENTS INTO CONTRACT

A Bid submitted in response to this Solicitation is an offer to contract with Transit. This Solicitation document, all incorporated documents, any subsequent Amendments and/or Addenda, and the successful Bidder's Response will be incorporated into the resulting Contract.

1.18 PROTECTION OF PROPERTY

In addition to the requirements set forth elsewhere in the Contract Documents, the Contractor shall protect all public and private property, insofar as it may be endangered by the Contractor's operations, and take every reasonable precaution to avoid damage to such property.

The Contractor shall restore and bear the cost of restoration of any public or private improvement, facility, structure or land and landscaping inside or outside of the right-of-way or easement, which is damaged or injured directly or indirectly by or on account of an act, omission, or neglect in the execution of the work. If this is not feasible, make a suitable settlement with the owner of the damaged property. All restoration shall be governed by the requirements of local authorities, including but not limited to local codes, standards, and permit conditions.

Should the Contractor fail to repair damage to such property determined to have been caused by their work, Transit reserves the right to retain another Contractor of their choosing to repair the damage to equally or better. The cost incurred by Transit will be reduced from the Contractor's Pay Estimate. If the Contractor disputes the determination for cause, the Contractor shall have the right to file a claim and resolve the issue in accordance with the Contract Documents.

1.19 LIENS PROHIBITED

The Contractor shall not permit any lien or claim to be filed or prosecuted against Transit, its property or its right-of-way on account of any labor or material furnished or any other reason for work arising out of this Contract. If any lien shall be filed, the Contractor shall satisfy, discharge and extinguish or cause such lien to be satisfied, discharged and extinguished immediately, including at Transit's option obtaining a court order extinguishing the lien, as a condition precedent to final payment.

SECTION 2 – BID SUBMITTAL

2.1 BID SUBMITTAL REQUIREMENTS

Bidder must complete and provide the following information in the Bid Submittal Document of [Appendix A](#). Failure to complete and submit all items listed in this section may disqualify the Bidder from further participation in this RFB:

1. Bidder Acknowledgements

The Bidder Acknowledgements must be signed by the Bidder's Authorized Official. Bidder must complete the acknowledgement of Addenda receipt box(es) by filling in the Addenda number fields for each Addenda issued, and complete the signature box information on the Bidder Acknowledgements page.

2. Bidder Information

Bidder must complete the Bidder Profile, Bidder's Authorized Representative, Bidder Qualifications, and Certified DBE and SBE Status sections.

3. Bid Guaranty Bond

The Bid must be accompanied by a Bid Guaranty Bond, using the form provided in the Bid Submittal Document, or a form containing provisions substantially similar to those in the Transit's form. The form must be duly completed by (i) a guaranty company authorized to conduct business in Washington State, or, (ii) a certified or cashier's check, payable to Intercity Transit in an amount not less than five (5) percent of the base Bid, drawn upon a banking institution with a branch office in Washington State. The signing Surety must be registered with the Washington State Insurance Commissioner. The Surety's name shall appear in the current Washington State Authorized Insurance Company List published by the Office of the Insurance Commissioner. Failure to furnish a bid guarantee in the proper form and amount, by the time set for opening of bids, may be cause for rejection of bid.

The amount payable to Transit under the Bid Guaranty Bond, or the certified or cashier's check and the amount thereof, will be forfeited to Transit in the event that the Bidder fails or neglects to furnish, execute and deliver the required performance bond and evidences of insurance, and enter into, execute and deliver the agreement on the form provided in the Contract Documents to Transit within ten (10) calendar days after being notified in writing by Transit that the award has been made to and the agreement is ready for execution by the Bidder.

4. Subcontractor Information

Bidder is instructed to complete the Subcontractor Information section if the Bidder intends on utilizing Subcontractors. If Bidder does not intend to use Subcontractors, the Bidder is not required to complete this section of the Bid Submittal Document. If no information is entered, Transit will assume that Subcontractors will not be used.

Transit will accept Bids that include third party involvement only if the Bidder submitting the Bid agrees to take complete responsibility for all actions of such Subcontractors. Bidder must disclose the use of any Subcontractor(s) in their Bid.

If applicable, Bidder will identify all Subcontractors who will perform services in fulfillment of Contract requirements, including their name, the nature of services to be performed, address, telephone, email, federal tax identification number (TIN), Washington State

Unified Business Identifier (UBI), and DBE or SBE certification status. Transit reserves the right to approve or reject any and all Subcontractors that Bidder proposes.

Any Subcontractors not listed in the Bidder's Response, who are engaged after award of the Contract, must be pre-approved, in writing, by Transit before providing services under the Contract.

In accordance with RCW 39.06, a Public Works Contractor must verify responsibility criteria for each first tier Subcontractor, and a Subcontractor of any tier that hires other Subcontractors must verify responsibility criteria for each of its Subcontractors. Verification shall include that each Subcontractor, at the time of subcontract execution, meets the responsibility criteria outlined above and possesses appropriate licenses as required by RCW. This verification requirement, as well as the responsibility criteria, must be included in all Public Works Contract and subcontract of every tier. This shall in no way release the Contractor from its obligations under the Contract and Contract Documents. The Contractor shall be fully responsible to Transit for the acts and omissions of its Subcontractors. Nothing contained herein shall create any contractual relationship between Transit and any Subcontractor.

5. References

Bidder shall submit a **minimum of three (3)** references for which the Bidder has provided services similar to those described herein.

Through this submission, Bidder grants permission to Transit to independently contact the references. Transit reserves the right to obtain and consider information from other sources concerning a Bidder, such as Bidder's capability and performance under other contracts, Bidder's financial stability, past or pending litigation, and other publicly available information.

6. Bid Form

Bidder must complete and submit the Bid Pricing Section and Bidder's Signature. Bidder may attach additional sheets if necessary.

Prices will be in U.S. dollars. Bidders will extend unit pricing as required. In the event of an error in the extension of prices, the unit price will prevail. All Bid prices will remain firm for a minimum of sixty (60) Calendar Days from the Bid due date.

Bid prices will include everything necessary for the procurement of the Contract, execution and completion of the work, and fulfillment of the Contract. This includes but is not limited to, furnishing of all materials, delivery costs, equipment, tools, labor and services, Bid preparation costs, Contract management costs and administrative costs, except as may be provided otherwise in the Contract Documents

All applicable taxes which the Contractor is required to pay, including retail sales or use taxes, must be included in the Bidder's proposed price(s) for the work under the Contract. No adjustments will be made in the amount to be paid by Transit under the Contract due to any misunderstanding by or lack of knowledge of the Bidder as to liability for, or the amount of, any taxes for which the Bidder is liable or responsible by law or under the Contract or because of any increases in tax rates imposed by any Federal, State or local government.

No payments in advance or in anticipation of goods or services to be provided under any resulting Contract will be made. Contractor will only be compensated for performance delivered and accepted by Transit.

7. Certification Regarding Debarment, Suspension, and other Responsibility Matters

Bidder must complete and submit the Certification Regarding Debarment, Suspension and Other Responsibility Matters. This form must be completed and signed by the Bidder's Authorized Official.

8. Non-Collusion Affidavit

Bidder must complete and sign the Non-Collusion Affidavit. The form must be signed by the Bidder's Authorized Official.

2.2 SUBMITTAL INSTRUCTIONS

Bidder will submit their complete Bid in the following manner:

A. Bid: Bidder must complete and submit all sections of the Bid Submittal Document, located in [Appendix A](#), as their Bid. Bid Submittal must be received by Intercity Transit on or before the **Bid Due Date and Time** set forth in the Procurement Schedule.

B. Delivery of Bid: The Bid must be delivered as follows:

1. Enclose the Bid Submittal in a sealed envelope or container labeled as follows:

▪ **Mail in and received prior to 11:00 a.m. July 30, 2020:**

Intercity Transit
Attn: Tammy Ferris
526 Pattison Street, SE
Olympia, WA 98501

BID – DO NOT OPEN
Bus Stop Pad Construction and Improvements–Project #2003C

▪ **Hand-deliver only between the hours of 9:00 a.m. and prior to 11:00 a.m., July 30, 2020:**

Intercity Transit
Attn: Tammy Ferris
526 Pattison Street, SE
Olympia, WA 98501

BID – DO NOT OPEN
Bus Stop Pad Construction and Improvements–Project #2003C

C. Time of Receipt: Submit bid by the submittal deadline as specified in the Procurement Schedule to Intercity Transit at 526 Pattison Street, SE, Olympia, WA 98501. The telephone number for shipping purposes is (360) 786-1881.

No oral, faxed, e-mailed or telephone Bids or modifications will be accepted or considered. All Bids and any accompanying documentation become the property of Transit and will not be returned.

2.3 LATE BIDS

Any Bid received after the exact time specified for Bid due date and time will not be accepted or receive consideration by Transit and returned unopened. The exact time is designated as the time displayed on the Transit's Receptionist clock. Bidder accepts all risks of late delivery regardless of fault or chosen method of delivery.

2.4 BID OPENING

Transit will publicly open and read Bids outside and under the covered canopy of Intercity Transit's Administrative Building (526 Pattison Street, SE, Olympia, WA) as specified in the Procurement Schedule. Any time following the public bid opening, Bidders may obtain a list of Bidders. Contact the Procurement Coordinator for requests for all other information related to this Solicitation.

Transit reserves the right to postpone the date and time of bid opening at any time prior to the date and time established herein.

2.5 PROGRESS AND COMPLETION

Progress and completion of the work must comply with all stated requirements. The submission of a Bid shall constitute the Bidder's acknowledgment that timely progress and completion requirements are accounted for in the Bidder's pricing.

2.6 BIDDER RESPONSIVENESS

Bidder must respond to the requirements contained in this RFB. Failure to demonstrate to Transit compliance with RFB requirements and/or comply with any applicable item may result in the Response being deemed non-responsive and disqualified from further consideration.

Transit, at its sole discretion, reserves the right to consider the actual level of Bidder's compliance with Solicitation requirements, accept or reject any and all Bids received, waive any irregularities or minor informalities, to accept any items or combination of items, and to request additional information required to fully evaluate a Bid.

2.7 BID EVALUATION AND AWARD

Bids will be evaluated by Transit to determine the lowest responsive responsible Bidder and which Bid, if any, should be accepted by Transit. Transit in its sole discretion reserves the right, but without obligation, to waive informalities and irregularities.

1. Responsiveness. Transit will consider all the material submitted by the Bidder to determine whether the Bidder's offering is in compliance with the Bid documents.
2. Responsibility. Transit will consider all material submitted by the Bidder, and evidence it may obtain otherwise, to determine whether the Bidder, its key personnel, and proposed Subcontractors have the qualifications and experience to successfully fulfill the Contract obligations.
3. Price. The lowest bid price(s) offered for the goods and services listed.

Within five (5) calendar days after the opening of Bids, Transit will either accept a Bid, reject all Bids, or take such other action as may be in its best interest. Transit reserves the right to request extension of the Bid acceptance period. The acceptance of a Bid will be evidenced by a written notice of award of Contract.

SECTION 4 – SPECIAL PROVISIONS

INTRODUCTION TO THE SPECIAL PROVISIONS

(August 14, 2013 APWA GSP)

The work on this project shall be accomplished in accordance with the *Standard Specifications for Road, Bridge and Municipal Construction*, 2020 edition, as issued by the Washington State Department of Transportation (WSDOT) and the American Public Works Association (APWA), Washington State Chapter (hereafter “Standard Specifications”). The Standard Specifications, as modified or supplemented by the Amendments to the Standard Specifications and these Special Provisions, all of which are made a part of the Contract Documents, shall govern all of the Work.

These Special Provisions are made up of both General Special Provisions (GSPs) from various sources, which may have project-specific fill-ins; and project-specific Special Provisions. Each Provision either supplements, modifies, or replaces the comparable Standard Specification, or is a new Provision. The deletion, amendment, alteration, or addition to any subsection or portion of the Standard Specifications is meant to pertain only to that particular portion of the section, and in no way should it be interpreted that the balance of the section does not apply.

The project-specific Special Provisions are not labeled as such. The GSPs are labeled under the headers of each GSP, with the effective date of the GSP and its source. For example:

(March 8, 2013 APWA GSP)

(April 1, 2013 WSDOT GSP)

*(****, PROJECT GSP)*

Also incorporated into the Contract Documents by reference are:

- *Manual on Uniform Traffic Control Devices for Streets and Highways*, currently adopted edition, with Washington State modifications, if any
- *Standard Plans for Road, Bridge and Municipal Construction*, WSDOT/APWA, current edition

Contractor shall obtain copies of these publications, at Contractor’s own expense.

Division 1 General Requirements

1-01 DEFINITIONS AND TERMS

1-01.3 Definitions

(January 4, 2016 APWA GSP)

Delete the heading **Completion Dates** and the three paragraphs that follow it, and replace them with the following:

Dates

Bid Opening Date

The date on which the Contracting Agency publicly opens and reads the Bids.

Award Date

The date of the formal decision of the Contracting Agency to accept the lowest responsible and responsive Bidder for the Work.

Contract Execution Date

The date the Contracting Agency officially binds the Agency to the Contract.

Notice to Proceed Date

The date stated in the Notice to Proceed on which the Contract time begins.

Substantial Completion Date

The day the Engineer determines the Contracting Agency has full and unrestricted use and benefit of the facilities, both from the operational and safety standpoint, any remaining traffic disruptions will be rare and brief, and only minor incidental work, replacement of temporary substitute facilities, plant establishment periods, or correction or repair remains for the Physical Completion of the total Contract.

Physical Completion Date

The day all of the Work is physically completed on the project. All documentation required by the Contract and required by law does not necessarily need to be furnished by the Contractor by this date.

Completion Date

The day all the Work specified in the Contract is completed and all the obligations of the Contractor under the contract are fulfilled by the Contractor. All documentation required by the Contract and required by law must be furnished by the Contractor before establishment of this date.

Final Acceptance Date

The date on which the Contracting Agency accepts the Work as complete.

Supplement this Section with the following:

All references in the Standard Specifications, Amendments, or WSDOT General Special Provisions, to the terms "Department of Transportation", "Washington State Transportation Commission", "Commission", "Secretary of Transportation", "Secretary", "Headquarters", and "State Treasurer" shall be revised to read "Contracting Agency".

All references to the terms “State” or “state” shall be revised to read “Contracting Agency” unless the reference is to an administrative agency of the State of Washington, a State statute or regulation, or the context reasonably indicates otherwise.

All references to “State Materials Laboratory” shall be revised to read “Contracting Agency designated location”.

All references to “final contract voucher certification” shall be interpreted to mean the Contracting Agency form(s) by which final payment is authorized, and final completion and acceptance granted.

Additive

A supplemental unit of work or group of bid items, identified separately in the Bid Proposal, which may, at the discretion of the Contracting Agency, be awarded in addition to the base bid.

Alternate

One of two or more units of work or groups of bid items, identified separately in the Bid Proposal, from which the Contracting Agency may make a choice between different methods or material of construction for performing the same work.

Business Day

A business day is any day from Monday through Friday except holidays as listed in Section 1-08.5.

Contract Bond

The definition in the Standard Specifications for “Contract Bond” applies to whatever bond form(s) are required by the Contract Documents, which may be a combination of a Payment Bond and a Performance Bond.

Contract Documents

See definition for “Contract”.

Contract Time

The period of time established by the terms and conditions of the Contract within which the Work must be physically completed.

Notice of Award

The written notice from the Contracting Agency to the successful Bidder signifying the Contracting Agency’s acceptance of the Bid Proposal.

Notice to Proceed

The written notice from the Contracting Agency or Engineer to the Contractor authorizing and directing the Contractor to proceed with the Work and establishing the date on which the Contract time begins.

Traffic

Both vehicular and non-vehicular traffic, such as pedestrians, bicyclists, wheelchairs, and equestrian traffic.

1-02 BID PROCEDURES AND CONDITIONS

1-02.1 Prequalification of Bidders

Delete this section and replace it with the following:

1-02.1 Qualifications of Bidder (January 24, 2011 APWA GSP)

Before award of a public works contract, a bidder must meet at least the minimum qualifications of RCW 39.04.350(1) to be considered a responsible bidder and qualified to be awarded a public works project.

1-02.2 Plans and Specifications (June 27, 2011 APWA GSP)

Delete this section and replace it with the following:

Information as to where Bid Documents can be obtained or reviewed can be found in the Call for Bids (Advertisement for Bids) for the work.

After award of the contract, plans and specifications will be issued to the Contractor at no cost as detailed below:

To Prime Contractor	No. of Sets	Basis of Distribution
Reduced plans (11" x 17")	ONE (1)	Furnished automatically upon award.
Contract Provisions	ONE (1)	Furnished automatically upon award.
Large plans (e.g., 22" x 34")	ONE (1)	Furnished only upon request.

Additional plans and Contract Provisions may be obtained by the Contractor from the source stated in the Call for Bids, at the Contractor's own expense.

1-02.6 Preparation of Proposal (July 11, 2018 APWA GSP)

Supplement the second paragraph with the following:

4. If a minimum bid amount has been established for any item, the unit or lump sum price must equal or exceed the minimum amount stated.
5. Any correction to a bid made by interlineation, alteration, or erasure, shall be initialed by the signer of the bid.

Delete the last two paragraphs, and replace them with the following:

If no Subcontractor is listed, the Bidder acknowledges that it does not intend to use any Subcontractor to perform those items of work.

The Bidder shall submit with their Bid a completed Contractor Certification Wage Law Compliance form, provided by the Contracting Agency. Failure to return this certification as part of the Bid Proposal package will make this Bid Nonresponsive and ineligible for Award. A Contractor Certification of Wage Law Compliance form is included in the Proposal Forms.

The Bidder shall make no stipulation on the Bid Form, nor qualify the bid in any manner.

A bid by a corporation shall be executed in the corporate name, by the president or a vice president (or other corporate officer accompanied by evidence of authority to sign).

A bid by a partnership shall be executed in the partnership name, and signed by a partner. A copy of the partnership agreement shall be submitted with the Bid Form if any UDBE requirements are to be satisfied through such an agreement.

A bid by a joint venture shall be executed in the joint venture name and signed by a member of the joint venture. A copy of the joint venture agreement shall be submitted with the Bid Form if any UDBE requirements are to be satisfied through such an agreement.

1-02.7 Bid Deposit
(March 8, 2013 APWA GSP)

Supplement this section with the following:

Bid bonds shall contain the following:

1. Contracting Agency-assigned number for the project;
2. Name of the project;
3. The Contracting Agency named as obligee;
4. The amount of the bid bond stated either as a dollar figure or as a percentage which represents five percent of the maximum bid amount that could be awarded;
5. Signature of the bidder's officer empowered to sign official statements. The signature of the person authorized to submit the bid should agree with the signature on the bond, and the title of the person must accompany the said signature;
6. The signature of the surety's officer empowered to sign the bond and the power of attorney.

If so stated in the Contract Provisions, bidder must use the bond form included in the Contract Provisions.

If so stated in the Contract Provisions, cash will not be accepted for a bid deposit.

(****)

1-02.9 Delivery of Proposal

Delete this section and replace it with the following:

Each proposal shall be submitted in a sealed envelope, with the Project Name and Project Number as stated in the Call for Bids clearly marked on the outside of the envelope, or as otherwise required in the Bid Documents, to ensure proper handling and delivery.

The Contracting Agency will not open or consider any Bid Proposal that is received after the

time specified in the Call for Bids for receipt of Bid Proposals, or received in a location other than that specified in the Call for Bids.

1-02.10 Withdrawing, Revising, or Supplementing Proposal
(July 23, 2015 APWA GSP)

Delete this section, and replace it with the following:

After submitting a physical Bid Proposal to the Contracting Agency, the Bidder may withdraw, revise, or supplement it if:

1. The Bidder submits a written request signed by an authorized person and physically delivers it to the place designated for receipt of Bid Proposals, and
2. The Contracting Agency receives the request before the time set for receipt of Bid Proposals, and
3. The revised or supplemented Bid Proposal (if any) is received by the Contracting Agency before the time set for receipt of Bid Proposals.

If the Bidder's request to withdraw, revise, or supplement its Bid Proposal is received before the time set for receipt of Bid Proposals, the Contracting Agency will return the unopened Proposal package to the Bidder. The Bidder must then submit the revised or supplemented package in its entirety. If the Bidder does not submit a revised or supplemented package, then its bid shall be considered withdrawn.

Late revised or supplemented Bid Proposals or late withdrawal requests will be date recorded by the Contracting Agency and returned unopened. Mailed, emailed, or faxed requests to withdraw, revise, or supplement a Bid Proposal are not acceptable.

1-02.15 Pre Award Information
(August 14, 2013 APWA GSP)

Revise this section to read:

Before awarding any contract, the Contracting Agency may require one or more of these items or actions of the apparent lowest responsible bidder:

1. A complete statement of the origin, composition, and manufacture of any or all materials to be used,
2. Samples of these materials for quality and fitness tests,
3. A progress schedule (in a form the Contracting Agency requires) showing the order of and time required for the various phases of the work,
4. A breakdown of costs assigned to any bid item,
5. Attendance at a conference with the Engineer or representatives of the Engineer,
6. Obtain, and furnish a copy of, a business license to do business in the city or county where the work is located.
7. Any other information or action taken that is deemed necessary to ensure that the bidder is the lowest responsible bidder.

1-03 AWARD AND EXECUTION OF CONTRACT

1-03.1 Consideration of Bids

(January 23, 2006 APWA GSP)

Revise the first paragraph to read:

After opening and reading proposals, the Contracting Agency will check them for correctness of extensions of the prices per unit and the total price. If a discrepancy exists between the price per unit and the extended amount of any bid item, the price per unit will control. If a minimum bid amount has been established for any item and the bidder's unit or lump sum price is less than the minimum specified amount, the Contracting Agency will unilaterally revise the unit or lump sum price, to the minimum specified amount and recalculate the extension. The total of extensions, corrected where necessary, including sales taxes where applicable and such additives and/or alternates as selected by the Contracting Agency, will be used by the Contracting Agency for award purposes and to fix the Awarded Contract Price amount and the amount of the contract bond.

1-03.3 Execution of Contract

(October 1, 2005 APWA GSP)

Revise this section to read:

Copies of the Contract Provisions, including the unsigned Form of Contract, will be available for signature by the successful bidder on the first business day following award. The number of copies to be executed by the Contractor will be determined by the Contracting Agency.

Within ten (10) calendar days after the award date, the successful bidder shall return the signed Contracting Agency-prepared contract, an insurance certification as required by Section 1-07.18, and a satisfactory bond as required by law and Section 1-03.4. Before execution of the contract by the Contracting Agency, the successful bidder shall provide any pre-award information the Contracting Agency may require under Section 1-02.15.

Until the Contracting Agency executes a contract, no proposal shall bind the Contracting Agency nor shall any work begin within the project limits or within Contracting Agency-furnished sites. The Contractor shall bear all risks for any work begun outside such areas and for any materials ordered before the contract is executed by the Contracting Agency.

If the bidder experiences circumstances beyond their control that prevents return of the contract documents within ten (10) calendar days after the award date stated above, the Contracting Agency may grant up to a maximum of five (5) additional calendar days for return of the documents, provided the Contracting Agency deems the circumstances warrant it.

1-03.4 Contract Bond

(July 23, 2015 APWA GSP)

Delete the first paragraph and replace it with the following:

The successful bidder shall provide executed payment and performance bond(s) for the full contract amount. The bond may be a combined payment and performance bond; or be

separate payment and performance bonds. In the case of separate payment and performance bonds, each shall be for the full contract amount. The bond(s) shall:

1. Be on Contracting Agency-furnished form(s);
2. Be signed by an approved surety (or sureties) that:
 - a. Is registered with the Washington State Insurance Commissioner, and
 - b. Appears on the current Authorized Insurance List in the State of Washington published by the Office of the Insurance Commissioner,
3. Guarantee that the Contractor will perform and comply with all obligations, duties, and conditions under the Contract, including but not limited to the duty and obligation to indemnify, defend, and protect the Contracting Agency against all losses and claims related directly or indirectly from any failure:
 - a. Of the Contractor (or any of the employees, subcontractors, or lower tier subcontractors of the Contractor) to faithfully perform and comply with all contract obligations, conditions, and duties, or
 - b. Of the Contractor (or the subcontractors or lower tier subcontractors of the Contractor) to pay all laborers, mechanics, subcontractors, lower tier subcontractors, material person, or any other person who provides supplies or provisions for carrying out the work;
4. Be conditioned upon the payment of taxes, increases, and penalties incurred on the project under titles 50, 51, and 82 RCW; and
5. Be accompanied by a power of attorney for the Surety's officer empowered to sign the bond; and
6. Be signed by an officer of the Contractor empowered to sign official statements (sole proprietor or partner). If the Contractor is a corporation, the bond(s) must be signed by the president or vice president, unless accompanied by written proof of the authority of the individual signing the bond(s) to bind the corporation (i.e., corporate resolution, power of attorney, or a letter to such effect signed by the president or vice president).

1-04 SCOPE OF WORK

1-04.2 Coordination of Contract Documents, Plans, Special Provisions, Specifications, and Addenda

(March 13, 2012 APWA GSP)

Revise the second paragraph to read:

Any inconsistency in the parts of the contract shall be resolved by following this order of precedence (e.g., 1 presiding over 2, 2 over 3, 3 over 4, and so forth):

1. Addenda,
2. Proposal Form,
3. Special Provisions,
4. Contract Plans,
5. Amendments to the Standard Specifications,
6. Standard Specifications,
7. Contracting Agency's Standard Plans or Details (if any), and
8. WSDOT Standard Plans for Road, Bridge, and Municipal Construction.

NOTE: In the event of a conflict between information in Section 1 of this Project Manual and the project special provisions of Section 4, the information in Section 1 will take precedence.

(****)

1-04.4 Changes

The last two paragraphs of Section 1-04.4 are deleted and replaced with the following:

Contractor-Requested Alternate Design or Materials:

In the event that the Contractor shall request, or submit, an alternate design or material for some portions of the Work, the Engineer will consider such alternative design with reasonable promptness. Such request for either a design review from alternate Plans submitted by the Contractor, or request for a redesign initiated by the Contractor, as set forth above, shall be made in writing to the Engineer. When the Contractor submits Plans for an alternate design, it shall be in the form of reproducible drawings. For each proposed substitution, the Contractor shall submit samples, descriptive and technical data, and reports of tests to the Engineer for approval. The Contractor shall also indicate the difference in Contract cost by reason of the proposed substitution. No substitute items shall be furnished or installed without the Engineers written approval.

1-05 CONTROL OF WORK

(****)

1-05.3 Plans and Working Drawings

Section 1-05.3 is supplemented with the following:

The Contractor shall submit six (6) complete sets of Working Drawings directly to the Engineer for review. The Engineer will check and return three (3) copies of such Working Drawings. The Contractor shall make such corrections to the Working Drawings as have been indicated and shall furnish the Engineer with three (3) corrected copies. Some Working Drawings may require more than six (6) copies. The Contractor shall furnish additional copies when requested.

The Contractor shall be fully responsible for the accuracy of dimensions and details on the Working Drawings, and for complete conformity with the Contract Documents, even if the Working Drawings have been reviewed by the Engineer, or if the Contractor and the Engineer agree on dimensions and details. The Contracting Agency does not accept Working Drawings as accurate or adequate, and does not take responsibility for, or warrant that Working Drawings will meet Contract requirements.

The Contractor shall allow five (5) calendar days (from receipt of Working Drawings by the Engineer) for the Engineer's review and return of comments. The Contractor shall make any corrections required by the Engineer and shall return corrected copies of the Working Drawings for the Engineer's review. The Contractor shall direct specific attention in writing to revisions other than the corrections called for by the Engineer on previous submittals. If rejected by the Engineer, the Contractor shall re-submit the rejected Working Drawings allowing an additional five (5) calendar days for each review required until no exception is taken by the Engineer.

The Engineer's review of Working Drawings shall not relieve the Contractor from responsibility for any variation from the requirements of the Contract Documents unless the Contractor has in writing called the Engineers attention to each such variation at the time of submission, and the Engineer has given written approval of each such variation by a specific written notation thereof incorporated in or accompanying the returned Working Drawings; nor will any review

by the Engineer relieve the Contractor from responsibility for errors or omissions in the Working Drawings or from responsibility for having complied with the provisions of this Section.

Any deviations from Standard Plans will be subject to a Working Drawing submitted by the Contractor and approved by the Engineer. Where a Working Drawing is required by the Specifications, any related Work performed prior to completion of the Engineers review of the pertinent submission will be the sole expense and responsibility of the Contractor.

1-05.7 Removal of Defective and Unauthorized Work

(October 1, 2005 APWA GSP)

Supplement this section with the following:

If the Contractor fails to remedy defective or unauthorized work within the time specified in a written notice from the Engineer, or fails to perform any part of the work required by the Contract Documents, the Engineer may correct and remedy such work as may be identified in the written notice, with Contracting Agency forces or by such other means as the Contracting Agency may deem necessary.

If the Contractor fails to comply with a written order to remedy what the Engineer determines to be an emergency situation, the Engineer may have the defective and unauthorized work corrected immediately, have the rejected work removed and replaced, or have work the Contractor refuses to perform completed by using Contracting Agency or other forces. An emergency situation is any situation when, in the opinion of the Engineer, a delay in its remedy could be potentially unsafe, or might cause serious risk of loss or damage to the public.

Direct or indirect costs incurred by the Contracting Agency attributable to correcting and remedying defective or unauthorized work, or work the Contractor failed or refused to perform, shall be paid by the Contractor. Payment will be deducted by the Engineer from monies due, or to become due, the Contractor. Such direct and indirect costs shall include in particular, but without limitation, compensation for additional professional services required, and costs for repair and replacement of work of others destroyed or damaged by correction, removal, or replacement of the Contractor's unauthorized work.

No adjustment in contract time or compensation will be allowed because of the delay in the performance of the work attributable to the exercise of the Contracting Agency's rights provided by this Section.

The rights exercised under the provisions of this section shall not diminish the Contracting Agency's right to pursue any other avenue for additional remedy or damages with respect to the Contractor's failure to perform the work as required.

(**)**

1-05.10 Guarantees

Section 1-05.10 is supplemented with the following:

The Contractor shall be responsible for correcting all defects in workmanship and material within one year after Final Acceptance of this Work by the Contracting Agency. The Contractor shall start Work to remedy such defects within seven (7) calendar days of written notice of discovery thereof by the Contracting Agency and shall complete such

Work within the time stated in the notice. In emergencies, where damages may result from delay or where loss of services may result, such corrections may be made by the Contracting Agency, in which case the cost shall be borne by the Contractor. Said defects shall include settlement of the backfill of trenches within existing streets or driveways, Traveled Ways and Shoulders, and under and around Structures.

1-05.11 Final Inspection

Delete this section and replace it with the following:

1-05.11 Final Inspections and Operational Testing

(October 1, 2005 APWA GSP)

1-05.11(1) Substantial Completion Date

When the Contractor considers the work to be substantially complete, the Contractor shall so notify the Engineer and request the Engineer establish the Substantial Completion Date. The Contractor's request shall list the specific items of work that remain to be completed in order to reach physical completion. The Engineer will schedule an inspection of the work with the Contractor to determine the status of completion. The Engineer may also establish the Substantial Completion Date unilaterally.

If, after this inspection, the Engineer concurs with the Contractor that the work is substantially complete and ready for its intended use, the Engineer, by written notice to the Contractor, will set the Substantial Completion Date. If, after this inspection the Engineer does not consider the work substantially complete and ready for its intended use, the Engineer will, by written notice, so notify the Contractor giving the reasons therefor.

Upon receipt of written notice concurring in or denying substantial completion, whichever is applicable, the Contractor shall pursue vigorously, diligently and without unauthorized interruption, the work necessary to reach Substantial and Physical Completion. The Contractor shall provide the Engineer with a revised schedule indicating when the Contractor expects to reach substantial and physical completion of the work.

The above process shall be repeated until the Engineer establishes the Substantial Completion Date and the Contractor considers the work physically complete and ready for final inspection.

1-05.11(2) Final Inspection and Physical Completion Date

When the Contractor considers the work physically complete and ready for final inspection, the Contractor by written notice, shall request the Engineer to schedule a final inspection. The Engineer will set a date for final inspection. The Engineer and the Contractor will then make a final inspection and the Engineer will notify the Contractor in writing of all particulars in which the final inspection reveals the work incomplete or unacceptable. The Contractor shall immediately take such corrective measures as are necessary to remedy the listed deficiencies. Corrective work shall be pursued vigorously, diligently, and without interruption until physical completion of the listed deficiencies. This process will continue until the Engineer is satisfied the listed deficiencies have been corrected.

If action to correct the listed deficiencies is not initiated within seven (7) calendar days after receipt of the written notice listing the deficiencies, the Engineer may, upon written notice to

the Contractor, take whatever steps are necessary to correct those deficiencies pursuant to Section 1-05.7.

The Contractor will not be allowed an extension of contract time because of a delay in the performance of the work attributable to the exercise of the Engineer's right hereunder.

Upon correction of all deficiencies, the Engineer will notify the Contractor and the Contracting Agency, in writing, of the date upon which the work was considered physically complete. That date shall constitute the Physical Completion Date of the contract, but shall not imply acceptance of the work or that all the obligations of the Contractor under the contract have been fulfilled.

1-05.11(3) Operational Testing

It is the intent of the Contracting Agency to have at the Physical Completion Date a complete and operable system. Therefore when the work involves the installation of machinery or other mechanical equipment; street lighting, electrical distribution or signal systems; irrigation systems; buildings; or other similar work it may be desirable for the Engineer to have the Contractor operate and test the work for a period of time after final inspection but prior to the physical completion date. Whenever items of work are listed in the Contract Provisions for operational testing they shall be fully tested under operating conditions for the time period specified to ensure their acceptability prior to the Physical Completion Date. During and following the test period, the Contractor shall correct any items of workmanship, materials, or equipment which prove faulty, or that are not in first class operating condition. Equipment, electrical controls, meters, or other devices and equipment to be tested during this period shall be tested under the observation of the Engineer, so that the Engineer may determine their suitability for the purpose for which they were installed. The Physical Completion Date cannot be established until testing and corrections have been completed to the satisfaction of the Engineer.

The costs for power, gas, labor, material, supplies, and everything else needed to successfully complete operational testing, shall be included in the unit contract prices related to the system being tested, unless specifically set forth otherwise in the proposal.

Operational and test periods, when required by the Engineer, shall not affect a manufacturer's guaranties or warranties furnished under the terms of the contract.

(****)

1-05.12 Final Inspection

Section 1-05.12 is deleted and replaced with the following:

The Contractor must perform all the obligations under the Contract before the Completion Date can be established. A certificate of completion of the Work issued by the Contracting Agency will establish the Completion Date and certify the Work as complete. The following must occur before the Completion Date can be established:

1. The physical Work on the project must be complete.
2. The Contractor must furnish all documentation required by the Contract and required by law, necessary to allow the Contracting Agency to certify the Contract as complete including all Work relating to the Substantial Completion punch list per Sections 1- 08.5 and 1-05.11. If the physical Work is not completed in accordance with Section 1- 08.5

Time for Completion, liquidated damages shall be charged to the Contractor in accordance with Section 1-08.9.

3. The Final Contract Voucher Certification must be signed by the Contractor verifying agreement to the final Contract price.

A certificate of completion for the Work, signed by the Contracting Agency, will constitute acceptance of the Work. The issuance of this certificate of completion will not constitute acceptance of previously unauthorized or defective Work or material.

Failure of the Contractor to perform all of the Contractor's obligations under the Contract shall not bar the Contracting Agency from unilaterally certifying the Contract complete so the Engineer may calculate a final Contract price as provided in Section 1-09.9.

1-05.13 SUPERINTENDENTS, LABOR AND EQUIPMENT OF CONTRACTOR (August 14, 2013 APWA GSP)

Delete the sixth and seventh paragraphs of this section.

(****)

1-05.14 Cooperation With Other Contractors

Section 1-05.14 is supplemented with the following:

Nothing in the Contract shall be interpreted as granting to the Contractor exclusive occupancy of the project area. The Contractor must ascertain to its own satisfaction the scope of the project and the nature of any other Contracts that have been or may be Awarded by the Contracting Agency in the construction of the project, or to the end that the Contractor may perform this Contract in the light of such other Contracts, if any.

The Contractor shall not cause any unnecessary hindrance or delay to any others working on the project. If the performance of any Contract for the project is likely to be interfered with by the simultaneous performance of some other Contract or Contracts, the Engineer will decide which Contractor shall cease Work temporarily and which Contractor shall continue, or whether the Work under the Contracts can be coordinated so that the Contractors may proceed simultaneously. On all questions concerning conflicting interest of Contractors performing related Work, the decision of the Engineer shall be binding upon all Contractors concerned and the Contracting Agency, the Engineer, the Contracting Agency's Representative, and their consultants shall not be held responsible for any damages suffered or extra costs incurred by the Contractor resulting directly or indirectly from the Award or performance or attempted performance of any other Contract or Contracts on the project or caused by a decision or omission of the Engineer respecting the order of precedence in the performance of the Contracts.

If, through acts of neglect on the part of the Contractor, any others suffer loss or damage on the Work, the Contractor agrees to settle with such others by agreement or arbitration, if such others will so settle. If such others shall assert any claim against the Contracting Agency, the Engineer, the Contracting Agency's Representative, or their consultants on account of any damage alleged to have been so sustained, the Contracting Agency will notify the Contractor, who shall hold harmless, indemnify, and defend the Contracting Agency, Engineer, the Contracting Agency's Representative, and their consultants, and each of their directors, officers, employees, and agents against any such claim, including all attorney's fees and any

other costs incurred by the indemnified parties relative to any such claim.

The Contractor shall coordinate its Work with other Contractors and utility companies, which may have facilities in the project area and cooperate with them. The Contractor shall also coordinate its activities with the Contracting Agency; and no water mains, individual water services, street, or private driveways may be closed off without a minimum of seven (7) calendar days' notice to the Contracting Agency and the private property owner. Should the property owner or the Contracting Agency have adequate reason, as determined by the Engineer, to avoid access or water service shutoff at the scheduled time, the Contractor shall reschedule its Work to meet the new condition.

Final grading to Subgrade and Subgrade preparation in those areas disturbed by the utilities companies shall be the responsibility of the Contractor and considered incidental to the street construction and no additional compensation will be paid. The Contractor shall cooperate with the utility companies and/or their Subcontractors and so conduct its operations that the necessary construction of their facilities can be accomplished to the mutual satisfaction of the Contracting Agency, the local municipalities, and the utility companies.

(****)

1-05.14(1) Notifications Relative to Contractor's Activities

Section 1-05.14(1) is added as follows:

The Contractor shall notify the following listed agencies and individuals, prior to commencement of the Work, and submit to these agencies/individuals:

- a. The name(s) of the construction superintendent in responsible charge, and other individuals having full authority to execute the orders or directions of the Engineer, in the event of an emergency.
- b. The time of the commencement and completion of Work.
- c. Names of streets or locations of alleys to be closed.
- d. Schedule of operations.
- e. Routes of detours where possible.
- f. Planned utility shutdown times and locations.
- g. Construction staging.

Notification shall be written, with a copy delivered to the Engineer seven (7) calendar days prior to the commencement of Work on the project.

The Contractor must notify the same parties, in writing, of all changes to any of the above items during the project.

The following addresses and telephone numbers of public and franchise utilities and public services are supplied for the Contractor's convenience.

City of Olympia Police Department
900 Plum St SE
Olympia WA 98501
Telephone: (360) 753-8300

City of Olympia Fire Department
100 Eastside Street NE
Olympia, WA 98501
Telephone: (360) 753-8348

City of Lacey Police Department
420 College Street SE
Lacey, WA 98509-3400
Telephone: (360) 459-4333

Thurston County Comm. 911
2703 Pacific Ave. SE
Olympia, WA 98501
Telephone: (360) 704-2730

Thurston County Sheriff's
2000 Lakeridge Drive SW
Olympia, WA 98502-6045
Telephone: (360) 786-5500

Office Underground Utilities Location
Center
("One-Call" Center)
Telephone: 811

Intercity Transit
526 Pattison SE
Olympia, WA 98501
Telephone:(360) 705-5877

1-05.15 Method of Serving Notices
(March 25, 2009 APWA GSP)

Revise the second paragraph to read:

All correspondence from the Contractor shall be directed to the Project Engineer. All correspondence from the Contractor constituting any notification, notice of protest, notice of dispute, or other correspondence constituting notification required to be furnished under the Contract, must be in paper format, hand delivered or sent via mail delivery service to the Project Engineer's office. Electronic copies such as e-mails or electronically delivered copies of correspondence will not constitute such notice and will not comply with the requirements of the Contract.

Add the following new section:

1-05.16 Water and Power
(October 1, 2005 APWA GSP)

The Contractor shall make necessary arrangements and shall bear the costs for power and water necessary for the performance of the work, unless the contract includes power and water as a pay item.

Add the following new section:

(****)

1-05.18 Contractor's Daily Diary
Section 1-05.18 is added as follows:

The Contractor and Subcontractors shall maintain and provide to the Engineer a Daily Diary Record of this Work. This diary will be created by pen entries in a hardbound diary book of the type that is commonly available through commercial outlets. The diary must contain the project title and project number, if the diary is in loose-leaf form, this information must appear on every page. The diary must be kept and maintained by the Contractor's designated project superintendent(s). Entries must be made on a daily basis and must accurately represent all of the project activities on each day.

At a minimum, the diary shall show:

1. The day and date.
2. The weather conditions, including changes throughout the day.
3. A complete description of Work accomplished during the day with adequate references to the Plans and Contract Provisions so that the reader can easily and accurately identify said Work in the Plans. Identify location/description of photographs or videos taken that day.
4. An entry for each and every changed condition, dispute or potential dispute, incident, accident, or occurrence of any nature whatsoever which might affect the Contractor, the Contracting Agency, or any third party in any manner.
5. Listing of any materials received and stored on or off-site by the Contractor for the future installation, to include the manner of storage and protection of the same.
6. Listing of materials installed during each day.
7. List of Subcontractors working on-site each day.
8. Listing of the number of Contractor's employees working during each day by category of employment.
9. Listing of Contractor's equipment working on the site during each day. Idle equipment on the site shall be listed and designated as idle.
10. Notation to explain inspections, testing, stake-out, and all other services furnished by the Contracting Agency or other party during each day.
11. Entries to verify the daily (including non-Work days) inspection and maintenance of traffic control devices and condition of traveled Roadway surfaces. The Contractor shall not allow any condition to develop that would be hazardous to the public.
12. Any other information that serves to give an accurate and complete record of the nature, quantity, and quality of the Contractor's progress on each day..
13. Plan markups showing location and dimensions of constructed features to be used by the Engineer to produce Record Drawings.
14. All pages of the diary must be numbered consecutively with no omissions in page numbers.
15. Each page must be signed and dated by the Contractor's official representative of the project.

The Contractor may use additional sheets separate from the diary book if necessary to provide a complete diary record, but they must be signed, dated, and labeled with project name and number.

IMPORTANT – PLEASE NOTE:

It is expressly agreed between Contractor and Contracting Agency that the Daily Diary Record maintained by the Contractor shall be the “Contractor’s Book of Original Entry” for the documentation of any potential claims or disputes that might arise during the Contract. Failure of the Contractor to maintain the diary in the manner described above will constitute a waiver of any claims or disputes by the Contractor.

1-06 Control of Material

Section 1-06 is supplemented with the following:

Buy America

(August 6, 2012)

In accordance with Buy America requirements contained in 23 CFR 635.410, the major quantities of steel and iron construction material that is permanently incorporated into the project shall consist of American-made materials only. Buy America does not apply to temporary steel items, e.g., temporary sheet piling, temporary bridges, steel scaffolding and falsework.

Minor amounts of foreign steel and iron may be utilized in this project provided the cost of the foreign material used does not exceed one-tenth of one percent of the total contract cost or \$2,500.00, whichever is greater.

American-made material is defined as material having all manufacturing processes occurring domestically. To further define the coverage, a domestic product is a manufactured steel material that was produced in one of the 50 States, the District of Columbia, Puerto Rico, or in the territories and possessions of the United States.

If domestically produced steel billets or iron ingots are exported outside of the area of coverage, as defined above, for any manufacturing process then the resulting product does not conform to the Buy America requirements. Additionally, products manufactured domestically from foreign source steel billets or iron ingots do not conform to the Buy America requirements because the initial melting and mixing of alloys to create the material occurred in a foreign country.

Manufacturing begins with the initial melting and mixing, and continues through the coating stage. Any process which modifies the chemical content, the physical size or shape, or the final finish is considered a manufacturing process. The processes include rolling, extruding, machining, bending, grinding, drilling, welding, and coating. The action of applying a coating to steel or iron is deemed a manufacturing process. Coating includes epoxy coating, galvanizing, aluminizing, painting, and any other coating that protects or enhances the value of steel or iron. Any process from the original reduction from ore to the finished product constitutes a manufacturing process for iron.

Due to a nationwide waiver, Buy America does not apply to raw materials (iron ore and alloys), scrap (recycled steel or iron), and pig iron or processed, pelletized, and reduced iron ore.

The following are considered to be steel manufacturing processes:

1. Production of steel by any of the following processes:
 - a. Open hearth furnace.
 - b. Basic oxygen.
 - c. Electric furnace.
 - d. Direct reduction.
2. Rolling, heat treating, and any other similar processing.
3. Fabrication of the products.
 - a. Spinning wire into cable or strand.
 - b. Corrugating and rolling into culverts.
 - c. Shop fabrication.

A certification of materials origin will be required for any items comprised of, or containing, steel or iron construction materials prior to such items being incorporated into the permanent work. The certification shall be on DOT Form 350-109EF provided by the Engineer, or such other form the Contractor chooses, provided it contains the same information as DOT Form 350-109EF.

(*****)

1-06.1 Approval of Materials Prior to Use

The second paragraph of Section 1-06.1 is supplemented with the following:

5. Equipment Approval Data:

The Contractor shall furnish six (6) copies of the complete catalog data for the manufactured items of equipment and all components to be used in the Work including specific performance data, material description, rating, capacity, working pressure, material gauge or thickness, brand name, catalog number and general type.

This submission shall be compiled by the Contractor and approved by the Engineer before any of the equipment is ordered.

Each data sheet or catalog in the submission shall be indexed according to Specification section and paragraph for each reference.

After written approval, this submission shall become part of the Contract and may not be deviated from except upon written approval of the Engineer.

Catalog data for equipment approved by the Engineer shall not in any case supersede the Contract Documents. The approval of the Engineer shall not relieve the Contractor from responsibility for deviations from Plans or Specifications unless the Contractor has, in writing, called the Engineer's attention to such deviations at the time of submission and secured the Engineer's written approval nor shall it relive the Contractor from responsibility for errors of any sort in the items submitted.

The Contractor shall check and approve the Work described by the catalog data with the Contract Documents for deviations and errors prior to submission to the Engineer for approval.

It shall be the responsibility of the Contractor to ensure that items to be furnished fit the space available. The Contractor shall make necessary field measurements, including those for connections, and shall order such sizes and shapes of equipment that the final installation shall suit the true intent and meaning of the Plans and Specifications.

Where equipment requiring different arrangement of connections from those shown is approved, it shall be the responsibility of the Contractor to install the equipment to operate properly and in harmony with the intent of the Plans and Specifications and to make all changes in the Work required by the different arrangement of connections.

Upon approval of the equipment by the Engineer, the Contractor shall furnish three (3) copies of catalog data of all process equipment or components thereof together with operating and maintenance instructions.

The Engineer will require up to seven (7) calendar days for review of requested changes to the Plans as described in Section 1-05.3 of the Special Provisions.

Section 1-06.1 is supplemented with the following:

No source has been provided for any materials necessary for the construction of this improvement. The Contractor shall make its own arrangements to obtain the necessary materials at its own expense, and all cost of acquiring, producing, and placing this material in the finished Work shall be included in the unit Contract prices for the various items involved. If the sources of materials provided by the Contractor necessitates hauling over roads other than City streets, the Contractor shall, at its own cost and expense, make all arrangements for the use of haul routes.

1-06.6 Recycled Materials

(January 4, 2016 APWA GSP)

Delete this section, including its subsections, and replace it with the following:

The Contractor shall make their best effort to utilize recycled materials in the construction of the project. Approval of such material use shall be as detailed elsewhere in the Standard Specifications.

Prior to Physical Completion the Contractor shall report the quantity of recycled materials that were utilized in the construction of the project for each of the items listed in Section 9-03.21. The report shall include hot mix asphalt, recycled concrete aggregate, recycled glass, steel furnace slag and other recycled materials (e.g. utilization of on-site material and aggregates from concrete returned to the supplier). The Contractor's report shall be provided on DOT form 350-075 Recycled Materials Reporting.

Add the following new section:

(*****)

1-06.7 Materiel Testing and Acceptance

Contractor to submit material submittals for ALL materials installed for this project. Material submittals will be reviewed and approved by the Project Engineer.

Subgrade compaction testing will consist of visual inspection of the subgrade by the Project Engineer. If additional testing is deemed necessary by the Project Engineer, the contractor shall complete the testing at their expense.

No on-site concrete testing will be required; however it will be at the discretion of the Project Engineer to determine if additional testing is required. If additional testing is deemed necessary by the Project Engineer, the contractor shall complete the testing at his expense.

Inspection of placed asphalt concrete will include a visual inspection by the Project Engineer. If additional testing is deemed necessary by the Project Engineer, the contractor shall complete the testing at his expense

1-07 LEGAL RELATIONS AND RESPONSIBILITIES TO THE PUBLIC

1-07.1 Laws to be Observed

(October 1, 2005 APWA GSP)

Supplement this section with the following:

In cases of conflict between different safety regulations, the more stringent regulation shall apply.

The Washington State Department of Labor and Industries shall be the sole and paramount administrative agency responsible for the administration of the provisions of the Washington Industrial Safety and Health Act of 1973 (WISHA).

The Contractor shall maintain at the project site office, or other well-known place at the project site, all articles necessary for providing first aid to the injured. The Contractor shall establish, publish, and make known to all employees, procedures for ensuring immediate removal to a hospital, or doctor's care, persons, including employees, who may have been injured on the project site. Employees should not be permitted to work on the project site before the Contractor has established and made known procedures for removal of injured persons to a hospital or a doctor's care.

The Contractor shall have sole responsibility for the safety, efficiency, and adequacy of the Contractor's plant, appliances, and methods, and for any damage or injury resulting from their failure, or improper maintenance, use, or operation. The Contractor shall be solely and completely responsible for the conditions of the project site, including safety for all persons and property in the performance of the work. This requirement shall apply continuously, and not be limited to normal working hours. The required or implied duty of the Engineer to conduct construction review of the Contractor's performance does not, and shall not, be intended to include review and adequacy of the Contractor's safety measures in, on, or near the project site.

(May 13, 2020)

In response to COVID-19, the Contractor shall prepare a project specific COVID-19 health and safety plan (CHSP) in conformance with Section 1-07.4(2) as supplemented 4 in these specifications, COVID-19 Health and Safety Plan (CHSP).

1-07.2 State Taxes

Delete this section, including its sub-sections, in its entirety and replace it with the following:

1-07.2 State Sales Tax

(June 27, 2011 APWA GSP)

The Washington State Department of Revenue has issued special rules on the State sales tax. Sections 1-07.2(1) through 1-07.2(3) are meant to clarify those rules. The Contractor should contact the Washington State Department of Revenue for answers to questions in this area. The Contracting Agency will not adjust its payment if the Contractor bases a bid on a misunderstood tax liability.

The Contractor shall include all Contractor-paid taxes in the unit bid prices or other contract amounts. In some cases, however, state retail sales tax will not be included. Section 1-07.2(2) describes this exception.

The Contracting Agency will pay the retained percentage (or release the Contract Bond if a FHWA-funded Project) only if the Contractor has obtained from the Washington State Department of Revenue a certificate showing that all contract-related taxes have been paid (RCW 60.28.051). The Contracting Agency may deduct from its payments to the Contractor any amount the Contractor may owe the Washington State Department of Revenue, whether the amount owed relates to this contract or not. Any amount so deducted will be paid into the proper State fund.

1-07.2(1) State Sales Tax — Rule 171

WAC 458-20-171, and its related rules, apply to building, repairing, or improving streets, roads, etc., which are owned by a municipal corporation, or political subdivision of the state, or by the United States, and which are used primarily for foot or vehicular traffic. This includes storm or combined sewer systems within and included as a part of the street or road drainage system and power lines when such are part of the roadway lighting system. For work performed in such cases, the Contractor shall include Washington State Retail Sales Taxes in the various unit bid item prices, or other contract amounts, including those that the Contractor pays on the purchase of the materials, equipment, or supplies used or consumed in doing the work.

1-07.2(2) State Sales Tax — Rule 170

WAC 458-20-170, and its related rules, apply to the constructing and repairing of new or existing buildings, or other structures, upon real property. This includes, but is not limited to, the construction of streets, roads, highways, etc., owned by the state of Washington; water mains and their appurtenances; sanitary sewers and sewage disposal systems unless such sewers and disposal systems are within, and a part of, a street or road drainage system; telephone, telegraph, electrical power distribution lines, or other conduits or lines in or above streets or roads, unless such power lines become a part of a street or road lighting system;

and installing or attaching of any article of tangible personal property in or to real property, whether or not such personal property becomes a part of the realty by virtue of installation.

For work performed in such cases, the Contractor shall collect from the Contracting Agency, retail sales tax on the full contract price. The Contracting Agency will automatically add this sales tax to each payment to the Contractor. For this reason, the Contractor shall not include the retail sales tax in the unit bid item prices, or in any other contract amount subject to Rule 170, with the following exception.

Exception: The Contracting Agency will not add in sales tax for a payment the Contractor or a subcontractor makes on the purchase or rental of tools, machinery, equipment, or consumable supplies not integrated into the project. Such sales taxes shall be included in the unit bid item prices or in any other contract amount.

1-07.2(3) Services

The Contractor shall not collect retail sales tax from the Contracting Agency on any contract wholly for professional or other services (as defined in Washington State Department of Revenue Rules 138 and 244).

1-07.4 Sanitation

1-07.4(2) Health Hazards

Section 1-07.4(2) is supplemented with the following:

(May 13, 2020)

COVID-19 Health and Safety Plan (CHSP)

The Contractor shall prepare a project specific COVID-19 health and safety plan (CHSP). The CHSP shall be prepared and submitted as a Type 2 Working Drawing prior to beginning physical Work. The CHSP shall be based on the most current State and Federal requirements. If the State or Federal requirements are revised, the CHSP shall be updated as necessary to conform to the current requirements. The Contractor shall update and resubmit the CHSP as the work progresses and new activities appear on the look ahead schedule required under Section 1- 08.3(2)D. If the conditions change on the project, or a particular activity, the Contractor shall update and resubmit the CHSP. Work on any activity shall cease if conditions prevent full compliance with the CHSP. The CHSP shall address the health and safety of all people associated with the project including State workers in the field, Contractor personnel, consultants, project staff, subcontractors, suppliers and anyone on the project site, staging areas, or yards.

COVID-19 Health and Safety Plan (CHSP) Inspection

The Contractor shall grant full and unrestricted access to the Engineer for CHSP Inspections. The Engineer (or designee) will conduct periodic compliance inspections on the project site, staging areas, or yards to verify that any ongoing work activity is following the CHSP plan. If the Engineer becomes aware of a noncompliance incident either through a site inspection or other means, the Contractor will be notified immediately (within 1 hour). The Contractor shall immediately remedy the noncompliance incident or suspend all or part of the associated work activity. The Contractor shall satisfy the Engineer that the noncompliance incident has been corrected before the suspension will end.

1-07.6 Permits and Licenses

Section 1-07.6 is supplemented with the following:

(****)

The Contracting Agency has obtained construction permits from each agency jurisdiction to complete work within their respective right-of-way. The Contracting Agency has paid for all permits.

Prior to work, the Contractor shall contact each jurisdiction and provide the necessary contractor information required to fully complete the construction permits. No work should commence until the Contractor has obtained the final construction permit from the applicable Agency.

The following agencies have permits required to work within the Right-of-Way.

- City of Lacey - Right-of-Way Access Application Permit
- City of Olympia - Right of Way Obstruction and Excavation Permit and Sidewalk Permit

Contractor is required to maintain copies of the agency permits and agency approved construction plans on the job site at all times. Approved plans will be provided to the Contractor prior to construction.

It is the Contractors responsibility to complete all work required to obtain agency approved site specific traffic control plans for all bus stop locations. Any additional fees or expenses required to obtain such approvals shall be the responsibility of the Contractor.

1-07.9 Wages

1-07.9(1) General

(January 6, 2020)

Supplement this section with the following:

The Federal wage rates for Highway Construction incorporated in this contract have been established by the Secretary of Labor under United States Department of Labor General Decision No. WA20200001. These rates are applicable to highway construction.

The State rates incorporated in this contract are applicable to all construction activities associated with this contract.

1-07.9 Wages

1-07.9(1) General

(January 6, 2020)

Supplement this section with the following:

The Federal wage rates for Highway Construction incorporated in this contract have been established by the Secretary of Labor under United States Department of Labor General Decision No. WA20200001.

1-07.9(5) Required Documents

Section 1-07.9(5) is revised to read:

(January 6, 2020)

General

All "Statements of Intent to Pay Prevailing Wages", "Affidavits of Wages Paid" and Certified Payrolls, including a signed Statement of Compliance for Federal-aid projects, shall be submitted to the Engineer using the State L&I online Prevailing Wage Intent & Affidavit (PWIA) system.

Intent and Affidavits

On forms provided by the Industrial Statistician of State L&I, the Contractor shall submit to the Engineer the following for themselves and for each firm covered under RCW 39.12 that will or has provided Work and materials for the Contract:

1. The approved "Statement of Intent to Pay Prevailing Wages" State L&I's form number F700-029-000. The Contracting Agency will make no payment under this Contract until this statement has been approved by State L&I and reviewed by the Engineer.
2. The approved "Affidavit of Prevailing Wages Paid", State L&I's form number F700-007-000. The Contracting Agency will not grant Completion until all approved Affidavit of Wages paid for the Contractor and all Subcontractors have been received by the Engineer. The Contracting Agency will not release to the Contractor any funds retained under RCW 60.28.011 until "Affidavit of Prevailing Wages Paid" forms have been approved by State L&I and all of the approved forms have been submitted to the Engineer for every firm that worked on the Contract.

The Contractor is responsible for requesting these forms from State L&I and for paying any fees required by State L&I.

Certified Payrolls

Certified payrolls are required to be submitted by the Contractor for themselves, all Subcontractors and all lower tier subcontractors. The payrolls shall be submitted weekly on all Federal-aid projects and no less than monthly on State funded projects.

Penalties for Noncompliance

The Contractor is advised, if these payrolls are not supplied within the prescribed deadlines, any or all payments may be withheld until compliance is achieved. In addition, failure to provide these payrolls may result in other sanctions as provided by State laws (RCW 39.12.050) and/or Federal regulations (29 CFR 5.12).

1-07.12 Federal Agency Inspection

Section 1-07.12 is supplemented with the following:

(****)

REQUIRED FEDERAL AID PROVISIONS

This Contract is not a FHWA Federally funded project. This Contract is a Federal Transit Administration (FTA) funded project.

1-07.14 RESPONSIBILITY FOR DAMAGE

(****)

1-07.14(1) ATTORNEY'S FEES, COSTS, AND INTEREST

Section 1-07.14(1) is added as follows:

The Contractor shall reimburse the Contracting Agency for attorney's fees, whether incident to suit or not, court costs, and other expenses incurred by the Contracting Agency in enforcing any provision of this Contract; or made necessary by any default of the Contractor. Any charge by the Contracting Agency to the Contractor, pursuant to the terms of this Contract shall bear interest at the rate of eight percent (8%) per annum from the date of demand by the Contracting Agency, except that, if such claims are satisfied from funds withheld by the Contracting Agency from the Contractor, no interest shall be charged

1-07.17 Utilities and Similar Facilities

Section 1-07.17 is supplemented with the following:

(****)

Locations and dimensions shown in the Plans for existing buried facilities are in accordance with available information obtained by researching existing as-built information. The techniques utilized did not uncover the existing utility to verify its location.

Where a potential utility conflict may exist with the proposed design, the Contractor shall coordinate with the Engineer and Utility Company to pothole and locate the utility 48 hours in advance prior to construction so that field design adjustments may be accomplished as necessary. If necessary, field design adjustments shall be performed in accordance with Section 1-04.4.

The Contractor shall call the Utility Coordinating Council One Call Center, 811, for field location, not less than four (4) or more than ten (10) calendar days before the scheduled date for commencement of excavation which may affect underground utility facilities, unless otherwise agreed upon by the parties involved. A business day is defined as any day other than Saturday, Sunday, or a legal local, State, or Federal holiday.

The Contractor is alerted to the existence of Chapter 19.122 RCW, a law relating to underground utilities. Any cost to the Contractor incurred as a result of this law shall be at the Contractor's expense.

No excavation shall begin until all known facilities, in the vicinity of the excavation area, have been located and marked.

In addition to Contractor having all utilities field marked before starting Work, the Contractor shall have all utilities field marked after they are relocated in conjunction with this project. Utilities of record are shown on the construction Plans insofar as it is possible to do so. Failure of the Contracting Agency to show the existence of subsurface objects or installation on the Plans shall not relieve the Contractor from its responsibility to make an independent check on the ground, nor relieve the Contractor from all liability for damages resulting from its operations unless otherwise provided in the Special Provisions. It shall be entirely the responsibility of the Contractor to give proper notification to the agencies that have utilities in place and to coordinate with these agencies in the protection and relocation of the various underground

installations. These agencies will give assistance in the location of the various utilities, but this shall not relieve the Contractor from responsibility for any damage incurred. The Contracting Agency shall require a notification of at least seven (7) calendar days. The Contractor shall hold the Contracting Agency harmless against any claim of any nature resulting from delays in attending to same.

If or when utility conflicts occur, the Contractor shall continue the construction process on other aspects of the project whenever possible. No additional compensation will be made to the Contractor for reason of delay caused by the actions of any utility company and the Contractor shall consider such costs to be incidental to the other items of the Contract.

Utility Potholing

Potholing is not included as a Bid item and shall be considered incidental to other Bid items. No additional compensation will be made to the Contractor for potholing.

1-07.23 Public Convenience and Safety

1-07.23(1) Construction Under Traffic

The second paragraph of Section 1-07.23(1) is supplemented with the following:

(*****)

6. Notify the local Police and Fire Departments before the beginning of each phase of construction so that these agencies may re-route their emergency vehicles around the construction zone.

7. Notify the School District Transportation Office of all Street closures or delays at least twenty-four (24) hours in advance to enable rerouting of buses.

8. Notify the property owners at least forty-eight (48) hours in advance to enable them to remove vehicles parked in the vicinity of Work. Towing vehicles shall be the responsibility of the Contractor and no additional payment will be made.

Section 1-07.23(1) is supplemented with the following:

The Contractor may request permission to close a portion of the Roadway during construction. The request shall be submitted to the Engineering agency with jurisdiction minimum one (1) week in advance and must be accompanied with a closure schedule and a signing plan. The request shall address the provisions for local access.

The Contractor shall notify the City of Olympia and City of Lacey Police, Fire, Parks, Public Works Department, Police, Thurston County Sheriff's Office and the School District of approved closing and opening of streets and parking within the Right-of-Way.

All signs and other traffic control devices shall be in place and in effect immediately prior to commencing any Work. The Contractor shall maintain patrol of the working area to ensure that all traffic signs and other traffic control devices are properly placed and in effect. Temporary traffic control shall be in accordance with Section 1-10.

See Section 1-10 of the Special Provisions for further provisions regarding pedestrian and vehicle traffic control.

The Contractor shall be responsible for proper notification to and coordination with all school districts, fire departments, Intercity Transit, local postal service, and all other persons and services, which will be affected by this project, and notification shall be given at least one (1) week in advance of construction. It shall be the Contractor's responsibility to keep the school district and fire departments and others fully advised of its construction progress, any required detours, and also the time of completion of the project. The Contractor shall be responsible for notification to all affected property owners or access, parking and street closures (if approved by the Engineer).

The following is a partial list of contacts for the Contractor's use:

City of Olympia Police Department
900 Plum St SE
Olympia WA 98501
Telephone: (360) 753-8300

City of Olympia Fire Department
100 Eastside Street NE
Olympia, WA 98501
Telephone: (360) 753-8348

City of Lacey Police Department
420 College Street SE
Lacey, WA 98509-3400
Telephone: (360) 459-4333

Thurston County Comm. 911
2703 Pacific Ave. SE
Olympia, WA 98501
Telephone: (360) 704-2730

Thurston County Sheriff's
2000 Lakeridge Drive SW
Olympia, WA 98502-6045
Telephone: (360) 786-5500

Office Underground Utilities Location
Center
("One-Call" Center)
Telephone: 811

Intercity Transit
526 Pattison SE
Olympia, WA 98501
Telephone:(360) 705-5877

(February 3, 2020)

Work Zone Clear Zone

The Work Zone Clear Zone (WZCZ) applies during working and nonworking hours. The WZCZ applies only to temporary roadside objects introduced by the Contractor's operations and does not apply to preexisting conditions or permanent Work. Those work operations that are actively in progress shall be in accordance with adopted and approved Traffic Control Plans, and other contract requirements.

During nonworking hours equipment or materials shall not be within the WZCZ unless they are protected by permanent guardrail or temporary concrete barrier. The use of temporary concrete barrier shall be permitted only if the Engineer approves the installation and location.

During actual hours of work, unless protected as described above, only materials absolutely necessary to construction shall be within the WZCZ and only construction vehicles absolutely necessary to construction shall be allowed within the WZCZ or allowed to stop or park on the shoulder of the roadway.

The Contractor's nonessential vehicles and employees private vehicles shall not be permitted to park within the WZCZ at any time unless protected as described above.

Deviation from the above requirements shall not occur unless the Contractor has requested the deviation in writing and the Engineer has provided written approval.

Minimum WZCZ distances are measured from the edge of traveled way and will be determined as follows:

Regulatory Posted Speed	Distance From Traveled Way (Feet)
35 mph or less	10
40 mph	15
45 to 50 mph	20
55 to 60 mph	30
65 mph or greater	35

Minimum Work Zone Clear Zone Distance

1-07.24 Rights of Way
(July 23, 2015 APWA GSP)

Delete this section and replace it with the following:

Street Right of Way lines, limits of easements, and limits of construction permits are indicated in the Plans. The Contractor's construction activities shall be confined within these limits, unless arrangements for use of private property are made.

Generally, the Contracting Agency will have obtained, prior to bid opening, all rights of way and easements, both permanent and temporary, necessary for carrying out the work. Exceptions to this are noted in the Bid Documents or will be brought to the Contractor's attention by a duly issued Addendum.

Whenever any of the work is accomplished on or through property other than public Right of Way, the Contractor shall meet and fulfill all covenants and stipulations of any easement agreement obtained by the Contracting Agency from the owner of the private property. Copies of the easement agreements may be included in the Contract Provisions or made available to the Contractor as soon as practical after they have been obtained by the Engineer.

Whenever easements or rights of entry have not been acquired prior to advertising, these areas are so noted in the Plans. The Contractor shall not proceed with any portion of the work in areas where right of way, easements or rights of entry have not been acquired until the Engineer certifies to the Contractor that the right of way or easement is available or that the right of entry has been received. If the Contractor is delayed due to acts of omission on the part of the Contracting Agency in obtaining easements, rights of entry or right of way, the Contractor will be entitled to an extension of time. The Contractor agrees that such delay shall not be a breach of contract.

Each property owner shall be given 48 hours notice prior to entry by the Contractor. This includes entry onto easements and private property where private improvements must be adjusted.

The Contractor shall be responsible for providing, without expense or liability to the Contracting Agency, any additional land and access thereto that the Contractor may desire for temporary construction facilities, storage of materials, or other Contractor needs.

However, before using any private property, whether adjoining the work or not, the Contractor shall file with the Engineer a written permission of the private property owner, and, upon vacating the premises, a written release from the property owner of each property disturbed or otherwise interfered with by reasons of construction pursued under this contract. The statement shall be signed by the private property owner, or proper authority acting for the owner of the private property affected, stating that permission has been granted to use the property and all necessary permits have been obtained or, in the case of a release, that the restoration of the property has been satisfactorily accomplished. The statement shall include the parcel number, address, and date of signature. Written releases must be filed with the Engineer before the Completion Date will be established.

1-08 PROSECUTION AND PROGRESS

Add the following new section:

(****)

1-08.0 Preliminary Matters

(May 25, 2006 APWA GSP)

1-08.0(1) Preconstruction Conference

(October 10, 2008 APWA GSP)

Prior to the Contractor beginning the work, the Contracting Agency shall setup and arrange a preconstruction conference to be held between the Contracting Agency, the Contractor, the Engineer, local agencies, and such other interested parties as may be invited. The purpose of the preconstruction conference will be:

1. To review the initial progress schedule;
2. To establish a working understanding among the various parties associated or affected by the work;
3. To establish and review procedures for progress payment, notifications, approvals, submittals, etc.;
4. To establish normal working hours for the work;
5. To review safety standards and traffic control; and
6. To discuss such other related items as may be pertinent to the work.

The Contractor shall prepare and submit at the preconstruction conference the following:

1. A breakdown of all lump sum items;
2. A preliminary schedule of working drawing submittals; and
3. A list of material sources for approval if applicable.

Add the following new section:

1-08.0(2) Hours of Work

(December 8, 2014 APWA GSP)

Except in the case of emergency or unless otherwise approved by the Engineer, the normal working hours for the Contract shall be any consecutive 8-hour period between 7:00 a.m. and 6:00 p.m. Monday through Friday, exclusive of a lunch break. If the Contractor desires different than the normal working hours stated above, the request must be submitted in writing prior to the preconstruction conference, subject to the provisions below. The working hours for the Contract shall be established at or prior to the preconstruction conference.

All working hours and days are also subject to local permit and ordinance conditions (such as noise ordinances).

If the Contractor wishes to deviate from the established working hours, the Contractor shall submit a written request to the Engineer for consideration. This request shall state what hours are being requested, and why. Requests shall be submitted for review no later than two (2) Working Days prior to the day(s) the Contractor is requesting to change the hours.

If the Contracting Agency approves such a deviation, such approval may be subject to certain other conditions, which will be detailed in writing. For example:

1. On non-Federal aid projects, requiring the Contractor to reimburse the Contracting Agency for the costs in excess of straight-time costs for Contracting Agency representatives who worked during such times. (The Engineer may require designated representatives to be present during the work. Representatives who may be deemed necessary by the Engineer include, but are not limited to: survey crews; personnel from the Contracting Agency's material testing lab; inspectors; and other Contracting Agency employees or third party consultants when, in the opinion of the Engineer, such work necessitates their presence.)
2. Considering the work performed on Saturdays, Sundays, and holidays as working days with regard to the contract time.
3. Considering multiple work shifts as multiple working days with respect to contract time even though the multiple shifts occur in a single 24-hour period.
4. If a 4-10 work schedule is requested and approved the non working day for the week will be charged as a working day.
5. If Davis Bacon wage rates apply to this Contract, all requirements must be met and recorded properly on certified payroll

1-08.3 Progress Schedule

Section 1-08.3 is supplemented with the following:

(****)

The Contractor shall conduct a weekly construction meeting with the Engineer to update the project status, review the schedule and address project issues, especially pertaining to local business access, traffic control and safety.

The Weekly Activity Schedule shall indicate the Contractor's and Subcontractor's proposed activities for the forthcoming week and the following next week. The schedule shall also include material procurements dates and delivery schedules.

The written weekly activity schedule shall be submitted to the Engineer or designated representative by 9:00 am of the last working day of the week preceding the indicated activities, or other mutually agreeable time.

No progress payments shall be made until the above scheduling submittals are made. If at any time, in the opinion of the Engineer, the progress of construction falls significantly behind schedule, the Contractor may be required to submit a plan for regaining progress and a revised schedule indicating how the remaining Work items will be completed within the authorized Contract time.

The Contractor shall promptly report to the Engineer any conditions, which the Contractor feels will require revision of the schedule and shall promptly submit proposed revisions in the progress schedule for acceptance by the Engineer.

The Engineer will periodically check actual progress of the Work against the progress schedule a minimum of two (2) times per month. Failure, without just cause, to maintain progress in accordance with the approved schedule shall constitute a breach of Contract and shall constitute reason for invoking pertinent portions of the Standard Specifications and Special Provisions. If, through no fault of the Contractor, the proposed construction schedule cannot be met, the Engineer will require the Contractor to submit a revised schedule to the Engineer for acceptance. The approved revisions will thereafter, in all respects, apply in lieu of the original schedule.

Failure of the Contractor to follow the progress schedule submitted and accepted, including revisions thereof, shall relieve the Contracting Agency of any and all responsibility for furnishing and making available all or any portion of the job site from time to time, and will relieve the Contracting Agency of any responsibility for delays to the Contractor in the performance of the Work.

The cost of preparing the progress schedule, any supplementary progress schedules, and weekly schedules shall be included in the various lump sum items of the Contract and no other compensation shall be made.

Add the following new section:

(****)

1-08.3(1) ORDER OF WORK

The work shall be completed in accordance with the plans and the following:

The contractor shall develop an order of work plan subject to review by the Project Engineer and Intercity Transit. The plan must demonstrate to the Engineer that it has minimal impact on local traffic, business and residents and accommodates pedestrian/bicycle traffic. The plan must demonstrate that the Work can be completed within the allowable Working Days. The Engineer/Intercity Transit will have 5 calendar days to review and comment.

1-08.4 Prosecution of Work

Delete this section and replace it with the following:

1-08.4 Notice to Proceed and Prosecution of Work

(July 23, 2015 APWA GSP)

Notice to Proceed will be given after the contract has been executed and the contract bond and evidence of insurance have been approved and filed by the Contracting Agency. The Contractor shall not commence with the work until the Notice to Proceed has been given by the Engineer. The Contractor shall commence construction activities on the project site within ten days of the Notice to Proceed Date, unless otherwise approved in writing. The Contractor shall diligently pursue the work to the physical completion date within the time specified in the contract. Voluntary shutdown or slowing of operations by the Contractor shall not relieve the Contractor of the responsibility to complete the work within the time(s) specified in the contract.

When shown in the Plans, the first order of work shall be the installation of high visibility fencing to delineate all areas for protection or restoration, as described in the Contract. Installation of high visibility fencing adjacent to the roadway shall occur after the placement of all necessary signs and traffic control devices in accordance with 1-10.1(2). Upon construction of the fencing, the Contractor shall request the Engineer to inspect the fence. No other work shall be performed on the site until the Contracting Agency has accepted the installation of high visibility fencing, as described in the Contract.

1-08.5 Time for Completion

(November 30, 2018 APWA GSP, Option A)

Revise the third and fourth paragraphs to read:

Contract time shall begin on the first working day following the Notice to Proceed Date.

Each working day shall be charged to the contract as it occurs, until the contract work is physically complete. If substantial completion has been granted and all the authorized working days have been used, charging of working days will cease. Each week the Engineer will provide the Contractor a statement that shows the number of working days: (1) charged to the contract the week before; (2) specified for the physical completion of the contract; and (3) remaining for the physical completion of the contract. The statement will also show the

nonworking days and any partial or whole day the Engineer declares as unworkable. Within 10 calendar days after the date of each statement, the Contractor shall file a written protest of any alleged discrepancies in it. To be considered by the Engineer, the protest shall be in sufficient detail to enable the Engineer to ascertain the basis and amount of time disputed. By not filing such detailed protest in that period, the Contractor shall be deemed as having accepted the statement as correct. If the Contractor is approved to work 10 hours a day and 4 days a week (a 4-10 schedule) and the fifth day of the week in which a 4-10 shift is worked would ordinarily be charged as a working day then the fifth day of that week will be charged as a working day whether or not the Contractor works on that day.

(****)

The project shall be Substantially Completed within 28 working days after the date when the Contract Time commences to run as specified in Section 1-08.4 of the APWA Supplement. Upon Substantial Completion of all Work required by the Contract, the Engineer will provide the Contractor in writing with a punch-list of items to complete prior to being ready for Final Inspection. The Contractor shall have 7 working days after Substantial Completion to complete the punch-list items in preparation for Final Inspection. The project shall be Physically Completed in a total of 42 working days. The Contractor shall schedule and conduct operations such that all Work conforms to the Plans, Specifications, and other requirements of the Contract.

Upon or prior to Substantial Completion date, the Engineer and Intercity Transit shall conduct an inspection with the Contractor to determine that the following items have been successfully accomplished in order to consider the project "Substantially Complete".

- Installation of the bus stop pad
- Sidewalk construction
- Installation of utility relocations/adjustments of storm drainage facilities
- Pavement repair
- Site grading
- Site restoration

After this inspection, the Engineer will give the Contractor written notice of the Substantial Completion date and will be given a punch-list of Contract Work items to be completed prior to Final inspection in accordance with Section 1-05.00. The Contractor shall notify the Engineer that the project is ready for Final inspection upon completion of the punch-list items upon or prior to the Physical Completion date of the Contract. After all the Contractor's obligations under the Contract have been performed by the Contractor, the Engineer will provide the Contractor notification of the date of Physical Completion in accordance with Section 1-05.12, however, this will not constitute final acceptance of the Work by the Contracting Agency.

Section 1-08.5 is supplemented with the following:

(****)

All references to "working days" in this Section shall be synonymous with "calendar days". Delete all references to "non-working day(s)" in the first paragraph. All calendar days including Saturday, Sunday and holidays shall be considered working days; therefore, working days and calendar days will be used interchangeably in these Specifications for this project.

If the Contractor elects to Work on weekends and Holidays, the Contracting Agency reserves the right to change the Contractor for additional Construction Administration services for weekend and overtime hours worked in accordance with APWA Section 1-08.0(3). The

Contractor shall notify the Contracting Agency in writing prior to working weekends and holidays.

1-08.9 Liquidated Damages
(December 2, 2019 APWA GSP)

Revise the fourth paragraph to read:

When the Contract Work has progressed to Substantial Completion as defined in the Contract, the Engineer may determine that the work is Substantially Complete. The Engineer will notify the Contractor in writing of the Substantial Completion Date. For overruns in Contract time occurring after the date so established, the formula for liquidated damages shown above will not apply. For overruns in Contract time occurring after the Substantial Completion Date, liquidated damages shall be assessed on the basis of direct engineering and related costs assignable to the project until the actual Physical Completion Date of all the Contract Work. The Contractor shall complete the remaining Work as promptly as possible. Upon request by the Project Engineer, the Contractor shall furnish a written schedule for completing the physical Work on the Contract.

1-08.10 Removal of Equipment

Section 1-08.10 is supplemented with the following:

(****)

In case of termination of this Contract before completion for any cause whatever, the Contractor, if notified to do so by the Contracting Agency, shall promptly remove all Contractor-owned equipment and supplies from the property of the Contracting Agency and, if the Contractor fails to do so within five (5) calendar days from such notice by the Contracting Agency, the Contracting Agency shall have the right to remove such equipment and supplies at the expense of the Contractor, deducting the cost thereof from any funds otherwise due the Contractor.

1-09 Measurement and Payment

1-09.7 Mobilization

Section 1-09.7 is supplemented with the following:

(****)

The Contractor shall include all costs for Mobilization in the lump sum price for each site improvement. No additional or separate payment shall be made for Mobilization.

Items which are included in mobilization include but are not limited to: the movement of the Contractor's personnel, equipment, supplies, and incidentals to and from the project site; the establishment of the Contractor's office, buildings, and other facilities necessary for Work on the project; providing sanitary facilities for the Contractor's personnel; obtaining permits or licenses required to complete the project not furnished by the Contracting Agency; other Work and operations which must be performed or costs that must be incurred.

The Contractor shall also include any and all costs for remobilizing temporary shut downs and or time extensions due to abnormal weather conditions in the lump sum price for each site improvement.

1-09.9 Payments

Section 1-09.9 is supplemented with the following:

(****)

Applications for payment shall be itemized and supported to the extent required by the Engineer by receipts or other vouchers showing payment for materials and labor, payments to Subcontractors, and other such evidence of the Contractors right to payment as the Engineer may direct. The Contractor shall submit a progress report with each monthly request for a progress payment. The progress report shall indicate the estimated percent complete for each activity listed on the progress

1-09.9(1) Retainage

Section 1-09.9(1) content and title is deleted and replaced with the following:

(June 27, 2011)

Vacant

1-09.13(3) Claims \$250,000 or Less

(October 1, 2005 APWA GSP)

Delete this section and replace it with the following:

The Contractor and the Contracting Agency mutually agree that those claims that total \$250,000 or less, submitted in accordance with Section 1-09.11 and not resolved by nonbinding ADR processes, shall be resolved through litigation unless the parties mutually agree in writing to resolve the claim through binding arbitration.

1-09.13(3)A Administration of Arbitration

(July 23, 2015 APWA GSP)

Revise the third paragraph to read:

The Contracting Agency and the Contractor mutually agree to be bound by the decision of the arbitrator, and judgment upon the award rendered by the arbitrator may be entered in the Superior Court of the county in which the Contracting Agency's headquarters is located, provided that where claims subject to arbitration are asserted against a county, RCW 36.01.05 shall control venue and jurisdiction of the Superior Court. The decision of the arbitrator and the specific basis for the decision shall be in writing. The arbitrator shall use the Contract as a basis for decisions.

1-10 Temporary Traffic Control

1-10.2 Traffic Control Management

Section 1-10.2(1) is supplemented with the following:

(January 3, 2017)

Only training with WSDOT TCS card and WSDOT training curriculum is recognized in the State of Washington. The Traffic Control Supervisor shall be certified by one of the following:

The Northwest Laborers-Employers Training Trust
27055 Ohio Ave.
Kingston, WA 98346
(360) 297-3035

Evergreen Safety Council
12545 135th Ave. NE
Kirkland, WA 98034-8709
1-800-521-0778

The American Traffic Safety Services Association
15 Riverside Parkway, Suite 100
Fredericksburg, Virginia 22406-1022
Training Dept. Toll Free (877) 642-4637
Phone: (540) 368-1701

1-10.2(2) TRAFFIC CONTROL PLANS

Section 1-10.2(2) is supplemented with the following:

(****)

The Contractor shall be fully responsible for traffic control on the project. All signing, cones and barricades shall conform to the requirements of the current edition of the Manual on Uniform Traffic Control Devices. The Contractor shall prepare a Traffic Control Plan(s) showing the necessary construction traffic control and equipment required for the project. The Traffic Control Plan(s) shall be submitted to the Engineer and local jurisdictions for review and approval at the Pre-Construction Conference in advance of the commencement of Work. The Traffic Control Plan(s) shall identify lane restriping, closures, and pedestrian traffic control that are planned throughout the construction of the project; the Traffic Control Plan(s) shall be updated as appropriate or required by the Contracting Agency for the duration of construction. The Traffic Control Plan(s) shall designate the responsible person in charge of traffic control and furnish Work and emergency telephone numbers.

1-10.5 Payment

Section 1-10.5 is supplemented with the following:

(*****)

The Contractor shall include all costs for Project Temporary Traffic Control in the lump sum price "Bus Stop NO. _____" when involving this item of Work.

Division 2 Earthwork

2-01 CLEARING, GRUBBING, AND ROADSIDE CLEANUP

2-01.3 (4) ROADSIDE CLEANUP

Section 2-01.1 is supplemented with the following:

(*****)

Property Restoration shall include private property restoration, Roadside Cleanup per Section 2-01, and Trimming and Cleanup per Section 2-11.

The Contractor shall restore all areas damaged (disturbed) by construction operations to their original or better condition. This may include cleaning, pruning, and restoring fencing, vegetation, and other objects or structures not covered by a specific bid item.

All finished pruning must be done according to recognized, approved standards of the industry (reference the National Arborist Association Pruning Standards for Shade Trees [NAAPSST]). All pruning shall be done in accordance with the Class II requirements, as described in NAAPSST. The Contractor shall trim all vegetation adjacent to and above the new improvements such that there is a vertical clearance of 9 feet from the surface and 1 foot from the sides of the new improvements.

Section 2-01.3(4) is supplemented with the following:

(****)

6. Blending of new construction into developed properties adjacent to or within project Right-of-Way using similar materials to those existing (e.g. sod shall be used to match into lawn areas, bark shall be used to match into planting areas, topsoil shall be used to match into garden areas, etc.).

2-01.5 Payment

The first and second paragraphs of Section 2-01.5 are revised to read:

(****)

The Contractor shall include all costs for Roadside Cleanup in the lump sum price "Bus Stop NO. _____" when involving this item of Work.

2-02 REMOVAL OF STRUCTURES AND OBSTRUCTIONS

2-02.3 Construction Requirements

Section 2-02.3 is supplemented with the following:

(****)

Removing Cement Concrete Sidewalk or Driveway

Where shown in the Plans and as directed by the Engineer, the Contractor shall remove existing cement concrete sidewalk or driveway.

Prior to removal, the Contractor shall make a vertical saw cut the full depth of the sidewalk or driveway to delineate the areas of sidewalk or driveway removal from those areas of sidewalk or driveway to remain. The saw cut shall occur at an existing score line, expansion joint, or as directed by the Engineer.

The removed sidewalk or driveway shall become the property of the Contractor and shall be removed from the project.

Damage caused to portions of the sidewalk or driveway to remain, due to the Contractor's operation, shall be repaired by the Contractor at the Contractor's expense and to the satisfaction of the Engineer.

Removing Asphalt Concrete Pavement

Where shown in the Plans and as directed by the Engineer, the Contractor shall remove existing asphalt pavement.

Prior to removal, the Contractor shall make a vertical saw cut the full depth of the pavement to delineate the areas of pavement removal from those areas of pavement to remain.

The removed pavement shall become the property of the Contractor and shall be removed from the project.

Removing Plants

Where shown in the Plans and as directed by the Engineer, the Contractor shall remove existing plants.

At the time of removal, the Contractor shall use an approved method to remove the plant with as little damage to the surrounding landscaping as possible.

The removed plants shall become the property of the Contractor and shall be removed from the project.

Damage caused to surrounding landscaping to remain, due to the Contractor's operation, shall be repaired by the Contractor at the Contractor's expense and to the satisfaction of the Engineer.

Removing Signs

Where shown in the Plans and as directed by the Engineer, the Contractor shall remove existing signs.

At the time of removal, the Contractor shall use an approved method to remove the sign with as little damage to the surrounding landscaping as possible. The Contractor shall place the sign in a five gallon concrete bucket with concrete for removal and backfill with crushed surfacing top course.

Damage caused to surrounding landscaping to remain, due to the Contractor's operation, shall be repaired by the Contractor at the Contractor's expense and to the satisfaction of the Engineer.

Removing Existing Foundations

The existing bus stop signs will be cut off at the concrete base and removed from site by Intercity Transit (contractor to coordinate). Contractor will be responsible for removal and disposal of existing concrete base as noted on the plans.

2-02.5 Payment

Section 2-02.5 is supplemented with the following:

(****)

The Contractor shall include all costs for Removal of Structures and Obstructions in the lump sum price "Bus Stop NO. _____" when involving this item of Work.

2-03 ROADWAY EXCAVATION AND EMBANKMENT

2-03.5 Payment

Section 2-03.5 is supplemented with the following:

(****)

The Contractor shall include all costs for Roadway Excavation Including Haul, and Gravel Borrow Including Haul in the lump sum price "Bus Stop NO. _____" when involving this item of Work.

2-09 STRUCTURE EXCAVATION

2-09.5 Payment

Section 2-09.5 is supplemented with the following:

(****)

The Contractor shall include all costs for Structure Excavation Class A Including Haul in the lump sum price "Bus Stop NO. _____" when involving this item of Work.

**Division 4
Bases**

4-04 BALLAST AND CRUSHED SURFACING

4-04.5 Payment

Section 4-04.5 is supplemented with the following:

(*****)

The Contractor shall include all costs for Crushed Surfacing Base Course and Crushed Surfacing Top Course in the lump sum price "Bus Stop NO. _____" when involving this item of Work.

Division 7
Drainage Structures, Storm Sewers, Sanitary
Sewers, Water Mains, and Conduits

7-02 CULVERTS

7-02.5 Payment

Section 7-02.5 is supplemented with the following:

(***)**

The Contractor shall include all costs for all types and sizes of culvert pipe in the lump sum price "Bus Stop NO. _____" when involving this item of Work.

**Division 8
Miscellaneous Construction**

8-01 EROSION CONTROL AND WATER POLLUTION CONTROL

8-01.5 Payment

Section 8-01 .5 is supplemented with the following:

(*****)

The Contractor shall include all costs for Inlet Protection in the lump sum price “Bus Stop NO. _____” when involving this item of Work.

8-02 ROADSIDE RESTORATION

8-02-03 Construction Requirements

8-02.3(4) Topsoil

8-02.3(4)A Topsoil Type A

Section 8-02.3(4)A is supplemented with the following:

(*****)

Topsoil Type A shall be a commercially available three-way mix.

8-02.5 Payment

Section 8-02.5 is supplemented with the following:

(*****)

The Contractor shall include all costs for Roadside Restoration and Topsoil Type A in the lump sum price for “Bus Stop NO. _____” when involving this item of Work.

8-04 CURBS, GUTTERS, AND SPILLWAYS

8-04.3 Construction Requirements

Section 8-04.3 is supplemented with the following:

The Contractor shall set either a string line grade or construct formwork for the proposed gutter and curb lines after the initial staking. Prior to ordering and placing concrete, the Contractor shall provide a twenty-four (24) hour notice for the Engineer’s approval of string line grade or formwork placement. The Contractor shall attend the review with the Engineer and shall allow sufficient time for any final vertical adjustment of string line or forms ordered by the Engineer prior to placing concrete. The Engineer will interpolate and adjust gutter and curb profiles in the field as necessary to provide pavement cross slopes and gutter flow line grades that are adequate for Roadway and parking area drainage. No adjustment or cause for claim shall be allowed for final adjustment of forms or string line by the Engineer as a result of this review.

The top of the finished concrete shall not deviate more than 1/8” in 10’, or the alignment 1/4” in 10’.

Cement concrete curb and/or gutter shall be constructed within their respective jurisdictions, or as shown in plans.

Cement concrete pedestrian curb shall be constructed as shown on the plans.

Cement concrete integral curb, integral to cement concrete bus shelter pads, shall be constructed as shown on the plans.

Curb transitions constructed as shown in the Plans.

The Contractor shall coordinate and complete all required construction inspections by the local agency.

See plans for additional construction inspection requirements.

8-04.3(1) Cement Concrete Curbs, Gutters, and Spillways`

The first paragraph of Section 8-04.3(1) is replaced with the following:

(*****)

Cement Concrete curb, curb and gutter, and spillway shall be constructed with air entrained concrete Class 4000 conforming to the requirements of Section 6-02.

Section 8-04.3(1) is supplemented with the following:

(*****)

White pigmented curing compounds will not be allowed.

8-04.5 Payment

Section 8-04.5 is supplemented with the following:

(*****)

The Contractor shall include all costs for Cement Concrete Curb and Gutter, Cement Concrete Pedestrian Curb, and Integral Curb in the lump sum price "Bus Stop NO. _____" when involving this item of Work.

(*****)

8-05 BUS STOP PADS

Section 8-05 is added as follows:

8-05.1 Description

This Works consists of removal of materials, constructing cement concrete bus stop pads, sidewalks, storm drainage facilities, and repair of roadways and adjacent surfaces of mulch, grass, and concrete in accordance with details shown in the Plans and these Specifications, and in conformity to lines and grades shown in the Plans or as directed by the Engineer.

8-05.2 Materials

Materials shall meet the requirements of the following Sections:

Portland Cement	9-01
Aggregates	9-03
Premolded Joint Filler	9-04.1
Cement Curing Materials and Admixtures	9-23

8-05.3 Construction Requirements

Cement concrete bus pads shall be constructed with air entrained concrete Class 4000 conforming to the requirements of Section 6-02.

Cement concrete bus pads shall be constructed in accordance with Section 8-14.

It is suggested that the Contractor phase the bus pad construction Work so that not more than five sites (pads) are under construction at any time.

Prior to the Contractor's bus pad construction Work, the Contracting Agency will remove existing bus stop sign (agency will cut off sign post at base) and shelters. The Contractor shall contact the Contracting Agency at least seven (7) calendar days prior to beginning Work on any specific bus stop location. The Contracting Agency contact is:

Mike Burnham, Project Coordinator
Intercity Transit
526 Pattison Street SE
Olympia, WA 98501
(360) 705-5877

The Contractor shall provide preliminary bus pad locations for review by the Engineer, prior to beginning any bus pad construction. Final bus pad locations shall be as approved by the Engineer.

When the bus pad abuts sidewalk or curb, expansion joints shall be constructed in accordance with Section 8-14.3(3).

The Contractor shall be responsible for barricading, patrolling, or otherwise protecting newly placed concrete. Damaged, vandalized, or unsightly concrete shall be removed and replaced at the Contractor's expense.

8-05.5 Payment

Payment will be made for the following bid item

"Bus Stop No. _____" lump sum.

All costs for mobilizations, project temporary traffic control, removal of structures and obstructions, sawcutting, roadway excavation including haul, crushed surfacing top course, HMA, topsoil, handrail, property restoration, rebar, culvert pipe, cement concrete traffic curbs, pedestrian curbs, curb and gutter, cement concrete sidewalk, bus stop pads, shelter pads, and ramps of the type shown in the Plans, and detectable warning surface including barricading, patrolling, or otherwise protecting newly placed concrete, shall be included in the lump sum contract prices(s) for "Bus Stop No _____".

(*****)

8-19 LAWN AND LANDSCAPE RESTORATION

Add the following new section:

8-19.1 Description

The Contractor shall take every precaution to preserve and protect existing lawn and landscape areas including existing irrigation systems. Only those landscaped areas necessary for construction shall be disturbed. All lawn areas and landscaping damaged or removed shall be repaired as directed by the Engineer. Lawn areas damaged or removed shall be restored with sod as directed by the Engineer.

8-19.3 Construction Requirements

The Contractor shall repair any impacts to existing irrigation systems, vegetation, fencing, culverts, ditch sections, or any other objects or structures that are not covered by a specific bid item. Restoration shall return anything damaged by construction to their original condition or to a condition superior to the original condition. The Contractor shall be responsible to evaluate the site prior to bidding this project to determine the areas to be affected by the particular construction method or machinery proposed to be used.

8-19.5 Payment

The Contractor shall include all costs for “Lawn and Landscape Restoration” in the lump sum price for “Bus Stop NO. _____” when involving this item of Work.

The lump sum price for “Bus Stop NO. _____” shall include pay for all labor, materials, and equipment to restore the project site to condition equal to, or superior to the original condition.

Division 9 Materials

(February 5, 2020)

Standard Plans

The State of Washington Standard Plans for Road, Bridge and Municipal Construction M21-01 transmitted under Publications Transmittal No. PT 16-048, effective September 3, 2019 is made a part of this contract.

The Standard Plans are revised as follows:

A-50.10

Sheet 2 of 2, Plan, with Single Slope Barrier, reference C-14a is revised to C-70.10

A-50.20

Sheet 2 of 2, Plan, with Anchored Barrier, reference C-14a is revised to C-70.10

A-50.30

Sheet 2 of 2, Plan (top), reference C-14a is revised to C-70.1

B-10.60

DELETED

B-82.20

DELETED

B-90.40

Valve Detail – DELETED

C-1

Delete Note 1.

Revise Note 2 to read “Remove all rail washers, also called “Snow Load Rail Washers”, when encountered during raising beam guardrail work and the guardrail raising work requires removal of the rail.

Re-number all notes.

C-4b

DELETED

C-4e

DELETED

C-8a

Delete “Section A-A, Type 4 Detail

C-20.11

Delete Notes 1 & 2. Re-Number all notes.

Delete “ Snow Load Post Washer” and “Snow Load Rail Washer” details.

C-20.19
DELETED

C-22.14
DELETED

C-22.16
Note 3, formula, was: "Elevation G = (Elevation S – D x (0.1) + 31" is revised to read: "Elevation G = (Elevation S – D x (0.1) + 31/12"

C-22.45
For the SOFTSTOP (TL-2) elevation view detail, the callout "SOFTSTOP (TL-2) SYSTEM LENGTH = 38' – 4 1/2'" is revised to read "SOFTSTOP (TL-2) SYSTEM LENGTH = 38' – 3 1/2"

C-40.14
DELETED

C-60.10
Sheet 1, Side Elevation: The bottom set of ① - #4 horizontal rebar (2x) located at the base of the barrier is repositioned to be aligned with the bottom of ② - #4 stirrup bars to match the bar positioning shown on Sheet 1, Section A.

Sheet 1, Reinforcing Steel Bending Diagram, ③ - Pin Slot Bar detail: Add the following callout to the detail, "HOT DIP GALVANIZE AFTER FABRICATION (ASTM A123 OR AASHTO M 111)".

Sheet 2, ANCHORING PIN ASSEMBLY DETAIL: The first line of the description under the title was "1 1/2" DIAMETER (ASTM A36), COLD ROLL" is now changed to "1 1/2" DIAMETER (ASTM A36), HOT ROLL".

C-70.10
Sheet 1, Note 1 was - "1. PERMANENT INSTALLATION requirements: Embed barrier 3" (in) minimum; ..." is revised to read: "1. Installation requirements: Embed barrier 3" (in) minimum in asphalt or concrete; embed barrier 10" (in) minimum in soil; ..."

Sheet 1, existing Notes 2 and 4 are deleted. Existing Note 3 is renumbered to Note 2.

Sheet 1, add new Note 3, "3. See Sheet 2 for barrier with a 2'-10" reveal installed in asphalt or concrete. See Sheet 3 for barrier with a 3'-6" reveal installed in asphalt or concrete."

Sheet 1, Elevation: The dimension from the barrier end to the barrier lifting slot was "3' – 4" (TYP)" is now changed to "4' – 8" (TYP)", and the barrier lifting slot dimension was "5' – 0" (TYP)" is now changed to "3' – 0" (TYP)".

Sheet 2, the detail titled "3' – 6" BARRIER FOR USE WITH A 0" (IN) TO 5" (IN) MAX. GRADE SEPARATION" has the following changes:

1. The detail title is changed to "3' – 6" BARRIER FOR USE WITH A 0" (IN) TO 4" (IN) MAX. GRADE SEPARATION".
2. The callout "GRADE SEPARATION--5" MAX." is changed to "GRADE SEPARATION--4" MAX."

C-75.10

Note 2 is deleted. Renumber subsequent notes.

C-75.20

Note 2 is deleted. Renumber subsequent notes.

C-75.30

Note 2 is deleted. Renumber subsequent notes.

C-85.11

Add new Note 3 “3. The intended use of this plan is for placing concrete barrier in front of bridge piers on bridge retrofit projects only. Contact the HQ Bridge traffic barrier specialist before using this barrier placement plan for projects involving new or reconstructed bridges.”

C-85.14

DELETED

C-90.10

DELETED

D-10.10

Wall Type 1 may be used if no traffic barrier is attached on top of the wall. Walls with traffic barriers attached on top of the wall are considered non-standard and shall be designed in accordance with the current WSDOT Bridge Design Manual (BDM) and the revisions stated in the 11/3/15 Bridge Design memorandum.

D-10.15

Wall Type 2 may be used if no traffic barrier is attached on top of the wall. Walls with traffic barriers attached on top of the wall are considered non-standard and shall be designed in accordance with the current WSDOT BDM and the revisions stated in the 11/3/15 Bridge Design memorandum.

D-10.30

Wall Type 5 may be used in all cases.

D-10.35

Wall Type 6 may be used in all cases.

D-10.40

Wall Type 7 may be used if no traffic barrier is attached on top of the wall. Walls with traffic barriers attached on top of the wall are considered non-standard and shall be designed in accordance with the current WSDOT BDM and the revisions stated in the 11/3/15 Bridge Design memorandum.

D-10.45

Wall Type 8 may be used if no traffic barrier is attached on top of the wall. Walls with traffic barriers attached on top of the wall are considered non-standard and shall be designed in accordance with the current WSDOT BDM and the revisions stated in the revisions stated in the 11/3/15 Bridge Design memorandum.

D-15.10

STD Plans D-15 series “Traffic Barrier Details for Reinforced Concrete Retaining Walls” are withdrawn. Special designs in accordance with the current WSDOT BDM are required in place of these STD Plans.

D-15.20

STD Plans D-15 series “Traffic Barrier Details for Reinforced Concrete Retaining Walls” are withdrawn. Special designs in accordance with the current WSDOT BDM are required in place of these STD Plans.

D-15.30

STD Plans D-15 series “Traffic Barrier Details for Reinforced Concrete Retaining Walls” are withdrawn. Special designs in accordance with the current WSDOT BDM are required in place of these STD Plans.

F-10.12

Section Title, was – “Depressed Curb Section” is revised to read: “Depressed Curb and Gutter Section”

F-10.40

“EXTRUDED CURB AT CUT SLOPE”, Section detail - Deleted

F-10.42

DELETE – “Extruded Curb at Cut Slope” View

G-25.10

Key Note 3, second sentence, was – “For single-post installations, divide the (#2w/diamond shape symbol) post MAX. XYZ in half.” Is revised to read: “For single-post installations, divide the two-post MAX. XYZ in half.”

G-60.10

DELETED

G-60.20

DELETED

G-60.30

DELETED

G-70.10

DELETED

G-70.20

DELETED

H-70.20

Sheet 2, Spacing Detail, Mailbox Support Type 1, reference to Standard Plan I-70.10 is revised to H-70.10

J-10.21

Note 18, was – “When service cabinet is installed within right of way fence, see Standard Plan J-10.22 for details.” Is revised to read; “When service cabinet is installed within right of way fence, or the meter base is mounted on the exterior of the cabinet, see Standard Plan J-10.22 for details.”

J-10.22

Key Note 1, was – “Meter base per serving utility requirements~ as a minimum, the meter base shall be safety socket box with factory-installed test bypass facility that meets the requirements of EUSERC drawing 305.” Is revised to read; “Meter base per serving utility requirements~ as a minimum, the meter base shall be safety socket box with factory-installed test bypass facility that meets the requirements of EUSERC drawing 305. When the utility requires meter base to be mounted on the side or back of the service cabinet, the meter base enclosure shall be fabricated from type 304 stainless steel.”

Key Note 4, “Test with (SPDT Snap Action, Positive close 15 Amp – 120/277 volt “T” rated). Is revised to read: “Test Switch (SPDT snap action, positive close 15 amp – 120/277 volt “T” rated).”

Key Note 14, was – “Hinged dead front with ¼ turn fasteners or slide latch.” Is revised to read; “Hinged dead front with ¼ turn fasteners or slide latch. ~ Dead front panel bolts shall not extend into the vertical limits of the breaker array(s).”

Key Note 15, was – “Cabinet Main Bonding Jumper. Buss shall be 4 lug tinned copper. See Cabinet Main bonding Jumper detail, Standard Plan J-3b.” is revised to read; “Cabinet Main Bonding Jumper Assembly ~ Buss shall be 4 lug tinned copper ~ See Standard Plan J-10.20 for Cabinet Main Bonding Jumper Assembly details.”

Note 1, was – “...socket box mounting detail, see Standard Plan J-3b.” is revised to read to read: “...socket box mounting detail, see Standard Plan J-10.20.”

Note 6, was – “...See door hinge detail, Standard Plan J-3b.” is revised to read: “...See door hinge detail, Standard Plan J-10.20.”

J-20.26

Add Note 1, “1. One accessible pedestrian pushbutton station per pedestrian pushbutton post.”

J-20.16

View A, callout, was – LOCK NIPPLE, is revised to read; CHASE NIPPLE

J-21.10

Sheet 1, Elevation View, Round Concrete Foundation Detail, callout – “ANCHOR BOLTS ~ ¾” (IN) x 30” (IN) FULL THREAD ~ THREE REQ'D. PER ASSEMBLY” IS REVISED TO READ: “ANCHOR BOLTS ~ ¾” (IN) x 30” (IN) FULL THREAD ~ FOUR REQ'D. PER ASSEMBLY”

Sheet 1 of 2, Elevation view (Round), add dimension depicting the distance from the top of the foundation to find 2 #4 reinforcing bar shown, to read; 3” CLR.. Delete “(TYP.)” from the 2 ½” CLR. dimension, depicting the distance from the bottom of the foundation to find 2 # 4 reinf. Bar.

Sheet 1 of 2, Elevation view (Square), add dimension depicting the distance from the top of the foundation to find 1 #4 reinforcing bar shown, to read; 3” CLR. Delete “(TYP.)” from the 2 ½” CLR. dimension, depicting the distance from the bottom of the foundation to find 1 # 4 reinf. Bar.

Sheet 2 of 2, Elevation view (Round), add dimension depicting the distance from the top of the foundation to find 2 #4 reinforcing bar shown, to read; 3” CLR. Delete “(TYP.)” from the 2 ½” CLR. dimension, depicting the distance from the bottom of the foundation to find 2 # 4 reinf. Bar.

Sheet 2 of 2, Elevation view (Square), add dimension depicting the distance from the top of the foundation to find 1 #4 reinforcing bar shown, to read; 3" CLR. Delete "(TYP.)" from the 2 1/2" CLR. dimension, depicting the distance from the bottom of the foundation to find 1 # 4 reinf. Bar.

Detail F, callout, "Heavy Hex Clamping Bolt (TYP.) ~ 3/4" (IN) Diam. Torque Clamping Bolts (see Note 3)" is revised to read; "Heavy Hex Clamping Bolt (TYP.) ~ 3/4" (IN) Diam. Torque Clamping Bolts (see Note 1)"

Detail F, callout, "3/4" (IN) x 2' - 6" Anchor Bolt (TYP.) ~ Four Required (See Note 4)" is revised to read; "3/4" (IN) x 2' - 6" Anchor Bolt (TYP.) ~ Three Required (See Note 2)"

J-21.15

Partial View, callout, was - LOCK NIPPLE ~ 1 1/2" DIAM., is revised to read; CHASE NIPPLE ~ 1 1/2" (IN) DIAM.

J-21.16

Detail A, callout, was - LOCKNIPPLE, is revised to read; CHASE NIPPLE

J-22.15

Ramp Meter Signal Standard, elevation, dimension 4' - 6" is revised to read; 6'-0"
(2x) Detail A, callout, was - LOCK NIPPLE ~ 1 1/2" DIAM. is revised to read; CHASE NIPPLE ~ 1 1/2" (IN) DIAM.

J-28.24

Case E and Case F Section View dimension callout, "3' - 0" MIN. FOR BEAM GUARDRAIL, 4' - 0" MIN. FOR CONC. BARRIER TYPE 2" is revised to read, "5' - 0" MIN. FOR BEAM GUARDRAIL, 8' - 0" MIN. FOR UNANCHORED TYPE F CONC. BARRIER, 4' - 0" MIN. FOR ANCHORED TYPE F CONC. BARRIER".

J-40.10

Sheet 2 of 2, Detail F, callout, "12 - 13 x 1 1/2" S.S. PENTA HEAD BOLT AND 12" S. S. FLAT WASHER" is revised to read; "12 - 13 x 1 1/2" S.S. PENTA HEAD BOLT AND 1/2" (IN) S. S. FLAT WASHER"

J-75.20

Key Notes, note 16, second bullet point, was: "1/2" (IN) x 0.45" (IN) Stainless Steel Bands", add the following to the end of the note: "Alternate: Stainless steel cable with stainless steel ends, nuts, bolts, and washers may be used in place of stainless steel bands and associated hardware."

J-81.10

Power Distribution Block Diagram, lower left corner, Sheet 1 of 3; Switch Pack 2; circuit 623 (T4-5) [middle ckt] is revised to read; circuit **622 (T4-5)**.

K-80.10

SIGN INSTALLATION (BEHIND TRAFFIC BARRIER) detail dimension callout, "3' MIN." is revised to read, "5' MIN.".

K-80.30

DELETED

K-80.35

Add New Note 1 – “1. The intended use of this plan is for the temporary installation of Type 2 concrete barrier (See Standard Plan C-8) on cement concrete pavement, bridge decks, or hot mix asphalt pavement, and Type F concrete barrier on cement concrete pavement or bridge decks.

Re-number all notes.

The TYPE 1 ANCHOR detail description “TEMPORARY INSTALLATION OF PRECAST CONC. BARRIER TYPE 2 (STD. PLAN C-8) AND TEMPORARY CONC. BARRIER (F-SHAPE) (STD. PLAN K-80.30) ON CEMENT CONC. PAVEMENT OR BRIDGE DECK” is revised to read, “TEMPORARY INSTALLATION OF PRECAST CONC. BARRIER TYPE F (STD. PLAN C-60.10) OR PRECAST CONC. BARRIER TYPE 2 (STD. PLAN C-8) ON CEMENT CONC. PAVEMENT OR BRIDGE DECK.”

The TYPE 3 ANCHOR detail description “TEMPORARY INSTALLATION OF PRECAST CONC. BARRIER TYPE 2 (STD. PLAN C-8) AND TEMPORARY CONC. BARRIER (F-SHAPE) (STD. PLAN K-80.30) ON HOT MIX ASPHALT PAVEMENT” is revised to read, “TEMPORARY INSTALLATION OF PRECAST CONC. BARRIER TYPE 2 (STD. PLAN C-8) ON HOT MIX ASPHALT PAVEMENT.”

K-80.37

Revise Note 1 to read: “1. The intended use of this plan is for the temporary installation of Type F NARROW BASE concrete barrier (See Standard Plan C-60.10) or Type 4 (Type 2 Narrow Base – See Std. Plan C-8a) Concrete Barrier on cement concrete pavement, bridge decks.”

Replace all callouts stating “NARROW BASE, ALTERNATIVE TEMPORARY CONCRETE BARRIER SEGMENT” with “Type F NARROW BASE or Type 4 (Type 2 Narrow Base) concrete barrier segment.”

M-3.50

Double-Left Turn Channelization (with Right Turn Pocket) view, dimension, upper left corner, “taper” dimension; callout – was “40’ if Posted Speed is 40 MPH or less 100’ if Posted Speed is more than 40 MPH” is revised to read; “See Contract”

M-5.10

Right-Turn Channelization view, dimension, upper right corner, “taper” dimension; callout – was “50’ MIN.” is revised to read; “See Contract”

M-12.10

Add Note 5. “Check with Region Traffic Office for RPM and Guidepost placements.”

M-24.50

DELETED

The following are the Standard Plan numbers applicable at the time this project was advertised. The date shown with each plan number is the publication approval date shown in the lower right-hand corner of that plan. Standard Plans showing different dates shall not be used in this contract.

A-10.10-00.....8/7/07	A-40.00-00.....8/11/09	A-50.30-00.....11/17/08
A-10.20-00.....10/5/07	A-40.10-04.....7/31/19	A-50.40-00.....11/17/08
A-10.30-00.....10/5/07	A-40.15-00.....8/11/09	A-60.10-03.....12/23/14
A-20.10-00.....8/31/07	A-40.20-04.....1/18/17	A-60.20-03.....12/23/14
A-30.10-00.....11/8/07	A-40.50-02.....12/23/14	A-60.30-01.....6/28/18
A-30.30-01.....6/16/11	A-50.10-00.....11/17/08	A-60.40-00.....8/31/07
A-30.35-00.....10/12/07	A-50.20-01.....9/22/09	

B-5.20-02.....1/26/17	B-30.50-03.....2/27/18	B-75.20-02.....2/27/18
B-5.40-02.....1/26/17	B-30.70-04.....2/27/18	B-75.50-01.....6/10/08
B-5.60-02.....1/26/17	B-30.80-01.....2/27/18	B-75.60-00.....6/8/06
B-10.20-02.....3/2/18	B-30.90-02.....1/26/17	B-80.20-00.....6/8/06
B-10.40-01.....1/26/17	B-35.20-00.....6/8/06	B-80.40-00.....6/1/06
B-10.70-00.....1/26/17	B-35.40-00.....6/8/06	B-85.10-01.....6/10/08
B-15.20-01.....2/7/12	B-40.20-00.....6/1/06	B-85.20-00.....6/1/06
B-15.40-01.....2/7/12	B-40.40-02.....1/26/17	B-85.30-00.....6/1/06
B-15.60-02.....1/26/17	B-45.20-01.....7/11/17	B-85.40-00.....6/8/06
B-20.20-02.....3/16/12	B-45.40-01.....7/21/17	B-85.50-01.....6/10/08
B-20.40-04.....2/27/18	B-50.20-00.....6/1/06	B-90.10-00.....6/8/06
B-20.60-03.....3/15/12	B-55.20-02.....2/27/18	B-90.20-00.....6/8/06
B-25.20-02.....2/27/18	B-60.20-01.....6/28/18	B-90.30-00.....6/8/06
B-25.60-02.....2/27/18	B-60.40-01.....2/27/18	B-90.40-01.....1/26/17
B-30.10-03.....2/27/18	B-65.20-01.....4/26/12	B-90.50-00.....6/8/06
B-30.15-00.....2/27/18	B-65.40-00.....6/1/06	B-95.20-01.....2/3/09
B-30.20-04.....2/27/18	B-70.20-00.....6/1/06	B-95.40-01.....6/28/18
B-30.30-03.....2/27/18	B-70.60-01.....1/26/17	
B-30.40-03.....2/27/18		

C-1.....6/28/18	C-20.15-02.....6/11/14	C-40.18-03.....7/21/17
C-1a.....7/14/15	C-20.18-03.....8/12/19	C-60.10-00.....8/22/19
C-1b.....8/12/19	C-20.19-03.....8/12/19	C-70.10-01.....6/17/14
C-1d.....10/31/03	C-20.40-07.....8/12/19	C-75.10-01.....6/11/14
C-2c.....8/12/19	C-20.41-02.....8/12/19	C-75.20-01.....6/11/14
C-4f.....8/12/19	C-20.42-05.....7/14/15	C-75.30-01.....6/11/14
C-6a.....10/14/09	C-20.45.02.....8/12/19	C-80.10-01.....6/11/14
C-7.....6/16/11	C-22.16-06.....7/21/17	C-80.20-01.....6/11/14
C-7a.....6/16/11	C-22.40-07.....8/12/19	C-80.30-01.....6/11/14
C-8.....2/10/09	C-22.45-04.....8/12/19	C-80.40-01.....6/11/14
C-8a.....7/25/97	C-23.60-04.....7/21/17	C-80.50-00.....4/8/12
C-8b.....2/29/16	C.24.10-02.....8/12/19	C-85.10-00.....4/8/12
C-8e.....2/21/07	C-25.20-06.....7/14/15	C-85.11-00.....4/8/12
C-8f.....6/30/04	C-25.22-05.....7/14/15	C-85.14-01.....6/11/14
C-16a.....7/21/17	C-25.26-04.....8/12/19	C-85.15-01.....6/30/14
C-20.10-05.....8/12/19	C-25.30-00.....6/28/18	C-85.16-01.....6/17/14
C-20.11-00.....7/21/17	C-25.80-05.....8/12/19	C-85.18-01.....6/11/14
C-20.14-04.....8/12/19	C-40.16-02.....7/2/12	C-85.20-01.....6/11/14

D-2.04-00.....11/10/05	D-2.48-00.....11/10/05	D-3.17-02.....5/9/16
D-2.06-01.....1/6/09	D-2.64-01.....1/6/09	D-4.....12/11/98
D-2.08-00.....11/10/05	D-2.66-00.....11/10/05	D-6.....6/19/98
D-2.14-00.....11/10/05	D-2.68-00.....11/10/05	D-10.10-01.....12/2/08

D-2.16-00.....11/10/05	D-2.80-00.....11/10/05	D-10.15-01.....12/2/08
D-2.18-00.....11/10/05	D-2.82-00.....11/10/05	D-10.20-01.....8/7/19
D-2.20-00.....11/10/05	D-2.84-00.....11/10/05	D-10.25-01.....8/7/19
D-2.32-00.....11/10/05	D-2.86-00.....11/10/05	D-10.30-00.....7/8/08
D-2.34-01.....1/6/09	D-2.88-00.....11/10/05	D-10.35-00.....7/8/08
D-2.36-03.....6/11/14	D-2.92-00.....11/10/05	D-10.40-01.....12/2/08
D-2.42-00.....11/10/05	D-3.09-00.....5/17/12	D-10.45-01.....12/2/08
D-2.44-00.....11/10/05	D-3.10-01.....5/29/13	
D-2.60-00.....11/10/05	D-3.11-03.....6/11/14	
D-2.62-00.....11/10/05	D-3.15-02.....6/10/13	
D-2.46-01.....6/11/14	D-3.16-02.....5/29/13	
E-1.....2/21/07	E-4.....8/27/03	
E-2.....5/29/98	E-4a.....8/27/03	
F-10.12-03.....6/11/14	F-10.62-02.....4/22/14	F-40.15-03.....6/29/16
F-10.16-00.....12/20/06	F-10.64-03.....4/22/14	F-40.16-03.....6/29/16
F-10.18-01.....7/11/17	F-30.10-03.....6/11/14	F-45.10-02.....7/15/16
F-10.40-03.....6/29/16	F-40.12-03.....6/29/16	F-80.10-04.....7/15/16
F-10.42-00.....1/23/07	F-40.14-03.....6/29/16	
G-10.10-00.....9/20/07	G-25.10-04.....6/10/13	G-95.10-02.....6/28/18
G-20.10-02.....6/23/15	G-26.10-00.....7/31/19	G-95.20-03.....6/28/18
G-22.10-04.....6/28/18	G-30.10-04.....6/23/15	G-95.30-03.....6/28/18
G-24.10-00.....11/8/07	G-50.10-03.....6/28/18	
G-24.20-01.....2/7/12	G-90.10-03.....7/11/17	
G-24.30-02.....6/28/18	G-90.11-00.....4/28/16	
G-24.40-07.....6/28/18	G-90.20-05.....7/11/17	
G-24.50-05.....8/7/19	G-90.30-04.....7/11/17	
G-24.60-05.....6/28/18	G-90.40-02.....4/28/16	
H-10.10-00.....7/3/08	H-32.10-00.....9/20/07	H-70.10-01.....2/7/12
H-10.15-00.....7/3/08	H-60.10-01.....7/3/08	H-70.20-01.....2/16/12
H-30.10-00.....10/12/07	H-60.20-01.....7/3/08	H-70.30-02.....2/7/12
I-10.10-01.....8/11/09	I-30.20-00.....9/20/07	I-40.20-00.....9/20/07
I-30.10-02.....3/22/13	I-30.30-02.....6/12/19	I-50.20-01.....6/10/13
I-30.15-02.....3/22/13	I-30.40-02.....6/12/19	I-60.10-01.....6/10/13
I-30.16-01.....7/11/19	I-30.60-02.....6/12/19	I-60.20-01.....6/10/13
I-30.17-01.....6/12/19	I-40.10-00.....9/20/07	I-80.10-02.....7/15/16
J-10.....7/18/97	J-28.40-02.....6/11/14	J-60.13-00.....6/16/10
J-10.10-03.....6/3/15	J-28.42-01.....6/11/14	J-60.14-01.....7/31/19
J-10.15-01.....6/11/14	J-28.43-01.....6/28/18	J-75.10-02.....7/10/15
J-10.16-00.....6/3/15	J-28.45-03.....7/21/16	J-75.20-01.....7/10/15
J-10.17-00.....6/3/15	J-28.50-03.....7/21/16	J-75.30-02.....7/10/15
J-10.18-00.....6/3/15	J-28.60-02.....7/21/16	J-75.40-02.....6/1/16
J-10.20-02.....7/31/19	J-28.70-03.....7/21/17	J-75.41-01.....6/29/16
J-10.21-00.....6/3/15	J-29.10-01.....7/21/16	J-75.45-02.....6/1/16
J-10.22-00.....5/29/13	J-29.15-01.....7/21/16	J-80.10-00.....6/28/18

J-10.25-00.....7/11/17	J-29.16-02.....7/21/16	J-80.15-00.....6/28/18
J-12.15-00.....6/28/18	J-30.10-00.....6/18/15	J-81.10-00.....6/28/18
J-12.16-00.....6/28/18	J-40.05-00.....7/21/16	J-86.10-00.....6/28/18
J-15.10-01.....6/11/14	J-40.10-04.....4/28/16	J-90.10-03.....6/28/18
J-15.15-02.....7/10/15	J-40.20-03.....4/28/16	J-90.20-03.....6/28/18
J-20.10-04.....7/31/19	J-40.30-04.....4/28/16	J-90.21-02.....6/28/18
J-20.11-03.....7/31/19	J-40.35-01.....5/29/13	J-90.50-00.....6/28/18
J-20.15-03.....6/30/14	J-40.36-02.....7/21/17	
J-20.16-02.....6/30/14	J-40.37-02.....7/21/17	
J-20.20-02.....5/20/13	J-40.38-01.....5/20/13	
J-20.26-01.....7/12/12	J-40.39-00.....5/20/13	
J-21.10-04.....6/30/14	J-40.40-02.....7/31/19	
J-21.15-01.....6/10/13	J-45.36-00.....7/21/17	
J-21.16-01.....6/10/13	J-50.05-00.....7/21/17	
J-21.17-01.....6/10/13	J-50.10-01.....7/31/19	
J-21.20-01.....6/10/13	J-50.11-02.....7/31/19	
J-22.15-02.....7/10/15	J-50.12-02.....8/7/19	
J-22.16-03.....7/10/15	J-50.13-00.....8/22/19	
J-26.10-03.....7/21/16	J-50.15-01.....7/21/17	
J-26.15-01.....5/17/12	J-50.16-01.....3/22/13	
J-26.20-01.....6/28/18	J-50.18-00.....8/7/19	
J-27.10-01.....7/21/16	J-50.19-00.....8/7/19	
J-27.15-00.....3/15/12	J-50.20-00.....6/3/11	
J-28.10-02.....8/7/19	J-50.25-00.....6/3/11	
J-28.22-00.....8/07/07	J-50.30-00.....6/3/11	
J-28.24-01.....6/3/15	J-60.05-01.....7/21/16	
J-28.26-01.....12/02/08	J-60.11-00.....5/20/13	
J-28.30-03.....6/11/14	J-60.12-00.....5/20/13	

K-70.20-01.....6/1/16
 K-80.10-01.....6/1/16
 K-80.20-00.....12/20/06
 K-80.35-00.....2/21/07
 K-80.37-00.....2/21/07

L-10.10-02.....6/21/12	L-40.10-02.....6/21/12	L-70.10-01.....5/21/08
L-20.10-03.....7/14/15	L-40.15-01.....6/16/11	L-70.20-01.....5/21/08
L-30.10-02.....6/11/14	L-40.20-02.....6/21/12	

M-1.20-03.....6/24/14	M-11.10-03.....8/7/19	M-40.20-00...10/12/07
M-1.40-02.....6/3/11	M-12.10-01.....6/28/18	M-40.30-01.....7/11/17
M-1.60-02.....6/3/11	M-15.10-01.....2/6/07	M-40.40-00.....9/20/07
M-1.80-03.....6/3/11	M-17.10-02.....7/3/08	M-40.50-00.....9/20/07
M-2.20-03.....7/10/15	M-20.10-02.....6/3/11	M-40.60-00.....9/20/07
M-2.21-00.....7/10/15	M-20.20-02.....4/20/15	M-60.10-01.....6/3/11
M-3.10-03.....6/3/11	M-20.30-04.....2/29/16	M-60.20-02.....6/27/11
M-3.20-02.....6/3/11	M-20.40-03.....6/24/14	M-65.10-02.....5/11/11
M-3.30-03.....6/3/11	M-20.50-02.....6/3/11	M-80.10-01.....6/3/11
M-3.40-03.....6/3/11	M-24.20-02.....4/20/15	M-80.20-00.....6/10/08
M-3.50-02.....6/3/11	M-24.40-02.....4/20/15	M-80.30-00.....6/10/08
M-5.10-02.....6/3/11	M-24.60-04.....6/24/14	

M-7.50-01.....1/30/07	M-24.65-00.....7/11/17
M-9.50-02.....6/24/14	M-24.66-00.....7/11/17
M-9.60-00.....2/10/09	M-40.10-03.....6/24/14

APPENDIX A

BID SUBMITTAL DOCUMENT

INSTRUCTIONS:

Bidder must complete and submit all sections of this Bid Submittal Document as their Bid by the Bid Due Date and Time.

The Bid must include all completed sections of this Bid Submittal Document as listed below:

1. Bidder Acknowledgements
2. Bidder Information
3. Bidder Guaranty Bond
4. Subcontractor Information
5. References
6. Bid Form
7. Certification Regarding Debarment, Suspension, and other Responsibility Matters
8. Non-Collusion Affidavit

BIDDER ACKNOWLEDGEMENTS
Bus Stop Pad Construction and Improvements – Project #2003C
Issued by Intercity Transit

Having carefully examined all requirements and terms and conditions identified in this Request for Bids (RFB), the undersigned, as Bidder, declares to that I/we have examined all of the Contract Documents and that I/we will contract with Intercity Transit (Transit) to do everything necessary for fulfillment of **RFB #2003C, Bus Stop Pad Construction and Improvements**, and the resulting Contract, at the prices and on the terms and conditions contained herein.

I/We certify, under penalty of perjury, that this is not a sham or collusive Bid, nor made in the interest or on behalf of any person not herein named. I/We have not directly or indirectly induced or solicited any Bidder on the above work, or suppliers to put in a sham Bid, nor any other person or corporation to refrain from Bidding. I/We have not in any manner sought by collusion to secure advantage over any other Bidders.

I/We agree that our Bid constitutes an offer to Transit, which shall be binding for sixty (60) Calendar Days from the Bid due date. If our Bid is accepted, we agree to sign the Contract form and furnish evidences of insurance required herein within ten (10) Calendar Days after receipt from Transit of written notice of award of Contract.

I/We certify that we are, at the time of submitting this Bid and shall remain throughout the period of the Contract, registered and licensed by the state of Washington to perform the type of work required under the Contract Documents. We further certify that we are skilled and regularly engage in the general class and type of work called for in the Contract Documents.

I/We hereby certify that, within the three-year period immediately preceding the Bid/Proposal solicitation date for this Project, I/We are not a “willful” violator, as defined in RCW 49.48.082, of any provision of chapters 49.46, 49.48, or 49.52 RCW, as determined by a final and binding citation and notice of assessment issued by the Department of Labor and Industries or through a civil judgment entered by a court of limited or general jurisdiction. In addition, I/We certify under penalty of perjury under the laws of the state of Washington that the foregoing is true and correct.

I/We further agree, if our Bid is accepted and a Contract is awarded by Transit, to plan and prosecute the work with such diligence that the work and portions thereof shall be completed and ready for use within the period set forth.

I/We acknowledge receipt of addenda numbers _____ through _____ and have been taken into account as part of our Bid.

The following information is accurate to the best of our knowledge. Any required documentation has been attached separately. We understand that failure to complete this form in its entirety may deem our Bid “Non-Responsive”. If our business is not required to have one of the following items, we have attached a letter explaining why.

I/We certify that we:

- a. Have examined the work site and all existing conditions;
- b. Fully understand the manner in which payment is proposed;
- c. Propose to furnish all labor, equipment, and materials required to perform and complete specified work within the time fixed;
- d. Will observe the national, Washington State, and local codes;
- e. Have a valid Washington State Contractor’s license and a current registration with the Washington State Department of Labor & Industries;
- f. Have the insurance coverage required for this Contract; and
- g. Are current in payment of industrial insurance premiums.

The signatory below represents that he/she has the authority to bind the company named below to the Bid submitted and any Contract awarded as a result of this Solicitation. The authorized signatory acknowledges having read and understood the entire Solicitation and agrees to comply with the terms and conditions of the Solicitation in submitting and fulfilling the offer made in its Bid. By submitting this Bid, Bidder hereby offers to furnish materials, supplies, services and/or equipment in compliance with all terms, conditions, and specifications contained in this Solicitation.

"I certify (or declare) under penalty of perjury under the laws of the State of Washington that the foregoing is true and correct":

Bidder Signature:

Date:

Print Name and Title

Location or Place Executed: (City, State)

END OF FORM

BIDDER INFORMATION

1. **Bidder Profile:** Bidder must provide the following:

Firm Name	
DBA Name (if applicable)	
Street Address	
City, State, Zip Code	
Federal Tax ID Number	
WA State UBI Number	
DUNS #	

2. **Bidder Authorized Official:**

Bidder must designate an Authorized Official who will be the principal point of contact for the Procurement Coordinator for the duration of this RFB process. Bidder's Authorized Official will serve as the focal point for business matters and administrative activities.

Representative Name:	
Street Address	
City, State, Zip Code	
Telephone Number	
Email Address	

3. **Bidder Qualifications:** Bidder must provide the following:

WA State Contractor Registration No.	
WA State Employment Security Dept. No.	
WA State Excise Tax Registration No.	
WA State Worker's Comp Account No. <i>(If you do not have an account, please explain why)</i>	
WA State L&I Debarred Contractor <i>(If "yes", your firm is not qualified to bid on this project)</i>	Is your firm disqualified from bidding on Public Works contracts in WA? <input type="checkbox"/> Yes <input type="checkbox"/> No
Federal Government Debarred Contractor <i>(If "yes" your firm is not qualified to bid on this project)</i>	Is your firm disqualified from bidding on Federal Projects, as verified through the System for Award Management (SAM)? <input type="checkbox"/> Yes <input type="checkbox"/> No

4. Certified DBE and SBE Status:

Intercity Transit gathers the following Disadvantaged Business Enterprise (DBE) and Small Business Enterprise (SBE) information for reporting purposes. Bidder is instructed to check the applicable boxes and enter associated certification numbers, as applicable, below:

Not Applicable

DBE

Certification #: _____

SBE

Certification #: _____

5. Statement of Prior Contract Termination:

Bidder must disclose below if the Bidder's firm and/or any proposed subcontractors have had a contract terminated for either cause or convenience in the last five (5) years. If a contract was terminated for cause or convenience during this timeframe, submit full details of the termination including but not limited to, the reason for termination, the other party's contact information (name, address, email address, and telephone number), and the Bidder's position on the matter. Transit will evaluate the information and may, at its sole discretion, reject the Response based on the risk to the Agency. *If not applicable, Bidder is instructed to enter "NA" in the box below.*

END OF FORM

BIDDER GUARANTY BOND

KNOW ALL BY THESE PRESENTS: That we, _____,
as Principal, and _____, as Surety, are jointly and severally held
and firmly bound unto INTERCITY TRANSIT, hereinafter called the Obligee, each in the penal
sum of five percent (5%) of the Base Bid price of the Principal for the work, this sum not to
exceed _____ DOLLARS
(\$_____) of lawful money of the United States, for the payment whereof unto the
Obligee, the Principal and Surety jointly and severally bind themselves forever firmly by these
presents.

WHEREAS, the Principal is herewith submitting its offer for the fulfillment of
Project #2003C – Bus Stop Pad Construction and Improvements

NOW, THEREFORE, the condition of this obligation is such that if the Principal is
awarded the Contract, and if the Principal, within the time specified in the Bid for such Contract,
fulfills all of the requirements of the Contract Documents which are conditions precedent to the
execution of the agreement, enters into, executes and delivers to the Obligee an agreement on
the form provided herein complete with evidences of insurance, and if the Principal, within the
time specified in the Bid, gives to the Obligee the performance bond on the form provided
herein, then this obligation shall be void; otherwise, the Principal and Surety will pay unto the
Obligee the difference in money between the total amount of the Bid of the Principal and the
amount for which the Obligee legally contracts with another party to fulfill the Contract if the
latter amount be in excess of the former, but in no event shall the Surety's liability exceed the
penal sum hereof.

AND IT IS HEREBY DECLARED AND AGREED that the Surety shall be liable under
this obligation as Principal, and that nothing of any kind or nature whatsoever that will not
discharge the Principal shall operate as a discharge or a release of liability of the Surety.

IT IS HEREBY FURTHER DECLARED AND AGREED that this obligation shall be
binding upon and inure to the benefit of the Principal, the Surety and the Obligee and their
respective heirs, executors, administrators, successors and assigns.

SIGNED AND SEALED this ____ day of _____, 2020.

Principal: _____
By: _____
Title: _____
Address: _____
City/Zip: _____
Telephone: _____
Witness: _____

Surety: _____
By: _____
Title: _____
Address: _____
City/Zip: _____
Telephone: _____
Witness: _____

Note: A power of attorney must be provided which appoints the Surety's true and lawful
attorney-in-fact to make execute, seal and deliver this Bid guaranty bond.

END OF FORM

SUBCONTRACTOR INFORMATION

Check the applicable box:

Yes No Bidding firm intends on utilizing subcontractors to fulfill the service requirements outlined in **RFB #2003C, Bus Stop Pad Construction and Improvements.**

Contractor will be required to perform all work under this Contract using his/her own employees carried on payroll or by using Subcontractors. Where Subcontractors are used in the performance of the Contract, Bidder will indicate as required with the Response. Contractor will be held responsible for all work performed or not performed by the subcontractor(s). Subcontractor(s) will be required to bill through the Contractor.

If revisions are required in the subcontract assignment, new parties are to be proposed in advance of assignment, in writing to the Transit Procurement Coordinator and Contract Administrator.

If applicable, Bidder will identify below all subcontractors who will perform services in fulfillment of Contract requirements, including their name, the nature of services to be performed, address, telephone number, email address, federal tax identification number (TIN), Washington State Unified Business Identifier (UBI), and DBE or SBE certification status:

Subcontractor 1

Name: _____
Services: _____
Address: _____
Telephone: _____
Email: _____
Fed ID: _____
UBI: _____
Certified DBE: Yes No
Certified SBE: Yes No

Subcontractor 2

Name: _____
Services: _____
Address: _____
Telephone: _____
Email: _____
Fed ID: _____
UBI: _____
Certified DBE: Yes No
Certified SBE: Yes No

Subcontractor 3

Name: _____
Services: _____
Address: _____
Telephone: _____
Email: _____
Fed ID: _____
UBI: _____
Certified DBE: Yes No
Certified SBE: Yes No

Subcontractor 4

Name: _____
Services: _____
Address: _____
Telephone: _____
Email: _____
Fed ID: _____
UBI: _____
Certified DBE: Yes No
Certified SBE: Yes No

END OF FORM

SUBCONTRACTOR INFORMATION

In accordance with RCW 39.30.060, every invitation to bid on a prime contract that is expected to cost one million dollars (\$1,000,000) or more for the construction, alteration, or repair of any public building or public work of a municipality shall require each prime contract bidder to submit as part of the bid, or within one hour after the published bid submittal time, the names of the subcontractors with whom the bidder, if awarded the contract, will subcontract for performance of the work for: HVAC (heating, ventilation, and air conditioning); plumbing as described in chapter 18.106 RCW; and electrical as described in chapter 19.28 RCW, or to name itself for the work. The prime contract bidder shall not list more than one subcontractor for each category of work identified, unless subcontractors vary with bid alternates, in which case the prime contract bidder must indicate which subcontractor will be used for which alternate. Failure of the prime contract bidder to submit as part of the bid the names of such subcontractors to perform such work or the naming of two or more subcontractors to perform the same work shall render the prime contract bidder's bid nonresponsive and, therefore, void.

HVAC Subcontractor Name: _____
Plumbing Subcontractor Name: _____
Electrical Subcontractor Name: _____

The Contractor will NOT use subcontractor(s) for the following categories of work and, instead, will perform the work itself: *(Check all categories that apply)*

- HVAC (Heating, Ventilation, and Air Conditioning)
- Plumbing
- Electrical
- Not Applicable, these categories of work not part of contract.

END OF FORM

REFERENCES

Bidder must provide a minimum of three (3) references for which the Bidder has provided goods and/or services similar to those described in this Solicitation. References must not be from an individual, company or organization with any special interest, financial or otherwise, to the Bidder.

Reference 1

Company Name: _____
Type of Organization:* _____
Contact Name: _____
Job Title: _____
Street Address: _____
City, State, Zip: _____
Telephone: _____
Email: _____
Brief Reference Project Description: _____

Reference 2

Company Name: _____
Type of Organization:* _____
Contact Name: _____
Job Title: _____
Street Address: _____
City, State, Zip: _____
Telephone: _____
Email: _____
Brief Reference Project Description: _____

Reference 3

Company Name: _____
Type of Organization:* _____
Contact Name: _____
Job Title: _____
Street Address: _____
City, State, Zip: _____
Telephone: _____
Email: _____
Brief Reference Project Description: _____

Reference 4

Company Name: _____
Type of Organization:* _____
Contact Name: _____
Job Title: _____
Street Address: _____
City, State, Zip: _____
Telephone: _____
Email: _____
Brief Reference Project Description: _____

*Type of Organization – Municipality, Public Agency, Etc.

END OF FORM

BID FORM

Transit has the right to contract based on the total Bid or a portion thereof. Transit has the right to correct obvious mathematical errors. Bidders are cautioned against making erasures or alterations of any kind, and Bids which contain omissions, erasures or irregularities of any kind may be rejected. Any qualification, addition, limitation or provision attached to a Bid may render the Bid non-responsive.

Item No.	Item Description	Bid Amount
1	MINOR CHANGE	\$5,000.00
2	BUS STOP #152	
3	BUS STOP #381	
4	BUS STOP #489	
5	BUS STOP #1035	
6	BUS STOP #1041	
7	BUS STOP #1045	
8	BUS STOP #1050	
9	BUS STOP #1052	
10	BUS STOP #1056	
11	BUS STOP #1060	
12	BUS STOP #1062	
13	BUS STOP #1067	
14	BUS STOP RT-42-SPSCC-WB	
15	BUS STOP RT-42-SPSCC-EB	
TOTAL BID PRICE:		

We, the Bidder, propose to perform the work under the terms and conditions contained herein for the Contract Total price set forth above.

Signature of Bidder

Firm

=====

BID EVALUATION AND CONTRACT AWARD

In accordance with the provisions of these Bidding Documents, Bids will be evaluated to determine the lowest Total Bid offered by a responsive, responsible Bidder. A Contract will be awarded, if at all, based on the lowest Total Bid proposed by a responsive, responsible Bidder. Transit reserves the right to reject any portion of any Bid and/or to reject all Bids. Transit further reserves the right, but without obligation, to waive informalities and irregularities.

END OF FORM

CERTIFICATION REGARDING DEBARMENT, SUSPENSION, AND OTHER RESPONSIBILITY MATTERS

Required of prime and subcontractor whose contract participation is expected to exceed \$100,000. If this is not applicable, please check the box below:

Not Applicable

The undersigned certifies, to the best of its knowledge and belief, that it and its principals:

1. Are not presently debarred, suspended, proposed for debarment, declared ineligible, or voluntarily excluded from covered transactions by any federal department or agency;
2. Have not within a three-year period preceding this bid been convicted of or had a civil judgment rendered against them for commission of fraud or a criminal offense in connection with obtaining, attempting to obtain, or performing a public (federal, state or local) transaction or contract under a public transaction; violation of federal or state antitrust statutes or commission of embezzlement, theft, forgery, bribery, falsification of records, making false statements, or receiving stolen property;
3. Are not presently indicted for or otherwise criminally or civilly charged by a governmental entity (federal, state or local) with commission of any of the offenses enumerated paragraph (2) of this certification; and
4. Have not within a three-year period preceding this application/Bid had one or more public transactions (federal, state or local) terminated for cause or default.

(If the primary participant (applicant for an FTA grant, or cooperative agreement, or potential third party Contractor) is unable to certify to any of the statements in this certification, the participant shall attach an explanation to this certification.)

THE CONTRACTOR, _____, CERTIFIES OR AFFIRMS THE TRUTHFULNESS AND ACCURACY OF THE CONTENTS OF THE STATEMENTS SUBMITTED ON OR WITH THIS CERTIFICATION AND UNDERSTANDS THAT THE PROVISIONS OF 31 U.S.C. SECTION 3801 ET. SEQ. ARE APPLICABLE THERETO.

Signature of Contractor's Authorized Official

Date

Name and Title of Contractor's Authorized Official

END OF FORM

NON-COLLUSION AFFIDAVIT

STATE OF: _____

COUNTY OF: _____

_____, being first fully sworn, on his/her oath says that (s)he certifies that the Bid above submitted is genuine and not a sham or collusive Bid, nor made in the interest or on behalf of any person not herein named; and (s)he further says that the said Bidder has not directly or indirectly induced or solicited any Bidder on the above work, or supplies to put in a sham Bid not any other person or corporation to refrain from Bidding; and that said Bidder has not in any manner sought by collusion to secure to self-advantage over any other Bidder or Bidders.

SIGN HERE: _____

Subscribed and sworn before me this ____ day of _____, 2020

Print Name: _____

Notary Public for the State of _____

Residing in _____

END OF FORM

APPENDIX B

SOLICITATION STANDARDS

Solicitation Standards:

This document contains important information for Bidders applicable to the Contract Documents administered by Intercity Transit. This information applies directly, and is incorporated by reference, into the solicitation and contracts resulting from this solicitation. As such, Bidders do not need to attach this document with their response to the solicitation. It is the responsibility of the Bidder to read and fully understand the details of all items contained herein prior to Bid submittal.

1. DEFINITIONS

This section contains definitions of terms commonly used in Solicitations conducted by Intercity Transit.

Agency	Intercity Transit (Transit).
Amendment or Addendum	A change to a legal document. For the purposes of a Solicitation document, an amendment is a unilateral change issued by Transit, at its sole discretion.
Authorized Representative	An individual designated by the Bidder to act on its behalf with the authority to legally bind the Bidder concerning the terms and conditions set forth in Solicitation and Bid documents.
Procurement Coordinator	The individual authorized by Transit who is responsible for conducting a specific Solicitation.
RCW	Revised Code of Washington

2. AMENDMENTS AND ADDENDA

Transit reserves the right to amend this Solicitation at any time before the Bid due date and time. Amendments may be for any reason deemed necessary by Transit including, without limitation, changes in quantity, quality, delivery requirements, due date, procedures, baseline technical requirements, statement of work requirements, or selection criteria.

All Addenda will be posted on the [Builder's Exchange of Washington](#) (BXWA). It is the Bidder's sole responsibility to check periodically for addenda related to this Solicitation.

If there is any conflict between Addenda, or between an Addendum and the original Solicitation document, whichever document was issued last in time shall be controlling.

3. COLLUSION

If Transit determines that collusion has occurred among Bidders, none of the Bids of the participants in the collusion will be considered. Transit's determination shall be final.

4. SUSTAINABILITY COMMITMENT

Transit is a founding signatory with Gold Level recognition for the American Public Transportation Association Sustainability Commitment. Our Environmental and Sustainability Policy directs all employees including those working our behalf of Transit to be in compliance with all environmental laws and regulations, policy communication, pollution prevention, incorporation of sustainability practices in all operations, and maintaining an ISO14001 Certified Environmental and Sustainability Management System ([ESMS](#)).

Transit is committed to implementing core processes which set the basis for environmental, social, and economic sustainability. Transit administers these practices on an ongoing basis with a commitment to continual improvement.

Should the resulting contract impact Transit's sustainability commitments, Contractor may be required to provide relevant information about the goods or services being procured. Contractor may also be required to validate their ability to comply with Transit's environmental management and sustainability practices.

5. ENVIRONMENTAL POLLUTION PREVENTION AND PUBLIC NATURAL RESOURCES PRESERVATION

The Successful Bidder will comply with applicable portions of the following statutes, ordinances and regulations and such other regulatory measures dealing with the prevention of environmental pollution and the preservation of public natural resources as may be subsequently identified by Transit or other public agencies as applicable to the work.

- A. Federal. Natural Environmental Policy Act of 1969, 42 USC 4321 et seq.; Executive Order 11514; Clean Water Act, 33 USC 1251 et seq.
- B. State. Water Pollution Control Act, Chapter 90.48 RCW; State Environmental Policy Act of 1971, Chapter 43.21C RCW and WAC Chapter 1997-10; Noise Control Act of 1974, Chapter 70.107 RCW; Washington Clean Air Act, Chapter 70.94 RCW and WAC Chapter 1; Shoreline Management Act of 1971, Chapter 90.58 RCW.
- C. Regional. Any applicable Air Pollution Control District regulations.
- D. Thurston County. Any applicable County ordinances and regulations.
- E. Local. Any applicable City ordinances and regulations.

6. INSURANCE

The Successful Bidder is required to obtain insurance to protect Transit should there be any claims, suits, actions, costs, or damages or expenses arising from any negligent or intentional act or omission of the Bidder or its Subcontractor(s), or their agents, while performing work under the terms of any Contract resulting from this Solicitation. Bidders will find a complete description of the specific insurance requirements in the Sample Contract document located in Appendix C of the Solicitation document.

7. MINORITY, WOMEN, DISADVANTAGED AND SMALL BUSINESS ENTERPRISES

Transit is committed to maximum utilization of minority, women, and disadvantaged businesses enterprises (DBE), and small businesses enterprises (SBE). All businesses are encouraged to respond.

Interested firms are reminded to provide all potential business partners an equal, non-discriminatory opportunity to compete for business as joint venture partners or subcontractors. Transit is interested in firms that demonstrate a commitment to equal employment opportunity and encourages firms to employ a workforce that reflects the region's diversity and to adhere to non-discrimination.

8. NO COSTS OR CHARGES

Costs or charges under the proposed Contract incurred before the Contract is fully executed will be the sole responsibility of the Bidder.

9. NO OBLIGATION TO CONTRACT

This Solicitation does not obligate Transit to contract for the service(s) or product(s) specified. Transit reserves the right to cancel or reissue this Solicitation in whole or in part, for any reason, prior to Contract award.

10. POLICY COMPLIANCE

Transit does not permit alcohol, drugs and weapons on Transit property. Tobacco products must only be used in designated areas. The Contractor is responsible to ensure that all employees and any Subcontractors assigned to work on Transit property are aware of and comply with these policies.

11. PROJECT PERSONNEL

Bidder represents that it has, or will obtain, all qualified personnel necessary to perform the services required under this Solicitation. All services required under this Solicitation shall be performed by the Bidder, its employees, agents, representatives, or authorized Subcontractors. Upon Contract award, Contractor will not change assigned project personnel or subcontractors without prior Transit approval.

12. BID CLARIFICATION

Transit will make the sole determination of clarity and completeness in the Bids relative to any of the provisions in this Solicitation. Transit reserves the right to require clarification, additional information and materials in any form relative to any or all of the provisions or conditions of this Solicitation.

To aid in the Response evaluation process, after Response due date and time, Transit may require individual Bidders to appear at a date, time and place determined by Transit for the purpose of conducting discussions to determine whether both parties have a full and complete understanding of the nature and scope of contractual requirements. In no manner shall such action be construed as negotiations or an indication of Transit's intention to award.

13. BID COSTS

Bidder is solely liable for any and all costs associated with preparing, submitting or presenting a Bid in response to this Solicitation. Transit is not liable for any cost incurred by the Bidder in the process of responding to this Solicitation.

14. BID DEADLINE POSTPONEMENT

Transit reserves the right to postpone the Bid due date and time at any time prior to the set due date and time.

15. BID OWNERSHIP

All Bids and materials submitted in response to this Solicitation will become the property of Transit. Information in each Bid will be shared with Transit employees and other persons involved in Bid evaluation. Transit will have the right to use ideas or adaptations of ideas that are presented in the Bid. Selection or rejection of the offer will not affect this right.

16. BID REJECTION

Transit reserves the right to reject any Bid for any reason including, but not limited to, the following:

- A. Any Bid which is incomplete, obscure, irregular or lacking necessary detail and specificity;
- B. Any Bid which contains figures (price, percentage or others) that are not legible or subject to more than one interpretation;
- C. Any Bid from Bidder(s) who (in the sole judgment of Transit) lack the qualification and/or responsibility necessary to perform the work properly;
- D. Any Bid for which a Bidder fails or neglects to complete and submit any qualification information within the time specified by Transit; and

- E. Any Bid submitted by a Bidder who is not registered or licensed as may be required by the laws of the state of Washington.

Transit further reserves the right to reject any or all Bids, to waive any minor irregularities or informalities (without obligation) in any response to the Solicitation, and to accept any items or combination of items. In consideration for Transit's review and evaluation of its Bid, the Bidder waives and releases any claims against Transit arising from rejection of any or all Bids.

17. BID WITHDRAWAL OR MODIFICATION

A modification of a Bid already received will be considered only if the modification is received prior to the Bid due date and time. All modifications shall be made in writing, executed and submitted in the same form and manner as the original Bid. Notwithstanding the above, a late modification of an otherwise successful Bid that makes its terms more favorable to Transit may be considered at any time it is received and may be accepted.

Bidders may withdraw their Bid by written request to the Procurement Coordinator. The withdrawal request must be received by the Procurement Coordinator prior to Bid due date and time. Bids may be withdrawn in person by the Bidder or an Authorized Representative, if the representative's identity is made known and the representative signs a receipt for the Bid before the Bid due date and time.

No Bidder may withdraw a Bid after the Bid due date and time, or before the award and execution of the Contract, unless the award is delayed for a period exceeding sixty (60) Calendar Days from the Bid due date and time. Transit reserves the right to request that Bidders grant an extension of such effective period.

Transit will not give consideration to a claim of error in a Bid unless written notice and supporting evidence of such claim, including cost breakdown sheets, are delivered to Transit within forty-eight (48) hours after Bid opening. Any review by Transit of a Bid and/or any review of such a claim of error (including supporting evidence) creates no duty or liability on Transit to discover any other error or mistake, and the sole liability for any Bid errors rests with the Bidder.

18. PROPRIETARY OR CONFIDENTIAL INFORMATION

Transit will not disclose any information contained in competing Bids or the number of Bids received until after Contract award. Transit will keep information submitted through this process confidential to the extent allowed by state or federal law.

All information contained in the Bids is subject to the Washington State Public Records Act, RCW Chapter 42.56, and may be subject to public inspection. It should be noted that RCW 42.56.270(1) states that the following information is exempt from disclosure: "Valuable formulae, designs, drawings, computer source code or object code, and research data obtained by any agency within five years of the request for disclosure when disclosure would produce private gain and public loss."

Bidders, who include data in their Bids which conforms to the above limitations and that they do not want disclosed to the public for any purpose or used by Transit, except for in evaluation purposes, must indicate any pages and/or sections of the Response that Bidder desires to claim as proprietary in the Proposer Information section of the Bid Submittal Document titles "Proprietary or Confidential Information".

19. PROTEST PROCEDURES

Protests shall be filed and resolved in accordance with the following procedure:

- A. **Right to Protest.** Any actual or prospective Bidder, including sub-contractors and suppliers showing a substantial economic interest in this project, who is aggrieved in connection with the solicitation or award of this project, may file a protest. A protest with respect to the RFB shall be submitted in writing to the Intercity Transit General Manager prior to the established Bid due date and time unless the aggrieved person did not know the facts giving rise to such protest prior to Bid date. The protest shall be submitted within seven (7) Calendar Days after such aggrieved person knows or should have known of the facts giving rise thereto. If the protester is not satisfied with the solution of the General Manager, a written protest may be filed with the Intercity Transit Authority. Protests filed more than seven (7) Calendar Days following the receipt of the General Manager's written determination will not be accepted or require a response.
- B. **Stay of Procurements during Protests.** In the event of a timely protest, the General Manager shall not proceed further with the solicitation or award of the Contract until all administrative and judicial remedies have been exhausted or until the Intercity Transit Authority makes a determination on the record that the award of a Contract without delay is necessary to protect substantial interests of Transit.
- C. **Entitlement of Costs.** In addition to any other relief, when a protest is sustained and the protesting Bidder should have been awarded the Contract under the solicitation, but is not, then the protesting Bidder shall be entitled to the reasonable costs incurred in connection with the solicitation, including preparation costs, other than attorney's fees.
- D. **Process.** In order to be considered, a protest shall be in writing and shall include:
 1. The name and address of the aggrieved person;
 2. The project number and title under which the protest is submitted;
 3. A detailed description of the specific grounds for protest and any supporting documentation; and
 4. The specific ruling or relief requested.

The written protest will be addressed to:

Intercity Transit
Attention: General Manager
Bid Protest
526 SE Pattison Street
P.O. Box 659
Olympia, WA 98501

Failure to comply with these protest procedures shall render a protest untimely or inadequate and may result in rejection by Transit.

For procurements that include federal funding, FTA may entertain a protest that alleges Transit failed to have or follow written protest procedures. Such protest must be filed with FTA not later than five (5) days after Transit renders a final decision or five (5) days after the protester knows or has reason to know that Transit failed to render a final decision. A protest to FTA must be filed in accordance with FTA Circular 4220.1F.

20. SINGLE BID RECEIVED

If Transit receives a single responsive, responsible Bid, Transit shall have the right, in its sole discretion, to extend to the Bid acceptance period for an additional forty-five (45) Calendar Days and to conduct a price or cost analysis on such Bid. The Bidder shall promptly provide all cost or pricing data, documentation and explanation requested by Transit to assist in such analysis.

By conducting such analysis, Transit shall not be obligated to accept the single Bid. Transit reserves the right to reject such Bid or any portion thereof.

21. WORK PROGRESS AND COMPLETION

Progress and completion of the work must comply with all stated requirements. The submission of a Bid shall constitute the Bidder's acknowledgment that such progress and completion requirements are taken into account in formulating Bidder's pricing.

22. WORK SITE INSPECTION

Bidder must understand and inspect the work location(s). By signing its Bid, Bidder is accepting the work conditions. The Awarded Contractor will be responsible to complete all required work in accordance with the Solicitation and Contract Documents. If during the course of or as a result of the inspection and examination, a Bidder finds facts or conditions which appear to conflict with the letter or spirit of the Solicitation and Contract Documents, or with any other data or material made available to the Bidder relating to the work, the Bidder will promptly notify Transit in writing and request additional information and explanation before submitting a Bid.

APPENDIX C

SAMPLE CONTRACT

**INTERCITY TRANSIT
CONTRACT NO. 2003C
FOR
BUS STOP PAD CONSTRUCTION AND IMPROVEMENTS**

THIS CONTRACT is made and entered into duplicate this _____ day of _____, 2020 by and between Intercity Transit, a Washington municipal corporation, hereinafter referred to as "Transit", and the below named company, hereinafter referred to as "Contractor", for the project known as Bus Stop Pad Construction and Improvements - Contract No. 2003C.

Contractor:	Firm Name
Authorized Rep:	Authorized Rep. Name
Address:	Street Address City, State Zip Code
Phone:	(###) ###-####
Email:	Email Address
Federal TIN:	##-#####
WA State UBI No.:	###-###-###

1. RECITALS

WHEREAS, Transit desires to have certain services and/or tasks performed as hereinafter set forth requiring specialized skills and other supportive capabilities; and WHEREAS, sufficient Transit resources are not available to provide such services; and WHEREAS, Contractor represents that Contractor is qualified and possesses sufficient skills and the necessary capabilities, including technical and professional expertise where required, to perform the services and/or tasks set forth in this Contract.

NOW, THEREFORE, in consideration of the terms, conditions, covenants and performance contained herein, Transit and Contractor agree as follows:

2. PURPOSE

The purpose of this Contract is to enter into an agreement for the construction of fourteen (14) bus stop pads located at various sites throughout the City of Lacey and Thurston County. The project consists of, but is not limited to, excavation and removal items, installation of curb and gutter, sidewalk, concrete bus stop pads, traffic control, erosion control measures, construction survey, and all other work described in the Plans and Specifications.

3. SCOPE OF WORK AND SPECIFICATIONS

- A. Contractor will perform such services and comply with the requirements set forth in this Contract document, including furnishing all materials and equipment necessary to complete the Bus Stop Pad Construction and Improvements Project #2003C, and as identified in the following attached Exhibits which are incorporated by reference:
 - 1. Request for Bids (RFB) Project #2003C, Released July 13, 2020, attached as Exhibit "A"
 - 2. Addenda (if applicable), attached as Exhibit "B"
 - 3. Contractor's Response to RFB #2003C, dated [DATE], attached as Exhibit "C"
- B. In the case of any inconsistency between the Contractor's response to RFB #2003C and the Scope of Work and Specifications described herein, the latter shall control.

4. ADMINISTRATION AND SUPERVISION

- A. The work and services under this Contract is subject to certain federal laws, regulations, and other requirements in effect on the date of execution of this Contract. Transit and the Service Provider agree that such federal laws, regulations, and other requirements supersede any conflicting provisions of this Contract.
- B. The Service Provider represents that it has, or will obtain, all personnel necessary to perform the services required under this Contract and that such personnel are qualified, experienced, and licensed as may be necessary or required by laws and regulations to perform such services. All services required under this Contract must be performed by the Contractor, its employees, or by subs whose selection has been authorized by Transit; provided, that Transit's authorization will not relieve the Contractor or its subs from any duties or obligations under this Contract or at law to perform in a satisfactory and competent manner. The Contractor will remove from the Project any of its subs or personnel assigned to the Project if, after the matter has been thoroughly considered by Transit and the Contractor. Transit considers such removal necessary and in the best interests of the Project and so advises the Contractor in writing.
- C. The Project must be coordinated and integrated with other Transit activities.

5. TIME OF COMMENCEMENT AND SUBSTANTIAL COMPLETION

The work to be performed under this Contract will commence within ten (10) Calendar Days from the date Transit issues the Notice to Proceed to Contractor. Subject to authorized adjustments, Contractor shall complete all work within 35 Working Days. If said work is not completed within the time specified, Contractor agrees to pay to Transit the sum as calculated per the formula in WSDOT Section 1-08.9 of the Standard Specifications for each and every day said work remains uncompleted after expiration of the specified time, as liquidated damages. Transit shall not be responsible for delays caused by weather, soil conditions, underground

obstructions, labor disputes, fire, flood, delays by third parties, particularly public and private utilities, or reasonable foreseen delays.

6. COMPENSATION AND METHOD OF PAYMENT

- A. This is a firm-fixed Contract. Transit will reimburse the Contractor for satisfactory completion for the performance of the work, subject to additions and deductions by Change Order as specified in this Contract, in a maximum amount not to exceed \$_____, as described in Exhibit C.
- B. Contractor may request monthly progress payments based upon the amount of work completed for each of the deliverables required by the Scope of Work and Specifications of Exhibits A and B. Each request for a progress payment will include:
1. The period of time covered by the request for payment.
 2. A brief description of the work completed for each deliverable during the period of time including any milestones accomplished.
 3. The total percentage of work completed to date for each deliverable.
- C. Contractor will submit its final invoice and other required documents pursuant to this Contract within forty-five (45) Calendar Days of Statement of Work completion. Unless waived by Transit in writing, Contractor failure to submit the final invoice and required documents may, at Transit's sole discretion, relieve Transit from any and all liability for payment to the Contractor for the amount set forth in such invoice or any subsequent invoice.
- D. If Contractor fails to comply with any terms or conditions of this Contract or to provide, in any manner, the work or services agreed to in this Contract, Transit may withhold any payment due the Contractor until Transit is satisfied that corrective action, as specified by Transit, has been completed. This right is in addition to, and not in lieu of, Transit's right to terminate this Contract as provided in Section 29, Termination.

7. FINAL PAYMENT

Final payment, constituting the entire unpaid balance of the Contract sum, shall be paid by Transit to the Contractor when the work has been completed and accepted by Transit, and the Contract fully performed. Release of retainage (if applicable) shall not occur until Transit has received a certified copy of Affidavit of Wages Paid for the Contractor and each Subcontractor, final acceptance by Transit of work performed, receipt of all necessary releases including a certificate from the Washington State Department of Revenue showing that all Contract related taxes have been paid, and after any other requirements are met.

8. BILLING PROCEDURES

- A. Payments for services and materials provided under this Contract will be made on not more than a monthly basis, following the full performance and acceptance of such service and materials. No payment will be made for any service rendered or material provided by Contractor except for services and materials

identified and set forth in this Contract unless otherwise permitted by law and approved in writing by Transit.

- B. Contractor will submit an invoice for services rendered to Transit on forms approved by Transit. Invoices should be submitted electronically to tferris@intercitytransit.com. If Contractor is unable to submit invoices electronically, invoices may be submitted by mail to:

INTERCITY TRANSIT
Attn: Procurement Office
526 Pattison Street SE
Olympia, WA 98501

- C. Transit will submit payment for stated services to Contractor within thirty (30) days following Transit's receipt of each accurate and complete invoice. No payments in advance of, or in anticipation of, receipt of goods or services to be provided under this Contract will be made by Transit.

9. WAGES AND LABOR PROVISIONS

- A. This Contract is subject to Chapter 39.12 RCW, and amendments and regulations, relating to Washington State prevailing wages, benefits, and other requirements.
- B. Contractor, each Subcontractor, and any other person doing any work under this Contract must pay laborers, workmen or mechanics not less than the prevailing rate of wage for an hours work in the same trade or occupation in the Washington State locality where such labor is performed.
- C. Contractor must comply with State and Federal determinations. In the event of a discrepancy between Federal and State rates and requirements, Contractor will comply with the higher rates and more stringent requirements. The cost of such compliance shall be deemed included in the Contract Price.
- D. Contractor is responsible to ensure proper wages are paid and the appropriate documentation is submitted to Transit. Wages and benefits higher than the minimums required by law may be paid. In the event wage rates and benefits change during the Contract term, Contractor will bear the cost of changes and will not have any claim against Transit on account of such changes.

10. RETAINAGE

In accordance with RCW 60.28.011, Transit will retain five (5) percent of each invoice or pay request. Unless the Contractor arranges otherwise, retained amounts will be remitted to the Contractor upon receipt of a certified copy of Affidavit of Wages Paid for the Contractor and each subcontractor, final acceptance by Transit of work performed, receipt of all necessary releases, and after any other requirements are met.

11. PROJECT MANAGEMENT

The individuals listed below, or their successors will be the designated points of contact for services provided under this Contract. Transit's Project Manager or his/her successor is responsible for monitoring Contractor's performance and will

be the contact person for all communications regarding Contract performance and deliverables. Transit’s Project Manager has the authority to accept or reject the services provided and if satisfactory, certify acceptance of each invoice submitted for payment. Notifications regarding changes to Project Management personnel must be in writing and maintained in the project file, but will not require a formal Contract amendment.

Contractor’s Project Manager	Transit’s Project Manager
First Last	TBD
Company	Intercity Transit
Street Address	526 Pattison Street SE
City, State Zip	Olympia, WA 98501
Phone: (###) ###-####	Phone: (360) 705-xxxx
Email address: [Enter email address]	Email address: xxxx@intercitytransit.com

12. CONTRACT ADMINISTRATION

The individual listed below, or his/her successor, will be Contract Administrator for this Contract. The Contract Administrator is designated to receive legal notices, invoices, and to administer, amend, or terminate this Contract. All Contract Documents under this Contract will be processed by the Contract Administrator and submitted to Contractor for acceptance. Contact information for the Contract Administrator is:

Tammy Ferris
 Intercity Transit
 526 Pattison Street, SE
 Olympia, WA 98501
 Phone: (360) 705-5818
 Email address: tferris@intercitytransit.com

13. CHANGES

Either party may request changes to the scope of services and performance to be provided under this Contract; however, no change or addition to this Contract will be valid or binding upon either party unless such change or addition is in writing and signed by both parties. All amendments will be attached to and incorporated into this Contract.

14. PROJECT PERSONNEL

Contractor represents that it has, or will obtain, all personnel necessary to perform the services required under this Contract. All services required under this Contract will be performed by the Contractor, its employees, agents, representatives, or authorized subcontractors.

15. INDEPENDENT CONTRACTOR RELATIONSHIP

- A. The parties intend that an independent Contractor relationship between Contractor and Transit will be created by this Contract. Transit is interested primarily in the results to be achieved; subject to the provisions herein, the implementation of services will lie solely with the discretion of Contractor. No agent, employee, servant or representative of Contractor shall be deemed to be an employee, agent, servant or representative of Transit for any purpose, and the employees of Contractor are not entitled to any of the benefits Transit provides to its employees. Contractor will be solely and entirely responsible for its acts and for the acts of its agents, employees, servants, subcontractors or representatives during the performance of this Contract.
- B. In the performance of the services required by this Contract, Contractor is an independent Contractor with the authority to control and direct the performance of the details of the work, however, the results of the required work must meet the approval of Transit and shall be subject to Transit's general rights of inspection and review to secure the satisfactory completion thereof in accordance with applicable agreed upon testing procedures between Transit and Contractor.

16. NON-EXCLUSIVE PROVIDER

Transit reserves the right to obtain services or supplies not specifically covered by this Contract from other providers as deemed in the best interest of Transit.

17. ASSIGNMENT

Contractor will not assign its performance under this Contract, or any portion of this Contract, without the written consent of Transit. Contractor must seek consent from Transit, in writing, not less than thirty (30) days prior to the date of any proposed assignment. Transit reserves the right to reject any assignment without cause.

18. HOLD HARMLESS AND INDEMNIFICATION

The Contractor shall defend, indemnify, and hold Transit and its officers and employees harmless from all claims, demands, or suits at law or equity arising in whole or in part from the negligence of, or the breach of any obligation under this Contract by, the Contractor or the Contractor's agents, employees, sub consultants, subcontractors or vendors, of any tier, or any other persons for whom the Contractor may be legally liable; provided, that nothing herein shall require a Contractor to defend, indemnify or hold harmless Transit and its officers and employees from claims, demands or suits based upon the sole negligence of, or breach of any obligation under this Contract by Transit, its agents, officers, employees, sub-consultants, subcontractors or vendors, of any tier, or any other persons for whom Transit may be legally liable; and provided further, that if the claims or suits are caused by or result from the concurrent negligence of (a) the Contractor or the Contractor's agents, employees, sub-consultants, subcontractors or vendors, of any tier, or any other persons for whom the Contractor is legally liable, and (b) Transit, its agents, officers, employees, sub-consultants, subcontractors and or vendors, of any tier, or any other persons for whom Transit may be legally liable, the defense

and indemnity obligation shall be valid and enforceable only to the extent of the Contractor's negligence or the negligence of the Contractor's agents, employees, sub-consultants, subcontractors or vendors, of any tier, or any other persons for whom the Consultant/Contractor may be legally liable. This provision shall be included in any Contract between Contractor and any sub-consultant, subcontractor and vendor, of any tier.

The Contractor shall also defend, indemnify, and hold Transit and its officers and employees harmless from all claims, demands, or suits at law or equity arising in whole or in part from the alleged patent or copyright infringement or other allegedly improper appropriation or use of trade secrets, patents, proprietary information, know-how, copyright rights or inventions by the Contractor or the Contractor's agents, employees, sub-consultants, subcontractors or vendors, of any tier, or any other persons for whom the Contractor may be legally liable, in performance of the Work under this Contract or arising out of any use in connection with the Contract of methods, processes, designs, information or other items furnished or communicated to Transit, its agents, officers and employees pursuant to the Contract; provided that this indemnity shall not apply to any alleged patent or copyright infringement or other allegedly improper appropriation or use of trade secrets, patents, proprietary information, know-how, copyright rights or inventions resulting from Transit, or its agents', officers' and employees' failure to comply with specific written instructions regarding use provided to Transit, its agents, officers and employees by the Contractor, its agents, employees, sub-consultants, subcontractors or vendors, of any tier, or any other persons for whom the Contractor may be legally liable.

The Contractor's relation to Transit shall be at all times as an independent contractor.

Notwithstanding any determination by the Executive Ethics Board or other tribunal, Transit may, in its sole discretion, by written notice to the Contractor terminate this Contract if it is found after due notice and examination by Transit that there is a violation of the Ethics in Public Service Act, Chapter 42.52 RCW; or any similar statute involving the Consultant/Contractor in the procurement of, or performance under, this Contract.

The Contractor specifically assumes potential liability for actions brought by the Contractor's own employees or its agents against Transit and, solely for the purpose of this indemnification and defense, the Contractor specifically waives any immunity under the state industrial insurance law, Title 51 RCW. This waiver has been mutually negotiated between the Parties.

Unless otherwise specified in this Contract, Transit shall be responsible for administration of construction contracts, if any, on the project. Subject to the processing of a new sole source, or an acceptable supplemental Contract, the Contractor shall provide On-Call assistance to Transit during contract administration. By providing such assistance, the Contractor shall assume no

responsibility for: proper construction techniques, job site safety, or any construction contractor's failure to perform its work in accordance with the contract documents.

The Contractor shall obtain and keep in force during the terms of this Contract, or as otherwise required, the following insurance with companies or through sources approved by the State Insurance Commissioner pursuant to Title 48 RCW.

19. INSURANCE

- A. Insurance Requirements – Contractor shall obtain and maintain the minimum insurance set forth below. By requiring such minimum insurance, Transit shall not be deemed or construed to have assessed the risks that may be applicable to the Contractor under this Contract. The Contractor shall assess its own risks and, if it deems appropriate and/or prudent, maintain greater limits and/or broader coverage.
1. *Commercial General Liability Insurance* on an occurrence basis in an amount not less than \$1,000,000 per occurrence and at least \$2,000,000 in the annual aggregate, including but not limited to: premises/operations (including off-site operations), blanket contractual liability and broad form property damage.
 2. *Business Automobile Liability Insurance* in an amount not less than \$1,000,000 per occurrence, extending to any automobile, including owned, non-owned and hired vehicles.
 3. *Workers' Compensation Insurance* as required by Washington State law and *Employer's Liability Insurance (Stop Gap)* with limits not less than \$1,000,000 per occurrence.
- B. Additional Requirements – Contractor shall provide to Transit Certificates of Insurance and copies of policies, if requested, prior to commencement of work. All policies of insurance shall:
- i. Contain an endorsement specifically naming Intercity Transit its officers, officials, agents, and employees, as Additional Insureds with respect to the Commercial General Liability Policy only.
 - ii. Include a Severability of Interest clause (cross liability) applicable to Commercial General Liability and Business Automobile Liability Policies only.
 - iii. Any cancelled or non-renewed policy will be replaced with no coverage gap and a current Certificate of Insurance will be provided.
 - iv. Be provided on forms and by insurance companies satisfactory to Transit.

No provision in this paragraph shall be construed to limit the liability of the Contractor for work not done in accordance with the Contract, or express or implied warranties. The Contractor's liability for the work shall extend as far as the appropriate periods of limitation provided by law.

- C. Worker's Compensation - The Contractor and its subcontractors shall maintain worker's compensation insurance in the amount and type required by law for all employees employed under this Contract who may come within the protection of worker's compensation laws. The Contractor shall make all payments arising from the performance of this Contract due the State Washington pursuant to Titles 50 and 51 RCW.
- D. Evidences and Cancellation of Insurance - Prior to execution of the Contract, the Bidder/Contractor shall file with Transit evidences of insurance from the insurer(s) certifying to the coverage of all insurance required herein. All evidences of insurance must be certified by a properly authorized officer, agent, general agent or qualified representative of the insurer(s) and shall certify the name of the insured, the type and amount of insurance, the location and operations to which the insurance applies, the expiration date, and that the insurer(s) shall give, by registered mail, notice to Transit at least thirty days prior to the effective date of any cancellation, lapse, or material change in the policy. Any failure to mail such notice shall not relieve the insurance company, its agents, or representatives from obligations and/or liability hereunder.
- E. The Contractor shall, upon demand of Transit, deliver to Transit all such policy or policies of insurance and the receipts for payment of premiums thereon; and should the Contractor neglect so to obtain and maintain in force any such insurance or deliver such policy or action plan to acquire such insurance and/or deliver policies and receipts within three days or before any further performance hereunder, whichever is first. Failure to provide such insurance in a timeframe acceptable to Transit shall enable Transit to suspend or terminate the Contractor's work. Suspension or termination of this Contract shall not relieve the Contractor from its insurance obligations hereunder.

20. BONDING REQUIREMENTS

A. Performance and Payment Bonds

Contractor is required to obtain performance and payment bonds as follows:

1. Performance Bonds

- a. The penal amount of performance bonds shall be 100 percent of the original Contract price, unless Transit determines that a lesser amount would be adequate for the protection of Transit.
- b. Transit may require additional performance bond protection when a Contract price is increased. The increase in protection shall generally equal 100 percent of the increase in Contract price. Transit may secure additional protection by directing the Contractor to increase the penal amount of the existing bond or to obtain an additional bond.

2. *Payment Bonds*

- a. The penal amount of performance bonds shall be 100 percent of the original Contract price, unless Transit determines that a lesser amount would be adequate.
- b. Transit may require additional performance bond protection when a Contract price is increased. The increase in protection shall generally equal 100 percent of the increase in Contract price. Transit may secure additional protection by directing the Contractor to increase the penal amount of the existing bond or to obtain an additional bond.

B. Warranty of the Work and Maintenance Bonds

1. Contractor warrants to Transit, the Architect and/or Engineer that all materials and equipment furnished under this Contract will be of highest quality and new unless otherwise specified by Transit, free from faults and defects and in conformance with the Contract Documents. All work not so conforming to these standards shall be considered defective. If required by Transit, Contractor shall furnish satisfactory evidence as to the kind and quality of materials and equipment.
2. The work furnished must be of first quality and the workmanship, and must be the best obtainable in the various trades. The work must be of safe, substantial and durable construction in all respects. Contractor hereby guarantees the work against defective materials or faulty workmanship for a minimum period of one (1) year after Final Payment by Transit, and shall replace or repair any defective materials or equipment or faulty workmanship during the period of the guarantee at no cost to Transit.

21. TREATMENT OF ASSETS

- A. Title to all property furnished by Transit shall remain in the name of Transit. Transit shall become the owner of the work product and other documents, if any, prepared or developed specifically by Contractor for Transit pursuant to this Contract, unless otherwise expressly provided herein.
- B. Work product shall include, but not be limited to, research, reports, computer programs, manuals, drawings, recordings, photographs, artwork and any data or information in any form; Contractor and Transit intend that such work product shall be deemed "work made for hire" of which Transit shall be deemed the author.

22. COMPLIANCE WITH LAWS

- A. In the performance of this Contract, Contractor shall comply with all applicable federal, state or local laws and ordinances, including regulations for licensing, certification and operation of equipment, and licensing of individuals, and any other standards or criteria described in this Contract to assure quality of services.
- B. Contractor agrees to pay any applicable business and occupation (B&O) taxes which may be due on account of this Contract.

- C. If sales tax becomes applicable to the professional services covered by this Contract, Transit shall pay such tax to Contractor, and Contractor shall pay the tax as required by law.

23. POLITICAL ACTIVITY PROHIBITED

None of the funds, materials, property, or services provided directly or indirectly under this Contract shall be used for any partisan political activity, or to further the election or defeat of any candidate for public office.

24. PROHIBITED INTEREST

No Authority member, officer or employee of Transit shall have any personal interest, direct or indirect, in this Contract or the proceeds thereof.

25. NONDISCRIMINATION

- A. Equal Opportunity. Transit is an equal opportunity employer.
- B. Nondiscrimination in Employment. In the performance of this Contract, Contractor will not discriminate against any employee or applicant for employment on the grounds of race, creed, color, national origin, sex, marital status, age or the presence of any sensory, mental or physical handicap; provided that the prohibition against discrimination in employment because of handicap shall not apply if the particular disability prevents the proper performance of the particular work involved. Contractor shall ensure that applicants are employed, and that employees are treated during employment, without regard to their race, creed, color, national origin, sex, marital status, age or the presence of any sensory, mental or physical handicap. Such action shall include, but not be limited to: employment, upgrading, demotion, or transfer; recruitment or recruitment advertising, layoff or termination, rates of pay or other forms of compensation and programs for training including apprenticeships. Contractor shall take such action with respect to this Contract as may be required to ensure full compliance with Chapter 49.60 Revised Code of Washington, Law against Discrimination.
- C. Nondiscrimination in Services. Contractor will not discriminate against any recipient of any services or benefits provided for in this Contract on the grounds of race, creed, color, national origin, sex, marital status, age or the presence of any sensory, mental or physical handicap.
- D. Nondiscrimination in Sub-Contracting. If any assignment and/or subcontracting have been authorized by Transit, said assignment or subcontract shall include appropriate safeguards against discrimination. Contractor shall take such action as may be required to ensure full compliance with the provisions in the immediately preceding paragraphs herein and further agrees to insert a similar provision in all subcontracts, except subcontracts for standard commercial supplies or raw materials.

26. GRATUITIES AND KICKBACKS

- A. Gratuities – It shall be a breach of ethical standards for any person to offer, give or agree to give any Intercity Transit Authority member, officer, employee, agent or former Authority member, officer, employee, or agent or for any Authority member, officer, employee, agent or former Authority member, officer, employee or agent to solicit, demand, accept, or agree to accept from another person, a gratuity or an offer of employment in connection with any decision, approval, disapproval, recommendation, preparation of any part of a program requirement or a purchase request, influencing the content of any specification or procurement standard, rendering of advice, investigation, auditing, or in any other advisory capacity in any proceeding or application, request for ruling, determination, claim or controversy, or other particular matter, pertaining to any program requirement or a contract or subcontract, or to any solicitation therefore.
- B. Kickbacks – It shall be a breach of ethical standards for any payment, gratuity, or offer of employment to be made by or on behalf of a subcontractor under a contract to the prime Contractor or higher tier subcontractor or any person associated therewith, as an inducement for the award of a subcontract or order.

27. LIENS, CLAIMS AND ENCUMBRANCES

Contractor certifies that all materials, equipment or services shall be free of all liens, claims, or encumbrances of any kind, and if Transit requests, a formal release of same shall be provided.

28. MAINTENANCE AND INSPECTION OF RECORDS

- A. Contractor shall maintain books, records, documents which sufficiently and properly reflect all direct and indirect costs related to the performance of this Contract and shall undertake such accounting procedures and practices as may be deemed necessary to assure proper accounting of all funds paid pursuant to this Contract. These records shall be subject at all reasonable times to inspection, review or audit, by Transit, its authorized representative, the State Auditor or any of their authorized representatives or other governmental officials authorized by law to monitor this Contract.
- B. Contractor shall retain all books, records, documents and other material relevant to this Contract for five (5) years after Transit's final payment and all other pending matters are closed. Contractor agrees that Transit, or its designee, shall have full access and right to examine any of said materials at all reasonable times during said period.
- C. Contractor's fiscal management system shall include the capability to provide accurate, current and complete disclosure of the financial status of this Contract upon request.

29. DISPUTES

Disputes arising in the performance of this Contract which are not resolved by agreement of the parties will be decided by arbitration if the parties mutually agree, or in the Superior Court of Thurston County, Washington, which shall have exclusive jurisdiction and venue over all matters in question between Transit and Contractor.

30. TERMINATION

A. Termination for Convenience or Default. Transit may terminate the Contract, in whole or in part, for Transit's convenience or because of the failure of Contractor to fulfill the Contract obligations. Transit shall terminate by delivering to Contractor a Notice of Termination specifying the nature, extent, and effective date of the termination. Upon receipt of the notice, Contractor shall (1) immediately discontinue all services affected (unless the notice directs otherwise or Transit has granted Contractor a cure period as set forth in (B) below), and (2) deliver to Transit all data, drawings, specifications, reports, estimates, summaries, and other information and materials accumulated in performing this Contract, whether completed or in process.

- i. If the termination is for the convenience of Transit, Transit shall make an equitable adjustment in the Contract price such that all amounts due to Contractor for Products delivered and services performed are paid, but shall allow no anticipated profit on unperformed services.
- ii. If the termination is for failure of Contractor to fulfill the contract obligations, the Contractor shall only be paid for work delivered and accepted unless such work does not fulfill the Contract obligations. Transit may complete the work by Contract or otherwise and Contractor shall be liable for any additional cost incurred by Transit.
- iii. If, after termination for failure to fulfill Contract obligations, it is determined that Contractor was not in default, the rights and obligations of the parties shall be the same as if the termination had been issued for the convenience of Transit.

B. Opportunity to Cure. Transit in its sole discretion may, in the case of a termination for breach or default, allow Contractor a commercially reasonable period of time in which to cure the defect. In such case, the notice of termination will state the time period in which cure is permitted and other appropriate conditions.

- i. If Contractor fails to remedy to Transit's satisfaction, the breach or default or any of the terms, covenants, or conditions of this Contract within ten (10) days after receipt by Contractor of written notice from Transit setting forth the nature of said breach or default, Transit shall have the right to terminate the Contract without any further obligation to Contractor, except that Contractor shall be paid for work delivered and accepted unless such work does not fulfill the Contract obligations. Any such

termination for default shall not in any way operate to preclude Transit from also pursuing all available remedies against Contractor and its sureties for said breach or default.

31. WAIVER OF REMEDIES FOR ANY BREACH

In the event that Transit elects to waive its remedies for any breach by the Contractor of any covenant, term or condition of this Contract, such waiver by Transit shall not limit Transit's remedies for any succeeding breach of that or of any other term, covenant, or condition of this Contract.

32. WAIVER

Waiver of any breach of any term or condition of the Contract shall not be deemed a waiver of any prior or subsequent breach. No term or condition of the Contract shall be held to be waived, modified or deleted except by an instrument in writing signed by the parties hereto.

33. NOTICE

Notice provided for in this Contract shall be sent by certified mail to the addresses designated for the parties on the last page of this Contract.

34. ATTORNEYS FEES AND COSTS

If any legal proceeding is brought for the enforcement of this Contract, or because of an alleged dispute, breach, default, or misrepresentation in connection with any of the provisions of this Contract, the prevailing party shall be entitled to recover from the other party, in addition to any other relief to which such party may be entitled, reasonable attorney's fees and costs incurred in such action or proceeding.

35. LIQUIDATED DAMAGES

- A. Contractor agrees to pay Transit, as liquidated damages in accordance with Section 1-08.9 of the WSDOT Standard Specifications, as amended, for each working day in excess of the number of working days stipulated in the Contract Documents. Transit shall have the right to deduct and retain the amount of such liquidated damages from any monies due the Contractor.
- B. Contractor shall be entitled to reasonable extension of time for unavoidable delay in delivery due to causes not reasonably foreseeable by the parties at the time of the Contract execution, and that are entirely beyond the control and without the fault or negligence of the Contractor. These causes include, but are not limited to, acts of God or the public enemy, war, or national emergency making delivery temporarily impossible or illegal, acts or omissions of other suppliers, strikes and labor disputes not brought on by any act or omission of the Contractor, fire, flood, epidemics, quarantines, or freight embargos.

36. BREACHES AND DISPUTE RESOLUTION

- A. Except as otherwise provided in the Contract, Contractor must notify Transit in writing within thirty (30) Calendar Days of any dispute arising under the Contract which is not disposed of by agreement.

- B. All disputes shall be decided by the General Manager of Transit who shall indicate his/her decision in writing and mail or otherwise furnish a copy thereof to the Contractor. The decisions of the General Manager shall be final and conclusive, unless determined by a court of competent jurisdiction to have been fraudulent, capricious, arbitrary, so grossly erroneous as necessarily to imply bad faith, or not supported by substantial evidence.
- C. In connection with any appeal proceeding under this clause, the Contractor shall be afforded an opportunity to be heard within thirty (30) calendar days of the decision, and to offer evidence in support of their appeal. Pending final decisions of a dispute hereunder, the Contractor shall proceed diligently with the performance of the Contract in accord with the General Manager's decision, and such continued performance does not in any manner imply acceptance of our agreement with that decision by the Contractor, nor does it infringe upon the Contractor's right to appeal that decision. This clause does not preclude consideration of law questions in connection with decisions provided for in the above paragraph, provided that nothing in this Contract shall be construed as making final decision of any administrative official, representative, or board on a question of law.

37. PROMPT PAYMENT

In accordance with RCW 39.04.250, the Contractor is required to pay its subcontractors performing work related to this Contract for satisfactory performance of that work no later than ten (10) days after the Contractor's receipt of payment for that work from Transit. In addition, the Contractor is required to return any retainage payments to those subcontractors within thirty (30) days after the subcontractor's work related to this contract is satisfactorily completed. Any delay or postponement of payment from the above referenced time frame may occur only for good cause following written approval of Transit. This clause applies to both DBE and non-DBE subcontracts.

38. JURISDICTION

- A. This Contract has been and shall be construed as having been made and delivered within the state of Washington and it is agreed by each party hereto that this Contract shall be governed by laws of the state of Washington, both as to interpretation and performance.
- B. Any action of law, suit in equity, or judicial proceeding for the enforcement of this Contract or any provisions thereof shall be instituted and maintained only in any of the courts of competent jurisdiction in Thurston County, Washington.

39. SEVERABILITY

- A. It is understood and agreed by the parties that if any part, term or provision of this Contract is held by the courts to be illegal, the validity of the remaining provisions shall not be affected, and the rights and obligations of the parties shall

be construed and enforced as if the Contract did not contain the particular provision held to be invalid.

- B. If it should appear that any provision of this Contract is in conflict with any statutory provision of the State of Washington, said provision which may conflict therewith shall be deemed inoperative and null and void insofar as it may be in conflict therewith, and shall be deemed modified to conform to such statutory provision.

40. ENTIRE CONTRACT

The parties agree that this Contract is the complete expression of the terms hereto and any oral representations or understandings not incorporated herein are excluded. Failure to comply with any of the provisions stated herein shall constitute material breach of Contract and cause for termination. Both parties recognize time is of the essence in the performance of the provisions of this Contract. It is also agreed by the parties that the forgiveness of the nonperformance of any provision of this Contract does not constitute a waiver of the provisions of this Contract.

41. APPROVAL

The signatories to this Contract represent that they have the authority to bind their respective organizations to this Contract.

IN WITNESS WHEREOF, the parties hereto have caused this Contract to be executed the day and year first hereinabove written.

INTERCITY TRANSIT
526 Pattison Street SE
Olympia, WA 98507

CONTRACTOR
Address
City, State, Zip

By: Ann Freeman-Manzanares Date
Its: General Manager

By: Authorized Representative Date
Its: Title

APPENDIX D

PAYMENT BOND

PAYMENT BOND

Bond No. _____

Intercity Transit (Obligee) has awarded to _____ (Principal), a contract for the construction of the project designated as _____, Project No. _____, in Thurston County, Washington (Contract), and said Principal is required under the terms of that Contract to furnish a Payment Bond in accord with RCW Titles 39 and 60.

The Principal, and _____ (Surety), a corporation organized under the laws of the State of _____ and licensed to do business in the State of Washington as surety and named in the current list of "Surety Companies Acceptable in Federal Bonds" as published in the Federal Register by the Audit Staff Bureau of Accounts, U.S. Treasury Dept., are jointly and severally held and firmly bound to the Obligee, in the sum of _____ US Dollars (\$ _____) Total Contract Amount, subject to the provisions herein.

This statutory Payment Bond shall become null and void, if and when the Principal, its heirs, executors, administrators, successors, or assigns shall pay all persons in accordance with RCW Titles 39, and 60, including all workers, laborers, mechanics, subcontractors, and materialmen, and all persons who shall supply such Contractor or subcontractor with provisions and supplies for the carrying on of such work, and all taxes incurred on said Contract under RCW Titles 50 and 51 and all taxes imposed on the Principal under RCW Title 82 ; and if such payment obligations have not been fulfilled, this bond shall remain in full force and effect.

The above-named Principal and Surety hereby jointly and severally agree that every claimant, who has not been paid in full, may sue on this bond for the use of such claimant, prosecute the suit to final judgment in for such sum or sums as may be justly due claimant, and have execution thereon. The Obligee shall not be liable for the payment of any judgment, costs, expenses or attorneys' fees of any such suit.

The Surety for value received agrees that no change, extension of time, alteration or addition to the terms of the Contract, the specifications accompanying the Contract, or to the Work to be performed under the Contract shall in any way affect its obligation on this bond, and waives notice of any change, extension of time, alteration or addition to the terms of the Contract or the Work performed. The Surety agrees that modifications and changes to the terms and conditions of the Contract that increase the total amount to be paid the Principal shall automatically increase the obligation of the Surety on this bond and notice to Surety is not required for such increase obligation.

This obligation shall continue to bind the Principal and Surety, notwithstanding successive payments made hereunder, until the full amount of the obligation is exhausted, or if the full amount of the obligation is not exhausted and no claim is pending resolution, until such time as no further claims can be made pursuant to law with regard to the above-described project.

APPENDIX E

PERFORMANCE BOND

PERFORMANCE BOND

Bond No. _____

Intercity Transit (Obligee) has awarded to _____ (Principal), a contract for the construction of the project designated as _____, Project No. _____, in Thurston County, Washington (Contract), and said Principal is required to furnish a bond for performance of all obligations under the Contract.

The Principal, and _____ (Surety), a corporation organized under the laws of the State of _____ and licensed to do business in the State of Washington as surety and named in the current list of "Surety Companies Acceptable in Federal Bonds" as published in the Federal Register by the Audit Staff Bureau of Accounts, U.S. Treasury Dept., are jointly and severally held and firmly bound to the Obligee, in the sum of _____ U.S. DOLLARS (\$ _____) Total Contract Amount, subject to the provisions herein.

This statutory Performance Bond shall become null and void, if and when the Principal, its heirs, executors, administrators, successors, or assigns shall well and faithfully perform all of the Principal's obligations under the Contract and fulfill all the terms and conditions of all duly authorized modifications, additions, and changes to said Contract that may hereafter be made, at the time and in the manner therein specified; and if such performance obligations have not been fulfilled, this bond shall remain in full force and effect.

The Surety for value received agrees that no change, extension of time, alteration or addition to the terms of the Contract, the specifications accompanying the Contract, or to the Work to be performed under the Contract shall in any way affect its obligation on this bond, and waives notice of any change, extension of time, alteration or addition to the terms of the Contract or the Work performed. The Surety agrees that modifications and changes to the terms and conditions of the Contract that increase the total amount to be paid the Principal shall automatically increase the obligation of the Surety on this bond and notice to Surety is not required for such increase obligation.

This bond may be executed in two (2) original counterparts and shall be signed by the parties' duly authorized officers. This bond will only be accepted if it is accompanied by a fully executed and original Power of Attorney for the officer executing on behalf of the Surety.

PRINCIPAL

Principal Signature Date

Printed Name

Title

Address

City State Zip

Telephone Number

SURETY

Surety Signature Date

Printed Name

Title

Address

City State Zip

Telephone Number

APPENDIX F

CONTRACTOR'S REQUIREMENTS FOR WORKING IN THE ROW



CONTRACTOR REQUIREMENTS FOR WORKING IN THE RIGHT OF WAY

Date: _____

To: _____

From: _____

Subject: RIGHT-OF-WAY BOND AND INSURANCE REQUIREMENTS

The City of Olympia requires the following bond and insurance information before a permit can be issued for work in the City Right-of-Way (ROW)

- City License Current City of Olympia business license
- State License Current State contractors license
- ROW Bond A ten thousand dollar (\$10,000.00) Street Excavation and Obstruction Bond.
For your use, a copy of our bond form is attached.

Note: Prior to issuance of any permits to work within the public right-of-way, a performance of work surety, of a value of no less than 125 percent of the work proposed, will be submitted and approved by the Director of Community Planning and Development. This surety is in addition to any contractor licenses, contractor bonds, or insurance requirements.

The type and amount of security will be pursuant to code or, if not specified, be at a minimum of \$10,000 or 125 percent of the value of the work performed, whichever is greater, at the discretion of the City of Olympia. Types of securities include, but are not limited to, a bond with a surety qualified to do a bonding business in this state, a cash deposit, an assigned savings account, or a set-aside letter as acceptable by the City Attorney.

- ROW Insurance A copy of your Certificate of Insurance with the following minimums:

100,000 Personal
50,000 Property
200,000 Per Occurrence

The certificate must list the City as: "**City of Olympia is added as additionally insured.**"



RIGHT OF WAY OBSTRUCTION CHECKLIST

Right of Way Obstruction Permit Application Checklist

- A licensed and bonded contractor is required to be able to perform work in the City's right of ways.
- A current City business license is required.
- A minimum of a \$10,000 bond is required to be submitted to perform the work.
- Have the dates and times of the obstruction ready.
- Have the contractor's UBI number ready for the application process. What is a UBI number? A UBI number is a **Washington State Unified Business Identifier**. A UBI number is a 9-digit number that registers you with several state agencies and allows you to do business in Washington State.

Submittal Requirement in PDF Format

- Traffic Control Plan meeting the standards in the Manual on Uniform Traffic Control Devices (MUTCD)
- Scope of Work Letter

Upload digital submittals after application has been submitted on the portal.



CONTRACTOR REQUIREMENTS FOR WORKING IN THE RIGHT OF WAY

Date: _____

To: _____

From: _____

Subject: RIGHT-OF-WAY BOND AND INSURANCE REQUIREMENTS

The City of Olympia requires the following bond and insurance information before a permit can be issued for work in the City Right-of-Way (ROW)

- City License Current City of Olympia business license
- State License Current State contractors license
- ROW Bond A ten thousand dollar (\$10,000.00) Street Excavation and Obstruction Bond.
For your use, a copy of our bond form is attached.

Note: Prior to issuance of any permits to work within the public right-of-way, a performance of work surety, of a value of no less than 125 percent of the work proposed, will be submitted and approved by the Director of Community Planning and Development. This surety is in addition to any contractor licenses, contractor bonds, or insurance requirements.

The type and amount of security will be pursuant to code or, if not specified, be at a minimum of \$10,000 or 125 percent of the value of the work performed, whichever is greater, at the discretion of the City of Olympia. Types of securities include, but are not limited to, a bond with a surety qualified to do a bonding business in this state, a cash deposit, an assigned savings account, or a set-aside letter as acceptable by the City Attorney.

- ROW Insurance A copy of your Certificate of Insurance with the following minimums:

100,000 Personal
50,000 Property
200,000 Per Occurrence

The certificate must list the City as: "**City of Olympia is added as additionally insured.**"

CITY OF OLYMPIA
RIGHT OF WAY PERFORMANCE BOND
BOND # _____

KNOW ALL PEOPLE BY THESE PRESENTS That we, _____ as Principal, and _____ incorporated under the laws of the State of Washington, with principal office in _____, as Surety, are held firmly bound unto CITY OF OLYMPIA as Obligee, in penal sum of Ten Thousand and no/100 dollars (\$10,000), [OR **ENTER AMOUNT**] _____ lawful money of the United States for which payment well and truly to be made, we bond ourselves, our heirs, executors, administrators, and assigns, jointly and severally, firmly, by these presents.

WHEREAS, the above bounden Principal has obtained or is about to obtain from the said Obligee a license or permit for obstruction or construction of improvements per Section 12.20 of Olympia City Code, EDDS Section 2.030 F, and DDECM Vol 1-2.6.1; and the term of said license or permit is as indicated opposite the block checked below:

Beginning the ____ day of _____, 20____
and ending the ____ day of _____, 20____, OR
Continuous, beginning the ____ day of _____, 20____.

WHEREAS, the Principal is required by law to file with the City of Olympia, by virtue of Olympia City Code, Section 12.20.060 a bond for the above-indicated term and conditioned as hereinafter set forth.

NOW, THEREFORE THE CONDITION OF THIS OBLIGATION IS SUCH, that if the above bounded Principal as such Licensee or Permittee shall indemnify said Obligee against all claims, loss, costs, expenses or damage to it caused by the work performed by said Principal under authority of said City of Olympia permit performed during the term of this bond, then this obligation shall be void, otherwise to remain in full force and effect. If the City of Olympia or any part to this agreement files suit to enforce the terms of this agreement, attorney's fees shall be awarded to the prevailing party.

PROVIDED, that if this bond is for a fixed term, it may be continued by Certificate executed by the Surety hereon; and

PROVIDED FURTHER, that regardless of the number of years this bond shall continue or be continued in force and of the number of premiums that shall be payable or paid, the Surety shall not be liable hereunder for a larger amount, in the aggregate, than the amount of this bond; and

PROVIDED FURTHER, that if this is a continuous bond and the Surety shall so elect, this bond may be canceled by the Surety as to subsequent liability by giving thirty (30) days notice in writing to said Obligee.

Signed, sealed and dated the ____ day of _____, 20____.

LOCAL AGENT NAME:

Principal

ADDRESS: _____

By: _____

TELEPHONE: _____

By: _____
Attorney-in-Fact

ATTACHMENT A

WAGE RATES

State of Washington
 Department of Labor & Industries
 Prevailing Wage Section - Telephone 360-902-5335
 PO Box 44540, Olympia, WA 98504-4540

Washington State Prevailing Wage

The PREVAILING WAGES listed here include both the hourly wage rate and the hourly rate of fringe benefits. On public works projects, worker's wage and benefit rates must add to not less than this total. A brief description of overtime calculation requirements are provided on the Benefit Code Key.

Journey Level Prevailing Wage Rates for the Effective Date: 7/13/2020

<u>County</u>	<u>Trade</u>	<u>Job Classification</u>	<u>Wage</u>	<u>Holiday</u>	<u>Overtime</u>	<u>Note</u>	<u>*Risk Class</u>
Thurston	Asbestos Abatement Workers	Journey Level	\$50.86	<u>5D</u>	<u>1H</u>		View
Thurston	Boilermakers	Journey Level	\$69.29	<u>5N</u>	<u>1C</u>		View
Thurston	Brick Mason	Journey Level	\$58.82	<u>5A</u>	<u>1M</u>		View
Thurston	Brick Mason	Pointer-Caulker-Cleaner	\$58.82	<u>5A</u>	<u>1M</u>		View
Thurston	Building Service Employees	Janitor	\$13.50		<u>1</u>		View
Thurston	Building Service Employees	Shampooer	\$13.50		<u>1</u>		View
Thurston	Building Service Employees	Waxer	\$13.50		<u>1</u>		View
Thurston	Building Service Employees	Window Cleaner	\$13.50		<u>1</u>		View
Thurston	Cabinet Makers (In Shop)	Journey Level	\$13.50		<u>1</u>		View
Thurston	Carpenters	Acoustical Worker	\$62.44	<u>7A</u>	<u>4C</u>		View
Thurston	Carpenters	Carpenter	\$62.44	<u>7A</u>	<u>4C</u>		View
Thurston	Carpenters	Carpenters on Stationary Tools	\$62.57	<u>7A</u>	<u>4C</u>		View
Thurston	Carpenters	Creosoted Material	\$62.54	<u>7A</u>	<u>4C</u>		View
Thurston	Carpenters	Floor Finisher	\$62.44	<u>7A</u>	<u>4C</u>		View
Thurston	Carpenters	Floor Layer	\$62.44	<u>7A</u>	<u>4C</u>		View
Thurston	Carpenters	Scaffold Erector	\$62.44	<u>7A</u>	<u>4C</u>		View
Thurston	Cement Masons	Application of all Composition Mastic	\$62.97	<u>7A</u>	<u>4U</u>		View
Thurston	Cement Masons	Application of all Epoxy Material	\$62.47	<u>7A</u>	<u>4U</u>		View
Thurston	Cement Masons	Application of all Plastic Material	\$62.97	<u>7A</u>	<u>4U</u>		View
Thurston	Cement Masons	Application of Sealing Compound	\$62.47	<u>7A</u>	<u>4U</u>		View
Thurston	Cement Masons	Application of Underlayment	\$62.97	<u>7A</u>	<u>4U</u>		View
Thurston	Cement Masons	Building General	\$62.47	<u>7A</u>	<u>4U</u>		View
Thurston	Cement Masons		\$62.97	<u>7A</u>	<u>4U</u>		View

		Composition or Kalman Floors					
Thurston	Cement Masons	Concrete Paving	\$62.47	<u>7A</u>	<u>4U</u>		View
Thurston	Cement Masons	Curb & Gutter Machine	\$62.97	<u>7A</u>	<u>4U</u>		View
Thurston	Cement Masons	Curb & Gutter, Sidewalks	\$62.47	<u>7A</u>	<u>4U</u>		View
Thurston	Cement Masons	Curing Concrete	\$62.47	<u>7A</u>	<u>4U</u>		View
Thurston	Cement Masons	Finish Colored Concrete	\$62.97	<u>7A</u>	<u>4U</u>		View
Thurston	Cement Masons	Floor Grinding	\$62.97	<u>7A</u>	<u>4U</u>		View
Thurston	Cement Masons	Floor Grinding/Polisher	\$62.47	<u>7A</u>	<u>4U</u>		View
Thurston	Cement Masons	Green Concrete Saw, self-powered	\$62.97	<u>7A</u>	<u>4U</u>		View
Thurston	Cement Masons	Grouting of all Plates	\$62.47	<u>7A</u>	<u>4U</u>		View
Thurston	Cement Masons	Grouting of all Tilt-up Panels	\$62.47	<u>7A</u>	<u>4U</u>		View
Thurston	Cement Masons	Gunite Nozzleman	\$62.97	<u>7A</u>	<u>4U</u>		View
Thurston	Cement Masons	Hand Powered Grinder	\$62.97	<u>7A</u>	<u>4U</u>		View
Thurston	Cement Masons	Journey Level	\$62.47	<u>7A</u>	<u>4U</u>		View
Thurston	Cement Masons	Patching Concrete	\$62.47	<u>7A</u>	<u>4U</u>		View
Thurston	Cement Masons	Pneumatic Power Tools	\$62.97	<u>7A</u>	<u>4U</u>		View
Thurston	Cement Masons	Power Chipping & Brushing	\$62.97	<u>7A</u>	<u>4U</u>		View
Thurston	Cement Masons	Sand Blasting Architectural Finish	\$62.97	<u>7A</u>	<u>4U</u>		View
Thurston	Cement Masons	Screed & Rodding Machine	\$62.97	<u>7A</u>	<u>4U</u>		View
Thurston	Cement Masons	Spackling or Skim Coat Concrete	\$62.47	<u>7A</u>	<u>4U</u>		View
Thurston	Cement Masons	Troweling Machine Operator	\$62.97	<u>7A</u>	<u>4U</u>		View
Thurston	Cement Masons	Troweling Machine Operator on Colored Slabs	\$62.97	<u>7A</u>	<u>4U</u>		View
Thurston	Cement Masons	Tunnel Workers	\$62.97	<u>7A</u>	<u>4U</u>		View
Thurston	Divers & Tenders	Bell/Vehicle or Submersible Operator (Not Under Pressure)	\$116.20	<u>7A</u>	<u>4C</u>		View
Thurston	Divers & Tenders	Dive Supervisor/Master	\$79.23	<u>7A</u>	<u>4C</u>		View
Thurston	Divers & Tenders	Diver	\$116.20	<u>7A</u>	<u>4C</u>	<u>8V</u>	View
Thurston	Divers & Tenders	Diver On Standby	\$74.23	<u>7A</u>	<u>4C</u>		View
Thurston	Divers & Tenders	Diver Tender	\$67.31	<u>7A</u>	<u>4C</u>		View
Thurston	Divers & Tenders	Manifold Operator	\$67.31	<u>7A</u>	<u>4C</u>		View
Thurston	Divers & Tenders	Manifold Operator Mixed Gas	\$72.31	<u>7A</u>	<u>4C</u>		View
Thurston	Divers & Tenders	Remote Operated Vehicle Operator/Technician	\$67.31	<u>7A</u>	<u>4C</u>		View
Thurston	Divers & Tenders	Remote Operated Vehicle Tender	\$62.69	<u>7A</u>	<u>4C</u>		View
Thurston	Dredge Workers	Assistant Engineer	\$56.44	<u>5D</u>	<u>3F</u>		View

Thurston	Dredge Workers	Assistant Mate (Deckhand)	\$56.00	5D	3F		View
Thurston	Dredge Workers	Boatmen	\$56.44	5D	3F		View
Thurston	Dredge Workers	Engineer Welder	\$57.51	5D	3F		View
Thurston	Dredge Workers	Leverman, Hydraulic	\$58.67	5D	3F		View
Thurston	Dredge Workers	Mates	\$56.44	5D	3F		View
Thurston	Dredge Workers	Oiler	\$56.00	5D	3F		View
Thurston	Drywall Applicator	Journey Level	\$62.44	5D	1H		View
Thurston	Drywall Tapers	Journey Level	\$62.81	5P	1E		View
Thurston	Electrical Fixture Maintenance Workers	Journey Level	\$29.54		1		View
Thurston	Electricians - Inside	Cable Splicer	\$74.69	5C	1G		View
Thurston	Electricians - Inside	Journey Level	\$69.96	5C	1G		View
Thurston	Electricians - Inside	Lead Covered Cable Splicer	\$79.41	5C	1G		View
Thurston	Electricians - Inside	Welder	\$74.69	5C	1G		View
Thurston	Electricians - Motor Shop	Craftsman	\$15.37		1		View
Thurston	Electricians - Motor Shop	Journey Level	\$14.69		1		View
Thurston	Electricians - Powerline Construction	Cable Splicer	\$82.39	5A	4D		View
Thurston	Electricians - Powerline Construction	Certified Line Welder	\$75.64	5A	4D		View
Thurston	Electricians - Powerline Construction	Groundperson	\$49.17	5A	4D		View
Thurston	Electricians - Powerline Construction	Heavy Line Equipment Operator	\$75.64	5A	4D		View
Thurston	Electricians - Powerline Construction	Journey Level Lineperson	\$75.64	5A	4D		View
Thurston	Electricians - Powerline Construction	Line Equipment Operator	\$64.54	5A	4D		View
Thurston	Electricians - Powerline Construction	Meter Installer	\$49.17	5A	4D	8W	View
Thurston	Electricians - Powerline Construction	Pole Sprayer	\$75.64	5A	4D		View
Thurston	Electricians - Powerline Construction	Powderperson	\$56.49	5A	4D		View
Thurston	Electronic Technicians	Journey Level	\$44.70	6Z	1B		View
Thurston	Elevator Constructors	Mechanic	\$97.31	7D	4A		View
Thurston	Elevator Constructors	Mechanic In Charge	\$105.06	7D	4A		View
Thurston	Fabricated Precast Concrete Products	Journey Level	\$13.50		1		View
Thurston	Fabricated Precast Concrete Products	Journey Level - In-Factory Work Only	\$13.50		1		View
Thurston	Fence Erectors	Fence Erector	\$43.11	7A	4V	8Y	View
Thurston	Fence Erectors	Fence Laborer	\$43.11	7A	4V	8Y	View
Thurston	Flaggers	Journey Level	\$43.11	7A	4V	8Y	View
Thurston	Glaziers	Journey Level	\$66.51	7L	1Y		View
Thurston		Journeyman	\$76.61	5J	4H		View

	Heat & Frost Insulators And Asbestos Workers						
Thurston	Heating Equipment Mechanics	Journey Level	\$85.88	<u>7F</u>	<u>1E</u>		View
Thurston	Hod Carriers & Mason Tenders	Journey Level	\$52.44	<u>7A</u>	<u>4V</u>	<u>8Y</u>	View
Thurston	Industrial Power Vacuum Cleaner	Journey Level	\$13.50		<u>1</u>		View
Thurston	Inland Boatmen	Boat Operator	\$61.41	<u>5B</u>	<u>1K</u>		View
Thurston	Inland Boatmen	Cook	\$56.48	<u>5B</u>	<u>1K</u>		View
Thurston	Inland Boatmen	Deckhand	\$57.48	<u>5B</u>	<u>1K</u>		View
Thurston	Inland Boatmen	Deckhand Engineer	\$58.81	<u>5B</u>	<u>1K</u>		View
Thurston	Inland Boatmen	Launch Operator	\$58.89	<u>5B</u>	<u>1K</u>		View
Thurston	Inland Boatmen	Mate	\$57.31	<u>5B</u>	<u>1K</u>		View
Thurston	Inspection/Cleaning/Sealing Of Sewer & Water Systems By Remote Control	Cleaner Operator, Foamer Operator	\$13.50		<u>1</u>		View
Thurston	Inspection/Cleaning/Sealing Of Sewer & Water Systems By Remote Control	Grout Truck Operator	\$13.50		<u>1</u>		View
Thurston	Inspection/Cleaning/Sealing Of Sewer & Water Systems By Remote Control	Head Operator	\$13.50		<u>1</u>		View
Thurston	Inspection/Cleaning/Sealing Of Sewer & Water Systems By Remote Control	Technician	\$25.00		<u>1</u>		View
Thurston	Inspection/Cleaning/Sealing Of Sewer & Water Systems By Remote Control	Tv Truck Operator	\$13.50		<u>1</u>		View
Thurston	Insulation Applicators	Journey Level	\$62.44	<u>7A</u>	<u>4C</u>		View
Thurston	Ironworkers	Journeyman	\$73.73	<u>7N</u>	<u>1O</u>		View
Thurston	Laborers	Air, Gas Or Electric Vibrating Screed	\$50.86	<u>7A</u>	<u>4V</u>	<u>8Y</u>	View
Thurston	Laborers	Airtrac Drill Operator	\$52.44	<u>7A</u>	<u>4V</u>	<u>8Y</u>	View
Thurston	Laborers	Ballast Regular Machine	\$50.86	<u>7A</u>	<u>4V</u>	<u>8Y</u>	View
Thurston	Laborers	Batch Weighman	\$43.11	<u>7A</u>	<u>4V</u>	<u>8Y</u>	View
Thurston	Laborers	Brick Pavers	\$50.86	<u>7A</u>	<u>4V</u>	<u>8Y</u>	View
Thurston	Laborers	Brush Cutter	\$50.86	<u>7A</u>	<u>4V</u>	<u>8Y</u>	View
Thurston	Laborers	Brush Hog Feeder	\$50.86	<u>7A</u>	<u>4V</u>	<u>8Y</u>	View
Thurston	Laborers	Burner	\$50.86	<u>7A</u>	<u>4V</u>	<u>8Y</u>	View
Thurston	Laborers	Caisson Worker	\$52.44	<u>7A</u>	<u>4V</u>	<u>8Y</u>	View
Thurston	Laborers	Carpenter Tender	\$50.86	<u>7A</u>	<u>4V</u>	<u>8Y</u>	View
Thurston	Laborers	Cement Dumper-paving	\$51.80	<u>7A</u>	<u>4V</u>	<u>8Y</u>	View
Thurston	Laborers	Cement Finisher Tender	\$50.86	<u>7A</u>	<u>4V</u>	<u>8Y</u>	View
Thurston	Laborers	Change House Or Dry Shack	\$50.86	<u>7A</u>	<u>4V</u>	<u>8Y</u>	View
Thurston	Laborers	Chipping Gun (30 Lbs. And Over)	\$51.80	<u>7A</u>	<u>4V</u>	<u>8Y</u>	View

Thurston	Laborers	Chipping Gun (Under 30 Lbs.)	\$50.86	7A	4V	8Y	View
Thurston	Laborers	Choker Setter	\$50.86	7A	4V	8Y	View
Thurston	Laborers	Chuck Tender	\$50.86	7A	4V	8Y	View
Thurston	Laborers	Clary Power Spreader	\$51.80	7A	4V	8Y	View
Thurston	Laborers	Clean-up Laborer	\$50.86	7A	4V	8Y	View
Thurston	Laborers	Concrete Dumper/Chute Operator	\$51.80	7A	4V	8Y	View
Thurston	Laborers	Concrete Form Stripper	\$50.86	7A	4V	8Y	View
Thurston	Laborers	Concrete Placement Crew	\$51.80	7A	4V	8Y	View
Thurston	Laborers	Concrete Saw Operator/Core Driller	\$51.80	7A	4V	8Y	View
Thurston	Laborers	Crusher Feeder	\$43.11	7A	4V	8Y	View
Thurston	Laborers	Curing Laborer	\$50.86	7A	4V	8Y	View
Thurston	Laborers	Demolition: Wrecking & Moving (Incl. Charred Material)	\$50.86	7A	4V	8Y	View
Thurston	Laborers	Ditch Digger	\$50.86	7A	4V	8Y	View
Thurston	Laborers	Diver	\$52.44	7A	4V	8Y	View
Thurston	Laborers	Drill Operator (Hydraulic, Diamond)	\$51.80	7A	4V	8Y	View
Thurston	Laborers	Dry Stack Walls	\$50.86	7A	4V	8Y	View
Thurston	Laborers	Dump Person	\$50.86	7A	4V	8Y	View
Thurston	Laborers	Epoxy Technician	\$50.86	7A	4V	8Y	View
Thurston	Laborers	Erosion Control Worker	\$50.86	7A	4V	8Y	View
Thurston	Laborers	Faller & Bucker Chain Saw	\$51.80	7A	4V	8Y	View
Thurston	Laborers	Fine Graders	\$50.86	7A	4V	8Y	View
Thurston	Laborers	Firewatch	\$43.11	7A	4V	8Y	View
Thurston	Laborers	Form Setter	\$50.86	7A	4V	8Y	View
Thurston	Laborers	Gabian Basket Builders	\$50.86	7A	4V	8Y	View
Thurston	Laborers	General Laborer	\$50.86	7A	4V	8Y	View
Thurston	Laborers	Grade Checker & Transit Person	\$52.44	7A	4V	8Y	View
Thurston	Laborers	Grinders	\$50.86	7A	4V	8Y	View
Thurston	Laborers	Grout Machine Tender	\$50.86	7A	4V	8Y	View
Thurston	Laborers	Groutmen (Pressure) Including Post Tension Beams	\$51.80	7A	4V	8Y	View
Thurston	Laborers	Guardrail Erector	\$50.86	7A	4V	8Y	View
Thurston	Laborers	Hazardous Waste Worker (Level A)	\$52.44	7A	4V	8Y	View
Thurston	Laborers	Hazardous Waste Worker (Level B)	\$51.80	7A	4V	8Y	View
Thurston	Laborers	Hazardous Waste Worker (Level C)	\$50.86	7A	4V	8Y	View
Thurston	Laborers	High Scaler	\$52.44	7A	4V	8Y	View

Thurston	Laborers	Jackhammer	\$51.80	7A	4V	8Y	View
Thurston	Laborers	Laserbeam Operator	\$51.80	7A	4V	8Y	View
Thurston	Laborers	Maintenance Person	\$50.86	7A	4V	8Y	View
Thurston	Laborers	Manhole Builder-Mudman	\$51.80	7A	4V	8Y	View
Thurston	Laborers	Material Yard Person	\$50.86	7A	4V	8Y	View
Thurston	Laborers	Motorman-Dinky Locomotive	\$51.80	7A	4V	8Y	View
Thurston	Laborers	Nozzleman (Concrete Pump, Green Cutter When Using Combination Of High Pressure Air & Water On Concrete & Rock, Sandblast, Gunite, Shotcrete, Water Blaster, Vacuum Blaster)	\$51.80	7A	4V	8Y	View
Thurston	Laborers	Pavement Breaker	\$51.80	7A	4V	8Y	View
Thurston	Laborers	Pilot Car	\$43.11	7A	4V	8Y	View
Thurston	Laborers	Pipe Layer Lead	\$52.44	7A	4V	8Y	View
Thurston	Laborers	Pipe Layer/Tailor	\$51.80	7A	4V	8Y	View
Thurston	Laborers	Pipe Pot Tender	\$51.80	7A	4V	8Y	View
Thurston	Laborers	Pipe Reliner	\$51.80	7A	4V	8Y	View
Thurston	Laborers	Pipe Wrapper	\$51.80	7A	4V	8Y	View
Thurston	Laborers	Pot Tender	\$50.86	7A	4V	8Y	View
Thurston	Laborers	Powderman	\$52.44	7A	4V	8Y	View
Thurston	Laborers	Powderman's Helper	\$50.86	7A	4V	8Y	View
Thurston	Laborers	Power Jacks	\$51.80	7A	4V	8Y	View
Thurston	Laborers	Railroad Spike Puller - Power	\$51.80	7A	4V	8Y	View
Thurston	Laborers	Raker - Asphalt	\$52.44	7A	4V	8Y	View
Thurston	Laborers	Re-timberman	\$52.44	7A	4V	8Y	View
Thurston	Laborers	Remote Equipment Operator	\$51.80	7A	4V	8Y	View
Thurston	Laborers	Rigger/Signal Person	\$51.80	7A	4V	8Y	View
Thurston	Laborers	Rip Rap Person	\$50.86	7A	4V	8Y	View
Thurston	Laborers	Rivet Buster	\$51.80	7A	4V	8Y	View
Thurston	Laborers	Rodder	\$51.80	7A	4V	8Y	View
Thurston	Laborers	Scaffold Erector	\$50.86	7A	4V	8Y	View
Thurston	Laborers	Scale Person	\$50.86	7A	4V	8Y	View
Thurston	Laborers	Sloper (Over 20")	\$51.80	7A	4V	8Y	View
Thurston	Laborers	Sloper Sprayer	\$50.86	7A	4V	8Y	View
Thurston	Laborers	Spreader (Concrete)	\$51.80	7A	4V	8Y	View
Thurston	Laborers	Stake Hopper	\$50.86	7A	4V	8Y	View
Thurston	Laborers	Stock Piler	\$50.86	7A	4V	8Y	View
Thurston	Laborers	Swinging Stage/Boatswain Chair	\$43.11	7A	4V	8Y	View
Thurston	Laborers		\$51.80	7A	4V	8Y	View

		Tamper & Similar Electric, Air & Gas Operated Tools					
Thurston	Laborers	Tamper (Multiple & Self-propelled)	\$51.80	7A	4V	8Y	View
Thurston	Laborers	Timber Person - Sewer (Lagger, Shorer & Cribber)	\$51.80	7A	4V	8Y	View
Thurston	Laborers	Toolroom Person (at Jobsite)	\$50.86	7A	4V	8Y	View
Thurston	Laborers	Topper	\$50.86	7A	4V	8Y	View
Thurston	Laborers	Track Laborer	\$50.86	7A	4V	8Y	View
Thurston	Laborers	Track Liner (Power)	\$51.80	7A	4V	8Y	View
Thurston	Laborers	Traffic Control Laborer	\$46.10	7A	4V	9C	View
Thurston	Laborers	Traffic Control Supervisor	\$48.84	7A	4V	9C	View
Thurston	Laborers	Truck Spotter	\$50.86	7A	4V	8Y	View
Thurston	Laborers	Tugger Operator	\$51.80	7A	4V	8Y	View
Thurston	Laborers	Tunnel Work-Compressed Air Worker 0-30 psi	\$120.61	7A	4V	9B	View
Thurston	Laborers	Tunnel Work-Compressed Air Worker 30.01-44.00 psi	\$125.64	7A	4V	9B	View
Thurston	Laborers	Tunnel Work-Compressed Air Worker 44.01-54.00 psi	\$129.32	7A	4V	9B	View
Thurston	Laborers	Tunnel Work-Compressed Air Worker 54.01-60.00 psi	\$135.02	7A	4V	9B	View
Thurston	Laborers	Tunnel Work-Compressed Air Worker 60.01-64.00 psi	\$137.14	7A	4V	9B	View
Thurston	Laborers	Tunnel Work-Compressed Air Worker 64.01-68.00 psi	\$142.24	7A	4V	9B	View
Thurston	Laborers	Tunnel Work-Compressed Air Worker 68.01-70.00 psi	\$144.14	7A	4V	9B	View
Thurston	Laborers	Tunnel Work-Compressed Air Worker 70.01-72.00 psi	\$146.14	7A	4V	9B	View
Thurston	Laborers	Tunnel Work-Compressed Air Worker 72.01-74.00 psi	\$148.14	7A	4V	9B	View
Thurston	Laborers	Tunnel Work-Guage and Lock Tender	\$52.54	7A	4V	8Y	View
Thurston	Laborers	Tunnel Work-Miner	\$52.54	7A	4V	8Y	View
Thurston	Laborers	Vibrator	\$51.80	7A	4V	8Y	View
Thurston	Laborers	Vinyl Seamer	\$50.86	7A	4V	8Y	View
Thurston	Laborers	Watchman	\$39.18	7A	4V	8Y	View
Thurston	Laborers	Welder	\$51.80	7A	4V	8Y	View

Thurston	Laborers	Well Point Laborer	\$51.80	7A	4V	8Y	View
Thurston	Laborers	Window Washer/Cleaner	\$39.18	7A	4V	8Y	View
Thurston	Laborers - Underground Sewer & Water	General Laborer & Topman	\$50.86	7A	4V	8Y	View
Thurston	Laborers - Underground Sewer & Water	Pipe Layer	\$51.80	7A	4V	8Y	View
Thurston	Landscape Construction	Landscape Construction/Landscaping Or Planting Laborers	\$39.18	7A	4V	8Y	View
Thurston	Landscape Construction	Landscape Operator	\$65.71	7A	3K	8X	View
Thurston	Landscape Maintenance	Groundskeeper	\$14.41		1		View
Thurston	Lathers	Journey Level	\$62.44	5D	1H		View
Thurston	Marble Setters	Journey Level	\$58.82	5A	1M		View
Thurston	Metal Fabrication (In Shop)	Fitter	\$27.10	6T	2U		View
Thurston	Metal Fabrication (In Shop)	Laborer	\$16.91	6T	2U		View
Thurston	Metal Fabrication (In Shop)	Layrout	\$30.63	6T	2U		View
Thurston	Metal Fabrication (In Shop)	Machine Operator	\$20.86	6T	2U		View
Thurston	Metal Fabrication (In Shop)	Welder	\$24.74	6T	2U		View
Thurston	Millwright	Journey Level	\$63.94	7A	4C		View
Thurston	Modular Buildings	Cabinet Assembly	\$13.50		1		View
Thurston	Modular Buildings	Electrician	\$13.50		1		View
Thurston	Modular Buildings	Equipment Maintenance	\$13.50		1		View
Thurston	Modular Buildings	Plumber	\$13.50		1		View
Thurston	Modular Buildings	Production Worker	\$13.50		1		View
Thurston	Modular Buildings	Tool Maintenance	\$13.50		1		View
Thurston	Modular Buildings	Utility Person	\$13.50		1		View
Thurston	Modular Buildings	Welder	\$13.50		1		View
Thurston	Painters	Journey Level	\$43.40	6Z	2B		View
Thurston	Pile Driver	Crew Tender	\$67.31	7A	4C		View
Thurston	Pile Driver	Crew Tender/Technician	\$67.31	7A	4C		View
Thurston	Pile Driver	Hyperbaric Worker - Compressed Air Worker 0-30.00 PSI	\$77.93	7A	4C		View
Thurston	Pile Driver	Hyperbaric Worker - Compressed Air Worker 30.01 - 44.00 PSI	\$82.93	7A	4C		View
Thurston	Pile Driver	Hyperbaric Worker - Compressed Air Worker 44.01 - 54.00 PSI	\$86.93	7A	4C		View
Thurston	Pile Driver	Hyperbaric Worker - Compressed Air Worker 54.01 - 60.00 PSI	\$91.93	7A	4C		View
Thurston	Pile Driver	Hyperbaric Worker - Compressed Air Worker 60.01 - 64.00 PSI	\$94.43	7A	4C		View
Thurston	Pile Driver	Hyperbaric Worker - Compressed Air Worker 64.01 - 68.00 PSI	\$99.43	7A	4C		View

Thurston	Pile Driver	Hyperbaric Worker - Compressed Air Worker 68.01 - 70.00 PSI	\$101.43	7A	4C		View
Thurston	Pile Driver	Hyperbaric Worker - Compressed Air Worker 70.01 - 72.00 PSI	\$103.43	7A	4C		View
Thurston	Pile Driver	Hyperbaric Worker - Compressed Air Worker 72.01 - 74.00 PSI	\$105.43	7A	4C		View
Thurston	Pile Driver	Journey Level	\$62.69	7A	4C		View
Thurston	Plasterers	Journey Level	\$59.29	7Q	1R		View
Thurston	Playground & Park Equipment Installers	Journey Level	\$13.50		1		View
Thurston	Plumbers & Pipefitters	Journey Level	\$76.22	5A	1G		View
Thurston	Power Equipment Operators	Asphalt Plant Operator	\$66.81	7A	3K	8X	View
Thurston	Power Equipment Operators	Assistant Engineers	\$62.85	7A	3K	8X	View
Thurston	Power Equipment Operators	Barrier Machine (zipper)	\$66.22	7A	3K	8X	View
Thurston	Power Equipment Operators	Batch Plant Operator: Concrete	\$66.22	7A	3K	8X	View
Thurston	Power Equipment Operators	Bobcat	\$62.85	7A	3K	8X	View
Thurston	Power Equipment Operators	Brokk - Remote Demolition Equipment	\$62.85	7A	3K	8X	View
Thurston	Power Equipment Operators	Brooms	\$62.85	7A	3K	8X	View
Thurston	Power Equipment Operators	Bump Cutter	\$66.22	7A	3K	8X	View
Thurston	Power Equipment Operators	Cableways	\$66.81	7A	3K	8X	View
Thurston	Power Equipment Operators	Chipper	\$66.22	7A	3K	8X	View
Thurston	Power Equipment Operators	Compressor	\$62.85	7A	3K	8X	View
Thurston	Power Equipment Operators	Concrete Pump: Truck Mount With Boom Attachment Over 42m	\$66.81	7A	3K	8X	View
Thurston	Power Equipment Operators	Concrete Finish Machine - laser Screed	\$62.85	7A	3K	8X	View
Thurston	Power Equipment Operators	Concrete Pump - Mounted Or Trailer High Pressure Line Pump, Pump High Pressure	\$65.71	7A	3K	8X	View
Thurston	Power Equipment Operators	Concrete Pump: Truck Mount With Boom Attachment Up To 42m	\$66.22	7A	3K	8X	View
Thurston	Power Equipment Operators	Conveyors	\$65.71	7A	3K	8X	View
Thurston	Power Equipment Operators	Cranes, 100 Tons - 199 Tons, Or 150 Ft Of Boom (including Jib With Attachments)	\$67.49	7A	3K	8X	View
Thurston	Power Equipment Operators	Cranes: 20 Tons Through 44 Tons With Attachments	\$66.22	7A	3K	8X	View
Thurston	Power Equipment Operators	Cranes: 200 tons to 299 tons, or 250' of boom (including jib with attachments)	\$68.17	7A	3K	8X	View

Thurston	Power Equipment Operators	Cranes: 300 tons and over, or 300' of boom (including jib with attachments)	\$68.84	7A	3K	8X	View
Thurston	Power Equipment Operators	Cranes: 45 Tons Through 99 Tons, Under 150' Of Boom (including Jib With Attachments)	\$66.81	7A	3K	8X	View
Thurston	Power Equipment Operators	Cranes: A-frame - 10 Tons And Under	\$62.85	7A	3K	8X	View
Thurston	Power Equipment Operators	Cranes: Friction 200 tons and over. Tower Cranes: over 250' in height from base to boom.	\$68.84	7A	3K	8X	View
Thurston	Power Equipment Operators	Cranes: Friction cranes through 199 tons	\$68.17	7A	3K	8X	View
Thurston	Power Equipment Operators	Cranes: Through 19 Tons With Attachments A-frame Over 10 Tons	\$65.71	7A	3K	8X	View
Thurston	Power Equipment Operators	Crusher	\$66.22	7A	3K	8X	View
Thurston	Power Equipment Operators	Deck Engineer/deck Winches (power)	\$66.22	7A	3K	8X	View
Thurston	Power Equipment Operators	Derricks, On Building Work	\$66.81	7A	3K	8X	View
Thurston	Power Equipment Operators	Dozers D-9 & Under	\$65.71	7A	3K	8X	View
Thurston	Power Equipment Operators	Drill Oilers: Auger Type, Truck Or Crane Mount	\$65.71	7A	3K	8X	View
Thurston	Power Equipment Operators	Drilling Machine	\$67.49	7A	3K	8X	View
Thurston	Power Equipment Operators	Elevator And Man-lift: Permanent And Shaft Type	\$62.85	7A	3K	8X	View
Thurston	Power Equipment Operators	Finishing Machine, Bidwell And Gamaco & Similar Equipment	\$66.22	7A	3K	8X	View
Thurston	Power Equipment Operators	Forklift: 3000 Lbs And Over With Attachments	\$65.71	7A	3K	8X	View
Thurston	Power Equipment Operators	Forklifts: Under 3000 Lbs. With Attachments	\$62.85	7A	3K	8X	View
Thurston	Power Equipment Operators	Grade Engineer: Using Blueprints, Cut Sheets, etc.	\$66.22	7A	3K	8X	View
Thurston	Power Equipment Operators	Gradechecker/stakeman	\$62.85	7A	3K	8X	View
Thurston	Power Equipment Operators	Guardrail punch/Auger	\$66.22	7A	3K	8X	View
Thurston	Power Equipment Operators	Hard Tail End Dump Articulating Off- Road Equipment 45 Yards. & Over	\$66.81	7A	3K	8X	View
Thurston	Power Equipment Operators	Hard Tail End Dump Articulating Off-road Equipment Under 45 Yards	\$66.22	7A	3K	8X	View
Thurston	Power Equipment Operators		\$65.71	7A	3K	8X	View

		Horizontal/directional Drill Locator					
Thurston	Power Equipment Operators	Horizontal/directional Drill Operator	\$66.22	7A	3K	8X	View
Thurston	Power Equipment Operators	Hydralifts/Boom Trucks Over 10 Tons	\$65.71	7A	3K	8X	View
Thurston	Power Equipment Operators	Hydralifts/boom Trucks, 10 Tons And Under	\$62.85	7A	3K	8X	View
Thurston	Power Equipment Operators	Loader, Overhead 8 Yards. & Over	\$67.49	7A	3K	8X	View
Thurston	Power Equipment Operators	Loader, Overhead, 6 Yards. But Not Including 8 Yards	\$66.81	7A	3K	8X	View
Thurston	Power Equipment Operators	Loaders, Overhead Under 6 Yards	\$66.22	7A	3K	8X	View
Thurston	Power Equipment Operators	Loaders, Plant Feed	\$66.22	7A	3K	8X	View
Thurston	Power Equipment Operators	Loaders: Elevating Type Belt	\$65.71	7A	3K	8X	View
Thurston	Power Equipment Operators	Locomotives, All	\$66.22	7A	3K	8X	View
Thurston	Power Equipment Operators	Material Transfer Device	\$66.22	7A	3K	8X	View
Thurston	Power Equipment Operators	Mechanics, All (Leadmen - \$0.50 Per Hour Over Mechanic)	\$67.49	7A	3K	8X	View
Thurston	Power Equipment Operators	Motor patrol graders	\$66.81	7A	3K	8X	View
Thurston	Power Equipment Operators	Mucking Machine, Mole, Tunnel Drill, Boring, Road Header And/or Shield	\$66.81	7A	3K	8X	View
Thurston	Power Equipment Operators	Oil Distributors, Blower Distribution & Mulch Seeding Operator	\$62.85	7A	3K	8X	View
Thurston	Power Equipment Operators	Outside Hoists (elevators And Manlifts), Air Tuggers, strato	\$65.71	7A	3K	8X	View
Thurston	Power Equipment Operators	Overhead, Bridge Type Crane: 20 Tons Through 44 Tons	\$66.22	7A	3K	8X	View
Thurston	Power Equipment Operators	Overhead, Bridge Type: 100 Tons And Over	\$67.49	7A	3K	8X	View
Thurston	Power Equipment Operators	Overhead, Bridge Type: 45 Tons Through 99 Tons	\$66.81	7A	3K	8X	View
Thurston	Power Equipment Operators	Pavement Breaker	\$62.85	7A	3K	8X	View
Thurston	Power Equipment Operators	Pile Driver (other Than Crane Mount)	\$66.22	7A	3K	8X	View
Thurston	Power Equipment Operators	Plant Oiler - Asphalt, Crusher	\$65.71	7A	3K	8X	View
Thurston	Power Equipment Operators	Posthole Digger, Mechanical	\$62.85	7A	3K	8X	View
Thurston	Power Equipment Operators	Power Plant	\$62.85	7A	3K	8X	View
Thurston	Power Equipment Operators	Pumps - Water	\$62.85	7A	3K	8X	View
Thurston	Power Equipment Operators		\$66.81	7A	3K	8X	View

		Quad 9, HD 41, D10 And Over					
Thurston	Power Equipment Operators	Quick Tower - No Cab, Under 100 Feet In Height Based To Boom	\$62.85	7A	3K	8X	View
Thurston	Power Equipment Operators	Remote Control Operator On Rubber Tired Earth Moving Equipment	\$66.81	7A	3K	8X	View
Thurston	Power Equipment Operators	Rigger And Bellman	\$62.85	7A	3K	8X	View
Thurston	Power Equipment Operators	Rigger/Signal Person, Bellman (Certified)	\$65.71	7A	3K	8X	View
Thurston	Power Equipment Operators	Rollagon	\$66.81	7A	3K	8X	View
Thurston	Power Equipment Operators	Roller, Other Than Plant Mix	\$62.85	7A	3K	8X	View
Thurston	Power Equipment Operators	Roller, Plant Mix Or Multi-lift Materials	\$65.71	7A	3K	8X	View
Thurston	Power Equipment Operators	Roto-mill, Roto-grinder	\$66.22	7A	3K	8X	View
Thurston	Power Equipment Operators	Saws - Concrete	\$65.71	7A	3K	8X	View
Thurston	Power Equipment Operators	Scraper, Self Propelled Under 45 Yards	\$66.22	7A	3K	8X	View
Thurston	Power Equipment Operators	Scrapers - Concrete & Carry All	\$65.71	7A	3K	8X	View
Thurston	Power Equipment Operators	Scrapers, Self-propelled: 45 Yards And Over	\$66.81	7A	3K	8X	View
Thurston	Power Equipment Operators	Service Engineers - Equipment	\$65.71	7A	3K	8X	View
Thurston	Power Equipment Operators	Shotcrete/gunite Equipment	\$62.85	7A	3K	8X	View
Thurston	Power Equipment Operators	Shovel, Excavator, Backhoe, Tractors Under 15 Metric Tons	\$65.71	7A	3K	8X	View
Thurston	Power Equipment Operators	Shovel, Excavator, Backhoe: Over 30 Metric Tons To 50 Metric Tons	\$66.81	7A	3K	8X	View
Thurston	Power Equipment Operators	Shovel, Excavator, Backhoes, Tractors: 15 To 30 Metric Tons	\$66.22	7A	3K	8X	View
Thurston	Power Equipment Operators	Shovel, Excavator, Backhoes: Over 50 Metric Tons To 90 Metric Tons	\$67.49	7A	3K	8X	View
Thurston	Power Equipment Operators	Shovel, Excavator, Backhoes: Over 90 Metric Tons	\$68.17	7A	3K	8X	View
Thurston	Power Equipment Operators	Slipform Pavers	\$66.81	7A	3K	8X	View
Thurston	Power Equipment Operators	Spreader, Topsider & Screedman	\$66.81	7A	3K	8X	View
Thurston	Power Equipment Operators	Subgrader Trimmer	\$66.22	7A	3K	8X	View
Thurston	Power Equipment Operators	Tower Bucket Elevators	\$65.71	7A	3K	8X	View
Thurston	Power Equipment Operators	Tower crane over 175' through 250' in height, base to boom	\$68.17	7A	3K	8X	View

Thurston	Power Equipment Operators	Tower Crane Up: To 175' In Height, Base To Boom	\$67.49	7A	3K	8X	View
Thurston	Power Equipment Operators	Transporters, All Track Or Truck Type	\$66.81	7A	3K	8X	View
Thurston	Power Equipment Operators	Trenching Machines	\$65.71	7A	3K	8X	View
Thurston	Power Equipment Operators	Truck Crane Oiler/driver - 100 Tons And Over	\$66.22	7A	3K	8X	View
Thurston	Power Equipment Operators	Truck Crane Oiler/driver Under 100 Tons	\$65.71	7A	3K	8X	View
Thurston	Power Equipment Operators	Truck Mount Portable Conveyor	\$66.22	7A	3K	8X	View
Thurston	Power Equipment Operators	Welder	\$66.81	7A	3K	8X	View
Thurston	Power Equipment Operators	Wheel Tractors, Farmall Type	\$62.85	7A	3K	8X	View
Thurston	Power Equipment Operators	Yo Yo Pay Dozer	\$66.22	7A	3K	8X	View
Thurston	Power Equipment Operators- Underground Sewer & Water	Asphalt Plant Operator	\$66.81	7A	3K	8X	View
Thurston	Power Equipment Operators- Underground Sewer & Water	Assistant Engineers	\$62.85	7A	3K	8X	View
Thurston	Power Equipment Operators- Underground Sewer & Water	Barrier Machine (zipper)	\$66.22	7A	3K	8X	View
Thurston	Power Equipment Operators- Underground Sewer & Water	Batch Plant Operator: Concrete	\$66.22	7A	3K	8X	View
Thurston	Power Equipment Operators- Underground Sewer & Water	Bobcat	\$62.85	7A	3K	8X	View
Thurston	Power Equipment Operators- Underground Sewer & Water	Brokk - Remote Demolition Equipment	\$62.85	7A	3K	8X	View
Thurston	Power Equipment Operators- Underground Sewer & Water	Brooms	\$62.85	7A	3K	8X	View
Thurston	Power Equipment Operators- Underground Sewer & Water	Bump Cutter	\$66.22	7A	3K	8X	View
Thurston	Power Equipment Operators- Underground Sewer & Water	Cableways	\$66.81	7A	3K	8X	View
Thurston	Power Equipment Operators- Underground Sewer & Water	Chipper	\$66.22	7A	3K	8X	View
Thurston	Power Equipment Operators- Underground Sewer & Water	Compressor	\$62.85	7A	3K	8X	View
Thurston	Power Equipment Operators- Underground Sewer & Water	Concrete Pump: Truck Mount With Boom Attachment Over 42m	\$66.81	7A	3K	8X	View
Thurston			\$62.85	7A	3K	8X	View

	Power Equipment Operators- Underground Sewer & Water	Concrete Finish Machine - laser Screed					
Thurston	Power Equipment Operators- Underground Sewer & Water	Concrete Pump - Mounted Or Trailer High Pressure Line Pump, Pump High Pressure	\$65.71	7A	3K	8X	View
Thurston	Power Equipment Operators- Underground Sewer & Water	Concrete Pump: Truck Mount With Boom Attachment Up To 42m	\$66.22	7A	3K	8X	View
Thurston	Power Equipment Operators- Underground Sewer & Water	Conveyors	\$65.71	7A	3K	8X	View
Thurston	Power Equipment Operators- Underground Sewer & Water	Cranes, 100 Tons - 199 Tons, Or 150 Ft Of Boom (including Jib With Attachments)	\$67.49	7A	3K	8X	View
Thurston	Power Equipment Operators- Underground Sewer & Water	Cranes, 200 tons to 299 tons, or 250' of boom (including jib with attachments)	\$68.17	7A	3K	8X	View
Thurston	Power Equipment Operators- Underground Sewer & Water	Cranes, Over 300 Tons, Or 300' Of Boom Including Jib With Attachments	\$68.84	7A	3K	8X	View
Thurston	Power Equipment Operators- Underground Sewer & Water	Cranes: 20 Tons Through 44 Tons With Attachments	\$66.22	7A	3K	8X	View
Thurston	Power Equipment Operators- Underground Sewer & Water	cranes: 300 tons and over, or 300' of boom (including jib with attachments)	\$68.84	7A	3K	8X	View
Thurston	Power Equipment Operators- Underground Sewer & Water	Cranes: 45 Tons Through 99 Tons, Under 150' Of Boom (including Jib With Attachments)	\$66.81	7A	3K	8X	View
Thurston	Power Equipment Operators- Underground Sewer & Water	Cranes: A-frame - 10 Tons And Under	\$62.85	7A	3K	8X	View
Thurston	Power Equipment Operators- Underground Sewer & Water	Cranes: Friction 200 tons and over. Tower Cranes: over 250' in height from base to boom.	\$68.84	7A	3K	8X	View
Thurston	Power Equipment Operators- Underground Sewer & Water	Cranes: Friction cranes through 199 tons	\$68.17	7A	3K	8X	View
Thurston	Power Equipment Operators- Underground Sewer & Water	Cranes: Through 19 Tons With Attachments A-frame Over 10 Tons	\$65.71	7A	3K	8X	View
Thurston	Power Equipment Operators- Underground Sewer & Water	Crusher	\$66.22	7A	3K	8X	View
Thurston	Power Equipment Operators- Underground Sewer & Water	Deck Engineer/deck Winches (power)	\$66.22	7A	3K	8X	View

Thurston	Power Equipment Operators- Underground Sewer & Water	Derricks, On Building Work	\$66.81	7A	3K	8X	View
Thurston	Power Equipment Operators- Underground Sewer & Water	Dozers D-9 & Under	\$65.71	7A	3K	8X	View
Thurston	Power Equipment Operators- Underground Sewer & Water	Drill Oilers: Auger Type, Truck Or Crane Mount	\$65.71	7A	3K	8X	View
Thurston	Power Equipment Operators- Underground Sewer & Water	Drilling Machine	\$67.49	7A	3K	8X	View
Thurston	Power Equipment Operators- Underground Sewer & Water	Elevator And Man-lift: Permanent And Shaft Type	\$62.85	7A	3K	8X	View
Thurston	Power Equipment Operators- Underground Sewer & Water	Finishing Machine, Bidwell And Gamaco & Similar Equipment	\$66.22	7A	3K	8X	View
Thurston	Power Equipment Operators- Underground Sewer & Water	Forklift: 3000 Lbs And Over With Attachments	\$65.71	7A	3K	8X	View
Thurston	Power Equipment Operators- Underground Sewer & Water	Forklifts: Under 3000 Lbs. With Attachments	\$62.85	7A	3K	8X	View
Thurston	Power Equipment Operators- Underground Sewer & Water	Grade Engineer: Using Blueprints, Cut Sheets, etc.	\$66.22	7A	3K	8X	View
Thurston	Power Equipment Operators- Underground Sewer & Water	Gradechecker/stakeman	\$62.85	7A	3K	8X	View
Thurston	Power Equipment Operators- Underground Sewer & Water	Guardrail punch/Auger	\$66.22	7A	3K	8X	View
Thurston	Power Equipment Operators- Underground Sewer & Water	Hard Tail End Dump Articulating Off- Road Equipment 45 Yards. & Over	\$66.81	7A	3K	8X	View
Thurston	Power Equipment Operators- Underground Sewer & Water	Hard Tail End Dump Articulating Off-road Equipment Under 45 Yards	\$66.22	7A	3K	8X	View
Thurston	Power Equipment Operators- Underground Sewer & Water	Horizontal/directional Drill Locator	\$65.71	7A	3K	8X	View
Thurston	Power Equipment Operators- Underground Sewer & Water	Horizontal/directional Drill Operator	\$66.22	7A	3K	8X	View
Thurston	Power Equipment Operators- Underground Sewer & Water	Hydralifts/Boom Trucks Over 10 Tons	\$65.71	7A	3K	8X	View
Thurston	Power Equipment Operators- Underground Sewer & Water	Hydralifts/boom Trucks, 10 Tons And Under	\$62.85	7A	3K	8X	View

Thurston	Power Equipment Operators- Underground Sewer & Water	Loader, Overhead 8 Yards. & Over	\$67.49	7A	3K	8X	View
Thurston	Power Equipment Operators- Underground Sewer & Water	Loader, Overhead, 6 Yards. But Not Including 8 Yards	\$66.81	7A	3K	8X	View
Thurston	Power Equipment Operators- Underground Sewer & Water	Loaders, Overhead Under 6 Yards	\$66.22	7A	3K	8X	View
Thurston	Power Equipment Operators- Underground Sewer & Water	Loaders, Plant Feed	\$66.22	7A	3K	8X	View
Thurston	Power Equipment Operators- Underground Sewer & Water	Loaders: Elevating Type Belt	\$65.71	7A	3K	8X	View
Thurston	Power Equipment Operators- Underground Sewer & Water	Locomotives, All	\$66.22	7A	3K	8X	View
Thurston	Power Equipment Operators- Underground Sewer & Water	Material Transfer Device	\$66.22	7A	3K	8X	View
Thurston	Power Equipment Operators- Underground Sewer & Water	Mechanics, All (Leadmen - \$0.50 Per Hour Over Mechanic)	\$67.49	7A	3K	8X	View
Thurston	Power Equipment Operators- Underground Sewer & Water	Motor patrol graders	\$66.81	7A	3K	8X	View
Thurston	Power Equipment Operators- Underground Sewer & Water	Mucking Machine, Mole, Tunnel Drill, Boring, Road Header And/or Shield	\$66.81	7A	3K	8X	View
Thurston	Power Equipment Operators- Underground Sewer & Water	Oil Distributors, Blower Distribution & Mulch Seeding Operator	\$62.85	7A	3K	8X	View
Thurston	Power Equipment Operators- Underground Sewer & Water	Outside Hoists (elevators And Manlifts), Air Tuggers, strato	\$65.71	7A	3K	8X	View
Thurston	Power Equipment Operators- Underground Sewer & Water	Overhead, Bridge Type Crane: 20 Tons Through 44 Tons	\$66.22	7A	3K	8X	View
Thurston	Power Equipment Operators- Underground Sewer & Water	Overhead, Bridge Type: 100 Tons And Over	\$67.49	7A	3K	8X	View
Thurston	Power Equipment Operators- Underground Sewer & Water	Overhead, Bridge Type: 45 Tons Through 99 Tons	\$66.81	7A	3K	8X	View
Thurston	Power Equipment Operators- Underground Sewer & Water	Pavement Breaker	\$62.85	7A	3K	8X	View
Thurston	Power Equipment Operators- Underground Sewer & Water	Pile Driver (other Than Crane Mount)	\$66.22	7A	3K	8X	View
Thurston		Plant Oiler - Asphalt, Crusher	\$65.71	7A	3K	8X	View

	Power Equipment Operators- Underground Sewer & Water						
Thurston	Power Equipment Operators- Underground Sewer & Water	Posthole Digger, Mechanical	\$62.85	7A	3K	8X	View
Thurston	Power Equipment Operators- Underground Sewer & Water	Power Plant	\$62.85	7A	3K	8X	View
Thurston	Power Equipment Operators- Underground Sewer & Water	Pumps - Water	\$62.85	7A	3K	8X	View
Thurston	Power Equipment Operators- Underground Sewer & Water	Quad 9, HD 41, D10 And Over	\$66.81	7A	3K	8X	View
Thurston	Power Equipment Operators- Underground Sewer & Water	Quick Tower - No Cab, Under 100 Feet In Height Based To Boom	\$62.85	7A	3K	8X	View
Thurston	Power Equipment Operators- Underground Sewer & Water	Remote Control Operator On Rubber Tired Earth Moving Equipment	\$66.81	7A	3K	8X	View
Thurston	Power Equipment Operators- Underground Sewer & Water	Rigger And Bellman	\$62.85	7A	3K	8X	View
Thurston	Power Equipment Operators- Underground Sewer & Water	Rigger/Signal Person, Bellman (Certified)	\$65.71	7A	3K	8X	View
Thurston	Power Equipment Operators- Underground Sewer & Water	Rollagon	\$66.81	7A	3K	8X	View
Thurston	Power Equipment Operators- Underground Sewer & Water	Roller, Other Than Plant Mix	\$62.85	7A	3K	8X	View
Thurston	Power Equipment Operators- Underground Sewer & Water	Roller, Plant Mix Or Multi-lift Materials	\$65.71	7A	3K	8X	View
Thurston	Power Equipment Operators- Underground Sewer & Water	Roto-mill, Roto-grinder	\$66.22	7A	3K	8X	View
Thurston	Power Equipment Operators- Underground Sewer & Water	Saws - Concrete	\$65.71	7A	3K	8X	View
Thurston	Power Equipment Operators- Underground Sewer & Water	Scraper, Self Propelled Under 45 Yards	\$66.22	7A	3K	8X	View
Thurston	Power Equipment Operators- Underground Sewer & Water	Scrapers - Concrete & Carry All	\$65.71	7A	3K	8X	View
Thurston	Power Equipment Operators- Underground Sewer & Water	Scrapers, Self-propelled: 45 Yards And Over	\$66.81	7A	3K	8X	View
Thurston		Service Engineers - Equipment	\$65.71	7A	3K	8X	View

	Power Equipment Operators- Underground Sewer & Water						
Thurston	Power Equipment Operators- Underground Sewer & Water	Shotcrete/gunite Equipment	\$62.85	7A	3K	8X	View
Thurston	Power Equipment Operators- Underground Sewer & Water	Shovel, Excavator, Backhoe, Tractors Under 15 Metric Tons	\$65.71	7A	3K	8X	View
Thurston	Power Equipment Operators- Underground Sewer & Water	Shovel, Excavator, Backhoe: Over 30 Metric Tons To 50 Metric Tons	\$66.81	7A	3K	8X	View
Thurston	Power Equipment Operators- Underground Sewer & Water	Shovel, Excavator, Backhoes, Tractors: 15 To 30 Metric Tons	\$66.22	7A	3K	8X	View
Thurston	Power Equipment Operators- Underground Sewer & Water	Shovel, Excavator, Backhoes: Over 50 Metric Tons To 90 Metric Tons	\$67.49	7A	3K	8X	View
Thurston	Power Equipment Operators- Underground Sewer & Water	Shovel, Excavator, Backhoes: Over 90 Metric Tons	\$68.17	7A	3K	8X	View
Thurston	Power Equipment Operators- Underground Sewer & Water	Slipform Pavers	\$66.81	7A	3K	8X	View
Thurston	Power Equipment Operators- Underground Sewer & Water	Spreader, Topsider & Screedman	\$66.81	7A	3K	8X	View
Thurston	Power Equipment Operators- Underground Sewer & Water	Subgrader Trimmer	\$66.22	7A	3K	8X	View
Thurston	Power Equipment Operators- Underground Sewer & Water	Tower Bucket Elevators	\$65.71	7A	3K	8X	View
Thurston	Power Equipment Operators- Underground Sewer & Water	Tower crane over 175' through 250' in height, base to boom	\$68.17	7A	3K	8X	View
Thurston	Power Equipment Operators- Underground Sewer & Water	Tower Crane: Up To 175' In Height, Base To Boom	\$67.49	7A	3K	8X	View
Thurston	Power Equipment Operators- Underground Sewer & Water	Transporters, All Track Or Truck Type	\$66.81	7A	3K	8X	View
Thurston	Power Equipment Operators- Underground Sewer & Water	Trenching Machines	\$65.71	7A	3K	8X	View
Thurston	Power Equipment Operators- Underground Sewer & Water	Truck Crane Oiler/driver - 100 Tons And Over	\$66.22	7A	3K	8X	View
Thurston	Power Equipment Operators- Underground Sewer & Water	Truck Crane Oiler/driver Under 100 Tons	\$65.71	7A	3K	8X	View
Thurston		Truck Mount Portable Conveyor	\$66.22	7A	3K	8X	View

	Power Equipment Operators- Underground Sewer & Water						
Thurston	Power Equipment Operators- Underground Sewer & Water	Welder	\$66.81	<u>7A</u>	<u>3K</u>	<u>8X</u>	View
Thurston	Power Equipment Operators- Underground Sewer & Water	Wheel Tractors, Farmall Type	\$62.85	<u>7A</u>	<u>3K</u>	<u>8X</u>	View
Thurston	Power Equipment Operators- Underground Sewer & Water	Yo Yo Pay Dozer	\$66.22	<u>7A</u>	<u>3K</u>	<u>8X</u>	View
Thurston	Power Line Clearance Tree Trimmers	Journey Level In Charge	\$53.10	<u>5A</u>	<u>4A</u>		View
Thurston	Power Line Clearance Tree Trimmers	Spray Person	\$50.40	<u>5A</u>	<u>4A</u>		View
Thurston	Power Line Clearance Tree Trimmers	Tree Equipment Operator	\$53.10	<u>5A</u>	<u>4A</u>		View
Thurston	Power Line Clearance Tree Trimmers	Tree Trimmer	\$47.48	<u>5A</u>	<u>4A</u>		View
Thurston	Power Line Clearance Tree Trimmers	Tree Trimmer Groundperson	\$36.10	<u>5A</u>	<u>4A</u>		View
Thurston	Refrigeration & Air Conditioning Mechanics	Journey Level	\$76.21	<u>5A</u>	<u>1G</u>		View
Thurston	Residential Brick Mason	Journey Level	\$35.53		<u>1</u>		View
Thurston	Residential Carpenters	Journey Level	\$33.49		<u>1</u>		View
Thurston	Residential Cement Masons	Journey Level	\$18.09		<u>1</u>		View
Thurston	Residential Drywall Applicators	Journey Level	\$46.43	<u>7A</u>	<u>4C</u>		View
Thurston	Residential Drywall Tapers	Journey Level	\$23.25		<u>1</u>		View
Thurston	Residential Electricians	Journey Level	\$36.53	<u>5A</u>	<u>1B</u>		View
Thurston	Residential Glaziers	Journey Level	\$45.90	<u>7L</u>	<u>1H</u>		View
Thurston	Residential Insulation Applicators	Journey Level	\$24.16		<u>1</u>		View
Thurston	Residential Laborers	Journey Level	\$22.73		<u>1</u>		View
Thurston	Residential Marble Setters	Journey Level	\$35.53		<u>1</u>		View
Thurston	Residential Painters	Journey Level	\$20.77		<u>1</u>		View
Thurston	Residential Plumbers & Pipefitters	Journey Level	\$26.35		<u>1</u>		View
Thurston	Residential Refrigeration & Air Conditioning Mechanics	Journey Level	\$34.42		<u>1</u>		View
Thurston	Residential Sheet Metal Workers	Journey Level (Field or Shop)	\$51.89	<u>7F</u>	<u>1R</u>		View
Thurston	Residential Soft Floor Layers	Journey Level	\$20.67		<u>1</u>		View
Thurston	Residential Sprinkler Fitters (Fire Protection)	Journey Level	\$24.63		<u>1</u>		View
Thurston	Residential Stone Masons	Journey Level	\$35.53		<u>1</u>		View
Thurston	Residential Terrazzo Workers	Journey Level	\$14.86		<u>1</u>		View

Thurston	Residential Terrazzo/Tile Finishers	Journey Level	\$21.96		<u>1</u>		View
Thurston	Residential Tile Setters	Journey Level	\$14.86		<u>1</u>		View
Thurston	Roofers	Journey Level	\$54.62	<u>5A</u>	<u>20</u>		View
Thurston	Roofers	Using Irritable Bituminous Materials	\$57.62	<u>5A</u>	<u>20</u>		View
Thurston	Sheet Metal Workers	Journey Level (Field or Shop)	\$85.88	<u>7F</u>	<u>1E</u>		View
Thurston	Shipbuilding & Ship Repair	New Construction Boilermaker	\$36.36	<u>7V</u>	<u>1</u>		View
Thurston	Shipbuilding & Ship Repair	New Construction Carpenter	\$36.36	<u>7V</u>	<u>1</u>		View
Thurston	Shipbuilding & Ship Repair	New Construction Crane Operator	\$36.36	<u>7V</u>	<u>1</u>		View
Thurston	Shipbuilding & Ship Repair	New Construction Electrician	\$36.36	<u>7V</u>	<u>1</u>		View
Thurston	Shipbuilding & Ship Repair	New Construction Heat & Frost Insulator	\$76.61	<u>5J</u>	<u>4H</u>		View
Thurston	Shipbuilding & Ship Repair	New Construction Laborer	\$36.36	<u>7V</u>	<u>1</u>		View
Thurston	Shipbuilding & Ship Repair	New Construction Machinist	\$36.36	<u>7V</u>	<u>1</u>		View
Thurston	Shipbuilding & Ship Repair	New Construction Operating Engineer	\$36.36	<u>7V</u>	<u>1</u>		View
Thurston	Shipbuilding & Ship Repair	New Construction Painter	\$36.36	<u>7V</u>	<u>1</u>		View
Thurston	Shipbuilding & Ship Repair	New Construction Pipefitter	\$36.36	<u>7V</u>	<u>1</u>		View
Thurston	Shipbuilding & Ship Repair	New Construction Rigger	\$36.36	<u>7V</u>	<u>1</u>		View
Thurston	Shipbuilding & Ship Repair	New Construction Sheet Metal	\$36.36	<u>7V</u>	<u>1</u>		View
Thurston	Shipbuilding & Ship Repair	New Construction Shipfitter	\$36.36	<u>7V</u>	<u>1</u>		View
Thurston	Shipbuilding & Ship Repair	New Construction Warehouse/Teamster	\$36.36	<u>7V</u>	<u>1</u>		View
Thurston	Shipbuilding & Ship Repair	New Construction Welder / Burner	\$36.36	<u>7V</u>	<u>1</u>		View
Thurston	Shipbuilding & Ship Repair	Ship Repair Boilermaker	\$46.15	<u>7X</u>	<u>4J</u>		View
Thurston	Shipbuilding & Ship Repair	Ship Repair Carpenter	\$44.95	<u>7X</u>	<u>4J</u>		View
Thurston	Shipbuilding & Ship Repair	Ship Repair Crane Operator	\$45.06	<u>7Y</u>	<u>4K</u>		View
Thurston	Shipbuilding & Ship Repair	Ship Repair Electrician	\$46.22	<u>7X</u>	<u>4J</u>		View
Thurston	Shipbuilding & Ship Repair	Ship Repair Heat & Frost Insulator	\$76.61	<u>5J</u>	<u>4H</u>		View
Thurston	Shipbuilding & Ship Repair	Ship Repair Laborer	\$46.15	<u>7X</u>	<u>4J</u>		View
Thurston	Shipbuilding & Ship Repair	Ship Repair Machinist	\$46.15	<u>7X</u>	<u>4J</u>		View
Thurston	Shipbuilding & Ship Repair	Ship Repair Operating Engineer	\$45.06	<u>7Y</u>	<u>4K</u>		View
Thurston	Shipbuilding & Ship Repair	Ship Repair Painter	\$46.15	<u>7X</u>	<u>4J</u>		View
Thurston	Shipbuilding & Ship Repair	Ship Repair Pipefitter	\$46.15	<u>7X</u>	<u>4J</u>		View

Thurston	Shipbuilding & Ship Repair	Ship Repair Rigger	\$46.15	<u>7X</u>	<u>4J</u>	View
Thurston	Shipbuilding & Ship Repair	Ship Repair Sheet Metal	\$46.15	<u>7X</u>	<u>4J</u>	View
Thurston	Shipbuilding & Ship Repair	Ship Repair Shipwright	\$44.95	<u>7X</u>	<u>4J</u>	View
Thurston	Shipbuilding & Ship Repair	Ship Repair Warehouse / Teamster	\$45.06	<u>7Y</u>	<u>4K</u>	View
Thurston	Sign Makers & Installers (Electrical)	Journey Level	\$18.04		<u>1</u>	View
Thurston	Sign Makers & Installers (Non-Electrical)	Journey Level	\$15.50		<u>1</u>	View
Thurston	Soft Floor Layers	Journey Level	\$51.07	<u>5A</u>	<u>3J</u>	View
Thurston	Solar Controls For Windows	Journey Level	\$13.50		<u>1</u>	View
Thurston	Sprinkler Fitters (Fire Protection)	Journey Level	\$82.39	<u>5C</u>	<u>1X</u>	View
Thurston	Stage Rigging Mechanics (Non Structural)	Journey Level	\$13.50		<u>1</u>	View
Thurston	Stone Masons	Journey Level	\$58.82	<u>5A</u>	<u>1M</u>	View
Thurston	Street And Parking Lot Sweeper Workers	Journey Level	\$16.00		<u>1</u>	View
Thurston	Surveyors	Chain Person	\$65.11	<u>7A</u>	<u>3K</u>	View
Thurston	Surveyors	Instrument Person	\$65.71	<u>7A</u>	<u>3K</u>	View
Thurston	Surveyors	Party Chief	\$66.81	<u>7A</u>	<u>3K</u>	View
Thurston	Telecommunication Technicians	Journey Level	\$44.70	<u>6Z</u>	<u>1B</u>	View
Thurston	Telephone Line Construction - Outside	Cable Splicer	\$41.81	<u>5A</u>	<u>2B</u>	View
Thurston	Telephone Line Construction - Outside	Hole Digger/Ground Person	\$23.53	<u>5A</u>	<u>2B</u>	View
Thurston	Telephone Line Construction - Outside	Installer (Repairer)	\$40.09	<u>5A</u>	<u>2B</u>	View
Thurston	Telephone Line Construction - Outside	Special Aparatus Installer I	\$41.81	<u>5A</u>	<u>2B</u>	View
Thurston	Telephone Line Construction - Outside	Special Apparatus Installer II	\$40.99	<u>5A</u>	<u>2B</u>	View
Thurston	Telephone Line Construction - Outside	Telephone Equipment Operator (Heavy)	\$41.81	<u>5A</u>	<u>2B</u>	View
Thurston	Telephone Line Construction - Outside	Telephone Equipment Operator (Light)	\$38.92	<u>5A</u>	<u>2B</u>	View
Thurston	Telephone Line Construction - Outside	Telephone Lineperson	\$38.92	<u>5A</u>	<u>2B</u>	View
Thurston	Telephone Line Construction - Outside	Television Groundperson	\$22.32	<u>5A</u>	<u>2B</u>	View
Thurston	Telephone Line Construction - Outside	Television Lineperson/Installer	\$29.60	<u>5A</u>	<u>2B</u>	View
Thurston	Telephone Line Construction - Outside	Television System Technician	\$35.20	<u>5A</u>	<u>2B</u>	View
Thurston	Telephone Line Construction - Outside	Television Technician	\$31.67	<u>5A</u>	<u>2B</u>	View
Thurston	Telephone Line Construction - Outside	Tree Trimmer	\$38.92	<u>5A</u>	<u>2B</u>	View

Thurston	Terrazzo Workers	Journey Level	\$54.06	<u>5A</u>	<u>1M</u>		<u>View</u>
Thurston	Tile Setters	Journey Level	\$54.06	<u>5A</u>	<u>1M</u>		<u>View</u>
Thurston	Tile, Marble & Terrazzo Finishers	Finisher	\$44.89	<u>5A</u>	<u>1B</u>		<u>View</u>
Thurston	Traffic Control Stripers	Journey Level	\$47.68	<u>7A</u>	<u>1K</u>		<u>View</u>
Thurston	Truck Drivers	Asphalt Mix Over 16 Yards	\$60.84	<u>5D</u>	<u>4Y</u>	<u>8L</u>	<u>View</u>
Thurston	Truck Drivers	Asphalt Mix To 16 Yards	\$60.00	<u>5D</u>	<u>4Y</u>	<u>8L</u>	<u>View</u>
Thurston	Truck Drivers	Dump Truck	\$60.00	<u>5D</u>	<u>4Y</u>	<u>8L</u>	<u>View</u>
Thurston	Truck Drivers	Dump Truck & Trailer	\$60.84	<u>5D</u>	<u>4Y</u>	<u>8L</u>	<u>View</u>
Thurston	Truck Drivers	Other Trucks	\$60.84	<u>5D</u>	<u>4Y</u>	<u>8L</u>	<u>View</u>
Thurston	Truck Drivers - Ready Mix	Transit Mix	\$60.84	<u>5D</u>	<u>4Y</u>	<u>8L</u>	<u>View</u>
Thurston	Well Drillers & Irrigation Pump Installers	Irrigation Pump Installer	\$17.53		<u>1</u>		<u>View</u>
Thurston	Well Drillers & Irrigation Pump Installers	Oiler	\$13.50		<u>1</u>		<u>View</u>
Thurston	Well Drillers & Irrigation Pump Installers	Well Driller	\$18.00		<u>1</u>		<u>View</u>

Benefit Code Key – Effective 3/4/2020 thru 9/1/2020

Overtime Codes

Overtime calculations are based on the hourly rate actually paid to the worker. On public works projects, the hourly rate must be not less than the prevailing rate of wage minus the hourly rate of the cost of fringe benefits actually provided for the worker.

1. ALL HOURS WORKED IN EXCESS OF EIGHT (8) HOURS PER DAY OR FORTY (40) HOURS PER WEEK SHALL BE PAID AT ONE AND ONE-HALF TIMES THE HOURLY RATE OF WAGE.
 - B. All hours worked on Saturdays shall be paid at one and one-half times the hourly rate of wage. All hours worked on Sundays and holidays shall be paid at double the hourly rate of wage.
 - C. The first two (2) hours after eight (8) regular hours Monday through Friday and the first ten (10) hours on Saturday shall be paid at one and one-half times the hourly rate of wage. All other overtime hours and all hours worked on Sundays and holidays shall be paid at double the hourly rate of wage.
 - D. The first two (2) hours before or after a five-eight (8) hour workweek day or a four-ten (10) hour workweek day and the first eight (8) hours worked the next day after either workweek shall be paid at one and one-half times the hourly rate of wage. All additional hours worked and all worked on Sundays and holidays shall be paid at double the hourly rate of wage.
 - E. The first two (2) hours after eight (8) regular hours Monday through Friday and the first eight (8) hours on Saturday shall be paid at one and one-half times the hourly rate of wage. All other hours worked Monday through Saturday, and all hours worked on Sundays and holidays shall be paid at double the hourly rate of wage.
 - F. The first two (2) hours after eight (8) regular hours Monday through Friday and the first ten (10) hours on Saturday shall be paid at one and one-half times the hourly rate of wage. All other overtime hours worked, except Labor Day, shall be paid at double the hourly rate of wage. All hours worked on Labor Day shall be paid at three times the hourly rate of wage.
 - G. The first ten (10) hours worked on Saturdays and the first ten (10) hours worked on a fifth calendar weekday in a four-ten hour schedule, shall be paid at one and one-half times the hourly rate of wage. All hours worked in excess of ten (10) hours per day Monday through Saturday and all hours worked on Sundays and holidays shall be paid at double the hourly rate of wage.
 - H. All hours worked on Saturdays (except makeup days if work is lost due to inclement weather conditions or equipment breakdown) shall be paid at one and one-half times the hourly rate of wage. All hours worked Monday through Saturday over twelve (12) hours and all hours worked on Sundays and holidays shall be paid at double the hourly rate of wage.
 - I. All hours worked on Sundays and holidays shall also be paid at double the hourly rate of wage.
 - J. The first two (2) hours after eight (8) regular hours Monday through Friday and the first ten (10) hours on Saturday shall be paid at one and one-half times the hourly rate of wage. All hours worked over ten (10) hours Monday through Saturday, Sundays and holidays shall be paid at double the hourly rate of wage.
 - K. All hours worked on Saturdays and Sundays shall be paid at one and one-half times the hourly rate of wage. All hours worked on holidays shall be paid at double the hourly rate of wage.
 - M. All hours worked on Saturdays (except makeup days if work is lost due to inclement weather conditions) shall be paid at one and one-half times the hourly rate of wage. All hours worked on Sundays and holidays shall be paid at double the hourly rate of wage.
 - N. All hours worked on Saturdays (except makeup days) shall be paid at one and one-half times the hourly rate of wage. All hours worked on Sundays and holidays shall be paid at double the hourly rate of wage.

Overtime Codes Continued

1. O. The first ten (10) hours worked on Saturday shall be paid at one and one-half times the hourly rate of wage. All hours worked on Sundays, holidays and after twelve (12) hours, Monday through Friday and after ten (10) hours on Saturday shall be paid at double the hourly rate of wage.
- P. All hours worked on Saturdays (except makeup days if circumstances warrant) and Sundays shall be paid at one and one-half times the hourly rate of wage. All hours worked on holidays shall be paid at double the hourly rate of wage.
- Q. The first two (2) hours after eight (8) regular hours Monday through Friday and up to ten (10) hours worked on Saturdays shall be paid at one and one-half times the hourly rate of wage. All hours worked in excess of ten (10) hours per day Monday through Saturday and all hours worked on Sundays and holidays (except Christmas day) shall be paid at double the hourly rate of wage. All hours worked on Christmas day shall be paid at two and one-half times the hourly rate of wage.
- R. All hours worked on Sundays and holidays shall be paid at two times the hourly rate of wage.
- S. The first two (2) hours after eight (8) regular hours Monday through Friday and the first eight (8) hours on Saturday shall be paid at one and one-half times the hourly rate of wage. All hours worked on holidays and all other overtime hours worked, except Labor Day, shall be paid at double the hourly rate of wage. All hours worked on Labor Day shall be paid at three times the hourly rate of wage.
- U. All hours worked on Saturdays shall be paid at one and one-half times the hourly rate of wage. All hours worked on Sundays and holidays (except Labor Day) shall be paid at two times the hourly rate of wage. All hours worked on Labor Day shall be paid at three times the hourly rate of wage.
- V. All hours worked on Sundays and holidays (except Thanksgiving Day and Christmas day) shall be paid at one and one-half times the hourly rate of wage. All hours worked on Thanksgiving Day and Christmas day shall be paid at double the hourly rate of wage.
- W. All hours worked on Saturdays and Sundays (except make-up days due to conditions beyond the control of the employer)) shall be paid at one and one-half times the hourly rate of wage. All hours worked on holidays shall be paid at double the hourly rate of wage.
- X. The first four (4) hours after eight (8) regular hours Monday through Friday and the first twelve (12) hours on Saturday shall be paid at one and one-half times the hourly rate of wage. All hours worked over twelve (12) hours Monday through Saturday, Sundays and holidays shall be paid at double the hourly rate of wage. When holiday falls on Saturday or Sunday, the day before Saturday, Friday, and the day after Sunday, Monday, shall be considered the holiday and all work performed shall be paid at double the hourly rate of wage.
- Y. All hours worked outside the hours of 5:00 am and 5:00 pm (or such other hours as may be agreed upon by any employer and the employee) and all hours worked in excess of eight (8) hours per day (10 hours per day for a 4 x 10 workweek) and on Saturdays and holidays (except labor day) shall be paid at one and one-half times the hourly rate of wage. (except for employees who are absent from work without prior approval on a scheduled workday during the workweek shall be paid at the straight-time rate until they have worked 8 hours in a day (10 in a 4 x 10 workweek) or 40 hours during that workweek.) All hours worked Monday through Saturday over twelve (12) hours and all hours worked on Sundays and Labor Day shall be paid at double the hourly rate of wage.
- Z. All hours worked on Saturdays and Sundays shall be paid at one and one-half times the hourly rate of wage. All hours worked on holidays shall be paid the straight time rate of pay in addition to holiday pay.

Overtime Codes Continued

2. ALL HOURS WORKED IN EXCESS OF EIGHT (8) HOURS PER DAY OR FORTY (40) HOURS PER WEEK SHALL BE PAID AT ONE AND ONE-HALF TIMES THE HOURLY RATE OF WAGE.
- B. All hours worked on holidays shall be paid at one and one-half times the hourly rate of wage.
 - C. All hours worked on Sundays shall be paid at one and one-half times the hourly rate of wage. All hours worked on holidays shall be paid at two times the hourly rate of wage.
 - F. The first eight (8) hours worked on holidays shall be paid at the straight hourly rate of wage in addition to the holiday pay. All hours worked in excess of eight (8) hours on holidays shall be paid at double the hourly rate of wage.
 - G. All hours worked on Sunday shall be paid at two times the hourly rate of wage. All hours worked on paid holidays shall be paid at two and one-half times the hourly rate of wage including holiday pay.
 - H. All hours worked on Sunday shall be paid at two times the hourly rate of wage. All hours worked on holidays shall be paid at one and one-half times the hourly rate of wage.
 - O. All hours worked on Sundays and holidays shall be paid at one and one-half times the hourly rate of wage.
 - R. All hours worked on Sundays and holidays and all hours worked over sixty (60) in one week shall be paid at double the hourly rate of wage.
 - U. All hours worked on Saturdays shall be paid at one and one-half times the hourly rate of wage. All hours worked over 12 hours in a day or on Sundays and holidays shall be paid at double the hourly rate of wage.
 - W. The first two (2) hours after eight (8) regular hours Monday through Friday and the first eight (8) hours on Saturday shall be paid at one and one-half times the hourly rate of wage. All other hours worked Monday through Saturday, and all hours worked on Sundays and holidays shall be paid at double the hourly rate of wage. On a four-day, ten-hour weekly schedule, either Monday thru Thursday or Tuesday thru Friday schedule, all hours worked after ten shall be paid at double the hourly rate of wage. The first eight (8) hours worked on the fifth day shall be paid at one and one-half times the hourly rate of wage. All other hours worked on the fifth, sixth, and seventh days and on holidays shall be paid at double the hourly rate of wage.
3. ALL HOURS WORKED IN EXCESS OF EIGHT (8) HOURS PER DAY OR FORTY (40) HOURS PER WEEK SHALL BE PAID AT ONE AND ONE-HALF TIMES THE HOURLY RATE OF WAGE.
- A. Work performed in excess of eight (8) hours of straight time per day, or ten (10) hours of straight time per day when four ten (10) hour shifts are established, or forty (40) hours of straight time per week, Monday through Friday, or outside the normal shift, and all work on Saturdays shall be paid at time and one-half the straight time rate. Hours worked over twelve hours (12) in a single shift and all work performed after 6:00 pm Saturday to 6:00 am Monday and holidays shall be paid at double the straight time rate of pay. Any shift starting between the hours of 6:00 pm and midnight shall receive an additional one dollar (\$1.00) per hour for all hours worked that shift. The employer shall have the sole discretion to assign overtime work to employees. Primary consideration for overtime work shall be given to employees regularly assigned to the work to be performed on overtime situations. After an employee has worked eight (8) hours at an applicable overtime rate, all additional hours shall be at the applicable overtime rate until such time as the employee has had a break of eight (8) hours or more.
 - C. Work performed in excess of eight (8) hours of straight time per day, or ten (10) hours of straight time per day when four ten (10) hour shifts are established, or forty (40) hours of straight time per week, Monday through Friday, or outside the normal shift, and all work on Saturdays shall be paid at one and one-half times the hourly rate of wage. All work performed after 6:00 pm Saturday to 5:00 am Monday and Holidays shall be paid at double the hourly rate of wage. After an employee has worked eight (8) hours at an applicable overtime rate, all additional hours shall be at the applicable overtime rate until such time as the employee has had a break of eight (8) hours or more.

Overtime Codes Continued

3.
 - E. All hours worked Sundays and holidays shall be paid at double the hourly rate of wage. Each week, once 40 hours of straight time work is achieved, then any hours worked over 10 hours per day Monday through Saturday shall be paid at double the hourly wage rate.
 - F. All hours worked on Saturday shall be paid at one and one-half times the hourly rate of wage. All hours worked on Sunday shall be paid at two times the hourly rate of wage. All hours worked on paid holidays shall be paid at two and one-half times the hourly rate of wage including holiday pay.
 - H. All work performed on Sundays between March 16th and October 14th and all Holidays shall be compensated for at two (2) times the regular rate of pay. Work performed on Sundays between October 15th and March 15th shall be compensated at one and one half (1-1/2) times the regular rate of pay.
 - J. All hours worked between the hours of 10:00 pm and 5:00 am, Monday through Friday, and all hours worked on Saturdays shall be paid at a one and one-half times the hourly rate of wage. All hours worked on Sundays and holidays shall be paid at double the hourly rate of wage.
 - K. Work performed in excess of eight (8) hours of straight time per day, or ten (10) hours of straight time per day when four ten (10) hour shifts are established, or forty (40) hours of straight time per week, Monday through Friday, or outside the normal 5 am to 6pm shift, and all work on Saturdays shall be paid at one and one-half times the hourly rate of wage. All work performed after 6:00 pm Saturday to 5:00 am Monday and Holidays, and all hours worked in excess of twelve (12) hours in a single shift shall be paid at double the hourly rate of wage.

After an employee has worked eight (8) hours at an applicable overtime rate, all additional hours shall be at the applicable overtime rate until such time as the employee has had a break of eight (8) hours or more. When an employee returns to work without at least eight (8) hours time off since their previous shift, all such time shall be a continuation of shift and paid at the applicable overtime rate until he/she shall have the eight (8) hours rest period.

4. ALL HOURS WORKED IN EXCESS OF EIGHT (8) HOURS PER DAY OR FORTY (40) HOURS PER WEEK SHALL BE PAID AT ONE AND ONE-HALF TIMES THE HOURLY RATE OF WAGE.
 - A. All hours worked in excess of eight (8) hours per day or forty (40) hours per week shall be paid at double the hourly rate of wage. All hours worked on Saturdays, Sundays and holidays shall be paid at double the hourly rate of wage.
 - B. All hours worked over twelve (12) hours per day and all hours worked on holidays shall be paid at double the hourly rate of wage.
 - C. On Monday through Friday, the first four (4) hours of overtime after eight (8) hours of straight time work shall be paid at one and one half (1-1/2) times the straight time rate of pay, unless a four (4) day ten (10) hour workweek has been established. On a four (4) day ten (10) hour workweek scheduled Monday through Thursday, or Tuesday through Friday, the first two (2) hours of overtime after ten (10) hours of straight time work shall be paid at one and one half (1-1/2) times the straight time rate of pay. On Saturday, the first twelve (12) hours of work shall be paid at one and one half (1-1/2) times the straight time rate of pay, except that if the job is down on Monday through Friday due to weather conditions or other conditions outside the control of the employer, the first ten (10) hours on Saturday may be worked at the straight time rate of pay. All hours worked over twelve (12) hours in a day and all hours worked on Sunday and Holidays shall be paid at two (2) times the straight time rate of pay.

Overtime Codes Continued

4. D. All hours worked in excess of eight (8) hours per day or forty (40) hours per week shall be paid at double the hourly rate of wage. All hours worked on Saturday, Sundays and holidays shall be paid at double the hourly rate of pay. Rates include all members of the assigned crew.

EXCEPTION:

On all multipole structures and steel transmission lines, switching stations, regulating, capacitor stations, generating plants, industrial plants, associated installations and substations, except those substations whose primary function is to feed a distribution system, will be paid overtime under the following rates:

The first two (2) hours after eight (8) regular hours Monday through Friday of overtime on a regular workday, shall be paid at one and one-half times the hourly rate of wage. All hours in excess of ten (10) hours will be at two (2) times the hourly rate of wage. The first eight (8) hours worked on Saturday will be paid at one and one-half (1-1/2) times the hourly rate of wage. All hours worked in excess of eight (8) hours on Saturday, and all hours worked on Sundays and holidays will be at the double the hourly rate of wage.

All overtime eligible hours performed on the above described work that is energized, shall be paid at the double the hourly rate of wage.

- E. The first two (2) hours after eight (8) regular hours Monday through Friday and the first eight (8) hours on Saturday shall be paid at one and one-half times the hourly rate of wage. All other hours worked Monday through Saturday, and all hours worked on Sundays and holidays shall be paid at double the hourly rate of wage.

On a four-day, ten-hour weekly schedule, either Monday thru Thursday or Tuesday thru Friday schedule, all hours worked after ten shall be paid at double the hourly rate of wage. The Monday or Friday not utilized in the normal four-day, ten hour work week, and Saturday shall be paid at one and one half (1½) times the regular shift rate for the first eight (8) hours. All other hours worked Monday through Saturday, and all hours worked on Sundays and holidays shall be paid at double the hourly rate of wage.

- F. All hours worked between the hours of 6:00 pm and 6:00 am, Monday through Saturday, shall be paid at a premium rate of 20% over the hourly rate of wage. All hours worked on Sundays shall be paid at one and one-half times the hourly rate of wage. All hours worked on holidays shall be paid at double the hourly rate of wage.

- G. All hours worked on Saturdays shall be paid at one and one-half times the hourly rate of wage. All hours worked Monday through Saturday over twelve (12) hours and all hours worked on Sundays and holidays shall be paid at double the hourly rate of wage.

- H. The first two (2) hours after eight (8) regular hours Monday through Friday and the first eight (8) hours on Saturday shall be paid at one and one-half times the hourly rate of wage. All other overtime hours worked, except Labor Day, and all hours on Sunday shall be paid at double the hourly rate of wage. All hours worked on Labor Day shall be paid at three times the hourly rate of wage.

- I. The First eight (8) hours worked on Saturdays shall be paid at one and one-half times the hourly rate of wage. All hours worked in excess of eight (8) per day on Saturdays shall be paid at double the hourly rate of wage. All hours worked on Sundays and holidays shall be paid at double the hourly rate of wage.

- J. The first eight (8) hours worked on a Saturday shall be paid at one and one-half times the hourly rate of wage. All hours worked in excess of eight (8) hours on a Saturday shall be paid at double the hourly rate of wage. All hours worked over twelve (12) in a day, and all hours worked on Sundays and Holidays shall be paid at double the hourly rate of wage.

- K. All hours worked on a Saturday shall be paid at one and one-half times the hourly rate of wage, so long as Saturday is the sixth consecutive day worked. All hours worked over twelve (12) in a day Monday through Saturday, and all hours worked on Sundays and Holidays shall be paid at double the hourly rate of wage.

Overtime Codes Continued

4. L. The first twelve (12) hours worked on a Saturday shall be paid at one and one-half times the hourly rate of wage. All hours worked on a Saturday in excess of twelve (12) hours shall be paid at double the hourly rate of pay. All hours worked over twelve (12) in a day Monday through Friday, and all hours worked on Sundays shall be paid at double the hourly rate of wage. All hours worked on a holiday shall be paid at one and one-half times the hourly rate of wage, except that all hours worked on Labor Day shall be paid at double the hourly rate of pay.
- M. All hours worked on Sunday and Holidays shall be paid at double the hourly rate. Any employee reporting to work less than nine (9) hours from their previous quitting time shall be paid for such time at time and one-half times the hourly rate.
- N. All hours worked on Saturdays shall be paid at one and one-half times the hourly rate of wage. All hours worked on Sundays and holidays, and all work performed between the hours of midnight (12:00 AM) and eight AM (8:00 AM) every day shall be paid at double the hourly rate of wage.
- O. All hours worked between midnight Friday to midnight Sunday shall be paid at one and one-half the hourly rate of wage. After an employee has worked in excess of eight (8) continuous hours in any one or more calendar days, all additional hours shall be at the applicable overtime rate until such time as the employee has had a break of six (6) hours or more. All hours worked on Holidays shall be paid at double the hourly rate of wage.
- P. All hours worked on Holidays shall be paid at one and one-half times the hourly rate of wage.
- Q. The first four (4) hours after eight (8) regular hours Monday through Friday and the first eight (8) hours on Saturday shall be paid at one and one-half times the hourly rate of wage. All hours worked over twelve (12) hours Monday through Saturday shall be paid at double the hourly rate. All hours worked on Sundays and holidays shall be paid at double the hourly rate of wage.
- R. All hours worked on Saturdays shall be paid at one and one-half times the hourly rate of wage, so long as Saturday is the sixth consecutive day worked. All hours worked on Sundays and holidays shall be paid at double the hourly rate of wage.
- S. All hours worked on Saturdays and Holidays shall be paid at one and one-half times the hourly rate of wage. All hours worked on Sundays shall be paid at double the hourly rate of wage.
- T. The first two (2) hours of overtime for hours worked Monday-Friday shall be paid at one and one-half times the hourly rate of wage. All hours worked in excess of ten (10) hours per day shall be paid at double the hourly rate of wage. All hours worked on Sundays and holidays shall be paid at double the hourly rate of wage. For work on Saturday which is scheduled prior to the end of shift on Friday, the first six (6) hours work shall be paid at one and one-half times the hourly rate of wage, and all hours over (6) shall be paid double the hourly rate of wage. For work on Saturday which was assigned following the close of shift on Friday, all work shall be paid at double the hourly rate of wage.
- U. The first four (4) hours after eight (8) regular hours Monday through Friday and the first twelve (12) hours on Saturday shall be paid at one and one-half times the hourly rate of wage. (Except on makeup days if work is lost due to inclement weather, then the first eight (8) hours on Saturday may be paid the regular rate.) All hours worked over twelve (12) hours Monday through Saturday, and all hours worked on Sundays and holidays shall be paid at double the hourly rate of wage.

Overtime Codes Continued

4. V. Work performed in excess of ten (10) hours of straight time per day when four ten (10) hour shifts are established or outside the normal shift (5 am to 6pm), and all work on Saturdays, except for make-up days shall be paid at time and one-half (1 ½) the straight time rate.

In the event the job is down due to weather conditions, then Saturday may, be worked as a voluntary make-up day at the straight time rate. However, Saturday shall not be utilized as a make-up day when a holiday falls on Friday. All work performed on Sundays and holidays and work in excess of twelve (12) hours per day shall be paid at double (2x) the straight time rate of pay.

After an employee has worked eight (8) hours at an applicable overtime rate, all additional hours shall be at the applicable overtime rate until such time as the employee has had a break of eight (8) hours.

When an employee returns to work without a break of eight (8) hours since their previous shift, all such time shall be a continuation of shift and paid at the applicable overtime rate until such time as the employee has had a break of eight (8) hours.

- W. All hours worked on Saturdays (except makeup days if work is lost due to inclement weather conditions) shall be paid at one and one-half times the hourly rate of wage. All hours worked on Sundays and holidays shall be paid at double the hourly rate of wage.

When an employee returns to work without at least eight (8) hours time off since their previous shift, all such time shall be a continuation of shift and paid at the applicable overtime rate until such time as the employee has had a break of eight (8) hours.

- X. All hours worked on Saturdays shall be paid at one and one-half times the hourly rate of wage. All hours worked on Sundays and holidays shall be paid at double the hourly rate of wage. Work performed outside the normal shift of 6 am to 6pm shall be paid at one and one-half the straight time rate, (except for special shifts or three shift operations). All work performed on Sundays and holidays shall be paid at double the hourly rate of wage. Shifts may be established when considered necessary by the Employer.

The Employer may establish shifts consisting of eight (8) or ten (10) hours of work (subject to WAC 296-127-022), that shall constitute a normal forty (40) hour work week. The Employer can change from a 5-eight to a 4-ten hour schedule or back to the other. All hours of work on these shifts shall be paid for at the straight time hourly rate. Work performed in excess of eight hours (or ten hours per day (subject to WAC 296-127-022) shall be paid at one and one-half the straight time rate.

When due to conditions beyond the control of the Employer, or when contract specifications require that work can only be performed outside the regular day shift, then by mutual agreement a special shift may be worked at the straight time rate, eight (8) hours work for eight (8) hours pay. The starting time shall be arranged to fit such conditions of work.

When an employee returns to work without at a break of eight (8) hours since their previous shift, all such time shall be a continuation of shift and paid at the applicable overtime rate until such time as the employee has had a break of eight (8) hours.

Overtime Codes Continued

4. Y. Work performed in excess of eight (8) hours of straight time per day, or ten (10) hours of straight time per day when four ten (10) hour shifts are established, or forty (40) hours of straight time per week, Monday through Friday, or outside the normal shift, and all work on Saturdays shall be paid at time and one-half the straight time rate. All work performed after 6:00 pm Saturday to 6:00 am Monday and holidays shall be paid at double the straight time rate of pay.

Any shift starting between the hours of 6:00 pm and midnight shall receive an additional one dollar (\$1.00) per hour for all hours worked that shift.

After an employee has worked eight (8) hours at an applicable overtime rate, all additional hours shall be at the applicable overtime rate until such time as the employee has had a break of eight (8) hours or more.

Holiday Codes

5. A. Holidays: New Year's Day, Memorial Day, Independence Day, Labor Day, Thanksgiving Day, Friday after Thanksgiving Day, and Christmas Day (7).
- B. Holidays: New Year's Day, Memorial Day, Independence Day, Labor Day, Thanksgiving Day, Friday after Thanksgiving Day, the day before Christmas, and Christmas Day (8).
- C. Holidays: New Year's Day, Presidents' Day, Memorial Day, Independence Day, Labor Day, Thanksgiving Day, the Friday after Thanksgiving Day, And Christmas Day (8).
- D. Holidays: New Year's Day, Memorial Day, Independence Day, Labor Day, Thanksgiving Day, the Friday and Saturday after Thanksgiving Day, And Christmas Day (8).
- H. Holidays: New Year's Day, Memorial Day, Independence Day, Thanksgiving Day, the Day after Thanksgiving Day, And Christmas (6).
- I. Holidays: New Year's Day, Memorial Day, Independence Day, Labor Day, Thanksgiving Day, and Christmas Day (6).
- J. Holidays: New Year's Day, Memorial Day, Independence Day, Thanksgiving Day, Friday after Thanksgiving Day, Christmas Eve Day, And Christmas Day (7).
- K. Holidays: New Year's Day, Presidents' Day, Memorial Day, Independence Day, Labor Day, Thanksgiving Day, Friday After Thanksgiving Day, The Day Before Christmas, And Christmas Day (9).
- L. Holidays: New Year's Day, Martin Luther King Jr. Day, Memorial Day, Independence Day, Labor Day, Thanksgiving Day, Friday after Thanksgiving Day, And Christmas Day (8).
- N. Holidays: New Year's Day, Presidents' Day, Memorial Day, Independence Day, Labor Day, Veterans' Day, Thanksgiving Day, The Friday After Thanksgiving Day, And Christmas Day (9).
- P. Holidays: New Year's Day, Memorial Day, Independence Day, Labor Day, Thanksgiving Day, Friday And Saturday After Thanksgiving Day, The Day Before Christmas, And Christmas Day (9). If A Holiday Falls On Sunday, The Following Monday Shall Be Considered As A Holiday.
- Q. Paid Holidays: New Year's Day, Memorial Day, Independence Day, Labor Day, Thanksgiving Day, and Christmas Day (6).

Benefit Code Key – Effective 3/4/2020 thru 9/1/2020

Holiday Codes Continued

5. R. Paid Holidays: New Year's Day, Memorial Day, Independence Day, Labor Day, Thanksgiving Day, Day After Thanksgiving Day, One-Half Day Before Christmas Day, And Christmas Day. (7 1/2).
- S. Paid Holidays: New Year's Day, Presidents' Day, Memorial Day, Independence Day, Labor Day, Thanksgiving Day, And Christmas Day (7).
- T. Paid Holidays: New Year's Day, Washington's Birthday, Memorial Day, Independence Day, Labor Day, Thanksgiving Day, The Friday After Thanksgiving Day, Christmas Day, And The Day Before Or After Christmas (9).
- Z. Holidays: New Year's Day, Memorial Day, Independence Day, Labor Day, Veterans Day, Thanksgiving Day, the Friday after Thanksgiving Day, And Christmas Day (8).
6. A. Paid Holidays: New Year's Day, Presidents' Day, Memorial Day, Independence Day, Labor Day, Thanksgiving Day, the Friday after Thanksgiving Day, And Christmas Day (8).
- E. Paid Holidays: New Year's Day, Day Before Or After New Year's Day, Presidents Day, Memorial Day, Independence Day, Labor Day, Thanksgiving Day, the Friday after Thanksgiving Day, Christmas Day, and a Half-Day On Christmas Eve Day. (9 1/2).
- G. Paid Holidays: New Year's Day, Martin Luther King Jr. Day, Presidents' Day, Memorial Day, Independence Day, Labor Day, Veterans' Day, Thanksgiving Day, the Friday after Thanksgiving Day, Christmas Day, and Christmas Eve Day (11).
- H. Paid Holidays: New Year's Day, New Year's Eve Day, Memorial Day, Independence Day, Labor Day, Thanksgiving Day, Friday After Thanksgiving Day, Christmas Day, The Day After Christmas, And A Floating Holiday (10).
- I. Paid Holidays: New Year's Day, Memorial Day, Independence Day, Labor Day, Thanksgiving Day, Friday After Thanksgiving Day, And Christmas Day (7).
- T. Paid Holidays: New Year's Day, Presidents' Day, Memorial Day, Independence Day, Labor Day, Thanksgiving Day, The Friday After Thanksgiving Day, The Last Working Day Before Christmas Day, And Christmas Day (9).
- Z. Holidays: New Year's Day, Memorial Day, Independence Day, Labor Day, Thanksgiving Day, Friday after Thanksgiving Day, And Christmas Day (7). If a holiday falls on Saturday, the preceding Friday shall be considered as the holiday. If a holiday falls on Sunday, the following Monday shall be considered as the holiday.
7. A. Holidays: New Year's Day, Memorial Day, Independence Day, Labor Day, Thanksgiving Day, the Friday and Saturday after Thanksgiving Day, And Christmas Day (8). Any Holiday Which Falls On A Sunday Shall Be Observed As A Holiday On The Following Monday. If any of the listed holidays falls on a Saturday, the preceding Friday shall be a regular work day.
- B. Holidays: New Year's Day, Memorial Day, Independence Day, Labor Day, Thanksgiving Day, the Friday and Saturday after Thanksgiving Day, And Christmas Day (8). Any holiday which falls on a Sunday shall be observed as a holiday on the following Monday. Any holiday which falls on a Saturday shall be observed as a holiday on the preceding Friday.
- C. Holidays: New Year's Day, Martin Luther King Jr. Day, Memorial Day, Independence Day, Labor Day, Thanksgiving Day, the Friday after Thanksgiving Day, And Christmas Day (8). Any holiday which falls on a Sunday shall be observed as a holiday on the following Monday. Any holiday which falls on a Saturday shall be observed as a holiday on the preceding Friday.

Benefit Code Key – Effective 3/4/2020 thru 9/1/2020

Holiday Codes Continued

7. D. Paid Holidays: New Year's Day, Memorial Day, Independence Day, Labor Day, Veteran's Day, Thanksgiving Day, the Friday after Thanksgiving Day, And Christmas Day (8). Unpaid Holidays: President's Day. Any paid holiday which falls on a Sunday shall be observed as a holiday on the following Monday. Any paid holiday which falls on a Saturday shall be observed as a holiday on the preceding Friday.
- E. Holidays: New Year's Day, Memorial Day, Independence Day, Labor Day, Thanksgiving Day, the Friday after Thanksgiving Day, And Christmas Day (7). Any holiday which falls on a Sunday shall be observed as a holiday on the following Monday. Any holiday which falls on a Saturday shall be observed as a holiday on the preceding Friday.
- F. Holidays: New Year's Day, Memorial Day, Independence Day, Labor Day, Thanksgiving Day, the Friday after Thanksgiving Day, the last working day before Christmas day and Christmas day (8). Any holiday which falls on a Sunday shall be observed as a holiday on the following Monday. Any holiday which falls on a Saturday shall be observed as a holiday on the preceding Friday.
- G. Holidays: New Year's Day, Memorial Day, Independence Day, Labor Day, Thanksgiving Day, and Christmas Day (6). Any holiday which falls on a Sunday shall be observed as a holiday on the following Monday.
- H. Holidays: New Year's Day, Martin Luther King Jr. Day, Independence Day, Memorial Day, Labor Day, Thanksgiving Day, the Friday after Thanksgiving Day, the Last Working Day before Christmas Day and Christmas Day (9). Any holiday which falls on a Sunday shall be observed as a holiday on the following Monday. Any holiday which falls on a Saturday shall be observed as a holiday on the preceding Friday.
- I. Holidays: New Year's Day, President's Day, Independence Day, Memorial Day, Labor Day, Thanksgiving Day, The Friday After Thanksgiving Day, The Day Before Christmas Day And Christmas Day (9). Any holiday which falls on a Sunday shall be observed as a holiday on the following Monday. Any holiday which falls on a Saturday shall be observed as a holiday on the preceding Friday.
- J. Holidays: New Year's Day, Independence Day, Memorial Day, Labor Day, Thanksgiving Day and Christmas Day (6). Any holiday which falls on a Sunday shall be observed as a holiday on the following Monday. Any holiday which falls on a Saturday shall be observed as a holiday on the preceding Friday.
- K. Holidays: New Year's Day, Memorial Day, Independence Day, Thanksgiving Day, the Friday and Saturday after Thanksgiving Day, And Christmas Day (8). Any holiday which falls on a Sunday shall be observed as a holiday on the following Monday. Any holiday which falls on a Saturday shall be observed as a holiday on the preceding Friday.
- L. Holidays: New Year's Day, Memorial Day, Labor Day, Independence Day, Thanksgiving Day, the Last Work Day before Christmas Day, And Christmas Day (7). Any holiday which falls on a Sunday shall be observed as a holiday on the following Monday. Any holiday which falls on a Saturday shall be observed as a holiday on the preceding Friday.
- M. Paid Holidays: New Year's Day, The Day after or before New Year's Day, President's Day, Memorial Day, Independence Day, Labor Day, Thanksgiving Day, the Friday after Thanksgiving Day, Christmas Day, And the Day after or before Christmas Day (10). Any holiday which falls on a Sunday shall be observed as a holiday on the following Monday. Any holiday which falls on a Saturday shall be observed as a holiday on the preceding Friday.
- N. Holidays: New Year's Day, Memorial Day, Independence Day, Labor Day, Thanksgiving Day, the Friday after Thanksgiving Day, And Christmas Day (7). Any holiday which falls on a Sunday shall be observed as a holiday on the following Monday. When Christmas falls on a Saturday, the preceding Friday shall be observed as a holiday.
- P. Holidays: New Year's Day, Memorial Day, Independence Day, Labor Day, Thanksgiving Day, Friday after Thanksgiving Day, And Christmas Day (7). Any holiday which falls on a Sunday shall be observed as a holiday on the following Monday.

Holiday Codes Continued

7. Q. Holidays: New Year's Day, Memorial Day, Independence Day, Labor Day, Thanksgiving Day, the Friday after Thanksgiving Day, the Last Working Day before Christmas Day and Christmas Day (8). Any holiday which falls on a Sunday shall be observed as a holiday on the following Monday. If any of the listed holidays falls on a Saturday, the preceding Friday shall be a regular work day.
- R. Paid Holidays: New Year's Day, the day after or before New Year's Day, President's Day, Memorial Day, Independence Day, Labor Day, Thanksgiving Day, the Friday after Thanksgiving Day, Christmas Day, and the day after or before Christmas Day (10). If any of the listed holidays fall on Saturday, the preceding Friday shall be observed as the holiday. If any of the listed holidays falls on a Sunday, the day observed by the Nation shall be considered a holiday and compensated accordingly.
- S. Paid Holidays: New Year's Day, Memorial Day, Independence Day, Labor Day, Thanksgiving Day, Friday after Thanksgiving Day, Christmas Day, the Day after Christmas, and A Floating Holiday (9). If any of the listed holidays falls on a Sunday, the day observed by the Nation shall be considered a holiday and compensated accordingly.
- T. Paid Holidays: New Year's Day, the Day after or before New Year's Day, President's Day, Memorial Day, Independence Day, Labor Day, Thanksgiving Day, the Friday after Thanksgiving Day, Christmas Day, and The Day after or before Christmas Day. (10). If any of the listed holidays falls on a Sunday, the day observed by the Nation shall be considered a holiday and compensated accordingly. Any holiday which falls on a Saturday shall be observed as a holiday on the preceding Friday.
- V. Holidays: New Year's Day, President's Birthday, Memorial Day, Independence Day, Labor Day, Thanksgiving Day, the Friday after Thanksgiving Day, Christmas Day, the day before or after Christmas, and the day before or after New Year's Day. If any of the above listed holidays falls on a Sunday, the day observed by the Nation shall be considered a holiday and compensated accordingly.
- W. Holidays: New Year's Day, Day After New Year's, Memorial Day, Independence Day, Labor Day, Thanksgiving Day, the Friday after Thanksgiving Day, Christmas Eve Day, Christmas Day, the day after Christmas, the day before New Year's Day, and a Floating Holiday.
- X. Holidays: New Year's Day, Day before or after New Year's Day, Presidents' Day, Memorial Day, Independence Day, Labor Day, Thanksgiving Day, the Friday after Thanksgiving Day, Christmas Day, and the day before or after Christmas day. If a holiday falls on a Saturday or on a Friday that is the normal day off, then the holiday will be taken on the last normal workday. If the holiday falls on a Monday that is the normal day off or on a Sunday, then the holiday will be taken on the next normal workday.
- Y. Holidays: New Year's Day, Presidents' Day, Memorial Day, Independence Day, Labor Day, Thanksgiving Day, the Friday after Thanksgiving Day, and Christmas Day. (8) If the holiday falls on a Sunday, then the day observed by the federal government shall be considered a holiday and compensated accordingly.
- Z. Holidays: New Year's Day, President's Day, Independence Day, Memorial Day, Labor Day, Thanksgiving Day, The Friday After Thanksgiving Day, And Christmas Day (8). Any holiday which falls on a Sunday shall be observed as a holiday on the following Monday. Any holiday which falls on a Saturday shall be observed as a holiday on the preceding Friday.
15. A. Holidays: New Year's Day, Memorial Day, Independence Day, Labor Day, Thanksgiving Day, the Friday after Thanksgiving Day, the day before Christmas Day and Christmas Day. (8) Any holiday which falls on a Sunday shall be observed as a holiday on the following Monday.
- B. Holidays: New Year's Day, Martin Luther King Jr. Day, President's Day, Memorial Day, Independence Day, Labor Day, Veteran's Day, Thanksgiving Day, and Christmas Day. (9)
- C. Holidays: New Year's Day, Memorial Day, Independence Day, Labor Day, Thanksgiving Day, the Friday after Thanksgiving Day, the day before Christmas Day and Christmas Day. (8)

Benefit Code Key – Effective 3/4/2020 thru 9/1/2020

Holiday Codes Continued

15. D. Holidays: New Year's Day, Presidents' Day, Memorial Day, Independence Day, Labor Day, Thanksgiving Day, Friday after Thanksgiving Day, Christmas Day, and the day after Christmas.
- E. Holidays: the day before New Years's Day, New Year's Day, Martin Luther King, Jr. Day, Presidents' Day, Memorial Day, Independence Day, Labor Day, Veteran's Day, Thanksgiving Day, Friday after Thanksgiving Day, the day before Christmas, and Christmas Day. (12)

Note Codes

8. D. Workers working with supplied air on hazmat projects receive an additional \$1.00 per hour.
- L. Workers on hazmat projects receive additional hourly premiums as follows -Level A: \$0.75, Level B: \$0.50, And Level C: \$0.25.
- M. Workers on hazmat projects receive additional hourly premiums as follows: Levels A & B: \$1.00, Levels C & D: \$0.50.
- N. Workers on hazmat projects receive additional hourly premiums as follows -Level A: \$1.00, Level B: \$0.75, Level C: \$0.50, And Level D: \$0.25.
- P. Workers on hazmat projects receive additional hourly premiums as follows -Class A Suit: \$2.00, Class B Suit: \$1.50, Class C Suit: \$1.00, And Class D Suit \$0.50.
- Q. The highest pressure registered on the gauge for an accumulated time of more than fifteen (15) minutes during the shift shall be used in determining the scale paid.
- S. Effective August 31, 2012 – A Traffic Control Supervisor shall be present on the project whenever flagging or spotting or other traffic control labor is being utilized. Flaggers and Spotters shall be posted where shown on approved Traffic Control Plans or where directed by the Engineer. All flaggers and spotters shall possess a current flagging card issued by the State of Washington, Oregon, Montana, or Idaho. This classification is only effective on or after August 31, 2012.
- T. Effective August 31, 2012 – A Traffic Control Laborer performs the setup, maintenance and removal of all temporary traffic control devices and construction signs necessary to control vehicular, bicycle, and pedestrian traffic during construction operations. Flaggers and Spotters shall be posted where shown on approved Traffic Control Plans or where directed by the Engineer. All flaggers and spotters shall possess a current flagging card issued by the State of Washington, Oregon, Montana, or Idaho. This classification is only effective on or after August 31, 2012.
- U. Workers on hazmat projects receive additional hourly premiums as follows – Class A Suit: \$2.00, Class B Suit: \$1.50, And Class C Suit: \$1.00. Workers performing underground work receive an additional \$0.40 per hour for any and all work performed underground, including operating, servicing and repairing of equipment. The premium for underground work shall be paid for the entire shift worked. Workers who work suspended by a rope or cable receive an additional \$0.50 per hour. The premium for work suspended shall be paid for the entire shift worked. Workers who do “pioneer” work (break open a cut, build road, etc.) more than one hundred fifty (150) feet above grade elevation receive an additional \$0.50 per hour.

Note Codes Continued

8. V. In addition to the hourly wage and fringe benefits, the following depth and enclosure premiums shall be paid. The premiums are to be calculated for the maximum depth and distance into an enclosure that a diver reaches in a day. The premiums are to be paid one time for the day and are not used in calculating overtime pay.
- Depth premiums apply to depths of fifty feet or more. Over 50' to 100' - \$2.00 per foot for each foot over 50 feet. Over 101' to 150' - \$3.00 per foot for each foot over 101 feet. Over 151' to 220' - \$4.00 per foot for each foot over 220 feet. Over 221' - \$5.00 per foot for each foot over 221 feet.
- Enclosure premiums apply when divers enter enclosures (such as pipes or tunnels) where there is no vertical ascent and is measured by the distance travelled from the entrance. 25' to 300' - \$1.00 per foot from entrance. 300' to 600' - \$1.50 per foot beginning at 300'. Over 600' - \$2.00 per foot beginning at 600'.
- W. Meter Installers work on single phase 120/240V self-contained residential meters. The Lineman/Groundmen rates would apply to meters not fitting this description.
- X. Workers on hazmat projects receive additional hourly premiums as follows - Class A Suit: \$2.00, Class B Suit: \$1.50, Class C Suit: \$1.00, and Class D Suit: \$0.50. Special Shift Premium: Basic hourly rate plus \$2.00 per hour.
- When due to conditions beyond the control of the Employer or when an owner (not acting as the contractor), a government agency or the contract specifications requires that work can only be performed outside the normal 5 am to 6pm shift, then the special shift premium will be applied to the basic hourly rate. When an employee works on a special shift, they shall be paid a special shift premium for each hour worked unless they are in OT or Double-time status. (For example, the special shift premium does not waive the overtime requirements for work performed on Saturday or Sunday.)
- Y. Tide Work: When employees are called out between the hours of 6:00 p.m. and 6:00 a.m. to work on tide work (work located in the tide plane) all time worked shall be at one and one-half times the hourly rate of pay.
- Swinging Stage/Boatswains Chair: Employees working on a swinging state or boatswains chair or under conditions that require them to be tied off to allow their hands to be free shall receive seventy-five cents (\$0.75) per hour above the classification rate.
- Z. Workers working with supplied air on hazmat projects receive an additional \$1.00 per hour.
- Special Shift Premium: Basic hourly rate plus \$2.00 per hour. When due to conditions beyond the control of the Employer or when an owner (not acting as a contractor), a government agency or the contract specifications require that more than (4) hours of a special shift can only be performed outside the normal 6 am to 6pm shift, then the special shift premium will be applied to the basic straight time for the entire shift. When an employee works on a special shift, they will be paid a special shift premium for each hour worked unless they are in overtime or double-time status. (For example, the special shift premium does not waive the overtime requirements for work performed on Saturday or Sunday.)

Note Codes Continued

9. A. Workers working with supplied air on hazmat projects receive an additional \$1.00 per hour.

Special Shift Premium: Basic hourly rate plus \$2.00 per hour. When due to conditions beyond the control of the Employer or when an owner (not acting as the contractor), a government agency or the contract specifications require that more than four (4) hours of a special shift can only be performed outside the normal 6 am to 6pm shift, then the special shift premium will be applied to the basic straight time for the entire shift. When an employee works on a special shift, they shall be paid a special shift premium for each hour worked unless they are in overtime or double-time status. (For example, the special shift premium does not waive the overtime requirements for work performed on Saturday or Sunday.)

Certified Crane Operator Premium: Crane operators requiring certifications shall be paid \$0.50 per hour above their classification rate.

Boom Pay Premium: All cranes including tower shall be paid as follows based on boom length:

(A) – 130' to 199' – \$0.50 per hour over their classification rate.

(B) – 200' to 299' – \$0.80 per hour over their classification rate.

(C) – 300' and over – \$1.00 per hour over their classification rate.

- B. The highest pressure registered on the gauge for an accumulated time of more than fifteen (15) minutes during the shift shall be used in determining the scale paid.

Tide Work: When employees are called out between the hours of 6:00 p.m. and 6:00 a.m. to work on tide work (work located in the tide plane) all time worked shall be at one and one-half times the hourly rate of pay. Swinging Stage/Boatswains Chair: Employees working on a swinging stage or boatswains chair or under conditions that require them to be tied off to allow their hands to be free shall receive seventy-five cents (\$0.75) per hour above the classification rate.

- C. Tide Work: When employees are called out between the hours of 6:00 p.m. and 6:00 a.m. to work on tide work (work located in the tide plane) all time worked shall be at one and one-half times the hourly rate of pay. Swinging Stage/Boatswains Chair: Employees working on a swinging stage or boatswains chair or under conditions that require them to be tied off to allow their hands to be free shall receive seventy-five cents (\$0.75) per hour above the classification rate.

Effective August 31, 2012 – A Traffic Control Supervisor shall be present on the project whenever flagging or spotting or other traffic control labor is being utilized. A Traffic Control Laborer performs the setup, maintenance and removal of all temporary traffic control devices and construction signs necessary to control vehicular, bicycle, and pedestrian traffic during construction operations. Flaggers and Spotters shall be posted where shown on approved Traffic Control Plans or where directed by the Engineer. All flaggers and spotters shall possess a current flagging card issued by the State of Washington, Oregon, Montana, or Idaho. These classifications are only effective on or after August 31, 2012.

- D. Industrial Painter wages are required for painting within industrial facilities such as treatment plants, pipelines, towers, dams, bridges, power generation facilities and manufacturing facilities such as chemical plants, etc., or anywhere abrasive blasting is necessary to prepare surfaces, or hazardous materials encapsulation is required.

- E. Heavy Construction includes construction, repair, alteration or additions to the production, fabrication or manufacturing portions of industrial or manufacturing plants, hydroelectric or nuclear power plants and atomic reactor construction. Workers on hazmat projects receive additional hourly premiums as follows -Level A: \$1.00, Level B: \$0.75, Level C: \$0.50, And Level D: \$0.25.

ATTACHMENT B

PLANS



EXISTING CONDITIONS
N.T.S.

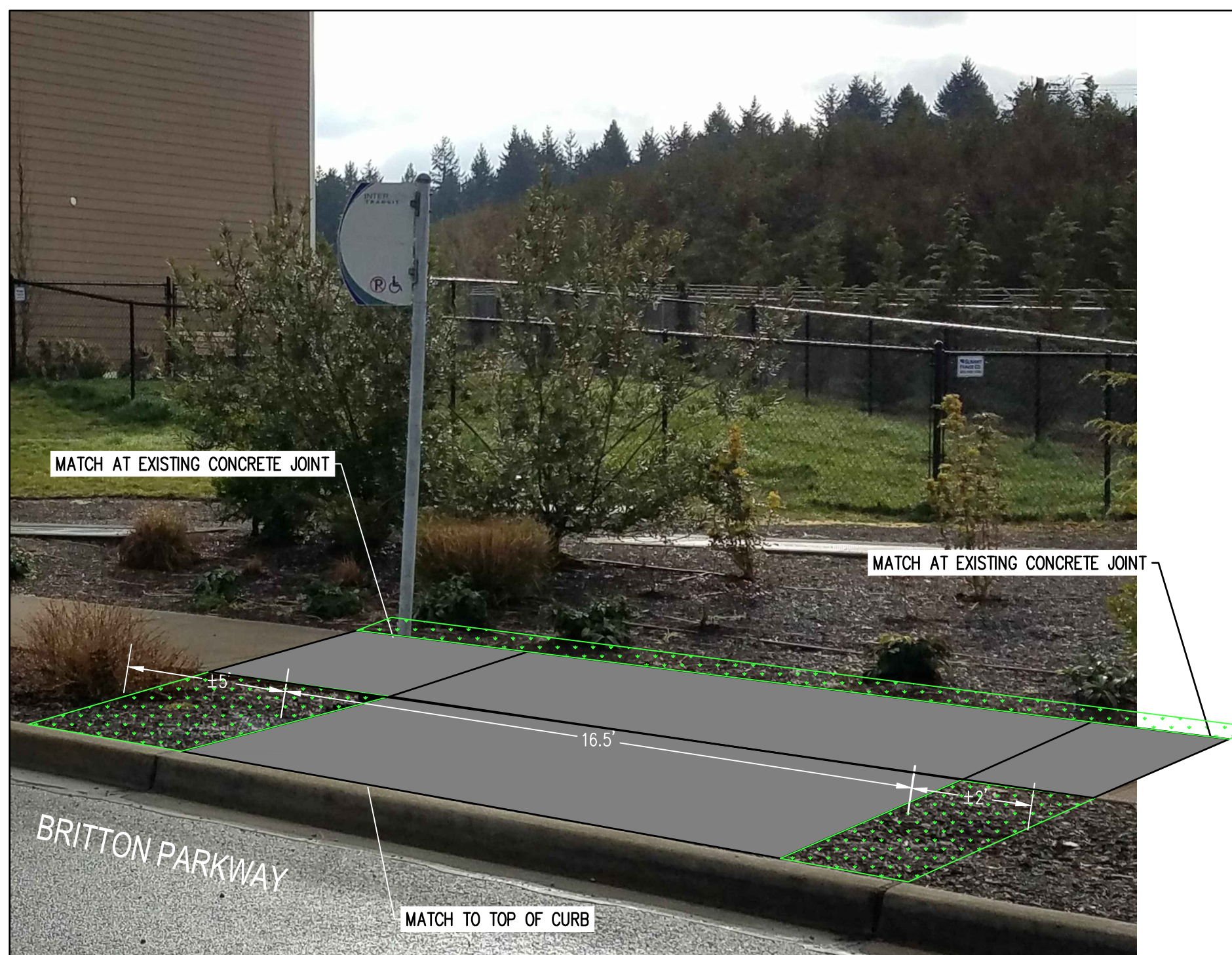

PROPOSED CONDITIONS
N.T.S.

LEGEND

- CEMENT CONCRETE SIDEWALK (PLAN VIEW)
- REMOVE EXISTING SIDEWALK
- CEMENT CONCRETE SIDEWALK (CROSS SECTION VIEW)
- CSBC (CRUSHED SURFACING BASE COURSE)
- SITE RESTORATION - BARK/TOPSOIL MIX (SEE SPECIAL PROVISIONS)

GENERAL NOTES

1. LACEYS' STANDARD CONSTRUCTION NOTES AND DETAILS HAVE BEEN PROVIDED AND REFERENCED ON THE PLANS. ALL WORKMANSHIP AND MATERIALS SHALL BE IN ACCORDANCE WITH THE CITY OF LACEY STANDARDS AND THE MOST CURRENT COPY OF THE WSDOT STANDARD SPECIFICATIONS FOR ROAD, BRIDGE, AND MUNICIPAL CONSTRUCTION.
2. CONTRACTOR SHALL HAVE A COPY OF THE APPROVED CONSTRUCTION PLANS AND SPECIFICATIONS ON THE JOB SITE AT ALL TIMES DURING CONSTRUCTION.
3. THE CONTRACTOR SHALL BE IN COMPLIANCE WITH ALL SAFETY STANDARDS AND REQUIREMENTS AS SET FORTH BY OSHA, WSHA, AND THE WASHINGTON STATE DEPARTMENT OF LABOR AND INDUSTRIES.
4. PRIOR TO WORK ON ANY BUS STOP LOCATION, THE CONTRACTOR SHALL SUBMIT A CONSTRUCTION SCHEDULE TO THE PROJECT ENGINEER FOR REVIEW. THE CONSTRUCTION SCHEDULE SHALL NOTE CONSTRUCTION START AND END DATES FOR EACH BUS STOP. INTERCITY TRANSIT WILL UTILIZE THE SCHEDULE PROVIDED TO COORDINATE AND IMPLEMENT TEMPORARY BUS STOP LOCATIONS. CONTRACTOR TO NOTIFY ENGINEER IMMEDIATELY IF A TEMPORARY BUS STATION HAS NOT BEEN SET UP FOR A BUS STOP SCHEDULED FOR CONSTRUCTION.
5. PRIOR TO WORK ON A SPECIFIC BUS STOP, IT IS THE CONTRACTORS RESPONSIBILITY TO NOTIFY THE CITY OF LACEY THAT WORK WILL BE COMMENCING WITHIN THEIR RIGHT-OF-WAY AND SCHEDULE/ATTEND A PRE-CONSTRUCTION MEETING IF REQUIRED BY THE CITY OF LACEY. CONTRACTOR SHALL NOTIFY THE PROJECT ENGINEER OF ALL SCHEDULED PRE-CONSTRUCTION MEETINGS.
6. THE ENGINEER RESPONSIBLE FOR PREPARATION OF THESE PLANS AND SPECIFICATIONS WILL NOT BE RESPONSIBLE FOR, OR LIABLE FOR, UNAUTHORIZED CHANGES TO OR USES OF THESE PLANS. ALL CHANGES TO THE PLANS MUST BE IN WRITING AND MUST BE APPROVED BY THE ENGINEER RESPONSIBLE FOR PREPARATION OF THESE PLANS.
7. CONTRACTOR TO NOTE THAT CONSTRUCTION ACTIVITY WILL OCCUR IN AREAS WHERE EXISTING UNDERGROUND UTILITIES ARE LOCATED. THE CONTRACTOR SHALL BE FULLY RESPONSIBLE FOR THE LOCATION AND PROTECTION OF ALL EXISTING UTILITIES. THE CONTRACTOR SHALL VERIFY ALL UTILITY LOCATIONS PRIOR TO CONSTRUCTION BY CALLING THE UNDERGROUND LOCATE LINE AT 811 A MINIMUM OF 72 HOURS PRIOR TO THE START OF CONSTRUCTION.

GENERAL CONSTRUCTION NOTES

8. EROSION CONTROL MEASURES SHALL BE IMPLEMENTED AT ALL BUS STOP CONSTRUCTION LOCATION AS REQUIRED TO PREVENT SILT LADEN WATER FROM EXITING THE SITE OR ENTERING INTO STORM DRAINAGE FACILITIES. THE PLANS MAY NOTE SPECIFIC EROSION CONTROL MEASURES THAT MAY BE REQUIRED, HOWEVER IT IS THE CONTRACTORS RESPONSIBILITY TO IMPLEMENT ALL EROSION CONTROL MEASURES NECESSARY DURING CONSTRUCTION AND SITE STABILIZATION. SEE PLANS FOR EROSION CONTROL GENERAL NOTES AND DETAILS.
9. TRAFFIC CONTROL WILL BE REQUIRED AT EACH BUS STOP CONSTRUCTION LOCATION. CONTRACTOR TO MEET ALL TRAFFIC CONTROL REQUIREMENTS PER WSDOT, MUTCD, AND CITY OF LACEY STANDARDS. PRIOR TO DISRUPTION OF ANY TRAFFIC, THE CONTRACTOR SHALL PREPARE A SITE SPECIFIC TRAFFIC CONTROL PLAN FOR EACH BUS STOP LOCATION FOR REVIEW AND APPROVAL BY THE CITY OF LACEY. NO WORK SHALL COMMENCE UNTIL ALL APPROVED TRAFFIC CONTROL IS IN PLACE. WORK SHALL BE SUSPENDED IF TRAFFIC CONTROL FAILS TO MEET MINIMUM REQUIREMENTS. CONTRACTOR TO ENSURE THAT TRAFFIC CONTROL ADDRESSES PEDESTRIAN AND BICYCLE TRAFFIC THROUGH THE CONSTRUCTION SITE. TRAFFIC CONTROL MUST BE MAINTAINED 24 HOURS A DAY, 7 DAYS A WEEK WHILE IN USE. PRIOR TO WORK, CONTRACTOR SHALL PROVIDE THE NAME AND PHONE NUMBER OF THE 24 HOUR TRAFFIC CONTROL CONTACT PERSON TO THE PERMITTING AGENCY AND PROJECT ENGINEER.
10. EXISTING SURVEY MONUMENTS, INCLUDING BUT NOT RESTRICTED TO PROPERTY CORNERS AND CENTERLINE MONUMENT MAY BE DISTURBED OR DESTROYED BY CONSTRUCTION OPERATIONS. THE CONTRACTOR, AS PART OF THE BASE BID, SHALL RETAIN A LICENSED PROFESSIONAL LAND SURVEYOR FOR REPLACEMENT OF ANY DISTURBED OR DESTROYED MONUMENTS OR PROPERTY CORNERS IN ACCORDANCE WITH WASHINGTON STATE LAWS.
11. SITE RESTORATION HAS BEEN CALLED OUT ON THE PLANS FOR AREAS THAT WILL BE DISTURBED DURING CONSTRUCTION. CONTRACTOR SHALL INCLUDE IN THE BASE BID RESTORATION OF ALL DISTURBED AREAS AS A RESULT OF CONSTRUCTION. AREAS SHALL BE REPAIRED, REPLACED, AND STABILIZED TO MATCH THE PRE-PROJECT CONDITIONS OR AS NOTED ON THE PLANS. FOR SITE RESTORATION WITH GRASS, CONTRACTOR SHALL INSTALL 6 INCHES MINIMUM OF TOPSOIL. THEN SEED FERTILIZE AND MULCH PER WSDOT SPECIFICATIONS. THE CONTRACTOR IS RESPONSIBLE FOR PROVIDING AT THEIR EXPENSE, ANY TEMPORARY WATER NEEDED TO ESTABLISH SEED GERMINATION AND PROVIDE SUBSTANTIAL GROWTH AND STABILIZATION. IF SEED GERMINATION DOES NOT OCCUR, CONTRACTOR SHALL RESEED AT THEIR EXPENSE. CONTRACTOR SHALL ASSUME A MINIMUM OF 2 FEET BEYOND THE PROPOSED IMPROVEMENTS (ALL LOCATION) WILL REQUIRE SITE RESTORATION UNLESS SPECIFICALLY NOTED DIFFERENTLY ON THE PLANS. CONTRACTOR SHALL REPAIR CONDITIONS. IF UNDERGROUND IRRIGATION SYSTEMS ARE ENCOUNTERED CONTRACTOR SHALL PROTECT AND PRESERVE OR MODIFY THE EXISTING SYSTEM AS REQUIRED TO ACCOMMODATE BUS STOP CONSTRUCTION.
12. EXISTING VEGETATION SHALL BE PROTECTED AND PRESERVED TO THE EXTENT FEASIBLE. ALL EXISTING TREES SHALL BE PROTECTED UNLESS SHOWN ON THE PLANS TO BE REMOVED OR TRIMMED. NO TREE SHALL BE REMOVED WITHOUT WRITTEN AUTHORIZATION FROM THE PROJECT ENGINEER. AT HIS EXPENSE, CONTRACTOR SHALL CONSULT WITH A CERTIFIED ARBORIST PRIOR TO TRIMMING OF EXISTING TREES/ROOT REMOVAL TO ENSURE TRIMMING MAINTAINS THE LONG TERM VIABILITY OF THE TREE.

13. CONTRACTOR SHALL INCLUDE IN BASE BID ALL MATERIALS AND LABOR REQUIRED TO INSTALL AND REMOVE ANY TEMPORARY SHORING SYSTEMS REQUIRED TO CONSTRUCT THESE IMPROVEMENTS. CONTRACTOR SHALL NOTE THAT MANY OF THE BUS STOP LOCATIONS ARE IN CLOSE PROXIMITY TO EXISTING FEATURES AND PRIVATE PROPERTY. IT IS THE CONTRACTORS RESPONSIBILITY TO ENSURE THAT CONSTRUCTION ACTIVITIES DO NOT DAMAGE OR INFRINGE ON PRIVATE PROPERTY.

BUS STOP CONSTRUCTION

14. INTERCITY TRANSIT WILL BE FURNISHING AND INSTALLING THE POLE AND SIGN FOR ALL OF THESE STOPS. DURING CONSTRUCTION THE CONTRACTOR WILL NEED TO REMOVE AND DISPOSE OF THE BURIED CEMENT BUCKET.
15. CONTRACTOR SHALL PROVIDE A CONCRETE JOINT LAYOUT PLAN TO PROJECT ENGINEER FOR REVIEW ONE WEEK PRIOR TO A SCHEDULED CONCRETE POUR. THE CONCRETE JOINT LAYOUT PLAN SHALL PROVIDE DETAILS ON THE LOCATION OF CONTRACTION, CONSTRUCTION, AND ISOLATION JOINTS. THE PLAN MUST BE APPROVED BY THE ENGINEER PRIOR TO THE CONCRETE POUR.
16. ALL FILL PLACED DURING BUS STOP CONSTRUCTION SHALL BE STRUCTURAL FILL MEETING WSDOT STANDARD SPECIFICATION 9-03.14(3) COMMON BORROW AND SHALL BE COMPACTED TO WSDOT SPECIFICATIONS UNLESS OTHERWISE NOTED ON THE PLANS.
17. CONTRACTOR SHALL PROVIDE A TOWELED EDGE ALONG THE OUTSIDE PERIMETER OF ALL CONCRETE BUS STOP PADS, CURBS, AND WALLS; CONCRETE EDGING SHALL BE 4 INCHES WIDE WITH A 1/2 INCH RADIUS.
18. FOR BUS PAD CONSTRUCTION, CROSS SLOPE GRADES SHALL NOT EXCEED 1.7% LONGITUDINAL GRADES FOR TRANSITIONAL RAMPS SHALL NOT EXCEED 8% IF UPON FINAL INSPECTION OF THE COMPLETED WORK, AND PORTION OF THE WORK DOES NOT MEET THESE REQUIREMENTS, THE WORK SHALL BE REMOVED AND RECONSTRUCTED, AT THE EXPENSE OF THE CONTRACTOR. NO EXCEPTION WILL BE PROVIDED. ALL CONCRETE CONSTRUCTION SHALL HAVE A MINIMUM SLOPED 1% FOR WATER DRAINAGE, UNLESS OTHERWISE NOTED ON THE PLANS.
19. CONTRACTOR TO NOTE ALL BUS STOP PAD DIMENSIONS (LENGTH AND WIDTH) ARE THE ACTUAL SLAB DIMENSIONS. ALL ADDITIONAL CONSTRUCTION SUCH AS PEDESTRIAN CURBS OR WALLS SHALL ABUT THE SLAB AS NOTED IN THE CROSS SECTIONS. AS SUCH, A 6'x8' SLAB WILL RESULT IN 48 SQUARE FEET OF CONCRETE SURFACE. SEE PLANS FOR BUS PAD DIMENSIONS, AS THIS VARIES FOR SPECIFIC SITES.

CONSTRUCTION INSPECTION

20. ALL CONCRETE WORK FOR THIS PROJECT WILL BE INSPECTED BY THE PROJECT ENGINEER AND CITY OF LACEY INSPECTOR. REQUIRED INSPECTIONS INCLUDE CONSTRUCTION STAKING, SUBGRADE INSPECTION, CONCRETE FORMWORK, AND FINAL INSPECTION OF CONCRETE AND FINISHED GRADES. CONTRACTOR SHALL PROVIDE A 24 HOUR NOTICE TO THE PROJECT ENGINEER AND CITY OF LACEY INSPECTOR PRIOR TO THE REQUIRED INSPECTIONS. NO CONCRETE WORK SHALL BE COMPLETED WITHOUT INSPECTION APPROVAL FROM THE PROJECT ENGINEER AND CITY OF LACEY INSPECTOR. ANY CONCRETE WORK COMPLETED BY THE CONTRACTOR WITHOUT THE REQUIRED INSPECTIONS WILL BE AT THE RISK OF THE CONTRACTOR. THE CONTRACTOR IS URGED TO COORDINATE SITE INSPECTIONS FOR MAXIMUM EFFICIENCY, I.E. COMPLETE MULTIPLE SITE INSPECTIONS IN ONE DAY WITHIN CLOSE PROXIMITY OF EACH OTHER.

JURISDICTION NOTES

1. SEE DRAWING DET-01 FOR CITY OF LACEY STANDARD NOTES AND DETAILS.

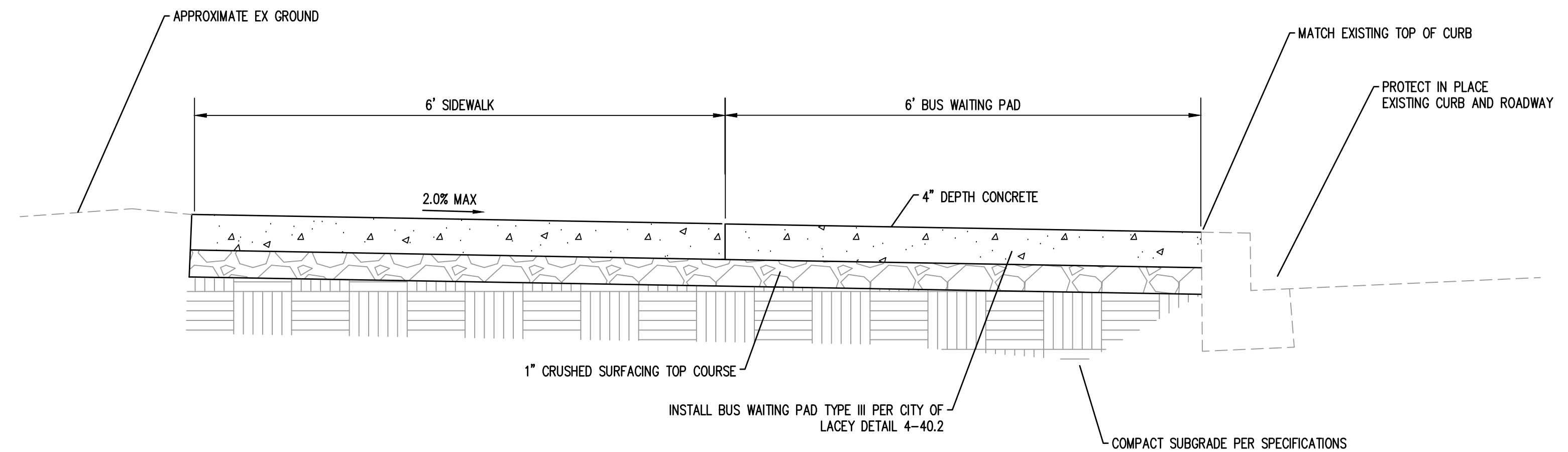

REVISIONS	DATE	BY

SCJ ALLIANCE
CONSULTING SERVICES
8730 TALLON LANE, NE SUITE 200, LACEY, WA 98516
P: 360.352.1465 F: 360.352.1509
SCJALLIANCE.COM

BUS STOP 1045
INTERCITY TRANSIT BUS STOP CONSTRUCTION
IT PROJECT # 2003C
LACEY, WA

SEAL:

DESIGNER:	W HOLM
DRAWN BY:	M KNECHT
APPROVED BY:	B SHEA
DATE:	APRIL, 2020
JOB NO:	768-AA
DRAWING FILE NO:	768.44-STOP-1045
DRAWING NO:	BP-01
SHEET NO:	2 of 17

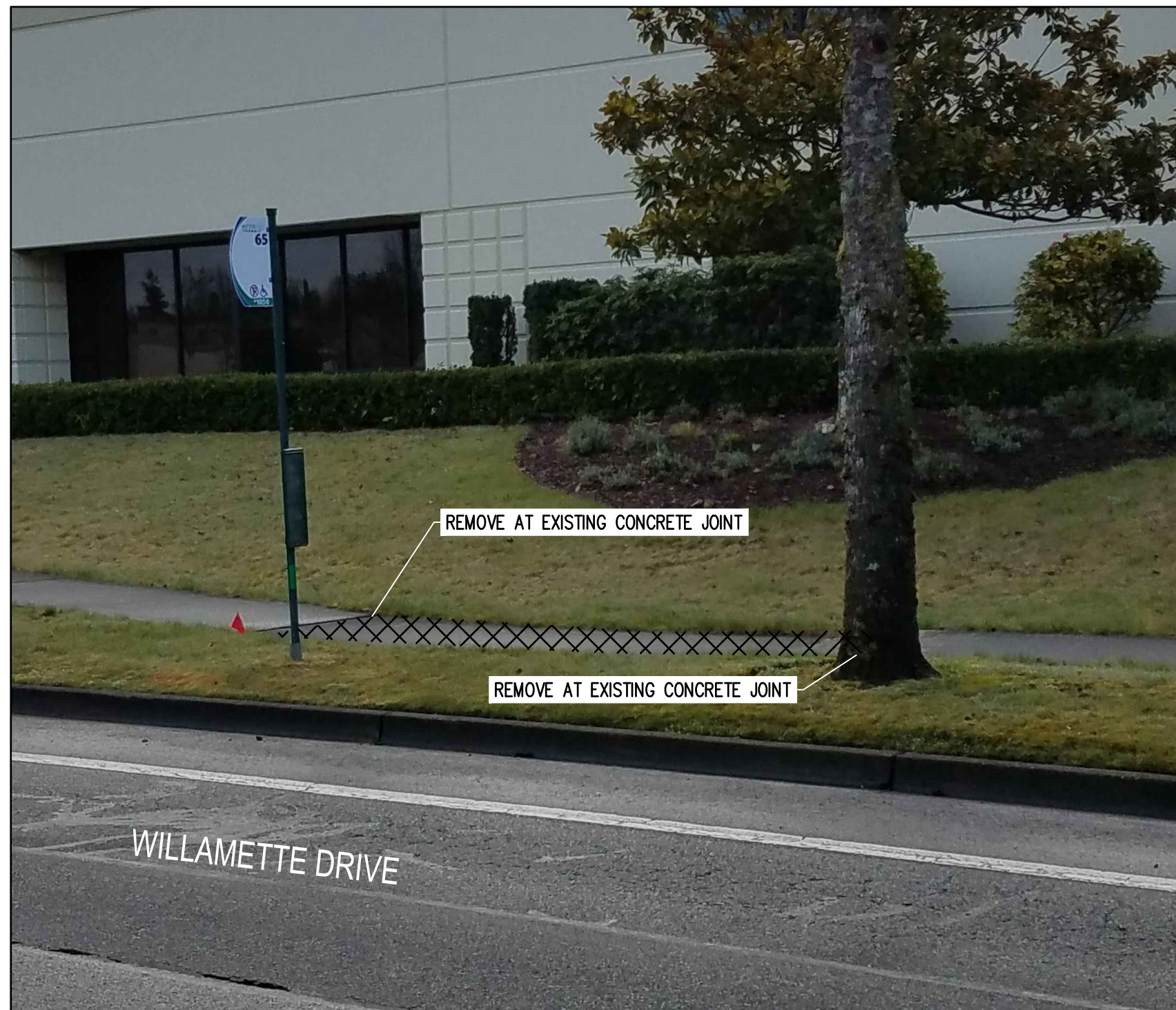



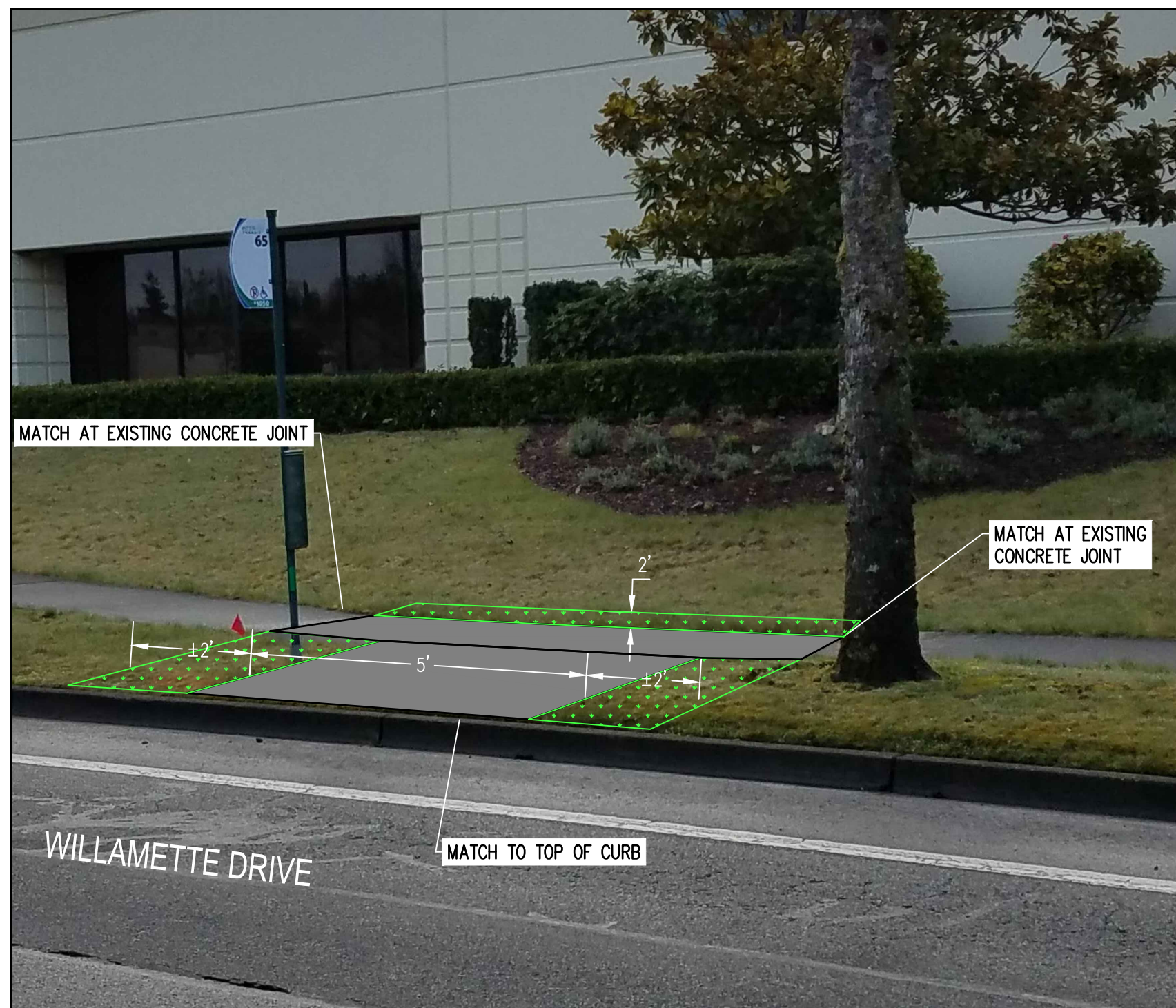

EXISTING CONDITIONS
N.T.S.

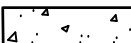

PROPOSED CONDITIONS
N.T.S.

LEGEND

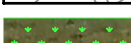
-  CEMENT CONCRETE (PLAN VIEW)
-  REMOVE EXISTING SIDEWALK
-  CEMENT CONCRETE (CROSS SECTION VIEW)
-  CSBS (CRUSHED SURFACING BASE COURSE)
-  SITE RESTORATION - SOD INSTALLATION

GENERAL NOTES

1. LACEYS' STANDARD CONSTRUCTION NOTES AND DETAILS HAVE BEEN PROVIDED AND REFERENCED ON THE PLANS. ALL WORKMANSHIP AND MATERIALS SHALL BE IN ACCORDANCE WITH THE CITY OF LACEY STANDARDS AND THE MOST CURRENT COPY OF THE WSDOT STANDARD SPECIFICATIONS FOR ROAD, BRIDGE, AND MUNICIPAL CONSTRUCTION.
2. CONTRACTOR SHALL HAVE A COPY OF THE APPROVED CONSTRUCTION PLANS AND SPECIFICATIONS ON THE JOB SITE AT ALL TIMES DURING CONSTRUCTION.
3. THE CONTRACTOR SHALL BE IN COMPLIANCE WITH ALL SAFETY STANDARDS AND REQUIREMENTS AS SET FORTH BY OSHA, WSHA, AND THE WASHINGTON STATE DEPARTMENT OF LABOR AND INDUSTRIES.
4. PRIOR TO WORK ON ANY BUS STOP LOCATION, THE CONTRACTOR SHALL SUBMIT A CONSTRUCTION SCHEDULE TO THE PROJECT ENGINEER FOR REVIEW. THE CONSTRUCTION SCHEDULE SHALL NOTE CONSTRUCTION START AND END DATES FOR EACH BUS STOP. INTERCITY TRANSIT WILL UTILIZE THE SCHEDULE PROVIDED TO COORDINATE AND IMPLEMENT TEMPORARY BUS STOP LOCATIONS. CONTRACTOR TO NOTIFY ENGINEER IMMEDIATELY IF A TEMPORARY BUS STATION HAS NOT BEEN SET UP FOR A BUS STOP SCHEDULED FOR CONSTRUCTION.
5. PRIOR TO WORK ON A SPECIFIC BUS STOP, IT IS THE CONTRACTORS RESPONSIBILITY TO NOTIFY THE CITY OF LACEY THAT WORK WILL BE COMMENCING WITHIN THEIR RIGHT-OF-WAY AND SCHEDULE/ATTEND A PRE-CONSTRUCTION MEETING IF REQUIRED BY THE CITY OF LACEY. CONTRACTOR SHALL NOTIFY THE PROJECT ENGINEER OF ALL SCHEDULED PRE-CONSTRUCTION MEETINGS.
6. THE ENGINEER RESPONSIBLE FOR PREPARATION OF THESE PLANS AND SPECIFICATIONS WILL NOT BE RESPONSIBLE FOR, OR LIABLE FOR, UNAUTHORIZED CHANGES TO OR USES OF THESE PLANS. ALL CHANGES TO THE PLANS MUST BE IN WRITING AND MUST BE APPROVED BY THE ENGINEER RESPONSIBLE FOR PREPARATION OF THESE PLANS.
7. CONTRACTOR TO NOTE THAT CONSTRUCTION ACTIVITY WILL OCCUR IN AREAS WHERE EXISTING UNDERGROUND UTILITIES ARE LOCATED. THE CONTRACTOR SHALL BE FULLY RESPONSIBLE FOR THE LOCATION AND PROTECTION OF ALL EXISTING UTILITIES. THE CONTRACTOR SHALL VERIFY ALL UTILITY LOCATIONS PRIOR TO CONSTRUCTION BY CALLING THE UNDERGROUND LOCATE LINE AT 811 A MINIMUM OF 72 HOURS PRIOR TO THE START OF CONSTRUCTION.

GENERAL CONSTRUCTION NOTES

8. EROSION CONTROL MEASURES SHALL BE IMPLEMENTED AT ALL BUS STOP CONSTRUCTION LOCATION AS REQUIRED TO PREVENT SILT LADEN WATER FROM EXITING THE SITE OR ENTERING INTO STORM DRAINAGE FACILITIES. THE PLANS MAY NOTE SPECIFIC EROSION CONTROL MEASURES THAT MAY BE REQUIRED, HOWEVER IT IS THE CONTRACTORS RESPONSIBILITY TO IMPLEMENT ALL EROSION CONTROL MEASURES NECESSARY DURING CONSTRUCTION AND SITE STABILIZATION. SEE PLANS FOR EROSION CONTROL GENERAL NOTES AND DETAILS.
9. TRAFFIC CONTROL WILL BE REQUIRED AT EACH BUS STOP CONSTRUCTION LOCATION. CONTRACTOR TO MEET ALL TRAFFIC CONTROL REQUIREMENTS PER WSDOT, MUTCD, AND CITY OF LACEY STANDARDS. PRIOR TO DISRUPTION OF ANY TRAFFIC, THE CONTRACTOR SHALL PREPARE A SITE SPECIFIC TRAFFIC CONTROL PLAN FOR EACH BUS STOP LOCATION FOR REVIEW AND APPROVAL BY THE CITY OF LACEY. NO WORK SHALL COMMENCE UNTIL ALL APPROVED TRAFFIC CONTROL IS IN PLACE. WORK SHALL BE SUSPENDED IF TRAFFIC CONTROL FAILS TO MEET MINIMUM REQUIREMENTS. CONTRACTOR TO ENSURE THAT TRAFFIC CONTROL ADDRESSES PEDESTRIAN AND BICYCLE TRAFFIC THROUGH THE CONSTRUCTION SITE. TRAFFIC CONTROL MUST BE MAINTAINED 24 HOURS A DAY, 7 DAYS A WEEK WHILE IN USE. PRIOR TO WORK, CONTRACTOR SHALL PROVIDE THE NAME AND PHONE NUMBER OF THE 24 HOUR TRAFFIC CONTROL CONTACT PERSON TO THE PERMITTING AGENCY AND PROJECT ENGINEER.
10. EXISTING SURVEY MONUMENTS, INCLUDING BUT NOT RESTRICTED TO PROPERTY CORNERS AND CENTERLINE MONUMENT MAY BE DISTURBED OR DESTROYED BY CONSTRUCTION OPERATIONS. THE CONTRACTOR, AS PART OF THE BASE BID, SHALL RETAIN A LICENSED PROFESSIONAL LAND SURVEYOR FOR REPLACEMENT OF ANY DISTURBED OR DESTROYED MONUMENTS OR PROPERTY CORNERS IN ACCORDANCE WITH WASHINGTON STATE LAWS.
11. SITE RESTORATION HAS BEEN CALLED OUT ON THE PLANS FOR AREAS THAT WILL BE DISTURBED DURING CONSTRUCTION. CONTRACTOR SHALL INCLUDE IN THE BASE BID RESTORATION OF ALL DISTURBED AREAS AS A RESULT OF CONSTRUCTION. AREAS SHALL BE REPAIRED, REPLACED, AND STABILIZED TO MATCH THE PRE-PROJECT CONDITIONS OR AS NOTED ON THE PLANS. FOR SITE RESTORATION WITH GRASS, CONTRACTOR SHALL INSTALL 6 INCHES MINIMUM OF TOPSOIL. THEN SEED FERTILIZE AND MULCH PER WSDOT SPECIFICATIONS. THE CONTRACTOR IS RESPONSIBLE FOR PROVIDING AT THEIR EXPENSE, ANY TEMPORARY WATER NEEDED TO ESTABLISH SEED GERMINATION AND PROVIDE SUBSTANTIAL GROWTH AND STABILIZATION. IF SEED GERMINATION DOES NOT OCCUR, CONTRACTOR SHALL RESEED AT THEIR EXPENSE. CONTRACTOR SHALL ASSUME A MINIMUM OF 2 FEET BEYOND THE PROPOSED IMPROVEMENTS (ALL LOCATION) WILL REQUIRE SITE RESTORATION UNLESS SPECIFICALLY NOTED DIFFERENTLY ON THE PLANS. CONTRACTOR SHALL REPAIR CONDITIONS. IF UNDERGROUND IRRIGATION SYSTEMS ARE ENCOUNTERED CONTRACTOR SHALL PROTECT AND PRESERVE OR MODIFY THE EXISTING SYSTEM AS REQUIRED TO ACCOMMODATE BUS STOP CONSTRUCTION.
12. EXISTING VEGETATION SHALL BE PROTECTED AND PRESERVED TO THE EXTENT FEASIBLE. ALL EXISTING TREES SHALL BE PROTECTED UNLESS SHOWN ON THE PLANS TO BE REMOVED OR TRIMMED. NO TREE SHALL BE REMOVED WITHOUT WRITTEN AUTHORIZATION FROM THE PROJECT ENGINEER. AT HIS EXPENSE, CONTRACTOR SHALL CONSULT WITH A CERTIFIED ARBORIST PRIOR TO TRIMMING OF EXISTING TREES/ROOT REMOVAL TO ENSURE TRIMMING MAINTAINS THE LONG TERM VIABILITY OF THE TREE.

13. CONTRACTOR SHALL INCLUDE IN BASE BID ALL MATERIALS AND LABOR REQUIRED TO INSTALL AND REMOVE ANY TEMPORARY SHORING SYSTEMS REQUIRED TO CONSTRUCT THESE IMPROVEMENTS. CONTRACTOR SHALL NOTE THAT MANY OF THE BUS STOP LOCATIONS ARE IN CLOSE PROXIMITY TO EXISTING FEATURES AND PRIVATE PROPERTY. IT IS THE CONTRACTORS RESPONSIBILITY TO ENSURE THAT CONSTRUCTION ACTIVITIES DO NOT DAMAGE OR INFRINGE ON PRIVATE PROPERTY.

BUS STOP CONSTRUCTION

14. INTERCITY TRANSIT WILL BE FURNISHING AND INSTALLING THE POLE AND SIGN FOR ALL OF THESE STOPS. DURING CONSTRUCTION THE CONTRACTOR WILL NEED TO REMOVE AND DISPOSE OF THE BURIED CEMENT BUCKET.
15. CONTRACTOR SHALL PROVIDE A CONCRETE JOINT LAYOUT PLAN TO PROJECT ENGINEER FOR REVIEW ONE WEEK PRIOR TO A SCHEDULED CONCRETE POUR. THE CONCRETE JOINT LAYOUT PLAN SHALL PROVIDE DETAILS ON THE LOCATION OF CONTRACTION, CONSTRUCTION, AND ISOLATION JOINTS. THE PLAN MUST BE APPROVED BY THE ENGINEER PRIOR TO THE CONCRETE POUR.
16. ALL FILL PLACED DURING BUS STOP CONSTRUCTION SHALL BE STRUCTURAL FILL MEETING WSDOT STANDARD SPECIFICATION 9-03.14(3) COMMON BORROW AND SHALL BE COMPACTED TO WSDOT SPECIFICATIONS UNLESS OTHERWISE NOTED ON THE PLANS.
17. CONTRACTOR SHALL PROVIDE A TOWELED EDGE ALONG THE OUTSIDE PERIMETER OF ALL CONCRETE BUS STOP PADS, CURBS, AND WALLS; CONCRETE EDGING SHALL BE 4 INCHES WIDE WITH A 1/2 INCH RADIUS.
18. FOR BUS PAD CONSTRUCTION, CROSS SLOPE GRADES SHALL NOT EXCEED 1.7%. LONGITUDINAL GRADES FOR TRANSITIONAL RAMPS SHALL NOT EXCEED 8% IF UPON FINAL INSPECTION OF THE COMPLETED WORK, AND PORTION OF THE WORK DOES NOT MEET THESE REQUIREMENTS, THE WORK SHALL BE REMOVED AND RECONSTRUCTED, AT THE EXPENSE OF THE CONTRACTOR. NO EXCEPTION WILL BE PROVIDED. ALL CONCRETE CONSTRUCTION SHALL HAVE A MINIMUM SLOPED 1% FOR WATER DRAINAGE, UNLESS OTHERWISE NOTED ON THE PLANS.
19. CONTRACTOR TO NOTE ALL BUS STOP PAD DIMENSIONS (LENGTH AND WIDTH) ARE THE ACTUAL SLAB DIMENSIONS. ALL ADDITIONAL CONSTRUCTION SUCH AS PEDESTRIAN CURBS OR WALLS SHALL ABUT THE SLAB AS NOTED IN THE CROSS SECTIONS. AS SUCH, A 6'x8' SLAB WILL RESULT IN 48 SQUARE FEET OF CONCRETE SURFACE. SEE PLANS FOR BUS PAD DIMENSIONS, AS THIS VARIES FOR SPECIFIC SITES.

CONSTRUCTION INSPECTION

20. ALL CONCRETE WORK FOR THIS PROJECT WILL BE INSPECTED BY THE PROJECT ENGINEER AND CITY OF LACEY INSPECTOR. REQUIRED INSPECTIONS INCLUDE CONSTRUCTION STAKING, SUBGRADE INSPECTION, CONCRETE FORMWORK, AND FINAL INSPECTION OF CONCRETE AND FINISHED GRADES. CONTRACTOR SHALL PROVIDE A 24 HOUR NOTICE TO THE PROJECT ENGINEER AND CITY OF LACEY INSPECTOR PRIOR TO THE REQUIRED INSPECTIONS. NO CONCRETE WORK SHALL BE COMPLETED WITHOUT INSPECTION APPROVAL FROM THE PROJECT ENGINEER AND CITY OF LACEY INSPECTOR. ANY CONCRETE WORK COMPLETED BY THE CONTRACTOR WITHOUT THE REQUIRED INSPECTIONS WILL BE AT THE RISK OF THE CONTRACTOR. THE CONTRACTOR IS URGED TO COORDINATE SITE INSPECTIONS FOR MAXIMUM EFFICIENCY, I.E. COMPLETE MULTIPLE SITE INSPECTIONS IN ONE DAY WITHIN CLOSE PROXIMITY OF EACH OTHER.

JURISDICTION NOTES

1. SEE DRAWING DET-01 FOR CITY OF LACEY STANDARD NOTES AND DETAILS.

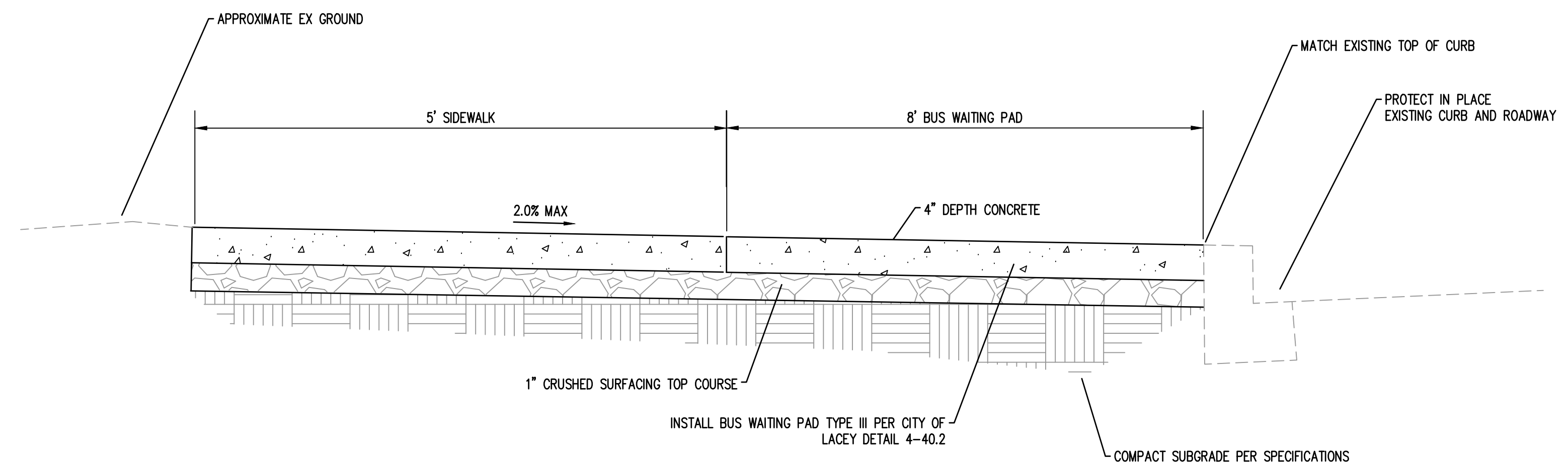

REVISIONS	DATE	BY

SCJ ALLIANCE
CONSULTING SERVICES
8730 TALLOW LANE, NE SUITE 200, LACEY, WA 98516
P: 360.352.1465 F: 360.352.1509
SCJALLIANCE.COM

BUS STOP 1050
INTERCITY TRANSIT BUS STOP CONSTRUCTION
IT PROJECT # 2003C
LACEY, WA

SEAL: 
07/09/2020

DESIGNER: W HOLM
DRAWN BY: M KNECHT
APPROVED BY: B SHEA
DATE: APRIL, 2020
JOB NO: 768.AA
DRAWING FILE NO: 768.44-STOP-1050
DRAWING NO: BP-02
SHEET NO: 3 of 17

Jul 10, 2020 7:24:27am - User: whitneyholm - W:\PROJECTS\0708 INTERCITY TRANSIT\0708.AA TD-1 BUS STOP PAD IMPROVEMENTS.RVT: 651\CAD\1768.44-STOP-1050.DWG



EXISTING CONDITIONS
N.T.S.

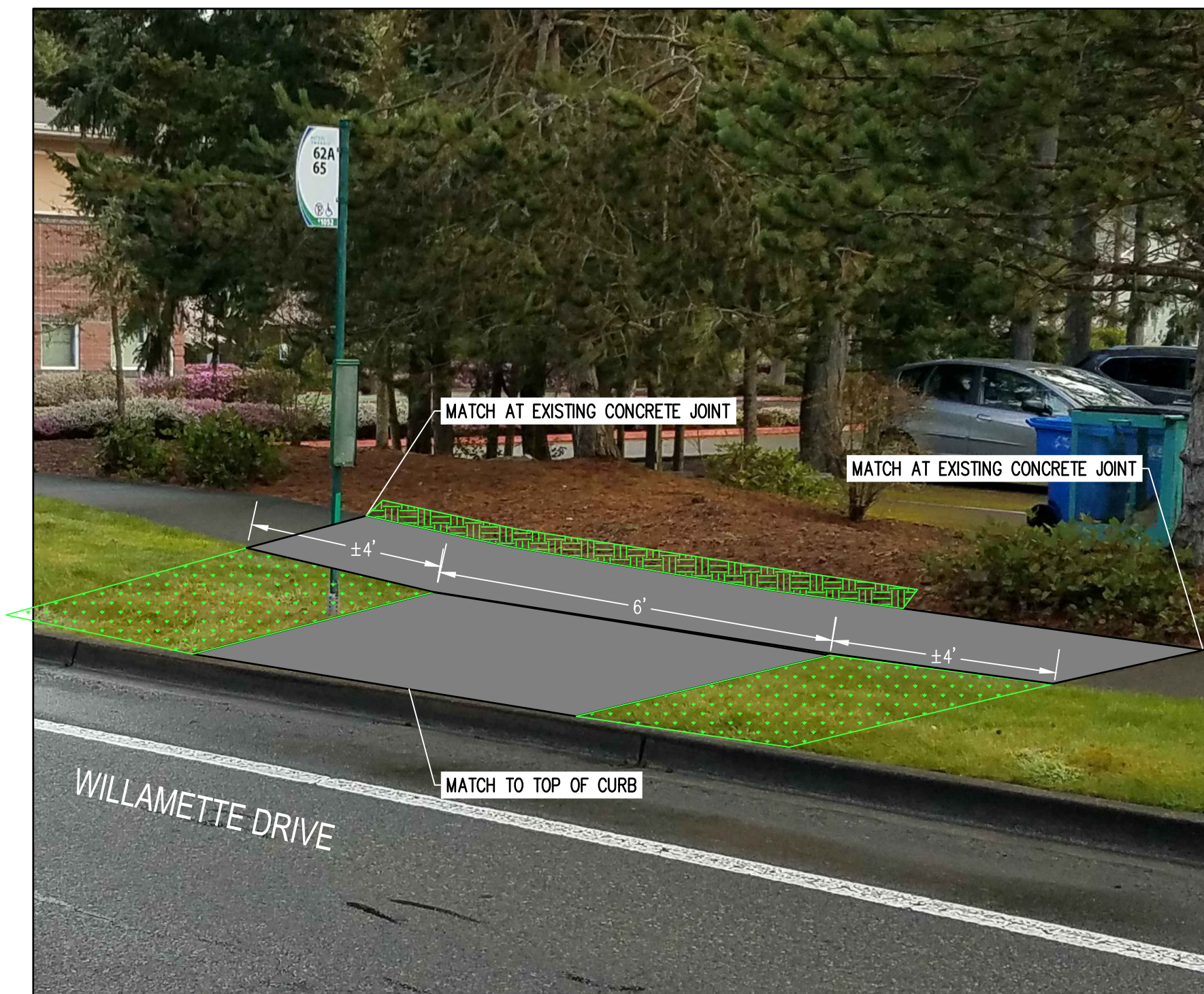

PROPOSED CONDITIONS
N.T.S.

LEGEND

- CEMENT CONCRETE (PLAN VIEW)
- REMOVE EXISTING SIDEWALK
- CEMENT CONCRETE (CROSS SECTION VIEW)
- CSBS (CRUSHED SURFACING BASE COURSE)
- SITE RESTORATION - SOD INSTALLATION
- SITE RESTORATION - BARK MULCH (SEE SPECIAL PROVISIONS)

GENERAL NOTES

1. LACEYS' STANDARD CONSTRUCTION NOTES AND DETAILS HAVE BEEN PROVIDED AND REFERENCED ON THE PLANS. ALL WORKMANSHIP AND MATERIALS SHALL BE IN ACCORDANCE WITH THE CITY OF LACEY STANDARDS AND THE MOST CURRENT COPY OF THE WSDOT STANDARD SPECIFICATIONS FOR ROAD, BRIDGE, AND MUNICIPAL CONSTRUCTION.
2. CONTRACTOR SHALL HAVE A COPY OF THE APPROVED CONSTRUCTION PLANS AND SPECIFICATIONS ON THE JOB SITE AT ALL TIMES DURING CONSTRUCTION.
3. THE CONTRACTOR SHALL BE IN COMPLIANCE WITH ALL SAFETY STANDARDS AND REQUIREMENTS AS SET FORTH BY OSHA, WSHA, AND THE WASHINGTON STATE DEPARTMENT OF LABOR AND INDUSTRIES.
4. PRIOR TO WORK ON ANY BUS STOP LOCATION, THE CONTRACTOR SHALL SUBMIT A CONSTRUCTION SCHEDULE TO THE PROJECT ENGINEER FOR REVIEW. THE CONSTRUCTION SCHEDULE SHALL NOTE CONSTRUCTION START AND END DATES FOR EACH BUS STOP. INTERCITY TRANSIT WILL UTILIZE THE SCHEDULE PROVIDED TO COORDINATE AND IMPLEMENT TEMPORARY BUS STOP LOCATIONS. CONTRACTOR TO NOTIFY ENGINEER IMMEDIATELY IF A TEMPORARY BUS STATION HAS NOT BEEN SET UP FOR A BUS STOP SCHEDULED FOR CONSTRUCTION.
5. PRIOR TO WORK ON A SPECIFIC BUS STOP, IT IS THE CONTRACTORS RESPONSIBILITY TO NOTIFY THE CITY OF LACEY THAT WORK WILL BE COMMENCING WITHIN THEIR RIGHT-OF-WAY AND SCHEDULE/ATTEND A PRE-CONSTRUCTION MEETING IF REQUIRED BY THE CITY OF LACEY. CONTRACTOR SHALL NOTIFY THE PROJECT ENGINEER OF ALL SCHEDULED PRE-CONSTRUCTION MEETINGS.
6. THE ENGINEER RESPONSIBLE FOR PREPARATION OF THESE PLANS AND SPECIFICATIONS WILL NOT BE RESPONSIBLE FOR, OR LIABLE FOR, UNAUTHORIZED CHANGES TO OR USES OF THESE PLANS. ALL CHANGES TO THE PLANS MUST BE IN WRITING AND MUST BE APPROVED BY THE ENGINEER RESPONSIBLE FOR PREPARATION OF THESE PLANS.
7. CONTRACTOR TO NOTE THAT CONSTRUCTION ACTIVITY WILL OCCUR IN AREAS WHERE EXISTING UNDERGROUND UTILITIES ARE LOCATED. THE CONTRACTOR SHALL BE FULLY RESPONSIBLE FOR THE LOCATION AND PROTECTION OF ALL EXISTING UTILITIES. THE CONTRACTOR SHALL VERIFY ALL UTILITY LOCATIONS PRIOR TO CONSTRUCTION BY CALLING THE UNDERGROUND LOCATE LINE AT 811 A MINIMUM OF 72 HOURS PRIOR TO THE START OF CONSTRUCTION.

GENERAL CONSTRUCTION NOTES

8. EROSION CONTROL MEASURES SHALL BE IMPLEMENTED AT ALL BUS STOP CONSTRUCTION LOCATION AS REQUIRED TO PREVENT SILT LADEN WATER FROM EXITING THE SITE OR ENTERING INTO STORM DRAINAGE FACILITIES. THE PLANS MAY NOTE SPECIFIC EROSION CONTROL MEASURES THAT MAY BE REQUIRED, HOWEVER IT IS THE CONTRACTORS RESPONSIBILITY TO IMPLEMENT ALL EROSION CONTROL MEASURES NECESSARY DURING CONSTRUCTION AND SITE STABILIZATION. SEE PLANS FOR EROSION CONTROL GENERAL NOTES AND DETAILS.
9. TRAFFIC CONTROL WILL BE REQUIRED AT EACH BUS STOP CONSTRUCTION LOCATION. CONTRACTOR TO MEET ALL TRAFFIC CONTROL REQUIREMENTS PER WSDOT, MUTCD, AND CITY OF LACEY STANDARDS. PRIOR TO DISRUPTION OF ANY TRAFFIC, THE CONTRACTOR SHALL PREPARE A SITE SPECIFIC TRAFFIC CONTROL PLAN FOR EACH BUS STOP LOCATION FOR REVIEW AND APPROVAL BY THE CITY OF LACEY. NO WORK SHALL COMMENCE UNTIL ALL APPROVED TRAFFIC CONTROL IS IN PLACE. WORK SHALL BE SUSPENDED IF TRAFFIC CONTROL FAILS TO MEET MINIMUM REQUIREMENTS. CONTRACTOR TO ENSURE THAT TRAFFIC CONTROL ADDRESSES PEDESTRIAN AND BICYCLE TRAFFIC THROUGH THE CONSTRUCTION SITE. TRAFFIC CONTROL MUST BE MAINTAINED 24 HOURS A DAY, 7 DAYS A WEEK WHILE IN USE. PRIOR TO WORK, CONTRACTOR SHALL PROVIDE THE NAME AND PHONE NUMBER OF THE 24 HOUR TRAFFIC CONTROL CONTACT PERSON TO THE PERMITTING AGENCY AND PROJECT ENGINEER.
10. EXISTING SURVEY MONUMENTS, INCLUDING BUT NOT RESTRICTED TO PROPERTY CORNERS AND CENTERLINE MONUMENT MAY BE DISTURBED OR DESTROYED BY CONSTRUCTION OPERATIONS. THE CONTRACTOR, AS PART OF THE BASE BID, SHALL RETAIN A LICENSED PROFESSIONAL LAND SURVEYOR FOR REPLACEMENT OF ANY DISTURBED OR DESTROYED MONUMENTS OR PROPERTY CORNERS IN ACCORDANCE WITH WASHINGTON STATE LAWS.
11. SITE RESTORATION HAS BEEN CALLED OUT ON THE PLANS FOR AREAS THAT WILL BE DISTURBED DURING CONSTRUCTION. CONTRACTOR SHALL INCLUDE IN THE BASE BID RESTORATION OF ALL DISTURBED AREAS AS A RESULT OF CONSTRUCTION. AREAS SHALL BE REPAIRED, REPLACED, AND STABILIZED TO MATCH THE PRE-PROJECT CONDITIONS OR AS NOTED ON THE PLANS. FOR SITE RESTORATION WITH GRASS, CONTRACTOR SHALL INSTALL 6 INCHES MINIMUM OF TOPSOIL. THEN SEED FERTILIZE AND MULCH PER WSDOT SPECIFICATIONS. THE CONTRACTOR IS RESPONSIBLE FOR PROVIDING AT THEIR EXPENSE, ANY TEMPORARY WATER NEEDED TO ESTABLISH SEED GERMINATION AND PROVIDE SUBSTANTIAL GROWTH AND STABILIZATION. IF SEED GERMINATION DOES NOT OCCUR, CONTRACTOR SHALL RESEED AT THEIR EXPENSE. CONTRACTOR SHALL ASSUME A MINIMUM OF 2 FEET BEYOND THE PROPOSED IMPROVEMENTS (ALL LOCATION) WILL REQUIRE SITE RESTORATION UNLESS SPECIFICALLY NOTED DIFFERENTLY ON THE PLANS. CONTRACTOR SHALL REPAIR CONDITIONS. IF UNDERGROUND IRRIGATION SYSTEMS ARE ENCOUNTERED CONTRACTOR SHALL PROTECT AND PRESERVE OR MODIFY THE EXISTING SYSTEM AS REQUIRED TO ACCOMMODATE BUS STOP CONSTRUCTION.
12. EXISTING VEGETATION SHALL BE PROTECTED AND PRESERVED TO THE EXTENT FEASIBLE. ALL EXISTING TREES SHALL BE PROTECTED UNLESS SHOWN ON THE PLANS TO BE REMOVED OR TRIMMED. NO TREE SHALL BE REMOVED WITHOUT WRITTEN AUTHORIZATION FROM THE PROJECT ENGINEER. AT HIS EXPENSE, CONTRACTOR SHALL CONSULT WITH A CERTIFIED ARBORIST PRIOR TO TRIMMING OF EXISTING TREES/ROOT REMOVAL TO ENSURE TRIMMING MAINTAINS THE LONG TERM VIABILITY OF THE TREE.

13. CONTRACTOR SHALL INCLUDE IN BASE BID ALL MATERIALS AND LABOR REQUIRED TO INSTALL AND REMOVE ANY TEMPORARY SHORING SYSTEMS REQUIRED TO CONSTRUCT THESE IMPROVEMENTS. CONTRACTOR SHALL NOTE THAT MANY OF THE BUS STOP LOCATIONS ARE IN CLOSE PROXIMITY TO EXISTING FEATURES AND PRIVATE PROPERTY. IT IS THE CONTRACTORS RESPONSIBILITY TO ENSURE THAT CONSTRUCTION ACTIVITIES DO NOT DAMAGE OR INFRINGE ON PRIVATE PROPERTY.

BUS STOP CONSTRUCTION

14. INTERCITY TRANSIT WILL BE FURNISHING AND INSTALLING THE POLE AND SIGN FOR ALL OF THESE STOPS. DURING CONSTRUCTION THE CONTRACTOR WILL NEED TO REMOVE AND DISPOSE OF THE BURIED CEMENT BUCKET.
15. CONTRACTOR SHALL PROVIDE A CONCRETE JOINT LAYOUT PLAN TO PROJECT ENGINEER FOR REVIEW ONE WEEK PRIOR TO A SCHEDULED CONCRETE POUR. THE CONCRETE JOINT LAYOUT PLAN SHALL PROVIDE DETAILS ON THE LOCATION OF CONTRACTION, CONSTRUCTION, AND ISOLATION JOINTS. THE PLAN MUST BE APPROVED BY THE ENGINEER PRIOR TO THE CONCRETE POUR.
16. ALL FILL PLACED DURING BUS STOP CONSTRUCTION SHALL BE STRUCTURAL FILL MEETING WSDOT STANDARD SPECIFICATION 9-03.14(3) COMMON BORROW AND SHALL BE COMPACTED TO WSDOT SPECIFICATIONS UNLESS OTHERWISE NOTED ON THE PLANS.
17. CONTRACTOR SHALL PROVIDE A TOWELED EDGE ALONG THE OUTSIDE PERIMETER OF ALL CONCRETE BUS STOP PADS, CURBS, AND WALLS; CONCRETE EDGING SHALL BE 4 INCHES WIDE WITH A 1/2 INCH RADIUS.
18. FOR BUS PAD CONSTRUCTION, CROSS SLOPE GRADES SHALL NOT EXCEED 1.7% LONGITUDINAL GRADES FOR TRANSITIONAL RAMPS SHALL NOT EXCEED 8% IF UPON FINAL INSPECTION OF THE COMPLETED WORK, AND PORTION OF THE WORK DOES NOT MEET THESE REQUIREMENTS, THE WORK SHALL BE REMOVED AND RECONSTRUCTED, AT THE EXPENSE OF THE CONTRACTOR. NO EXCEPTION WILL BE PROVIDED. ALL CONCRETE CONSTRUCTION SHALL HAVE A MINIMUM SLOPED 1% FOR WATER DRAINAGE, UNLESS OTHERWISE NOTED ON THE PLANS.
19. CONTRACTOR TO NOTE ALL BUS STOP PAD DIMENSIONS (LENGTH AND WIDTH) ARE THE ACTUAL SLAB DIMENSIONS. ALL ADDITIONAL CONSTRUCTION SUCH AS PEDESTRIAN CURBS OR WALLS SHALL ABUT THE SLAB AS NOTED IN THE CROSS SECTIONS. AS SUCH, A 6'x8' SLAB WILL RESULT IN 48 SQUARE FEET OF CONCRETE SURFACE. SEE PLANS FOR BUS PAD DIMENSIONS, AS THIS VARIES FOR SPECIFIC SITES.

CONSTRUCTION INSPECTION

20. ALL CONCRETE WORK FOR THIS PROJECT WILL BE INSPECTED BY THE PROJECT ENGINEER AND CITY OF LACEY INSPECTOR. REQUIRED INSPECTIONS INCLUDE CONSTRUCTION STAKING, SUBGRADE INSPECTION, CONCRETE FORMWORK, AND FINAL INSPECTION OF CONCRETE AND FINISHED GRADES. CONTRACTOR SHALL PROVIDE A 24 HOUR NOTICE TO THE PROJECT ENGINEER AND CITY OF LACEY INSPECTOR PRIOR TO THE REQUIRED INSPECTIONS. NO CONCRETE WORK SHALL BE COMPLETED WITHOUT INSPECTION APPROVAL FROM THE PROJECT ENGINEER AND CITY OF LACEY INSPECTOR. ANY CONCRETE WORK COMPLETED BY THE CONTRACTOR WITHOUT THE REQUIRED INSPECTIONS WILL BE AT THE RISK OF THE CONTRACTOR. THE CONTRACTOR IS URGED TO COORDINATE SITE INSPECTIONS FOR MAXIMUM EFFICIENCY, I.E. COMPLETE MULTIPLE SITE INSPECTIONS IN ONE DAY WITHIN CLOSE PROXIMITY OF EACH OTHER.

JURISDICTION NOTES

1. SEE DRAWING DET-01 FOR CITY OF LACEY STANDARD NOTES AND DETAILS.

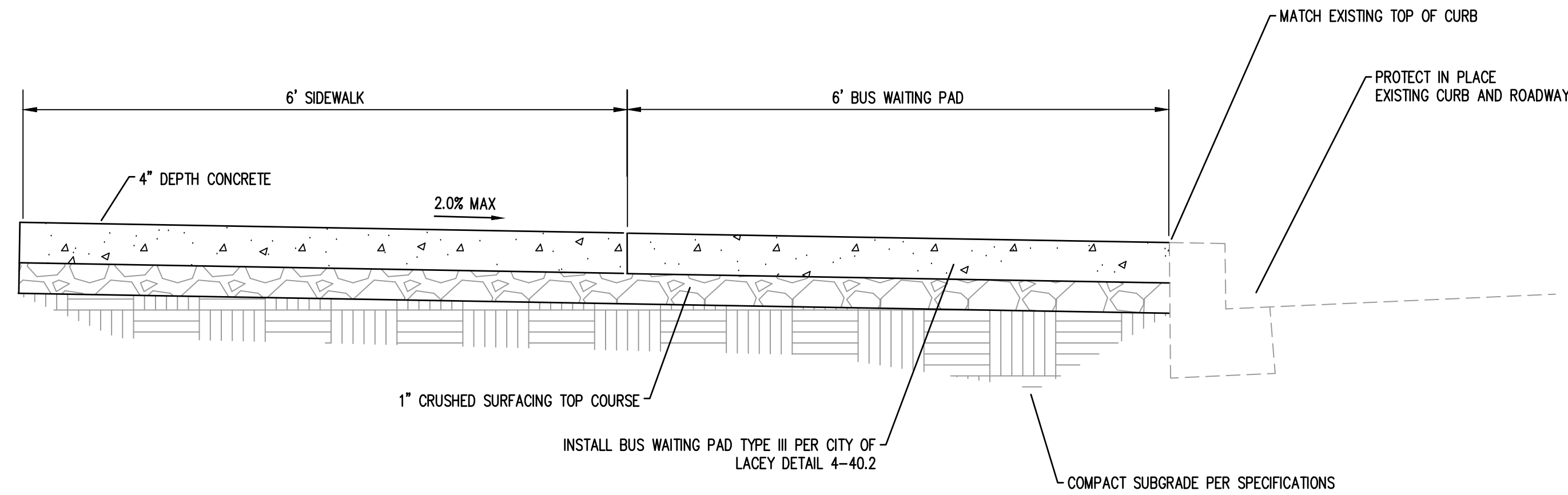

REVISIONS	DATE	BY

SCJ ALLIANCE
CONSULTING SERVICES
8730 TALLOW LANE, NE SUITE 200, LACEY, WA 98516
P: 360.352.1465 F: 360.352.1509
SCJALLIANCE.COM

BUS STOP 1052
PROJECT NAME:
INTERCITY TRANSIT BUS STOP CONSTRUCTION
IT PROJECT # 2003C
LACEY, WA

SEAL:

07/09/2020

DESIGNER:
W HOLM
DRAWN BY:
M KNECHT
APPROVED BY:
B SHEA
DATE:
APRIL, 2020
JOB NO:
768AA
DRAWING FILE NO:
768.44-STOP-1052
DRAWING NO:
BP-03
SHEET NO:
4 of 17

Jul 10, 2020 7:24:47am - User: whitneyholm
C:\PROJECTS\0708 INTERCITY TRANSIT\0708.44-STOP-1052.DWG



EXISTING CONDITIONS
N.T.S.

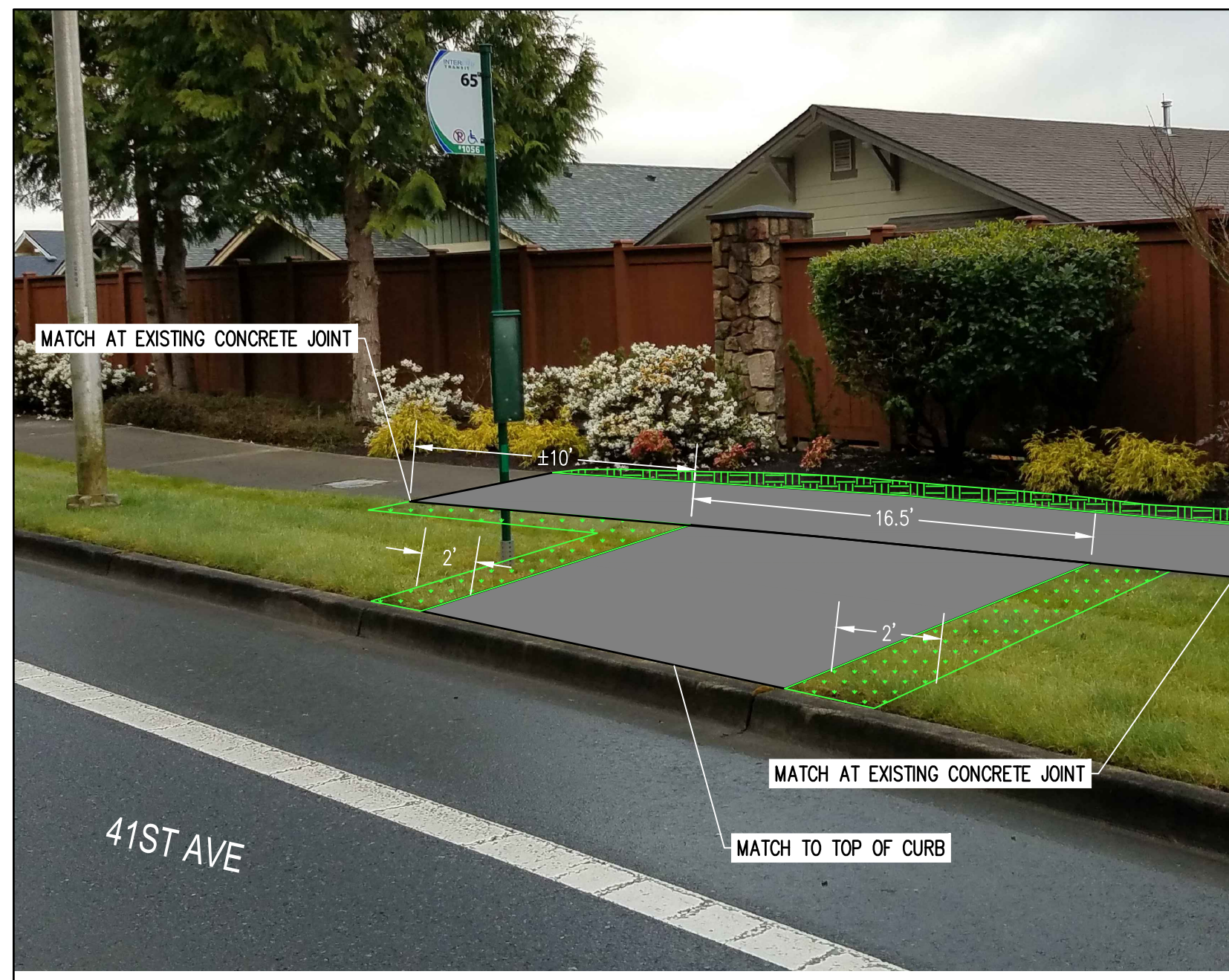

PROPOSED CONDITIONS
N.T.S.

LEGEND

- CEMENT CONCRETE (PLAN VIEW)
- REMOVE EXISTING SIDEWALK
- CEMENT CONCRETE (CROSS SECTION VIEW)
- CSBS (CRUSHED SURFACING BASE COURSE)
- SITE RESTORATION - SOD INSTALLATION
- SITE RESTORATION - BARK MULCH (SEE SPECIAL PROVISIONS)

GENERAL NOTES

1. LACEYS' STANDARD CONSTRUCTION NOTES AND DETAILS HAVE BEEN PROVIDED AND REFERENCED ON THE PLANS. ALL WORKMANSHIP AND MATERIALS SHALL BE IN ACCORDANCE WITH THE CITY OF LACEY STANDARDS AND THE MOST CURRENT COPY OF THE WSDOT STANDARD SPECIFICATIONS FOR ROAD, BRIDGE, AND MUNICIPAL CONSTRUCTION.
2. CONTRACTOR SHALL HAVE A COPY OF THE APPROVED CONSTRUCTION PLANS AND SPECIFICATIONS ON THE JOB SITE AT ALL TIMES DURING CONSTRUCTION.
3. THE CONTRACTOR SHALL BE IN COMPLIANCE WITH ALL SAFETY STANDARDS AND REQUIREMENTS AS SET FORTH BY OSHA, WSHA, AND THE WASHINGTON STATE DEPARTMENT OF LABOR AND INDUSTRIES.
4. PRIOR TO WORK ON ANY BUS STOP LOCATION, THE CONTRACTOR SHALL SUBMIT A CONSTRUCTION SCHEDULE TO THE PROJECT ENGINEER FOR REVIEW. THE CONSTRUCTION SCHEDULE SHALL NOTE CONSTRUCTION START AND END DATES FOR EACH BUS STOP. INTERCITY TRANSIT WILL UTILIZE THE SCHEDULE PROVIDED TO COORDINATE AND IMPLEMENT TEMPORARY BUS STOP LOCATIONS. CONTRACTOR TO NOTIFY ENGINEER IMMEDIATELY IF A TEMPORARY BUS STATION HAS NOT BEEN SET UP FOR A BUS STOP SCHEDULED FOR CONSTRUCTION.
5. PRIOR TO WORK ON A SPECIFIC BUS STOP, IT IS THE CONTRACTORS RESPONSIBILITY TO NOTIFY THE CITY OF LACEY THAT WORK WILL BE COMMENCING WITHIN THEIR RIGHT-OF-WAY AND SCHEDULE/ATTEND A PRE-CONSTRUCTION MEETING IF REQUIRED BY THE CITY OF LACEY. CONTRACTOR SHALL NOTIFY THE PROJECT ENGINEER OF ALL SCHEDULED PRE-CONSTRUCTION MEETINGS.
6. THE ENGINEER RESPONSIBLE FOR PREPARATION OF THESE PLANS AND SPECIFICATIONS WILL NOT BE RESPONSIBLE FOR, OR LIABLE FOR, UNAUTHORIZED CHANGES TO OR USES OF THESE PLANS. ALL CHANGES TO THE PLANS MUST BE IN WRITING AND MUST BE APPROVED BY THE ENGINEER RESPONSIBLE FOR PREPARATION OF THESE PLANS.
7. CONTRACTOR TO NOTE THAT CONSTRUCTION ACTIVITY WILL OCCUR IN AREAS WHERE EXISTING UNDERGROUND UTILITIES ARE LOCATED. THE CONTRACTOR SHALL BE FULLY RESPONSIBLE FOR THE LOCATION AND PROTECTION OF ALL EXISTING UTILITIES. THE CONTRACTOR SHALL VERIFY ALL UTILITY LOCATIONS PRIOR TO CONSTRUCTION BY CALLING THE UNDERGROUND LOCATE LINE AT 811 A MINIMUM OF 72 HOURS PRIOR TO THE START OF CONSTRUCTION.

GENERAL CONSTRUCTION NOTES

8. EROSION CONTROL MEASURES SHALL BE IMPLEMENTED AT ALL BUS STOP CONSTRUCTION LOCATION AS REQUIRED TO PREVENT SILT LADEN WATER FROM EXITING THE SITE OR ENTERING INTO STORM DRAINAGE FACILITIES. THE PLANS MAY NOTE SPECIFIC EROSION CONTROL MEASURES THAT MAY BE REQUIRED, HOWEVER IT IS THE CONTRACTORS RESPONSIBILITY TO IMPLEMENT ALL EROSION CONTROL MEASURES NECESSARY DURING CONSTRUCTION AND SITE STABILIZATION. SEE PLANS FOR EROSION CONTROL GENERAL NOTES AND DETAILS.
9. TRAFFIC CONTROL WILL BE REQUIRED AT EACH BUS STOP CONSTRUCTION LOCATION. CONTRACTOR TO MEET ALL TRAFFIC CONTROL REQUIREMENTS PER WSDOT, MUTCD, AND CITY OF LACEY STANDARDS. PRIOR TO DISRUPTION OF ANY TRAFFIC, THE CONTRACTOR SHALL PREPARE A SITE SPECIFIC TRAFFIC CONTROL PLAN FOR EACH BUS STOP LOCATION FOR REVIEW AND APPROVAL BY THE CITY OF LACEY. NO WORK SHALL COMMENCE UNTIL ALL APPROVED TRAFFIC CONTROL IS IN PLACE. WORK SHALL BE SUSPENDED IF TRAFFIC CONTROL FAILS TO MEET MINIMUM REQUIREMENTS. CONTRACTOR TO ENSURE THAT TRAFFIC CONTROL ADDRESSES PEDESTRIAN AND BICYCLE TRAFFIC THROUGH THE CONSTRUCTION SITE. TRAFFIC CONTROL MUST BE MAINTAINED 24 HOURS A DAY, 7 DAYS A WEEK WHILE IN USE. PRIOR TO WORK, CONTRACTOR SHALL PROVIDE THE NAME AND PHONE NUMBER OF THE 24 HOUR TRAFFIC CONTROL CONTACT PERSON TO THE PERMITTING AGENCY AND PROJECT ENGINEER.
10. EXISTING SURVEY MONUMENTS, INCLUDING BUT NOT RESTRICTED TO PROPERTY CORNERS AND CENTERLINE MONUMENT MAY BE DISTURBED OR DESTROYED BY CONSTRUCTION OPERATIONS. THE CONTRACTOR, AS PART OF THE BASE BID, SHALL RETAIN A LICENSED PROFESSIONAL LAND SURVEYOR FOR REPLACEMENT OF ANY DISTURBED OR DESTROYED MONUMENTS OR PROPERTY CORNERS IN ACCORDANCE WITH WASHINGTON STATE LAWS.
11. SITE RESTORATION HAS BEEN CALLED OUT ON THE PLANS FOR AREAS THAT WILL BE DISTURBED DURING CONSTRUCTION. CONTRACTOR SHALL INCLUDE IN THE BASE BID RESTORATION OF ALL DISTURBED AREAS AS A RESULT OF CONSTRUCTION. AREAS SHALL BE REPAIRED, REPLACED, AND STABILIZED TO MATCH THE PRE-PROJECT CONDITIONS OR AS NOTED ON THE PLANS. FOR SITE RESTORATION WITH GRASS, CONTRACTOR SHALL INSTALL 6 INCHES MINIMUM OF TOPSOIL. THEN SEED FERTILIZE AND MULCH PER WSDOT SPECIFICATIONS. THE CONTRACTOR IS RESPONSIBLE FOR PROVIDING AT THEIR EXPENSE, ANY TEMPORARY WATER NEEDED TO ESTABLISH SEED GERMINATION AND PROVIDE SUBSTANTIAL GROWTH AND STABILIZATION. IF SEED GERMINATION DOES NOT OCCUR, CONTRACTOR SHALL RESEED AT THEIR EXPENSE. CONTRACTOR SHALL ASSUME A MINIMUM OF 2 FEET BEYOND THE PROPOSED IMPROVEMENTS (ALL LOCATION) WILL REQUIRE SITE RESTORATION UNLESS SPECIFICALLY NOTED DIFFERENTLY ON THE PLANS. CONTRACTOR SHALL REPAIR CONDITIONS. IF UNDERGROUND IRRIGATION SYSTEMS ARE ENCOUNTERED CONTRACTOR SHALL PROTECT AND PRESERVE OR MODIFY THE EXISTING SYSTEM AS REQUIRED TO ACCOMMODATE BUS STOP CONSTRUCTION.
12. EXISTING VEGETATION SHALL BE PROTECTED AND PRESERVED TO THE EXTENT FEASIBLE. ALL EXISTING TREES SHALL BE PROTECTED UNLESS SHOWN ON THE PLANS TO BE REMOVED OR TRIMMED. NO TREE SHALL BE REMOVED WITHOUT WRITTEN AUTHORIZATION FROM THE PROJECT ENGINEER. AT HIS EXPENSE, CONTRACTOR SHALL CONSULT WITH A CERTIFIED ARBORIST PRIOR TO TRIMMING OF EXISTING TREES/ROOT REMOVAL TO ENSURE TRIMMING MAINTAINS THE LONG TERM VIABILITY OF THE TREE.

13. CONTRACTOR SHALL INCLUDE IN BASE BID ALL MATERIALS AND LABOR REQUIRED TO INSTALL AND REMOVE ANY TEMPORARY SHORING SYSTEMS REQUIRED TO CONSTRUCT THESE IMPROVEMENTS. CONTRACTOR SHALL NOTE THAT MANY OF THE BUS STOP LOCATIONS ARE IN CLOSE PROXIMITY TO EXISTING FEATURES AND PRIVATE PROPERTY. IT IS THE CONTRACTORS RESPONSIBILITY TO ENSURE THAT CONSTRUCTION ACTIVITIES DO NOT DAMAGE OR INFRINGE ON PRIVATE PROPERTY.

BUS STOP CONSTRUCTION

14. INTERCITY TRANSIT WILL BE FURNISHING AND INSTALLING THE POLE AND SIGN FOR ALL OF THESE STOPS. DURING CONSTRUCTION THE CONTRACTOR WILL NEED TO REMOVE AND DISPOSE OF THE BURIED CEMENT BUCKET.
15. CONTRACTOR SHALL PROVIDE A CONCRETE JOINT LAYOUT PLAN TO PROJECT ENGINEER FOR REVIEW ONE WEEK PRIOR TO A SCHEDULED CONCRETE POUR. THE CONCRETE JOINT LAYOUT PLAN SHALL PROVIDE DETAILS ON THE LOCATION OF CONTRACTION, CONSTRUCTION, AND ISOLATION JOINTS. THE PLAN MUST BE APPROVED BY THE ENGINEER PRIOR TO THE CONCRETE POUR.
16. ALL FILL PLACED DURING BUS STOP CONSTRUCTION SHALL BE STRUCTURAL FILL MEETING WSDOT STANDARD SPECIFICATION 9-03.14(3) COMMON BORROW AND SHALL BE COMPACTED TO WSDOT SPECIFICATIONS UNLESS OTHERWISE NOTED ON THE PLANS.
17. CONTRACTOR SHALL PROVIDE A TOWELED EDGE ALONG THE OUTSIDE PERIMETER OF ALL CONCRETE BUS STOP PADS, CURBS, AND WALLS; CONCRETE EDGING SHALL BE 4 INCHES WIDE WITH A 1/2 INCH RADIUS.
18. FOR BUS PAD CONSTRUCTION, CROSS SLOPE GRADES SHALL NOT EXCEED 1.7%. LONGITUDINAL GRADES FOR TRANSITIONAL RAMPS SHALL NOT EXCEED 8%. IF UPON FINAL INSPECTION OF THE COMPLETED WORK, AND PORTION OF THE WORK DOES NOT MEET THESE REQUIREMENTS, THE WORK SHALL BE REMOVED AND RECONSTRUCTED, AT THE EXPENSE OF THE CONTRACTOR. NO EXCEPTION WILL BE PROVIDED. ALL CONCRETE CONSTRUCTION SHALL HAVE A MINIMUM SLOPED 1% FOR WATER DRAINAGE, UNLESS OTHERWISE NOTED ON THE PLANS.
19. CONTRACTOR TO NOTE ALL BUS STOP PAD DIMENSIONS (LENGTH AND WIDTH) ARE THE ACTUAL SLAB DIMENSIONS. ALL ADDITIONAL CONSTRUCTION SUCH AS PEDESTRIAN CURBS OR WALLS SHALL ABUT THE SLAB AS NOTED IN THE CROSS SECTIONS. AS SUCH, A 6'x8' SLAB WILL RESULT IN 48 SQUARE FEET OF CONCRETE SURFACE. SEE PLANS FOR BUS PAD DIMENSIONS, AS THIS VARIES FOR SPECIFIC SITES.

CONSTRUCTION INSPECTION

20. ALL CONCRETE WORK FOR THIS PROJECT WILL BE INSPECTED BY THE PROJECT ENGINEER AND CITY OF LACEY INSPECTOR. REQUIRED INSPECTIONS INCLUDE CONSTRUCTION STAKING, SUBGRADE INSPECTION, CONCRETE FORMWORK, AND FINAL INSPECTION OF CONCRETE AND FINISHED GRADES. CONTRACTOR SHALL PROVIDE A 24 HOUR NOTICE TO THE PROJECT ENGINEER AND CITY OF LACEY INSPECTOR PRIOR TO THE REQUIRED INSPECTIONS. NO CONCRETE WORK SHALL BE COMPLETED WITHOUT INSPECTION APPROVAL FROM THE PROJECT ENGINEER AND CITY OF LACEY INSPECTOR. ANY CONCRETE WORK COMPLETED BY THE CONTRACTOR WITHOUT THE REQUIRED INSPECTIONS WILL BE AT THE RISK OF THE CONTRACTOR. THE CONTRACTOR IS URGED TO COORDINATE SITE INSPECTIONS FOR MAXIMUM EFFICIENCY, I.E. COMPLETE MULTIPLE SITE INSPECTIONS IN ONE DAY WITHIN CLOSE PROXIMITY OF EACH OTHER.

JURISDICTION NOTES

1. SEE DRAWING DET-01 FOR CITY OF LACEY STANDARD NOTES AND DETAILS.

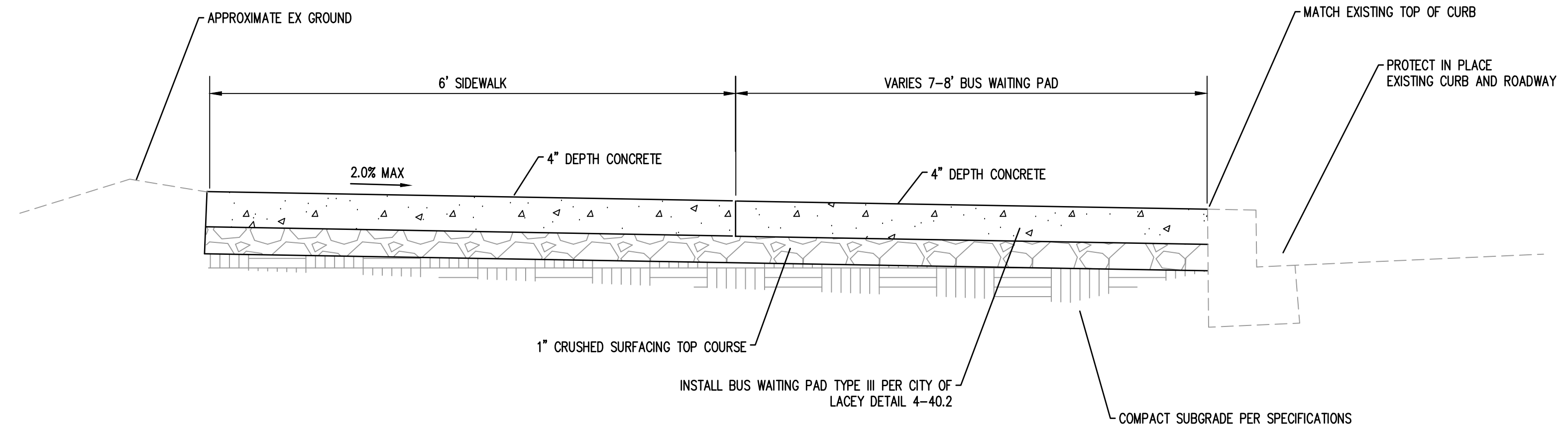

BY									
DATE									
REVISIONS									
<p>SCJ ALLIANCE CONSULTING SERVICES 8730 TALLOW LANE, NE SUITE 200, LACEY, WA 98516 P: 360.352.1465 F: 360.352.1509 SCJALLIANCE.COM</p>									
<p>BUS STOP 1056</p> <p>INTERCITY TRANSIT BUS STOP CONSTRUCTION</p> <p>IT PROJECT # 2003C LACEY, WA</p>									
<p>07/09/2020</p>									
DESIGNER: W HOLM									
DRAWN BY: M KNECHT									
APPROVED BY: B SHEA									
DATE: APRIL, 2020									
JOB NO: 768-AA									
DRAWING FILE NO: 768.44-STOP-1056									
DRAWING NO: BP-04									
SHEET NO: 5 of 17									

Jul 10, 2020 7:25:05am - User: whitneyg.holm
 C:\PROJECTS\0708 INTERCITY TRANSIT\0708AA TD-1 BUS STOP PAD IMPROVEMENTS.RVT: 651\CAD\1768.44-STOP-1056.DWG



EXISTING CONDITIONS
N.T.S.

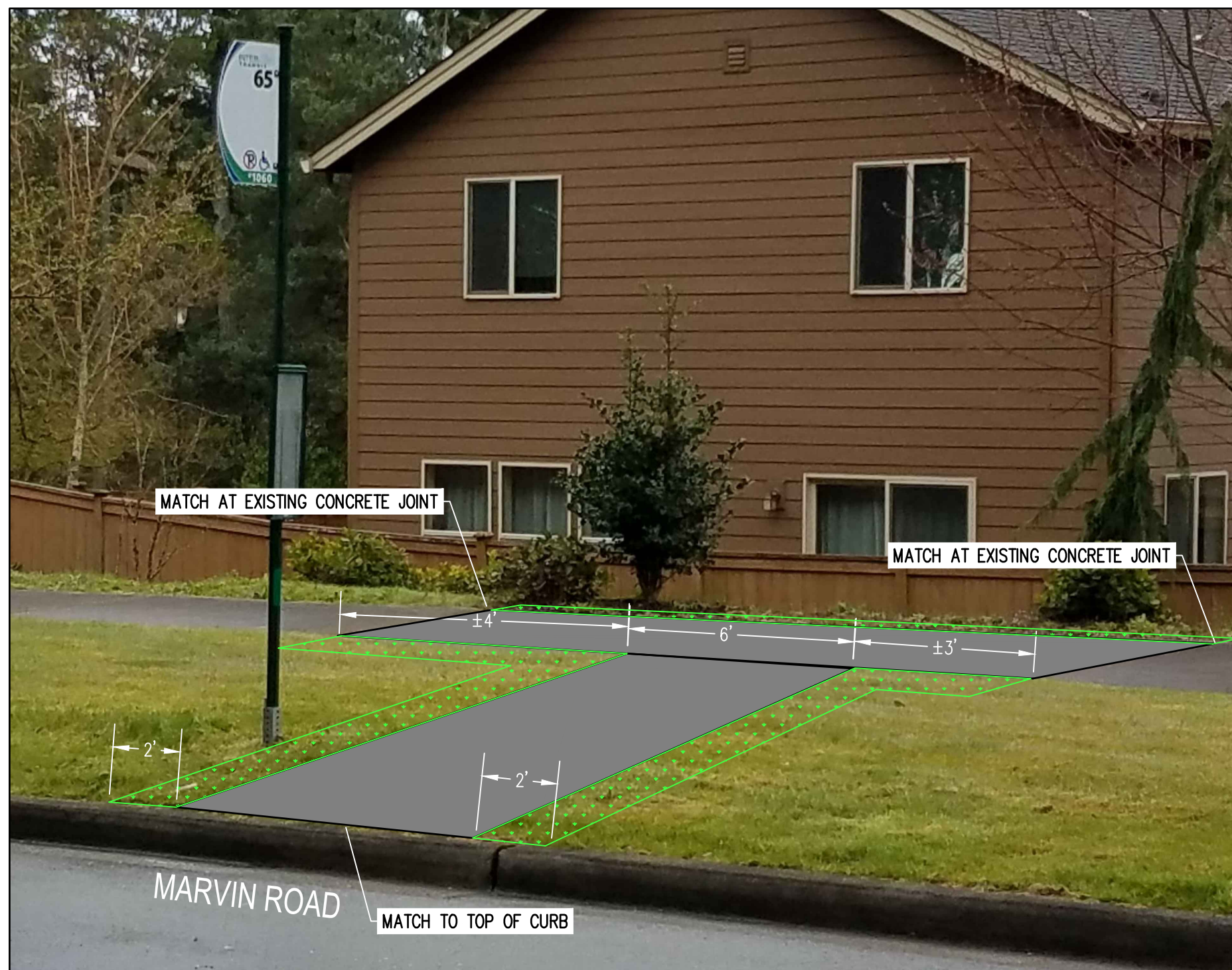

PROPOSED CONDITIONS
N.T.S.

LEGEND

- CEMENT CONCRETE (PLAN VIEW)
- REMOVE EXISTING SIDEWALK
- CEMENT CONCRETE (CROSS SECTION VIEW)
- CSBS (CRUSHED SURFACING BASE COURSE)
- SITE RESTORATION - SOD INSTALLATION

GENERAL NOTES

1. LACEYS' STANDARD CONSTRUCTION NOTES AND DETAILS HAVE BEEN PROVIDED AND REFERENCED ON THE PLANS. ALL WORKMANSHIP AND MATERIALS SHALL BE IN ACCORDANCE WITH THE CITY OF LACEY STANDARDS AND THE MOST CURRENT COPY OF THE WSDOT STANDARD SPECIFICATIONS FOR ROAD, BRIDGE, AND MUNICIPAL CONSTRUCTION.
2. CONTRACTOR SHALL HAVE A COPY OF THE APPROVED CONSTRUCTION PLANS AND SPECIFICATIONS ON THE JOB SITE AT ALL TIMES DURING CONSTRUCTION.
3. THE CONTRACTOR SHALL BE IN COMPLIANCE WITH ALL SAFETY STANDARDS AND REQUIREMENTS AS SET FORTH BY OSHA, WSHA, AND THE WASHINGTON STATE DEPARTMENT OF LABOR AND INDUSTRIES.
4. PRIOR TO WORK ON ANY BUS STOP LOCATION, THE CONTRACTOR SHALL SUBMIT A CONSTRUCTION SCHEDULE TO THE PROJECT ENGINEER FOR REVIEW. THE CONSTRUCTION SCHEDULE SHALL NOTE CONSTRUCTION START AND END DATES FOR EACH BUS STOP. INTERCITY TRANSIT WILL UTILIZE THE SCHEDULE PROVIDED TO COORDINATE AND IMPLEMENT TEMPORARY BUS STOP LOCATIONS. CONTRACTOR TO NOTIFY ENGINEER IMMEDIATELY IF A TEMPORARY BUS STATION HAS NOT BEEN SET UP FOR A BUS STOP SCHEDULED FOR CONSTRUCTION.
5. PRIOR TO WORK ON A SPECIFIC BUS STOP, IT IS THE CONTRACTORS RESPONSIBILITY TO NOTIFY THE CITY OF LACEY THAT WORK WILL BE COMMENCING WITHIN THEIR RIGHT-OF-WAY AND SCHEDULE/ATTEND A PRE-CONSTRUCTION MEETING IF REQUIRED BY THE CITY OF LACEY. CONTRACTOR SHALL NOTIFY THE PROJECT ENGINEER OF ALL SCHEDULED PRE-CONSTRUCTION MEETINGS.
6. THE ENGINEER RESPONSIBLE FOR PREPARATION OF THESE PLANS AND SPECIFICATIONS WILL NOT BE RESPONSIBLE FOR, OR LIABLE FOR, UNAUTHORIZED CHANGES TO OR USES OF THESE PLANS. ALL CHANGES TO THE PLANS MUST BE IN WRITING AND MUST BE APPROVED BY THE ENGINEER RESPONSIBLE FOR PREPARATION OF THESE PLANS.
7. CONTRACTOR TO NOTE THAT CONSTRUCTION ACTIVITY WILL OCCUR IN AREAS WHERE EXISTING UNDERGROUND UTILITIES ARE LOCATED. THE CONTRACTOR SHALL BE FULLY RESPONSIBLE FOR THE LOCATION AND PROTECTION OF ALL EXISTING UTILITIES. THE CONTRACTOR SHALL VERIFY ALL UTILITY LOCATIONS PRIOR TO CONSTRUCTION BY CALLING THE UNDERGROUND LOCATE LINE AT 811 A MINIMUM OF 72 HOURS PRIOR TO THE START OF CONSTRUCTION.

GENERAL CONSTRUCTION NOTES

8. EROSION CONTROL MEASURES SHALL BE IMPLEMENTED AT ALL BUS STOP CONSTRUCTION LOCATION AS REQUIRED TO PREVENT SILT LADEN WATER FROM EXITING THE SITE OR ENTERING INTO STORM DRAINAGE FACILITIES. THE PLANS MAY NOTE SPECIFIC EROSION CONTROL MEASURES THAT MAY BE REQUIRED, HOWEVER IT IS THE CONTRACTORS RESPONSIBILITY TO IMPLEMENT ALL EROSION CONTROL MEASURES NECESSARY DURING CONSTRUCTION AND SITE STABILIZATION. SEE PLANS FOR EROSION CONTROL GENERAL NOTES AND DETAILS.
9. TRAFFIC CONTROL WILL BE REQUIRED AT EACH BUS STOP CONSTRUCTION LOCATION. CONTRACTOR TO MEET ALL TRAFFIC CONTROL REQUIREMENTS PER WSDOT, MUTCD, AND CITY OF LACEY STANDARDS. PRIOR TO DISRUPTION OF ANY TRAFFIC, THE CONTRACTOR SHALL PREPARE A SITE SPECIFIC TRAFFIC CONTROL PLAN FOR EACH BUS STOP LOCATION FOR REVIEW AND APPROVAL BY THE CITY OF LACEY. NO WORK SHALL COMMENCE UNTIL ALL APPROVED TRAFFIC CONTROL IS IN PLACE. WORK SHALL BE SUSPENDED IF TRAFFIC CONTROL FAILS TO MEET MINIMUM REQUIREMENTS. CONTRACTOR TO ENSURE THAT TRAFFIC CONTROL ADDRESSES PEDESTRIAN AND BICYCLE TRAFFIC THROUGH THE CONSTRUCTION SITE. TRAFFIC CONTROL MUST BE MAINTAINED 24 HOURS A DAY, 7 DAYS A WEEK WHILE IN USE. PRIOR TO WORK, CONTRACTOR SHALL PROVIDE THE NAME AND PHONE NUMBER OF THE 24 HOUR TRAFFIC CONTROL CONTACT PERSON TO THE PERMITTING AGENCY AND PROJECT ENGINEER.
10. EXISTING SURVEY MONUMENTS, INCLUDING BUT NOT RESTRICTED TO PROPERTY CORNERS AND CENTERLINE MONUMENT MAY BE DISTURBED OR DESTROYED BY CONSTRUCTION OPERATIONS. THE CONTRACTOR, AS PART OF THE BASE BID, SHALL RETAIN A LICENSED PROFESSIONAL LAND SURVEYOR FOR REPLACEMENT OF ANY DISTURBED OR DESTROYED MONUMENTS OR PROPERTY CORNERS IN ACCORDANCE WITH WASHINGTON STATE LAWS.
11. SITE RESTORATION HAS BEEN CALLED OUT ON THE PLANS FOR AREAS THAT WILL BE DISTURBED DURING CONSTRUCTION. CONTRACTOR SHALL INCLUDE IN THE BASE BID RESTORATION OF ALL DISTURBED AREAS AS A RESULT OF CONSTRUCTION. AREAS SHALL BE REPAIRED, REPLACED, AND STABILIZED TO MATCH THE PRE-PROJECT CONDITIONS OR AS NOTED ON THE PLANS. FOR SITE RESTORATION WITH GRASS, CONTRACTOR SHALL INSTALL 6 INCHES MINIMUM OF TOPSOIL. THEN SEED FERTILIZE AND MULCH PER WSDOT SPECIFICATIONS. THE CONTRACTOR IS RESPONSIBLE FOR PROVIDING AT THEIR EXPENSE, ANY TEMPORARY WATER NEEDED TO ESTABLISH SEED GERMINATION AND PROVIDE SUBSTANTIAL GROWTH AND STABILIZATION. IF SEED GERMINATION DOES NOT OCCUR, CONTRACTOR SHALL RESEED AT THEIR EXPENSE. CONTRACTOR SHALL ASSUME A MINIMUM OF 2 FEET BEYOND THE PROPOSED IMPROVEMENTS (ALL LOCATION) WILL REQUIRE SITE RESTORATION UNLESS SPECIFICALLY NOTED DIFFERENTLY ON THE PLANS. CONTRACTOR SHALL REPAIR CONDITIONS. IF UNDERGROUND IRRIGATION SYSTEMS ARE ENCOUNTERED CONTRACTOR SHALL PROTECT AND PRESERVE OR MODIFY THE EXISTING SYSTEM AS REQUIRED TO ACCOMMODATE BUS STOP CONSTRUCTION.
12. EXISTING VEGETATION SHALL BE PROTECTED AND PRESERVED TO THE EXTENT FEASIBLE. ALL EXISTING TREES SHALL BE PROTECTED UNLESS SHOWN ON THE PLANS TO BE REMOVED OR TRIMMED. NO TREE SHALL BE REMOVED WITHOUT WRITTEN AUTHORIZATION FROM THE PROJECT ENGINEER. AT HIS EXPENSE, CONTRACTOR SHALL CONSULT WITH A CERTIFIED ARBORIST PRIOR TO TRIMMING OF EXISTING TREES/ROOT REMOVAL TO ENSURE TRIMMING MAINTAINS THE LONG TERM VIABILITY OF THE TREE.

13. CONTRACTOR SHALL INCLUDE IN BASE BID ALL MATERIALS AND LABOR REQUIRED TO INSTALL AND REMOVE ANY TEMPORARY SHORING SYSTEMS REQUIRED TO CONSTRUCT THESE IMPROVEMENTS. CONTRACTOR SHALL NOTE THAT MANY OF THE BUS STOP LOCATIONS ARE IN CLOSE PROXIMITY TO EXISTING FEATURES AND PRIVATE PROPERTY. IT IS THE CONTRACTORS RESPONSIBILITY TO ENSURE THAT CONSTRUCTION ACTIVITIES DO NOT DAMAGE OR INFRINGE ON PRIVATE PROPERTY.

BUS STOP CONSTRUCTION

14. INTERCITY TRANSIT WILL BE FURNISHING AND INSTALLING THE POLE AND SIGN FOR ALL OF THESE STOPS. DURING CONSTRUCTION THE CONTRACTOR WILL NEED TO REMOVE AND DISPOSE OF THE BURIED CEMENT BUCKET.
15. CONTRACTOR SHALL PROVIDE A CONCRETE JOINT LAYOUT PLAN TO PROJECT ENGINEER FOR REVIEW ONE WEEK PRIOR TO A SCHEDULED CONCRETE POUR. THE CONCRETE JOINT LAYOUT PLAN SHALL PROVIDE DETAILS ON THE LOCATION OF CONTRACTION, CONSTRUCTION, AND ISOLATION JOINTS. THE PLAN MUST BE APPROVED BY THE ENGINEER PRIOR TO THE CONCRETE POUR.
16. ALL FILL PLACED DURING BUS STOP CONSTRUCTION SHALL BE STRUCTURAL FILL MEETING WSDOT STANDARD SPECIFICATION 9-03.14(3) COMMON BORROW AND SHALL BE COMPACTED TO WSDOT SPECIFICATIONS UNLESS OTHERWISE NOTED ON THE PLANS.
17. CONTRACTOR SHALL PROVIDE A TOWELED EDGE ALONG THE OUTSIDE PERIMETER OF ALL CONCRETE BUS STOP PADS, CURBS, AND WALLS; CONCRETE EDGING SHALL BE 4 INCHES WIDE WITH A 1/2 INCH RADIUS.
18. FOR BUS PAD CONSTRUCTION, CROSS SLOPE GRADES SHALL NOT EXCEED 1.7%. LONGITUDINAL GRADES FOR TRANSITIONAL RAMPS SHALL NOT EXCEED 8% IF UPON FINAL INSPECTION OF THE COMPLETED WORK, AND PORTION OF THE WORK DOES NOT MEET THESE REQUIREMENTS, THE WORK SHALL BE REMOVED AND RECONSTRUCTED, AT THE EXPENSE OF THE CONTRACTOR. NO EXCEPTION WILL BE PROVIDED. ALL CONCRETE CONSTRUCTION SHALL HAVE A MINIMUM SLOPED 1% FOR WATER DRAINAGE, UNLESS OTHERWISE NOTED ON THE PLANS.
19. CONTRACTOR TO NOTE ALL BUS STOP PAD DIMENSIONS (LENGTH AND WIDTH) ARE THE ACTUAL SLAB DIMENSIONS. ALL ADDITIONAL CONSTRUCTION SUCH AS PEDESTRIAN CURBS OR WALLS SHALL ABUT THE SLAB AS NOTED IN THE CROSS SECTIONS. AS SUCH, A 6'x8' SLAB WILL RESULT IN 48 SQUARE FEET OF CONCRETE SURFACE. SEE PLANS FOR BUS PAD DIMENSIONS, AS THIS VARIES FOR SPECIFIC SITES.

CONSTRUCTION INSPECTION

20. ALL CONCRETE WORK FOR THIS PROJECT WILL BE INSPECTED BY THE PROJECT ENGINEER AND CITY OF LACEY INSPECTOR. REQUIRED INSPECTIONS INCLUDE CONSTRUCTION STAKING, SUBGRADE INSPECTION, CONCRETE FORMWORK, AND FINAL INSPECTION OF CONCRETE AND FINISHED GRADES. CONTRACTOR SHALL PROVIDE A 24 HOUR NOTICE TO THE PROJECT ENGINEER AND CITY OF LACEY INSPECTOR PRIOR TO THE REQUIRED INSPECTIONS. NO CONCRETE WORK SHALL BE COMPLETED WITHOUT INSPECTION APPROVAL FROM THE PROJECT ENGINEER AND CITY OF LACEY INSPECTOR. ANY CONCRETE WORK COMPLETED BY THE CONTRACTOR WITHOUT THE REQUIRED INSPECTIONS WILL BE AT THE RISK OF THE CONTRACTOR. THE CONTRACTOR IS URGED TO COORDINATE SITE INSPECTIONS FOR MAXIMUM EFFICIENCY, I.E. COMPLETE MULTIPLE SITE INSPECTIONS IN ONE DAY WITHIN CLOSE PROXIMITY OF EACH OTHER.

JURISDICTION NOTES

1. SEE DRAWING DET-01 FOR CITY OF LACEY STANDARD NOTES AND DETAILS.

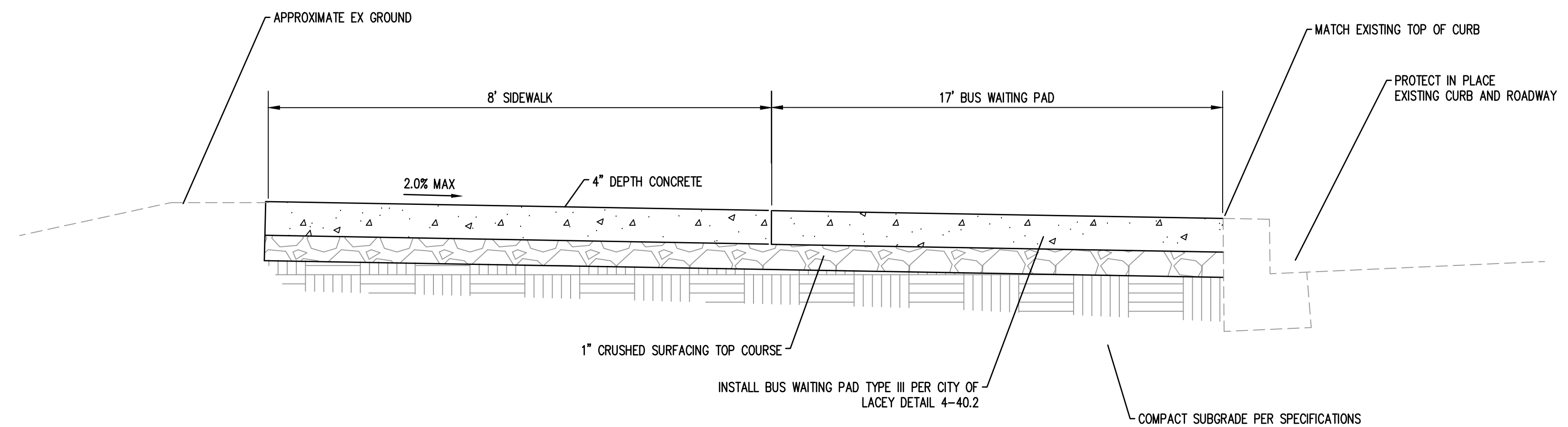

REVISIONS	DATE	BY

SCJ ALLIANCE
CONSULTING SERVICES
8730 TALLOW LANE, NE SUITE 200, LACEY, WA 98516
P: 360.352.1465 F: 360.352.1509
SCJALLIANCE.COM

BUS STOP 1060
PROJECT TITLE:
INTERCITY TRANSIT BUS STOP CONSTRUCTION
PROJECT NAME:
IT PROJECT # 2003C
LACEY, WA

SEAL:

DESIGNER:
W HOLM
DRAWN BY:
M KNECHT
APPROVED BY:
B SHEA
DATE:
APRIL, 2020
JOB NO:
788AA
DRAWING FILE NO:
788.44-STOP-1060
DRAWING NO:
BP-05
SHEET NO:
6 of 17

Jul 10, 2020 7:25:27am - User: whitneyg.holm - C:\PROJECTS\0788 INTERCITY TRANSIT\0788.44-STOP-1060.DWG





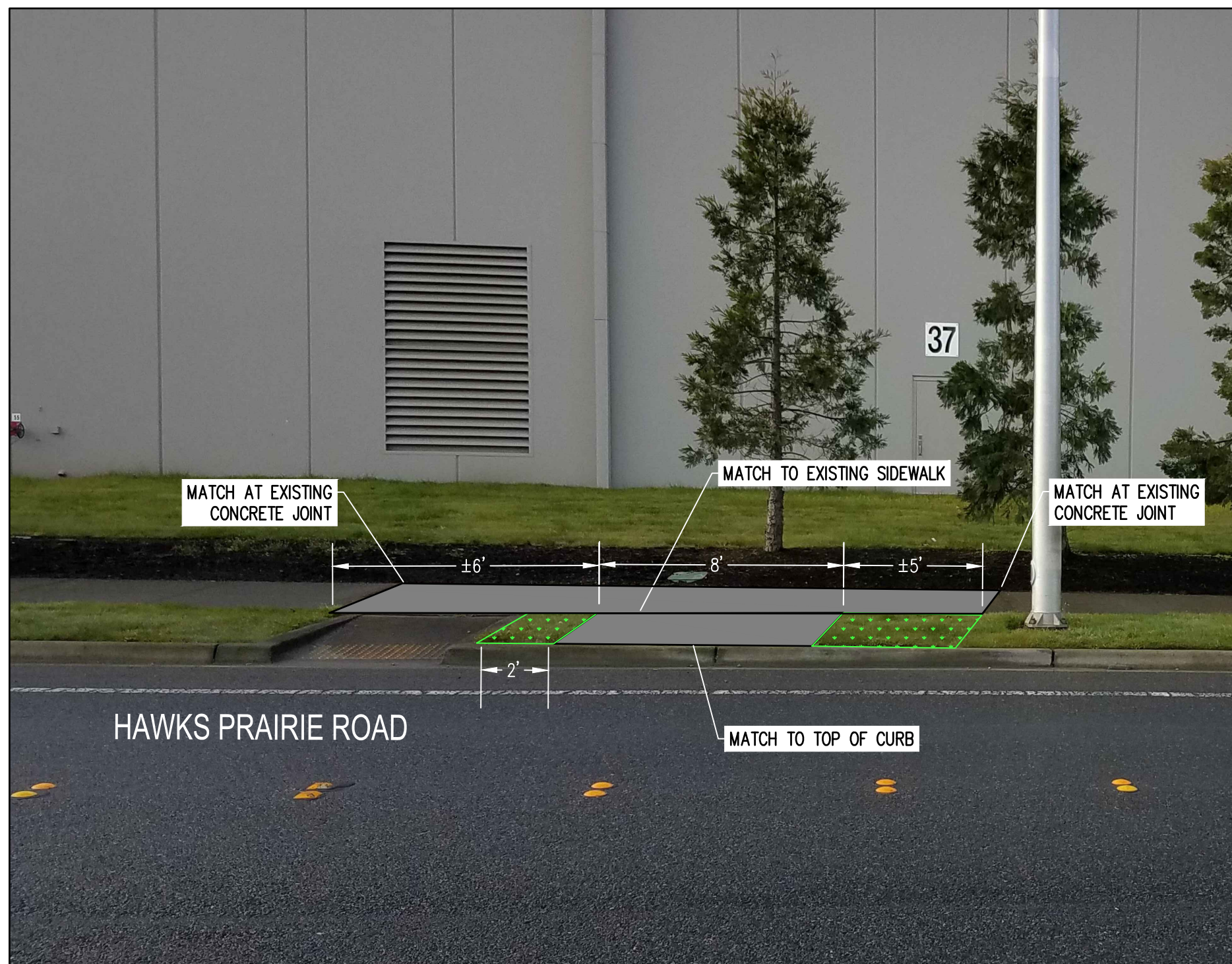

EXISTING CONDITIONS
N.T.S.

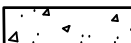

PROPOSED CONDITIONS
N.T.S.

LEGEND

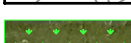
-  CEMENT CONCRETE (PLAN VIEW)
-  REMOVE EXISTING SIDEWALK
-  CEMENT CONCRETE (CROSS SECTION VIEW)
-  CSBS (CRUSHED SURFACING BASE COURSE)
-  SITE RESTORATION - SOD INSTALLATION

GENERAL NOTES

1. LACEYS' STANDARD CONSTRUCTION NOTES AND DETAILS HAVE BEEN PROVIDED AND REFERENCED ON THE PLANS. ALL WORKMANSHIP AND MATERIALS SHALL BE IN ACCORDANCE WITH THE CITY OF LACEY STANDARDS AND THE MOST CURRENT COPY OF THE WSDOT STANDARD SPECIFICATIONS FOR ROAD, BRIDGE, AND MUNICIPAL CONSTRUCTION.
2. CONTRACTOR SHALL HAVE A COPY OF THE APPROVED CONSTRUCTION PLANS AND SPECIFICATIONS ON THE JOB SITE AT ALL TIMES DURING CONSTRUCTION.
3. THE CONTRACTOR SHALL BE IN COMPLIANCE WITH ALL SAFETY STANDARDS AND REQUIREMENTS AS SET FORTH BY OSHA, WSHA, AND THE WASHINGTON STATE DEPARTMENT OF LABOR AND INDUSTRIES.
4. PRIOR TO WORK ON ANY BUS STOP LOCATION, THE CONTRACTOR SHALL SUBMIT A CONSTRUCTION SCHEDULE TO THE PROJECT ENGINEER FOR REVIEW. THE CONSTRUCTION SCHEDULE SHALL NOTE CONSTRUCTION START AND END DATES FOR EACH BUS STOP. INTERCITY TRANSIT WILL UTILIZE THE SCHEDULE PROVIDED TO COORDINATE AND IMPLEMENT TEMPORARY BUS STOP LOCATIONS. CONTRACTOR TO NOTIFY ENGINEER IMMEDIATELY IF A TEMPORARY BUS STATION HAS NOT BEEN SET UP FOR A BUS STOP SCHEDULED FOR CONSTRUCTION.
5. PRIOR TO WORK ON A SPECIFIC BUS STOP, IT IS THE CONTRACTORS RESPONSIBILITY TO NOTIFY THE CITY OF LACEY THAT WORK WILL BE COMMENCING WITHIN THEIR RIGHT-OF-WAY AND SCHEDULE/ATTEND A PRE-CONSTRUCTION MEETING IF REQUIRED BY THE CITY OF LACEY. CONTRACTOR SHALL NOTIFY THE PROJECT ENGINEER OF ALL SCHEDULED PRE-CONSTRUCTION MEETINGS.
6. THE ENGINEER RESPONSIBLE FOR PREPARATION OF THESE PLANS AND SPECIFICATIONS WILL NOT BE RESPONSIBLE FOR, OR LIABLE FOR, UNAUTHORIZED CHANGES TO OR USES OF THESE PLANS. ALL CHANGES TO THE PLANS MUST BE IN WRITING AND MUST BE APPROVED BY THE ENGINEER RESPONSIBLE FOR PREPARATION OF THESE PLANS.
7. CONTRACTOR TO NOTE THAT CONSTRUCTION ACTIVITY WILL OCCUR IN AREAS WHERE EXISTING UNDERGROUND UTILITIES ARE LOCATED. THE CONTRACTOR SHALL BE FULLY RESPONSIBLE FOR THE LOCATION AND PROTECTION OF ALL EXISTING UTILITIES. THE CONTRACTOR SHALL VERIFY ALL UTILITY LOCATIONS PRIOR TO CONSTRUCTION BY CALLING THE UNDERGROUND LOCATE LINE AT 811 A MINIMUM OF 72 HOURS PRIOR TO THE START OF CONSTRUCTION.

GENERAL CONSTRUCTION NOTES

8. EROSION CONTROL MEASURES SHALL BE IMPLEMENTED AT ALL BUS STOP CONSTRUCTION LOCATION AS REQUIRED TO PREVENT SILT LADEN WATER FROM EXITING THE SITE OR ENTERING INTO STORM DRAINAGE FACILITIES. THE PLANS MAY NOTE SPECIFIC EROSION CONTROL MEASURES THAT MAY BE REQUIRED, HOWEVER IT IS THE CONTRACTORS RESPONSIBILITY TO IMPLEMENT ALL EROSION CONTROL MEASURES NECESSARY DURING CONSTRUCTION AND SITE STABILIZATION. SEE PLANS FOR EROSION CONTROL GENERAL NOTES AND DETAILS.
9. TRAFFIC CONTROL WILL BE REQUIRED AT EACH BUS STOP CONSTRUCTION LOCATION. CONTRACTOR TO MEET ALL TRAFFIC CONTROL REQUIREMENTS PER WSDOT, MUTCD, AND CITY OF LACEY STANDARDS. PRIOR TO DISRUPTION OF ANY TRAFFIC, THE CONTRACTOR SHALL PREPARE A SITE SPECIFIC TRAFFIC CONTROL PLAN FOR EACH BUS STOP LOCATION FOR REVIEW AND APPROVAL BY THE CITY OF LACEY. NO WORK SHALL COMMENCE UNTIL ALL APPROVED TRAFFIC CONTROL IS IN PLACE. WORK SHALL BE SUSPENDED IF TRAFFIC CONTROL FAILS TO MEET MINIMUM REQUIREMENTS. CONTRACTOR TO ENSURE THAT TRAFFIC CONTROL ADDRESSES PEDESTRIAN AND BICYCLE TRAFFIC THROUGH THE CONSTRUCTION SITE. TRAFFIC CONTROL MUST BE MAINTAINED 24 HOURS A DAY, 7 DAYS A WEEK WHILE IN USE. PRIOR TO WORK, CONTRACTOR SHALL PROVIDE THE NAME AND PHONE NUMBER OF THE 24 HOUR TRAFFIC CONTROL CONTACT PERSON TO THE PERMITTING AGENCY AND PROJECT ENGINEER.
10. EXISTING SURVEY MONUMENTS, INCLUDING BUT NOT RESTRICTED TO PROPERTY CORNERS AND CENTERLINE MONUMENT MAY BE DISTURBED OR DESTROYED BY CONSTRUCTION OPERATIONS. THE CONTRACTOR, AS PART OF THE BASE BID, SHALL RETAIN A LICENSED PROFESSIONAL LAND SURVEYOR FOR REPLACEMENT OF ANY DISTURBED OR DESTROYED MONUMENTS OR PROPERTY CORNERS IN ACCORDANCE WITH WASHINGTON STATE LAWS.
11. SITE RESTORATION HAS BEEN CALLED OUT ON THE PLANS FOR AREAS THAT WILL BE DISTURBED DURING CONSTRUCTION. CONTRACTOR SHALL INCLUDE IN THE BASE BID RESTORATION OF ALL DISTURBED AREAS AS A RESULT OF CONSTRUCTION. AREAS SHALL BE REPAIRED, REPLACED, AND STABILIZED TO MATCH THE PRE-PROJECT CONDITIONS OR AS NOTED ON THE PLANS. FOR SITE RESTORATION WITH GRASS, CONTRACTOR SHALL INSTALL 6 INCHES MINIMUM OF TOPSOIL. THEN SEED FERTILIZE AND MULCH PER WSDOT SPECIFICATIONS. THE CONTRACTOR IS RESPONSIBLE FOR PROVIDING AT THEIR EXPENSE, ANY TEMPORARY WATER NEEDED TO ESTABLISH SEED GERMINATION AND PROVIDE SUBSTANTIAL GROWTH AND STABILIZATION. IF SEED GERMINATION DOES NOT OCCUR, CONTRACTOR SHALL RESEED AT THEIR EXPENSE. CONTRACTOR SHALL ASSUME A MINIMUM OF 2 FEET BEYOND THE PROPOSED IMPROVEMENTS (ALL LOCATION) WILL REQUIRE SITE RESTORATION UNLESS SPECIFICALLY NOTED DIFFERENTLY ON THE PLANS. CONTRACTOR SHALL REPAIR CONDITIONS. IF UNDERGROUND IRRIGATION SYSTEMS ARE ENCOUNTERED CONTRACTOR SHALL PROTECT AND PRESERVE OR MODIFY THE EXISTING SYSTEM AS REQUIRED TO ACCOMMODATE BUS STOP CONSTRUCTION.
12. EXISTING VEGETATION SHALL BE PROTECTED AND PRESERVED TO THE EXTENT FEASIBLE. ALL EXISTING TREES SHALL BE PROTECTED UNLESS SHOWN ON THE PLANS TO BE REMOVED OR TRIMMED. NO TREE SHALL BE REMOVED WITHOUT WRITTEN AUTHORIZATION FROM THE PROJECT ENGINEER. AT HIS EXPENSE, CONTRACTOR SHALL CONSULT WITH A CERTIFIED ARBORIST PRIOR TO TRIMMING OF EXISTING TREES/ROOT REMOVAL TO ENSURE TRIMMING MAINTAINS THE LONG TERM VIABILITY OF THE TREE.

13. CONTRACTOR SHALL INCLUDE IN BASE BID ALL MATERIALS AND LABOR REQUIRED TO INSTALL AND REMOVE ANY TEMPORARY SHORING SYSTEMS REQUIRED TO CONSTRUCT THESE IMPROVEMENTS. CONTRACTOR SHALL NOTE THAT MANY OF THE BUS STOP LOCATIONS ARE IN CLOSE PROXIMITY TO EXISTING FEATURES AND PRIVATE PROPERTY. IT IS THE CONTRACTORS RESPONSIBILITY TO ENSURE THAT CONSTRUCTION ACTIVITIES DO NOT DAMAGE OR INFRINGE ON PRIVATE PROPERTY.

BUS STOP CONSTRUCTION

14. INTERCITY TRANSIT WILL BE FURNISHING AND INSTALLING THE POLE AND SIGN FOR ALL OF THESE STOPS. DURING CONSTRUCTION THE CONTRACTOR WILL NEED TO REMOVE AND DISPOSE OF THE BURIED CEMENT BUCKET.
15. CONTRACTOR SHALL PROVIDE A CONCRETE JOINT LAYOUT PLAN TO PROJECT ENGINEER FOR REVIEW ONE WEEK PRIOR TO A SCHEDULED CONCRETE POUR. THE CONCRETE JOINT LAYOUT PLAN SHALL PROVIDE DETAILS ON THE LOCATION OF CONTRACTION, CONSTRUCTION, AND ISOLATION JOINTS. THE PLAN MUST BE APPROVED BY THE ENGINEER PRIOR TO THE CONCRETE POUR.
16. ALL FILL PLACED DURING BUS STOP CONSTRUCTION SHALL BE STRUCTURAL FILL MEETING WSDOT STANDARD SPECIFICATION 9-03.14(3) COMMON BORROW AND SHALL BE COMPACTED TO WSDOT SPECIFICATIONS UNLESS OTHERWISE NOTED ON THE PLANS.
17. CONTRACTOR SHALL PROVIDE A TOWELED EDGE ALONG THE OUTSIDE PERIMETER OF ALL CONCRETE BUS STOP PADS, CURBS, AND WALLS; CONCRETE EDGING SHALL BE 4 INCHES WIDE WITH A 1/2 INCH RADIUS.
18. FOR BUS PAD CONSTRUCTION, CROSS SLOPE GRADES SHALL NOT EXCEED 1.7%. LONGITUDINAL GRADES FOR TRANSITIONAL RAMPS SHALL NOT EXCEED 8% IF UPON FINAL INSPECTION OF THE COMPLETED WORK, AND PORTION OF THE WORK DOES NOT MEET THESE REQUIREMENTS, THE WORK SHALL BE REMOVED AND RECONSTRUCTED, AT THE EXPENSE OF THE CONTRACTOR. NO EXCEPTION WILL BE PROVIDED. ALL CONCRETE CONSTRUCTION SHALL HAVE A MINIMUM SLOPED 1% FOR WATER DRAINAGE, UNLESS OTHERWISE NOTED ON THE PLANS.
19. CONTRACTOR TO NOTE ALL BUS STOP PAD DIMENSIONS (LENGTH AND WIDTH) ARE THE ACTUAL SLAB DIMENSIONS. ALL ADDITIONAL CONSTRUCTION SUCH AS PEDESTRIAN CURBS OR WALLS SHALL ABUT THE SLAB AS NOTED IN THE CROSS SECTIONS. AS SUCH, A 6'x8' SLAB WILL RESULT IN 48 SQUARE FEET OF CONCRETE SURFACE. SEE PLANS FOR BUS PAD DIMENSIONS, AS THIS VARIES FOR SPECIFIC SITES.

CONSTRUCTION INSPECTION

20. ALL CONCRETE WORK FOR THIS PROJECT WILL BE INSPECTED BY THE PROJECT ENGINEER AND CITY OF LACEY INSPECTOR. REQUIRED INSPECTIONS INCLUDE CONSTRUCTION STAKING, SUBGRADE INSPECTION, CONCRETE FORMWORK, AND FINAL INSPECTION OF CONCRETE AND FINISHED GRADES. CONTRACTOR SHALL PROVIDE A 24 HOUR NOTICE TO THE PROJECT ENGINEER AND CITY OF LACEY INSPECTOR PRIOR TO THE REQUIRED INSPECTIONS. NO CONCRETE WORK SHALL BE COMPLETED WITHOUT INSPECTION APPROVAL FROM THE PROJECT ENGINEER AND CITY OF LACEY INSPECTOR. ANY CONCRETE WORK COMPLETED BY THE CONTRACTOR WITHOUT THE REQUIRED INSPECTIONS WILL BE AT THE RISK OF THE CONTRACTOR. THE CONTRACTOR IS URGED TO COORDINATE SITE INSPECTIONS FOR MAXIMUM EFFICIENCY, I.E. COMPLETE MULTIPLE SITE INSPECTIONS IN ONE DAY WITHIN CLOSE PROXIMITY OF EACH OTHER.

JURISDICTION NOTES

1. SEE DRAWING DET-01 FOR CITY OF LACEY STANDARD NOTES AND DETAILS.

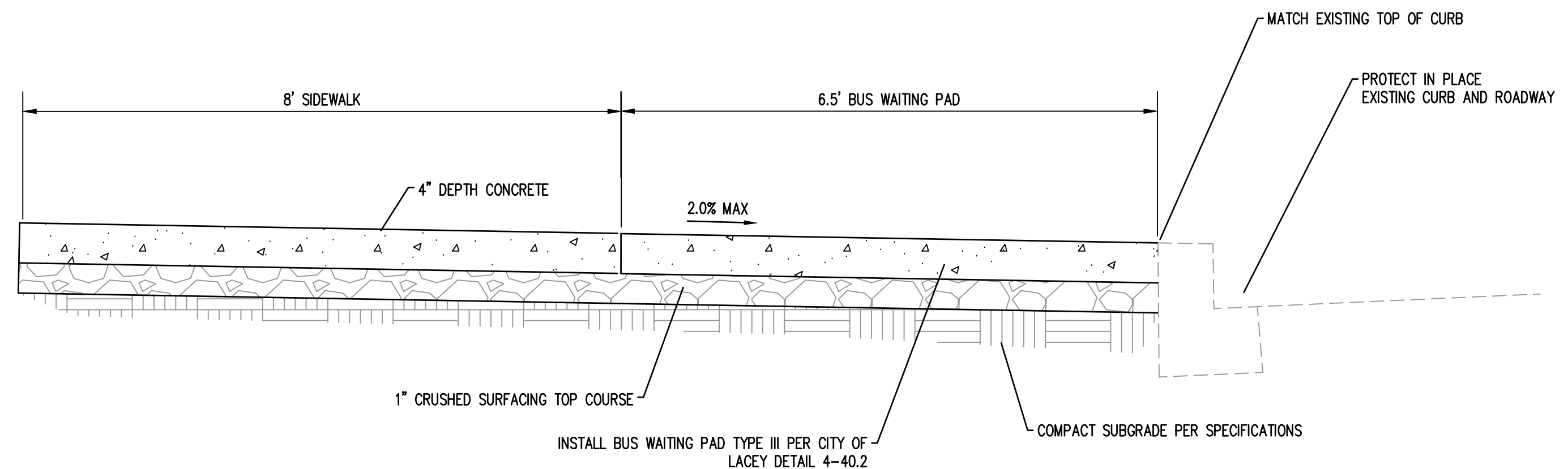

REVISIONS	DATE	BY

SCJ ALLIANCE
CONSULTING SERVICES
8730 TALLOW LANE, NE SUITE 200, LACEY, WA 98516
P: 360.352.1465 F: 360.352.1509
SCJALLIANCE.COM

BUS STOP 1062
PROJECT TITLE:
PROJECT NAME:
INTERCITY TRANSIT BUS STOP CONSTRUCTION
IT PROJECT # 2003C
LACEY, WA

SEAL:

07/09/2020

DESIGNER:
W HOLM
DRAWN BY:
M KNECHT
APPROVED BY:
B SHEA
DATE:
APRIL, 2020
JOB NO:
768-AA
DRAWING FILE NO:
768-AA-STOP-1062
DRAWING NO:
BP-06
SHEET NO:
7 of 17



EXISTING CONDITIONS
N.T.S.



PROPOSED CONDITIONS
N.T.S.

LEGEND

- CEMENT CONCRETE (PLAN VIEW)
- REMOVE EXISTING SIDEWALK
- CEMENT CONCRETE (CROSS SECTION VIEW)
- CSBS (CRUSHED SURFACING BASE COURSE)
- SITE RESTORATION - BARK/TOPSOIL MIX (SEE SPECIAL PROVISIONS)

GENERAL NOTES

1. LACEYS' STANDARD CONSTRUCTION NOTES AND DETAILS HAVE BEEN PROVIDED AND REFERENCED ON THE PLANS. ALL WORKMANSHIP AND MATERIALS SHALL BE IN ACCORDANCE WITH THE CITY OF LACEY STANDARDS AND THE MOST CURRENT COPY OF THE WSDOT STANDARD SPECIFICATIONS FOR ROAD, BRIDGE, AND MUNICIPAL CONSTRUCTION.
2. CONTRACTOR SHALL HAVE A COPY OF THE APPROVED CONSTRUCTION PLANS AND SPECIFICATIONS ON THE JOB SITE AT ALL TIMES DURING CONSTRUCTION.
3. THE CONTRACTOR SHALL BE IN COMPLIANCE WITH ALL SAFETY STANDARDS AND REQUIREMENTS AS SET FORTH BY OSHA, WSHA, AND THE WASHINGTON STATE DEPARTMENT OF LABOR AND INDUSTRIES.
4. PRIOR TO WORK ON ANY BUS STOP LOCATION, THE CONTRACTOR SHALL SUBMIT A CONSTRUCTION SCHEDULE TO THE PROJECT ENGINEER FOR REVIEW. THE CONSTRUCTION SCHEDULE SHALL NOTE CONSTRUCTION START AND END DATES FOR EACH BUS STOP. INTERCITY TRANSIT WILL UTILIZE THE SCHEDULE PROVIDED TO COORDINATE AND IMPLEMENT TEMPORARY BUS STOP LOCATIONS. CONTRACTOR TO NOTIFY ENGINEER IMMEDIATELY IF A TEMPORARY BUS STATION HAS NOT BEEN SET UP FOR A BUS STOP SCHEDULED FOR CONSTRUCTION.
5. PRIOR TO WORK ON A SPECIFIC BUS STOP, IT IS THE CONTRACTORS RESPONSIBILITY TO NOTIFY THE CITY OF LACEY THAT WORK WILL BE COMMENCING WITHIN THEIR RIGHT-OF-WAY AND SCHEDULE/ATTEND A PRE-CONSTRUCTION MEETING IF REQUIRED BY THE CITY OF LACEY. CONTRACTOR SHALL NOTIFY THE PROJECT ENGINEER OF ALL SCHEDULED PRE-CONSTRUCTION MEETINGS.
6. THE ENGINEER RESPONSIBLE FOR PREPARATION OF THESE PLANS AND SPECIFICATIONS WILL NOT BE RESPONSIBLE FOR, OR LIABLE FOR, UNAUTHORIZED CHANGES TO OR USES OF THESE PLANS. ALL CHANGES TO THE PLANS MUST BE IN WRITING AND MUST BE APPROVED BY THE ENGINEER RESPONSIBLE FOR PREPARATION OF THESE PLANS.
7. CONTRACTOR TO NOTE THAT CONSTRUCTION ACTIVITY WILL OCCUR IN AREAS WHERE EXISTING UNDERGROUND UTILITIES ARE LOCATED. THE CONTRACTOR SHALL BE FULLY RESPONSIBLE FOR THE LOCATION AND PROTECTION OF ALL EXISTING UTILITIES. THE CONTRACTOR SHALL VERIFY ALL UTILITY LOCATIONS PRIOR TO CONSTRUCTION BY CALLING THE UNDERGROUND LOCATE LINE AT 811 A MINIMUM OF 72 HOURS PRIOR TO THE START OF CONSTRUCTION.

GENERAL CONSTRUCTION NOTES

8. EROSION CONTROL MEASURES SHALL BE IMPLEMENTED AT ALL BUS STOP CONSTRUCTION LOCATION AS REQUIRED TO PREVENT SILT LADEN WATER FROM EXITING THE SITE OR ENTERING INTO STORM DRAINAGE FACILITIES. THE PLANS MAY NOTE SPECIFIC EROSION CONTROL MEASURES THAT MAY BE REQUIRED, HOWEVER IT IS THE CONTRACTORS RESPONSIBILITY TO IMPLEMENT ALL EROSION CONTROL MEASURES NECESSARY DURING CONSTRUCTION AND SITE STABILIZATION. SEE PLANS FOR EROSION CONTROL GENERAL NOTES AND DETAILS.
9. TRAFFIC CONTROL WILL BE REQUIRED AT EACH BUS STOP CONSTRUCTION LOCATION. CONTRACTOR TO MEET ALL TRAFFIC CONTROL REQUIREMENTS PER WSDOT, MUTCD, AND CITY OF LACEY STANDARDS. PRIOR TO DISRUPTION OF ANY TRAFFIC, THE CONTRACTOR SHALL PREPARE A SITE SPECIFIC TRAFFIC CONTROL PLAN FOR EACH BUS STOP LOCATION FOR REVIEW AND APPROVAL BY THE CITY OF LACEY. NO WORK SHALL COMMENCE UNTIL ALL APPROVED TRAFFIC CONTROL IS IN PLACE. WORK SHALL BE SUSPENDED IF TRAFFIC CONTROL FAILS TO MEET MINIMUM REQUIREMENTS. CONTRACTOR TO ENSURE THAT TRAFFIC CONTROL ADDRESSES PEDESTRIAN AND BICYCLE TRAFFIC THROUGH THE CONSTRUCTION SITE. TRAFFIC CONTROL MUST BE MAINTAINED 24 HOURS A DAY, 7 DAYS A WEEK WHILE IN USE. PRIOR TO WORK, CONTRACTOR SHALL PROVIDE THE NAME AND PHONE NUMBER OF THE 24 HOUR TRAFFIC CONTROL CONTACT PERSON TO THE PERMITTING AGENCY AND PROJECT ENGINEER.
10. EXISTING SURVEY MONUMENTS, INCLUDING BUT NOT RESTRICTED TO PROPERTY CORNERS AND CENTERLINE MONUMENT MAY BE DISTURBED OR DESTROYED BY CONSTRUCTION OPERATIONS. THE CONTRACTOR, AS PART OF THE BASE BID, SHALL RETAIN A LICENSED PROFESSIONAL LAND SURVEYOR FOR REPLACEMENT OF ANY DISTURBED OR DESTROYED MONUMENTS OR PROPERTY CORNERS IN ACCORDANCE WITH WASHINGTON STATE LAWS.
11. SITE RESTORATION HAS BEEN CALLED OUT ON THE PLANS FOR AREAS THAT WILL BE DISTURBED DURING CONSTRUCTION. CONTRACTOR SHALL INCLUDE IN THE BASE BID RESTORATION OF ALL DISTURBED AREAS AS A RESULT OF CONSTRUCTION. AREAS SHALL BE REPAIRED, REPLACED, AND STABILIZED TO MATCH THE PRE-PROJECT CONDITIONS OR AS NOTED ON THE PLANS. FOR SITE RESTORATION WITH GRASS, CONTRACTOR SHALL INSTALL 6 INCHES MINIMUM OF TOPSOIL. THEN SEED FERTILIZE AND MULCH PER WSDOT SPECIFICATIONS. THE CONTRACTOR IS RESPONSIBLE FOR PROVIDING AT THEIR EXPENSE, ANY TEMPORARY WATER NEEDED TO ESTABLISH SEED GERMINATION AND PROVIDE SUBSTANTIAL GROWTH AND STABILIZATION. IF SEED GERMINATION DOES NOT OCCUR, CONTRACTOR SHALL RESEED AT THEIR EXPENSE. CONTRACTOR SHALL ASSUME A MINIMUM OF 2 FEET BEYOND THE PROPOSED IMPROVEMENTS (ALL LOCATION) WILL REQUIRE SITE RESTORATION UNLESS SPECIFICALLY NOTED DIFFERENTLY ON THE PLANS. CONTRACTOR SHALL REPAIR CONDITIONS. IF UNDERGROUND IRRIGATION SYSTEMS ARE ENCOUNTERED CONTRACTOR SHALL PROTECT AND PRESERVE OR MODIFY THE EXISTING SYSTEM AS REQUIRED TO ACCOMMODATE BUS STOP CONSTRUCTION.
12. EXISTING VEGETATION SHALL BE PROTECTED AND PRESERVED TO THE EXTENT FEASIBLE. ALL EXISTING TREES SHALL BE PROTECTED UNLESS SHOWN ON THE PLANS TO BE REMOVED OR TRIMMED. NO TREE SHALL BE REMOVED WITHOUT WRITTEN AUTHORIZATION FROM THE PROJECT ENGINEER. AT HIS EXPENSE, CONTRACTOR SHALL CONSULT WITH A CERTIFIED ARBORIST PRIOR TO TRIMMING OF EXISTING TREES/ROOT REMOVAL TO ENSURE TRIMMING MAINTAINS THE LONG TERM VIABILITY OF THE TREE.

13. CONTRACTOR SHALL INCLUDE IN BASE BID ALL MATERIALS AND LABOR REQUIRED TO INSTALL AND REMOVE ANY TEMPORARY SHORING SYSTEMS REQUIRED TO CONSTRUCT THESE IMPROVEMENTS. CONTRACTOR SHALL NOTE THAT MANY OF THE BUS STOP LOCATIONS ARE IN CLOSE PROXIMITY TO EXISTING FEATURES AND PRIVATE PROPERTY. IT IS THE CONTRACTORS RESPONSIBILITY TO ENSURE THAT CONSTRUCTION ACTIVITIES DO NOT DAMAGE OR INFRINGE ON PRIVATE PROPERTY.

BUS STOP CONSTRUCTION

14. INTERCITY TRANSIT WILL BE FURNISHING AND INSTALLING THE POLE AND SIGN FOR ALL OF THESE STOPS. DURING CONSTRUCTION THE CONTRACTOR WILL NEED TO REMOVE AND DISPOSE OF THE BURIED CEMENT BUCKET.
15. CONTRACTOR SHALL PROVIDE A CONCRETE JOINT LAYOUT PLAN TO PROJECT ENGINEER FOR REVIEW ONE WEEK PRIOR TO A SCHEDULED CONCRETE POUR. THE CONCRETE JOINT LAYOUT PLAN SHALL PROVIDE DETAILS ON THE LOCATION OF CONTRACTION, CONSTRUCTION, AND ISOLATION JOINTS. THE PLAN MUST BE APPROVED BY THE ENGINEER PRIOR TO THE CONCRETE POUR.
16. ALL FILL PLACED DURING BUS STOP CONSTRUCTION SHALL BE STRUCTURAL FILL MEETING WSDOT STANDARD SPECIFICATION 9-03.14(3) COMMON BORROW AND SHALL BE COMPACTED TO WSDOT SPECIFICATIONS UNLESS OTHERWISE NOTED ON THE PLANS.
17. CONTRACTOR SHALL PROVIDE A TOWELED EDGE ALONG THE OUTSIDE PERIMETER OF ALL CONCRETE BUS STOP PADS, CURBS, AND WALLS; CONCRETE EDGING SHALL BE 4 INCHES WIDE WITH A 1/2 INCH RADIUS.
18. FOR BUS PAD CONSTRUCTION, CROSS SLOPE GRADES SHALL NOT EXCEED 1.7%. LONGITUDINAL GRADES FOR TRANSITIONAL RAMPS SHALL NOT EXCEED 8% IF UPON FINAL INSPECTION OF THE COMPLETED WORK, AND PORTION OF THE WORK DOES NOT MEET THESE REQUIREMENTS, THE WORK SHALL BE REMOVED AND RECONSTRUCTED, AT THE EXPENSE OF THE CONTRACTOR. NO EXCEPTION WILL BE PROVIDED. ALL CONCRETE CONSTRUCTION SHALL HAVE A MINIMUM SLOPED 1% FOR WATER DRAINAGE, UNLESS OTHERWISE NOTED ON THE PLANS.
19. CONTRACTOR TO NOTE ALL BUS STOP PAD DIMENSIONS (LENGTH AND WIDTH) ARE THE ACTUAL SLAB DIMENSIONS. ALL ADDITIONAL CONSTRUCTION SUCH AS PEDESTRIAN CURBS OR WALLS SHALL ABUT THE SLAB AS NOTED IN THE CROSS SECTIONS. AS SUCH, A 6'x8' SLAB WILL RESULT IN 48 SQUARE FEET OF CONCRETE SURFACE. SEE PLANS FOR BUS PAD DIMENSIONS, AS THIS VARIES FOR SPECIFIC SITES.

CONSTRUCTION INSPECTION

20. ALL CONCRETE WORK FOR THIS PROJECT WILL BE INSPECTED BY THE PROJECT ENGINEER AND CITY OF LACEY INSPECTOR. REQUIRED INSPECTIONS INCLUDE CONSTRUCTION STAKING, SUBGRADE INSPECTION, CONCRETE FORMWORK, AND FINAL INSPECTION OF CONCRETE AND FINISHED GRADES. CONTRACTOR SHALL PROVIDE A 24 HOUR NOTICE TO THE PROJECT ENGINEER AND CITY OF LACEY INSPECTOR PRIOR TO THE REQUIRED INSPECTIONS. NO CONCRETE WORK SHALL BE COMPLETED WITHOUT INSPECTION APPROVAL FROM THE PROJECT ENGINEER AND CITY OF LACEY INSPECTOR. ANY CONCRETE WORK COMPLETED BY THE CONTRACTOR WITHOUT THE REQUIRED INSPECTIONS WILL BE AT THE RISK OF THE CONTRACTOR. THE CONTRACTOR IS URGED TO COORDINATE SITE INSPECTIONS FOR MAXIMUM EFFICIENCY, I.E. COMPLETE MULTIPLE SITE INSPECTIONS IN ONE DAY WITHIN CLOSE PROXIMITY OF EACH OTHER.

JURISDICTION NOTES

1. SEE DRAWING DET-01 FOR CITY OF LACEY STANDARD NOTES AND DETAILS.

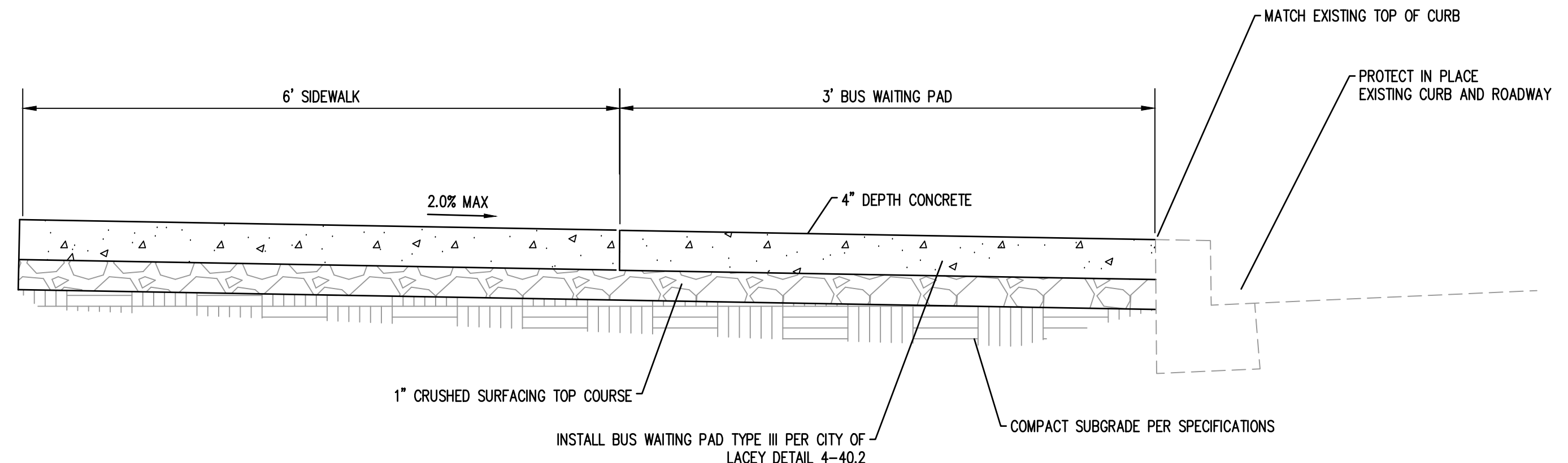

REVISIONS	DATE	BY

SCJ ALLIANCE
CONSULTING SERVICES
8730 TALLOW LANE, NE SUITE 200, LACEY, WA 98516
P: 360.352.1465 F: 360.352.1509
SCJALLIANCE.COM

BUS STOP 1067
PROJECT TITLE:
INTERCITY TRANSIT BUS STOP CONSTRUCTION
IT PROJECT # 2003C
LACEY, WA

SEAL:

DESIGNER: W HOLM
DRAWN BY: M KNECHT
APPROVED BY: B SHEA
DATE: APRIL, 2020
JOB NO: 768AA
DRAWING FILE NO: 768.44-STOP-1067
DRAWING NO: BP-07
SHEET NO: 8 of 17

Jul 10, 2020 7:26:33am - User: whitneyholm - User: whitneyholm - User: whitneyholm
C:\PROJECTS\0768 INTERCITY TRANSIT\0768AA TD-1 BUS STOP PAD IMPROVEMENTS.RVT: 651\CAD\0768.44-STOP-1067.DWG

1416 26TH AVE NE - NORTH SIDE OF 26TH



EXISTING CONDITIONS
N.T.S.

GENERAL NOTES

- OLYMPIA'S STANDARD CONSTRUCTION NOTES AND DETAILS HAVE BEEN PROVIDED AND REFERENCED ON THE PLANS. ALL WORKMANSHIP AND MATERIALS SHALL BE IN ACCORDANCE WITH THE CITY OF OLYMPIA STANDARDS AND THE MOST CURRENT COPY OF THE WSDOT STANDARD SPECIFICATIONS FOR ROAD, BRIDGE, AND MUNICIPAL CONSTRUCTION.
- CONTRACTOR SHALL HAVE A COPY OF THE APPROVED CONSTRUCTION PLANS AND SPECIFICATIONS ON THE JOB SITE AT ALL TIMES DURING CONSTRUCTION.
- THE CONTRACTOR SHALL BE IN COMPLIANCE WITH ALL SAFETY STANDARDS AND REQUIREMENTS AS SET FORTH BY OSHA, WSHA, AND THE WASHINGTON STATION DEPARTMENT OF LABOR AND INDUSTRIES.
- PRIOR TO WORK ON ANY BUS STOP LOCATION, THE CONTRACTOR SHALL SUBMIT A CONSTRUCTION SCHEDULE TO THE PROJECT ENGINEER FOR REVIEW. THE CONSTRUCTION SCHEDULE SHALL NOTE CONSTRUCTION START AND END DATES FOR EACH BUS STOP. INTERCITY TRANSIT WILL UTILIZE THE SCHEDULE PROVIDED TO COORDINATE AND IMPLEMENT TEMPORARY BUS STOP LOCATIONS. CONTRACTOR TO NOTIFY ENGINEER IMMEDIATELY IF A TEMPORARY BUS STATION HAS NOT BEEN SET UP FOR A BUS STOP SCHEDULED FOR CONSTRUCTION.
- PRIOR TO WORK ON A SPECIFIC BUS STOP, IT IS THE CONTRACTORS RESPONSIBILITY TO NOTIFY THE CITY OF OLYMPIA THAT WORK WILL BE COMMENCING WITHIN THEIR RIGHT-OF-WAY AND SCHEDULE/ATTEND A PRE-CONSTRUCTION MEETING IF REQUIRED BY THE CITY OF OLYMPIA. CONTRACTOR SHALL NOTIFY THE PROJECT ENGINEER OF ALL SCHEDULED PRE-CONSTRUCTION MEETINGS.
- THE ENGINEER RESPONSIBLE FOR PREPARATION OF THESE PLANS AND SPECIFICATIONS WILL NOT BE RESPONSIBLE FOR, OR LIABLE FOR, UNAUTHORIZED CHANGES TO OR USES OF THESE PLANS. ALL CHANGES TO THE PLANS MUST BE IN WRITING AND MUST BE APPROVED BY THE ENGINEER RESPONSIBLE FOR PREPARATION OF THESE PLANS.
- CONTRACTOR TO NOTE THAT CONSTRUCTION ACTIVITY WILL OCCUR IN AREAS WHERE EXISTING UNDERGROUND UTILITIES ARE LOCATED. THE CONTRACTOR SHALL BE FULLY RESPONSIBLE FOR THE LOCATION AND PROTECTION OF ALL EXISTING UTILITIES. THE CONTRACTOR SHALL VERIFY ALL UTILITY LOCATIONS PRIOR TO CONSTRUCTION BY CALLING THE UNDERGROUND LOCATE LINE AT 811 A MINIMUM OF 72 HOURS PRIOR TO THE START OF CONSTRUCTION.

GENERAL CONSTRUCTION NOTES

- EROSION CONTROL MEASURES SHALL BE IMPLEMENTED AT ALL BUS STOP CONSTRUCTION LOCATION AS REQUIRED TO PREVENT SILT LADEN WATER FROM EXITING THE SITE OR ENTERING INTO STORM DRAINAGE FACILITIES. THE PLANS MAY NOTE SPECIFIC EROSION CONTROL MEASURES THAT MAY BE REQUIRED, HOWEVER IT IS THE CONTRACTORS RESPONSIBILITY TO IMPLEMENT ALL EROSION CONTROL MEASURES NECESSARY DURING CONSTRUCTION AND SITE STABILIZATION. SEE PLANS FOR EROSION CONTROL GENERAL NOTES AND DETAILS.
- TRAFFIC CONTROL WILL BE REQUIRED AT EACH BUS STOP CONSTRUCTION LOCATION. CONTRACTOR TO MEET ALL TRAFFIC CONTROL REQUIREMENTS PER WSDOT, MUTCD, AND CITY OF OLYMPIA STANDARDS. PRIOR TO DISRUPTION OF ANY TRAFFIC, THE CONTRACTOR SHALL PREPARE A SITE SPECIFIC TRAFFIC CONTROL PLAN FOR EACH BUS STOP LOCATION FOR REVIEW AND APPROVAL BY THE CITY OF OLYMPIA. NO WORK SHALL COMMENCE UNTIL ALL APPROVED TRAFFIC CONTROL IS IN PLACE. WORK SHALL BE SUSPENDED IF TRAFFIC CONTROL FAILS TO MEET MINIMUM REQUIREMENTS. CONTRACTOR TO ENSURE THAT TRAFFIC CONTROL ADDRESSES PEDESTRIAN AND BICYCLE TRAFFIC THROUGH THE CONSTRUCTION SITE. TRAFFIC CONTROL MUST BE MAINTAINED 24 HOURS A DAY, 7 DAYS A WEEK WHILE IN USE. PRIOR TO WORK, CONTRACTOR SHALL PROVIDE THE NAME AND PHONE NUMBER OF THE 24 HOUR TRAFFIC CONTROL CONTACT PERSON TO THE PERMITTING AGENCY AND PROJECT ENGINEER.
- EXISTING SURVEY MONUMENTS, INCLUDING BUT NOT RESTRICTED TO PROPERTY CORNERS AND CENTERLINE MONUMENT MAY BE DISTURBED OR DESTROYED BY CONSTRUCTION OPERATIONS. THE CONTRACTOR, AS PART OF THE BASE BID, SHALL RETAIN A LICENSED PROFESSIONAL LAND SURVEYOR FOR REPLACEMENT OF ANY DISTURBED OR DESTROYED MONUMENTS OR PROPERTY CORNERS IN ACCORDANCE WITH WASHINGTON STATE LAWS.
- SITE RESTORATION HAS BEEN CALLED OUT ON THE PLANS FOR AREAS THAT WILL BE DISTURBED DURING CONSTRUCTION. CONTRACTOR SHALL INCLUDE IN THE BASE BID RESTORATION OF ALL DISTURBED AREAS AS A RESULT OF CONSTRUCTION. AREAS SHALL BE REPAIRED, REPLACED, AND STABILIZED TO MATCH THE PRE-PROJECT CONDITIONS OR AS NOTED ON THE PLANS. FOR SITE RESTORATION WITH GRASS, CONTRACTOR SHALL INSTALL 6 INCHES MINIMUM OF TOPSOIL. THEN SEED FERTILIZE AND MULCH PER WSDOT SPECIFICATIONS. THE CONTRACTOR IS RESPONSIBLE FOR PROVIDING AT THEIR EXPENSE, ANY TEMPORARY WATER NEEDED TO ESTABLISH SEED GERMINATION AND PROVIDE SUBSTANTIAL GROWTH AND STABILIZATION. IF SEED GERMINATION DOES NOT OCCUR, CONTRACTOR SHALL RESEED AT THEIR EXPENSE. CONTRACTOR SHALL ASSUME A MINIMUM OF 2 FEET BEYOND THE PROPOSED IMPROVEMENTS (ALL LOCATION) WILL REQUIRE SITE RESTORATION UNLESS SPECIFICALLY NOTED DIFFERENTLY ON THE PLANS. CONTRACTOR SHALL REPAIR CONDITIONS. IF UNDERGROUND IRRIGATION SYSTEMS ARE ENCOUNTERED CONTRACTOR SHALL PROTECT AND PRESERVE OR MODIFY THE EXISTING SYSTEM AS REQUIRED TO ACCOMMODATE BUS STOP CONSTRUCTION.
- EXISTING VEGETATION SHALL BE PROTECTED AND PRESERVED TO THE EXTENT FEASIBLE. ALL EXISTING TREES SHALL BE PROTECTED UNLESS SHOWN ON THE PLANS TO BE REMOVED OR TRIMMED. NO TREE SHALL BE REMOVED WITHOUT WRITTEN AUTHORIZATION FROM THE PROJECT ENGINEER. AT HIS EXPENSE, CONTRACTOR SHALL CONSULT WITH A CERTIFIED ARBORIST PRIOR TO TRIMMING OF EXISTING TREES/ROOT REMOVAL TO ENSURE TRIMMING MAINTAINS THE LONG TERM VIABILITY OF THE TREE.

LEGEND

- CEMENT CONCRETE (PLAN VIEW)
- CEMENT CONCRETE (CROSS SECTION VIEW)
- CSBS (CRUSHED SURFACING BASE COURSE)
- SITE RESTORATION - SOD INSTALLATION

- CONTRACTOR SHALL INCLUDE IN BASE BID ALL MATERIALS AND LABOR REQUIRED TO INSTALL AND REMOVE ANY TEMPORARY SHORING SYSTEMS REQUIRED TO CONSTRUCT THESE IMPROVEMENTS. CONTRACTOR SHALL NOTE THAT MANY OF THE BUS STOP LOCATIONS ARE IN CLOSE PROXIMITY TO EXISTING FEATURES AND PRIVATE PROPERTY. IT IS THE CONTRACTORS RESPONSIBILITY TO ENSURE THAT CONSTRUCTION ACTIVITIES DO NOT DAMAGE OR INFRINGE ON PRIVATE PROPERTY.

BUS STOP CONSTRUCTION

- INTERCITY TRANSIT WILL BE FURNISHING AND INSTALLING THE POLE AND SIGN FOR ALL OF THESE STOPS. DURING CONSTRUCTION THE CONTRACTOR WILL NEED TO REMOVE AND DISPOSE OF THE BURIED CEMENT BUCKET.
- CONTRACTOR SHALL PROVIDE A CONCRETE JOINT LAYOUT PLAN TO PROJECT ENGINEER FOR REVIEW ONE WEEK PRIOR TO A SCHEDULED CONCRETE POUR. THE CONCRETE JOINT LAYOUT PLAN SHALL PROVIDE DETAILS ON THE LOCATION OF CONTRACTION, CONSTRUCTION, AND ISOLATION JOINTS. THE PLAN MUST BE APPROVED BY THE ENGINEER PRIOR TO THE CONCRETE POUR.
- ALL FILL PLACED DURING BUS STOP CONSTRUCTION SHALL BE STRUCTURAL FILL MEETING WSDOT STANDARD SPECIFICATION 9-03.14(3) COMMON BORROW AND SHALL BE COMPACTED TO WSDOT SPECIFICATIONS UNLESS OTHERWISE NOTED ON THE PLANS.
- CONTRACTOR SHALL PROVIDE A TOWELED EDGE ALONG THE OUTSIDE PERIMETER OF ALL CONCRETE BUS STOP PADS, CURBS, AND WALLS; CONCRETE EDGING SHALL BE 4 INCHES WIDE WITH A 1/2 INCH RADIUS.
- FOR BUS PAD CONSTRUCTION, CROSS SLOPE GRADES SHALL NOT EXCEED 1.7%. LONGITUDINAL GRADES FOR TRANSITIONAL RAMPS SHALL NOT EXCEED 8%. IF UPON FINAL INSPECTION OF THE COMPLETED WORK, AND PORTION OF THE WORK DOES NOT MEET THESE REQUIREMENTS, THE WORK SHALL BE REMOVED AND RECONSTRUCTED, AT THE EXPENSE OF THE CONTRACTOR. NO EXCEPTION WILL BE PROVIDED. ALL CONCRETE CONSTRUCTION SHALL HAVE A MINIMUM SLOPED 1% FOR WATER DRAINAGE, UNLESS OTHERWISE NOTED ON THE PLANS.
- CONTRACTOR TO NOTE ALL BUS STOP PAD DIMENSIONS (LENGTH AND WIDTH) ARE THE ACTUAL SLAB DIMENSIONS. ALL ADDITIONAL CONSTRUCTION SUCH AS PEDESTRIAN CURBS OR WALLS SHALL ABUT THE SLAB AS NOTED IN THE CROSS SECTIONS. AS SUCH, A 6'x8' SLAB WILL RESULT IN 48 SQUARE FEET OF CONCRETE SURFACE. SEE PLANS FOR BUS PAD DIMENSIONS, AS THIS VARIES FOR SPECIFIC SITES.

CONSTRUCTION INSPECTION

- ALL CONCRETE WORK FOR THIS PROJECT WILL BE INSPECTED BY THE PROJECT ENGINEER AND CITY OF OLYMPIA INSPECTOR. REQUIRED INSPECTIONS INCLUDE CONSTRUCTION STAKING, SUBGRADE INSPECTION, CONCRETE FORMWORK, AND FINAL INSPECTION OF CONCRETE AND FINISHED GRADES. CONTRACTOR SHALL PROVIDE A 24 HOUR NOTICE TO THE PROJECT ENGINEER AND CITY OF OLYMPIA INSPECTOR PRIOR TO THE REQUIRED INSPECTIONS. NO CONCRETE WORK SHALL BE COMPLETED WITHOUT INSPECTION APPROVAL FROM THE PROJECT ENGINEER AND CITY OF OLYMPIA INSPECTOR. ANY CONCRETE WORK COMPLETED BY THE CONTRACTOR WITHOUT THE REQUIRED INSPECTIONS WILL BE AT THE RISK OF THE CONTRACTOR. THE CONTRACTOR IS URGED TO COORDINATE SITE INSPECTIONS FOR MAXIMUM EFFICIENCY, I.E. COMPLETE MULTIPLE SITE INSPECTIONS IN ONE DAY WITHIN CLOSE PROXIMITY OF EACH OTHER.

JURISDICTION NOTES

- SEE DRAWING DET-02 FOR CITY OF OLYMPIA STANDARD NOTES AND DETAILS.



PROPOSED CONDITIONS
N.T.S.

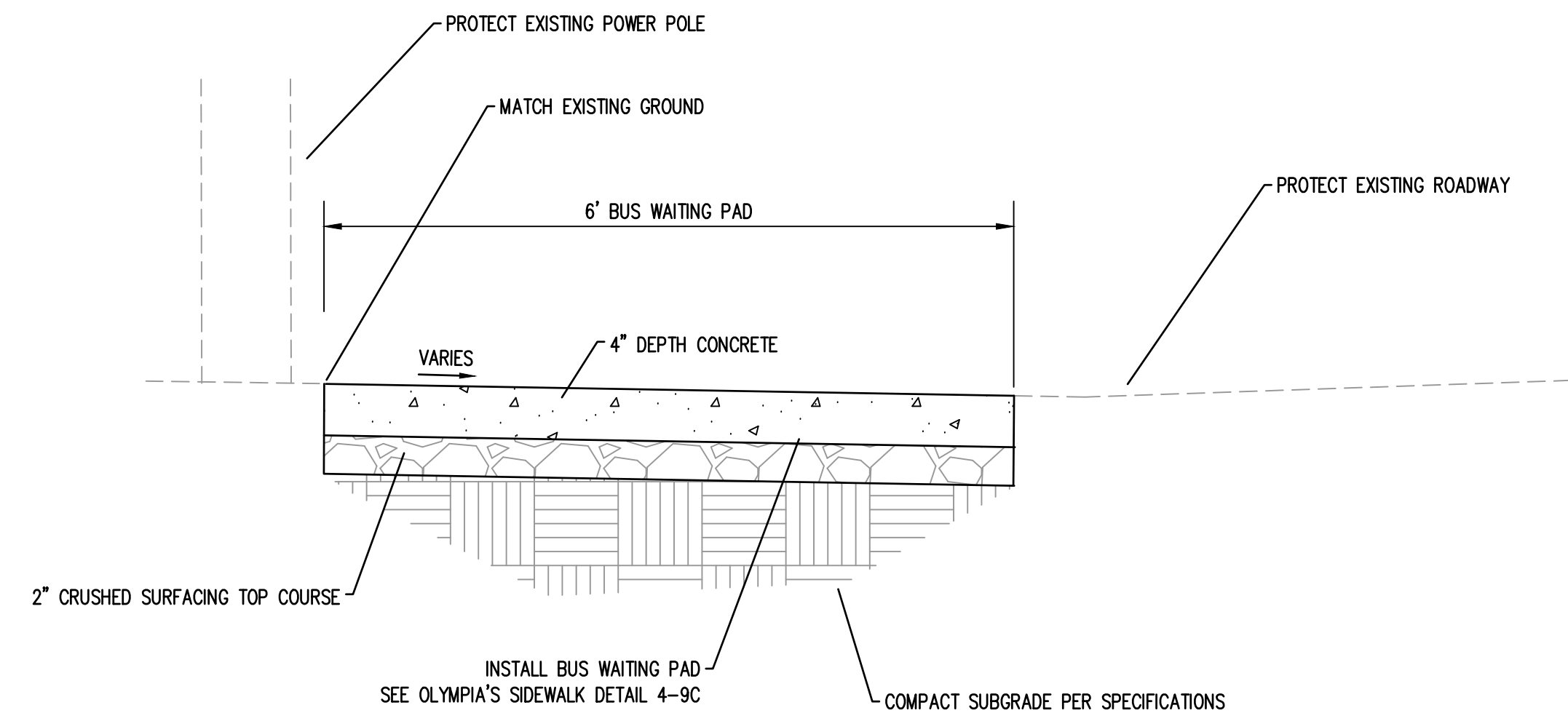

REVISIONS	DATE	BY

SCJ ALLIANCE
CONSULTING SERVICES
8730 TALLON LANE NE SUITE 200, LACEY, WA 98516
P: 360.352.1465 F: 360.352.1509
SCJALLIANCE.COM

BUS STOP 152
PROJECT TITLE:
PROJECT NAME:
INTERCITY TRANSIT BUS STOP CONSTRUCTION
IT PROJECT # 2003C
LACEY, WA

SEAL:

DESIGNER:
W HOLM
DRAWN BY:
M KNECHT
APPROVED BY:
B SHEA
DATE:
APRIL, 2020
JOB NO:
788-AA
DRAWING FILE NO:
788.44-STOP-152
DRAWING NO:
BP-08
SHEET NO:
9 of 17



EXISTING CONDITIONS
N.T.S.

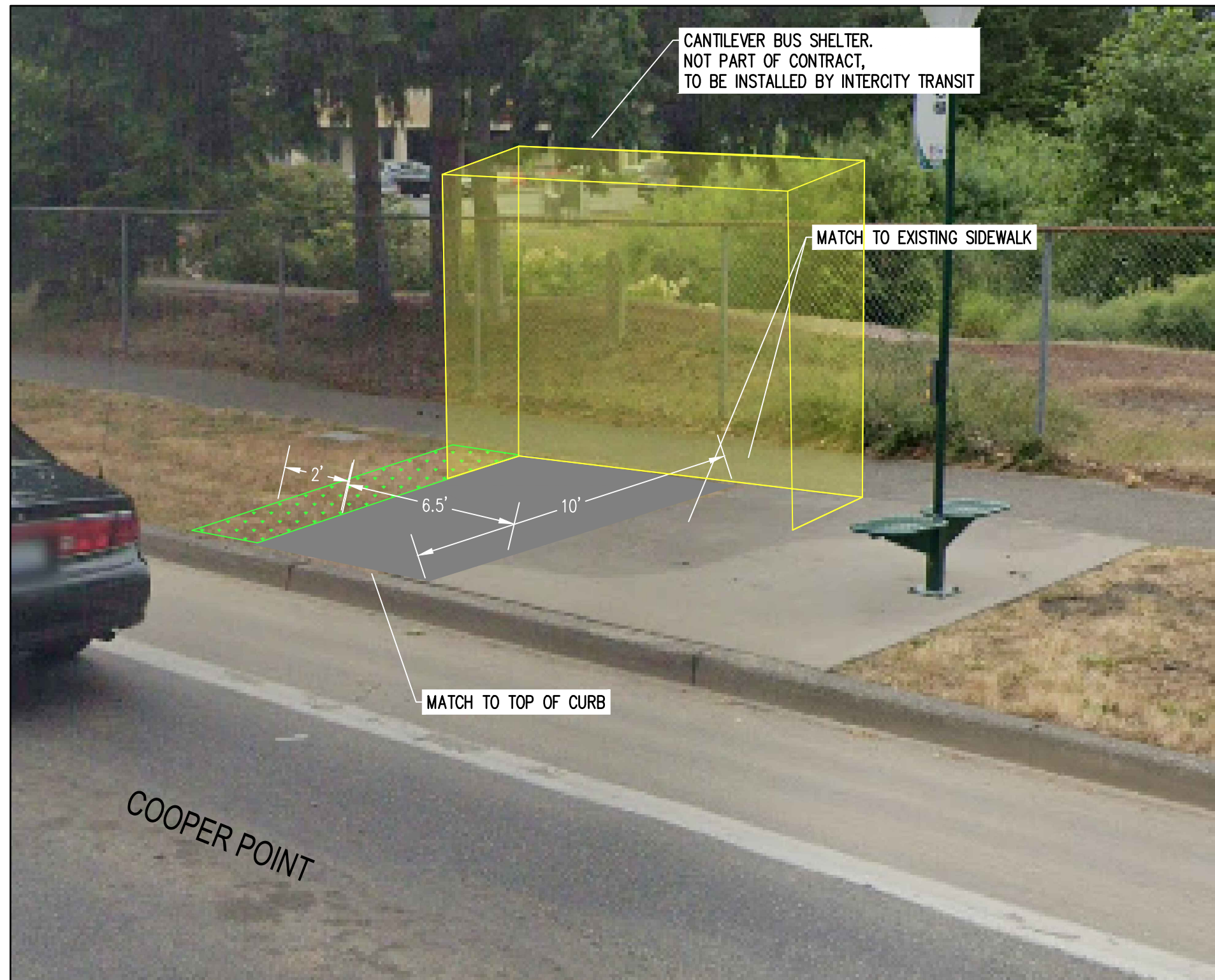

PROPOSED CONDITIONS
N.T.S.

LEGEND

- CEMENT CONCRETE (PLAN VIEW)
- REMOVE EXISTING SIDEWALK
- CEMENT CONCRETE (CROSS SECTION VIEW)
- CSBS (CRUSHED SURFACING BASE COURSE)
- SITE RESTORATION - SOD INSTALLATION

GENERAL NOTES

1. OLYMPIA'S STANDARD CONSTRUCTION NOTES AND DETAILS HAVE BEEN PROVIDED AND REFERENCED ON THE PLANS. ALL WORKMANSHIP AND MATERIALS SHALL BE IN ACCORDANCE WITH THE CITY OF OLYMPIA STANDARDS AND THE MOST CURRENT COPY OF THE WSDOT STANDARD SPECIFICATIONS FOR ROAD, BRIDGE, AND MUNICIPAL CONSTRUCTION.
2. CONTRACTOR SHALL HAVE A COPY OF THE APPROVED CONSTRUCTION PLANS AND SPECIFICATIONS ON THE JOB SITE AT ALL TIMES DURING CONSTRUCTION.
3. THE CONTRACTOR SHALL BE IN COMPLIANCE WITH ALL SAFETY STANDARDS AND REQUIREMENTS AS SET FORTH BY OSHA, WSHA, AND THE WASHINGTON STATE DEPARTMENT OF LABOR AND INDUSTRIES.
4. PRIOR TO WORK ON ANY BUS STOP LOCATION, THE CONTRACTOR SHALL SUBMIT A CONSTRUCTION SCHEDULE TO THE PROJECT ENGINEER FOR REVIEW. THE CONSTRUCTION SCHEDULE SHALL NOTE CONSTRUCTION START AND END DATES FOR EACH BUS STOP. INTERCITY TRANSIT WILL UTILIZE THE SCHEDULE PROVIDED TO COORDINATE AND IMPLEMENT TEMPORARY BUS STOP LOCATIONS. CONTRACTOR TO NOTIFY ENGINEER IMMEDIATELY IF A TEMPORARY BUS STATION HAS NOT BEEN SET UP FOR A BUS STOP SCHEDULED FOR CONSTRUCTION.
5. PRIOR TO WORK ON A SPECIFIC BUS STOP, IT IS THE CONTRACTORS RESPONSIBILITY TO NOTIFY THE CITY OF OLYMPIA THAT WORK WILL BE COMMENCING WITHIN THEIR RIGHT-OF-WAY AND SCHEDULE/ATTEND A PRE-CONSTRUCTION MEETING IF REQUIRED BY THE CITY OF OLYMPIA. CONTRACTOR SHALL NOTIFY THE PROJECT ENGINEER OF ALL SCHEDULED PRE-CONSTRUCTION MEETINGS.
6. THE ENGINEER RESPONSIBLE FOR PREPARATION OF THESE PLANS AND SPECIFICATIONS WILL NOT BE RESPONSIBLE FOR, OR LIABLE FOR, UNAUTHORIZED CHANGES TO OR USES OF THESE PLANS. ALL CHANGES TO THE PLANS MUST BE IN WRITING AND MUST BE APPROVED BY THE ENGINEER RESPONSIBLE FOR PREPARATION OF THESE PLANS.
7. CONTRACTOR TO NOTE THAT CONSTRUCTION ACTIVITY WILL OCCUR IN AREAS WHERE EXISTING UNDERGROUND UTILITIES ARE LOCATED. THE CONTRACTOR SHALL BE FULLY RESPONSIBLE FOR THE LOCATION AND PROTECTION OF ALL EXISTING UTILITIES. THE CONTRACTOR SHALL VERIFY ALL UTILITY LOCATIONS PRIOR TO CONSTRUCTION BY CALLING THE UNDERGROUND LOCATE LINE AT 811 A MINIMUM OF 72 HOURS PRIOR TO THE START OF CONSTRUCTION.

GENERAL CONSTRUCTION NOTES

8. EROSION CONTROL MEASURES SHALL BE IMPLEMENTED AT ALL BUS STOP CONSTRUCTION LOCATION AS REQUIRED TO PREVENT SILT LADEN WATER FROM EXITING THE SITE OR ENTERING INTO STORM DRAINAGE FACILITIES. THE PLANS MAY NOTE SPECIFIC EROSION CONTROL MEASURES THAT MAY BE REQUIRED, HOWEVER IT IS THE CONTRACTORS RESPONSIBILITY TO IMPLEMENT ALL EROSION CONTROL MEASURES NECESSARY DURING CONSTRUCTION AND SITE STABILIZATION. SEE PLANS FOR EROSION CONTROL GENERAL NOTES AND DETAILS.
9. TRAFFIC CONTROL WILL BE REQUIRED AT EACH BUS STOP CONSTRUCTION LOCATION. CONTRACTOR TO MEET ALL TRAFFIC CONTROL REQUIREMENTS PER WSDOT, MUTCD, AND CITY OF OLYMPIA STANDARDS. PRIOR TO DISRUPTION OF ANY TRAFFIC, THE CONTRACTOR SHALL PREPARE A SITE SPECIFIC TRAFFIC CONTROL PLAN FOR EACH BUS STOP LOCATION FOR REVIEW AND APPROVAL BY THE CITY OF OLYMPIA. NO WORK SHALL COMMENCE UNTIL ALL APPROVED TRAFFIC CONTROL IS IN PLACE. WORK SHALL BE SUSPENDED IF TRAFFIC CONTROL FAILS TO MEET MINIMUM REQUIREMENTS. CONTRACTOR TO ENSURE THAT TRAFFIC CONTROL ADDRESSES PEDESTRIAN AND BICYCLE TRAFFIC THROUGH THE CONSTRUCTION SITE. TRAFFIC CONTROL MUST BE MAINTAINED 24 HOURS A DAY, 7 DAYS A WEEK WHILE IN USE. PRIOR TO WORK, CONTRACTOR SHALL PROVIDE THE NAME AND PHONE NUMBER OF THE 24 HOUR TRAFFIC CONTROL CONTACT PERSON TO THE PERMITTING AGENCY AND PROJECT ENGINEER.
10. EXISTING SURVEY MONUMENTS, INCLUDING BUT NOT RESTRICTED TO PROPERTY CORNERS AND CENTERLINE MONUMENT MAY BE DISTURBED OR DESTROYED BY CONSTRUCTION OPERATIONS. THE CONTRACTOR, AS PART OF THE BASE BID, SHALL RETAIN A LICENSED PROFESSIONAL LAND SURVEYOR FOR REPLACEMENT OF ANY DISTURBED OR DESTROYED MONUMENTS OR PROPERTY CORNERS IN ACCORDANCE WITH WASHINGTON STATE LAWS.
11. SITE RESTORATION HAS BEEN CALLED OUT ON THE PLANS FOR AREAS THAT WILL BE DISTURBED DURING CONSTRUCTION. CONTRACTOR SHALL INCLUDE IN THE BASE BID RESTORATION OF ALL DISTURBED AREAS AS A RESULT OF CONSTRUCTION. AREAS SHALL BE REPAIRED, REPLACED, AND STABILIZED TO MATCH THE PRE-PROJECT CONDITIONS OR AS NOTED ON THE PLANS. FOR SITE RESTORATION WITH GRASS, CONTRACTOR SHALL INSTALL 6 INCHES MINIMUM OF TOPSOIL. THEN SEED FERTILIZE AND MULCH PER WSDOT SPECIFICATIONS. THE CONTRACTOR IS RESPONSIBLE FOR PROVIDING AT THEIR EXPENSE, ANY TEMPORARY WATER NEEDED TO ESTABLISH SEED GERMINATION AND PROVIDE SUBSTANTIAL GROWTH AND STABILIZATION. IF SEED GERMINATION DOES NOT OCCUR, CONTRACTOR SHALL RESEED AT THEIR EXPENSE. CONTRACTOR SHALL ASSUME A MINIMUM OF 2 FEET BEYOND THE PROPOSED IMPROVEMENTS (ALL LOCATION) WILL REQUIRE SITE RESTORATION UNLESS SPECIFICALLY NOTED DIFFERENTLY ON THE PLANS. CONTRACTOR SHALL REPAIR CONDITIONS. IF UNDERGROUND IRRIGATION SYSTEMS ARE ENCOUNTERED CONTRACTOR SHALL PROTECT AND PRESERVE OR MODIFY THE EXISTING SYSTEM AS REQUIRED TO ACCOMMODATE BUS STOP CONSTRUCTION.
12. EXISTING VEGETATION SHALL BE PROTECTED AND PRESERVED TO THE EXTENT FEASIBLE. ALL EXISTING TREES SHALL BE PROTECTED UNLESS SHOWN ON THE PLANS TO BE REMOVED OR TRIMMED. NO TREE SHALL BE REMOVED WITHOUT WRITTEN AUTHORIZATION FROM THE PROJECT ENGINEER. AT HIS EXPENSE, CONTRACTOR SHALL CONSULT WITH A CERTIFIED ARBORIST PRIOR TO TRIMMING OF EXISTING TREES/ROOT REMOVAL TO ENSURE TRIMMING MAINTAINS THE LONG TERM VIABILITY OF THE TREE.

13. CONTRACTOR SHALL INCLUDE IN BASE BID ALL MATERIALS AND LABOR REQUIRED TO INSTALL AND REMOVE ANY TEMPORARY SHORING SYSTEMS REQUIRED TO CONSTRUCT THESE IMPROVEMENTS. CONTRACTOR SHALL NOTE THAT MANY OF THE BUS STOP LOCATIONS ARE IN CLOSE PROXIMITY TO EXISTING FEATURES AND PRIVATE PROPERTY. IT IS THE CONTRACTORS RESPONSIBILITY TO ENSURE THAT CONSTRUCTION ACTIVITIES DO NOT DAMAGE OR INFRINGE ON PRIVATE PROPERTY.

BUS STOP CONSTRUCTION

14. INTERCITY TRANSIT WILL BE FURNISHING AND INSTALLING THE POLE AND SIGN FOR ALL OF THESE STOPS. DURING CONSTRUCTION THE CONTRACTOR WILL NEED TO REMOVE AND DISPOSE OF THE BURIED CEMENT BUCKET.
15. CONTRACTOR SHALL PROVIDE A CONCRETE JOINT LAYOUT PLAN TO PROJECT ENGINEER FOR REVIEW ONE WEEK PRIOR TO A SCHEDULED CONCRETE POUR. THE CONCRETE JOINT LAYOUT PLAN SHALL PROVIDE DETAILS ON THE LOCATION OF CONTRACTION, CONSTRUCTION, AND ISOLATION JOINTS. THE PLAN MUST BE APPROVED BY THE ENGINEER PRIOR TO THE CONCRETE POUR.
16. ALL FILL PLACED DURING BUS STOP CONSTRUCTION SHALL BE STRUCTURAL FILL MEETING WSDOT STANDARD SPECIFICATION 9-03.14(3) COMMON BORROW AND SHALL BE COMPACTED TO WSDOT SPECIFICATIONS UNLESS OTHERWISE NOTED ON THE PLANS.
17. CONTRACTOR SHALL PROVIDE A TOWELED EDGE ALONG THE OUTSIDE PERIMETER OF ALL CONCRETE BUS STOP PADS, CURBS, AND WALLS; CONCRETE EDGING SHALL BE 4 INCHES WIDE WITH A 1/2 INCH RADIUS.
18. FOR BUS PAD CONSTRUCTION, CROSS SLOPE GRADES SHALL NOT EXCEED 1.7%. LONGITUDINAL GRADES FOR TRANSITIONAL RAMPS SHALL NOT EXCEED 8%. IF UPON FINAL INSPECTION OF THE COMPLETED WORK, AND PORTION OF THE WORK DOES NOT MEET THESE REQUIREMENTS, THE WORK SHALL BE REMOVED AND RECONSTRUCTED, AT THE EXPENSE OF THE CONTRACTOR. NO EXCEPTION WILL BE PROVIDED. ALL CONCRETE CONSTRUCTION SHALL HAVE A MINIMUM SLOPED 1% FOR WATER DRAINAGE, UNLESS OTHERWISE NOTED ON THE PLANS.
19. CONTRACTOR TO NOTE ALL BUS STOP PAD DIMENSIONS (LENGTH AND WIDTH) ARE THE ACTUAL SLAB DIMENSIONS. ALL ADDITIONAL CONSTRUCTION SUCH AS PEDESTRIAN CURBS OR WALLS SHALL ABUT THE SLAB AS NOTED IN THE CROSS SECTIONS. AS SUCH, A 6'x8' SLAB WILL RESULT IN 48 SQUARE FEET OF CONCRETE SURFACE. SEE PLANS FOR BUS PAD DIMENSIONS, AS THIS VARIES FOR SPECIFIC SITES.

CONSTRUCTION INSPECTION

20. ALL CONCRETE WORK FOR THIS PROJECT WILL BE INSPECTED BY THE PROJECT ENGINEER AND CITY OF OLYMPIA INSPECTOR. REQUIRED INSPECTIONS INCLUDE CONSTRUCTION STAKING, SUBGRADE INSPECTION, CONCRETE FORMWORK, AND FINAL INSPECTION OF CONCRETE AND FINISHED GRADES. CONTRACTOR SHALL PROVIDE A 24 HOUR NOTICE TO THE PROJECT ENGINEER AND CITY OF OLYMPIA INSPECTOR PRIOR TO THE REQUIRED INSPECTIONS. NO CONCRETE WORK SHALL BE COMPLETED WITHOUT INSPECTION APPROVAL FROM THE PROJECT ENGINEER AND CITY OF OLYMPIA INSPECTOR. ANY CONCRETE WORK COMPLETED BY THE CONTRACTOR WITHOUT THE REQUIRED INSPECTIONS WILL BE AT THE RISK OF THE CONTRACTOR. THE CONTRACTOR IS URGED TO COORDINATE SITE INSPECTIONS FOR MAXIMUM EFFICIENCY, I.E. COMPLETE MULTIPLE SITE INSPECTIONS IN ONE DAY WITHIN CLOSE PROXIMITY OF EACH OTHER.

JURISDICTION NOTES

1. SEE DRAWING DET-02 FOR CITY OF OLYMPIA STANDARD NOTES AND DETAILS.

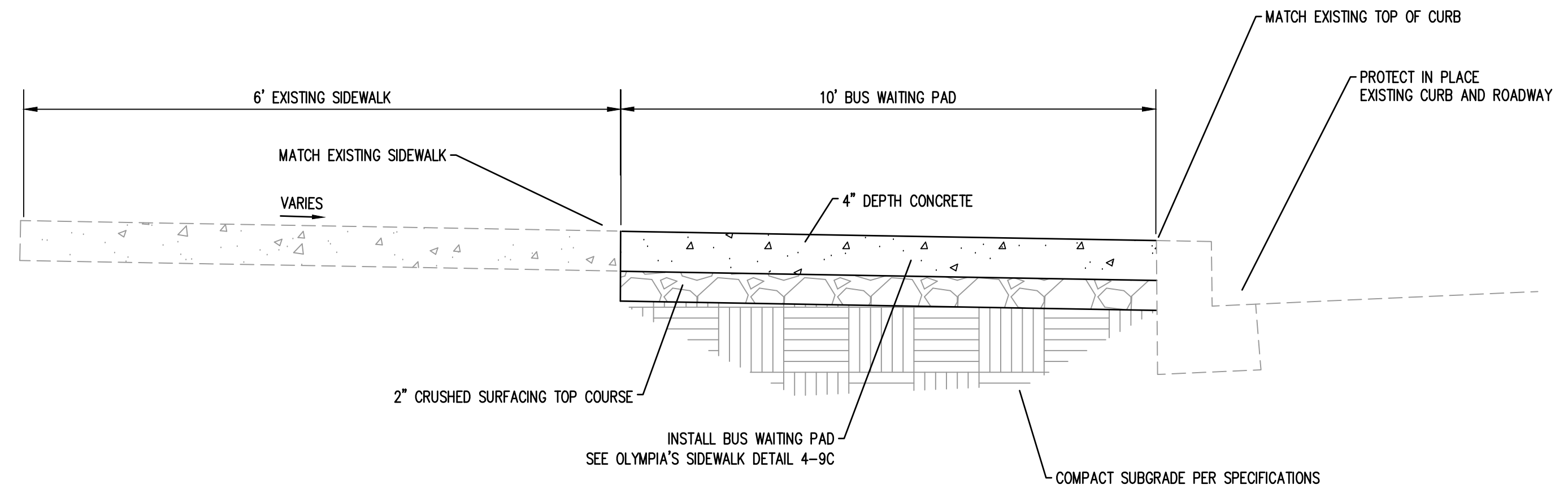

REVISIONS	DATE	BY

SCJ ALLIANCE
CONSULTING SERVICES
8730 TALLON LANE NE SUITE 200, LACEY, WA 98516
P: 360.352.1465 F: 360.352.1509
SCJALLIANCE.COM

SHEET TITLE: **BUS STOP 381**
PROJECT NAME: **INTERCITY TRANSIT BUS STOP CONSTRUCTION**
IT PROJECT # 2003C
LACEY, WA

SEAL:

DESIGNER: W HOLM
DRAWN BY: M KNECHT
APPROVED BY: B SHEA
DATE: APRIL, 2020
JOB NO: 788-AA
DRAWING FILE NO: 788.44-ST0P-381
DRAWING NO: BP-9
SHEET NO: 10 of 17

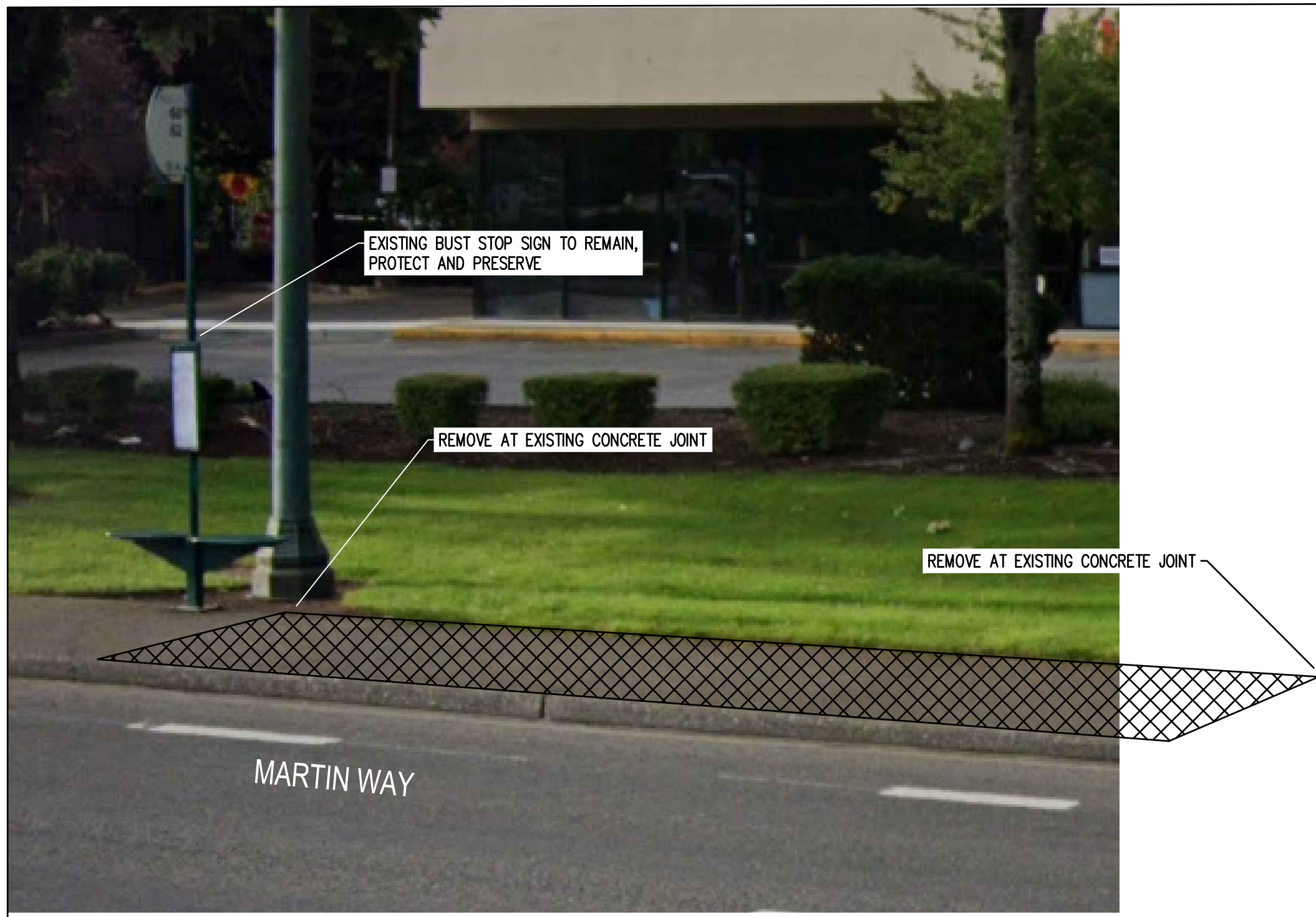

EXISTING CONDITIONS
N.T.S.

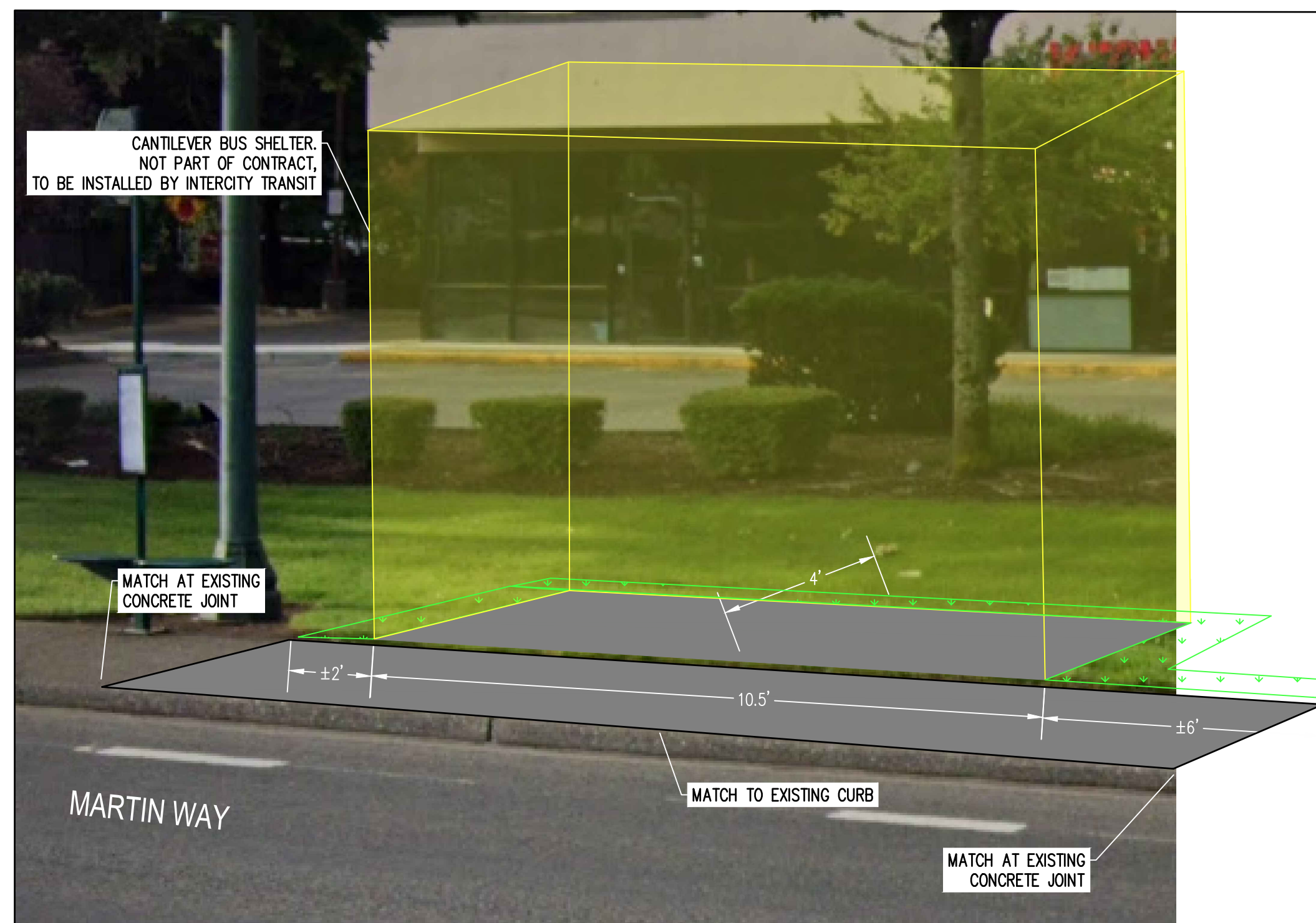

PROPOSED CONDITIONS
N.T.S.

3959 MARTIN WAY

LEGEND

- CEMENT CONCRETE (PLAN VIEW)
- REMOVE EXISTING SIDEWALK
- CEMENT CONCRETE (CROSS SECTION VIEW)
- CSBS (CRUSHED SURFACING BASE COURSE)
- SITE RESTORATION - SOD INSTALLATION

GENERAL NOTES

1. OLYMPIA'S STANDARD CONSTRUCTION NOTES AND DETAILS HAVE BEEN PROVIDED AND REFERENCED ON THE PLANS. ALL WORKMANSHIP AND MATERIALS SHALL BE IN ACCORDANCE WITH THE CITY OF OLYMPIA STANDARDS AND THE MOST CURRENT COPY OF THE WSDOT STANDARD SPECIFICATIONS FOR ROAD, BRIDGE, AND MUNICIPAL CONSTRUCTION.
2. CONTRACTOR SHALL HAVE A COPY OF THE APPROVED CONSTRUCTION PLANS AND SPECIFICATIONS ON THE JOB SITE AT ALL TIMES DURING CONSTRUCTION.
3. THE CONTRACTOR SHALL BE IN COMPLIANCE WITH ALL SAFETY STANDARDS AND REQUIREMENTS AS SET FORTH BY OSHA, WSHA, AND THE WASHINGTON STATE DEPARTMENT OF LABOR AND INDUSTRIES.
4. PRIOR TO WORK ON ANY BUS STOP LOCATION, THE CONTRACTOR SHALL SUBMIT A CONSTRUCTION SCHEDULE TO THE PROJECT ENGINEER FOR REVIEW. THE CONSTRUCTION SCHEDULE SHALL NOTE CONSTRUCTION START AND END DATES FOR EACH BUS STOP. INTERCITY TRANSIT WILL UTILIZE THE SCHEDULE PROVIDED TO COORDINATE AND IMPLEMENT TEMPORARY BUS STOP LOCATIONS. CONTRACTOR TO NOTIFY ENGINEER IMMEDIATELY IF A TEMPORARY BUS STATION HAS NOT BEEN SET UP FOR A BUS STOP SCHEDULED FOR CONSTRUCTION.
5. PRIOR TO WORK ON A SPECIFIC BUS STOP, IT IS THE CONTRACTORS RESPONSIBILITY TO NOTIFY THE CITY OF OLYMPIA THAT WORK WILL BE COMMENCING WITHIN THEIR RIGHT-OF-WAY AND SCHEDULE/ATTEND A PRE-CONSTRUCTION MEETING IF REQUIRED BY THE CITY OF OLYMPIA. CONTRACTOR SHALL NOTIFY THE PROJECT ENGINEER OF ALL SCHEDULED PRE-CONSTRUCTION MEETINGS.
6. THE ENGINEER RESPONSIBLE FOR PREPARATION OF THESE PLANS AND SPECIFICATIONS WILL NOT BE RESPONSIBLE FOR, OR LIABLE FOR, UNAUTHORIZED CHANGES TO OR USES OF THESE PLANS. ALL CHANGES TO THE PLANS MUST BE IN WRITING AND MUST BE APPROVED BY THE ENGINEER RESPONSIBLE FOR PREPARATION OF THESE PLANS.
7. CONTRACTOR TO NOTE THAT CONSTRUCTION ACTIVITY WILL OCCUR IN AREAS WHERE EXISTING UNDERGROUND UTILITIES ARE LOCATED. THE CONTRACTOR SHALL BE FULLY RESPONSIBLE FOR THE LOCATION AND PROTECTION OF ALL EXISTING UTILITIES. THE CONTRACTOR SHALL VERIFY ALL UTILITY LOCATIONS PRIOR TO CONSTRUCTION BY CALLING THE UNDERGROUND LOCATE LINE AT 811 A MINIMUM OF 72 HOURS PRIOR TO THE START OF CONSTRUCTION.

GENERAL CONSTRUCTION NOTES

8. EROSION CONTROL MEASURES SHALL BE IMPLEMENTED AT ALL BUS STOP CONSTRUCTION LOCATION AS REQUIRED TO PREVENT SILT LADEN WATER FROM EXITING THE SITE OR ENTERING INTO STORM DRAINAGE FACILITIES. THE PLANS MAY NOTE SPECIFIC EROSION CONTROL MEASURES THAT MAY BE REQUIRED, HOWEVER IT IS THE CONTRACTORS RESPONSIBILITY TO IMPLEMENT ALL EROSION CONTROL MEASURES NECESSARY DURING CONSTRUCTION AND SITE STABILIZATION. SEE PLANS FOR EROSION CONTROL GENERAL NOTES AND DETAILS.
9. TRAFFIC CONTROL WILL BE REQUIRED AT EACH BUS STOP CONSTRUCTION LOCATION. CONTRACTOR TO MEET ALL TRAFFIC CONTROL REQUIREMENTS PER WSDOT, MUTCD, AND CITY OF OLYMPIA STANDARDS. PRIOR TO DISRUPTION OF ANY TRAFFIC, THE CONTRACTOR SHALL PREPARE A SITE SPECIFIC TRAFFIC CONTROL PLAN FOR EACH BUS STOP LOCATION FOR REVIEW AND APPROVAL BY THE CITY OF OLYMPIA. NO WORK SHALL COMMENCE UNTIL ALL APPROVED TRAFFIC CONTROL IS IN PLACE. WORK SHALL BE SUSPENDED IF TRAFFIC CONTROL FAILS TO MEET MINIMUM REQUIREMENTS. CONTRACTOR TO ENSURE THAT TRAFFIC CONTROL ADDRESSES PEDESTRIAN AND BICYCLE TRAFFIC THROUGH THE CONSTRUCTION SITE. TRAFFIC CONTROL MUST BE MAINTAINED 24 HOURS A DAY, 7 DAYS A WEEK WHILE IN USE. PRIOR TO WORK, CONTRACTOR SHALL PROVIDE THE NAME AND PHONE NUMBER OF THE 24 HOUR TRAFFIC CONTROL CONTACT PERSON TO THE PERMITTING AGENCY AND PROJECT ENGINEER.
10. EXISTING SURVEY MONUMENTS, INCLUDING BUT NOT RESTRICTED TO PROPERTY CORNERS AND CENTERLINE MONUMENT MAY BE DISTURBED OR DESTROYED BY CONSTRUCTION OPERATIONS. THE CONTRACTOR, AS PART OF THE BASE BID, SHALL RETAIN A LICENSED PROFESSIONAL LAND SURVEYOR FOR REPLACEMENT OF ANY DISTURBED OR DESTROYED MONUMENTS OR PROPERTY CORNERS IN ACCORDANCE WITH WASHINGTON STATE LAWS.
11. SITE RESTORATION HAS BEEN CALLED OUT ON THE PLANS FOR AREAS THAT WILL BE DISTURBED DURING CONSTRUCTION. CONTRACTOR SHALL INCLUDE IN THE BASE BID RESTORATION OF ALL DISTURBED AREAS AS A RESULT OF CONSTRUCTION. AREAS SHALL BE REPAIRED, REPLACED, AND STABILIZED TO MATCH THE PRE-PROJECT CONDITIONS OR AS NOTED ON THE PLANS. FOR SITE RESTORATION WITH GRASS, CONTRACTOR SHALL INSTALL 6 INCHES MINIMUM OF TOPSOIL. THEN SEED FERTILIZE AND MULCH PER WSDOT SPECIFICATIONS. THE CONTRACTOR IS RESPONSIBLE FOR PROVIDING AT THEIR EXPENSE, ANY TEMPORARY WATER NEEDED TO ESTABLISH SEED GERMINATION AND PROVIDE SUBSTANTIAL GROWTH AND STABILIZATION. IF SEED GERMINATION DOES NOT OCCUR, CONTRACTOR SHALL RESEED AT THEIR EXPENSE. CONTRACTOR SHALL ASSUME A MINIMUM OF 2 FEET BEYOND THE PROPOSED IMPROVEMENTS (ALL LOCATION) WILL REQUIRE SITE RESTORATION UNLESS SPECIFICALLY NOTED DIFFERENTLY ON THE PLANS. CONTRACTOR SHALL REPAIR CONDITIONS. IF UNDERGROUND IRRIGATION SYSTEMS ARE ENCOUNTERED CONTRACTOR SHALL PROTECT AND PRESERVE OR MODIFY THE EXISTING SYSTEM AS REQUIRED TO ACCOMMODATE BUS STOP CONSTRUCTION.
12. EXISTING VEGETATION SHALL BE PROTECTED AND PRESERVED TO THE EXTENT FEASIBLE. ALL EXISTING TREES SHALL BE PROTECTED UNLESS SHOWN ON THE PLANS TO BE REMOVED OR TRIMMED. NO TREE SHALL BE REMOVED WITHOUT WRITTEN AUTHORIZATION FROM THE PROJECT ENGINEER. AT HIS EXPENSE, CONTRACTOR SHALL CONSULT WITH A CERTIFIED ARBORIST PRIOR TO TRIMMING OF EXISTING TREES/ROOT REMOVAL TO ENSURE TRIMMING MAINTAINS THE LONG TERM VIABILITY OF THE TREE.

13. CONTRACTOR SHALL INCLUDE IN BASE BID ALL MATERIALS AND LABOR REQUIRED TO INSTALL AND REMOVE ANY TEMPORARY SHORING SYSTEMS REQUIRED TO CONSTRUCT THESE IMPROVEMENTS. CONTRACTOR SHALL NOTE THAT MANY OF THE BUS STOP LOCATIONS ARE IN CLOSE PROXIMITY TO EXISTING FEATURES AND PRIVATE PROPERTY. IT IS THE CONTRACTORS RESPONSIBILITY TO ENSURE THAT CONSTRUCTION ACTIVITIES DO NOT DAMAGE OR INFRINGE ON PRIVATE PROPERTY.

BUS STOP CONSTRUCTION

14. INTERCITY TRANSIT WILL BE FURNISHING AND INSTALLING THE POLE AND SIGN FOR ALL OF THESE STOPS. DURING CONSTRUCTION THE CONTRACTOR WILL NEED TO REMOVE AND DISPOSE OF THE BURIED CEMENT BUCKET.
15. CONTRACTOR SHALL PROVIDE A CONCRETE JOINT LAYOUT PLAN TO PROJECT ENGINEER FOR REVIEW ONE WEEK PRIOR TO A SCHEDULED CONCRETE POUR. THE CONCRETE JOINT LAYOUT PLAN SHALL PROVIDE DETAILS ON THE LOCATION OF CONTRACTION, CONSTRUCTION, AND ISOLATION JOINTS. THE PLAN MUST BE APPROVED BY THE ENGINEER PRIOR TO THE CONCRETE POUR.
16. ALL FILL PLACED DURING BUS STOP CONSTRUCTION SHALL BE STRUCTURAL FILL MEETING WSDOT STANDARD SPECIFICATION 9-03.14(3) COMMON BORROW AND SHALL BE COMPACTED TO WSDOT SPECIFICATIONS UNLESS OTHERWISE NOTED ON THE PLANS.
17. CONTRACTOR SHALL PROVIDE A TOWELED EDGE ALONG THE OUTSIDE PERIMETER OF ALL CONCRETE BUS STOP PADS, CURBS, AND WALLS; CONCRETE EDGING SHALL BE 4 INCHES WIDE WITH A 1/2 INCH RADIUS.
18. FOR BUS PAD CONSTRUCTION, CROSS SLOPE GRADES SHALL NOT EXCEED 1.7%. LONGITUDINAL GRADES FOR TRANSITIONAL RAMPS SHALL NOT EXCEED 8%. IF UPON FINAL INSPECTION OF THE COMPLETED WORK, AND PORTION OF THE WORK DOES NOT MEET THESE REQUIREMENTS, THE WORK SHALL BE REMOVED AND RECONSTRUCTED, AT THE EXPENSE OF THE CONTRACTOR. NO EXCEPTION WILL BE PROVIDED. ALL CONCRETE CONSTRUCTION SHALL HAVE A MINIMUM SLOPED 1% FOR WATER DRAINAGE, UNLESS OTHERWISE NOTED ON THE PLANS.
19. CONTRACTOR TO NOTE ALL BUS STOP PAD DIMENSIONS (LENGTH AND WIDTH) ARE THE ACTUAL SLAB DIMENSIONS. ALL ADDITIONAL CONSTRUCTION SUCH AS PEDESTRIAN CURBS OR WALLS SHALL ABUT THE SLAB AS NOTED IN THE CROSS SECTIONS. AS SUCH, A 6'x8' SLAB WILL RESULT IN 48 SQUARE FEET OF CONCRETE SURFACE. SEE PLANS FOR BUS PAD DIMENSIONS, AS THIS VARIES FOR SPECIFIC SITES.

CONSTRUCTION INSPECTION

20. ALL CONCRETE WORK FOR THIS PROJECT WILL BE INSPECTED BY THE PROJECT ENGINEER AND CITY OF OLYMPIA INSPECTOR. REQUIRED INSPECTIONS INCLUDE CONSTRUCTION STAKING, SUBGRADE INSPECTION, CONCRETE FORMWORK, AND FINAL INSPECTION OF CONCRETE AND FINISHED GRADES. CONTRACTOR SHALL PROVIDE A 24 HOUR NOTICE TO THE PROJECT ENGINEER AND CITY OF OLYMPIA INSPECTOR PRIOR TO THE REQUIRED INSPECTIONS. NO CONCRETE WORK SHALL BE COMPLETED WITHOUT INSPECTION APPROVAL FROM THE PROJECT ENGINEER AND CITY OF OLYMPIA INSPECTOR. ANY CONCRETE WORK COMPLETED BY THE CONTRACTOR WITHOUT THE REQUIRED INSPECTIONS WILL BE AT THE RISK OF THE CONTRACTOR. THE CONTRACTOR IS URGED TO COORDINATE SITE INSPECTIONS FOR MAXIMUM EFFICIENCY, I.E. COMPLETE MULTIPLE SITE INSPECTIONS IN ONE DAY WITHIN CLOSE PROXIMITY OF EACH OTHER.

JURISDICTION NOTES

1. SEE DRAWING DET-02 FOR CITY OF OLYMPIA STANDARD NOTES AND DETAILS.

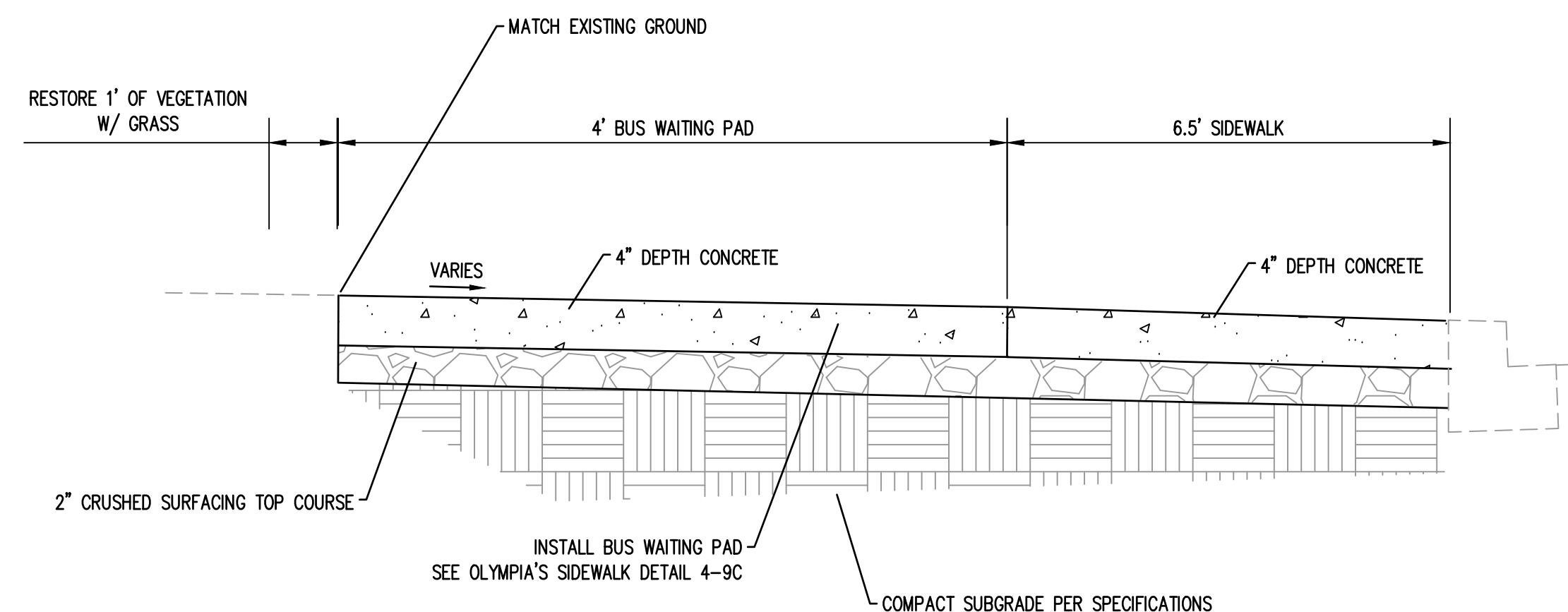

REVISIONS	DATE	BY

SCJ ALLIANCE
CONSULTING SERVICES
8730 TALLON LANE NE SUITE 200, LACEY, WA 98516
P: 360.352.1465 F: 360.352.1509
SCJALLIANCE.COM

BUS STOP 489
PROJECT TITLE:
PROJECT NAME:
INTERCITY TRANSIT BUS STOP CONSTRUCTION
IT PROJECT # 2003C
LACEY, WA

SEAL:

DESIGNER:
W HOLM
DRAWN BY:
M KNECHT
APPROVED BY:
B SHEA
DATE:
APRIL, 2020
JOB NO:
788-AA
DRAWING FILE NO:
788.44-STOP-489
DRAWING NO:
BP-10
SHEET NO:
11 OF 17

Jul 10, 2020 7:33:16am - User: whitneyholm
R:\PROJECTS\0188 INTERCITY TRANSIT\0188AA TD-1 BUS STOP PAD IMPROVEMENTS RT. 65\CAD\1768.44-STOP-489.DWG

3350 MOTTMAN ROAD - NORTH SIDE OF THE STREET



EXISTING CONDITIONS
N.T.S.

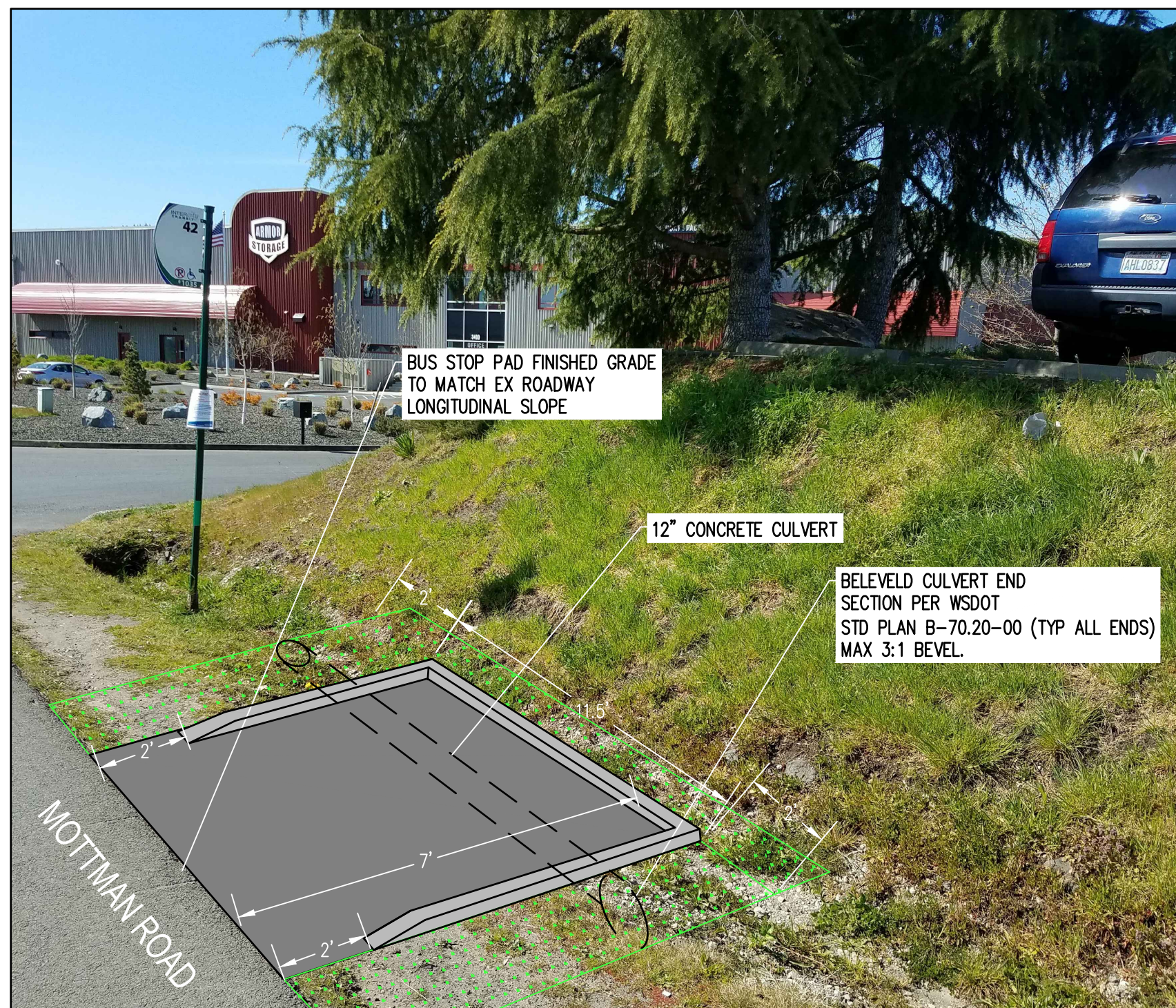

PROPOSED CONDITIONS
N.T.S.

LEGEND

- CEMENT CONCRETE (PLAN VIEW)
- PEDESTRIAN CURB (PLAN VIEW)
- CEMENT CONCRETE (CROSS SECTION VIEW)
- CSBS (CRUSHED SURFACING BASE COURSE)
- SITE RESTORATION - SOD INSTALLATION

GENERAL NOTES

1. OLYMPIA'S STANDARD CONSTRUCTION NOTES AND DETAILS HAVE BEEN PROVIDED AND REFERENCED ON THE PLANS. ALL WORKMANSHIP AND MATERIALS SHALL BE IN ACCORDANCE WITH THE CITY OF OLYMPIA STANDARDS AND THE MOST CURRENT COPY OF THE WSDOT STANDARD SPECIFICATIONS FOR ROAD, BRIDGE, AND MUNICIPAL CONSTRUCTION.
2. CONTRACTOR SHALL HAVE A COPY OF THE APPROVED CONSTRUCTION PLANS AND SPECIFICATIONS ON THE JOB SITE AT ALL TIMES DURING CONSTRUCTION.
3. THE CONTRACTOR SHALL BE IN COMPLIANCE WITH ALL SAFETY STANDARDS AND REQUIREMENTS AS SET FORTH BY OSHA, WSHA, AND THE WASHINGTON STATE DEPARTMENT OF LABOR AND INDUSTRIES.
4. PRIOR TO WORK ON ANY BUS STOP LOCATION, THE CONTRACTOR SHALL SUBMIT A CONSTRUCTION SCHEDULE TO THE PROJECT ENGINEER FOR REVIEW. THE CONSTRUCTION SCHEDULE SHALL NOTE CONSTRUCTION START AND END DATES FOR EACH BUS STOP. INTERCITY TRANSIT WILL UTILIZE THE SCHEDULE PROVIDED TO COORDINATE AND IMPLEMENT TEMPORARY BUS STOP LOCATIONS. CONTRACTOR TO NOTIFY ENGINEER IMMEDIATELY IF A TEMPORARY BUS STATION HAS NOT BEEN SET UP FOR A BUS STOP SCHEDULED FOR CONSTRUCTION.
5. PRIOR TO WORK ON A SPECIFIC BUS STOP, IT IS THE CONTRACTORS RESPONSIBILITY TO NOTIFY THE CITY OF OLYMPIA THAT WORK WILL BE COMMENCING WITHIN THEIR RIGHT-OF-WAY AND SCHEDULE/ATTEND A PRE-CONSTRUCTION MEETING IF REQUIRED BY THE CITY OF OLYMPIA. CONTRACTOR SHALL NOTIFY THE PROJECT ENGINEER OF ALL SCHEDULED PRE-CONSTRUCTION MEETINGS.
6. THE ENGINEER RESPONSIBLE FOR PREPARATION OF THESE PLANS AND SPECIFICATIONS WILL NOT BE RESPONSIBLE FOR, OR LIABLE FOR, UNAUTHORIZED CHANGES TO OR USES OF THESE PLANS. ALL CHANGES TO THE PLANS MUST BE IN WRITING AND MUST BE APPROVED BY THE ENGINEER RESPONSIBLE FOR PREPARATION OF THESE PLANS.
7. CONTRACTOR TO NOTE THAT CONSTRUCTION ACTIVITY WILL OCCUR IN AREAS WHERE EXISTING UNDERGROUND UTILITIES ARE LOCATED. THE CONTRACTOR SHALL BE FULLY RESPONSIBLE FOR THE LOCATION AND PROTECTION OF ALL EXISTING UTILITIES. THE CONTRACTOR SHALL VERIFY ALL UTILITY LOCATIONS PRIOR TO CONSTRUCTION BY CALLING THE UNDERGROUND LOCATE LINE AT 811 A MINIMUM OF 72 HOURS PRIOR TO THE START OF CONSTRUCTION.

GENERAL CONSTRUCTION NOTES

8. EROSION CONTROL MEASURES SHALL BE IMPLEMENTED AT ALL BUS STOP CONSTRUCTION LOCATION AS REQUIRED TO PREVENT SILT LADEN WATER FROM EXITING THE SITE OR ENTERING INTO STORM DRAINAGE FACILITIES. THE PLANS MAY NOTE SPECIFIC EROSION CONTROL MEASURES THAT MAY BE REQUIRED, HOWEVER IT IS THE CONTRACTORS RESPONSIBILITY TO IMPLEMENT ALL EROSION CONTROL MEASURES NECESSARY DURING CONSTRUCTION AND SITE STABILIZATION. SEE PLANS FOR EROSION CONTROL GENERAL NOTES AND DETAILS.
9. TRAFFIC CONTROL WILL BE REQUIRED AT EACH BUS STOP CONSTRUCTION LOCATION. CONTRACTOR TO MEET ALL TRAFFIC CONTROL REQUIREMENTS PER WSDOT, MUTCD, AND CITY OF OLYMPIA STANDARDS. PRIOR TO DISRUPTION OF ANY TRAFFIC, THE CONTRACTOR SHALL PREPARE A SITE SPECIFIC TRAFFIC CONTROL PLAN FOR EACH BUS STOP LOCATION FOR REVIEW AND APPROVAL BY THE CITY OF OLYMPIA. NO WORK SHALL COMMENCE UNTIL ALL APPROVED TRAFFIC CONTROL IS IN PLACE. WORK SHALL BE SUSPENDED IF TRAFFIC CONTROL FAILS TO MEET MINIMUM REQUIREMENTS. CONTRACTOR TO ENSURE THAT TRAFFIC CONTROL ADDRESSES PEDESTRIAN AND BICYCLE TRAFFIC THROUGH THE CONSTRUCTION SITE. TRAFFIC CONTROL MUST BE MAINTAINED 24 HOURS A DAY, 7 DAYS A WEEK WHILE IN USE. PRIOR TO WORK, CONTRACTOR SHALL PROVIDE THE NAME AND PHONE NUMBER OF THE 24 HOUR TRAFFIC CONTROL CONTACT PERSON TO THE PERMITTING AGENCY AND PROJECT ENGINEER.
10. EXISTING SURVEY MONUMENTS, INCLUDING BUT NOT RESTRICTED TO PROPERTY CORNERS AND CENTERLINE MONUMENT MAY BE DISTURBED OR DESTROYED BY CONSTRUCTION OPERATIONS. THE CONTRACTOR, AS PART OF THE BASE BID, SHALL RETAIN A LICENSED PROFESSIONAL LAND SURVEYOR FOR REPLACEMENT OF ANY DISTURBED OR DESTROYED MONUMENTS OR PROPERTY CORNERS IN ACCORDANCE WITH WASHINGTON STATE LAWS.
11. SITE RESTORATION HAS BEEN CALLED OUT ON THE PLANS FOR AREAS THAT WILL BE DISTURBED DURING CONSTRUCTION. CONTRACTOR SHALL INCLUDE IN THE BASE BID RESTORATION OF ALL DISTURBED AREAS AS A RESULT OF CONSTRUCTION. AREAS SHALL BE REPAIRED, REPLACED, AND STABILIZED TO MATCH THE PRE-PROJECT CONDITIONS OR AS NOTED ON THE PLANS. FOR SITE RESTORATION WITH GRASS, CONTRACTOR SHALL INSTALL 6 INCHES MINIMUM OF TOPSOIL. THEN SEED FERTILIZE AND MULCH PER WSDOT SPECIFICATIONS. THE CONTRACTOR IS RESPONSIBLE FOR PROVIDING AT THEIR EXPENSE, ANY TEMPORARY WATER NEEDED TO ESTABLISH SEED GERMINATION AND PROVIDE SUBSTANTIAL GROWTH AND STABILIZATION. IF SEED GERMINATION DOES NOT OCCUR, CONTRACTOR SHALL RESEED AT THEIR EXPENSE. CONTRACTOR SHALL ASSUME A MINIMUM OF 2 FEET BEYOND THE PROPOSED IMPROVEMENTS (ALL LOCATION) WILL REQUIRE SITE RESTORATION UNLESS SPECIFICALLY NOTED DIFFERENTLY ON THE PLANS. CONTRACTOR SHALL REPAIR CONDITIONS. IF UNDERGROUND IRRIGATION SYSTEMS ARE ENCOUNTERED CONTRACTOR SHALL PROTECT AND PRESERVE OR MODIFY THE EXISTING SYSTEM AS REQUIRED TO ACCOMMODATE BUS STOP CONSTRUCTION.
12. EXISTING VEGETATION SHALL BE PROTECTED AND PRESERVED TO THE EXTENT FEASIBLE. ALL EXISTING TREES SHALL BE PROTECTED UNLESS SHOWN ON THE PLANS TO BE REMOVED OR TRIMMED. NO TREE SHALL BE REMOVED WITHOUT WRITTEN AUTHORIZATION FROM THE PROJECT ENGINEER. AT HIS EXPENSE, CONTRACTOR SHALL CONSULT WITH A CERTIFIED ARBORIST PRIOR TO TRIMMING OF EXISTING TREES/ROOT REMOVAL TO ENSURE TRIMMING MAINTAINS THE LONG TERM VIABILITY OF THE TREE.

13. CONTRACTOR SHALL INCLUDE IN BASE BID ALL MATERIALS AND LABOR REQUIRED TO INSTALL AND REMOVE ANY TEMPORARY SHORING SYSTEMS REQUIRED TO CONSTRUCT THESE IMPROVEMENTS. CONTRACTOR SHALL NOTE THAT MANY OF THE BUS STOP LOCATIONS ARE IN CLOSE PROXIMITY TO EXISTING FEATURES AND PRIVATE PROPERTY. IT IS THE CONTRACTORS RESPONSIBILITY TO ENSURE THAT CONSTRUCTION ACTIVITIES DO NOT DAMAGE OR INFRINGE ON PRIVATE PROPERTY.

BUS STOP CONSTRUCTION

14. INTERCITY TRANSIT WILL BE FURNISHING AND INSTALLING THE POLE AND SIGN FOR ALL OF THESE STOPS. DURING CONSTRUCTION THE CONTRACTOR WILL NEED TO REMOVE AND DISPOSE OF THE BURIED CEMENT BUCKET.
15. CONTRACTOR SHALL PROVIDE A CONCRETE JOINT LAYOUT PLAN TO PROJECT ENGINEER FOR REVIEW ONE WEEK PRIOR TO A SCHEDULED CONCRETE POUR. THE CONCRETE JOINT LAYOUT PLAN SHALL PROVIDE DETAILS ON THE LOCATION OF CONTRACTION, CONSTRUCTION, AND ISOLATION JOINTS. THE PLAN MUST BE APPROVED BY THE ENGINEER PRIOR TO THE CONCRETE POUR.
16. ALL FILL PLACED DURING BUS STOP CONSTRUCTION SHALL BE STRUCTURAL FILL MEETING WSDOT STANDARD SPECIFICATION 9-03.14(3) COMMON BORROW AND SHALL BE COMPACTED TO WSDOT SPECIFICATIONS UNLESS OTHERWISE NOTED ON THE PLANS.
17. CONTRACTOR SHALL PROVIDE A TOWELED EDGE ALONG THE OUTSIDE PERIMETER OF ALL CONCRETE BUS STOP PADS, CURBS, AND WALLS; CONCRETE EDGING SHALL BE 4 INCHES WIDE WITH A 1/2 INCH RADIUS.
18. FOR BUS PAD CONSTRUCTION, CROSS SLOPE GRADES SHALL NOT EXCEED 1.7%. LONGITUDINAL GRADES FOR TRANSITIONAL RAMPS SHALL NOT EXCEED 8% IF UPON FINAL INSPECTION OF THE COMPLETED WORK, AND PORTION OF THE WORK DOES NOT MEET THESE REQUIREMENTS, THE WORK SHALL BE REMOVED AND RECONSTRUCTED, AT THE EXPENSE OF THE CONTRACTOR. NO EXCEPTION WILL BE PROVIDED. ALL CONCRETE CONSTRUCTION SHALL HAVE A MINIMUM SLOPED 1% FOR WATER DRAINAGE, UNLESS OTHERWISE NOTED ON THE PLANS.
19. CONTRACTOR TO NOTE ALL BUS STOP PAD DIMENSIONS (LENGTH AND WIDTH) ARE THE ACTUAL SLAB DIMENSIONS. ALL ADDITIONAL CONSTRUCTION SUCH AS PEDESTRIAN CURBS OR WALLS SHALL ABUT THE SLAB AS NOTED IN THE CROSS SECTIONS. AS SUCH, A 6'x8' SLAB WILL RESULT IN 48 SQUARE FEET OF CONCRETE SURFACE. SEE PLANS FOR BUS PAD DIMENSIONS, AS THIS VARIES FOR SPECIFIC SITES.

CONSTRUCTION INSPECTION

20. ALL CONCRETE WORK FOR THIS PROJECT WILL BE INSPECTED BY THE PROJECT ENGINEER AND CITY OF OLYMPIA INSPECTOR. REQUIRED INSPECTIONS INCLUDE CONSTRUCTION STAKING, SUBGRADE INSPECTION, CONCRETE FORMWORK, AND FINAL INSPECTION OF CONCRETE AND FINISHED GRADES. CONTRACTOR SHALL PROVIDE A 24 HOUR NOTICE TO THE PROJECT ENGINEER AND CITY OF OLYMPIA INSPECTOR PRIOR TO THE REQUIRED INSPECTIONS. NO CONCRETE WORK SHALL BE COMPLETED WITHOUT INSPECTION APPROVAL FROM THE PROJECT ENGINEER AND CITY OF OLYMPIA INSPECTOR. ANY CONCRETE WORK COMPLETED BY THE CONTRACTOR WITHOUT THE REQUIRED INSPECTIONS WILL BE AT THE RISK OF THE CONTRACTOR. THE CONTRACTOR IS URGED TO COORDINATE SITE INSPECTIONS FOR MAXIMUM EFFICIENCY, I.E. COMPLETE MULTIPLE SITE INSPECTIONS IN ONE DAY WITHIN CLOSE PROXIMITY OF EACH OTHER.

JURISDICTION NOTES

1. SEE DRAWING DET-02 FOR CITY OF OLYMPIA STANDARD NOTES AND DETAILS.

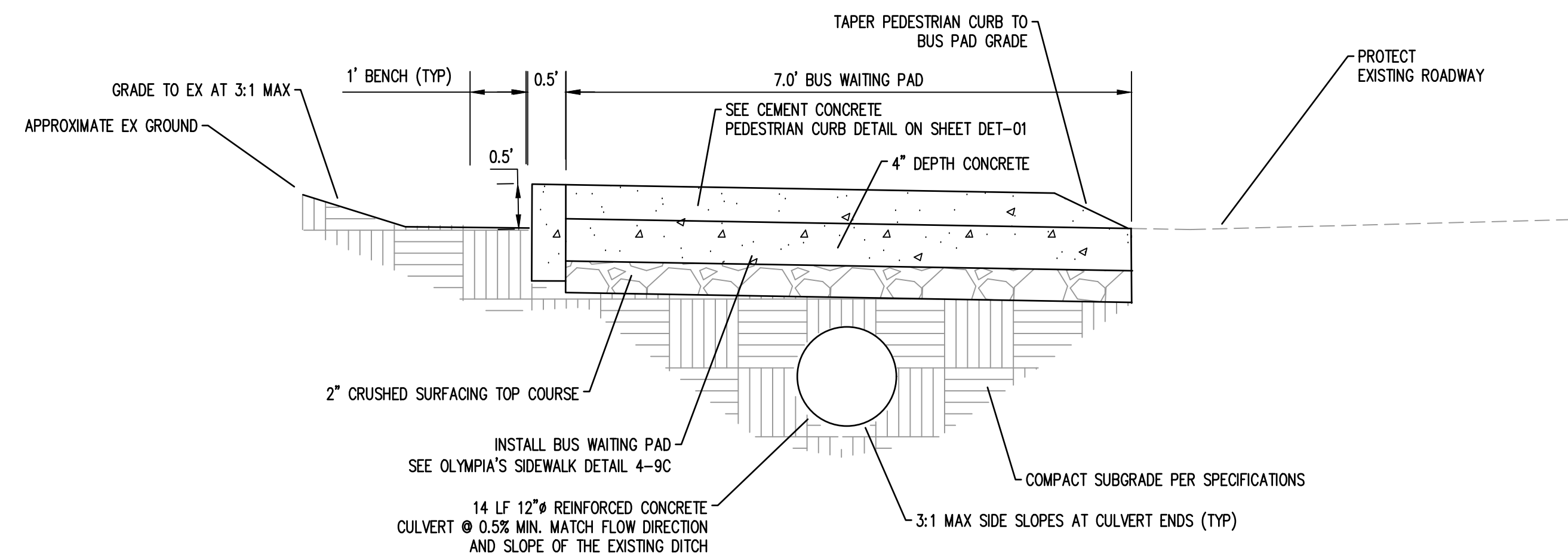

REVISIONS	DATE	BY

SCJ ALLIANCE
CONSULTING SERVICES
8730 TALLOW LANE, NE SUITE 200, LACEY, WA 98516
P: 360.352.1465 F: 360.352.1509
SCJALLIANCE.COM

BUS STOP 1035
INTERCITY TRANSIT BUS STOP CONSTRUCTION
IT PROJECT # 2003C
LACEY, WA



SEAL:

DESIGNER:	W HOLM
DRAWN BY:	M KNECHT
APPROVED BY:	B SHEA
DATE:	APRIL, 2020
JOB NO:	768-AA
DRAWING FILE NO:	768-44-STOP-1035
DRAWING NO:	BP-11
SHEET NO:	12 OF 17

2120 MOTTMAN ROAD - NORTH SIDE OF MOTTMAN ROAD

NOTE: INTERCITY TRANSIT IS CURRENTLY IN THE PROCESS OF FINALIZING AN EASEMENT WITH SOUTH PUGET SOUND COMMUNITY COLLEGE FOR THE INSTALLATION OF THIS BUS STOP. SEE SECTION 1-07.24 OF THE SPECIAL PROVISIONS.

LEGEND

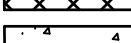
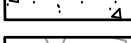
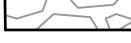
-  CEMENT CONCRETE (PLAN VIEW)
-  REMOVE EXISTING SIDEWALK
-  CEMENT CONCRETE (CROSS SECTION VIEW)
-  CSBS (CRUSHED SURFACING BASE COURSE)
-  SITE RESTORATION - SOD INSTALLATION



EXISTING CONDITIONS
N.T.S.

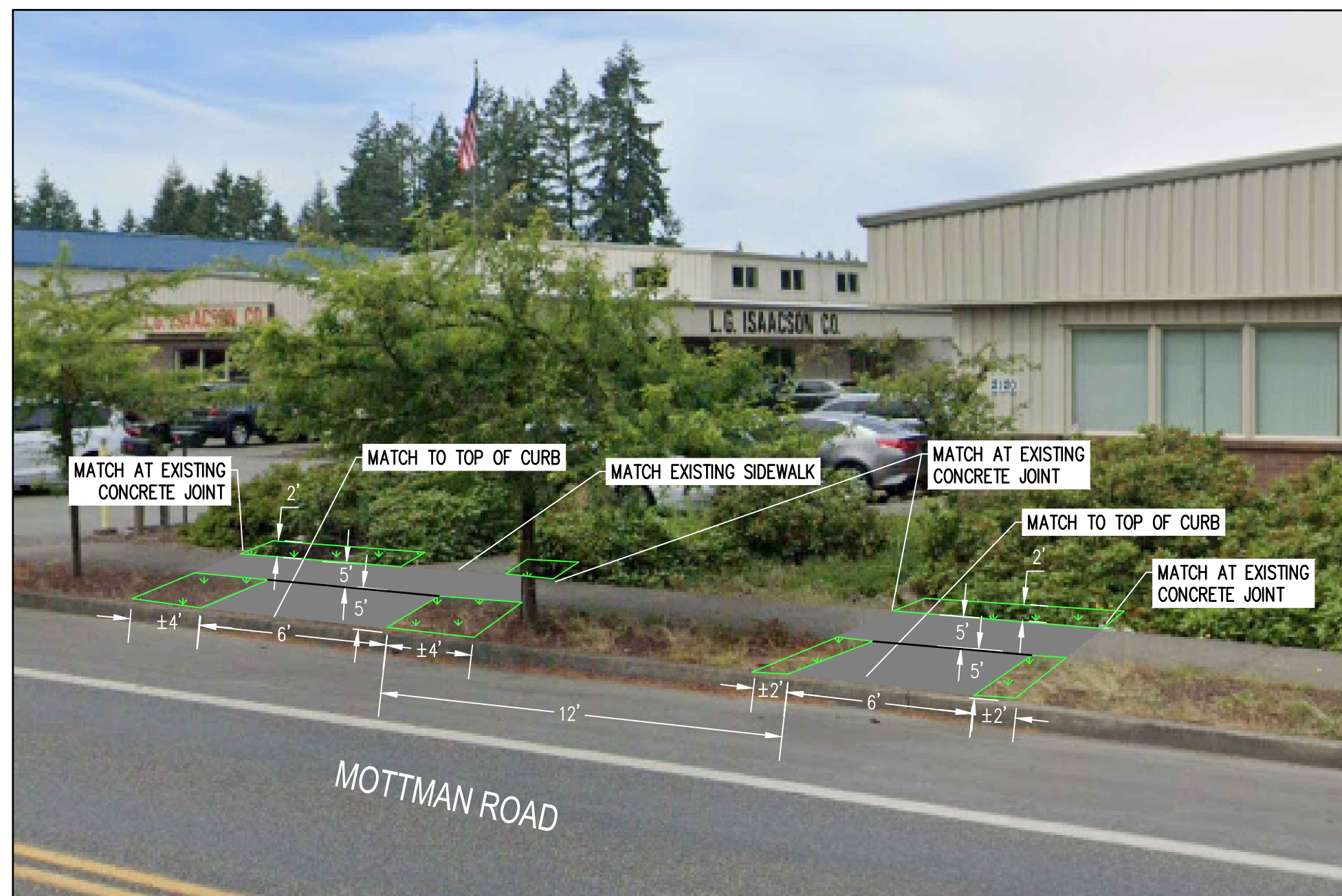

PROPOSED CONDITIONS
N.T.S.

GENERAL NOTES

1. OLYMPIA'S STANDARD CONSTRUCTION NOTES AND DETAILS HAVE BEEN PROVIDED AND REFERENCED ON THE PLANS. ALL WORKMANSHIP AND MATERIALS SHALL BE IN ACCORDANCE WITH THE CITY OF OLYMPIA STANDARDS AND THE MOST CURRENT COPY OF THE WSDOT STANDARD SPECIFICATIONS FOR ROAD, BRIDGE, AND MUNICIPAL CONSTRUCTION.
2. CONTRACTOR SHALL HAVE A COPY OF THE APPROVED CONSTRUCTION PLANS AND SPECIFICATIONS ON THE JOB SITE AT ALL TIMES DURING CONSTRUCTION.
3. THE CONTRACTOR SHALL BE IN COMPLIANCE WITH ALL SAFETY STANDARDS AND REQUIREMENTS AS SET FORTH BY OSHA, WSHA, AND THE WASHINGTON STATE DEPARTMENT OF LABOR AND INDUSTRIES.
4. PRIOR TO WORK ON ANY BUS STOP LOCATION, THE CONTRACTOR SHALL SUBMIT A CONSTRUCTION SCHEDULE TO THE PROJECT ENGINEER FOR REVIEW. THE CONSTRUCTION SCHEDULE SHALL NOTE CONSTRUCTION START AND END DATES FOR EACH BUS STOP. INTERCITY TRANSIT WILL UTILIZE THE SCHEDULE PROVIDED TO COORDINATE AND IMPLEMENT TEMPORARY BUS STOP LOCATIONS. CONTRACTOR TO NOTIFY ENGINEER IMMEDIATELY IF A TEMPORARY BUS STATION HAS NOT BEEN SET UP FOR A BUS STOP SCHEDULED FOR CONSTRUCTION.
5. PRIOR TO WORK ON A SPECIFIC BUS STOP, IT IS THE CONTRACTORS RESPONSIBILITY TO NOTIFY THE CITY OF OLYMPIA THAT WORK WILL BE COMMENCING WITHIN THEIR RIGHT-OF-WAY AND SCHEDULE/ATTEND A PRE-CONSTRUCTION MEETING IF REQUIRED BY THE CITY OF OLYMPIA. CONTRACTOR SHALL NOTIFY THE PROJECT ENGINEER OF ALL SCHEDULED PRE-CONSTRUCTION MEETINGS.
6. THE ENGINEER RESPONSIBLE FOR PREPARATION OF THESE PLANS AND SPECIFICATIONS WILL NOT BE RESPONSIBLE FOR, OR LIABLE FOR, UNAUTHORIZED CHANGES TO OR USES OF THESE PLANS. ALL CHANGES TO THE PLANS MUST BE IN WRITING AND MUST BE APPROVED BY THE ENGINEER RESPONSIBLE FOR PREPARATION OF THESE PLANS.
7. CONTRACTOR TO NOTE THAT CONSTRUCTION ACTIVITY WILL OCCUR IN AREAS WHERE EXISTING UNDERGROUND UTILITIES ARE LOCATED. THE CONTRACTOR SHALL BE FULLY RESPONSIBLE FOR THE LOCATION AND PROTECTION OF ALL EXISTING UTILITIES. THE CONTRACTOR SHALL VERIFY ALL UTILITY LOCATIONS PRIOR TO CONSTRUCTION BY CALLING THE UNDERGROUND LOCATE LINE AT 811 A MINIMUM OF 72 HOURS PRIOR TO THE START OF CONSTRUCTION.

GENERAL CONSTRUCTION NOTES

8. EROSION CONTROL MEASURES SHALL BE IMPLEMENTED AT ALL BUS STOP CONSTRUCTION LOCATION AS REQUIRED TO PREVENT SILT LADEN WATER FROM EXITING THE SITE OR ENTERING INTO STORM DRAINAGE FACILITIES. THE PLANS MAY NOTE SPECIFIC EROSION CONTROL MEASURES THAT MAY BE REQUIRED, HOWEVER IT IS THE CONTRACTORS RESPONSIBILITY TO IMPLEMENT ALL EROSION CONTROL MEASURES NECESSARY DURING CONSTRUCTION AND SITE STABILIZATION. SEE PLANS FOR EROSION CONTROL GENERAL NOTES AND DETAILS.
9. TRAFFIC CONTROL WILL BE REQUIRED AT EACH BUS STOP CONSTRUCTION LOCATION. CONTRACTOR TO MEET ALL TRAFFIC CONTROL REQUIREMENTS PER WSDOT, MUTCD, AND CITY OF OLYMPIA STANDARDS. PRIOR TO DISRUPTION OF ANY TRAFFIC, THE CONTRACTOR SHALL PREPARE A SITE SPECIFIC TRAFFIC CONTROL PLAN FOR EACH BUS STOP LOCATION FOR REVIEW AND APPROVAL BY THE CITY OF OLYMPIA. NO WORK SHALL COMMENCE UNTIL ALL APPROVED TRAFFIC CONTROL IS IN PLACE. WORK SHALL BE SUSPENDED IF TRAFFIC CONTROL FAILS TO MEET MINIMUM REQUIREMENTS. CONTRACTOR TO ENSURE THAT TRAFFIC CONTROL ADDRESSES PEDESTRIAN AND BICYCLE TRAFFIC THROUGH THE CONSTRUCTION SITE. TRAFFIC CONTROL MUST BE MAINTAINED 24 HOURS A DAY, 7 DAYS A WEEK WHILE IN USE. PRIOR TO WORK, CONTRACTOR SHALL PROVIDE THE NAME AND PHONE NUMBER OF THE 24 HOUR TRAFFIC CONTROL CONTACT PERSON TO THE PERMITTING AGENCY AND PROJECT ENGINEER.
10. EXISTING SURVEY MONUMENTS, INCLUDING BUT NOT RESTRICTED TO PROPERTY CORNERS AND CENTERLINE MONUMENT MAY BE DISTURBED OR DESTROYED BY CONSTRUCTION OPERATIONS. THE CONTRACTOR, AS PART OF THE BASE BID, SHALL RETAIN A LICENSED PROFESSIONAL LAND SURVEYOR FOR REPLACEMENT OF ANY DISTURBED OR DESTROYED MONUMENTS OR PROPERTY CORNERS IN ACCORDANCE WITH WASHINGTON STATE LAWS.
11. SITE RESTORATION HAS BEEN CALLED OUT ON THE PLANS FOR AREAS THAT WILL BE DISTURBED DURING CONSTRUCTION. CONTRACTOR SHALL INCLUDE IN THE BASE BID RESTORATION OF ALL DISTURBED AREAS AS A RESULT OF CONSTRUCTION. AREAS SHALL BE REPAIRED, REPLACED, AND STABILIZED TO MATCH THE PRE-PROJECT CONDITIONS OR AS NOTED ON THE PLANS. FOR SITE RESTORATION WITH GRASS, CONTRACTOR SHALL INSTALL 6 INCHES MINIMUM OF TOPSOIL. THEN SEED FERTILIZE AND MULCH PER WSDOT SPECIFICATIONS. THE CONTRACTOR IS RESPONSIBLE FOR PROVIDING AT THEIR EXPENSE, ANY TEMPORARY WATER NEEDED TO ESTABLISH SEED GERMINATION AND PROVIDE SUBSTANTIAL GROWTH AND STABILIZATION. IF SEED GERMINATION DOES NOT OCCUR, CONTRACTOR SHALL RESEED AT THEIR EXPENSE. CONTRACTOR SHALL ASSUME A MINIMUM OF 2 FEET BEYOND THE PROPOSED IMPROVEMENTS (ALL LOCATION) WILL REQUIRE SITE RESTORATION UNLESS SPECIFICALLY NOTED DIFFERENTLY ON THE PLANS. CONTRACTOR SHALL REPAIR CONDITIONS. IF UNDERGROUND IRRIGATION SYSTEMS ARE ENCOUNTERED CONTRACTOR SHALL PROTECT AND PRESERVE OR MODIFY THE EXISTING SYSTEM AS REQUIRED TO ACCOMMODATE BUS STOP CONSTRUCTION.
12. EXISTING VEGETATION SHALL BE PROTECTED AND PRESERVED TO THE EXTENT FEASIBLE. ALL EXISTING TREES SHALL BE PROTECTED UNLESS SHOWN ON THE PLANS TO BE REMOVED OR TRIMMED. NO TREE SHALL BE REMOVED WITHOUT WRITTEN AUTHORIZATION FROM THE PROJECT ENGINEER. AT HIS EXPENSE, CONTRACTOR SHALL CONSULT WITH A CERTIFIED ARBORIST PRIOR TO TRIMMING OF EXISTING TREES/ROOT REMOVAL TO ENSURE TRIMMING MAINTAINS THE LONG TERM VIABILITY OF THE TREE.

13. CONTRACTOR SHALL INCLUDE IN BASE BID ALL MATERIALS AND LABOR REQUIRED TO INSTALL AND REMOVE ANY TEMPORARY SHORING SYSTEMS REQUIRED TO CONSTRUCT THESE IMPROVEMENTS. CONTRACTOR SHALL NOTE THAT MANY OF THE BUS STOP LOCATIONS ARE IN CLOSE PROXIMITY TO EXISTING FEATURES AND PRIVATE PROPERTY. IT IS THE CONTRACTORS RESPONSIBILITY TO ENSURE THAT CONSTRUCTION ACTIVITIES DO NOT DAMAGE OR INFRINGE ON PRIVATE PROPERTY.

BUS STOP CONSTRUCTION

14. INTERCITY TRANSIT WILL BE FURNISHING AND INSTALLING THE POLE AND SIGN FOR ALL OF THESE STOPS. DURING CONSTRUCTION THE CONTRACTOR WILL NEED TO REMOVE AND DISPOSE OF THE BURIED CEMENT BUCKET.
15. CONTRACTOR SHALL PROVIDE A CONCRETE JOINT LAYOUT PLAN TO PROJECT ENGINEER FOR REVIEW ONE WEEK PRIOR TO A SCHEDULED CONCRETE POUR. THE CONCRETE JOINT LAYOUT PLAN SHALL PROVIDE DETAILS ON THE LOCATION OF CONTRACTION, CONSTRUCTION, AND ISOLATION JOINTS. THE PLAN MUST BE APPROVED BY THE ENGINEER PRIOR TO THE CONCRETE POUR.
16. ALL FILL PLACED DURING BUS STOP CONSTRUCTION SHALL BE STRUCTURAL FILL MEETING WSDOT STANDARD SPECIFICATION 9-03.14(3) COMMON BORROW AND SHALL BE COMPACTED TO WSDOT SPECIFICATIONS UNLESS OTHERWISE NOTED ON THE PLANS.
17. CONTRACTOR SHALL PROVIDE A TOWELED EDGE ALONG THE OUTSIDE PERIMETER OF ALL CONCRETE BUS STOP PADS, CURBS, AND WALLS; CONCRETE EDGING SHALL BE 4 INCHES WIDE WITH A 1/2 INCH RADIUS.
18. FOR BUS PAD CONSTRUCTION, CROSS SLOPE GRADES SHALL NOT EXCEED 1.7%. LONGITUDINAL GRADES FOR TRANSITIONAL RAMPS SHALL NOT EXCEED 8%. IF UPON FINAL INSPECTION OF THE COMPLETED WORK, AND PORTION OF THE WORK DOES NOT MEET THESE REQUIREMENTS, THE WORK SHALL BE REMOVED AND RECONSTRUCTED, AT THE EXPENSE OF THE CONTRACTOR. NO EXCEPTION WILL BE PROVIDED. ALL CONCRETE CONSTRUCTION SHALL HAVE A MINIMUM SLOPED 1% FOR WATER DRAINAGE, UNLESS OTHERWISE NOTED ON THE PLANS.
19. CONTRACTOR TO NOTE ALL BUS STOP PAD DIMENSIONS (LENGTH AND WIDTH) ARE THE ACTUAL SLAB DIMENSIONS. ALL ADDITIONAL CONSTRUCTION SUCH AS PEDESTRIAN CURBS OR WALLS SHALL ABUT THE SLAB AS NOTED IN THE CROSS SECTIONS. AS SUCH, A 6'x8' SLAB WILL RESULT IN 48 SQUARE FEET OF CONCRETE SURFACE. SEE PLANS FOR BUS PAD DIMENSIONS, AS THIS VARIES FOR SPECIFIC SITES.

CONSTRUCTION INSPECTION

20. ALL CONCRETE WORK FOR THIS PROJECT WILL BE INSPECTED BY THE PROJECT ENGINEER AND CITY OF OLYMPIA INSPECTOR. REQUIRED INSPECTIONS INCLUDE CONSTRUCTION STAKING, SUBGRADE INSPECTION, CONCRETE FORMWORK, AND FINAL INSPECTION OF CONCRETE AND FINISHED GRADES. CONTRACTOR SHALL PROVIDE A 24 HOUR NOTICE TO THE PROJECT ENGINEER AND CITY OF OLYMPIA INSPECTOR PRIOR TO THE REQUIRED INSPECTIONS. NO CONCRETE WORK SHALL BE COMPLETED WITHOUT INSPECTION APPROVAL FROM THE PROJECT ENGINEER AND CITY OF OLYMPIA INSPECTOR. ANY CONCRETE WORK COMPLETED BY THE CONTRACTOR WITHOUT THE REQUIRED INSPECTIONS WILL BE AT THE RISK OF THE CONTRACTOR. THE CONTRACTOR IS URGED TO COORDINATE SITE INSPECTIONS FOR MAXIMUM EFFICIENCY, I.E. COMPLETE MULTIPLE SITE INSPECTIONS IN ONE DAY WITHIN CLOSE PROXIMITY OF EACH OTHER.

JURISDICTION NOTES

1. SEE DRAWING DET-02 FOR CITY OF OLYMPIA STANDARD NOTES AND DETAILS.

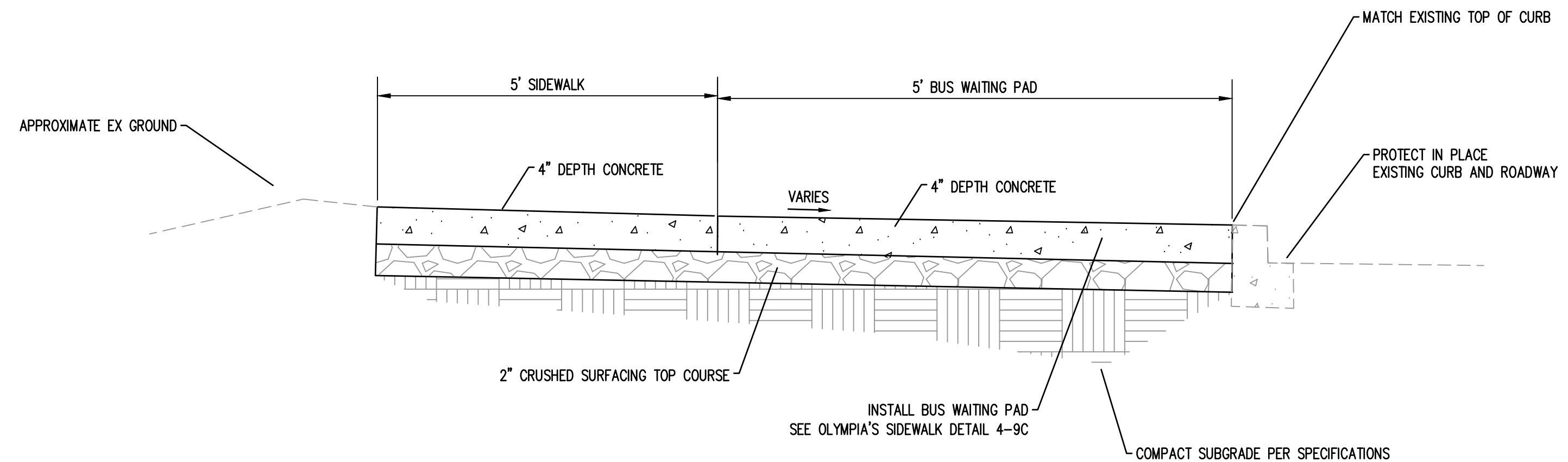

REVISIONS	DATE	BY

SCJ ALLIANCE
CONSULTING SERVICES
8730 TALLON LANE NE SUITE 200, LACEY, WA 98516
P: 360.352.1465 F: 360.352.1509
SCJALLIANCE.COM

SHEET TITLE: RT-42-SPSCC-WB
PROJECT NAME: INTERCITY TRANSIT BUS STOP CONSTRUCTION
IT PROJECT # 2003C
LACEY, WA

SEAL: WHITTNEY G. HOLM
STATE OF WASHINGTON
REGISTERED PROFESSIONAL ENGINEER
07/09/2020

DESIGNER: W HOLM
DRAWN BY: M KNECHT
APPROVED BY: B SHEA
DATE: APRIL, 2020
JOB NO: 788-AA
DRAWING FILE NO: 788.44-STOP-RT-42-SPSCC-WB
DRAWING NO: BP-13
SHEET NO: 14 OF 17

Jul 10, 2020 7:41:05am - User: whitneyholm
R:\PROJECTS\0788 INTERCITY TRANSIT\0788-44-STOP-RT-42-SPSCC-WB.DWG

NEXT TO 2011 MOTTMAN ROAD DRIVEWAY - SOUTH SIDE OF MOTTMAN

INTERCITY TRANSIT IS IN THE PROCESS OF OBTAINING AN EASEMENT FOR CONSTRUCTION OF THE BUS SHELTER PAD LOCATED OUTSIDE OF CITY OF OLYMPIA RIGHT OF WAY. THE EASEMENT MAY NOT BE APPROVED AT THE TIME OF NTP. CONTRACTOR SHALL SCHEDULE THEIR WORK ACCORDINGLY. SEE SECTION 1-07.24 OF THE SPECIAL PROVISIONS.

LEGEND

- CEMENT CONCRETE (PLAN VIEW)
- REMOVE EXISTING SIDEWALK
- CEMENT CONCRETE (CROSS SECTION VIEW)
- CSBS (CRUSHED SURFACING BASE COURSE)
- SITE RESTORATION - SOD INSTALLATION



MOTTMAN ROAD

EXISTING CONDITIONS
N.T.S.

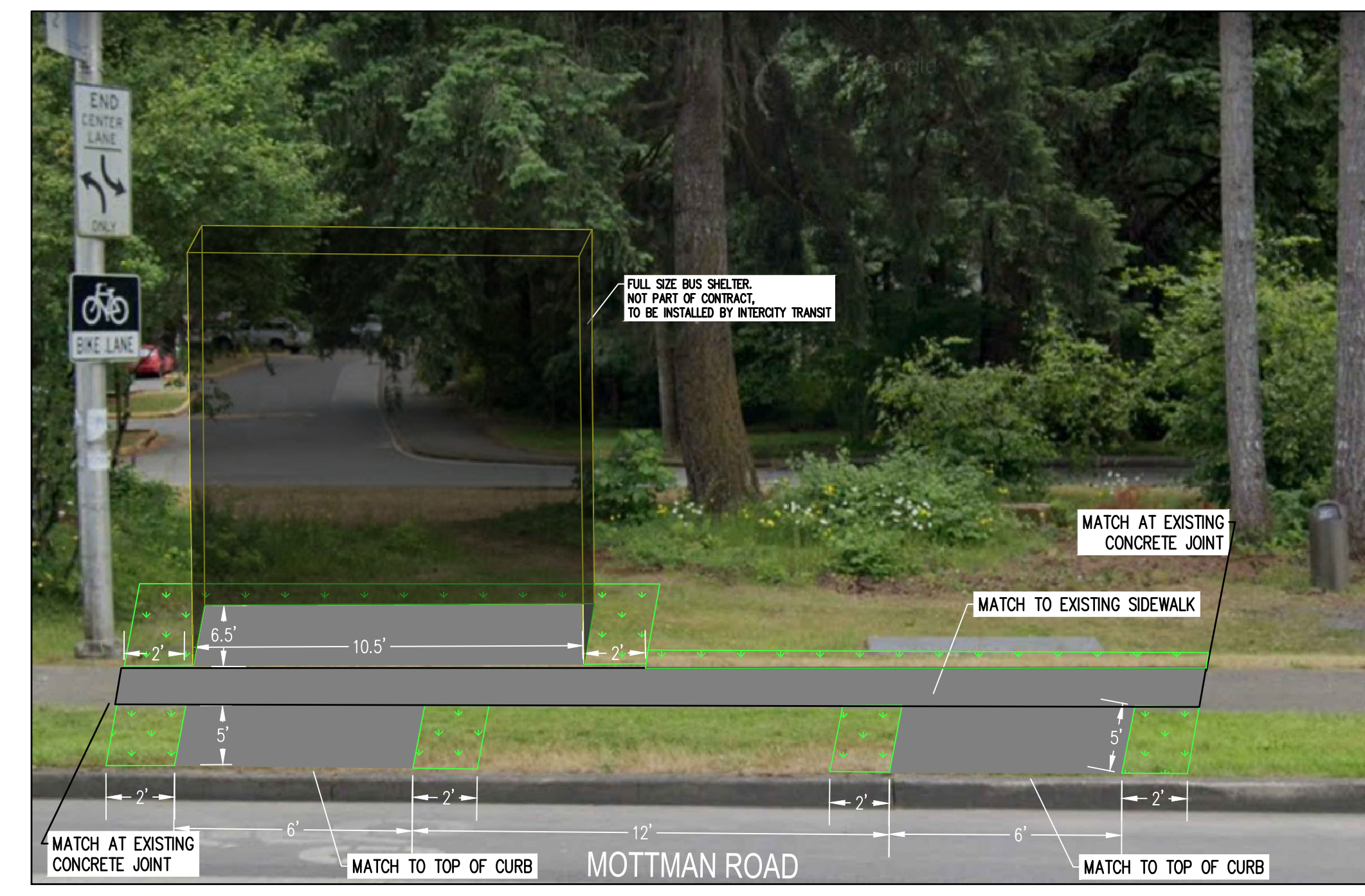

PROPOSED CONDITIONS
N.T.S.

GENERAL NOTES

1. OLYMPIA'S STANDARD CONSTRUCTION NOTES AND DETAILS HAVE BEEN PROVIDED AND REFERENCED ON THE PLANS. ALL WORKMANSHIP AND MATERIALS SHALL BE IN ACCORDANCE WITH THE CITY OF OLYMPIA STANDARDS AND THE MOST CURRENT COPY OF THE WSDOT STANDARD SPECIFICATIONS FOR ROAD, BRIDGE, AND MUNICIPAL CONSTRUCTION.
2. CONTRACTOR SHALL HAVE A COPY OF THE APPROVED CONSTRUCTION PLANS AND SPECIFICATIONS ON THE JOB SITE AT ALL TIMES DURING CONSTRUCTION.
3. THE CONTRACTOR SHALL BE IN COMPLIANCE WITH ALL SAFETY STANDARDS AND REQUIREMENTS AS SET FORTH BY OSHA, WSHA, AND THE WASHINGTON STATE DEPARTMENT OF LABOR AND INDUSTRIES.
4. PRIOR TO WORK ON ANY BUS STOP LOCATION, THE CONTRACTOR SHALL SUBMIT A CONSTRUCTION SCHEDULE TO THE PROJECT ENGINEER FOR REVIEW. THE CONSTRUCTION SCHEDULE SHALL NOTE CONSTRUCTION START AND END DATES FOR EACH BUS STOP. INTERCITY TRANSIT WILL UTILIZE THE SCHEDULE PROVIDED TO COORDINATE AND IMPLEMENT TEMPORARY BUS STOP LOCATIONS. CONTRACTOR TO NOTIFY ENGINEER IMMEDIATELY IF A TEMPORARY BUS STATION HAS NOT BEEN SET UP FOR A BUS STOP SCHEDULED FOR CONSTRUCTION.
5. PRIOR TO WORK ON A SPECIFIC BUS STOP, IT IS THE CONTRACTORS RESPONSIBILITY TO NOTIFY THE CITY OF OLYMPIA THAT WORK WILL BE COMMENCING WITHIN THEIR RIGHT-OF-WAY AND SCHEDULE/ATTEND A PRE-CONSTRUCTION MEETING IF REQUIRED BY THE CITY OF OLYMPIA. CONTRACTOR SHALL NOTIFY THE PROJECT ENGINEER OF ALL SCHEDULED PRE-CONSTRUCTION MEETINGS.
6. THE ENGINEER RESPONSIBLE FOR PREPARATION OF THESE PLANS AND SPECIFICATIONS WILL NOT BE RESPONSIBLE FOR, OR LIABLE FOR, UNAUTHORIZED CHANGES TO OR USES OF THESE PLANS. ALL CHANGES TO THE PLANS MUST BE IN WRITING AND MUST BE APPROVED BY THE ENGINEER RESPONSIBLE FOR PREPARATION OF THESE PLANS.
7. CONTRACTOR TO NOTE THAT CONSTRUCTION ACTIVITY WILL OCCUR IN AREAS WHERE EXISTING UNDERGROUND UTILITIES ARE LOCATED. THE CONTRACTOR SHALL BE FULLY RESPONSIBLE FOR THE LOCATION AND PROTECTION OF ALL EXISTING UTILITIES. THE CONTRACTOR SHALL VERIFY ALL UTILITY LOCATIONS PRIOR TO CONSTRUCTION BY CALLING THE UNDERGROUND LOCATE LINE AT 811 A MINIMUM OF 72 HOURS PRIOR TO THE START OF CONSTRUCTION.

GENERAL CONSTRUCTION NOTES

8. EROSION CONTROL MEASURES SHALL BE IMPLEMENTED AT ALL BUS STOP CONSTRUCTION LOCATION AS REQUIRED TO PREVENT SILT LADEN WATER FROM EXITING THE SITE OR ENTERING INTO STORM DRAINAGE FACILITIES. THE PLANS MAY NOTE SPECIFIC EROSION CONTROL MEASURES THAT MAY BE REQUIRED, HOWEVER IT IS THE CONTRACTORS RESPONSIBILITY TO IMPLEMENT ALL EROSION CONTROL MEASURES NECESSARY DURING CONSTRUCTION AND SITE STABILIZATION. SEE PLANS FOR EROSION CONTROL GENERAL NOTES AND DETAILS.
9. TRAFFIC CONTROL WILL BE REQUIRED AT EACH BUS STOP CONSTRUCTION LOCATION. CONTRACTOR TO MEET ALL TRAFFIC CONTROL REQUIREMENTS PER WSDOT, MUTCD, AND CITY OF OLYMPIA STANDARDS. PRIOR TO DISRUPTION OF ANY TRAFFIC, THE CONTRACTOR SHALL PREPARE A SITE SPECIFIC TRAFFIC CONTROL PLAN FOR EACH BUS STOP LOCATION FOR REVIEW AND APPROVAL BY THE CITY OF OLYMPIA. NO WORK SHALL COMMENCE UNTIL ALL APPROVED TRAFFIC CONTROL IS IN PLACE. WORK SHALL BE SUSPENDED IF TRAFFIC CONTROL FAILS TO MEET MINIMUM REQUIREMENTS. CONTRACTOR TO ENSURE THAT TRAFFIC CONTROL ADDRESSES PEDESTRIAN AND BICYCLE TRAFFIC THROUGH THE CONSTRUCTION SITE. TRAFFIC CONTROL MUST BE MAINTAINED 24 HOURS A DAY, 7 DAYS A WEEK WHILE IN USE. PRIOR TO WORK, CONTRACTOR SHALL PROVIDE THE NAME AND PHONE NUMBER OF THE 24 HOUR TRAFFIC CONTROL CONTACT PERSON TO THE PERMITTING AGENCY AND PROJECT ENGINEER.
10. EXISTING SURVEY MONUMENTS, INCLUDING BUT NOT RESTRICTED TO PROPERTY CORNERS AND CENTERLINE MONUMENT MAY BE DISTURBED OR DESTROYED BY CONSTRUCTION OPERATIONS. THE CONTRACTOR, AS PART OF THE BASE BID, SHALL RETAIN A LICENSED PROFESSIONAL LAND SURVEYOR FOR REPLACEMENT OF ANY DISTURBED OR DESTROYED MONUMENTS OR PROPERTY CORNERS IN ACCORDANCE WITH WASHINGTON STATE LAWS.
11. SITE RESTORATION HAS BEEN CALLED OUT ON THE PLANS FOR AREAS THAT WILL BE DISTURBED DURING CONSTRUCTION. CONTRACTOR SHALL INCLUDE IN THE BASE BID RESTORATION OF ALL DISTURBED AREAS AS A RESULT OF CONSTRUCTION. AREAS SHALL BE REPAIRED, REPLACED, AND STABILIZED TO MATCH THE PRE-PROJECT CONDITIONS OR AS NOTED ON THE PLANS. FOR SITE RESTORATION WITH GRASS, CONTRACTOR SHALL INSTALL 6 INCHES MINIMUM OF TOPSOIL. THEN SEED FERTILIZE AND MULCH PER WSDOT SPECIFICATIONS. THE CONTRACTOR IS RESPONSIBLE FOR PROVIDING AT THEIR EXPENSE, ANY TEMPORARY WATER NEEDED TO ESTABLISH SEED GERMINATION AND PROVIDE SUBSTANTIAL GROWTH AND STABILIZATION. IF SEED GERMINATION DOES NOT OCCUR, CONTRACTOR SHALL RESEED AT THEIR EXPENSE. CONTRACTOR SHALL ASSUME A MINIMUM OF 2 FEET BEYOND THE PROPOSED IMPROVEMENTS (ALL LOCATION) WILL REQUIRE SITE RESTORATION UNLESS SPECIFICALLY NOTED DIFFERENTLY ON THE PLANS. CONTRACTOR SHALL REPAIR CONDITIONS. IF UNDERGROUND IRRIGATION SYSTEMS ARE ENCOUNTERED CONTRACTOR SHALL PROTECT AND PRESERVE OR MODIFY THE EXISTING SYSTEM AS REQUIRED TO ACCOMMODATE BUS STOP CONSTRUCTION.
12. EXISTING VEGETATION SHALL BE PROTECTED AND PRESERVED TO THE EXTENT FEASIBLE. ALL EXISTING TREES SHALL BE PROTECTED UNLESS SHOWN ON THE PLANS TO BE REMOVED OR TRIMMED. NO TREE SHALL BE REMOVED WITHOUT WRITTEN AUTHORIZATION FROM THE PROJECT ENGINEER. AT HIS EXPENSE, CONTRACTOR SHALL CONSULT WITH A CERTIFIED ARBORIST PRIOR TO TRIMMING OF EXISTING TREES/ROOT REMOVAL TO ENSURE TRIMMING MAINTAINS THE LONG TERM VIABILITY OF THE TREE.

13. CONTRACTOR SHALL INCLUDE IN BASE BID ALL MATERIALS AND LABOR REQUIRED TO INSTALL AND REMOVE ANY TEMPORARY SHORING SYSTEMS REQUIRED TO CONSTRUCT THESE IMPROVEMENTS. CONTRACTOR SHALL NOTE THAT MANY OF THE BUS STOP LOCATIONS ARE IN CLOSE PROXIMITY TO EXISTING FEATURES AND PRIVATE PROPERTY. IT IS THE CONTRACTORS RESPONSIBILITY TO ENSURE THAT CONSTRUCTION ACTIVITIES DO NOT DAMAGE OR INFRINGE ON PRIVATE PROPERTY.

BUS STOP CONSTRUCTION

14. INTERCITY TRANSIT WILL BE FURNISHING AND INSTALLING THE POLE AND SIGN FOR ALL OF THESE STOPS. DURING CONSTRUCTION THE CONTRACTOR WILL NEED TO REMOVE AND DISPOSE OF THE BURIED CEMENT BUCKET.
15. CONTRACTOR SHALL PROVIDE A CONCRETE JOINT LAYOUT PLAN TO PROJECT ENGINEER FOR REVIEW ONE WEEK PRIOR TO A SCHEDULED CONCRETE POUR. THE CONCRETE JOINT LAYOUT PLAN SHALL PROVIDE DETAILS ON THE LOCATION OF CONTRACTION, CONSTRUCTION, AND ISOLATION JOINTS. THE PLAN MUST BE APPROVED BY THE ENGINEER PRIOR TO THE CONCRETE POUR.
16. ALL FILL PLACED DURING BUS STOP CONSTRUCTION SHALL BE STRUCTURAL FILL MEETING WSDOT STANDARD SPECIFICATION 9-03.14(3) COMMON BORROW AND SHALL BE COMPACTED TO WSDOT SPECIFICATIONS UNLESS OTHERWISE NOTED ON THE PLANS.
17. CONTRACTOR SHALL PROVIDE A TOWELED EDGE ALONG THE OUTSIDE PERIMETER OF ALL CONCRETE BUS STOP PADS, CURBS, AND WALLS; CONCRETE EDGING SHALL BE 4 INCHES WIDE WITH A 1/2 INCH RADIUS.
18. FOR BUS PAD CONSTRUCTION, CROSS SLOPE GRADES SHALL NOT EXCEED 1.7%. LONGITUDINAL GRADES FOR TRANSITIONAL RAMPS SHALL NOT EXCEED 8%. IF UPON FINAL INSPECTION OF THE COMPLETED WORK, AND PORTION OF THE WORK DOES NOT MEET THESE REQUIREMENTS, THE WORK SHALL BE REMOVED AND RECONSTRUCTED, AT THE EXPENSE OF THE CONTRACTOR. NO EXCEPTION WILL BE PROVIDED. ALL CONCRETE CONSTRUCTION SHALL HAVE A MINIMUM SLOPED 1% FOR WATER DRAINAGE, UNLESS OTHERWISE NOTED ON THE PLANS.
19. CONTRACTOR TO NOTE ALL BUS STOP PAD DIMENSIONS (LENGTH AND WIDTH) ARE THE ACTUAL SLAB DIMENSIONS. ALL ADDITIONAL CONSTRUCTION SUCH AS PEDESTRIAN CURBS OR WALLS SHALL ABUT THE SLAB AS NOTED IN THE CROSS SECTIONS. AS SUCH, A 6'x8' SLAB WILL RESULT IN 48 SQUARE FEET OF CONCRETE SURFACE. SEE PLANS FOR BUS PAD DIMENSIONS, AS THIS VARIES FOR SPECIFIC SITES.

CONSTRUCTION INSPECTION

20. ALL CONCRETE WORK FOR THIS PROJECT WILL BE INSPECTED BY THE PROJECT ENGINEER AND CITY OF OLYMPIA INSPECTOR. REQUIRED INSPECTIONS INCLUDE CONSTRUCTION STAKING, SUBGRADE INSPECTION, CONCRETE FORMWORK, AND FINAL INSPECTION OF CONCRETE AND FINISHED GRADES. CONTRACTOR SHALL PROVIDE A 24 HOUR NOTICE TO THE PROJECT ENGINEER AND CITY OF OLYMPIA INSPECTOR PRIOR TO THE REQUIRED INSPECTIONS. NO CONCRETE WORK SHALL BE COMPLETED WITHOUT INSPECTION APPROVAL FROM THE PROJECT ENGINEER AND CITY OF OLYMPIA INSPECTOR. ANY CONCRETE WORK COMPLETED BY THE CONTRACTOR WITHOUT THE REQUIRED INSPECTIONS WILL BE AT THE RISK OF THE CONTRACTOR. THE CONTRACTOR IS URGED TO COORDINATE SITE INSPECTIONS FOR MAXIMUM EFFICIENCY, I.E. COMPLETE MULTIPLE SITE INSPECTIONS IN ONE DAY WITHIN CLOSE PROXIMITY OF EACH OTHER.

JURISDICTION NOTES

1. SEE DRAWING DET-02 FOR CITY OF OLYMPIA STANDARD NOTES AND DETAILS.

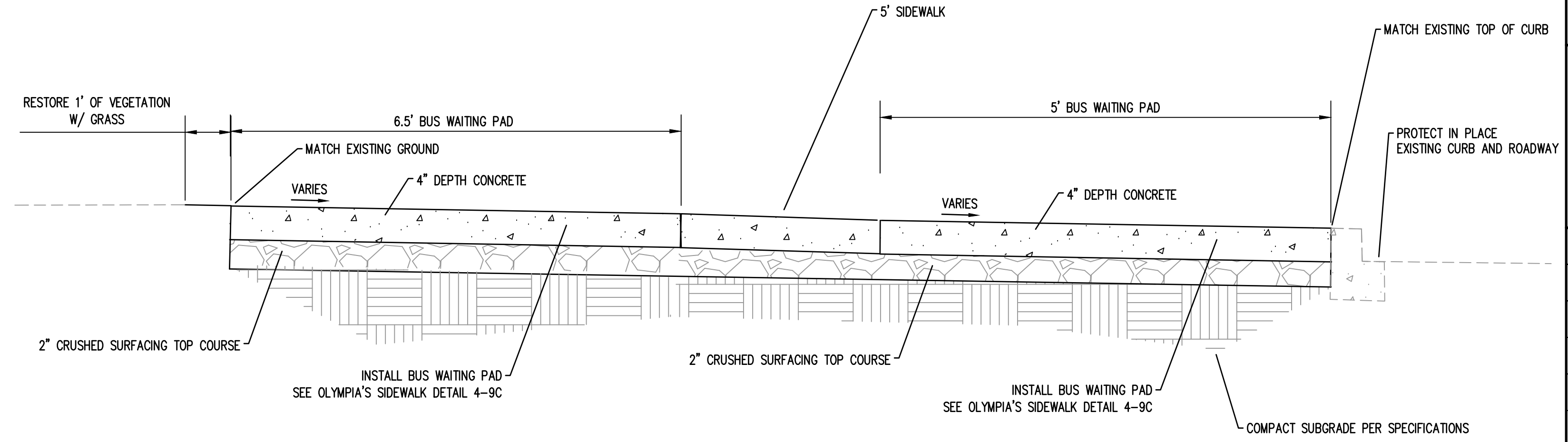

REVISIONS	DATE	BY

SCJ ALLIANCE
CONSULTING SERVICES
8730 TALLON LANE NE SUITE 200, LACEY, WA 98516
P: 360.352.1465 F: 360.352.1509
SCJALLIANCE.COM

SHEET TITLE: RT-42-SPSCC-EB
PROJECT NAME: INTERCITY TRANSIT BUS STOP CONSTRUCTION
IT PROJECT # 2003C
LACEY, WA

SEAL: WHITTNEY G. HOLM
STATE OF WASHINGTON
REGISTERED PROFESSIONAL ENGINEER
07/09/2020

DESIGNER: W HOLM
DRAWN BY: M KNECHT
APPROVED BY: B SHEA
DATE: APRIL, 2020
JOB NO: 788-AA
DRAWING FILE NO: 788.44-STOP-RT-42-SPSCC-EB
DRAWING NO: BP-14
SHEET NO: 15 OF 17

Jul 10, 2020 7:42:27am - User: whitneyholm
R:\PROJECTS\088 INTERCITY TRANSIT\088AA TD-1 BUS STOP PAD IMPROVEMENTS RT. 65\CAD\1768.44-STOP-RT-42-SPSCC-EB.DWG

CITY OF LACEY'S GENERAL CONSTRUCTION NOTES (ALL PUBLIC WORKS IMPROVEMENTS)

- ALL WORKMANSHIP AND MATERIALS SHALL BE IN ACCORDANCE WITH CITY OF LACEY STANDARDS AND THE MOST CURRENT EDITION OF THE STATE OF WASHINGTON STANDARD SPECIFICATIONS FOR ROAD, BRIDGE AND MUNICIPAL CONSTRUCTION (WSDOT/APWA). IN CASES OF CONFLICT, THE MOST STRINGENT STANDARD SHALL APPLY.
- THE CONTRACTOR SHALL BE IN COMPLIANCE WITH ALL SAFETY STANDARDS AND REQUIREMENTS AS SET FORTH BY OSHA, WISHA AND THE STATE OF WASHINGTON, DEPARTMENT OF LABOR AND INDUSTRIES.
- ALL APPROVALS AND PERMITS REQUIRED BY THE CITY OF LACEY SHALL BE OBTAINED BY THE CONTRACTOR PRIOR TO THE START OF CONSTRUCTION.
- IF CONSTRUCTION IS TO TAKE PLACE IN THE COUNTY RIGHT-OF-WAY, THE CONTRACTOR SHALL NOTIFY THE COUNTY AND OBTAIN ALL THE REQUIRED APPROVALS AND PERMITS.
- A PRE-CONSTRUCTION MEETING SHALL BE HELD WITH THE CITY OF LACEY CONSTRUCTION INSPECTOR A MINIMUM 72 HOURS PRIOR TO THE START OF CONSTRUCTION.
- THE CITY OF LACEY CONSTRUCTION INSPECTOR SHALL BE NOTIFIED A MINIMUM OF 48 HOURS IN ADVANCE OF A TAP CONNECTION TO AN EXISTING MAIN. THE INSPECTOR SHALL BE PRESENT AT THE TIME OF THE TAP.
- THE CONTRACTOR SHALL BE FULLY RESPONSIBLE FOR THE LOCATION AND PROTECTION OF ALL EXISTING UTILITIES. THE CONTRACTOR SHALL VERIFY ALL UTILITY LOCATIONS PRIOR TO CONSTRUCTION BY CALLING THE UNDERGROUND LOCATE LINE AT 811 NOT LESS THAN TWO BUSINESS DAYS AND NOT MORE THAN 10 BUSINESS DAYS PRIOR TO ANY EXCAVATION. THE CONTRACTOR WILL ALSO BE RESPONSIBLE FOR MAINTAINING ALL LOCATE MARKS ONCE THE UTILITIES HAVE BEEN LOCATED.
- TEMPORARY STREET PATCHING SHALL BE ALLOWED FOR AS APPROVED BY THE CITY ENGINEER. TEMPORARY STREET PATCHING SHALL BE PROVIDED BY PLACEMENT AND COMPACTION OF 1 INCH MAXIMUM ASPHALT CONCRETE COLD MIX. CONTRACTOR SHALL BE RESPONSIBLE FOR MAINTENANCE AS REQUIRED.
- THE CONTRACTOR SHALL BE RESPONSIBLE FOR ALL TRAFFIC CONTROL IN ACCORDANCE WITH THE WSDOT/APWA STANDARD PLANS FOR ROAD, BRIDGE AND MUNICIPAL CONSTRUCTION (ALL APPLICABLE "K" PLANS) AND/OR THE MANUAL ON UNIFORM TRAFFIC CONTROL DEVICES (MUTCD). PRIOR TO DISRUPTION OF ANY TRAFFIC, A TRAFFIC CONTROL PLAN SHALL BE PREPARED AND SUBMITTED TO THE CITY FOR APPROVAL. NO WORK SHALL COMMENCE UNTIL ALL APPROVED TRAFFIC CONTROL IS IN PLACE.
- EROSION CONTROL/WATER POLLUTION MEASURES SHALL BE REQUIRED IN ACCORDANCE WITH SECTION 1-07.15 OF THE WSDOT/APWA STANDARD SPECIFICATIONS FOR ROAD, BRIDGE AND MUNICIPAL CONSTRUCTION AND THE CITY OF LACEY 2010 STORMWATER DESIGN MANUAL. AT NO TIME WILL SILTS AND DEBRIS BE ALLOWED TO DRAIN INTO AN EXISTING OR NEWLY INSTALLED FACILITY UNLESS SPECIAL PROVISIONS HAVE BEEN DESIGNED.
- ALL SURVEYING AND STAKING SHALL BE PERFORMED PER THE CORRESPONDING CHAPTER OF THE CITY OF LACEY DEVELOPMENT GUIDELINES AND PUBLIC WORKS STANDARDS.
- IT SHALL BE THE RESPONSIBILITY OF THE CONTRACTOR TO HAVE A COPY OF AN APPROVED SET OF PLANS ON THE CONSTRUCTION SITE AT ALL TIMES.
- ANY CHANGES TO THE DESIGN SHALL FIRST BE REVIEWED AND APPROVED BY THE PROJECT ENGINEER AND THE CITY OF LACEY.
- IF CONSTRUCTION IS TO TAKE PLACE IN OTHER JURISDICTION'S RIGHT-OF-WAY (I.E., THE COUNTY, THE STATE, THE CITY OF OLYMPIA, OR OTHER ADJACENT MUNICIPALITIES), THE CONTRACTOR SHALL NOTIFY THE JURISDICTION AND OBTAIN ALL THE REQUIRED APPROVALS AND PERMITS.
- PRIOR TO BACKFILL ALL MAINS AND APPURTENANCES SHALL BE INSPECTED AND APPROVED BY THE CITY OF LACEY CONSTRUCTION INSPECTOR. APPROVAL SHALL NOT RELIEVE THE CONTRACTOR FOR CORRECTION OF ANY DEFICIENCIES AND/OR FAILURES AS DETERMINED BY SUBSEQUENT TESTING AND INSPECTIONS. IT SHALL BE THE CONTRACTOR'S RESPONSIBILITY TO NOTIFY THE CITY OF LACEY FOR THE REQUIRED INSPECTIONS.
- THE CITY WILL BE GIVEN 72 HOURS NOTICE PRIOR TO SCHEDULING A SHUTDOWN. WHERE CONNECTIONS REQUIRE "FIELD VERIFICATION", CONNECTION POINTS SHALL BE EXPOSED BY THE CONTRACTOR AND FITTINGS VERIFIED 72 HOURS PRIOR TO DISTRIBUTING SHUT-DOWN NOTICES.

GENERAL NOTES (STREET CONSTRUCTION)

- SEE APPROPRIATE DETAIL FOR SPECIFICATIONS FOR JOINING NEW AND EXISTING ASPHALT.
- COMPACTION OF SUBGRADE, ROCK, AND ASPHALT SHALL BE IN ACCORDANCE WITH THE MOST CURRENT ADOPTED VERSION OF THE WSDOT/APWA STANDARD SPECIFICATIONS FOR ROAD, BRIDGE AND MUNICIPAL CONSTRUCTION.
- FORM AND SUBGRADE INSPECTION BY THE CITY IS REQUIRED BEFORE POURING CONCRETE. (SEE WSDOT/APWA STANDARD SPECIFICATIONS FOR ROAD, BRIDGE AND MUNICIPAL CONSTRUCTION 8-14.3 (1) THROUGH (4)). TWENTY-FOUR HOURS NOTICE IS REQUIRED FOR FORM INSPECTION.
- SEE CITY OF LACEY DEVELOPMENT GUIDELINES AND PUBLIC WORKS STANDARDS, CHAPTER 4B.200, FOR TESTING AND SAMPLING FREQUENCIES.
- THE CITY MANUFACTURES AND INSTALLS PUBLIC AND PRIVATE STREET NAME SIGNS, AND REGULATORY SIGNS AT THE CONTRACTOR'S/DEVELOPER'S EXPENSE. OTHER SIGNS THAT SHALL BE MANUFACTURED AND INSTALLED BY THE CITY AND PAID FOR BY THE CONTRACTOR/DEVELOPER'S WILL INCLUDE SIGNS FOR WELL SITES, TANK SITES, LIFT STATIONS, ODOR CONTROL STATIONS, MAINTENANCE AND/OR FIRE ACCESS THROUGH AN EASEMENT. (SEE 4B.050). SIGNS SHALL BE REQUESTED AT THE TIME STREET CONSTRUCTION BEGINS.
- MATERIAL USED FOR ALL PLASTIC STOP LINES, PLASTIC CROSSWALK LINES, PLASTIC TRAFFIC ARROWS, PLASTIC TRAFFIC LETTERS, PLASTIC LEGENDS, AND PLASTIC SYMBOLS SHALL BE TYPE B - PRE-FORMED FUSED THERMOPLASTIC AT 120 MIL THICKNESS.

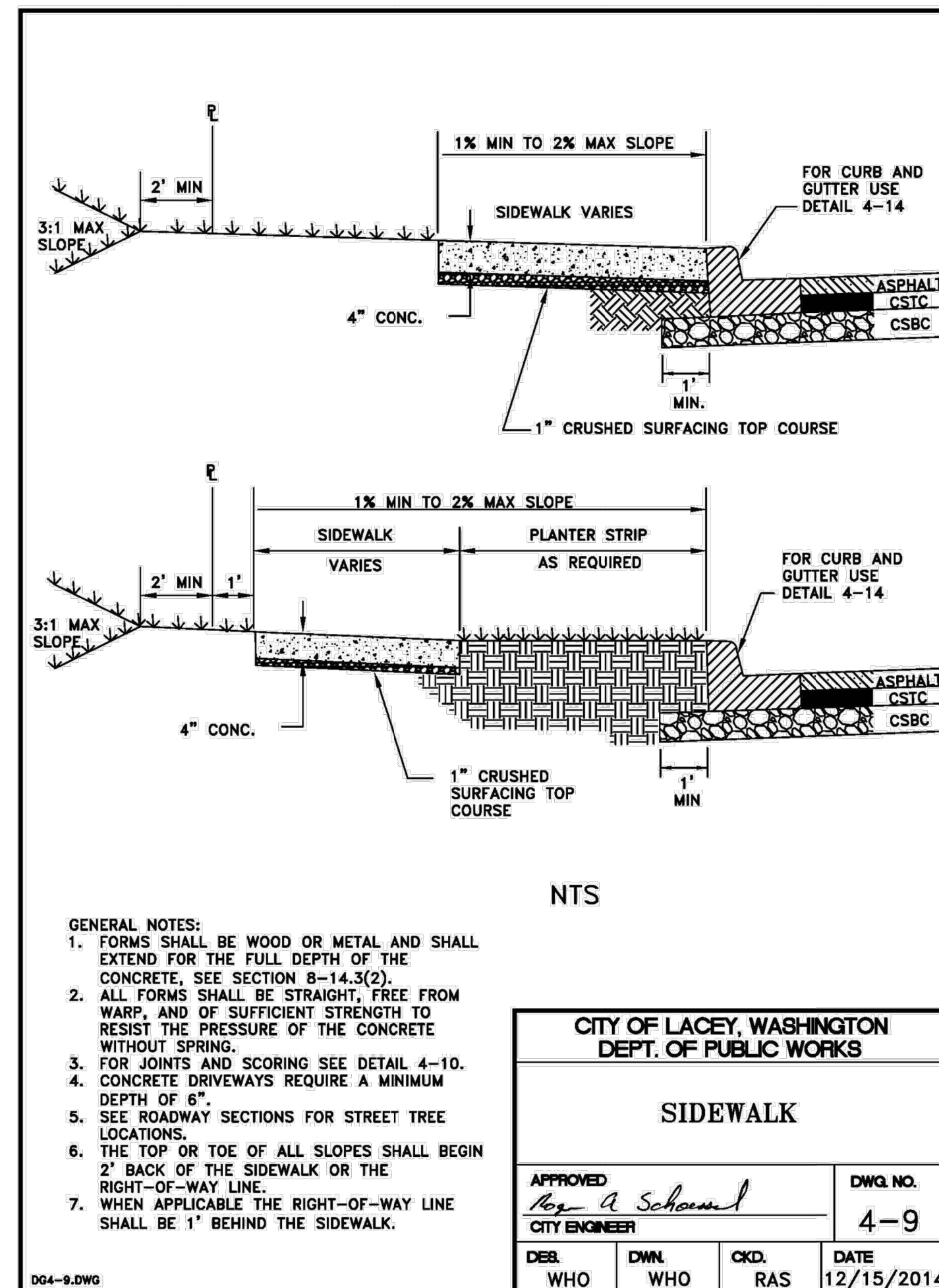

CITY OF LACEY, WASHINGTON DEPT. OF PUBLIC WORKS			
SIDEWALK			
APPROVED <i>Roy A. Schmitt</i> CITY ENGINEER	DWG. NO. 4-9		
DES. WHO	DWN. WHO	CKD. RAS	DATE 12/15/2014

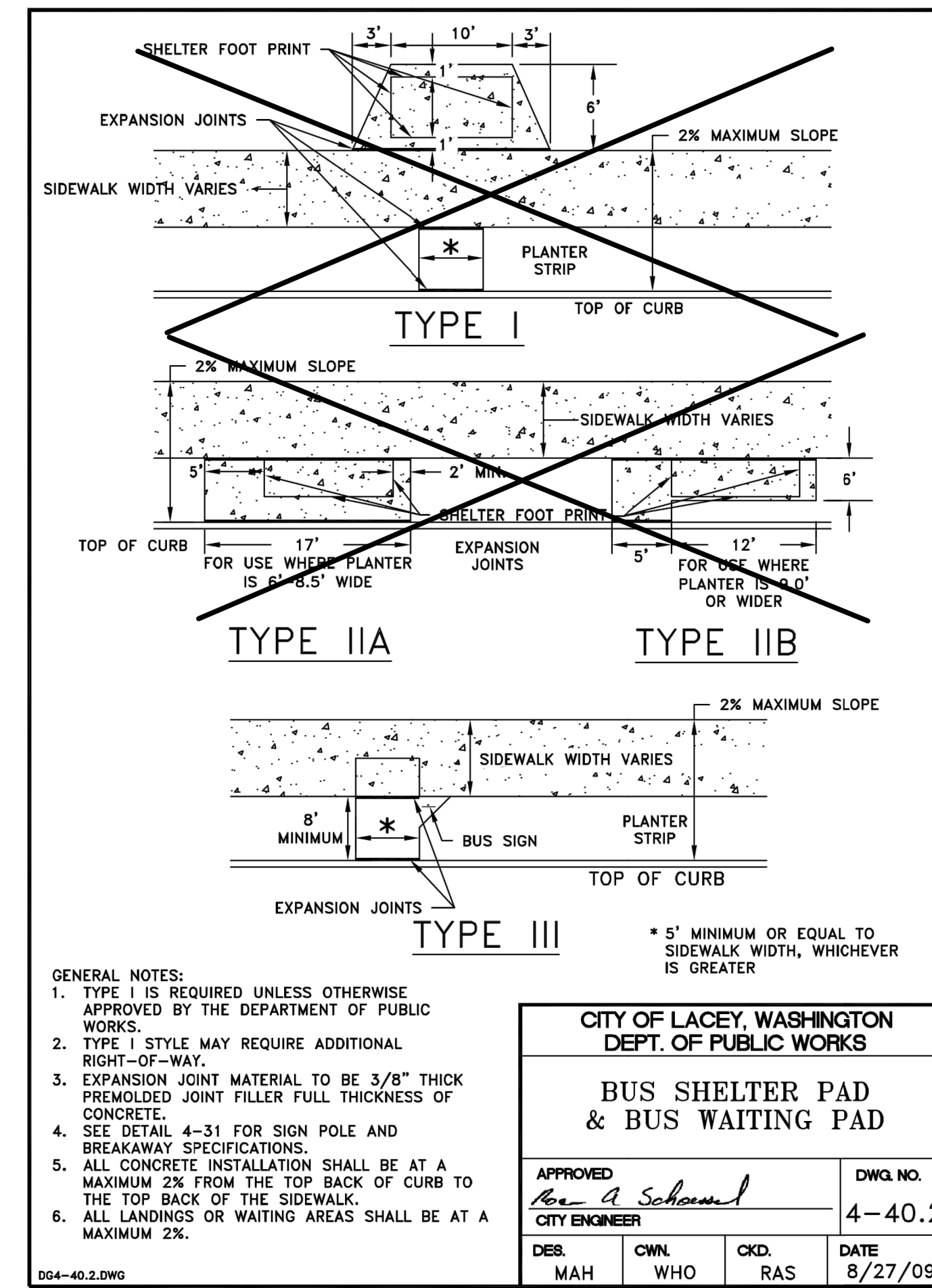

CITY OF LACEY, WASHINGTON DEPT. OF PUBLIC WORKS			
BUS SHELTER PAD & BUS WAITING PAD			
APPROVED <i>Roy A. Schmitt</i> CITY ENGINEER	DWG. NO. 4-40.2		
DES. MAH	DWN. WHO	CKD. RAS	DATE 8/27/09

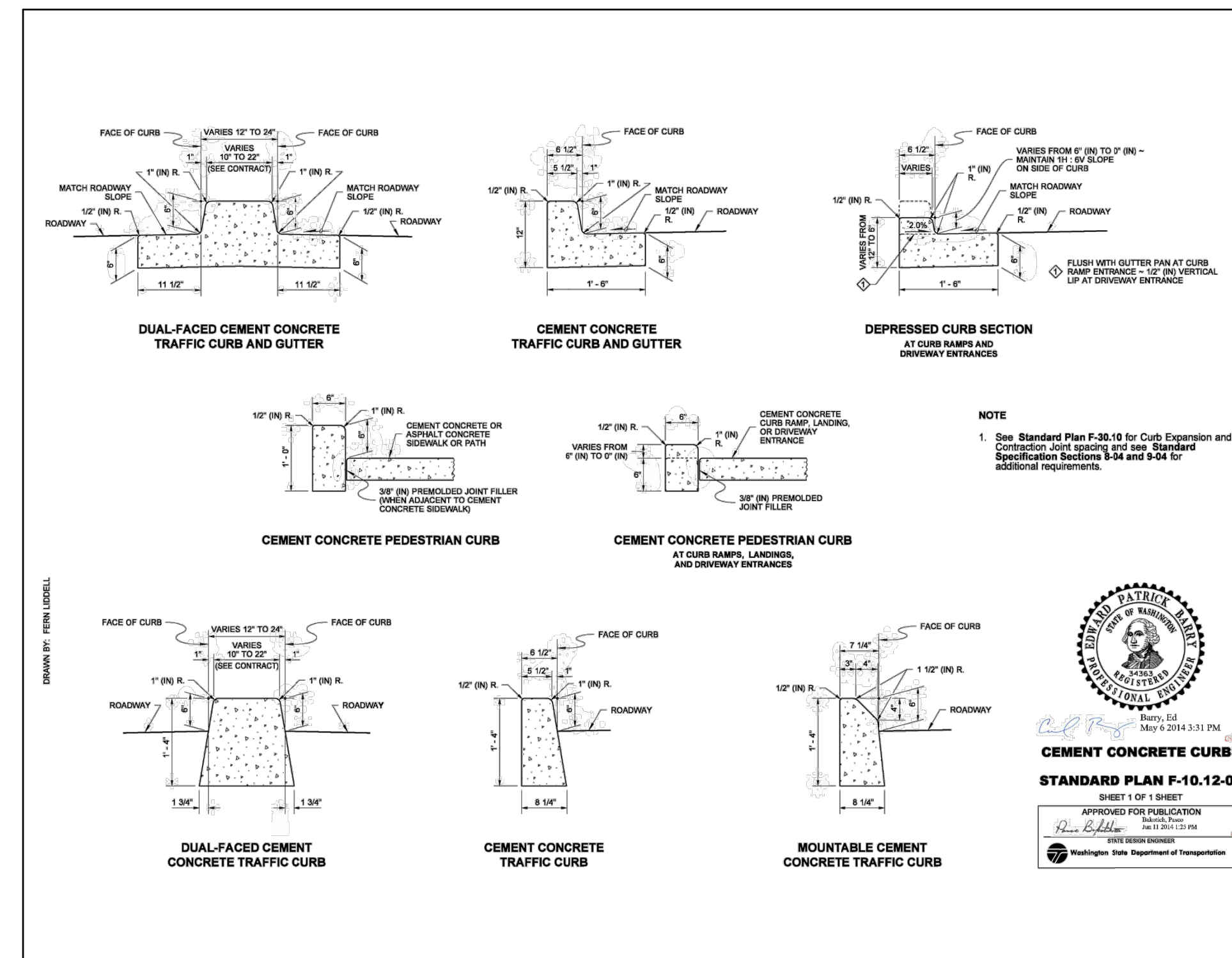

CEMENT CONCRETE CURBS
STANDARD PLAN F-10.12-03

APPROVED FOR PUBLICATION
DATE 11/20/13
BY *Roy A. Schmitt*
CITY ENGINEER

Jul 10, 2020 7:28:48am - User: whitneyh@dm.com - PROJECTS\0788 INTERCITY TRANSIT\BUS STOP CONSTRUCTION\0788-44-DETAIL-1.DWG

BY	
DATE	
REVISIONS	

SCJ ALLIANCE
CONSULTING SERVICES

8730 TALLON LANE NE SUITE 200, LACEY, WA 98516
P: 360.352.1465 F: 360.352.1509
SCJALLIANCE.COM

BUS STOP DETAILS

PROJECT NAME:
INTERCITY TRANSIT BUS STOP CONSTRUCTION
IT PROJECT # 2003C
LACEY, WA

SHEET TITLE:

DESIGNED BY: W HOLM
DRAWN BY: W HOLM
APPROVED BY: B SHEA

DATE: APRIL, 2020
JOB NO: 788.AA
DRAWING FILE NO: 788.44-DETAIL-1
DRAWING NO: DET-01
SHEET NO: 16 of 17

DESIGNER:
W HOLM

DRAWN BY:
W HOLM

APPROVED BY:
B SHEA

DATE:
APRIL, 2020

JOB NO:
788.AA

DRAWING FILE NO:
788.44-DETAIL-1

DRAWING NO:
DET-01

SHEET NO:
16 of 17

