

We touch
your **electricity**
everyday!



Price Schedule

w.e.f 1st June, 2022

Low Voltage Components



CX Partner Program



An IEC 61439
Design Verified Panel

List Price	Page No.
Power Distribution Components	5 ~ 54
WiNmaster3 ACB	6 ~ 9
WiNmaster2 ACB	10 ~ 13
AH/AHA ACB	14 ~ 26
WiNbreak1 MCCB	27 ~ 33
WiNbreak2 MCCB	34 ~ 38
WiNbreak MCCB - CS Series	39
WiNbreak MCCB - CSC Series	40-43
Switch Disconnecter Fuse Unit	43 ~ 44
Switch Disconnecter	45 ~ 47
Changeover Switch	48 ~ 49
Bypass Switch	50-52
Fusegear	53 ~ 54
Maximum Retail Price	
Power Control Components	56 ~ 98
Motor Protection Circuit Breaker (MPCB)	57 ~ 58
robusTa2 Contactor & Overload Relay	60
Powe Contactor DX-Series	61
Mini Contactor	62 ~ 63
ExceeD Contactor	64-65
robusTa Power Contactor	66 -69
Capacitor Duty Contactor	70
robusTa Overload Relay	71
Accessories - robusTa & ExceeD Contactor	72 ~ 75
D Range Contactor & Overload Relay	76 ~ 78
4 Pole & 2 Pole Contactor & Overload Relay, Definite Purpose Contactor	79-81
Industrial Plug & Socket	83
Control & Signalling Device	84 ~ 91
Motor Starters	94 ~ 98
Protection, Measurement & Control Devices	99 -108
Digital Panel Meter	100
Multi Function Meter	100
Power Quality Measurement	101
Demand Controller	102
Power Factor Controller	102
Electronic Motor Protection Relay	103-105
Electronic Motor Protection Relay-CSMP	106
ELR - Earth Leakage Relay	107
DG AMF / Synchronizing Controller	107
Voltage & Current Monitoring Relay & Timer	108
Final Power Distribution Components	109 ~ 127
Miniature Circuit Breaker, Isolator & MCB Type Changeover Switch	110 ~ 116
Residual Current Circuit Breaker	118 ~ 119
ACCL	120
Distribution Board	121 ~ 126
Plug & Socket DB	127
Wiring Accessories	128 ~ 143
Modular Switches - DIVINO	129 ~ 132
Weather Proof Enclosure - COMBI	133
Accessories	134
Modular Switches - PRIMO Plus	136 ~ 139
Modular Switches - PRIMO	140 ~ 143
Central Customer Care (CCC)	144



List Price

Power Distribution Components

General Terms & Conditions

Prices are subject to change without any prior notice and will be applicable as prevailing at the time of dispatch. Further prices are ex-works basis.

- This Price List supercedes all previous Price Lists.
- The List Prices (LP) mentioned are exclusive of all taxes.
- All Prices are in Indian Rupees.

Warranty

All our listed products carry a warranty, against manufacturing defects for a period of 12 months from the date of invoicing subject to it's usages in normal recommended operating conditions. The company liability shall be limited to exchange or repair of the product, at its discretion, provided that such defective products are returned to billing address with all necessary documents.

CENTRAL CUSTOMER CARE (CCC)

Single stop Customer Support for all service needs, please contact:

Toll Free Number: 1800 572 2012

E-mail: customercare@cselectric.co.in

POR - Price on request

Products have been classified as Stockable & Non Stockable items.

Non Stockable items has been marked as 

HSN Code denoted as below:

[HSN Code 8536] GST@18%+

[HSN Code 8537] GST@18%+

[HSN Code 8538] GST@18%+

*Subject to change as per Government of India notification

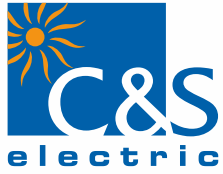

Power Distribution Components



- Air Circuit Breakers
- Moulded Case Circuit Breakers
- Switch Disconnecter Fuses
- Switch Disconnectors
- Changeover & Bypass Switches
- HRC Fuse Links, Fuse Bases & Fuse Holders



Efficient Partner in Power Distribution & Protection



CE RoHS
Compliant

WiNmaster 3 Air Circuit Breaker

- Rated Operational Voltage up to 690V
- $I_{cu}=I_{cs}=I_{cw}$ (1sec)
- Truly Modular
- Universal Termination
- No deration upto 50°C
- Wider Terminal
- Line / Load Reversibility
- Complete range of accessories
- Intelligent Release family- Micropro-3

Quenching The Needs



INTELLIGENT RELEASE

Micropro
Series



- LSIG ; Neutral & Advance Protection
- MCR & HSISC Protection
- Thermal Memory for LT & ST
- LCD Display
- Self Diagnostics in Test Mode
- Modbus Protocol, ZSI and Breaker Failure Protection
- Contact wear Indication, Total no of operations, & operating time
- ACB ID assignment
- Bar Representation for Input Current and Voltage on Home Screen

Winmaster3 Air Circuit Breakers

- Rated Operational Voltage up to 690V
- Icu = Ics = Icw (1sec)
- ACB with Universal Termination*
- Microprocessor release with Individual Fault Annunciation LEDs

Manual Fixed (MF)

- Microprocessor Release
- Aux Switch 6NO+6NC/ 4NO 4 NC
- 60 Nos SIC

Electrical Fixed (EF)

- Microprocessor Release
- Aux Switch 6NO + 6NC/ 4NO 4 NC
- Charging Motor-220V AC
- Shunt - 220V AC
- 60 Nos SIC

Manual Drawout (MF)

- Microprocessor Release
- Aux Switch 6NO + 6NC/ 4NO 4 NC
- 60 Nos SIC

Electrical Draout (EDO)

- Microprocessor Release
- Aux Switch 6NO + 6NC/ 4NO 4 NC
- Charging Motor-220V AC
- Shunt - 220V AC
- Closing Coil - 220V AC
- 60 Nos SIC

3 Pole, Winmaster3 Air Circuit Breakers with Micropro3- 3.1 Release with LSING Protection							[HSN Code: 8536]
Rating (Amps)	Breaking Capacity Icu=Ics=Icw (1sec)	Reference	List Price (₹)				
			Manual Fixed	Manual Drawout	Electrical Fixed	Electrical Drawout	
630A	65kA	WX306S3P*A(S)	POR	POR	POR	POR	
800A		WX308S3P*A(S)					
1000A		WX310S3P*A(S)					
1250A		WX312S3P*A(S)					
1600A		WX316S3P*A(S)					
2000A		WX320S3P*A(S)					
2500A		WX325S3P*A(S)					
800A	80kA	WX308H3P*A(S)	POR	POR	POR	POR	
1000A		WX310H3P*A(S)					
1250A		WX312H3P*A(S)					
1600A		WX316H3P*A(S)					
2000A		WX320H3P*A(S)					
2500A		WX325H3P*A(S)					
3200A		WX332H3P*A(S)					
4000A	WX340H3P*A(S)						

4 Pole, Winmaster3 Air Circuit Breakers with Micropro3- 3.1 Release with LSING Protection							[HSN Code: 8536]
Rating (Amps)	Breaking Capacity Icu=Ics=Icw (1sec)	Reference	List Price (₹)				
			Manual Fixed	Manual Drawout	Electrical Fixed	Electrical Drawout	
630A	65kA	WX306S4P*A(S)	POR	POR	POR	POR	
800A		WX308S4P*A(S)					
1000A		WX310S4P*A(S)					
1250A		WX312S4P*A(S)					
1600A		WX316S4P*A(S)					
2000A		WX320S4P*A(S)					
2500A		WX325S4P*A(S)					
800A	80kA	WX308H4P*A(S)	POR	POR	POR	POR	
1000A		WX310H4P*A(S)					
1250A		WX312H4P*A(S)					
1600A		WX316H4P*A(S)					
2000A		WX320H4P*A(S)					
2500A		WX325H4P*A(S)					
3200A		WX332H4P*A(S)					
4000A	WX340H4P*A(S)						

MRP & Reference Code changes as per the release modification	Ordering Code	List Price (₹)
Without release ACB	WR	POR
MicroPro3 3.1 (LSING)	A	
MicroPro3 4.1 (LSING, LED Display, Current Measurement, Trip History)	B	
MicroPro3 5.1 (LSING, 2 LED Display, Current + Voltage + Power Measurement, Trip History,	C	
MicroPro3 7.1 (LSING + Advanced Protections, LCD Display, Current + Voltage + Power + Harmonics Measurement, Trip History, ZSI, Communication, Maintenance Indicator)	D	

NOTE: Breaking capacity @415V



Winmaster3 ACB Order Form

Please fill separate sheet for each type of ACB, Tick the box in front of each appropriate item and fill in the blanks.					
Customer Name		Order No. & date		Delivery Date	End user/ Panel Builder Name & Ph. No.
Frame1 ACB 65kA@415V AC 42kA@690V AC	<input type="checkbox"/> 630A	<input type="checkbox"/> 1000A	<input type="checkbox"/> 1600A	<input type="checkbox"/> 2500A	Product Code
	<input type="checkbox"/> 800A	<input type="checkbox"/> 1250A	<input type="checkbox"/> 2000A		
Fraem2-ACB 80kA@415V AC 50kA@690V AC	<input type="checkbox"/> 800A	<input type="checkbox"/> 1250A	<input type="checkbox"/> 2000A	<input type="checkbox"/> 3200A	Qty
	<input type="checkbox"/> 1000A	<input type="checkbox"/> 1600A	<input type="checkbox"/> 2500A	<input type="checkbox"/> 4000A	
No. of Poles	<input type="checkbox"/> 3 Pole	<input type="checkbox"/> 4 Pole	<input type="checkbox"/> 3Pole + N	<input type="checkbox"/> Fixed	<input type="checkbox"/> Drawout
Termination (Selection is mandatory)					
<input type="checkbox"/> Universal Termination (630A-3200A)					
Termination for 4000A (Factory fitted only)					
<input type="checkbox"/> Vertical Termination 4000A					
<input type="checkbox"/> Manual	Closing Coil	<input type="checkbox"/> 110V AC/DC		<input type="checkbox"/> 220V AC/DC	
		<input type="checkbox"/> 24V DC		<input type="checkbox"/> 48V DC	
<input type="checkbox"/> Electrical	Shunt Trip Coil	<input type="checkbox"/> 110V AC/DC		<input type="checkbox"/> 220V AC/DC	
		<input type="checkbox"/> 24V DC		<input type="checkbox"/> 48V DC	
<input type="checkbox"/> Auxiliary switch (4NO+4NC)	Charging Motor	<input type="checkbox"/> 110V AC/DC		<input type="checkbox"/> 220V AC/DC	
		<input type="checkbox"/> 110V AC/DC		<input type="checkbox"/> 220V AC/DC	
<input type="checkbox"/> Auxiliary switch (6NO+6NC)	UVT	<input type="checkbox"/> 100-130V AC		<input type="checkbox"/> 220-250V AC	
		<input type="checkbox"/> 110V DC		<input type="checkbox"/> 220V DC	
		<input type="checkbox"/> Without Time Delay		<input type="checkbox"/> With Time Delay	
Release	<input type="checkbox"/> MicroPro3- 3.1	<input type="checkbox"/> MicroPro3- 4.1	<input type="checkbox"/> MicroPro3- 5.1	<input type="checkbox"/> MicroPro3- 7.1	
	<input type="checkbox"/> No Release				
PSM	<input type="checkbox"/> 220V AC	<input type="checkbox"/> 220V DC	<input type="checkbox"/> 415V AC	<input type="checkbox"/> 24V DC	
	<input type="checkbox"/> Door Interlock	<input type="checkbox"/> Mechanical Interlock Cable Type	<input type="checkbox"/> Rating Preventor		
<input type="checkbox"/> Key Interlock	<input type="checkbox"/> 1 ACB	<input type="checkbox"/> Electrical Position Indication	<input type="checkbox"/> Phase Barriers		
	<input type="checkbox"/> 2 ACB	<input type="checkbox"/> IP 54 Protection (For Drawout ACB only)	<input type="checkbox"/> Mechanical Counter		
		<input type="checkbox"/> 3 ACB	<input type="checkbox"/> Aux. SW 6NO + 6 NC		<input type="checkbox"/> Aux. SW 4 NO + 4 NC
Special Requirement if any					
Note: (1) Please refer to catalog / price list for further details of MicroPro3 release (2) Neutral CT is required along with Micropro3 release having ground fault protection. This has to be mounted on earth / neutral busbar of panel					



WiNmaster2

Breaker with intelligence

WiNmaster2 Power Circuit Breakers are a new generation of Air Circuit Breakers having modular construction to offer a truly global product platform meeting IEC, ANSI and UL standards.

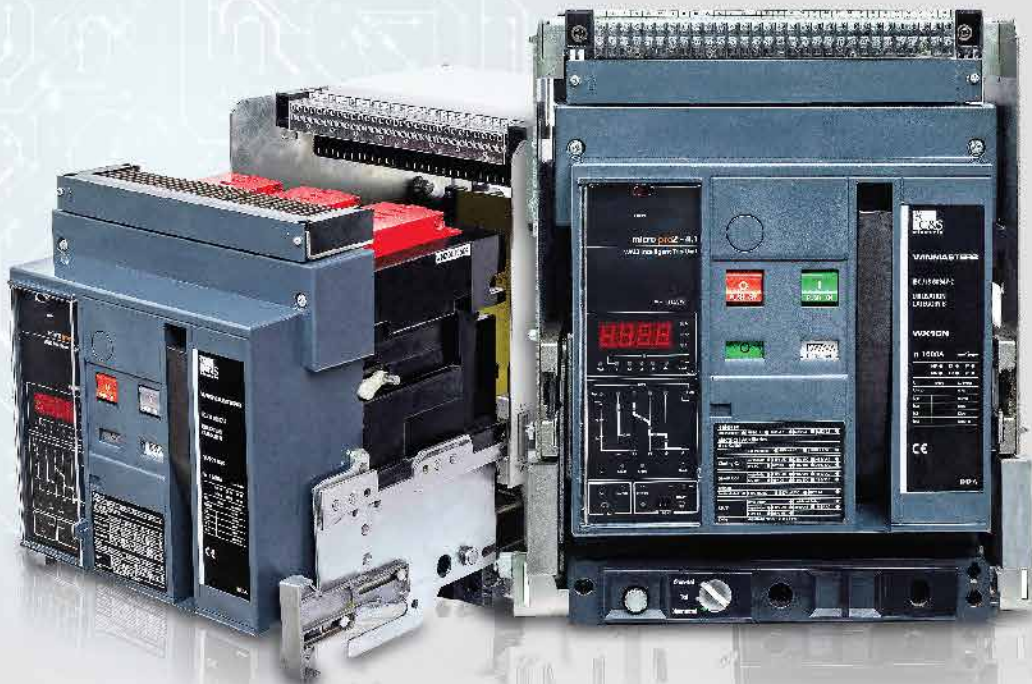

Range
630A-2500A

Single frame
for
complete
range

Poles
3P & 4P

Versions
Fixed & Drawout
(Mechanical
& Electrical)

Ics=Icu=Icw
(for 1 sec)
at 50kA

CE **RoHS**
Compliant

Intelligent releases

- Micropro2 3.1
- Micropro2 4.1
- Micropro2 7.1

Measurement

Trip
History

ZSI

Fault
LED retention

Short Circuit
Protection

Communication





Air Circuit Breaker

WiNmaster2 Air Circuit Breaker

630A-2500A

Features:

- LSING Protection
- Digital Display
- Communication through RS 485 Port
- True RMS Sensing
- Current, Voltage, Power Measurement with Maximeter
- Thermal Memory
- Trip History
- Fault Indication
- Zone Selectivity
- Harmonics



WiNmaster2 Breakers fitted with standard accessories, tabulated below, are included in the Prices mentioned in subsequent tables.

Manual Fixed (MF)	Electrical Fixed (EF)	Manual Drawout (MDO)	Electrical Drawout (EDO)
<ul style="list-style-type: none"> - Microprocessor Release - Auxiliary Switch 6NO+6NC - Main CTs - Terminal Type - Horizontal 	<ul style="list-style-type: none"> - Microprocessor Release - Auxiliary Switch 6NO+6NC - Main CTs - AC/DC Charging Motor - Closing Coil - Shunt Trip - Terminal Type - Horizontal 	<ul style="list-style-type: none"> - Microprocessor Release - Auxiliary Switch 6NO+6NC - Main CTs - Safety Shutter - 60 Way auxiliary isolating contacts - Terminal Type - Horizontal 	<ul style="list-style-type: none"> - Microprocessor Release - Auxiliary Switch 6NO+6NC - Main CTs - Safety Shutter - 60 Way auxiliary isolating contacts - AC/DC Charging Motor - Closing Coil - Shunt Trip - Terminal Type - Horizontal

Air Circuit Breaker with Intelligent Release Micropro2-3.1

Fixed 3 Pole			[HSN Code: 8536]	
Rating (Amps)	Breaking Capacity Icu=Ics=Icw (1sec)	Reference	List Price (₹)	
			*MF	*EF
630	50kA	WX06N3P*A(S)	169180	226400
800	50kA	WX08N3P*A(S)	169180	226400
1000	50kA	WX10N3P*A(S)	178100	237680
1250	50kA	WX12N3P*A(S)	206690	267090
1600	50kA	WX16N3P*A(S)	231640	290050
2000	50kA	WX20N3P*A(S)	272050	329910
2500	50kA	WX25N3P*A(S)	304700	374540

Air Circuit Breaker with Intelligent Release Micropro2-3.1

Fixed 4 Pole			[HSN Code: 8536]	
Rating (Amps)	Breaking Capacity Icu=Ics=Icw (1sec)	Reference	List Price (₹)	
			*MF	*EF
630	50kA	WX06N4P*A(S)	213060	269290
800	50kA	WX08N4P*A(S)	213060	269290
1000	50kA	WX10N4P*A(S)	222490	279220
1250	50kA	WX12N4P*A(S)	260720	319120
1600	50kA	WX16N4P*A(S)	296570	354420
2000	50kA	WX20N4P*A(S)	355560	417370
2500	50kA	WX25N4P*A(S)	376890	438250

Drawout 3 Pole			[HSN Code: 8536]	
Rating (Amps)	Breaking Capacity Icu=Ics=Icw (1sec)	Reference	List Price (₹)	
			*MDO	*EDO
630	50kA	WX06N3P*A(S)	235360	286190
800	50kA	WX08N3P*A(S)	235360	286190
1000	50kA	WX10N3P*A(S)	245000	297650
1250	50kA	WX12N3P*A(S)	265130	324650
1600	50kA	WX16N3P*A(S)	304160	360860
2000	50kA	WX20N3P*A(S)	371760	431270
2500	50kA	WX25N3P*A(S)	455300	519110

Drawout 4 Pole			[HSN Code: 8536]	
Rating (Amps)	Breaking Capacity Icu=Ics=Icw (1sec)	Reference	List Price (₹)	
			*MDO	*EDO
630	50kA	WX06N4P*A(S)	279290	337590
800	50kA	WX08N4P*A(S)	279290	340810
1000	50kA	WX10N4P*A(S)	295280	354260
1250	50kA	WX12N4P*A(S)	314710	389640
1600	50kA	WX16N4P*A(S)	364250	423230
2000	50kA	WX20N4P*A(S)	448020	506420
2500	50kA	WX25N4P*A(S)	532380	589120

List Price & Reference Code changes for ACB with Neutral CT

For ACB with NCT add to the above price of 3 Pole ACB with MP2 3.1		ADD	8980
With NCT ordering Code will be	Existing Code	New Code	
	WX06N3PMFA(S)	WX06N3PNMFA(S)	
	WX06N3PNEFA(S)	WX06N3PNEFA(S)	
	WX06N3PNEDOA(S)	WX06N3PNEDOA(S)	
	WX06N3PNMDOA(S)	WX06N3PNMDOA(S)	

#Price Changes for ACB with high end release w.r.t MicroPro2 3.1 ACB			
Release	Description	List Price (₹)	Ordering Code
MicroPro2 3.1	LSIG	As mentioned above in Reference	A
Micropro2 4.1	LSING, Thermal Memory, Last Fault Trip History & current display	Add 6280	B
Micropro2 7.1	LSING, Earth Leakage Protection, Trip History, Over & under voltage/ Frequency, voltage imbalance, current imbalance, Reverse power, Phase Sequence, Leakage Alarm, Current imbalance Protection, Fault Indication, current, voltage and power display with maximeter feature with inbuilt communication	Add 47110	C

NOTES:

- 1) While ordering an ACB, the complete catalogue reference by replacing '*' with ACB type: MF-Manual Fixed, EF-Electrical Fixed, MDO-Manual Drawout, EDO-Electrical Drawout
- 2) In TP ACB, if earth fault facility required. Please add Price of neutral CT to ACB Price as mentioned above.
- 3) Other options of terminals are available on request.
- 4) #For ordering replace A with B or C, as per requirement.
- 5) All configurable products are non stockable.

WiNmaster2/3 Air Circuit Breaker Accessories

Main Accessories (Please specify ACB rating & type while placing order)

1. Under Voltage Trip Device				[HSN Code: 8538]
Sl. No.	Compatible with	Description	Reference	List Price (₹)
1.1	WM2/ WM3	Without Delay Common for 630A-4000A	CS-WM2-AUH-V-ABC-**	8770
1.2	WM2/ WM3	With Delay Common for 630A-4000A	CS-WM2-AUH-D-ABC-**	9590

2. Continuous rated Shunt Trip and Closing Coil				[HSN Code: 8538]
Sl. No.	Compatible with	Description	Reference	List Price (₹)
2.1	WM2/ WM3	Shunt Coil Common for 630A-4000A	CS-WM2-AVH-SC-ABC-**	4380
2.2	WM2/ WM3	Closing Coil Common for 630A-4000A	CS-WM2-AVH-CC-ABC-**	4380

3. Accessories				[HSN Code: 8538]
Sl. No.	Compatible with	Description	Reference	List Price (₹)
3.1	WM2 / WM3	Universal Charging Motor-Common for 630A-2500A (for 220VAC/DC)	CS-WM2-AMH-AV-A-M	38870
3.2	WM2 / WM3	Universal Charging Motor-Common for 630A-2500A (for 415VAC)	CS-WM2-AMH-AU-A1-N	
3.3	WM2 / WM3	Universal Charging Motor-Common for 630A-2500A (for 110VAC/DC)	CS-WM2-AMH-AS-A1-F	
3.4	WM3	Universal Charging Motor for Frame2, Common for 800A-4000A (for 220VAC/DC)	CS-WM3-AMH-AV-A2-M	POR
3.5	WM3	Universal Charging Motor for Frame2, Common for 800A-4000A (for 415VAC)	CS-WM3-AMH-AU-A2-N	
3.6	WM3	Universal Charging Motorfor Frame2, Common for 800A-4000A (for 11 0VAC/DC)	CS-WM3-AMH-AS-A2-F	
3.7	WM2 / WM3	LIFTER	LIFTER (580x600)*	162970
			LIFTER-SPL (690x570)*	179180
3.8	WM2 / WM3	Mismatch Prevention Device	CS-WM2-MIP-AB	1740
3.9	WM2	Panel Door Lock (Drawout)	CS-WM2-PDL-AB	2500
3.10	WM2 / WM3	Mechanical interlock for interlocking 2 ACBs (Drawout)	CS-WM2-MIL-HD	41280
3.11	WM2 / WM3	Mechanical interlock for interlocking 2 ACBs (Fixed)	CS-WM2-MIL-HF	35270
3.12	WM2 / WM3	Key Lock (1 Lock + 1 Key)	CS-WM2-AKI-AB	7050
3.13	WM2 / WM3	Key Lock (3 Lock + 2 Key)	CS-WM2-AKI-1-AB	7370
3.14	WM2 / WM3	Key Lock (2 Lock + 1 Key)	CS-WM2-AKI-2-AB	5630
3.15	WM2 / WM3	Mechanical operation counter	CS-WM2-ASC-ABC	3230
3.16	WM2 / WM3	Ready to close contact	CS-WM2-RTC-ABC	1740
3.17	WM2 / WM3	Phase Barrier - 3 Pole (Drawout)	CS-WM2-PB-3P	POR
3.18	WM2 / WM3	Phase Barrier - 4 Pole (Drawout)	CS-WM2-PB-4P	
3.19	WM2 / WM3	Mechanical Interlock for 1 to 3 ACBs (DrawOut)	CS-WM2-MIL3-HD	49380
3.20	WM2 / WM3	Mechanical Interlock for 1 to 3 ACBs (Fixed)	CS-WM2-MIL3-HF	53450
3.21	WM2 / WM3	Panel Door Lock (Fixed)	CS-WM2-PDLF-AB	POR
3.22	WM2 / WM3	Phase Barrier- 3Pole (Fixed)	CS-WM2-PBF-3P	
3.23	WM2 / WM3	Phase Barrier- 4Pole (Fixed)	CS-WM2-PBF-4P	
3.24	WM2 / WM3	Position Indication Switch	CS-WM2-ALB-AB	
3.25	WM2 / WM3	Auxiliary Switch	CS-WM2-AXH-6A6B	
3.26	WM2 / WM3	IP54 cover for Drawout ACB- Frame-1	CS-WM3-CVRIP54-FR1	
3.27	WM3	IP54 cover for Drawout ACB- Frame-2	CS-WM3-CVRIP54-FR2	
3.28	WM3	Panel Door Lock (Drawout)	CS-WM3-DOOR-INT-DRAB	

* in (mm)

**Options for Coil Voltage							
Description	AC Control Voltage			DC Control Voltage			
	110V	220-250V	380-440V	24V	48V	110V	220V
UVT	FA	MA	NA	-	-	FD	MD

Shunt & Closing Coil	100/130V AC/DC	220-250V AC/DC	380V AC	24V DC	28V DC
	F	M	N	BD	ED

NOTES: All configurable products are non stockable.

Winmaster2 ACB Order Form

Please fill separate sheet for each type of ACB. Tick the box in front of each appropriate item and fill in the blanks.

CUSTOMER NAME		ORDER NO. & DATE		DELIVERY DATE		END USER / PANEL BUILDER NAME & PHONE NO.			
RATING OF ACB REQUIRED	<input type="checkbox"/> 630 A	<input type="checkbox"/> 1000 A	<input type="checkbox"/> 1600 A	<input type="checkbox"/> 2500 A	QTY. (NOS.)		Product Reference		
	<input type="checkbox"/> 800 A	<input type="checkbox"/> 1250 A	<input type="checkbox"/> 2000 A						
NO. OF POLES	<input type="checkbox"/> 3 POLE	<input type="checkbox"/> 3P+N	<input type="checkbox"/> 4 POLE		Breaking capacity				
MOUNTING	<input type="checkbox"/> FIXED <input type="checkbox"/> DRAWOUT <input type="checkbox"/> 60 WAY AUX. ISOLATING CONTACT ASSLY.								
OPERATION	<input type="checkbox"/> MANUAL <input type="checkbox"/> ELECTRICAL		CLOSING COIL		<input type="checkbox"/> 110V AC	<input type="checkbox"/> 220~250V AC	<input type="checkbox"/> 380~440V AC		
					<input type="checkbox"/> 24V DC	<input type="checkbox"/> 48V DC	<input type="checkbox"/> 110V DC	<input type="checkbox"/> 220V DC	
					SHUNT TRIP COIL		<input type="checkbox"/> 110V AC	<input type="checkbox"/> 220~250V AC	<input type="checkbox"/> 380~440V AC
							<input type="checkbox"/> 24V DC	<input type="checkbox"/> 48V DC	<input type="checkbox"/> 110V DC
		MOTOR		<input type="checkbox"/> 110V AC	<input type="checkbox"/> 220V AC	<input type="checkbox"/> 415V AC			
				<input type="checkbox"/> 110V DC	<input type="checkbox"/> 220V DC				
RELEASES	MICROPROCESSOR RELEASE <input type="checkbox"/> MicroPro2 3.1 <input type="checkbox"/> MicroPro2 4.1 <input type="checkbox"/> MicroPro2 7.1		UNLESS & OTHERWISE SPECIFIED, ALL SETTINGS OF RELEASES WOULD BE SET AT MINIMUM VALUES.		MAIN CT RATING _____ A,				
					SETTINGS : OVERLOAD _____ A, SHORT CIRCUIT _____ A,				
					GROUND FAULT _____ A INSTANTANEOUS _____ A, NEUTRAL _____ A,				
ACCESSORIES	<input type="checkbox"/> AUX. SW 6 NO+6 NC <input type="checkbox"/> AUX. SW 4 NO+4 NC <input type="checkbox"/> DOOR INTERLOCK (AVAILABLE ONLY WITH DRAW OUT TYPE ACB)								
	<input type="checkbox"/> UVT <input type="checkbox"/> 110V AC <input type="checkbox"/> 220~250V AC <input type="checkbox"/> 380~440V AC <input type="checkbox"/> 110V DC <input type="checkbox"/> 220V DC		<input type="checkbox"/> MECHANICAL INTERLOCK (Cable Type) <input type="checkbox"/> HORIZONTAL						
	<input type="checkbox"/> KEY INTERLOCK <input type="checkbox"/> 1 ACB <input type="checkbox"/> 2 ACBs <input type="checkbox"/> 3 ACBs								
	<input type="checkbox"/> SPRING CHARGE IND. SWITCH (ONLY WITH ELECTRICAL ACB)								
SPECIAL REQUIREMENT/ ACCESSORIES (IF ANY)									
Notes : (1) Please refer catalogue / Price-List, for further details of Micropro Release. (2) Neutral CT is required alongwith Microprocessor Release having Ground -Fault Protection. This has to be mounted on Earth / Neutral Busbar of Panel.									



Air Circuit Breaker AH / AHA



RoHS
Compliant

The AH/ AHA series circuit breakers are robust circuit breakers complying to IEC 60947-2 & are equipped with unique 'Slow Close Operation of Contacts'.

Equipped with smart features of advance Micropro-V4*

- Power & Current Measurement
- Individual Fault Annunciation
- ZSI
- 100 Event records
- Advance Protection
- SCADA compatibility - RS485 Port
- Data Uploading to PC / Laptop through USB port

Intelligent Protection Releases



Air Circuit Breaker AH / AHA

630A-6300A

(I) ACB with Intelligent Release MicroPro 3.1

Features:

- LSIG Protection
- True RMS Sensing
- Fault Indication

(For standard configuration, please refer AH / AHA ACB Order Form)



LT Air Circuit Breaker fitted with Intelligent Release MicroPro 3.1

Fixed 3 Pole			[HSN Code: 8536]	
Rating (Amps)	Breaking Capacity I _{cu} =I _{cs} =I _{cw} (1sec)	Reference	List Price (₹)	
			*MF	*EF
630	50kA	AHA06N3P*MP3.1(S)	136050	186300
800	50kA	AHA08N3P*MP3.1(S)	136050	186300
1000	50kA	AHA10N3P*MP3.1(S)	140750	192880
1250	50kA	AHA12N3P*MP3.1(S)	168720	227380
1600	50kA	AHA16N3P*MP3.1(S)	178420	229270
2000	50kA	AHA20N3P*MP3.1(S)	219700	298460
2500	50kA	AHA25N3P*MP3.1(S)	264640	321630
3200	65kA	AH30DCSMP3.1*(S)	396180	464790
4000	85kA	AH40DCSMP3.1*(S)	638290	695260

Fixed 4 Pole			[HSN Code: 8536]	
Rating (Amps)	Breaking Capacity I _{cu} =I _{cs} =I _{cw} (1sec)	Reference	List Price (₹)	
			*MF	*EF
630	50kA	AHA06N4P*MP3.1(S)	169740	218940
800	50kA	AHA08N4P*MP3.1(S)	169740	218940
1000	50kA	AHA10N4P*MP3.1(S)	173890	225670
1250	50kA	AHA12N4P*MP3.1(S)	211940	266720
1600	50kA	AHA16N4P*MP3.1(S)	242380	289550
2000	50kA	AHA20N4P*MP3.1(S)	290410	366700
2500	50kA	AHA25N4P*MP3.1(S)	330630	398440
3200	65kA	AH30D4CSMP3.1*(S)	525650	587800
4000	85kA	AH40D4CSMP3.1*(S)	761290	870030

Drawout 3 Pole			[HSN Code: 8536]	
Rating (Amps)	Breaking Capacity I _{cu} =I _{cs} =I _{cw} (1sec)	Reference	List Price (₹)	
			*MD	*ED
630	50kA	AHA06N3P*MP3.1(S)	206120	253040
800	50kA	AHA08N3P*MP3.1(S)	206120	253040
1000	50kA	AHA10N3P*MP3.1(S)	215820	262730
1250	50kA	AHA12N3P*MP3.1(S)	249360	289530
1600	50kA	AHA16N3P*MP3.1(S)	265000	325810
2000	50kA	AHA20N3P*MP3.1(S)	336650	386900
2500	50kA	AHA25N3P*MP3.1(S)	406670	457040
3200	65kA	AHA30S3P*MP3.1(S)	519930	570580
4000	65kA	AHA40S3P*MP3.1(S)	648070	683740
4000	85kA	AH40DCSMP3.1*(S)	674540	705620
5000	85kA	AH50CCSMP3.1*(S)	POR	POR
6300	100kA	AH60CCSMP3.1*(S)		

Drawout 4 Pole			[HSN Code: 8536]	
Rating (Amps)	Breaking Capacity I _{cu} =I _{cs} =I _{cw} (1sec)	Reference	List Price (₹)	
			*MD	*ED
630	50kA	AHA06N4P*MP3.1(S)	266640	318660
800	50kA	AHA08N4P*MP3.1(S)	266640	318660
1000	50kA	AHA10N4P*MP3.1(S)	272590	329940
1250	50kA	AHA12N4P*MP3.1(S)	321580	352280
1600	50kA	AHA16N4P*MP3.1(S)	344190	390200
2000	50kA	AHA20N4P*MP3.1(S)	437300	475090
2500	50kA	AHA25N4P*MP3.1(S)	513910	555250
3200	65kA	AHA30S4P*MP3.1(S)	605570	680100
4000	65kA	AHA40S4P*MP3.1(S)	863770	874100
4000	85kA	AH40D4CSMP3.1*(S)	875660	887090
5000	85kA	AH50C4CSMP3.1*(S)	POR	POR
6300	100kA	AH60C4CSMP3.1*(S)		

NOTES: All configurable products are non stockable.

Air Circuit Breaker AH / AHA

630A-6300A

(III) ACB with Thermal Magnetic Release

(For standard configuration, please refer AH / AHA ACB Order Form)

LT Air Circuit Breaker fitted with Thermal Magnetic Release and Standard Accessories, as applicable.

Fixed 3 Pole			[HSN Code: 8536]	
Rating (Amps)	Breaking Capacity Icu=Ics=Icw (1sec)	Reference	List Price (₹)	
			*MF	*EF
630	50kA	AHA06N3P*TM(S)	109370	152380
800	50kA	AHA08N3P*TM(S)	117190	169180
1000	50kA	AHA10N3P*TM(S)	119570	170180
1250	50kA	AHA12N3P*TM(S)	159240	207130
1600	50kA	AHA16N3P*TM(S)	165170	222320
2000	50kA	AHA20N3P*TM(S)	189710	264460
2500	50kA	AHA25N3P*TM(S)	212670	305840
3200	65kA	AH30DCSTM*(S)	355770	427550
4000	85kA	AH40DCSTM*(S)	550960	621810

Fixed 4 Pole			[HSN Code: 8536]	
Rating (Amps)	Breaking Capacity Icu=Ics=Icw (1sec)	Reference	List Price (₹)	
			*MF	*EF
630	50kA	AHA06N4P*TM(S)	146430	188570
800	50kA	AHA08N4P*TM(S)	155380	197790
1000	50kA	AHA10N4P*TM(S)	158100	206420
1250	50kA	AHA12N4P*TM(S)	197660	249380
1600	50kA	AHA16N4P*TM(S)	214070	272900
2000	50kA	AHA20N4P*TM(S)	259450	316510
2500	50kA	AHA25N4P*TM(S)	306580	363010
3200	65kA	AH30D4CSTM*(S)	444940	510280
4000	85kA	AH40D4CSTM*(S)	652580	756800

Drawout 3 Pole			[HSN Code: 8536]	
Rating (Amps)	Breaking Capacity Icu=Ics=Icw (1sec)	Reference	List Price (₹)	
			*MD	*ED
630	50kA	AHA06N3P*TM(S)	174600	225480
800	50kA	AHA08N3P*TM(S)	176500	232270
1000	50kA	AHA10N3P*TM(S)	181320	235200
1250	50kA	AHA12N3P*TM(S)	218720	265450
1600	50kA	AHA16N3P*TM(S)	252650	297820
2000	50kA	AHA20N3P*TM(S)	298950	343220
2500	50kA	AHA25N3P*TM(S)	360670	407860
3200	65kA	AHA30S3P*TM(S)	454430	502220
4000	65kA	AHA40S3P*TM(S)	601880	648760
4000	85kA	AH40DCSTM*(S)	632440	688440
5000	85kA	AH50CCSTM*(S)	POR	POR
6300	100kA	AH60CCSTM*(S)	POR	POR

Drawout 4 Pole			[HSN Code: 8536]	
Rating (Amps)	Breaking Capacity Icu=Ics=Icw (1sec)	Reference	List Price (₹)	
			*MD	*ED
630	50kA	AHA06N4P*TM(S)	219200	278500
800	50kA	AHA08N4P*TM(S)	223980	289120
1000	50kA	AHA10N4P*TM(S)	231350	292710
1250	50kA	AHA12N4P*TM(S)	280600	326830
1600	50kA	AHA16N4P*TM(S)	308260	355150
2000	50kA	AHA20N4P*TM(S)	389770	413580
2500	50kA	AHA25N4P*TM(S)	462440	500060
3200	65kA	AHA30S4P*TM(S)	567040	615770
4000	65kA	AHA40S4P*TM(S)	764690	786060
4000	85kA	AH40D4CSTM*(S)	763080	822150
5000	85kA	AH50C4CSTM*(S)	POR	POR
6300	100kA	AH60C4CSTM*(S)	POR	POR

NOTES: All configurable products are non stockable.



Air Circuit Breaker

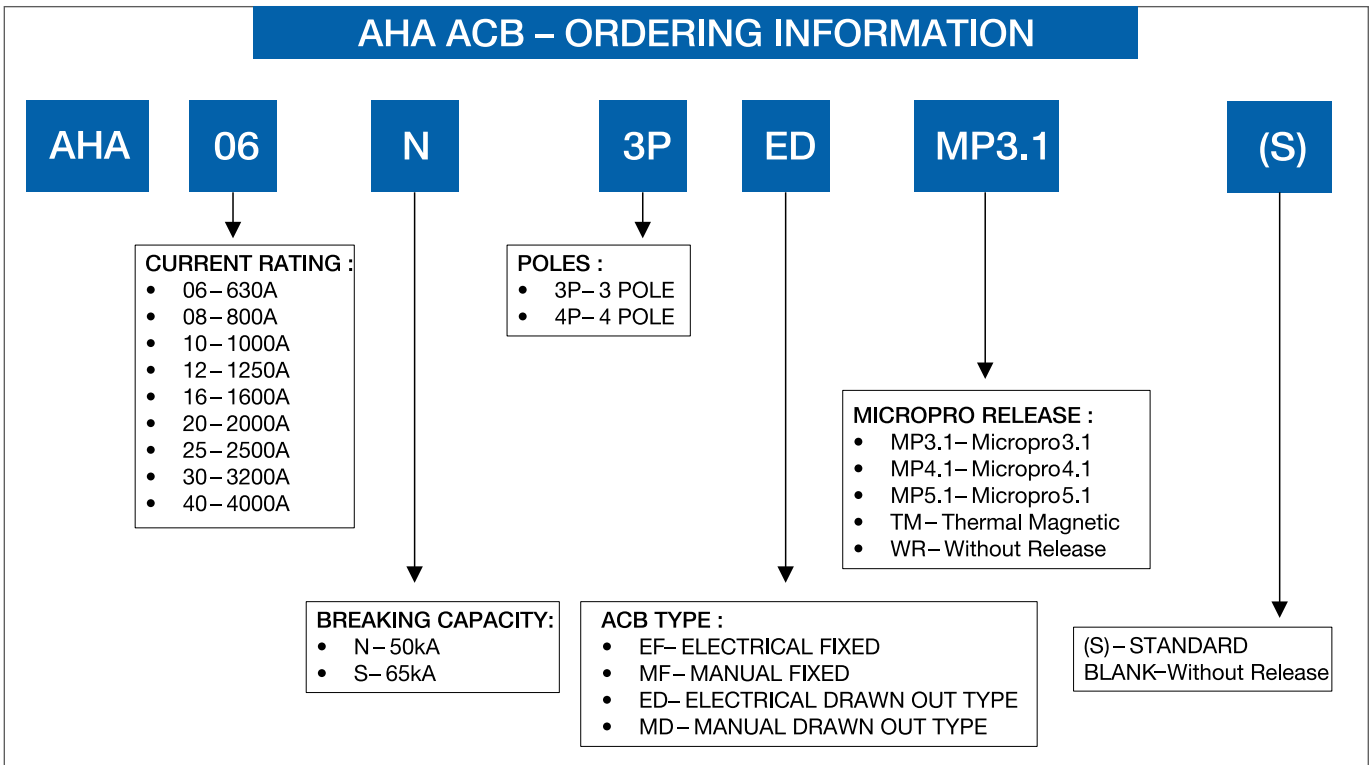

List Price & Reference changes as per the release modification	Ordering Code	List Price(₹)
MicroPro 4.1 (LSING, Display, Current Measurement, Trip History, Communication) add to the price of ACB with MP3.1	ADD	17470
MicroPro5.1 (LSING, Display, Current Measurement, Trip History, ZSI, Communication) add to the price of ACB with MP3.1	ADD	26260

NOTES:

- 1) In TP ACB if Earth Fault facility is required, add price of Neutral CTs from table no. 4.1 on page 19.
- 2) Drawout type ACB with vertical terminal (factory fitted only) is available in ratings 8D~16D/06N-20S (AHA)
- 3) Fixed type ACB with vertical terminal adapter option is available in rating 8D~16D/06N-20S (AHA). For further detail, please refer item No. 32 on page 21.
- 4) All configurable products are non stockable.

For ordering ACB without Release following price needs to be reduced as per the rating from the price of ACB with Thermal Magnetic Release.	Remarks	List Price(₹)
630A-1600A	Reduce	6190
2000A	Reduce	7750
2500A-3200A	Reduce	10060
4000A	Reduce	12080

Notes :

- In TP ACB if Earth Fault facility is required, add prices of Earth Fault Relay from item no. 2 on page 18 & item No. 4.2 on page 19
- Drawout type ACB with vertical terminal (factory fitted only) is available in ratings 6D~16D/08N-20S(AHA)

Air Circuit Breaker (B-Type)

630A-2000A

- Auxiliary Switch 1NO*
- Main CTs
- Shunt Trip

*Auxiliary Switch with other combination is also available. See item No. 6.1 & 6.2 on page 20.



Manual Fixed, 3 Pole with Thermal Magnetic Release [HSN Code: 8536]			
Rating (Amps)	Breaking Capacity Icu=Ics=Icw (1sec)	Reference	List Price (₹)
			MF
630	50kA	AH06BCSTM*(S)	101850
800	50kA	AH08BCSTM*(S)	102370
1000	50kA	AH10BCSTM*(S)	103290
1250	50kA	AH12BCSTM*(S)	116810
1600	50kA	AH16BCSTM*(S)	140480
2000	50kA	AH20BCSTM*(S)	154530

Manual Fixed, 3 Pole with Intelligent Release MicroPro 3.1 [HSN Code: 8536]			
Rating (Amps)	Breaking Capacity Icu=Ics=Icw (1sec)	Reference	List Price (₹)
			MF
630	50kA	AH06BCSMP3.1*(S)	108160
800	50kA	AH08BCSMP3.1*(S)	112620
1000	50kA	AH10BCSMP3.1*(S)	120100
1250	50kA	AH12BCSMP3.1*(S)	153970
1600	50kA	AH16BCSMP3.1*(S)	175750
2000	50kA	AH20BCSMP3.1*(S)	191640

1. Main Accessories-AH / AHA (Please specify ACB rating & type while placing order) [HSN Code: 8538]			
Sl. No.	Description	Reference	List Price (₹)
1.0	Earth Fault Relay for 6D-60C / 06N-40S	CS-EFR	7450

2. Earth Fault Relay (for ACB with thermal release) [HSN Code: 8538]					
Sl. No.	EFR with NCT and Wiring Bunch for 3P Breaker			EFR with Wiring Bunch for 4P Breaker	
	Description	Reference	List Price (₹)	Reference	List Price (₹)
2.1	06D/06N	CS-EFR-06D3P	9860	CS-EFR-06D4P	7150
2.2	08D/08N	CS-EFR-08D3P		CS-EFR-08D4P	
2.3	10D/10N	CS-EFR-10D3P		CS-EFR-10D4P	
2.4	12D/12N	CS-EFR-12D3P		CS-EFR-12D4P	
2.5	16D/16N	CS-EFR-16D3P		CS-EFR-16D4P	
2.6	20N/20S	CS-EFR-20N3P		CS-EFR-20N4P	
2.7	20D	CS-EFR-20D3P	11470	CS-EFR-20D4P	7460
2.8	25D/25N	CS-EFR-25D3P		CS-EFR-25D4P	
2.9	30S	CS-EFR-30S3P		CS-EFR-30S4P	
2.10	30D	CS-EFR-30D3P		CS-EFR-30D4P	
2.11	40S	CS-EFR-40S3P	15630	CS-EFR-40S4P	8580
2.12	40D	CS-EFR-40D3P		CS-EFR-40D4P	
2.13	50C	CS-EFR-50C3P		CS-EFR-50C4P	
2.14	60C	CS-EFR-60C3P	POR	CS-EFR-60C4P	POR



3. FRP Safety Shutter Assembly [HSN Code: 8538]			
Sl. No.	Description	Reference	List Price (₹)
3.1	For 6D-16D / 06N-16N, 3 Pole	ASH-1	3210
	For 6D-16D / 06N-16N, 4 Pole	ASH-1 (4P)	4140
3.2	For 20N / 20S, 3 Pole	ASH-1-20N/S (3P)	3370
	For 20N / 20S, 4 Pole	ASH-1-20N/S (4P)	4310
3.3	For 20D-25D/30S, 3 Pole	ASH-2	3670
	For 20D-25D/30S, 4 Pole	ASH-2 (4P)	4770
3.4	For 30D/40S, 3 Pole	ASH-3	4990
	For 30D/40S, 4 Pole	ASH-3 (4P)	7130
3.5	For 40D, 3 Pole	ASH-4	6100
	For 40D, 4 Pole	ASH-4 (4P)	7990
3.6	For 50C / 60C, 3 Pole	ASH-5	POR
	For 50C / 60C, 4 Pole	ASH-5 (4P)	POR

NOTES: All configurable products are non stockable.

Main Accessories For "AH/AHA" ACB

(Please specify ACB rating & type while placing orders)

[HSN Code: 8538]

4.1 Single Phase Resin Cast CTs for "AH/AHA" ACB for MicroPro 3.1, 4.1 & 5.1 Release					
1CT per pole is required. In TP ACB, one additional CT will be required if, Ground Fault Protection is selected.					
Sl. No.	Type	Description	Phase CT	Neutral CT	List Price (₹)
4.1.1	-	100/0.2A	CS-WMCT-014	CS-ATBWM-010	3740
4.1.2	-	200/0.2A	CS-WMCT-02	CS-ATBWM-02	
4.1.3	-	250/0.2A	CS-WMCT-024	CS-ATBWM-024	
4.1.4	-	300/0.2A	CS-WMCT-034	CS-ATBWM-030	
4.1.5	-	400/0.2A	CS-WMCT-044	CS-ATBWM-040	
4.1.6	6D / 06N	630/0.2A	CS-WMCT-064	CS-ATBWM-060	
4.1.7	8D/08N	800/0.2A	CS-WMCT-084	CS-ATBWM-080	3940
4.1.8	10D/10N	1000/0.2A	CS-WMCT-104	CS-ATBWM-110	
4.1.9	12D / 12N	1250/0.2A	CS-WMCT-124	CS-ATBWM-120	
4.1.10	16D / 16N	1600/0.2A	CS-WMCT-164	CS-ATBWM-160	5270
4.1.11	20N/20S	2000/0.2A	CS-WMCT-220	CS-ATBWM-220	
4.1.12	20D	2000/0.2A	CS-ATBWM-220	CS-ATBWM-220	
4.1.13	25D / 25N	2500/0.2A	CS-ATBWM-225	CS-ATBWM-225	6580
4.1.14	30S	3200/0.2A	CS-ATBWM-2532	CS-ATBWM-332	
4.1.15	30D	3200/0.2A	CS-ATBWM-332	CS-ATBWM-332	
4.1.16	40S / 40D	4000/0.2A	CS-ATBWM-440	CS-ATBWM-440	9410
4.1.17	50C	5000/0.2A	CS-ATBWM-550	CS-ATBWM-554	POR
4.1.18	60C	6300/0.2A	CS-ATBWM-660	CS-ATBWM-664	



4.2 Single Phase Resin Cast CTs for "AH/AHA" ACB for Thermal release					
1 CT per pole is required. In TP ACB, one additional CT will be required if, Ground Fault Protection is selected.					
Sl. No.	Type	Description	Phase CT	Neutral CT	List Price (₹)
4.2.1		100/5A	CS-ATB-014	CS-ATB-010	3480
4.2.2		200/5A	CS-ATB-020	CS-ATB-020N	
4.2.2	-	250/5A	CS-ATB-024	CS-ATB-020	
4.2.4		300/5A	CS-ATB-034	CS-ATB-030	
4.2.5	-	400/5A	CS-ATB-044	CS-ATB-040	
4.2.6	6D / 06N	630/5A	CS-ATB-064	CS-ATB-060	
4.2.7	8D/08N	800/5A	CS-ATB-084	CS-ATB-080	3560
4.2.8	10D/10N	1000/5A	CS-ATB-104	CS-ATB-110	
4.2.9	12D / 12N	1250/5A	CS-ATB-134	CS-ATB-120	
4.2.10	16D / 16N	1600/5A	CS-ATB-164	CS-ATB-160	4140
4.2.11	20N/20S	2000/5A	CS-ATB-220	CS-ATB-220	4690
4.2.12	20D	2000/5A	CS-ATB-220	CS-ATB-220	
4.2.13	25D / 25N	2500/5A	CS-ATB-225	CS-ATB-225	5270
4.2.14	30S	3200/5A	CS-ATB-2532	CS-ATB-332	6100
4.2.15	30D	3200/5A	CS-ATB-332	CS-ATB-332	
4.2.16	40S / 40D	4000/5A	CS-ATB-440	CS-ATB-440	8730
4.2.17	50C	5000/5A	CS-ATB-554	CS-ATB-550	POR
4.2.18	60C	5000/5A	CS-ATB-664	CS-ATB-660	



5. Auxiliary Isolating Contact Assembly					
Sl. No.	Description	Reference	List Price (₹)		
5.1	24 way 6D-16D/06N-20S, 3P 6D-16D/06N-20S, 4P 20D-25D/25N-30S,3P 20D-25D/25N-30S, 4P 30D-40D/40S, 3P 30D-40D/40S, 4P 50C-60C, 3P 50C-60C, 4P	Set of two contact block on ACB Side & four block on Cradle side	CS-AIH-2-116 CS-AIH-2-116 (4P) CS-AIH-2-220 CS-AIH-2-220 (4P) CS-AIH-2-320 CS-AIH-2-320 (4P) CS-AIH-2-440 CS-AIH-2-440 (4P)	4670	
5.2	36 way 6D-16D/06N-20S, 3P 6D-16D/06N-20S, 4P 20D-25D/25N-30S,3P 20D-25D/25N-30S, 4P 30D-40D/40S, 3P 30D-40D/40S, 4P 50C-60C, 3P 50C-60C, 4P	Set of three contact block on ACB Side & six block on Cradle side	CS-AIH-3-116 CS-AIH-3-116 (4P) CS-AIH-3-220 CS-AIH-3-220 (4P) CS-AIH-3-320 CS-AIH-3-320 (4P) CS-AIH-3-440 CS-AIH-3-440 (4P)	14290	

NOTES: All configurable products are non stockable.

Main Accessories For "AH/AHA" ACB

(Please specify ACB rating & type while placing orders)



6. Auxiliary Switch				[HSN Code: 8538]
Sl. No.	Description		Reference	List Price (₹)
6.1	5 way (3NO+2NC)	6D-16D/06N-20S	CS-AXH-3A2B-116	1840
		20D-40D/25N-40S	CS-AXH-3A2B-220	1840
6.2	10 way (5NO+5NC)	6D-16D/08N-20S	CS-AXH-5A5B-116	2770
		20D-40D/25N-40S / 50C-60C	CS-AXH-5A5B-220	2770
6.3	14 way (7NO+7NC)	6D-16D/06N-20S	CS-AXH-7A7B-116	4520
		20D-40D/25N-40S / 50C-60C	CS-AXH-7A7B-220	4520



7. UVT Device				[HSN Code: 8538]
Sl. No.	Description		Reference	List Price (₹)
7.1	Compact UVT Coil	6D-16D/06N-20S	CS-AUH-V-A-**	6340
7.2		20D-40D/25N-40S / 50C-60C	CS-AUH-V-B-**	



8. Shunt Trip and Closing Coil				[HSN Code: 8538]
Sl. No.	Description		Reference	List Price (₹)
8.1	Shunt Trip	6D-16D/06N-20S	CS-AVH-S-116-**	3530
		20D-40D/25N-40S/50C-60C	CS-AVH-S-220-**	
8.2	Closing Coil	6D-16D/06N-20S	CS-AVH-C-116-**	3530
		20D-40D/25N-40S/ 50C-60C	CS-AVH-C-220-**	

**Please specify voltage while ordering

**Options for Coils Voltage							
Description	AC Control Voltage			DC Control Voltage			
	100~130V	220~250V	380~440V	24V	48V	100~130V	220~250V
UVT	FA	MA	NA	-	-	FD	MD
SHUNT	FA	MA	NA	BD	ED	FD	MD
Closing Coil	FA	MA	NA	BD	ED	FD	MD



[HSN Code: 8538]

Sl. No.	Description	Suitable for ACB frame size / rating			
		6D-16D/06N-20S Reference	List Price (₹)	20D-40D/25S-40S / 50C-60C Reference	List Price (₹)
9	OCR (Fault) Alarm Switch (for fault indication in ACB with MP & TM release)	ALA-1	1070	ALA-2	1070
10	Trip Indication Switch (For both manual and Fault indication in ACB)	CS-TIS-1	1070	CS-TIS-2	
11	Spring Charged Indication Switch	SCIS-M	1400	SCIS-M2	1400
12	Position Indication Switch (Right side)	ALB-4P-1	3490	ALB-IP-2	3490
13	Position Indication Switch (Left side)	ALB-FR-1-L	3490	ALB-FR-2-L	3490
14	Mechanical operation counter	ASC-1	3230	ASC-2	3230
15	Key Lock (One lock + One key)	AKI-116D	2450	AKI-2D	2450
16	Castle Key Lock-3 Pole	CKI-116 (3P)	7500	CKI-220 (3P)	7500
	Castle Key Lock-4 Pole	CKI-116 (4P)	7500	CKI-220 (4P)	7500
17	Key Interlock (Consisting of 3-Key Locks with 2 Keys (same No.) fitted on 3 ACBs)	AKI-1-1	6670	AKI-1-2	6670
18	Key Interlock (Consisting of 2-Key Locks with 1 Key (same No.) fitted on 2 ACBs)	AKI-2-1	5100	AKI-2-2	5100
19	Short Circuit Contact for Shunting Auxiliary Isolating Contacts when ACB withdrawn	SCC	600	SCC	600
20	Rectifier Unit input 240V AC / output 24V DC, used for Fault LED Retention	CS-ARO-1BMA	3490	CS-ARO-1BMA	3490
21	Mal Insertion Preventor	MIP-NPCIL	POR	MPI-2-NPCL	POR

NOTES: All configurable products are non stockable.

Spares For "AH / AHA" ACB

(Please specify ACB rating & type while placing order for spares)

[HSN Code: 8538]

Sl. No.	Description	Reference	List Price (₹)
22	Power Supply Module	CSPSM-MICROPRO	13240
22.1	Communication Module for Micropro 4.1 & 5.1 Release	CSPSCM-MICROPRO	26580
23	Battery Module for MicroPro 4.1 & 5.1 Release	CS-MPBU4.1.1	13240

Sl. No.	Description	Suitable for ACB frame size / rating					
		6D-16D/ 08N-20S (AHA) Reference		List Price (₹)	20D-25D / 25N-30S Reference		List Price (₹)
		3 Pole	4 Pole				
24	Mechanical Interlock (Fixed Vertical)	MIL-16D3P-VF	MIL-16D4P-VF	12290	MIL-20D3P-VF/4P	MIL-20D4P-VF	12790
25	Mechanical Interlock (Fixed Horizontal)	MIL-16D3P-HF	MIL-16D4P-HF		MIL-20D3P-HF/4P	MIL-20D4P-HF	
26	Mechanical Interlock (D/o Vertical)	MIL-16D3P-VDO	MIL-16D4P-VDO	POR	MIL-20D3P-VDO/4P	MIL-20D4P-VDO	POR
27	Mechanical Interlock (D/o Horizontal)	MIL-16D3P-HDO	MIL-16D4P-HDO	POR	MIL-20D3P-HDO/4P	MIL-20D4P-HDO	POR

Sl. No.	For Air Circuit Breaker	Reference	List Price (₹)
28	Lifter (for all sizes of ACBs)	LIFTER (580x600)*	162970
		LIFTER-SPL (690x570)*	179180
29	Door Interlock		
30	Door Interlock 6D-16D / 06N-20S (Right side)	DOOR-INT-116	3600
31	Door Interlock		
31.1	Door Interlock (20D-40D) / 25N-40S (Right side)	DOOR-INT-220	3600

Sl. No. 25, 26, 30 & 31 should be ordered with ACB & will come at factory fitted.

32. Vertical Terminal Adapter for AH/AHA Fixed type ACB				[HSN Code: 8538]
Sl. No.	Description	Reference	Qty. Required Per Pole*	List Price (₹)
32.1	06N-10N	CUADPTR-VC(6D-8D)	1	6610
32.2	10D-12D & 12N	CUADPTR-VC(10D-12D)	1	8150
32.3	16D & 16N-20S	CUADPTR-VC(16D)	1	9760
32.4	20D-25D & 25N	CUADPTR-VC(20D-25D)	1	21520

33. Drawout Mould Base (Cradle Side)				[HSN Code: 8538]
For ACB Rating	Reference	Qty. Required Per Pole*	List Price (₹)	
6D-16D/08N-20S (AHA)	DRMOULD-20S	2	2120	
20D	DRMOULD-20D	2	2530	
25D/30S (AHA)	DRMOULD-25D	2	2980	
30D/40S (AHA)	DRMOULD-30D	1	5990	
40D	DRMOULD-40D	1	6200	
50C-60C	DRMOULD-60C	1	POR	

34. Arcing Contacts (Set of 1 No. Fixed 1 No. Moving)				[HSN Code: 8538]
For ACB Rating	Reference	Qty. Required Per Pole*	List Price (₹)	
6D-8D / 06N-10N	CS-ARCCONT-08D	1	6700	
10D-12D / 12N	CS-ARCCONT-12D	1	6810	
16D / 16N	CS-ARCCONT-16D	1	7300	
20N (Fixed ACB)	CS-ARCCONT-20N	1	7490	
20N / 20S (Drawout ACB)	CS-ARCCONT-20S	1	7830	
20D	CS-ARCCONT-20D	1	15550	
25D / 25N-30S	CS-ARCCONT-25D	1	15730	
30D/40S	CS-ARCCONT-30D	1	15670	
40D	CS-ARCCONT-40D	1	18660	
50C	CS-ARCCONT-50C	1	POR	
60C	CS-ARCCONT-60C	1		

NOTES: 1. All configurable products are non stockable.
2. *M - Moving, F - Fixed

Spares For "AH/AHA" ACB

(Please specify ACB rating & type while placing order for spares)

35. Main Isolating Contacts (Jaw Contacts)			[HSN Code: 8538]
For ACB Rating	Reference	Qty. Required Per Pole	List Price (₹)*
06N-08N / 10N	CS-MIC-08D(50k)	2	13210
10D-12D / 12N	CS-MIC-12D	2	13210
16D / 16N	CS-MIC-16D	2	13800
20N / 20S	CS-MIC-20S	2	17450
20D	CS-MIC-20D	2	31590
25D / 25N-30S	CS-MIC-25D	2	33650
30D / 40S	CS-MIC-30D	2	54390
40D	CS-MIC-40D	2	65250
50C	CS-MIC-50C	2	POR
60C	CS-MIC-60C	2	POR

*Prices for 2 Nos.

36. Main Fixed Contacts (Upper Terminals)			[HSN Code: 8538]
For ACB Rating	Reference	Qty. Required Per Pole*	List Price (₹)
06N-10N	FIXCONT-08N	1	12340
10D-12D / 12N	FIXCONT-10D-12D	1	12760
16D / 16N	FIXCONT-16D	1	17740
20N(AHA)-Fixed type ACB	FIXCONT-20N	1	18140
20N(AHA)-/20S Drawout ACB	FIXCONT-20S	1	18490
20D	FIXCONT-20D	1	19210
25D / 25N-30S	FIXCONT-25D	1	31820
30D/40S	FIXCONT-30D	1	75250
40D	FIXCONT-40D	1	76700
50C	FIXCONT-50C	1	POR
60C	FIXCONT-60C	1	POR

37. Lower Terminals with fitting plates			[HSN Code: 8538]
For ACB Rating	Reference	Qty. Required Per Pole*	List Price (₹)
6D-8D / 06N-10N (AHA)	LWR-TRNL-8D	1	8700
10D-12D / 12N (AHA)	LWR-TRNL-12D	1	9790
16D / 16N (AHA)	LWR-TRNL-16D	1	13570
20N (AHA) (Fixed ACB)	LWR-TRNL-20N	1	15770
20N(AHA) / 20S(AHA) (Drawout ACB)	LWR-TRNL-20S	1	15980
20D	LWR-TRNL-20C-20D	1	25190
25D / 25N-30S (AHA)	LWR-TRNL-25C-25D	1	30680
30D/40S (AHA)	LWR-TRNL-30C-30D	1	45910
40D	LWR-TRNL-40C-40D	1	80840
50C	LWR-TRNL-50C	1	POR
60C	LWR-TRNL-60C	1	POR

38. Cradle Terminal for Drawout AH/AHA ACB			[HSN Code: 8538]	
For ACB Rating	Reference	Terminal Configuration	Qty. Required Per Pole*	List Price (₹)
6D-8D / 06N-10N	CS-CKTTML-08N	Horizontal	1	8020
	CS-CKTTML-08N(V)	Vertical	1	12170
10D-12D / 12N	CS-CKTTML-12D	Horizontal	1	11900
	CS-CKTTML-12D(V)	Vertical	1	17820
16D / 16N	CS-CKTTML-16D	Horizontal	1	19060
	CS-CKTTML-16D(V)	Vertical	1	25260
20N/20S	CS-CKTTML-20S	Horizontal	1	19060
	CS-CKTTML-20S(V)	Vertical	1	25260
20D	CS-CKTTML-20D	Horizontal	1	19060
	CS-CKTTML-20D(V)	Vertical	1	25260
25D / 25N, 25D / 25N-30S	CS-CKTTML-25D	Horizontal	1	28010
	CS-CKTTML-25D(V)	Vertical	1	55360
30D / 40S	CS-CKTTML-30D	Vertical	1	55460
40D	CS-CKTTML-40D	Vertical	1	70170
50C	CS-CKTTML-50C	Vertical	1	POR
60C	CS-CKTTML-60C	Vertical	1	POR

NOTES: All configurable products are non stockable.

Spares For "AH/AHA" ACB

(Please specify ACB rating & type while placing order for spares)

39. Main Moving Contacts Assembly			[HSN Code: 8538]
For ACB Rating	Reference	Qty. Required Per Pole*	List Price (₹)
6D-8D	MOVMAIN-06D-08D	1	POR
06N-10N	MOVMAIN-08N	1	9370
10D-20D / 12N	MOVMAIN-10D-12D	1	9560
16D / 16N	MOVMAIN-16D	1	13890
20N (AHA)-(Fixed Type ACB)	MOVMAIN-20N	1	15440
20N (AHA)-20S (Drawout Type ACB)	MOVMAIN-20S	1	17120
20D	MOVMAIN-20D	1	18460
25D / 25N-30S	MOVMAIN-25D	1	24230
30D / 40S	MOVMAIN-30D	1	55650
40D	MOVMAIN-40D	1	74290
50C	MOVMAIN-50C	1	POR
60C	MOVMAIN-60C	1	POR

*** To arrive at total quantity per ACB, multiply by 3 or 4 depending upon number of poles in the ACB.



40. Complete Pole Unit (Common for 3 & 4 Pole ACBs)			[HSN Code: 8538]
Sl. No.	For Air Circuit Breaker	Reference	List Price (₹)
40.1	Single Pole unit for 08N-10N	CS-CONDUNIT-8N	27800
40.2	Single Pole unit for 10D / 12D & 12N	CS-CONDUNIT-12D	29010
40.3	Single Pole unit for 16D / 16N	CS-CONDUNIT-16D	35130
40.4	Single Pole unit for 20N (AHA)-F■	CS-CONDUNIT-20N	39440
40.5	Single Pole unit for 20N (AHA)-DO■/20S	CS-CONDUNIT-20S	43580
40.6	Single Pole Unit for 20D	CS-CONDUNIT-20D	53250
40.7	Single Pole Unit for 25D / 25N-30S	CS-CONDUNIT-25D	57740
40.8	Single Pole Unit for 30D/40S	CS-CONDUNIT-30D	115670
40.9	Single Pole Unit for 40D	CS-CONDUNIT-40D	137790
40.10	Single Pole Unit for 50C	CS-CONDUNIT-50C	POR
40.11	Single Pole Unit for 60C	CS-CONDUNIT-60C	POR



41. Arc Chutes			[HSN Code: 8538]
For ACB Rating	Reference	Qty. Required Per Pole*	List Price (₹)
6D-16D/06N-20N	CS-ARCCHT-06D-16D	1	5300
20S	CS-ARCCHT-20S	1	6840
20D	CS-ARCCHT-20D	1	6950
25D/30S	CS-ARCCHT-25D	1	8000
30D/40S	CS-ARCCHT-30D	1	17350
40D	CS-ARCCHT-40D	1	18590
50C	CS-ARCCHT-50C	1	POR
60C	CS-ARCCHT-60C	1	POR

*** To arrive at total quantity per ACB, multiply by 3 or 4 depending upon number of poles in the ACB.



42. Charging Motors (110V AC/DC, 220V AC/DC, 250V AC/DC)			[HSN Code: 8538]
For ACB Rating	Reference	List Price (₹)	
6D-16D / 06N-20S (AHA)	CS-AMH-1	31210	
20D-40D/30S-40S(AHA)	CS-AMH-2	40680	

43. Control Relay for Charging Motor (110V AC/DC, 220V AC/DC)			[HSN Code: 8538]
For ACB Rating	Reference	List Price (₹)	
6D-16D / 06N-20S (AHA)	CS-AMH-1-AS	4330	
20D-40D / 30S-40S (AHA)	CS-AMH-2-AS	5090	

NOTES: All configurable products are non stockable.

Spares For "AH/AHA" ACB

(Please specify ACB rating & type while placing order for spares)

43. Other Spares			[HSN Code: 8538]
Sl. No.	Description	Reference	List Price (₹)
43.1	Micro Switch for Motor cut off 6D-40D/06N-40S /50C-60C	MICROSW *	1580
43.2	Anti-Pumping Relay■ 6D-16D/06N-20S, 3P	CS-ANTPUMPRLY-116	6450
	20D-25D/30S, 3P	CS-ANTPUMPRLY-220	7550
	30D-40D/40S / 50C-60C, 3P	CS-ANTPUMPRLY-320	8670
43.3	Manual Charging Handle 6D-16D/06N-20S	MCLHND-6D-16D	5120
43.4	Manual Charging Handle 20D-40D/25N-40S	MCLHND-20D-40D	5560
43.5	Drawout Handle 6D-16D/06N-20S	DRHND-6D-16D	4230
43.6	Drawout Handle 20D-40D/25N-40S	DRHND-20D-40D	5120
43.7	Magnet Hold Trigger 6D-16D/06N-20S, 3P 6D-16D/06N-20S, 4P	CS-MHT-16D	5560
		CS-MHT-16D-4P	6550
43.8	Magnet Hold Trigger 20D-25D / 25N-30S, 3P 20D-25D / 25N-30S, 4P	CS-MHT-20D-25D3P	7220
		CS-MHT-20D-25D4P	8220
43.9	Magnet Hold Trigger 30D-40D/40S (AHA), 3P 50C-60C 3P	CS-MHT-30D-3P	7450
		CS-MHT-40D-60C3P	
43.10	D/O Telescopic Rail (Left) 6D-16D / 06N-20S 20D-25D / 25N-30S 30D-40D /40S	DRTLRAIL (L)-1	2010
		DRTLRAIL (L)-2	
DRTLRAIL (L)-3			
43.11	D/O Telescopic Rail (Right) 6D-16D / 06N-20S 20D-25D / 25N-30S 30D-40D / 40S	DRTLRAIL (R)-1	2010
		DRTLRAIL (R)-2	
DRTLRAIL (R)-3			

Note: "****" Please specify ACB rating & type while ordering for spares.

**Options for Anti-Pumping Relay					
	24/30V	48V	110V	220V	415V
AC	--	--	FA	MA	NA
DC	BD	ED	FD	MD	-

44. *Auxiliary Isolating Contact Blocks			[HSN Code: 8538]
Description	Reference	List Price (₹)	
Breaker & Cradle Side 12 Way	AIH-BC	7800	

NOTES:

- 1) All configurable products are non stockable.
- 2) *Auxiliary Isolating Contact Blocks has to be order together for Cradle & Breaker side.
- 3) ■Anti-Pumping Relay same code will be applicable for 4P

Please fill separate sheet for each type of ACB . Tick the box in front of each appropriate item and fill in the blanks.

AH/AHA ACB ORDER FORM																								
Customer Name			Order No & Date			Delivery Date			End User/Panel Builder Name & Phone no.			Qty. (NOS.)												
PRODUCT REFERENCE		AH <input type="checkbox"/>		AHA <input type="checkbox"/>																				
RATING OF ACB REQUIRED	630A <input type="checkbox"/>	800A <input type="checkbox"/>	1000A <input type="checkbox"/>	1250A <input type="checkbox"/>	1600A <input type="checkbox"/>	2000A <input type="checkbox"/>																		
	2500A <input type="checkbox"/>	3200A <input type="checkbox"/>	4000A <input type="checkbox"/>	5000A <input type="checkbox"/>	6300A <input type="checkbox"/>																			
NO. OF POLES	3 POLE <input type="checkbox"/>			4 POLE <input type="checkbox"/>			BREAKING CAPACITY : AH : D		C	(Only for 50C & 60C)														
							AHA : N		S															
		MF		EF		MDO		EDO																
STANDARD CONFIGURATION	With Microprocessor Release	Release		Release		Release		Release																
		Power Supply Module (ac/dc)		Power Supply Module (ac/dc)		Power Supply Module (ac/dc)		Power Supply Module (ac/dc)																
		Aux Switch 4NO + 4NC		Aux Switch 3NO + 4NC		Aux Switch 4NO + 4NC		Aux Switch 4NO + 4NC																
		Main CTs		Main CTs		Main CTs		Main CT s																
				Charging Motor		Safety shutter		Charging Motor																
				Shunt Trip		36 Way Aux Isolating Contacts		Shunt Trip																
				Closing Coil				Closing Coil																
				Anti Pumping Relay				Anti Pumping Relay																
								Safety shutter																
							36 Way Aux Isolating Contacts																	
			MF		EF		MDO		EDO															
	With Thermal Magnetic Release	Thermal Magnetic Release		Thermal Magnetic Release		Thermal Magnetic Release		Thermal Magnetic Release																
		Aux Switch 4NO + 4NC		Aux Switch 3NO + 4NC		Aux Switch 3NO + 3NC		Aux Switch 5NO + 6NC																
		Main CTs		Charging Motor		Main CTs		Main CT s																
		Shunt Trip		Main CTs		Shunt Trip		Safety shutter																
				Shunt Trip		Safety shutter		Charging Motor																
				Closing Coil		24 Way Aux Isolating Contacts		Closing Coil																
				Anti Pumping Relay				Shunt Trip																
						Anti Pumping Relay																		
						36 Way Aux Isolating Contacts																		
VOLTAGE RATING	Motor ---->		<table border="1" style="font-size: small;"> <tr><td>110V</td><td>AC</td><td>DC</td></tr> <tr><td>220V</td><td>AC</td><td>DC</td></tr> </table>	110V	AC	DC	220V	AC	DC	Closing Coil -->		<table border="1" style="font-size: small;"> <tr><td>100~130V AC</td><td>220~250V AC</td><td>380~440V AC</td></tr> <tr><td>24V DC</td><td>48V DC</td><td>110V DC</td><td>220V DC</td></tr> </table>	100~130V AC	220~250V AC	380~440V AC	24V DC	48V DC	110V DC	220V DC					
	110V	AC	DC																					
220V	AC	DC																						
100~130V AC	220~250V AC	380~440V AC																						
24V DC	48V DC	110V DC	220V DC																					
UVT ----> (W/O time delay)		<table border="1" style="font-size: small;"> <tr><td>100~130V AC</td><td>220~250V AC</td><td>380~440V AC</td></tr> <tr><td>110V DC</td><td>220V DC</td><td></td></tr> </table>	100~130V AC	220~250V AC	380~440V AC	110V DC	220V DC		Shunt trip coil -->		<table border="1" style="font-size: small;"> <tr><td>100~130V AC</td><td>220~250V AC</td><td>380~440V AC</td></tr> <tr><td>24V DC</td><td>48V DC</td><td>110V DC</td><td>220V DC</td></tr> </table>	100~130V AC	220~250V AC	380~440V AC	24V DC	48V DC	110V DC	220V DC						
100~130V AC	220~250V AC	380~440V AC																						
110V DC	220V DC																							
100~130V AC	220~250V AC	380~440V AC																						
24V DC	48V DC	110V DC	220V DC																					
ACCESSORIES	Without Release <input type="checkbox"/>		CT Rating _____ A		Thermal Magnetic :																			
	MicroPro 3.1 <input type="checkbox"/>		Overload _____ A		Earth Fault : Req. <input type="checkbox"/>	Not Req. <input type="checkbox"/>																		
	MicroPro 4.1 <input type="checkbox"/>		Ground Fault _____ A		CT Rating <input type="checkbox"/>	NCT Rating <input type="checkbox"/>																		
	MicroPro 5.1 <input type="checkbox"/>		Short Circuit _____ A		Setting of non-adj. Mag. Inst. Trip _____																			
	Communication Module* (Modbus Protocol) <input type="checkbox"/>		Instantaneous _____ A																					
	Battery Unit* <input type="checkbox"/>		Neutral _____ A																					
ACCESSORIES	Trip Ind. Switch <input type="checkbox"/>	Spring charge Ind. Switch <input type="checkbox"/>	Castle Key Interlock** <input type="checkbox"/>																					
	Position Ind. Switch <input type="checkbox"/>	Mech. Operation Counter <input type="checkbox"/>	Key Interlock : 2 ACB <input type="checkbox"/>	3 ACB <input type="checkbox"/>																				
	Key Lock** <input type="checkbox"/>	Door Interlock <input type="checkbox"/>																						
	OCR Alaram Switch <input type="checkbox"/>	Mechanical Interlock : Hor. <input type="checkbox"/> Ver. <input type="checkbox"/>																						
Special Requirements, If any																								
NOTES:	(1) Neutral CT is required alongwith MicroPro Release having Ground-Fault Protection for 3P ACB, used for 3 phase 3 wire system. This has to be mounted on Earth / NeutralBusbar of Panel.																							
	(2) 220V AC Shunt/Closing.Coil/Motor is provided as standard.																							
	(3) Castle lock is not available for C-type Breaker.																							
(4) For WR ACB, Aux contact shall be 4NO+4NC for MF and 3NO+4NC for EF & 3NO + 3 NC for MDO and 5NO+6NC for EDO.																								
** (Breaker will be fitted either with Key lock or with Castle key interlock)																								
* (220V AC input is required)																								

NOTE: For thermal magnetic EDO ACB with EFR, Aux Contact shall be 4NO+6NC

B-Type ACB Order Form

Please fill separate sheet for each type of ACB . Tick the box in front of each appropriate item and fill in the blanks.

B TYPE ORDER FORM																	
Customer Name	Order No & Date	Delivery Date	End User/Panel Builder Name & Phone	Qty. (NOS.)													
PRODUCT REFERENCE																	
RATING OF ACB REQUIRED	630A <input type="checkbox"/> 800A <input type="checkbox"/> 1000A <input type="checkbox"/> 1250A <input type="checkbox"/> 1600A <input type="checkbox"/> 2000A <input type="checkbox"/>																
NO. OF POLES	3 POLE <input type="checkbox"/>		BREAKING CAPACITY :														
STANDARD CONFIGURATION	With Microprocessor Release	MF															
		Release															
		Power Supply Module (ac/dc)															
		Aux Switch 1NO															
		Main CTs															
	With Thermal Magnetic Release	MF															
		Thermal Magnetic Release															
		Aux Switch 1NO															
		Main CTs															
		Shunt Trip															
UVT ----> <table border="1" style="display: inline-table; border-collapse: collapse;"> <tr><td>100~130V AC</td><td>220~250V AC</td><td>380~440V AC</td></tr> <tr><td>110V DC</td><td>220V DC</td><td></td></tr> </table> Shunt trip coil ----> <table border="1" style="display: inline-table; border-collapse: collapse;"> <tr><td>100~130V AC</td><td>220~250V AC</td><td>380~440V AC</td></tr> <tr><td>24V DC</td><td>48V DC</td><td>110V DC</td><td>220V DC</td></tr> </table>					100~130V AC	220~250V AC	380~440V AC	110V DC	220V DC		100~130V AC	220~250V AC	380~440V AC	24V DC	48V DC	110V DC	220V DC
100~130V AC	220~250V AC	380~440V AC															
110V DC	220V DC																
100~130V AC	220~250V AC	380~440V AC															
24V DC	48V DC	110V DC	220V DC														
RELEASE	Without Release <input type="checkbox"/> CT Rating _____ A MicroPro 3.1 <input type="checkbox"/> Overload _____ A MicroPro 4.1 <input type="checkbox"/> Ground Fault _____ A MicroPro 5.1 <input type="checkbox"/> Short Circuit _____ A Instantaneous _____ A Neutral _____ A		Thermal Magnetic : Earth Fault : Req'd. <input type="checkbox"/> Not Req'd. <input type="checkbox"/> CT Rating <input type="checkbox"/> NCT Rating <input type="checkbox"/> Setting of non-adj. Mag. Inst. Trip _____														
ACCESSORIES	Trip Ind. Switch <input type="checkbox"/> Mech. Operation Counter <input type="checkbox"/> Key Lock <input type="checkbox"/> OCR Alaram Switch <input type="checkbox"/>																
Special Requirements, If any																	
NOTES	(1) Neutral CT is required alongwith MicroPro Release having Ground-Fault Protection for 3P ACB, used for 3 phase 3 wire system. This has to be mounted on Earth / NeutralBusbar of Panel. (2) 220V AC Shunt is provided as standard. * (220V AC input is required)																

WiNbreak1

Moulded Case Circuit Breaker

- Complying to IEC 60947-2
- Unique 'Reserve Trip Assembly'
- Suitable for voltage up to 690V / Ui 1000 V AC
- Suitable for Motor loads, Capacitor switching
- 100% Ics value ensuring high performance
- Total Selectivity
- Multiple trip units offering variety of choice for the user
- Available with a 'Single Pole' variant MCCB
- Inbuilt Current Measurement & last trip history
- Complete range of accessories
- Communication

For communication Module please contact nearest Branch Office.





Wbreak1 MCCB

- Conforms to IS/IEC 60947-2
- Ics=100% Icu, 75% Icu
- Range: 16A-400A, 3 & 4 Pole
- Breaking capacity: 10kA to 55kA Max.
- Positive Isolation
- Trip free mechanism
- Neutral with 100% rated current
- Bounce free contact structure
- Wide range of Internal & External Accessories
- SS Enclosure available
- Standard packing includes insulating phase barrier and hardware



FMU (Thermal Magnetic) Release ● Adjustable Overload 80-100% ● Fixed short circuit						[HSN Code: 8536]
Size	Rated Current (Amps)	Breaking capacity Icu at 415V AC	3 Pole Reference	List Price (₹)	4 Pole Reference	List Price (₹)
Frame 1	16, 20, 25, 32, 40, 50	25kA	CSE1M125FMU3P-*	7560	CSE1M125FMU4P-*	9720
	16, 20, 25, 32, 40, 50	36kA	CSE1NN125FMU3P-*	9700	CSE1NN125FMU4P-*	11830

ATM (Thermal Magnetic) Release ● Adjustable Overload 80-100% ● Adjustable Short Circuit 5-10 In						[HSN Code: 8536]	
Size	Rated Current (Amps)	Breaking capacity Icu at 415V AC	3 Pole Reference	List Price (₹)	4 Pole Reference	List Price (₹)	
Frame 1	63, 80, 100	25kA	CSE1M125ATM3P-*	8080	CSE1M125ATM4P-*	10670	
	125		CSE1M125ATM3P-*	11070	CSE1M125ATM4P-*	12450	
Frame 2	160		CSE2M250ATM3P-*	14450	CSE2M250ATM4P-*	17310	
	200		CSE2M250ATM3P-*	18240	CSE2M250ATM4P-*	20800	
	250		CSE2M250ATM3P-*	21590	CSE2M250ATM4P-*	24550	
Frame 3	320		CSE3M400ATM3P-*	27520	CSE3M400ATM4P-*	32150	
	350		CSE3M400ATM3P-*	27520	CSE3M400ATM4P-*	32150	
	400		CSE3M400ATM3P-*	27930	CSE3M400ATM4P-*	33940	
Frame 1	63, 80, 100		36kA	CSE1NN125ATM3P-*	9700	CSE1NN125ATM4P-*	12180
	125			CSE1NN125ATM3P-*	11330	CSE1NN125ATM4P-*	13230
Frame 2	160			CSE2NN250ATM3P-*	16720	CSE2NN250ATM4P-*	21260
	200			CSE2NN250ATM3P-*	20310	CSE2NN250ATM4P-*	22880
	250	#CSE2SX250ATM3P-*		23170	#CSE2SX250ATM4P-*	27560	
Frame 3	320	CSE3N400ATM3P-*		27710	CSE3N400ATM4P-*	32500	
	350	CSE3N400ATM3P-*		27710	CSE3N400ATM4P-*	32500	
	400	CSE3N400ATM3P-*		28080	CSE3N400ATM4P-*	34310	
Frame 1	63, 80, 100	50kA		CSE1S125ATM3P-*	12920	CSE1S125ATM4P-*	15680
	125			CSE1S125ATM3P-*	15140	CSE1S125ATM4P-*	18960
Frame 2	160			CSE2S250ATM3P-*	20020	CSE2S250ATM4P-*	25660
	200			CSE2S250ATM3P-*	22670	CSE2S250ATM4P-*	28680
	250		CSE2S250ATM3P-*	24260	CSE2S250ATM4P-*	30110	
Frame 3	320		CSE3S400ATM3P-*	29240	CSE3S400ATM4P-*	33800	
	350		CSE3S400ATM3P-*	29240	CSE3S400ATM4P-*	33800	
	400		CSE3S400ATM3P-*	30420	CSE3S400ATM4P-*	34870	

- NOTES :** 1. #Icu 50kA(Ics=75% Icu)
 2. While Ordering, Replace"***" by Current Rating.
 3. For spreader terminals reference code & List Price, please refer page no. 32

WiNbreak1 MCCB

Microprocessor Release 'MicroPro WB'

- Conforms to IS/IEC 60947-2
- Ics=100%Icu
- Range: 40A-400A, 3P & 4P
- Breaking capacity: 36kA & 50kA
- Communication*
- Trip History
- LCD: Indication of measurement and information
- Suitable for isolation
- Adjustable over load from 0.4-1.0In
- Adjustable short circuit from 2-12Ir
- Inbuilt ground fault protection available 20% to 100% of In
- Adjustable neutral overload protection available: 50% to 100% of Ir
- Adjustable current imbalance protection available: (30%-70%) of Ir
- Provision of thermal memory: ON/OFF
- View last trip information



ETM (with in-built Earth fault Protection) ● Adjustable Overload 40 - 100% ● Adjustable shortcircuit 2~12 Ir						[HSN Code: 8536]	
Size	Release Range (A)	Breaking Capacity Icu at 415V AC	3 Pole - Reference	List Price (₹)	4 Pole - Reference	List Price (₹)	
Frame 1	16-40	36kA	CSE1NN125ETM3P-40A	19700	CSE1NN125ETM4P-40A	23170	
	25-63		CSE1NN125ETM3P-63A	19700	CSE1NN125ETM4P-63A	23170	
	40-100		CSE1NN125ETM3P-100A	20880	CSE1NN125ETM4P-100A	24320	
	50-125		CSE1NN125ETM3P-125A	21560	CSE1NN125ETM4P-125A	26520	
Frame 2	63-160		CSE2NN250ETM3P-160A	24750	CSE2NN250ETM4P-160A	29130	
	80-200		CSE2NN250ETM3P-200A	29400	CSE2NN250ETM4P-200A	36190	
	100-250		#CSE2SX250ETM3P-250A	30270	#CSE2SX250ETM4P-250A	38660	
Frame 3	160-400		CSE3N400ETM3P-400A	43710	CSE3N400ETM4P-400A	54530	
ETM (with in-built Earth fault Protection) ● Adjustable Overload 40-100% ● Adjustable shortcircuit 2~12 Ir ● Ics=100%Icu						[HSN Code: 8536]	
Size	Release Range (A)		Breaking Capacity Icu at 415V AC	3 Pole - Reference	List Price (₹)	4 Pole - Reference	List Price (₹)
Frame 1	16-40		50kA	CSE1S125ETM3P-40A	21810	CSE1S125ETM4P-40A	24350
	25-63			CSE1S125ETM3P-63A	21810	CSE1S125ETM4P-63A	24350
	40-100	CSE1S125ETM3P-100A		21810	CSE1S125ETM4P-100A	24350	
	50-125	CSE1S125ETM3P-125A		22320	CSE1S125ETM4P-125A	29330	
Frame 2	63-160	CSE2S250ETM3P-160A		27790	CSE2S250ETM4P-160A	34800	
	80-200	CSE2S250ETM3P-200A		29200	CSE2S250ETM4P-200A	36760	
	100-250	CSE2S250ETM3P-250A		29920	CSE2S250ETM4P-250A	44120	
Frame 3	160-400	CSE3S400ETM3P-400A		45860	CSE3S400ETM4P-400A	58580	

- NOTE:**
1. #Icu 50kA(Ics=75% Icu)
 2. While ordering, Replace "*" with Current rating
 3. For spreader terminals reference code & List Price, please refer page no. 32
 4. For 3 Pole ETM (Microprocessor) MCCB one Neutral CT will be required, if ground fault protection is required. For reference & price please refer page 33.
 5. *For Communication Module details please contact nearest Branch Office.

Wbreak1 MCCB - Frame 'S'

- Conforms to IS/IEC 60947-2
- Ics=100%Icu (for 10kA & 18kA), 75% & 50% for 10kA
- Range: 16A-125A
- Breaking capacity: 10kA, 18kA & 25kA
- Compact Size
- Quick free mechanism
- Precise settings
- Termination possibility for unprepared cables
- Flexibility for installation as Horizontal / Vertical
- Standard packing includes insulating phase barrier and hardware



FMU (Thermal Magnetic) Release ● Adjustable Overload 80-100% ● *Fixed short circuit 10In						[HSN Code: 8536]
Size	Rating Range (A)	Breaking Capacity Icu at 415V AC	3 Pole - Reference	List Price (₹)	4 Pole - Reference	List Price (₹)
Frame 'S'	16, 20, 25, 32, 40, 50,	10kA	CSESK125FMU3P-*A	3110	CSESK125FMU4P-*A	3520
	63, 80, 100A		CSESK125FMU3P-*A	3750	CSESK125FMU4P-*A	5000
	125A		CSESK125FMU3P-*A	4080	CSESK125FMU4P-*A	5210
	16, 20, 25, 32, 40, 50,	18kA	CSESL125FMU3P-*A	4840	CSESL125FMU4P-*A	6330
	63, 80, 100A		CSESL125FMU3P-*A	4970	CSESL125FMU4P-*A	6460
	125A		CSESL125FMU3P-*A	5320	CSESL125FMU4P-*A	7070
	16, 20, 25, 32, 40, 50	25kA	CSESMX125FMU3P-*A	5250	CSESMX125FMU4P-*A	6450
	63, 80, 100A		CSESMX125FMU3P-*A	5460	CSESMX125FMU4P-*A	6780
	125A		CSESMX125FMU3P-*A	5730	CSESMX125FMU4P-*A	7100

- NOTES :**
1. While Ordering, Replace "*" by Current Rating.
 2. * Ics=75%Icu
 3. For accessories please refer page No. 32
 4. Frame 'S' MCCB with box type terminal is also available on request.
 5. *From 63--125A

WiNbreak1 MCCB
MCCB for Motor Protection

- Conforms to IS/IEC 60947-2
- Ics=100% Icu
- Range 20A~400A
- Breaking Capacity -50kA
- Upto 50A-Fixed Magnetic setting - Upto 17In
- Adjustable Magnetic setting 6~12In for rating above 50A
- Positive Isolation
- Trip Free mechanism
- Standard packing includes phase barriers and hardware

FMTU (Fixed Magnetic) Release • MTU (Adjustable Magnetic) Release • Adjustable short circuit upto 6~12In				[HSN Code: 8536]
Size	Breaking Capacity Icu at 415V AC	Rating (A)	3 Pole - Reference	List Price (₹)
Frame-1	50kA	20	CSE1S125FMTU3P-20A	9040
		32	CSE1S125FMTU3P-32A	
		50	CSE1S125FMTU3P-50A	
		63	CSE1S125MTU3P-63A	9190
		100	CSE1S125MTU3P-100A	10310
		125	CSE1S125MTU3P-125A	
Frame-2	50kA	160	CSE2S250MTU3P-160A	15970
		200	CSE2S250MTU3P-200A	20700
		220	CSE2S250MTU3P-220A	25740
		250	CSE2S250MTU3P-250A	
Frame-3	50kA	320	CSE3S400MTU3P-320A	30620
		350	CSE3S400MTU3P-350A	
		400A	CSE3S400MTU3P-400A	

Accessories										[HSN Code: 8538]
Suitable for use on WB1 MCCBs	Shunt Trip (SHT)	List Price (₹)	Under Voltage Trip (UVT)	List Price (₹)	Auxiliary Switch (AX)	List Price (₹)	Alarm Switch (AL)	List Price (₹)	Combination Switch (AX+AL)	List Price (₹)
CSES	STW1-S (...V)	1430	-	-	AXWS-L	1090	ALWS-L	1160	XLWS-L	2070
CSE1	STW1-(...V)	2430	UVTW1-(...V)	4210	AXW1-*	1270	ALW1-*	1270	XLW1-*	3000
CSE2							ALW1-2*	1270	XLW1-2*	3000
CSE3	STW1-3(...V)	3600	UVTW1-3(...V)	4910	AXW1-3	1610	ALW1-3*	1610	XLW1-3*	3600

NOTE:

- Please replace "*" with L as MCCB Left hand side position & R as MCCB right hand position
- Maximum Possibilities for Internal Accessories
 - 3 Pole, MCCB with Thermal Release, Any two accessories can be fitted at one time
 - 4 Pole, MCCB with Thermal Release, Any Three accessories can be fitted at one time
 - 3 Pole, MCCB with Microprocessor Release, Right hand seat is not available. Hence, one accessory can be fitted at one time
 - 4 Pole, MCCB with Microprocessor Release, Any two accessories can be fitted at one time
 - Alarm & combination switch can be fitted in left hand seat only on CSE3-4P Microprocessor Release MCCB
 - UVT can be fitted only in left hand seat
 - 3 & 4 Pole, CSES MCCB can have Shunttrip fitment only in Right Side pocket

Voltage Selection UVT & Shunt			
Size	AC	DC	AC / DC Common
UVT			
Frame 1 & 2	220V, 415V	24V, 48V, 110V, 220V	-
Frame 3 / 4	220V, 415V		220V
Shunt			
Frame S	110V, 220V, 415V	110V, 220V	-
Frame 1 & 2	220V, 415V	24V, 48V, 110V, 220V	-
Frame 3	220V, 415V		24V, 48V, 110V

Extended Rotary Handle			[HSN Code: 8538]
Suitable for use on WB1 MCCBs	Reference	List Price (₹)	
CSES	EHW1-0T-125	2270	
CSE1	EHW1-125	2520	
CSE2	EHW1-250	2970	
CSE3 / CSE4	EHW1-400-630	3550	



Panel Door Mounted Key Lock for Extended Rotary Handle			[HSN Code: 8538]
Suitable for use on WB1 MCCBs	Reference Code	List Price (₹)	
CSE1	EXTKLWB1-125AF-T1	4110	
CSE2	EXTKLWB1-250AF-T1	4110	
CSE3 / CSE4	EXTKLWB1-400AF-T1	4830	

Mechanical Interlock					[HSN Code: 8538]
Suitable for use on WB1 MCCBs	Applied between two MCCBs				
	Reference 3 Pole	List Price (₹)	Reference 4 Pole	List Price (₹)	
CSE1	MIW1-125-3P	2940	MIW1-125-4P	3640	
CSE2	MIW1-250-3P	3200	MIW1-250-4P	3780	



Locking Devices*					[HSN Code: 8538]
Suitable for use on MCCBs	Key Lock*		Padlocking		
	Reference	List Price (₹)	Reference	List Price (₹)	
CSE1	KLW1-125	1640	PLW1-125	1720	
CSE2	KLW1-250	1780	PLW1-250	1900	
CSE3 / CSE4	-	-	PLW1-400	POR	



Spreader Terminals for WB1 MCCB						[HSN Code: 8538]
Suitable for use on MCCBs	Current Rating (A)	Reference	List Price (₹)	MOQ		
CSES	3 Pole	16, 20, 25, 32, 40, 50, 63, 80, 90, 100, 125	CSET0033	190	Set of 3	
	4 Pole				CSET0044	290
CSE1	3 Pole	15, 20, 32, 40, 50, 63	CSET1033	190	Set of 3	
CSE1	3 Pole	80, 100, 125	CSET1033C	280	Set of 3	
CSE1	4 Pole	15, 20, 32, 40, 50, 63	CSET1044	310	Set of 4	
CSE1	4 Pole	80, 100, 125	CSET1044C	380	Set of 4	
CSE2	3 Pole	160, 200	CSET2033	460	Set of 3	
CSE2	3 Pole	250	CSET2503-ST	740	Set of 3	
CSE2	4 Pole	160, 200	CSET2044	690	Set of 4	
CSE2	4 Pole	250	CSET2504-ST	970	Set of 4	
CSE3	3 Pole	320, 350, 400	CSET3033	1680	Set of 3	
CSE3	4 Pole	320, 350, 400	CSET3044	2310	Set of 4	





Earth Fault Relay (Built in CBCT) Suitable for 3 Phase 3 wire distribution network			[HSN Code: 8538]
Rating (Amps)	Earth Fault Relay Setting Range	Reference	List Price (₹)
32A	3.2-32A	EFR-CBCT125-AF-32	6930
40A	4-40A	EFR-CBCT125-AF-40	
63A	6.3-63A	EFR-CBCT125-AF-63	
80A	8-80A	EFR-CBCT125-AF-80	
100A	10-100A	EFR-CBCT125-AF-100	
125A	12.5-125A	EFR-CBCT125-AF-125	7380
200A	20-200A	EFR-CBCT250-AF-200	8250
250A	25-250A	EFR-CBCT250-AF-250	
400A	40-400A	EFR-CBCT400-AF-400	
630A	63-630A	EFR-CBCT630-AF-630	9550
800A	80-800A	EFR-CBCT800-AF-800	14730
1000A	100-1000A	EFR-CBCT1250-AF-1000	
1250A	125-1250A	EFR-CBCT1250-AF-1250	

Earth Fault Relay (with NCT) Suitable for 3 Phase 4 wire distribution network			[HSN Code: 8538]
Rating (Amps)	Earth Fault Relay Setting Range	Reference	List Price (₹)
40A	4-40A	EFR125-AF-40(N)	6420
100A	10-100A	EFR125-AF-100(N)	
125A	12.5-125A	EFR125-AF-125(N)	
200A	20-200A	EFR250-AF-200	6820
250A	25-250A	EFR250-AF-250	
400A	40-400A	EFR400-AF-400	
630A	63-630A	EFR630-AF-630	7610
800A	80-800A	EFR800-AF-800	
1000A	100-1000A	EFR1250-AF-1000	
1250A	125-1250A	EFR1250-AF-1250	8760
			14450

NCT WiBreak1 ETM (Microprocessor) 3 Pole MCCB if ground fault facility is required			[HSN Code: 8538]
Rating (Amps)	Description	Reference	List Price (₹)
40	40/0.1A	ETMNCT40A	2110
63	63/0.1A	ETMNCT63A	
80	80/0.1A	ETMNCT80A	
100	100/0.1A	ETMNCT100A	
125	125/0.1A	ETMNCT125A	
160	160/0.1A	ETMNCT160A	
200	200/0.1A	ETMNCT200A	2960
250	250/0.1A	ETMNCT250A	
400	400/0.1A	ETMNCT400A	



SS Enclosure for WB1 MCCB			[HSN Code: 8538]
Size	Suitable for WB1 MCCBs	Reference	List Price (₹)
FrameS	CSE1	CSE-ENCL-125S-3P	POR
	CSE1	CSE-ENCL-125S-4P	
Frame1	CSE1	CSE-ENCL-125-3P	
	CSE1	CSE-ENCL-125-4P	
Frame2	CSE1	CSE-ENCL-250-3P	
	CSE1	CSE-ENCL-250-4P	

NOTES:

1. Reference Code is for Enclosure only (without MCCB)
2. For Placing an order for MCCB along with Enclosure, please apply prefix E-before MCCB Reference Code. For Price, please contact nearest Branch Office.



WiNbreak2

An Absolute solution for power distribution

C&S Electric offers innovative, intelligent, integrated and intuitive solution



Conforms to IS/IEC 60947-2

I_{cs} = 100% I_{cu}

I_{cw} = 25kA / 1s

Range : 800A to 1600A, 3P & 4P

Breaking capacity : 50kA, 70kA & 150kA

U_i : 1000V

U_{imp} : 8kV

**N Type
(Normal)**



**A Type
(Ammeter)**



**P Type
(Power Meter)**



**S Type
(Supreme Meter)**



WiNbreak2 MCCB (1600AF)
Features:

- LSIG Protection
- Thermal Memory
- Current, Voltage, Power, Energy, Frequency measurement
- Trip History
- Digital Display
- Fault recording
- Event Recording
- Communication
- Harmonics
- True RMS Sensing
- ZSI
- IDMTL Setting
- Self Power
- LED for Tripping Information
- RTC Timer
- Pre Trip Alarm

MCCB with Intelligent Release - N Type [HSN Code: 8536]						
Size	Release Range (A)	Breaking Capacity @ 415VAC	3 Pole Reference	List Price (₹)	4 Pole Reference	List Price (₹)
Frame 5	400-800	50kA	CS1000NNG5800A3P	POR	CS1000NNG5800A4P	POR
	500-1000		CS1000NNG51000A3P		CS1000NNG51000A4P	
	625-1250		CS1250NNG51250A3P		CS1250NNG51250A4P	
	800-1600		CS1600NNG51600A3P		CS1600NNG51600A4P	
	400-800	70kA	CS1000HNG5800A3P	POR	CS1000HNG5800A4P	POR
	500-1000		CS1000HNG51000A3P		CS1000HNG51000A4P	
	625-1250		CS1250HNG51250A3P		CS1250HNG51250A4P	
	800-1600		CS1600HNG51600A3P		CS1600HNG51600A4P	

List Price Changes for MCCB with high end release w.r.t "Intelligent release - N Type" [HSN Code: 8536]	
Release	List Price (₹)
Intelligent release - A Type*	ADD
Intelligent release - P Type*	ADD
Intelligent release - S Type*	ADD

Note : Standard packing includes insulating phase barriers and Hardwares.

Internal Accessories [HSN Code: 8538]										
WB2 MCCBs	Shunt Trip (SHT)	List Price (₹)	Under Voltage Trip (UVT)	List Price (₹)	Auxiliary Switch (AX)	List Price (₹)	Alarm Switch (AL)	List Price (₹)	Fault Alarm Switch (FAL)*	List Price (₹)
CS1000-1600	SHT5-T(...V)	POR	UVT5-T(...V)	POR	AX5-T	POR	AL5-T	POR	FAL5-T	POR

Voltage Selection UVT & Shunt [HSN Code: 8538]			
Size	AC	DC	AC / DC Common
UVT			
Frame 5	48V, 380-480V	24-30V, 48-60V	100-130V, 200-250V
Shunt			
Frame 5	48V, 380-480V	24-30V, 48-60V	100-130V, 200-250V

WB2 MCCBs	Direct Rotary Handle	List Price (₹)	Direct Rotary Handle with Keylock	List Price (₹)	Extended Rotary Handle	List Price (₹)
CS1000-1600	DH5-S	POR	DHK5-S	POR	EH5-S	POR

Mechanical Interlock [HSN Code: 8538]				
WB2 MCCBs	Applied between two MCCBs			
	3 Pole		4 Pole	
	Reference	List Price (₹)	Reference	List Price (₹)
CS1000-1600	MIT53	POR	MIT54	POR

Padlocking Device [HSN Code: 8538]				
WB2 MCCBs	Fixed Lock		Removable Lock	
	Reference	List Price (₹)	Reference	List Price (₹)
CS1000-1600	PHL5	POR	PL5	POR

NOTE : Above mentioned products are non stockable.

WiNbreak2 MCCB

- Conforms to IS/IEC 60947-2
- Ics = 100% Icu
- Range: 16A-1600A, 3P & 4P
- Breaking capacity: 50kA, 65kA, 70kA, 85kA & 150kA
- Positive Isolation
- Trip Free Mechanism
- Double contact structure
- Communication compatible
- No Line-load Bias
- Neutral with 100% rated current
- Tripping by pressure
- Current limiting
- Manual, Rotary or Motorized available
- Wide range of internal & external accessories
- Standard packing includes spreaders terminals, insulating phase barriers and hardware



FMU (Thermal Magnetic) Release ● Adjustable Overload 80-100% ● Fixed short circuit 10 In [HSN Code: 8536]						
Size	Rated Current (Amps)	Breaking capacity Icu at 415V AC	3 Pole Reference	List Price (₹)	4 Pole Reference	List Price (₹)
Frame 1	16, 20, 25, 32, 40, 50, 63	50kA	☒ CD100NFMU*3P	13900	☒ CD100NFMU*4P	17240
	80, 100		CD100NFMU*3P	14030	CD100NFMU*4P	17390
Frame 3	300, 400	65kA	☒ CS400NFMU*3P	46200	CS400NFMU*4P	58970
	500, 630		*CS630NFMU*3P	52780	CS630NFMU*4P	63800
Frame 4	800	65kA	☒ CS800NFMU*3P	68180	CS800NFMU*4P	91240

ATU (Thermal Magnetic) Release ● Adjustable Overload 80 - 100% ● Adjustable Short circuit 5 - 10 In [HSN Code: 8536]						
Size	Rated Current (Amps)	Breaking capacity Icu at 415V AC	3 Pole Reference	List Price (₹)	4 Pole Reference	List Price (₹)
Frame 2	125	50kA	CS160NATU*3P	21620	☒ CS160NATU*4P	27350
	160		☒ CS160NATU*3P	26630	☒ CS160NATU*4P	34550
	200		☒ CS250NATU*3P	32030	☒ CS250NATU*4P	41000
	250		CS250NATU*3P	36780	CS250NATU*4P	49280
Frame 3	300, 400	65kA	*CS400NATU*3P	47190	*CS400NATU*4P	62880
	500, 630		*CS630NATU*3P	56070	*CS630NATU*4P	68460
Frame 4	800	65kA	☒ CS800NATU*3P	76500	CS800NATU*4P	94850

ETS (Microprocessor based) Release ● Adjustable Overload 40 - 100% ● Adjustable shortcircuit 1.5 - 10 In [HSN Code: 8536]						
Size	Rated Current (Amps)	Breaking capacity Icu at 415V AC	3 Pole Reference	List Price (₹)	4 Pole Reference	List Price (₹)
Frame 2	40	50kA	CS160NETS*3P	35530	☒ CS160NETS*4P	44430
	80, 160		CS160NETS*3P	36020	☒ CS160NETS*4P	44440
	250		CS250NETS*3P	43820	☒ CS250NETS*4P	55740
Frame 3	400	65kA	CS400NETS*3P	48550	☒ CS400NETS*4P	72500
	630		☒ CS630NETS*3P	55740	☒ CS630NETS*4P	85360
Frame 4	800	65kA	☒ CS800NETS*3P	82300	CS800NETS*4P	105010

☒ non stockable items.

ATU - *Rated Current (Amp) 300, 500 for 3 Pole & 4 Pole are non stockable items.

WiNbreak2 MCCB

ETM (Microprocessor Release with in-built Earth fault Protection) ● Adjustable Overload 40 - 100% ● Adjustable shortcircuit 1.5 - 10 In							[HSN Code: 8536]
Size	Rated Current (Amps)	Breaking capacity Icu at 415V AC	3 Pole Reference	List Price (₹)	4 Pole Reference	List Price (₹)	
Frame 3	160	65kA	☒ CS400NETM33160A3PE	80040	CS400NETM33160A4PE	95950	
	250		CS400NETM33250A3PE	80040	CS400NETM33250A4PE	95950	
	400		CS400NETM33400A3PE	80220	CS400NETM33400A4PE	103630	
	630		☒ CS630NETM33630A3PE	96610	CS630NETM33630A4PE	114990	
Frame 4	800	65kA	☒ CS800NETM43800A3PE	135120	☒ CS800NETM43800A4PE	168900	

NOTE :

- While ordering replace "*" by Current Rating
- Spreader Terminals are not included MCCBs upto 63A
- For 3 Pole ETM (Microprocessor) MCCB one Neutral CT will be required, if ground fault protection is required, for reference & List Price Please refer page 38.
- MCCB with Ammeter, ZSI & communication feature is also available. For reference & List Price contact nearest Branch Office.
- MCCB for Motor Backup Protection is also available. For prices contact nearest Branch Office.



Accessories											[HSN Code: 8536]
Suitable for use on WB2 MCCBs	Shunt Trip (SHT)	List Price (₹)	Under Voltage Trip (UVT)	List Price (₹)	Auxiliary Switch (AX)	List Price (₹)	Alarm Switch (AL)	List Price (₹)	Fault Alarm Switch (FAL)*	List Price (₹)	
CD100-CS800	ST-T(..V)	4190	UVT-T(..V)	5710	AX-T	1810	AL-T	1810	FAL-T	1810	

NOTE :

- The above accessories are common for CD100-CS800
- FAL (Fault Alarm Switch)* It can be applied to only circuit breakers with electronic trip units
- Maximum Possibilities for Internal Accessories

Voltage Selection UVT & Shunt			
Size	AC	DC	AC / DC Common
UVT			
Frame 1/2/3/4	380-440V, 440-480V	-	24V, 48V, 110-130V, 200-240VAC/ 250VDC
Shunt			
Frame 1/2/3/4	380-500V	12V	24V, 48V, 110-130V, 200-240VAC / 250VDC

	Accessory	CD100	CS160/ 250	CS400 / 630	CS800
Left	AX	-	1	3	3
	AL	1	1	-	-
	SHT / UVT	1	1	1	1
Right	AX	2	1	-	-
	AL	-	-	1	2
	FAL	-	1	1	1



Rotary Handle							[HSN Code: 8538]
Suitable for use on WB2 MCCBs	Direct Rotary Handle	List Price (₹)	Direct Rotary Handle with Keylock	List Price (₹)	Extended Rotary Handle	List Price (₹)	
CD100	☒ DH1-S	2260	☒ DHK1-S	5960	EH1-S	3400	
CS160, CS250	☒ DH2-S	2460	☒ DHK2-S	6260	EH2-S	4530	
CS400, CS630	☒ DH3-S	4830	☒ DHK3-S	6560	EH3-S	6340	
CS800	☒ DH4-S	5770	☒ DHK4-S	6840	EH4-S	7480	



Mechanical Interlock (Used to prevent mechanically closing together)					[HSN Code: 8538]
Suitable for use on WB2 MCCBs	3 Pole Reference	List Price (₹)	4 Pole Reference	List Price (₹)	
CD100	MIT13	10760	MIT14	11290	
CS160, CS250	MIT23	13100	MIT24	13560	
CS400, CS630	MIT33	13900	MIT34	14280	
CS800	MIT43	14890	MIT44	15200	

☒ non stockable items.

WiNbreak2 MCCB

Motor Operator - For remote "ON/OFF" operation only		[HSN Code: 8538]	
Suitable for MCCB Type	Control Voltage	Reference	List Price (₹)
CD100	<input checked="" type="checkbox"/> 24V DC	MOP1(..V)	25820
	<input checked="" type="checkbox"/> AC100-240V/DC100-220V		
CS160, CS250	<input checked="" type="checkbox"/> 24V DC	MOP2(..V)	35050
	<input checked="" type="checkbox"/> AC110V/DC110V		
	AC230V/DC220V		
CS400, CS630	<input checked="" type="checkbox"/> 24V DC	MOP3(..V)	54160
	<input checked="" type="checkbox"/> AC110V/DC110V		
	AC230V/DC220V		
CS800	<input checked="" type="checkbox"/> 24V DC	MOP4(..V)	65320
	<input checked="" type="checkbox"/> AC110V/DC110V		
	AC230V/DC220V		

*Replace (....V) by require voltage.



Padlocking Device		[HSN Code: 8538]		
Suitable for use on WB2 MCCBs	Fixed Lock		Removable Lock	
	Reference	List Price (₹)	Reference	List Price (₹)
CD100	<input checked="" type="checkbox"/> PHL 1	1850	<input checked="" type="checkbox"/> PL 1	1060
CS160, CS250	<input checked="" type="checkbox"/> PHL 2	2030	<input checked="" type="checkbox"/> PL 2	1380
CS400, CS630	<input checked="" type="checkbox"/> PHL 3	3270	<input checked="" type="checkbox"/> PL 3	1680
CS800	<input checked="" type="checkbox"/> PHL 4	3300	<input checked="" type="checkbox"/> PL 4	1750



Base for Plug-in MCCB		[HSN Code: 8538]	
Suitable for use on WB2 MCCBs	Reference (for 3 Pole)	List Price (₹)	
CD100	<input checked="" type="checkbox"/> PB13	21140	
CS160, CS250	<input checked="" type="checkbox"/> PB23	26240	
CS400, CS630	<input checked="" type="checkbox"/> PB33	42100	
CS800	<input checked="" type="checkbox"/> PB43	105350	

NCT for WiNbreak2 ETM-Microprocessor (3 Pole MCCB if ground fault facility is required)		[HSN Code: 8538]	
Description	Reference	List Price (₹)	
160/0.1A	<input checked="" type="checkbox"/> NCT-WB2-016	7460	
250/0.1A	<input checked="" type="checkbox"/> NCT-WB2-025	7620	
400/0.1A	<input checked="" type="checkbox"/> NCT-WB2-040	8200	
630/0.1A	<input checked="" type="checkbox"/> NCT-WB2-063	8820	
800/0.1A	NCT-WB2-080	9400	

Panel Door Mounted Key Lock for Extended Rotary Handle		[HSN Code: 8538]	
Suitable for WB2 MCCBs	Reference	List Price (₹)	
CD100, CS160, CS250	<input checked="" type="checkbox"/> EXTKLWB2-250AF-T1	3250	

non stockable items.



WiNbreak MCCB - CS Series

- Conforms to IS/IEC 60947-2
- Range: 15A-400A, 2, 3 & 4 Pole
- Breaking capacity: 10kA, 18kA & 25kA
- Positive Isolation
- Trip free mechanism
- SS Enclosure available
- Standard packing includes Spreader terminals, Insulating phase barriers and Hardwares.



FTM (Thermal Magnetic) Release • Fixed Overload • Fixed short circuit								[HSN Code: 8536]
Size	Rated Current (Amps)	Breaking capacity Icu at 415V AC	2 Pole Reference	List Price (₹)	3 Pole Reference	List Price (₹)	4 Pole Reference	List Price (₹)
Frame 1	10, 16, 20, 25, 30, 32, 40, 50, 60, 63□	10kA	☒CS2A2c*	2840	CS2A3c*	3260	CS2A4c*	4480
	75		CS2A2c*	2960	CS2A3c*	3370	☒CS2A4c*	4640
	80		CS2A2c*	2960	☒CS2A3c*	3370	CS2A4c*	4640
	100		CS2A2c*	2960	CS2A3c*	3370	CS2A4c*	4640
	125		-	-	CS2A3c*	5180	CS2A4c*	6860
Frame 2	16, 20, 25, 30, 32, 40, 50, 60, 63	25kA	CS2B2c*	6220	CS2B3c*	6990	CS2B4c*	8510
	75, 80, 100		CS2B2c*	6310	CS2B3c*	7200	CS2B4c*	8700
Frame 3	125, 140, 160#	18kA	-	-	*CS3A3c*	10930	CS3A4c*	14420
	200		CS3A2*	10810	CS3A3c*	11910	CS3A4c*	15570
	250		☒CS3A2*	11780	☒CS3A3c*	13320	CS3A4c*	16580
	125, 140, 160#	25kA	-	-	CS3B3c*	12690	CS3B4c*	16490
	200		☒CS3B2*	14200	CS3B3c*	14670	☒CS3B4c*	19050
	250		CS3B2*	18960	☒CS3B3c*	19930	☒CS3B4c*	24880

NOTES : 1. While ordering replace "*" by current rating. 2. #150A & 175A also available on request. 3. □ Upto 63A Spreader Terminals are not included.



SS Enclosure for WB MCCB					[HSN Code: 8538]
Size	Suitable for use on MCCBs	Reference* 3 Pole	Reference* 4 Pole	List Price (₹)	
Frame 1	CS2A	☒CS-CNM0100020	☒CS-CNM0100020	3790	
Frame 2	CS2B	CS-CNM0100021	CS-CNM0100021	3820	
Frame 3	CS3A, CS3B	CS-CNM0100021	CS-CNM0100021	3820	

NOTES:

- *Reference code is for Enclosure only (without MCCB)
- For placing an order for MCCB along with Enclosure, please apply Prefix **E-** before MCCB Reference Code. For Price, please contact nearest Branch Office.

Accessories										[HSN Code: 8538]
Suitable for use on MCCBs	Shunt Trip (SHT)	List Price (₹)	Auxiliary Switch (AX)	List Price (₹)	Alarm Switch (AL)	List Price (₹)	Direct Rotary Handle	List Price (₹)	Extended Rotary Handle	List Price (₹)
CS2A..c	ST-A(..V)	2190	ASW-A(*)	1220	ALSW-A(*)	1220	D-35S	1670	CSE-35S	1540
CS2B..c	ST-B(..V)	2190	ASW-B(*)	1220	ALSW-B(*)	1220	D-45S	1880	CSE-45S	1540
CS3A / CS3B..c	ST-C(..V)	2190	ASW-C(*)	1220	ALSW-C(*)	1220	D-55S	2000	CSE-55S	1710

NOTES:

- *Please read R as MCCB left hand side position & T as right hand position.
- For Frame1, Frame 2 & Frame3 shunt trip is available in 12VAC/DC, 24VAC/DC, 48VAC/DC, 110VAC/DC, 220VAC/DC, 415VAC (Replace ST-A(..V) , ST-B(..V) and ST-C(..V) by required voltage)
- For Frame4 shunt trip is available in 24-48VAC/DC, 100-220VDC, 100-240VAC, 380-550VAC/DC (Replace ST-6A (...V) by required voltage)
- Rotary Handle for 2 Pole, Frame1 & Frame2 is not available.
- Maximum possibilities for internal accessories

Frame1, Frame2 & Frame3:

Left hand seat - AX or AL Right hand seat - AX or AL or SHT

Frame 4:

Left hand seat - 2AX, 2AL and SHT Right hand seat - 2AX, 2AL and SHT

☒ non stockable items.

Rectification in Accessories for CS MCCB

WiNbreak MCCB - CSC Series

- Conforms to IS/IEC 60947-2
- Ics=100%Icu
- Range: 15A-1200A, 2, 3 & 4 Pole
- Breaking capacity: 18kA, 26kA, 37kA, 50kA, 65kA & 85kA
- Positive Isolation
- Trip free mechanism
- Wide range of Internal & External Accessories
- SS Enclosure available
- Standard packing includes insulating phase barriers and hardwares



FTM (Thermal Magnetic) Release ● Fixed Overloadv ● Fixed short circuit								[HSN Code: 8536]
Size	Rated Current (Amps)	Breaking capacity Icu at 415V AC	2 Pole Reference	List Price (₹)	3 Pole Reference	List Price (₹)	4 Pole Reference	List Price (₹)
Frame 1	15, 20, 30, 40, 50	18kA	CSC1S2*	4990	-	-	-	-
	60, 75, 100		CSC2N2*	5050	-	-	-	
Frame 3	150, 175	26kA	CSC4N2*	12040	-	-	-	-
	200		CSC4N2*	13580	-	-	-	
	250		CSC4N2*	17740	-	-	-	
Frame 2	15, 20, 30, 40, 50, 60	37kA	☒CSC3S2*	6600	-	-	-	-
	75, 100		☒CSC3S2*	6630	-	-	-	
	125		CSC3S2*	6800	-	-	-	
Frame 5	500, 630	-	-	-	CSC6N3*	42170	CSC6N4*	48500
	700, 800		-	-	CSC6N3*	57680	☒CSC6N4*	68880
Frame 4	300◆	65kA	-	-	CSC5H3*	41450	☒CSC5H4*	50570
	350, 400◆		-	-	☒CSC5H3*	42780	☒CSC5H4*	52190
Frame 5	500, 630	-	-	-	☒CSC6S3*	43220	☒CSC6S4*	55160
	700, 800		-	-	CSC6S3*	62500	CSC6S4*	79110
Frame 4	300◆	85kA	-	-	☒CSC5L3*	53090	CSC5L4*	74440
	350, 400◆		-	-	CSC5L3*	54480	☒CSC5L4*	76000
Frame 5	500, 630	-	-	-	CSC6L3*	77930	☒CSC6L4*	97520
	700, 800		-	-	CSC6L3*	133070	CSC6L4*	149690

FTM (Thermal Magnetic) Release ● Fixed Overload ● Fixed short circuit ● Ics=50%Icu								[HSN Code: 8536]
Size	Rated Current (Amps)	Breaking capacity Icu at 415V AC	2 Pole Reference	List Price (₹)	3 Pole Reference	List Price (₹)	4 Pole Reference	List Price (₹)
Frame 6	1000◆	65kA	-	-	CSC7S3*	158270	☒CSC7S4*	198130
	1200◆		-	-	CSC8S3*	168250	CSC8S4*	200700
Frame 6	1000◆	85kA	-	-	CSC7L3*	202240	CSC7L4*	242310
	1200◆		-	-	CSC8L3*	235310	CSC8L4*	283210

- NOTES :**
1. While Ordering, Replace "*" by Current rating.
 2. ◆Spreader Terminals are included as standard packing.
 3. For Spreader Terminals reference & List Price, please refer page 44.

☒ non stockable items.

WiNbreak MCCB - CSC Series

Accessories										[HSN Code: 8538]
Suitable for use on WB-CSC MCCBs	Shunt Trip (SHT)	List Price (₹)	Under Voltage Trip (UVT)	List Price (₹)	Auxiliary Switch (AX)	List Price (₹)	Alarm Switch (AL)	List Price (₹)	Combination Switch (AX + AL)	List Price (₹)
CSC1, CSC2, CSC3, CSC4	STC(...V)	2050	UVTC-(...V)	2400	AXWC-(*)	1430	ALWC-(*)	1300	XLC-(*)	2880
CSC5, CSC6	ST-6A(...V)	2730	UVT-6A(...V)	3340	ASW-6A	2600	ALSW-6A	2600	-	-
CSC7, CSC8	ST-7A(...V)	13400	UVT-7A(...V)	13400	ASW-7A	4740	ALSW-7A	4530	-	-



Rotary Handle							[HSN Code: 8538]
Suitable for use on WB-CSC MCCBs	Direct Rotary Handle	List Price (₹)	Direct Rotary Handle with Key Lock	List Price (₹)	Extended Rotary Handle	List Price (₹)	
CSC1, CSC2	DHC100	2520	☒ DHCK100	5560	CSE-35S■	1540	
					EHC100	4270	
CSC3	DHC125	2600	☒ DHCK125	5730	CSE-45S■	1540	
					EHC125	4510	
CSC4	DHC250	3080	☒ DHCK250	6060	EHC250	4990	
CSC5	N70S	3570	-	-	E70U	5800	
CSC6	-	-	-	-	E80U	6450	

NOTES:

- Please replace "*" with R as MCCB left hand side position & T as MCCB right hand position.
- Left Hand seat is not available in 2 Pole MCCB in Frame 1 & Frame 2
- Rotary Handle for 2 Pole Frame 1 & Frame 2 is not available.
- Conventional type

Selection UVT & Shunt				
Accessories	FRAME	AC	DC	AC/DC COMMON
UVT	1, 2, 3	AC 380-440V	-	AC/DC 24V
		AC 440-480V	-	AC/DC 48V
		-	-	AC/DC 100-110V
		-	-	AC/DC 200-220V
	4, 5	AC 380-440V	-	AC/DC 48V
		AC 440-480V	-	100-125VAC/100-110VDC
		-	-	AC 200-240V/ DC 200-220V
	6	-	-	100-110V
		-	-	125V
		-	-	200-220V
-		-	380-440V	
SHUNT	1, 2, 3	AC 380-450V	DC 12V	AC/DC 48-60V
		AC 440-500V	-	AC/DC 100-130V
		-	-	AC/DC 200-250V
	4, 5	AC 380-550V	-	AC/DC 24-48V
		-	-	AC 100-240V/ DC 100-220V
	6	100-110V	24V	-
		125V	48V	-
		200-220V	100-110V	-
		380-440V	125V	-
		480-550V	200-220V	-

☒ non stockable items.

Winbreak MCCB - CSC Series

Terminal Covers [HSN Code: 8538]						
Suitable for use on WB-CSC MCCBs	For Line/Load Side					
	2P Reference	List Price (₹)	3P Reference	List Price (₹)	4P Reference	List Price (₹)
CSC1, CSC2	TCS12	460	TCS13	600	TCS14	670
CSC3	TCS22	490	TCS23	860	TCS24	990
CSC4	TCS33	1020	TCS33	1020	TCS34	1130



Mechanical Interlock [HSN Code: 8538]				
Suitable for use on MCCBs	Applied between two MCCBs			
	Reference 3 Pole	List Price (₹)	Reference 4 Pole	List Price (₹)
CSC5	MI43S	5930	MI44S	7390
CSC6	MI83S	7390	MI84S	8720



Spreader Terminals [HSN Code: 8538]					
Suitable for use on MCCBs	Pole	Current Rating (A)	Reference	List Price (₹)	MOQ
CSC1, CSC2, CSC3	2 Pole	15, 20, 30, 40, 50, 60	CSET1022	140	Set of 2
CSC1, CSC2, CSC3	2 Pole	75, 100, 125	CSET1022C	160	Set of 2
CSC1, CSC2, CSC3	3Pole	15, 20, 30, 40, 50, 60	CSET1033	190	Set of 3
CSC1, CSC2, CSC3	3Pole	75, 100, 125	CSET1033C	280	Set of 3
CSC1, CSC2, CSC3	4 Pole	15, 20, 30, 40, 50, 60	CSET1044	310	Set of 4
CSC1, CSC2, CSC3	4 Pole	75, 100, 125	CSET1044C	380	Set of 4
CSC4	2 Pole	150, 175, 200	CSET2022	310	Set of 2
CSC4	2 Pole	250	CSET2502-ST	400	Set of 2
CSC4	3 Pole	150, 175, 200	CSET2033	460	Set of 3
CSC4	3 Pole	250	CSET2503-ST	740	Set of 3
CSC4	4 Pole	150, 175, 200	CSET2044	690	Set of 4
CSC4	4 Pole	250	CSET2504-ST	970	Set of 4
CSC5	3 Pole	300, 350, 400	CSET4033	3280	Set of 3
CSC5	4 Pole	300, 350, 400	CSET4044	3320	Set of 4
CSC6	3 Pole	500, 630, 700, 800	CSET8033	3250	Set of 3
CSC6	4 Pole	500, 630, 700, 800	CSET8044	3950	Set of 4



SS Enclosure for WB MCCB [HSN Code: 8538]				
Size	Suitable for use on MCCBs	3 Pole Reference*	4 Pole Reference*	List Price (₹)
Frame 1	CSC1, CSC2	CS-CNM0100020	-	3790
Frame 2	CSC3	CS-CNM0100021	-	3820
Frame 3	CSC4	CS-CNM0100021	-	3820
Frame 4	CSC5	ENCL-250-400AF3	ENCL-250-400AF4	5930
Frame 5	CSC6	CS-CNM0100203	-	9950
Frame 6	CSC7, CSC8	CS-CNM0100204	-	11090

NOTES:

- *Reference code is for Enclosure only (without MCCB)
- For placing an order for MCCB along with Enclosure, please apply Prefix **E-** before MCCB Reference Code. For Price please contact nearest Branch Office.

 non stockable items.



Switch Disconnector Fuse Unit

Switch Disconnector Fuse Unit (without Fuse Links)

- Conforms to IS/IEC 60947-3
- Range: 32-800A, 415V AC 50Hz
- Door Interlock and Padlock facility
- Version: 2P / TP / TPN / 4P
- Modular Construction
- Positive Isolation
- Suitable for DIN & Bolted HRC Fuse Links



[HSN Code: 8537]

Size	Rating Amps	Pole	CSSDF in Open Execution				CSSDF in Sheet Steel Enclosure				Recommended Fuse Links Type (IEC Size)			
			Reference	List Price (₹)	Reference	List Price (₹)	Reference	List Price (₹)	Reference	List Price (₹)	DIN	BS		
			DIN		BS		DIN		BS					
Frame 1	32A	2P	CSSDF32D2	2350	CSSDF32B2	2860							CDFL00 32	CTIA-32(A2)
		TP	CSSDF32D3	2810	CSSDF32B3	2930	☒E-CSSDF32D3	5390	E-CSSDF32B3	5600				
		TPN	CSSDF32D3N	3000	CSSDF32B3N	3010	E-CSSDF32D3N	5600	E-CSSDF32B3N	5700				
		4P	☒CSSDF32D4FN	3460	☒CSSDF32B4FN	3260	E-CSSDF32D4FN	6100	☒E-CSSDF32B4FN	6190				
Frame 1	63A	2P	CSSDF63D2	3460	CSSDF63B2	3310							CDFL00 63	CSTIS-63(A3)
		TP	CSSDF63D3	3610	CSSDF63B3	3560	☒E-CSSDF63D3	6370	E-CSSDF63B3	6430				
		TPN	CSSDF63D3N	3670	CSSDF63B3N	3830	E-CSSDF63D3N	6830	E-CSSDF63B3N	6930				
		4P	CSSDF63D4FN	4030	CSSDF63B4FN	4160	E-CSSDF63D4FN	7170	☒E-CSSDF63B4FN	7190				
Frame 2	100A	2P	CSSDF100D2	6000	CSSDF100B2	6920							CSDFL00 100	CTCP-100(A4)
		TP	CSSDF100D3	7260	CSSDF100B3	8000	E-CSSDF100D3	10680	E-CSSDF100B3	10920				
		TPN	CSSDF100D3N	7760	CSSDF100B3N	8140	E-CSSDF100D3N	11340	E-CSSDF100B3N	11020				
		4P	CSSDF100D4FN	9140	☒CSSDF100B4FN	9670	E-CSSDF100D4FN	12900	☒E-CSSDF100B4FN	13460				
Frame 2	125A	2P	CSSDF125D2	7270	CSSDF125B2	7380							CSDFL00 125	CTCP-125(A4)
		TP	CSSDF125D3	7760	☒CSSDF125B3	8060	☒E-CSSDF125D3	12250	E-CSSDF125B3	12090				
		TPN	CSSDF125D3N	8530	CSSDF125B3N	8710	E-CSSDF125D3N	12730	E-CSSDF125B3N	13620				
		4P	CSSDF125D4FN	10590	CSSDF125B4FN	10580	☒E-CSSDF125D4FN	13910	☒E-CSSDF125B4FN	14440				
Frame 2	160A	2P	☒CSSDF160D2	8860	CSSDF160B2	9140							CSDFL00 160	CTF-160(B2)
		TP	CSSDF160D3	9850	☒CSSDF160B3	10000	E-CSSDF160D3	13860	E-CSSDF160B3	14020				
		TPN	CSSDF160D3N	10030	CSSDF160B3N	10170	E-CSSDF160D3N	14920	☒E-CSSDF160B3N	15460				
		4P	☒CSSDF160D4FN	11950	☒CSSDF160B4FN	13230	E-CSSDF160D4FN	18550	E-CSSDF160B4FN	20470				
Frame 3	200A	2P	CSSDF200D2	10820	CSSDF200B2	11380							CDFL1 200 / CSDFL1 200	CTF-200(B2)
		TP	CSSDF200D3	11710	☒CSSDF200B3	12280	☒E-CSSDF200D3	15960	E-CSSDF200B3	19000				
		TPN	CSSDF200D3N	13170	CSSDF200B3N	13170	E-CSSDF200D3N	17280	E-CSSDF200B3N	20000				
		4P	CSSDF200D4FN	13990	CSSDF200B4FN	15070	☒E-CSSDF200D4FN	19980	E-CSSDF200B4FN	21020				
Frame 3	250A	2P	CSSDF250D2	12290	☒CSSDF250B2	12660							CDFL1 250/ CSDFL1 250	CTKF(B3)
		TP	CSSDF250D3	14210	CSSDF250B3	14600	☒E-CSSDF250D3	18540	E-CSSDF250B3	20000				
		TPN	CSSDF250D3N	14280	CSSDF250B3N	14770	E-CSSDF250D3N	19290	E-CSSDF250B3N	20590				
		4P	CSSDF250D4FN	16020	CSSDF250B4FN	16430	☒E-CSSDF250D4FN	22450	E-CSSDF250B4FN	22940				
Frame 3	315A	2P	CSSDF315D2	14440	CSSDF315B2	15150							CDFL2 315/ CSDFL2 315	CTKF-315(B3)
		TP	CSSDF315D3	18460	CSSDF315B3	18690	E-CSSDF315D3	23070	E-CSSDF315B3	24230				
		TPN	CSSDF315D3N	19000	CSSDF315B3N	19070	E-CSSDF315D3N	23300	E-CSSDF315B3N	24430				
		4P	CSSDF315D4FN	21910	CSSDF315B4FN	21750	☒E-CSSDF315D4FN	30530	E-CSSDF315B4FN	32970				
Frame 3	400A	2P	☒CSSDF400D2	18620	CSSDF400B2	19330							CDFL2 400/ CSDFL2 400	CTMF-400(B4)
		TP	CSSDF400D3	22090	☒CSSDF400B3	23200	☒E-CSSDF400D3	28190	E-CSSDF400B3	29400				
		TPN	CSSDF400D3N	22750	CSSDF400B3N	23470	E-CSSDF400D3N	28400	E-CSSDF400B3N	29600				
		4P	CSSDF400D4FN	25390	CSSDF400B4FN	27500	☒E-CSSDF400D4FN	32180	E-CSSDF400B4FN	35450				
Frame 4	630A	2P	CSSDF630D2	31510	☒CSSDF630B2	28070							CDFL3 630	CTTM-630(C2)
		TP	CSSDF630D3	38710	☒CSSDF630B3	39830	E-CSSDF630D3	41490	E-CSSDF630B3	46000				
		TPN	CSSDF630D3N	40000	CSSDF630B3N	40330	E-CSSDF630D3N	43610	☒E-CSSDF630B3N	49680				
		4P	CSSDF630D4FN	44300	CSSDF630B4FN	47530	☒E-CSSDF630D4FN	53150	E-CSSDF630B4FN	56550				
Frame 4	800A	2P	CSSDF800D2	42080	CSSDF800B2	39140							-	CTLM-800(C3)
		TP	☒CSSDF800D3	45810	CSSDF800B3	49600	E-CSSDF800D3		E-CSSDF800B3					
		TPN	CSSDF800D3N	47000	CSSDF800B3N	52000	☒E-CSSDF800D3N		☒E-CSSDF800B3N					
		4P	☒CSSDF800D4FN	53920	CSSDF800B4FN	58750	E-CSSDF800D4FN		E-CSSDF800B4FN					

☒ non stockable items.

Accessories Switch Disconnecter Fuse Unit



Key Interlocks (3 Locks - 2 Keys)		[HSN Code: 8538]
For Switch Type	Reference	List Price (₹)
CSSDF 32A - 160A	☒ CSSDFZW-16	4520
CSSDF 200A - 800A	CSSDFZW-5	5070



Castle Key Locks		[HSN Code: 8538]
For Switch Type	Reference	List Price (₹)
CSSDF 32A - 160A	CSSDFZW-15	5790
CSSDF 200A - 800A	CSSDFZW-4	6090



Auxiliary Contacts		[HSN Code: 8538]
For Switch Type	Reference	List Price (₹)
1 NO + 1 NC CSSDF 32A - 63A for 3P	CSSDFZX46	770
2 NO + 2 NC CSSDF 32A - 63A for 3P	CSSDFZX32	1420
1 NO + 1 NC CSSDF 32A - 63A for 2P & 4P	CSSDFZX46B	770
2 NO + 2 NC CSSDF 32A - 63A for 2P & 4P	☒ CSSDFZX32B	1420
1 NO + 1 NC CSSDF 100A - 160A	CSSDFZX1	770
2 NO + 2 NC CSSDF 100A - 160A	☒ CSSDFZX16	1420
1 NO + 1 NC CSSDF 200A - 400A	CSSDFZX33	930
2 NO + 2 NC CSSDF 200A - 400A	CSSDFZX34	1720
1 NO + 1 NC CSSDF 630A - 800A	CSSDFZX35	930
2 NO + 2 NC CSSDF 630A - 800A	☒ CSSDFZX36	1420



Handle Mounting Kit (for independent mounting of O/E Switches)		[HSN Code: 8538]
For Switch Type	Reference	List Price (₹)
CSSDF 200A - 400A	HMK-1-2	1970
CSSDF 630A - 800A	HMK-3-2	2080



Extended Terminals							[HSN Code: 8538]
For Switch Type	TPN	ET-323	510	4P	ET-324	610	List Price (₹)
32A-63A	TPN	ET-323	510	4P	ET-324	610	1810
100A-160A	TPN	ET-327	1270	4P	ET-328	1810	1810
200A-400A	TPN	ET-329	3710	4P	ET-330	4520	4520



Spare Handle		[HSN Code: 8538]
For Switch Type	Reference	List Price (₹)
CSSDF 32A-160A (Moulded)	CSWH80S6	810
CSSDF 200A-400A (Moulded)	CSWH145S12	1400
CSSDF 630A-800A (Moulded)	CSWH220S12	1780

Spare Handle Shaft		[HSN Code: 8538]
For Switch Type	Reference	List Price (₹)
CSSDF 32A-160A	CSP6x165	360
CSSDF 200A-800A	CSP12x255	630



Spare Neutral Links		[HSN Code: 8538]
For Switch Type	Reference	List Price (₹)
CSSDF 32A-63A	CSSDFZX87	490
CSSDF 100A-160A	CSSDFZX86	600
CSSDF 200A-400A	CSSDFZX85	1030
CSSDF 630A-800A	☒ CSSDFZX88	1180

Spare Poles (Price per Pole)			[HSN Code: 8538]
Rating (Amps)	Reference		List Price (₹)
	DIN	BS	
32	☒ CSSDF-SP-32D	CSSDF-SP-32B	1390
63	CSSDF-SP-63D	CSSDF-SP-63B	1740
100	CSSDF-SP-100D	CSSDF-SP-100B	3380
125	☒ CSSDF-SP-125D	CSSDF-SP-125B	3690
160	☒ CSSDF-SP-160D	CSSDF-SP-160B	4320
200	☒ CSSDF-SP-200D	CSSDF-SP-200B	5010
250	CSSDF-SP-250D	CSSDF-SP-250B	6840
315	CSSDF-SP-315D	CSSDF-SP-315B	7650
400	☒ CSSDF-SP-400D	CSSDF-SP-400B	9830
630	☒ CSSDF-SP-630D	CSSDF-SP-630B	13980
800	CSSDF-SP-800D	☒ CSSDF-SP-800B	17050

☒ non stockable items.

Switch Disconnectors (Load Break Switches)

- Conforms to IS/IEC 60947-3
- Range: 25A-400A, 415V AC 50Hz
- Version: TP / 4P
- Compact Construction
- Door Interlock and Padlock facility
- Positive Isolation



[HSN Code: 8536]

Size	Rating Amps	Pole	CSSD In Open Execution		In Sheet Steel Enclosure		
			Reference	List Price (₹)	Reference	List Price (₹)	
D-Series	Frame 1	25	3	CSSD25D3	2020	☒E-CSSD25D3	4400
			4	☒CSSD25D4	2670	E-CSSD25D4	4790
	Frame 1	40	3	CSSD40D3	2160	E-CSSD40D3	5070
			4	CSSD40D4	4200	☒E-CSSD40D4	5530
	Frame 2	63	3	CSSD63K3	2870	☒E-CSSD63K3	6040
	Frame 3		4	CSSD63D4	4580	☒E-CSSD63D4	7250
Frame 3	125	3	CSSD125D3	6440	E-CSSD125D3	10130	
Frame 3		4	CSSD125D4	7830	☒E-CSSD125D4	11250	
NM-Series	Frame 1	125	3	CSSD125NM3	7550	E-CSSD125NM3	11160
			4	CSSD125NM4	9300	E-CSSD125NM4	13770
	Frame 1	160	3	☒CSSD160NM3	8420	E-CSSD160NM3	12460
			4	☒CSSD160NM4	10020	E-CSSD160NM4	14850
	Frame 1	200	3	☒CSSD200NM3	10750	E-CSSD200NM3	13970
			4	CSSD200NM4	13940	E-CSSD200NM4	18130
	Frame 1	250	3	CSSD250NM3	10880	E-CSSD250NM3	16100
			4	CSSD250NM4	15090	☒E-CSSD250NM4	22350
	☘ Frame 2	315	3	CSSD315NM3	14180	E-CSSD315NM3	POR
			4	CSSD315NM4	15300	E-CSSD315NM4	
☘ Frame 2	400	3	CSSD400NM3	16990	E-CSSD400NM3		
		4	CSSD400NM4	20610	E-CSSD400NM4		

NOTE:

- Rotary Handle with door defeat Mechanism / Pistol grip handle is available only for 25-63A.
- Switch Disconnecter with Direct Handle and Extended Terminals are also available. Please contact nearest Branch Office for prices.
- ☒non stockable items.

Switch Disconnectors (Load Break Switches)

- Conforms to IS/IEC 60947-3
- Range: 125A-3150A, 415V, 50Hz
- Version: 2P, 3P, 4P
- Modular construction
- Positive Isolation
- Door Interlock and Padlock facility ■



Size	Rating Amps	Pole	CSSD In Open Execution [HSN Code: 8536]		In Sheet Steel Enclosure [HSN Code: 8536]			
			Reference	List Price (₹)	Reference	List Price (₹)		
DM-Series	Frame 4	125	3	CSSD125DM3	8470	E-CSSD125DM3	11430	
		4	CSSD125DM4	10490	☒E-CSSD125DM4	14150		
	Frame 5	160	3	CSSD160DM3	9690	E-CSSD160DM3	12790	
		4	CSSD160DM4	11190	E-CSSD160DM4	15380		
	Frame 5	200	3	CSSD200DM3	12000	E-CSSD200DM3	16330	
			4	CSSD200DM4	17840	E-CSSD200DM4	21230	
	Frame 5	250	3	CSSD250DM3	14640	E-CSSD250DM3	19290	
			4	CSSD250DM4	16050	E-CSSD250DM4	22560	
	Frame 5	315	3	CSSD315DM3	16990	E-CSSD315DM3	21100	
			4	CSSD315DM4	20660	E-CSSD315DM4	24530	
	Frame 5	400	3	CSSD400DM3	20590	E-CSSD400DM3	25010	
			4	CSSD400DM4	24020	E-CSSD400DM4	29630	
	K-Series	Frame 6	630	3	CSSD630K3	30510	E-CSSD630K3	35720
			4	CSSD630K4	35790	E-CSSD630K4	41500	
Frame 6		800	3	CSSD800K3	36020	E-CSSD800K3	41780	
			4	CSSD800K4	39710	E-CSSD800K4	50260	
P-Series	Frame 7	1000	3	☒CSSD1000P3	41080	E-CSSD1000P3	67530	
		4	CSSD1000P4	58560	E-CSSD1000P4	88830		
	Frame 7	1250	3	☒CSSD1250P3	60870	E-CSSD1250P3	82770	
			4	☒CSSD1250P4	80430	E-CSSD1250P4	108880	
	Frame 7	1600	3	☒CSSD1600P3	76220	E-CSSD1600P3	103660	
			4	☒CSSD1600P4	101620	E-CSSD1600P4	138200	
	Frame 8	2000	3	CSSD2000P3	152510	E-CSSD2000P3	200140	
			4	CSSD2000P4	173260	E-CSSD2000P4	223560	
	Frame 8	2500	3	CSSD2500P3	170580	E-CSSD2500P3	222110	
			4	CSSD2500P4	193860	E-CSSD2500P4	248140	
	Frame 8	3150	3	CSSD3150P3	215270	E-CSSD3150P3	297860	
			4	CSSD3150P4	244620	E-CSSD3150P4	345890	

☒ non stockable items.

NOTES:

'K' series from 1000A to 3150A in open execution is also available on special request for retrofit orders only. For price, please contact nearest Branch Office.
Handle colour: Red Knob and Yellow Base (standard) Black Base and Knob on request. ■ upto 800A

Switch Disconnectors (Moulded construction)



Accessories		[HSN Code: 8538]		
For Switch Type	Reference	List Price (₹)		
Key Interlocks (3 Locks - 2 Keys)				
CSSD 125A-160A	CSSDZW - 16	6070		
CSSD 200A-3150A	CSSDZW - 5			
Castle Key Locks				
CSSD 25A-160A	CSSDZW - 15	5110		
CSSD 200A-3150A	CSSDZW - 4			
Auxiliary Contacts				
1 NO+1 NC CSSD 25A-40A	3	<input checked="" type="checkbox"/> CSSDZX49	800	
2 NO+2 NC CSSD 25A-40A	3	<input checked="" type="checkbox"/> CSSDZX50	1500	
1 NO+1 NC CSSD 25A-40A	4	CSSDZX87	800	
2 NO+2 NC CSSD 25A-40A	4	<input checked="" type="checkbox"/> CSSDZX88	1500	
1 NO+1 NC CSSD 63A	3	<input checked="" type="checkbox"/> CSSDZX79	800	
2 NO+2 NC CSSD 63A	3	<input checked="" type="checkbox"/> CSSDZX80	1500	
1 NO+1 NC CSSD 125A	3	<input checked="" type="checkbox"/> CSSDZX52	800	
2 NO+2 NC CSSD 125A	3	<input checked="" type="checkbox"/> CSSDZX53	1500	
1 NO+1 NC CSSD 63A-125A	4	<input checked="" type="checkbox"/> CSSDZX55	800	
2 NO+2 NC CSSD 63A-125A	4	<input checked="" type="checkbox"/> CSSDZX56	1500	
1 NO+1 NC CSSD 125A-160A (DM)	3/4	<input checked="" type="checkbox"/> CSSDZX1	1500	
2 NO+2 NC CSSD 125A-160A (DM)	3/4	CSSDZX16		
1 NO+1 NC CSSD 200A-400A (DM)	3/4	CSSDZX37		
2 NO+2 NC CSSD 200A-400A (DM)	3/4	CSSDZX38		
1 NO+1 NC CSSD 630A-800A	3/4	<input checked="" type="checkbox"/> CSSDZX33		
2 NO+2 NC CSSD 630A-800A	3/4	<input checked="" type="checkbox"/> CSSDZX34		
1 NO+1 NC CSSD 1000A-3150A	3/4	CSSDZX35		
2 NO+2 NC CSSD 1000A-3150A	3/4	<input checked="" type="checkbox"/> CSSDZX36		
Handle Mounting Kit (for independent mounting of O/E Switches)				
CSSD 200A-400A (Compact Series)		HMK-2		1980
CSSD 630A-800A		HMK-1-1	2000	
CSSD 1000A-1600A		HMK-3-1	2140	
Extended Terminals				
125A	TPN	ET-325 710	4P ET-326 770	
100A-160A	TPN	ET-327 1270	4P ET-328 1810	
200A-400A	TPN	ET-329 3710	4P ET-330 4520	
Rotary Knob Handles				
CSSD 25A-125A (Moulded-Red/Yellow)		<input checked="" type="checkbox"/> CSSDZX108	490	
CSSD 25A-125A (Moulded-Black)		CSSDZX111BL		
Switch Handles				
CSSD 200A-800A (Moulded)		CSWH145S12	1400	
CSSD 1000A-1600A (Moulded)		CSWH220S12	1780	
CSSD 2500A-3150A (Metallic)		CSDA8	2100	
CSSD 125A-160A (Moulded)		CSWH80S6	810	
CSSD 200A-315A (Moulded)		<input checked="" type="checkbox"/> CSWH80S8		
Switch Handle Shaft				
CSSD 25A-125A		<input checked="" type="checkbox"/> CSP5X70	550	
CSSD 125A-160A (DM)		CAP6X165	360	
CSSD 200A-400A (DM)		<input checked="" type="checkbox"/> CSP8X240		
CSSD 630A-1600A		CSP12X255	630	
CSSD 2500A-3150A		CSP12X325	760	
Switch Poles (Price per Pole)				
125A		CSSD-SP-125DM	1920	
160A		CSSD-SP-160DM	1920	
200A		<input checked="" type="checkbox"/> CSSD-SP200DM	2570	
250A		<input checked="" type="checkbox"/> CSSD-SP250DM	3410	
315A		<input checked="" type="checkbox"/> CSSD-SP315DM	4960	
400A		<input checked="" type="checkbox"/> CSSD-SP400DM	9570	
630A		CSSD-SP630K	10970	
800A		<input checked="" type="checkbox"/> CSSD-SP800K	14460	
1000A		CSSD-SP1000P	21940	
1250A		CSSD-SP1250P	26160	
1600A		CSSD-SP1600P	27480	

non stockable items.

On Load Changeover Switches

- Conforms to IS/IEC 60947-3
- Range: 63A–3150A, 415V, 50Hz
- Version: 4P
- Modular construction
- Positive Isolation
- Door Interlock and Padlock facility ■



In Open Execution [HSN Code: 8536]					
Size	Rating (Amps)	Pole	Reference	List Price (₹)	
NM-Series	Frame 1	63	4	CSCS63NM4CO	7120
	Frame 1	100	4	CSCS100NM4CO	9460
	Frame 2	125	4	CSCS125NM4CO	13820
	Frame 2	160	4	CSCS160NM4CO	15190
	Frame 2	200	4	CSCS200NM4CO	18270
	Frame 2	250	4	CSCS250NM4CO	27420
DM-Series	Frame 2	315	4	CSCS315DM4CO	28580
	Frame 2	400	4	CSCS400DM4CO	41880
K-Series	Frame 3	630	4	CSCS630K4CO	48870
	Frame 3	800	4	CSCS800K4CO	69520
P-Series	Frame 4	1000	4	☒CSCS1000P4CO	123500
	Frame 4	1250	4	☒CSCS1250P4CO	166970
	Frame 4	1600	4	☒CSCS1600P4CO	211480
	Frame 5	2000	4	☒CSCS2000P4CO	305590
	Frame 5	2500	4	☒CSCS2500P4CO	404840
	Frame 5	3150	4	☒CSCS3150P4CO	557930

In Sheet Steel Enclosure [HSN Code: 8536]					
Size	Rating (Amps)	Pole	Reference	List Price (₹)	
NM-Series	Frame 1	63	4	E-CSCS63NM4CO	10020
	Frame 1	100	4	E-CSCS100NM4CO	12610
	Frame 2	125	4	E-CSCS125NM4CO	18380
	Frame 2	160	4	E-CSCS160NM4CO	20010
	Frame 2	200	4	E-CSCS200NM4CO	23150
	Frame 2	250	4	E-CSCS250NM4CO	35010
DM-Series	Frame 2	315	4	E-CSCS315DM4CO	36170
	Frame 2	400	4	E-CSCS400DM4CO	53270
K-Series	Frame 3	630	4	E-CSCS630K4CO	61330
	Frame 3	800	4	E-CSCS800K4CO	91480
P-Series	Frame 4	1000	4	☒E-CSCS1000P4CO	159360
	Frame 4	1250	4	☒E-CSCS1250P4CO	206770
	Frame 4	1600	4	☒E-CSCS1600P4CO	268920
	Frame 5	2000	4	☒E-CSCS2000P4CO	379590
	Frame 5	2500	4	☒E-CSCS2500P4CO	485710
	Frame 5	3150	4	☒E-CSCS3150P4CO	658360

☒ non stockable items.

NOTES:

'K' series from 1000A to 3150A in open execution is also available on special request for retrofit orders only. For price, please contact nearest Branch Office.

- Upto 800A

Changeover Switch

Accessories [HSN Code: 8538]		
Auxiliary Contacts for NM Type Changeover		
Description	Reference	List Price (₹)
1NO +1NC for 63~100A	CSCONM1AUX10	680
1NO +1NC for 125~250A	CSCONM2AUX10	

Direct handle Mounting Kit for NM Type Changeover [HSN Code: 8538]		
Rating (Amps)	Reference	List Price (₹)
63~100A	☒CSCONM1HMB	550
125~250A	☒CSCONM2HMB	680

Switch Handle Shaft for NM Type Changeover [HSN Code: 8538]		
Rating (Amps)	Reference	List Price (₹)
63~100A	☒CSPNM18X80	390
125~250A	CSPNM28X110	510

Handle Sub Assembly for NM Type Changeover [HSN Code: 8538]		
Rating (Amps)	Reference	List Price (₹)
63~100A	CSCONM1H80S8	760
125~250A	☒CSCONM2H145S8	1100



Bypass Switches

LT Bypass Switch complete with Handle Assembly having Door Interlock and Padlocking arrangement.

In Open Execution				[HSN Code: 8536]
Size	Rating (Amps)	Pole	Reference	List Price (₹)
Frame 1	63	4	CSBS63DM4	19150
	80	4	CSBS80DM4	23400
	100	4	CSBS100DM4	24400
	125	4	CSBS125DM4	26850
	160	4	CSBS160DM4	31730
Frame 2	200	4	CSBS200DM4	32440
	250	4	CSBS250DM4	49370
	315	4	CSBS315DM4	51250
	400	4	CSBS400K4	72380
Frame 3	630	4	CSBS630K4	86590
	800	4	☒CSBS800K4	108620
Frame 4	1000	4	☒CSBS1000P4	202570
	1250	4	☒CSBS1250P4	278210
	1600	4	☒CSBS1600P4	373290

In Sheet Steel Enclosure				[HSN Code: 8536]
Size	Rating (Amps)	Pole	Reference	List Price (₹)
Frame 1	63	4	☒E-CSBS63DM4	27270
	80	4	E-CSBS80DM4	29200
	100	4	☒E-CSBS100DM4	29960
	125	4	☒E-CSBS125DM4	34140
	160	4	☒E-CSBS160DM4	36850
Frame 2	200	4	☒E-CSBS200DM4	41670
	250	4	☒E-CSBS250DM4	59900
	315	4	E-CSBS315DM4	64080
	400	4	E-CSBS400K4	89670
Frame 3	630	4	E-CSBS630K4	102510
	800	4	☒E-CSBS800K4	151870
Frame 4	1000	4	☒E-CSBS1000P4	250150
	1250	4	☒E-CSBS1250P4	337710
	1600	4	☒E-CSBS1600P4	454420

NOTES:

'K' series from 1000A to 1600A is also available on request for retrofit only. For price, please contact nearest Branch Office. Door interlock & Pad locking arrangements are available upto 800A

Bypass Switch application				
Table of Operation				
Handle	Switch-I	Switch-II	Switch-III	Remarks
Position-I	ON	OFF	ON	Regulated Supply to Load
Position-O	OFF	OFF	OFF	No Supply, Load as well as Regulator Isolated from incoming source
Position-II	OFF	ON	OFF	Direct Supply, Regulator By-passed & Isolated

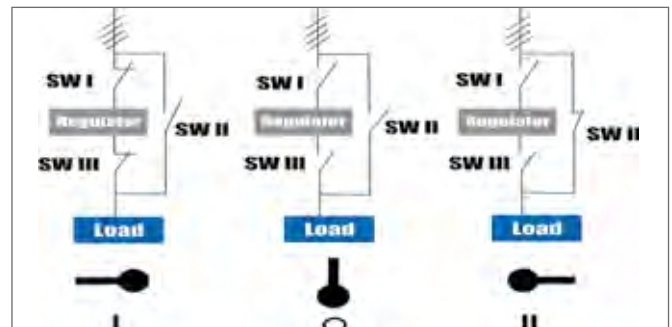

Bypass Switches

LT Bypass Switch complete with Handle Assembly having Door Interlock and Padlocking arrangement.

Accessories for Changeover -Type DM/K/P

Auxiliary Contacts				[HSN Code: 8538]
Contacts Configuration	For Switch Type	Qty./Switch	Reference	List Price (₹)
1NO+1NC	CSCS/CSBS 63A-160A Upper CSCF 125A-160A	1	☒CSCSZX1-U	750
1NO+1NC	CSCS/CSBS 63A-160A Lower CSCF 125A-160A	1	☒CSCSZX1-L	750
2NO+2NC	CSCS/CSBS 63A-160A Upper CSCF 125A-160A	1	☒CSCSZX3-U	1460
2NO+2NC	CSCS/CSBS 63A-160A Lower CSCF 125A-160A	1	CSCSZX3-L	1460
1NO+1NC	CSCS/CSBS 200A-1600A CSCF 200A-800A	2	CSCSZX2	1510
2NO+2NC	CSCS/CSBS 200A-1600A CSCF 200A-800A	2	CSCSZX4	2930

NOTES: If changeovers switch is required with Auxiliary contacts, please order the same separately. Prices listed are for the pair of auxiliary contacts, if applicable.

Spare Poles (Price per Pole)				[HSN Code: 8538]
Rating (Amps)	Type	Reference	List Price (₹)	
63	CSCS/CSBS	CSSD-SP-63DM	1670	
80	CSCS/CSBS	CSSD-SP-80DM	1720	
100	CSCS/CSBS	CSSD-SP-100DM	1860	
125	CSCS/CSBS/CSCF	CSSD-SP-125DM	1930	
160	CSCS/CSBS/CSCF	CSSD-SP-160DM	1930	
200	CSCS/CSBS/CSCF	CSSD-SP200DM	2570	
250	CSCS/CSBS/CSCF	CSSD-SP250DM	3450	
315	CSCS/CSBS/CSCF	CSSD-SP315DM	5010	
400	CSCS/CSBS/CSCF	CSCS-SP400DM	9640	
630	CSCS/CSBS/CSCF	CSCS-SP630K	10940	
800	CSCS/CSBS/CSCF	CSCS-SP800K	14560	
1000	CSCS/CSBS	☒CSCS-SP1000P	21900	
1250	CSCS/CSBS	☒CSCS-SP1250P	27420	
1600	CSCS/CSBS	☒CSCS-SP1600P	31570	

NOTES: For one changeover of 4 pole, 8 Nos of sparepoles are required.

Spare Handle			[HSN Code: 8538]
Rating (Amps)	Reference	List Price (₹)	
CSCS/CSBS 63-315A/CSCF125-315A	CCOH145S8	1500	
CSCS/CSBS 400A-1600A/CSCF400-800A	CCOH220S12	1520	
CSCS 2000A-3150A (Metallic)	CSDA6	1740	

Spare Handle Shaft			[HSN Code: 8538]
Type	Reference	List Price (₹)	
CSCS 63-315A CSBS 63-315A CSCF125-315A	CSP8X200	410	
CSCS 400A-1600A	CSP12X205	460	
CSCS 2000A-3150A CSBS 400A-1600A CSCF 400A-1600A	☒CSP12X305	750	

☒non stockable items.

Switch Disconnecter Fuse Changeover (Conventional Type / Side-by-Side)

LT Heavy Duty 4 Pole Changeover Switch Disconnecter Fuse unit comprising of two Switches, 32A - 800A, 415V, 50Hz mounted on common chasis complete with Mechanical Interlock and Handle Assembly having Door Interlock & Padlocking arrangements.

CSSDF in Open Execution, 4 Pole [HSN Code: 8536]				
Size	Rating (Amps)	Reference		List Price (₹)
		DIN	BIS	
Frame 1	32	CSSDF32D4CO	CSSDF32B4CO	POR
	63	CSSDF63D4CO	CSSDF63B4CO	
Frame 2	100	CSSDF100D4CO	CSSDF100B4CO	
	125	CSSDF125D4CO	CSSDF125B4CO	
	160	CSSDF160D4CO	CSSDF160B4CO	
Frame 3	200	☒CSSDF200D4CO	CSSDF200B4CO	
	250	☒CSSDF250D4CO	CSSDF250B4CO	
	315	☒CSSDF315D4CO	CSSDF315B4CO	
Frame 4	400	☒CSSDF400D4CO	CSSDF400B4CO	
	630	☒CSSDF630D4CO	CSSDF630B4CO	
Frame 4	800	-	CSSDF800B4CO	

Load Break Changeover Conventional Type / Side-by-Side)

LT Heavy Duty 4 Pole Changeover Load Break Switch comprising of two Switches 25A - 3150A, 415V, 50Hz mounted on common chasis complete with Mechanical Interlock and Handle Assembly having Door Interlock and Padlocking arrangements.

CSSD in Open Execution, 4 Pole [HSN Code: 8536]			
Size	Rating (Amps)	Reference	List Price (₹)
Frame 1	25	CSSD25D4CO	POR
	40	CSSD40D4CO	
Frame 2	63	CSSD63D4CO	
Frame 3	125	☒CSSD125DM4CO	
	160	☒CSSD160DM4CO	
Frame 4	200	☒CSSD200DM4CO	
	250	☒CSSD250DM4CO	
	400	☒CSSD400DM4CO	
Frame 5	630	☒CSSD630K4CO	
	800	☒CSSD800K4CO	
Frame 6	1000	☒CSSD1000P4CO	
	1250	☒CSSD1250P4CO	
	1600	☒CSSD1600P4CO	
Frame 7	1800	☒CSSD1800P4CO	
	3150	☒CSSD3150P4CO	

NOTE:

- Shorting Links/Busbars NOT provides with open execution in conventional type Changeover Switches Enclosure Prices on request.
- 'K' series from 1000A to 3150A in open execution is also available on special request for retrofit jobs only. For price, please contact nearest Branch Office.

Off-Load Changeover Switches [HSN Code: 8536]				
Reference	Rating (Amps)	Pole	Rated Voltage	List Price (₹)
CSCSO32CO2	32	2	250 V	2440
CSCSO63CO2	63	2	250 V	5170
CSCSO32CO4	32	4	415 V	4020
CSCSO63CO4	63	4	415 V	8210
CSCSO100CO4	100	4	415 V	18220
CSCSO200CO4	200	4	415 V	26330
CSCSO315CO4	315	4	415 V	32240
CSCSO400CO4	400	4	415 V	35800

Accessories-Changeover Switches (CSSDF) [HSN Code: 8538]		
Spare Handles		
For Switch Type	Reference	List Price (₹)
CSSDF 32A - 160A (Moulded)	CCOH80S6	POR
CSSDF 200A - 400A (Moulded)	CCOH220S12	
CSSDF 630A - 800A (Metallic)	CSDA6	

Accessories-CSSDF Changeover Switches [HSN Code: 8538]		
Operating Mechanism		
For Switch Type	Reference	List Price (₹)
CSSDF 32A-160A	☒CSSDFZW1	POR
CSSDF 200A-400A	☒CSSDZW12/1	
CSSDF 630A-800A	CSSDZW12	

Accessories-Changeover Switch (CSSD) [HSN Code: 8538]		
Spare Handles		
For Switch Type	Reference	List Price (₹)
CSSD 25A-125A (Moulded)	CCOH00S6	POR
CSSD 200A-800A (Moulded)	CCOH220S12	
CSSD 1000A-3150A (Metallic)	CSDA6	

Operating Mechanism [HSN Code: 8538]		
For Switch Type	Reference	List Price (₹)
CSSD 25A - 40A	☒CSSDZW6	POR
CSSD 63A - 125A (DM type)	☒CSSDZW6/1	
CSSD 200A - 400A (DM type)	☒CSSDZW11A	
CSSD 400A - 800A (K type)	☒CSSDZW11	
CSSD 1000A - 3150A (P type)	☒CSSDZW12	

Switch Fuse Unit: Rewirable with Side Handle [HSN Code: 8536]				
Reference	Rating (Amps)	Pole	Rated Voltage	List Price (₹)
☒CSRW16P1NS	16	SPN	240 V	970
☒CSRW32P1NS	32	SPN	240 V	2370
☒CSRW16P2S	16	DP	240 V	990
CSRW32P2S	32	DP	240 V	2640
CSRW32P3NS	32	TPN	415V	3950
CSRW63P3NS	63	TPN	415V	7860
CSRW100P3NS	100	TPN	415V	15760
CSRW200P3NS	200	TPN	415V	20950



☒non stockable items.

HRC Fuse Link, Fuse Base & Fuse Holder

Range: 2A~800A

- Conforms to IS 13703-Part 2
- Conforms to IEC 60269-Part 2
- Range: DIN type (6~630A), 500V, AC 50Hz, Bolted type (2~800A), 415V, AC 50Hz
- High breaking capacity: 80kA



DIN Type HRC Fuse Link				[HSN Code: 8536]
IS/IEC Size	In A	Reference	List Price (₹)	MOQ
00	6, 10, 16, 20, 25, 32, 35	CDFL00*	380	3
	40, 50, 63	CSDFL00*	385	
	80, 100	CSDFL00*	390	
	125, 160	CSDFL00*	400	
1	32, 35, 50, 63	CDFL01*	670	
	80, 100, 125	CDFL01*	720	
	160	CDFL01*	720	
	200	CSDFL1*	740	
	250	CSDFL1*	810	
2	100, 125	CDFL02*	1050	
	160, 200	CDFL02*	1070	
	250	CDFL02*	1070	
	315	CSDFL2*	1110	
	400	CSDFL2*	1170	
3	315, 400	CDFL03*	1490	
	500	CDFL3*	1790	
	630	CDFL3*	1790	

While ordering, replace "*" by current rating.



Fuse Bases for DIN Type Fuse Link (ISI Mark)				[HSN Code: 8536]
IS/IEC Size	In A	Reference	List Price (₹)	MOQ
00	160	CSDFB00	450	3
1	250	CSDFB1	820	
2	400	CSDFB2	1220	
3	630	CDFB3	1980	



Solid Link				[HSN Code: 8536]
IS/IEC Size	In A	Reference	List Price (₹)	MOQ
00	160	CDSL00	560	3
1	250	CDSL1	740	
2	400	☒CDSL2	1020	
3	630	☒CDSL3	1250	

Bolted Type HRC Fuse Link



Off Set TAG Type				[HSN Code: 8536]
IS/IEC Size	Rating (Amps)	Reference	List Price (₹)	MOQ
A1	2, 4, 6, 8, 10, 12 & 16	CNIT*	90	20
	20, 25, & 32	CNIT*		
A2	4, 6,10,16, 20, 25 & 32	CSTIA*	130	20
A3	32, 40, 50 & 63	CSTIS*	190	10
A4	50, 63, 80, 100, 125	CTCP*	360	6
-	125, 160, 200	CTFP*	520	3

CNS (Off Set) clip in Type				[HSN Code: 8536]
IS/IEC Size	In A	Reference	List Price (₹)	MOQ
F1	2, 4, 6, 8,10,12,16	CNS*	90	20
F1	20, 25, 32	CNS*	90	20

☒ non stockable items.
MOQ-Minimum Order Quantity.

Bolted Type HRC Fuse Link



Central TAG (2 hole fixing) Type				[HSN Code: 8536]	
IS/IEC Size	In A	Reference	List Price (₹)	MOQ	
B1	80, 100	CTC*	380	6	
B1	125	CTC*	380		
B2	125, 160, 200	CTF*	570	3	
B3	250, 300, 315	CTKF*	820	1	
B4	355, 400	CTMF*	1590		

☒ non stockable items. MOQ-Minimum Order Quantity.

HRC Fuse Link, Fuse Base & Fuse Holder



Central TAG (4 Hole Fixing) Type				[HSN Code: 8536]	
IS/IEC Size	In A	Reference	List Price (₹)	MOQ	
C1	355, 400	☒CTM*	1510	1	
C2	450, 500	☒CTTM*	2500		
C2	630	CTTM*	3240		
C3	670, 710, 750, 800	☒CTLM*	3450		



Cylindrical HRC Fuse Link				[HSN Code: 8536]	
IS/IEC Size	In A	Reference	List Price (₹)	MOQ	
(14*51)	2, 4, 6, 8 & 10	CHF*	180	20	
(14*51)	16, 20 & 25	CHF*	180		
(14*51)	32 & 40	CHF*	190		
(14*51)	50	CHF*	350		
(14*51)	63	CHF*	370		
(10*38)	2, 4, 6, 8, 10 & 16	CGF*	76	20	
(10*38)	20 & 25	CGF*	80		
(10*38)	32	CGF*	80		



HRC Fuse Holder for Bolted Type Fuse Link								[HSN Code: 8536]	
IS/IEC Size	In A	Reference	List Price (₹)	MOQ	Reference	List Price (₹)	MOQ		
F1	20	CNS20HN	200	10					
F1	32	CNS32H	230	10	-	-	-		
A2	32	CSM32HN	412	10					
A3	63	CSM63HN	480	5					
A4	100	-	-	-	CSM100H*	1400	3		
A4	100	-	-	-	CSM100B*	1570	3		

* H-Both side cable B-Top busbar & bottom cable



Fuse Holder for Cylindrical HRC Fuse Link				[HSN Code: 8536]	
IS/IEC Size	In A	Reference	List Price (₹)	MOQ	
14 x 51	32	CHO32R	220	10	
14 x 51	63	CHC63R	270		



Fuse Puller (for DIN type Fuse Link 6-630Amp)			[HSN Code: 8536]	
Reference	List Price (₹)	MOQ		
CDFH003	400	1		

Porcelain Rewirable Fuse Holder (Kit-Kat)				[HSN Code: 8536]	
Reference	Rating (Amps)	Fuse Wire Size (Max.)	List Price (₹)	MOQ	
CSKTRW32	32	22SWG	350	3	
CSKTRW63	63	18SWG	610		
CSKTRW100	100	14SWG	1080		
CSKTRW200	200	2 X 14SWG	2280	1	

Maximum Retail Price

Power Control Components

Protection, Measurement & Control Devices

Final Power Distribution Components

Wiring Accessories

General Terms & Conditions

Maximum Retail Price are subject to revision without prior notice and will be applicable as prevailing at the time of dispatch.

- This Price List supercedes all previous Price Lists.
- All prices are on Maximum Retail Price basis inclusive of all Duties, GST and any other Tax as applicable.
- All Prices are in Indian Rupees.

Warranty

All our listed products carry a warranty, against manufacturing defects for a period of 12 months from the date of invoicing subject to it's usages in normal recommended operating conditions. The company liability shall be limited to exchange or repair of the product, at its discretion, provided that such defective products are returned to billing address with all necessary documents.

CENTRAL CUSTOMER CARE (CCC)

Single stop Customer Support for all service needs, please contact:

Toll Free Number: 1800 572 2012

E-mail: customercare@cselectric.co.in

POR - Price on request

Products have been classified as Stockable & Non Stockable items.

Non Stockable items has been marked as 

HSN Code denoted as below:

[HSN Code 8536] GST@18%*

[HSN Code 8537] GST@18%*

[HSN Code 8538] GST@18%*

*Subject to change as per Government of India notification

Power Control Components



MPCBs ■ Power Contactors ■ Mini Contactors
Overload Relays ■ Industrial Plugs & Sockets
Control & Signalling Devices ■ Motor Starters

Motor Protection Circuit Breaker

Conforming IS/IEC 60947-1, IS/IEC 60947-2, IS/IEC 60947-4-1

TCMS-Model - Thermal Magnetic									[HSN Code: 8536]
<input type="checkbox"/> Adjustable thermal release <input type="checkbox"/> Magnetic release 13 X Ie Max. <input type="checkbox"/> Trip class 10 <input type="checkbox"/> Ambient temperature compensation <input type="checkbox"/> Phase failure protection									
Frame	Power Rating 3-PhMotors AC3-duty 415V, 50Hz	Adjustable range (Amp)	Breaking Capacity (kA) 415V, 50Hz	Reference	MRP (₹)	Breaking Capacity (kA) 415V, 50Hz	Reference	MRP (₹)	MOQ
	kW		Standard Model/ Toggle Switch			High Breaking Capacity / Rotary Handle			
32AF	0.02	0.1-0.16	100	<input checked="" type="checkbox"/> TCMS-32S-0.16	3910	100	TCMS-32H-0.16	4940	1
	0.06	0.16-0.25	100	<input checked="" type="checkbox"/> TCMS-32S-0.25	3910	100	<input checked="" type="checkbox"/> TCMS-32H-0.25	5080	
	0.09	0.25-0.4	100	TCMS-32S-0.4	3910	100	<input checked="" type="checkbox"/> TCMS-32H-0.4	5080	
	0.12	0.4-0.63	100	TCMS-32S-0.63	4140	100	<input checked="" type="checkbox"/> TCMS-32H-0.63	5450	
	0.25	0.63-1	100	TCMS-32S-1	4140	100	TCMS-32H-1	5450	
	0.55	1-1.6	100	TCMS-32S-1.6	4140	100	TCMS-32H-1.6	5490	
	0.75	1.6-2.5	100	TCMS-32S-2.5	4140	100	TCMS-32H-2.5	5490	
	1.5	2.5-4	100	TCMS-32S-4	4350	100	TCMS-32H-4	5490	
	2.2	4-6	100	TCMS-32S-6	4380	100	TCMS-32H-6	5660	
	3	5-8	100	TCMS-32S-8	4490	100	TCMS-32H-8	5730	
	4	6-10	50	TCMS-32S-10	4510	100	TCMS-32H-10	5730	
	5.5	9-13	50	TCMS-32S-13	5140	100	TCMS-32H-13	6750	
	7.5	11-17	20	TCMS-32S-17	5950	50	TCMS-32H-17	7410	
	7.5	14-22	15	TCMS-32S-22	5950	50	TCMS-32H-22	8200	
11	18-26	15	TCMS-32S-26	6300	50	TCMS-32H-26	8320		
15	22-32	15	TCMS-32S-32	11620	50	TCMS-32H-32	13830		
63AF	18.5	28-40	-	-	-	50	TCMS-63H-40	17470	
	22	34-50	-	-	-	50	TCMS-63H-50	20250	
	30	45-63	-	-	-	50	TCMS-63H-63	21610	
100AF	37	55-75	-	-	-	75	<input checked="" type="checkbox"/> TCMS-100H-75	21750	
	45	70-90	-	-	-	75	<input checked="" type="checkbox"/> TCMS-100H-90	21780	
	45	80-100	-	-	-	75	<input checked="" type="checkbox"/> TCMS-100H-100	21960	

TCMS-Model - Magnetic (Short Circuit Protection only)						[HSN Code: 8536]
<input type="checkbox"/> Without thermal release <input type="checkbox"/> Magnetic release 13 X Ie Max.						
Frame	Breaking Capacity (kA) at 415V, 50Hz	Power Rating 3-Ph Motors AC3 duty 415V, 50Hz	Rated Operational Current Ie (A)	Reference	MRP (₹)	MOQ
		kW				
32AF	100	0.02	0.16	TCMS-32HI-0.16	4330	1
	100	0.06	0.25	TCMS-32HI-0.25	4330	
	100	0.09	0.4	<input checked="" type="checkbox"/> TCMS-32HI-0.4	4330	
	100	0.12	0.63	<input checked="" type="checkbox"/> TCMS-32HI-0.63	5280	
	100	0.25	1	TCMS-32HI-1	5280	
	100	0.55	1.6	<input checked="" type="checkbox"/> TCMS-32HI-1.6	5280	
	100	0.75	2.5	<input checked="" type="checkbox"/> TCMS-32HI-2.5	5280	
	100	1.5	4	<input checked="" type="checkbox"/> TCMS-32HI-4	5350	
	100	2.2	6	<input checked="" type="checkbox"/> TCMS-32HI-6	5350	
	100	3	8	<input checked="" type="checkbox"/> TCMS-32HI-8	5350	
	100	4	10	<input checked="" type="checkbox"/> TCMS-32HI-10	5540	
	100	5.5	13	<input checked="" type="checkbox"/> TCMS-32HI-13	5540	
	50	7.5	17	<input checked="" type="checkbox"/> TCMS-32HI-17	5940	
	50	7.5	22	<input checked="" type="checkbox"/> TCMS-32HI-22	5940	
	50	11	26	<input checked="" type="checkbox"/> TCMS-32HI-26	5940	
	50	15	32	<input checked="" type="checkbox"/> TCMS-32HI-32	10900	
63AF	50	18.5	40	<input checked="" type="checkbox"/> TCMS-63HI-40	14060	
	50	22	50	<input checked="" type="checkbox"/> TCMS-63HI-50	16280	
	50	30	63	<input checked="" type="checkbox"/> TCMS-63HI-63	16410	
100AF	75	37	75	TCMS-100HI-75	17460	
	75	45	90	<input checked="" type="checkbox"/> TCMS-100HI-90	17980	
	75	45	100	TCMS-100HI-100	17980	

Non Stockable item

Motor Protection Circuit Breaker

Conforming IS/IEC 60947-1, IS/IEC 60947-2, IS/IEC 60947-4-1



Accessories			[HSN Code: 8538]		
Description	Configuration	Model	MRP (₹)	MOQ	
Auxiliary switch for front mounting	1NO+1NC	TFX11 (32A)	830	1	
	1NO+1NC	TFX11			
	2NC	TFX02			
	2NO	TFX20			
Auxiliary switch for front side mounting on the left	1NO+1NC	TLX11	1000	1	
	2NC	<input checked="" type="checkbox"/> TLX02			
	2NO	<input checked="" type="checkbox"/> TLX20			
Any trip alarm switch for side mounting on the left (TCMS-32)	1NO+1NC	TLA11	1270	1	
	2NC	TLA02			
Any trip alarm switch for side mounting on the left (TCMS-63-100)	1NO+1NC	TLA11(63-100)	1320	1	
	2NC	TLA02(63-100)			
Magnetic trip alarm switch for side mounting on the left	1NO+1NC	<input checked="" type="checkbox"/> TLAM11	1320	1	
Shunt release for side mounting on the right	110~127V50Hz	<input checked="" type="checkbox"/> TRS110~127V50Hz	2120	1	
	220~230V50Hz	<input checked="" type="checkbox"/> TRS220~230V50Hz			
	415~440V50Hz	TRS415~440V50Hz			
Undervoltage release for side mounting on the right	110~127V50Hz	TRU110~127V50Hz	2170	1	
	220~230V50Hz	<input checked="" type="checkbox"/> TRU220~230V50Hz			
	415~440V50Hz	TRU415~440V50Hz			
Undervoltage release with switch for side mounting on the right	110~127V50Hz	TRUX110~127V50Hz	2170	1	
	220~230V50Hz	<input checked="" type="checkbox"/> TRUX220~230V50Hz			
	415~440V50Hz	TRUX415~440V50Hz			
Insulation Barrier (for TCMS-100H/100HI only)		<input checked="" type="checkbox"/> TIB100	650	1	
Adaptor kit for MPCB + Mini Contactors	TCMS-32S+TC1M06-16	TDA-16SA	1090	1	
	TCMS-32S+TP1M06-16	TDA-16SD			
	TCMS-32H/32HI+TC1M06-16	TDA-16HA			
	TCMS-32H/32HI+TP1M06-16	<input checked="" type="checkbox"/> TDA-16HD			
Busbar	2 Point	PB322	1260	1	
		<input checked="" type="checkbox"/> PB323			
MPCB Enclosure (IP 65 Category)	For TCMS-32H/HI	PB632	1800	1	
		<input checked="" type="checkbox"/> PB633			
Extended Handle (Door Mounting with Door Interlock, Defeat Interlock & Padlock)	Extension Shaft 115mm		1540	1	
	TCMS-32H/HI	MEH32-115			
	TCMS-63H/HI	<input checked="" type="checkbox"/> MEH63-115			
		TCMS-100H/HI	<input checked="" type="checkbox"/> MEH100-115	1840	1
	Extension Shaft 315mm				
	TCMS-32H/HI	MEH32-315			
		TCMS-63H/HI	<input checked="" type="checkbox"/> MEH63-315		
		TCMS-100H/HI	<input checked="" type="checkbox"/> MEH100-315		

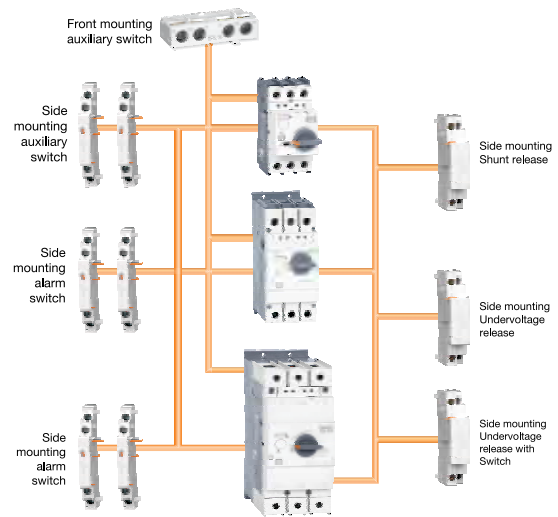

Non Stockable item



robustTa2
Contactor 7A~38A

robustTa
Contactor 9A~800A



TC Contactors. Enjoy life, non-stop.



robustTa2 Contactor

Conforming IEC60947-1, IEC60947-4-1 & IEC60947-5-1



Contactor				[HSN Code: 8536]			
AC1 Duty (A)	AC2/AC3/ AC4 415V Long life			Auxiliary Contacts	Reference	MRP (₹)	MOQ
	kW	HP	A				
25	2.2	3	7	1 NO+1NC	TC1D0711	1560	1
25	4	5.5	9	1 NO+1NC	TC1D0911	1710	
25	5.5	7.5	12	1 NO+1NC	TC1D1211	1830	
32	9	12	18	1 NO+1NC	TC1D1811	2190	
40	11	15	25	1 NO+1NC	TC1D2511	2780	
50	15	20	32	1 NO+1NC	TC1D3211	5900	
50	18.5	25	38	1 NO+1NC	TC1D3811	8180	

Spare Top Housing for 3P Contactors				[HSN Code: 8538]	
For Contactor	Reference	MRP (₹)	MOQ		
TC1-D0711	TA5-D0711	1180	1		
TC1-D0911	TA5-D0911				
TC1-D1211	TA5-D1211				
TC1-D1811	TA5-D1811	1360			
TC1-D2511	TA5-D2511	1750			
TC1-D3211	TA5-D3211	3340			
TC1-D3811	TA5-D3811	4930			

Coil Surge Suppressor					[HSN Code: 8538]	
Description	Voltage Ratings	Reference	MRP (₹)	MOQ		
Varistor (AC/DC) Clip on mounting	12~55V 50/60Hz	TAD4VE	730	10		
	56~136V 50/60Hz	TAD4VF				
	137~277V 50/60Hz	TAD4VU				
	278~575V 50/60Hz	TAD4VN				

Spare AC Coils for Contactor				[HSN Code: 8538]	
Use for Contactor	Reference	MRP (₹)	MOQ		
TC1D07	TX1-D3	740	1		
TC1D09					
TC1D12					
TC1D18					
TC1D25					
TC1D32					
TC1D38					

Mechanical Interlocks-Horizontal Mounted				[HSN Code: 8538]	
Use of Contactor	Reference	MRP (₹)	MOQ		
TC1D07~TC1D38	LA9-D09978	660	10		

robustTa2 Contactor Coils							[HSN Code: 8538]	
Contactor TC1-D/TX1D3	24V	48V	110V	220V	240V	415V		
50 Hz	B5	E5	F5	M5	U5	N5		

Thermal Overload Relay						[HSN Code: 8536]		
Relay setting range (A)	Standard power ratings of 3-Phase Motors 50/60Hz, AC3 Category		Reference	Suitable for Contactor Rating (Amps)	MRP (₹)	Independent Mounting Kit		
	HP	kW						
23-32	20	15	TR2DM32353	32	3210	TA7D3264 MRP ₹440		
30-38	30	22	TR2DM38355	38				

NOTE: robustTa 2 Thermal Overload Relay reference TR2DM32353 ~TR2DM38355 can be mounted directly on robustTa 2 Contactor without any additional fixing attachment.

How to order:

- i) Select applicable Coil Voltage required for Contactor.
- ii) Complete the code by replacing the ■ from above.
- iii) For common accessories please refer Page No. 72 & 73.
- iv) MOQ- Minimum Order Quantity

* Stock for accessories are subject to availability. ❌ Non Stockable item

Power Contactor DX-Series

Conforming IEC60947-1, IEC60947-4-1

Features:

- Suitable for Bus-Bar termination
- Single termination upto Power Contact
- Easy Coil Replacement
- Same Auxiliary blocks as Robusta
- Suitable for ring type busbar connection

Application:

- DG Panels
- Motor Feeder & Control System
- Street lighting
- VFD, Soft Starters applications
- UPS, Battery Charging
- Solar and Wind inverters

3 Pole Power Contactor
[HSN Code: 8536]

AC1 Duty A	AC3 415 V Long Life			With AC Coil		MOQ
	kW	HP	A	Reference	MRP (₹)	
85	25	34	45	TC1DX453 ■	7300	1
	26	35	50	TC1DX503 ■	9170	
100	37	50	70	TC1DX703 ■	12900	
	40	54	80	TC1DX803 ■	15720	

Add-On Block for Contactor Rating 45A-80A
[HSN Code: 8536]

Contact Configuration		Reference	MRP (₹)	MOQ	
Front Mounted	2 NO	TA1-DN20	500	20	
	1 NO+1 NC	TA1-DN11			
	2 NC	TA1-DN02			
	Front Mounted	4 NO	TA1-DN40	740	20
		3 NO+1 NC	TA1-DN31		
		2 NO+2 NC	TA1-DN22		
		1 NO+3 NC	TA1-DN13		
Side Mounted	4 NC	TA1-DN04	740	10	
	1 NO+1 NC	TA8-DN11			
	2 NO	TA8-DN20			

Spare Coil
[HSN Code: 8536]

Reference	Coil Voltage	MRP (₹)	MOQ
LX1DX45 ■	110 / 220 / 240 / 415	2300	1

Spare Contact Kit
[HSN Code: 8536]

Reference	Description	MRP (₹)	MOQ
TA5X453	45A Contact Kit, 3 Pole	4320	1
TA5X503	50A Contact Kit, 3 Pole	5170	
TA5X703	70A Contact Kit, 3 Pole	7360	
TA5X803	80A Contact Kit, 3 Pole	9720	

Mechanical Interlock Kit
[HSN Code: 8536]

Reference	Description	MRP (₹)	MOQ
LA9DX8002	Mechanical Interlock Kit for Contactor TC1DX45A-80A	2950	1

Coil Surge Suppressor for Contactor 45A-80A
[HSN Code: 8536]

Description	Voltage Ratings	Reference	MRP (₹)	MOQ
RC Circuit (AC)	110-240V AC	LA9DX980U	670	1

AC Coil Voltage Codes for Contactors 45A-80A
[HSN Code: 8536]

Contactor	Voltage			
	110	220	240	415
TC1DX45-80 50Hz	F	M	U	N

■ To specify Coil Voltage.

NOTE: Stock for accessories are subject to availability

MOQ - Minimum Order Quantity

Mini Contactors

Conforming IEC60947-1, IEC60947-4-1 & IEC60947-5-1



Control Relays - 10 Amps [HSN Code: 8536]							
Rated Current (Ith)	Contact Configuration	With AC Coil			With DC Coil		
		Reference	MRP (₹)	MOQ	Reference	MRP (₹)	MOQ
10	2NO+2NC	☒TCA2-M22	1720	10	☒TCA3-M22	2290	10
	3NO+1NC	☒TCA2-M31			☒TCA3-M31		
	4NO	☒TCA2-M40			☒TCA3-M40		
	1NO + 3NC	☒TCA2-M13			☒TCA3-M13		
	4NC	☒TCA2-M04			☒TCA3-M04		

■ Please specify Coil Voltage.

Power Contactors - 3 Pole [HSN Code: 8536]											
AC1 Duty A	AC3 415V Long Life			Auxiliary Contacts	With AC Coil			Auxiliary Contacts	With DC Coil		
	kW	HP	A		Reference	MRP (₹)	MOQ		Reference	MRP (₹)	MOQ
20	2.2	3	6	1NO -	☒TC1-M0610	1480	10	1NO -	☒TP1-M0610	2160	10
				- 1NC	☒TC1-M0601			- 1NC	☒TP1-M0601		
	4	5.5	9	1NO -	☒TC1-M0910	1600	1NO -	☒TP1-M0910	2250		
				- 1NC	☒TC1-M0901		- 1NC	☒TP1-M0901			
	5.5	7.5	12	1NO -	☒TC1-M1210	1710	1NO -	☒TP1-M1210	2470		
				- 1NC	☒TC1-M1201		- 1NC	☒TP1-M1201			
	7.5	10	16	1NO -	☒TC1-M1610	2020	1NO -	☒TP1-M1610	2730		
				- 1NC	☒TC1-M1601		- 1NC	☒TP1-M1601			

■ Please specify Coil Voltage.

Coil Voltage Codes for Mini Contactors & Control Relays					
Contactor	Voltage				
	24	48	110	220	415
AC	B	E	F	M	N
DC	BD	ED	FD	MD	-

Overload Relays for Mini Contactors - Direct Mounting [HSN Code: 8536]				
Relay Range (Amps)	Reference	MRP (₹)	MOQ	Independent Mounting Kit
0.10 - 0.16	TR2 - M0.14A	2000	1	Reference TA7-M0964 MRP (₹) 600 [HSN Code: 8538]
0.16 - 0.25	☒TR2 - M0.21A			
0.25 - 0.4	TR2 - M0.33A			
0.4 - 0.63	TR2 - M0.52A			
0.63 - 1	TR2 - M0.82A			
1 - 1.6	TR2 - M1.3A			
1.6 - 2.5	TR2 - M2.1A			
2.5 - 4	TR2 - M3.3A			
4 - 6	TR2 - M5A			
5 - 8	☒TR2 - M6.5A			
6 - 9	☒TR2 - M7.5A			
7 - 10	TR2 - M8.5A			
9 - 13	TR2 - M11A	2170		
12 - 16	☒TR2 - M14A			

☒ Non Stockable item. MOQ- Minimum Order Quantity

Accessories

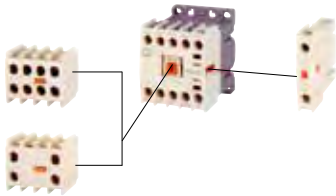

Add-On-Block		[HSN Code: 8538]		
Contact Configuration		Reference	MRP (₹)	MOQ
Front Mounted	2 NO	TA1-M20	450	10
	1 NO+1 NC	TA1-M11		
	2 NC	TA1-M02		
	4 NO	TA1-M40	730	
	3 NO+1 NC	☒ TA1-M31		
	2 NO+2 NC	TA1-M22		
	1 NO+3 NC	☒ TA1-M13		
Side Mounted	1 NC	TA8-M01	440	
	1 NO	TA8-M10		



Mechanical Interlocks for Horizontally Mounted		[HSN Code: 8538]		
Use For Contactor		Reference	MRP (₹)	MOQ
AC	DC			
TC1-MS06	TP1-MS06	☒ TA9-M978	680	1
TC1-MS09	TP1-MS09			
TC1-MS12	TP1-MS12			
TC1-MS16	TP1-MS16			



Electronic Timer					[HSN Code: 8538]
Description	Delay	Time	Voltage	Reference	MRP (₹)
Front Mounting Electronic Timer	ON Delay	0.1-30Sec	AC / DC24-48V	☒ TA2-M/ 1N	2190
	ON Delay	0.1-30Sec	AC110-220V	☒ TA2-M/ 2N	
	OFF Delay	0.1-30Sec	AC / DC24-48V	TA3-M/ 1F	
	OFF Delay	0.1-30Sec	AC110-220V	TA3-M/ 2F	

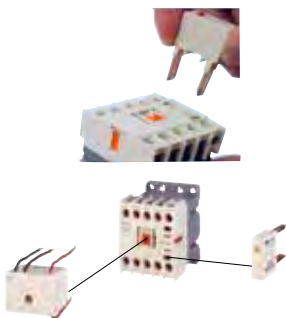

Coil Suppressor		[HSN Code: 8538]		
Description	Voltage	Reference	MRP (₹)	MOQ
Varistor	AC 24-48V	TA9-M980/1	720	10
	AC 60-127V	TA9-M980/2		
	AC 200-240V	☒ TA9-M980/3		
	DC 12-24V	TA9-M980/4		
	DC 30-72V	TA9-M980/5		
	DC 100-127 V	TA9-M980/6		
	DC 200-250 V	TA9-M980/7		

* Stock for accessories are subject to availability. ☒ Non Stockable item

Exceed Contactor

Conforming IEC60947-1, IEC60947-4-1 & IEC60947-5-1



Exceed 3 Pole Power Contactor rating 6A-95A							[HSN Code: 8536]		
Size	AC1 Duty A	AC2/AC3/AC4 415 V Long Life			Auxiliary Contacts		Reference	MRP (₹)	MOQ
		kW	HP	A					
Frame 1	25	2.2	3	6	1NO	-	TC1D0610E	1160	1
					-	1NC	TC1D0601E	1160	
		4	5.5	9	1NO	-	TC1D0910E	1320	
					-	1NC	TC1D0901E	1320	
		5.5	7.5	12	1NO	-	TC1D1210E	1440	
					-	1NC	TC1D1201E	1440	
32	9	12.5	18	1NO	-	TC1D1810E	1680		
				-	1NC	TC1D1801E	1680		
Frame 2	40	11	15	25	1NO	-	TC1D2510E	2310	
					-	1NC	TC1D2501E	2310	
	50	15	20	32	1NO	-	TC1D3210E	4920	
					-	1NC	TC1D3201E	4920	
Frame 3	60	22	30	40	1NO	1NC	TC1D4011E	6940	
					1NO	1NC	TC1D5011E	8360	
	80	37	50	65	1NO	1NC	TC1D6511E	11910	
					1NO	1NC	TC1D8011E	15160	
					1NO	1NC	TC1D9511E	18080	

Exceed 4 Pole Power Contactor rating 12A-95A				
AC1 Duty A	Auxiliary Contacts	Reference	MRP (₹)	MOQ
25	4NO	--	TC1D12004E	1620
	2NO	2NC	TC1D12008E	2050
32	4NO	--	TC1D18004E	1880
	2NO	2NC	TC1D18008E	2400
40	4NO	--	TC1D25004E	2740
	2NO	2NC	TC1D25008E	4040
60	4NO	--	TC1D40004E	7380
	2NO	2NC	TC1D40008E	11640
80	4NO	--	TC1D50004E	9320
	2NO	2NC	TC1D50008E	12560
	4NO	--	TC1D65004E	11990
	2NO	2NC	TC1D65008E	13810
125	4NO	--	TC1D80004E	15360
	2NO	2NC	TC1D80008E	18840
	4NO	--	TC1D95004E	19140
	2NO	2NC	TC1D95008E	20560



Exceed - DC 3 Pole Power Contactor rating 9A-40A									
Size	AC1 Duty A	AC3 415 V Long Life			Auxiliary Contacts		With DC Coil		MOQ
		kW	HP	A			Reference	MRP (₹)	
Frame 1	25	4	5.5	9	1NO	-	TP1D0910E	2020	1
					-	1NC	TP1D0901E	2020	
		5.5	7.5	12	1NO	-	TP1D1210E	2200	
					-	1NC	TP1D1201E	2200	
	32	9	12.5	18	1NO	-	TP1D1810E	2480	
					-	1NC	TP1D1801E	2480	
Frame 2	40	11	15	22	1NO	-	TP1D2510E	3600	
					-	1NC	TP1D2501E	3600	
	50	15	20	32	1NO	-	TP1D3210E	7330	
					-	1NC	TP1D3201E	7330	
60	18.5	25	38	1NO	-	TP1D4011E	10800		
				-	1NC	TP1D4001E	11340		
Frame 3	22	30	40	1NO	-	TP1D5011E	16150		
				-	1NC	TP1D5001E	20550		
60	22	30	40	1NO	1NC	TP1D9511E	24520		

Exceed Contactor

Conforming IEC60947-1, IEC60947-4-1 & IEC60947-5-1



Exceed Contactor 3 Pole: Rating 115 A~ 630A								[HSN Code: 8536]
AC1 Duty A	AC3 415 V Long Life			With AC Coil		With DC Coil		MOQ
	kW	HP	A	Reference	MRP (₹)	Reference	MRP (₹)	
200	59	80	115	LC1FDP115AE ■	22120	LC1FDP115AE ■	POR	5
250	80	108	150	LC1FDP150AE ■	31410	LC1FDP150AE ■		
275	100	136	185	LC1FDP185AE ■	36430	LC1FDP185AE ■		
315	110	148	225	LC1FDP225AE ■	41180	LC1FDP225AE ■		
350	140	190	265	LC1FDP265AE ■	49020	LC1FDP265AE ■		
400	180	240	330	LC1FDP330AE ■	59640	LC1FDP330AE ■		
500	220	300	400	LC1FDP400AE ■	70270	LC1FDP400AE ■		
700	280	380	500	LC1FDP500AE ■	99460	LC1FDP500AE ■		
1000	375	500	630	LC1FDP630AE ■	145480	LC1FDP630AE ■		

Exceed Contactors 4 Pole: Rating AC1 200A ~ 1000A						[HSN Code: 8536]
AC1/AC3 Duty A	Main Pole Configuration	With AC Coil		With DC Coil		MOQ
		Reference	MRP (₹)	Reference	MRP (₹)	
200	4 NO	LC1FDP1154AE ■	27230	LC1FDP1154AE ■	POR	5
250	4 NO	LC1FDP1504AE ■	34900	LC1FDP1504AE ■		
275	4 NO	LC1FDP1854AE ■	51520	LC1FDP1854AE ■		
315	4 NO	LC1FDP2254AE ■	52170	LC1FDP2254AE ■		
350	4 NO	LC1FDP2654AE ■	56800	LC1FDP2654AE ■		
400	4 NO	LC1FDP3304AE ■	67310	LC1FDP3304AE ■		
500	4 NO	LC1FDP4004AE ■	86800	LC1FDP4004AE ■		
700	4 NO	LC1FDPM5004AE ■	104160	LC1FDPM5004AE ■		
1000	4 NO	LC1FDP6304AE ■	205990	LC1FDP6304AE ■		

AC Coil Voltage for exceed contactor							[HSN Code: 8538]
Contactor	Voltage						
	110	24	235	220	240	415	
50Hz	F5	B5	C5W*	M5	U5	N5	

- NOTE:**
1. Add Suffix ■ Coil voltage to complete product code
 2. 235 V (C5W) Coil available only upto 38 Amps (AC3) Contactors.
 3. 22A, 38A & 45A current ratings also available on request. (MOQ - 50 Nos.)
 4. For add-on accessories and spare coil refer Page No. 74.



robustTa Power Contactors

Conforming IEC60947-1, IEC60947-4-1 & IEC60947-5-1



Control Relays - 10 Amps										[HSN Code: 8536]		
Rated Current(Ie) AC15 at 240V (Amps)	Contact Configuration	With AC Coil			With DC Coil							
		Reference	MRP (₹)	MOQ	Reference	MRP (₹)	MOQ					
10	2NO + 2NC	TCA2-DN22	1600	10	TCA3-DN22	2490	10					
	3NO + 1NC	TCA2-DN31			TCA3-DN31							
	4NO	TCA2-DN40			TCA3-DN40							

Power Contactors 3 Pole : Rating 9A ~ 95A										[HSN Code: 8536]				
Size	AC1 Duty A	AC3 415 V Long Life			Auxiliary Contacts		With AC Coil		MOQ	Auxiliary Contacts		With DC Coil		MOQ
		kW	HP	A			Reference	MRP (₹)				Reference	MRP (₹)	
Frame 1	25	4	5.5	9	1NO	-	TC1-D0910	1490	1	1NO	-	TP1-D0910	2330	1
					-	1NC	TC1-D0901	1490		-	1NC	TP1-D0901	2330	
		5.5	7.5	12	1NO	-	TC1-D1210	1680		1NO	-	TP1-D1210	2590	
					-	1NC	TC1-D1201	1680		-	1NC	TP1-D1201	2590	
	32	9	12.5	18	1NO	-	TC1-D1810	2040		1NO	-	TP1-D1810	2950	
					-	1NC	TC1-D1801	2040		-	1NC	TP1-D1801	2950	
		11	15	22	1NO	-	TC1-D2210	2370		1NO	-	TP1-D2210	4180	
					-	1NC	TC1-D2201	2370		-	1NC	TP1-D2201	4180	
Frame 2	40	11	15	25	1NO	-	TC1-D2510	2600	1NO	-	TP1-D2510	4340		
					-	1NC	TC1-D2501	2600	-	1NC	TP1-D2501	4340		
	50	15	20	32	1NO	-	TC1-D3210	5350	1NO	-	TP1-D3210	8410		
					-	1NC	TC1-D3201	5350	-	1NC	TP1-D3201	8410		
		18.5	25	38	1NO	-	TC1-D3810	7490	1NO	-	TP1-D3810	9730		
					-	1NC	TC1-D3801	7490	-	1NC	TP1-D3801	9730		
Frame 3	60	22	30	40	1NO	1NC	TC1-D4011	7970	1NO	1NC	TP1-D4011	11740		
					1NO	1NC	TC1-D4511	9450	1NO	1NC	TP1-D4511	13990		
	80	25	35	50	1NO	1NC	TC1-D5011	9930	1NO	1NC	TP1-D5011	14840		
					1NO	1NC	TC1-D6511	13220	1NO	1NC	TP1-D6511	15890		
	100	37	50	70	1NO	1NC	TC1-D7011	13660	1NO	1NC	TP1-D7011	18480		
					1NO	1NC	TC1-D8011	16660	1NO	1NC	TP1-D8011	19860		
	125	45	60	80	1NO	1NC	TC1-D8011	16660	1NO	1NC	TP1-D8011	19860		
					1NO	1NC	TC1-D9511	20180	1NO	1NC	TP1-D9511	25390		

* To specify Coil Voltage, please refer Page No. 72.

MOQ- Minimum Order Quantity

robustTa Power Contactors

Conforming IEC60947-1 & IEC60947-4-1



Power Contactors 3 Pole : 115~160A AC3							[HSN Code: 8536]	
AC1 Duty A	AC3 415 V Long Life			Auxiliary contacts		With AC Coil		MOQ
	kW	HP	A			Reference	MRP (₹)	
200A	55	73	115	1NO	1NC	TC1-D115116■*	23780	1
	55	73	115	1NO	1NC	TC1-D115111■*	23990	
	55	73	120	1NO	1NC	TC1-D120116■*	24490	
	55	73	120	1NO	1NC	TC1-D120111■*	24810	
	75	101	150	1NO	1NC	TC1-D150116■*	31970	
	75	101	150	1NO	1NC	TC1-D150111■*	32480	
	75	101	160	1NO	1NC	TC1-D160116■*	33150	
	75	101	160	1NO	1NC	TC1-D160111■*	33470	

Power Contactors 4 Pole: Rating AC1 200A					[HSN Code: 8536]	
AC1 Duty A	Main Pole Configuration		With AC Coil		MOQ	
			Reference	MRP (₹)		
200A	4NO	--	TC1-D115004■*	25990	1	
	4NO	--	TC1-D1150046■*	25650		
	4NO	--	TC1-D150004■*	33800		
	4NO	--	TC1-D1500046■*	33640		

* Busbar connection * Cable connection

Spare main contacts sets (115~160), 3P/4P				[HSN Code: 8538]
Contactor	Reference	MRP (₹)	MOQ	
TC1D115	TA5 D115118031	8930	1	
TC1D120	TA5 D120118031	9260		
TC1D150	TA5 D150118031	10480		
TC1D160	TA5 D160118031	11260		
TC1D115004	TA5 D115804	10970		
TC1D150004	TA5 D150804	11590		

Spare Busbar connection sets (115~160), 3P/4P			
TC1D115	TA9 D11511503	480	1
TC1D120			
TC1D150			
TC1D160			
TC1D115004	TA9 D115504	740	1
TC1D150004			

Spare Arc Chamber (top housing) for 3P Contactors (115-160)			
TC1D115	TA5 D1151150	310	1
TC1D120	TA5 D1201150		
TC1D150	TA5 D1501150		
TC1D160	TA5 D1601150		

Spare Coils (115-160), 3 Pole / 4 Pole			
AC Coil 50 Hz AC	TX1D8■B5	2500	1
	TX1D8■F5		
	TX1D8■M5		
	TX1D8■N5		

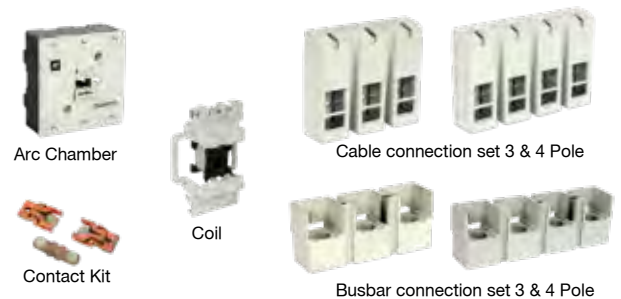

Spare Cable connection sets (115~160), 3P/4P				[HSN Code: 8538]
Contactor	Reference	MRP (₹)	MOQ	
TC1D115	TA9 D11511603	960	1	
TC1D120				
TC1D150				
TC1D160				
TC1D115004	TA9 D115604	1300	1	
TC1D150004				

AC Coil Voltage				
Contactor	Voltage			
	50Hz	F5	B5	M5

■ Non Stockable item

Note: Stock for accessories are subject to availability

robustTa Power Contactors

Conforming IEC60947-1 & IEC60947-4-1



Power Contactors with Dust Cover 3 Pole						[HSN Code: 8536]			
AC1 Duty A	AC2/AC3/AC4 Long Life			With AC Coil		MOQ	With DC Coil		MOQ
	kW	HP	A	Reference	MRP (₹)		Reference	MRP (₹)	
200	59	80	115	LC1FDP115A ■	25740	1	LC1FDP115A ■	30270	1
250	80	108	150	LC1FDP150A ■	35710		LC1FDP150A ■	43970	
275	100	136	185	LC1FDP185A ■	41900		LC1FDP185A ■	53870	
275	105	140	200	LC1FDP200A ■	45810		LC1FDP200A ■	54290	
315	110	148	225	LC1FDP225A ■	47550		LC1FDP225A ■	59220	
350	140	190	265	LC1FDP265A ■	58350		LC1FDP265A ■	63540	
350	150	200	300	LC1FDP300A ■	63580		LC1FDP300A ■	74900	
400	180	240	330	LC1FDP330A ■	70000		LC1FDP330A ■	84000	
500	220	300	400	LC1FDP400A ■	81370		LC1FDP400A ■	100650	
600	240	320	460	LC1FDP460A ■	106760		-	-	
700	280	380	500	LC1FDP500A ■	112350		LC1FDP500A ■	121640	
800	355	430	580	LC1FDP580A ■	114880		-	-	
1000	375	500	630	LC1FDP630A ■	166400		LC1FDP630A ■	186700	
1600	425	580	780	☒ LC1FDP780A ■	POR		☒ LC1FDP780A ■	-	
1000	450	610	800	☒ LC1FDP800A ■	311020		☒ LC1FDP800A ■*	319420	

- Power Contactors with dust cover 2 Pole variants available on requests
- Power Contactors with dust cover rating 115~800A are supplied factory assembled complete with No-Volt Coil and auxiliary contact block 2NO+2NC.
- *For DC supply, Bypass rectifier and connect DC supply directly to coil terminals A1-A2

Hoisting Power Contactors with dust cover 3 Pole: Rating 115A ~ 630A						[HSN Code: 8536]	
AC1 Duty A	AC3 415 V Long Life			With AC Coil		MOQ	
	kW	HP	A	Reference	MRP (₹)		
200	59	80	115	LC1FDP115HCA ■	POR	1	
250	80	110	150	LC1FDP150HCA ■			
275	100	135	185	LC1FDP185HCA ■			
315	110	150	225	LC1FDP225HCA ■			
350	140	190	265	LC1FDP265HCA ■			
355	150	200	300	LC1FDP300HCA ■			
400	180	220	330	LC1FDP330HCA ■			
500	220	300	400	LC1FDP400HCA ■			
700	280	380	500	LC1FDP500HCA ■			
1000	375	500	630	LC1FDP630HCA ■			

Minimum Order Qty. for Hoisting Power Contactors will be 10 Nos.

Power Contactors with Dust Cover 3 Pole: Rating 1260A ~ 2600A (for general use) [HSN Code: 8536]				
AC1 Duty A	Main Pole Configuration	With AC & DC Coil		MOQ
		Reference	MRP (₹)	
1260	3 NO	☒ LC1FDP1250A ■	POR	1
1400	3 NO	☒ LC1FDP1400A ■		
1700	3 NO	☒ LC1FDP1700A ■		
2100	3 NO	☒ LC1FDP2100A ■		
2600	3 NO	☒ LC1FDP2600A ■		



■ To specify Coil Voltage, please refer Page No. 72

☒ Non Stockable item. Stock for accessories are subject to availability

robusta Power Contactors

Conforming IEC60947-1 & IEC60947-4-1



Power Contactors 4 Pole : Rating AC1 25A ~ 125A						[HSN Code: 8536]			
AC1 Duty A	AC1 Duty A	Main Pole Configuration		With AC Coil		MOQ	With DC Coil		MOQ
				Reference	MRP (₹)		Reference	MRP (₹)	
Frame 1	25	4NO	--	TC1-D12004	1870	1	TP1-D12004	3660	1
		2NO	2NC	TC1-D12008	2290		TP1-D12008	4590	
Frame 2	40	4NO	--	TC1-D18004	2140		-	-	
		2NO	2NC	TC1-D25004	3160		TP1-D25004	7050	
Frame 3	60	4NO	--	TC1-D40004	8410		TP1-D40004	12590	
		2NO	2NC	TC1-D40008	12440		TP1-D40008	18750	
	80	4NO	--	TC1-D50004	10500		-	-	
		2NO	2NC	TC1-D50008	14410		-	-	
		4NO	--	TC1-D65004	13620		TP1-D65004	20100	
		2NO	2NC	TC1-D65008	15860		TP1-D65008	24360	
	100	4NO	--	TC1-D70004	14110		TP1-D70004	23150	
		4NO	--	TC1-D80004	17620		TP1-D80004	25250	
		2NO	2NC	TC1-D80008	21450	TP1-D80008	28240		
		4NO	--	TC1-D95004	21300	TP1-D95004	26900		
	125	2NO	2NC	TC1-D95008	23380	TP1-D95008	29190		

■ To specify Coil Voltage, please refer page no. 68

Power Contactors 4 Pole 4NC : Rating 9A ~ 25A						[HSN Code: 8536]	
Size	AC1 Duty A	AC2/ AC3/ AC4 415 V Long Life			With AC Coil	MRP (₹)	MOQ
		KW	HP	A	Reference		
Frame 1	25	4	5.5	9	TC1-D09006	2010	10
		5.5	7.5	12	TC1-D12006	3720	
Frame 2	40	11	15	25	TC1-D25006	4150	

■ To specify Coil Voltage, please refer page no. 70

Power Contactors with dust cover 4 Pole : Rating AC1 200A ~ 1600A						[HSN Code: 8536]	
AC1 Duty A	Main Pole Configuration	With AC Coil		MOQ	With DC Coil		MOQ
		Reference	MRP (₹)		Reference	MRP (₹)	
200	4 NO	LC1FDP1154	31000	1	LC1FDP1154	41600	1
250	4 NO	LC1FDP1504	38970		LC1FDP1504	55690	
275	4 NO	LC1FDP1854	58660		LC1FDP1854	74470	
315	4 NO	LC1FDP2254	59980		LC1FDP2254	73430	
350	4 NO	LC1FDP2654	64950		LC1FDP2654	81460	
400	4 NO	LC1FDP3304	75490		LC1FDP3304	98130	
500	4 NO	LC1FDP4004	98330		LC1FDP4004	117580	
700	4 NO	LC1FDPM5004	119110		LC1FDPM5004	141710	
1000	4 NO	LC1FDP6304	229830		LC1FDP6304	237330	
1600	4 NO	LC1FDP7804	POR		LC1FDP7804	POR	



■ To specify Coil Voltage, please refer Page No. 72

● 4 Pole Power Contactors with dust cover rating AC1 200-1600A are supplied factory assembled complete with No-Volt Coil and auxiliary contact block 2NO+2NC.

☒ Non Stockable item. MOQ- Minimum Order Quantity

Capacitor Duty Contactors 3 Pole, AC

Conforming IEC60947-1 & IEC60947-4-1



[HSN Code: 8536]

Size	kVAR Rating	Auxiliary Contacts	Reference	MRP (₹)	MOQ
Frame 1	7	1NO+1NC	<input checked="" type="checkbox"/> TC1D07K11 <input type="checkbox"/>	3010	1
		2NC	TC1D07K02 <input type="checkbox"/>	3010	
	10	1NO+1NC	<input checked="" type="checkbox"/> TC1D10K11 <input type="checkbox"/>	3270	
		2NC	TC1D10K02 <input type="checkbox"/>	3270	
	12.5	1NO+1NC	<input checked="" type="checkbox"/> TC1D12K11 <input type="checkbox"/>	3510	
		2NC	TC1D12K02 <input type="checkbox"/>	3510	
16.7	1NO+1NC	<input checked="" type="checkbox"/> TC1D16K11 <input type="checkbox"/>	4950		
	2NC	TC1D16K02 <input type="checkbox"/>	4950		
Frame 2	20	1NO+1NC	<input checked="" type="checkbox"/> TC1D20K11 <input type="checkbox"/>	5610	
		2NC	TC1D20K02 <input type="checkbox"/>	5610	
	25	1NO+1NC	<input checked="" type="checkbox"/> TC1D25K11 <input type="checkbox"/>	6250	
		2NC	TC1D25K02 <input type="checkbox"/>	6250	
Frame 3	33.3	1NO+2NC	<input checked="" type="checkbox"/> TC1D33K12 <input type="checkbox"/>	11220	
	40	1NO+2NC	<input checked="" type="checkbox"/> TC1D40K12 <input type="checkbox"/>	16760	
	50	1 NO+2NC	<input checked="" type="checkbox"/> TC1D50K12 <input type="checkbox"/>	17280	
	60	1NO+2NC	<input checked="" type="checkbox"/> TC1D60K12 <input type="checkbox"/>	19780	
	75	1NO+2NC	<input checked="" type="checkbox"/> TC1D75K12 <input type="checkbox"/>	22950	
	80	1NO+2NC	<input checked="" type="checkbox"/> TC1D80K12 <input type="checkbox"/>	24610	
	100	1NO+2NC	<input checked="" type="checkbox"/> TC1D100K12 <input type="checkbox"/>	25230	

robusta Contactors Coils [HSN Code: 8538]

AC Coil Voltage Codes for Contactors 9A-95A & Control Relays							
Contactor	Voltage						
TCA2-DN/TC1-D	24	48	110	220	235	240	415
50Hz	B5	E5	F5	M5	C5W*	U5	N5
50/60Hz	B7	E7	F7	M7	-	U7	N7

Non-Standard coil Extra MRP @ ₹ 170 per contactor
 * Available from CR-38A Contactor only.

DC Coil Voltage Codes for Contactors 9A-95A & Control Relays					
Contactor	Voltage				
TCA3-DN/TP1-D	24	48	72	110	220
Normal Coil	BD	ED	SD	FD	MD
Wide band Coil#	BW	EW	-	FW	-

Wide band Coil available in 50 Hz only
 Note: Stock for accessories are subject to availability

AC Coil Voltage robusta Capacitor Duty Contactors						
Contactor	Voltage					
TC1-D**K	24	110	220	235	240	415
50Hz	B5	F5	M5	C5W*	U5	N5
50/60Hz	B7	F7	M7	-	U7	N7

* Available upto 25kVAR only.

AC Coil Voltage Codes for Contactors 115A-780A				
Contactor	Voltage			
	110	220	240 <input checked="" type="checkbox"/>	415
LC1FDP115-225 50Hz	F5	M5	U5	N5
LC1FDP265-780 50/60Hz	F7	M7	U7	N7

Not Available for LC1FDP780

AC Coil for 4 Pole Telecom Contactor				
Contactor	Voltage			
TC1-DT**Ne	230	235	240	415
50Hz	P	C5W	M	N

All coils codes applicable for extra wide band coils.

DC Coil Voltage Codes for Contactors 115A-780A				
Contactor	Voltage			
	24#	48	110	220
LC1FDP	BD	ED	FD	MD

Not available for LCFDP630 & LC1FDP780

How to order:

- Select applicable Coil Voltage required for Contactor.
 - Complete the code by replacing the
 - To order additional Auxiliary Block, Timers and other accessories, please refer Page No. 72
- Non-Standard coil available on request, Extra MRP@ ₹ 860 each per Contactor rating 115#780A

Coil Voltage Codes for Contactor 800A			
Contactor	Voltage		
	110/127	220/240	380/400
LC1-FDP - AC	FW*	MW*	QW**
LC1-FDP-DC	FW	MW	QW

*With rectifier DRTE4U **With rectifier DRTE4S

Non Stockable item. MOQ- Minimum Order Quantity

robusta Overload Relay

Conforming IEC60947-1, IEC60947-4-1 & IEC60947-5-1

GLOBAL CERTIFICATION



Thermal Overload Relays Direct Mounting Trip class 10							[HSN Code: 8536]	
Relay Setting Range (Amps)	Standard Power Rating for 3 Ph. Motor at 415V		Reference	Suitable for Contactor Rating (Amps)	MRP (₹)	Independent Mounting Kit	MOQ	
	HP	kW						
Direct Mounting								
0.10 ~ 0.16	*	*	☒ TRD09301	9	1890	TA7-D0964 MRP ₹340 [HSN Code: 8538]	1	
0.16 ~ 0.25	*	*	☒ TR2D09302		1890			
0.25 ~ 0.40	*	*	TR2D09303		1890			
0.40 ~ 0.63	*	*	TR2D09304		1890			
0.63 ~ 1.00	0.5	0.37	TR2D09305		1890			
1.00 ~ 1.60	0.75	0.55	TR2D09306		1890			
1.25 ~ 2.00	1	0.75	TR2D093X6		1890			
1.60 ~ 2.50	1.5	1.1	TR2D09307		1890			
2.50 ~ 4.00	2	1.5	TR2D09308		1890			
4.00 ~ 6.00	3	2.2	TR2D09310		1890			
5.50 ~ 8.00	5	3.7	TR2D09312		1890			
7.00 ~ 10.0	5.5	4	TR2D09314		1890			
9.0 ~ 13.0	7.5	5.5	TR2D12316		12			1890
9.0 ~ 14.0	7.5	5.5	TR2D12316X		12			1890
12.0 ~ 18.0	12	9	TR2D18321	18	2280			
14.0 ~ 22.0	12	9	TR2D18321X	18	2280			
17.0 ~ 25.0	15	11	TR2D25322	25	2280			
23.0 ~ 32.0	20	15	TR2D32353	32	3250	TA7-D3264 MRP ₹ 440 [HSN Code: 8538]		
28.0 ~ 36.0	25	18	TR2D32355		3250			
23.0 ~ 32.0	20	15	TR2D40353	40	3530	TA7-D4064 MRP ₹ 1610 [HSN Code: 8538]		
30.0 ~ 40.0	30	22	TR2D40355		3530			
37.0 ~ 50.0	35	25	TR2D65357	50	4550			
48.0 ~ 65.0	40	30	TR2D65359	65	5850			
55.0 ~ 70.0	50	37	TR2D65361		5850			
63.0 ~ 80.0	60	45	TR2D80363	80	6460			
80.0 ~ 93.0	65	49	TR2D95365	95	6510			
Independent Mounting								
65 ~ 105	75	55	LR1F105	-	10480	-	1	
80 ~ 125	80	59	LR1F125		10480			
100 ~ 160	110	80	LR1F160		10480			
125 ~ 200	135	100	LR1F200		10480			
160 ~ 250	175	129	LR1F250		10480			
200 ~ 315	220	160	☒ LR1F315		13440			
250 ~ 400	270	200	☒ LR1F400		13440			
315 ~ 500	350	257	☒ LR1F500		13440			
400 ~ 630	480	355	☒ LR1F630		13440			
500 ~ 800	580	425	☒ LR1F800		38470			
630 ~ 1000	680	500	☒ LR1F1000		38470			

Thermal Overload Relays Protective Shroud for LR1-F105-630				[HSN Code: 8538]
Relay Type	Reference	MRP (₹)	MOQ	
LR1-F105	☒ LA9F702	2290	1	
LR1-F125		2290		
LR1-F160		2290		
LR1-F200		2290		
LR1-F250	LA9F703	3010		
LR1-F315		3010		
LR1-F400		3010		
LR1-F500		3010		
LR1-F630	LA9F704	3250		
LR1-F800		3250		

Heavy Duty Overload Relays Independent Mounting Trip class 30				[HSN Code: 8536]
Relay Setting Range (Amps)	Reference	MRP (₹)	MOQ	
2.5-4.0	TR6F4	14740	1	
4.0-6.3	TR6F6.3	14740		
6.3-10	TR6F10	14740		
8.0-12.5	TR6F12.5	14740		
10-16	TR6F16	14740		
16-25	TR6F25	14740		
25-40	☒ TR6F40	14740		
40-63	☒ TR6F63	14740		
63-100	☒ TR6F100	14740		
100-160	☒ TR6F160	14740		
125-200	☒ TR6F200	14740		
160-250	☒ TR6F250	14740		
250-400	☒ TR6F400	14740		

☒ Non Stockable item

Accessories for robusTa & Exceed Contactors

Add-On Block for Contactor Rating 9A-800A [HSN Code: 8538]					
Contact Configuration		Reference	MRP (₹)	MOQ	
Front Mounted	1 NO	TA1-DN10*	240	10	
	1 NC	TA1-DN01*			
	2 NO	TA1-DN20	500	20	
	1 NO+1 NC	TA1-DN11			
	2 NC	TA1-DN02			
	4 NO	TA1-DN40			
	Front Mounted	3 NO+1 NC	TA1-DN31	740	20
		2 NO+2 NC	TA1-DN22		
1 NO+3 NC		TA1-DN13			
4 NC		TA1-DN04			
1 NO+1 NC		TA8-DN11**	740		
2 NO	TA8-DN20**				

* Suitable for robusTa Contactor rating 25-95A only.
 * 25A-38A, 1 Nos can be fitted & for 40-95A, 2 Nos.
 ** Suitable for robusTa Contactor rating 9-95A only & can be used for TC1-D115-160A

Spare AC Coils Control Relay & Contactor 9A-95A [HSN Code: 8538]				
Use for Contactor AC	Reference	MRP (₹)	MOQ	
TCA2-DN	TX1-D2 ■	690	20	
TC1-D09				
TC1-D12				
TC1-D18				
TC1-D25	TX1-D4 ■	830	10	
TC1-D32				
TC1-D40				
TC1-D50	TX1-D6 ■	2170	10	
TC1-D63				
TC1-D80				
TC1-D95				

Spare DC Coils Control Relay & Contactor 9A-80A [HSN Code: 8538]				
Use for Contactor DC	Reference		MRP (₹)	MOQ
	Normal	Wideband		
TCA3 - DN	TX4-D2 ■	TX5-D2 ■	1110	1
TP1 - D09				
TP1 - D12				
TP1 - D18	TX4-D4 ■	TX5-D4 ■	1230	
TP1 - D25				
TP1 - D32	TX4-D40 ■	TX5-D40 ■	2860	
TP1 - D40				
TP1 - D50				
TP1 - D65	TX4-D80 ■	TX5-D80 ■	5980	
TP1 - D80				
TP1 - D95				

■ Complete the code for Spare Coil by indicating the Coil Voltage required after the reference *Please refer Page No. 70 for Coil Voltage available

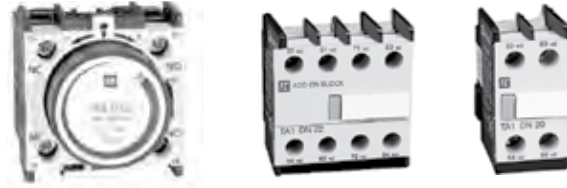

Mechanical Interlocks - Horizontal Mounted [HSN Code: 8538]				
Contact Configuration		Reference	MRP (₹)	MOQ
AC	DC			
TC1-D09	TP1-D09	LA9-D09978	660	10
TC1-D12	TP1-D12			
TC1-D18	TP1-D18			
TC1-D25	TP1-D25			
TC1-D32	TP1-D32	LA9-D50978	1610	10
TC1-D40	TP1-D40			
TC1-D50	TP1-D50			
TC1-D65	TP1-D65			
TC1-D70	TP1-D70	LA9-D80978	2110	10
TC1-D80	TP1-D80			
TC1-D95	TP1-D95			

Pneumatic Timer Block - Front Mounted [HSN Code: 8538]					
Contact Configuration		Reference	MRP (₹)	MOQ	
ON delay	1 NO+1 NC	TA2-DT0	0.1...3s	2480	
ON delay	1 NO+1 NC	TA2-DT2	0.1...30s		
ON delay	1 NO+1 NC	TA2-DT4	10...180s		
OFF delay	1 NO+1 NC	TA3-DR0	0.1...3s	10	
OFF delay	1 NO+1 NC	TA3-DR2	0.1...30s		
OFF delay	1 NO+1 NC	TA3-DR4	10...180s		
Star Delta	1 NO+1 NC	TA2-DS2	1...30s	2750	10

Coil Surge Suppressor for Contactor 9-95A [HSN Code: 8538]				
Description	Voltage Ratings	Reference	MRP (₹)	MOQ
Varistor (AC/DC) Clip-on mounting	24-48VAC/DC	TA9AMOV980E	660	10
	110-240V AC/DC	TA9AMOV980U		
	70-150V AC/DC	TA9AMOV980F		
RC Circuit (AC) Clip-on mounting	24-48V AC	TA9RC980E	660	10
	110-240V AC	TA9RC980U		
	380-440V AC	TA9RC980N		

Electrical & Mechanical Interlocks-Horizontal Mounted [HSN Code: 8538]				
Use for Contactor		Reference*	MRP (₹)	MOQ
AC	DC			
TC1-D09	TP1-D09	ELA9-D09978	780	10
TC1-D12	TP1-D12			
TC1-D18	TP1-D18			
TC1-D25	TP1-D25			
TC1-D32	TP1-D32	ELA9-D50978	1750	
TC1-D40	TP1-D40			
TC1-D50	TP1-D50			
TC1-D65	TP1-D65			
TC1-D80	TP1-D80	ELA9-D80978	2280	
TC1-D95	TP1-D95			

NOTE: Stock for accessories are subject to availability

Accessories

Spare AC Coils for Hoisting Power Contactor [HSN Code: 8538]					
Contactor	110V	220V	240V	415V	MRP (₹)
LC1-FDP115HCA	LX9FF110V	LX9FF220V	LX9FF240V	-	4700
LC1-FDP150HCA					
LC1-FDP185HCA	LX9FG110V	LX9FG220V	LX9FG240V	-	6890
LC1-FDP225HCA					
LC1-FDP265HCA	LX9FH1102V	LX9FH2202V	LX9FH2402V	-	7510
LC1-FDP330HCA					
LC1-FDP400HCA	LX9FJ925	LX9FJ931	LX9FJ932	LX9FJ936	15240
LC1-FDP500HCA	LX9FK925	LX9FK931	LX9FK932	LX9FK936	25760
LC1-FDP630HCA	LX9FL924	LX9FL930	LX9FL931	LX9FL936	26050

NOTE: The above Coil includes rectifier price. Standard Packing 1 No.

Spare AC Coils for Contactors Rating 115~800A [HSN Code: 8538]					
Contactor	110V	220V	240V	415V	MRP (₹)
LC1-FDP115A	LX1FF-110V	LX1FF-220V	LX1FF-240V	LX1FF-415V	3560
LC1-FDP150A					
LC1-FDP185A	LX1FG-110V	LX1FG-220V	LX1FG-240V	LX1FG-415V	6420
LC1-FDP200A					
LC1-FDP225A	LX1FH-1102V	LX1FH-2202V	LX1FH-2402V	LX1FH-4152V	7510
LC1-FDP265A					
LC1-FDP300A	LX1FJ-110V	LX1FJ-220V	LX1FJ-240V	LX1FJ-415V	9990
LC1-FDP330A					
LC1-FDP400A	LX1FK-110V	LX1FK-220V	LX1FK-240V	LX1FK-415V	23780
LC1-FDP500A					
LC1-FDP630A	LX1FL-110V	LX1FL-220V	LX1FL-240V	LX1FL-415V	24200
LC1-FDP780A					
LC1-FDP800A	LX4F8FW	LX4F8MW	LX4F8MW	LX4F8QW*	25380

AC Coils will be suitable for 50Hz only. *Available in 380/400V only

NOTE: The above Coil includes rectifier price. Std. Packing 1 Nos.

Mechanical Interlocks for Contactor 115A-630A Vertically/Horizontally Mounted [HSN Code: 8538]			
Contactor	Reference	MRP (₹)	MOQ
Horizontally Mounted			
LC1-FDP115A	LA9-FF970	4320	1
LC1-FDP150A			
LC1-FDP185A	LA9-FG970	4850	
LC1-FDP200A			
LC1-FDP225A	LA9-FJ970	5590	
LC1-FDP265A			
LC1-FDP300A	LA9-FH4H	6370	
LC1-FDP330A			
LC1-FDP400A	LA9-FJ4J	6370	
LC1-FDP500A / LC1-FDPM5004A			
LC1-F630A / LC1-FDP800A	LA9-FL970	5590	
Vertically Mounted			
LC1-FDP115A	LA9-FF4F	4900	1
LC1-FDP150A			
LC1-FDP185A	LA9-FG4G	5170	
LC1-FDP200A			
LC1-FDP225A	LA9-FH4H	6370	
LC1-FDP265A			
LC1-FDP300A	LA9-FJ4J	6370	
LC1-FDP330A			
LC1-FDP400A	LA9-FK4K	6370	
LC1-FDP500A/LC1-FDPM5004A			
LC1-FDP800A/LC1-F630A	LA9-FL4L	6370	
LC1-FDP780A	LA9-FX970	40650	

Note: Stock for accessories are subject to availability

Spare DC Coils for Contactors Rating 115A-800A [HSN Code: 8538]					
Contactor	110V	220V	24V	48V	MRP (₹)
LC1-FDP115A	LX4FF-110V	LX4FF-220V	LX4FF-24V	LX4FF-48V	11650
LC1-FDP150A					
LC1-FDP185A	LX4FG-110V	LX4FG-220V	LX4FG-24V	LX4FG-48V	14920
LC1-FDP225A					
LC1-FDP265A	LX4FH-110V	LX4FH-220V	LX4FH-24V	LX4FH-48V	18190
LC1-FDP330A					
LC1-FDP400A	LX4FJ-110V	LX4FJ-220V	Not Available	LX4FJ-48V	29110
LC1-FDP500A	LX4FK-110V	LX4FK-220V	Not Available	LX4FK-48V	32110
LC1-FDP630A	LX4FL-110V	LX4FL-220V	Not Available	LX4FL-48V	37610
LC1-FDP780A	•	LX4FX-220V	•	•	34600
LC1-FDP800A	LX4F8FW	LX4F8MW	-	LX4F8QW*	30950

NOTE: The above Coil includes rectifier price. Standard Packing 1 No.

•Contact Branch Office for product code. *Available in 380/400V only.

Spare Top Housing for 3P/4P robusta Contactors [HSN Code: 8538]					
For Control Relay Contactor	Reference		MRP (₹)	MOQ	
	AC	DC			
For 3 Pole					
TCA2-DN40, TCA3-DN40	TA5-DN40	TA5-DN40 DC	1290	1	
TCA2-DN31, TCA3-DN31	TA5-DN31	TA5-DN31 DC			
TCA2-DN22, TCA3-DN22	TA5-DN22	TA5-DN22 DC			
TC1-D0910, TP1-D0910	TA5-D0910	TA5-D0910 DC			
TC1-D0901, TP1-D0901	TA5-D0901	TA5-D0901 DC			
TC1-D1210, TP1-D1210	TA5-D1210	TA5-D1210 DC			
TC1-D1201, TP1-D1201	TA5-D1201	TA5-D1201 DC			
TC1-D1810, TP1-D1810	TA5-D1810	TA5-D1810 DC			1500
TC1-D1801, TP1-D1801	TA5-D1801	TA5-D1801 DC			
TC1-D2210, TP1-D2210	TA5-D2210	TA5-D2210 DC			1830
TC1-D2201, TP1-D2201	TA5-D2201	TA5-D2201 DC			
TC1-D2510, TP1-D2510	TA5-D2510	TA5-D2510 DC	1960		
TC1-D2501, TP1-D2501	TA5-D2501	TA5-D2501 DC			
TC1-D3210, TP1-D3210	TA5-D3210	TA5-D3210 DC	3580		
TC1-D3201, TP1-D3201	TA5-D3201	TA5-D3201 DC			
TC1-D3810, TP1-D3810	TA5-D3810	TA5-D3810 DC	5250		
TC1-D3801, TP1-D3801	TA5-D3801	TA5-D3801 DC			
TC1-D4011, TP1-D4011	TA5-D4011	TA5-D4011 DC	5380		
TC1-D5011, TP1-D5011	TA5-D5011	TA5-D5011 DC	6690		
TC1-D6511, TP1-D6511	TA5-D6511	TA5-D6511 DC	9200		
TC1-D7011, TP1-D7011	TA5-D7011	TA5-D6511 DC	9810		
TC1-D8011, TP1-D8011	TA5-D8011	TA5-D8011 DC	10880		
TC1-D9511, TP1-D9511	TA5-D9511	TA5-D9011 DC	12660		
For 4 Pole					
TC1-D09004, TP1-D09004	TA5-D09004	TA5-D09004DC	1630	1	
TC1-D09008, TP1-D09008	TA5-D09008	TA5-D09008DC	1790		
TC1-D12004, TP1-D12004	TA5-D12004	TA5-D12004DC	1860		
TC1-D12008, TP1-D12008	TA5-D12008	TA5-D12008DC	2010		
TC1-D25004, TP1-D25004	TA5-D25004	TA5-D25004DC	2850		
TC1-D25008, TP1-D25008	TA5-D25008	TA5-D25008DC	3310		
TC1-D40004, TP1-D40004	TA5-D40004	TA5-D40004DC	6070		
TC1-D40008, TP1-D40008	TA5-D40008	TA5-D40008DC	7770		
TC1-D65004, TP1-D65004	TA5-D65004	TA5-D65004DC	10310		
TC1-D65008, TP1-D65008	TA5-D65008	TA5-D65008DC	12080		
TC1-D80004, TP1-D80004	TA5-D80004	TA5-D80004DC	12270		

MOQ- Minimum Order Quantity

Accessories

Spare Top Housing for 3P exceed Contactors		[HSN Code: 8538]	
For Control Relay Contactor	Reference AC	MRP (₹)	MOQ
TCA2-DN40E	TA5-DN40E	1000	1
TCA2-DN31E	TA5-DN31E		
TCA2-DN22E	TA5-DN22E		
TC1D0901E	TA5-D0901E		
TC1D0910E	TA5-D0910E		
TC1D1201E	TA5-D1201E		
TC1D1210E	TA5-D1210E		
TC1D1801E	TA5-D1801E	1170	
TC1D1810E	TA5-D1810E	1410	
TC1D2501E	TA5-D2501E		
TC1D2510E	TA5-D2510E		
TC1D4011E	TA5-D4011E	3660	
TC1D5011E	TA5-D5011E	5020	
TC1D6511E	TA5-D6511E	7010	
TC1D8011E	TA5-D8011E	9220	
TC1D9511E	TA5-D9511E	10020	

Spare Main Contact for 3P Contactors Rating 115A-800A		[HSN Code: 8538]	
Contactor	Reference	MRP (₹)	MOQ
LC1-FDP115A	LA5-FF431 (F115)	12490	1
LC1-FDP150A	LA5-FF431 (F150)	17290	
LC1-FDP185A	LA5-FG431 (F185)	21710	
LC1-FDP200A	LA5-FG431 (F200)	25510	
LC1-FDP225A	LA5-FG431 (F225)	28550	
LC1-FDP265A	LA5-FH431 (F265)	30480	
LC1-FDP300A	LA5-FH431 (F300)	31820	
LC1-FDP330A	LA5-F400803 (F330)	34190	
LC1-FDP400A	LA5-F400803 (F400)	42920	
LC1-FDP500A	LA5-F500803 (F500)	56980	
LC1-FDP630A	LA5-F630803 (F630)	80920	
LC1-FDP780A	LA5F780801(F780)*	45520	
LC1-FDP800A	LA5F800803(F800)	90760	

Spare Main Contact Sets for 4P Power Contactors Rating 115A-780A		[HSN Code: 8538]	
Contactor	Reference	MRP (₹)	MOQ
LC1-FDP1154A	LA5-FF441 (F1154)	14630	1
LC1-FDP1504A	LA5-FF441 (F1504)	21780	
LC1-FDP1854A	LA5FG441(F1854)	32120	
LC1-FDP2254A	LA5FG441(F2254)	33560	
LC1-FDP2654A	LA5-FH441 (F2654)	35900	
LC1-FDP3304A	LA5-F400804 (F3304)	43430	
LC1-FDP4004A	LA5-F400804 (F4004)	49410	
LC1-FDPM5004A	LA5-F500804 (F5004)	77960	
LC1-FDP6304A	LA5-F630804 (F6304)	99840	
LC1-FDP7804A	LA5-F780801 (F780)**	44920	

Spare Arc Chamber 3P		[HSN Code: 8538]	
Contactor	Reference	MRP (₹)	MOQ
LC1-FDP115A	LA5-F11550	3610	1
LC1-FDP150A	LA5-F15050		
LC1-FDP185A	LA5-F18550	3870	
LC1-FDP200A	LA5-F20050	3930	
LC1-FDP225A	LA5-F22550	3960	
LC1-FDP265A	LA5-F26550	4320	
LC1-FDP300A	LA5-F30050	5430	
LC1-FDP330A	LA5-F33050	5840	
LC1-FDP400A	LA5-F40050	6230	
LC1-FDP500A	LA5-F50050	6950	
LC1-FDP630A	LA5-F63050	16160	
LC1-FDP780A	LA5-F780150*	POR	

Spare Arc Chamber 4P		[HSN Code: 8538]	
Contactor	Reference	MRP (₹)	MOQ
LC1-FDP1154A	LA5-F115450	3700	1
LC1-FDP1504A	LA5-F150450		
LC1-FDP1854A	LA5-F185450	5230	
LC1-FDP2254A	LA5-F225450	5460	
LC1-FDP2654A	LA5-F265450	6520	
LC1-FDP3304A	LA5-F330450	6890	
LC1-FDP4004A	LA5-F400450	8580	
LC1-FDPM5004A	LA5-F500450	9860	
LC1-FDP6304A	LA5-F630450	19720	
LC1-FDP7804A	LA5-F780150*	12520	
LC1-FDP8004A	LA5-F80050	19820	

Main Contacts set per pole includes (2 Fixed Contacts & Moving Contact, 2 Deflectors, 1 Backplate, Fixing Screws and Washers).

* Main Contacts are for one pole only. (Set of two) Order 3 Nos for 3 pole Contactors & 4 Nos for 4 pole Contactors.

** Set of Main Contacts provided is 1 set of 2 blocks for one pole.

*Coil Surge Suppressor - Contactor 115-630A [HSN Code: 8538]			
Description	Reference	MRP (₹)	MOQ
Coil Surge Suppressor for LC1FDP115-630A (3P/4P)	LA9F980(BR)*	2870	5

* Common for Exceed & Robusta Contactors.

* Only for 220V AC

Main Contacts set per pole includes (2 Fixed Contacts & Moving Contact, 2 Deflectors, 1 Backplate, Fixing Screws and Washers).

* Main Contacts are for one pole only. (Set of two) Order 3 Nos for 3 pole contactors & 4 Nos for 4 pole Contactors.

** Set of Main Contacts provided is 1 set of 2 blocks for one pole.

* Stock for accessories are subject to availability

Front Mount Add on block with IP67

Robusta TA2 contactors			[HSN Code: 8538]		
Reference Item	Pole Configuration	MRP (₹)	Reference Item	Pole Configuration	MRP (₹)
TA1DX11	11	1460	TA1DX11 N11	X11 N11	1640
TA1DX20	20	1460	TA1DX11 N20	X11 N20	1640
TA1DX02	02	1460	TA1DX11 N02	X11 N02	1650
TA1DX20 N20	X20 N20	1640	TA1DX02 N11	X02 N11	1640
TA1DX20 N11	X20 N11	1640	TA1DX02 N20	X02 N20	1640
TA1DX20 N02	X20 N02	1650	TA1DX02 N02	X02 N02	1650

**NOTE :- "X" DENOTES IP67
"N" DENOTES NORMAL CONTACTS**

FOR EXAMPLE:- TA1D(X)02(N)20

ADD ON BLOCK SERIES | IP67 | NORMAL CONTACT

NO CONTACT ('2' NC)
NC CONTACT ('0' NC)

IP [] []

The first digit shows the level of protection against solid objects

The second digit shows the level of protection against liquids

6 Complete dust protection (No ingress of dust)

7 Protected against submersion in water under defined conditions of pressure and time

7 Harmful ingress of water when immersed between a depth of 150 to 1000mm (5.9~40 In)

Compatible products

- 9A-800A Robusta & Exceed 3 Pole & 4 Pole Contactors
- 9A-90A D-Range Contactors
- 1250A to 2600A Robusta 3 Pole Contactors

Spare AC Coils for Contactors Rating 115A to 2600A					
Contactor	110V	220V	240V	415V	MRP (₹)
LC1-FDP1250A	LX1FL110V	LX1FL220V	LX1FL240V	LX1FL415V	24200
LC1-FDP1400A	LX1FK065V	LX1FK110V	LX1FK127	LX1FK220V	23780
LC1-FDP1700A					
LC1-FDP2100A					
LC1-FDP2600A	LX1FL065V	LX1FL110V	LX1FL127V	LX1FL220V	24200

* For 1400A-2600A 2 Nos required for each contactor
* For 1250A 1 Nos required for each contactor

Spare DC Coils for Contactors Rating 115A to 2600A					
Contactor	110V	220V	240V	415V	MRP (₹)
LC1-FDP1250A	LX4FL110V	LX4FL220V	-	LX4FL48V	37610
LC1-FDP1400A	LX4FK055V	LX4FK110V	-	-	32110
LC1-FDP1700A					
LC1-FDP2100A					
LC1-FDP2600A	LX4FL055V	LX4FL110V	-	-	37610

* For 1400A-2600A 2 Nos required for each contactor
* For 1250A 1 Nos required for each contactor

* Stock for accessories are subject to availability. MOQ- Minimum Order Quantity



D Range Contactors & Overload Relays

Conforming IEC60947-1, IEC60947-4-1 & IEC60947-5-1



Control Relays 10 Amps [HSN Code: 8536]			
Contact Configuration	A.C. Reference	MRP (₹)	MOQ
2NO+2NC	CA2DN1229	1580	1
3NO+1NC	CA2DN1319		
4NO	CA2DN140		

■ Please specify Coil Voltage.

Power Contactors - 3 Pole, AC [HSN Code: 8536]								
Size	AC1 Duty A	AC3 415V Long Life			Auxiliary Contacts	Reference	MRP (₹)	MOQ
		KW	HP	A				
Frame 1	25	4	5.5	9	1NO -	LC1D093	1470	1
					- 1NC	LC1D099	1470	
	25	5.5	7.5	12	1NO -	LC1D123	1650	
					- 1NC	LC1D129	1650	
	32	9	12.5	16	1NO -	LC1D173	1930	
					- 1NC	LC1D179	1930	
	32	11	15	22	1NO -	LC1D223	2230	
					- 1NC	LC1D229	2230	
Frame 2	40	11	15	25	1NO -	LC1D253	2580	
					- 1NC	LC1D259	2580	
	50	15	20	32	1NO -	LC1D323	5260	
					- 1NC	LC1D329	5260	
Frame 3	60	22	30	40	1NO 1NC	LC1D403	7710	
	80	25	35	50	1NO 1NC	LC1D503	9260	
	80	37	50	63	1NO 1NC	LC1D633	13050	
	125	45	60	80	1NO 1NC	LC1D803	16380	

☒ Non Stockable item
MOQ - Minimum Order Quantity

AC Coil Voltage Codes for D Range Contactors (Standard)						
Contactor	Voltage					
	24	48	110*	220*	240*	415*
LC1-D	B	E	F	M	U	N

* Coils also available in wide band.

* Stock for accessories are subject to availability

Thermal Overload Relays Type LR1-Direct Mounting [HSN Code: 8536]						
Relay Setting Range A	Std. Power Rating for 3 Phase Motor at 415V		Reference	MRP (₹)	Independent Mounting Kit	MOQ
	HP	KW				
0.10-0.16	*	*	☒ LR1D09301	1860	Reference LA7-D0964 MRP ₹ 320 [HSN Code: 8538]	10
0.16-0.25	*	*	☒ LR1D09302			
0.25-0.40	*	*	LR1D09303			
0.40-0.63	*	*	LR1D09304			
0.63-1.00	0.5	0.37	LR1D09305			
1.00-1.60	0.75	0.55	LR1D09306			
1.60-2.50	1.5	1.10	LR1D09307			
2.50-4.00	2.00	1.50	LR1D09308			
4.00-6.00	3.00	2.20	LR1D09310			
5.50-8.00	5.00	3.70	LR1D09312			
7.00-10.0	5.50	4.00	LR1D09314			
10.0-13.0	7.50	5.50	LR1D12316			
13.0-18.0	12.00	9.00	LR1D16321			
18.0-25.0	15.00	11.00	LR1D25322			
23.0-32.0	20.00	15.00	LR1D32353			
28.0-40.0	20.00	15.00	LR1D32355			
23.0-32.0	20.00	15.00	LR1D40353			
30.0-40.0	30.00	22.00	LR1D40355			
38.0-50.0	35.00	25.00	LR1D63357			
48.0-57.0	40.00	30.00	LR1D63359			
57.0-66.0	50.00	37.00	LR1D63361			

* There is no standard power rating for these motors. Select the overload relay in relation to the full load current.

AC Coil Voltage Codes for D Range Contactors (Non-Standard)			
Contactor	Voltage		
	42	360	380
LC1-D	D	UW	Q

For Non-Standard Coil Voltage, please add ₹ 170/- in the list price.

Thermal OLR Type LR1-Independent Mounting [HSN Code: 8536]					
Relay Setting Range A	Std. Power Rating for 3 Phase Motor at 415V		Reference	MRP (₹)	MOQ
	HP	KW			
66.0 to 80.0	60	45	LR1-D80363	6340	1

Consisting of 1 NO+1 NC make before break contacts.

Accessories



Add-on-Blocks for D Range Contactors [HSN Code: 8538]					
Contactor		Reference	MRP (₹)	MOQ	
Additional Instantaneous Aux.Contact Blocks	Front Mounted	2 NO	LA1D20	470	20
		1 NO+1 NC	LA1D11		
		2 NC	LA1D02		
		4 NO	LA1D40	700	
		3 NO+1 NC	LA1D31		
		2 NO+2 NC	LA1D22		
		1 NO+3 NC	LA1D13		
		4 NC	LA1D04		
Overlapping Aux. Contacts	Front Mounted	2 NO+2 NC	LA1D1111#	1010	10

Spare AC Coil Voltage for D Range Contactors AC (Standard) [HSN Code: 8538]			
Use for Contactor AC (Standard)	Reference	MRP (₹)	MOQ
CA2-DN1	☒ LX1-D09 ■	700	15
LC1-D09			
LC1-D12			
LC1-D17			
LC1-D25	☒ LX1-D25 ■	840	10
LC1-D32			
LC1-D40	☒ LX1-D40 ■	2080	10
LC1-D50**			
LC1-D63			
LC1-D80**			

■ Please specify Coil Voltage by indicating the Coil Voltage required.

** Spare Moulded Base for these Coils has Product code LA7-D40 and unit price is ₹210

D Range Mechanical Interlocks Horizontally Mounted [HSN Code: 8538]			
Use for Contactor AC	Reference	MRP (₹)	MOQ
LC1-D09	LA9-D09978	660	10
LC1-D12			
LC1-D17			
LC1-D22			
LC1-D25			
LC1-D32			
LC1-D40	LA9-D50978	1610	10
LC1-D50			
LC1-D63			
LC1-D80	LA9-D80978	2110	10

Spare Top Housing 3P [HSN Code: 8538]			
For Control Relay/Contactor AC	Reference	MRP (₹)	MOQ
CA2-DN140	LA5-DN140	1220	1
CA2-DN1319	LA5-DN1319		
CA2-DN1229	LA5-DN1229		
LC1-D093	☒ LA5-D093		
LC1-D099	LA5-D099		
LC1-D123	☒ LA5-D123	1390	1
LC1-D129	LA5-D129		
LC1-D173	LA5-D173	1500	1
LC1-D179	☒ LA5-D179		
LC1-D223	LA5-D223	1970	1
LC1-D229	LA5-D229		
LC1-D253	☒ LA5-D253		
LC1-D259	☒ LA5-D259	3920	1
LC1-D323	☒ LA5-D323		
LC1-D329	LA5-D329	6080	1
LC1-D403	☒ LA5-D403		
LC1-D503	☒ LA5-D503	7460	1
LC1-D633	LA5-D633	9610	1
LC1-D803	LA5-D803	12540	1

Coil Suppressor [HSN Code: 8538]			
Description	Reference	MRP (₹)	MOQ
For mounting across coil of contactor upto 80Amp, with C network suitable for <250V AC & <400V AC	LA9-D09980	700	10

* Stock for accessories are subject to availability

Accessories



Add-on Starting Switch		[HSN Code: 8538]	
Description	Reference	MRP (₹)	MOQ
NO starting Switch suitable for direct mounting on Control Relays & Contactors	LA9-D09906	230	10



Mechanical Latching Blocks		[HSN Code: 8538]	
Description for Contractors / Control Relays Type	Reference	MRP (₹)	MOQ
CA2-DN1 LC1-D09, LC1-D12 LC1-D17, LC1-D25, LC1-D32	LA6-DK01	2850	10

■ Replace by voltage code

AC Coil Voltage Codes (Standard)								
For Mechanical Latching Block	Voltage							
	24	48	72	110	220	240	380	415/440
LA6-DK01	B	E	EN	F	M	U	Q	N

* Stock for accessories are subject to availability

Contactors - 2 Pole & 4 Pole, AC

Conforming IEC60947-1, IEC60947-4-1



Contactors - 4 Pole, AC					[HSN Code: 8536]	
AC3, 415V			Main Poles Configuration	Reference	MRP (₹)	MOQ
kW	HP	A				
7.5	10	20	4NO	TC1DX204	3860	1
11	15	25	4NO	TC1DX254	5670	
22	30	40	4NO	TC1DX404	9220	

■ Please specify Coil Voltage.

AC Coil Voltage Codes (Standard) for 4 Pole Contactors				
Contactor 4P	Voltage			
	110	220	190~400	250~450
TC1-DX204/254	F	M	Q	N

Spare Coil for 4 Pole Contactors				[HSN Code: 8538]
Reference	Coil Voltage	MRP (₹)	MOQ	
TX1D20	110/220/190~400/250~450	670	1	

Spare Contact Kit for 4 Pole Contactor				[HSN Code: 8538]
Reference	Description	MRP (₹)	MOQ	
TA5DX204	20A Contact Kit, 4-Pole	1270	1	
TA5DX254	25A Contact Kit, 4-Pole	2190		
TA5DX404	40A Contact Kit, 4-Pole	3550		

Add-on-Blocks for 4 Pole Contactors					[HSN Code: 8538]
Description	Contact Configuration	Reference	MRP (₹)	MOQ	
Front mounted Aux. contact Block	1 NO+1 NC	TA1-DN11A	510	2	

Note : Also available with 2NC.

Mechanical Interlock for 4 Pole Contactors				[HSN Code: 8538]
Description	Reference	MRP (₹)	MOQ	
Horizontal Mounted	LA9-D09978	620	10	

Contactors - 2 Pole, AC					[HSN Code: 8536]
AC1 Duty	AC3 220V AC		Reference	MRP (₹)	MOQ
	A				
32	20		AC2-D202	1520	2
40	25		AC2-D252	2080	
40	40		AC2-D402	2840	

AC Coil Voltage Codes (Standard) for 2 Pole Contactors			
Contactor 2P	Voltage		
	220*	220/240*	380 / 415*
AC2-D2/D3/D4	M5W	MU	QN

* Wide band Coils ■ Please specify Coil Voltage.

Spare Coil for 2 Pole Contactors				[HSN Code: 8538]
Reference	Coil Voltage	MRP (₹)	MOQ	
AX1D2 MU	220/240V, 50Hz	450	5	
AX1D2 M	220V, 50Hz			
AX1D2 QN	380/415V, 50Hz			
AX1D2 N	415V, 50Hz			

Spare Contact Kit for 2 Pole Contactor				[HSN Code: 8538]
Reference	Description	MRP (₹)	MOQ	
AC5D202	20A Contact Kit, 2-Pole	680	1	
AC5D252	25A Contact Kit, 2-Pole	1350		
AC5D402	40A Contact Kit, 2-Pole	1650		
☒ AC5D2011	20A Contact Kit, 1NO+1NC	700		

Add-on-Blocks for 2 Pole Contactors					[HSN Code: 8538]
Description	Contact Configuration	Reference	MRP (₹)	MOQ	
Front mounted Aux. contact Block	2 NO 1 NO+1 NC 2 NC	LA1-D20A	480	20	
		LA1-D11A			
		☒ LA1-D02A			

Thermal OLR 2 Pole type LR7D-Direct Mounting					[HSN Code: 8536]
Relay Setting Range (A)	Reference	MRP (₹)	Independent Mounting Kit	MOQ	
4.0-6.0	LR7D09210	730	LA7D0964 MRP ₹300 [HSN Code: 8538]	1	
5.5-8.0	LR7D09212				
7.0-10	LR7D09214				
9.0-14	LR7D12216X	880			
13-18	LR7D16221				
14-22	LR7D16221X				
18-25	LR7D25222	1070			
23-32	LR7D32253				

☒ Non Stockable item

New Agro 4 Pole Contactor Series

Available in 2 Unique flexible models:

- Front opening model

- Rear opening model

- Front mounted Add-on block option.
- Easy field replaceable fixed / moving contact Easy maintenance
- Wide band encapsulated magnet coil. Easy replacement
- Common spare kits, coils, accessories in both models
- Flexible design permits change in coil and contacts locally
- Contactor conforming to IEC 60947-4-1
- Thick inter-phase molding walls with liberal clearance & creepage minimizes phase shorting risk



New Agro Contactors - Front Opening					[HSN Code: 8536]	
AC1 Duty	AC3 415V Long life			Reference	MRP (₹)	
A	KW	HP	A			
25	7.5	10	16	TC1DXN164*	3070	
32	9	12.5	20	TC1DXN204*	3710	
40	11	15	25	TC1DXN254*	5450	
45	15	20	32	TC1DXN324*	6860	
50	18.5	25	40	TC1DXN404*	8690	

New Agro Contactors - Rear Opening					[HSN Code: 8536]	
AC1 Duty	AC3 415V Long life			Reference	MRP (₹)	
A	KW	HP	A			
25	7.5	10	16	TC1DXRN164*	3140	
32	9	12.5	20	TC1DXRN204*	3790	
40	11	15	25	TC1DXRN254*	5560	
45	15	20	32	TC1DXRN324*	7000	
50	18.5	25	40	TC1DXRN404*	8860	

Spare Contact Kit Codes		
Combination	Reference	MRP (₹)
16A CONTACT KIT, 4 - POLE	TA5DXN164	1180
20A CONTACT KIT, 4 - POLE	TA5DXN204	1190
25A CONTACT KIT, 4 - POLE	TA5DXN254	POR
32A CONTACT KIT, 4 - POLE	TA5DXN324	
40A CONTACT KIT, 4 - POLE	TA5DXN404	3040

C&S Standard Coil Voltages		
* Coil Code	Coil Voltage	Common for both Front & Rear opening
B	24V, 50 Hz	
E	48V, 50 Hz	
F	110V, 50 Hz	
MU	220/240V, 50 Hz	
QN	380/415V, 50 Hz	

Spare Coil Codes		
* Coil Code	Coil Voltage	MRP (₹)
TX1DN30N	415V 50Hz	640
TX1DN30Q	380V 50Hz	
TX1DN30QN	380/415V 50Hz	
TX1DN30M	220V 50Hz	
TX1DN30MU	220/240V 50Hz	
TX1DN30F	110V 50Hz	
TX1DN30E	48V 50Hz	
TX1DN30B	24V 50Hz	

Auxiliary Block		
Combination	Reference	MRP (₹)
1NO + 1NC	TA1DXN11	500
2NO	TA1DXN20	
2NC	TA1DXN02	

- Stock for accessories are subject to availability

* Indicates Coil Code

☒ Non Stockable item

MOQ- Minimum Order Quantity

Definite Purpose Contactor

Conforming IEC60947-1, IEC60947-4-1

GLOBAL CERTIFICATION



Contactor				[HSN Code: 8536]
FLA	Resistive AMP Rating	Reference	MRP (₹)	MOQ
Single Pole (Without Shunt)				
25	30	TCDP251	1060	1
30	40	TCDP301	1120	
40	50	TCDP401	1180	
Single Pole (With Shunt)				
25	30	TCDP251S	1100	1
30	40	TCDP301S	1160	
40	50	TCDP401S	1270	
Two Pole				
20	30	TCDP202	1210	1
30	40	TCDP302	1220	
40	50	TCDP402	1300	
Three Pole				
20	30	TCDP203	1440	1
30	40	TCDP303	1480	
40	50	TCDP403	1680	

AC Coil Voltage Codes for Definite Purpose Contactors

Voltage	24VAC	110VAC	240VAC
50Hz	B5	G5	U5
60Hz	B6	G6	U6

DT-Series 4 Pole Rating AC1 25A-63A

[HSN Code: 8536]

AC1 Duty A	Main Pole Configuration	With AC Coil		MOQ
		Reference	MRP (₹)	
25	4 NO	TC1DT254Ne	POR	1
32	4 NO	TC1DT324Ne		
32	2 NO+2 NC	TC1DT328Ne		
40	4 NO	TC1DT404Ne		
50	4 NO	TC1DT504Ne		
45	4 NO	TC1DT45004E		
45	2 NO+2 NC	TC1DT45008E		
50	4 NO	TC1DT50004E		
50	2 NO+2 NC	TC1DT50008E		
63	4 NO	TC1DT63004E		
63	2 NO+2 NC	TC1DT63008E		

☒ Non Stockable item

* Stock for accessories are subject to availability

MOQ- Minimum Order Quantity

Industrial Plugs & Sockets



IEC 60309 Series
IP44 & IP67 Protection

BENEFITS

- Safety through interchangeability
- High grade thermo plastic material assures:
 - Exceptional high impact resistance
 - High thermal stability
 - High insulated Quality
 - Good resistance to various chemicals
- Colour codes for easy identification of Plug & Sockets
- Locking device prevent unintended withdrawal



Control & Signalling Devices

Metallic & Polycarbonate Series



Push Buttons & Pilot Lamps

- Ø22.5 mm Push Buttons, Emergency Stop PB, Selector switch
Illuminated & Non Illuminated Actuators in Plastic & Metallic variants
- Pilot Lamps in LED / Filament / Neon types
- Push Button Stations 1/2/3/4 ways, IP65 / 166, NEMA-41/X protection
- High Mechanical and Electrical life
- Aesthetic and Elegant outlook
- Wide Range of colors | voltages available

Globally accepted

IEC 60309 Series

[HSN Code: 8536]

IP 44 & IP 67 Versions	Description	Rating (Amp)	Protection Degree	3 PIN, 2P+E 240V AC			4 PIN, 3P+E 415V AC			5 PIN, 3P+N+E 415V AC		
				Code	MRP (₹)	Reference h	Code	MRP (₹)	Reference h	Code	MRP (₹)	Reference h
	Panel Mounting Socket - Splash Proof	16	IP 44	CS62205	620	6	-	-	-	CS62210	1030	6
		32		CS62216	1060	6	-	-	-	CS62221	1190	6
	Panel Mounting Socket - Water Tight	16	IP 67	CS62227	1330	6	-	-	-	CS62232	1410	6
		32		CS62238	1430	6	-	-	-	CS62243	1870	6
		63		☒CS63249	5250	6	-	-	-	CS63254	4820	6
		125		-	n	-	-	-	CS62262	18070	6	
	Surface Mounting Socket - Splash Proof	16	IP 44	CS62404	1020	6	-	-	-	CS62409	1110	6
		32		CS62415	1260	6	-	-	-	CS62420	1340	6
	Surface Mounting Socket - Water Tight	16	IP 67	CS62426	1720	6	-	-	-	☒CS62431	2250	6
		32		☒CS62437	2150	6	☒CS62283	2410	3	CS62442	2590	6
		63		☒CS63448	6630	6	-	-	-	CS63453	6790	6
		125		-	n	-	-	-	☒CS63463	23400	6	
	Plugs - Splash Proof	16	IP 44	CS60004	530	6	-	-	-	CS60009	710	6
		32		CS60015	850	6	-	-	-	CS60020	1030	6
	Plugs - Water Tight	16	IP 67	CS60026	1140	6	-	-	-	CS60031	1500	6
		32		CS60037	1770	6	CS60145	1800	3	CS60042	1840	6
		63		☒CS61048	4990	6	-	-	-	CS61053	5160	6
		125		-	n	-	-	-	CS60061	15330	6	
	Surface Mounting Interlocked Switched Socket Outlet - Horizontal	16	IP 44	CS66004(H)	8090	6	-	-	-	☒CS66109(H)	10320	6
		32		☒CS66015(H)	9630	6	-	-	-	☒CS66020(H)	11530	6
	Surface Mounting Interlocked Switched Socket Outlet - Vertical	16	IP 67	CS66200	8870	6	-	-	-	☒CS66202	12560	6
		32		☒CS66201	12390	6	-	-	-	☒CS66203	14980	6
	Connector - Splash Proof	16	IP 44	CS62004	780	6	-	-	-	☒CS66215	890	-
		32		CS62015	980	6	-	-	-	CS66225	1250	-
	Connector Water Tight	32	IP 67	-	-	-	CS62128	2410	3	-	-	

Note: Plugs & Sockets 3 PIN, 2P+E 240V AC are in Blue color, 5 PIN, 3P+N+E 415V AC are in Red color

[HSN Code: 8536]

AC Distribution Box with Socket	Description	Rating (Amp)	Protection Degree	Code	MRP (₹)	Reference h
	AC Distribution Box (Includes Socket & Plug)	16A 3P 240V	IP 40	CS60045	1950	6
		32A 3P 240V		CS60046	2410	6
		32A 5P 415V		CS60047	3620	6
		63A 5P 415V		CS60048	9420	6

☒ Non Stockable item

* Stock for accessories are subject to availability

MOQ- Minimum Order Quantity

Push Buttons: 22.5mm
Without Contact Elements

Push Button Actuators with Carrier-Non-Illuminated [HSN Code: 8536]				
Description	Reference	MRP (₹)	MOQ	Product Picture
Push Spring Return Push Button	RCP2-BA1○	110	20	
	☒RCP2-BA2●			
	RCP2-BA3●			
	RCP2-BA4●			
	RCP2-BA5●			
	☒RCP2-BA6●			
Flush Spring Return Push Button with contact	☒RCP2BA33●	260	10	
	RCP2BA35●			
Projecting Push Button	RCP2-BL1○	110	20	
	RCP2-BL2●			
	RCP2-BL3●			
	RCP2-BL4●			
	RCP2-BL5●			
	RCP2-BL6●			
Mushroom Head Push Button, Spring Return	RCP2-BC2●	160	8	
	RCP2-BC3●			
	☒RCP2-BC4●			
	RCP2-BC5●			
	RCP2-BC6●			
Mushroom Head Push Button, Spring Return with contact	RCP2-BC21●	240	8	
	RCP2-BC31●			
	☒RCP2-BC42●			
	RCP2-BC51●			
	RCP2-BC61●			
Mushroom Head ∅40mm Push Button Stay Put turn to release	RCP2BS54●	220	8	
Mushroom Head ∅40mm Push to Stay Pull to release	RCP2BT4●			
Mushroom Head ∅60mm Push Button Stay Put turn to release	RCP2BS64●	320	5	
Mushroom Head Push Button, Push to Stay & Key to release	RCP2BS14●	440	8	
Push Button Stay Put ∅30mm (Press to Lock turn to release)	RCP2BS44●	210	10	

Push Button Actuators with Carrier & Contact Element-Non-Illuminated [HSN Code: 8536]				
Description	Reference	MRP (₹)	MOQ	Product Picture
Flush Spring Return Push Button with 1NO Block	☒RCP2-BA11○	175	10	
	☒RCP2-BA21●			
	RCP2-BA31●			
	RCP2-BA51●			
	RCP2-BA61●			
	RCP2-BA41●			
Push Button with 1NC Block	RCP2-BA42●			
Projecting Head Push Button with 1NO Block	RCP2-BL11○	175	10	
	RCP2-BL21●			
	☒RCP2-BL31●			
	RCP2-BL51●			
	RCP2-BL61●			
Projecting PB with 1NC Block	☒RCP2-BL42●			

PB Actuators-Illuminated Flush w/o Series Resistor [HSN Code: 8536]				
Description	Reference	MRP (₹)	MOQ	Product Picture
Illuminated Actuator, Flush (With BA9 Filament Bulb) 12V, 24V, 48V, 110V AC / DC	RCP2-BW316▲○	260	10	
	RCP2-BW336▲●			
	RCP2-BW346▲●			
	RCP2-BW356▲●			
	RCP2-BW366▲●			
	RCP2-BW376▲○			
Illuminated Actuator, Flush (With BA9 Neon Bulb) 220V, 380V, 415V AC / DC	RCP2-BWN336▲○			
	RCP2-BWN346▲●			
	RCP2-BWN356▲●			

Push Button Actuators - Illuminated Flush with Series Resistor [HSN Code: 8536]				
Description	Reference	MRP (₹)	MOQ	Product Picture
Illuminated Actuator, Flush (with BA9S Filament Bulb, 130V) 220V AC/DC	RCP2-BW317▲○	280	10	
	☒RCP2-BW337▲●			
	☒RCP2-BW347▲●			
	RCP2-BW357▲●			
	RCP2-BW367▲●			
	RCP2-BW377▲○			
	RCP2-BW387▲●			

LED Type Push Button Actuators - Illuminated Flush				
Description	Reference	MRP (₹)	MOQ	Product Picture
Flush Illuminated with Integral Circuit LED 48V, 24V & 12V (AC/DC) also available in 110V AC, 110V DC, 240V AC, 220DC	RCP2-BWL317▲○	320	10	
	RCP2-BWL337▲●			
	☒RCP2-BWL347▲●			
	☒RCP2-BWL357▲●			
	☒RCP2-BWL377▲○			
	RCP2-BWL387▲●			
	RCP2-BWL367▲●			
	RCP2-BWL367▲●	570		

Push Button Actuator-Illuminated Projecting without Series Resistor				
Description	Reference	MRP (₹)	MOQ	Product Picture
Illuminated Actuator, Flush (with BA9 filament bulb) 48V, 24V & 12V (AC/DC) also available in 110V AC, 110V DC, 240V AC, 220DC	RCP2-BW116▲○	250	10	
	RCP2-BW136▲●			
	RCP2-BW146▲●			
	RCP2-BW156▲●			
	RCP2-BW186▲●			
	RCP2-BW166▲●			
Illuminated Actuator, Flush (With BA9 Neon Bulb) 220V, 380V, 415V (AC/DC)	RCP2-BW176▲○	POR		
	RCP2-BWN136▲●			
	RCP2-BWN146▲●			
	RCP2-BWN156▲●			
	RCP2-BWN186▲●			



Push Button Actuator-Illuminated projecting without Series Resistor				
Description	Reference	MRP (₹)	MOQ	Product Picture
Illuminated Actuator, Projecting (with BA9S Filament Bulb, 130V) 220V (AC/DC)	RCP2-BW117▲○	260	10	
	RCP2-BW137▲●			
	RCP2-BW147▲●			
	RCP2-BW157▲●			
	RCP2-BW187▲●			
	RCP2-BW167▲●			
	RCP2-BW177▲○			





LED Type Push Button Actuators - Illuminated Projecting Type of voltage AC/DC to be specified				
Description	Reference	MRP (₹)	MOQ	Product Picture
Projecting Illuminated Actuator, with integral LED, suitable for operating 48V, 24V & 12V (AC/DC) also available in 110V AC, 110V DC, 240V AC, 220DC	RCP2-BWL117▲○	320	10	
	☒RCP2-BWL137▲●			
	☒RCP2-BWL147▲●			
	RCP2-BWL157▲●			
	RCP2-BWL177▲○			
	RCP2-BWL187▲●			
	RCP2-BWL167▲●			
	RCP2-BWL167▲●	580		

Colour Code for Actuator / Lens

Colour Code	1	2	3	4	5	6	7	8
Colour of Actuator	White ○	Black ●	Green ●	Red ●	Yellow ●	Blue ●	-	-
Colour of Lens	White ○	-	Green ●	Red ●	Amber ●	Blue ●	Clear ○	Yellow ●

Push Buttons: 22.5mm Without Contact Elements

Selector Switch Actuators with Carrier		[HSN Code: 8536]		
Description	Reference	MRP (₹)	MOQ	Product Picture
2-Position Selector Switch (stay put)	RCP2-BD2	310	10	
3-Position Selector Switch, centre 'OFF' (stay put)	RCP2-BD3			
2-Position Selector Switch with extra long knob (stay put)	☒ RCP2-BJ2	310	10	
3-Position Selector Switch, with extra long knob centre 'OFF' (stay put)	RCP2-BJ3			
3-Position Selector Switch (Spring Return)	RCP2-BDR3	330	10	
3-Position Selector Switch extra long knob (Spring Return)	☒ RCP2-BJR3	330	10	
Selector Switch Actuators with Carrier & Contact Element				
2-Position Selector Switch (stay put) with 1NO Block	☒ RCP2-BD21	360	10	
2-Position Selector Switch, centre 'OFF' (stay put) with NO+NC Block	RCP2-BD25	440		
3-Position Selector Switch, centre 'OFF' (stay put) with NO+NC Block	RCP2-BD35			
Key Actuators with Carrier				
2-Position Key Switch, Key removable in unactuated position	☒ RCP2-BG2	445	10	
2-Position Key Switch, Key removable in both position	☒ RCP2-BG4			
2-Position Key Switch, Key removable in 'Right Hand' position	RCP2-BG02			
3-Position Key Switch, Key removable in centre 'OFF' position	☒ RCP2-BG3	460	10	
3-Position Key Switch, Key removable in all position	RCP2-BG0			
3-Position Key Switch, Key removable in 'Left Hand & Right Hand' position	RCP2-BG5			
3-Position Key Switch, Key removable in 'Left Hand' position	☒ RCP2-BG9			
3-Position Key Switch, Key removable in 'Right Hand' position	RCP2-BG7			
Push Buttons Extended Range				
Reset Extended Actuator Pushbutton - Round Type	☒ RCB2AL8R	100	24	
Reset Extended Actuator Pushbutton - Hex Type	☒ RCB2AL8H			
Plastic Adopter for 30 mm hole to 22.5 mm.	☒ RP2-BZ41M	30	30	
Metal Adopter for 30 mm hole to 22.5 mm	☒ RB2-BZ41M			
Recess (Guarded) Push button - Plastic	RP2-BA16 ○	90	20	
	RP2-BA26 ●			
	☒ RP2-BA36 ●			
	☒ RP2-BA46 ●			
	RP2-BA56 ●			
	RP2-BA66 ●			

Push Buttons Extended Range		[HSN Code: 8536]		
Description	Reference	MRP (₹)	MOQ	Product Picture
Intermittent Sounding Flashing Buzzer 15 ~ 20 mA, sound level 80 dB.24V, 48V, 110V AC/DC 240V AC (* Add Voltage code)	☒ RB2-KS* ●	340	15	
Pilot Lamps with Series Resistor				
Pilot Lamp (with BA9S Filament Bulb 130V) 220V AC / DC	RCP2-BV71▲○	225	10	
	RCP2-BV73▲●			
	RCP2-BV74▲●			
	RCP2-BV75▲●			
	RCP2-BV76▲●			
RCP2-BV77▲○				
Pilot Lamps with Series Resistor & Diode				
Pilot Lamp (with BA9S Filament Bulb 130V) 110V AC, 220V DC,	RCP2 BVD71▲○	245	10	
	RCP2-BVD73▲●			
	☒ RCP2-BVD74▲●			
	☒ RCP2-BVD75▲●			
	☒ RCP2-BVD76▲●			
RCP2-BVD77▲○				
LED Type Pilot Lamp Type of voltage AC / DC to be specified				
Pilot Light with integral circuit LED 48V, 24V & 12V (AC/DC) also available in 110V AC, 110V DC, 240V AC, 220DC	☒ RCP2-BVL73▲●	295	10	
	☒ RCP2-BVL74▲●			
	☒ RCP2-BVL75▲●			
	RCP2-BVL77▲○			
	RCP2-BVL71▲○			
	☒ RCP2-BVL78▲●			
☒ RCP2-BVL76▲●	530			

How to Order:

Actuators, Contact Elements, Lens Assemblies can also be ordered separately or in combination, as required.

▲ Add Voltage Code

☒ Non Stockable item

NOTE: For contact elements NO/NC please refer page no. 87.

Push Buttons: 22.5mm

Metallic Range (Without Contact Elements)

GLOBAL CERTIFICATION



Push Button Actuators with Carrier-Non-Illuminated [HSN Code: 8536]				
Description	Reference	MRP (₹)	MOQ	Product Picture
Flush Spring Return Push Button	RCB2-BA1 ○	120		
	RCB2-BA2 ●			
	RCB2-BA3 ●			
	RCB2-BA4 ●			
	RCB2-BA5 ●			
	RCB2-BA6 ●			
Projecting Push Button	RCB2-BL1 ○	125	20	
	RCB2-BL2 ●			
	RCB2-BL3 ●			
	RCB2-BL4 ●			
	RCB2-BL5 ●			
	RCB2-BL6 ●			
Booted Push Button	RCB2-BP2 ●	185		
	RCB2-BP3 ●			
	RCB2-BP4 ●			
	RCB2-BP5 ●			
	RCB2-BP6 ●			
	RCB2-BC2 ●			
Mushroom Head Push Button, Spring Return	RCB2-BC3 ●	185	8	
	RCB2-BC4 ●			
	RCB2-BC5 ●			
	RCB2-BC6 ●			
Mushroom Head Push Button Stay Put (press to lock, turn to release)	RCB2-BS54 ●	260	8	
	RCB2-BS64 ●	320	5	
Mushroom Head Push Button, Push to Stay & Pull to release	RCB2-BT4 ●	290	8	
Mushroom Head Push Button, premarked Pull to Reset	RCB2-BT43 ●			
Mushroom Head Key Switch, StayPut, Key removable in both positions (press to lock and key to release)	RCB2-BS14 ●	500	8	
Push Button Stay Put (press to lock, turn to release)	RCB2-BS44 ●	250	10	
Push Button Actuators with Carrier & Contact Element-Non-Illuminated [HSN Code: 8536]				
Flush Spring Return Push Button with 1NO Block	RCB2-BA11 ○	220	10	
	RCB2-BA21 ●			
	RCB2-BA31 ●			
	RCB2-BA51 ●			
	RCB2-BA61 ●			
	RCB2-BA41 ●			
Push Button with 1NC Block	RCB2-BA42 ●	305		
Push Button with 2NO Block	RCB2-BA33 ●			
Projecting Head Push Button with 1NO Block	RCB2-BL11 ○	220	10	
	RCB2-BL21 ●			
	RCB2-BL31 ●			
	RCB2-BL51 ●			
Projecting PB with 1NC Block	RCB2-BL42 ●	340	8	
Mushroom Head Push Button Stay Put (press to lock, turn to release) with 1NC Block	RCB2-BS642 ●			
Mushroom Head Actuators - Illuminated [HSN Code: 8536]				
Mushroom head push button illuminated (with BA9S Filament Bulb, 130V) 220V AC/DC -2 Position Momentary	RCB2-BW437 ●	620	8	
	RCB2-BW447 ●			
	RCB2-BW637 ●	680		
	RCB2-BW647 ●			

Push Button Actuators-Illuminated Flush without Series Resistor [HSN Code: 8536]				
Description	Reference	MRP (₹)	MOQ	Product Picture
Illuminated Actuator, Flush (with BA9S Filament Bulb) 12V, 24V, 48V, 110V AC/DC	RCB2-BW316 ▲○	285	10	
	RCB2-BW336 ▲●			
	RCB2-BW346 ▲●			
	RCB2-BW356 ▲●			
	RCB2-BW366 ▲●			
	RCB2-BW376s ▲○			
Illuminated Actuator, Flush (with BA9S Neon Bulb) 220V, 380V, 415V AC/DC	RCB2-BWN336 ▲●	285		
	RCB2-BWN346 ▲●			
	RCB2-BWN356 ▲●			
Push Button Actuators-Illuminated Flush with Series Resistor				
Illuminated Actuator, Flush (with BA9S Filament Bulb, 130V) 220V AC/DC	RCB2-BW317 ▲○	300	10	
	RCB2-BW337 ▲●			
	RCB2-BW347 ▲●			
	RCB2-BW357 ▲●			
	RCB2-BW387 ▲●			
	RCB2-BW367 ▲●			
LED Type Push Button Actuators - Illuminated Flush	RCB2-BWL337 ▲●	360	10	
	RCB2-BWL347 ▲●			
	RCB2-BWL357 ▲●			
	RCB2-BWL317 ▲○			
	RCB2-BWL377 ▲●			
	RCB2-BWL387 ▲●			
Push Button Actuators-Illuminated Projecting without Series Resistor	RCB2-BW116 ▲○	260	10	
	RCB2-BW136 ▲●			
	RCB2-BW146 ▲●			
	RCB2-BW156 ▲●			
	RCB2-BW166 ▲●			
	RCB2-BW176 ▲○			
Illuminated Actuator, Projecting (with BA9S Neon Bulb) 220V, 380V, 415V AC/DC	RCB2-BWN136 ▲●	257		
	RCB2-BWN146 ▲●			
	RCB2-BWN156 ▲●			
Push Button Actuators - Illuminated Projecting with Series Resistor				
Illuminated Actuator, Projecting (with BA9S Filament Bulb, 130V) 220VAC/DC	RCB2-BW117 ▲○	260	10	
	RCB2-BW137 ▲●			
	RCB2-BW147 ▲●			
	RCB2-BW157 ▲●			
	RCB2-BW167 ▲●			
	RCB2-BW177 ▲○			
LED Type Push Button Actuators - Illuminated Projecting Type of voltage AC/DC to be specified				
Projecting Illuminated Actuator, with integral circuit LED 48V, 24V & 12V (AC/DC) also available in 110V AC, 110V DC, 240V AC, 220DC	RCB2-BWL137 ▲●	360	10	
	RCB2-BWL147 ▲●			
	RCB2-BWL157 ▲●			
Projecting Illuminated Actuator, with integral circuit LED 48V, 24V & 12V (AC/DC) also available in 110V AC, 110V DC, 240V AC, 220DC	RCB2-BWL167 ▲●	690		
Double Push Button Actuators - Illuminated Flush without Series Resistor				
Illuminated Double Push Button, Flush Green & Red Knob marked I&O respectively (with BA9S Neon Bulb) 220V, 380V, 415V AC/DC	RCB2-BWN96 ▲●	415	8	

* Stock for accessories are subject to availability ☒ Non Stockable item

MOQ-Minimum Order Quantity

Push Buttons: 22.5mm

Metallic Range (Without Contact Elements)

Description	Reference	MRP (₹)	MOQ	Product Picture
Push Button Actuators with Carrier - Non-Illuminated [HSN Code: 8536]				
Double Push Button, Flush Green & Red Knob marked I&O respectively	RCB2-BA87	220	10	
Selector Switch Actuators with Carrier				
2-Position Selector Switch (stay put)	RCB2-BD2 RCB2-BD27*	350	10	
3-Position Selector Switch, centre 'OFF' (stay put)	RCB2-BD3 RCB2-BD37*			
2-Position Selector Switch with extra long knob (stay put)	RCB2-BJ2 RCB2-BJ27*	360	10	
3-Position Selector Switch, with extra long knob centre 'OFF' (stay put)	RCB2-BJ3 RCB2-BJ37*			
2-Position Selector Switch (Spring Return)	RCB2-BDR2 RCB2-BDR27*	400	10	
3-Position Selector Switch (Spring Return)	RCB2-BDR3 RCB2-BDR37*			
2-Position Selector Switch extra long knob (Spring Return)	RCB2-BJR2 RCB2-BJR27*	400	10	
3-Position Selector Switch extra long knob (Spring Return)	RCB2-BJR3 RCB2-BJR37*			
Selector Switch Actuators with Carrier & Contact Element [HSN Code: 8536]				
2-Position Selector Switch (stay put) with 1NO Block	RCB2-BD21 RCB2-BD271*	430	10	
2-Position Selector Switch, centre 'OFF' (stay put) with NO+NC Block	RCB2-BD25 RCB2-BD275*	515		
3-Position Selector Switch, centre 'OFF' (stay put) with NO+NC Block	RCB2-BD35 RCB2-BD375*			

*with Black Bezel

Selector Switch Actuators-Illuminated with Series Resistor [HSN Code: 8536]				
2-Position Illuminated Selector Switch (with BA9S Filament Bulb 130V) suitable for operation at 220V AC/DC	RCB2-BK1237	560	10	
	RCB2-BK1247			
	RCB2-BK1257			
3-Position Illuminated Selector Switch (with BA9S Filament Bulb 130V) suitable for operation at 220V AC/DC	RCB2-BK1337	560	10	
	RCB2-BK1347			
	RCB2-BK1357			
Selector Switch Actuators-Illuminated with integral circuit LED available on request				
Selector Switch Actuators - Illuminated without series resistor				
3-Position Illuminated Selector Switch (with BA9S Filament Bulb) 48V, 24V & 12V (AC/DC) also available in 110V AC, 110V DC, 240V AC, 220DC	RCB2-BK1336	560	10	
	RCB2-BK1346			
	RCB2-BK1356			
2-Position Illuminated Selector Switch (with LED Bulb) 48V, 24V & 12V (AC/DC) also available in 110V AC, 110V DC, 240V AC, 220DC	RCB2BKL1237	560	10	
	RCB2BKL1247			
	RCB2BKL1257			
3-Position Illuminated Selector Switch (with LED Bulb) 48V, 24V & 12V (AC/DC) also available in 110V AC, 110V DC, 240V AC, 220DC	RCB2BKL1337	560	10	
	RCB2BKL1347			
	RCB2BKL1357			

* Stock for accessories are subject to availability. Non Stockable item

Description	Reference	MRP (₹)	MOQ	Product Picture
Key Actuators with Carrier [HSN Code: 8536]				
2-Position Key Switch, Key removable in unactuated position	RCB2-BG2 RCB2-BG27*	505	10	
2-Position Key Switch, Key removable in both position	RCB2-BG4 RCB2-BG47*			
2-Position Key Switch, Key removable in 'Right Hand' position	RCB2-BG02 RCB2-BG027*	520	10	
3-Position Key Switch, Key removable in centre 'OFF' position	RCB2-BG3 RCB2-BG37*			
3-Position Key Switch, Key removable in all position	RCB2-BG0 RCB2-BG0-7*	520	10	
3-Position Key Switch, Key removable in 'Left Hand & Right Hand' position	RCB2-BG5 RCB2-BG57*			
3-Position Key Switch, Key removable in 'Left Hand' position	RCB2-BG9 RCB2-BG97*	520	10	
3-Position Key Switch, Key removable in 'Right Hand' position	RCB2-BG09 RCB2-BG097*			
3-Position (Spring Return) Key Switch, Key removable in 'Center' position	RCB2-BG7 RCB2-BG77*	550	10	
2-Position Key Switch with 1NO Block, Key removable in unactuated position	RCB2-BG21 RCB2-BG271*			
2-Position Key Switch with 1NO Block, Key removable in both position	RCB2-BG41 RCB2-BG471*	650	10	
3-Position Key Switch with 1NO+1NC Block key removable in centre 'OFF' position	RCB2-BG31 RCB2-BG371*			
3-Position Key Switch with 1NO+1NC Block key removable in all position	RCB2-BG04 RCB2-BG074*	650	10	

* with Black Bezel

Contact Elements - NO/NC (Non UL)* [HSN Code: 8536]				
Contact Element 1 NO	RE2BE101	88	50	
Contact Element 1 NC	RE2BE102			
Contact Elements - NO/NC (UL)*				
Contact Element 1 NO	RB2-BE-101	97	50	
Contact Element 1 NC	RB2-BE-102			

*Applicable for Both Metallic and Plastic range

How to Order:

Actuators, Contact Elements, Lens Assemblies can also be ordered separately or in combination, as required.

Add Voltage Code

Colour Code for Actuator / Lens								
Colour Code	1	2	3	4	5	6	7	8
Colour of Actuator	White ○	Black ●	Green ●	Red ●	Yellow ●	Blue ●	-	-
Colour of Lens	White ○	-	Green ●	Red ●	Amber ●	Blue ●	Clear ○	Yellow ●

Add Voltage Code

Pilot Lamps: 22.5mm
Metallic Range

GLOBAL CERTIFICATION



Description	Reference	MRP (₹)	MOQ	Product Picture
LED Type Pilot Lamp-Type of voltage AC/DC [HSN Code: 8536]				
Pilot Light with integral circuit LED 48V, 24V & 12V (AC/DC) also available in 110V AC, 110V DC, 240V AC, 220DC	<input checked="" type="checkbox"/> RCB2BVL71▲○	320	10	
	<input checked="" type="checkbox"/> RCB2BVL73▲●	320		
	<input checked="" type="checkbox"/> RCB2BVL74▲●			
	<input checked="" type="checkbox"/> RCB2BVL75▲●			
	RCB-BVL77▲○			
	<input checked="" type="checkbox"/> RCB2BVL78▲●			
	<input checked="" type="checkbox"/> RCB2BVL76▲●			
	Pilot Lamps with Series Resistor			
Pilot Lamp (with BA9S Filament bulb 130V) 220V AC/DC	RCB2-BV71▲○	240	10	
	<input checked="" type="checkbox"/> RCB2-BV73▲●			
	<input checked="" type="checkbox"/> RCB2-BV74▲●			
	RCB2-BV75▲●			
	<input checked="" type="checkbox"/> RCB2-BV76▲●			
	RCB2-BV77▲○			
	<input checked="" type="checkbox"/> RCB2-BV78▲●			
	Pilot Lamps with Series Resistor & Diode			
Pilot Lamp (with BA9S Filament Bulb 130V) 240V AC	RCB2-BVD71▲○	260	10	
	RCB2-BVD73▲●			
	RCB2-BVD74▲●			
	RCB2-BVD75▲●			
	RCB2-BVD76▲●			
	RCB2-BVD77▲○			
	RCB2-BVD78▲●			

Description	Reference	MRP (₹)	MOQ	Product Picture
Economical Barrel LED Series - Type of voltage AC/DC [HSN Code: 8536]				
Suitable for operating at 12V DC, 240V AC, 415V AC AC/DC-24V, 110V, 220V	RCN7-IVL71 ▲○	330	20	
	<input checked="" type="checkbox"/> RCN7-IVL76▲●			
	RCN7-IVL73▲●	185		
	RCN7-IVL74▲●			
	<input checked="" type="checkbox"/> RCN7-IVL75▲●			
	<input checked="" type="checkbox"/> RCN7-IVL77▲○			
	<input checked="" type="checkbox"/> RCN7-IVL78▲●			

Description	Reference	MRP (₹)	MOQ	Product Picture
Push Button Powder Coated Actuators with Carrier [HSN Code: 8536]				
Flush Spring Return Push Button powder coated	RCB2-BA17 ○	120	20	
	RCB2-BA27 ●			
	RCB2-BA37 ●			
	RCB2-BA47 ●			
	RCB2-BA57 ●			
	RCB2-BA67 ●			
	Projecting Push Button			
RCB2-BL27 ●				
RCB2-BL37 ●				
RCB2-BL47 ●				
RCB2-BL57 ●				
RCB2-BL67 ●				
Integrated LED Pilot Lamp - Type of voltage AC/DC				
Integral LED pilot Lamp suitable for operating at common voltage (AC/DC) 110V, 48V, 24V & 12V Also available at operational voltage 240V AC, 220V DC, 110V AC, 110V DC	<input checked="" type="checkbox"/> RCB7-IVL71▲○	380	15	
	<input checked="" type="checkbox"/> RCB7-IVL76▲●			
	<input checked="" type="checkbox"/> RCB7-IVL73▲●	220		
	<input checked="" type="checkbox"/> RCB7-IVL74▲●			
	<input checked="" type="checkbox"/> RCB7-IVL75▲●			
	<input checked="" type="checkbox"/> RCB7-IVL77▲○			
	<input checked="" type="checkbox"/> RCB7-IVL78▲●			
	RCB7-IVL71▲○			
	RCB7-IVL76▲●			
	Wide range: 12V-240V (AC/DC)	RCB7-IVL73▲●		
RCB7-IVL74▲●				
RCB7-IVL75▲●				
<input checked="" type="checkbox"/> RCB7-IVL77▲○				
RCB7-IVL78▲●				













Colour Code for Actuator / Lens								
Colour Code	1	2	3	4	5	6	7	8
Colour of Actuator	White ○	Black ●	Green ●	Red ●	Yellow ●	Blue ●	-	-
Colour of Lens	White ○	-	Green ●	Red ●	Amber ●	Blue ●	Clear ○	Yellow ●



▲Add Voltage Code

* Stock for accessories are subject to availability. MOQ- Minimum Order Quantity

Accessories

Metallic Range (For Push Buttons & Pilot Lamps : 22.5mm)

Operating Heads Without Contact Block and Carrier [HSN Code: 8536]				
Description	Reference	MRP (₹)	MOQ	Product Picture
Pilot Lamp Head	RB2-BV01 ○	120	20	
	RB2-BV03 ●			
	RB2-BV04 ●			
	RB2-BV05 ●			
	RB2-BV06 ●			
	RB2-BV07 ○			
	RB2-BV08 ●			
Flush Push Button	RB2-BA1 ○	105	20	
	RB2-BA2 ●			
	RB2-BA3 ●			
	RB2-BA4 ●			
	RB2-BA5 ●			
	RB2-BA6 ●			
Projecting Push Button	RB2-BL1 ○	120	20	
	RB2-BL2 ●			
	RB2-BL3 ●			
	RB2-BL4 ●			
	RB2-BL5 ●			
	RB2-BL6 ●			
Mushroom Spring Return	RB2-BC2 ●	175	8	
	RB2-BC3 ●			
	RB2-BC4 ●			
	RB2-BC5 ●			
Mushroom Stay Put	φ30mm RB2-BS44 ●	220	10	
	φ40mm RB2-BS54 ●	230	8	
	φ60mm RB2-BS64 ●	310	5	
Mushroom illuminated - 2 position Momentary - 2 position Maintained	RCB2-BW43 ●	390	8	
	RCB2-BW44 ●			
	RCB2-BW64 ●			
	RCB2-BW63 ●			
Booted Push Button	RB2-BP2 ●	180	20	
	RB2-BP3 ●			
	RB2-BP4 ●			
	RB2-BP5 ●			
	RB2-BP6 ●			
Double Headed without Light	RB2-BA87	220	10	
Double Headed Push Button with Light	RB2-BW9	240		
Illuminated Flush Push Button	RB2-BW31 ○	140	10	
	RB2-BW33 ●			
	RB2-BW34 ●			
	RB2-BW35 ●			
	RB2-BW36 ●			
	RB2-BW37 ○			
Illuminated Projecting Push Button	RB2-BW13 ●	150	10	
	RB2-BW14 ●			
	RB2-BW15 ●			
	RB2-BW16 ●			
	RB2-BW17 ○			
Illuminated Selector 2-Position Stay Put	RB2-BK123 ●	340	10	
	RB2-BK124 ●			
	RB2-BK125 ●			
Illuminated Selector 3-Position Stay Put	RB2-BK133 ●	360	10	
	RB2-BK134 ●			
	RB2-BK135 ●			

Operating Heads LED, Neon Pilot Lamp / Push Button Without Contact Block and Carrier [HSN Code: 8536]				
Description	Reference	MRP (₹)	MOQ	Product Picture
LED Pilot Lamp Head	RB2-BVL01 ○	100	20	
	RB2-BVL03 ●			
	RB2-BVL04 ●			
	RB2-BVL05 ●			
	RB2-BVL06 ●			
	RB2-BVL07 ○			
	RB2-BVL08 ●			
LED Illuminating Flush Push Button	RB2-BWL31 ○	150	10	
	RB2-BWL33 ●			
	RB2-BWL34 ●			
	RB2-BWL35 ●			
	RB2-BWL36 ●			
	RB2-BWL37 ○			
LED Illuminating Projecting Push Button	RB2-BWL11 ○	170	10	
	RB2-BWL13 ●			
	RB2-BWL14 ●			
	RB2-BWL15 ●			
	RB2-BWL16 ●			
	RB2-BWL17 ○			
RB2-BWL18 ●				

Operating Heads LED, Neon Pilot Lamp / Push Button Without Contact Block and Carrier [HSN Code: 8536]					
Description	Reference	Operating Handle	MRP (₹)	MOQ	Product Picture
Selector 2-Position, Stay Put	RB2-BD2	Standard	310	10	
Selector 2-Position, Stay Put	RB2-BJ2	Long	340		
Selector 2-Position, Spring Return	RB2-BDR2	Standard	310		
Selector 2-Position, Stay Put	RB2-BJR2	Long	340		
Selector 3-Position, Stay Put (Centre OFF)	RB2-BD3	Standard	310		
Selector 3-Position, Stay Put (Centre OFF)	RB2-BJ3	Long	340		
Selector 3-Position, Spring Return (Centre OFF)	RB2-BDR3	Standard	310		
Selector 3-Position, Stay Put	RB2-BJR3	Long	340		
Key Selector 2-Position, Stay Put	RB2-BG2	Key removable in L.H. position	470		
Key Selector 2-Position, Stay Put	RB2-BG4	Key removable in both positions	470		
Key Selector 2-Position, Stay Put	RB2-BG02	Key removable in R . H. position			
Key Selector 2-Position, Spring Return Stay Put	RB2-BG6	Key removable in L.H. position	470		
Key Selector 3-Position, Stay Put	RB2-BG3	Key removable in centre position			
Key Selector 3-Position, Stay Put	RB2-BG0	Key removable in all positions	470		
Key Selector 3-Position, Stay Put	RB2-BG5	Key removable in L.. H. & R. H. position			
Key Selector 3-Position, Stay Put	RB2-BG9	Key removable in L. H. position	480		
Key Selector 3-Position, Stay Put	RB2-BG09	Key removable in R. H. position			
Key Selector 3-Position, Both Side Spring Return	RB2-BG7	Key removable in Centre position	480		
Mushroom Head with Key Stay Put	RB2-BS14 ●	Key removable in both positions		480	8

Accessories

Metallic Range (For Push Buttons & Pilot Lamps : 22.5mm)

Body Assemblies with Contact Blocks, Screw & Captive Clamp Connection [HSN Code: 8536]					
Description	Reference	Contact Type	MRP (₹)	MOQ	Product Picture
For Actuators, Push Buttons, Selectors & Key Switches	RB2-BZ101	NO	150	20	
	RB2-BZ102	NC			
	RB2-BZ103	1NO+1NO	250	10	
	RB2-BZ104	1NC+1NC			
	RB2-BZ105	1NO+1NC			

Description	Reference	MRP (₹)	MOQ	Product Picture
Filament Bulb (BA9S) 130V, 48V, 24V, 12V & 6V (2.6W max.)	RL1-CF	45	100	
Neon Bulb (BA9S) 415V, 380V, 220V	RL1-CN			
Set of Lens (one inner and one outer) for Pilot Lamp Head	RB2-BV00*	26	20	
Lens for LED & Neon Type Pilot Lamp (w/o inner lens)	RB2-BVL00*			
Set of Lens (one inner and one outer) for Illuminating Actuator	RB2-BW00*			
Lens for Illuminating LED & Neon actuator (w/o inner lens)	RB2-BWL00*			
Silicon Cap suitable for, -Booted Push Button (coloured)	RB2BP00	26		
-Push Buttons Flush (Natural)	RC-S			
-Push Buttons Illuminated (Natural)	RCL	39		
Legend Plate with inscription (On, Off, Start, Stop, Slow, Fast, Forward, Reverse, Up, Down, Open, Close, Auto, Auto-o-Hand, Auto-Hand, Reset, Inch.)	RB2-BYN#	26	100	
Body / Carrier with mounting screws (passivated) for making different assemblies	RB2-B*	52	20	
Yellow legend (PVC) φ60mm	RB2-PY9330	65	50	
Emergency Stop φ90mm	RB2-PY8330	71	50	

#Minimum Order Qty. will be 500 Nos.

How to Order :

1. Actuators, switch elements, lens assemblies can be ordered separately or in combination.
2. Basic type designation for actuators is "RB2-B". Numerical colour code is added as a suffix to indicate the colour of the actuator or lens. Remove "*" and put numerical code as indicated below:

Colour Code	1	2	3	4	5	6	7	8
Colour of Actuator	White	Black	Green	Red	Yellow	Blue	-	-
Colour of Lens	White	-	Green	Red	Amber	Blue	Clear	Yellow

3. Different suffixes are assigned for flush, projecting, selector actuators etc.
4. The type designation for contact element is '1' for NO and '2' for NC.
5. Basic type designation for legend plates is "RB2-BY". To complete code with type of inscription please remove "*" and put numerical code as indicated below.

Standard Text	Reference	Standard Text	Reference	MRP (₹)	MOQ
Start	2303	Stop	2304	26	250
Forward	2305	Reverse	2306		
Up	2307	Down	2308		
On	2311	Off	2312		
Open	2313	Close	2314		
Auto	2315	Hand	2316		
Reset	2323	Inch	2321		
Slow	2327	Fast	2328		
Auto - Hand	2364	Auto-O-Hand	2385		
		Hand-O-Auto	2387		

Important :

- 1) Ordered quantities should be in multiple of standard packing.
- 2) Illuminated Push Buttons & Pilot Lamps will be supplied with bulb only.
- 3) N in product code stands for Neon Bulb.

☒ Non Stockable item. MOQ- Minimum Order Quantity

Control Stations (Assembled)

Complete Control Stations-Start & Stop Functions Plastic, Spring Return						
Description	Scheme	Colour	Making on legend	Reference	MRP (₹)	Product Picture
1 Flush Push Button	NO	3	I START	RC1P102	770	
				RC1P103		
1 Flush Push Button	NC	4	O STOP	RC1P112		
				RC1P114		
Latching Push Button	NC	4	STOP	RC1PBS542 RC1PYBS542	830	
Mushroom Head Key Switch	NC	4	STOP	RC1PBS142 RC1PYBS142	1140	
2 Flush Push Button	NO+NC	3	I	RC2P213	1100	
		4	O			
2 Flush Push Button	NO+NC	3	START	RC2P215		
		4	STOP			

Complete Control Stations Directional/Movement Control Functions Plastic, Spring Return [HSN Code: 8536]							
Description	Scheme	Colour	Marking on legend	Reference	MRP (₹)	Product Picture	
2 Flush Push Button	NO + NO	1 2	↑ Down	RC2P222	1230		
				RC2P222A			
			↔ Left	RC2P223			
				RC2P223A			
			1	Open Close			RC2P241
				2			Forward Reverse
3 Flush Push Button	NO + NC + NO	3 4 3	Forward Stop Reverse	RC3P311	1590		
				Up Stop Down			RC3P321
			Right Stop Left	RC3P331			
				Open Stop Close			RC3P341
			1 4 2	↑ ↓ ← →			RC3P324
							RC3P334

Control Stations for Customer Assembly Empty Enclosure, Plastic [HSN Code: 8536]					
Description	Number of Ways		Reference	MRP (₹)	Product Picture
	Top	Base			
Yellow		1	RC - 1PY	620	
		1	RC - 1P		
Bone Grey	Jet Black	2	RC - 2P	690	
		3	RC - 3P	780	
		4	RC - 4P	880	

- * Empty Enclosure's are available without contact blocks and push buttons and can be assembled with the accessories / spare parts as per specified requirements.
- * Stock for accessories are subject to availability

Control Stations (Assembled)

Complete Control Stations-Start and Stop Functions Metal, Spring Return [HSN Code: 8536]						
Description	Scheme	Colour	Marking on legend	Reference	MRP (₹)	Product Picture
1 Flush Push Button	NO	3	I START	RC 1M 102	1140	
				RC 1M 103		
1 Flush Push Button	NC	4	O STOP	RC 1M 112	1269	
				RC 1M 114		
Latching Push Button	NC	4	STOP	RC1MBS542	1463	
Mushroom Head Key Switch	NC	4	STOP	RC1MBS142	1463	
2 Flush Push Button	NO+NC	3	I O	RC 2M 213	1450	
				RC 2M 215		

Complete Control Stations Directional/ Movement Control Functions Metal, Spring Return [HSN Code: 8536]						
Description	Scheme	Colour	Marking on legend	Reference	MRP (₹)	Product Picture
2 Flush Push Button	NO + NO	1 2	↑ ↓ Up-Down	RC 2M 222	1399	
				RC 2M 222A		
		1 2	↔ Right-Left	RC 2M 223		
				RC 2M 223A		
		1 2	Open-Close Forward-Reverse	RC 2M 241		
				RC2M222B		
3 Flush Push Button	NO + NC + NO	3 4 3	Forward Stop Reverse	RC 3M 311	1780	
				Up Stop Down		
			Right Stop Left	RC 3M 331		
				Open Stop Close		
		1 2	⊕ ⊖ ↺	RC 3M 324		
RC 3M 334						

Control Stations for Customer Assembly Empty Enclosure, Metal [HSN Code: 8536]					
Description		Number of Ways	Reference	MRP (₹)	Product Picture
Top	Base				
Smoke Grey	Dark Grey	1	RC - 1M	881	
		2	RC - 2M	919	
		3	RC - 3M	1101	
		4	RC - 4M*	1340	

* Empty Enclosure's are available without contact blocks and push buttons and can be assembled with the accessories / spare parts as per specified requirements.

☒ Non Stockable item

Operating Head for Control Stations

For Customer assembly

Plastic Operating Heads without Contact Block use with RC.P & RC.M enclosures - IP65 [HSN Code: 8536]				
Description	Reference	MRP (₹)	MOQ	Product Picture
Flush Push Button Spring Return	RP2-BA1 ○	104	20	
	RP2-BA2 ●			
	RP2-BA3 ●			
	RP2-BA4 ●			
	RP2-BA5 ●			
	RP2-BA6 ●			
Projecting Push Button	RP2-BA334 ↑	104	20	
	RP2-BA335 ↓			
	RP2-BL1 ○			
	RP2-BL2 ●			
	RP2-BL3 ●			
	RP2-BL4 ●			
Mushroom Spring Return	RP2-BL5 ●	155	8	
	RP2-BL6 ●			
	RP2-BC2 ●			
	RP2-BC3 ●			
Mushroom Stay Put	RP2-BC4 ●	194	10	
	RP2-BC5 ●			
	RP2-BS44 ●			
	RP2-BS54 ●			
	φ30mm	207	8	
	φ40mm	337	5	
	φ60mm			

Operating Heads for Control Stations Without Contact Block and Carrier [HSN Code: 8536]					
Description	Reference	Operating Handle	MRP (₹)	MOQ	Product Picture
Selector 2-Position, Stay Put	RP2-BD2	Standard	298	10	
Selector 3-Position, Stay Put (Centre OFF)	RP2-BD3	Standard			
Selector 3-Position, Spring Return (Centre OFF)	RP2-BDR3	Standard			
Key Selector 2-Position, Stay Put	RP2-BG2	Key removable in L.H. position	427		
Key Selector 2-Position, Stay Put	RP2-BG4	Key removable in both positions	440		
Key Selector 2-Position, Stay Put	RP2-BG02	Key removable in R. H. position			
Key Selector 3-Position, Stay Put	RP2-BG3	Key removable in centre position	453		
Key Selector 3-Position, Stay Put	RP2-BG0	Key removable in all positions			
Key Selector 3-Position, Stay Put	RP2-BG5	Key removable in L. H. & R. H. position	427		
Key Selector 3-Position, Stay Put	RP2-BG9	Key removable in L. H. position			
Key Selector 3-Position, Stay Put	RP2-BG09	Key removable in R. H. position			
Key Selector 3-Position, Both Side Spring Return	RP2-BG7	Key removable in Centreposition	427	8	
Mushroom Head with Key Stay Put	RP2-BS14	Key removable in both positions			

Operating Head for Control Stations

For Customer assembly



Metallic Operating Heads without Contact Block for RC.P & RC.M enclosures - IP65 [HSN Code: 8536]					
Description	Reference	MRP (₹)	MOQ	Product Picture	
Flush Push Button Spring Return	RM2-BA1 ○	117	20		
	RM2-BA2 ●				
	RM2-BA3 ●				
	RM2-BA4 ●				
	RM2-BA5 ●				
	RM2-BA6 ●				
	RM2-BA334 †				
Projecting Push Button	RM2-BA335 ●	117	20		
	RM2-BL1 ○				
	RM2-BL2 ●				
	RM2-BL3 ●				
	RM2-BL4 ●				
	RM2-BL5 ●				
Mushroom Spring Return φ40mm	RM2-BL6 ●	175	8		
	RM2-BC2 ●				
	RM2-BC3 ●				
	RM2-BC4 ●				
	RM2-BC5 ●				
Mushroom Stay Put φ30mm φ40mm φ60mm	RM2-BC6 ●	220	10		
	RM2-BS44 ●				
	RM2-BS54 ●				
Mushroom Push-Pull Type φ40mm	RM2-BS64 ●	246	5		
	RM2-BT43 ●	246	8		

Contact Blocks - Base Mounted For Control Stations Customer Assembly [HSN Code: 8536]					
Description	Reference	Contact Type	MRP (₹)	MOQ	Product Picture
Contact Block	RB2BE-101BM/P*	NO	104	50	
Slow Break	RB2BE-102BM/P*	NC			

* Please specify 'M' if required for Metallic and 'P' if required for Plastic.

Legends (Stickers) are supplied with the following Standard Texts, Plastic [HSN Code: 8536]					
Description	Reference	Standard Text	Reference	MRP (₹)	MOQ
Start	RP2-BY2303	Stop	RP2-BY2304	13	100
Forward	RP2-BY2305	Reverse	RP2-BY2306		
Up	RP2-BY2307	Down	RP2-BY2308		
On	RP2-BY2311	Off	RP2-BY2312		
Open	RP2-BY2313	Close	RP2-BY2314		
Auto	RP2-BY2315	Hand	RP2-BY2316		
Reset	RP2-BY2323	Inch	RP2-BY2321		
Slow	RP2-BY2327	Fast	RP2-BY2328		
Power On	RP2-BY2326	Emer. Stop	RP2-BY2330		
Right	RP2-BY2309	Left	RP2-BY2310		
O	RP2-BY2146	--	RP2-BY2147		
→	RP2-BY1912	←	RP2-BY1913		
↑	RP2-BY1914	↑	RP2-BY1915		

Note: Minimum order of #10 each.

Operating Heads for Control Stations Without Contact Block and Carrier [HSN Code: 8536]					
Description	Reference	Operating Handle	MRP (₹)	MOQ	Product Picture
Selector 2-Position, Stay Put	RM2-BD2	Standard	311	10	
Selector 2-Position, Spring Return	RM2-BDR2	Standard			
Selector 3-Position, Stay Put (Centre OFF)	RM2-BD3	Standard			
Selector 3-Position, Spring Return (Centre OFF)	RM2-BDR3	Standard			
Key Selector 2-Position, Stay Put	RM2-BG2	Key removable in L.H. position	427	10	
Key Selector 2-Position, Stay Put	RM2-BG4	Key removable in both positions	453		
Key Selector 2-Position, Stay Put	RM2-BG02	Key removable in R. H. position			
Key Selector 2-Position, Spring Return Stay Put	RM2-BG6	Key removable in L.H. position	479		
Key Selector 3-Position, Stay Put	RM2-BG3	Key removable in centre position			
Key Selector 3-Position, Stay Put	RM2-BG0	Key removable in all positions	479		
Key Selector 3-Position, Stay Put	RM2-BG5	Key removable in L.H. & R.H. position			
Key Selector 3-Position, Stay Put	RM2-BG9	Key removable in L.H. position	518		
Key Selector 3-Position, Stay Put	RM2-BG09	Key removable in R. H. position			
Key Selector 3-Position, Both Side Spring Return	RM2-BG7	Key removable in Centre position			
Mushroom Head with Key Stay Put	RM2-BS141	Key removable in both positions	453	8	

Legends (Stickers) are supplied with the following standard texts, Metal [HSN Code: 8536]					
Description	Reference	Standard Text	Reference	MRP (₹)	MOQ
Start	RM2-BY2303	Stop	RM2-BY2304	13	100
Forward	RM2-BY2305	Reverse	RM2-BY2306		
Up	RM2-BY2307	Down	RM2-BY2308		
On	RM2-BY2311	Off	RM2-BY2312		
Open	RM2-BY2313	Close	RM2-BY2314		
Auto	RM2-BY2315	Hand	RM2-BY2316		
Reset	RM2-BY2323	Inch	RM2-BY2321		
Slow	RM2-BY2327	Fast	RM2-BY2328		
Power On	RM2-BY2326	Emer. Stop	RM2-BY2330		
Right	RM2-BY2309	Left	RM2-BY2310		
O	RM2-BY2146	--	RM2-BY2147		
→	RM2-BY1912	←	RM2-BY1913		
↑	RM2-BY1914	↑	RM2-BY1915		

Note: Minimum order of #10 each.

MOQ- Minimum Order Quantity

Motor Starters



Features

- Conforms to IS 13947-4-1
- 3Ø DOL Starter range: 0.50HP~60HP
- 3Ø Reversing DOL Starter range: 0.5HP~20HP
- 3Ø Star Delta Starter range: 7.5HP~350HP

Custom built Starter solutions with incomer MCCB & Electronic Motor Protection Relay

- 3Ø Intelligent Star Delta Starter range: 40HP~ 350HP
- 3Ø Intelligent Auto Transformer Starter range: 40HP~ 350HP



Motor Starters

Conforming IS/IEC60947-4-1



Heavy Duty DOL Starter Type DX-P with robust 4 Pole Contactor & LR1D OLR in S.S. enclosure					[HSN Code: 8536]
Std. Power Rating for 3Ph. Motor at 415V		Reference	Relay LR1D Range Amps	MRP (₹)	MOQ
HP	kW				
1.5	1.1	BE1-DXP204■307	1.6-2.5	5030	6
2.0	1.5	BE1-DXP204■308	2.5-4.0	5030	
3	2.2	BE1-DXP204■310	4.0-6.0	5030	
5	3.7	BE1-DXP204■312	5.5-8.0	5030	
5.5	4.0	BE1-DXP204■314	7-10	5030	
7.5	5.5	BE1-DXP204■316X	9-14	5030	
12	9	BE1-DXP204■321	13-18	5690	
15	11	BE1-DXP254■321XH	14-22	5690	
		BE1-DXP254■322	18-25	5690	
25	18	BE1-DXP404■353	23-32	8610	



Heavy Duty Automatic Star Delta Starter Type DX-P with robust 4 Pole Contactor & LR1D OLR, Electronic Star Delta Timer in S.S. enclosure					[HSN Code: 8536]
Std. Power Rating for 3Ph. Motor at 415V		Reference	Relay LR1D Range Amps	MRP (₹)	MOQ
HP	kW				
7.5	5.5	BE3-DXP204■312	5.5-8.0	18090	2
12	9	BE3-DXP204■314	7.0-10	18090	
15	11	BE3-DXP204■316X	9-14	18090	
20	15	BE3-DXP204■321	13-18	18310	
		BE3-DXP254■321XH	14-22	20570	
25	18	BE3-DXP254■322	18-25	20570	
30	22	BE3-DXP254■353	23-32	23650	

AC Coil Voltage Codes (Standard) for Heavy Duty Industrial Starter Type DX-P			
Industrial Starter	Voltage		
BE1-DXP	220	190-400#	250-450#
BE3-DXP	-	190-400#	250-450#
Coil Code	M	Q	N

Industrial Starters are available in the above wide band operating range Standard coil voltages.



DOL Starter with D range Contactor & LR1D OLR in Plastic Enclosure					[HSN Code: 8536]
Std. Power Rating for 3Ph. Motor at 415V		Reference	Relay Range Amps	MRP (₹)	MOQ
HP	kW				
0.5	0.37	LE1-D173■305	0.63-1.00	3840	1
0.75	0.55	LE1-D173■306	1.0-1.60	3840	
1.5	1.1	LE1-D173■307	1.60-2.50	3840	
2	1.5	LE1-D173■308	2.50 ~ 4.00	3840	
3	2.2	LE1-D173■310	4.00 ~ 6.00	3840	
5	3.7	LE1-D173■312	5.50 ~ 8.00	3840	
7.5	5.5	LE1-D173■316X	9.0 ~ 14.0	3840	
12	9	LE1-D253■321	13.0 ~ 18.0	7890	
15	11	LE1-D253■322	18.0 ~ 25.0	7890	

Motor Starters

Conforming IS/IEC60947-4-1



Std. Power Rating for 3Ph. Motor at 415V			Reference	Relay Range Amps	MRP (₹)	MOQ
HP	kW					
0.5	0.37		BE1-D1735■305	0.63-1.00	4540	1
0.75	0.55		BE1-D1735■306	1.0-1.60	4540	
1.5	1.1		BE1-D1735■307	1.60-2.50	4540	
2	1.50		BE1-D1735■308	2.50-4.0	4540	
3	2.2		BE1-D1735■310	4.00-6.00	4540	
5	3.7		BE1-D1735■312	5.50-8.00	4540	
7.5	5.5		BE1-D1735■316X	9.0-14.0	4540	
12	9		BE1-D2535■321	13.0-18.0	9430	
15	11		BE1-D2535■322	18.0-25.0	9430	
20	15		BE1-D3235■353	23.0-32.0	15620	
30	22		BE1-D4035■355	28.0-40.0	22880	
35	25		BE1-D5035■357	38.0-50.0	25510	
40	30		BE1-D6335■359	48.0-57.0	29710	

[HSN Code: 8536]



Std. Power Rating for 3Ph. Motor at 415V			Reference	Relay Range Amps	MRP (₹)	MOQ
HP	kW					
0.5	0.37		BE2-D1735■305	0.63-1.00	14010	1
0.75	0.55		BE2-D1735■306	1.0-1.60	14010	
1.5	1.1		BE2-D1735■307	1.60-2.50	14010	
2.0	1.5		BE2-D1735■308	2.50-4.00	14010	
3.0	2.2		BE2-D1735■310	4.00-6.00	14010	
5.0	3.7		BE2-D1735■312	5.50-8.00	14010	
5.5	4.0		BE2-D1735■314	7.00-10.0	14010	
7.5	5.5		BE2-D1735■316X	9.0-14.0	14010	
12.0	9.0		BE2-D2535■321	13.0-18.0	17330	
15.0	11.0		BE2-D2535■322	18.0-25.0	19480	
20.0	15.0		BE2-D3235■353	23.0-32.0	28720	

[HSN Code: 8536]



Std. Power Rating for 3Ph. Motor at 415V			Reference	Relay Range Amps	MRP (₹)	MOQ
kW	HP					
3	4		BE3-D1735■308	2.5-4.0	16640	1
4	5.5		BE3-D1735■310	4.0-6.0	16640	
5.5	7.5		BE3-D1735■312	5.5 - 8.0	16640	
9	12		BE3-D1735■314	7.0 ~ 10.0	16640	
11	15		BE3-D1735■316X	9.0 ~ 14.0	16640	
15	20		BE3-D2235■321	13.0 ~ 18.0	17290	
18	25		BE3-D2535■322	18.0 - 25.0	23430	
22	30		BE3-D3235■322	18.0 - 25.0	39050	
25	35		BE3-D3235■353	23.0 - 32.0	39050	
30	40		BE3-D4035■355	30.0 - 40.0	47000	
37	50		BE3-D5035■355	30.0 - 40.0	62690	
51	70		BE3-D6335■359	48.0 - 57.0	103380	
59	80		BE3-D8035N 361	57.0 - 66.0	103380	
75	100		BE3-F115 363	66.0 - 80.0	127090	
90	125		BE3-F115N105	65.0 ~ 105.0	151100	
110	150		BE3-F150N125	80.0 ~ 125.0	155860	
132	180		☒ BE3-F185N160	100.0-160.0	248770	
160	220		☒ BE3-F185N200	125.0-200.0	248770	
200	270		☒ BE3-F265N250	160.0-250.0	272090	
220	300		☒ BE3-F330N315	200.0-315.0	282000	
260	350		☒ BE3-F330S315	200.0-315.0	282000	

[HSN Code: 8536]

☒ Non Stockable item

Motor Starters

Conforming IS/IEC60947-4-1

Semi-Automatic Star Delta Starter with D range Contactor, LR1D OLR					
Std. Power Rating for 3 Ph. Motor at 415V		Reference	Relay Range Amps	MRP (₹)	MOQ
KW	HP				
3	4	BE3-D1735■308SA	2.5 ~ 4.0	11940	1
4	5.5	BE3-D1735■310SA	4.0 ~ 6.0	11940	
5.5	7.5	BE3-D1735■312SA	5.5 ~ 8.0	11940	
9	12	BE3-D1735■314SA	7.0 ~ 10.0	11940	
11	15	BE3-D1735■316XSA	9.0 ~ 14.0	11940	
15	20	BE3-D2535■321SA	13.0 ~ 18.0	16460	
18	25	BE3-D2535■322SA	18.0 ~ 25.0	16460	

Coil Voltage Codes (Standard) for DOL Starters with D range Contactor		
Motor Starter	Voltage	
BE1-D/LE1-D	220V	415V
Coil Code	UW	N

** DOL Motor Starter are available only in the above Standard Coil Voltages.

Coil Voltage Codes (Standard) for DOL & Star Delta Starters with D range Contactor		
Motor Starter	Voltage	
BE1-D / BE2-D / BE3-D / BE3-F	380#	415
Coil Code	NW	N

Wide Band Coil available for Star Delta Starters upto 40HP only.

How to order Industrial Starter:

- (i) Complete the code by replacing the blue square (■) by the letter(s) corresponding to the Coil Voltage selected.
- (ii) Industrial DOL Starters should be selected based on the FLC of Pump/Motor & Coil Voltage required.

How to order Star Delta Starter:

- (i) Complete the code by replacing the blue square (■) by the letter(s) corresponding to the Coil Voltage selected.
- (ii) Star Delta starters should be selected based on the FLC of the Pump/Motor phase current (Motor FLC X 0.58) & Coil Voltage required.

Custom Built Motor Starters Solutions

■ **Smart Start Delta Starter rating 40 HP to 150 HP 3 Phase 415V AC**

- Incomer 3 Pole MCCB, 10~25kA
- Selection of liberal D range, air break Contactor
Electronic motor protection relay with built-in feature having pause of 0.30 sec for motor protection against single phasing
- Electronic Star Delta Timer
- Housed in free standing IP 54 sheet steel enclosure with bottom cable entry
- Optional facility: Water Level Controller also available

■ **Intelligent Star Delta Starter rating 40 HP to 350 HP 3 Phase 415V AC**

- Incomer 3 Pole MCCB, 10~25kA
- Selection of liberal D range, air break Contactor
- Digital motor protection Relay type mPro100 with 7 segment display to assure complete motor protection against overload, phase loss, under current, unbalance, motor stall, earth fault, locked rotor
- Electronic Star Delta Timer
- Housed in free standing IP 54 sheet steel enclosure with bottom cable entry

■ **Intelligent Auto Transformer Starter rating 40 HP to 350 HP 3 Phase 415V AC (closed transition)**

- Incomer 3 Pole MCCB, 10~25kA
- Selection of liberal D range, air break Contactor
- Digital motor protection Relay type mPro100 with 7 segment display to assure complete motor protection against overload, phase loss, under current, unbalance, motor stall, earth fault, lock rotor
- Auto Transformer, air cooled, 6 starts/hours with built-in thermister having tapping at 50%, 60% & 80% of the rated voltage
- Electronic Timer for changeover function
- Housed in free standing IP 54 sheet steel enclosure with bottom cable entry

MOQ- Minimum Order Quantity

Motor Starters

CS1 Series starters (DOL & Star Delta) are available with contactors type CS1, CS2 & CS3 having 16A, 25A, 32A AC3 duty. These Starters are specially designed for agricultural use and have following features:

- Conforms to IEC 60947-4-1
- Wide band coil
- Rugged design which is durable and easy for maintenance
- Spares are available across the country
- Elegant powder coated sheet metal box made from 0.8 mm CRCA sheet



New

3Ø DOL Starters in SS Enclosure [HSN Code: 8536] GST@18%					
Reference	Relay Range (Amp)	Maximum Motor Output at 415V, 3 Phase		MRP (₹)	Std. Pkg. (Nos.)
		kW	HP		
CS1DO■1525NR	1.5-2.5	0.75	1	2691	1
CS1DO■2504NR	2.5-4	1.5	2		
CS1DO■0406NR	4-6.5	3	4		
CS1DO■0610NR	6-10	4.5	6		
CS1DO■0914NR	9-14	5.5	7.5		
CS1DO■1118NR	11-18	5.5	7.5	2746	
CS1DO■1322NR	13-22	5.5	7.5	2799	
CS2DO■1322NR	13-22	5.5	7.5	3002	
CS2DO■2032NR	20-32	5.5	7.5	3088	
CS3DO■2032NR	20-32	5.5	7.5	3212	



New

3Ø Fully Automatic Star-Delta starters in SS Enclosure [HSN Code: 8536] GST@18%					
Reference	Relay Range (Amp)	Max. Motor Output at 415V, 3Ph		MRP (₹)	Std. Pkg. (Nos.)
		KW	HP		
CS1SD■0610NR	6-10	7.5	10	9822	1
CS1SD■0914NR	9-14	9.3	12.5		
CS1SD■1118NR	11-18	11	15	9947	
CS1SD■1322NR	13-22	11	15	10019	
CS2SD■1322NR	13-22	11	15	10158	
CS2SD■2032NR	20-32	11	15	10334	
CS3SD■2032NR	20-32	16	22	10596	



New

3Ø DOL in S.S. Enclosure [HSN Code: 8536] GST@18%					
Incorporating Heavy Duty 4 Pole Contactor type TC1-DX with wide band operating coil, Overload relay type LR3D with manual re-set and yellow flag for trip indication					
Reference	Relay Range (Amp)	Standard Power Rating		MRP (₹)	Std. Pkg. (Nos.)
		kW	HP		
BE1-DXM204■307NR	1.6-2.5	0.75	1	4158	6
BE1-DXM204■308NR	2.5-4.0	1.1/1.5	1.5/2		
BE1-DXM204■310NR	4.0-6.0	2.2	3		
BE1-DXM204■312NR	5.5-8.0	2.2	3		
BE1-DXM204■314NR	7.0-10	3.7	5		
BE1-DXM204■316XNR	9.0-14	3.7/4	5/5.5		
BE1-DXM204■321NR	13-18	5.5	7.5	4447	
BE1-DXM254■321XNR	14-22	7.5	10	4663	
BE1-DXM254■322NR	18-25	10	12	4824	
BE1-DXM404■353NR	23-32	11	15	6667	

3Ø Automatic Star Delta Starter in S.S Enclosure [HSN Code: 8536] GST@18%
 Incorporating Heavy Duty 4 Pole Contactor type TC1-DX with wide band operating coil, Overload relay type LR3D for motor protection & Electronic Star Delta Timer

Reference	Relay Range (Amp)	Std. Power Rating for 3P at 415V		MRP (₹)	Std. Pkg. (Nos.)
		kW	HP		
BE3-DXM204■308NR	2.5-4	1.5	2	13588	2
BE3-DXM204■310NR	4-6	2.2	3		
BE3-DXM204■312NR	5.5-8	3.7	5		
BE3-DXM204■314NR	7-10	5.5	7.5		
BE3-DXM204■316XNR	9-14	9	7.5		
BE3-DXM204■321NR	13-18	11	15	14008	
BE3-DXM254■321XNR	14-22	11	15	16038	
BE3-DXM254■322NR	18-25	11	15		
BE3-DXM254■353NR	23-32	15/18	20/25	16977	



New

3Ø Semi Automatic Star Delta Starter in S.S Enclosure [HSN Code: 8536] GST@18%
 Incorporating Heavy Duty 4 Pole Contactor type TC1-DX with wide band operating coil, Overload relay type LR3D for motor protection

Reference	Relay Range (Amp)	Std. Power Rating for 3P at 415V		MRP (₹)	Std. Pkg. (Nos.)
		kW	HP		
BE3-DXM204■314SANR	7.0-10	9	12	11289	2
BE3-DXM204■316XSANR	9.0-14	11	15		
BE3-DXM204■321SANR	13.0-18	15	20	11643	
BE3-DXM254■321XSANR	14.0-22	18	25	14449	
BE3-DXM254■322SANR	18.0-25	18	25		
BE3-DXM254■353SANR	23.0-32	22.5	30	15859	



New

3Ø Submersible Pump Starter Automatic Star Delta in S.S. Enclosure [HSN Code: 8536] GST@18%
 Incorporating Heavy Duty 4 Pole contactor type TC1-DX with wide band operating coil, Overload relay type LR1D with pneumatic timer

Reference	Relay (Amp)	Standard Power Rating		MRP (₹)	Std. Pkg. (Nos.)
		kW	HP		
BE3-DXM204■307-PTNR	1.6-2.5	1.5	2	13649	1
BE3-DXM204■308-PTNR	2.5-4.0	3	4		
BE3-DXM204■310-PTNR	4.0-6.0	4	5.5		
BE3-DXM204■312-PTNR	5.5-8.0	5.5	7.5		
BE3-DXM204■316X-PTNR	9.0-14.0	11	15		
BE3-DXM204■321-PTNR	13.0-18.0	15	20	14088	
BE3-DXM254■321X-PTNR	14.0-22.0	18	25	16155	
BE3-DXM254■322-PTNR	18.0-25.0	18	25		
BE3-DXM254■353-PTNR	23.0-32.0	22.5	30	17087	



New

Coil Voltage Codes (Standard) for DOL / Star Delta Starters

Coil Voltage (AC) 50Hz	Voltage	
	190-400 Q	250-440 N



Protection Measurement & Control Devices



- Digital Panel Meters
- Multi Function Meters
- Power Factor Controller
- Power Quality Measurements
- Demand Controller
- Electronic Motor Protection Relay
- Electronic Motor Protection Relay-CSMP
- Earth Leakage Relay
- DG AMF / Synchronizing Controller
- Voltage & Current Monitoring Relay & Timer

Digital Panel Meters

Models

1/3 Phase Voltage, Current, Frequency, Power Factor

Features

- Accuracy Class: 1.0
- Direct Current Measurement up to 60A based on Model selection.
- Programmable CT/PT Primary & CT/PT Secondary based on Model Selection
- 4 Quadrant Measurement
- True RMS Measurement
- Smart Keys for easy access of parameters
- Conforming to IEC 62053-21



Description	Reference	Communication	Accuracy class	HSN Code	MRP (₹)
1 Phase Voltage - 230V or 415V	CSM-A-V1-S1	NA	Class1	85364900	1390
1 Phase Current	CSM-A-I1-S1	NA	Class1	85364900	1390
1 Phase Frequency	CSM-A-F1-S1	NA	Class1	85364900	1390
1 Phase PF	CSM-A-P1-S1	NA	Class1	85364900	1390
3 Phase voltage	CSM-A-V3-S1	NA	Class1	85364900	1960
3 Phase Current	CSM-A-I3-S1	NA	Class1	85364900	1960
3 Phase Frequency	CSM-A-F3-S1	NA	Class1	85364900	1960
3 Phase kWh	CSM-A-E3-S3	NA	Class1	85364900	4270
3 Phase kWh	CSM-A-E3-S3-C	Available	Class1	85364900	5000

Multi Function Meters

Features

- Accuracy Class: 1.0
- 2 Output Contact for trip
- Optional RS-485 Modbus Communication
- 4 Digit, 7 Segment LED Display
- Number of sample per cycle 50 at 50Hz.
- Use on LV & HT System
- 4 Quadrant Measurement
- Conforming to IEC 62053-21



Description	Reference	Communication	Accuracy class	HSN Code	MRP (₹)
3 Phase Voltage, Current, Frequency	CSM-A-M3-S3	NA	Class1	90303310	3240
3 Phase Voltage, Current, Frequency With communication	CSM-A-M3-S3-C	Available	Class1	90303310	3870
3 Phase Voltage, Current, Frequency, PF, kW, kVA, kVAR, kWh	CSM-A-M4-S3	NA	Class1	90303310	5700
3 Phase Voltage, Current, Frequency, PF, kW, kVA, kVAR, kWh with communication	CSM-A-M4-S3-C	Available	Class1	90303310	6640
3 Phase Voltage, Current, Frequency, PF, kW, kVA, kVAR, kWh, kVAh, kVARh	CSM-A-M5-S3	NA	Class1	90303310	8220
3 Phase Voltage, Current, Frequency, PF, kW, kVA, kVAR, kWh, kVAh, kVARh with Communication	CSM-A-M5-S3-C	Available	Class1	90303310	9170



Power Quality Measurement

Multifunction Metering

Current/ Voltage/ Frequency/ Power Factor/ Unbalance/ Phase Angle/ Energy Values/ THD/ Mode Dependent Export/Import Energy

Features

- Accuracy Class: 1 & 0.5
- 2 Output Contact for trip
- Optional RS-485 Modbus Communication
- LED Display
- Number of sample per cycle 50 at 50Hz.
- Use on LV & HT System
- Programmable CT/PT Primary & CT/PT Secondary based on Model Selection



Description	Reference	Communication	Accuracy class	HSN Code	MRP (₹)
3 Phase Per Phase Current, Neutral Current, Ph to Ph Voltage, Ph to N Voltage, Frequency, Per Ph & Average PF, Per Ph & total kW OR Per Ph & total kVA, Current & Voltage unbalance, RPM, kWh OR kVAh, THD Per Ph for Voltage & Current, Run hour, Contact for V/I/F/PF/W/VA, LED pulse check	CSM-T-MF2810	-	Class 1	90303310	22790
3 Phase Per Phase Current, Neutral Current, Ph to Ph Voltage, Ph to N Voltage, Frequency, Per Ph & Average PF, Per Ph & total kW OR Per Ph & total kVA, Current & Voltage unbalance, RPM, kWh OR kVAh, THD Per Ph for Voltage & Current, Run hour, Contact for V/I/F/PF/W/VA, LED pulse check	CSM-T-MFR2810	Modbus RS485	Class 1	90303310	24780
3 Phase Per Phase Current, Neutral Current, Ph to Ph Voltage, Ph to N Voltage, Frequency, Per Ph & Average PF, Per Ph & total kW OR Per Ph & total kVA, Current & Voltage unbalance, RPM, kWh OR kVAh, THD Per Ph for Voltage & Current, Run hour, Contact for V/I/F/PF/W/VA, LED pulse check	CSM-T-MF2805	-	Class 0.5	90303310	23730
3 Phase Per Phase Current, Neutral Current, Ph to Ph Voltage, Ph to N Voltage, Frequency, Per Ph & Average PF, Per Ph & total kW OR Per Ph & total kVA, Current & Voltage unbalance, RPM, kWh OR kVAh, THD Per Ph for Voltage & Current, Run hour, Contact for V/I/F/PF/W/VA, LED pulse check	CSM-T-MFR2805	Modbus RS485	Class 0.5	90303310	25830
3 Phase Per Phase Current, Neutral Current, Ph to Ph Voltage, Ph to N Voltage, Frequency, Per Ph & Average PF, Per Ph & total kW, Per Ph & total kVA, Per Ph & total kVAR, Current & Voltage unbalance, RPM, kWh, kVAh, kVARh, THD Per Ph for Voltage & Current, Run & ON hour, No of interrupt, LED pulse check, Phase angle between V&I for Ph1, Ph2, Ph3	CSM-T-MF4210	-	Class 1	90303310	32130
3 Phase Per Phase Current, Neutral Current, Ph to Ph Voltage, Ph to N Voltage, Frequency, Per Ph & Average PF, Per Ph & total kW, Per Ph & total kVA, Per Ph & total kVAR, Current & Voltage unbalance, RPM, kWh, kVAh, kVARh, THD Per Ph for Voltage & Current, Run & ON hour, No of interrupt, LED pulse check, Phase angle between V&I for Ph1, Ph2, Ph3	CSM-T-MFR4210	Modbus RS485	Class 1	90303310	35280
3 Phase Per Phase Current, Neutral Current, Ph to Ph Voltage, Ph to N Voltage, Frequency, Per Ph & Average PF, Per Ph & total kW, Per Ph & total kVA, Per Ph & total kVAR, Current & Voltage unbalance, RPM, kWh, kVAh, kVARh, THD Per Ph for Voltage & Current, Run & ON hour, No of interrupt, LED pulse check, Phase angle between V&I for Ph1, Ph2, Ph3	CSM-T-MF4205	-	Class 0.5	90303310	34230
3 Phase Per Phase Current, Neutral Current, Ph to Ph Voltage, Ph to N Voltage, Frequency, Per Ph & Average PF, Per Ph & total kW, Per Ph & total kVA, Per Ph & total kVAR, Current & Voltage unbalance, RPM, kWh, kVAh, kVARh, THD Per Ph for Voltage & Current, Run & ON hour, No of interrupt, LED pulse check, Phase angle between V&I for Ph1, Ph2, Ph3	CSM-T-MFR4205	Modbus RS485	Class 0.5	90303310	36330
3 Phase Per Phase Current, Neutral Current, Ph to Ph Voltage, Ph to N Voltage, Frequency, Per Ph & Average PF, Per Ph & total kW, Per Ph & total kVA, Per Ph & total kVAR, Current & Voltage unbalance, RPM, kWh, kVAh, kVARh, THD Per Ph for Voltage & Current, Run & ON hour, No of interrupt, Contact for V/I/F/PF/W/VA, LED pulse check	CSM-T-MFRR4210	Modbus RS485	Class 1	90303310	39480
3 Phase Per Phase Current, Neutral Current, Ph to Ph Voltage, Ph to N Voltage, Frequency, Per Ph & Average PF, Per Ph & total kW, Per Ph & total kVA, Per Ph & total kVAR, Current & Voltage unbalance, RPM, kWh, kVAh, kVARh, THD Per Ph for Voltage & Current, Run & ON hour, No of interrupt, Contact for V/I/F/PF/W/VA, LED pulse check	CSM-T-MFRR4205	Modbus RS485	Class 0.5	90303310	41580
3 Phase Per Phase Current, Neutral Current, Ph to Ph Voltage, Ph to N Voltage, Frequency, Per Ph & Average PF, Per Ph & total kW, Per Ph & total kVA, Per Ph & total kVAR, Current & Voltage unbalance, kWh, kVAh, kVARh, Export/Import, THD Per Ph for Voltage & Current, LED pulse check	CSM-T-MFR4805	Modbus RS485	Class 0.5	90303310	POR

Demand Controller

Metering

Current/ Voltage/ Frequency/ Power Factor/ Unbalance/ Phase Angle/ Energy Values/ THD

Features

- Accuracy Class1 (0.5 Optional)
- 2 Output Contact for trip
- Optional RS-485 Modbus Communication
- LED Display
- Number of sample per cycle 50 at 50Hz.
- Use on LV & HT System



Description	Reference	Communication	Accuracy class	HSN Code	MRP (₹)
Demand controller with 3 Phase Per Phase Current, Neutral Current, Ph to Ph Voltage, Ph to N Voltage, Frequency, Per Ph & Average PF, Per Ph & total kW, Per Ph & total kVA, Per Ph & total kVAR, Phase angle between V&I for Ph1, Ph2, Ph3, RTC, Current & Voltage unbalance, kWh, kVAh, kVARh, THD Per Ph for Voltage & Current, LED pulse check, 2 output contacts for Demand control	CSM-T-SDC5110	Modbus RS485	Class 1	90303310	POR
Demand controller with 3 Phase Per Phase Current, Neutral Current, Ph to Ph Voltage, Ph to N Voltage, Frequency, Per Ph & Average PF, Per Ph & total kW, Per Ph & total kVA, Per Ph & total kVAR, Phase angle between V&I for Ph1, Ph2, Ph3, RTC, Current & Voltage unbalance, kWh, kVAh, kVARh, THD Per Ph for Voltage & Current, LED pulse check, 2 output contacts for Demand control	CSM-T-SDC5105	Modbus RS485	Class 0.5	90303310	POR

Power Factor Controller

Features

- 6/8/12 Conventional (Contactor switching) Power Factor Controller
- Protection & Indication of abnormal condition such as over/under compensation, over Voltage, over/under Current etc.
- Wide range of CT ratio & Target PF Selection
- Automatic C/K Setup Mode.
- Indication of Active bank through LED's
- Selection of various wiring scheme



Description	Reference	HSN Code	MRP (₹)
Single CT Input Controller (LED based)			
6 Stage APFC Controller with Single CT Input	CSPF-100-R06-100	85381010	11430
8 Stage APFC Controller with Single CT Input	CSPF-100-R08-100	85381010	13530
12 Stage APFC Controller with Single CT Input	CSPF-100-R12-100	85381010	15460
Single CT Input Controller (LCD based)			
6 Stage APFC Controller with Single CT Input	CSPF-200-R06-200	85381010	15230
8 Stage APFC Controller with Single CT Input	CSPF-200-R08-200	85381010	16700
12 Stage APFC Controller with Single CT Input	CSPF-200-R12-200	85381010	18270



Electronic Motor Protection Relay

Models

mPRO200, mPRO100, mPRO90, mPRO 50

Protection

Overload/ Phase loss/ Locked rotor/ Stall/ Phase reversal/ Current unbalance/ Short circuit/ Under current/ Earthfault (Residual / CBCT) Over temperature, external fault

Features

- Din mount Base & Door mount LCD Display
- High Accurate Compact Multi Protection LV Protection Relay
- Trip Class Selection from 5 to 60
- Can be use in Inverter Circuit (20~200Hz)
- Last 5 fault records / Motor Run hour
- Option Modbus on RS485 or 4~20 mA analog output
- Last 3 START / STOP record
- DI / DO Matrix programmability
- Multiple Reset functions



mPRO200

Description	Reference	Current Range (A)	HSN Code	MRP (₹)
MPRO-200, Rated current range (5-60A), with internal residual calculation, Aux supply (190-260V AC)	MPRO-200-60-E-00-H-V2	5.0-60	85364900	17120
MPRO-200, Rated current range (1-5A), with internal residual calculation, Aux supply (190-260V AC)	MPRO-200-05-E-00-H-V2	1.0-5.0	85364900	17120
MPRO-200, Rated current range (5-60A), with internal residual calculation, Aux supply (100-160V AC)	MPRO-200-60-E-00-L-V2	5.0-60	85364900	17120
MPRO-200, Rated current range (1-5A), with internal residual calculation, Aux supply (100-160V AC)	MPRO-200-05-E-00-L-V2	1.0-5.0	85364900	17120
MPRO-200, Rated current range (1-5A), with internal residual calculation, 4-20mA output + DI, Aux supply (190-260V AC)	MPRO-200-05-E-A0-H-V2	1.0-5.0	85364900	21400
MPRO-200, Rated current range (1-5A), with internal residual calculation, 4-20mA output + DI, Aux supply (100-160V AC)	MPRO-200-05-E-A0-L-V2	1.0-5.0	85364900	21400
MPRO-200, Rated current range (1-5A), with internal residual calculation, MODBUS RS485+DI, Aux supply (190-260V AC)	MPRO-200-05-E-C0-H-V2	1.0-5.0	85364900	21400
MPRO-200, Rated current range (1-5A), with internal residual calculation, MODBUS RS485+DI, Aux supply (100-160V AC)	MPRO-200-05-E-C0-L-V2	1.0-5.0	85364900	21400
MPRO-200, Rated current range (1-5A), with external CBCT Circular ID=57mm, Plastic casing, Aux Supply (190-260V AC)	MPRO-200-05-Z55-00-H-V2	1.0-5.0	85364900	22470
MPRO-200, Rated current range (1-5A), with external CBCT Circular ID=57mm, Plastic casing, Aux Supply (100-160V AC)	MPRO-200-05-Z55-00-L-V2	1.0-5.0	85364900	22470
MPRO-200, Rated current range (1-5A), with external CBCT Circular ID=57mm, Plastic casing, 4-20mA output + DI, Aux Supply (190-260V AC)	MPRO-200-05-Z55-A0-L-C1-V2	1.0-5.0	85364900	42800
MPRO-200, Rated current range (1-5A), with external CBCT Circular ID=57mm, Plastic casing, 4-20mA output + DI, Aux Supply (100-160V AC)	MPRO-200-05-Z55-A0-L-V2	1.0-5.0	85364900	31030
MPRO-200, Rated current range (1-5A), with external CBCT Circular ID=57mm, Plastic casing, 4-20mA output + DI, Aux Supply (190-260V AC)	MPRO-200-05-Z55-A0-H-V2	1.0-5.0	85364900	31030
MPRO-200, Rated current range (1-5A), with external CBCT Circular ID=57mm, Plastic casing, MODBUS RS485 + DI, Aux Supply (100-160V AC)	MPRO-200-05-Z55-C0-L-V2	1.0-5.0	85364900	31030
MPRO-200, Rated current range (5-60A), with internal residual calculation, 4-20mA output + DI, Aux supply (100-160V AC)	MPRO-200-60-E-A0-L-V2	5.0-60	85364900	21400
MPRO-200, Rated current range (5-60A), with internal residual calculation, 4-20mA output + DI, Aux supply (190-260V AC)	MPRO-200-60-E-A0-H-V2	5.0-60	85364900	21400
MPRO-200, Rated current range (5-60A), with internal residual calculation or external CBCT (field selectable), Aux Supply (85-300V AC/DC)	MPRO-200-60-EZ-00-W-V2	5.0-60	85364900	42800
MPRO-200, Rated current range (5-60A), with internal residual calculation or external CBCT (field selectable), MODBUS RS485, Aux Supply (85-300V AC/DC)	MPRO-200-60-EZ-R0-W-V2	5.0-60	85364900	42800
MPRO-200, Rated current range (5-60A), with internal residual calculation, MODBUS RS485 + DI, Aux supply (190-260V AC)	MPRO-200-60-E-C0-H-V2	5.0-60	85364900	21400
MPRO-200, Rated current range (5-60A), with external CBCT Circular ID=57mm, Plastic casing, 4-20mA output + DI, Aux supply (100-160V AC)	MPRO-200-60-Z55-A0-L-C1-V2	5.0-60	85364900	42800
MPRO-200, Rated current range (5-60A), with external CBCT Circular ID=57mm Plastic casing, 4-20mA + DI, Aux supply (100-160V AC)	MPRO-200-60-Z55-A0-L-V2	5.0-60	85364900	31030
MPRO-200, Rated current range (5-60A), with external CBCT Circular ID=57mm Plastic casing, 4-20mA + DI, Aux supply (190-260V AC)	MPRO-200-60-Z55-A0-H-V2	5.0-60	85364900	31030
MPRO-200, Rated current range (5-60A), with external CBCT Circular ID=57mm Plastic casing, Aux supply (190-260V AC)	MPRO-200-60-Z55-00-H-V2	5.0-60	85364900	22470
MPRO-200, Rated current range (5-60A), with external CBCT Circular ID=57mm Plastic casing, Aux supply (100-160V AC)	MPRO-200-60-Z55-00-L-V2	5.0-60	85364900	22470
MPRO-200, Rated current range (1-5A), with external CBCT Circular ID=92mm, Plastic casing, Aux Supply (190-260V AC)	MPRO-200-05-Z90-00-H-V2	1.0-5.0	85364900	27290
MPRO-200, Rated current range (1-5A), with external CBCT Circular ID=57mm Plastic casing, MODBUS RS485 + DI, Aux Supply (190-260V AC)	MPRO-200-05-Z55-C0-H-V2	1.0-5.0	85364900	31030



mPRO100



mPRO90

Description	Reference	Current Range (A)	HSN Code	MRP (₹)
MPRO-100, Rated current range (1-5A), with internal residual calculation, Aux Supply (190-260V AC)	MPRO-100-5-E-H-V2	1.0-5.0	85364900	15520
MPRO-100, Rated current range (1-5A), with internal residual calculation, Aux Supply (100-160V AC)	MPRO-100-5-E-L-V2	1.0-5.0	85364900	15520
MPRO-100, Rated current range (5-60A), with internal residual calculation, Aux Supply (190-260V AC)	MPRO-100-60-E-H-V2	5.0-60	85364900	15520
MPRO-100, Rated current range (5-60A), with internal residual calculation, Aux Supply (100-160V AC)	MPRO-100-60-E-L-V2	5.0-60	85364900	15520
MPRO-100, Rated current range (1-5A), with external CBCT circular, ID=57mm, plastic casing, Aux Supply (100-160V AC)	MPRO-100-5-Z55-L-V2	1.0-5.0	85364900	21400
MPRO-100, Rated current range (1-5A), with external CBCT circular, ID=70mm, plastic casing, Aux Supply (100-160V AC)	MPRO-100-5-Z70-L-V2	1.0-5.0	85364900	26220
MPRO-100, Rated current range (1-5A), with external CBCT circular, ID=92mm, plastic casing, Aux Supply (100-160V AC)	MPRO-100-5-Z90-L-V2	1.0-5.0	85364900	26220
MPRO-100, Rated current range (1-5A), with external CBCT circular, ID=120mm, plastic casing, Aux Supply (100-160V AC)	MPRO-100-5-Z120-L-V2	1.0-5.0	85364900	24610
MPRO-100, Rated current range (5-60A), with external CBCT circular, ID=57mm, plastic casing, Aux supply (100-160V AC)	MPRO-100-60-Z55-L-V2	5.0-60	85364900	21400
MPRO-100, Rated current range (5-60A), with external CBCT circular, ID=70mm, plastic casing, Aux supply (100-160V AC)	MPRO-100-60-Z70-L-V2	5.0-60	85364900	22470
MPRO-100, Rated current range (5-60A), with external CBCT circular, ID=92mm, plastic casing, Aux supply (100-160V AC)	MPRO-100-60-Z90-L-V2	5.0-60	85364900	23540
MPRO-100, Rated current range (5-60A), with external CBCT circular, ID=120mm, plastic casing, Aux supply (100-160V AC)	MPRO-100-60-Z120-L-V2	5.0-60	85364900	24610
MPRO-100, Rated current range (1-5A), with external CBCT circular, ID=57mm, plastic casing, Aux Supply (190-260V AC)	MPRO-100-5-Z55-H-V2	1.0-5.0	85364900	21400
MPRO-100, Rated current range (1-5A), with external CBCT Circular ID=70mm, Plastic casing, Aux Supply (190-260V AC)	MPRO-100-5-Z70-H-V2	1.0-5.0	85364900	22470
MPRO-100, Rated current range (1-5A), with external CBCT circular, ID=92 mm, plastic casing, Aux Supply (190-260V AC)	MPRO-100-5-Z90-H-V2	1.0-5.0	85364900	23540
MPRO-100, Rated current range (1-5A), with external CBCT Circular ID=120mm, Plastic casing, Aux Supply (190-260V AC)	MPRO-100-5-Z120-H-V2	1.0-5.0	85364900	24610
MPRO-90, External CT1 Rated current Range (0.2-10A), with internal residual calculation	MPRO-90-CT1-E	0.2-10	85364900	9420
MPRO-90, External CT2 Rated current Range (0.8-25A), with internal residual calculation	MPRO-90-CT2-E	0.8-25	85364900	9420
MPRO-90, External CT3 Rated current Range (2-62.5A), with internal residual calculation	MPRO-90-CT3-E	2.0-62.5	85364900	9950
MPRO-90, External CT4 Rated current Range (4-125A), with internal residual calculation	MPRO-90-CT4-E	4.0-125	85364900	11770
MPRO-90, External CT5 Rated current Range (8-250A), with internal residual calculation	MPRO-90-CT5-E	8.0-250	85364900	14980
MPRO-90, External CT1 Rated current Range (0.2-10A), with internal residual calculation, Star-Delta	MPRO-90-CT1-E-SDT	0.2-10	85364900	19800
MPRO-90, External CT2 Rated current Range (0.8-25A), with internal residual calculation, Star-Delta	MPRO-90-CT2-E-SDT	0.8-25	85364900	19800
MPRO-90, External CT3 Rated current Range (2-62.5A), with internal residual calculation, Star-Delta	MPRO-90-CT3-E-SDT	2.0-62.5	85364900	20330
MPRO-90, External CT4 Rated current Range (4-125A), with internal residual calculation, star-Delta	MPRO-90-CT4-E-SDT	4.0-125	85364900	22470
MPRO-90, External CT5 Rated current Range (8-250A), with internal residual calculation, Star-Delta	MPRO-90-CT5-E-SDT	8.0-250	85364900	25680



Protection, Measurement & Control Devices



Description	Reference	Current Range (A)	HSN Code	MRP (₹)
MPRO-50, Rated current range (5-60A), Aux Supply 110VAC (100-160V AC)	MPRO-50-60-L-V2	5.0-60	85364900	14740
MPRO-50, Rated current range (5-60A), Aux Supply 230VAC (190-260V AC)	MPRO-50-60-H-V2	5.0-60	85364900	14740
MPRO-50, Rated current range (1-5A), Aux Supply 110VAC (100-160V AC)	MPRO-50-5-L-V2	1.0-5	85364900	14740
MPRO-50, Rated current range (1-5A), Aux Supply 230VAC (190-260V AC)	MPRO-50-5-H-V2	1.0-5	85364900	14740



Accessories				
Description	Reference	HSN Code	MRP (₹)	
Current Transformer Ratio 100/5A, Burden 5VA, Cl.1.0	3-CT-100/5	85043100	4550	
Current Transformer Ratio 200/5A, Burden 5VA, Cl.1.0	3-CT-200/5	85043100	4550	
Current Transformer Ratio 300/5A, Burden 5VA, Cl.1.0	3-CT-300/5	85043100	5670	
Current Transformer Ratio 400/5A, Burden 5VA, Cl.1.0	3-CT-400/5	85043100	5670	
Current Transformer Ratio 500/5A, Burden 5VA, Cl.1.0	3-CT-500/5	85043100	8030	
Current Transformer Ratio 600/5A, Burden 5VA, Cl.1.0	3-CT-600/5	85043100	8030	

ORDERING INFORMATION

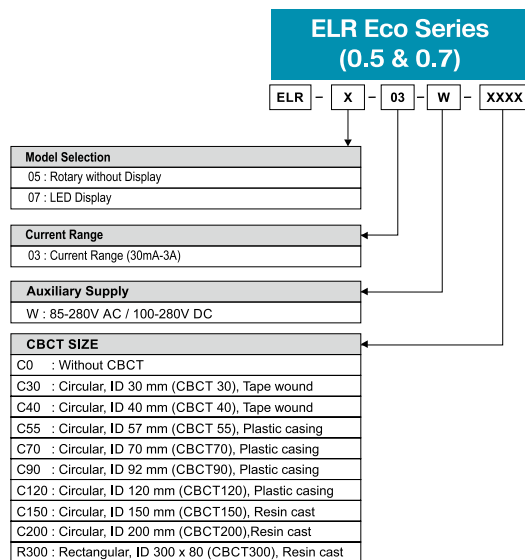
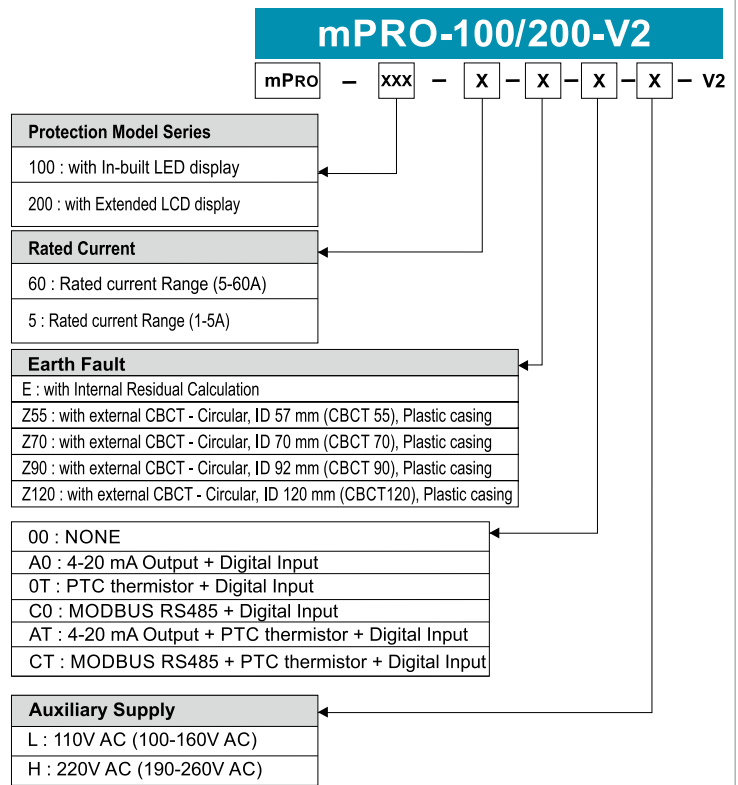
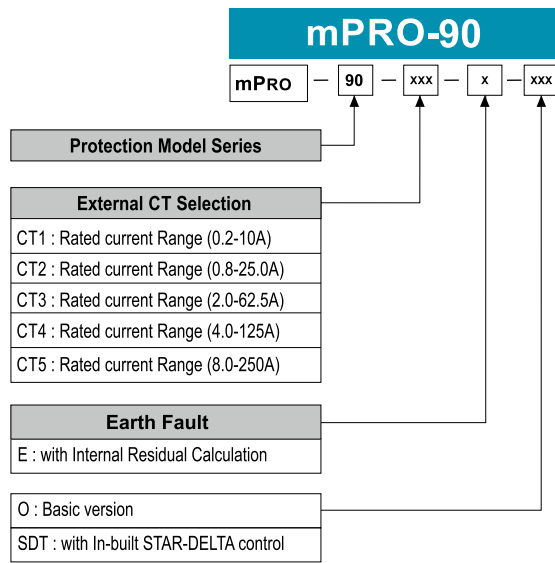

* CBCT Ordering Information (To be selected for mPRO-200-x-Z-x-x model)

CBCT SIZE
Z55 : Circular, ID 57 mm (CBCT 55), Plastic casing
Z70 : Circular, ID 70 mm (CBCT 70), Plastic casing
Z90 : Circular, ID 92 mm (CBCT 90), Plastic casing
Z120 : Circular, ID 120 mm (CBCT 120), Plastic casing



Electronic Motor Protection Relay - CSMP

Protection

Overload/ Phase loss/ Locked rotor/ Phase reversal/ Current unbalance/ Short circuit/ Under current/ Earthfault

Features

- Detachable Din mount Base & Door mount LED Display
- High Accurate Compact Multi Protection LV Protection Relay
- Trip Class Selection from 5 to 60
- Display of 3 phase RMS Current, % current unbalance
- Looping option is available for FHP motors
- Fault diagnostic by LED indication



Description	Reference	Current Range (A)	HSN Code	MRP (₹)
Relay CSMPA-80-3SR,80A,100-260VAC	CSMPA-80-3SR,80A,100-260VAC	16-80	85364900	15750
Relay CSMPA-40-3SR,40A,100-260VAC	CSMPA-40-3SR,40A,100-260VAC	8.0-40	85364900	14700
Relay CSMPA-40-3SR,20A,100-260VAC	CSMPA-40-3SR,20A,100-260VAC	4.0-20	85364900	14700
Relay CSMPA-22-3SR,22A,100-260VAC	CSMPA-22-3SR,22A,100-260VAC	4.4-22	85364900	14700
Relay CSMPA-22-3SR,5A,100-260VAC	CSMPA-22-3SR,5A,100-260VAC	1.0-5	85364900	14700
Relay CSMPA-22-3SR,1.5A,100-260VAC	CSMPA-22-3SR,1.5A,100-260VAC	0.3-1.5	85364900	14700
Relay CSMPM-06i-S (2a+1b) AC/DC85-260V 50/60Hz	CSMPM-06i-S(2A+1B)AC/DC85-260V 50/60HZ	0.5-6.0	85364900	28350
Relay CSMPM-06i-SE (2a+1b) AC/DC85-260V 50/60Hz	CSMPM-06i-SE(2A+1B)AC/DC85-260V 50/60HZ	0.5-6.0	85364900	33600
Relay CSMPM-06i-SI (2a+1b) AC/DC85-260V 50/60Hz	CSMPM-06i-SI(2A+1B)AC/DC85-260V 50/60HZ	0.5-6.0	85364900	28350
Relay CSMPM-06i-SM (2a+1b) AC/DC85-60V 50/60Hz	CSMPM-06i-SM(2A+1B)AC/DC85-60V 50/60HZ	0.5-6.0	85364900	33600
Relay CSMPM-06i-SZ (2a+1b) AC/DC85-260V 50/60Hz	CSMPM-06i-SZ(2A+1B)AC/DC85-260V 50/60HZ	0.5-6.0	85364900	28350
Relay CSMPM-06i-SZIA (2a+1b) AC/DC85-260V 50/60Hz	CSMPM-06i-SZIA(2A+1B)AC/DC85-260V50/60HZ	0.5-6.0	85364900	42000
Relay CSMPM-65i-S (2a+1b) AC/DC85-260V 50/60Hz	CSMPM-65i-S(2A+1B)AC/DC85-260V 50/60HZ	5.0-65	85364900	28350
Relay CSMPM-65i-SE (2a+1b) AC/DC85-260V 50/60Hz	CSMPM-65i-SE(2A+1B)AC/DC85-260V 50/60HZ	5.0-65	85364900	33600
Relay CSMPM-65i-SI (2a+1b) AC/DC85-260V 50/60Hz	CSMPM-65i-SI(2A+1B)AC/DC85-260V 50/60HZ	5.0-65	85364900	28350
Relay CSMPM-65i-SM (2a+1b) AC/DC85-260V 50/60Hz	CSMPM-65i-SM(2A+1B)AC/DC85-260V 50/60HZ	5.0-65	85364900	33600
Relay CSMPM-65i-SZ (2a+1b) AC/DC85-260V 50/60Hz	CSMPM-65i-SZ(2A+1B)AC/DC85-260V 50/60HZ	5.0-65	85364900	28350
IMC-IIIIM4852MAC110V50/60Hz	IMC-III-M485-2-MAC110V50/60Hz	6 / 60	85364900	78230
Relay IMP-CNOAC/DC85-245V	IMP-C-NO AC/DC85-245V	10 / 100	85364900	38850
Relay IMP-CA420AC/DC85-245V	IMP-C-A420 AC/DC85-245V	10 / 100	85364900	44630
Relay IMP-C-M485-AC/DC 85-245-40/60	IMP-C-M485-AC/DC 85-245-40/60	10 / 100	85364900	44630
Relay CSMPA-60-T,6A,220VAC	CSMPA-60-T,6A,220VAC	0.5-6.0	85364900	6140
Relay CSMPA-60-T,60A,220VAC	CSMPA-60-T,60A,220VAC	5.0-60	85364900	6140
Relay CSMPA-60-T,60A,110VAC	CSMPA-60-T,60A,110VAC	s5.0-60	85364900	6140
Relay CSMPA-60-T,6A,110VAC	CSMPA-60-T,6A,110VAC	0.5-6.0	85364900	6140
Relay CSMPA-60-T,60A,415VAC	CSMPA-60-T,60A,415VAC	5.0-60	85364900	6140
Relay CSMPA-60-T,6A,415VAC	CSMPA-60-T,6A,415VAC	0.5-60	85364900	6140

Accessories			
Description	Reference	HSN Code	MRP (₹)
Display Cable-1-1.15 m	ASSY.,(1-1.5)CSMPM	85381090	3360
Display Cable-4 m	ASSY.,(4M)CSMPM	85381090	3680
Z-CTD with ID=30mm	Z-CTD30	85043100	4460
Z-CTD with ID=50mm	Z-CTD50	85043100	5040
Z-CTD with ID=65mm	Z-CTD65	85043100	5570
Z-CTD with ID=80mm	Z-CTD80	85043100	6090



Protection, Measurement & Control Devices

ELR - Earth Leakage Relay

Models

ELR 1.0, ELR 3.0, ELR 0.5 & ELR 0.7



ELR 1.0



ELR 3.0

Protection & Features

- Monitors, Detects & Protects Power system from Earth Leakage Fault
- Wide range of Selectable Earth Leakage Current Setting (30mA-3A), Aux Supply (85-280V AC / 95-280V DC), CBCT Type Circular, ID 150 mm Resin Cast
- Configurable Earth Leakage Trip time 0-30s
- LED indication for Earth Leakage Fault & Alarm indication
- Trip Circuit Failure Indication
- Last 10 Fault records with date & time
- CBCT measures the leakage current to the highest accuracy
- Flush / DIN Rail mountable based on model selection



ELR 0.5



ELR 0.7

Description	Reference		HSN Code	MRP (₹)
Earth Leakage Relay ELR1.0 protection series, LED display with panel front mounting, current range (30mA-3A), Aux Supply (85-280V AC / 95-280V DC), CBCT Type Circular, ID 120 mm with plastic casing	ELR1.0-S-03-W-C120	30mA-3A	85364900	6830
Earth Leakage Relay ELR1.0 protection series, LED display with panel front mounting, current range (30mA-3A), Aux Supply (85-280V AC / 95-280V DC), CBCT Type Circular, ID 150 mm Resin Cast	ELR1.0-S-03-W-C150	30mA-3A	85364900	10500
Earth Leakage Relay ELR1.0 protection series, LED display with panel front mounting, current range (30mA-3A), Aux Supply (85-280V AC / 95-280V DC), CBCT Type Circular, ID 200 mm Resin cast	ELR1.0-S-03-W-C200	30mA-3A	85364900	13130
Earth Leakage Relay ELR1.0 protection series, LED display with panel front mounting, current range (30mA-3A), Aux Supply (85-280V AC / 95-280V DC), CBCT Type Circular, ID 57 mm with plastic casing	ELR-1.0-S-03-W-C55	30mA-3A	85364900	5250
Earth Leakage Relay ELR1.0 protection series, LED display with panel front mounting, current range (30mA-3A), Aux Supply (85-280V AC / 95-280V DC), CBCT Type Circular, ID 70 mm with plastic casing	ELR-1.0-S-03-W-C70	30mA-3A	85364900	5780
Earth Leakage Relay ELR1.0 protection series, LED display with panel front mounting, current range (30mA-3A), Aux Supply (85-280V AC / 95-280V DC), CBCT Type Circular, ID 92 mm with plastic casing	ELR-1.0-S-03-W-C90	30mA-3A	85364900	5780
Earth Leakage Relay ELR1.0 protection series, LED display with panel front mounting, current range (30mA-3A), Aux Supply (85-280V AC/95-280V DC), CBCT Rectangular type ID 300 x 80 (CCT 300) Resin cast	ELR1.0-S-03-W-R300	30mA-3A	85364900	15750
Earth Leakage Relay ELR1.0 protection series, LED display with panel front mounting, current range (300mA-12A), Aux Supply (85-280V AC / 95-280V DC), CBCT Type Circular, ID 92 mm with plastic casing	ELR-1.0-S-12-W-C120	30mA-3A	85364900	6830
Earth Leakage Relay ELR1.0 protection series, LED display with panel front mounting, current range (300mA-12A), Aux Supply (85-280V AC / 95-280V DC), CBCT Type Circular, ID 120 mm with plastic casing	ELR-1.0-S-12-W-C90	30mA-3A	85364900	5780
Earth Leakage Relay ELR3.0 protection series, LCD display with panel front mounting, current range (300mA-12A), Aux Supply (85-280V AC / 95-280V DC), CBCT Type Circular, ID 120 mm with plastic casing	ELR-3.0-L-03-W-C120	30mA-3A	85364900	13130
ELR-0.5, Rotary without Display, current range of 30mA-3A, with Aux supply (W) 85-280VAC/100-280VDC without CBCT	ELR-05-03-W-C0	30mA-3A	85364900	5250
New ELR-0.5, Rotary without Display, current range of 30mA-3A, with Aux supply (W) 85-280VAC/100-280VDC, CBCT(30) : circular ID 30mm, tape wound	ELR-05-03-W-C30	30mA-3A	85364900	5250
ELR-0.5, Rotary without Display, current range of 30mA-3A, with Aux supply (W) 85-280VAC/100-280VDC, CBCT(40) : circular ID 40mm, tape wound	ELR-05-03-W-C40	30mA-3A	85364900	5250
ELR-0.5, Rotary without Display, current range of 30mA-3A, with Aux supply (W) 85-280VAC/100-280VDC, CBCT(55) : circular ID 57mm, plastic casing	ELR-05-03-W-C55	30mA-3A	85364900	5250
ELR-0.5, Rotary without Display, current range of 30mA-3A, with Aux supply (W) 85-280VAC/100-280VDC, CBCT(70) : circular ID 70mm, plastic casing	ELR-05-03-W-C70	30mA-3A	85364900	5780
ELR-0.5, Rotary without Display, current range of 30mA-3A, with Aux supply (W) 85-280VAC/100-280VDC, CBCT(90) : circular ID 92mm, plastic casing	ELR-05-03-W-C90	30mA-3A	85364900	5780
ELR-0.5, Rotary without Display, current range of 30mA-3A, with Aux supply (W) 85-280VAC/100-280VDC, CBCT(120) : circular ID 120mm, plastic casing	ELR-05-03-W-C120	30mA-3A	85364900	6830
ELR-0.5, Rotary without Display, current range of 30mA-3A, with Aux supply (W) 85-280VAC/100-280VDC, CBCT(150) : circular ID 150mm, Resin cast	ELR-05-03-W-C150	30mA-3A	85364900	10500
ELR-0.5, Rotary without Display, current range of 30mA-3A, with Aux supply (W) 85-280VAC/100-280VDC, CBCT(200) : circular ID 200mm, Resin cast	ELR-05-03-W-C200	30mA-3A	85364900	13130
ELR-0.5, Rotary without Display, current range of 30mA-3A, with Aux supply (W) 85-280VAC/100-280VDC, CBCT(300) : Rectangular, ID 300x80, Resin cast	ELR-05-03-W-R300	30mA-3A	85364900	15750
New ELR-0.7, Rotary without Display, current range of 30mA-3A, with Aux supply (W) 85-280VAC/100-280VDC without CBCT	ELR-07-03-W-C0	30mA-3A	85364900	5250
ELR-0.7, Rotary without Display, current range of 30mA-3A, with Aux supply (W) 85-280VAC/100-280VDC, CBCT(30) : circular ID 30mm, tape wound	ELR-07-03-W-C30	30mA-3A	85364900	5250
ELR-0.7, Rotary without Display, current range of 30mA-3A, with Aux supply (W) 85-280VAC/100-280VDC, CBCT(40) : circular ID 40mm, tape wound	ELR-07-03-W-C40	30mA-3A	85364900	5250
ELR-0.7, Rotary without Display, current range of 30mA-3A, with Aux supply (W) 85-280VAC/100-280VDC, CBCT(55) : circular ID 57mm, plastic casing	ELR-07-03-W-C55	30mA-3A	85364900	5250
ELR-0.7, Rotary without Display, current range of 30mA-3A, with Aux supply (W) 85-280VAC/100-280VDC, CBCT(70) : circular ID 70mm, plastic casing	ELR-07-03-W-C70	30mA-3A	85364900	5780
ELR-0.7, Rotary without Display, current range of 30mA-3A, with Aux supply (W) 85-280VAC/100-280VDC, CBCT(90) : circular ID 92mm, plastic casing	ELR-07-03-W-C90	30mA-3A	85364900	5780
ELR-0.7, Rotary without Display, current range of 30mA-3A, with Aux supply (W) 85-280VAC/100-280VDC, CBCT(120) : circular ID 120mm, plastic casing	ELR-07-03-W-C120	30mA-3A	85364900	6830
ELR-0.7, Rotary without Display, current range of 30mA-3A, with Aux supply (W) 85-280VAC/100-280VDC, CBCT(150) : circular ID 150mm, Resin cast	ELR-07-03-W-C150	30mA-3A	85364900	10500
ELR-0.7, Rotary without Display, current range of 30mA-3A, with Aux supply (W) 85-280VAC/100-280VDC, CBCT(200) : circular ID 200mm, Resin cast	ELR-07-03-W-C200	30mA-3A	85364900	13130
ELR-0.7, Rotary without Display, current range of 30mA-3A, with Aux supply (W) 85-280VAC/100-280VDC, CBCT(300) : Rectangular, ID 300x80, Resin cast	ELR-07-03-W-R300	30mA-3A	85364900	15750

DG AMF / Synchronizing Controller

Models

EC2, EGA-250, EC-RXA, CD 2.0, CD 5.0

Protection & Features

- Display 3 Phase Mains Parameters: Voltage & Frequency
- Display of 3 Phase Generator Parameters: Voltage, Frequency, Speed, Run Hours
- Multi-genset Synchronizer & Load Share Unit
- Fault record with date & time stamp
- Event record with date & time stamp
- ATS/ATF/ Remote Start Controller/ Engine Controller



Description	Reference	HSN Code	MRP (₹)
Relay EC2(VER1.10)	EC2(VER1.10)	85364900	22050
Relay EC-RXA_V2	EC-RXA_V2	85364900	13390
Relay EGA-250-0	EGA-250-0	85364900	15750
Relay EC2(VER 2.10)	EC2-V2.10	85364900	22050
AMF Relay CD2.0 with MPU	AMF RELAY CD2.0 WITH MPU	85364900	17330
AMF Relay CD 5.0	AMF Relay CD 5.0	85364900	47250
Relay DG Synchronizer Relay CD5.0 with RS485/Ethernet	DG SYNC RELAY CD5.0 RS485/ETHERNET	85364900	158550
Relay EGC-250-0	EGC-250-0	85364900	16800

Voltage & Current Monitoring Relay & Timer

Model

Voltage Monitoring, Current Monitoring & Timers

Protection & features

- 3 Phase Voltage Monitoring
- 1 Phase Current Monitoring
- ON / OFF Delay Timer



Description	Reference	HSN Code	MRP (₹)
ENYA series- Multifunction Timer,Up to 7 functions,7 time ranges,Wide input voltage range	E1Z1E1024-240VAC/DC VE10 (110204A)	85364900	8090
Monitoring relays - ENYA series, Voltage monitoring in 3- and 1-phase mains	E1YM400VS10 (1340405H)	85364900	4990
Monitoring relays - GAMMA series, AC/DC current monitoring in 1-phase mains	G2IM10AL20,24-240V (2390410)	85364900	25200
ENYA series-Multifunction Timer,Up to 7 functions,7 time ranges,Wide input voltage range	E1ZM10 12-240VAC/DC	85364900	8400
Monitoring relays - ENYA series, Tripping unit for temperature monitoring	E3TF01 230VAC	85364900	13650
Monitoring relays - ENYA series - AC/DC current monitoring in 1-phase mains	E3IM10AL20,230VAC (1341200)	85364900	21210
ENYA series, Timers - Multifunctional,Up to 7 functions,7 time ranges,Wide input voltage range	E1ZMQ10,24-240VAC/DC	85364900	8400
ENYA series- Timers - Asymmetric flasher	E1ZI10 12-240VAC/DC	85364900	8400
Monitoring relays - GAMMA series,Voltage monitoring in 3-phase mains	G2PM690VSY20	85364900	26250
Monitoring relays - GAMMA series, Voltage monitoring in 3-phase mains	G2PM400VSY20(2390504)	85364900	19430
Monitoring relays - GAMMA series,a.c./d.c. current monitoring in 1-phase mains	G2IM5AL20,24-240V	85364900	25200
Monitoring relays - GAMMA series, a.c./d.c. current monitoring in 1-phase mains	G2IM10AL20 24-240V AC/DC	85364900	25200
Monitoring Relays-TR Series	TR2-400VAC(282117)	85364900	2520

Final Power Distribution Components



Miniature Circuit Breakers ■ Residual Current Circuit Breakers
Isolators ■ MCB Type Changeover Switches ■ ACCL ■ Distribution Boards
Cable End Boxes ■ Plugs & Socket DBs ■ MCB Enclosures

WiNtrip2 Miniature Circuit Breaker

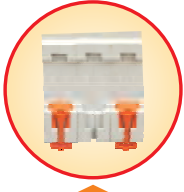

Two stage easy snapping device for Din Rail Mounting



Bi-connect terminals for Cable and Busbar

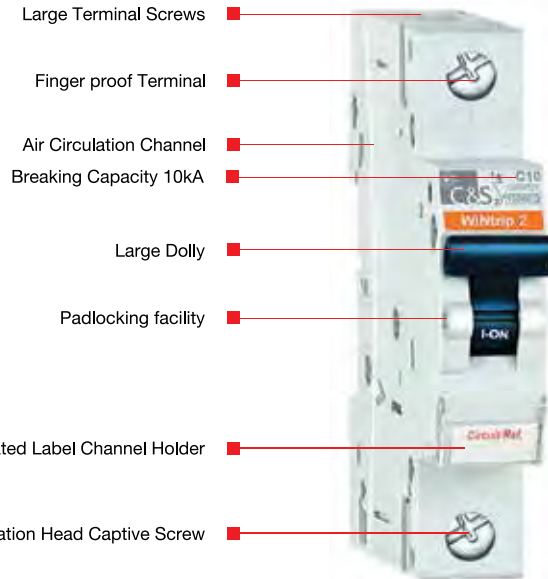

B-Series

Lighting & Distribution with no Surge Current

[HSN Code: 8536]



Current rating (Amps.)	Product Code	MRP (₹)	Std. Pkg. (Nos.)
1 Pole			
6	CSMBS1B6	265	12
10	CSMBS1B10	265	
16	CSMBS1B16	265	
20	CSMBS1B20	265	
25	CSMBS1B25	265	
32	CSMBS1B32	265	
40	CSMBS1B40	620	
50	☒ CSMBS1B50	695	
63	CSMBS1B63	695	

Current rating (Amps.)	Product Code	MRP (₹)	Std. Pkg. (Nos.)
3 Pole			
6	CSMBS3B6	1440	4
10	CSMBS3B10	1440	
16	CSMBS3B16	1440	
20	CSMBS3B20	1440	
25	CSMBS3B25	1440	
32	CSMBS3B32	1440	
40	CSMBS3B40	2140	
50	☒ CSMBS3B50	2140	
63	CSMBS3B63	2140	



Current rating (Amps.)	Product Code	MRP (₹)	Std. Pkg. (Nos.)
1 Pole + N			
6	CSMBS1B6N	870	6
10	CSMBS1B10N	870	
16	CSMBS1B16N	870	
20	CSMBS1B20N	870	
25	CSMBS1B25N	870	
32	CSMBS1B32N	870	
40	CSMBS1B40N	1255	
50	☒ CSMBS1B50N	1415	
63	CSMBS1B63N	1415	

Current rating (Amps.)	Product Code	MRP (₹)	Std. Pkg. (Nos.)
3 Pole + N			
6	☒ CSMBS3B6N	1890	3
10	☒ CSMBS3B10N	1890	
16	CSMBS3B16N	1890	
20	☒ CSMBS3B20N	1890	
25	☒ CSMBS3B25N	1890	
32	CSMBS3B32N	1890	
40	CSMBS3B40N	2510	
50	☒ CSMBS3B50N	2790	
63	CSMBS3B63N	2790	



Current rating (Amps.)	Product Code	MRP (₹)	Std. Pkg. (Nos.)
2 Pole			
6	CSMBS2B6	965	6
10	CSMBS2B10	965	
16	CSMBS2B16	965	
20	CSMBS2B20	965	
25	CSMBS2B25	965	
32	CSMBS2B32	965	
40	CSMBS2B40	1365	
50	☒ CSMBS2B50	1570	
63	CSMBS2B63	1570	

Current rating (Amps.)	Product Code	MRP (₹)	Std. Pkg. (Nos.)
4 Pole			
6	☒ CSMBS4B6	2085	3
10	☒ CSMBS4B10	2085	
16	☒ CSMBS4B16	2085	
20	☒ CSMBS4B20	2085	
25	☒ CSMBS4B25	2085	
32	CSMBS4B32	2085	
40	CSMBS4B40	2725	
50	CSMBS4B50	2905	
63	CSMBS4B63	2905	

☒ Non Stockable item

WiNtrip2 Miniature Circuit Breaker

C-Series

Inductive load with surge current - Motor Circuit Applications

[HSN Code: 8536]



Current rating (Amps.)	Product Code	MRP (₹)	Std. Pkg. (Nos.)
1 Pole			
0.5	CSMBS1C0.5	470	12
1	CSMBS1C1	470	
2	CSMBS1C2	470	
3	CSMBS1C3	470	
4	CSMBS1C4	470	
5	CSMBS1C5	470	
6	CSMBS1C6	275	
10	CSMBS1C10	275	
16	CSMBS1C 16	275	
20	CSMBS1C20	275	
25	CSMBS1C25	275	
32	CSMBS1C32	275	
40	CSMBS1C40	655	
50	CSMBS1C50	705	
63	CSMBS1C63	705	

Current rating (Amps.)	Product Code	MRP (₹)	Std. Pkg. (Nos.)
3 Pole			
0.5	CSMBS3C0.5	1905	4
1	CSMBS3C1	1905	
2	CSMBS3C2	1905	
3	CSMBS3C3	1905	
4	CSMBS3C4	1905	
5	CSMBS3C5	1905	
6	CSMBS3C6	1525	
10	CSMBS3C10	1525	
16	CSMBS3C16	1525	
20	CSMBS3C20	1525	
25	CSMBS3C25	1525	
32	CSMBS3C32	1525	
40	CSMBS3C40	2260	
50	CSMBS3C50	2355	
63	CSMBS3C63	2355	



Current rating (Amps.)	Product Code	MRP (₹)	Std. Pkg. (Nos.)
1 Pole + N			
0.5	CSMBS1C0.5N	1300	6
1	CSMBS1C1N	1300	
2	CSMBS1C2N	1300	
3	CSMBS1C3N	1300	
4	CSMBS1C4N	1300	
5	CSMBS1C5N	1300	
6	CSMBS1C6N	920	
10	CSMBS1C10N	920	
16	CSMBS1C16N	920	
20	CSMBS1C20N	920	
25	CSMBS1C25N	920	
32	CSMBS1C32N	920	
40	CSMBS1C40N	1340	
50	CSMBS1C50N	1515	
63	CSMBS1C63N	1515	

Current rating (Amps.)	Product Code	MRP (₹)	Std. Pkg. (Nos.)
3 Pole + N			
0.5	CSMBS3C0.5N	2465	3
1	CSMBS3C1N	2465	
2	CSMBS3C2N	2465	
3	CSMBS3C3N	2465	
4	CSMBS3C4N	2465	
5	CSMBS3C5N	2465	
6	CSMBS3C6N	1935	
10	CSMBS3C10N	1935	
16	CSMBS3C16N	1935	
20	CSMBS3C20N	1935	
25	CSMBS3C25N	1935	
32	CSMBS3C32N	1935	
40	CSMBS3C40N	2635	
50	CSMBS3C50N	2800	
63	CSMBS3C63N	2800	



Current rating (Amps.)	Product Code	MRP (₹)	Std. Pkg. (Nos.)
2 Pole			
0.5	CSMBS2C0.5	1355	6
1	CSMBS2C1	1355	
2	CSMBS2C2	1355	
3	CSMBS2C3	1355	
4	CSMBS2C4	1355	
5	CSMBS2C5	1355	
6	CSMBS2C6	965	
10	CSMBS2C10	965	
16	CSMBS2C16	965	
20	CSMBS2C20	965	
25	CSMBS2C25	965	
32	CSMBS2C32	965	
40	CSMBS2C40	1415	
50	CSMBS2C50	1610	
63	CSMBS2C63	1610	

Current rating (Amps.)	Product Code	MRP (₹)	Std. Pkg. (Nos.)
4 Pole			
0.5	CSMBS4C0.5	2625	3
1	CSMBS4C1	2625	
2	CSMBS4C2	2625	
3	CSMBS4C3	2625	
4	CSMBS4C4	2625	
5	CSMBS4C5	2625	
6	CSMBS4C6	2140	
10	CSMBS4C10	2140	
16	CSMBS4C16	2140	
20	CSMBS4C20	2140	
25	CSMBS4C25	2140	
32	CSMBS4C32	2140	
40	CSMBS4C40	2940	
50	CSMBS4C50	3035	
63	CSMBS4C63	3035	

☒ Non Stockable item

WiNtrip2 Miniature Circuit Breaker

D-Series

High Inductive Load & High Inrush Current

[HSN Code: 8536]



Current rating (Amps.)	Product Code	MRP (₹)	Std. Pkg. (Nos.)
1 Pole			
0.5	CSMBS1D0.5	530	12
1	CSMBS1D1	530	
2	☒CSMBS1D2	530	
3	CSMBS1D3	530	
4	CSMBS1D4	530	
5	CSMBS1D5	530	
6	☒CSMBS1D6	435	
10	☒CSMBS1D10	435	
16	☒CSMBS1D16	435	
20	☒CSMBS1D20	435	
25	☒CSMBS1D25	435	
32	☒CSMBS1D32	435	
40	CSMBS1D40	745	
50	CSMBS1D50	835	
63	CSMBS1D63	835	

Current rating (Amps.)	Product Code	MRP (₹)	Std. Pkg. (Nos.)
3 Pole			
0.5	CSMBS3D0.5	2120	4
1	CSMBS3D1	2120	
2	CSMBS3D2	2120	
3	CSMBS3D3	2120	
4	CSMBS3D4	2120	
5	CSMBS3D5	2120	
6	☒CSMBS3D6	1675	
10	CSMBS3D10	1675	
16	☒CSMBS3D16	1675	
20	☒CSMBS3D20	1675	
25	☒CSMBS3D25	1675	
32	☒CSMBS3D32	1675	
40	☒CSMBS3D40	2540	
50	CSMBS3D50	2635	
63	☒CSMBS3D63	2635	



Current rating (Amps.)	Product Code	MRP (₹)	Std. Pkg. (Nos.)
1 Pole + N			
0.5	CSMBS1D0.5N	1340	6
1	CSMBS1D1N	1340	
2	CSMBS1D2N	1340	
3	CSMBS1D3N	1340	
4	CSMBS1D4N	1340	
5	CSMBS1D5N	1340	
6	CSMBS1D6N	1060	
10	CSMBS1D10N	1060	
16	CSMBS1D16N	1060	
20	CSMBS1D20N	1060	
25	CSMBS1D25N	1060	
32	☒CSMBS1D32N	1060	
40	CSMBS1D40N	1570	
50	CSMBS1D50N	1675	
63	☒CSMBS1D63N	1675	

Current rating (Amps.)	Product Code	MRP (₹)	Std. Pkg. (Nos.)
3 Pole + N			
0.5	CSMBS3D0.5N	2735	3
1	CSMBS3D1N	2735	
2	CSMBS3D2N	2735	
3	CSMBS3D3N	2735	
4	CSMBS3D4N	2735	
5	CSMBS3D5N	2735	
6	CSMBS3D6N	2495	
10	CSMBS3D10N	2495	
16	☒CSMBS3D16N	2495	
20	CSMBS3D20N	2495	
25	☒CSMBS3D25N	2495	
32	☒CSMBS3D32N	2495	
40	CSMBS3D40N	2765	
50	CSMBS3D50N	2895	
63	☒CSMBS3D63N	2895	



Current rating (Amps.)	Product Code	MRP (₹)	Std. Pkg. (Nos.)
2 Pole			
0.5	☒CSMBS2D0.5	1420	6
1	CSMBS2D1	1420	
2	☒CSMBS2D2	1420	
3	CSMBS2D3	1420	
4	☒CSMBS2D4	1420	
5	CSMBS2D5	1420	
6	☒CSMBS2D6	1135	
10	☒CSMBS2D10	1135	
16	☒CSMBS2D16	1135	
20	☒CSMBS2D20	1135	
25	☒CSMBS2D25	1135	
32	☒CSMBS2D32	1135	
40	CSMBS2D40	1645	
50	CSMBS2D50	1710	
63	☒CSMBS2D63	1710	

Current rating (Amps.)	Product Code	MRP (₹)	Std. Pkg. (Nos.)
4 Pole			
0.5	CSMBS4D0.5	2800	3
1	CSMBS4D1	2800	
2	CSMBS4D2	2800	
3	CSMBS4D3	2800	
4	CSMBS4D4	2800	
5	CSMBS4D5	2800	
6	CSMBS4D6	2570	
10	CSMBS4D10	2570	
16	☒CSMBS4D16	2570	
20	CSMBS4D20	2570	
25	CSMBS4D25	2570	
32	CSMBS4D32	2570	
40	☒CSMBS4D40	3125	
50	CSMBS4D50	3425	
63	☒CSMBS4D63	3425	

☒ Non Stockable item



WiNtrip2 Miniature Circuit Breaker

K-Series, 'C' Curve

IS/IEC 60947-2

Inductive load with surge current - Motor Circuit Applications

[HSN Code: 8536]



Current rating (Amps.)	Product Code	MRP (₹)	Std. Pkg. (Nos.)
1 Pole			
0.5	CSMBS1K0.5	545	12
1	CSMBS1K1	545	
2	CSMBS1K2	545	
3	CSMBS1K3	545	
4	CSMBS1K4	545	
5	CSMBS1K5	545	
6	CSMBS1K6	340	
10	CSMBS1K10	340	
16	CSMBS1K16	340	
20	CSMBS1K20	340	
25	CSMBS1K25	340	
32	CSMBS1K32	340	
40	CSMBS1K40	765	
50	CSMBS1K50	835	
63	CSMBS1K63	835	
1 Pole + N			
0.5	CSMBS1K0.5N	1460	6
1	CSMBS1K1N	1460	
2	CSMBS1K2N	1460	
3	CSMBS1K3N	1460	
4	CSMBS1K4N	1460	
5	CSMBS1K5N	1460	
6	CSMBS1K6N	1040	
10	CSMBS1K10N	1040	
16	CSMBS1K16N	1040	
20	CSMBS1K20N	1040	
25	CSMBS1K25N	1040	
32	CSMBS1K32N	1040	
40	CSMBS1K40N	1490	
50	CSMBS1K50N	1680	
63	CSMBS1K63N	1680	
2 Pole			
0.5	CSMBS2K0.5	1535	6
1	CSMBS2K1	1535	
2	CSMBS2K2	1535	
3	CSMBS2K3	1535	
4	CSMBS2K4	1535	
5	CSMBS2K5	1535	
6	CSMBS2K6	1105	
10	CSMBS2K10	1105	
16	CSMBS2K16	1105	
20	CSMBS2K20	1105	
25	CSMBS2K25	1105	
32	CSMBS2K32	1105	
40	CSMBS2K40	1645	
50	CSMBS2K50	1865	
63	CSMBS2K63	1865	

Current rating (Amps.)	Product Code	MRP (₹)	Std. Pkg. (Nos.)
3 Pole			
0.5	CSMBS3K0.5	2130	4
1	CSMBS3K1	2130	
2	CSMBS3K2	2130	
3	CSMBS3K3	2130	
4	CSMBS3K4	2130	
5	CSMBS3K5	2130	
6	CSMBS3K6	1760	
10	CSMBS3K10	1760	
16	CSMBS3K16	1760	
20	CSMBS3K20	1760	
25	CSMBS3K25	1760	
32	CSMBS3K32	1760	
40	CSMBS3K40	2570	
50	CSMBS3K50	2735	
63	CSMBS3K63	2735	
3 Pole + N			
0.5	CSMBS3K0.5N	2755	3
1	CSMBS3K1N	2755	
2	CSMBS3K2N	2755	
3	CSMBS3K3N	2755	
4	CSMBS3K4N	2755	
5	CSMBS3K5N	2755	
6	CSMBS3K6N	2250	
10	CSMBS3K10N	2250	
16	CSMBS3K16N	2250	
20	CSMBS3K20N	2250	
25	CSMBS3K25N	2250	
32	CSMBS3K32N	2250	
40	CSMBS3K40N	3015	
50	CSMBS3K50N	3240	
63	CSMBS3K63N	3240	
4 Pole			
0.5	CSMBS4K0.5	2940	3
1	CSMBS4K1	2940	
2	CSMBS4K2	2940	
3	CSMBS4K3	2940	
4	CSMBS4K4	2940	
5	CSMBS4K5	2940	
6	CSMBS4K6	2495	
10	CSMBS4K10	2495	
16	CSMBS4K16	2495	
20	CSMBS4K20	2495	
25	CSMBS4K25	2495	
32	CSMBS4K32	2495	
40	CSMBS4K40	3340	
50	CSMBS4K50	3610	
63	CSMBS4K63	3610	

Non Stockable item

Note: K- Series 'B' Curve POR (for prices please contact the nearest branch office.)



WiNtrip2 DC MCB

- 250V (SP) & 500V (DP), 3kA / 6kA breaking capacity
- Range: 6A~40A
- Standard Conformity: IEC60947-2;2016



WiNtrip2 Miniature Circuit Breaker

[HSN Code: 8536]



Description	Current rating (Amps.)	Product Code	MRP (₹)	Std. Pkg. (Nos.)
1 Pole				
DC MCB SP 6A-250V	6	CSMBS1DC6-250	600	12
DC MCB SP 10A-250V	10	CSMBS1DC10-250	600	
DC MCB SP 16A-250V	16	CSMBS1DC16-250	600	
DC MCB SP 20A-250V	20	CSMBS1DC20-250	600	
DC MCB SP 25A-250V	25	CSMBS1DC25-250	600	
DC MCB SP 32A-250V	32	CSMBS1DC32-250	600	
DC MCB SP 40A-250V	40	CSMBS1DC40-250	835	
Shorting link		SHMT8101	115	
2 Pole				
DC MCB DP 6A-500V	6	CSMBS2DC6-500	1255	6
DC MCB DP 10A-500V	10	CSMBS2DC10-500	1255	
DC MCB DP 16A-500V	16	CSMBS2DC16-500	1255	
DC MCB DP 20A-500V	20	CSMBS2DC20-500	1255	
DC MCB DP 25A-500V	25	CSMBS2DC25-500	1255	
DC MCB DP 32A-500V	32	CSMBS2DC32-500	1255	
DC MCB DP 40A-500V	40	CSMBS2DC40-500	1800	
Shorting link		SHMT8101	115	

DC MCB-Series

[HSN Code: 8536]

Current rating (Amps.)	Product Code	MRP (₹)	Std. Pkg. (Nos.)	Current rating (Amps.)	Product Code	MRP (₹)	Std. Pkg. (Nos.)
1 Pole				2 Pole			
0.5	<input checked="" type="checkbox"/> CSMBS1DC0.5	630	12	0.5	CSMBS2DC0.5	1470	6
1	<input checked="" type="checkbox"/> CSMBS1DC1	630		1	CSMBS2DC1	1470	
2	<input checked="" type="checkbox"/> CSMBS1DC2	630		2	<input checked="" type="checkbox"/> CSMBS2DC2	1470	
3	CSMBS1DC3	630		3	CSMBS2DC3	1470	
4	<input checked="" type="checkbox"/> CSMBS1DC4	630		4	CSMBS2DC4	1470	
5	<input checked="" type="checkbox"/> CSMBS1DC5	630		5	CSMBS2DC5	1470	
6	CSMBS1DC6	545		6	CSMBS2DC6	1145	
10	<input checked="" type="checkbox"/> CSMBS1DC10	545		10	CSMBS2DC10	1145	
16	<input checked="" type="checkbox"/> CSMBS1DC16	545		16	CSMBS2DC16	1145	
20	<input checked="" type="checkbox"/> CSMBS1DC20	545		20	CSMBS2DC20	1145	
25	<input checked="" type="checkbox"/> CSMBS1DC25	545		25	CSMBS2DC25	1145	
32	<input checked="" type="checkbox"/> CSMBS1DC32	545		32	CSMBS2DC32	1145	
40	<input checked="" type="checkbox"/> CSMBS1DC40	765		40	<input checked="" type="checkbox"/> CSMBS2DC40	1595	
50	<input checked="" type="checkbox"/> CSMBS1DC50	885		50	<input checked="" type="checkbox"/> CSMBS2DC50	1795	
63	<input checked="" type="checkbox"/> CSMBS1DC63	885	63	CSMBS2DC63	1795		



Accessories (Site fit-able)								[HSN Code: 8538]
Description	Product Code	Configuration	Type of contact	Fitment	Module Size	Suitable MCB Rating (A)	MRP (₹)	
Auxiliary Contact	CSMBAXSF1	1NO-1NC	Changeover	Right	9 mm	Wintrip2 0.5-63	1060	
Auxiliary Contact	CSMBAXSF2	2NO-2NC	Changeover	Right	9 mm	Wintrip2 0.5-63	1105	
Auxiliary Contact	CSMBAXSF11	1NO-1NC	Potential free	Left	18 mm	Wintrip2 0.5-63	1060	
Alarm Contact	CSMBALSF1	1 Changeover	Changeover	Right	9 mm	Wintrip2 0.5-63	915	
Shunt Trip	CSMBS01DCSF	-	-	Left	18 mm	Wintrip2 0.5-63	1255	
Shunt Trip	CSMBS02DCSF	-	-	Left	18 mm	Wintrip2 0.5-63	1255	
Shunt Trip	CSMBS04DCSF	-	-	Left	18 mm	Wintrip2 0.5-63	1255	
Shunt Trip	CSMBS220ACSF	-	-	Left	18 mm	Wintrip2 0.5-63	1255	

 Non Stockable item

WiNtrip2 Isolator



[HSN Code: 8536]

Current rating (Amps.)	Product Code	MRP (₹)	Std. Pkg. (Nos.)
1 Pole			
25	CSMBS1SD25	350	12
40	CSMBS1SD40	460	
63	CSMBS1SD63	505	
80	CSMBS1SD80	565	
100	CSMBS1SD100	660	
125	CSMBS1SD125	770	

Current rating (Amps.)	Product Code	MRP (₹)	Std. Pkg. (Nos.)
3 Pole			
25	CSMBS3SD25	1090	4
40	CSMBS3SD40	1245	
63	CSMBS3SD63	1390	
80	CSMBS3SD80	1600	
100	CSMBS3SD100	1650	
125	CSMBS3SD125	1745	

Current rating (Amps.)	Product Code	MRP (₹)	Std. Pkg. (Nos.)
2 Pole			
25	CSMBS2SD25	580	6
40	CSMBS2SD40	640	
63	CSMBS2SD63	805	
80	CSMBS2SD80	1020	
100	CSMBS2SD100	1045	
125	CSMBS2SD125	1165	

Current rating (Amps.)	Product Code	MRP (₹)	Std. Pkg. (Nos.)
4 Pole			
25	CSMBS4SD25	1150	3
40	CSMBS4SD40	1420	
63	CSMBS4SD63	1560	
80	CSMBS4SD80	1930	
100	CSMBS4SD100	1955	
125	CSMBS4SD125	2160	

[HSN Code: 8536]



Current rating (Amps.)	Product Code	MRP (₹)	Std. Pkg. (Nos.)
1 Pole			
25	<input checked="" type="checkbox"/> CSMBS1ISO25	POR	12
40	<input checked="" type="checkbox"/> CSMBS1ISO40		
63	<input checked="" type="checkbox"/> CSMBS1ISO63		
80	CSMBS1ISO80		
100	<input checked="" type="checkbox"/> CSMBS1ISO100		
125	<input checked="" type="checkbox"/> CSMBS1ISO125		

Current rating (Amps.)	Product Code	MRP (₹)	Std. Pkg. (Nos.)
3 Pole			
25	CSMBS3ISO25	POR	4
40	CSMBS3ISO40		
63	CSMBS3ISO63		
80	<input checked="" type="checkbox"/> CSMBS3ISO80		
100	CSMBS3ISO100		
125	<input checked="" type="checkbox"/> CSMBS3ISO125		



Current rating (Amps.)	Product Code	MRP (₹)	Std. Pkg. (Nos.)
2 Pole			
25	CSMBS2ISO25	POR	6
40	CSMBS2ISO40		
63	CSMBS2ISO63		
80	<input checked="" type="checkbox"/> CSMBS2ISO80		
100	CSMBS2ISO100		
125	CSMBS2ISO125		

Current rating (Amps.)	Product Code	MRP (₹)	Std. Pkg. (Nos.)
4 Pole			
25	<input checked="" type="checkbox"/> CSMBS4ISO25	POR	3
40	CSMBS4ISO40		
63	CSMBS4ISO63		
80	<input checked="" type="checkbox"/> CSMBS4ISO80		
100	CSMBS4ISO100		
125	CSMBS4ISO125		

Available till the stock last

Higher Rating Miniature Circuit Breakers

[HSN Code: 8536]



Current rating (Amps.)	Product Code	MRP (₹)	Std. Pkg. (Nos.)
1 Pole			
80	CSMBH1C80	2570	3
100	CSMBH1C100	2885	
125	CSMBH1C125	3125	
2 Pole			
80	CSMBH2C80	5715	3
100	CSMBH2C100	6105	
125	CSMBH2C125	6710	

Current rating (Amps.)	Product Code	MRP (₹)	Std. Pkg. (Nos.)
3 Pole			
80	CSMBH3C80	9020	1
100	CSMBH3C100	9605	
125	CSMBH3C125	10670	
4 Pole			
80	CSMBH4C80	11480	1
100	CSMBH4C100	11970	
125	CSMBH4C125	13515	

Accessories (Site fit-able)

[HSN Code: 8538]

Description	Product Code	Configuration	Type of contact	Fitment	Module Size	Suitable MCB Rating (A)	MRP (₹)
Auxiliary Contact	CSMBAXHSF1	1NO-1NC	Changeover	Right	9 mm	Wintrip2 80-100	1155
Auxiliary Contact	CSMBAXHSF2	2NO-2NC	Changeover	Right	9 mm	Wintrip2 80-100	1200
Alarm Contact	CSMBALHSF1	1 Changeover	Changeover	Right	9 mm	Wintrip2 80-100	1155
Shunt Trip	CSMBHS012DCSF	-	-	Left	18 mm	Wintrip2 80-100	1355
Shunt Trip	CSMBHS024DCSF	-	-	Left	18 mm	Wintrip2 80-100	1355
Shunt Trip	CSMBHS048DCSF	-	-	Left	18 mm	Wintrip2 80-100	1355
Shunt Trip	CSMBHS220ACSF	-	-	Left	18 mm	Wintrip2 80-100	1355

Wintrip MCB Type Changeover Switch

[HSN Code: 8536]



Description	Pole	Rating (Amps.)	Product Code	MRP (₹)	Std. Pkg. (Nos.)
2 Pole					
Two way centre OFF Changeover Switch	2	25	CSCOS2P25A	1850	6
Two way centre OFF Changeover Switch	2	40	CSCOS2P40A	2735	
Two way centre OFF Changeover Switch	2	63	CSCOS2P63A	3175	
4 Pole					
Two way centre OFF Changeover Switch	4	25	CSCOS4P25A	3490	3
Two way centre OFF Changeover Switch	4	40	CSCOS4P40A	5230	
Two way centre OFF Changeover Switch	4	63	CSCOS4P63A	5605	

[HSN Code: 8536]

SmartSol Mini MCB DP

Description	Current rating (Amps.)	Reference	MRP (₹)
DP "C" 6-32A Mini MCB with Enclosure	6-32	CSMBSS2C6-32	615
SPN "C" 6-32A Mini MCB with Enclosure	6-32	CSMBSS1C6-32*N	615

 Non Stockable item

WiNtrip Residual Current Circuit Breaker



2 Pole, 30mA 10kA			[HSN Code: 8536]
Current rating (Amps.)	Product Code	MRP (₹)	Std. Pkg. (Nos.)
10	CSRB2P10A30-10kA	3460	6
16	CSRB2P16A30-10kA	3460	
20	☒CSRB2P20A30-10kA	3460	
25	CSRB2P25A30-10kA	3565	
32	CSRB2P32A30-10kA	3640	
40	CSRB2P40A30-10kA	3665	
63	CSRB2P63A30-10kA	4895	
80	☒CSRB2P80A30-10kA	7305	
100	☒CSRB2P100A30-10kA	7345	

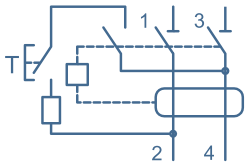

2 Pole, 100mA 10kA			[HSN Code: 8536]
Current rating (Amps.)	Product Code	MRP (₹)	Std. Pkg. (Nos.)
10	☒CSRB2P10A100-10kA	3460	6
16	CSRB2P16A100-10kA	3460	
20	☒CSRB2P20A100-10kA	3460	
25	CSRB2P25A100-10kA	3565	
32	CSRB2P32A100-10kA	3640	
40	CSRB2P40A100-10kA	3665	
63	CSRB2P63A100-10kA	4895	
80	CSRB2P80A100-10kA	7305	
100	☒CSRB2P100A100-10kA	7345	



Test Button



Bi-connect Terminals

2 Pole, 300mA 10kA			[HSN Code: 8536]
Current rating (Amps.)	Product Code	MRP (₹)	Std. Pkg. (Nos.)
10	CSRB2P10A300-10kA	3470	6
16	☒CSRB2P16A300-10kA	3470	
20	CSRB2P20A300-10kA	3480	
25	CSRB2P25A300-10kA	3750	
32	☒CSRB2P32A300-10kA	3795	
40	☒CSRB2P40A300-10kA	4020	
63	☒CSRB2P63A300-10kA	5035	
80	☒CSRB2P80A300-10kA	7345	
100	CSRB2P100A300-10kA	7380	

☒ Non Stockable item

WiNtrip Residual Current Circuit Breaker

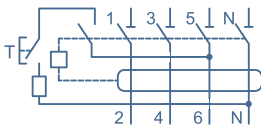

Test Button



Bi-connect Terminals

4 Pole, 30mA 10kA			[HSN Code: 8536]
Current rating (Amps.)	Product Code	MRP (₹)	Std. Pkg. (Nos.)
10	☒CSRB4P10A30-10kA	4300	3
16	CSRB4P16A30-10kA	4320	
20	☒CSRB4P20A30-10kA	4365	
25	CSRB4P25A30-10kA	4570	
32	CSRB4P32A30-10kA	4580	
40	CSRB4P40A30-10kA	4690	
63	CSRB4P63A30-10kA	5325	
80	CSRB4P80A30-10kA	8050	
100	☒CSRB4P100A30-10kA	8265	

4 Pole, 100mA 10kA			[HSN Code: 8536]
Current rating (Amps.)	Product Code	MRP (₹)	Std. Pkg. (Nos.)
10	☒CSRB4P10A100-10kA	4300	3
16	☒CSRB4P16A100-10kA	4320	
20	CSRB4P20A100-10kA	4365	
25	CSRB4P25A100-10kA	4570	
32	CSRB4P32A100-10kA	4580	
40	CSRB4P40A100-10kA	4690	
63	CSRB4P63A100-10kA	5325	
80	CSRB4P80A100-10kA	8050	
100	CSRB4P100A100-10kA	8265	

4 Pole, 300mA 10kA			[HSN Code: 8536]
Current rating (Amps.)	Product Code	MRP (₹)	Std. Pkg. (Nos.)
10	☒CSRB4P10A300-10kA	4320	3
16	☒CSRB4P16A300-10kA	4355	
20	CSRB4P20A300-10kA	4385	
25	☒CSRB4P25A300-10kA	4785	
32	☒CSRB4P32A300-10kA	4785	
40	CSRB4P40A300-10kA	4990	
63	CSRB4P63A300-10kA	5360	
80	☒CSRB4P80A300-10kA	8100	
100	CSRB4P100A300-10kA	8305	

NOTE:

1. MCB in bulk packing are available on request.
2. The industrial MCB will have non-retail (NR) suffix in their part codes.
3. For MCB technical Data sheet, Dimesion details etc. please refer product catalogue or contact nearest Branch Office.

ACCL

Automatic Changeover with Current Limiter

- Complying to IEC 60947-6 & IEC 60947-3
- Utilization Category AC 32A
- Rating : Mains - 30A, DG - 0.5A-30A
- Individual LED for Mains & DG
- Quick Transfer Time
- Fault Annunciation
- Higher Electrical Life
- Low Blackout Time
- Din Rail Mounting
- Auto Reset Facility
- Can be used for New Installations as Well as for Retrofits



ACCL			[HSN Code: 8536]
Product Code	Mains Rating (Amps.)	Genset Rating (Amps.)	MRP (₹)
TCALSS005	30	0.5	3925
TCALSS010	30	1	3925
TCALSS015	30	1.5	3925
TCALSS025	30	2.5	3925
TCALSS030	30	3	3925
TCALSS040	30	4	3925
TCALSS050	30	5	3925
TCALSS060	30	6	3925
TCALSS080	30	8	3925
TCALSS090	30	9	3925
TCALSS100	30	10	3925
TCALSS150	30	15	3925
TCALSS200	30	20	3925
TCALSS250	30	25	3925
TCALSS300	30	30	3925



Epitome IP43 Distribution Boards

for household & industrial application

- Heavy duty Gasket to inhibit the entry of foreign particles
- Choice of multiple incomers as MCB/Isolator/RCCB
- Adequate wiring space
- Also available with lock & key mechanism for safety

EPIHOME IP43 Distribution Boards			[HSN Code: 8537]
Description	Product Code	No. of Modules (Incomer+Outgoing)	MRP (₹)
SPN Distribution Board			
SPN Double Door 04 Way IP43 DB	CSDBSPNPWXDD04	4	2270
SPN Double Door 06 Way IP43 DB	CSDBSPNPWXDD06	6	2660
SPN Double Door 08 Way IP43 DB	CSDBSPNPWXDD08	8	2870
SPN Double Door 10 Way IP43 DB	CSDBSPNPWXDD10	10	3455
SPN Double Door 12 Way IP43 DB	CSDBSPNPWXDD12	12	3635
SPN Double Door 16 Way IP43 DB	CSDBSPNPWXDD16	16	4630
SPN Double Door 20 Way IP43 DB	CSDBSPNPWXDD20	20	6250
SPN Double Door 24 Way IP43 DB	CSDBSPNPWXDD24	24	7080
TPN Distribution Board			
TPNH Double Door 04 Way IP43 DB	CSDBTPNHPWXDD04	8+12	6115
TPNH Double Door 06 Way IP43 DB	CSDBTPNHPWXDD06	8+18	7645
TPNH Double Door 08 Way IP43 DB	CSDBTPNHPWXDD08	8+24	9495
TPNH Double Door 12 Way IP43 DB	CSDBTPNHPWXDD12	8+36	12865
TPNH Double Door 16 Way IP43 DB	CSDBTPNHPWXDD16	8+48	16770

Non Stockable item

Epic Distribution Board			
			[HSN Code: 8537]
Description	Product Code	Total Modules	MRP (₹)
SPN Distribution Board			
04 Way SPN Single Door	CSDBSPNPESD04	4	1080
06 Way SPN Single Door	CSDBSPNPESD06	6	1175
08 Way SPN Single Door	CSDBSPNPESD08	8	1385
12 Way SPN Single Door	CSDBSPNPESD12	12	1765
16 Way SPN Single Door	CSDBSPNPESD16	16	2265
SPN Distribution Board			
04 Way SPN Double Door	CSDBSPNPEDD04	4	1795
06 Way SPN Double Door	CSDBSPNPEDD06	6	1940
08 Way SPN Double Door	CSDBSPNPEDD08	8	2245
10 Way SPN Double Door	CSDBSPNPEDD10	10	2715
12 Way SPN Double Door	CSDBSPNPEDD12	12	2955
16 Way SPN Double Door	CSDBSPNPEDD16	16	3670
TPN-Horizontal Distribution Board			
04 Way TPNH Single Door	CSDBTPNHPESD04	20	3400
06 Way TPNH Single Door	CSDBTPNHPESD06	26	4265
08 Way TPNH Single Door	CSDBTPNHPESD08	32	4995
12 Way TPNH Single Door	CSDBTPNHPESD12	44	6735
TPN-Horizontal Distribution Board			
04 Way TPNH Double Door	CSDBTPNHPEDD04	20	4925
06 Way TPNH Double Door	CSDBTPNHPEDD06	26	6070
08 Way TPNH Double Door	CSDBTPNHPEDD08	32	7270
12 Way TPNH Double Door	CSDBTPNHPEDD12	44	9895
TPN-Vertical Distribution Board			
04 Way TPNH Double Door	CSDBTPNVPECGDD04	20	8965
06 Way TPNH Double Door	CSDBTPNVPECGDD06	26	10570
08 Way TPNH Double Door	CSDBTPNVPECGDD08	32	12290
12 Way TPNH Double Door	CSDBTPNVPECGDD12	44	15665



C&S Distribution Board			
			[HSN Code: 8537]
Description	Product Code	No. of Modules (Incomer+Outgoing)	MRP (₹)
SPN Distribution Board			
04 Way SPN Single Door	CSDBSPNPESD04	4	1120
06 Way SPN Single Door	CSDBSPNPESD06	6	1230
08 Way SPN Single Door	CSDBSPNPESD08	8	1420
12 Way SPN Single Door	CSDBSPNPESD12	12	1860
16 Way SPN Single Door	CSDBSPNPESD16	16	2430
SPN Distribution Board			
04 Way SPN Double Door	CSDBSPNPGDD04	4	1825
06 Way SPN Double Door	CSDBSPNPGDD06	6	2045
08 Way SPN Double Door	CSDBSPNPGDD08	8	2290
10 Way SPN Double Door	CSDBSPNPGDD10	10	2775
12 Way SPN Double Door	CSDBSPNPGDD12	12	3015
16 Way SPN Double Door	CSDBSPNPGDD16	16	3755
TPN-Horizontal Distribution Board			
04 Way TPNH Single Door	CSDBTPNHPSD04	8+12	3620
06 Way TPNH Single Door	CSDBTPNHPSD06	8+18	4515
08 Way TPNH Single Door	CSDBTPNHPSD08	8+24	5255
12 Way TPNH Single Door	CSDBTPNHPSD12	8+36	7090
TPN-Horizontal Distribution Board			
04 Way TPNH Double Door	CSDBTPNHPCGDD04	8+12	4920
06 Way TPNH Double Door	CSDBTPNHPCGDD06	8+18	6130
08 Way TPNH Double Door	CSDBTPNHPCGDD08	8+24	7460
12 Way TPNH Double Door	CSDBTPNHPCGDD12	8+36	10430



CSDBTPNHPSD06 Non Stockable item



C&S WiNclass Distribution Board (Deep Drawn)



SPN WiNclass Distribution Board			[HSN Code: 8537]
Description	Product Code	No. of Modules (Incomer+Outgoing)	MRP (₹)
2+04 Way Single Door	CSDBSPNSD04S	2+04	1430
2+08 Way Single Door	CSDBSPNSD08S	2+08	1790
2+12 Way Single Door	CSDBSPNSD12S	2+12	2450
2+14 Way Single Door	CSDBSPNSD16S	2+14	3050
2+04 Way Double Door	CSDBSPNDD04S	2+04	2320
2+08 Way Double Door	CSDBSPNDD08S	2+08	2890
2+12 Way Double Door	CSDBSPNDD12S	2+12	3780
2+14 Way Double Door	CSDBSPNDD16S	2+14	4950
TPN WiNclass Distribution Board			
04 Way Single Door DB	CSDBTPNHSD04S	8+12	4655
06 Way Single Door DB	CSDBTPNHSD06S	8+18	5580
08 Way Single Door DB	CSDBTPNHSD08S	8+24	6125
12 Way Single Door DB	CSDBTPNHSD12S	8+36	8100
16 Way Single Door DB	CSDBTPNHSD16S	8+48	10140
04 Way Double Door DB	CSDBTPNHDD04SN	4+12	6115
04 Way Double Door DB	CSDBTPNHDD04S	8+12	6180
06 Way Double Door DB	CSDBTPNHDD06S	8+18	7740
08 Way Double Door DB	CSDBTPNHDD08S	8+24	9745
12 Way Double Door DB	CSDBTPNHDD12S	8+36	13875
16 Way Double Door DB	CSDBTPNHDD16S	8+48	17505

WiNtrip Distribution Board



Distribution Board (Deep Drawn with Pan Assembly)			[HSN Code: 8537]
SPN Distribution Board			
Description	Product Code	No. of Modules (Incomer+Outgoing)	MRP (₹)
04 Way Single Door	CSDBSPNSD04	4	POR
08 Way Single Door	CSDBSPNSD08	8	
12 Way Single Door	CSDBSPNSD12	12	
16 Way Single Door	CSDBSPNSD16	16	
04 Way Double Door	CSDBSPNDD04	4	
08 Way Double Door	CSDBSPNDD08	8	
12 Way Double Door	CSDBSPNDD12	12	
16 Way Double Door	CSDBSPNDD16	16	
TPN Distribution Board - Horizontal			
04 Way Single Door	CSDBTPNHSD04	8+12	POR
06 Way Single Door	CSDBTPNHSD06	8+18	
08 Way Single Door	CSDBTPNHSD08	8+24	
12 Way Single Door	CSDBTPNHSD12	8+36	
16 Way Single Door	CSDBTPNHSD16	8+48	
04 Way Double Door	CSDBTPNHDD04	8+12	
06 Way Double Door	CSDBTPNHDD06	8+18	
08 Way Double Door	CSDBTPNHDD08	8+24	
12 Way Double Door	CSDBTPNHDD12	8+36	
16 Way Double Door	CSDBTPNHDD16	8+48	



Polycarbonate Cover Consumer Unit DB			[HSN Code: 8537]
Description	Product Code	No. of Modules (Incomer+Outgoing)	MRP (₹)
SPN WC 06 Way SD With Acrylic Door	CSDBSPNSDCA06	6	2080
SPN WC 08 Way SD With Acrylic Door	CSDBSPNSDCA08	8	2320
SPN WC 12 Way SD With Acrylic Door	CSDBSPNSDCA12	12	2995
SPN WC 16 Way SD With Acrylic Door	CSDBSPNSDCA16	16	3815

☒ Non Stockable item

WiNtrip Distribution Board



Double Door DB (with Acrylic Window)		[HSN Code: 8537]
Description	Product Code	MRP (₹)
SPN Distribution Board Double Door 4 Way	CSDBSPNDDA2+04	2680
SPN Distribution Board Double Door 8 Way	CSDBSPNDDA2+08	3140
SPN Distribution Board Double Door 12 Way	CSDBSPNDDA2+12	3820
SPN Distribution Board Double Door 16 Way	CSDBSPNDDA2+14	4730



Phase Selector Distribution Board - TPN Phase Selector DD DB for incorporating MCB / Isolator / RCCB, equipped with 3 Nos 63A Phase Selector Switches & 3 No Plano Switches		[HSN Code: 8537]
Description	Product Code	MRP (₹)
4 Way DD with 63A Rotary Switch	CSDBPHSCDD04RS63	17830
6 Way DD with 63A Rotary Switch	CSDBPHSCDD06RS63	18240
8 Way DD with 63A Rotary Switch	CSDBPHSCDD08RS63	20130
12 Way DD with 63A Rotary Switch	CSDBPHSCDD12RS63	22300
4 Way DD with 40A Rotary Switch	CSDBPHSCDD04RS40	17720
6 Way DD with 40A Rotary Switch	CSDBPHSCDD06RS40	17920
8 Way DD with 40A Rotary Switch	CSDBPHSCDD08RS40	19940
12Way DD with 40A Rotary Switch	CSDBPHSCDD12RS40	21920
4 Way DD without Rotary Switch	CSDBPHSCDD04	15240
6 Way DD without Rotary Switch	CSDBPHSCDD06	15620
8 Way DD without Rotary Switch	CSDBPHSCDD08	17190
12 Way DD without Rotary Switch	CSDBPHSCDD12	19640



VTPN Distribution Board (with provision for WiNtrip2 MCB)		[HSN Code: 8537]	
Description	Product Code	No. of Modules (Incomer+Outgoing)	MRP (₹)
4 way Double Door	CSDBTPNVDD04S	8+12	15845
6 way Double Door	CSDBTPNVDD06S	8+18	18160
8 way Double Door	CSDBTPNVDD08S	8+24	20075
12 way Double Door	CSDBTPNVDD12S	8+36	26890



VTPN Distribution Board (with provision for MCCB WiNbreak1 as incomer & WiNtrip2 MCB as outgoing)		[HSN Code: 8537]
Description	Product Code	MRP (₹)
DB MCCB AS I/C 100A DD04 Way IP43	CSDBMCCB125PDD04S	15430
DB MCCB AS I/C 100A DD08 Way IP43	CSDBMCCB125PDD08S	17380
DB MCCB AS I/C 100A DD12 Way IP43	CSDBMCCB125PDD12S	24030
DB MCCB AS I/C 250A DD04 Way IP43	CSDBMCCB250PDD04S	18520
DB MCCB AS I/C 250A DD08 Way IP43	CSDBMCCB250PDD08S	24120
DB MCCB AS I/C 250A DD12 Way IP43	CSDBMCCB250PDD12S	30130

WiNtrip Distribution Board



Selection Table for MCCB as Incomer VTPN Distribution Boards				
	Description	Product Code	Type/ Breaking Capacity Ics=100%Icu	MCCB Rating (A)
WiNbreak 1 MCCB	CSE1M125ATM3P-*, CSE1M125ATM4P-*	CSDBMCCB125PDD04S	25kA, 36kA & 50kA	15, 20, 30, 40, 50, 60, 75 & 100
	CSE1NN125ATM3P-*, CSE1NN125ATM4P-*	CSDBMCCB125PDD08S		
	CSE1S125ETM3P-*, CSE1S125ETM4P-*	CSDBMCCB125PDD12S		
	CSE2M250ATM3P-*, CSE2M250A M4P-*	CSDBMCCB250PDD04S	25kA, 36kA & 50kA	160, 200, 250 & 63~160 80~100, 100~250
	CSE2NN250ATM3P-*, CSE2NN250ATM4P-*	CSDBMCCB250PDD08S		
	CSE2S250ETM3P-*, CSE2S250ETM4P-*	CSDBMCCB250PDD12S		
CSE2SX250ATM3P-*, CSE2SX250ATM4P-*	CSDBMCCB250PDD12S			

NOTE: While Ordering, Replace "*" by current Rating.



7 Segment Distribution Board				[HSN Code: 8537]
Description	Product Code	No. of Modules (Incomer+Outgoing)	MRP (₹)	
7 Segment TPN DD DB With Provision for FP MCB/Isolator/RCCB as incomer, DP MCB/Isolator/RCCB as sub incomer and SP MCBs as outgoing	<input checked="" type="checkbox"/> CSDB7SEGDD04	8+12+12	13970	
	CSDB7SEGDD06	8+12+18	15730	
	<input checked="" type="checkbox"/> CSDB7SEGDD08	8+12+24	17580	
	<input checked="" type="checkbox"/> CSDB7SEGDD12	8+12+36	22330	

Price on request : Prewired Distribution Board fitted with Busbar, Terminal Block for incoming/outgoing phase neutral & Earth duly wired with Provision for ISO/RCCB/MCB as incomer and SP outgoing (without MCBs)



*FLEXI (Tier) DBs (with Metal Door)			[HSN Code: 8537]
Description	Product Code	MRP (₹)	
Flexi DD DB 2 Row 13 Modules	CSDBFLDD2R13	7670	
Flexi DD DB 3 Row 13 Modules	CSDBFLDD3R13	9040	
Flexi DD DB 4 Row 13 Modules	CSDBFLDD4R13	9990	

*Without Wire bunch



PPI Distribution Board				[HSN Code: 8537]
Description	Product Code	No. of Modules (Incomer+Outgoing)	MRP (₹)	
4 Way Double Door	<input checked="" type="checkbox"/> CSDBTPNPPIDD04	8+6+12	7930	
6 Way Double Door	<input checked="" type="checkbox"/> CSDBTPNPPIDD06	8+6+18	9900	
8 Way Double Door	CSDBTPNPPIDD08	8+6+24	12020	
12 Way Double Door	CSDBTPNPPIDD12	8+6+36	13900	

WiNtrip Distribution Board



WiNtrip Telephone & Television Socket Distribution Board		[HSN Code: 8537]
Description	Product Code	MRP (₹)
SPN 04 Way Tel & TV Socket DB (2+4)	CSDBSPNDDTELV04	4785
SPN 06 Way Tel & TV Socket DB (2+6)	CSDBSPNDDTELV06	5075
SPN 08 Way Tel & TV Socket DB (2+8)	CSDBSPNDDTELV08	5385
SPN 10 Way Tel & TV Socket DB (2+10)	CSDBSPNDDTELV10	5740
SPN 12 Way Tel & TV Socket DB (2+12)	CSDBSPNDDTELV12	6385
SPN 14 Way Tel & TV Socket DB (2+14)	CSDBSPNDDTELV14	6590
TPN 04 Way Tel & TV Socket DB (8+12)	CSDBTPNDDTELV04	7945
TPN 06 Way Tel & TV Socket DB (8+18)	CSDBTPNDDTELV06	9120
TPN 08 Way Tel & TV Socket DB (8+24)	CSDBTPNDDTELV08	10515
TPN 12 Way Tel & TV Socket DB (8+36)	CSDBTPNDDTELV12	13685

Cable End Box



WiNtrip Cable End Box		[HSN Code: 8537]
Description	Product Code	MRP (₹)
SPN Cable End Box		
SPN 4 Way	CSDBCSPNDD04	1155
SPN 8 Way	CSDBCSPNDD08	1440
SPN 12 Way	CSDBCSPNDD12	1690
SPN 16 Way	CSDBCSPNDD16	1985
TPNH Cable End Box		
TPNH 4 Way	CSDBCSTPNHDD04	1720
TPNH 6 Way	CSDBCSTPNHDD06	1795
TPNH 8 Way	CSDBCSTPNHDD08	2265
TPNH 12 Way	CSDBCSTPNHDD12	2515
TPNH 16 Way	CSDBCSTPNHDD16	2985
TPNV Cable End Box		
TPNV 4 Way	CSDBCSTPNVDD	2330
TPNV 8 Way	CSDBCSTPNVDD	2330
TPNV 12 Way	CSDBCSTPNVDD	2330

WiNclass Cable End Box		[HSN Code: 8537]
Description	Product Code	MRP (₹)
SPN Cable End Box		
SPN 4 Way	CSDBCSPNDD04S	1065
SPN 8 Way	CSDBCSPNDD08S	1310
SPN 12 Way	CSDBCSPNDD12S	1545
SPN 16 Way	CSDBCSPNDD16S	1855
TPNH Cable End Box		
TPNH 4 Way	CSDBCSTPNHDD04SN	1385
TPNH 6 Way	CSDBCSTPNHDD06S	1645
TPNH 8 Way	CSDBCSTPNHDD08S	1910
TPNH 12 Way	CSDBCSTPNHDD12S	2410
TPNH 16 Way	CSDBCSTPNHDD16S	2865



New C&S / Epic Cable End Box		[HSN Code: 8537]
Description	Product Code	MRP (₹)
SPN Cable End Box		
SPN 4 Way	CSDBCSPNPDD04	880
TPNH 6 Way	CSDBCSPNPDD06	990
SPN 8 Way	CSDBCSPNPDD08	1110
SPN 12 Way	CSDBCSPNPDD12	1375
SPN 16 Way	CSDBCSPNPDD16	1680
TPNH Cable End Box		
TPNH 4 Way	CSDBCSTPNHPDD04	1430
TPNH 6 Way	CSDBCSTPNHPDD06	1655
TPNH 8 Way	CSDBCSTPNHPDD08	1875
TPNH 12 Way	CSDBCSTPNHPDD12	2395

PPI Kit		[HSN Code: 8537]
Description	Product Code	MRP (₹)
PPI KIT TO CONVERT TPNHP/TPNHPE DD 04 TO DD 02 WAY	CSDBPPPIKT01	2840
PPI KIT TO CONVERT TPNHP/TPNHPE DD 06 TO DD 04 WAY	CSDBPPPIKT02	3195
PPI KIT TO CONVERT TPNHP/TPNHPE DD 08 TO DD 06 WAY	CSDBPPPIKT03	3595
PPI KIT TO CONVERT TPNHP/TPNHPE DD 12 TO DD 10 WAY	CSDBPPPIKT04	4315

Non Stockable item



WiNtrip Plug and Socket DBs (without MCB) [HSN Code: 8537]
Powder Coated Sheet Metal Deep Drawn DBs with Plug & Socket including insulated Neutral link, adjustable Din Rail and connecting links.

Description	Product Code	MRP (₹)	Std. Pkg. (No.s)
10Amp SPN	CSDBPSSPN010	1610	12
20Amp SPN	CSDBPSSPN020	1610	12
20Amp SPN (SP Cutout)	CSDBPSSPN020SP	1610	12
20Amp TPN	CSDBPSTPN020	3890	6
30Amp TPN	CSDBPSTPN030	4285	6



WiNtrip Plug and Sockets (Metal Clad) [HSN Code: 8537]

Description	Product Code	MRP (₹)	Std. Pkg. (No.s)
10Amp SPN Plug	CSDBPSPN010	330	36
10Amp SPN Socket	CSDBSSPN010	315	36
20Amp SPN Plug	CSDBPSPN020	350	36
20Amp SPN Socket	CSDBSSPN020	415	36
20Amp TPN Plug	CSDBPTPN020	425	36
20Amp TPN Socket	CSDBSTPN020	425	36
30Amp TPN Plug	CSDBPTPN030	665	36
30Amp TPN Socket	CSDBSTPN030	665	36



WiNtrip Metal Enclosures (with Din Rail) [HSN Code: 8537]
For Mounting WiNtrip MCBs / RCCBs / Isolators

Description	Product Code	MRP (₹)	Std. Pkg. (No.s)
SP Enclosure	CSDBMCBESP	560	24
DP Enclosure	CSDBMCBEDP	560	24
TP Enclosure	CSDBMCBETP	660	12
FP Enclosure	CSDBMCBEFP	660	12



WiNtrip Plastic Enclosure without MCB [HSN Code: 8537]

Description	Product Code	MRP (₹)
Plastic MCB Enclosure SP&DP/STD	CSDBMCBEPPD	220
Plastic MCB Enclosure TP&FP/STD	CSDBMCBEPPP	295

MCB Enclosure IP55 [HSN Code: 8537]

4 Pole Enclosure			
Description	Product Code	MRP (₹)	Std. Pkg. (No.s)
MCB Enclosure IP55 04 Way	CSDBEP04	2225	1



YOUR SAFETY MATTERS US

C&S Primo Plus Antibacterial Switches protects from Germs & Bacterial infections

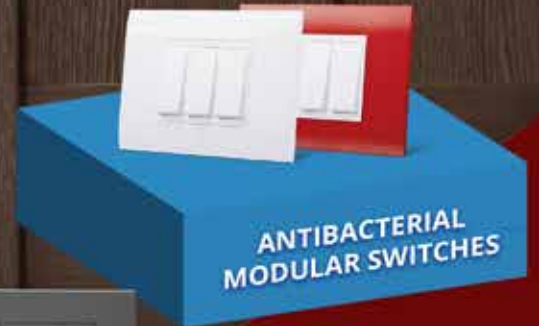

PrimoPlus SWITCHES

- Available with Anti Bacterial features*
Sleek design, compatible with PRIMO range of switches
- Highly aesthetic break free design
- Compatible to market boxes
- High gloss design
- Designed with front mounting and removable feature
- Ease of mounting
- Available in 1M -18M

DIVINO
S W I T C H E S

PrimoPlus
SWITCHES

COMBI
WEATHER-PROOF ENCLOSURES.

primo
S W I T C H E S



Modular Switches | DIVINO

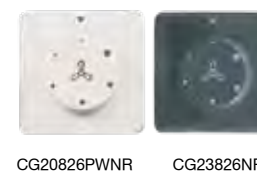
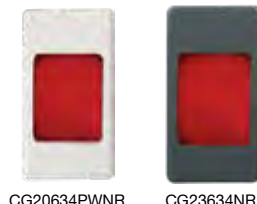
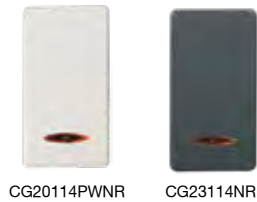

Switches							
Product Code - Pure White / Grey	HSN Code	Description	Type	No. of Modules	MRP (₹)	Std. Pkg. (Nos.)	
One-Way Switches							
CG20113PWNR / CG23113NR	85361010	1P-6A	General	1	107	20	
CG20114PWNR / CG23114NR	85361010	1P-6A	Luminous	1	151		
CG20573PWNR / CG23573NR	85361020	1P-16A	General	1	174		
CG20574PWNR / CG23574NR	85361020	1P-16A	Luminous	1	200		
CG20117PWNR / CG23117NR	85361020	1P-25A	General	1	225		
CG20118PWNR / CG23118NR	85361020	1P-25A	Luminous	1	276		
CG20120PWNR / CG23120NR	85361020	2P-32A	Luminous	2	407	10	
Two-Way Switches							
CG20123PWNR / CG23123NR	85361010	1P-6A	General	1	147	20	
CG20578PWNR / CG23578NR	85361020	1P-16A	General	1	217		

Product Code - Pure White / Grey	HSN Code	Description	Type	No. of Modules	MRP (₹)	Std. Pkg. (Nos.)	
Bell Push Switches							
CG20508PWNR / CG23508NR	85361010	1P-6A	Luminous	1	191	20	
CG20509PWNR / CG23509NR	85361010	1P-6A	With Symbol	1	151		

Product Code - Pure White / Grey	HSN Code	Description	Type	No. of Modules	MRP (₹)	Std. Pkg. (Nos.)	
Blanking Modules							
CG20056PWNR / CG23056NR	85381010	1 Gang	-	1	35	40	
CG20073PWNR / CG23073NR	85381010	2 Gang	-	2	61	20	

Product Code - Pure White / Grey	HSN Code	Description	Type	No. of Modules	MRP (₹)	Std. Pkg. (Nos.)	
Neon Indicators							
CG20634PWNR / CG23634NR	85361010	Red Color	-	1	100	20	

Fan Regulator / Dimmer							
Product Code - Pure White / Grey	HSN Code	Description	Type	No. of Modules	MRP (₹)	Std. Pkg. (Nos.)	
Fan Regulator							
CG20826PWNR / CG23826NR	85361010	5 Step (100W)	Rotary	2	464	10	
CG20827PWNR / CG23827NR	85361010	4 Step (100W)	Rotary	1	369	20	

Product Code - Pure White / Grey	HSN Code	Description	Type	No. of Modules	MRP (₹)	Std. Pkg. (Nos.)	
Dimmer							
CG20801PWNR / CG23801NR	85361010	500W	Rotary (Stepless)	2	461	10	
CG20804PWNR / CG23804NR	85361010	300W	Rotary (Stepless)	1	407	20	



CG20370PWNR CG23370NR



CG20353PWNR CG23353NR



CG20251PWNR CG23251NR



CG20275PWNR



CG20815PWNR



CG20609PWNR CG23609NR



CG20610PWNR CG23610NR



CG20611PWNR CG23611NR

Socket							
Product Code - Pure White / Grey	HSN Code	Description	For Plug Pin	No. of Modules	MRP (₹)	Std. Pkg. (Nos.)	
Sockets With Safety Shutters							
CG20370PWNR / CG23370NR	85361010	6A Socket 3 Pin (Flushed)	Round	2	144	10	
*CG20353PWNR / CG23353NR	85361010	6A Socket 5 Pin (Flushed)	Round	2	166	10	
CG20354PWNR / CG23354NR	85361020	6/16A Twin Socket 3 Pin (Flushed)	Round	3	277	6	
CG20352PWNR / CG23352NR	85361020	6/16A Twin Socket 3 Pin (Projected)	Round	2	263	10	
*CG20355PWNR / CG23355NR	85361020	25A-Socket (Flushed)	Round	3	289	6	
*CG20356PWNR / CG23356NR	85361020	25A-Socket (Projected)	Round	2	263	10	
*CG20359PWNR / CG23359NR	85361010	6A- 2 Pin Socket	Round	1	106	20	

Product Code - Pure White / Grey	HSN Code	Description	Nos. Pairs	For Plug Pin	No. of Modules	MRP (₹)	Std. Pkg. (Nos.)	
Telephone / Computer / TV Socket								
CG20251PWNR / CG23251NR	85361010	RJ11	2	Twisted pair	1	121	20	
CG20271PWNR / CG23271NR	85361010	RJ45 CAT5e	4	UTP		468		
CG20228PWNR / CG23228NR	85361010	TV Socket	-	-		114		
CG20272PWNR / CG23272NR	85361010	RJ45 CAT6	4	UTP		553		
CG20273PWNR / CG23273NR	85361010	RJ45 CAT6a		UTP	1216			

USB Charger Socket						
Product Code - Pure White / Grey	HSN Code	Description	No. of Modules	MRP (₹)	Std. Pkg. (Nos.)	
CG20275PWNR / CG23275NR	85044030	USB Charger Socket 2.1A (Fast Charging)	1	945	20	

Hospitality Range						
Product Code - Pure White / Grey	HSN Code	Description	No. of Modules	MRP (₹)	Std. Pkg. (Nos.)	
Energy Key Tag						
CG20815PWNR / CG23815NR	85361020	1P-25A, 230V-Energy Key Switch With Tag	2	608	1	
CG20434PWNR / CG23434NR	85361010	Tag For Energy Key Tag	-	125	-	
Application activation of functions service inside hotel rooms (e.g.m light, air-conditioner, minibar) when the room is occupied (with badge inserted)						
Do Not Disturb						
CG20609PWNR / CG23609NR	85361010	Indicator	1	110	20	
CG20124PWNR / CG23124NR	85361010	6A-230V, IW, SP Luminous Switch		156		
CG20612PWNR / CG23612NR	85361010	Unit (Indicator+Switch)	1+1	261	10	
Room Occupied						
CG20610PWNR / CG23610NR	85361010	Indicator	1	110	20	
CG20125PWNR / CG23125NR	85361010	6A-230V, IW, SP Luminous Switch		156		
CG20613PWNR / CG23613NR	85361010	Unit (Indicator+Switch)	1+1	261	10	
Make My Room						
CG20611PWNR / CG23611NR	85361010	Indicator	1	110	20	
CG20126PWNR / CG23126NR	85361010	6A-230V, IW, SP Luminous Switch		156		
CG20614PWNR / CG23614NR	85361010	Unit (Indicator+Switch)	1+1	261	10	

* Material available till stock last.



Modular Switches | DIVINO



CG20825PWNR



CG20632NR



CG20436PWNR



CG20443PWNR



CG26401PWNR



CG20362PWNR



CG25703PWNR



CG25803PWNR

Product Code - Pure White / Grey	HSN Code	Description	No. of Modules	MRP (₹)	Std. Pkg. (Nos.)
Time Delay Electronic Switch (Card Operated)					
CG20825PWNR / CG23825NR	85361020	25A	3	1356	6
Foot Lamp					
CG20631NR	94051090	230V-LED Yellow Night Lamp	3	379	6
CG20632NR	94051090	230V-LED Blue Night Lamp			
CG20633NR	94051090	230V-LED White Night Lamp			

Modular Miniature Case Circuit Breaker - WIntrip 'S'					
Product Code - Pure White	HSN Code	Description	No. of Modules	MRP (₹)	Std. Pkg. (Nos.)
Single Pole					
CG20431PWNR	85361010	6A Single Pole 4.5kA - Tripping Curve 'C'	1	221	12
CG20432PWNR	85361010	10A Single Pole 4.5kA - Tripping Curve 'C'			
CG20433PWNR	85361020	16A Single Pole 4.5kA - Tripping Curve 'C'			
CG20437PWNR	85361020	20A Single Pole 4.5kA - Tripping Curve 'C'			
CG20435PWNR	85361020	25A Single Pole 4.5kA - Tripping Curve 'C'			
CG20436PWNR	85361020	32A Single Pole 4.5kA - Tripping Curve 'C'			
Double Pole					
CG20438PWNR	85361010	6A Double Pole 4.5kA - Tripping Curve 'C'	2	528	6
CG20439PWNR	85361010	10A Double Pole 4.5kA - Tripping Curve 'C'			
CG20440PWNR	85361020	16A Double Pole 4.5kA - Tripping Curve 'C'			
CG20441PWNR	85361020	20A Double Pole 4.5kA - Tripping Curve 'C'			
CG20442PWNR	85361020	25A Double Pole 4.5kA - Tripping Curve 'C'			
CG20443PWNR	85361020	32A Double Pole 4.5kA - Tripping Curve 'C'			

Power Unit				
Product Code - Pure White	HSN Code	Description	MRP (₹)	Std. Pkg. (Nos.)
CG26401PWNR	85371000	16Amp Power Unit	968	1
*CG26402PWNR	85371000	20Amp Power Unit	1126	
*CG26403PWNR	85371000	25Amp Power Unit	1126	
Power Unit with PVC				
CG26404PWNR	85371000	16Amp Power Unit	843	1
*CG26405PWNR	85371000	20Amp Power Unit	1121	
*CG26404PWNR	85371000	25Amp Power Unit	1121	

Single Phase Motor Starter					
Product Code - Pure White / Grey	HSN Code	Description	No. of Modules	MRP (₹)	Std. Pkg. (Nos.)
CG20362PWNR /CG23362NR	85361020	Motor Starter 16A	2	452	1
CG20364PWNR /CG23364NR	85361020	Motor Starter 25A	2	575	

Pure White Cover Plates With Support Plate					
Product Code - Vera / Virna	HSN Code	Description	MRP (₹)	Std. Pkg. (Nos.)	
CG25701PWNR / CG25801PWNR	85381010	1 Module Plate	124	10	
CG25702PWNR / CG25802PWNR	85381010	2 Module Plate			
CG25703PWNR / CG25803PWNR	85381010	3 Module Plate			
CG25704PWNR / CG25804PWNR	85381010	4 Module Plate	197	5	
CG25706PWNR / CG25806PWNR	85381010	6 Module Plate	264		
CG25708PWNR / CG25808PWNR	85381010	8 Module Plate - Vertical	341		
CG25709PWNR / CG25809PWNR	85381010	8 Module Plate - Horizontal			
CG25712PWNR / CG25812PWNR	85381010	12 Module Plate	428		
CG25718PWNR / CG25818PWNR	85381010	18 Module Plate	649		

* Material available till stock last.

Glossy Grey Cover Plates With Support Plate				
Product Code Vera / Virna	HSN Code	Description	MRP (₹)	Std. Pkg. (Nos.)
CG25701GRNR / CG25801GRNR	85381010	1 Module Plate	178	10
CG25702GRNR / CG25802GRNR	85381010	2 Module Plate		
CG25703GRNR / CG25803GRNR	85381010	3 Module Plate		
CG25704GRNR / CG25804GRNR	85381010	4 Module Plate		
CG25706GRNR / CG25806GRNR	85381010	6 Module Plate	328	5
CG25708GRNR / CG25808GRNR	85381010	8 Module Plate - Vertical		
CG25709GRNR / CG25809GRNR	85381010	8 Module Plate - Horizontal		
CG25712GRNR / CG25812GRNR	85381010	12 Module Top Plate		
CG25718GRNR / CG25818GRNR	85381010	18 Module Plate	507	
			800	



CG25803GRNR

Cover Plates With Support Plate				
Product Code Vera / Virna	HSN Code	Description	MRP (₹)	Std. Pkg. (Nos.)
Cadet Grey / Black Olive / Argent Grey / Charcol Black / Arsenic Black / Champagne / Candy Red / Coral Red / British Green Plates				
CG25701NR / CG25801NR	85381010	1 Module Plate	267	10
CG25702NR / CG25802NR	85381010	2 Module Plate		
CG25703NR / CG25803NR	85381010	3 Module Plate		
CG25704NR / CG25804NR	85381010	4 Module Plate		
CG25706NR / CG25806NR	85381010	6 Module Plate	592	5
CG25708NR / CG25808NR	85381010	8 Module - Vertical		
CG25709NR / CG25809NR	85381010	8 Module - Horizontal		
CG25712NR / CG25812NR	85381010	12 Module Plate		
CG25718NR / CG25818NR	85381010	18 Module Plate	755	
			986	

Please add codes CG for Cadet Grey, BO for Black Olive, AG for Argent Grey, CB for Charcol Black, AB for Arsenic Black, CH for Champagne, CAR for Candy Red, COR for Coral Red, BG for British Green Plates e.g. for ordering one module Vera Cadet Grey plate code would be CG25701CG



CG25803BGNR



CG25803CORN

English Walnut & Burly Wood Cover Plates With Support Plate				
Product Code Vera / Virna	HSN Code	Description	MRP (₹)	Std. Pkg. (Nos.)
CG25701NR / CG25801NR	85381010	1 Module Plate	334	10
CG25702NR / CG25802NR	85381010	2 Module Plate		
CG25703NR / CG25803NR	85381010	3 Module Plate		
CG25704NR / CG25804NR	85381010	4 Module Plate		
CG25706NR / CG25806NR	85381010	6 Module Plate	721	5
CG25708NR / CG25808NR	85381010	8 Module Plate - Vertical		
CG25709NR / CG25809NR	85381010	8 Module Plate - Horizontal		
CG25712NR / CG25812NR	85381010	12 Module Top Plate		
CG25718NR / CG25818NR	85381010	18 Module Plate	970	
			1104	

Please add codes EW for English Walnut and BW for Burly Wood e.g. for ordering one module Vera English Walnut plate code would be CG25701EW



CG25703BWN



CG25803EWN

Cover Plate Sizes (All dimensions in mm)

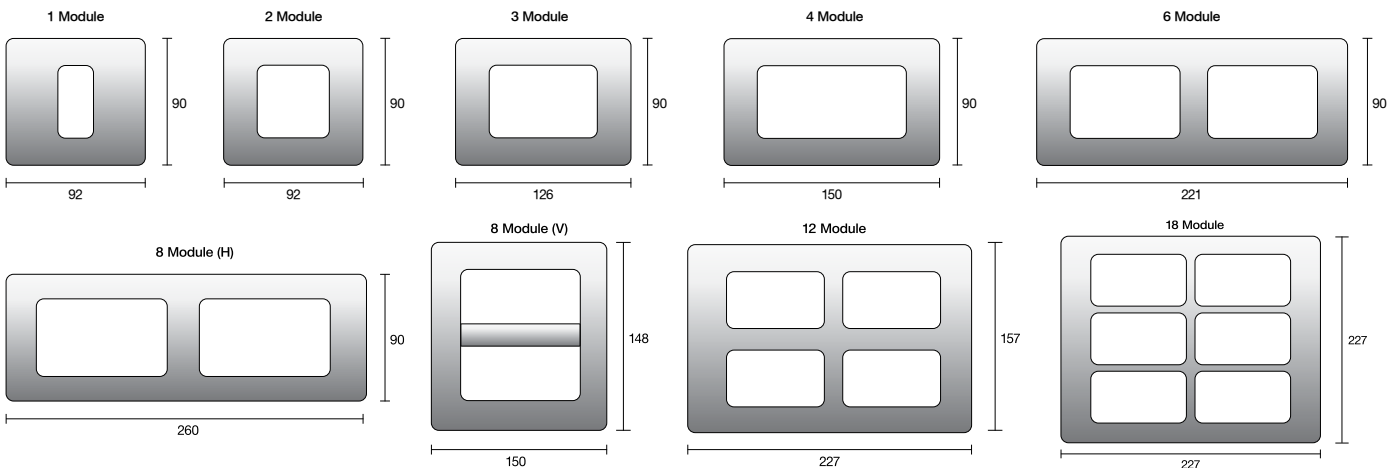



Weather Proof Enclosures COMBI



CG26000WNR

CG26400WNR



CG24025WNR



CG26012WNR

IP55 & IP40 Enclosures						
Product Code	HSN Code	Description	Configuration	MRP (₹)	Std. Pkg. (Nos.)	
Watertight And Dust Proof Enclosures IP55-Surface Mounting						
CG26000WNR	85371000	Bell Push	1 Module	706	1	
CG26400WNR	85371000	16A Switch, 6/16A Socket	3 Module	1202		
CG26016WNR	85371000	6A Switch	1 Module	652		
IP55 Motor Starter						
CG26018WNR	85381010	IP55 2M Enclosure With 16A Motor Starter		1176	1	
CG26019WNR	85381010	IP55 2M Enclosure With 25A Motor Starter		1382		
Watertight Plates For Flush Mounting Installations IP55 (Compatible with 3M concealed box)						
CG24025WNR	85381010	3 Gang		748	10	
Product Code	HSN Code	Description	Configuration	External Dim. LxHxD (mm)	MRP (₹)	Std. Pkg. (Nos.)
Watertight Enclosures For Fixed Or Movable Applications						
CG26010WNR	85381010	1 Gang	Module 1	80x64x59	505	10
CG26011WNR	85381010	2 Gang	Module 2	80x64x59	524	
CG26012WNR	85381010	3 Gang	Module 3	80x96x59	633	
CG26013WNR	85381010	4 Gang	Module 4x1	80x128x59	829	
CG26014WNR	85381010	8 Gang	Module 4x2	160x128x59	1415	5
CG26015WNR	85381010	12 Gang	Module 4x3	240x128x59	1865	3

COMBI
WEATHER PROOF ENCLOSURES

DUST PROOF
WATER PROOF

A Switch designed to win the biggest test.
Nature...



CG28015NR



CG28017NR



CG28023NR



CG28020NR



ACBHS001NR ACBHA004NR



ACBHA005NR



ACBHS006NR



ACBHS008NR



ACCR001NR



Top Plug				
Product Code	HSN Code	Description	MRP (₹)	Std. Pkg. (Nos.)
CG28014NR	85361010	6A Plug Top	72	10
CG28015NR	85361020	16A Plug Top	107	
*CG28018NR	85361020	25 A Plug Top	138	

Top Plug with Indicator				
Product Code	HSN Code	Description	MRP (₹)	Std. Pkg. (Nos.)
CG28017NR	85361020	16A Plug Top	114	10
*CG28019NR	853 61010	25A Plug Top	168	

Two Pin Socket				
Product Code	HSN Code	Description	MRP (₹)	Std. Pkg. (Nos.)
*CG28021NR	853 61010	6A 2 Pin Plug Top - Male	26	30
*CG28023NR	853 61010	6A 2 Pin Plug Top Combined Unit (Male & Female)	54	

Multi Plug Socket				
Product Code	HSN Code	Description	MRP (₹)	Std. Pkg. (Nos.)
CG28020NR	85361010	6A Multi Plug Socket	97	10

Batten Holder				
Product Code	HSN Code	Description	MRP (₹)	Std. Pkg. (Nos.)
ACBHS001NR	85381010	Straight Batten Holder (Plain)	57	20
ACBHA003NR	85381010	Angular Batten Holder (Plain)		
ACBHS002NR	85381010	Straight Batten Holder (Fancy)	68	
ACBHA004NR	85381010	Angular Batten Holder (Fancy)		
ACBHA005NR	85381010	Batten Holder common (2 in 1)	79	
ACBHS006NR	85381010	Square Batten Holder (Plain)	90	
ACBHA007NR	85381010	Square angle Batten Holder (Plain)		
ACBHS008NR	85381010	Slim Batten Holder (Fancy)	99	
ACBHA009NR	85381010	Slim angle Batten Holder (Fancy)		

Ceiling Rose				
Product Code	HSN Code	Description	MRP (₹)	Std. Pkg. (Nos.)
ACCR001NR	85381010	Ceiling rose	47	20

Surface Plastic Box				
Product Code	HSN Code	Description	MRP (₹)	Std. Pkg. (Nos.)
ACSMB001NR	85381010	1 Module	68	10
ACSMB001NR	85381010	2 Module	68	
ACSMB003NR	85381010	3 Module	88	
ACSMB004NR	85381010	4 Module	95	
ACSMB006NR	85381010	6 Module	128	
ACSMB008NR	85381010	8 Module (Horizontal)	176	
ACSMB009NR	85381010	8 Module (Vertical)	176	
ACSMB012NR	85381010	12 Module	223	
ACSMB018NR	85381010	18 Module	250	

* Material available till stock last.

A Piece of **Art** with Complete **Safety, Comfort & Aesthetics** for your **Walls**

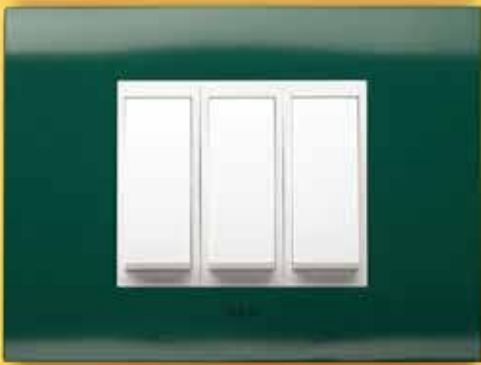

- Available in 1 Module to 18 Module*
- Sleek Design & Compatible with Primo Range of Switches
- Highly Aesthetic Break Free Design
- Compatible to Market Boxes
- Designed with Front Mount & Removal Option

* The Antibacterial feature are available only in White & Grey Top Plates & Accessories.



CS20114PNR



CS20123PNR



CS20511PNR



CS20056PNR



CS20631NR



CS20801PNR

Switches						
Product Code - Pure White / Grey	HSN Code	Description	Type	No. Modules	MRP (₹)	Std. Pkg. (Nos.)
One-Way Switches						
CS20113PNR / CS23113PNR	85361010	6A, 250V	General	1	94	20
CS20114PNR / CS23114PNR	85361010	6A, 250V	Luminous	1	122	
CS20115PNR / CS23115PNR	85361010	6A, 250V	Luminous	2	135	10
CS20573PNR / CS23573PNR	85361020	16A, 250V	General	1	141	20
CS20574PNR / CS23574PNR	85361020	16A, 250V	Luminous	1	177	
CS20575PNR / CS23575PNR	85361020	16A, 250V	Luminous	2	185	10
CS20117PNR / CS23117PNR	85361020	25A, 250V	General	1	186	20
CS20118PNR / CS23118PNR	85361020	25A, 250V	Luminous	1	220	
CS20119PNR / CS23119PNR	85361020	25A, 250V	General	2	222	10
CS20120PNR / CS23120PNR	85361020	25A, 250V	Luminous	2	246	
Two-Way Switches						
CS20123PNR / CS23123PNR	85361010	6A, 250V	General	1	134	20
CS20124PNR / CS23124PNR	85361010	6A, 250V	General	2	138	10
CS20578PNR / CS23578PNR	85361020	16A, 250V	General	1	210	20
CS20579PNR / CS23579PNR	85361020	16A, 250V	General	2	232	10
Product Code - Pure White / Grey	HSN Code	Description	Type	No. Modules	MRP (₹)	Std. Pkg. (Nos.)
Bell Push Switches						
CS20509PNR / CS23509PNR	85361010	6A, Bell Push	General	1	130	20
CS20508PNR / CS23508PNR	85361010	6A, Bell Push	Luminous	1	150	
CS20510PNR / CS23510PNR	85361010	6A, Bell Push	General	2	144	10
CS20511PNR / CS23511PNR	85361010	6A, Bell Push	Luminous	2	151	
Blanking Module						
CS20056PNR / CS23056PNR	85381010	1M Blank	General	1	34	50
Product Code - Pure White / Grey	HSN Code	Description	No. Modules	MRP (₹)	Std. Pkg. (Nos.)	
Neon Indicator						
CS20631PNR / CS23631PNR	85361010	Neon Indicator Red	1	79	20	
Product Code - Pure White / Grey	HSN Code	Description	No. Modules	MRP (₹)	Std. Pkg. (Nos.)	
Fan Regulator / Dimmer						
CS20826PNR / CS23826PNR	85361010	5-Step Fan Regulator 100W	2	417	10	
CS20827PNR / CS23827PNR	85361010	4-Step Fan Regulator 100W	1	335	20	
CS20801PNR / CS23801PNR	85361010	Rotary Type Dimmer 500W	2	446	10	
CS20804PNR / CS23804PNR	85361010	Rotary Type Dimmer 300W	1	327	20	



CS20359NR



CS20370PNR



CS20228PNR



CS20251PNR



CS20275PNR



CS20816PNR



CS20611PNR CS20610PNR



CS20632PNR CS20633PNR

Product Code - Pure White / Grey	HSN Code	Description	No. Modules	MRP (₹)	Std. Pkg. (Nos.)
Sockets with Safety Shutters					
*CS20359PNR / CS23359PNR	85361010	6A, 2 Pin Socket	1	100	20
CS20370PNR / CS23370PNR	85361010	6A, 3 Pin	2	122	10
*CS20353PNR / CS23353PNR	85361010	6A, 5 Pin	2	141	
CS20352PNR / CS23352PNR	85361020	6/16A, 6 Pin	3	226	
CS20354PNR / CS23354PNR	85361020	6/16A, Socket Projected	2	212	
*CS20355PNR / CS23355PNR	853 61020	6/25 A, 6 Pin	3	261	
*CS20356PNR / CS23356PNR	853 61020	6/16/25 A, 6 Pin Socket Projected	2	212	
*CS20358PNR / CS23358PNR	853 61020	13A Universal Socket	2	232	

Product Code - Pure White / Grey	HSN Code	Description	No. Modules	MRP (₹)	Std. Pkg. (Nos.)
TV Socket / Flex Outlet					
CS20228PNR / CS23228PNR	85361010	TV Socket	1	110	20
CS20237PNR / CS23237PNR	85361010	Flex Outlet	1	77	

Product Code - Pure White / Grey	HSN Code	Description	No. Modules	MRP (₹)	Std. Pkg. (Nos.)
Telephone / Computer Socket					
CS20251PNR / CS23251PNR	85361010	RJ 11, Telephone Jack	1	110	20
CS20271PNR / CS23271PNR	85361010	RJ 45, Computer Jack CAT5e	1	349	
CS20272PNR / CS23272PNR	85361010	RJ 45, Computer Jack CAT6	1	541	
CS20273PNR / CS23273PNR	85361010	RJ 45, Computer Jack CAT6a	1	1035	

Product Code - Pure White / Grey	HSN Code	Description	No. of Modules	MRP (₹)	Std. Pkg. (Nos.)
USB Charger Socket					
CS20275PNR / CS23275PNR	85044030	USB Charger Socket 2.1A (Fast Charging)	1	935	20

Product Code - Pure White / Grey	HSN Code	Description	No. of Modules	MRP (₹)	Std. Pkg. (Nos.)
Hospitality Range					
Energy Saving Switch					
CS20816PNR / CS23816PNR	85361020	25A, Energy Saving Switch With Key Tag & Indicator	2	479	1
APPLICATION: activation of functions and service inside hotel rooms (e.g. light, air-conditioner, minibar) when the room is occupied (with badge inserted).					
DND/MMR Switch Units					
CS20610PNR / CS23610PNR	85361010	DND/MMR External Unit	1	235	20
CS20611PNR / CS23611PNR	85361010	DND/MMR Internal Unit	1+1	228	10
Skirt Light & Night Lamp					
CS20632PNR / CS23632PNR	94051090	Skirt Light	2	372	10
CS20633PNR / CS23633PNR	94051090	Night Lamp	2	390	10



CS26404PWNR

Primo Plus Power Unit with PVC					
Product Code - Pure White	HSN Code	Description	No. of Modules	MRP (₹)	Std. Pkg. (Nos.)
CS26404PWNR	85371000	Power Unit Combo 16A MCB Protected Socket	4	796	1
*CS26405PWNR	85371000	Power Unit Combo 20A MCB Protected Socket	4	991	
*CS26406PWNR	85371000	Power Unit Combo 25A MCB Protected Socket	4	991	



CS25803WHNR

Product Code	HSN Code	Description	MRP (₹)	Std. Pkg. (Nos.)
Swan White (Cover Plates with Support Plate)				
CS25801WHNR	85381010	1 Module Plate	96	10
CS25802WHNR	85381010	2 Module Plate		
CS25803WHNR	85381010	3 Module Plate	134	
CS25804WHNR	85381010	4 Module Plate	140	
CS25806WHNR	85381010	6 Module Plate	204	
CS25808WHNR	85381010	8 Module Plate (Horizontal)	256	
CS25809WHNR	85381010	8 Module Plate (Vertical)		
CS25812WHNR	85381010	12 Module Plate	345	5
CS25816WHNR	85381010	16 Module Plate	399	
CS25818WHNR	85381010	18 Module Plate	423	
Glossy Grey (Cover Plates with Support Plate)				
CS25801GRNR	85381010	1 Module Plate	101	10
CS25802GRNR	85381010	2 Module Plate		
CS25803GRNR	85381010	3 Module Plate	130	
CS25804GRNR	85381010	4 Module Plate	145	
CS25806GRNR	85381010	6 Module Plate	208	
CS25808GRNR	85381010	8 Module Plate (Horizontal)	265	
CS25809GRNR	85381010	8 Module Plate (Vertical)		
CS25812GRNR	85381010	12 Module Plate	350	5
CS25816GRNR	85381010	16 Module Plate	432	
CS25818GRNR	85381010	18 Module Plate	460	



CS25803GRNR



Cover Plates with Support Plate				
Product Code	HSN Code	Description	MRP (₹)	Std. Pkg. (Nos.)
Cadet Grey / Black Olive / Argent Grey / Charcol Black / Arsenic Black / Champagne / Candy Red / Corel Red / British Green Plates				
CS25801NR	85381010	1 Module Plate	197	10
CS25802NR	85381010	2 Module Plate		
CS25803NR	85381010	3 Module Plate	233	
CS25804NR	85381010	4 Module Plate	261	
CS25806NR	85381010	6 Module Plate	394	5
CS25808NR	85381010	8 Module - Horizontal	441	
CS25809NR	85381010	8 Module - Vertical		
CS25812NR	85381010	12 Module Plate	571	
CS25816NR	85381010	16 Module Plate	610	
CS25818NR	85381010	18 Module Plate	739	
Please add codes CS for Cadet Grey, BO for Black Olive, AG for Argent Grey, CB for Charcol Black, AB for Arsenic Black, CH for Champagne, CAR for Candy Red, COR for Corel Red, BG for British Green Plates e.g. for ordering one module Cadet Grey plate code would be CS25801				

* Material available till stock last.



CS25803BWNR



CS25803EWNR

English Walnut & Burly Wood Cover Plates with Support Plate				
Product Code	HSN Code	Description	MRP (₹)	Std. Pkg. (Nos.)
CS25801NR	85381010	1 Module Plate	258	10
CS25802NR	85381010	2 Module Plate		
CS25803NR	85381010	3 Module Plate	282	
CS25804NR	85381010	4 Module Plate	297	
CS25806NR	85381010	6 Module Plate	508	5
CS25808NR	85381010	8 Module Plate - Horizontal	586	
CS25809NR	85381010	8 Module Plate - Vertical		
CS25812NR	85381010	12 Module Top Plate	759	
CS25816NR	85381010	16 Module Top Plate	847	
CS25818NR	85381010	18 Module Plate	901	

Please add codes EW for English Walnut and BW for Burly Wood e.g. for ordering one module English Walnut plate code would be CS25801EW

Metal Boxes- Fabricated (Box for DIVINO, PRIMO PLUS & PRIMO)					
Product Code	HSN Code	Description	Dimension LxHxD (mm)	MRP (₹)	Std. Pkg. (Nos.)
CG24271NR	85381010	1 Module Box	75 X 75 X 50	83	10
CG24271NR	85381010	2 Module Box	75 X 75 X 50		
CG24272NR	85381010	3 Module Box	100 X 75 X 50	98	
CG24273NR	85381010	4 Module Box	135 X 76 X 50	120	
CG24274NR	85381010	6 Module Box	210 X 75 X 50	169	5
CG24275NR	85381010	8 Module Box (4 +4)	134 X 140 X 52	196	
CG24276NR	85381010	8 Module Box (Horizontal)	232 X 79 X 52		
CG24277NR	85381010	12 Module Box	210 X 140 X 50	240	
CG24279NR	85381010	16 Module Box	210 X 140 X 60	302	7
CG24278NR	85381010	18 Module Box	210 X 210 X 56	339	5

* 10M Top Plate shall be fitted in 8M (4+4) Vertical Metal Box (i.e. CG 24 275)
 * 5M Top Plate Shall be fitted in 4M Metal Box (i.e. CG 24 273)
 * Deep Drawn Metal Boxes are available on request.



CG24272NR



CS20114NR



CS20123NR



CS20511NR



CS20056NR



CS20631NR



CS20801NR



CS20359NR



CS20370NR



CS20228NR



CS20251NR

Switches						
Product Code - Pure White	HSN Code	Description	Type	No. Modules	MRP (₹)	Std. Pkg. (Nos.)
One-Way Switches						
CS20113NR	85361010	6A, 250V	General	1	80	20
CS20114NR	85361010	6A, 250V	Luminous	1	112	
CS20115NR	85361010	6A, 250V	Luminous	2	125	10
CS20573NR	85361020	16A, 250V	General	1	131	20
CS20574NR	85361020	16A, 250V	Luminous	1	162	
CS20575NR	85361020	16A, 250V	Luminous	2	172	10
CS20117NR	85361020	25A, 250V	General	1	173	20
CS20118NR	85361020	25A, 250V	Luminous	1	205	
CS20119NR	85361020	25A, 250V	General	2	205	10
CS20120NR	85361020	25A, 250V	Luminous	2	229	
Two-Way Switches						
CS20123NR	85361010	6A, 250V	General	1	127	20
CS20124NR	85361010	6A, 250V	General	2	131	10
CS20578NR	85361020	16A, 250V	General	1	181	20
CS20579NR	85361020	16A, 250V	General	2	185	10

Product Code - Pure White	HSN Code	Description	Type	No. Modules	MRP (₹)	Std. Pkg. (Nos.)
Bell Push Switches						
CS20509NR	85361010	6A, Bell Push	General	1	108	20
CS20508NR	85361010	6A, Bell Push	Luminous	1	126	
CS20510NR	85361010	6A, Bell Push	General	2	134	10
CS20511NR	85361010	6A, Bell Push	Luminous	2	141	
Blanking Module						
CS20056NR	85381010	1M Blank	General	1	29	50

Product Code - Pure White	HSN Code	Description	No. Modules	MRP (₹)	Std. Pkg. (Nos.)
Neon Indicator					
CS20631NR	85361010	Neon Indicator Red	1	74	20

Product Code - Pure White	HSN Code	Description	No. Modules	MRP (₹)	Std. Pkg. (Nos.)
Fan Regulator / Dimmer					
CS20826NR	85361010	5-Step Fan Regulator 100W	2	405	10
CS20827NR	85361010	4-Step Fan Regulator 100W	1	314	20
CS20801NR	85361010	Rotary Type Dimmer 500W	2	410	10
CS20804NR	85361010	Rotary Type Dimmer 300W	1	310	20
Sockets with Safety Shutters					
*CS20359NR	85361010	6A, 2 Pin Socket	1	94	20
CS20370NR	85361010	6A, 3 Pin	2	110	
*CS20353NR	85361010	6A, 5 Pin	2	129	
CS20352NR	85361020	6/16A, 6 Pin	3	218	
CS20354NR	85361020	6/16A, Socket Projected	2	202	
*CS20355NR	85361020	6/25A, 6 Pin	3	250	
*CS20356NR	85361020	6/16/25A, 6 Pin Socket Projected	2	202	
*CS20358NR	85361020	13A Universal Socket	2	228	

Product Code - Pure White	HSN Code	Description	No. Modules	MRP (₹)	Std. Pkg. (Nos.)
TV Socket / Flex Outlet					
CS20228NR	85361010	TV Socket	1	103	20
CS20237NR	85361010	Flex Outlet	1	65	

Product Code - Pure White	HSN Code	Description	No. Modules	MRP (₹)	Std. Pkg. (Nos.)
Telephone / Computer Socket					
CS20251NR	85361010	RJ 11, Telephone Jack	1	103	20
CS20271NR	85361010	RJ 45, Computer Jack CAT5e	1	332	
CS20272NR	85361010	RJ 45, Computer Jack CAT6	1	513	
CS20273NR	85361010	RJ 45, Computer Jack CAT6a	1	985	

* Material available till stock last.



CS20275NR



CS20815NR



CS20611NR

CS20610NR



CS20632NR

CS20633NR

USB Charger Socket					
Product Code-Pure White	HSN Code	Description	No. of Modules	MRP (₹)	Std. Pkg. (Nos.)
CS20275NR	85044030	USB Charger Socket 2.1A (Fast Charging)	1	919	20

Hospitality Range					
Product Code-Pure White	HSN Code	Description	No. of Modules	MRP (₹)	Std. Pkg. (Nos.)
Energy Saving Switch					
CS20815NR	85361020	25A, Energy Saving Switch With Key Tag & Indicator	2	480	1
APPLICATION: activation of functions and service inside hotel rooms (e.g. light, air-conditioner, minibar) when the room is occupied (with badge inserted).					
DND/MMR Switch Units					
CS20610NR	85361010	DND/MMR External Unit	1	221	20
CS20611NR	85361010	DND/MMR Internal Unit	1+1	210	10
Skirt Light & Night Lamp					
CS20632NR	94051090	Skirt Light	2	358	10
CS20633NR	94051090	Night Lamp	2	375	10

Modular Miniature Case Circuit Breaker - Wintrip 'S'					
Product Code - Pure White	HSN Code	Description	No. of Modules	MRP (₹)	Std. Pkg. (Nos.)
Single & Double Pole					
CS20431NR	85361010	6A Single Pole 4.5kA - Tripping Curve 'C'	1	221	12
CS20432NR	85361010	10A Single Pole 4.5kA - Tripping Curve 'C'			
CS20433NR	85361020	16A Single Pole 4.5kA - Tripping Curve 'C'			
CS20437NR	85361020	20A Single Pole 4.5kA - Tripping Curve 'C'			
CS20435NR	85361020	25A Single Pole 4.5kA - Tripping Curve 'C'			
CS20436NR	85361020	32A Single Pole 4.5kA - Tripping Curve 'C'	2	528	6
CS20438NR	85361010	6A Double Pole 4.5kA - Tripping Curve 'C'			
CS20439NR	85361010	10A Double Pole 4.5kA - Tripping Curve 'C'			
CS20440NR	85361020	16A Double Pole 4.5kA - Tripping Curve 'C'			
CS20441NR	85361020	20A Double Pole 4.5kA - Tripping Curve 'C'			
CS20442NR	85361020	25A Double Pole 4.5kA - Tripping Curve 'C'			
CS20443NR	85361020	32A Double Pole 4.5kA - Tripping Curve 'C'			



CS20431NR

CS20443NR

Power Unit					
Product Code - Pure White	HSN Code	Description	No. of Modules	MRP (₹)	Std. Pkg. (Nos.)
CS26401WNR	85371000	Power Unit Combo 16A MCB Protected Socket	4	797	1
*CS26402WNR	85371000	Power Unit Combo 20A MCB Protected Socket	4	917	
*CS26403WNR	85371000	Power Unit Combo 25A MCB Protected Socket	4	917	



CS26401WNR



CS20364NR

Single Phase Motor Starter					
Product Code	HSN Code	Description	MRP (₹)	Std. Pkg. (Nos.)	
CS20364NR	85361020	Motor Starter 16A	593	10	
CS20366NR	85361020	Motor Starter 25A			

Top Plates with Support Plate				
Product Code - Pure White	HSN Code	Description	MRP (₹)	Std. Pkg. (Nos.)
CS25701WHNR	85381010	1 Module Plate	83	10
CS25702WHNR	85381010	2 Module Plate		
CS25703WHNR	85381010	3 Module Plate	129	
CS25704WHNR	85381010	4 Module Plate	135	
CS25705WHNR	85381010	5 Module Plate (Compatible with 4M Metal Box)		
CS25706WHNR	85381010	6 Module Plate	183	
CS25707WHNR	85381010	8 Module Horizontal	242	5
CS25709WHNR	85381010	8 Module Plate Horizontal (Compatible with 6M Metal Box)		
CS25710WHNR	85381010	10 Module-Vertical (Compatible With 8M (4+4) Metal Box)		
CS25711WHNR	85381010	10 Module-Horizontal (Compatible With 8M (H) Metal Box)	304	
CS25712WHNR	85381010	12 Module Plate	385	
CS25716WHNR	85381010	16 Module Plate (Compatible With 12M Metal Box)	396	
CS25718WHNR	85381010	18 Module Plate		
Red / Yellow/ Green/ Blue / Grey Plates				
CS25701NR	85381010	1 Module Plate	93	10
CS25702NR	85381010	2 Module Plate		
CS25703NR	85381010	3 Module Plate	136	
CS25704NR	85381010	4 Module Plate	141	
CS25705NR	85381010	5 Module Plate (Compatible With 4M Metal Box)		
CS25706NR	85381010	6 Module Plate	191	
CS25707NR	85381010	8 Module Horizontal	245	5
CS25709NR	85381010	8 Module Plate Horizontal (Compatible with 6M Metal Box)		
CS25710NR	85381010	10 Module-Vertical (Compatible With 8M (4+4) Metal Box)		
CS25711NR	85381010	10 Module-Horizontal (Compatible With 8M (H) Metal Box)	328	
CS25712NR	85381010	12 Module Plate	399	
CS25716NR	85381010	16 Module Plate (Compatible With 12M Metal Box)	458	
CS25718NR	85381010	18 Module Plate		
Please add following to codes for color selection GR for Grey / RD for RED / YL for Yellow / BL for Blue/ GN for Green e.g. for ordering one module red plate code would be CS25701RD				
Wooden				
CS25701WNNR	85381010	1 Module Plate	178	10
CS25702WNNR	85381010	2 Module Plate		
CS25703WNNR	85381010	3 Module Plate	226	
CS25704WNNR	85381010	4 Module Plate	245	
CS25705WNNR	85381010	5 Module Plate (Compatible With 4M Metal Box)		
CS25706WNNR	85381010	6 Module Plate	313	
CS25707WNNR	85381010	8 Module Horizontal	450	5
CS25709WNNR	85381010	8 Module Plate Horizontal (Compatible with 6M Metal Box)		
CS25710WNNR	85381010	10 Module-Vertical (Compatible With 8M (4+4) Metal Box)		
CS25711WNNR	85381010	10 Module-Horizontal (Compatible With 8M (H) Metal Box)	553	
CS25712WNNR	85381010	12 Module Plate	586	
CS25716WNNR	85381010	16 Module Plate (Compatible With 12M Metal Box)	695	
CS25718WNNR	85381010	18Module Plate		



Cover Plate Sizes (All dimensions in mm)

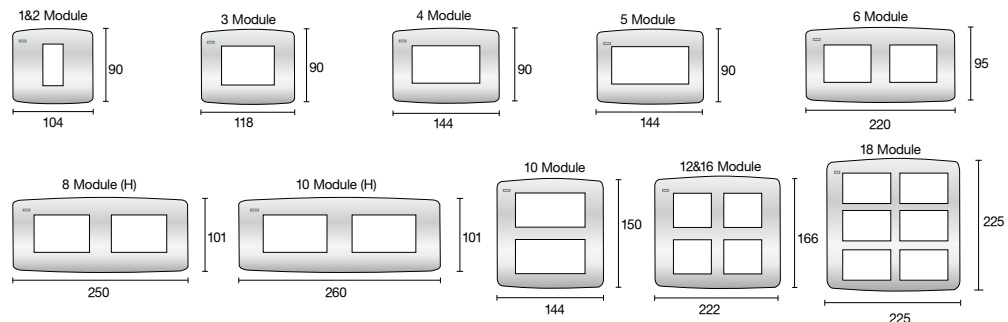



WiNtrip 'S'

Single Lock Modular MCB

The perfect solution for AC's, Refrigerators & Electrical Appliances

Safe | Convenient | Energy Saving | Wide Range
Compact Design | Overload & Short Circuit Protection
Rapid Closing Mechanism | Easy to Operate



CS20431RNR



CS20443RNR

Product Code	HSN Code	Description	No. of Modules	MRP (₹)	Std. Pkg. (Nos.)
Single Pole - Tripping Curve 'C'					
CG20431RNR	85361010	6A Single Pole 4.5kA-Tripping Curve 'C'	1	221	12
CG20432RNR	85361010	10A Single Pole 4.5kA-Tripping Curve 'C'			
CG20433RNR	85361020	16A Single Pole 4.5kA-Tripping Curve 'C'			
CG20437RNR	85361020	20A Single Pole 4.5kA-Tripping Curve 'C'			
CG20435RNR	85361020	25A Single Pole 4.5kA-Tripping Curve 'C'			
CG20436RNR	85361020	32A Single Pole 4.5kA-Tripping Curve 'C'			
Double Pole - Tripping Curve 'C'					
CG20438RNR	85361010	6A Double Pole 4.5kA-Tripping Curve 'C'	2	528	6
CG20439RNR	85361010	10A Double Pole 4.5kA-Tripping Curve 'C'			
CG20440RNR	85361020	16A Double Pole 4.5kA-Tripping Curve 'C'			
CG20441RNR	85361020	20A Double Pole 4.5kA-Tripping Curve 'C'			
CG20442RNR	85361020	25A Double Pole 4.5kA-Tripping Curve 'C'			
CG20443RNR	85361020	32A Double Pole 4.5kA-Tripping Curve 'C'			



CS20436NR

CS20438NR

Non-Modular Miniature Case Circuit Breaker - WiNtrip 'S'					
Product Code - Pure White	HSN Code	Description	No. of Modules	MRP (₹)	Std. Pkg. (Nos.)
Single & Double Pole					
CS20431NNR	85361010	6A Single Pole 4.5kA-Tripping Curve 'C'	1	221	12
CS20432NNR	85361010	10A Single Pole 4.5kA-Tripping Curve 'C'			
CS20433NNR	85361020	16A Single Pole 4.5kA-Tripping Curve 'C'			
CS20437NNR	85361020	20A Single Pole 4.5kA-Tripping Curve 'C'			
CS20435NNR	85361020	25A Single Pole 4.5kA-Tripping Curve 'C'			
CS20436NNR	85361020	32A Single Pole 4.5kA-Tripping Curve 'C'			
CS20438NNR	85361010	6A Double Pole 4.5kA-Tripping Curve 'C'	2	528	6
CS20439NNR	85361010	10A Double Pole 4.5kA-Tripping Curve 'C'			
CS20440NNR	85361020	16A Double Pole 4.5kA-Tripping Curve 'C'			
CS20441NNR	85361020	20A Double Pole 4.5kA-Tripping Curve 'C'			
CS20442NNR	85361020	25A Double Pole 4.5kA-Tripping Curve 'C'			
CS20443NNR	85361020	32A Double Pole 4.5kA-Tripping Curve 'C'			

Wiring Accessories

General Terms & Conditions

Price are subject to revision without prior notice and will be applicable as prevailing at the time of dispatch.

- This Pricelist supercedes all previous Price Lists.
- Maximum Retail Price (MRP) mentioned are maximum recommended selling prices inclusive of GST.
- All Prices are in Indian Rupees.

Warranty

All our listed Electro-mechanical wiring devices carry a warranty, against manufacturing defects for a period of 10 years from the date of invoicing & 2 years for all mains related electronic wiring products viz. Dimmers, Step Fan regulator and Indicators subject to it's usages in normal recommended operating conditions. Guarantee does not include Metal Box, Plug Tops and other stand alone products. The guarantee defines the company's entire liability & does not cover consequences loss or damage or re-installations cost arising from defective product. The company liability shall be limited to exchange or repair of the product, at our discretion, provided that such defective products are returned to nearest Branch office.



24x7
SERVICE DESK

CENTRAL CUSTOMER CARE (CCC)

C&S Electric is committed to create a unique alchemy of outstanding products, operational excellence, path breaking customer services & compelling marketing. Further to enhance the post sales customer service experience, C&S introduces a service monitoring software "Salesforce". The software provides a transparent service tracking system and helps in efficient monitoring and quick resolution of queries.



Key Features & Benefits

- Transparent process
- Efficient monitoring & tracking of each Service Request
- Quick resolution time
- All relevant customer data in one single location
- Improved customer relationships
- Strengthen C&S brand image & reputation in the market

Escalation Matrix

*C&S Branch Service Engineer “ ≥ 24 Hours”

Central Customer Care (CCC) “ ≥ 48 Hours”
(Connect via Toll free no., Email ID, & Whatsapp no.)

GM Services - Mr. Bikram Rana “ ≥ 72 Hours”
WhatsApp No.: 95994 45253, Email: bikram.rana@cselectric.co.in

Sr.VP - Mr. P. Anandan “ ≥ 96 Hours”
Email: anandan.p@cselectric.co.in

FOR QUICK SUPPORT

Toll Free Number: 1800 572 2012

WhatsApp No.: 95994 45253

Email: customercare@cselectric.co.in





Marketing offices spread all over India

CENTRAL MARKETING OFFICE

C-60, Wing-A, Phase-II, Noida, District Gautam Budh Nagar, Uttar Pradesh-201 305 (INDIA)

Tel.: +91 120 387 4800 / 01 | Email : cmo@cselectric.co.in

CUSTOMER CARE

Toll Free Number: 1800 572 2012

E-mail: customercare@cselectric.co.in

NORTHERN REGION

DELHI

Email: cmo@cselectric.co.in

LUDHIANA

Email: ludhiana@cselectric.co.in

LUCKNOW

Email: lucknow@cselectric.co.in

KANPUR

Email: lucknow@cselectric.co.in

JAIPUR

Email: jaipur@cselectric.co.in

CENTRAL REGION

INDORE

Email: indore@cselectric.co.in

RAIPUR

Email: raipur@cselectric.co.in

NAGPUR

Email: nagpur@cselectric.co.in

EASTERN REGION

KOLKATA

Email: kolkata@cselectric.co.in

GUWAHATI

Email: guwahati@cselectric.co.in

RANCHI

Email: ranchi@cselectric.co.in

BHUBANESWAR

Email: bhubaneshwar@cselectric.co.in

WESTERN REGION

MUMBAI

Email: mumbai@cselectric.co.in

PUNE

Email: pune@cselectric.co.in

AHMEDABAD

Email: ahmedabad@cselectric.co.in

RAJKOT

Email: ahmedabad@cselectric.co.in

BARODA

Email: baroda@cselectric.co.in

SURAT

Email: surat@cselectric.co.in

SOUTHERN REGION

CHENNAI

Email: chennai@cselectric.co.in

COIMBATORE

Email: coimbatore@cselectric.co.in

KOCHI

Email: cochin@cselectric.co.in

MADURAI

Email: commercial.madurai@cselectric.co.in

BENGALURU

Email: bangalore@cselectric.co.in

HYDERABAD

Email: hyderabad@cselectric.co.in

VIJAYAWADA

Email: vijayawada@cselectric.co.in

RESIDENT ENGINEERS

AHMEDABAD: Visnagar **BANGALORE:** Bellary, Hassan, Hubli, Mangalore **BARODA:** Anand, Vapi **BHUBANESWAR:** Behrampur, Cuttack, Rourkela, Sambalpur **CHENNAI:** Vellore, Trichy **KOCHI:** Kollam **COIMBATORE:** Erode **DELHI & HARYANA:** Gurugram, Hissar, Panipat, **UP (W) & UK:** Agra, Bareilly, Dehradun, Ghaziabad, Meerut, Moradabad, Noida **GUWAHATI:** Silchar, Tezpur **HYDERABAD:** Karimnagar, Warangal **INDORE:** Bhopal, Gwalior, Jabalpur, Rewa, Ujjain **J&K:** Kashmir, Srinagar **JAIPUR:** Bhilwara, Bikaner, Jodhpur, Kota, Sikar, Udaipur **KOLKATA:** Bankura, Bardhaman, Siliguri **LUCKNOW:** Gorakhpur, Prayagraj, Shahjhanpur, Varanasi **LUDHIANA:** Amritsar, Barnala, Jammu, Mansa **MADURAI:** Nagercoil, Rajapalayam **MUMBAI:** Aurangabad, Nasik **NAGPUR:** Akola, Amravati, Chandrapur **PUNE:** Goa, Nasik, Kolhapur, Sangali, Solapur **RAIPUR:** Ambikapur **RAJKOT:** Bhavnagar, Jamnagar **RANCHI:** Dhanbad, Muzaffarpur, Patna, Purnia, Siwan **SURAT:** Aurangabad, Nasik **VIJAYAWADA:** Chittoor, Rajahmundry, Tirupathi, Vishakhapatnam

WAREHOUSES

National Warehouse

NOIDA

B-58, Sector-80, Phase-II, Noida, District Gautam Budh Nagar, Uttar Pradesh - 201305 INDIA
Ph.: +91 120 3857483/84/88/89

Regional Warehouses

INDORE

Liberty Agencies 53, Udyog Nagar, Near Musakhedi Square, Ring Road, Indore - 452001 INDIA
Ph.: +91 88780 62000 / 64000

RANCHI

Plot No. 145/C, Mandir Marg-D, Road No. 4, Ashok Nagar, Distt. Ranchi, Jharkhand - 834002 INDIA
Ph.: +91 651 2242202, 2242224

AHMEDABAD

B-25-B/C Meldi Industrial Estate, Opp. West Coast Pharmaceutical, Nr. Gota Over Bridge, Gota, Ahmedabad - 382481 INDIA
Mob.: +91 7698996868 / 6351725096,

BENGALURU

No. 25, Pattanagere Village, Kengeri Hobli, Rajarajeshwari Nagar, Bangalore - 560098 INDIA
Ph.: +91 80 29700265

