



**Corbin
Russwin**

ASSA ABLOY



2023 Price List

Number 38

USA & Canada Prices Effective April 17, 2023



Experience a safer
and more open world

SECTION	PAGE
Service Center Business Hours, Holiday Schedule	5
Partner Services in Canada, Business Hours, Holiday Schedule	5
Order Forms	6
Key System Information Request Form	10
Keyed Order Lead Sheet	11
Tools and Rules	16
Terms and Conditions	20
Warranty	24
Finishes, Samples, Templates	26
KEY SYSTEMS	
General Information	28
Policy	31
Construction Core	32
Keying, Stamping, Cut Keys	33
Bitting List	34
Key Wizard	35
Key Blanks	36
Access 3 AP Security Cylinders	38
Pyramid Cylinders	44
Conventional Cylinders	50
Interchangeable Core Cylinders	58
Security Cylinders	64
Master Ring Cylinders	70
Service Equipment	73
MORTISE LOCKSETS AND TRIM	
MicroShield® How to Order	76
ML2000 Series / Museo Levers & Inspire Trim, Roses & Thumbturns, Escutcheons	77
Vineyard™ Collection	92
Vandal Resistant Trim	94
ML20900 Series & ML20600 NAC Series / Museo Levers	95
Cylinder and Keying Options	114
Miscellaneous Options	117
HEALTHCARE HARDWARE	
MicroShield® Healthcare Hardware Finishes, How to Order, Pricing	120
CLX3300 Series Behavioral Health Series™ Lever Design: BHSS	121
CLX3300 Series Cylinder and Miscellaneous Options	122
ML2000 Series Behavioral Health Series™ Lever Design: BHSS	125
ML2000 Series Behavioral Health Series™ Lever Design: BLSS	126
ML2000 Series Anti-Harm Knob Trim Knob Design: HSS	127
ML2000 Series Healthcare Hardware HPSK Trim	128
ML2000 Series Cylinder and Miscellaneous Options	129
HP3000 Series Tubular Lock with Push/Pull Trim, Features & Ordering Example	133
HP3000 Series Strike, Door Thickness, Backset, Miscellaneous Options	134
CYLINDRICAL LOCKS	
MicroShield® How to Order	136
TL3700 Series: Museo Levers & Inspire Trim, Levers & Roses, Options	137
CL3100 Series Grade 1 Vandal Resistant Cylindrical Lever Locksets	142
CLX3300 Series Grade 1 Extra Heavy-Duty Cylindrical Lever Locksets	148
CL3300 Series Grade 1 Heavy-Duty Cylindrical Lever Locksets	154
CL3500 Series Grade 1 Cylindrical Lever Locksets	160
CL3800 Series Grade 2 Standard-Duty Lever Locksets	166
CK4300 Series Grade 1 Cylindrical Knob Locksets	170
CK4800 Series Grade 2 Cylindrical Knob Locksets	173
CK4400 Series Grade 2 Cylindrical Knob Locksets	176

PRE-ASSEMBLED UNIT LOCKSETS	PAGE
UT5200 Series	180
AUXILIARY HARDWARE	
PL5000 Series Padlocks	185
DL2200 Series Cylindrical Deadlocks	187
DL3000 Series Cylindrical Deadlocks	190
DL3200 Series Cylindrical Deadlocks	193
DL4100 Series Mortise Deadlocks	196
MULTIPOINT LOCKS	
FE5400S	201
MP6600	215
FE6600	228
BL6600	241
FE6700	254
MP9800	258
EXIT DEVICES	
MicroShield® Technology	273
ED2000 Pushpad Series	274
ED3000 Crossbar Series	283
ED4000 Narrow Stile Pushpad Series / Museo Levers with 800 Series Escutcheon	296
ED5000 Pushpad Series / Museo Levers with 900 Series Escutcheon	310
ED7000 Narrow Stile Crossbar Series	335
DOOR CLOSERS	
DC3000 Series	346
DC5000 Series (Cam Action Door Closer)	348
DC6000 Series	350
DC8000 Series	354
DC62900 Series	358
PARTS	
Key Systems	
Plugs and Shells	360
Cylinder Parts	361-362
Standard Diameter Cylinder Collars	363
Master Ring Cylinder Collars	364
Tools	364
Mortise Locksets and Trim	
ML2000 Series – Mortise Locks	365-367
ML2000 Series – Mortise Trim	368-376
Vandal Resistant Cylindrical Lever Locksets	
CL3100 Series	377-379
Extra Heavy-Duty Cylindrical Lever Locksets	
CLX3300 Series	380-384
Extra Heavy-Duty Cylindrical Lever Locksets	
CL3300 Series	385-388
Heavy-Duty Cylindrical Lever Locksets	
CL3500 Series	389-390
Grade 2 Key-In-Lever	
CL3800 Series	391-392
Heavy-Duty Cylindrical Knob Locksets	
CK4300 Series	393

Continued on next page.

PARTS <i>(continued)</i>	PAGE
Standard-Duty Cylindrical Knob Locksets	
CK4400 Series	394
CK4800 Series	394
Pre-Assembled Unit Locksets	
UT5200 Series	395-396
Padlocks, Deadlocks and Push-Pull Latches	
Padlocks	396
DL3000 Series Deadlocks	396
ED4000 and ED5000 Series	
Device Parts	397-399
Trim Parts	399-401
Crossbar Exit Devices and Trims	
ED7000 Series	402-406
Door Closers	
DC3000 Series	407
DC5000 Series	407
DC6000 Series	408
DC8000 Series	408
Electronic Hardware Parts	
DC62900 Series	410
Access 800® AC2 Series	410
Parts Index	411

BUSINESS HOURS

**ASSA ABLOY CUSTOMER SERVICE
– CORBIN RUSSWIN**

8:00 a.m – 4:30 p.m. (Eastern)

225 Episcopal Road

Berlin, CT 06037-4004

Telephone: (800) 438-1951

Fax: (888) 338-0965

customerservice.corbinrusswin@assaabloy.com

orders.corbinrusswin@assaabloy.com

SPECIFIC WHO'S WHO CONTACTS

<https://go.corbinrusswin.com/whoswho>

TECHNICAL PRODUCT SUPPORT

8:00 a.m – 4:30 p.m. (Eastern)

Telephone: (800) 543-3658

techsupport.corbinrusswin@assaabloy.com

ELECTRIFIED TECHNICAL PRODUCT SUPPORT

8:00 a.m – 4:30 p.m. (Eastern)

Telephone: (800) 810-WIRE (9473)

Fax: (203) 603-5981

**ASSA ABLOY DOOR SECURITY SOLUTIONS
CANADA CUSTOMER SERVICE – VAUGHAN**

8:00 a.m – 4:30 p.m. (Eastern)

160 Four Valley Drive

Vaughan ON L4K4T9

Telephone: (800) 461-3007

Fax: (800) 461-8989

HOLIDAY SCHEDULE*

ASSA ABLOY Door Security Solutions Customer Support Services – Corbin Russwin will be CLOSED on the following holidays:

- January 2, 2023
- February 20, 2023
- April 7, 2023
- May 29, 2023
- July 3-4, 2023
- September 4, 2023
- November 23-24, 2023
- December 25-26, 2023

*Dates subject to change

ASSA ABLOY Door Security Solutions Customer Service - Vaughan

- January 1, 2023 New Year's Day
- February 20, 2023..... Family Day
- April 7, 2023 Good Friday
- May 22, 2023 Victoria Day
- July 1, 2023..... Canada Day
- August 7, 2023..... Civic Holiday
- September 4, 2023 Labour Day
- October 9, 2023 Thanksgiving
- December 25, 2023 Christmas Day
- December 26, 2023 Boxing Day

Technical Product Support will be CLOSED on the following holidays:

- January 2, 2023
- February 20, 2023
- April 7, 2023
- May 29, 2023
- July 3-4, 2023
- September 4, 2023
- November 23-24, 2023
- December 25-26, 2023



ASSA ABLOY

CUSTOMER ACCOUNT #		PLEASE CHECK			DATE REQUESTED	SOLD TO ADDRESS			
		<input type="checkbox"/> PART SHIP	<input type="checkbox"/> SHIP COMPLETE						
CUSTOMER P.O. #		P.O. DATE	CONTACT PERSON			SHIP TO ADDRESS			
			PHONE #						
			FAX #						
SHIP VIA		MARKS <small>If markings are required, purchase order will be entered to the factory. See <i>Stock Condensed Order Form</i> to include appropriate information.</small>			BUYING PROGRAM <input type="checkbox"/>			OR CPQ NUMBER <input type="checkbox"/>	
QTY <i>Required</i>	PART # <i>Required</i>	CYLINDER <i>(2000X033)</i>	KEY BLANKS <i>(6 pin-10)</i>	SERIES & FUNCTION <i>Required</i>	TRIM, DR WIDTH & HEIGHT	HAND <i>R, L, RR, LR</i>	FINISH <i>Required</i>	KEYWAY/ SECTION	QUICK CODE <i>M52, M54, M55, M94, KR Electrified Locks (Requires Voltage)</i>

Sheet _____ of _____

This Sheet Only

Customer Name				Purchase Order No.	
Qty.	Series and Function	Trim	Keyway	Finish	Quick Code Options
Special Notes:					

Item	Qty.	Key Symbol	Hand				Door Number (Up to 7 characters)	Heading (Up to 15 characters)
			RH	LH	RHR	LHR		

**Keyed Order – Condensed Form
(Cylinders Ordered Separately)**

USA & Canada Prices Effective April 17, 2023

Sheet _____ of _____

This Sheet Only

Customer Name				Purchase Order No.		
Qty.	Cylinder	Length	Pins	Keyway	Cam/Tailpiece	Finish

Special Notes:

Item	Qty.	Key Symbol	Door Number (Up to 7 characters)	Heading (Up to 15 characters)	Keyed Function Used

Keyed Order – Condensed Form (Cylinders Ordered With Lockset/Device)

USA & Canada Prices Effective April 17, 2023

Sheet _____ of _____

This Sheet Only

Customer Name				Purchase Order No.	
Qty.	Series and Function	Trim	Keyway	Finish	Quick Code Options
Special Notes:					

Item	Qty.	Key Symbol	Hand				Door Number (Up to 7 characters)	Heading (Up to 15 characters)
			RH	LH	RHR	LHR		



ASSA ABLOY

Date: _____

KEY SYSTEMS INFORMATION

*Registry Number: _____

*Job Name and Location: _____

*Keyway: _____ Top Master Key Bitting: _____

Any Other Known System Information:

Information Requested:

Requested By: _____

Phone: _____ Fax: _____ Email: _____

Agency/Distributor Name: _____

Key System Administration Response:

Please attach a Letter of Authorization from the end user if requesting bitting information.

***Required Information**

Note: Only One Leadsheet/Key System Per Purchase Order

Distributor Name: _____
 P.O. # _____
 Job Name* (will be used as the Key System Name on file): _____
 *REQUIRED
 End User Name: _____
 Address: _____
 City: _____ State: _____ Zip: _____

(1) SYSTEM STATUS

- New (Corbin Russwin Generated); Please complete System Design Section 2 below and identify Future Cylinder Features required in Section 7
- Field-Specified Bittings; Field-Specified Bittings must be attached if your order needs to be keyed to specific bittings
- Existing. Please complete one of the following:
 Registry Number*: _____
 TMK Bitting & Keyway: _____
 Prior Corbin Russwin Order Number*: _____

*Used to locate keying information ONLY. All other order requirements must be identified in sections below.

(2) SYSTEM DESIGN LAYOUT (New Systems ONLY) - Select Level & Indicate Future Requirements
[Click here for System Design Layout example](#)

Please note, this section is for system layout only. Please provide estimated number of keys for future expansion. For cut key quantities, please refer to section 6.

<input type="checkbox"/> Level 4 GGMK		<input type="checkbox"/> Level 3 GMK		<input type="checkbox"/> Level 2 MK	
# of Grand Masters under Great Grand Master		# of Masters under the Grand Master		# of Changes under Master	
# of Masters under each Grand Master		# of Changes under each Master			
# of Changes under each Master					

- 5-Pin System 6-Pin System (Default) 7-Pin System

Additional Information (Please complete the following if your system will have Sub-Master level or SKDs)

- SubMaster Keying Level Required: See Keying Notes Attached
 # of SubMaster Keys under each Master _____
 # of Change Keys under each SubMaster _____
- SKD's No of Different SKDs: _____

(3) SYSTEM TYPE (Required for New Systems only)

- System 70 Pre System 70 (IC, Master Ring, Security) Pyramid** Access 3 (AP, AS, AHS)

Note: Select Future Cylinder Features required in Section 7.

***Required documentation must accompany each initial Pyramid or Access 3 order to avoid delay. See Section 5.*

(4) KEY WAY (Only required if you need a specific keyway)

Keyway Selection: Corbin Russwin will assign keyways unless specified otherwise below.

- Customer Specified Keyway _____

Use of Restricted Keyways (39, 93, F and J series keyways) have to be pre-approved by Corbin Russwin Key Records.

PO# _____

(5) AUTHORIZATION

Security, Protected, Pyramid and Access 3 Keyway Products Require Authorization

Access 3 Job ID #: _____ Access 3 Random Security Code: _____

[Click Here](#) For NEW System Forms: Pyramid, Access 3 - Print and sign and submit with PO

Form Attached: Yes No

Not required if LOA is provided or order is shipping to end user.

Letter of Authorization Attached:

NOTE: Letter Of Authorization is required for and product listed in Section 5 including keys, keyblanks and bitting lists only.

Security: Yes
 Pyramid: Yes
 Access 3: Yes

If LOA is not attached, please [click here](#) to review LOA template.

(6) CUT KEY QUANTITY FOR CURRENT PO

Great Grand Master Keys	Keyset Designation	Cut Key Qty
Grand Master Keys	_____	_____
Master Keys	_____	_____
	_____	_____
	_____	_____
Sub Master Keys	_____	_____
	_____	_____
	_____	_____
Special Keys	_____	_____
MK Control Keys		_____
SKD Control Keys		_____
MK Construction Master Keys		_____
SKD Construction Master Keys		_____
Housekeeping (HSKP) Keys		_____
Janitor (JAN) Keys		_____
Maintenance (MAINT) Keys		_____
Change Keys		Keys Per Cylinder
(Two cut keys are standard per lockset/cylinder, see pricebook for additional key charges)		_____
Keys Total	Keyset Symbol	Quantity
	_____	_____
	_____	_____
	_____	_____

Additional Notes

Check box if additional notes are attached in a separate document

PO# _____

(7) SYSTEM CYLINDER SET-UP REQUIREMENTS

Features	Apply to Current Orders	Apply to Future Orders
Large Format Interchangeable Core - LFIC	<input type="checkbox"/>	<input type="checkbox"/>
Hotel Function	<input type="checkbox"/>	<input type="checkbox"/>
Construction Lost Ball	<input type="checkbox"/>	<input type="checkbox"/>
Security	<input type="checkbox"/>	<input type="checkbox"/>
Master Ring	<input type="checkbox"/>	<input type="checkbox"/>
Pyramid	<input type="checkbox"/>	<input type="checkbox"/>
Pyramid Large Format Interchangeable Core - LFIC	<input type="checkbox"/>	<input type="checkbox"/>
Access 3 (AP)	<input type="checkbox"/>	<input type="checkbox"/>
Access 3 (AS)	<input type="checkbox"/>	<input type="checkbox"/>
Access 3 UL437 (AHS)	<input type="checkbox"/>	<input type="checkbox"/>
Access 3 Large Format Interchangeable Core - LFIC	<input type="checkbox"/>	<input type="checkbox"/>
Access 3 Hotel Function	<input type="checkbox"/>	<input type="checkbox"/>
Access 3 Construction Lost Wafer	<input type="checkbox"/>	<input type="checkbox"/>

Note: If a cylinder feature needs to be included in a future order, you must select Apply to Future Order now. To Avoid Your Order Being Delayed, please ensure the selected features are also listed on your P.O.

(8) STAMPING REQUIREMENTS

Default stamping will apply unless specified otherwise below.
Potential charges and additional lead times apply, see price book.

Keys Stamping

- Bittings
 - Keyset Symbols
 - Alternate (provide separate sheet)
 - No Stamping. Blank Keys.
- } Select One
- Key Bow Style _____
(If none selected default will apply)
 - Less Logo
 - Less Keyway
- New Die Stamp
 - Existing Die Stamp _____
- Do Not Duplicate (no charge)
 - US Property - Do Not Duplicate (no charge)

Cylinder Stamping

- Bittings
 - Keyset
 - Alternate (provide separate sheet)
- } Select One
- Visual
 - Concealed
 - Less Logo

(9) CROSS KEYING

For the portion of the system ordered on current PO, all Cross Keying must be noted on PO.
Complete below for future requirements.

Keyset Symbol:	To Be Operated By:

Additional Notes Attached

Note: Cross Keying minimizes cylinder security level and is not recommended by Corbin Russwin

PO# _____

THIS ORDER ONLY (Section 10 - 17)**Complete these sections only if shipping address is different than on PO****10) PACKING INSTRUCTIONS FOR CHANGE KEYS** Pack Change Keys With Locks (Standard) Pack Change Keys separately - See Price Book for Additional Charges**When CMK, Security, Pyramid or Access 3, keys will always be packed and shipped separately from product with no additional charges.****11) SHIPPING INSTRUCTIONS FOR CHANGE KEYS**Ship Change Keys To: _____

Attention: _____

**12) SHIPPING INSTRUCTIONS FOR MASTER KEYS
(INCLUDES GGM, GM, MASTER, SUBMASTER, CONTROL AND EMERGENCY KEYS)**Ship Master Keys To: _____

Attention: _____

13) SHIPPING INSTRUCTIONS FOR KEY BLANKSShip Keyblanks To: _____

Attention: _____

14) SHIPPING INSTRUCTIONS FOR CORESShip Cores To: _____

Attention: _____

15) SHIPPING INSTRUCTIONS FOR CONSTRUCTION KEYSShip Construction Keys To: _____

Attention: _____

PO# _____

16) SHIPPING INSTRUCTIONS FOR BITTING LIST

- Only bittings for Keysets ordered with product on this PO (N/C)
- Expanded Bitting List (Please provide requirements)

Select One:

- Email (Preferred, no freight charge)
- Provide on Disc (UPS)
- Provide on Flash Drive (UPS)
- Provide on Paper (Standard, UPS)

Email: _____

Ship to: _____

Attn: _____

BITTING LIST FOR KEYWIZARD

- Check if Bitting List Required for Keywizard

Select One:

- Email (Preferred, no freight charge)
- Provide on Disc (UPS)
- Provide on Flash Drive (UPS)

Email: _____

Ship to: _____

Attn: _____

Note: Please see Price Book for prices and additional information regarding bitting lists.

Expanded Bitting List Requirements:

17) CONTACT INFORMATION FOR INDIVIDUAL COMPLETING THIS FORM

Name: _____

Phone #: _____

Fax #: _____

Email: _____

Ordering Tips

- Please submit **Quick Ship Program Orders** and **Plant Product Orders** on separate order forms.
- Please use **Quick Ship Program Forms** for all **Quick Ship Product Orders** and include **Quick Ship Part Numbers**.
- **Order Forms** are included in the Price Book and at www.corbinrusswin.com.
- We recommend using the **Order Form** included with this Price Book when placing purchase orders for Corbin Russwin products. The **Order Form** is available for copying prior to placing your order.
- Please include **Job Name and Registry Number** for all contract orders.
- Be sure to include **Voltage** on all Electrified Hardware orders.
- A **Letter of Authorization** is required for all security and high security (ACC3, System 70 HS) and Pyramid products.
- **Keying Lead Sheets** are required for all master keyed orders.
- Remember to include **Keysets** on all contract orders.
- Be sure to include **Handing** for all unit locks, mortise locks and exit devices.
- If you have a **Quote**, please include it with the purchase order. Orders without this information may be delayed.

Ordering Tip — Administrative Documentation

When submitting purchase orders to ASSA ABLOY Door Security Solutions® Consultants for processing, please remember that certain cylinder types and/or keyways require additional administrative documentation before the order can be entered.

Purchase orders will be held and questioned if the following keyway/cylinder types do not have the proper administrative documentation submitted with each purchase order:

- Pyramid keyway products
- Security cylinders and keys
- High security cylinders and keys

All of the above product types must be accompanied by additional administrative documents unless they are shipping direct to the end user facility. These administrative documents include, but may not be limited to, the following:

- Letter of Authorization – must be submitted on the end user facility letterhead, dated and signed by an authorized individual from the facility. Letter must be quantity specific for certain product types. ASSA ABLOY Door Security Solutions Consultants does not keep letters of authorization on file.

Ordering Checklist

Before placing your order, check for the following:

- ✓ Purchase Order on company letterhead
- ✓ Purchase Order is legible
- ✓ Purchase Order Number
- ✓ Account Number
- ✓ Ship To Address
- ✓ Contact Person for additional information requirements
- ✓ Pricing Requirements – Buying Program or CPQ (please attach)
- ✓ Quick Ship Order (Quick Ship Order Form or Quick Ship part numbers included)
- ✓ Contract Order (Keyed Lead Sheets attached)
- ✓ Handing (if applicable)
- ✓ Design (if applicable)
- ✓ Backset & Strike (if applicable)
- ✓ Finish (if applicable)

Website

Corbin Russwin’s website at www.corbinrusswin.com is the place to go for all your Corbin Russwin product information needs. Easy-to-navigate menus and intuitive icons allow simple and fast access to the latest on new products, as well as the most up-to-date catalogs, templates and installation instructions.

Another great benefit of the Corbin Russwin website is the ability to become an eBusiness member. Access gives additional information for Corbin Russwin account customers only.

eBusiness

Visit www.corbinrusswin.com to sign up for ASSA ABLOY Door Security Solutions eBusiness access.

ASSA ABLOY Door Security Solutions Consultants provides sales, marketing and support for Corbin Russwin.

To sign up for eBusiness, follow the simple instructions listed below. Register today and start enjoying the many benefits!

eBusiness offers anytime access to:

- Order Status
- Stock Status Check
- Key Systems
- Newsletters
- Contact Webmaster
- Fax Order Acknowledgment
- Extended Literature (Price Books, Order Forms, Keyed Lead Sheets)
- Order Check by P.O.
- Cross Reference Guide
- Key Wizard® Order Forms
- ASSA ABLOY Door Security Solutions Online Store
- Fax Program Sign Up
- Fax Invoice

How to sign up for eBusiness access:

Step 1: Visit our website at www.corbinrusswin.com

Step 2: Double-click eBusiness icon (top right corner)

Step 3: Complete ASSA ABLOY Door Security Solutions eBusiness sign up form

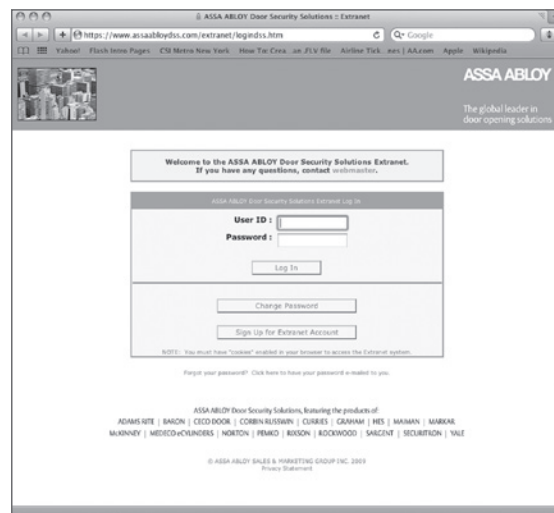

Online Order Entry

Would you like to reduce the time to get your orders entered to the factory and eliminate errors associated with manual order entry?

Then try our on-line order entry system. Our convenient web-based order forms can help you submit your orders directly to the factory in minutes.

Contact your customer service representative who will be able to issue your user name and password as well as set up appropriate training sessions for you and your staff.

ASSA ABLOY LOG OUT

START | TEMPLATES | PARTS | HISTORY | CART | QUICK ORDER | QUICK SEARCH | ORDER EXPORT | CONTACT Welcome Susanna Brial

Search customer name, etc. Advanced search

NEWS

For CURRIES ordering, please use the CURRIES Order Writer (COW).

For GRAHAM ordering, please use the GRAHAM ordering site.

Consultative Key Systems Services

BRANDS

ADAMS RITE

PLACE AN ORDER

FIND A CUSTOMER / SELECT A CUSTOMER / FIND PARTS / ADD PARTS / REVIEW & SUBMIT

1 | 2 | 3 | 4 | 5 | 6 | 7 | 8 | 9 | 10 >> Last

Brand	Customer Number	Customer Name	Territory	Ship To Address
CORBIN RUSSWIN	404051	84 LUMBER COMPANY #1975	A28	22770 N. WESTLAKE HOUSTON TX 77095
CORBIN RUSSWIN	403670	A G MAURO COMPANY	A08	1221 BERNARD DRIVE BALTIMORE MD 21223

Fax Program

Would you like to receive your acknowledgments and invoices, invoices and Return good Authorizations quickly and efficiently?

If so, ASSA ABLOY Door Security Solutions offers the Order Acknowledgment and Invoice, invoices and Return good Authorizations Fax Program. Please see the simple steps below to get signed up today!

Requirement: Valid eBusiness User ID and Password. (If you do not have an eBusiness User ID and Password, please refer to eBusiness Sign Up Section included in this Price Book.)

Step 1: Log into eBusiness.

Step 2: Double-click on "Sign Up for ASSA ABLOY Door Security Solutions' Fax Program Now!"

Step 3: Fill in appropriate information and send.

Fax Program Signup

If your distributor would like to receive their CORBIN RUSSWIN, NORTON, RIXSON and YALE order acknowledgements, invoices, and return goods authorizations by fax, please complete the form below to sign them up today!

Yes - Fax Invoices to Fax #:

Yes - Fax Order Acknowledgements to Fax #:

Yes - Fax Return Goods Authorizations to Fax #:

Enter the distributor's Account Number in the input box below and click [Add] to add it to your Account Number list. Repeat for each distributor Account Number that you have.

Enter Account Number:

Account Number List:

Terms and Conditions

ACCEPTANCE

Corbin Russwin reserves the right to decline an order, in whole or in part, when the type or quantity of goods or credit worthiness of the Purchaser is not satisfactory to us in our sole and absolute discretion.

Purchase Orders, Quote Requests, Acknowledgments or the like issued by the Purchaser that have contrary standard terms and conditions are not binding on Corbin Russwin, unless such terms and conditions are approved in a separate written agreement by Corbin Russwin's authorized representatives. In the event of an acceptance of Purchaser's Purchase Order by Corbin Russwin, the Purchaser agrees that such acceptance is solely conditioned on Purchaser's acceptance of the terms and conditions set forth in this instrument, regardless of the terms and conditions specified in Purchaser's Purchase Order. The terms and conditions in Purchaser's Purchase Order which conflict with the terms and conditions of this instrument shall be disregarded and are hereby rejected, and this instrument shall constitute the entire agreement between Corbin Russwin and the Purchaser.

In the event that Corbin Russwin does not enforce or require strict performance of any term or condition hereof, or of any other document, instrument or other agreement relating to goods sold, such lack of enforcement or requirement of strict performance will not waive, affect or diminish any right of Corbin Russwin to enforce or require strict performance of such term or condition in the future.

PRICES

All prices are subject to change without notice and are not guaranteed. All shipments will be made at prices in effect at the time of shipment.

Possession of this price list does not constitute an agreement to sell.

We reserve the right to correct clerical, stenographic and other obvious errors at any time.

TERMS

Invoices dated the 1st through the 15th will be due for 2% discount on the *10th of the following month. Invoices dated the 16th through the 31st will be due for 2% discount on the *25th of the following month. *Net immediately thereafter. (Corbin Russwin retains the right to sell or to decline to sell to any Customer for any reason whatsoever when in its judgment is deemed sufficient.)

It is understood that Corbin Russwin may impose and charge a finance charge which is the lesser of one and one-half percent (1-1/2%) per month or the highest rate allowed by law on any amount which becomes past due and delinquent. Additionally the Customer shall be responsible for all collection costs, court costs and reasonable attorney's fees (where allowed by law) in connection with the recovery of any delinquent amount.

FREIGHT

All orders are shipped FOB factory/warehouse, except as expressly provided below. When delivered to the Transportation Company, the Purchaser assumes the risk of loss or damage in transit.

Customer orders with net product value in excess of \$12,000.00 will be shipped prepaid by Corbin Russwin's carrier of choice to a single destination point in the United States.

Customer orders with net product value less than \$12,000.00 will be shipped prepaid by Corbin Russwin's carrier of choice and freight and handling charges will be added to the customer's invoice.

A minimum freight and handling charge of \$15.00 will be charged on orders with net product value of \$400.00 or less. The minimum freight and handling charge will not apply to orders for only Cut (bitted) keys of any type, Master Keys, Master keyed cylinders or padlocks and factory generated bitting lists that do not have any other product types included on the order. Freight on these orders will be charged as the percentage of invoice value.

For orders with net product value greater than \$400.00 and less than \$12,000.00, freight charges will be calculated as a percentage of the net invoice value and will be added to Customer's invoice. The percentage is based on the National U.S. Average On Highway Diesel Fuel Prices as reported by the US Department of Energy in effect at the beginning of each quarter. On the first Monday of each quarter, the new rate will be published on the Corbin Russwin and Door Security Solutions extranet and will go into effect on the 2nd Monday of the quarter. Please refer to the extranet for the rate chart and information on the current freight charge percentage. The percentage in effect at the time of shipment of the order will be charged.

Great Grand Master keys, Grand Master keys, Master keys, Construction Master keys, Control Keys, Lot Day Keys which are shipped separate from customer order for security reasons, on orders with total net product value in excess of \$12,000.00 will be shipped prepaid by Corbin Russwin's carrier of choice. If the total order value is less than \$12,000.00, the shipping charges will be added to Customer's invoice.

If a customer provides their own freight account # for the freight charges, Corbin Russwin will apply a handling fee of \$25.00 to the invoice.

Quick Ship Orders – All 1-Week Quick Ship orders are guaranteed to ship from Corbin Russwin 5 working days after receipt of all information necessary to process order or Corbin Russwin will pay freight costs. If Quick Ship is held for credit reasons Corbin Russwin will not be responsible for freight costs.

Expedited shipping options – If the customer requests an expedited method of shipment such as "Next Day Air" the charges will be prepaid by Corbin Russwin and the full rate for the service, as published by the carrier, will be added to the customer's invoice.

Terms and Conditions continued

Packing – Corbin Russwin will pack, mark and ship the products according to its standard procedures for shipment, unless the parties agree, in writing, that Corbin Russwin will comply with any special instructions provided by the customer. Special instructions must be submitted, in writing, at time of order placement. Compliance with special instructions may result in an increased price.

MINIMUM ORDER

Minimum order value for complete product is \$250.00 net product value. The minimum order value for parts orders is \$100.00 net product value. In the event that the net product value does not meet the required net minimum, Corbin Russwin may, at its sole discretion (a) apply a minimum order charge, (b) reject the order or (c) waive the minimum requirement provided that the waiver of the requirement for one order shall not constitute a waiver of the requirement for any future orders.

The following products are exempt from this policy: Cut (bitted) Keys of any type, Master Keyed Cylinders, Master Keyed Padlocks and Factory Generated Biting Lists.

QUOTATIONS

If Corbin Russwin elects to offer a quote, such quote will be valid until the expiration date on that quote. Complete shipment of the order must be accepted by Purchaser within standard manufacturing lead times. The quote number must be referenced on the order. Any invoiced order that has the incorrect discount applied to it and did not have the quote number written on the order will have a service fee of \$100.00 net DEDUCTED from any sales credit issued for the difference in discount. The quote is null and void if the Purchase Order does not include ALL product lines listed on the quote or if the quantities for any item covered by the quote deviate by 10% or more. With the issuance and acceptance of a quote for the purchase of products, the Purchaser agrees that products so purchased will not be resold or transferred to any Distributor not authorized by Corbin Russwin to sell its products. This would be inclusive of branches of the quoted Distributor. Failure to abide by this restriction may result in the Distributor's ineligibility for Quotations, or other actions in Corbin Russwin's discretion. Corbin Russwin and its sales representatives reserve the right, in their sole discretion and for any reason, to refuse a Distributor's request to quote a price other than Corbin Russwin's standard list price and regardless of whether Corbin Russwin or its sales representatives have previously quoted discounted prices to the Distributor on some or all of its orders.

NON-CATALOGED PRODUCTS

Products not cataloged or listed in this price book will be considered as special products, and will not be manufactured without prior written approval from Corbin Russwin. A minimum special handling charge of \$50.00 will be added for non-cataloged product. Any additional labor or material required will be charged accordingly. Special products require special handling, and therefore standard lead times may not apply. Please consult with your Sales Representative for further details.

CHANGES/CANCELLATION OF ORDERS

Changes or cancellations to an order will result in a charge of costs for material and labor expenses that have been incurred prior to notification from Customer. If products have already been made and/or are located in the shipping room, the 45% change/cancellation fee will apply. Handling charges are billed on Customer's original order. All Non-Cataloged Goods and Corbin Russwin Quick Ship Orders may not be changed or canceled.

All change requests for goods, other than for the reasons stated above, must be submitted in writing to Customer Service within two (2) business days of receipt of acknowledgment of the order.

ADD-ON ORDERS TO QUOTE

Any new order requesting special pricing to match an existing quote number, which has already been ordered, will be accepted up to sixty (60) days after the acknowledgment of the original order. All add-on orders must reference the original factory order number, and the corresponding quote number to receive the quoted pricing discount. Add-on orders for stock will not be accepted.

PACKAGING

Many items are defined as to Case Lot Packaging or Minimum Order. The Case Lot policy does not apply to hardware to be used on a specific hardware project.

DELIVERY

Orders will be acknowledged and given a scheduled delivery date based on estimated manufacturing lead times. Complete information is required to process all orders. Orders with insufficient information for processing (i.e. keying information, door sizes, handing, etc.) may be subject to extended lead times which are relative to the time required in obtaining the necessary information for order processing. Manufacturing lead time will begin once all information is received to process an order. Corbin Russwin will use reasonable efforts to deliver products as estimated, but makes no guarantees as to delivery dates. Corbin Russwin will not be liable for back charges incurred based on availability of product or as a result of delays in delivery caused by insufficient information required to process an order. Corbin Russwin will not be held responsible for delays in delivery caused by strikes, fires, floods or any other causes beyond our control, including the delivery of material to us. Under no circumstances shall Corbin Russwin be liable or accountable for consequential damages due to failure of delivery.

CLAIMS

In the event of Company or Customer error, claims for shortages, pricing errors and/or incorrectly filled orders must be submitted in writing to Customer Service within thirty (30) days from receipt of material. Any claims for shortages or damage by the Carrier must be made by the Customer directly to the Carrier.

Terms and Conditions continued**INVOICE DEDUCTION**

A Corbin Russwin Sales Representative or Customer Service Representative must be notified of any disputed invoices within sixty (60) days from the date of invoice. Deductions should only be taken for the disputed amount and the balance of the invoice is due and payable within standard payment terms.

RETURNED GOODS

It is the policy of Corbin Russwin to not accept returns of any materials that are correctly furnished as per the Distributor's Purchase Order. Return of product due to customer order error or accommodation must be pre-arranged with Corbin Russwin and approved in writing by Sales Management.

All products returned as "Goodwill" must meet the following criteria to be considered a return:

- Be in original, unmarked and undamaged cartons.
- Be valued in excess of \$250.00 net.
- Shipped and invoiced within the previous one hundred twenty (120) days.
- Custom, non-cataloged goods, master-keyed or Corbin Russwin Quick Ship product is not returnable.

A MINIMUM reprocessing fee of 45% will be charged. Upon receipt and verification by Corbin Russwin that the returned merchandise meets the foregoing conditions, a credit will be issued for the original invoice amount less the MINIMUM 45% reprocessing fee.

Defective goods and "Goodwill" products that meet the foregoing criteria may be returned by fulfilling the following conditions:

- Send an RGA request in writing to the Corbin Russwin Sales Representative serving the Purchaser's area.
- Ensure the RGA labels that are sent to Purchaser by Corbin Russwin are visible on return goods shipment.
- Ensure that the RGA number appears on the return shipment label and is legible.
- Return the authorized merchandise within sixty (60) days from the date of RGA issuance date.
- Return shipments must be freight prepaid to the location specified on the RGA.
- Corbin Russwin is not liable for damages to product during shipping.

No credit may be taken or issued prior to RGA approval and receipt of product.

All defective goods within the terms of our limited warranty may be returned for credit or replacement.

RETURNED GOODS – ELECTROMECHANICAL

All defective replacement requests for electromechanical products/components must be authorized by contacting the Electromechanical Applications Team at 1-800-810-WIRE to obtain a case number. In order to receive credit for the replacement of an electromechanical product the following criteria needs to be met:

- Defective product return must be under warranty
- Defective product/component return must arrive at factory within 60 days of the Returned Goods Authorization issuance
- Returned product must be found defective or nonfunctional upon test at factory
- Returned product must not have been damaged during installation process

TAXES

Prices do not include any present or future Federal, State, or Local property, license, privilege, sales, use, excise, gross receipts or other like taxes or assessments, which may result from transactions or any services performed in connection herewith.

GOVERNING LAW

The rights and obligations of the parties shall be governed by the laws of the State of North Carolina, excluding any conflicts of law provisions. The United Nations Convention on Contracts for the International Sale of Goods shall not apply to this Agreement.

LIMITED WARRANTY

The Terms and Conditions outlined above are subject to Corbin Russwin's Limited Warranty, which is included in this Price List and incorporated herein by reference.

PRODUCT MODIFICATIONS

Corbin Russwin products are not designed or intended for aftermarket modification. The warranty on Corbin Russwin products becomes void if the product is modified in any way, regardless of whether the modification causes or contributes to any alleged defect. Warranty voiding modifications include, but are not limited to, third-party electrification of non-electric products and/or the installation of non-approved or non-Corbin Russwin components.

If a Corbin Russwin product is modified it no longer meets industry certification and quality control standards applicable to the original product and is no longer a genuine Corbin Russwin product. A modified product may not be sold as a Corbin Russwin product and the Corbin Russwin and Design® trademark or certification marks based on the original Corbin Russwin product, such as U.L. or ANSI/BHMA marks, may not appear anywhere on the modified product or on any packaging, literature, or instructions sold with the modified product.

All original Corbin Russwin packaging and literature carries the Corbin Russwin and Design® trademark and must be destroyed if the original Corbin Russwin product is modified. Portions of the product that carry the Corbin Russwin and Design® trademark or certification mark must be discarded and/or replaced by the party making the modification. U.L. and other certification testing and marking are also the responsibility of the party making modification. The use of the Corbin Russwin and Design® trademark on modified products constitutes trademark infringement.

Terms and Conditions continued**DELAYED ORDER NOTIFICATIONS (DON's)**

The orders awaiting a response for a DON will be cancelled if no answer is received from the customer after 5 days.

FIRE RATED OPENINGS

Any retrofit or other field modification to a fire rated opening can potentially impact the fire rating of the opening, and Corbin Russwin, Inc. makes no representations or warranties concerning what such impact may be in any specific situation. When retrofitting any portion of an existing fire-rated opening, or specifying and installing a new fire-rated opening, please consult with a code specialist or local code official (Authority Having Jurisdiction) to ensure compliance with all applicable codes and ratings.

TRADEMARK USE POLICY: ASSA ABLOY AMERICAS

The following policy ("Policy") of ASSA ABLOY Americas ("ASSA ABLOY"), and all of its affiliated group companies (collectively, the "Group Companies"), applies to the use of certain intellectual property of all such Group Companies, including all trademarks, names, logos, product images, and related information (the "ASSA ABLOY Marks").

ASSA ABLOY Marks are proprietary and critical to the success of ASSA ABLOY and the Group Companies, and may only be used in strict compliance with this Policy.

This Policy covers any person or entity reselling any product of any Group Company with the consent of such Group Company (each, an "Approved Reseller"). Each Approved Reseller has a non-exclusive right to use certain of the ASSA ABLOY Marks relating to any of the Group Companies for which it is an Approved Reseller, subject to the following conditions:

- (1) Approved Reseller's use of ASSA ABLOY Marks must be truthful, fair, and not misleading;
- (2) Approved Reseller's advertising must clearly indicate that it is advertising of the Approved Reseller, and is not advertising of ASSA ABLOY;
- (3) Approved Reseller may not use any ASSA ABLOY Marks as part of or in connection with a domain name;
- (4) Approved Reseller's advertising must not imply or suggest an association between the Approved Reseller and ASSA ABLOY other than that of buyer and seller;
- (5) Approved Reseller's use of ASSA ABLOY Marks must be a positive representation of ASSA ABLOY, the Group Companies, and their products;
- (6) Approved Reseller's trade name must be more predominant on Approved Reseller's advertising than the ASSA ABLOY Marks;
- (7) Approved Reseller's use of ASSA ABLOY Marks must include the trademark symbol ® or ™, as appropriate, along with the following trademark legend printed in legible text on the Web page or document containing ASSA ABLOY Marks: "[describe ASSA ABLOY Marks] are trademarks or registered trademarks of ASSA ABLOY, Inc. or one of its affiliates in the United States and other countries.";
- (8) Approved Reseller must not make modifications of any ASSA ABLOY Marks; and
- (9) Approved Reseller may use only ASSA ABLOY Marks associated with the Group Companies for which it is an Approved Reseller (e.g., an Approved Reseller that sells Group Company X products but not Group Company Y products may use Group Company X trademarks in connection with its sale of Group Company X products, but may not use Group Company Y trademarks).

ASSA ABLOY reserves the right to review Approved Reseller's usage of ASSA ABLOY Marks at any time and may:

- (a) require changes to the use of ASSA ABLOY Marks at any time in its sole discretion, which changes must be implemented within 30 days of written notice to Approved Reseller;
- (b) condition the use of ASSA ABLOY Marks on ASSA ABLOY's prior approval of such use, which approval may be withheld in its sole discretion;
- (c) revoke permission to use ASSA ABLOY Marks at any time for any or no reason upon 30 days prior written notice to Approved Reseller; and
- (d) revoke permission to use ASSA ABLOY Marks immediately upon notice to Approved Reseller in the event Approved Reseller is in violation of this Policy, or of any other agreement with ASSA ABLOY or any Group Company.

Approved Reseller's right to use ASSA ABLOY Marks in no way conveys to Approved Reseller any proprietary or economic interest in any ASSA ABLOY Marks.

Use of ASSA ABLOY Marks in violation of this Policy may result in severe civil and criminal liabilities. ASSA ABLOY will vigorously enforce this Policy by seeking all appropriate legal remedies, including, but not limited to, pecuniary damages and injunctive relief.

TECHNICAL INFORMATION AND ADVICE

(a) All designs, data, and specifications provided by Company are proprietary and will not be disclosed or reused by Customer without the prior written consent of Company; (b) Company assumes no obligation or liability for any advice given by Company, the results obtained, or damages incurred, and all such advice is given and accepted at Customer's risk.

Limited Warranty

Corbin Russwin, Inc. (Company) warrants that its products sold under the Corbin Russwin and Design® trade name in the United States of America are free from defects in workmanship and materials under normal use and service. This warranty does not cover defects or damage arising from improper installation, lack of or improper maintenance, improper storage, shipping and handling, corrosion, erosion, ordinary wear and tear, misuse, abuse, accident, unauthorized service, or use with unauthorized non-Corbin Russwin products or parts. This warranty is void if any modification is made to the warranty product, regardless of whether the modification causes or contributes to the alleged defect. All modifications are made at the risk of the party making the modification.

The only liability of the Company in tort or contract whether under this warranty or otherwise shall be limited to the repair or replacement of any product or component part which shall prove defective as covered by this warranty, within the stated time frame listed below, after delivery to the original purchaser.

DC6200 & DC6400 Series Door Closers	30 years
DC8000 Series Door Closers.....	30 years
DC3200 Series Door Closers.....	15 years
DC5000 Series Door Closers.....	10 years
ML2000 Series Mortise Locksets.....	10 years
CL3100 Series Cylindrical Locksets	10 years
CLX3300 Series Cylindrical Locksets	10 years
CL3300/CL3500/CL3800 Series Cylindrical Locksets	7 years
FE5400S/FE6700/FE6800/MP6600/BL6600 Series Multi-point Locksets.....	7 years
ED4000, ED5000 Series Exit Devices, MELR Option & 900 Series Trim	5 years
MP9800 Series	5 years
Pyramid Cylinders.....	5 years
CK4300 Series Cylindrical Knob Locksets.....	3 years
All Electro-mechanical and electronic products.....	2 years
Electrified Exit Devices.....	2 years
Access 3 Cylinders.....	1 year
All Other Locksets	1 year
All Other Exit Device Trim.....	1 year
All Other Corbin Russwin Products.....	1 year
ED3000, ED7000, ED8000 Series Exit Devices & Trim.....	1 year
MicroShield® Finish	1 year

Finishes:

Corbin Russwin finishes are covered by a limited warranty period of one year after invoice date.

Warranty Requirements for Cylinders Factory or Field Combined:

Cylinders are lubricated at the factory with a petroleum based lubricant (Moist-Out / MO-10). Cylinders should be lubricated periodically depending upon environmental conditions. FLUID FILM lubricant is recommended. Never mix petroleum based lubricants with dry lubricants. Corbin Russwin cylinder and/or core warranty will be voided if used in non-Corbin Russwin locking devices.

Warranty Requirements for Cylinders Field Combined:

1. Keys shall be cut to the Corbin Russwin key biting specifications required for the particular keyway and depth system.
2. All pin lengths shall be selected according to prevailing factory standards.
3. Original Corbin Russwin cylinders and cylinder components, including pin tumblers and key blanks, shall be used. We reserve the right to void the warranty if we deem that a malfunction is a result of non-original components which do not conform to Corbin Russwin standards.

Continued on next page

Limited Warranty continued**Keying Systems:**

All bittings shall be originated or authorized by the Corbin Russwin Key Systems Department to be compatible with one another in a specific type of cylinder (Access 3, Pyramid, conventional, security, master ring, interchangeable core) and within a particular keying system. Product repair or replacement, or associated charges, will not be accepted under this warranty unless prior authorization from Corbin Russwin has been given. Upon receipt of products returned for repair or replacement, we will determine whether products qualify for repair or replacement under this warranty. If they do not, we will obtain authorization prior to proceeding. We have no liability to pay any costs of repair performed by anyone other than qualified personnel authorized by Corbin Russwin prior to the work being done.

The Company will not pay for the cost of repair performed other than in accordance with this warranty. Written notice of a product or component part believed to be defective as covered by this warranty should be sent to Corbin Russwin, Inc. 225 Episcopal Road, Berlin, CT 06037, and should include your name and address, an identification of the product or component part and a brief description of the defect. Upon receipt of such notice, the Company will inform you where to ship such product or component part, shipping charges prepaid, for examination and, in the event such examination reveals defect covered by this warranty, the product will be repaired or replaced. The Company reserves the right to replace discontinued product with an equivalent product as deemed by the Company.

THIS WARRANTY IS IN LIEU OF ALL OTHER EXPRESS WARRANTIES. TO THE EXTENT PERMITTED BY LAW, ALL IMPLIED WARRANTIES ARE LIMITED TO THE DURATION OF THIS WARRANTY. CORBIN RUSSWIN, INC. SHALL NOT BE LIABLE FOR ANY INCIDENTAL OR CONSEQUENTIAL DAMAGES. NO AGENT, SALES REPRESENTATIVE OR DEALER HAS THE AUTHORITY TO INCREASE OR ALTER THE OBLIGATIONS OF THIS WARRANTY. SOME STATES DO NOT ALLOW LIMITATIONS ON HOW LONG AN IMPLIED WARRANTY LASTS OR THE EXCLUSION OR LIMITATION OF INCIDENTAL OR CONSEQUENTIAL DAMAGES, SO THE ABOVE LIMITATION OR EXCLUSIONS MAY NOT APPLY TO YOU. THIS WARRANTY GIVES YOU SPECIFIC LEGAL RIGHTS, AND YOU MAY ALSO HAVE OTHER RIGHTS WHICH VARY FROM STATE TO STATE.

Finishes

ANSI/BHMA Designation	Finish/Description
600	Primed for Painting (USP)
605	Bright Brass (US3)
606	Satin Brass (US4)
611	Bright Bronze (US9)
612	Satin Bronze (US10)
613	Dark Oxidized Satin Bronze, Oil Rubbed (US10B)
613E	Dark Oxidized Satin Bronze - Equivalent
613L	Dark Oxidized Satin Bronze, Clear Coated
618	Bright Nickel Plated (US14)
619	Satin Nickel Plated (US15)
622	Flat Black Coated (US19)
625	Bright Chromium Plated (US26)
626	Satin Chromium Plated (US26D)
628	Satin Aluminum, Clear Anodized (808 Mullion)
629*	Bright Stainless Steel (US32)
630*	Satin Stainless Steel (US32D)
689	Silver Aluminum Painted (SBL)
690	Dark Bronze Painted (DBL)
691	Light Bronze Painted (LBL)
693	Black Painted (FBL)
695	Dark Bronze Painted or Anodized (808 Mullion)
696	Satin Brass Painted (GBL)
722	Black oxidized bronze, oil rubbed
BSP	Black Suede Powder Coat
WSP	White Suede Powder Coat

*629 and 630 finish options are Not available for the following Muséo levers: 104, 105,111, 112, 114, 115, 116, 117, 119, 121, 126, 127,130, 131, 132

Samples

Display Mounts (Base Hardware not included). Price covers mount only.

For Product Series	Specify	Price
CL3100, CK4400, CK4800	SM-CL-NTB	\$195.00
CLX3300, CL3300, CL3500, CL3800	SM-CL-TB	\$195.00
ML2000 x Sectional Trim (Lever, Knob, BLSS, HSS, HPSK)	SM-ML-L	\$182.00
ML2000 x BHSS trim	SM-ML-WAVE-CYL x TP	\$286.00

Finish folder with cylinder scalps.

Specify	Price
FP	\$176.00

Corbin Russwin Templates

Templates of Corbin Russwin products that are most commonly used are available through our website <http://www.corbinrusswin.com/en/site/corbin-russwin/Library/Product-Templates/>

General Information:

Standard Features: Keying, Keys, Pins	28
Keyway Availability	29
General Information	30
Policy	31
Construction Core Program	32
Keying, Stamping, Cut Keys	33
Bitting List	34
Key Wizard	35

Key Blanks:

Stamping, Standard, Pyramid, Access 3	36
Security Bow, Large Bow, Emergency Blanks, Emergency Master Key	37

Access 3 AP Security Cylinders

AP Fixed Core (Mortise/Rim), AP LFIC (Mortise/Rim)	38
AP LFIC, Fixed Core Component Cylinder, Deadlock Cylinder	39
AS Fixed Core (Mortise/Rim), AS LFIC (Mortise/Rim)	40
AS LFIC Core, AS Fixed Core Component Cylinder, AS Fixed Core Deadlock Cylinder	41
AHS Fixed Core (Mortise/Rim), AHS LFIC (Mortise/Rim)	42
AHS LFIC Core, AHS Fixed Core, Deadlock Cylinder, UL LFIC 6-Pin Housing (Mortise/Rim)	43

Pyramid Cylinders:

Fixed Core (Mortise/Rim)	44
Key-In-Lever/Knob High Security UL437 Listed	45
Interchangeable Core (Mortise/Rim)	46
Fixed Core (Mortise/Rim)	47
Key-In-Lever/Knob	48
Interchangeable Core (Mortise/Rim)	49

Conventional Cylinders:

Standard Mortise	50
Flexible Head Mortise, Concealed Shell Mortise	51
Special Function Mortise, Hotel Function Mortise	52
Non-Keyed Mortise, Thumbturn, Dummy, Rim Thumbturn Cylinders	53
Rim (.552 diameter Plug)	54
Key-In-Lever/Knob (.509 Plug), DL2200, DL3200 Series Cylindrical Deadlock	55
Key-In-Lever/Knob UT5200, CK4200, CK4400, G10, PL5000	56
Key-In-Lever/Knob (.552 dia Plug), Adams Rite 4025 Pull	57

Interchangeable Core Cylinders:

IC Mortise, Hotel Function IC Mortise	58
IC Rim, Core Only	59
SFIC Mortise, SFIC Rim	60
SFIC Rim, SFIC Core Only	61
LFIC Mortise Housing Only, LFIC Rim Housing Only	62
SFIC Mortise Housing Only, SFIC Rim Housing Only	63

Security Cylinders:

Standard Security Mortise	64
Special Function Security Mortise, Hotel	65
Security Rim	66
Security Key-In-Lever/Knob (.552 Plug)	67
Security Interchangeable Cylinders: IC Mortise, Hotel Function	68
Security Interchangeable Cylinders: IC Rim, Security Core	69

Master Ring Cylinders:

Standard Master Ring Cylinder	70
Flexible Head Master Ring Mortise	71
Master Ring Rim, CK4200 & UT5200 Series, Special Applications	72
Service Equipment	73
Blank Page	74

**Standard Features
Keying**

0-bitted except high security; random keying option offered at no charge

Keys

Two nickel silver keys

Pins

5-pin for 252, 752, 852 and A Class; all others furnished 6-pin

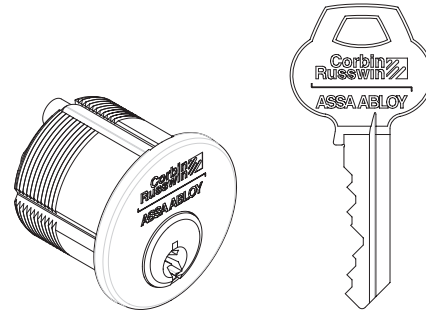

Ordering Examples

Stock Order - Conventional Cylinder

Quantity	Cylinder	Finish
25	CR1000	626

Contract/Detailed Order - Conventional Cylinder

Quantity	Keyset	Cylinder	Finish	Option
25	AA1	CR1000-138-A02-7	626	CKC2

Stock Order - IC Cylinder

Quantity	Cylinder	Finish
20	CR1080	626

Contract/Detailed Order - IC Cylinder

Quantity	Keyset	Cylinder	Finish	Misc.Option
4	AF3	CR1080-112-A04-7	606	CKC2

Keyway Availability

Corbin Russwin keyways are separated into categories known as **Key Classes**, based on blade width and bitting dimensions. **Certain key blanks and cylinders are not available for certain key classes**, and notes to that effect appear in the catalog and price book. If you find a keyway exclusion notice and do not know the class of the keyway you need, refer to the list below.

Some keyways listed here are *inactive*. They remain available to support existing systems, but no *new systems* are generated on them.

Keyway	Remarks
26	Discontinued
27 Series	X Class (28 and 29 are inactive)
57 Series	X Class
59 Series	Z Class
60	Z Class
67 Series	X Class (68 and 69 are inactive)
70	Z Class
77 Series	X Class (77 and 78 are inactive)
97 and 99	X Class
252	852 Class (inactive)
752	752 Class (inactive)
852	852 Class (inactive)
981, 982, 983	981 Class (inactive)
A1 thru A24	A Class (inactive)
Access 3	Access 3
AR, BR, BL	X Class
D1 thru D4	DH Class
G	852 Class (inactive)
H1 thru H8	DH Class
L1 thru L4	Z Class (L2 formerly CCL)
N1 thru N28	N Class (inactive)
Pyramid	Pyramid
Protected	DH or Z Class
Restricted	DH or Z Class
Best	Best keyways for SFIC

Keyway Name Changes

All Multiplex Keyways using letters with numbers are now standardized to have the letter first and number last. Also, keyway designation will no longer include the number of pins. K and Z designations are being replaced by the more common N and A Series, respectively. 960 and 970 Series are replaced by the more common 980 Series. Only the following Russwin® older keyways are affected:

Old Designation	Pins	New Designation
1N thru 28N	6	N1 thru N28
1K thru 28K	5 or 7	N1 thru N28
1A thru 24A	5	A1 thru A24
1Z thru 24Z	6	A1 thru A24
961, 962, 963	6	981, 982, 983
971, 972, 973	7	981, 982, 983

Category	Description	Price
Stock L4	Keyway used for stock orders and limited keying systems.	No Charge
Standard (see list at left)	Keyways in general use for keying systems.	No Charge
Restricted (not published)	Selective keyways for use in new and existing keying systems.	No Charge
Protected	Notice of Acceptance showing facilities name, address and contact information must be submitted to key records before orders can be processed. Key system administration approval required prior to processing of order.	No Charge
Pyramid	One of Corbin Russwin's line of high security cylinders	See Pyramid pages 44-49
Security	Old Emhart®/Security cylinders.	For existing systems only
Access 3	Corbin Russwin's highest level of key control.	See Access 3 pages 38-43

Key Systems Security Policy

The purpose of this security policy is to enforce our policies Access 3, Pyramid, Security, Protected & Restricted keyway product, including key system information.

No master key system information or security related product is to be given or sold to anyone other than the facility owner through written correspondence. Verification must be submitted (fax copy will be acceptable) to Key Systems Administration. The verification must be on the facility's letterhead and signed by a facility authorized systems administrator. Key Systems Administration does not maintain "Letters of Authorization" on file. Each order must be accompanied by proper authorization. Only after the authorization has been verified will the order be processed for production.

Also includes:

- Bitting information (even one bitting, absolutely no top-level master keys)
- Bitting lists (all formats; i.e., hard copy, disc)
- Key blanks and systems components for Access 3 AS/AHS, Pyramid, and security cylinder systems.

Please note:

- No orders are to be processed through Key Systems Administration without proper authorization.
- Only orders with appropriate authorization attached will be given priority.
- Requests for systems information without proper authorization from the owner will be denied.
- Requests for information regarding the purchase of any systems support products as listed above will be referred to the local authorized sales agency.
- Refer to the current price lists for additional policies and procedures as they relate to this security policy.

Remember:

The purpose for the establishment of any security system is to provide an increased level of protection for the Facility owner.

Construction Core Program

How To Order

Use Quick Code CT6 for 6-PIN LFIC, CT7 for 7-PIN LFIC, CT6SB for 6-PIN SFIC, CT7SB for 7-PIN SFIC, and CTP for Access 3, Pyramid IC products. Use a separate purchase order or line item to order the permanent systems' core.

Cut Keys

Specify the required number of change keys and control keys on the order. Two control keys are provided at no charge. Two change keys are provided at no charge for the first 20 units ordered. One additional change key is provided for every 10 additional units at no charge.

Examples: 25 units provide 2 operating keys; 30 units provide 3; 100 units provide 10. Additional keys will be invoiced at the prevailing cut key price.

How To Return Cores

Contact your Customer Service Representative for a Returned Goods Authorization.

Provide the factory order number and year of the original order. Credit is issued for all cores returned in good operating condition, based on the price of a standard 6- or 7-pin core at the time of the original order. Applicable discounts to the original unit are applied to the returned core.

Current pricing is as follows:	Price
6-PIN CONSTRUCTION CORE: (e.g. CR8000-CT6) returned for credit	\$104.00
7-PIN CONSTRUCTION CORE: (e.g. CR8000-CT7) returned for credit	\$106.00

How To Price

Use Quick Code charts in lockset and exit device price sections.

1 ea. Lockset	ML2051 NSA 626	\$1,332.00	List Price
x Construction Core	CTP	\$104.00	List Price
		\$1,436.00	Subtotal
	Less 50/25% discount	\$538.50	Subtotal Net Price
1 ea. Pyramid Permanent Core	CR8027 x 626	\$181.00	List Price
	Less 50% discount	\$90.50	Net Price
		\$629.00	Subtotal Net Price
Return Construction Core	CR8000 Construction Core	\$104.00	List Price
	Less 50/25% discount	\$39.00	(Credit - RGA from factory)
		\$590.00	Your Total Cost

Cylinders for Competitor Products:
 CORBIN RUSSWIN cylinders or cores for use in non-CORBIN RUSSWIN manufactured locking devices for which CORBIN RUSSWIN has an equivalent, will be assessed an additional Cylinder Service Fee. This fee applies to masterkeyed cylinder only orders, 1 bitted high security cylinders and zero or 1 bitted restricted cylinder orders.

Keying

Description	Specify Quick Code	Add or Deduct
Keyed random ³	KR	No Charge
Masterkey Service Fee. Applies to cylinders not being installed in Assa Abloy products		Consult Factory
Master keyed (all cylinders except CR8000, CR8020, CR8200, CR8027, CR8500, CR8600, CR8700 IC Cores)	specify keyset	Add \$16.00 per cylinder
Master keyed Pyramid (except CR8020, CR8027 IC Core)	specify keyset	Add \$16.00 per cylinder
Master keyed Access 3 (except CR8500, CR8600, CR8700 IC Core)	specify keyset	Add \$16.00 per cylinder
Master keyed Security (including IC cylinder and core)	specify keyset	Add \$16.00 per cylinder
Master keyed (CR8000, CR8020, CR8027, CR8200, CR8500, CR8600, CR8700 IC Cores)	specify keyset	No Charge
Master keyed to customer bittings or sample key	specify keyset	Add \$16.00 per cylinder
Construction master keyed ^{1,2}	CMK	Add \$16.00 per cylinder
Temporary Construction core, 6-pin LFIC (Red, Blue or Green) including Access 3 AP & AS	CT6R, CT6B, CT6G	No Charge
Temporary Construction core, 7-pin LFIC (Red, Blue or Green)	CT7R, CT7B, CT7G	No Charge
Temporary Construction core, 6-pin SFIC (Blue)	CT6SB	No Charge
Temporary Construction core, 7-pin SFIC (Blue)	CT7SB	No Charge
Temporary Construction core, 6-pin (Red, Blue or Green) Access 3 AHS	CT6AHR, CT6AHB, CT6AHG	No Charge
Temporary Construction core, Access 3 Pyramid	CTP	No Charge
Temporary Disposable core ⁶	CT6D, CT7D, CTPD	Deduct \$104.00 per cylinder
Small Format Temporary Disposable Cores ⁶	CTSD	Deduct \$93.00 per cylinder
Uncombined (Access 3, Pyramid, Security fixed and IC core) ⁷	UC	Deduct \$8.00
Uncombined (conventional CR8000 IC core) ⁷	UC	Deduct \$2.00
Bump-Resistant Cylinder	BRP	Add \$29.00 per cylinder
More than 2 keys per lock	KY# (e.g., KY6)	See Cut Keys Section Below
For keys packed separately (Indicate appropriate "ship to" address on keying cover sheet)		Add \$4.00 per cylinder

Stamping

Visual key control (VKC)		
- No stamping	VKC0	\$4.50
- Keys only	VKC1	No Charge
- Cylinders and Keys ⁴	VKC2	\$8.00
- Cylinders only ⁴	VKC3	\$8.00
Concealed key control (CKC)		
- CKC cylinders with VKC keys	CKC2	\$8.00
- CKC cylinders only ⁴	CKC3	\$8.00
DO NOT DUPLICATE	Order by number	See pages 36-37
End user custom die stamps* for key bows		\$4.00
Other stamping on keys or cylinders (Up to 7 characters on cylinders)		\$3.00 per character

* For development of custom key stamp add one-time charge of \$840.00. Die is property of Corbin Russwin.

Cut Keys

	Conventional Keyway ⁵ Restricted Keyway		Protected Keyway		SFIC Keys	Security Keys	Pyramid Keys	Access 3		
	10 Series Bow	50 Series Bow	10 Series Bow	50 Series Bow	KB42 or KB43	KB90 or KB92	KB28	AP	AS	AHS
Extra cut change keys with lockset/cylinder	\$6.80	\$7.40	\$7.90	\$8.40	\$11.20	\$25.30	\$13.40	\$6.70	\$13.40	\$13.40
Cut change keys without lockset/cylinder	\$14.20	\$14.80	\$15.30	\$15.80	\$11.20	\$25.30	\$19.40	\$14.20	\$20.90	\$20.90
Cut master keys (all levels) and control keys with or without lockset/cylinder	\$14.20	\$14.80	\$15.30	\$15.80	\$11.20	\$25.30	\$19.40	\$14.20	\$20.90	\$20.90
Cut construction master keys with or without lockset/cylinder	\$14.20	\$14.80	\$15.30	\$15.80	N/A	N/A	N/A	\$14.20	\$20.90	N/A

Cut Change/Control keys for temporary cores with or without lockset/cylinder (Conventional Keyway 10 series only & SFIC KB42 only carry pricing. All other N/A)

Note: Two (2) cut change keys are provided per lockset or cylinder at no charge. Keyblanks cannot be substituted for cut keys.

For keys with bows other than 10 and 90, specify "KB" + number as Quick Code, e.g. KB12. KB92 cannot be furnished with VKC or other markings. Cylinders pinned directly to GMK or MK level keys do not include cut keys. Please order GMK and MK keys separately.

Notes:

1. CMK Construction master keying charge is in addition to master keying charge.
2. CMK Construction master keying is not available in interchangeable core, Access 3, Pyramid, or Security series.
3. Access 3 and Pyramid series is not available keyed random or 0-bitting. All LFIC and SFIC cylinders unavailable keyed random.
4. VKC2, VKC3 is not available in Access 3, Pyramid or Security series.
5. Conventional cut change keys are furnished standard with key section, system type and bitting number.
6. Disposable cores ordered separately - \$56.00 per set. Sold in multiples of 10 sets.
7. Keys, springs, and spring covers not included.

Presentation Keys		Price
Specify:	Key Symbol; Plating (nickel is standard); Stamping; Bow, if available for key class	
Standard Bow:	51 for all except below	
	90 for Security series	Nickel Plated \$140.00
	10 for 6 PIN 852 & A Class keys	Gold Plated \$269.00

Bitting Lists

To protect the security of keying systems, bitting lists will only be sent to the end user or his designated agent, via Certified Mail Return Receipt Requested or UPS AOD. Copies will not be transmitted via fax. The complete name and address where the bitting list is to be sent must be indicated on the letter of authorization and on the purchase order.

Master key system bitting lists will not be created by Corbin Russwin Key Systems Administration unless the request is accompanied by an order for factory keyed product. Corbin Russwin releases all liabilities for cylinders not pinned to factory master key systems.

# Bittings	Paper	Disc	Simple K	Key Wizard	Paper Price	Disc Price	Simple K/ Key Wizard Price
1-50	KC1-CR	KCD1-CR	DLSK1-CR	DLKW1-CR	\$359.00	\$434.00	\$284.00
51-200	KC2-CR	KCD2-CR	DLSK2-CR	DLKW2-CR	\$509.00	\$584.00	\$434.00
201-1000	KC3-CR	KCD3-CR	DLSK3-CR	DLKW3-CR	\$657.00	\$732.00	\$582.00
1001-3000	KC4-CR	KCD4-CR	DLSK4-CR	DLKW4-CR	\$808.00	\$883.00	\$733.00
3001-6000*	KC5-CR	KCD5-CR	DLSK5-CR	DLKW5-CR	\$925.00	\$1,000.00	\$850.00
6001-9000*	KC6-CR	KCD6-CR	DLSK6-CR	DLKW6-CR	\$1,349.00	\$1,424.00	\$1,274.00
Over 9000*	KC7-CR	KCD7-CR	DLSK7-CR	DLKW7-CR	Consult Factory		

NOTE: Bitting Lists requested for keysets ordered with factory keyed product for either a new or existing system will be provided at no charge, except for Simple K DLSK1-CR thru DLSK7-CR & Key Wizard DLKW1-CR thru DLKW7-CR. For existing system pricing above will apply. For new system see page 35

- Additional Bittings or P.O.'s for Bitting Lists Only – **EXISTING MASTER KEY GROUPS**
Up to 10 **total** for keysets tied to **existing** master key groups will be provided at no charge
11 or more bittings will be charged per above chart
- Additional Bittings or P.O.'s for Bitting Lists Only – **NEW MASTER KEY GROUPS**
Regardless of the quantity being requested, will be charged per above chart

These prices are for a hierarchical Master Key system with no cross-keying of selected keys.
For special requirements or for systems prior to 1999, consult Key Systems Administration for a quote.

Corbin Russwin releases all liabilities for cylinders not pinned to factory master key systems.

Cylinders for Competitor Products:

CORBIN RUSSWIN cylinders or cores for use in non-CORBIN RUSSWIN manufactured locking devices for which CORBIN RUSSWIN has an equivalent, will be assessed an additional Cylinder Service Fee. This fee applies to masterkeyed cylinder only orders, 1 bitted high security cylinders and zero or 1 bitted restricted cylinder orders.

Key Management Software

Simple K – Special online ordering procedures accessible via the ASSA ABLOY Door Security Solutions Extranet (www.assaabloydss.com)
- contact customer service for more information.

SimpleK – Standard Edition	Description	Price
SMK040-30	Primary License (3 users)	\$2,981.00
SMK040-31	Updates & Support Plan on Primary License, 1 year	\$557.00
SimpleK – Professional Edition	Description	Price
SMK042-30	Primary License (3 users)	\$3,511.00
SMK042-32	Additional license	\$464.00
SMK042-35	Updates & Support Plan on Primary License, 1 year	\$835.00
SMK042-33	Updates & Support Plan on Additional License, 1 year (per Add. Lic.)	\$139.00
Add-On Modules	Description	Price
SMK032-31	Item Tracking	\$1,258.00
SMK032-33	Web Interface	\$1,657.00
SMK032-35	Room Management	\$795.00
SMK032-37	Mobile Applications	\$1,126.00

Key Systems Administration

Price

Customer Provided Bittings (CPB) 1,2,3,4,5

Add \$16.00 per cylinder

Notes:

1. This charge is for keying to customer supplied bittings only.
2. All cylinders requested to be keyed to combinations not supplied by Corbin Russwin will be subject to this charge.
3. Corbin Russwin releases all liabilities, including key interchange, to systems generated by customer-supplied bittings that are supplied by others.
4. Purchase orders with customer-supplied bittings not meeting Corbin Russwin's specifications will be processed 0-bitted in the specified keyway and exempt from upcharge.
5. Master keying or CMK charges not included.

Disclaimer

Corbin Russwin reserves the right to release total liability of any factory generated master key system which incorporates cross keying, both controlled and uncontrolled. A master key system incorporating cross keying yields less security and jeopardizes system expansion.

Controlled Cross Keying: A condition in which two or more different keys of the same level of keying and under the same higher level

Cross Keying

No Charge

key(s) operate one cylinder by design; e.g., XAA1 operated by AA2.

Uncontrolled Cross Keying: A condition in which two or more different keys under different higher-level keys operate one cylinder by design; e.g., XAA1 operated by AB, AB1.

Stamping Key Section on Key Blanks

Key blanks are furnished standard with no key section ID. When so specified, key blanks can be stamped with the key section at no charge. The minimum quantity for this service is a box of 50 key blanks

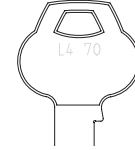

Standard Bow, Nickel Silver (Order in multiples of 50)



Coined Logo	Plain Both Sides	DO NOT DUPLICATE	US PROPERTY DO NOT DUPLICATE	RESTRICTED DO NOT DUPLICATE	Price Each		
					Standard Single Section	Restricted Single Section	Standard and Restricted Multi-Section**
(X1, Z1, R)*	(X4, Z4, P)*	(X5, Z5, P5)*	(X6, Z6, P6)*				
xx-5PIN-10	xx-5PIN-11	xx-5PIN-12	xx-5PIN-13	xx-5PIN-19	\$2.90	\$3.07	\$3.24
xx-6PIN-10	xx-6PIN-11	xx-6PIN-12	xx-6PIN-13	xx-6PIN-19			
xx-7PIN-10	xx-7PIN-11	xx-7PIN-12	xx-7PIN-13	xx-7PIN-19	\$2.98	\$3.15	\$3.26

*(Old Reference)

**Multi-section keys enter more than one keyway; eg. D12, H41, 2852, 9812, 59A, 57AD, 067, etc.

† Protected keyway keys will be stamped "Restricted"

Pyramid (Available in quantities of 10, 25, 50 and multiples of 50)

Standard bow furnished for all Pyramid Keys.



Key Blank Number	Description	Price Each
XX-7PIN-28	Single section	\$9.70
	Multi-section	\$18.10

Access 3



Key Blank Number	Description	Price Each
6PIN-38-AP	Standard key blanks for AP cylinders	\$5.00
6PIN-38-AS	Standard key blanks for AS & AHS cylinders	\$9.70

Security Bow No other shape for security keys. (Order in multiples of 50)

Not Available for 252, 752, 852, A, N, or X Class keys.

Inactive, for existing systems only.



Coined Logo	Plain Both Sides	DO NOT DUPLICATE	US PROPERTY DO NOT DUPLICATE	RESTRICTED DO NOT DUPLICATE	Price Each
xx-6PIN-90	xx-6PIN-91	xx-6PIN-92	xx-6PIN-93	xx-6PIN-99	\$9.70
xx-7PIN-90 for hotel EMK					\$12.20

Large Bows (Order in multiples of 50)

Large Not Available for 252, 752, 852 or A Class keys.

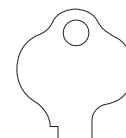

Plain Both Sides	DO NOT DUPLICATE	US PROPERTY DO NOT DUPLICATE	RESTRICTED DO NOT DUPLICATE	Price Each	PROTECTED DO NOT DUPLICATE	Price Each
(Y4 and S)	(Y5 and S5)	(Y6 and S6)				
xx-5PIN-51	xx-5PIN-52	xx-5PIN-53	xx-5PIN-59	\$4.60	xx-5PIN-59	\$6.80
xx-6PIN-51	xx-6PIN-52	xx-6PIN-53	xx-6PIN-59		xx-6PIN-59	
xx-7PIN-51	xx-7PIN-52	xx-7PIN-53	xx-7PIN-59		xx-7PIN-59	

SFIC Key Blanks

Description	Key Number	Price Each
Duplication Prohibited 6-Pin Key	6PIN-42-KB	\$3.60
Duplication Prohibited 7-Pin Key	7PIN-42-KB	\$3.60
US Property Do Not Duplicate 6-Pin Key	6PIN-43-KB	\$3.60
US Property Do Not Duplicate 7-Pin Key	7PIN-43-KB	\$3.60

Emergency Key Blanks for Hotel Function Access 3 Cylinder

Description	Key Number	Price Each
Emergency key for mortise AP cylinders	6PIN-38-E2-AP	\$7.00
Emergency key for mortise AS & AHS cylinders	6PIN-38-E2-AS	\$10.00
Emergency key for key-in lever AP cylinders	6PIN-38-E6-AP	\$7.00
Emergency key for key-in lever AS & AHS cylinders	6PIN-38-E2-AS	\$10.00

Emergency Master Key Blanks for Hotel Function Cylinder (Order in multiples of 10)

Non-IC mortise cylinder use 7PIN blanks, as already listed: xx-7PIN-51 & xx-7PIN-90. (Order in multiples of 50)

Not Available for 252, 752, 852 or A Class keys.



Lockset	EMK Blank	Price Each
IC Mortise	xx-6PIN-51-E1	\$7.00
IC Mortise, Security	xx-6PIN-90-E1	\$9.50
CK4229, including IC; CK4429	xx-6PIN-51-E4	\$7.00
CK4229 Security, Including IC	xx-6PIN-90-E4	\$9.50
CL3329, CL3429, CL3629 6PIN, Including IC	xx-6PIN-51-E8	\$7.00
CL3329, CL3429, CL3629 7PIN, Including IC	xx-7PIN-51-E8	\$7.00
1400/4300 and 5600/3300 Series	xx-6PIN-51-E5	\$8.20

Mortise Cylinder

Cylinder Number	Description	605, 606, 611, 612, 613, 613E, 618, 619, 622, 625, 626, 629, 630, 722, BSP, WSP
CR1500-114	ML2000 Series mortise locks (including electrified and EAC devices)	\$120.00
CR1500-138	DL3000 and DL4100 deadlocks	
CR1500-112	ED5600, ED6600 and ED7600 exit devices	
CR1500-134	All ED5000 cylinder dogging, alarm units, delayed egress cylinders	
CR1501-114-A01	AP Hotel Mortise Cylinder	\$161.00

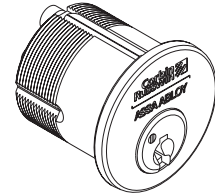

Rim Cylinder

Cylinder Number	Description	605, 606, 611, 612, 613, 613E, 618, 619, 622, 625, 626, 629, 630, 722, BSP, WSP
CR3500-058	5/8" tailpiece	\$120.00
CR3500-138	1-3/8" M61 & M62 option for ED8200 and obsolete ED9200 exit device alarms; ED5202(A) inside cylinder	
CR3500-200	2" tailpiece	
CR3500-200N	2" ED4000/ED5000 night latch function	
CR3500-200V	2" vertical tailpiece	\$122.00
CR3500-312	3-1/2" tailpiece	
CR3500-312V	3-1/2" vertical tailpiece	

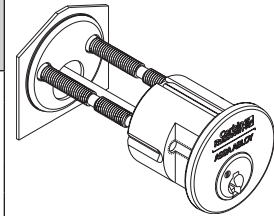

AP LFIC - Mortise Cylinder

Cylinder Number	Description	605, 606, 611, 612, 613, 613E, 618, 619, 622, 625, 626, 629, 630, 722, BSP, WSP
CR1580-114	ML2000 Series mortise locks (including electrified and EAC devices)	\$224.00
CR1580-138	DL3000 and DL4100 deadlocks	\$227.00
CR1580-112	ED5600, ED6600 and ED7600 exit devices	
CR1580-134	All ED5000 cylinder dogging, alarm units, delayed egress cylinders	\$235.00

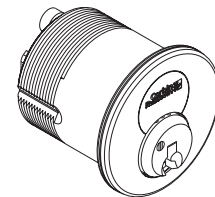

AP LFIC - Rim Cylinder

Cylinder Number	Description	605, 606, 611, 612, 613, 613E, 618, 619, 622, 625, 626, 629, 630, 722, BSP, WSP
CR3580-058	5/8" tailpiece	\$224.00
CR3580-114	1-1/4" M61 & M62 option for ED8200 and ED9200 exit device alarms	
CR3580-178	1-7/8" tailpiece	
CR3580-178V	1-7/8" vertical tailpiece	
CR3580-318	3-1/8" tailpiece	\$226.00

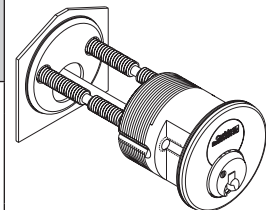

*LFIC Cores are provided in 606, 626 or BSP finish only.

AP LFIC Core

Cylinder Number	Description	Finish: 606, 626
CR8500	All Corbin Russwin LFIC cylinders	\$104.00

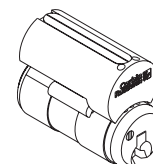

AP Fixed Core Component Cylinder

Cylinder Number	Description	Finish: 606, 626
CR2500-031	CL3100 Series Vandal Resistant, CK4300 Knob	\$111.00
CR2500-033	CL3300, CL3500, CL3600 (June 2000 and after), CL3800, Lever Trim - A6/N6/PR6	
CR2500-033H	G10 Exit Device Knob Trim	
CR2500-034	CLX3300	
CR2500-037	CL3700 Lever, CK4700 Knob	
CR2500-039	CL3900	
CR2500-039L	CL3900 Lever (2" and 2-1/4" Thick Door)	
CR2500-044	CK4400	
CR2500-052	CK4200/UT5200	

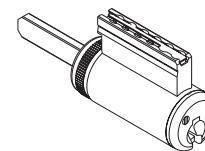

AP Fixed Core Deadlock Cylinder

Cylinder Number	Description	Finish: 606, 626
CR4500-134-A51	DL2200/DL3200 Series	\$111.00
CR4500-134-A52		
CR4500-214-A52		

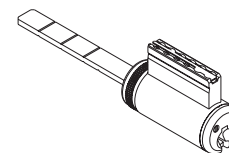

AP Fixed Core Hotel Cylinder

Cylinder Number	Description	Finish: 606, 626
CR2501-031	CL3100 Series Vandal Resistant	\$127.00
CR2501-034	CL3300, CLX3300	
CR2501-034A	CLX3300	

AP Fixed Core Component Cylinder for Other Manufacturer's Products

Cylinder Number	Description	Finish: 606, 626
CR2300-001-C21	Schlage D Series Lever Arrow H Series Knobs and Levers Sargent 10 Line ¹	\$265.00
CR2300-001-C22	Schlage AL and ND Series Levers	
CR2300-002-C21	Schlage D Series Knobs	
CR2300-002-C22	Schlage A Series Knobs (Ply, etc.)	
CR2300-002-C23	Schlage A Series Knobs (ORB only)	

1. SARGENT lock order must include 30- prefix.

AS Fixed Core - Mortise Cylinder

Cylinder Number	Description	605, 606, 611, 612, 613, 613E, 618, 619, 622, 625, 626, 629, 630, 722, BSP, WSP
CR1600-114	ML2000 Series mortise locks (including electrified and EAC devices)	\$198.00
CR1600-138	DL3000 and DL4100 deadlocks	
CR1600-112	ED5600, ED6600 and ED7600 exit devices	
CR1600-134	All ED5000 cylinder dogging, alarm units, delayed egress cylinders	
		\$208.00

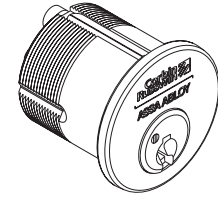

AS Fixed Core - Rim Cylinder

Cylinder Number	Description	605, 606, 611, 612, 613, 613E, 618, 619, 622, 625, 626, 629, 630, 722, BSP, WSP
CR3600-058	5/8" tailpiece	\$198.00
CR3600-138	1-3/8" M61 & M62 option for ED8200 and obsolete ED9200 exit device alarms; ED5202(A) inside cylinder	
CR3600-200	2" tailpiece	
CR3600-200N	2" night latch function	
CR3600-200V	2" vertical tailpiece	
CR3600-312	3-1/2" tailpiece	\$200.00
CR3600-312V	3-1/2" vertical tailpiece	

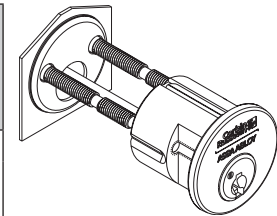

AS LFIC - Mortise Cylinder

Cylinder Number	Description	605, 606, 611, 612, 613, 613E, 618, 619, 622, 625, 626, 629, 630, 722, BSP, WSP
CR1680-114	ML2000 Series mortise locks (including electrified and EAC devices)	\$302.00
CR1680-138	DL3000 and DL4100 deadlocks	\$305.00
CR1680-112	ED5600, ED6600 and ED7600 exit devices	
CR1680-134	All ED5000 cylinder dogging, alarm units, delayed egress cylinders	\$313.00

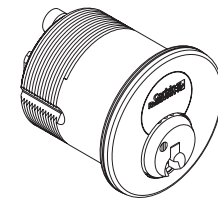

AS LFIC - Rim Cylinder

Cylinder Number	Description	605, 606, 611, 612, 613, 613E, 618, 619, 622, 625, 626, 629, 630, 722, BSP, WSP
CR3680-058	5/8" tailpiece	\$302.00
CR3680-114	1-1/4" M61 & M62 option for ED8200 and ED9200 exit device alarms	
CR3680-178	1-7/8" tailpiece	
CR3680-178V	1-7/8" vertical tailpiece	
CR3680-318	3-1/8" tailpiece	
		\$304.00

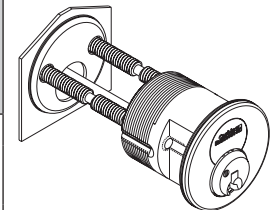

*LFIC Cores are provided in 606, 626 or BSP finish only.

AS LFIC Core

Cylinder Number	Description	Finish: 606, 626
CR8600	All Corbin Russwin LFIC Cylinders	\$182.00

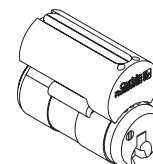

AS Fixed Core Component Cylinder

Cylinder Number	Description	Finish: 606, 626
CR2600-031	CL3100 Series Vandal Resistant, CK4300 Knob	\$175.00
CR2600-033	CL3300, CL3500, CL3600 (June 2000 and after), CL3800, Lever Trim - AG/NG/PR6	
CR2600-033H	G10 Exit Device Knob Trim	
CR2600-034	CLX3300	
CR2600-037	CL3700 Lever, CK4700 Knob	
CR2600-039	CL3900	
CR2600-039L	CL3900 Lever (2" and 2-1/4" Thick Door)	
CR2600-044	CK4400	
CR2600-052	CK4200/UT5200	

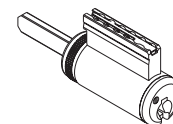

AS Fixed Core Deadlock Cylinder

Cylinder Number	Description	Finish: 606, 626
CR4600-134-A51	DL2200/DL3200 Series	\$175.00
CR4600-134-A52		
CR4600-214-A52		

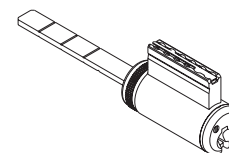

AS Fixed Core Hotel Cylinder

Cylinder Number	Description	Finish: 606, 626
CR2601-031	CL3100 Series Vandal Resistant	\$191.00
CR2601-034	CL3300, CLX3300	
CR2601-034A	CLX3300	

AS Fixed Core Component Cylinder for Other Manufacturer's Products

Cylinder Number	Description	Finish: 606, 626
CR2600-001-C21	Schlage D Series Lever Arrow H Series Knobs and Levers Sargent 10 Line ¹	\$330.00
CR2600-001-C22	Schlage AL and ND Series Levers	
CR2600-002-C21	Schlage D Series Knobs	
CR2600-002-C22	Schlage A Series Knobs (Ply, etc.)	
CR2600-002-C23	Schlage A Series Knobs (ORB only)	

1. SARGENT lock order must include 30- prefix.

AHS Fixed Core - Mortise Cylinder

Cylinder Number	Description	605, 606, 611, 612, 613, 613E, 618, 619, 622, 625, 626, 629, 630, 722, BSP, WSP
CR1700-114	ML2000 Series mortise locks (including electrified and EAC devices)	\$231.00
CR1700-138	DL3000 and DL4100 deadlocks	
CR1700-112	ED5600, ED6600 and ED7600 exit devices	\$241.00
CR1700-134	All ED5000 cylinder dogging, alarm units, delayed egress cylinders	

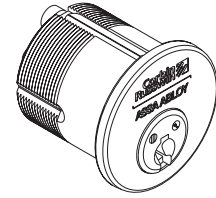

AHS Fixed Core - Rim Cylinder

Cylinder Number	Description	605, 606, 611, 612, 613, 613E, 618, 619, 622, 625, 626, 629, 630, 722, BSP, WSP
CR3700-058	5/8" tailpiece	\$231.00
CR3700-138	1-3/8" M61 & M62 option for ED8200 and obsolete ED9200 exit device alarms; ED5202(A) inside cylinder	
CR3700-200	2" tailpiece	
CR3700-200N	2" night latch function	
CR3700-200V	2" vertical tailpiece	\$233.00
CR3700-312	3-1/2" tailpiece	
CR3700-312V	3-1/2" vertical tailpiece	

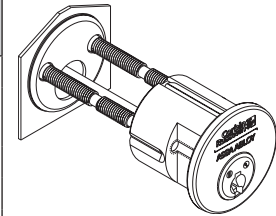

AHS LFIC - Mortise Cylinder

Cylinder Number	Description	605, 606, 611, 612, 613, 613E, 618, 619, 622, 625, 626, 629, 630, 722, BSP, WSP
CR1788-114	ML2000 Series mortise locks (including electrified and EAC devices)	\$335.00
CR1788-138	DL3000 and DL4100 deadlocks	\$338.00
CR1788-112	ED5600, ED6600 and ED7600 exit devices	
CR1788-134	All ED5000 cylinder dogging, alarm units, delayed egress cylinders	\$346.00

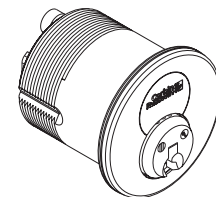

AHS LFIC - Rim Cylinder

Cylinder Number	Description	605, 606, 611, 612, 613, 613E, 618, 619, 622, 625, 626, 629, 630, 722, BSP, WSP
CR3788-058	5/8" tailpiece	\$335.00
CR3788-114	1-1/4" M61 & M62 option for ED8200 and ED9200 exit device alarms	
CR3788-178	1-7/8" tailpiece	
CR3788-178V	1-7/8" vertical tailpiece	
CR3788-318	3-1/8" tailpiece	\$337.00

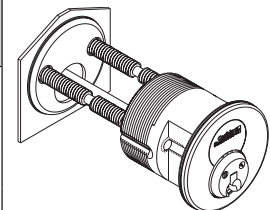

*LFIC Cores are provided in 606, 626 or BSP finish only.

AHS LFIC Core

Cylinder Number	Description	Finish: 606, 626
CR8700	All Corbin Russwin LFIC cylinders	\$215.00

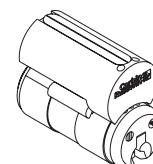

AHS Fixed Core Component Cylinder

Cylinder Number	Description	Finish: 606, 626
CR2700-031	CL3100 Series Vandal Resistant, CK4300 Knob	\$202.00
CR2700-033	CL3300, CL3500, CL3600 (June 2000 and after), CL3800, Lever Trim - A6/N6/PR6	
CR2700-033H	G10 Exit Device Knob Trim	
CR2700-034	CLX3300	
CR2700-037	CL3700 Lever, CK4700 Knob	
CR2700-039	CL3900	
CR2700-039L	CL3900 Lever (2" and 2-1/4" Thick Door)	
CR2700-044	CK4400	
CR2700-052	CK4200/UT5200	

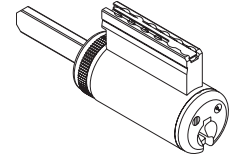

AHS Fixed Core Hotel Cylinder

Cylinder Number	Description	Finish: 606, 626
CR2701-031	CL3100 Series Vandal Resistant	\$218.00
CR2701-034	CL3300, CLX3300	
CR2701-034A	CLX3300	

AHS Fixed Core Deadlock Cylinder

Cylinder Number	Description	Finish: 606, 626
CR4700-134-A51	DL2200/3200 Series	\$202.00
CR4700-134-A52		
CR4700-214-A52		

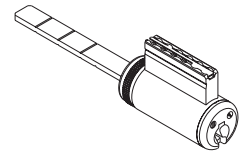

AHS Fixed Core Component Cylinder for Other Manufacturer's Products

Cylinder Number	Description	Finish: 606, 626
CR2900-001-C21	Schlage D Series Lever Arrow H Series Knobs and Levers Sargent 10 Line ¹	\$355.00
CR2900-001-C22	Schlage AL and ND Series Levers	
CR2900-002-C21	Schlage D Series Knobs	
CR2900-002-C22	Schlage A Series Knobs (Ply, etc.)	
CR2900-002-C23	Schlage A Series Knobs (ORB only)	

1. SARGENT lock order must include 30- prefix.

UL LFIC 6-Pin Mortise Housing

Cylinder Number	Description	605, 606, 611, 612, 613, 613E, 618, 619, 622, 625, 626, 629, 630, 722, BSP, WSP
CR1078-114	ML2000 Series mortise locks (including electrified and EAC devices)	\$120.00
CR1078-138	DL3000 and DL4100 deadlocks	\$123.00
CR1078-112	ED5600, ED6600 and ED7600 exit devices	
CR1078-134	All ED5000 cylinder dogging, alarm units, delayed egress cylinders	\$131.00

UL LFIC 6-Pin Rim Housing

Cylinder Number	Description	605, 606, 611, 612, 613, 613E, 618, 619, 622, 625, 626, 629, 630, 722, BSP, WSP
CR3078-058	5/8" tailpiece	\$120.00
CR3078-114	1-1/4" M61 & M62 option for ED8200 and ED9200 exit device alarms	
CR3078-178	1-7/8" tailpiece	
CR3078-178V	1-7/8" vertical tailpiece	
CR3078-318	3-1/8" tailpiece	

Fixed Core Mortise

7-Pin - No Cross Keying - Furnished standard with 610502 solid recessed collar unless otherwise indicated.
High Security UL437 Listed.

Cylinder Number Example

To simplify ordering, options designated "standard" may be omitted from the ordering sequence.



Length		Cam		Finish	
114	(1-1/4")	A01	Cloverleaf (standard)	605	622
		A02	Straight	606	625
112	(1-1/2")	A03	Adams Rite® MS	611	626
		A04	DL4000 Deadlock	612	629
		A05	Adams Rite® 4070	613	630
		A06 ²	Schlage® L9000	613E	722
		A07	DL4100 Series Deadlock	618	BSP
		A62	Straight	619	WSP
		A92	Exit Grip O1, O2		
		A93 ¹	For Obsolete Corbin® 610 Series and Russwin®1403 Series Deadlock		
Cylinder No.				Price	
CR1020-114				\$245.00	

- Notes: 1. Add \$2.00 per cylinder for A93 cam
2. Add \$5.00 per cylinder for A06 cam

Fixed Core Rim

7-Pin - No Cross Keying - Furnished standard with 422F88 surface mount collar unless otherwise indicated.
High Security UL437 Listed.

Cylinder Number Example

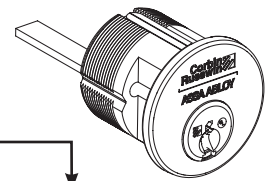
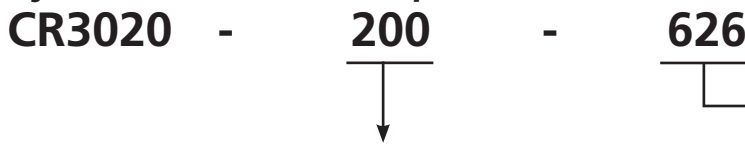

Tailpiece Length	Finish	
058 - 5/8"	605	622
138 - 1-3/8" M61 & M62 option for ED8200 and obsolete ED9200 exit device alarms	606	625
200 - 2"	611	626
	612	629
200N - 2" ED4000/ED5000 Night Latch Function	613	630
200V - 2" vertical	613E	722
312 - 3-1/2"	618	BSP
312V - 3-1/2" vertical	619	WSP
Cylinder Number	Price	
CR3020 - _____	\$245.00	

Key-In-Lever/Knob

7-Pin - No Cross Keying

High Security UL437 Listed

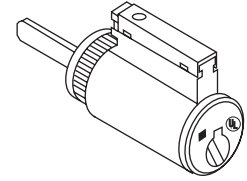

Cylinder Number	Used for	Finish: 606, 626
CR2020-031	CL3100 Lever, CK4300 Knob	\$232.00
CR2020-033	CL3300, CL3500, CL3800 [CL3600 (June 2000 and after)], A6, N6, PR6 Exit device trim	
CR2020-033H	G10 Exit device trim	
CR2020-034	CL3400, [CL3600 (prior to June 2000)], A5, N5 obsolete trims CLX3300	
CR2020-037	CL3700 Lever, CK4700 Knob	
CR2020-038	CL3800 Lever	
CR2020-039	CL3900 Lever	
CR2020-039L	CL3900 Lever (2" - 2-1/4" door)	
CR2020-051	G3 Exit Device Knob Trim	
CR2020-052	CK4200 Knob, UT5200 Knob and Lever	
CR4420-134-A51	DL2200, DL3200 Cylindrical Deadlock	
CR4420-134-A52	DL2200, DL3200 Cylindrical Deadlock	
CR4420-214-A52	DL2200, DL3200 Cylindrical Deadlock	

Key-In-Lever/Knob

For Other Manufacturers' Products

High Security UL437 Listed

Cylinder Number	Used for	Finish: 606, 626
CR2220-001-P21	Alarm Lock DL2500 Series	\$234.00
	Arrow® H Series Knobs and Levers	
	Arrow Q Series Levers	
	Sargent® 10 line*	
	Schlage® D Series Levers	
CR2220-002-P21	Schlage D Series Knobs	
CR2220-001-P22	Schlage AL and ND Series Levers	
CR2220-002-P22	Schlage A Series Knobs (PLY, etc.)	
CR2220-002-P23	Schlage A Series Knob (ORB only)	

* When ordered with a 30- prefix, this cylinder is accepted without modification to the lever.

*LFIC Cores are provided in 606 or 626 finish only.

IC Mortise

7-Pin - No Cross Keying - Furnished standard with 610F02 solid recessed collar unless otherwise indicated.

Cylinder Number Example

To simplify ordering, options designated "standard" may be omitted from the ordering sequence.

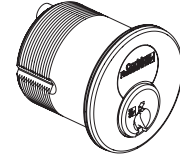

Length		Cam		Finish	
114	1-1/4"	A01	Cloverleaf (standard)	605	622
138	1-3/8"	A02	Straight	606	625
112	1-1/2"	A03	Adams Rite® MS & DL3000	611	626
134	1-3/4"	A04	DL4000 Deadlock	612	629
		A05	Adams Rite® 4070	613	630
		A06 ²	Schlage® L9000	613E	722
		A07	DL4100 Series Deadlock	618	BSP
		A62	Straight	619	WSP
		A92	Exit Grip 01, 02		
		A93 ¹	For Obsolete Corbin® 610 Series and Russwin® 1403 Series Deadlock		
Cylinder Number				Price	
CR1030-114				\$343.00	

Notes: 1. Add \$2.00 per cylinder for A93 cam.
2. Add \$5.00 per cylinder for A06 cam.

IC Rim

7-Pin - No Cross Keying - Furnished standard with 422F88 surface mount collar unless indicated.

Cylinder Number Example

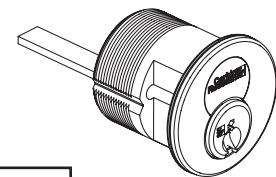

Tailpiece Length	Finish
058 - 5/8"	605 622
	606 625
114 - 1-1/4" M61 & M62 option for ED8200 and ED9200 exit device alarms	611 626
	612 629
178 - 1-7/8"	613 630
178V - 1-7/8" vertical	613E 722
	618 BSP
318 - 3-1/8"	619 WSP
Cylinder Number	Price
CR3030-_____	\$343.00

Pyramid Core Only – Finish: 606, 626

Cylinder Number	Price
CR8020	\$221.00

Note: For mortise and rim housing only, see page 93.

*LFIC Cores are provided in 606 or 626 finish only.

Fixed Core Mortise

7-Pin - No Cross Keying - Furnished standard with 605F43 spring collar unless otherwise indicated.

Cylinder Number Example

To simplify ordering, options designated "standard" may be omitted from the ordering sequence.

CR1027 - 114 - A01 - 626



Length	Cam	Finish	
114 (1-1/4")	A01 Cloverleaf (standard)	605	622
	A02 Straight	606	625
112 (1-1/2")	A03 Adams Rite® MS	611	626
	A04 DL4000 Deadlock	612	629
	A05 Adams Rite 4070	613	630
	A06 ² Schlage® L9000	613E	722
	A07 DL4100 Series Deadlock	618	BSP
	A62 Straight	619	
	A92 Exit Grip O1, O2		
	A93 ¹ For Obsolete Corbin® 610 Series and Russwin® 1403 Series Deadlock		

Cylinder Number	Price
CR1027-114	\$204.00

- Notes: 1. Add \$2.00 per cylinder for A93 cam.
2. Add \$5.00 per cylinder for A06 cam.

Fixed Core Rim

7-Pin - No Cross Keying - Furnished standard with 422F88 surface mount collar unless otherwise indicated.

Cylinder Number Example

CR3027 - 200 - 626

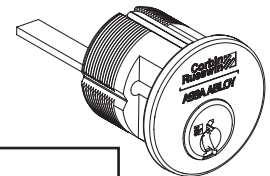

Tailpiece Length	Finish	
058 - 5/8"	605	622
138 - 1-3/8" M61 & M62 option for ED8200 and obsolete ED9200 exit device alarms	606	625
200 - 2"	611	626
200N - 2" ED4000/ED5000 Night Latch Function	612	629
200V - 2" (vertical)	613	630
312 - 3-1/2"	613E	722
312V - 3-1/2" (vertical)	618	BSP
	619	

Cylinder Number	Price
CR3027-_____	\$204.00

Key-In-Lever/Knob

7-Pin - No Cross Keying.

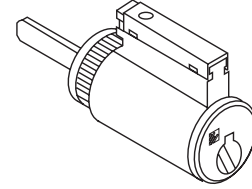

Cylinder Number	Used for	Finish: 606, 626
CR2027-031	CL3100 Lever, CK4300 Knob	\$194.00
CR2027-033	CL3300, CL3500, CL3800 [CL3600 (June 2000 and after)], A6, N6, PR6 Exit Device Trim	
CR2027-033H	G10 Exit device trim	
CR2027-034	CL3400, [CL3600 (before June 2000)], A5, N5 obsolete trims CLX3300	
CR2027-037	CL3700 Lever, CK4700 Knob	
CR2027-038	CL3800 Lever	
CR2027-039	CL3900 Lever	
CR2027-039L	CL3900 Lever (2" - 2-1/4" door)	
CR2027-051	G3 Exit Device Knob Trim	
CR2027-052	CK4200 knob, UT5200 Knob and Lever	
CR4427-134-A51	DL2200, DL3200 Cylindrical Deadlock	
CR4427-134-A52	DL2200, DL3200 Cylindrical Deadlock	
CR4427-214-A52	DL2200, DL3200 Cylindrical Deadlock	

Key-In-Lever/Knob

For Other Manufacturer's Products

Cylinder Number	Used for	Finish: 606, 626
CR2227-001-P21	Alarm Lock DL2500 Series	\$196.00
	Arrow® H Series Knobs and Levers	
	Arrow Q Series Levers	
	Sargent® 10 line (Enlarge Lever Hole)	
	Schlage® D Series Levers	
CR2227-002-P21	Schlage D Series Knobs	
CR2227-001-P22	Schlage AL and ND Series Levers	
CR2227-002-P22	Schlage A Series Knobs (PLY, etc.)	
CR2227-002-P23	Schlage A Series Knob (ORB only)	

IC Mortise

7-Pin - No Cross Keying - Furnished standard with 605F43 spring collar unless otherwise indicated.

Cylinder Number Example

To simplify ordering, options designated "standard" may be omitted from the ordering sequence.

CR1037 - 114 - A01 - 626

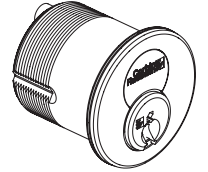

Length	Cam	Finish	
114 1-1/4"	A01 Cloverleaf (standard)	605	622
138 1-3/8"	A02 Straight	606	625
112 1-1/2"	A03 Adams Rite® MS & DL3000	611	626
134 1-3/4"	A04 DL4000 Deadlock	612	629
	A05 Adams Rite® 4070	613	630
	A06 ² Schlage® L9000	613E	722
	A07 DL4100 Series Deadlock	618	BSP
	A62 Straight	619	
	A92 Exit Grip 01, 02		
	A93 ¹ For Obsolete Corbin® 610 Series and Russwin® 1403 Series Deadlock		
Cylinder Number		Price	
CR1037-114		\$301.00	

- Notes: 1. Add \$2.00 per cylinder for A93 cam.
2. Add \$5.00 per cylinder for A06 cam.

IC Rim

7-Pin - No Cross Keying - Furnished standard with 422F88 surface mount collar unless otherwise indicated.

Cylinder Number Example

CR3037 - 178 - 626

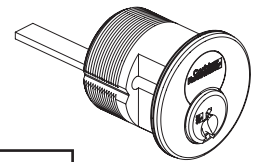

Tailpiece Length	Finish	
058 - 5/8"	605	622
114 - 1-1/4" M61 & M62 option for ED8200 and ED9200 exit device alarms	606	625
178 - 1-7/8"	611	626
	612	629
	613	630
178V - 1-7/8" vertical	613E	722
318 - 3-1/8"	618	BSP
	619	

Cylinder Number	Price
CR3037-_____	\$301.00

Pyramid Core Only

Cylinder Number	Price
CR8027	\$181.00

Note: For mortise and rim housing only, see page 95.

Standard Mortise

Cylinder Number Example

To simplify ordering, options designated "standard" may be omitted from the ordering sequence.



CR1000 - 118 - A01 - 6 - L4



Length	Cam	Pins	Keyway
100 1" (5-pin only)	A01 Cloverleaf (standard)	5	L4
118 1-1/8" (standard)	A02 Straight	6 (standard)	(standard)
114 1-1/4"	A03 Adams Rite® MS	7	
138 1-3/8"	A04 DL4000 Deadlock		
112 1-1/2"	A05 Adams Rite 4070		
134 1-3/4"	A06 ² Schlage® L9000		
200 2"	A07 DL4100 Series Deadlock		
	A62 Straight		
214 2-1/4"	A92 Exit Grip O1, O2		
212 2-1/2"	A93 ¹ For Obsolete		
234 2-3/4"	Corbin® 610 Series and Russwin®		
300 3"	1403 Series Deadlock		
314 3-1/4"			
312 3-1/2"			
334 3-3/4"			

Cylinder Number	Finish: 605, 606, 611, 612, 613, 613E, 618, 619, 622, 625, 626, 629, 630, 722, BSP, WSP	
	5- OR 6-PIN	7-PIN
CR1000-100-__-5- Keyway	\$120.00	Not Available
CR1000-118-__- Keyway		
CR1000-114-__- Keyway	\$120.00	\$122.00
CR1000-138-__- Keyway		
CR1000-112-__- Keyway	\$130.00	\$132.00
CR1000-134-__- Keyway		
CR1000-200-__- Keyway	\$140.00	\$142.00
CR1000-214-__- Keyway		
CR1000-212-__- Keyway	\$150.00	Not Available
CR1000-234-__- Keyway		
CR1000-300-__- Keyway	\$150.00	Not Available
CR1000-314-__- Keyway		
CR1000-312-__- Keyway		
CR1000-334-__- Keyway		

- Notes:
 1. Add \$2.00 per cylinder for A93 cam.
 2. Add \$5.00 per cylinder for A06 cam.

Flexible Head Mortise

Cylinder Number Example

To simplify ordering, options designated "standard" may be omitted from the ordering sequence.

CR1100 - 118 - A01 - 6 - L4



Length	Cam	Pins	Keyway
100 1" (6-pin standard)	A01 Cloverleaf (standard)	5	L4
118 1-1/8"	A02 Straight	6 (standard)	(standard)
114 1-1/4"		7	

Cylinder Number	Finish: 605, 606, 611, 612, 613, 613E, 618, 619, 622, 625, 626, 722, BSP, WSP	
	5- OR 6-PIN	7-PIN
CR1100-100-__ - __ - Keyway	\$228.00	Not Available
CR1100-118-__ - __ - Keyway		\$230.00
CR1100-114-__ - __ - Keyway	\$230.00	\$232.00

Concealed Shell Mortise

Cylinder Number Example

To simplify ordering, options designated "standard" may be omitted from the ordering sequence.

CR1200 - 118 - A01 - 6 - L4



Length	Cam	Pins	Keyways
100 1" (5-pin standard)	A01 Cloverleaf (standard)	5	L4
118 1-1/8" (6-pin standard)	A02 Straight	6 (standard)	(standard)
114 1-1/4"		7	
138 1-3/8"			
112 1-1/2"			

Cylinder Number	Finish: 606, 626	
	5- OR 6-PIN	7-PIN
CR1200-100-__ - 5 - Keyway	\$181.00	N/A
CR1200-118-__ - __ - Keyway		
CR1200-114-__ - __ - Keyway		
CR1200-138-__ - __ - Keyway		
CR1200-112-__ - __ - Keyway		\$183.00

Special Function Mortise

Hotel Function* Cylinders

To simplify ordering, you may specify only the first 4 digits (1001, 1101, 1201).

Cylinder Number	Description	605, 606, 611, 612, 613, 613E, 618, 619, 622, 625, 626, 629, 630, 722, BSP, WSP
CR1001-114-A01	Standard	\$177.00
CR1101-118-A01	Flex Head	\$205.00
CR1201-118-A01	Concealed Shell	\$190.00

* Not available with D1, D2, L1, L2, 752, 852 or A class keyways.

Cylinder for Discontinued Exit Device

Inside of Corbin® 3726-1/2, 3727-1/2 and Russwin® 736-1/2, 737-1/2

Cylinder Number	605, 606, 611, 612, 613, 613E, 618, 619, 622, 625, 626, 629, 630, 722, BSP, WSP
CR1006-118-A02	\$148.00

Non-Keyed Mortise

Thumbturn Cylinders

Cylinder Number	Description	605, 606, 611, 612, 613, 613E, 618, 619, 622, 625, 626, 629, 630, 722, BSP, WSP
CR1300-100-A02	Standard*	\$120.00
CR1300-118-A02		
CR1300-114-A02	Standard*	\$124.00
CR1300-138-A02		
CR1300-100-A03	Standard*	\$120.00
CR1300-118-A03		
CR1300-114-A03	Standard*	\$124.00
CR1300-138-A03		
CR1300-118-A93	Standard*	\$122.00
CR1303-100-A03	Classroom*	
CR1303-118-A03		
CR1303-114-A03	Classroom*	\$126.00
CR1303-138-A03		

Dummy Cylinders

Cylinder Number	605, 606, 611, 612, 613, 613E, 618, 619, 625, 626, 629, 630, 722, BSP, WSP
CR1400-118	\$103.00
CR1400-114	\$107.00
CR1400-138	\$111.00

Rim Thumbturn Cylinders

Cylinder Number	605, 606, 611, 612, 613, 613E, 618, 619, 625, 626, 629, 630, 722, BSP, WSP
CR3300 -138	\$111.00
CR3300-138-M34	\$131.00
CR3300-200	\$111.00
CR3300-200-M34	\$131.00

* All CR1300 and CR1303 are available with M34 Ergonomic Thumbturn.

Rim (.552 dia. Plug)

Cylinder Number Example

To simplify ordering, options designated "standard" may be omitted from the ordering sequence.

CR3000 - 200 - 6 - L4

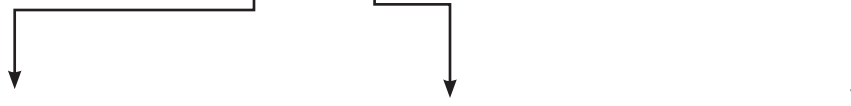
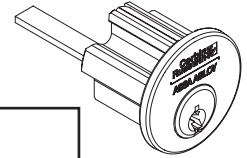

Tailpiece Length		Pins	Keyway
058	5/8"	5	L4 (Standard)
138	1-3/8" M61 & M62 option for ED8200 and obsolete ED9200 Exit Device Alarms	6 (Standard)	
		7	
200	2" (Standard)		
200N	2" ED4000/ED5000 Night Latch Function		
200V	2" Vertical		
312	3-1/2" (Thick door)		
312	3-1/2" (Thick door) Vertical		

Cylinder No.	605, 606, 611, 612, 613, 613E, 618, 619, 622, 625, 626, 629, 630, 722, BSP, WSP	
	5- OR 6-PIN	7-PIN
CR3000-058 __ - Keyway	\$120.00	\$122.00
CR3000-138 __ - Keyway		
CR3000-200- __ - Keyway		
CR3000-200N- __ - Keyway		
CR3000-200V- __ - Keyway		
CR3000-312- __ - Keyway	\$122.00	\$124.00
CR3000-312V- __ - Keyway		

Key-In-Lever/Knob (.509" plug)

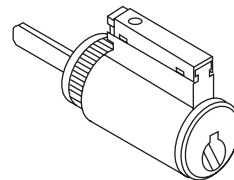

Cylinder Number		Finish: 606, 626, BSP		
		Series	6-PIN	7-PIN ⁴
CR2000-031	Standard	CL3100, CK4300	\$111.00	\$113.00
CR2001-031 ¹	Hotel	CL3100	\$127.00	\$129.00
CR2400-031-C ²	Schlage® C Keyway	CL3100	\$111.00	Not Available
CR2400-031-LA ³	Sargent® LA Keyway	CL3100		
CR2000-033	Standard	CL3300, CL3500, CL3600, CL3800 ^B		
CR2000-034	Standard	CLX3300		\$113.00
CR2000-038	Standard	CL3800 ^A		
CR2001-034 ¹	Hotel	CL3300, CLX3300		\$127.00
CR2400-033-C ^{2,5}	Schlage® C keyway	CL3300, CL3500, CL3600, CL3800 ^B	\$111.00	Not Available
CR2400-033-LA ^{3,5}	Sargent® LA keyway			
CR2000-037	Standard	CL3700, CK4700		
CR2400-037-C ^{2,5}	Schlage® C keyway			
CR2400-037-LA ⁵	Sargent® LA keyway			
CR2000-039	Standard	CL3900		
CR2000-039L	2" to 2-1/4" Door			
CR2400-039-C ^{2,5}	Schlage® C keyway			
CR2400-039-LA ^{3,5}	Sargent® LA keyway			
CR2000-034	Standard	CL3400, CL3600, CLX3300 (Prior to June 2000)	\$111.00	\$113.00
CR2001-034 ¹	Hotel		\$127.00	\$129.00
CR2400-034-C ^{2,5}	Schlage® C keyway		\$111.00	Not Available
CR2400-034-LA ^{3,5}	Sargent® LA keyway			

Notes:

1. Not available in 752, 852 or A Class keyways.
 2. Available 0-bitted & keyed random only.
 3. Available 0-bitted only.
 4. For 7-pin version suffix "-7" to number. Not available in 752, 852 or A Class keyways.
 5. Available in 606 or 626 finish only.
- A. CL3800 manf. 1993-1997
B. CL3800 manf. 2006 -

Cylindrical Deadlocks DL2200, DL3200 Series

Cylinder Number		Door Thickness	Function	Finish: 606, 626, BSP Price
CR4400-134-A51	6-Pin Conventional	All	11, 13, 17	\$111.00
CR4400-134-A52	6-Pin Conventional	1-3/8" to 1-3/4"	12	
CR4400-214-A52	6-Pin Conventional	2" to 2-1/4"	12	
CR4400-134-A51-7	7-Pin Conventional	All	11, 13, 17	\$113.00
CR4400-134-A52-7	7-Pin Conventional	1-3/8" to 1-3/4"	12	
CR4400-214-A52-7	7-Pin Conventional	2" to 2-1/4"	12	

Key-In-Lever/Knob

For UT5200 & CK4200 Series Locksets (.552" dia plug)

Cylinder Number	Description	Finish: 606, 626, BSP
CR2000-052	Standard	\$111.00
CR2001-052*	Hotel with Indicator	\$127.00
CR2100-052**	Discontinued Ronde & Continental Knob	\$127.00

For CK4400 Series Locksets (.509" dia plug)

Cylinder Number	Description	Finish: 606, 626, BSP
CR2000-044	All except below	\$111.00
CR2003-044	CK4455 & CK4482 before 8/93	
CR2001-044*	CK4429 with Indicator Pin New Style Straight Tailpiece	\$127.00
CR2001-066*	CK4429 with Indicator Pin Old Style Twisted Tailpiece	

For G10 Exit Device Knob Trim

Cylinder Number	Description	Finish: 606, 626, BSP
CR2000-033H	Standard	\$111.00

* Not available with 752, 852 or A Class keyways.

** Also available in 605, 611, 612, 613, 625 finishes. Not available with X Class keyways.

For PL5000 Series Rekeyable Fixed Core Padlocks

Cylinder Number	Description	Finish: 606, 626, BSP
CR2300PL	Standard 6-pin	\$111.00

For B2, G2, G3 Exit Device Trim

Cylinder Number	Description	Finish: 606, 626, BSP
CR2000-051	Standard 6-pin	\$111.00

Key-In-Lever/Knob (.552 dia Plug)

For Other Manufacturers' Products

Cylinder Number	Description	Finish: 606, 626, BSP
CR2200-001-A21	Alarm Lock DL2500 Series	\$115.00
	Arrow® H Series Knobs and Levers	
	Arrow Q Series Levers	
	Sargent® 10 line*	
	Schlage® D Series Levers	
CR2200-001-A22	Schlage AL and ND Series Levers	
CR2200-002-A21	Schlage D Series Knobs	
CR2200-002-A23	Schlage A Series Knobs (ORB only)	
CR2200-002-A22	Schlage A Series Knobs (PLY, etc.)	
CR2200-003-A24	Lockwood® H Series Knobs (Enlarge Knob Hole)	
CR2200-008	Sargent 7, 8, 9 Line (Enlarge Knob Hole)	
CR2200-054	Yale® 5400, 6200 Knobs Only (Enlarge Knob Hole)	
CR2200-076	Sargent 7600 Integrallock	\$121.00

* When ordered with a 30- prefix, this cylinder is accepted without modification to the lever.

For Adams Rite® 4025 Pull (.552" dia. Plug)

Cylinder Number	Description	Finish: 606, 626, BSP
CR4200-003-A47	Cylinder & Housing	\$189.00
CR4200-002-A47	Cylinder Only	\$111.00

LFlC Cores are provided in 606, 626, or BSP finish only.

IC Mortise

For Construction Core Program, see page 32.
For housing only, see page 62-63.

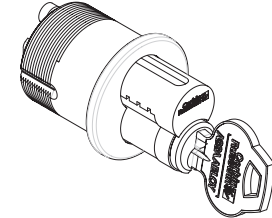

Cylinder Number Example

To simplify ordering, options designated "standard" may be omitted from the ordering sequence.

CR1080 - 114 - A01 - 6 - L4

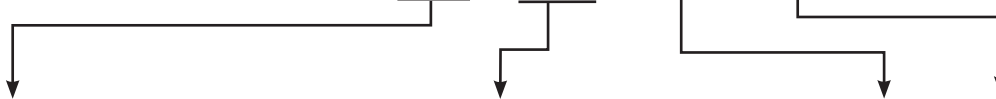

Length	Cam	Pins	Keyway
114 1-1/4" (6-pin standard)	A01 Cloverleaf (standard)	6 (standard)	L4 (standard)
138 1-3/8"	A02 Straight	7**	
112 1-1/2"	A03 Adams Rite® MS & DL300		
134 1-3/4"	A04 DL4000 Deadlock		
200 2"	A05 Adams Rite 4070		
214 2-1/4"	A06 ² Schlage® L9000		
212 2-1/2"	A07 DL4100 Series Deadlock		
234 2-3/4"	A62 Straight		
	A92 Exit Group 01, 02		
	A93 ¹ For obsolete Corbin® 610 Series and Russwin® 1403 Series Deadlocks		

Cylinder Number	605, 606, 611, 612, 613, 613E, 618, 619, 622, 625, 626, 629, 630, 722, BSP, WSP	
	6- PIN	7-PIN
CR1080-114-	\$224.00	Not Available
CR1080-138-	\$227.00	Not Available
CR1080-112-__-	\$227.00	\$231.00
CR1080-134-__-	\$235.00	\$239.00
CR1080-200-	\$235.00	\$239.00
CR1080-214-	\$241.00	\$245.00
CR1080-212-	\$247.00	\$251.00
CR1080-234-	\$251.00	\$255.00

Notes:

- 1. Add \$2.00 per cylinder for A93 Cam.
- 2. Add \$5.00 per cylinder for A06 Cam.

Hotel Function IC Mortise

To simplify ordering, options designated "standard" may be omitted from the ordering sequence.

Cylinder Number	605, 606, 611, 612, 613, 613E, 618, 619, 622, 625, 626, 629, 630, 722, BSP, WSP	
	6-PIN	7-PIN
CR1081-138-A01-6** (Hotel function uses E1-suffix EMK blank)	\$240.00	Not Available

- ** Not available with 752, 852 or A Class keyways.
- ** Only available in 1-1/2" and 1-3/4" length.

*LFIC Cores are provided in 606 or 626 finish only.

IC Rim

For Construction Core Program, see page 32.
For housing only, see page 62-63.

Cylinder Number Example

To simplify ordering, options designated "standard" may be omitted from the ordering sequence.

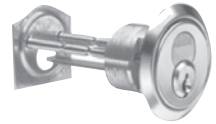

CR3080 - 178 - 6 - L4



Tailpiece Length		Pins	Keyway
058	5/8" Tailpiece	6 Pin (standard) 7 Pin	L4 (standard)
178	1-7/8" (standard)		
178V	1-7/8" Vertical		
318	3-1/8" (Thick door)		
114	1-1/4" M61 & M62 option for ED8200 and obsolete ED9200 exit device alarms		

Cylinder Number	605, 606, 611, 612, 613, 613E, 618, 619, 622, 625, 626, 629, 630, 722, BSP, WSP	
	6 PIN	7 PIN
CR3080-058-	\$224.00	\$228.00
CR3080-178-__		
CR3080-178V-__		
CR3080-318-__	\$226.00	\$230.00
CR3080-114-__ (no back plate or screw)	\$226.00	\$230.00

Core Only



Cylinder Number (specify keyway)		Finish: 626, 606, BSP
CR8000	6-Pin Standard	\$104.00
CR8000EMK*	6-Pin Standard set to hotel mortise EMK	
CR8000-7	7-Pin	\$106.00
CR8001-034*	6-Pin for CL3329, hotel indicator pin	\$120.00
CR8001-034-7*	7-Pin for CL3329, hotel indicator pin	\$122.00
CR8001-042*	6-Pin for CK4229, hotel indicator pin	\$120.00

* Not available with 752, 852 or A Class keyways.

Note: For uncombined cores suffix "UC". See page 48 for deduct.

*SFIC Cores are provided in 606 or 626 finish only.

SFIC Mortise

For Construction Core Program, see page 32.
For housing only, see page 62-63.

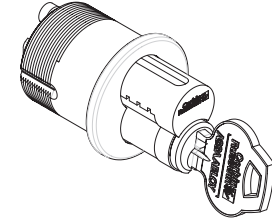

Cylinder Number Example

To simplify ordering, options designated "standard" may be omitted from the ordering sequence.

CR1050 - 114 - A01 - 6 - A

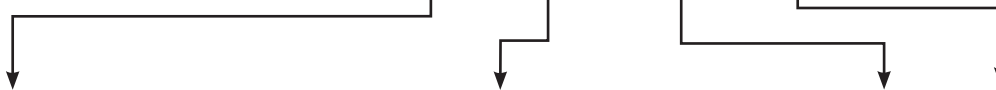

Length	Cam		Pins	Keyway
114 1-1/4" (6-pin standard)	A01	Cloverleaf (standard)	6 (standard)	A, B, C, D, E, F, G, H, J, K, L, M
138 1-3/8"	A02	Straight	7**	
112 1-1/2"	A03	Adams Rite® MS & DL300		
134 1-3/4"	A04	DL4000 Deadlock		
	A05	Adams Rite 4070		
	A06 ²	Schlage® L9000		
	A07	DL4100 Series Deadlock		
	A62	Straight		
	A92	Exit Group 01, 02		
	A93 ¹	For obsolete Corbin® 610 Series and Russwin® 1403 Series Deadlocks		
Cylinder Number		605, 606, 611, 612, 613, 613E, 618, 619, 622, 625, 626, 629, 630, 722, BSP, WSP		
		6- PIN	7-PIN	
CR1050-114-		\$213.00	Not Available	
CR1050-138-		\$216.00	\$218.00	
CR1050-112-		\$216.00	\$218.00	
CR1050-134-		\$224.00	\$226.00	

- Notes:
1. Add \$2.00 per cylinder for A93 Cam.
2. Add \$5.00 per cylinder for A06 Cam.

*SFIC Cores are provided in 606 or 626 finish only.

SFIC Rim

For Construction Core Program, see page 32.
For housing only, see page 62-63.

Cylinder Number Example

To simplify ordering, options designated "standard" may be omitted from the ordering sequence.

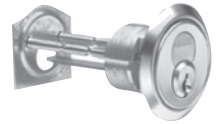

CR3050 - 178 - 6 - A

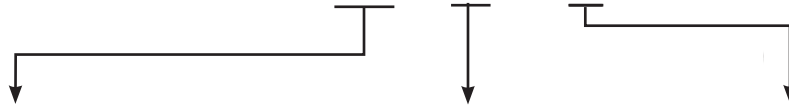

Tailpiece Length		Pins	Keyway
058	5/8" Tailpiece	6 Pin (standard) 7 Pin	A, B, C, D, E, F, G, H, J, K, L, M
178	1-7/8" (standard)		
318	3-1/8" (Thick door)		

Cylinder Number	605, 606, 611, 612, 613, 613E, 618, 619, 622, 625, 626, 629, 630, 722, BSP, WSP	
	6 PIN	7 PIN
CR3050-058-	\$213.00	\$215.00
CR3050-178-	\$213.00	\$215.00
CR3050-318-	\$215.00	\$217.00

SFIC Core Only



Cylinder Number (specify keyway)		Finish: 626, 606
CR8200	6-Pin Standard	\$93.00
CR8200-7	7-Pin	

Note: For uncombined cores suffix "UC". See page 33 for deduct.

LFIC Mortise Housing Only

Housing Number Example

To simplify ordering, options designated "standard" may be omitted from the ordering sequence.

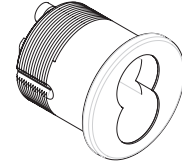

CR1070 - 114 - A01 - 6

Length	Cam		Pins
114 1-1/4" (6-pin standard)	A01	Cloverleaf (standard)	6 (standard)
138 1-3/8"	A02	Straight	7
112 1-1/2"	A03	Adams Rite® MS	
134 1-3/4"	A04	DL4000 Deadlock	
214 2-1/4"	A05	Adams Rite® 4070	
	A06 ²	Schlage® L9000	
	A07	DL4100 Series Deadlock	
	A62	Straight	
	A92	Exit Group 01, 02	
	A93 ¹	For obsolete Corbin® 610 Series and Russwin® 1403 Series Deadlocks	

Cylinder Number	605, 606, 611, 612, 613, 613E, 618, 619, 622, 625, 626, 629, 630, 722, BSP, WSP	
	6 PIN	7 PIN
CR1070-114-	\$120.00	Not Available
CR1070-138-	\$123.00	
CR1070-112-__-	\$123.00	\$125.00
CR1070-134-__-	\$131.00	\$133.00
CR1070-214-	\$137.00	Not Available
CR1071-138-A01 (Hotel function uses -E1 suffix EMK blank)	\$136.00	

Notes:

To simplify ordering, you may specify only "1071" since no length or cam variations exists.

1. Add \$2.00 per cylinder for A93 Cam.
2. Add \$5.00 per cylinder for A06 Cam.

LFIC Rim Housing Only

CR3070 - 058 - 626

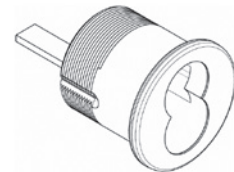

Cylinder Number	605, 606, 611, 612, 613, 613E, 618, 619, 622, 625, 626, 629, 630, 722, BSP, WSP	
	6 PIN	7 PIN
CR3070-058- 5/8" tailpiece	\$120.00	\$122.00
CR3070-178-__ 1-7/8" tailpiece (standard)		
CR3070-178V-__ 1-7/8" vertical		
CR3070-318-__ 3-1/8" tailpiece (thick door)	\$122.00	\$124.00
CR3070-114-__ 1-1/4" tailpiece for M61, M62 exit alarm options. No back plate or screws.		

SFIC Mortise Housing Only

Cylinder Number Example

CR1040 - 114 - A01 - 6



Length	Cam	Pins
114 1-1/4" (6-pin standard)	A01 Cloverleaf (standard)	6 (standard)
	A02 Straight	
	A03 Adams Rite® MS	
	A04 DL4000 Series Deadlock	
	A05 Adams Rite 4070	
	A06 Schlage® L9000	
	A07 DL4100 Series	
	A62 MR Straight	
	A93 Obsolete Deadlocks Corbin® 610 Series and Russwin® 1403 Series	
138 1-3/8" (7-pin standard) 112 1-1/2" (7-pin standard) 134 1-3/4" (7-pin standard)	A01 Cloverleaf (standard)	7
	A02 Straight	
	A03 Adams Rite® MS	
	A04 DL4000 Series Deadlock	
	A05 Adams Rite 4070	
	A06 Schlage® L9000	
	A07 DL4100 Series	
	A62 MR Straight	
	A93 Obsolete Deadlocks Corbin® 610 Series and Russwin® 1403 Series	

Cylinder Number	605, 606, 611, 612, 613, 613E, 618, 619, 622, 625, 626, 629, 630, 722, BSP, WSP	
	6 PIN	7 PIN
CR1040-114-__-	\$120.00	Not Available
CR1040-138-__-	\$123.00	\$125.00
CR1040-112-__-	\$123.00	\$125.00
CR1040-134-__-	\$131.00	\$133.00

SFIC Rim Housing Only

CR3040 - 058 - 626

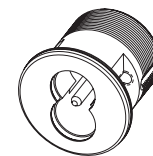

Cylinder Number		605, 606, 611, 612, 613, 613E, 618, 619, 622, 625, 626, 629, 630, 722, BSP, WSP	
		6 PIN	7 PIN
CR3040-058-	5/8" tailpiece	\$120.00	\$122.00
CR3040-178-__	1-7/8" tailpiece	\$120.00	\$122.00
CR3040-318-__	3-1/8" tailpiece	\$122.00	\$124.00

Standard Security Mortise

For Existing Systems Only.*
For uncombined cylinders, suffix "UC".
See page 33 for deduct.

6-Pin Only - No Cross Keying - Available in Z and DH Class Keyways only.
Available UC or master keyed only.
Not available KR or 0-bitted.

* L4, D1 and 60 keyway sections may be ordered Keyed Random only, without prior Key Systems Administration approval

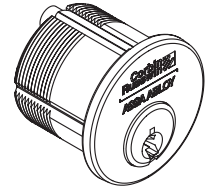

Cylinder Number Example

To simplify ordering, options designated "standard" may be omitted from the ordering sequence.

CR1010 - 118 - A01 - L4

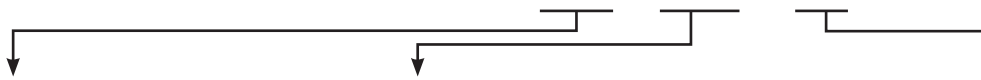

Length		Cam		Keyway
118	1-1/8" (standard)	A01	Cloverleaf (standard)	L4 (standard) Available only with Z and DH Class keyways.
114	1-1/4"	A02	Straight	
138	1-3/8"	A03	Adams Rite® MS & DL3000	
112	1-1/2"	A04	DL4000 Deadlock	
134	1-3/4"	A05	Adams Rite 4070	
200	2"	A06 ²	Schlage® L9000	
214	2-1/4"	A07	DL4100 Series Deadlock	
		A62	Straight	
		A92	Exit Grip 01, 02	
212	2-1/2"	A93 ¹	For obsolete Corbin® 610 Series and Russwin® 1403 Series Deadlocks	
234	2-3/4"			

Cylinder Number	605, 606, 611, 612, 613, 613E, 618, 619, 622, 625, 626, 629, 630, 722, BSP, WSP
CR1010-118-__	\$278.00
CR1010-114-__	
CR1010-138-__	\$286.00
CR1010-112-__	\$308.00
CR1010-134-__	\$318.00
CR1010-200-__	\$324.00
CR1010-214-__	\$330.00
CR1010-212-__	\$338.00
CR1010-234-__	\$342.00

- Notes:
1. Add \$2.00 per cylinder for A93 Cam.
 2. Add \$5.00 per cylinder for A06 Cam.

Special Function Security Mortise

For Existing Systems Only.*
 6-Pin Only - No Cross Keying - Available in Z and DH Class Keyways only.
 Available UC or master keyed only.
 Not available KR or 0-bitted.
 * L4, D1 and 60 keyway sections may be ordered Keyed Random only, without prior Key Systems Administration approval

Hotel Function Cylinders

Cylinder Number	Description	605, 606, 611, 612, 613, 613E, 618, 619, 622, 625, 626, 629, 630, 722, BSP, WSP
CR1011-114-A01	1-1/4" Cloverleaf cam only	\$298.00

To simplify ordering, you may specify only "1011" since no length or cam variations exist.
 For uncombined cylinders, suffix "UC". See page 33 for deduct.
 Not available in D1, D2, L1 or L2 keyways.

Security Rim

For Existing Systems Only.*

6-Pin Only - No Cross Keying - Available in Z and DH Class Keyways Only.
Available UC or master keyed only. Not available KR or 0-bitted.

* L4, D1 and 60 keyway sections may be ordered Keyed Random only, without prior Key Systems Administration approval

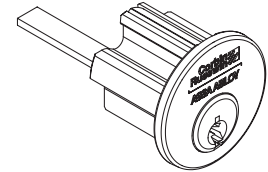

Cylinder Number Example

To simplify ordering, options designated "standard" may be omitted from the ordering sequence.

CR3010 - 200 - L4

Function	Tailpiece Length	Keyway
For 3010 Only:	For 3010 Only:	L4 (standard) Available only with Z and DH Class keyways.
0 (standard)	200 2" (standard)	
	200V 2" vertical	
	312 3-1/2" (thick door)	
	312V 3-1/2" (thick door) vertical	
	058 5/8" Tailpiece	
	138 1-3/8" M61 and M62 option for ED8200 and obsolete ED9200 exit device alarms	
	For 3012 Only:	
	178 1-7/8" (standard)	
	178V 1-7/8" vertical	
	318 3-1/8" (thick door)	
	318V 3-1/8" (thick door) vertical	

Cylinder Number	605, 606, 611, 612, 613, 613E, 618, 619, 622, 625, 626, 629, 630, 722, BSP, WSP
CR3010-058-__	\$278.00
CR3010-200-__	
CR3010-200V-__	
CR3010-312-__	\$280.00
CR3010-312V-__	
CR3010-138-__ No back plate or screws	\$278.00
CR3012-178-__	\$286.00
CR3012-178V-__	
CR3012-318-__	\$288.00
CR3012-318V-__	

Security Key-In-Lever/Knob

For Existing Systems Only.*
6-Pin Only - No Cross Keying - Available in Z and DH Class Keyways Only.
Available UC or master keyed only. Not available KR or 0-bitted.

* L4, D1 and 60 keyway sections may be ordered Keyed Random only, without prior Key Systems Administration approval

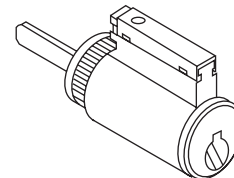

For Key-In-Lever/Knob Trim (.552" plug)

Cylinder Number	Series	Finish: 606, 626, BSP
CR2010-031	CL3100, CK4300	\$265.00
CR2010-033	CL3300, CL3500, CL3800 ^o , [CL3600 (June 2000 and after)]	
CR2010-034	CL3400, [CL3600 (prior to June 2000)], CLX3300	
CR2010-038	CL3800 ^A	
CR2010-039	CL3900	
CR2010-039L	CL3900 (2 - 2-1/4" door)	
CR2010-052	CK4200, UT5200	
CR2011-042	CK4229 Hotel Function*	\$281.00
CR2010-051	B2, G2 Exit Device Knob Trim	\$265.00
CR4410-134-A51	DL2200, DL3200 Cylindrical Deadlock	\$265.00
CR4410-134-A52	DL2200, DL3200 Cylindrical Deadlock	\$265.00
CR4410-214-A52	DL2200, DL3200 Cylindrical Deadlock	\$265.00

For uncombined cylinders suffix "UC" - See page 48 for deduct.

*Not available with 752, 852, or A Class Keyways.

Notes: A CL3800 manf. 1993-1997
B CL3800 manf. 2006 -

For Other Manufacturers' Products (.552" plug)

Cylinder Number	Series	Finish: 606, 626, BSP
2210-001-A21	Alarm Lock DL2500 Series	\$269.00
	Arrow® H Series Knobs and Levers	
	Arrow Q Series Levers	
	Sargent® 10 line*	
	Schlage® D Series Levers	
2210-001-A22	Schlage AL and ND Series Levers	
2210-002-A21	Schlage D Series Knobs	
2210-002-A23	Schlage A Series Knobs (ORB, only)	
2210-002-A22	Schlage A Series Knobs (PLY, ect)	
2210-003-A24	Lockwood® H Series Knobs (enlarge knob hole)	
2210-008	Sargent 7, 8, 9 Line (enlarge knob hole)	
2210-054	Yale® 5400, 6200 Knobs only (enlarge knob hole)	

* When ordered with a 30- prefix, this cylinder is accepted without modification to the lever.

*LFIC Cores are provided in 606 or 626 finish only.

IC Mortise

For Existing Systems Only.*
For Construction Core Program, see page 32. For housing only, see page 62-63.

6-Pin Only - No Cross Keying - Available in Z and DH Class Keyways Only.
Available UC or master keyed only. Not available KR or 0-bitted.

* L4, D1 and 60 keyway sections may be ordered Keyed Random only, without prior Key Systems Administration approval

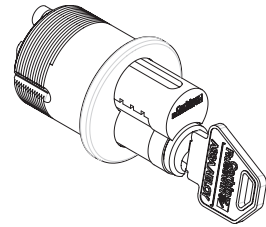

Cylinder Number Example

To simplify ordering, options designated "standard" may be omitted from the ordering sequence.

CR1090 - 114 - A01- L4

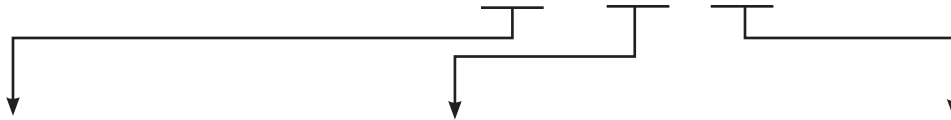

Length	Cam	Keyway
114 1-1/4" (standard)	A01 Cloverleaf (standard)	L4 (standard) Available only with Z and DH Class keyways.
138 1-3/8"	A02 Straight	
112 1-3/8"	A03 Adams Rite® MS & DL3000	
134 1-3/4"	A04 DL4000 Deadlock	
	A05 Adams Rite 4070	
	A06 ² Schlage® L9000	
	A07 DL4100 Series Deadlock	
	A62 Straight	
	A92 Exit Grip 01, 02	
	A93 ¹ For obsolete Corbin® 610 Series and Russwin® 1403 Series Deadlocks	

Cylinder Number	605, 606, 611, 612, 613, 613E, 618, 619, 622, 625, 626, 629, 630, 722, BSP, WSP
CR1090-114-	\$378.00
CR1090-138-	\$381.00
CR1090-112-	\$389.00
CR1090-134-	

- Notes:
1. Add \$2.00 per cylinder for A93 Cam.
2. Add \$5.00 per cylinder for A06 Cam.

Hotel Function IC Mortise

Cylinder Number	605, 606, 611, 612, 613, 613E, 618, 619, 622, 625, 626, 629, 630, 722, BSP, WSP
CR1091-138-A01 Hotel function uses - E1 suffix EMK blank	\$394.00

To simplify ordering, you may specify only "1091" since no length or cam variations exist.

*LFIC Cores are provided in 606 or 626 finish only.

IC Rim

For Existing Systems Only.*
 For Construction Core Program, see page 32.
 For housing only, see page 62-63.
 6-Pin Only - No Cross Keying - Available in Z and DH Class Keyways Only. Available UC or master keyed only. Not available 0-bitted.
 * L4, D1 and 60 keyway sections may be ordered Keyed Random only, without prior Key Systems Administration approval

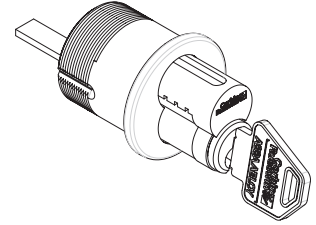

Cylinder Number Example

To simplify ordering, options designated "standard" may be omitted from the ordering sequence.

CR3090 - 178 - L4



Tailpiece Length		Keyway
058	5/8" Tailpiece	L4 (standard). Available only with Z and DH Class keyways.
178	1-7/8" (standard)	
178V	1-7/8" (standard) vertical	
318	3-1/8" (thick door)	
114	1-1/4" for M61 and M62 option alarmed exit devices	

Cylinder Number	605, 606, 611, 612, 613, 613E, 618, 619, 622, 625, 626, 629, 630, 722, BSP, WSP
CR3090-058	\$378.00
CR3090-178	
CR3090-178V	
CR3090-318	
CR3090-114 No back plate or screws	

Security Core Only

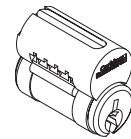

Cylinder Number	606, 626, BSP
CR8010 6-pin standard	\$258.00
CR8010EMK 6-pin standard set to hotel mortise EMK	
CR8011-042 6-pin for CK4229, hotel indicator pin	

For uncombined cores, suffix "UC," see page 33 for deduct.

Standard Master Ring Mortise

Cylinder Number Example

To simplify ordering, options designated "standard" may be omitted from the ordering sequence.

CR1060 - 118 - A61 - 6 - L4

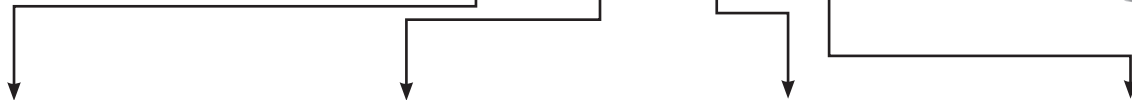

Length	Cam	Pins	Keyway
100 1" (5-pin only)	A61 New Cloverleaf (standard) (for locks made after 5/93; requires thumbturn hub 562F41-2)	5	L4 (standard)
118 1-1/8" (std)	A62 Straight	6 (standard)	
114 1-1/4"	A63* Large Short	7 (optional for 1-3/8" only)	
138 1-3/8"	A64* Large Long		
134 1-3/4"	A65* Old Cloverleaf (formerly 11A)		
112 1-1/2"			
200 2"			
214 2-1/4"			
212 2-1/2"			
234 2-3/4"			
300 3"			

Cylinder Number	605, 606, 611, 612, 613, 613E, 618, 619, 622, 625, 626, 722, BSP, WSP
CR1060-100-__-5	\$187.00
CR1060-118-__-__	
CR1060-114-__-__	
CR1060-138-__-__	\$197.00
CR1060-112-__-__	
CR1060-134-__-__	
CR1060-200-__-__	\$207.00
CR1060-214-__-__	
CR1060-212-__-__	
CR1060-234-__-__	\$207.00
CR1060-300-__-__	

*Add \$2.00 per cylinder for A63, A64 and A65 Cam.

Flexible Head Master Ring Mortise

Cylinder Number Example

To simplify ordering, options designated "standard" may be omitted from the ordering sequence.

CR1160 - 118 - A61 - 6 - L4

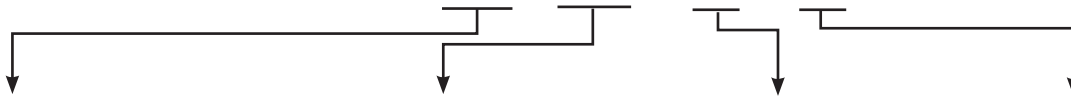

Length	Cam	Pins	Keyway
100 1" (6-pin std)	A61 New Cloverleaf (standard) (for locks made after 5/93; requires thumbturn hub 562F41-2)	5	L4 (standard)
118 1-1/8"		6 (standard)	
114 1-1/4"			
	A62 Straight		
	A63* Large Short		
	A64* Large Long		
	A65* Old Cloverleaf (formerly 11A)		

Cylinder Number	605, 606, 611, 612, 613, 613E, 618, 619, 622, 625, 626, 722, BSP, WSP
CR1160-100-__-__	\$230.00
CR1160-118-__-__	
CR1160-114-__-__	

* Add \$2.00 per cylinder for A63, A64 or A65 Cam.

Dummy Master Ring Mortise Cylinders

Cylinder Number	605, 606, 611, 612, 613, 613E, 618, 619, 622, 625, 626, 722, BSP, WSP
CR1460-118	\$177.00
CR1460-114	
CR1460-138	
CR1460-112	

Master Ring Rim

Cylinder Number (Specify Keyway)	F605, 606, 611, 612, 613, 613E, 618, 619, 622, 625, 626, 722, BSP, WSP
CR3060-200 Standard horizontal tailpiece	\$187.00
CR3060-312 Thick door, horizontal tailpiece	
CR3060-200V Vertical tailpiece	
CR3060-312V Thick door, vertical tailpiece	

For CK4200 & UT5200 Series Locksets (.552" dia. plug)

Cylinder Number	Finish: 606, 626, BSP
CR2060-052 Standard	\$156.00
CR2061-042* CK4229 Hotel with indicator pin	\$186.00
CR2160-052** Discontinued Ronde and Continental Knob	\$168.00

* Not Available with 752, 852 or A Class keyways.
 ** Also Available in 605, 611, 612, 613, 625 finishes.
 Not Available with X Class and certain restricted keyways.

Master Ring Special Applications For Exit Device Operators (.552" plug)

Cylinder Number	Finish: 606, 626, BSP
CR4266-001-A02 ED6800 x B5 or B6 trim ED7400 x 03 or 04 trim	\$172.00
CR4266-001-A92 ED6800 x 01 or 02 trim	

Pin Kits

Description	Catalog Number	Part Number	Price
Corbin Russwin System 70 and Pre-System 70, 752, 852 and A Class keyways Not for System 70 Security	PK-1070	610F538	\$1,269.00
Corbin® Z Class and Russwin® DH Class keyways System 70, all cylinders except Security	PK-70-ZDH	602F129	\$846.00
Russwin N Class System, all cylinders	PK-70-N	602F119	\$661.00
Corbin X Class, all cylinders	PK-70-X	602F109	\$646.00
Pyramid High Security cylinders	PK-20-HS	694F968	\$1,741.00
Pyramid Security cylinders	PK-20-PS	715F968	\$1,287.00
Security cylinders, including interchangeable core, blockout and Brink	PK-70-HS	610F529	\$2,401.00
Access 3 Key System AP only	PK-30-AP	763F088	\$1,238.00
Access 3 Key System - AP, AS, AHS	PK-30-MASTER	763F098	\$1,803.00

Tools

Description	Catalog Number	Part Number	Price
Tool kit - contains 1 each: CT-4, CT-11, CT-19, CT-21, CT-22, CT-23, CT-54	CT-93	612F588	\$353.00
Plug follower, .509" brass	CT-4	073F992	\$40.00
Pin chamber reamer	CT-5	239F758	\$114.00
Pin chamber burring tool	CT-7	382F188	\$302.00
Loading tool for .509" shell	CT-10	577F499	\$114.00
Key gauge, all Corbin® key classes	CT-11	239F377	\$40.00
Tweezers (was CT-6)	CT-19	239F368	\$48.00
Plug follower, .496	CT-20	694F972	\$14 (order in mult. of 10)
Key gauge, Pyramid	CT-20K	698F367	\$40.00
Key gauge, Access 3	CT-30K		
Key gauge, Russwin® N	CT-21	603F277	
Key gauge, Russwin® D & H	CT-22	604F197	
Key gauge, Russwin® 981/852	CT-23	604F187	
Plug follower, .552" brass	CT-54	073F982	\$49.00
IC mortise cylinder installation wrench	CT-80	363F612	\$70.00
Follower, disposable, .509" plug		484F729	\$1.00 (order in mult. Of 50)
Follower, disposable, .552" plug		484F739	\$0.50 (order in mult. Of 100)

Blank Page

ML2000 Series:

MicroShield®	76
ML2000 Series	77

ML2000 Museo Series:

ML2000 Series: Museo Georgia, Jackson, Salvador, Marc Levers, Inspire Trim	78
ML2000 Series: Museo Georgia, Jackson, Laszlo, Salvador, Marc, Josef Levers, Roses & Thumbturns	79
ML2000 Series: Museo Josef, Georges Levers, Roses & Thumbturns	80
ML2000 Series: Museo Piet Levers, Roses & Thumbturns	81
ML2000 Series: Museo Piet Levers, Roses & Thumbturns	82
ML2000 Series: Museo Georgia, Jackson, Laszlo, Salvador, Marc, Josef Levers & Escutcheons	83
ML2000 Series: Museo Josef, Georges Levers & Escutcheons	84
ML2000 Series: Museo Piet Levers & Escutcheons	85
ML2000 Series: Museo Piet Levers & Escutcheons	86

ML2000 Series:

ML2000 Series: LWA, RWA, LWN, LWM, LWP, LWR, LWVN	87
ML2000 Series: LSA, LSN, LSM, LSP, LSR, LSVN	88
ML2000 Series: ASA, CSA, NSA, PSA, RSA, NSM, NSN, NSP, NSR, NSVN	89
ML2000 Series: DSA, ESA, DSM, DSN, DSP, DSR, DSVN	90
ML2000 Series: GZA, GZB, GZF, GZH, YZA, YZB, YZF, YZH, GZM, GZP, GZR, GZVN	91
ML2000 Series Vineyard Collection: FSG, MSG, ZSG, FSL, MSL, ZSL, FSVN, MSVN, ZSVN	92
ML2000 Series: Deadbolts: M, N, P, L, R, VN	91
Vandal Resistant Trim: CSV, NSV	93

ML20900 Museo Series:

ML20900 Series: Museo Georgia, Jackson, Salvador, Marc Levers & Roses	95
ML20900 Series: Museo Georgia, Jackson, Salvador, Laszlo, Marc, Josef Levers, Escutcheons, Roses and Thumbturns	96
ML20900 Series: Museo Piet Levers, Escutcheons, Roses and Thumbturns	97
ML20900 Series: Museo Piet Levers, Escutcheons, Roses and Thumbturns	98
ML20900 Series: Museo Josef, Georges Levers, Escutcheons, Roses and Thumbturns	99

ML20900 Series:

ML20900 Series: LWA, RWA, LWM, LWN, LWR, ASA, CSA, LSA, NSA, PSA, RSA, NSM, NSN, NSR	100
ML20900 Series: DSA, ESA, DSM, DSN, DSR, CSV, NSV	101
ML20900 Series Vineyard Collection: FSG, MSG, ZSG, FSL, MSL, ZSL	102
ML20900 Series: GZA, GZB, GZF, GZH, YZA, YZB, YZF, YZH, GZM, GZP, GZR	103

ML20600 NAC Museo Series:

ML20600 NAC Series: Museo Georgia, Jackson, Salvador, Marc Levers with High Security Monitoring	104
ML20600 NAC Series: Museo Georgia, Jackson, Salvador, Laszlo, Marc, Josef Levers & Roses with High Security Monitoring	105
ML20600 NAC Series: Museo Piet Levers & Roses with High Security Monitoring	106
ML20600 NAC Series: Museo Piet Levers & Roses with High Security Monitoring	107
ML20600 NAC Series: Museo Josef, Georges Levers & Roses	108

ML20600 NAC Series:

ML20600 Series NAC: LWA, RWA, LWM, LWN, LWR, LWVN, ASA, CSA, LSA, NSA, PSA, RSA, NSM, NSN, NSR, NSVN	109
ML20600 Series NAC: DSA, ESA, DSM, DSN, DSR, DSVN, CSV, NSV	110
ML20600 Series NAC: Electrified Mortise with High Security Options: FSG, MSG, ZSG, FSL, MSL, ZSL, FSVN, MSVN, ZSVN	111

ML2000/20900 Series:

ML20600 NAC Series Lever Designs	112
ML2000 & ML20900 Series Ordering Options	113
ML2000 & ML20900 Series Cylinder & Keying Options	114
ML2000 & ML20900 Series Cylinder & Keying Options (Continued), ML2000/20900 Strike Options	115
ML2000 & ML20900 Series Door Thickness with Locksets Mortised on Center, Panel Applications	116
ML2000 & ML20900 Series Miscellaneous Options, Thumbturn Options	117
ML2000 & ML20900 Series Indicator Options, Sectional Trim Retrofit Kits for V Series Indicators, Ordering Examples	118

MicroShield®

Look for the *MicroShield* icon.

MicroShield®

As part of their promise to provide innovative solutions to their customers, certain ASSA ABLOY Group brands offer the MicroShield® technology, a silver-based antimicrobial coating designed to inhibit the growth of bacteria.

MicroShield® is a registered trademark of ASSA ABLOY Access and Egress Hardware Group, Inc.

Product	Series	MicroShield® Coated Components
Mortise Locks	ML2000 Series	Knobs/Levers, roses and/or escutcheons

AVAILABLE FINISHES

- MicroShield® is available on 626 and 630. Other finishes available by Special Product Application Request Form only.
- Specify 626C (satin chrome plated) or 630C (satin stainless steel) when ordering.
- MicroShield® coating will be applied over 626 and 630 finishes. All components will match 626.

Note: MicroShield® coating will only be applied to "high touch" components.

HOW TO ORDER

Product	How to Order
Mortise Locks	ML2055 x LWA x 626C x RHR

Description	Add
Mortise Locks	Add \$90.00

**Standard Features
Handing**

Field reversible

Door Thickness

1-3/4"

Backset

2-3/4"

Warranty

10 Years

Strike

ANSI straight lip
4-7/8" x 1-1/4" x 1-1/8" lip to center

Cylinder

Brass, 6-pin, L4 keyway, 0-bitted

Keys

Two nickel silver keys

Case Quantity

6

Case Weight

Variable

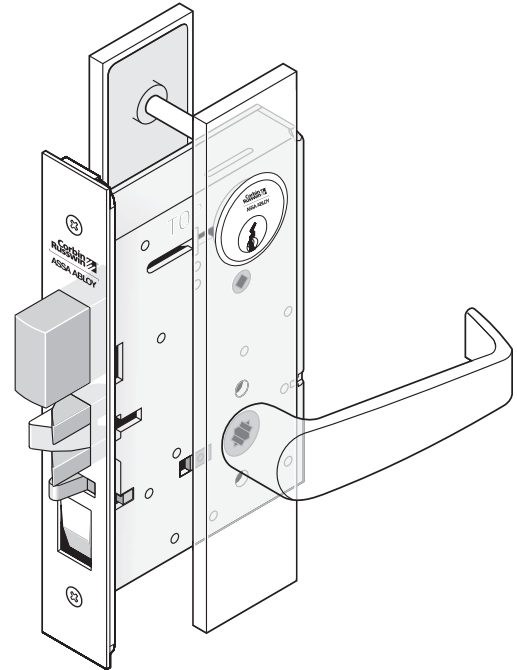

Please refer to the ML2000 Series catalog for more information.

Ordering Example:

Stock Order

Quantity	Series/Function	Trim	Finish	Hand
100	ML2055	LSB	626	RHR

Split Trim/Split Finish

Quantity	Series/Function	Trim		Finish		Hand
		Outside	Inside	Outside	Inside	
12	ML2055	LSB	NSB	626	625	RHR

Split trim is not available mixing escutcheon with sectional trim or with a different escutcheon

Contract/Detailed Order

Quantity	Keypad	Series/Function	Trim	Finish	Hand	Strike	Misc. Options	Cylinder and Keying
24	AA1	ML2055	LSB	626	RHR	SA200	M17-M26	C7-VKC3

Working Trim Only

Quantity	Function only	Trim	Finish	Hand	Door Thickness	Misc. Options
6	ML2055	LWA	626	RHR	D214	M31

(includes grip and spindle, rose or escutcheon, thumbturn, adapters and screws)

High Security Monitoring Option Order

Quantity	Series/Function	Technology Code	Trim	Finish	Hand	Fail Safe/ Fail Secure	High Security Monitoring Options
24	ML20608	NAC	ASA	626	RHR	SEC	PHRR01

Mortise Locksets

ML2000 Series: Muséo Levers and Inspire™ Roseless Trim

USA & Canada Prices Effective April 17, 2023

contemporary trim to complement the interior design of your next project

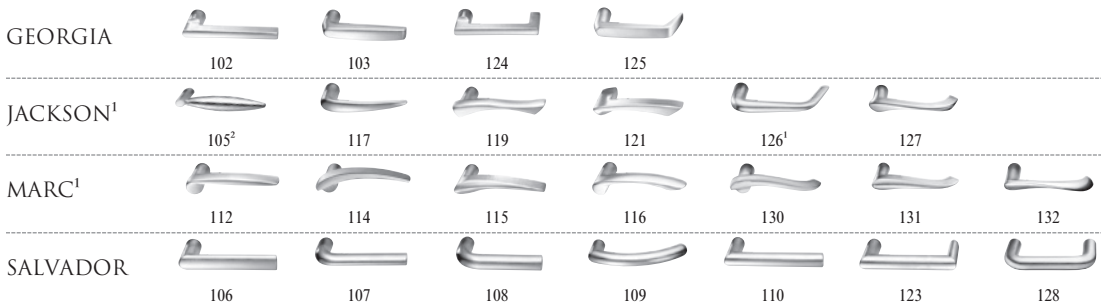

J Collar

¹Handed: specify hand when ordering.
²Contact factory for current lead time.

*629 and *630 finish options are Not available for all Muséo levers. Please refer to page 26 for availability.

613E	Dark Oxidized Satin Bronze - Equivalent	605	Bright Brass, Clear Coated	618	Bright Nickel Plated
626	Satin Chromium Plated	606	Satin Brass, Clear Coated	619	Satin Nickel Plated
BSP	Black Suede Powder Coat	611	Bright Bronze, Clear Coated	625	Bright Chromium Plated
WSP	White Suede Powder Coat	612	Satin Bronze, Clear Coated	629*	Bright Stainless Steel
		613	Dark Oxidized Satin Bronze, Oil Rubbed	630*	Satin Stainless Steel
		613L	Dark Oxidized Satin Bronze, Clear Coated	722	Black Oxidized Bronze, Oil Rubbed

Function

Function	Model	Description	Price	Price
Non-Keyed	ML2010	Passage	\$1,252.00	\$1,276.00
	ML2020	Privacy	\$1,489.00	\$1,513.00
	ML2030	Privacy	\$1,375.00	\$1,399.00
	ML2050	Half Dummy	\$510.00	\$522.00
	ML2070	Full Dummy	\$1,020.00	\$1,044.00
	ML2080	Half Active Dummy Trim	\$790.00	\$802.00
	ML2090	Full Active Dummy Trim	\$1,300.00	\$1,324.00
	Single Cylinder	ML2003	Classroom	\$1,549.00
ML2051		Office		
ML2055		Classroom		
ML2056		Classroom Holdback		
ML2057		Storeroom	\$1,569.00	\$1,593.00
ML2069		Institution Privacy		
ML2004		Classroom		
ML2053		Entrance		
Single Cylinder with Deadbolt	ML2054	Entrance	\$1,609.00	\$1,633.00
	ML2058	Entrance Holdback		
	ML2068	Privacy or Classroom		
	ML2024	Entrance		
	ML2048	Entrance	\$1,682.00	\$1,706.00
	ML2049	Storeroom Deadbolt		
	ML2059	Security Storeroom		
	ML2065	Dormitory		
Double Cylinder	ML2067	Apartment	\$1,669.00	\$1,693.00
	ML2073	Classroom Security		
	ML2075	Entrance/Office		
	ML2087	Security Vestibule		
	ML2029	Hotel		
Double Cylinder with Deadbolt	ML2002	Classroom Intruder	\$1,729.00	\$1,753.00
	ML2032	Institution		
	ML2042	Entrance		
	ML2052	Classroom Intruder		
	ML2082	Dormitory		
ML2092	Security Institution			
Full Working Trim (Quick Code M31) No cylinder; includes thumbturn lever			\$1,073.00	\$1,097.00

Ordering Example Details

ML2000	ML2051	Office Function
Sectional Trim	102	Georgia Family Lever
(rose)	J	Collar
	625	Finish
	RHR	Handing



Stock Order

Quantity	Series/Function	Trim	Finish	Hand
24	ML2051	102J	625	RHR



Experience a safer and more open world

Mortise Locksets

ML2000 Series: Muséo Levers, Roses and Thumbturns

USA & Canada Prices Effective April 17, 2023

contemporary levers to complement the interior design of your next project

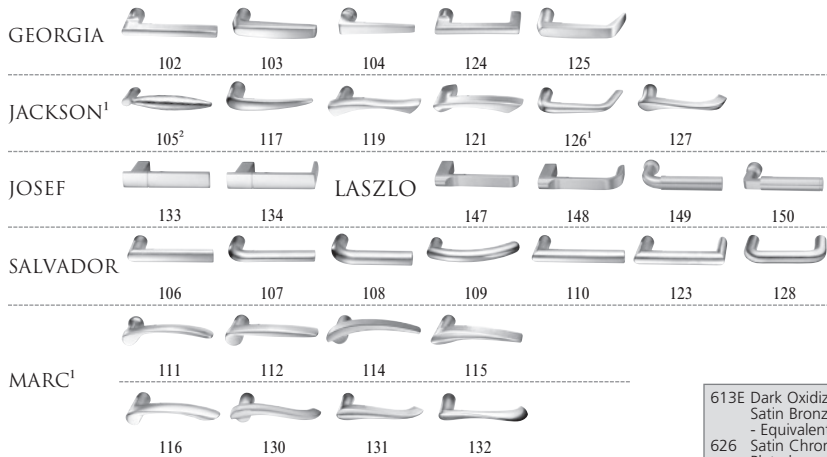

ROSES

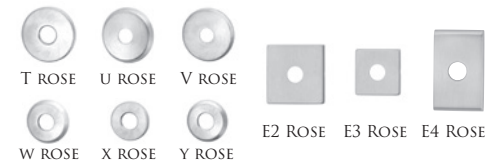

THUMBTURNS³



1. Handed: specify hand when ordering
2. Contact factory for current lead time
3. Specify thumbturn as quick code. Thumbturn backplate will match shape of rose chosen (i.e. round or square)

*629 and *630 finish options are Not available for all Muséo levers. Please refer to page 26 for availability.

613E Dark Oxidized Satin Bronze - Equivalent	605 Bright Brass, Clear Coated	618 Bright Nickel Plated
626 Satin Chromium Plated	606 Satin Brass, Clear Coated	619 Satin Nickel Plated
BSP Black Suede Powder Coat	611 Bright Bronze, Clear Coated	625 Bright Chromium Plated
WSP White Suede Powder Coat	612 Satin Bronze, Clear Coated	629* Bright Stainless Steel
	613 Dark Oxidized Satin Bronze, Oil Rubbed	630* Satin Stainless Steel
	613L Dark Oxidized Satin Bronze, Clear Coated	722 Black Oxidized Bronze, Oil Rubbed

Function

Function	Model	Description	Price (USA)	Price (Canada)		
Non-Keyed	ML2010	Passage	\$1,191.00	\$1,215.00		
	ML2020	Privacy	\$1,309.00	\$1,333.00		
	ML2030					
	ML2040	Passage w/Indicator – VXX Option on Page 116 Applies	\$1,277.00	\$1,301.00		
	ML2060	Privacy				
	ML2050	Half Dummy	\$488.00	\$500.00		
	ML2070	Full Dummy	\$976.00	\$1,000.00		
	ML2080	Half Active Dummy Trim	\$679.00	\$691.00		
ML2090	Full Active Dummy Trim	\$1,160.00	\$1,184.00			
Single Cylinder	ML2003	Classroom	\$1,369.00	\$1,393.00		
	ML2051	Office				
	ML2055	Classroom				
	ML2056	Classroom Holdback				
	ML2057	Storeroom				
	ML2069	Institution Privacy				
	ML2004	Classroom			\$1,389.00	\$1,413.00
	ML2053	Entrance				
ML2054	Entrance					
ML2058	Entrance Holdback					
ML2068	Privacy or Classroom					
Single Cylinder with Deadbolt	ML2024	Entrance	\$1,429.00	\$1,453.00		
	ML2048	Entrance				
	ML2049	Storeroom Deadbolt				
	ML2059	Security Storeroom				
	ML2065	Dormitory				
	ML2067	Apartment				
	ML2073	Classroom Security				
	ML2075	Entrance/Office				
ML2029	Hotel	\$1,472.00	\$1,496.00			
Double Cylinder	ML2002	Classroom Intruder	\$1,489.00	\$1,513.00		
	ML2032	Institution				
	ML2042	Entrance				
	ML2052	Classroom Intruder				
	ML2087	Security Vestibule				
Double Cylinder with Deadbolt	ML2022	Store Door	\$1,549.00	\$1,573.00		
	ML2062	Intruder Deadbolt				
	ML2072	Classroom Security Intruder				
	ML2082	Dormitory				
	ML2092	Security Institution				
Full Working Trim (Quick Code M31) No cylinder; includes thumbturn lever			\$1,002.00	\$1,026.00		

Ordering Example Details

ML2000	ML2051	Office Function
Sectional Trim	111	Marc Family Lever
(rose)	W	Rose
	625	Finish
	RHR	Handing

Stock Order

Quantity	Series/Function	Trim	Finish	Hand
24	ML2051	111W	625	RHR



Experience a safer and more open world

Copyright © 2002-2023 Corbin Russwin, Inc., an ASSA ABLOY Group company. All rights reserved. Reproduction in whole or in part without the express written permission of Corbin Russwin, Inc., is prohibited. Contact us at: 800-543-3658 or visit www.corbinrusswin.com. In Canada contact us at: 800-461-3007 or visit www.assaabloydss.ca

Mortise Locksets

ML2000 Series: Muséo Levers, Roses and Thumbturns

USA & Canada Prices Effective April 17, 2023

contemporary levers to complement the interior design of your next project

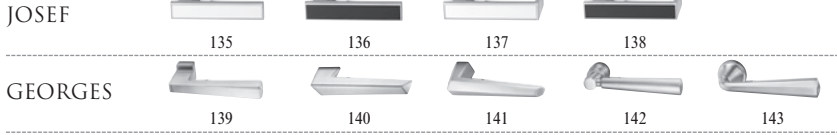

ROSES

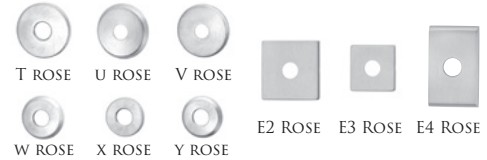

THUMBTURNS³



1. Handed: specify hand when ordering
2. Contact factory for current lead time
3. Specify thumbturn as quick code. Thumbturn backplate will match shape of rose chosen (i.e. round or square)

Function

613E	Dark Oxidized Satin Bronze - Equivalent	605	Bright Brass, Clear Coated	618	Bright Nickel Plated
626	Satin Chromium Plated	606	Satin Brass, Clear Coated	619	Satin Nickel Plated
BSP	Black Suede Powder Coat	611	Bright Bronze, Clear Coated	625	Bright Chromium Plated
WSP	White Suede Powder Coat	612	Satin Bronze, Clear Coated	629	Bright Stainless Steel
		613	Dark Oxidized Satin Bronze, Oil Rubbed	630	Satin Stainless Steel
		613L	Dark Oxidized Satin Bronze, Clear Coated	722	Black Oxidized Bronze, Oil Rubbed

Function	Model	Description	Price	Price
Non-Keyed	ML2010	Passage	\$1,496.00	\$1,520.00
	ML2020	Privacy	\$1,564.00	\$1,588.00
	ML2030			
	ML2040	Passage w/Indicator – VXX Option on Page 116 Applies	\$1,532.00	\$1,556.00
	ML2060	Privacy		
	ML2050	Half Dummy	\$583.00	\$595.00
	ML2070	Full Dummy	\$1,166.00	\$1,190.00
	ML2080	Half Active Dummy Trim	\$907.00	\$919.00
ML2090	Full Active Dummy Trim	\$1,490.00	\$1,514.00	
Single Cylinder	ML2003	Classroom		
	ML2051	Office		
	ML2055	Classroom	\$1,624.00	\$1,648.00
	ML2056	Classroom Holdback		
	ML2057	Storeroom		
	ML2069	Institution Privacy		
	ML2004	Classroom		
	ML2053	Entrance		
Single Cylinder with Deadbolt	ML2054	Entrance	\$1,644.00	\$1,668.00
	ML2058	Entrance Holdback		
	ML2068	Privacy or Classroom		
	ML2024	Entrance		
	ML2048	Entrance		
	ML2049	Storeroom Deadbolt		
	ML2059	Security Storeroom	\$1,684.00	\$1,708.00
	ML2065	Dormitory		
Double Cylinder	ML2067	Apartment		
	ML2073	Classroom Security		
	ML2075	Entrance/Office		
	ML2029	Hotel	\$1,728.00	\$1,752.00
	ML2002	Classroom Intruder		
	ML2032	Institution		
	ML2042	Entrance	\$1,744.00	\$1,768.00
	ML2052	Classroom Intruder		
Double Cylinder with Deadbolt	ML2087	Security Vestibule		
	ML2022	Store Door		
	ML2062	Intruder Deadbolt		
	ML2072	Classroom Security Intruder	\$1,804.00	\$1,828.00
	ML2082	Dormitory		
ML2092	Security Institution			
Full Working Trim (Quick Code M31) No cylinder; includes thumbturn lever			\$1,201.00	\$1,225.00

Ordering Example Details

ML2000	ML2051	Office Function
Sectional Trim (rose)	135	Josef Family Lever
	E4	Rose
	625	Finish
	RHR	Handing



Stock Order

Quantity	Series/Function	Trim	Finish	Hand
24	ML2051	135E4	625	RHR



Experience a safer and more open world

Mortise Locksets

ML2000 Series: Muséo Levers, Roses and Thumbturns

USA & Canada Prices Effective April 17, 2023



contemporary trim to complement the interior design of your next project



*613E, BSP, WSP finishes are not available with 21M levers

ROSES

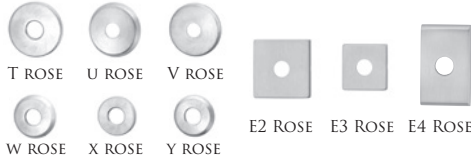

THUMBTURN



Specify thumbturn as quick code. Thumbturn backplate will match shape of rose chosen (i.e. round or square).

613E	Dark Oxidized Satin Bronze – Equivalent
629	Bright Stainless Steel
630	Satin Stainless Steel
BSP	Black Suede Powder Coat
WSP	White Suede Powder Coat

Function

Function	Model	Description	Price
Non-Keyed	ML2010	Passage	\$1,408.00
	ML2020	Privacy	\$1,477.00
	ML2030		
	ML2040	Passage w/Indicator – VXX Option on Page 116 Applies	\$1,443.00
	ML2060	Privacy	
	ML2050	Half Dummy	\$548.00
	ML2070	Full Dummy	\$1,096.00
	ML2080	Half Active Dummy Trim	\$855.00
ML2090	Full Active Dummy Trim	\$1,403.00	
Single Cylinder	ML2003	Classroom	\$1,537.00
	ML2051	Office	
	ML2055	Classroom	
	ML2056	Classroom Holdback	
	ML2057	Storeroom	\$1,557.00
	ML2069	Institution Privacy	
	ML2004	Classroom	
	ML2053	Entrance	
ML2054	Entrance	\$1,557.00	
ML2058	Entrance Holdback		
ML2068	Privacy or Classroom		
Single Cylinder with Deadbolt	ML2024	Entrance	\$1,597.00
	ML2048	Entrance	
	ML2049	Storeroom Deadbolt	
	ML2059	Security Storeroom	
	ML2065	Dormitory	
	ML2067	Apartment	
	ML2073	Classroom Security	
	ML2075	Entrance/Office	
ML2029	Hotel	\$1,640.00	
Double Cylinder	ML2002	Classroom Intruder	\$1,657.00
	ML2032	Institution	
	ML2042	Entrance	
	ML2052	Classroom Intruder	
	ML2087	Security Vestibule	
Double Cylinder with Deadbolt	ML2022	Store Door	\$1,717.00
	ML2062	Intruder Deadbolt	
	ML2072	Classroom Security Intruder	
	ML2082	Dormitory	
	ML2092	Security Institution	
Full Working Trim (Quick Code M31) No cylinder; includes thumbturn lever			\$1,130.00

Ordering Example Details

ML2000 Sectional Trim (rose)	Model	Description
ML2051	21M	Office Function Piet Family Lever - Polished with Satin Insert
	V	Rose
293029		Lever Finish
		Polished with satin stainless steel insert (630), polished stainless steel (629) shank and polished stainless steel (629) grip
629		Lock Finish
RHR		Handing

Stock Order

Quantity	Series/Function	Trim	Lever Finish	Lock Finish	Hand
2	ML2051	21MV	293029	629	RHR



ASSA ABLOY



Experience a safer and more open world

Mortise Locksets

ML2000 Series: Muséo Levers, Roses and Thumbturns

USA & Canada Prices Effective April 17, 2023

contemporary levers to complement the interior design of your next project



PIET

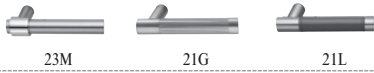

ROSES

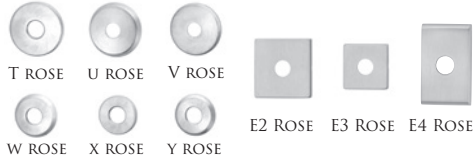

THUMBTURNS



Specify thumbturn as quick code. Thumbturn backplate will match shape of rose chosen (i.e. round or square)

613E	Dark Oxidized Satin Bronze – Equivalent
629	Bright Stainless Steel
630	Satin Stainless Steel
BSP	Black Suede Powder Coat
WSP	White Suede Powder Coat

Function

Function	Model	Description	Price
Non-Keyed	ML2010	Passage	\$1,520.00
	ML2020	Privacy	\$1,588.00
	ML2030		
	ML2040	Passage w/Indicator – VXX Option on Page 116 Applies	\$1,556.00
	ML2060	Privacy	
	ML2050	Half Dummy	\$595.00
	ML2070	Full Dummy	\$1,190.00
	ML2080	Half Active Dummy Trim	\$919.00
ML2090	Full Active Dummy Trim	\$1,514.00	
Single Cylinder	ML2003	Classroom	\$1,648.00
	ML2051	Office	
	ML2055	Classroom	
	ML2056	Classroom Holdback	
	ML2057	Storeroom	\$1,668.00
	ML2069	Institution Privacy	
	ML2004	Classroom	
	ML2053	Entrance	
ML2054	Entrance	\$1,708.00	
ML2058	Entrance Holdback		
ML2068	Privacy or Classroom		
ML2024	Entrance		\$1,752.00
ML2048	Entrance		
ML2049	Storeroom Deadbolt		
ML2059	Security Storeroom		
ML2065	Dormitory		
ML2067	Apartment		
ML2073	Classroom Security		
ML2075	Entrance/Office		
ML2029	Hotel	\$1,768.00	
ML2002	Classroom Intruder		
ML2032	Institution		
ML2042	Entrance		
ML2052	Classroom Intruder		
ML2087	Security Vestibule	\$1,828.00	
ML2022	Store Door		
ML2062	Intruder Deadbolt		
ML2072	Classroom Security Intruder		
ML2082	Dormitory		
ML2092	Security Institution	\$1,225.00	
Full Working Trim (Quick Code M31) No cylinder; includes thumbturn lever			

Ordering Example Details

ML2000	ML2051	Office Function
Sectional Trim	23M	Piet Family Lever - Wood Insert
(rose)	U	Rose
	29BH29	Lever Finish, Wood insert with polished stainless steel (629) shank and polished stainless steel (629) grip
	629	Lock Finish
	RHR	Handing

Stock Order

Quantity	Series/Function	Trim	Lever Finish	Lock Finish	Hand
2	ML2051	23MU	29BH29	629	RHR



Experience a safer and more open world

Copyright © 2002-2023 Corbin Russwin, Inc., an ASSA ABLOY Group company. All rights reserved. Reproduction in whole or in part without the express written permission of Corbin Russwin, Inc., is prohibited. Contact us at: 800-543-3658 or visit www.corbinrusswin.com. In Canada contact us at: 800-461-3007 or visit www.assaabloydss.ca

Mortise Locksets

ML2000 Series: Muséo Levers and Escutcheons

USA & Canada Prices Effective April 17, 2023

contemporary levers to complement the interior design of your next project

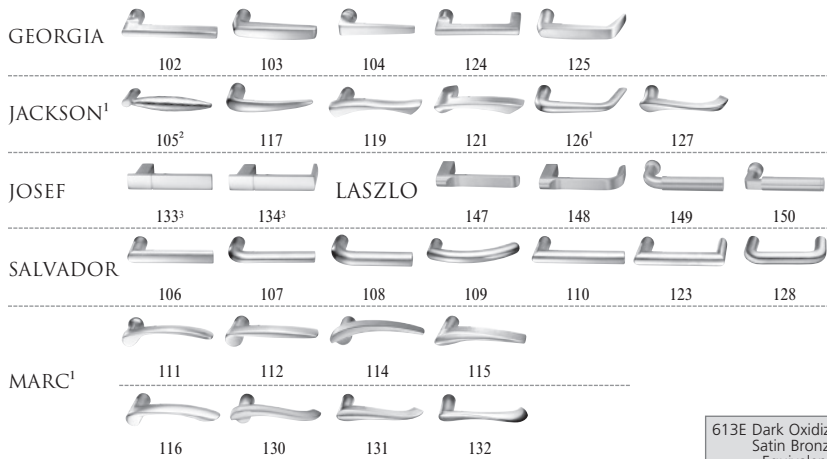

- 1. Handed: specify hand when ordering.
- 2. Contact factory for current lead time.
- 3. Not available with VN escutcheon.
- 4. VN escutcheon available only with indicators. Must be ordered with "V" indicator options. See page 116 for available functions. Option add also applies.

*629 and 630 finish options are Not available for all Muséo levers. Please refer to page 24 for availability.

613E	Dark Oxidized Satin Bronze - Equivalent	618	Bright Nickel Plated
626	Satin Chromium Plated	619	Satin Nickel Plated
BSP	Black Suede Powder Coat	625	Bright Chromium Plated
WSP	White Suede Powder Coat	629*	Bright Stainless Steel
605	Bright Brass, Clear Coated	630*	Satin Stainless Steel
606	Satin Brass, Clear Coated	722	Black Oxidized Bronze, Oil Rubbed
611	Bright Bronze, Clear Coated		
612	Satin Bronze, Clear Coated		
613	Dark Oxidized Satin Bronze, Oil Rubbed		
613L	Dark Oxidized Satin Bronze, Clear Coated		

Function

Function	Model	Description	Price (USA)	Price (Canada)		
Non-Keyed	ML2010	Passage	\$1,245.00	\$1,269.00		
	ML2020	Privacy	\$1,363.00	\$1,387.00		
	ML2030					
	ML2040	Passage w/Indicator – VXX Option on Page 116 Applies		\$1,331.00	\$1,355.00	
	ML2060	Privacy				
	ML2050	Half Dummy	\$515.00	\$527.00		
	ML2070	Full Dummy	\$1,030.00	\$1,054.00		
	ML2080	Half Active Dummy Trim	\$706.00	\$718.00		
ML2090	Full Active Dummy Trim	\$1,214.00	\$1,238.00			
Single Cylinder	ML2003	Classroom	\$1,423.00	\$1,447.00		
	ML2051	Office				
	ML2055	Classroom				
	ML2056	Classroom Holdback				
	ML2057	Storeroom				
	ML2069	Institution Privacy				
	ML2004	Classroom			\$1,443.00	\$1,467.00
	ML2053	Entrance				
ML2054	Entrance					
ML2058	Entrance Holdback					
ML2068	Privacy or Classroom					
Single Cylinder with Deadbolt	ML2024	Entrance	\$1,483.00	\$1,507.00		
	ML2048	Entrance				
	ML2049	Storeroom Deadbolt				
	ML2059	Security Storeroom				
	ML2065	Dormitory				
	ML2067	Apartment				
	ML2073	Classroom Security				
	ML2075	Entrance/Office				
ML2029	Hotel	\$1,526.00	\$1,550.00			
Double Cylinder	ML2002	Classroom Intruder	\$1,543.00	\$1,567.00		
	ML2032	Institution				
	ML2042	Entrance				
	ML2052	Classroom Intruder				
Double Cylinder with Deadbolt	ML2022	Store Door	\$1,603.00	\$1,627.00		
	ML2062	Intruder Deadbolt				
	ML2072	Classroom Security Intruder				
	ML2082	Dormitory				
ML2092	Security Institution					
Full Working Trim (Quick Code M31) No cylinder; includes thumbturn lever			\$1,056.00	\$1,080.00		

Ordering Example Details

ML2000	Office Function
Escutcheon Trim	Marc Family Lever
L	Escutcheon
619	Finish
RHR	Handing

Stock Order

Quantity	Series/Function	Trim	Finish	Hand
24	ML2051	111L	619	RHR



Experience a safer and more open world

Mortise Locksets

ML2000 Series: Muséo Levers and Escutcheons

USA & Canada Prices Effective April 17, 2023

contemporary levers to complement the interior design of your next project



JOSEF



135 136 137 138

GEORGES



139 140 141 142 143



L ESCUTCHEON



R ESCUTCHEON

1. Handed: specify hand when ordering.
2. Contact factory for current lead time.
3. Not available with escutcheon indicators.

613E Dark Oxidized Satin Bronze - Equivalent	605 Bright Brass, Clear Coated	618 Bright Nickel Plated
626 Satin Chromium Plated	606 Satin Brass, Clear Coated	619 Satin Nickel Plated
BSP Black Suede Powder Coat	611 Bright Bronze, Clear Coated	625 Bright Chromium Plated
WSP White Suede Powder Coat	612 Satin Bronze, Clear Coated	629 Bright Stainless Steel
	613 Dark Oxidized Satin Bronze, Oil Rubbed	630 Satin Stainless Steel
	613L Dark Oxidized Satin Bronze, Clear Coated	722 Black Oxidized Bronze, Oil Rubbed

Function

Model	Function	Price (L)	Price (R)
ML2010	Passage	\$1,569.00	\$1,593.00
ML2020	Privacy	\$1,637.00	\$1,661.00
ML2030	Privacy		
ML2040	Passage w/Indicator – VXX Option on Page 116 Applies	\$1,605.00	\$1,629.00
ML2060	Privacy		
ML2050	Half Dummy	\$620.00	\$632.00
ML2070	Full Dummy	\$1,239.00	\$1,263.00
ML2080	Half Active Dummy Trim	\$944.00	\$956.00
ML2090	Full Active Dummy Trim	\$1,563.00	\$1,587.00
ML2003	Classroom		
ML2051	Office		
ML2055	Classroom	\$1,697.00	\$1,721.00
ML2056	Classroom Holdback		
ML2057	Storeroom		
ML2069	Institution Privacy		
ML2004	Classroom		
ML2053	Entrance		
ML2054	Entrance	\$1,717.00	\$1,741.00
ML2058	Entrance Holdback		
ML2068	Privacy or Classroom		
ML2024	Entrance		
ML2048	Entrance		
ML2049	Storeroom Deadbolt		
ML2059	Security Storeroom	\$1,757.00	\$1,781.00
ML2065	Dormitory		
ML2067	Apartment		
ML2073	Classroom Security		
ML2075	Entrance/Office		
ML2029	Hotel	\$1,801.00	\$1,825.00
ML2002	Classroom Intruder		
ML2032	Institution	\$1,817.00	\$1,841.00
ML2042	Entrance		
ML2052	Classroom Intruder		
ML2022	Store Door		
ML2062	Intruder Deadbolt		
ML2072	Classroom Security Intruder	\$1,877.00	\$1,901.00
ML2082	Dormitory		
ML2092	Security Institution		
Full Working Trim (Quick Code M31) No cylinder; includes thumbturn lever		\$1,274.00	\$1,298.00



Ordering Example Details

ML2000 Escutcheon Trim

ML2051 Office Function
135 Josef Family Lever
L Escutcheon
619 Finish
RHR Handing

Stock Order

Quantity	Series/Function	Trim	Finish	Hand
24	ML2051	135L	619	RHR



ASSA ABLOY

Experience a safer and more open world

Mortise Locksets

ML2000 Series: Muséo Levers and Escutcheons

USA & Canada Prices Effective April 17, 2023

contemporary levers to complement the interior design of your next project



PIET

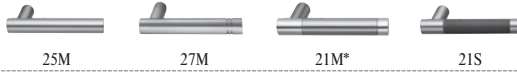

*613E, BSP, WSP finishes are not available with 21M levers.

- 1. VN escutcheon available only with indicators.
Must be ordered with "V" indicator options.
See page 116 for available functions.
Option add also applies.



613E	Dark Oxidized Satin Bronze – Equivalent
629	Bright Stainless Steel
630	Satin Stainless Steel
BSP	Black Suede Powder Coat
WSP	White Suede Powder Coat

Function

Non-Keypad	ML2010	Passage	\$1,481.00	
	ML2020	Privacy	\$1,550.00	
	ML2030			
	ML2040	Passage w/Indicator – VXX Option on Page 116 Applies	\$1,516.00	
	ML2060	Privacy		
	ML2050	Half Dummy	\$585.00	
	ML2070	Full Dummy	\$1,169.00	
	ML2080	Half Active Dummy Trim	\$892.00	
ML2090	Full Active Dummy Trim	\$1,476.00		
Single Cylinder	ML2003	Classroom	\$1,610.00	
	ML2051	Office		
	ML2055	Classroom		
	ML2056	Classroom Holdback		
	ML2057	Storeroom		
	ML2069	Institution Privacy		
	ML2004	Classroom		\$1,630.00
	ML2053	Entrance		
ML2054	Entrance			
ML2058	Entrance Holdback			
ML2068	Privacy or Classroom			
Single Cylinder with Deadbolt	ML2024	Entrance	\$1,670.00	
	ML2048	Entrance		
	ML2049	Storeroom Deadbolt		
	ML2059	Security Storeroom		
	ML2065	Dormitory		
	ML2067	Apartment		
	ML2073	Classroom Security		
	ML2075	Entrance/Office		
ML2029	Hotel	\$1,713.00		
Double Cylinder	ML2002	Classroom Intruder	\$1,730.00	
	ML2032	Institution		
	ML2042	Entrance		
	ML2052	Classroom Intruder		
Double Cylinder with Deadbolt	ML2022	Store Door	\$1,790.00	
	ML2062	Intruder Deadbolt		
	ML2072	Classroom Security Intruder		
	ML2082	Dormitory		
ML2092	Security Institution			
Full Working Trim (Quick Code M31) No cylinder; includes thumbturn lever			\$1,203.00	



Ordering Example Details

ML2000
Escutcheon
Trim

ML2051 Office Function
21M Piet Family Lever - Polished with Satin Insert
L Escutcheon
293029 Lever Finish
Polished with satin stainless steel insert (630),
polished stainless steel (629) shank and
polished stainless steel (629) grip
629 Lock Finish
RHR Handing

Stock Order

Quantity	Series/Function	Trim	Lever Finish	Lock Finish	Hand
2	ML2051	21ML	293029	629	RHR



ASSA ABLOY

Experience a safer
and more open world

Mortise Locksets

ML2000 Series: Muséo Levers and Escutcheons

USA & Canada Prices Effective April 17, 2023

contemporary levers to complement the interior design of your next project



PIET



1. VN escutcheon available only with indicators.
Must be ordered with "V" indicator options.
See page 116 for available functions.
Option add also applies.

613E	Dark Oxidized Satin Bronze – Equivalent
629	Bright Stainless Steel
630	Satin Stainless Steel
BSP	Black Suede Powder Coat
WSP	White Suede Powder Coat

Function

Function	Model	Description	Price	
Non-Keyed	ML2010	Passage	\$1,593.00	
	ML2020	Privacy	\$1,661.00	
	ML2030			
	ML2040	Passage w/Indicator – VXX Option on Page 116 Applies	\$1,629.00	
	ML2060	Privacy		
	ML2050	Half Dummy	\$632.00	
	ML2070	Full Dummy	\$1,263.00	
	ML2080	Half Active Dummy Trim	\$956.00	
ML2090	Full Active Dummy Trim	\$1,587.00		
Single Cylinder	ML2003	Classroom	\$1,721.00	
	ML2051	Office		
	ML2055	Classroom		
	ML2056	Classroom Holdback		
	ML2057	Storeroom		
	ML2069	Institution Privacy		
	ML2004	Classroom		\$1,741.00
	ML2053	Entrance		
	ML2054	Entrance		
ML2058	Entrance Holdback			
ML2068	Privacy or Classroom			
Single Cylinder with Deadbolt	ML2024	Entrance	\$1,781.00	
	ML2048	Entrance		
	ML2049	Storeroom Deadbolt		
	ML2059	Security Storeroom		
	ML2065	Dormitory		
	ML2067	Apartment		
	ML2073	Classroom Security		
	ML2075	Entrance/Office		
ML2029	Hotel	\$1,825.00		
Double Cylinder	ML2002	Classroom Intruder	\$1,841.00	
	ML2032	Institution		
	ML2042	Entrance		
	ML2052	Classroom Intruder		
Double Cylinder with Deadbolt	ML2022	Store Door	\$1,901.00	
	ML2062	Intruder Deadbolt		
	ML2072	Classroom Security Intruder		
	ML2082	Dormitory		
	ML2092	Security Institution		
Full Working Trim (Quick Code M31) No cylinder; includes thumbturn lever			\$1,298.00	



Ordering Example Details

ML2000
Escutcheon
Trim

ML2051 Office Function
23M Piet Family Lever - Wood Insert
L Escutcheon
29BH29 Lever Finish
Wood insert with polished stainless steel (629)
shank and polished stainless steel (629) grip
629 Lock Finish
RHR Handing

Stock Order

Quantity	Series/Function	Trim	Lever Finish	Lock Finish	Hand
2	ML2051	23M	29BH29	629	RHR



Experience a safer
and more open world



LWA
Lever: Wrought
Rose: Wrought



RWA

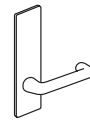

LWM
Lever: Wrought
Escutcheon: Wrought

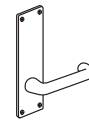

LWN

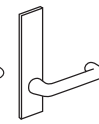

LWP

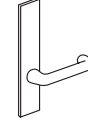

LWR
Lever: Wrought
Esc: Solid Stainless
Steel or Forged Brass

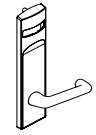

LWVN

Lever: Wrought
Escutcheon:
Steel or Forged Brass

Levers: LW, RW Roses: A Roses: B, F (see note 1)	
613E, 626, BSP, WSP	605, 606, 611, 612, 613, 618, 619, 625, 629, 630, 722

Levers: LW, RW Escutcheons: M, N, P	
613E, 626, BSP, WSP	605, 606, 611, 612, 613, 618, 619, 625, 629, 630, 722

Levers: LW, RW Escutcheons: R (see note 2) VN (see note 3)	
613E, 626, BSP, WSP	605, 606, 611, 612, 613, 618, 619, 625, 629, 630, 722

Function			613E, 626, BSP, WSP	605, 606, 611, 612, 613, 618, 619, 625, 629, 630, 722	613E, 626, BSP, WSP	605, 606, 611, 612, 613, 618, 619, 625, 629, 630, 722	613E, 626, BSP, WSP	605, 606, 611, 612, 613, 618, 619, 625, 629, 630, 722
Non-Keyed	ML2010	Passage	\$942.00	\$966.00	\$962.00	\$986.00	\$1,016.00	\$1,040.00
	ML2020	Privacy	\$1,029.00	\$1,053.00	\$1,049.00	\$1,073.00	\$1,103.00	\$1,127.00
	ML2030							
	ML2040	Passage w/Indicator – VXX Option on Page 118 Applies	\$1,005.00	\$1,029.00	\$1,025.00	\$1,049.00	\$1,079.00	\$1,103.00
	ML2060	Privacy						
	ML2050	Half Dummy	\$451.00	\$463.00	\$461.00	\$473.00	\$488.00	\$500.00
	ML2070	Full Dummy	\$902.00	\$926.00	\$922.00	\$946.00	\$976.00	\$1,000.00
	ML2080	Half Active Dummy Trim	\$506.00	\$518.00	\$516.00	\$528.00	\$543.00	\$555.00
ML2090	Full Active Dummy Trim	\$957.00	\$981.00	\$977.00	\$1,001.00	\$1,031.00	\$1,055.00	
Single Cylinder	ML2003	Classroom						
	ML2051	Office						
	ML2055	Classroom	\$1,089.00	\$1,113.00	\$1,109.00	\$1,133.00	\$1,163.00	\$1,187.00
	ML2056	Classroom						
	ML2057	Storeroom						
	ML2069	Institution Privacy						
	ML2004	Classroom						
	ML2053	Entrance	\$1,109.00	\$1,133.00	\$1,129.00	\$1,153.00	\$1,183.00	\$1,207.00
ML2054	Entrance							
ML2058	Entrance Holdback							
ML2068	Privacy or Apartment							
Single Cylinder with Deadbolt	ML2024	Entrance						
	ML2048	Entrance						
	ML2049	Storeroom Deadbolt	\$1,149.00	\$1,173.00	\$1,169.00	\$1,193.00	\$1,223.00	\$1,247.00
	ML2065	Dormitory						
	ML2059	Security Storeroom						
	ML2067	Apartment						
	ML2073	Classroom Security						
	ML2075	Entrance/Office						
ML2029	Hotel	\$1,193.00	\$1,217.00	\$1,213.00	\$1,237.00	\$1,267.00	\$1,291.00	
Double Cylinder	ML2002	Classroom Intruder						
	ML2032	Institution						
	ML2042	Entrance	\$1,209.00	\$1,233.00	\$1,229.00	\$1,253.00	\$1,283.00	\$1,307.00
	ML2052	Classroom Intruder						
	ML2087	Security Vestibule						
						N/A	N/A	
Double Cylinder with Deadbolt	ML2022	Store Door						
	ML2062	Intruder Deadbolt						
	ML2072	Classroom Security Intruder	\$1,269.00	\$1,293.00	\$1,289.00	\$1,313.00	\$1,343.00	\$1,367.00
	ML2082	Dormitory						
	ML2092	Security Institution						
Full Working Trim (Quick Code M31) No cylinder; includes thumbturn lever			\$769.00	\$793.00	\$789.00	\$813.00	\$843.00	\$867.00

NOTES: 1. Rose substitutions for LWA, RWA: 2-1/4" cast rose in place of 2-1/4" wrought rose, substitute letter "B" in place of "A" (e.g. LWB). **Add \$52.00 per lockset**
2-7/8" cast rose in place of 2-1/4" wrought rose, substitute letter "F" in place of "A" (e.g. RWF). **Add \$70.00 per lockset**
2. "R" Escutcheon trims are available for 1 3/8", 1 3/4", 2", or 2 1/4" door thickness only.
3. VN escutcheon available only with indicators. Must be ordered with "V" indicator options. See page 118 for available functions. Option add also applies.

LSA

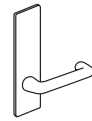
 Lever: Cast
Rose: Wrought

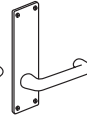
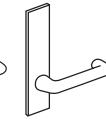
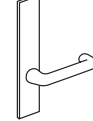
LSM

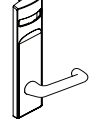
 Lever: Cast
Escutcheon: Wrought

LSN

LSP

LSR

 Lever: Cast
Esc: Solid Stainless
Steel or Forged Brass

LSVN

 Lever: Cast
Escutcheon:
Steel or Forged Brass

**Levers: LS
Roses: A
Roses: B, F (see note 1)**

613E, 626, BSP, WSP	605, 606, 611, 612, 613, 618, 619, 625, 629, 630, 722
---------------------------	---

**Levers: LS
Escutcheons: M, N, P**

613E, 626, BSP, WSP	605, 606, 611, 612, 613, 618, 619, 625, 629, 630, 722
---------------------------	---

**Levers: LS
Escutcheons: R (see note 2)
VN (see note 3)**

613E, 626, BSP, WSP	605, 606, 611, 612, 613, 618, 619, 625, 629, 630, 722
---------------------------	---

Function

Function	Levers: LS Roses: A Roses: B, F (see note 1)		Levers: LS Escutcheons: M, N, P		Levers: LS Escutcheons: R (see note 2) VN (see note 3)			
	613E, 626, BSP, WSP	605, 606, 611, 612, 613, 618, 619, 625, 629, 630, 722	613E, 626, BSP, WSP	605, 606, 611, 612, 613, 618, 619, 625, 629, 630, 722	613E, 626, BSP, WSP	605, 606, 611, 612, 613, 618, 619, 625, 629, 630, 722		
Non-Keyed	ML2010	Passage	\$980.00	\$1,070.00	\$1,175.00	\$1,199.00	\$1,209.00	\$1,233.00
	ML2020	Privacy	\$1,098.00	\$1,188.00	\$1,292.00	\$1,316.00	\$1,326.00	\$1,350.00
	ML2030							
	ML2040	Passage w/Indicator - VXX Option on Page 116 Applies	\$1,066.00	\$1,156.00	\$1,260.00	\$1,284.00	\$1,294.00	\$1,318.00
	ML2060	Privacy						
	ML2050	Half Dummy	\$368.00	\$413.00	\$528.00	\$552.00	\$545.00	\$569.00
	ML2070	Full Dummy	\$736.00	\$826.00	\$1,056.00	\$1,080.00	\$1,090.00	\$1,114.00
	ML2080	Half Active Dummy Trim	\$656.00	\$701.00	\$689.00	\$701.00	\$706.00	\$718.00
	ML2090	Full Active Dummy Trim	\$1,024.00	\$1,114.00	\$1,146.00	\$1,170.00	\$1,180.00	\$1,204.00
Single Cylinder	ML2003	Classroom	\$1,158.00	\$1,248.00	\$1,352.00	\$1,376.00	\$1,386.00	\$1,410.00
	ML2051	Office						
	ML2055	Classroom						
	ML2056	Classroom						
	ML2057	Storeroom						
	ML2069	Institution Privacy						
	ML2004	Classroom	\$1,178.00	\$1,268.00	\$1,372.00	\$1,396.00	\$1,406.00	\$1,430.00
	ML2053	Entrance						
	ML2054	Entrance						
ML2058	Entrance Holdback							
ML2068	Privacy or Apartment							
Single Cylinder with Deadbolt	ML2024	Entrance	\$1,218.00	\$1,308.00	\$1,412.00	\$1,436.00	\$1,446.00	\$1,470.00
	ML2048	Entrance						
	ML2049	Storeroom Deadbolt						
	ML2065	Dormitory						
	ML2059	Security Storeroom						
	ML2067	Apartment						
	ML2073	Classroom Security						
	ML2075	Entrance/Office						
ML2029	Hotel	\$1,262.00	\$1,352.00	\$1,456.00	\$1,480.00	\$1,490.00	\$1,514.00	
Double Cylinder	ML2002	Classroom Intruder	\$1,278.00	\$1,368.00	\$1,472.00	\$1,496.00	\$1,506.00	\$1,530.00
	ML2032	Institution						
	ML2042	Entrance						
	ML2052	Classroom Intruder						
ML2087	Security Vestibule					N/A	N/A	
Double Cylinder with Deadbolt	ML2022	Store Door	\$1,338.00	\$1,428.00	\$1,532.00	\$1,556.00	\$1,566.00	\$1,590.00
	ML2062	Intruder Deadbolt						
	ML2072	Classroom Security Intruder						
	ML2082	Dormitory						
ML2092	Security Institution							
Full Working Trim (Quick includes thumbturn lever	Code M31) No cylinder;	\$762.00	\$852.00	\$959.00	\$983.00	\$993.00	\$1,017.00	

NOTES: 1. Rose substitutions for LSA: 2-1/4" cast rose in place of 2-1/4" wrought rose, substitute letter "B" in place of "A" (e.g. LSB). **Add \$52.00 per lockset**
 2-7/8" cast rose in place of 2-1/4" wrought rose, substitute letter "F" in place of "A" (e.g. LSF). **Add \$70.00 per lockset**
 2. "R" Escutcheon trims are available for 1 3/8", 1 3/4", or 2 1/4" door thickness only
 3. VN escutcheon available only with indicators. Must be ordered with "V" indicator options. See page 118 for available functions. Option add also applies.

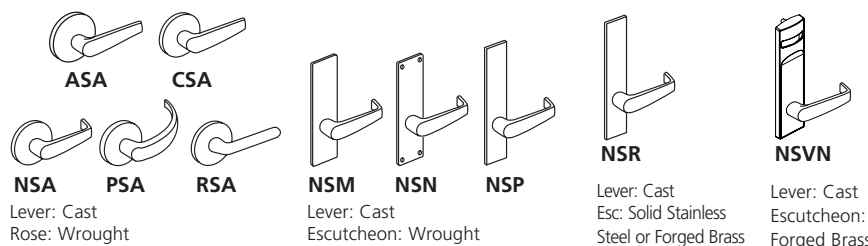

Levers: AS, CS, NS, PS, RS	
Roses: A	
Roses: B, F (see note 1)	
613E, 626, BSP, WSP	605, 606, 611, 612, 613, 618, 619, 625, 629, 630, 722

Levers: AS, CS, NS, PS, RS	
Escutcheons: M, N, P	
613E, 626, BSP, WSP	605, 606, 611, 612, 613, 618, 619, 625, 629, 630, 722

Levers: AS, CS, NS, PS, RS	
Escutcheons: R (see note 2)	
VN (see note 3)	
613E, 626, BSP, WSP	605, 606, 611, 612, 613, 618, 619, 625, 629, 630, 722

Function								
Non-Keyed	ML2010	Passage	\$1,155.00	\$1,179.00	\$1,175.00	\$1,199.00	\$1,209.00	\$1,233.00
	ML2020	Privacy	\$1,272.00	\$1,296.00	\$1,292.00	\$1,316.00	\$1,326.00	\$1,350.00
	ML2030							
	ML2040	Passage w/Indicator – VXX Option on Page 116 Applies	\$1,240.00	\$1,264.00	\$1,260.00	\$1,284.00	\$1,294.00	\$1,318.00
	ML2060	Privacy						
	ML2050	Half Dummy	\$456.00	\$468.00	\$466.00	\$478.00	\$483.00	\$495.00
	ML2070	Full Dummy	\$912.00	\$936.00	\$932.00	\$956.00	\$966.00	\$990.00
	ML2080	Half Active Dummy Trim	\$679.00	\$691.00	\$689.00	\$701.00	\$706.00	\$718.00
ML2090	Full Active Dummy Trim	\$1,126.00	\$1,150.00	\$1,146.00	\$1,170.00	\$1,180.00	\$1,204.00	
Single Cylinder	ML2003	Classroom	\$1,332.00	\$1,356.00	\$1,352.00	\$1,376.00	\$1,386.00	\$1,410.00
	ML2051	Office						
	ML2055	Classroom						
	ML2056	Classroom						
	ML2057	Storeroom	\$1,352.00	\$1,376.00	\$1,372.00	\$1,396.00	\$1,406.00	\$1,430.00
	ML2069	Institution Privacy						
	ML2004	Classroom						
	ML2053	Entrance						
ML2054	Entrance	\$1,436.00	\$1,460.00	\$1,456.00	\$1,480.00	\$1,490.00	\$1,514.00	
ML2058	Entrance Holdback							
ML2068	Privacy or Apartment							
Single Cylinder with Deadbolt	ML2024	Entrance	\$1,392.00	\$1,416.00	\$1,412.00	\$1,436.00	\$1,446.00	\$1,470.00
	ML2048	Entrance						
	ML2049	Storeroom Deadbolt						
	ML2065	Dormitory						
	ML2059	Security Storeroom						
	ML2067	Apartment						
	ML2073	Classroom Security						
	ML2075	Entrance/Office						
ML2029	Hotel	\$1,436.00	\$1,460.00	\$1,456.00	\$1,480.00	\$1,490.00	\$1,514.00	
Double Cylinder	ML2002	Classroom Intruder	\$1,452.00	\$1,476.00	\$1,472.00	\$1,496.00	\$1,506.00	\$1,530.00
	ML2032	Institution						
	ML2042	Entrance						
	ML2052	Classroom Intruder						
	ML2087	Security Vestibule						
Double Cylinder with Deadbolt	ML2022	Store Door	\$1,512.00	\$1,536.00	\$1,532.00	\$1,556.00	\$1,566.00	\$1,590.00
	ML2062	Intruder Deadbolt						
	ML2072	Classroom Security Intruder						
	ML2082	Dormitory						
	ML2092	Security Institution						
Full Working Trim (Quick Code M31) No cylinder; includes thumbturn lever			\$929.00	\$953.00	\$949.00	\$973.00	\$983.00	\$1,007.00

NOTES: 1. Rose substitutions for ASA, CSA, etc.: 2-1/4" cast rose in place of 2-1/4" wrought rose, substitute letter "B" in place of "A" (e.g. NSB). **Add \$52.00 per lockset**
 2-7/8" cast rose in place of 2-1/4" wrought rose, substitute letter "F" in place of "A" (e.g. NSF). **Add \$70.00 per lockset**
 2. "R" Escutcheon trims are available for 1 3/8", 1 3/4", or 2 1/4" door thickness only.
 3. VN escutcheon available only with indicators. Must be ordered with "V" indicator options. See page 118 for available functions. Option add also applies.

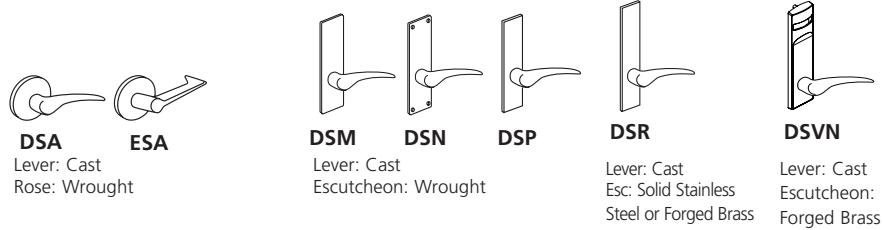

Levers: DS, ES Roses: A Roses: B, F (see note 1)		Levers: DS, ES Escutcheons: M, N, P		Levers: DS, ES Escutcheons: R (see note 2) VN (see note 3)	
613E, 626, BSP, WSP	605, 606, 611, 612, 613, 618, 619, 625, 629, 630, 722	613E, 626, BSP, WSP	605, 606, 611, 612, 613, 618, 619, 625, 629, 630, 722	613E, 626, BSP, WSP	605, 606, 611, 612, 613, 618, 619, 625, 629, 630, 722

Function	Model	Description	613E, 626, BSP, WSP	605, 606, 611, 612, 613, 618, 619, 625, 629, 630, 722	613E, 626, BSP, WSP	605, 606, 611, 612, 613, 618, 619, 625, 629, 630, 722	613E, 626, BSP, WSP	605, 606, 611, 612, 613, 618, 619, 625, 629, 630, 722
Non-Keyed	ML2010	Passage	\$1,191.00	\$1,215.00	\$1,211.00	\$1,235.00	\$1,245.00	\$1,269.00
	ML2020	Privacy	\$1,309.00	\$1,333.00	\$1,329.00	\$1,353.00	\$1,363.00	\$1,387.00
	ML2030							
	ML2040	Passage w/Indicator - VXX Option on Page 116 Applies	\$1,277.00	\$1,301.00	\$1,297.00	\$1,321.00	\$1,331.00	\$1,355.00
	ML2060	Privacy						
	ML2050	Half Dummy	\$488.00	\$500.00	\$498.00	\$510.00	\$515.00	\$527.00
	ML2070	Full Dummy	\$976.00	\$1,000.00	\$996.00	\$1,020.00	\$1,030.00	\$1,054.00
	ML2080	Half Active Dummy Trim	\$679.00	\$691.00	\$689.00	\$701.00	\$706.00	\$718.00
ML2090	Full Active Dummy Trim	\$1,160.00	\$1,184.00	\$1,180.00	\$1,204.00	\$1,214.00	\$1,238.00	
Single Cylinder	ML2003	Classroom	\$1,369.00	\$1,393.00	\$1,389.00	\$1,413.00	\$1,423.00	\$1,447.00
	ML2051	Office						
	ML2055	Classroom						
	ML2056	Classroom						
	ML2057	Storeroom						
	ML2069	Institution Privacy						
	ML2004	Classroom	\$1,389.00	\$1,413.00	\$1,409.00	\$1,433.00	\$1,443.00	\$1,467.00
	ML2053	Entrance						
ML2054	Entrance							
ML2058	Entrance Holdback							
ML2068	Privacy or Apartment							
Single Cylinder with Deadbolt	ML2024	Entrance	\$1,429.00	\$1,453.00	\$1,449.00	\$1,473.00	\$1,483.00	\$1,507.00
	ML2048	Entrance						
	ML2049	Storeroom Deadbolt						
	ML2065	Dormitory						
	ML2059	Security Storeroom						
	ML2067	Apartment						
	ML2073	Classroom Security						
	ML2075	Entrance/Office						
ML2029	Hotel	\$1,472.00	\$1,496.00	\$1,492.00	\$1,516.00	\$1,526.00	\$1,550.00	
Double Cylinder	ML2002	Classroom Intruder	\$1,489.00	\$1,513.00	\$1,509.00	\$1,533.00	\$1,543.00	\$1,567.00
	ML2032	Institution						
	ML2042	Entrance						
	ML2052	Classroom Intruder						
	ML2087	Security Vestibule						
Double Cylinder with Deadbolt	ML2022	Store Door	\$1,549.00	\$1,573.00	\$1,569.00	\$1,593.00	\$1,603.00	\$1,627.00
	ML2062	Intruder Deadbolt						
	ML2072	Classroom Security Intruder						
	ML2082	Dormitory						
	ML2092	Security Institution						
Full Working Trim (Quick Code M31) No cylinder; includes thumbturn lever		\$1,002.00	\$1,026.00	\$1,022.00	\$1,046.00	\$1,056.00	\$1,080.00	

NOTES: 1. Rose substitutions for DSA, ESA: 2-1/4" cast rose in place of 2-1/4" wrought rose, substitute letter "B" in place of "A" (e.g. DSB). **Add \$52.00 per lockset**
 2-7/8" cast rose in place of 2-1/4" wrought rose, substitute letter "F" in place of "A" (e.g. ESF). **Add \$70.00 per lockset**

2. "R" Escutcheon trims are available for 1 3/8", 1 3/4", or 2 1/4" door thickness only.

3. VN escutcheon available only with indicators. Must be ordered with "V" indicator options. See page 118 for available functions. Option add also applies.

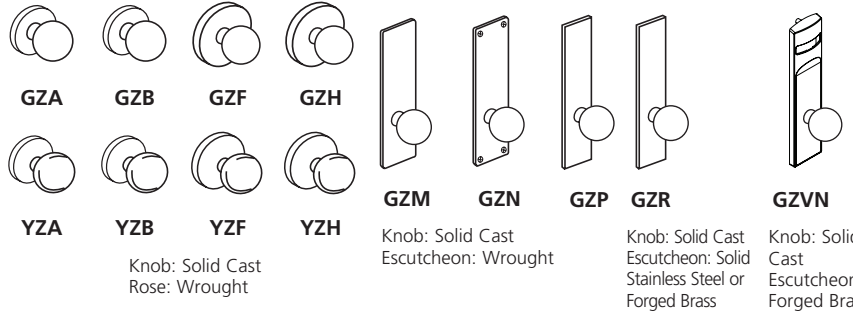

Function	Knobs: GZ, YZ Roses: A, H Roses: B, F (see note 2)		Knobs: GZ, YZ Escutcheons: M, N, P		Knobs: GZ, YZ Escutcheons: R (see note 2) VN (see note 3)			
	613E, 626, BSP, WSP	605, 606, 611, 612, 613, 618, 619, 625, 722	613E, 626, BSP, WSP	605, 606, 611, 612, 613, 618, 619, 625, 722	613E, 626, BSP, WSP	605, 606, 611, 612, 613, 618, 619, 625, 722		
Non-Keyed	ML2010	Passage	\$1,170.00	\$1,194.00	\$1,190.00	\$1,214.00	\$1,224.00	\$1,248.00
	ML2020	Privacy	\$1,345.00	\$1,369.00	\$1,365.00	\$1,389.00	\$1,399.00	\$1,423.00
	ML2030							
	ML2040	Passage w/Indicator – VXX Option on Page 116 Applies	\$1,327.00	\$1,351.00	\$1,347.00	\$1,371.00	\$1,381.00	\$1,405.00
	ML2060	Privacy						
	ML2050	Half Dummy	\$601.00	\$613.00	\$611.00	\$623.00	\$628.00	\$640.00
	ML2070	Full Dummy	\$1,202.00	\$1,226.00	\$1,222.00	\$1,246.00	\$1,256.00	\$1,280.00
	ML2080	Half Active Dummy Trim	\$625.00	\$637.00	\$635.00	\$647.00	\$652.00	\$664.00
ML2090	Full Active Dummy Trim	\$1,170.00	\$1,194.00	\$1,190.00	\$1,214.00	\$1,224.00	\$1,248.00	
Single Cylinder	ML2003	Classroom						
	ML2051	Office						
	ML2055	Classroom	\$1,405.00	\$1,429.00	\$1,425.00	\$1,449.00	\$1,459.00	\$1,483.00
	ML2056	Classroom						
	ML2057	Storeroom						
	ML2069	Institution Privacy						
	ML2004	Classroom						
	ML2053	Entrance	\$1,425.00	\$1,449.00	\$1,445.00	\$1,469.00	\$1,479.00	\$1,503.00
ML2054	Entrance							
ML2058	Entrance Holdback							
ML2068	Privacy or Apartment							
Single Cylinder with Deadbolt	ML2024	Entrance						
	ML2048	Entrance						
	ML2049	Storeroom Deadbolt						
	ML2065	Dormitory	\$1,465.00	\$1,489.00	\$1,485.00	\$1,509.00	\$1,519.00	\$1,543.00
	ML2059	Security Storeroom						
	ML2067	Apartment						
	ML2073	Classroom Security						
ML2075	Entrance/Office							
ML2029	Hotel	\$1,515.00	\$1,539.00	\$1,535.00	\$1,559.00	\$1,569.00	\$1,593.00	
Double Cylinder	ML2002	Classroom Intruder						
	ML2032	Institution						
	ML2042	Entrance	\$1,525.00	\$1,549.00	\$1,545.00	\$1,569.00	\$1,579.00	\$1,603.00
	ML2052	Classroom Intruder						
	ML2087	Security Vestibule						
						N/A	N/A	
Double Cylinder with Deadbolt	ML2022	Store Door						
	ML2062	Intruder Deadbolt						
	ML2072	Classroom Security Intruder	\$1,585.00	\$1,609.00	\$1,605.00	\$1,629.00	\$1,639.00	\$1,663.00
	ML2082	Dormitory						
	ML2092	Security Institution						
Full Working Trim (Quick Code M31) No cylinder; includes thumbturn lever.			\$1,069.00	\$1,093.00	\$1,089.00	\$1,113.00	\$1,123.00	\$1,147.00

- NOTES: 1. "R" Escutcheon trims are available for 1 3/8", 1 3/4", or 2 1/4" door thickness only.
 2. Rose substitutions: 2-1/4" cast rose in place of 2-1/4" wrought rose, substitute letter "B" in place of "A" (e.g. GZB). **Add \$52.00 per lockset**
 2-7/8" cast rose in place of 2-1/4" wrought rose, substitute letter "F" in place of "A" (e.g. GZF). **Add \$70.00 per lockset**
 3. VN escutcheon available only with indicators. Must be ordered with "V" indicator options. See page 118 for available functions. Option add also applies.

Lever Designs: FSG, MSG, ZSG

Lever: Rose:
Cast Cast



Frascati



Lever Designs: FSL, MSL¹, ZSL, FSVN, MSVN, ZSVN

Lever: Escutcheon:
Cast Cast

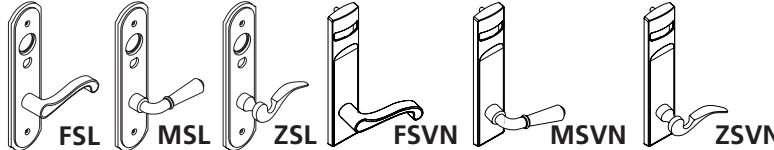

Merlot

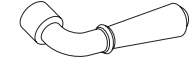

Zinfandel



Function	Description	FSG, MSG, ZSG		FSL, MSL, ZSL FSVN, MSVN, ZSVN (see note 3)		
		613E, 626, BSP, WSP	605, 606, 611, 612, 613 ² , 613L ² , 618, 619, 625, 722	613E, 626, BSP, WSP	605, 606, 611, 612, 613 ² , 613L ² , 618, 619, 625, 722	
Non-Keyed	ML2010	Passage	\$1,191.00	\$1,215.00	\$1,245.00	\$1,269.00
	ML2020	Privacy	\$1,309.00	\$1,333.00	\$1,363.00	\$1,387.00
	ML2030					
	ML2040	Passage w/Indicator - VXX Option on Page 116 Applies	\$1,277.00	\$1,301.00	\$1,331.00	\$1,355.00
	ML2060	Privacy				
	ML2050	Half Dummy	\$488.00	\$500.00	\$515.00	\$527.00
	ML2070	Full Dummy	\$976.00	\$1,000.00	\$1,030.00	\$1,054.00
	ML2080	Half Active Dummy Trim	\$679.00	\$691.00	\$706.00	\$718.00
ML2090	Full Active Dummy Trim	\$1,160.00	\$1,184.00	\$1,214.00	\$1,238.00	
Single Cylinder	ML2003	Classroom	\$1,369.00	\$1,393.00	\$1,423.00	\$1,447.00
	ML2051	Office				
	ML2055	Classroom				
	ML2056	Classroom Holdback				
	ML2057	Storeroom				
	ML2069	Institution Privacy				
	ML2004	Classroom	\$1,389.00	\$1,413.00	\$1,443.00	\$1,467.00
	ML2053	Entrance				
ML2054	Entrance					
ML2058	Entrance Holdback					
ML2068	Privacy or Apartment					
Single Cylinder with Deadbolt	ML2024	Entrance	\$1,429.00	\$1,453.00	\$1,483.00	\$1,507.00
	ML2048	Entrance				
	ML2049	Storeroom Deadbolt				
	ML2059	Dormitory				
	ML2065	Security Storeroom				
	ML2067	Apartment				
	ML2073	Classroom Security				
	ML2075	Entrance/Office				
ML2029	Hotel	\$1,472.00	\$1,496.00	\$1,526.00	\$1,550.00	
Double Cylinder	ML2002	Classroom Intruder	\$1,489.00	\$1,513.00	\$1,543.00	\$1,567.00
	ML2032	Institution				
	ML2042	Entrance				
	ML2052	Classroom Intruder				
	ML2087	Security Vestibule			N/A	N/A
Double Cylinder with Deadbolt	ML2022	Store Door	\$1,549.00	\$1,573.00	\$1,603.00	\$1,627.00
	ML2062	Intruder Deadbolt				
	ML2072	Classroom Security Intrude				
	ML2082	Dormitory				
	ML2092	Security Institution				
Full Working Trim (Quick Code M31) No cylinder; includes thumbturn lever			\$1,002.00	\$1,026.00	\$1,056.00	\$1,080.00

NOTES: 1. Escutcheon trims are available for 1-3/8", 1-3/4" or 2-1/4" door thicknesses only.
 2. 613 finish is brass base lever & rose/escutcheon.
 3. VN escutcheon available only with indicators. Must be ordered with "V" indicator options. See page 118 for available functions. Option add also applies.

Deadbolt Only

Include lockcase, armored front, strike, screw pack, cylinder(s) and thumbturn lever.

Ordering Example

Quantity	Series/Function	Trim Design (Escutcheon Type Only)	Finish	Door Thickness
12	ML2013	N	626	D138

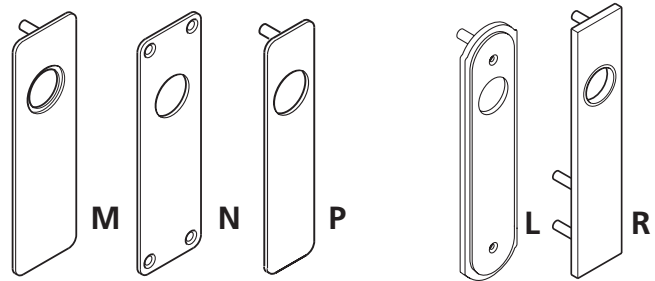

Deadlock No Trim

Wrought

L, R: Solid Stainless Steel or Forged Brass

Function	
613E, 626, BSP, WSP	605, 606, 611, 612, 613, 618, 619, 625, 629, 630, 722

M, N, P	
613E, 626, BSP, WSP	605, 606, 611, 612, 613, 618, 619, 625, 629, 630, 722

L, R	
613E, 626, BSP, WSP	605, 606, 611, 612, 613, 618, 619, 625, 629, 630, 722

Function	Series	613E, 626, BSP, WSP	605, 606, 611, 612, 613, 618, 619, 625, 629, 630, 722	M, N, P 613E, 626, BSP, WSP	M, N, P 605, 606, 611, 612, 613, 618, 619, 625, 629, 630, 722	L, R 613E, 626, BSP, WSP	L, R 605, 606, 611, 612, 613, 618, 619, 625, 629, 630, 722
Single Cylinder	ML2011	\$550.00	\$556.00	\$614.00	\$620.00	\$696.00	\$702.00
Double Cylinder	ML2012	\$670.00	\$676.00	\$765.00	\$771.00	\$867.00	\$873.00
Cylinder x Thumbturn	ML2013	\$570.00	\$576.00	\$665.00	\$671.00	\$767.00	\$773.00
Classroom Function Cylinder x Thumbturn	ML2017	\$570.00	\$576.00	\$665.00	\$671.00	\$767.00	\$773.00

NOTES: 1. Escutcheon trims are available for 1 3/8", 1 3/4", or 2 1/4" door thickness only.
2. VN escutcheon available only with sectional V series indicators. See page 118 for option codes.

Vandal Resistant Trim

Lever Designs: CSV, NSV

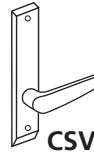

CSV

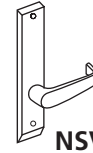

NSV

Lever: Cast
Escutcheon: Cast

Citation

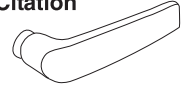

Newport

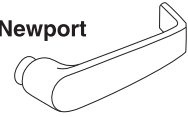

Function

CSV, NSV

630

Non-Keyed	ML2010VR	Passage	\$1,940.00
	ML2020VR	Privacy	\$2,058.00
	ML2030VR		
	ML2060VR		
	ML2090VR		\$2,026.00
Single Cylinder	ML2003VR	Classroom	\$2,118.00
	ML2051VR	Office	
	ML2055VR	Classro0m	
	ML2056VR	Classroom Holdback	
	ML2057VR	Storeroom	
	ML2069VR	Institution Privacy	\$2,138.00
	ML2004VR	Classroom	
	ML2053VR	Entrance	
	ML2054VR	Entrance	
	ML2058VR	Entrance Holdback	
Single Cylinder with Deadbolt	ML2024VR	Entrance	\$2,178.00
	ML2048VR	Entrance	
	ML2049VR	Storeroom Deadbolt	
	ML2059VR	Security Storeroom	
	ML2065VR	Dormitory	
	ML2067VR	Apartment	
	ML2073VR	Classroom Security	
	ML2075VR	Entrance/Office	
ML2029VR	Hotel	\$2,221.00	
Double Cylinder	ML2002VR	Classroom Intruder	\$2,238.00
	ML2032VR	Institution	
	ML2042VR	Entrance	
	ML2052VR	Classroom	\$2,298.00
	ML2022VR	Store Door	
	ML2062VR	Intruder Deadbolt	
	ML2072VR	Classroom Security Intruder	
	ML2082VR	Dormitory	
ML2092VR	Security Institution		
Deadlock	ML2011VR	Single Cylinder	\$1,722.00
	ML2013VR	Cylinder x Thumbturn	
	ML2017VR	Double Cylinder	\$1,842.00
	ML2012VR	Double Cylinder	
Full Working Trim (Quick Code M31) No cylinder; includes thumbturn lever			\$1,619.00

NOTE:
Escutcheon trims are available for 1 3/4", 2", or 2 1/4" door thickness only

Mortise Locksets

ML20900 Series Muséo Levers and Inspire Roseless Trim

USA & Canada Prices Effective April 17, 2023



contemporary levers to complement the interior design of your next project

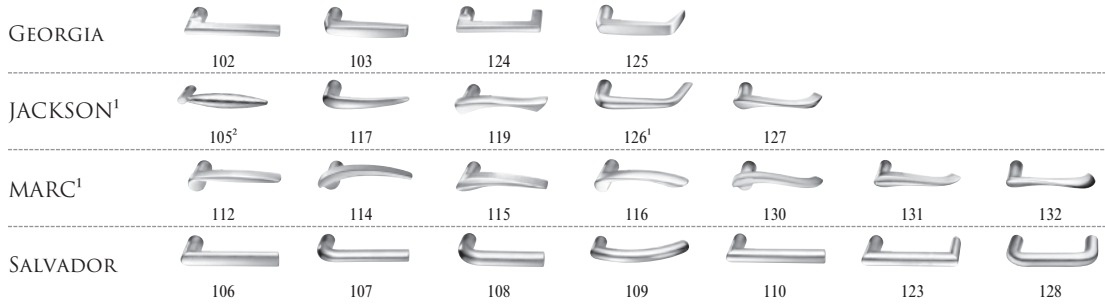

J Collar

1. Handed: specify hand when ordering
2. Contact factory for current lead time

613E	Dark Oxidized Satin Bronze - Equivalent	605	Bright Brass, Clear Coated	618	Bright Nickel Plated
626	Satin Chromium Plated	606	Satin Brass, Clear Coated	619	Satin Nickel Plated
BSP	Black Suede Powder Coat	611	Bright Bronze, Clear Coated	625	Bright Chromium Plated
WSP	White Suede Powder Coat	612	Satin Bronze, Clear Coated	629*	Bright Stainless Steel
		613	Dark Oxidized Satin Bronze, Oil Rubbed	630*	Satin Stainless Steel
		613L	Dark Oxidized Satin Bronze, Clear Coated	722	Black Oxidized Bronze, Oil Rubbed

Function

Lever with Roses				
Single Cylinder	ML20914	Fail Safe/Fail Secure	\$1,921.00	\$1,945.00
	ML20906			
No Cylinder Override	ML20907	Fail Safe/Fail Secure	\$1,801.00	\$1,825.00
	ML20915			
Double Cylinder	ML20932	Fail Safe/Fail Secure	\$2,041.00	\$2,065.00
	ML20987			



Ordering Example Details

ML2000	ML2051	Office Function
Sectional Trim (rose)	102	Georgia Family Lever
	J	Collar
	625	Finish
	RHR	Handing

Stock Order

Quantity	Series/Function	Trim	Finish	Hand
24	ML2051	102J	625	RHR

*629 and *630 finish options are Not available for all Muséo levers. Please refer to page 26 for availability.



Experience a safer and more open world

Electrically Controlled Mortise Locksets

ML20900 Series: Muséo Levers, Escutcheons, Roses and Thumbturns

USA & Canada Prices Effective April 17, 2023

contemporary levers to complement the interior design of your next project

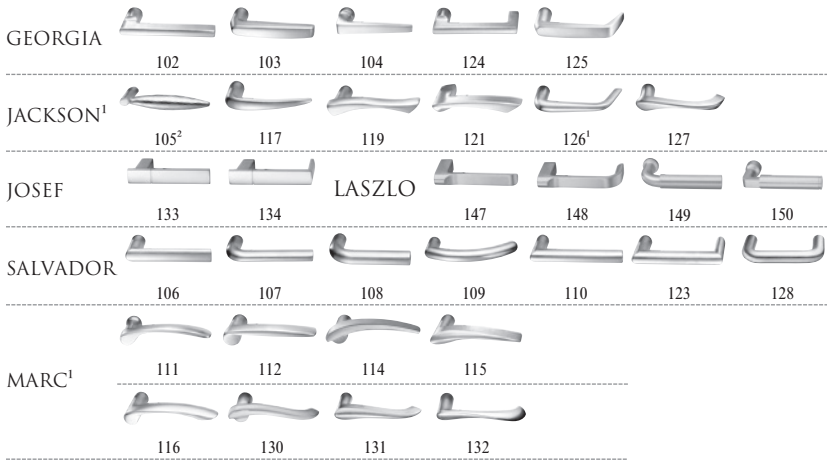

ROSES

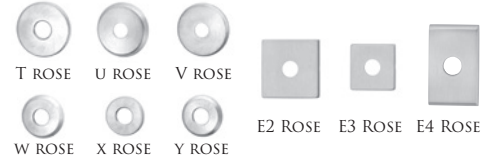

ESCUTCHEONS



THUMBTURNS³



1. Handed: specify hand when ordering
2. Contact factory for current lead time
3. Specify thumbturn as quick code. Thumbturn backplate will match shape of rose chosen (i.e. round or square). Not available with escutcheons.
4. ML20987 not available for L or R escutcheons.

*629 and *630 finish options are Not available for all Muséo levers. Please refer to page 26 for availability.

613E	Dark Oxidized Satin Bronze - Equivalent	605	Bright Brass, Clear Coated	618	Bright Nickel Plated
626	Satin Chromium Plated	606	Satin Brass, Clear Coated	619	Satin Nickel Plated
BSP	Black Suede Powder Coat	611	Bright Bronze, Clear Coated	625	Bright Chromium Plated
WSP	White Suede Powder Coat	612	Satin Bronze, Clear Coated	629*	Bright Stainless Steel
		613	Dark Oxidized Satin Bronze, Oil Rubbed	630*	Satin Stainless Steel
		613L	Dark Oxidized Satin Bronze, Clear Coated	722	Black Oxidized Bronze, Oil Rubbed

Function

Lever with Escutcheons: L,R						
Single Cylinder	ML20914	Fail Safe/Fail Secure*	\$1,783.00			\$1,807.00
	ML20906					
No Cylinder Override	ML20907	Fail Safe/Fail Secure*	\$1,663.00			\$1,687.00
	ML20915					
Double Cylinder	ML20932	Fail Safe/Fail Secure*	\$1,903.00			\$1,927.00
	ML20987		N/A			N/A
Lever with Roses: V,U,T,Y,X,W,E2,E3,E4						
Single Cylinder	ML20914	Fail Safe/Fail Secure*	\$1,719.00			\$1,743.00
	ML20906					
No Cylinder Override	ML20907	Fail Safe/Fail Secure*	\$1,599.00			\$1,623.00
	ML20915					
Double Cylinder	ML20932	Fail Safe/Fail Secure*	\$1,839.00			\$1,863.00
	ML20987					

*Must specify: SAF for Fail Safe or SEC for Fail Secure.



Ordering Example Details

ML20900 ECL
Escutcheon Trim

ML20914 Single Cylinder
SEC Fail Secure
104 Salvador Family Lever
L Escutcheon
613 Finish
RHR Handing
24 AD 24 Volt AC/DC

Stock Order

Quantity	Series/Function	Fail Safe/Fail Secure	Trim	Finish	Hand	Voltage
24	ML20914	SEC	104L	613	RHR	24 AD



Experience a safer and more open world

Electrically Controlled Mortise Locksets

ML20900 Series: Muséo Levers, Escutcheons, Roses and

Thumbturns

USA & Canada Prices Effective April 17, 2023



contemporary levers to complement the interior design of your next project

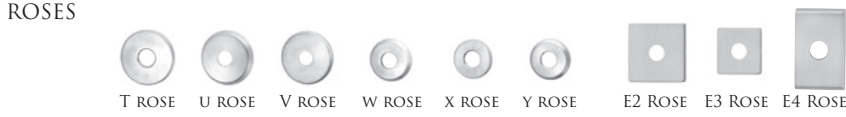

Specify thumbturn as quick code. Thumbturn backplate will match shape of rose chosen (i.e. round or square)

NOTE: ML20987 not available with L or R escutcheons.

613E	Dark Oxidized Satin Bronze – Equivalent
629	Bright Stainless Steel
630	Satin Stainless Steel
BSP	Black Suede Powder Coat
WSP	White Suede Powder Coat

Function

Lever with Escutcheons: L,R			
Single Cylinder	ML20914	Fail Safe/Fail Secure*	\$1,982.00
	ML20906		
No Cylinder Override	ML20907	Fail Safe/Fail Secure*	\$1,862.00
	ML20915		
Double Cylinder	ML20932	Fail Safe/Fail Secure*	\$2,102.00
	ML20987		N/A
Lever with Roses: V,U,T,Y,X,W,E2,E3,E4			
Single Cylinder	ML20914	Fail Safe/Fail Secure*	\$1,894.00
	ML20906		
No Cylinder Override	ML20907	Fail Safe/Fail Secure*	\$1,774.00
	ML20915		
Double Cylinder	ML20932	Fail Safe/Fail Secure*	\$2,014.00
	ML20987		

*Must specify: SAF for Fail Safe or SEC for Fail Secure.

BHMA CERTIFIED ML20900 ECL Escutcheon Trim

Ordering Example Details →

ML20914	Single Cylinder
SAF	Fail Safe
21M	Piet Family Lever - Polished with Satin Insert
L	Escutcheon
293029	Lever Finish
	Polished with satin stainless steel insert (630), polished stainless steel (629) shank and polished stainless steel (629) grip
629	Lock Finish
RHR	Handing
24 AD	24 Volt AC/DC

Stock Order							
Quantity	Series/Function	Fail Safe/Fail Secure	Trim	Lever Finish	Lock Finish	Hand	Voltage
2	ML20914	SAF	21ML	293029	629	RHR	24 AD



Experience a safer and more open world

Electrically Controlled Mortise Locksets

ML20900 Series: Muséo Levers, Escutcheons, Roses and Thumbturns

USA & Canada Prices Effective April 17, 2023

contemporary levers to complement the interior design of your next project



PIET

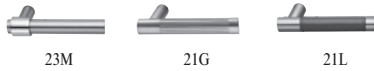

ROSES

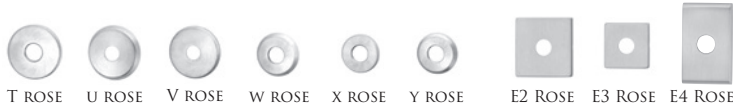

ESCUTCHEONS



THUMBTURNS



Specify thumbturn as quick code. Thumbturn backplate will match shape of rose chosen (i.e. round or square)

NOTE: ML20987 not available with L or R escutcheons.

613E	Dark Oxidized Satin Bronze – Equivalent
629	Bright Stainless Steel
630	Satin Stainless Steel
BSP	Black Suede Powder Coat
WSP	White Suede Powder Coat

Function

Lever with Escutcheons: L,R			
Single Cylinder	ML20914	Fail Safe/Fail Secure*	\$2,098.00
	ML20906		
No Cylinder Override	ML20907	Fail Safe/Fail Secure*	\$1,978.00
	ML20915		
Double Cylinder	ML20932	Fail Safe/Fail Secure*	\$2,218.00
	ML20987		N/A
Lever with Roses: V,U,T,Y,X,W,E2,E3,E4			
Single Cylinder	ML20914	Fail Safe/Fail Secure*	\$2,011.00
	ML20906		
No Cylinder Override	ML20907	Fail Safe/Fail Secure*	\$1,891.00
	ML20915		
Double Cylinder	ML20932	Fail Safe/Fail Secure*	\$2,131.00
	ML20987		

*Must specify: SAF for Fail Safe or SEC for Fail Secure.



Ordering Example Details

ML20900 ECL	ML20914 Single Cylinder
Escutcheon	SEC Fail Secure
Trim	23M Piet Family Lever - Wood Insert
	L Escutcheon
	29BH29 Lever Finish
	Wood insert with polished stainless steel (629) shank and polished stainless steel (629) grip
	629 Lock Finish
	RHR Handing
	24 AD 24 Volt AC/DC

Stock Order

Quantity	Series/Function	Fail Safe/Fail Secure	Trim	Lever Finish	Lock Finish	Hand	Voltage
2	ML20914	SEC	21ML	29BH29	629	RHR	24 AD



Experience a safer and more open world

Electrically Controlled Mortise Locksets

ML20900 Series: Muséo Levers, Escutcheons, Roses and Thumbturns

USA & Canada Prices Effective April 17, 2023

contemporary levers to complement the interior design of your next project



JOSEF



GEORGES



ROSES

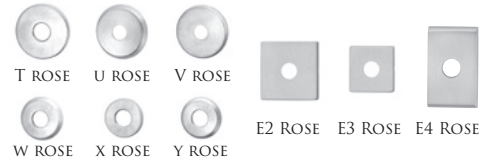

ESCUTCHEONS



THUMBTURN³



1. Handed: specify hand when ordering
2. Contact factory for current lead time
3. Specify thumbturn as quick code. Thumbturn backplate will match shape of rose chosen (i.e. round or square). Not available with escutcheons.
4. ML20987 not available with L or R escutcheons.

613E	Dark Oxidized Satin Bronze - Equivalent	605	Bright Brass, Clear Coated	618	Bright Nickel Plated
626	Satin Chromium Plated	606	Satin Brass, Clear Coated	619	Satin Nickel Plated
BSP	Black Suede Powder Coat	611	Bright Bronze, Clear Coated	625	Bright Chromium Plated
WSP	White Suede Powder Coat	612	Satin Bronze, Clear Coated	629	Bright Stainless Steel
		613	Dark Oxidized Satin Bronze, Oil Rubbed	630	Satin Stainless Steel
		613L	Dark Oxidized Satin Bronze, Clear Coated	722	Black Oxidized Bronze, Oil Rubbed

Function

Lever with Escutcheons: L,R					
Single Cylinder	ML20914	Fail Safe/Fail Secure*	\$2,074.00		\$2,098.00
	ML20906				
No Cylinder Override	ML20907	Fail Safe/Fail Secure*	\$1,954.00		\$1,978.00
	ML20915				
Double Cylinder	ML20932	Fail Safe/Fail Secure*	\$2,194.00		\$2,218.00
	ML20987		N/A		N/A
Lever with Roses: V,U,T,Y,X,W,E2,E3,E4					
Single Cylinder	ML20914	Fail Safe/Fail Secure*	\$1,987.00		\$2,011.00
	ML20906				
No Cylinder Override	ML20907	Fail Safe/Fail Secure*	\$1,867.00		\$1,891.00
	ML20915				
Double Cylinder	ML20932	Fail Safe/Fail Secure*	\$2,107.00		\$2,131.00
	ML20987				

*Must specify: SAF for Fail Safe or SEC for Fail Secure.

Ordering Example Details

ML20900 ECL	ML20914	Single Cylinder
Escutcheon Trim	SEC	Fail Secure
	135	Josef Family Lever
	L	Escutcheon
	613	Finish
	RHR	Handing
	24 AD	24 Volt AC/DC



Stock Order

Quantity	Series/Function	Technology Code	Trim	Finish	Hand	Voltage	Fail Safe/Fail Secure	High Security Monitoring Options
24	ML20914	NAC	135L	613	RHR	24 AD	SEC	PHRR01





Experience a safer and more open world

Electrically Controlled Mortise Locksets

ML20900 Series

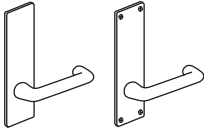
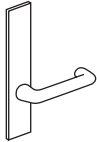
USA & Canada Prices Effective April 17, 2023

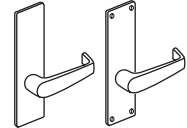
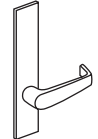
			 LWA RWA Lever: Wrought Rose: Wrought		 LWM LWN Lever: Wrought Escutcheon: Wrought		 LWR Lever: Wrought Escutcheon: Solid Stainless Steel or Forged Brass	
			Levers: LW, RW Roses: A Roses: B, F (see note 1)		Levers: LW, RW Escutcheons: M, N		Levers: LW, RW Escutcheons: R (see note 2)	
Description	Function	Option (See Note 3)	613E, 626, BSP, WSP	605, 606, 611, 612, 613, 618, 619, 625, 629, 630, 722	613E, 626, BSP, WSP	605, 606, 611, 612, 613, 618, 619, 625, 629, 630, 722	613E, 626, BSP, WSP	605, 606, 611, 612, 613, 618, 619, 625, 629, 630, 722
Single Cylinder	ML20914	Fail Safe/Fail Secure	\$1,427.00	\$1,451.00	\$1,450.00	\$1,474.00	\$1,515.00	\$1,539.00
	ML20906							
No Cylinder Override	ML20907	Fail Safe/Fail Secure	\$1,307.00	\$1,331.00	\$1,330.00	\$1,354.00	\$1,395.00	\$1,419.00
	ML20915							
Double Cylinder	ML20932	Fail Safe/Fail Secure	\$1,547.00	\$1,571.00	\$1,570.00	\$1,594.00	\$1,635.00	\$1,659.00
	ML20987						N/A	N/A
			 ASA CSA LSA Lever: Cast Rose: Wrought		 NSM NSN Lever: Cast Escutcheon: Wrought		 NSR Lever: Cast Escutcheon: Solid Stainless Steel or Forged Brass	
			Levers: AS, CS, LS, NS, PS, RS Roses: A Roses: B, F (see note 1)		Levers: AS, CS, LS, NS, PS, RS Escutcheons: M, N		Levers: AS, CS, LS, NS, PS, RS Escutcheons: R (see note 2)	
Description	Function	Option (See Note 3)	613E, 626, BSP, WSP	605, 606, 611, 612, 613, 618, 619, 625, 629, 630, 722	613E, 626, BSP, WSP	605, 606, 611, 612, 613, 618, 619, 625, 629, 630, 722	613E, 626, BSP, WSP	605, 606, 611, 612, 613, 618, 619, 625, 629, 630, 722
Single Cylinder	ML20914	Fail Safe/Fail Secure	\$1,681.00	\$1,705.00	\$1,705.00	\$1,729.00	\$1,745.00	\$1,769.00
	ML20906							
No Cylinder Override	ML20907	Fail Safe/Fail Secure	\$1,561.00	\$1,585.00	\$1,585.00	\$1,609.00	\$1,625.00	\$1,649.00
	ML20915							
Double Cylinder	ML20932	Fail Safe/Fail Secure	\$1,801.00	\$1,825.00	\$1,825.00	\$1,849.00	\$1,865.00	\$1,889.00
	ML20987						N/A	N/A

NOTES:

- 1 - Rose substitutions for LWA, LSA, etc.: 2-1/4" cast rose in place of 2-1/4" wrought rose, substitute letter "B" in place of "A" (e.g. LSB). **Add \$52.00 per lockset**
- 2-7/8" cast rose in place of 2-1/4" wrought rose, substitute letter "F" in place of "A" (e.g. LWF). **Add \$70.00 per lockset**
- 2 - "R" Escutcheon trims are available for 1 3/8", 1 3/4" or 2 1/4" door thickness only.
- 3. Must Specify: SAF for Fail Safe or SEC for Fail Secure.

ElectroLynx®

As part of their promise to provide innovative, fast and effective high security solutions to their customers, certain ASSA ABLOY Group brands offer *ElectroLynx®*, a universal quick-connect system that simplifies the electrification of the door opening.

Electrically Controlled Mortise Locksets ML20900 Series

USA & Canada Prices Effective April 17, 2023



Lever: Cast
Rose: Wrought

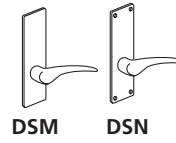

Lever: Cast
Escutcheon: Wrought

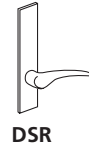

Lever: Cast
Escutcheon: Solid Stainless Steel
or Forged Brass

Description	Function	Option (See Note 3)	Lever: DS, ES Roses: A Roses: B, F (see note 1)		Lever: DS, ES Escutcheons: M, N		Lever: DS, ES Escutcheons: R (see note 2)	
			613E, 626, BSP, WSP	605, 606, 611, 612, 613, 618, 619, 625, 629, 630, 722	613E, 626, BSP, WSP	605, 606, 611, 612, 613, 618, 619, 625, 629, 630, 722	613E, 626, BSP, WSP	605, 606, 611, 612, 613, 618, 619, 625, 629, 630, 722
Single Cylinder	ML20914	Fail Safe/Fail Secure	\$1,719.00	\$1,743.00	\$1,743.00	\$1,767.00	\$1,783.00	\$1,807.00
	ML20906							
No Cylinder Override	ML20907	Fail Safe/Fail Secure	\$1,599.00	\$1,623.00	\$1,623.00	\$1,647.00	\$1,663.00	\$1,687.00
	ML20915							
Double Cylinder	ML20932	Fail Safe/Fail Secure	\$1,839.00	\$1,863.00	\$1,863.00	\$1,887.00	\$1,903.00	\$1,927.00
	ML20987						N/A	N/A

NOTES:

- 1 - Rose substitutions for DSA, ESA: 2-1/4" cast rose in place of 2-1/4" wrought rose, substitute letter "B" in place of "A" (e.g.DSB). **Add \$52.00 per lockset.** 2-7/8" cast rose in place of 2-1/4" wrought rose, substitute letter "F" in place of "A" (e.g. ESF). **Add \$70.00 per lockset.**
- 2 - "R" Escutcheon trims are available for 1 3/8", 1 3/4", or 2 1/4" door thickness only.
- 3. Must Specify: SAF for Fail Safe or SEC for Fail Secure.

Lever Designs: CSV, NSV

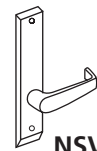
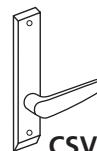

Lever: Cast
Escutcheon: Cast

Description	Function	Option (See Note 3)	CSV, NSV	
			Finish: 630	
Single Cylinder	ML20914VR	Fail Safe/Fail Secure	\$2,503.00	
	ML20906VR			
No Cylinder Override	ML20907VR	Fail Safe/Fail Secure	\$2,383.00	
	ML20915VR			
Double Cylinder	ML20932VR	Fail Safe/Fail Secure	\$2,623.00	

Note:

- Escutcheon trims are available for 1 3/8", 1 3/4", or 2 1/4" door thickness only.
- 3. Must Specify: SAF for Fail Safe or SEC for Fail Secure.

ElectroLynx®

As part of their promise to provide innovative, fast and effective high security solutions to their customers, certain ASSA ABLOY Group brands offer *ElectroLynx®*, a universal quick-connect system that simplifies the electrification of the door opening.

**Electrically Controlled Mortise Locksets
ML20900 Series**

USA & Canada Prices Effective April 17, 2023

Lever Designs: FSG, MSG, ZSG



Frascati



Lever: Rose:
Cast Cast



FSG



MSG



ZSG

Vineyard™
collection

Merlot



Lever Designs: FSL, MSL, ZSL



Zinfandel

Lever: Escutcheon:
Cast Cast



FSL

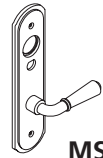

MSL



ZSL

Vineyard™
collection

Description	Function	Option (See Note 3)	FSG, MSG, ZSG		FSL, MSL, ZSL	
			613E, 626, BSP, WSP	605, 606, 611, 612, 613 ² , 613L ² , 618, 619, 625, 722	613E, 626, BSP, WSP	605, 606, 611, 612, 613 ² , 613L ² , 618, 619, 625, 722
Single Cylinder	ML20914	Fail Safe/Fail Secure	\$1,719.00	\$1,743.00	\$1,783.00	\$1,807.00
	ML20906					
No Cylinder Override	ML20907	Fail Safe/Fail Secure	\$1,599.00	\$1,623.00	\$1,663.00	\$1,687.00
	ML20915					
Double Cylinder	ML20932	Fail Safe/Fail Secure	\$1,839.00	\$1,863.00	\$1,903.00	\$1,927.00
	ML20987				N/A	N/A

Notes:

1. Escutcheon trims are available for 1-3/8", 1-3/4" or 2-1/4" door thicknesses only.
2. 613 finish is brass base lever & rose/escutcheon.
3. Must Specify: SAF for Fail Safe or SEC for Fail Secure

ElectroLynx®

As part of their promise to provide innovative, fast and effective high security solutions to their customers, certain ASSA ABLOY Group brands offer *ElectroLynx®*, a universal quick-connect system that simplifies the electrification of the door opening.

Electrically Controlled Mortise Locksets ML20900 Series

USA & Canada Prices Effective April 17, 2023

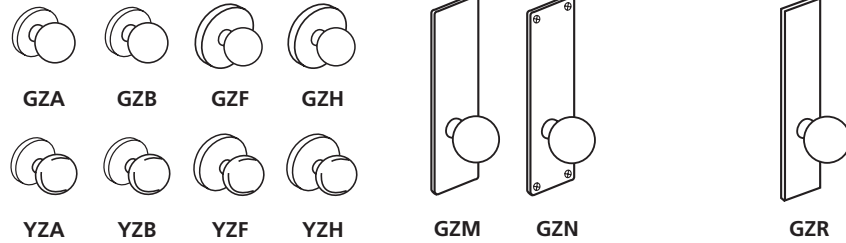

Knob: Solid Cast
Rose: Wrought

Knob: Solid Cast
Escutcheon: Wrought

Knob: Solid Cast
Escutcheon: Solid Stainless
Steel or Forged Brass

Knobs: GZ, YZ Roses: A, H Roses: B, F (see note 2)	
613E, 626, BSP, WSP	605, 606, 611, 612, 613, 618, 619, 625, 722

Knobs: GZ, YZ Escutcheons: M, N	
613E, 626, BSP, WSP	605, 606, 611, 612, 613, 618, 619, 625, 722

Knobs: GZ, YZ Escutcheons: R (see note 1)	
613E, 626, BSP, WSP	605, 606, 611, 612, 613, 618, 619, 625, 722

Description	Function	Option (See Note 3)	Knobs: GZ, YZ Roses: A, H Roses: B, F (see note 2)		Knobs: GZ, YZ Escutcheons: M, N		Knobs: GZ, YZ Escutcheons: R (see note 1)	
			613E, 626, BSP, WSP	605, 606, 611, 612, 613, 618, 619, 625, 722	613E, 626, BSP, WSP	605, 606, 611, 612, 613, 618, 619, 625, 722	613E, 626, BSP, WSP	605, 606, 611, 612, 613, 618, 619, 625, 722
Single Cylinder	ML20914	Fail Safe/ Fail Secure	\$1,764.00	\$1,788.00	\$1,788.00	\$1,812.00	\$1,829.00	\$1,853.00
	ML20906							
No Cylinder Override	ML20907	Fail Safe/ Fail Secure	\$1,644.00	\$1,668.00	\$1,668.00	\$1,692.00	\$1,709.00	\$1,733.00
	ML20915							
Double Cylinder	ML20932	Fail Safe/ Fail Secure	\$1,884.00	\$1,908.00	\$1,908.00	\$1,932.00	\$1,949.00	\$1,973.00
	ML20987						N/A	N/A

NOTE 1: "R" Escutcheon trims are available for 1 3/8", 1 3/4", or 2 1/4" door thickness only.

NOTE 2: Rose substitutions: 2-1/4" cast rose in place of 2-1/4" wrought rose, substitute letter "B" in place of "A" (e.g. GZB). **Add \$52.00 per lockset**
2-7/8" cast rose in place of 2-1/4" wrought rose, substitute letter "F" in place of "A" (e.g. GZF). **Add \$70.00 per lockset**

NOTE 3: Must Specify: SAF for Fail Safe or SEC for Fail Secure.

ElectroLynx®

As part of their promise to provide innovative, fast and effective high security solutions to their customers, certain ASSA ABLOY Group brands offer *ElectroLynx*®, a universal quick-connect system that simplifies the electrification of the door opening.

Electrically Controlled Mortise Locksets

ML20600 NAC Series Electrified Mortise Lock with High Security Monitoring

USA & Canada Prices Effective April 17, 2023



contemporary levers to complement the interior design of your next project

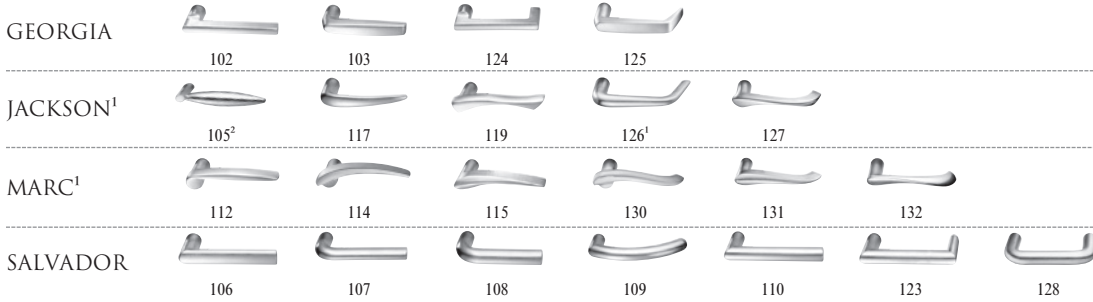

1. Handed: specify hand when ordering
2. Contact factory for current lead time

613E	Dark Oxidized Satin Bronze - Equivalent	605	Bright Brass, Clear Coated	618	Bright Nickel Plated
626	Satin Chromium Plated	606	Satin Brass, Clear Coated	619	Satin Nickel Plated
BSP	Black Suede Powder Coat	611	Bright Bronze, Clear Coated	625	Bright Chromium Plated
WSP	White Suede Powder Coat	612	Satin Bronze, Clear Coated	629*	Bright Stainless Steel
		613	Dark Oxidized Satin Bronze, Oil Rubbed	630*	Satin Stainless Steel
		613L	Dark Oxidized Satin Bronze, Clear Coated	722	Black Oxidized Bronze, Oil Rubbed

Function

Lever with Roses					
Single Cylinder	ML20606 x NAC	Fail Safe/Fail Secure	\$2,086.00		\$2,110.00
	ML20608 x NAC	Fail Safe/Fail Secure	\$2,176.00		\$2,200.00
No Cylinder Override	ML20607 x NAC	Fail Safe/Fail Secure	\$1,961.00		\$1,985.00
	ML20609 x NAC	Fail Safe/Fail Secure	\$2,050.00		\$2,074.00

ML20600 High Security Monitoring Options

Description	Specify	Add or Deduct
Mercury and Lenel compatible 1KΩ/2KΩ resistance supervision	R01	Add \$120.00 per lockset
Software House compatible 1KΩ/2KΩ resistance supervision	R03	Add \$120.00 per lockset
AMAG compatible 4-state supervision	R04	Add \$120.00 per lockset
Deadbolt Privacy Function	PHR	Add \$120.00 per lockset
Deadbolt Privacy and Mercury / Lenel 1KΩ/2KΩ	PHRR01	Add \$240.00 per lockset
Deadbolt Privacy and Software House 1KΩ/2KΩ	PHRR03	Add \$240.00 per lockset
Deadbolt Privacy and AMAG 4-State	PHRR04	Add \$240.00 per lockset



Ordering Example Details →

ML2000 Mortise Lock x NAC x No Cylinder x Deadbolt x Fail-Secure

- Muséo® lever 102 with J Collar
- Polished chrome finish
- Right hand reverse
- Deadbolt privacy function, Mercury and Lenel compatible 1KΩ/2KΩ resistance supervision

Stock Order							
Quantity	Series/Function	Technology Code	Trim	Finish	Hand	Fail Safe/Fail Secure	High Security Monitoring Options
24	ML20608	NAC	102J	625	RHR	SEC	PHRR01

*629 and *630 finish options are Not available for all Muséo levers. Please refer to page 26 for availability.



Experience a safer and more open world

Electrically Controlled Mortise Locksets

ML20600 NAC Series Electrified Mortise Lock with High Security Monitoring

USA & Canada Prices Effective April 17, 2023



contemporary levers to complement the interior design of your next project

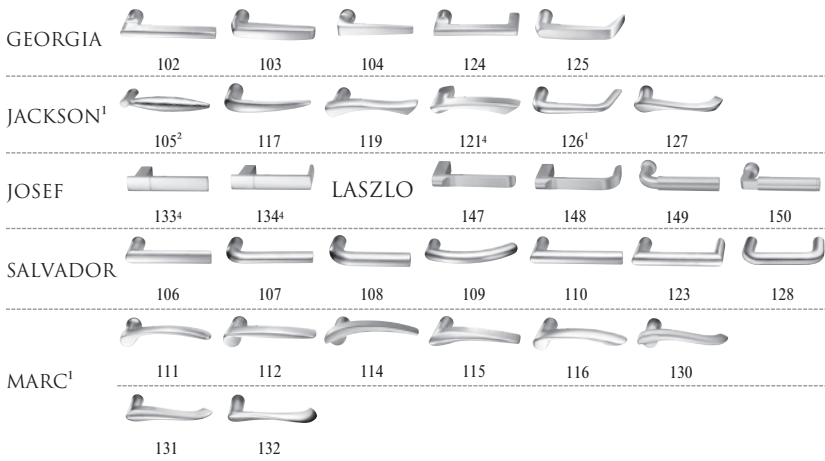

ROSES

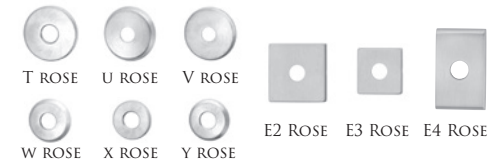

ESCUTCHEONS



THUMBTURNS³



1. Handed: specify hand when ordering
2. Contact factory for current lead time
3. Specify thumbturn as quick code. Thumbturn backplate will match shape of rose chosen (i.e. round or square). Not available with escutcheons.
4. Not available with VN escutcheon.
5. VN escutcheon available only with indicators. Must be ordered with "V" indicator options. See page 116 for available functions. Option add also applies.

*629 and *630 finish options are Not available for all Muséo levers. Please refer to page 26 for availability.

Function

Lever with Escutcheons: L,R				
Single Cylinder	ML20606 x NAC	Fail Safe/Fail Secure	\$1,993.00	\$2,017.00
	ML20608 x NAC	Fail Safe/Fail Secure	\$2,082.00	\$2,106.00
No Cylinder Override	ML20607 x NAC	Fail Safe/Fail Secure	\$1,867.00	\$1,891.00
	ML20609 x NAC	Fail Safe/Fail Secure	\$1,957.00	\$1,981.00

Lever with Roses: V,U,T,Y,X,W,E2,E3,E4				
Single Cylinder	ML20606 x NAC	Fail Safe/Fail Secure	\$1,927.00	\$1,951.00
	ML20608 x NAC	Fail Safe/Fail Secure	\$2,018.00	\$2,042.00
No Cylinder Override	ML20607 x NAC	Fail Safe/Fail Secure	\$1,802.00	\$1,826.00
	ML20609 x NAC	Fail Safe/Fail Secure	\$1,892.00	\$1,916.00

*Must specify: SAF for Fail Safe or SEC for Fail Secure.

ML20600 High Security Monitoring Options

Description	Specify	Add or Deduct
Mercury and Lenel compatible 1KΩ/2KΩ resistance supervision	R01	Add \$120.00 per lockset
Software House compatible 1KΩ/2KΩ resistance supervision	R03	Add \$120.00 per lockset
AMAG compatible 4-state supervision	R04	Add \$120.00 per lockset
Deadbolt Privacy Function	PHR	Add \$120.00 per lockset
Deadbolt Privacy and Mercury / Lenel 1KΩ/2KΩ	PHRR01	Add \$240.00 per lockset
Deadbolt Privacy and Software House 1KΩ/2KΩ	PHRR03	Add \$240.00 per lockset
Deadbolt Privacy and AMAG 4-State	PHRR04	Add \$240.00 per lockset



Ordering Example Details →

ML20600 NAC	ML20608	Single Cylinder
Escutcheon Trim	SEC	Fail Secure
	104	Salvador Family Lever
	L	Escutcheon
	613	Finish
	RHR	Handing
	24 AD	24 Volt AC/DC

Stock Order

Quantity	Series/Function	Technology Code	Trim	Finish	Hand	Fail Safe/Fail Secure	High Security Monitoring Options
24	ML20608	NAC	104L	613	RHR	SEC	PHRR01



ASSA ABLOY

Experience a safer and more open world

Electrically Controlled Mortise Locksets

ML20600 NAC Series Electrified Mortise Lock with High Security Monitoring

USA & Canada Prices Effective April 17, 2023



contemporary levers to complement the interior design of your next project

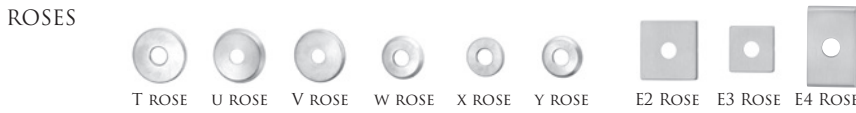

Specify thumbturn as quick code. Thumbturn backplate will match shape of rose chosen (i.e. round or square)

NOTES:
1. VN escutcheon available only with indicators. Must be ordered with "V" indicator options. See page 118 for available functions. Option add also applies.

613E	Dark Oxidized Satin Bronze – Equivalent
629	Bright Stainless Steel
630	Satin Stainless Steel
BSP	Black Suede Powder Coat
WSP	White Suede Powder Coat

Function

Lever with Escutcheons: L,R			
Single Cylinder	ML20606 x NAC	Fail Safe/Fail Secure*	\$2,190.00
	ML20608 x NAC		\$2,279.00
No Cylinder Override	ML20607 x NAC	Fail Safe/Fail Secure*	\$2,064.00
	ML20609 x NAC		\$2,154.00
Lever with Roses: V,U,T,Y,X,W,E2,E3,E4			
Single Cylinder	ML20606 x NAC	Fail Safe/Fail Secure*	\$2,103.00
	ML20608 x NAC		\$2,193.00
No Cylinder Override	ML20607 x NAC	Fail Safe/Fail Secure*	\$1,977.00
	ML20609 x NAC		\$2,068.00

ML20600 High Security Monitoring Options

Description	Specify	Add or Deduct
Mercury and Lenel compatible 1KΩ/2KΩ resistance supervision	R01	Add \$120.00 per lockset
Software House compatible 1KΩ/2KΩ resistance supervision	R03	Add \$120.00 per lockset
AMAG compatible 4-state supervision	R04	Add \$120.00 per lockset
Deadbolt Privacy Function	PHR	Add \$120.00 per lockset
Deadbolt Privacy and Mercury / Lenel 1KΩ/2KΩ	PHRR01	Add \$240.00 per lockset
Deadbolt Privacy and Software House 1KΩ/2KΩ	PHRR03	Add \$240.00 per lockset
Deadbolt Privacy and AMAG 4-State	PHRR04	Add \$240.00 per lockset

*Must specify: SAF for Fail Safe or SEC for Fail Secure.

Ordering Example Details

ML20600 NAC ML20914 Single Cylinder
 Escutcheon SEC Fail Secure
 Trim 23M Piet Family Lever - Wood Insert
 L Escutcheon
 29BH29 Lever Finish Wood insert with polished stainless steel (629) shank and polished stainless steel (629) grip
 Lock Finish
 629 Handing
 RHR
 24 AD 24 Volt AC/DC



ASSA ABLOY

Experience a safer and more open world

Stock Order									
Qty	Series/Function	Tech. Code	Trim	Lever Finish	Finish	Hand	Voltage	Fail Safe/Fail Secure	High Security Monitoring Options
2	ML20608	NAC	21ML	29BH29	629	RHR	24 AD	SEC	PHRR01

Electrically Controlled Mortise Locksets

ML20600 NAC Series Electrified Mortise Lock with High Security Monitoring

USA & Canada Prices Effective April 17, 2023



contemporary levers to complement the interior design of your next project

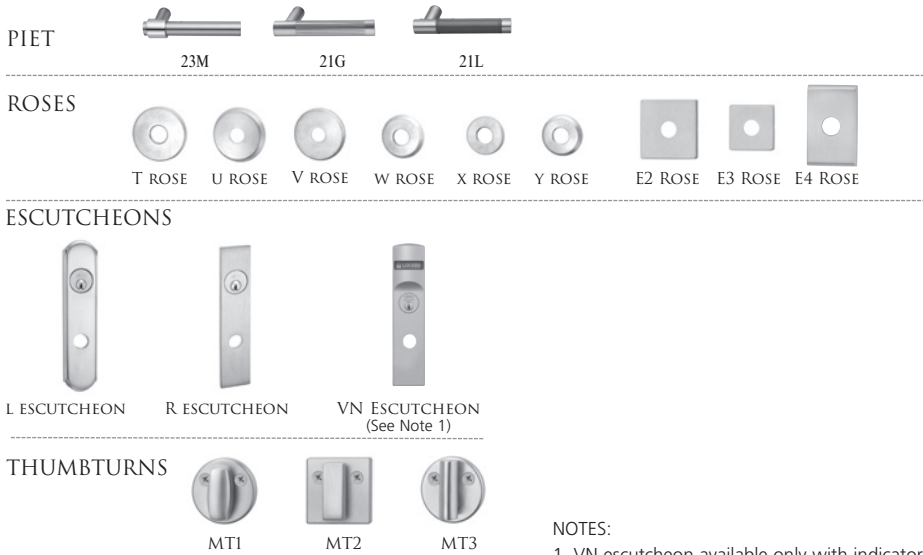

Specify thumbturn as quick code. Thumbturn backplate will match shape of rose chosen (i.e. round or square)

NOTES:

1. VN escutcheon available only with indicators. Must be ordered with "V" indicator options. See page 118 for available functions. Option add also applies.

613E	Dark Oxidized Satin Bronze – Equivalent
629	Bright Stainless Steel
630	Satin Stainless Steel
BSP	Black Suede Powder Coat
WSP	White Suede Powder Coat

Function

Lever with Escutcheons: L,R			
Single Cylinder	ML20606 x NAC	Fail Safe/Fail Secure*	\$2,308.00
	ML20608 x NAC		\$2,397.00
No Cylinder Override	ML20607 x NAC	Fail Safe/Fail Secure*	\$2,182.00
	ML20609 x NAC		\$2,272.00
Lever with Roses: V,U,T,Y,X,W,E2,E3,E4			
Single Cylinder	ML20606 x NAC	Fail Safe/Fail Secure*	\$2,220.00
	ML20608 x NAC		\$2,310.00
No Cylinder Override	ML20607 x NAC	Fail Safe/Fail Secure*	\$2,095.00
	ML20609 x NAC		\$2,184.00

ML20600 High Security Monitoring Options

Description	Specify	Add or Deduct
Mercury and Lenel compatible 1KΩ/2KΩ resistance supervision	R01	Add \$120.00 per lockset
Software House compatible 1KΩ/2KΩ resistance supervision	R03	Add \$120.00 per lockset
AMAG compatible 4-state supervision	R04	Add \$120.00 per lockset
Deadbolt Privacy Function	PHR	Add \$120.00 per lockset
Deadbolt Privacy and Mercury / Lenel 1KΩ/2KΩ	PHRR01	Add \$240.00 per lockset
Deadbolt Privacy and Software House 1KΩ/2KΩ	PHRR03	Add \$240.00 per lockset
Deadbolt Privacy and AMAG 4-State	PHRR04	Add \$240.00 per lockset

*Must specify: SAF for Fail Safe or SEC for Fail Secure.

BHMA CERTIFIED Ordering Example Details

ML20600 NAC	ML20608 Single Cylinder
Escutcheon Trim	SEC Fail Secure
23M	Piet Family Lever - Wood Insert
L	Escutcheon
29BH29	Lever Finish
629	Wood insert with polished stainless steel (629) shank and polished stainless steel (629) grip
RHR	Lock Finish
24 AD	Handing
	24 Volt AC/DC

Stock Order

Qty	Series/Function	Tech. Code	Trim	Lever Finish	Finish	Hand	Voltage	Fail Safe/Fail Secure	High Security Monitoring Options
2	ML20608	NAC	21ML	29BH29	629	RHR	24 AD	SEC	PHRR01



Experience a safer and more open world

Electrically Controlled Mortise Locksets

ML20600 NAC Series Electrified Mortise Lock with High Security Monitoring

USA & Canada Prices Effective April 17, 2023

contemporary levers to complement the interior design of your next project



JOSEF



GEORGES



ROSES

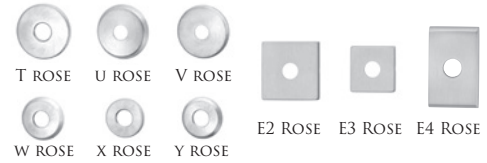

ESCUTCHEONS



THUMBTURNS³



1. Handed: specify hand when ordering.
2. Contact factory for current lead time.
3. Specify thumbturn as quick code. Thumbturn backplate will match shape of rose chosen (i.e. round or square).
Not available with escutcheons.
4. Not available with escutcheon indicators.

613E	Dark Oxidized Satin Bronze - Equivalent	605	Bright Brass, Clear Coated	618	Bright Nickel Plated
626	Satin Chromium Plated	606	Satin Brass, Clear Coated	619	Satin Nickel Plated
BSP	Black Suede Powder Coat	611	Bright Bronze, Clear Coated	625	Bright Chromium Plated
WSP	White Suede Powder Coat	612	Satin Bronze, Clear Coated	629	Bright Stainless Steel
		613	Dark Oxidized Satin Bronze, Oil Rubbed	630	Satin Stainless Steel
		613L	Dark Oxidized Satin Bronze, Clear Coated	722	Black Oxidized Bronze, Oil Rubbed

Function

Lever with Escutcheons: L,R					
Single Cylinder	ML20606 x NAC	Fail Safe/Fail Secure	\$2,284.00		\$2,308.00
	ML20608 x NAC	Fail Safe/Fail Secure	\$2,373.00		\$2,397.00
No Cylinder Override	ML20607 x NAC	Fail Safe/Fail Secure	\$2,158.00		\$2,182.00
	ML20609 x NAC	Fail Safe/Fail Secure	\$2,248.00		\$2,272.00

Lever with Roses: V,U,T,Y,X,W,E2,E3,E4					
Single Cylinder	ML20606 x NAC	Fail Safe/Fail Secure	\$2,196.00		\$2,220.00
	ML20608 x NAC	Fail Safe/Fail Secure	\$2,286.00		\$2,310.00
No Cylinder Override	ML20607 x NAC	Fail Safe/Fail Secure	\$2,071.00		\$2,095.00
	ML20609 x NAC	Fail Safe/Fail Secure	\$2,160.00		\$2,184.00

*Must specify: SAF for Fail Safe or SEC for Fail Secure.

ML20600 High Security Monitoring Options

Description	Specify	Add or Deduct
Mercury and Lenel compatible 1KΩ/2KΩ resistance supervision	R01	Add \$120.00 per lockset
Software House compatible 1KΩ/2KΩ resistance supervision	R03	Add \$120.00 per lockset
AMAG compatible 4-state supervision	R04	Add \$120.00 per lockset
Deadbolt Privacy Function	PHR	Add \$120.00 per lockset
Deadbolt Privacy and Mercury / Lenel 1KΩ/2KΩ	PHRR01	Add \$240.00 per lockset
Deadbolt Privacy and Software House 1KΩ/2KΩ	PHRR03	Add \$240.00 per lockset
Deadbolt Privacy and AMAG 4-State	PHRR04	Add \$240.00 per lockset

BHMA^{CERTIFIED} Ordering Example Details

ML20600 NAC Escutcheon Trim	ML20608	Single Cylinder
	SEC	Fail Secure
	104	Salvador Family Lever
	L	Escutcheon
	613	Finish
	RHR	Handing
	24 AD	24 Volt AC/DC



ASSA ABLOY

Experience a safer and more open world

Stock Order								
Quantity	Series/Function	Technology Code	Trim	Finish	Hand	Fail Safe/Fail Secure	High Security Monitoring Options	
24	ML20608	NAC	135L	613	RHR	SEC	PHRR01	

Copyright © 2002-2023 Corbin Russwin, Inc., an ASSA ABLOY Group company. All rights reserved. Reproduction in whole or in part without the express written permission of Corbin Russwin, Inc., is prohibited.

Contact us at: 800-543-3658 or visit www.corbinrusswin.com. In Canada contact us at: 800-461-3007 or visit www.assaabloydss.ca

Electrified Mortise Lock with High Security Monitoring ML20600 Series NAC

USA & Canada Prices Effective April 17, 2023

Description	Function	Option (See Note 3)	Levers: LW, RW Roses: A Roses: B, F (see note 1)		Levers: LW, RW Escutcheons: M, N		Levers: LW, RW Escutcheons: R (see note 2) VN (see note 4)	
			613E, 626, BSP, WSP	605, 606, 611, 612, 613, 618, 619, 625, 629, 630, 722	613E, 626, BSP, WSP	605, 606, 611, 612, 613, 618, 619, 625, 629, 630, 722	613E, 626, BSP, WSP	605, 606, 611, 612, 613, 618, 619, 625, 629, 630, 722
Single Cylinder	ML20606 x NAC	Fail Safe/Fail Secure	\$1,635.00	\$1,659.00	\$1,659.00	\$1,683.00	\$1,723.00	\$1,747.00
	ML20608 x NAC		\$1,724.00	\$1,748.00	\$1,748.00	\$1,772.00	\$1,813.00	\$1,837.00
No Cylinder Override	ML20607 x NAC	Fail Safe/Fail Secure	\$1,510.00	\$1,534.00	\$1,534.00	\$1,558.00	\$1,598.00	\$1,622.00
	ML20609 x NAC		\$1,599.00	\$1,623.00	\$1,623.00	\$1,647.00	\$1,687.00	\$1,711.00

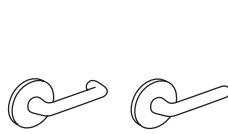

LWA RWA
Lever: Wrought
Rose: Wrought

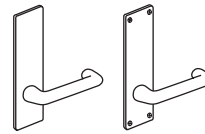

LWM LWN
Lever: Wrought
Escutcheon: Wrought

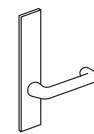

LWR
Lever: Wrought
Esc: Solid Stainless
Steel or Forged Brass

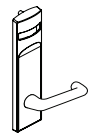

LWVN
Lever: Wrought
Escutcheon:
Forged Brass

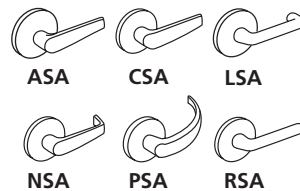

ASA CSA LSA
NSA PSA RSA
Lever: Cast
Rose: Wrought

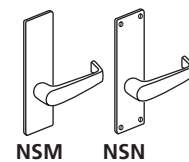

NSM NSN
Lever: Cast
Escutcheon: Wrought

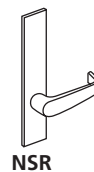

NSR
Lever: Cast
Esc: Solid Stainless
Steel or Forged Brass

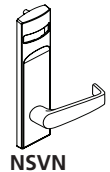

NSVN
Lever: Cast
Escutcheon:
Forged Brass

Description	Function	Option (See Note 3)	Levers: AS, CS, LS, NS, PS, RS Roses: A Roses: B, F (see note 1)		Levers: AS, CS, LS, NS, PS, RS Escutcheons: M, N		Levers: AS, CS, LS, NS, PS, RS Escutcheons: R (see note 2) VN (see note 4)	
			613E, 626, BSP, WSP	605, 606, 611, 612, 613, 618, 619, 625, 629, 630, 722	613E, 626, BSP, WSP	605, 606, 611, 612, 613, 618, 619, 625, 629, 630, 722	613E, 626, BSP, WSP	605, 606, 611, 612, 613, 618, 619, 625, 629, 630, 722
Single Cylinder	ML20606 x NAC	Fail Safe/Fail Secure	\$1,889.00	\$1,913.00	\$1,913.00	\$1,937.00	\$1,954.00	\$1,978.00
	ML20608 x NAC		\$1,979.00	\$2,003.00	\$2,002.00	\$2,026.00	\$2,044.00	\$2,068.00
No Cylinder Override	ML20607 x NAC	Fail Safe/Fail Secure	\$1,764.00	\$1,788.00	\$1,788.00	\$1,812.00	\$1,829.00	\$1,853.00
	ML20609 x NAC		\$1,854.00	\$1,878.00	\$1,877.00	\$1,901.00	\$1,918.00	\$1,942.00

- NOTES: 1. Rose substitutions for LWA, LSA, etc.: 2-1/4" cast rose in place of 2-1/4" wrought rose, substitute letter "B" in place of "A" (e.g. LSB).
Add \$52.00 per lockset. 2-7/8" cast rose in place of 2-1/4" wrought rose, substitute letter "F" in place of "A" (e.g. LWF). **Add \$70.00 per lockset.**
 2. "R" Escutcheon trims are available for 1 3/8", 1 3/4" or 2 1/4" door thickness only.
 3. Must Specify: SAF for Fail Safe or SEC for Fail Secure.
 4. VN escutcheon available only with indicators. Must be ordered with "V" indicator options. See page 118 for available functions.
 Option add also applies.

ElectroLynx®

As part of their promise to provide innovative, fast and effective high security solutions to their customers, certain ASSA ABLOY Group brands offer *ElectroLynx®*, a universal quick-connect system that simplifies the electrification of the door opening.

Electrified Mortise Lock with High Security Monitoring ML20600 Series NAC

USA & Canada Prices Effective April 17, 2023

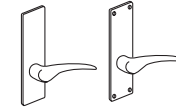
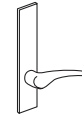
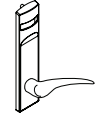
DSA **ESA**
 Lever: Cast
 Rose: Wrought

DSM **DSN**
 Lever: Cast
 Escutcheon: Wrought

DSR
 Lever: Cast
 Esc: Solid Stainless
 Steel or Forged Brass

DSVN
 Lever: Cast
 Escutcheon:
 Forged Brass

Lever: DS, ES
Roses: A
 Roses: B, F (see note 1)

Lever: DS, ES
Escutcheons: M, N
Lever: DS, ES
Escutcheons: R (see note 2)
VN (see note 4)

Description	Function	Option (See Note 3)	Lever: DS, ES Roses: A Roses: B, F (see note 1)		Lever: DS, ES Escutcheons: M, N		Lever: DS, ES Escutcheons: R (see note 2) VN (see note 4)	
			613E, 626, BSP, WSP	605, 606, 611, 612, 613, 618, 619, 625, 629, 630, 722	613E, 626, BSP, WSP	605, 606, 611, 612, 613, 618, 619, 625, 629, 630, 722	613E, 626, BSP, WSP	605, 606, 611, 612, 613, 618, 619, 625, 629, 630, 722
Single Cylinder	ML20606 x NAC	Fail Safe/Fail Secure	\$1,927.00	\$1,951.00	\$1,951.00	\$1,975.00	\$1,993.00	\$2,017.00
	ML20608 x NAC		\$2,018.00	\$2,042.00	\$2,040.00	\$2,064.00	\$2,082.00	\$2,106.00
No Cylinder Override	ML20607 x NAC	Fail Safe/Fail Secure	\$1,802.00	\$1,826.00	\$1,826.00	\$1,850.00	\$1,867.00	\$1,891.00
	ML20609 x NAC		\$1,892.00	\$1,916.00	\$1,915.00	\$1,939.00	\$1,957.00	\$1,981.00

NOTES: 1. Rose substitutions for DSA, ESA: 2-1/4" cast rose in place of 2-1/4" wrought rose, substitute letter "B" in place of "A" (e.g.DSB). **Add \$52.00 per lockset.** 2-7/8" cast rose in place of 2-1/4" wrought rose, substitute letter "F" in place of "A" (e.g. ESF). **Add \$70.00 per lockset.**

2. "R" Escutcheon trims are available for 1 3/8", 1 3/4", or 2 1/4" door thickness only.

3. Must Specify: SAF for Fail Safe or SEC for Fail Secure.

4. VN escutcheon available only with indicators. Must be ordered with "V" indicator options. See page 118 for available functions. Option add also applies.

Lever Designs: CSV, NSV

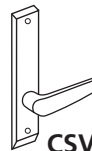
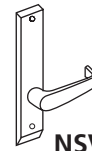
CSV

NSV

 Lever: Cast
 Escutcheon: Cast

Description	Function	Option (See Note 3)	CSV, NSV	
			Finish: 630	
Single Cylinder	ML20606VR x NAC	Fail Safe/Fail Secure	\$2,712.00	
	ML20608VR x NAC		\$2,801.00	
No Cylinder Override	ML20607VR x NAC	Fail Safe/Fail Secure	\$2,587.00	
	ML20609VR x NAC		\$2,676.00	

Note:
 Escutcheon trims are available for 1 3/8", 1 3/4", or 2 1/4" door thickness only.
 3. Must Specify: SAF for Fail Safe or SEC for Fail Secure.

ElectroLynx®

As part of their promise to provide innovative, fast and effective high security solutions to their customers, certain ASSA ABLOY Group brands offer *ElectroLynx®*, a universal quick-connect system that simplifies the electrification of the door opening.

Electrified Mortise Lock with High Security Monitoring ML20600 Series NAC

USA & Canada Prices Effective April 17, 2023

Lever Designs: FSG, MSG, ZSG



Frascati



Lever: Rose:
Cast Cast



Merlot

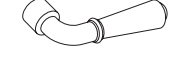

Lever Designs: FSL, MSL, ZSL, FSVN, MSVN, ZSVN



Zinfandel



Lever: Escutcheon:
Cast Cast

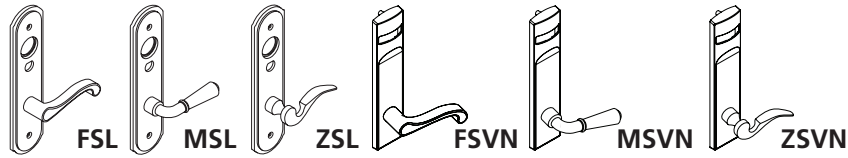

Description	Function	Option (See Note 3)	FSG, MSG, ZSG		FSL, MSL, ZSL FSVN, MSVN, ZSVN (see note 4)	
			Finish: 613E, 626, BSP, WSP	Finish: 605, 606, 611, 612, 613 ² , 613L ² , 618, 619, 625, 722	613E, 626, BSP, WSP	Finish: 605, 606, 611, 612, 613 ² , 613L ² , 618, 619, 625, 722
Single Cylinder	ML20606 x NAC	Fail Safe/Fail Secure	\$1,927.00	\$1,951.00	\$1,993.00	\$2,017.00
	ML20608 x NAC		\$2,018.00	\$2,042.00	\$2,082.00	\$2,106.00
No Cylinder Override	ML20607 x NAC	Fail Safe/Fail Secure	\$1,802.00	\$1,826.00	\$1,867.00	\$1,891.00
	ML20609 x NAC		\$1,892.00	\$1,916.00	\$1,957.00	\$1,981.00

- NOTES: 1. Escutcheon trims are available for 1-3/8", 1-3/4" or 2-1/4" door thicknesses only.
 2. 613 finish is brass base lever & rose/escutcheon.
 3. Must Specify: SAF for Fail Safe or SEC for Fail Secure.
 4. VN escutcheon available only with indicators. Must be ordered with "V" indicator options. See page 118 for available functions. Option add also applies.

ElectroLynx®

As part of their promise to provide innovative, fast and effective high security solutions to their customers, certain ASSA ABLOY Group brands offer *ElectroLynx®*, a universal quick-connect system that simplifies the electrification of the door opening.

Fail Safe/Fail Secure

Description	Specify Quick Code
Fail Safe	SAF
Fail Secure	SEC

Electrified Options for ML20900

Description	Specify Quick Code	Add or Deduct
Latchbolt Monitor	M91	\$279.00
Request to Exit (REX)	M92	\$276.00
Security monitor	M105	\$485.00
Latchbolt monitor x request to exit	M91 x M92	\$555.00
Request to Exit x security monitor	M92 x M105	\$761.00

Accessories

Part No.	Description	Add or Deduct
BPS-24-1	Power Supply 24V 1 AMP	\$485.00
BPS-12-1	Power Supply 12V 1 AMP	
BPS-24-2	Power Supply 24V 2 AMP	\$985.00
BPS-12-3	Power Supply 12V 3 AMP	

ML20600 High Security Monitoring Options

EcoFlex® Mortise Lock End-of-Line Resistors and Deadbolt Privacy Options

Description	Specify Quick Code	Add or Deduct
Mercury and Lenel compatible 1KΩ/2KΩ resistance supervision	R01	Add \$120.00 per lockset
Software House compatible 1KΩ/2KΩ resistance supervision	R03	Add \$120.00 per lockset
AMAG compatible 4-state supervision	R04	Add \$120.00 per lockset
Deadbolt Privacy Function	PHR	Add \$120.00 per lockset
Deadbolt Privacy and Mercury / Lenel 1KΩ/2KΩ	PHRR01	Add \$240.00 per lockset
Deadbolt Privacy and Software House 1KΩ/2KΩ	PHRR03	Add \$240.00 per lockset
Deadbolt Privacy and AMAG 4-State	PHRR04	Add \$240.00 per lockset

ElectroLynx®

As part of their promise to provide innovative, fast and effective high security solutions to their customers, certain ASSA ABLOY Group brands offer *ElectroLynx®*, a universal quick-connect system that simplifies the electrification of the door opening.

Lock Only

Includes lockcase, armored front, strike and screw pack. Cylinder(s) and thumbturn lever are not included.

Ordering Example

Quantity	Series/Function	Trim See Key Below	Finish	Door Thickness	Optional Strike
12	ML2055	LL	626	D138	SS078

Trim Key							
KK	Knob x Knob	LK	Lever x Knob	HL	Lever Inside only	LLBHSS	BHSS
LL	Lever x Lever	KL	Knob x Lever	HK	Knob inside Only		

Function	Description		LL, LK, KL, HL, HK ² , KK ² , LLBHSS
			Available in all listed mortise trim finishes
Non-Keyed	ML2010	Passage	\$531.00
	ML2020	Privacy	
	ML2030	Privacy	
	ML2040	Passage w/Indicator – VXX Option on Page 116 Applies	\$615.00
	ML2060	Privacy	
Single Cylinder	ML2003	Classroom	\$575.00
	ML2051	Office	
	ML2004	Classroom	
	ML2053	Entrance	\$590.00
	ML2054	Entrance	
	ML2055	Classroom	
	ML2056	Classroom Holdback	\$575.00
	ML2057	Storeroom	
	ML2058	Entrance Holdback	\$590.00
	ML2068	Privacy and Apartment	\$575.00
Single Cylinder with Deadbolt	ML2069	Institution Privacy	
	ML2024	Entrance	
	ML2048	Entrance	
	ML2049	Storeroom Deadbolt	
	ML2059	Security Storeroom	\$615.00
	ML2065	Dormitory	
	ML2067	Apartment	
	ML2073	Security	
Double Cylinder	ML2075	Classroom	
	ML2029	Hotel	\$626.00
	ML2002	Classroom Intruder	
	ML2032	Institution	
	ML2042	Entrance	
	ML2052	Classroom	
	ML2087	Security Vestibule	\$575.00
	ML2022	Store Door	
	ML2062	Intruder	
Single Cylinder	ML2072	Classroom	
	ML2082	Dormitory	
No Cylinder Override	ML2092	Security Institution	
	ML20914	Fail Safe/Fail Secure	
Double Cylinder	ML20906	Fail Safe/Fail Secure	
	ML20907	Fail Safe/Fail Secure	\$887.00
No Cylinder Override	ML20915	Fail Safe/Fail Secure	
	ML20932	Fail Safe/Fail Secure	
Single Cylinder	ML20987	Security Vestibule	
	ML20833	Without key override	
Deadbolt without key override	ML20834	With key override	
	ML20835	Deadbolt without key override	\$1,066.00
Single Cylinder with deadbolt	ML20836	Deadbolt with key override	

Notes: 1. Kits contain internal lock parts only. Order knobs, spindles, escutcheons, cylinders and collars separately.
 2. For master ring, specify quick code MR-LC. Add \$20.00. Not available for ML20900 series.

Cylinder & Keying Options		
Description	Specify Quick Code	Add or Deduct
Conventional 6-pin	(standard)	No Charge
Conventional 7-pin	7P	Add \$2.00 per cylinder
Less Standard Cylinder	LC	Deduct \$120.00 per cylinder
Less Hotel Cylinder	LC	Deduct \$177.00 per cylinder
Less Master Ring Cylinder ³	MR-LC	Deduct \$40.00 per cylinder
Less Concealed Shell Cylinder	PO-LC	Add \$5.00 per lockset
LFIC		
LFIC 6-pin	C6	Add \$104.00 per cylinder
LFIC 6-pin Less Core	CL6	No Charge
LFIC 6-pin with Temporary Construction Core (Red)	CT6R	Add \$104.00 per cylinder
LFIC 6-pin with Temporary Construction Core (Blue)	CT6B	Add \$104.00 per cylinder
LFIC 6-pin with Temporary Construction Core (Green)	CT6G	Add \$104.00 per cylinder
LFIC 6-pin with Temporary Disposable Core	CT6D	No Charge
LFIC 7-pin	C7	Add \$106.00 per cylinder
LFIC 7-pin Less Core	CL7	Add \$2.00 per cylinder
LFIC 7-pin with Temporary Construction Core (Red)	CT7R	Add \$106.00 per cylinder
LFIC 7-pin with Temporary Construction Core (Blue)	CT7B	Add \$106.00 per cylinder
LFIC 7-pin with Temporary Construction Core (Green)	CT7G	Add \$106.00 per cylinder
LFIC 7-pin with Temporary Disposable Core	CT7D	Add \$2.00 per cylinder
SFIC		
SFIC 6-pin	C6S	Add \$93.00 per cylinder
SFIC 6-pin with Less Core	CLS6	No Charge
SFIC 6-pin with Temporary Construction Core (Blue)	CT6SB	Add \$93.00 per cylinder
SFIC 6-pin with SFIC disposable temporary core	CT6SD	No Charge
SFIC 7-pin	C7S	Add \$93.00 per cylinder
SFIC 7-pin with Less Core	CLS7	No Charge
SFIC 7-pin with Temporary Construction Core (Blue)	CT7SB	Add \$93.00 per cylinder
SFIC 7-pin with SFIC disposable temporary core	CT7SD	No Charge
Security		
Security ⁵	HS	Add \$158.00 per cylinder
Security LFIC ^{1,5}	CHS	Add \$258.00 per cylinder
Access 3		
Access 3 Patented	AP	No Charge
Access 3 Security	AS	Add \$78.00 per cylinder
Access 3 High Security, UL 437	AHS	Add \$111.00 per cylinder
Access 3 LFIC Patented	ACP	Add \$104.00 per cylinder
Access 3 LFIC Security	ACS	Add \$182.00 per cylinder
Access 3 LFIC High Security, UL 437	ACHS	Add \$215.00 per cylinder
Pyramid		
Pyramid Security Fixed Core ²	PS	Add \$84.00 per cylinder
Pyramid Security LFIC	PCS	Add \$181.00 per cylinder
Pyramid High Security Fixed Core	PHS	Add \$125.00 per cylinder
Pyramid High Security LFIC	PCHS	Add \$223.00 per cylinder
Pyramid LFIC with Temporary Construction Core ⁴	CTP	Add \$104.00 per cylinder
Pyramid LFIC with Temporary Disposable Core ⁴	CTPD	No Charge
Pyramid LFIC Less Core ²	CLP	No Charge
Other		
Master Ring ³	MR	Add \$87.00 per cylinder
Flex Head Cylinder, 6-pin (sectional trim)	FX6	Add \$108.00 per cylinder
Flex Head Cylinder, 7-pin (sectional trim)	FX7	Add \$110.00 per cylinder
Flex Head Master Ring (sectional trim)	FXM	Add \$175.00 per cylinder
Plug only to show, 6-pin (concealed shell) (avail: for M & R escutcheons and single cyl. functions only)	P06	Add \$120.00 per lockset
Plug only to show, 7-pin (concealed shell) (avail: for M & R escutcheons and single cyl. functions only)	P07	Add \$122.00 per lockset

Notes:

1. CHS ordered with CT6 option no charge.
2. Pyramid series and LFIC-7 pin are not available in ML2029 function.
3. Available for "M" escutcheon and sectional trim only. Not available for 17, 29 or 32 functions, and ECL functions. Not available for ML20900 series.
4. Refer to Key construction core program, pg. 63 for example of CTP option pricing.
5. For existing systems only.

Cylinder & Keying Options* (continued)

Description	Specify Quick Code	Add or Deduct
0-Bitted with two blank keys ⁵	STDKEY	No Charge
Keyed Random ⁴	KR	No Charge
Master keyed (all cylinders except 8000, 8020, 8027, 8200)	MK	Add \$16.00 per cylinder
Master keyed Pyramid	MK	Add \$16.00 per cylinder
Master keyed Security (including LFIC cylinder and core)	MK	Add \$16.00 per cylinder
Master keyed (8000, 8020, 8027, 8200)	MK-IC	No Charge
Master keyed to customer bittings or sample key	MK-CB	Add \$16.00 per cylinder
Construction master keyed ^{1,2}	CMK	Add \$16.00 per cylinder
Visual key control (VKC)		
- No Stamping	VKC0	\$4.50
- Keys only	VKC1	No Charge
- Cylinders and Keys ³	VKC2	\$8.00
- Cylinders only ³	VKC3	\$8.00
Concealed key control (CKC)		
- CKC cylinders with VKC keys	CKC2	\$8.00
- CKC cylinders only ³	CKC3	\$8.00
More than 2 keys per lock	KY# (e.g., KY6)	See page 33 - Cut Keys Section

*Double Cylinder Keying: Unless otherwise specified, both cylinders of ML2012, 2022, 2032, 2052, 2062, 2072, 2082, 2092 function locks will be keyed alike. The inside cylinder of 42 function locks will be keyed to the master key(s) only, while the outside cylinder will include the change key. If different is required, specify outside cylinder first, then inside cylinder. For key bows other than 10 and 90, specify "KB" + bow number as Quick Code, e.g. KB12. No extra charge.

Notes:

1. CMK Construction master keying charge is in addition to master keying charge.
2. CMK Construction master keying is not available in interchangeable core, Access 3, Pyramid, or Security series.
3. VKC2, VKC3, CKC3 are not available in Pyramid or Security series.
4. Pyramid series is not available keyed random.
5. Security series is not available 0-bitted.

Strike Options*

(To purchase strike separately, see catalog or parts manual for part no.)

Lip Length	ANSI Straight Lip – Specify Quick Code	ANSI Curved Lip – Specify Quick Code	Add or Deduct
7/8"	SS078	N/A	No Charge
1-1/8"	(standard)	N/A	
1-1/4"	SS114	SA114	
1-3/8"	SS138	SA138	
1-1/2"	SS112	SA112	
1-3/4"	SS134	SA134	Add \$17.00 per lock
2"	SS200	SA200	
2-1/4"	SS214	SA214	
2-1/2"	SS212	SA212	
2-3/4"	SS234	SA234	
3"	SS300	SA300	

Description	Door Thickness	Specify Quick Code	Add or Deduct
Open Back Strike	1-3/4"	SB134	Add \$114.00 per lockset
Open Back Strike	2"	SB200	Add \$182.00 per lockset
Open Back Strike	2-1/4"	SB214	
Rabbeted front and strike		SR118	Add \$118.00 per lockset

* If door thickness is standard or has been specified and no special door or frame condition exist, then only the first two characters of the optional strike Quick Code must be specified (e.g. "SA").
The correct lip length will be determined by our order entry system based on the standard or specified door thickness.

Door Thickness with Locksets Mortised on Center

(Note: Door thickness with panel not to exceed 2" from centerline of lock.)

Door Thickness	Sectional Rose Trim Specify Quick Code	Escutcheon ^{1,2} Trim Specify Quick Code	Add or Deduct
1-3/4" (standard)	—	—	No Charge
1-3/8"	D138	D138	Add \$56.00
1-7/8"	D178	N/A	No Charge
2"	D200	D200	
2-1/8"	D218	N/A	
2-1/4"	D214	D214	
2-3/8"	D238	D238	
2-1/2"	D212	D212	Add \$92.00 per lockset
2-5/8"	D258	D258	
2-3/4"	D234	D234	
2-7/8"	D278	D278	
3"	D300	D300	
3-1/8"	D318	D318	
3-1/4"	D314	D314	
3-3/8"	D338	D338	
3-1/2"	D312	D312	
3-5/8"	D358	D358	
3-3/4"	D334	D334	
3-7/8"	D378	D378	
4"	D400	D400	

Notes:

1. For 2-3/8" to 4" door thickness: throughbolts and thumbturn lever spindle for 4" door will be provided. Throughbolts and spindles may be field cut.
2. "R" and "L" escutcheons are only available for 1-3/8", 1-3/4" and 2-1/4" door thicknesses.

Panel Applications

Specify Quick Code	Description	Add or Deduct
PNL ¹	Centerline of lockcase to edge of panel not to exceed 2"	Add \$92.00 per lockset

Note:

1. When ordering, specify door thickness (less panel), panel thickness, and side of door panel will be applied (outside or inside).

Custom Laser Engraving- LASER

Laser engraving processing charge (all engraving types)

- \$250.00 net per order. Charge will be applied to production order when placed.

Single Vanity, Logo or Other (same engraving on all parts)

- Lever - \$10.00 net add each
- Mortise Escutcheon - \$10.00 net add each
- HPSK Paddle - \$10.00 net add each

Unique laser engraving (i.e. Room Number, Apartment Number, etc)

- \$12.00 net add each (per piece)

Miscellaneous Options

Description	Specify Quick Code	Add or Deduct
Split designs and split finishes	Outside Trim x Inside Trim	Higher set price prevails
Spanner head screws	M02	Add \$28.00 per lockset
Torx® head screws (n/a with N escutcheon)	M04	Add \$34.00 per lockset
ANSI wrought strike box	M17	No Charge
Knurling outside and inside	M20**	Add \$196.00 per lockset
Knurling outside only	M21**	Add \$98.00 per lockset
Knurling inside only	M22**	Add \$98.00 per lockset
Abrasive coat outside and inside	M23 ¹	Add \$124.00 per lockset
Abrasive coat inside only	M24 ¹	Add \$62.00 per lockset
Abrasive coat outside only	M25 ¹	Add \$62.00 per lockset
Non-ferrous lockcase	M26	Add \$354.00 per lockset
Lead wrapped case	M29	Add \$373.00 per lockset
Half trim (for ML2010, ML2020, ML2022, ML2024, ML2029, ML2030, ML2032, ML2052, ML2053, ML2055, ML2056, ML2057, ML2058, ML2059, ML2062, ML2065 only) supplied with inside trim only	M30*	Deduct \$40.00 per lockset
Working trim only	M31	See pages 78 thru 94
Latch Hold Back 42, 51, 52, 55, 57 functions	LHB	Add \$58.00 per lockset
HPSK Positive Pull Stop Kit (813F068)		Add \$24.00
HPSK "PUSH" & "PULL" Identification (non-handed)	M38	\$35.00
HPSK Security Lever (not available on non-keyed functions)	M111	No Charge

* Not available with BHSS trim. Requires special application for BLSS, HSS, and HPSK trim.

** All levers provided in a powder coat finish will be supplied with an abrasive coating.

Thumbturn Options

Specify door thickness	Specify Quick Code	Add or Deduct
Ergonomic	M34 ²	Add \$20.00 per TT
Decorative	MT1	No Charge
Decorative square	MT2	No Charge
Decorative cylinder	MT3	No Charge



MT1



MT2



MT3

Notes:

1. Not available with Vineyard™ or Muséo® levers.
2. M34 is not available with M19N, M19VN or M19SN.

Note: Thumbturn backplate will match shape of rose chosen (i.e. round or square)

Indicator Options

Description	Specify Quick Code	Add or Deduct
Single Indicator Outside - Unlocked/Locked - Green/Red	V10	Add \$160.00 per lockset
Single Indicator Outside - Vacant/Occupied - Green/Red	V20	Add \$160.00 per lockset
Single Indicator Outside - Icons Only - Green/Red	V30	Add \$160.00 per lockset
Single Indicator Outside - Unlocked/Locked - White/Red	V40	Add \$160.00 per lockset
Single Indicator Outside - Vacant/Occupied - White/Red	V50	Add \$160.00 per lockset
Single Indicator Outside - Icons Only - White/Red	V60	Add \$160.00 per lockset
Single Indicator Inside - Unlocked/Locked - Green/Red	V01	Add \$160.00 per lockset
Single Indicator Inside - Icons Only - Green/Red	V03	Add \$160.00 per lockset
Single Indicator Inside - Unlocked/Locked - White/Red	V04	Add \$160.00 per lockset
Single Indicator Inside - Icons Only - White/Red	V06	Add \$160.00 per lockset
Double Indicator - Unlocked/Locked - Green/Red (Outside) Unlocked/Locked - Green/Red (Inside)	V11	Add \$320.00 per lockset
Double Indicator - Vacant/Occupied - Green/Red (Outside) Unlocked/Locked - Green/Red (Inside)	V21	Add \$320.00 per lockset
Double Indicator - Icons Only - Green/Red (Outside) Icons Only - Green/Red (Inside)	V33	Add \$320.00 per lockset
Double Indicator - Unlocked/Locked - White/Red (Outside) Unlocked/Locked - White/Red (Inside)	V44	Add \$320.00 per lockset
Double Indicator - Vacant/Occupied - White/Red (Outside) Unlocked/Locked - White/Red (Inside)	V54	Add \$320.00 per lockset
Double Indicator - Icons Only - White/Red (Outside) Icons Only - White/Red (Inside)	V66	Add \$320.00 per lockset
Single Indicator Outside - Secure/Unsecure - Green/Red (Sectional trim only)	M19S	Add \$175.00 per lockset
Single Indicator Outside - Vacant/Occupied - Green/Red (Sectional trim only)	M19V	Add \$175.00 per lockset
Single Indicator Inside - Secure/Unsecure - Green/Red (Sectional trim only)	M19N	Add \$175.00 per lockset
Double Indicator - Secure/Unsecure - Green/Red (Outside) Secure/Unsecure - Green/Red (Inside), (Sectional trim only)	M19SN	Add \$350.00 per lockset
Double Indicator - Vacant/Occupied - Green/Red (Outside) Secure/Unsecure - Green/Red (Inside) (Sectional trim only)	M19VN	Add \$350.00 per lockset
Outside Engraving with "Lock" and Directional Arrow	EMA	Add \$55.00 per lockset
Inside Engraving with "Lock" and Directional Arrow	EMB	Add \$55.00 per lockset
Engraving Both Sides with "Lock" and Directional Arrow	EMC	Add \$110.00 per lockset

French Options for V Series Indicators:

Description	Specify Quick Code	Add or Deduct
Single Indicator Outside - Ouvert/Fermé - Green/Red	V10F	Add \$160.00 per lockset
Single Indicator Outside - Libre/Occupée - Green/Red	V20F	
Single Indicator Inside - Ouvert/Fermé - Green/Red	V01F	Add \$320.00 per lockset
Double Indicator - Ouvert/Fermé - Green/Red (outside) Ouvert/Fermé - Green/Red (inside)	V11F	
Double Indicator - Ouvert/Fermé - Green/Red (outside) Libre/Occupée - Green/Red (inside)	V21F	

Sectional Trim Retrofit Kits for V Series Indicators (for M19 indicator refer to parts pages)

Description	Model #	List Price
Keyed Functions	ML190	\$260.00
Cointurn for Emergency Override	ML193	\$260.00
Thumbturn	ML194	\$260.00
No Input - Blank	ML197	\$260.00

NOTES:

When ordering sectional trim retrofit kits, specify finish, hand and V code required. i.e. ML190 x RH x 626 x V01. Kits accommodate indicators on one side of the door only. If indicators are required for both sides, 2 kits must be ordered as required by function. Add for indicator does not apply.

For escutcheon retrofit kits, specify function, trim, hand, finish and V code required X M31 option. See pages 78 thru 94 for pricing, add for indicator also applies.

Ordering Examples:

Function	Lever	Rose	Hand	Finish	Options
ML2002	NS	A	RH	626	V01

Double cylinder classroom intruder function x sectional trim x single indicator inside – Unlocked/Locked – Green/Red.

Function	Lever	Escutcheon	Hand	Finish	Options
ML2060	NS	VN	RH	626	V21 x EMB

Privacy function x escutcheon trim x double indicator – Vacant/Occupied – Green/Red (Outside) Unlocked/Locked – Green/Red (Inside) x inside engraving with "lock" and directional arrow.

NOTES:

- M19 series indicators are not available with BHSS or BLSS trims.
- V series indicators are not available with BHSS, BLSS, HSS or HPSK trims.
- EMA, EMB and EMC are only for use with V series indicators, for all other engraving, please refer to custom engraving options.
- Contact customer service for other available or custom indicator wording and/or colors.

Indicators and directional arrow engraving are available with the following functions:

ML2002, ML2003, ML2011, ML2012, ML2013, ML2017, ML2020, ML2022, ML2024, ML2029, ML2030, ML2040, ML2048, ML2049, ML2059, ML2060, ML2062, ML2065, ML2067, ML2068, ML2069, ML2072, ML2073, ML2075, ML2082, ML2092, ML20608 x NAC x SEC x PHR, ML20609 x NAC x SEC x PHR.

Please refer to the ML2000 Series catalog for more information.

MicroShield® Healthcare Hardware	120
Cylindrical Locks	
CLX3300 Series with BHSS Trim	121
CLX3300 Series Cylinder and Miscellaneous Options	122
Mortise Locks	
ML2000 Series with BHSS Trim	126
ML2000 Series with BLSS Trim	127
ML2000 Series with HSS Trim	128
ML2000 Series with HPSK Trim	129
ML2000 Series Cylinder and Miscellaneous Options	130
Tubular Locks	
HP3000 Series with HPSK Trim	133
HP3000 Series Miscellaneous Options	134

MicroShield®

Look for the *MicroShield* icon.

MicroShield®

As part of their promise to provide innovative solutions to their customers, certain ASSA ABLOY Group brands offer the MicroShield® technology, a silver-based antimicrobial coating designed to inhibit the growth of bacteria.

MicroShield® is a registered trademark of ASSA ABLOY Access and Egress Hardware Group, Inc.

Product	Trim	MicroShield® Coated Components
Healthcare Hardware	BHSS, BLSS, HSS, HPSK	Knobs/Levers, roses and/or escutcheons

AVAILABLE FINISHES

- MicroShield® is available on 626 and 630. Other finishes available by Special Product Application Request Form only.
- Specify 626C (satin chrome plated) or 630C (satin stainless steel) when ordering.
- MicroShield® coating will be applied over 626 and 630 finishes. All components will match 626.

Note: MicroShield® coating will only be applied to "high touch" components.

HOW TO ORDER

Product	How to Order
Mortise Locks	ML2055 x BHSS x 630C x RHR

Description	Add
Cylindrical Locks & Mortise Locks	Add \$90.00

Cylindrical Locks



Standard Features

Handing

Non-handed

Door Thickness

1-3/4" – 2"

Backset

2-3/4"

Strike

ANSI curved lip

4-7/8" x 1-1/4" x 1-1/4" lip
to center

Cylinder

Brass, 6-pin, L4 keyway, 0-bitted

Keys

Two nickel silver keys

Case Quantity

2

Case Weight

30 lbs



BHSS

Lever: Cast
Escutcheon: Cast

Ordering Examples

Stock Order

Quantity	Series/Function	Trim	Finish	Hand
100	CLX3355	BHSS	630	RHR

Contract/Detailed Order

Quantity	Keyset	Series/Function	Trim	Finish	Hand	Strike	Misc. Options	Cylinder and Keying
24	AA1	CLX3355	BHSS	630	RHR	SA112	M17	7P-VKC3

Product Number	Function	Description	630
CLX3310	Non-Keyed	Passage	\$1,915.00
CLX3330		Privacy	\$2,036.00
CLX3351	Single Cylinder	Entrance	\$2,165.00
CLX3355		Classroom	
CLX3357		Storeroom	
CLX3361		Entrance	
CLX3375		Corridor/Dormitory	
CLX3332	Double Cylinder	Institution	\$2,296.00
CLX3382		Store Door	

Note: Units are handed and are not field reversible. Lock handing must be specified on order.

Cylinder Options

Description	Specify Quick Code	Add or Deduct
Conventional 6-pin	(standard)	No Charge
Conventional 7-pin	7P	Add \$2.00 per cylinder
Less Cylinder(s)	LC	Deduct \$111.00 per cylinder
LFIC		
LFIC 6-pin	C6	Add \$104.00 per cylinder
LFIC 6-pin Less Core	CL6	No Charge
LFIC 6-pin with Temporary Construction Core (Red)	CT6R	Add \$104.00 per cylinder
LFIC 6-pin with Temporary Construction Core (Blue)	CT6B	Add \$104.00 per cylinder
LFIC 6-pin with Temporary Construction Core (Green)	CT6G	Add \$104.00 per cylinder
LFIC 6-Pin Disposable Core	CT6D	No Charge
LFIC 7-pin	C7	Add \$106.00 per cylinder
LFIC 7-pin Less Core	CL7	No Charge
LFIC 7-pin with Temporary Construction Core (Red)	CT7R	Add \$106.00 per cylinder
LFIC 7-pin with Temporary Construction Core (Blue)	CT7B	Add \$106.00 per cylinder
LFIC 7-pin with Temporary Construction Core (Green)	CT7G	Add \$106.00 per cylinder
LFIC 7-Pin Disposable Core	CT7D	No Charge
SFIC (all lever designs)		
SFIC 6-pin	C6S	Add \$93.00 per cylinder
SFIC 6-pin with Temporary Construction Core (Blue)	CT6SB	Add \$93.00 per cylinder
SFIC 6-pin or 7-pin Temporary Disposable core	CTSD	No Charge
SFIC 7-pin	C7S	Add \$93.00 per cylinder
SFIC 7-pin with Temporary Construction Core (Blue)	CT7SB	Add \$93.00 per cylinder
Security		
Security	HS	Add \$154.00 per cylinder
Security LFIC	CHS	Add \$258.00 per cylinder
Access 3		
Access 3® Patented Fixed Core	AP	No Charge
Access 3® Security Fixed Core	AS	Add \$78.00 per cylinder
Access 3® High Security Fixed Core	AHS	Add \$111.00 per cylinder
Access 3® Patented LFIC	ACP	Add \$104.00 per cylinder
Access 3® Security LFIC	ACS	Add \$182.00 per cylinder
Access 3® High Security LFIC	ACHS	Add \$215.00 per cylinder
Pyramid		
Pyramid Security Fixed Core	PS	Add \$83.00 per cylinder
Pyramid Security LFIC	PCS	Add \$181.00 per cylinder
Pyramid High Security Fixed Core	PHS	Add \$121.00 per cylinder
Pyramid High Security LFIC	PCHS	Add \$223.00 per cylinder
Pyramid with Temporary Construction Core	CTP	Add \$104.00 per cylinder
Pyramid Disposable Core	CTPD	No Charge
Pyramid LFIC Less Core	CLP	No Charge
Other		
Lockset furnished in Schlage® C Keyway	C	No Charge
Lockset furnished in Sargent® LA Keyway	LA	No Charge

Continued on next page

Cylinder Options (continued) & Keying Options*

Description	Specify Quick Code	Add or Deduct
Keying and Keys		
0-bitted with 2 Blank Keys	(standard)	No Charge
Keyed Random	KR	
Construction Master Keyed ¹	CMK	Add \$16.00 per cylinder
More than 2 Keys	KY# (e.g., KY6)	See page 33 - Cut Keys Section
Master Keying		
Master keyed (all cylinders except CR8000, CR8020, CR8027, CR8200, CR8500, CR8600, CR8700)	MK	Add \$16.00 per cylinder
Master keyed Pyramid (except CR8020, CR8027 LFIC cores)	MK	
Master keyed Security (including LFIC cylinder and core)	MK	
Master keyed Access 3 (except CR8500, CR8600, CR8700 LFIC cores)	MK	
Master keyed (CR8000, CR8020, CR8027, CR8200, CR8500, CR8600, CR8700)	MK-IC	No Charge
Master keyed to customer bittings or sample key	MK-CB	Add \$16.00 per cylinder
Visual Key Control (VKC)		
No bitting or keyset stamping on keys	VKC0	\$4.50
Keys only	VKC1	No Charge
Cylinders and keys (not for AS, AHS, ACS, ACHS, HS, CHS, PHS or PCHS)	VKC2	\$8.00
Cylinders only (not for AS, AHS, HS, ACS, ACHS, CHS, PHS or PCHS)	VKC3	
Concealed Key Control (CKC)		
CKC cylinders with VKC keys	CKC2	\$8.00
CKC cylinders only (not for AS, AHS, ACS, ACHS, PHS, PCHS)	CKC3	

Notes:

1. CMK Construction master keying charge is in addition to master keying charge and is not available in interchangeable core, Access 3, Pyramid, or Security series.

*Double cylinder keying: unless otherwise specified, both cylinders of 32 functions will be keyed alike. If different keying is required, specify outside cylinder first, then inside cylinder. For key bows other than 10 and 90, specify 'KB' + bow number as Quick Code, e.g. KB12.

Door Thickness Options

Description	Specify Quick Code	Add or Deduct
1-3/4" - 2"	(standard)	No Charge

Backset Options

Description	Specify Quick Code	Add or Deduct
2-3/4"	B234 (standard)	No Charge
3-3/4"	B334	Add \$15.00 per lockset
5"	B500	Add \$24.00 per lockset

Strike Options* (to purchase strike separately, see catalog or parts manual for part no.)

Lip Length	ANSI Curved Lip Specify Quick Code	Curved Lip Box Specify Quick Code	Full Lip Specify Quick Code	Add or Deduct
1"	SA100	SC100		No Charge
1-1/8"	SA118	SC118	SF118	
1-1/4"	SA114 (standard)	SC114		
1-3/8"	SA138	SC138		
1-1/2"	SA112	SC112		
1-3/4"	SA134	SC134		Add \$17.00 per lock
2"	SA200	SC200		
2-1/4"	SA214	SC214		
2-1/2"	SA212	SC212		
2-3/4"	SA234	SC234		
3"	SA300	SC300		

*If door thickness is standard or has been specified and no special door or frame condition exist, then only the first two characters of the optional strike Quick Code must be specified (e.g. "SC").
The correct lip length will be determined by our order entry system based on the standard or specified door thickness.

Miscellaneous Options

Description	Specify Quick Code	Add or Deduct
Torx® head screws (Standard)	M04	No Charge
Less cylinder, with tailpiece for Schlage® 6-pin fixed core cylinder (all designs)	M06	No Charge
Lever to accept 6 or 7-pin SFIC (all designs)	M08	No Charge
Lever to accept SARGENT® 6-pin fixed core cylinder (all designs)	M09	No Charge
1-1/8" latch front, rounded corners	M13	Add \$2.50 per latch
ANSI wrought strike box	M17	No Charge
Lead lining	M28	Add \$223.00 per lockset
Rigid outside lever when locked	M200	No Charge
Less cylinder, with tailpiece for Yale® 6-pin fixed core cylinder ² (all designs)	YC	
Less cylinder, with tailpiece for Yale® 7-pin fixed core cylinder ² (all designs)	YC7	

Mortise Locks



Standard Features

Handing

Handed – must specify

Door Thickness

1-3/4"

Backset

2-3/4"

Warranty

10 Years

Strike

ANSI curved lip

4-7/8" x 1-1/4" x 1-1/4" lip to center

Cylinder

Brass, 6-pin, L4 keyway, 0-bitted

Keys

Two nickel silver keys

Case Quantity

2

Case Weight

30 lbs

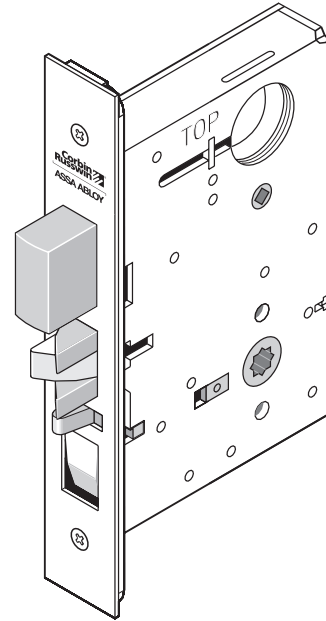

Ordering Example:

Stock Order

Quantity	Series/Function	Trim	Finish	Hand
100	ML2055	BLSS	630	RHR

Contract/Detailed Order

Quantity	Keyset	Series/Function	Trim	Finish	Hand	Strike	Misc. Options	Cylinder and Keying
24	AA1	ML2055	BHSS	630	RHR	SA200	M17-M29	C7-VKC3

Lever Design: BHSS

BHSS

Lever: Cast
Escutcheon: Cast

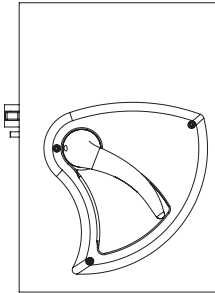

Function	Product No.	Description	630
Non-Keyed	ML2010	Passage	\$2,344.00
	ML2020	Privacy	\$2,437.00
	ML2030	Privacy	
	ML2060	Privacy	\$2,409.00
	ML2090	Full Active Dummy	\$2,021.00
Single Cylinder	ML2003	Classroom	\$2,497.00
	ML2051	Office	
	ML2055	Classroom	
	ML2056	Classroom HB	
	ML2057	Storeroom	
	ML2069	Institution Privacy	\$2,517.00
	ML2004	Classroom	
	ML2053	Entrance	
	ML2054	Entrance	
	ML2058	Entrance Holdback	
Single Cylinder with Deadbolt	ML2024	Entrance	\$2,557.00
	ML2048	Entrance	
	ML2049	Storeroom Deadbolt	
	ML2065	Dormitory	
	ML2059	Security Storeroom	
	ML2067	Apartment	
	ML2073	Classroom Security	
	ML2075	Entrance/Office	
ML2029	Hotel	\$2,601.00	
Double Cylinder	ML2002	Classroom Intruder	\$2,617.00
	ML2032	Institution	
	ML2042	Entrance	
	ML2052	Classroom Intruder	
Double Cylinder with Deadbolt	ML2022	Store Door	\$2,677.00
	ML2062	Intruder Deadbolt	
	ML2072	Classroom Security Intruder	
	ML2082	Dormitory	
	ML2092	Security Institution	
Single Cylinder	ML20906	Fail Safe/Fail Secure	\$2,902.00
	ML20914		
No Cylinder Override	ML20907	Fail Safe/Fail Secure	\$2,617.00
	ML20915		
Double Cylinder	ML20932	Fail Safe/Fail Secure	\$3,027.00
	ML20987		
Single Cylinder	ML20606	NAC Fail Safe/Fail Secure	\$3,111.00
	ML20608		
No Cylinder Override	ML20607	NAC Fail Safe/Fail Secure	\$2,826.00
	ML20609		
Full Working Trim	M31	No cylinder; includes thumbturn lever	\$1,885.00

Lever Design: BLSS

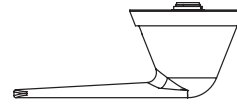
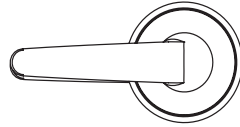

BLSS

Lever: Cast
Rose: Wrought

Function	Product No.	Description	630
Non-Keyed	ML2010	Passage	\$2,273.00
	ML2020	Privacy	\$2,366.00
	ML2030	Privacy	
	ML2060	Privacy	\$2,338.00
	ML2090	Full Active Dummy Trim	\$1,950.00
Single Cylinder	ML2003	Classroom	\$2,426.00
	ML2051	Office	
	ML2055	Classroom	
	ML2056	Classroom HB	
	ML2057	Storeroom	
	ML2069	Institution Privacy	\$2,446.00
	ML2004	Classroom	
	ML2053	Entrance	
	ML2054	Entrance	
	ML2058	Entrance	
Single Cylinder with Deadbolt	ML2024	Entrance	\$2,486.00
	ML2048	Entrance	
	ML2049	Storeroom Deadbolt	
	ML2059	Security Storeroom	
	ML2065	Dormitory	
	ML2067	Apartment	\$2,530.00
	ML2073	Classroom Security	
	ML2075	Classroom	
Double Cylinder	ML2002	Classroom Intruder	\$2,546.00
	ML2032	Institution	
	ML2042	Entrance	
	ML2052	Classroom	
Double Cylinder with Deadbolt	ML2022	Store Door	\$2,606.00
	ML2062	Intruder	
	ML2072	Classroom	
	ML2082	Dormitory	
	ML2092	Security Institution	
Single Cylinder	ML20906	Fail Safe/Fail Secure	\$2,831.00
	ML20914		
No Cylinder Override	ML20907	Fail Safe/Fail Secure	\$2,546.00
	ML20915		
Double Cylinder	ML20932	Fail Safe/Fail Secure	\$2,956.00
	ML20987		
Single Cylinder	ML20606	NAC Fail Safe/Fail Secure	\$3,040.00
	ML20608		\$3,129.00
No Cylinder Override	ML20607	NAC Fail Safe/Fail Secure	\$2,755.00
	ML20609		\$2,845.00
Full Working Trim	M31	No cylinder; includes thumbturn lever	\$1,814.00

Knob Design: HSS

HSS Knob: Brass



Function	Product No.	Description	630 ²
Non-Keyed	ML2010	Passage	\$2,063.00
	ML2020	Privacy	\$2,528.00
	ML2060	Privacy	\$2,495.00
	ML2090	Full Active Dummy Trim	\$2,096.00
Single Cylinder	ML2003	Classroom	\$2,588.00
	ML2051	Office	
	ML2055	Classroom	
	ML2056	Classroom HB	
	ML2057	Storeroom	
	ML2069	Inst. Privacy	\$2,608.00
	ML2004	Classroom	
	ML2053	Entrance	
	ML2054	Entrance	
	ML2058	Entrance	
	ML2068	Privacy	
Single Cylinder with Deadbolt	ML2024	Entrance	\$2,648.00
	ML2048		
Double Cylinder	ML2002	Classroom Intruder	\$2,708.00
	ML2032	Institution	
	ML2042	Entrance	
	ML2052	Classroom	
Double Cylinder with Deadbolt	ML2022	Store Door	\$2,768.00
	ML2092	Security Inst	
Deadlock	ML2011	Single Cylinder	\$805.00
	ML2012	Double Cylinder	\$925.00
	ML2013	Cylinder x Thumbturn	\$839.00
	ML2017	Classroom Function Cylinder x Thumbturn	
Single Cylinder	ML20906	Fail Safe/Fail Secure	\$2,995.00
	ML20914		
No Cylinder Override	ML20907	Fail Safe/Fail Secure	\$2,870.00
	ML20915		
Double Cylinder	ML20932	Fail Safe/Fail Secure	\$3,121.00
	ML20987		

Notes:

1. Sectional lever trim x HSS available.
2. 619 finish provided to match 630 finish.

Lever Design: HPSK

HPSK

Lever: Cast
Rose: Wrought

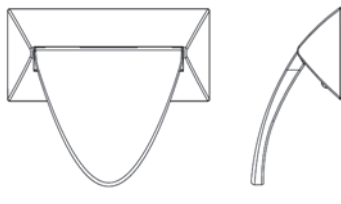

Function	Product No.	Description	630
Non-Keyed	ML2010	Passage	\$1,458.00
	ML2020	Privacy	\$1,525.00
	ML2030	Privacy	
	ML2060	Privacy	\$1,491.00
	ML2090	Full Active Dummy Trim	\$1,492.00
Single Cylinder	ML2003	Classroom	\$1,585.00
	ML2051	Office	
	ML2055	Classroom	
	ML2056	Classroom	
	ML2057	Storeroom	
	ML2069	Institution Privacy	\$1,605.00
	ML2004	Classroom	
	ML2053	Entrance	
	ML2054	Entrance	
	ML2058	Entrance Holdback	
Single Cylinder with Deadbolt	ML2068	Privacy or Apartment	\$1,688.00
	ML2024	Entrance	
	ML2048	Entrance	
	ML2065	Dormitory	
	ML2059	Security Storeroom	
	ML2067	Apartment	
	ML2073	Classroom Security	
	ML2075	Entrance/Office	
Double Cylinder	ML2029	Hotel	\$1,705.00
	ML2002	Classroom Intruder	
	ML2032	Institution	
	ML2042	Entrance	
	ML2052	Classroom Intruder	
Double Cylinder with Deadbolt	ML2087	Security Vestibule	\$1,765.00
	ML2022	Store Door	
	ML2062	Intruder Deadbolt	
	ML2072	Classroom Security Intruder	
	ML2082	Dormitory	
Single Cylinder	ML2092	Security Institution	\$1,946.00
	ML20906	Fail Safe/Fail Secure	
No Cylinder Override	ML20914	Fail Safe/Fail Secure	\$1,820.00
	ML20907	Fail Safe/Fail Secure	
Double Cylinder	ML20915	Fail Safe/Fail Secure	\$2,071.00
	ML20932	Fail Safe/Fail Secure	
Full Working Trim	ML20987	Fail Safe/Fail Secure	\$836.00
	M31	No cylinder, includes thumbturn lever	

Part of a continuum of Safer2Open™ low-touch and touchless door hardware solutions from ASSA ABLOY.

Cylinder & Keying Options		
Description	Specify Quick Code	Add or Deduct
Conventional 6-pin	(standard)	No Charge
Conventional 7-pin	7P	Add \$2.00 per cylinder
Less Standard Cylinder	LC	Deduct \$120.00 per cylinder
LFIC		
LFIC 6-pin	C6	Add \$104.00 per cylinder
LFIC 6-pin Less Core	CL6	No Charge
LFIC 6-pin with Temporary Construction Core (Red)	CT6R	Add \$104.00 per cylinder
LFIC 6-pin with Temporary Construction Core (Blue)	CT6B	Add \$104.00 per cylinder
LFIC 6-pin with Temporary Construction Core (Green)	CT6G	Add \$104.00 per cylinder
LFIC 6-pin with Temporary Disposable Core	CT6D	No Charge
LFIC 7-pin	C7	Add \$106.00 per cylinder
LFIC 7-pin Less Core	CL7	Add \$2.00 per cylinder
LFIC 7-pin with Temporary Construction Core (Red)	CT7R	Add \$106.00 per cylinder
LFIC 7-pin with Temporary Construction Core (Blue)	CT7B	Add \$106.00 per cylinder
LFIC 7-pin with Temporary Construction Core (Green)	CT7G	Add \$106.00 per cylinder
LFIC 7-pin with Temporary Disposable Core	CT7D	Add \$2.00 per cylinder
SFIC		
SFIC 6-pin	C6S	Add \$93.00 per cylinder
SFIC 6-pin with Less Core	CLS6	No Charge
SFIC 6-pin with Temporary Construction Core (Blue)	CT6SB	Add \$93.00 per cylinder
SFIC 6-pin with SFIC disposable temporary core	CT6SD	No Charge
SFIC 7-pin	C7S	Add \$93.00 per cylinder
SFIC 7-pin with Less Core	CLS7	No Charge
SFIC 7-pin with Temporary Construction Core (Blue)	CT7SB	Add \$93.00 per cylinder
SFIC 7-pin with SFIC disposable temporary core	CT7SD	No Charge
Security		
Security ⁴	HS	Add \$158.00 per cylinder
Security LFIC ^{1,4}	CHS	Add \$258.00 per cylinder
Access 3		
Access 3 Patented	AP	No Charge
Access 3 Security	AS	Add \$78.00 per cylinder
Access 3 High Security, UL 437	AHS	Add \$111.00 per cylinder
Access 3 LFIC Patented	ACP	Add \$104.00 per cylinder
Access 3 LFIC Security	ACS	Add \$182.00 per cylinder
Access 3 LFIC High Security, UL 437	ACHS	Add \$215.00 per cylinder
Pyramid		
Pyramid Security Fixed Core ²	PS	Add \$84.00 per cylinder
Pyramid Security LFIC	PCS	Add \$181.00 per cylinder
Pyramid High Security Fixed Core	PHS	Add \$125.00 per cylinder
Pyramid High Security LFIC	PCHS	Add \$223.00 per cylinder
Pyramid LFIC with Temporary Construction Core ³	CTP	Add \$104.00 per cylinder
Pyramid LFIC with Temporary Disposable Core ³	CTPD	No Charge
Pyramid LFIC Less Core ²	CLP	No Charge

Notes:

1. CHS ordered with CT6 option no charge.
2. Pyramid series and LFIC-7 pin are not available in ML2029 function.
3. Refer to Key construction core program, pg. 63 for example of CTP option pricing.
4. For existing systems only.

Cylinder & Keying Options* (continued)			
Description	Specify Quick Code	Add or Deduct	
0-Bitted with two blank keys ⁵	STDKEY	No Charge	
Keyed Random ⁴	KR	No Charge	
Master keyed (all cylinders except 8000, 8020, 8027, 8200)	MK	Add \$16.00 per cylinder	
Master keyed Pyramid	MK	Add \$16.00 per cylinder	
Master keyed Security (including LFIC cylinder and core)	MK	Add \$16.00 per cylinder	
Master keyed (8000, 8020, 8027, 8200)	MK-IC	No Charge	
Master keyed to customer bittings or sample key	MK-CB	Add \$16.00 per cylinder	
Construction master keyed ^{1,2}	CMK	Add \$16.00 per cylinder	
Visual key control (VKC)			
- No Stamping	VKC0	\$4.50	
- Keys only	VKC1	No Charge	
- Cylinders and Keys ³	VKC2	\$8.00	
- Cylinders only ³	VKC3	\$8.00	
Concealed key control (CKC)			
- CKC cylinders with VKC keys	CKC2	\$8.00	
- CKC cylinders only ³	CKC3	\$8.00	
More than 2 keys per lock	KY# (e.g., KY6)	See page 33 - Cut Keys Section	
<p>*Double Cylinder Keying: Unless otherwise specified, both cylinders of ML2012, 2022, 2032, 2052, 2062, 2072, 2082, 2092 function locks will be keyed alike. The inside cylinder of 42 function locks will be keyed to the master key(s) only, while the outside cylinder will include the change key. If different is required, specify outside cylinder first, then inside cylinder. For key bows other than 10 and 90, specify "KB" + bow number as Quick Code, e.g. KB12. No extra charge.</p> <p>Notes: 1. CMK Construction master keying charge is in addition to master keying charge. 2. CMK Construction master keying is not available in interchangeable core, Access 3, Pyramid, or Security series. 3. VKC2, VKC3, CKC3 are not available in Pyramid or Security series. 4. Pyramid series is not available keyed random. 5. Security series is not available 0-bitted.</p>			
Strike Options*			
(To purchase strike separately, see catalog or parts manual for part no.)			
Lip Length	ANSI Straight Lip – Specify Quick Code	ANSI Curved Lip – Specify Quick Code	Add or Deduct
7/8"	SS078	N/A	No Charge
1-1/8"	(standard)	N/A	
1-1/4"	SS114	SA114	
1-3/8"	SS138	SA138	
1-1/2"	SS112	SA112	
1-3/4"	SS134	SA134	Add \$17.00 per lock
2"	SS200	SA200	
2-1/4"	SS214	SA214	
2-1/2"	SS212	SA212	
2-3/4"	SS234	SA234	
3"	SS300	SA300	
<p>* If door thickness is standard or has been specified and no special door or frame condition exist, then only the first two characters of the optional strike Quick Code must be specified (e.g. "SA"). The correct lip length will be determined by our order entry system based on the standard or specified door thickness.</p>			

Door Thickness with Locksets Mortised on Center

Door Thickness	Specify Quick Code	Add or Deduct
1-3/4" (standard)	—	No Charge
2"	D200	
2-1/4"	D214	

Miscellaneous Options

Description	Specify Quick Code	Add or Deduct
Spanner head screws	M02	Add \$28.00 per lockset
Torx® head screws (Standard)	M04	No Charge
ANSI wrought strike box	M17	No Charge
Lead wrapped case	M29	Add \$373.00 per lockset
Latch Hold Back 42, 51, 52, 55, 57 functions	LHB	Add \$58.00 per lockset
HPSK Positive Pull Stop Kit (813F068)		Add \$24.00
HPSK "PUSH" & "PULL" Identification (non-handed)	M38	\$35.00
HPSK Security Lever (not available on non-keyed functions)	M111	No Charge

Tubular Locks



Standard Features

Handing

Passage (HP3010) function is non-handed
Privacy (HP3020) function is handed

Door Thickness

1-3/4" (44mm) standard.
Optional door thicknesses available

Backset (5" – Standard)

5" (127mm) standard.
Optional: 2-3/4" (70mm) and 7" (177mm)

Strike

ANSI curved lip strike standard,
4-7/8" x 1-1/4" x 1-1/4" lip to center.

Optional strikes, lip lengths and ANSI
wrought strike box available

Latchbolt

Brass, 1/2" (13mm) throw

Covers

Cast stainless steel

Paddles

Cast stainless steel



Ordering Example

Stock Order

Series/Function	Trim	Finish	Hand*
HP3010	HPSK	630	RH

*Passage (HP3010) function is non-handed and privacy (HP3020) function is handed.

Function	Description	630
HP3010	Passage	\$611.00
HP3020	Privacy	\$793.00

Part of a continuum of Safer2Open™ low-touch and touchless door hardware solutions from ASSA ABLOY.

Strike Options

Lip to Center	ANSI Curved Lip. Specify	Curved Lip Box. Specify	Full Lip. Specify	Add or Deduct
1" (25mm)	SA100	SC100		No Charge
1-1/8" (29mm)	SA118	SC118		
1-1/4" (32mm)	(standard)	SC114	SF114*	
1-3/8" (35mm)	SA138	SC138		
1-1/2" (38mm)	SA112	SC112		
1-3/4" (44mm)	SA134	SC134		Add \$17.00 per lock
2" (51mm)	SA200	SC200		
2-1/4" (57mm)	SA214	SC214		
2-1/2" (28mm)	SA212	SC212		
2-3/4" (70mm)	SA234	SC234		
3" (76mm)	SA300	SC300		

* Specify SFR114 for rounded corner.

Door Thickness Options

Description	Specify Quick Code	Add or Deduct
1-3/4" (44mm)	(standard)	No Charge
2" (51mm)	D200	

Backset Options

Description	Specify Quick Code	Add or Deduct
2-3/4" (70mm)	B234	No Charge
5" (127mm)	(standard)	
7" (177mm)	B700	Add \$6.00 per lockset

Miscellaneous Options

Description	Specify Quick Code	Add or Deduct
Spanner head screws	M02	Add \$28.00 per lockset
Torx® head screws	M04	Add \$34.00 per lockset
Latch front, rounded corners	M13	Add \$2.50 per latch
ANSI wrought strike box	M17	No Charge
Lead lining. Specify Push or Pull side.	M28	Add \$385.00 per lockset
"PUSH & PULL" Identification*	M38	Add \$35.00
Retrofit Kit (part no. 791F39)		Add \$76.00
HP3000 Positive Pull Stop Kit (813F068)		Add \$24.00

MicroShield® Cylindrical Locksets Finishes, How to Order, Pricing	136
TL3700 Museo Series Tubular Locksets:	
TL3700 Series: Museo Georgia, Jackson, Salvador, Marc Levers & Inspire Trim:	137
TL3700 Series: Museo Georgia, Jackson, Laszlo, Salvador, Marc Levers & Roses	138
TL3700 Series: Museo Josef, Georges Levers & Roses	139
TL3700 Series: Museo Piet Levers & Roses	140
TL3700 Series: Options	141
Grade 1 Vandal Resistant Cylindrical Lever Locksets CL3100 Series:	
CL3100 Series Standard Features, Ordering Examples	142
CL3100 Series Lever Designs	143
CL3100 Series Cylinder Options	144
CL3100 Series Keying Options	145
CL3100 Series Door Thickness, Backset, Strike Options	146
CL3100 Series Miscellaneous Options	147
Grade 1 Heavy-Duty Cylindrical Lever Locksets CLX3300 Series:	
CLX3300 Series Standard Features & Ordering Examples	148
CLX3300 Series Lever Designs	149
CLX3300 Series Cylinder Options	150
CLX3300 Series Keying Options	151
CLX3300 Series Door Thickness, Backset, Strike Options	152
CLX3300 Series Miscellaneous Options	153
Grade 1 Heavy-Duty Cylindrical Lever Locksets CL3300 Series:	
CL3300 Series Standard Features & Ordering Examples	154
CL3300 Series Lever Designs	155
CL3300 Series Cylinder Options	156
CL3300 Series Keying Options	157
CL3300 Series Door Thickness, Backset, Strike Options	158
CL3300 Series Miscellaneous Options	159
Grade 1 Cylindrical Lever Locksets CL3500 Series:	
CL3500 Series Standard Features & Ordering Examples	160
CL3500 Series Lever Designs	161
CL3500 Series Cylinder Options	162
CL3500 Series Keying Options	163
CL3500 Series Door Thickness, Backset, Strike Options	164
CL3500 Series Miscellaneous Options	165
Grade 2 Standard-Duty Lever Locksets CL3800 Series:	
CL3800 Series Standard Features & Ordering Options	166
CL3800 Series Lever Designs	167
CL3800 Series Cylinder & Keying Options	168
CL3800 Series Door Thickness, Backset, Strike, Miscellaneous Options	169
Grade 1 Cylindrical Knob Locksets CK4300 Series:	
CK4300 Series Standard Features & Ordering Example	170
CK4300 Series Knob Designs, Cylinder Keying Options	171
CK4300 Series Strike, Backset, Door Thickness, Miscellaneous Options	172
Grade 2 Cylindrical Knob Locksets CK4800 Series:	
CK4800 Series Standard Features & Ordering Example	173
CK4800 Series Knob Designs, Cylinder & Keying Options, Backset Options	174
CK4800 Series Strike, Miscellaneous Options	175
Grade 2 Cylindrical Knob Locksets CK4400 Series:	
CK4400 Series Standard Features & Ordering Example	176
CK4400 Series Knob Designs, Cylinder & Keying Options, Backset Options	177
CK4400 Series Strike, Miscellaneous Options	178

DISCONTINUED
CONTACT CUSTOMER SERVICE
FOR AVAILABILITY

MicroShield®

Look for the *MicroShield* icon.

TL3700
CL3100
CLX3300
CL3300
CL3500
CL3800

MicroShield®

As part of their promise to provide innovative solutions to their customers, certain ASSA ABLOY Group brands offer the MicroShield® technology, a silver-based antimicrobial coating designed to inhibit the growth of bacteria.

MicroShield® is a registered trademark of ASSA ABLOY Access and Egress Hardware Group, Inc.

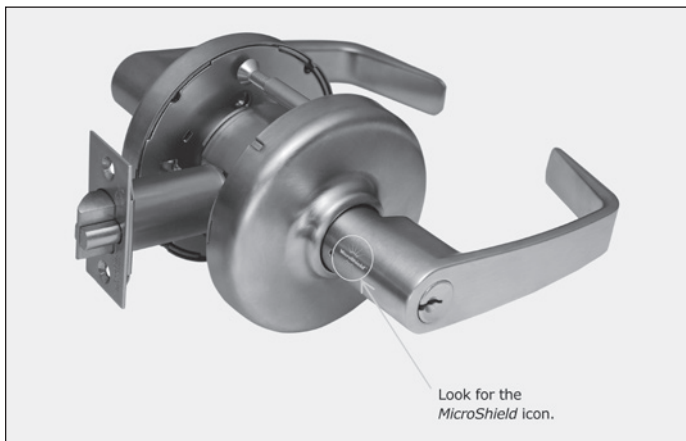

Product	Series	MicroShield® Coated Components
Cylindrical Locks	CL3100, CLX3300, CL3300, CL3500, and CL3800 Series	Levers*, roses

AVAILABLE FINISHES

- MicroShield® is available on 619 and 626. Other finishes available by Special Product Application Request Form only.
- Specify 619C (satin nickel plated) or 626C (satin chrome plated) when ordering.
- MicroShield® coating will be applied over 619 and 626 finishes. All components will match 626.

* MicroShield® coating will only be applied to "high touch" components.

HOW TO ORDER

Product	How to Order
Cylindrical Locks	CL3355 x NZD x 626C

Description	Add
Cylindrical Locks	Add \$90.00

Tubular Locksets

TL3700 Series: Muséo Levers and Inspire™ Roseless Trim

USA & Canada Prices Effective April 17, 2023



contemporary trim to complement the interior design of your next project

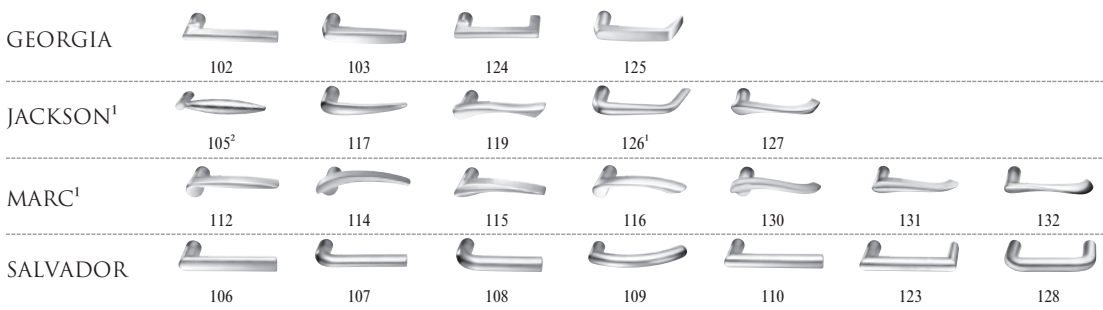

¹ Handed: specify hand when ordering
² Contact factory for current lead time

613E Dark Oxidized Satin Bronze - Equivalent
 626 Satin Chromium Plated
 BSP Black Suede Powder Coat
 WSP White Suede Powder Coat

605 Bright Brass, Clear Coated
 606 Satin Brass, Clear Coated
 611 Bright Bronze, Clear Coated
 612 Satin Bronze, Clear Coated
 613 Dark Oxidized Satin Bronze, Oil Rubbed
 613L Dark Oxidized Satin Bronze, Clear Coated
 618 Bright Nickel Plated
 619 Satin Nickel Plated
 625 Bright Chromium Plated
 629* Bright Stainless Steel
 630* Satin Stainless Steel
 722 Black Oxidized Bronze, Oil Rubbed

Function

TL3710	Passage Set	\$375.00	\$385.00
TL3710A	Passage Set-3 Hour	\$382.00	\$392.00
TL3720	Privacy Set	\$400.00	\$410.00
TL3720A	Privacy Set-3 Hour	\$407.00	\$417.00
TL3750	Single Lever Pull-Through Bolted	\$194.00	\$199.00
TL3770	Double Lever Pull	\$309.00	\$319.00
TL3780	Communicating Set	\$375.00	\$385.00
TL3780A	Communicating Set-3 Hour	\$382.00	\$392.00

Ordering Example Details

TL3710 Passage: Non-Keyed tubular lock
 102J Georgia Family Lever, J Collar
 626 Satin Chrome Finish
 LH Left Handed

Complete Lockset

Quantity	Series/Function	Trim	Finish	Hand
24	TL3710	102J	626	LH

*629 and *630 finish options are Not available for all Muséo levers. Please refer to page 26 for availability.



Experience a safer
and more open world

Tubular Locksets

TL3700 Series: Muséo Levers and Roses

USA & Canada Prices Effective April 17, 2023

contemporary trim to complement the interior design of your next project

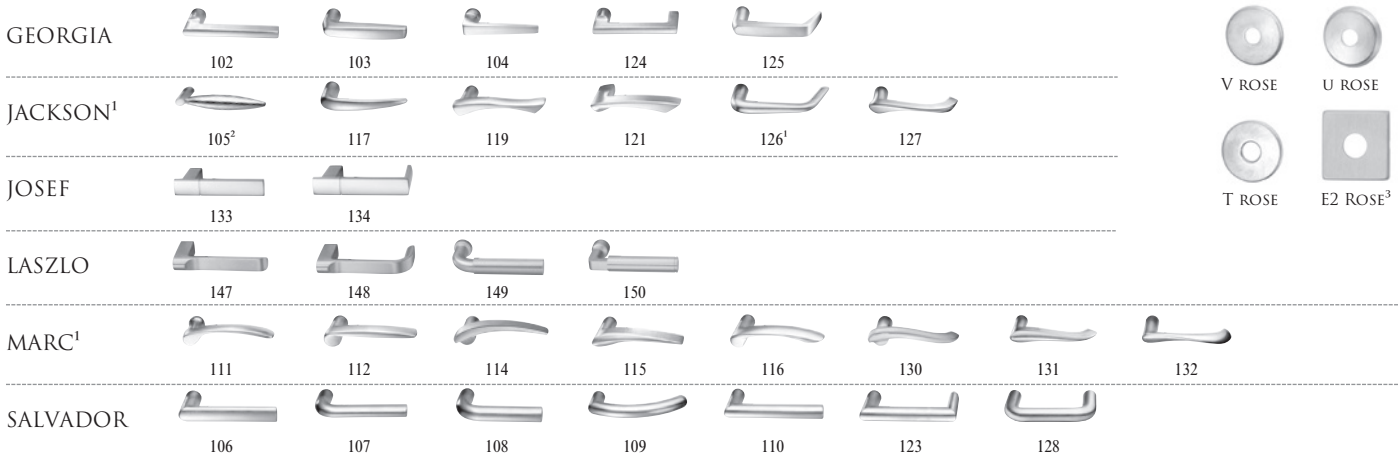

¹Handed: specify hand when ordering

²Contact factory for current lead time

³**CAUTION:** Cannot retrofit on existing cylindrical lock door preps with through-bolt holes outside the 2-1/8" bored hole (Ex. CL3300 & CL3500).

613E	Dark Oxidized Satin Bronze - Equivalent	605	Bright Brass, Clear Coated
626	Satin Chromium Plated	606	Satin Brass, Clear Coated
BSP	Black Suede Powder Coat	611	Bright Bronze, Clear Coated
WSP	White Suede Powder Coat	612	Satin Bronze, Clear Coated
		613	Dark Oxidized Satin Bronze, Oil Rubbed
		613L	Dark Oxidized Satin Bronze, Clear Coated
		618	Bright Nickel Plated
		619	Satin Nickel Plated
		625	Bright Chromium Plated
		629*	Bright Stainless Steel
		630*	Satin Stainless Steel
		722	Black Oxidized Bronze, Oil Rubbed

Function

TL3710	Passage Set	\$304.00	\$314.00
TL3710A	Passage Set-3 Hour	\$311.00	\$321.00
TL3720	Privacy Set	\$323.00	\$333.00
TL3720A	Privacy Set-3 Hour	\$330.00	\$340.00
TL3750	Single Lever Pull-Through Bolted	\$165.00	\$170.00
TL3750S	Single Lever Pull-Surface Mounted	\$134.00	\$139.00
TL3770	Double Lever Pull	\$254.00	\$264.00
TL3780	Communicating Set	\$304.00	\$314.00
TL3780A	Communicating Set-3 Hour	\$311.00	\$321.00

Ordering Example Details →

TL3710 Passage: Non-Keyed tubular lock
111T Marc Lever, T-Rose
626 Satin Chrome Finish
LH Left Handed

Complete Lockset				
Quantity	Series/Function	Trim	Finish	Hand
24	TL3710	111T	626	LH

*629 and *630 finish options are Not available for all Muséo levers. Please refer to page 26 for availability.



Experience a safer and more open world

Tubular Locksets

TL3700 Series: Muséo Levers and Roses

USA & Canada Prices Effective April 17, 2023

contemporary levers to complement the interior design of your next project



JOSEF



GEORGES

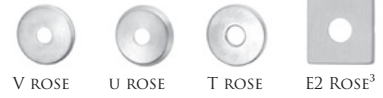

*Georges Levers 140, 141 and 143 are not available for the following functions: TL3720 and TL3720A

¹Handed: specify hand when ordering

²Contact factory for current lead time

³**CAUTION:** Cannot retrofit on existing cylindrical lock door preps with through-bolt holes outside the 2-1/8" bored hole (Ex. CL3300 & CL3500).

613E Dark Oxidized Satin Bronze - Equivalent
626 Satin Chromium Plated
BSP Black Suede Powder Coat
WSP White Suede Powder Coat

605 Bright Brass, Clear Coated
606 Satin Brass, Clear Coated
611 Bright Bronze, Clear Coated
612 Satin Bronze, Clear Coated
613 Dark Oxidized Satin Bronze, Oil Rubbed
613L Dark Oxidized Satin Bronze, Clear Coated
618 Bright Nickel Plated
619 Satin Nickel Plated
625 Bright Chromium Plated
629 Bright Stainless Steel
630 Satin Stainless Steel
722 Black Oxidized Bronze, Oil Rubbed

Function

Function	Price	Price
TL3710 Passage Set	\$423.00	\$433.00
TL3710A Passage Set-3 Hour	\$430.00	\$440.00
TL3720* Privacy Set	\$440.00	\$450.00
TL3720A* Privacy Set-3 Hour	\$447.00	\$457.00
TL3750 Single Lever Pull-Through Bolted	\$282.00	\$287.00
TL3750S Single Lever Pull-Surface Mounted	\$251.00	\$256.00
TL3770 Double Lever Pull	\$374.00	\$384.00
TL3780 Communicating Set	\$423.00	\$433.00
TL3780A Communicating Set-3 Hour	\$430.00	\$440.00

Ordering Example Details →

TL3710 Passage: Non-Keyed tubular lock
135E2 Josef Lever, E2 Rose
626 Satin Chrome Finish
LH Left Handed

Complete Lockset				
Quantity	Series/Function	Trim	Finish	Hand
24	TL3710	135E2	626	LH



Experience a safer and more open world

Tubular Locksets

TL3700 Series: Muséo Levers and Roses

USA & Canada Prices Effective April 17, 2023



contemporary trim to complement the interior design of your next project



*613E, BSP, WSP finishes are not available with 21M levers.



613E	Dark Oxidized Satin Bronze – Equivalent
629	Bright Stainless Steel
630	Satin Stainless Steel
BSP	Black Suede Powder Coat
WSP	White Suede Powder Coat

Function

TL3710	Passage Set	\$331.00
TL3710A	Passage Set - 3 Hour	\$338.00
TL3720	Privacy Set	\$350.00
TL3720A	Privacy Set - 3 Hour	\$357.00
TL3750	Single Lever Pull - Through Bolted	\$183.00
TL3750S	Single Lever Pull - Surface Mounted	\$152.00
TL3770	Double Lever Pull	\$280.00
TL3780	Communicating Set	\$331.00
TL3780A	Communicating Set - 3 Hour	\$338.00



613E	Dark Oxidized Satin Bronze – Equivalent
629	Bright Stainless Steel
630	Satin Stainless Steel
BSP	Black Suede Powder Coat
WSP	White Suede Powder Coat

Function

TL3710	Passage Set	\$433.00
TL3710A	Passage Set - 3 Hour	\$440.00
TL3720	Privacy Set	\$450.00
TL3720A	Privacy Set - 3 Hour	\$457.00
TL3750	Single Lever Pull - Through Bolted	\$287.00
TL3750S	Single Lever Pull - Surface Mounted	\$256.00
TL3770	Double Lever Pull	\$384.00
TL3780	Communicating Set	\$433.00
TL3780A	Communicating Set - 3 Hour	\$440.00

Ordering Example Details

TL3710	Passage: Non-Keyed tubular lock
23MU	Piet Family Lever - Wood Insert, U-Rose
29BH29	Lever Finish Wood insert with polished stainless steel (629) shank and polished stainless steel (629) grip
629	Lock Finish
LH	Left Handed

Complete Lockset					
Quantity	Series/Function	Trim	Lever Finish	Lock Finish	Hand
2	TL3710	23MU	29BH29	629	LH

¹**CAUTION:** Cannot retrofit on existing cylindrical lock door preps with through-bolt holes outside the 2-1/8" bored hole (Ex. CL3300 & CL3500).



Experience a safer and more open world

Door Thickness Options

Description	Specify Quick Code	Add or Deduct
1-3/8" (35mm) up to 1-3/4" (44mm)	D138	No Charge
1-3/4" (44mm) up to 2-1/4" (57mm)	(standard)	
2-1/4" (57mm) up to 2-1/2" (64mm)	D214	
Consult factory if over 2-1/2" (64mm)		

Backset Options

Description	Specify Quick Code	Add or Deduct
2-3/4"	B234 (standard)	No Charge
2-3/8" ¹	B238	

Strike Options

Lip Length	ANSI Curved Lip - Specify Quick Code	Curved Lip Box - Specify Quick Code	Full Lip Specify Quick Code	Full Lip Radius Corner Specify Quick Code	Add or Deduct
1"	SA100	SC100			No Charge
1-1/8"	SA118	SC118			
1-1/4"	SA114	SC114 (standard)	SF114	SFR114	
1-3/8"	SA138	SC138			
1-1/2"	SA112	SC112 ²			Add \$17.00 per lock
1-3/4"	SA134	SC134			
2"	SA200	SC200			
2-1/4"	SA214	SC214			
2-1/2"	SA212	SC212			
2-3/4"	SA234	SC234			
3"	SA300	SC300			

Miscellaneous Options

Description	Specify Quick Code	Add or Deduct
Latch front, rounded corners	M13	Add \$2.50 per latch
1" (25mm) latch front, square corners ³	M14	Add \$6.00 per lockset
1" (25mm) latch front, rounded corners	M15	Add \$2.50 per latch
ANSI wrought strike box	M17	Add \$6.00 per lockset

Notes:

- 1" front supplied standard
- Standard for D214
- Standard for 2-3/8" backset



Grade 1 Vandal Resistant Cylindrical Lever Locksets CL3100 Series

USA & Canada Prices Effective April 17, 2023

Standard Features

Handing

Non-handed

Door Thickness

1-3/4" - 2" standard

Backset

2-3/4" standard

Strike

ANSI curved lip
4-7/8" x 1-1/4" x 1-1/4" lip to center

Cylinder

Brass, 6-pin, L4 keyway,
0-bitted

Keys

Two nickel silver keys

Case Quantity

6

Case Weight

32 lbs

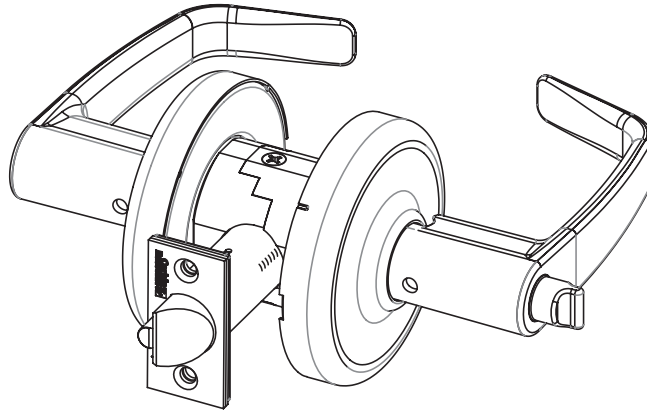

Ordering Examples

Stock Order

Quantity	Series/Function	Trim	Finish	Hand
100	CL3155	NZD	626	RHR

Split Finish Order

Quantity	Series/Function	Finish		Hand
		Outside	Inside	
12	CL3155	626	625	RHR

Note: Higher set price prevails

Contract/Detailed Order

Quantity	Keyset	Series/Function	Trim	Finish	Hand	Strike	Misc. Options	Cylinder and Keying
24	AA1	CL3155	NZD	626	RHR	SA112	M17	C6-VKC3

Lever Designs:  **Levers** **Roses**

Lever: Solid Cast Zinc
Rose: Brass

Newport



C ROSE

Armstrong



D ROSE

Princeton

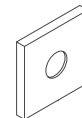

E ROSE



K ROSE

Function	Description		AZC, AZD, AZE, AZK, NZC, NZD, NZE, NZK, PZC, PZD, PZE, PZK	
			Finish: 613E, 626, BSP, WSP	Finish: 605, 606, 611, 612, 613, 613L, 618, 619, 625, 722
CL3110	Non-Keyed	Passage	\$699.00	\$715.00
CL3120		Privacy	\$795.00	\$811.00
CL3120H		Hospital Privacy		
CL3140NT		Exit Latch		
CL3150		Half Dummy	\$315.00	\$323.00
CL3170		Full Dummy	\$625.00	\$641.00
CL3180		Passage x blank plate	\$795.00	\$811.00
CL3151	Single Cylinder	Entrance	\$939.00	\$955.00
CL3155		Classroom		
CL3157		Storeroom		
CL3161		Entrance	\$959.00	\$975.00
CL3175		Corridor/dormitory	\$1,054.00	\$1,070.00
CL3193		Service Station		
CL3129		Hotel		
CL3132	Double Cylinder	Institution	\$1,101.00	\$1,117.00
CL3152		Classroom Intruder		
CL3162		Communicating		
CL3172		Public Toilet		

Grade 1 Vandal Resistant Cylindrical Lever Locksets CL3100 Series

USA & Canada Prices Effective April 17, 2023

Cylinder & Keying Options		
Description	Specify Quick Code	Add or Deduct
Conventional 6-pin	(standard)	No Charge
Conventional 7-pin	7P	Add \$2.00 per cylinder
Less Cylinder ⁴	LC	Deduct \$111.00 per cylinder
Less Hotel Cylinder	LC	Deduct \$127.00 per cylinder
LFIC		
LFIC 6-pin	C6	Add \$104.00 per cylinder
LFIC 6-pin Less Core ³	CL6	No Charge
LFIC 6-pin with Temporary Construction Core (Red) ³	CT6R	Add \$104.00 per cylinder
LFIC 6-pin with Temporary Construction Core (Blue) ³	CT6B	Add \$104.00 per cylinder
LFIC 6-pin with Temporary Construction Core (Green) ³	CT6G	Add \$104.00 per cylinder
LFIC 6-pin with Temporary Disposable Core	CT6D	No Charge
LFIC 7-pin	C7	Add \$106.00 per cylinder
LFIC 7-pin Less Core ³	CL7	No Charge
LFIC 7-pin with Temporary Construction Core (Red) ³	CT7R	Add \$106.00 per cylinder
LFIC 7-pin with Temporary Construction Core (Blue) ³	CT7B	Add \$106.00 per cylinder
LFIC 7-pin with Temporary Construction Core (Green) ³	CT7G	Add \$106.00 per cylinder
LFIC 7-pin with Temporary Disposable Core	CT7D	No Charge
SFIC³		
SFIC 6-pin	C6S	Add \$93.00 per cylinder
SFIC 6-pin with Temporary Construction Core (Blue)	CT6SB	Add \$93.00 per cylinder
SFIC 6-pin or 7-pin Temporary Disposable core	CTSD	No Charge
SFIC 7-pin	C7S	Add \$93.00 per cylinder
SFIC 7-pin with Temporary Construction Core (Blue)	CT7SB	Add \$93.00 per cylinder
Security		
Security ³	HS	Add \$154.00 per cylinder
Security LFIC ³	CHS	Add \$258.00 per cylinder
Access 3		
Access 3 Patented	AP	No Charge
Access 3 Security	AS	Add \$78.00 per cylinder
Access 3 High Security, UL 437	AHS	Add \$111.00 per cylinder
Access 3 LFIC Patented	ACP	Add \$104.00 per cylinder
Access 3 LFIC Security	ACS	Add \$182.00 per cylinder
Access 3 LFIC High Security, UL 437	ACHS	Add \$215.00 per cylinder
Pyramid		
Pyramid Security Fixed Core ³	PS	Add \$83.00 per cylinder
Pyramid Security LFIC ³	PCS	Add \$181.00 per cylinder
Pyramid High Security Fixed Core ³	PHS	Add \$121.00 per cylinder
Pyramid High Security LFIC ³	PCHS	Add \$223.00 per cylinder
Pyramid LFIC with Temporary Construction Core	CTP	Add \$104.00 per cylinder
Pyramid LFIC with Temporary Disposable Core	CTPD	No Charge
Pyramid LFIC Less Core	CLP	No Charge
Other		
Lockset furnished in Schlage® C Keyway ^{1,3}	C	No Charge
Lockset furnished in Sargent® LA Keyway ^{2,3}	LA	No Charge

Notes:

1. Available 0-bitted & key random (KR) only.
2. Available 0-bitted only.
3. Not available in CL3129 function.
4. CL3129 function is not available less cylinder.

Continued on next page

Cylinder & Keying Options* (continued)		
Description	Specify Quick Code	Add or Deduct
0-Bitted with 2 blank keys	STDKEY	No Charge
Keyed random	KR	
Construction master keyed ^{1, 2}	CMK	Add \$16.00 per cylinder
More than 2 keys per lock	KY# (e.g., KY6)	See page 33 - Cut Keys Section
Master Keying		
Master keyed (all cylinders except CR8000, CR8020, CR8027, CR8200, CR8500, CR8600, CR8700)	MK	Add \$16.00 per cylinder
Master keyed Pyramid (except CR8020, CR8027 LFIC cores)	MK	
Master keyed Security (including LFIC cylinder and core)	MK	
Master keyed Access 3 (except CR8500, CR8600, CR8700 LFIC cores)	MK	
Master keyed (CR8000, CR8020, CR8027, CR8200, CR8500, CR8600, CR8700)	MK-IC	No Charge
Master keyed to customer bittings or sample key	MK-CB	Add \$16.00 per cylinder
Visual key control (VKC)		
-No stamping	VKC0	\$4.50
-Keys only	VKC1	No Charge
-Cylinder and Keys ³	VKC2	\$8.00
-Cylinders only ³	VKC3	
Concealed key control (CKC)		
-CKC cylinders with VKC keys	CKC2	\$8.00
-CKC cylinders only ³	CKC3	

Notes:

1. CMK Construction master keying charge is in addition to master keying charge.
2. CMK Construction master keying is not available in interchangeable core, Access 3, Pyramid, or Security series.
3. VKC2, VKC3, CKC3 are not available in Access 3, Pyramid or Security series.

*Double cylinder keying: unless otherwise specified, both cylinders of 32, 52 and 62 functions will be keyed alike. The inside cylinder of 72 function will be keyed to the master key(s) only, while the outside cylinder will include the change key.
 If different keying is required, specify outside cylinder first, then inside cylinder.
 For key bows other than 10 and 90, specify 'KB' + bow number as Quick Code, e.g. KB12.

Grade 1 Vandal Resistant Cylindrical Lever Locksets CL3100 Series

USA & Canada Prices Effective April 17, 2023

Door Thickness Options

Description	Specify Quick Code	Add or Deduct
1-3/4" - 2"	(standard)	No Charge
Over 2" up to 2-1/4"	D214	

Backset Options

Description	Specify Quick Code	Add or Deduct
2-3/4"	B234 (standard)	No Charge
3-3/4"	B334	Add \$15.00 per lockset
5"	B500	Add \$24.00 per lockset

Strike Options² (to purchase strike separately, see catalog or parts manual for part no.)

Lip Length	ANSI Curved Lip - Specify Quick Code	Curved Lip Box - Specify Quick Code	Add or Deduct
1"	SA100	SC100	No Charge
1-1/8"	SA118	SC118	
1-1/4"	SA114 (standard)	SC114	
1-3/8"	SA138	SC138	
1-1/2"	SA112	SC112	
1-3/4"	SA134	SC134	Add \$17.00 per lock
2"	SA200	SC200	
2-1/4"	SA214	SC214	
2-1/2"	SA212	SC212	
2-3/4"	SA234	SC234	
3"	SA300	SC300	

^{1,2}If door thickness is standard or has been specified and no special door or frame condition exist, then only the first two characters of the optional strike Quick Code must be specified (e.g. "SC").
The correct lip length will be determined by our order entry system based on the standard or specified door thickness.

Miscellaneous Options		
Description	Specify Quick Code	Add or Deduct
Spanner head screws	M02	Add \$28.00 per lockset
Torx® head screws	M04	Add \$34.00 per lockset
Less cylinder and with tailpiece for Schlage® fixed core cylinder (AZ, NZ & PZ designs) ¹	M06	No Charge
Lever to accept 6 or 7-pin SFIC (AZ, NZ & PZ designs) ¹	M08	No Charge
Lever to accept Sargent® fixed core cylinder (AZ, NZ & PZ designs) ¹	M09	No Charge
Security Lever (not available on non-keyed functions)	M111	No Charge
3/4" throw fire latch x 2-3/4" backset (not available for CL3120, 29, 40, and 93 functions) <div style="display: flex; justify-content: space-between; margin-top: 5px;"> <div style="width: 30%;"> Finishes Available 605 606 626 </div> <div style="width: 30%;"> Matching Lock Finish 605, 611, 606, 612, 613, 613L, 722 613E, 618, 619, 625, 625, BSP, WSP </div> </div>	M16	Add \$100.00 per lockset
ANSI wrought strike box	M17	No Charge
Knurling outside and inside	M20*	Add \$196.00 per lockset
Knurling outside only	M21*	Add \$98.00 per lockset
Knurling inside only	M22*	Add \$98.00 per lockset
Abrasive coat outside and inside	M23	Add \$124.00 per lockset
Abrasive coat inside only	M24	Add \$62.00 per lockset
Abrasive coat outside only	M25	Add \$62.00 per lockset
Lead lining (roses)	M28	Add \$223.00 per lockset
Lever to accept Schlage® LFIC (AZ, NZ & PZ designs) ¹	M69	No Charge
Lever to accept Yale® 6-pin fixed core cylinder (NZ & PZ designs only) ¹	YC	
Lever to accept Yale® 7-pin fixed core cylinder (NZ & PZ designs only) ¹	YC7	
Lever to accept Yale® 6-pin LFIC (NZ & PZ designs only) ¹	YRC	
Lever to accept Yale® 7-pin LFIC (NZ & PZ designs only) ¹	YRC7	
STC 55 Acoustical Door Kit	M112	

Notes:

* All levers provided in a powder coat finish will be supplied with an abrasive coating.

1. Not available in CL3129 function.

Standard Features

Handing

Non-handed

Door Thickness

1-3/4" - 2"

Backset

2-3/4"

Strike

ANSI curved lip
4-7/8" x 1-1/4" x 1-1/4" lip to center

Cylinder

Brass, 6-pin, L4 keyway, 0-bitted

Keys

Two nickel silver keys

Case Quantity

6

Case Weight

32 lbs

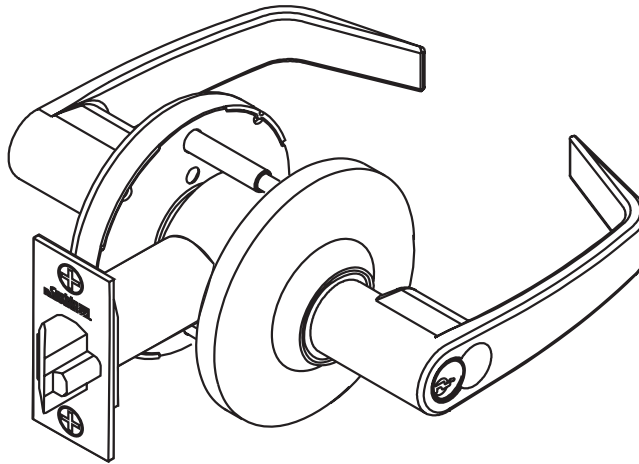

Ordering Examples

Stock Order

Quantity	Series/Function	Trim	Finish	Hand
100	CLX3355	NZD	626	RHR

Split Trim/Split Finish Order

Quantity	Series/Function	Trim		Finish		Hand
		Outside	Inside	Outside	Inside	
12	CLX3355	NZD	AZD	626	625	RHR

Contract/Detailed Order

Quantity	Keyset	Series/Function	Trim	Finish	Hand	Strike	Misc. Options	Cylinder and Keying
24	AA1	CLX3355	NZD	626	RHR	SA112	M17	C6-VKC3

Lever Designs: AZD, NZD, PZD, 102D, 106D, 123D, 124D



Lever: Solid Cast Zinc
Rose: Wrought Brass



AZD



NZD



PZD



102D



106D



123D



124D

Function	Description	AZD, NZD, PZD, 102D, 106D, 123D, 124D	
		Finish: 613E, 626, BSP, WSP	Finish: 605, 606, 611, 612, 613, 613L, 618, 619, 625, 722
CLX3310	Passage	\$631.00	\$647.00
CLX3380	Passage x Blank Plate		
CLX3390	Passage x Turnpiece	\$752.00	\$768.00
CLX3320	Privacy		
CLX3320H	Hospital Privacy	\$752.00	\$768.00
CLX3320TO	Time Out Lock		
CLX3330	Privacy x Cointurn Release	\$752.00	\$768.00
CLX3340	Patio		
CLX3340NT	Exit Latch		
CLX3350	Half Dummy	\$273.00	\$281.00
CLX3370	Full Dummy	\$548.00	\$564.00
CLX3351	Entrance		
CLX3355	Classroom	\$881.00	\$897.00
CLX3357	Storeroom		
CLX3359	Storeroom or Public Restroom		
CLX3361	Entrance	\$899.00	\$915.00
CLX3375	Corridor/Dormitory		
CLX3376	Corridor/Dormitory (modified)	\$978.00	\$994.00
CLX3393	Service Station		
CLX3329	Hotel		
CLX3381	Classroom x Blank Plate	\$881.00	\$897.00
CLX3383	Storeroom x Blank Plate		
CLX3332	Institution		
CLX3352	Classroom Intruder		
CLX3362	Communicating	\$1,012.00	\$1,028.00
CLX3372	Public Toilet		
CLX3382	Store Door		
CLX33903*	Fail Safe	\$1,346.00	\$1,362.00
CLX33905*	Fail Secure		

***ElectroLynx®**

As part of their promise to provide innovative, fast and effective, and higher security solutions to their customers, ASSA ABLOY Group companies offer ElectroLynx, a universal quick-connect system that simplifies the electrification of the door opening. ElectroLynx® is a registered trademark of ASSA ABLOY, Inc.

Grade 1 Heavy Duty Cylindrical Lever Locksets CLX3300 Series

USA & Canada Prices Effective April 17, 2023

Cylinder Options

Description	Specify Quick Code	Add or Deduct
Conventional 6-pin	(standard)	No Charge
Conventional 7-pin	7P	Add \$2.00 per cylinder
Less Cylinder(s)	LC	Deduct \$111.00 per cylinder
Less Hotel Cylinder	LC	Deduct \$127.00 per cylinder
LFIC		
LFIC 6-pin	C6	Add \$104.00 per cylinder
LFIC 6-pin Less Core ¹	CL6	No Charge
LFIC 6-pin with Temporary Construction Core (Red) ¹	CT6R	Add \$104.00 per cylinder
LFIC 6-pin with Temporary Construction Core (Blue) ¹	CT6B	Add \$104.00 per cylinder
LFIC 6-pin with Temporary Construction Core (Green) ¹	CT6G	Add \$104.00 per cylinder
LFIC 6-Pin Disposable Core ¹	CT6D	No Charge
LFIC 7-pin	C7	Add \$106.00 per cylinder
LFIC 7-pin Less Core ¹	CL7	No Charge
LFIC 7-pin with Temporary Construction Core (Red) ¹	CT7R	Add \$106.00 per cylinder
LFIC 7-pin with Temporary Construction Core (Blue) ¹	CT7B	Add \$106.00 per cylinder
LFIC 7-pin with Temporary Construction Core (Green) ¹	CT7G	Add \$106.00 per cylinder
LFIC 7-Pin Disposable Core ¹	CT7D	No Charge
SFIC (all lever designs) ¹		
SFIC 6-pin	C6S	Add \$93.00 per cylinder
SFIC 6-pin with Temporary Construction Core (Blue)	CT6SB	Add \$93.00 per cylinder
SFIC 6-pin or 7-pin Temporary Disposable core	CTSD	No Charge
SFIC 7-pin ¹	C7S	Add \$93.00 per cylinder
SFIC 7-pin with Temporary Construction Core (Blue)	CT7SB	Add \$93.00 per cylinder
Security		
Security ¹	HS	Add \$154.00 per cylinder
Security LFIC ¹	CHS	Add \$258.00 per cylinder
Access 3		
Access 3® Patented Fixed Core	AP	No Charge
Access 3® Security Fixed Core	AS	Add \$78.00 per cylinder
Access 3® High Security Fixed Core	AHS	Add \$111.00 per cylinder
Access 3® Patented LFIC ¹	ACP	Add \$104.00 per cylinder
Access 3® Security LFIC ¹	ACS	Add \$182.00 per cylinder
Access 3® High Security LFIC ¹	ACHS	Add \$215.00 per cylinder
Pyramid		
Pyramid Security Fixed Core ¹	PS	Add \$83.00 per cylinder
Pyramid Security LFIC ¹	PCS	Add \$181.00 per cylinder
Pyramid High Security Fixed Core ¹	PHS	Add \$121.00 per cylinder
Pyramid High Security LFIC ¹	PCHS	Add \$223.00 per cylinder
Pyramid with Temporary Construction Core ¹	CTP	Add \$104.00 per cylinder
Pyramid Disposable Core ¹	CTPD	No Charge
Pyramid LFIC Less Core ¹	CLP	No Charge
Other		
Lockset furnished in Schlage® C Keyway	C	No Charge
Lockset furnished in Sargent® LA Keyway	LA	No Charge

Notes:
1. Not available in CLX3329 function

Continued on next page

Cylinder Options (continued) & Keying Options*

Description	Specify Quick Code	Add or Deduct
Keying and Keys		
0-bitted with 2 Blank Keys	(standard)	No Charge
Keyed Random	KR	
Construction Master Keyed ²	CMK	Add \$16.00 per cylinder
More than 2 Keys	KY# (e.g., KY6)	See page 33 - Cut Keys Section
Master Keying		
Master keyed (all cylinders except CR8000, CR8020, CR8027, CR8200, CR8500, CR8600, CR8700)	MK	Add \$16.00 per cylinder
Master keyed Pyramid (except CR8020, CR8027 LFIC cores)	MK	
Master keyed Security (including LFIC cylinder and core)	MK	
Master keyed Access 3 (except CR8500, CR8600, CR8700 LFIC cores)	MK	
Master keyed (CR8000, CR8020, CR8027, CR8200, CR8500, CR8600, CR8700)	MK-IC	No Charge
Master keyed to customer bittings or sample key	MK-CB	Add \$16.00 per cylinder
Visual Key Control (VKC)		
No bitting or keyset stamping on keys	VKC0	\$4.50
Keys only	VKC1	No Charge
Cylinders and keys (not for AS, AHS, ACS, ACHS, HS, CHS, PHS or PCHS)	VKC2	\$8.00
Cylinders only (not for AS, AHS, HS, ACS, ACHS, CHS, PHS or PCHS)	VKC3	
Concealed Key Control (CKC)		
CKC cylinders with VKC keys (not for AS, AHS, ACS, ACHS, PHS, PCHS)	CKC2	\$8.00
CKC cylinders only	CKC3	

Notes:

1. Not available in CLX3329 function.
2. CMK Construction master keying charge is in addition to master keying charge and is not available in interchangeable core, Access 3, Pyramid, or Security series.

*Double cylinder keying: unless otherwise specified, both cylinders of 32, 62, 72 and 82 functions will be keyed alike. The inside cylinder of 52 function will be keyed to the master key(s) only, while the outside cylinder will include the change key. If different keying is required, specify outside cylinder first, then inside cylinder. For key bows other than 10 and 90, specify 'KB' + bow number as Quick Code, e.g. KB12.

Door Thickness Options

Description	Specify Quick Code	Add or Deduct
1-3/8" (adapter plates)	D138*	\$34.00
1-3/4" - 2"	(standard)	No Charge
Over 2" up to 2-1/4"	D214	

*Lock provided with adapter (spacer) plates. Supplied with 2-3/8" backset latch x square corner x 1" front.

Backset Options

Description	Specify Quick Code	Add or Deduct
2-3/8"	B238**	No Charge
2-3/4"	B234 (standard)	
3-3/4"	B334	Add \$15.00 per lockset
5"	B500	Add \$24.00 per lockset

** Supplied with square corners x 1" front.

Strike Options* (to purchase strike separately, see catalog or parts manual for part no.)

Lip Length	ANSI Curved Lip Specify Quick Code	Curved Lip Box Specify Quick Code	Full Lip Specify Quick Code	Add or Deduct
1"	SA100	SC100		No Charge
1-1/8"	SA118	SC118	SF118	
1-1/4"	SA114 (standard)	SC114		
1-3/8"	SA138	SC138		
1-1/2"	SA112	SC112		
1-3/4"	SA134	SC134		Add \$17.00 per lock
2"	SA200	SC200		
2-1/4"	SA214	SC214		
2-1/2"	SA212	SC212		
2-3/4"	SA234	SC234		
3"	SA300	SC300		

*If door thickness is standard or has been specified and no special door or frame condition exist, then only the first two characters of the optional strike Quick Code must be specified (e.g. "SC").
The correct lip length will be determined by our order entry system based on the standard or specified door thickness.

Miscellaneous Options		
Description	Specify Quick Code	Add or Deduct
Split designs and split finishes	Outside Trim x Inside Trim	Higher set price prevails
Spanner head screws	M02	Add \$28.00 per lockset
Torx® head screws	M04	Add \$34.00 per lockset
Less cylinder, with tailpiece for Schlage® 6-pin fixed core cylinder (all designs)	M06	No Charge
Lever to accept 6 or 7-pin SFIC ² (all designs)	M08	No Charge
Lever to accept SARGENT® 6-pin fixed core cylinder (all designs)	M09	No Charge
1-1/8" latch front, rounded corners	M13	Add \$2.50 per latch
3/4" throw fire latch x 2-3/4" backset <div style="display: flex; justify-content: space-between; margin-left: 20px;"> <div> Finishes Available 605 606 626 </div> <div> Matching Lock Finish 605, 611 606, 612, 613, 613L, 722 613E, 618, 619, 625, 626, BSP, WSP </div> </div>	M16	Add \$100.00 per lockset
ANSI wrought strike box	M17	No Charge
Knurling outside and inside (AZ, NZ, PZ only)	M20*	Add \$196.00 per lockset
Knurling outside only (AZ, NZ, PZ only)	M21*	Add \$98.00 per lockset
Knurling inside only (AZ, NZ, PZ only)	M22*	Add \$98.00 per lockset
Abrasive coat outside and inside (AZ, NZ, PZ only)	M23	Add \$124.00 per lockset
Abrasive coat inside only (AZ, NZ, PZ only)	M24	Add \$62.00 per lockset
Abrasive coat outside only (AZ, NZ, PZ only)	M25	Add \$62.00 per lockset
Lead lining	M28	Add \$223.00 per lockset
Lever to accept Schlage® LFIC ² (AZ, NZ, PZ only)	M69	No Charge
Request to Exit (REX) Switch (Available with CLX33900 and all mechanical functions except dummy)	M92	\$276.00
Rigid outside lever when locked	M200	No Charge
Less cylinder, with tailpiece for Yale® 6-pin fixed core cylinder (all designs)	YC	
Less cylinder, with tailpiece for Yale® 7-pin fixed core cylinder (all designs)	YC7	
Lever to accept Yale® 6-pin LFIC, AZ, NZ, PZ only	YRC	
Notes: *All levers provided in a powder coat finish will be supplied with an abrasive coating.		

Standard Features

Handing

Non-handed except FZD

Door Thickness

1-3/4" - 2"

Backset

2-3/4"

Strike

ANSI curved lip
4-7/8" x 1-1/4" x 1-1/4" lip to center

Cylinder

Brass, 6-pin, L4 keyway, 0-bitted

Keys

Two nickel silver keys

Case Quantity

6

Case Weight

32 lbs

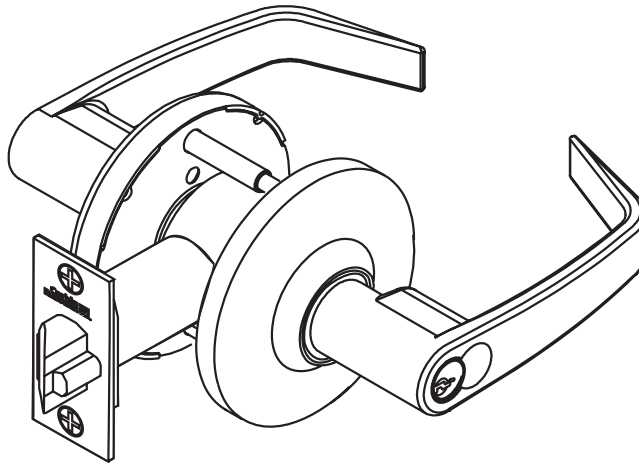

Ordering Examples

Stock Order

Quantity	Series/Function	Trim	Finish	Hand
100	CL3355	NZD	626	RHR

Split Trim/Split Finish Order

Quantity	Series/Function	Trim		Finish		Hand
		Outside	Inside	Outside	Inside	
12	CL3355	NZD	AZD	626	625	RHR

Contract/Detailed Order

Quantity	Keyset	Series/Function	Trim	Finish	Hand	Strike	Misc. Options	Cylinder and Keying
24	AA1	CL3355	NZD	626	RHR	SA112	M17	C6-VKC3

Lever Designs: AZD, NZD, PZD, FZD



Lever:

Die cast zinc

Rose:

Wrought Brass



Armstrong

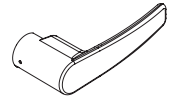

Newport

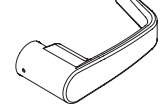

Princeton

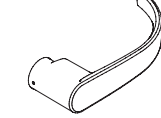

Frascati

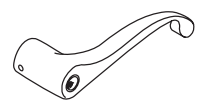

Function	Description	AZD, NZD, PZD, FZD	
		Finish: 613E, 626, BSP, WSP	Finish: 605, 606, 611, 612, 613, 613L, 618, 619, 625, 722
CL3310	Passage	\$631.00	\$647.00
CL3380	Passage x Blank Plate	\$752.00	\$768.00
CL3390	Passage x Turnpiece		
CL3320	Privacy	\$752.00	\$768.00
CL3320H	Hospital Privacy		
CL3320TO	Time Out Lock	\$752.00	\$768.00
CL3340	Patio		
CL3340NT	Exit Latch	\$273.00	\$281.00
CL3350	Half Dummy		
CL3370	Full Dummy	\$548.00	\$564.00
CL3351	Entrance	\$881.00	\$897.00
CL3355	Classroom		
CL3357	Storeroom		
CL3359	Storeroom or Public Restroom	\$899.00	\$915.00
CL3361	Entrance		
CL3375	Corridor/Dormitory		
CL3393	Service Station	\$978.00	\$994.00
CL3329	Hotel		
CL3381	Keyed x Blank Plate	\$881.00	\$897.00
CL3391	Keyed x Blank Plate		
CL3332	Institution	\$1,012.00	\$1,028.00
CL3352	Classroom Intruder		
CL3362	Communicating		
CL3372	Public Toilet	\$1,346.00	\$1,362.00
CL33903*	Fail Safe		
CL33905*	Fail Secure		

***ElectroLynx®**

As part of their promise to provide innovative, fast and effective, and higher security solutions to their customers, ASSA ABLOY Group companies offer ElectroLynx, a universal quick-connect system that simplifies the electrification of the door opening. ElectroLynx® is a registered trademark of ASSA ABLOY, Inc.

Grade 1 Heavy Duty Cylindrical Lever Locksets CL3300 Series

USA & Canada Prices Effective April 17, 2023

Cylinder Options

Description	Specify Quick Code	Add or Deduct
Conventional 6-pin	(standard)	No Charge
Conventional 7-pin	7P	Add \$2.00 per cylinder
Less Cylinder(s) ⁴	LC	Deduct \$111.00 per cylinder
Less Hotel Cylinder	LC	Deduct \$127.00 per cylinder
LFIC		
LFIC 6-pin	C6	Add \$104.00 per cylinder
LFIC 6-pin Less Core ³	CL6	No Charge
LFIC 6-pin with Temporary Construction Core (Red) ³	CT6R	Add \$104.00 per cylinder
LFIC 6-pin with Temporary Construction Core (Blue) ³	CT6B	Add \$104.00 per cylinder
LFIC 6-pin with Temporary Construction Core (Green) ³	CT6G	Add \$104.00 per cylinder
LFIC 6-pin with Temporary Disposable Core ³	CT6D	No Charge
LFIC 7-pin	C7	Add \$106.00 per cylinder
LFIC 7-pin Less Core ³	CL7	No Charge
LFIC 7-pin with Temporary Construction Core (Red) ³	CT7R	Add \$106.00 per cylinder
LFIC 7-pin with Temporary Construction Core (Blue) ³	CT7B	Add \$106.00 per cylinder
LFIC 7-pin with Temporary Construction Core (Green) ³	CT7G	Add \$106.00 per cylinder
LFIC 7-pin with Temporary Disposable Core	CT7D	No Charge
SFIC (all lever designs)³		
SFIC 6-pin	C6S	Add \$93.00 per cylinder
SFIC 6-pin with Temporary Construction Core (Blue)	CT6SB	Add \$93.00 per cylinder
SFIC 6-pin or 7-pin Temporary Disposable core	CTSD	No Charge
SFIC 7-pin	C7S	Add \$93.00 per cylinder
SFIC 7-pin with Temporary Construction Core (Blue)	CT7SB	Add \$93.00 per cylinder
Security		
Security ³	HS	Add \$154.00 per cylinder
Security LFIC ³	CHS	Add \$258.00 per cylinder
Access 3		
Access 3 Patented	AP	No Charge
Access 3 Security	AS	Add \$78.00 per cylinder
Access 3 High Security, UL 437	AHS	Add \$111.00 per cylinder
Access 3 LFIC Patented	ACP	Add \$104.00 per cylinder
Access 3 LFIC Security	ACS	Add \$182.00 per cylinder
Access 3 LFIC High Security, UL 437	ACHS	Add \$215.00 per cylinder
Pyramid		
Pyramid Security Fixed Core ³	PS	Add \$83.00 per cylinder
Pyramid Security LFIC ³	PCS	Add \$181.00 per cylinder
Pyramid High Security Fixed Core ³	PHS	Add \$121.00 per cylinder
Pyramid High Security LFIC ³	PCHS	Add \$223.00 per cylinder
Pyramid LFIC with Temporary Construction Core	CTP	Add \$104.00 per cylinder
Pyramid LFIC with Temporary Disposable Core	CTPD	No Charge
Pyramid LFIC Less Core	CLP	No Charge
Other		
Lockset furnished in Schlage® C Keyway ^{1,3}	C	No Charge
Lockset furnished in Sargent® LA Keyway ^{2,3}	LA	No Charge

Notes:

1. Available 0-bitted & key random (KR) only.
2. Available 0-bitted only.
3. Not available in CL3329 function.
4. CL3329 function is not available less cylinder.

Continued on next page

Cylinder Options (continued) & Keying Options*

Description	Specify Quick Code	Add or Deduct
Keying and Keys		
0-bitted with 2 Blank Keys	(standard)	No Charge
Keyed Random	KR	
Construction master keyed ^{1,2}	CMK	Add \$16.00 per cylinder
More than 2 Keys	KY# (e.g., KY6)	See page 33 - Cut Keys Section
Master Keying		
Master keyed (all cylinders except CR8000, CR8020, CR8027, CR8200, CR8500, CR8600, CR8700)	MK	Add \$16.00 per cylinder
Master keyed Pyramid (except CR8020, CR8027 LFIC cores)	MK	
Master keyed Security (including LFIC cylinder and core)	MK	
Master keyed Access 3 (except CR8500, CR8600, CR8700 LFIC cores)	MK	
Master keyed (CR8000, CR8020, CR8027, CR8200, CR8500, CR8600, CR8700)	MK-IC	No Charge
Master keyed to customer bittings or sample key	MK-CB	Add \$16.00 per cylinder
Visual Key Control (VKC)		
No bitting or keyset stamping on keys	VKC0	\$4.50
Keys only	VKC1	No Charge
Cylinder and Keys ³ (not for AS, AHS, ACS, ACHS, HS, CHS, PHS or PCHS)	VKC2	\$8.00
Cylinders only ³ (not for AS, AHS, HS, ACS, ACHS, CHS, PHS or PCHS)	VKC3	
Concealed Key Control (CKC)		
CKC cylinders with VKC keys	CKC2	\$8.00
CKC cylinders only (not for AS, AHS, ACS, ACHS, PHS, PCHS)	CKC3	

Notes:

1. CMK Construction master keying charge is in addition to master keying charge.
2. CMK Construction master keying is not available in interchangeable core, Access 3, Pyramid, or Security series.
3. VKC2, VKC3, CKC3 are not available in Access 3, Pyramid or Security series.

*Double cylinder keying: unless otherwise specified, both cylinders of 32 and 82 functions will be keyed alike. The inside cylinder of 72 function will be keyed to the master key(s) only, while the outside cylinder will include the change key.
 If different keying is required, specify outside cylinder first, then inside cylinder.
 For key bows other than 10 and 90, specify 'KB' + bow number as Quick Code, e.g. KB12.

Grade 1 Heavy Duty Cylindrical Lever Locksets CL3300 Series

USA & Canada Prices Effective April 17, 2023

Door Thickness Options

Description	Specify Quick Code	Add or Deduct
1-3/4" - 2"	(standard)	No Charge
Over 2" up to 2-1/4"	D214	

Backset Options

Description	Specify Quick Code	Add or Deduct
2-3/4"	B324 (standard)	No Charge
3-3/4"	B334	Add \$15.00 per lockset
5"	B500	Add \$24.00 per lockset

Strike Options* (to purchase strike separately, see catalog or parts manual for part no.)

Lip Length	ANSI Curved Lip - Specify Quick Code	Curved Lip Box - Specify Quick Code	Add or Deduct
1"	SA100	SC100	No Charge
1-1/8"	SA118	SC118	
1-1/4"	SA114 (standard)	SC114	
1-3/8"	SA138	SC138	
1-1/2"	SA112	SC112	
1-3/4"	SA134	SC134	Add \$17.00 per lock
2"	SA200	SC200	
2-1/4"	SA214	SC214	
2-1/2"	SA212	SC212	
2-3/4"	SA234	SC234	
3"	SA300	SC300	

Description	Specify Quick Code	Add or Deduct
Rabbeted front and strike	SR118	Add \$118.00 per lockset

*If door thickness is standard or has been specified and no special door or frame condition exist, then only the first two characters of the optional strike Quick Code must be specified (e.g. "SC").
The correct lip length will be determined by our order entry system based on the standard or specified door thickness.

Miscellaneous Options		
Description	Specify Quick Code	Add or Deduct
Split designs and split finishes	Outside Trim x Inside Trim	Higher set price prevails
Spanner head screws	M02	Add \$28.00 per lockset
Torx® head screws	M04	Add \$34.00 per lockset
Less cylinder and with tailpiece for Schlage® fixed core cylinder (all designs) ²	M06	No Charge
Lever to accept 6 or 7-pin SFIC ² (all designs)	M08	No Charge
Lever to accept Sargent® fixed core cylinder (all designs) ²	M09	No Charge
1-1/8" latch front, rounded corners	M13	Add \$2.50 per latch
3/4" throw fire latch x 2-3/4" backset (not available for CL3320, 29, 40, and 93 functions) <div style="display: flex; justify-content: space-between; margin-left: 40px;"> <div> Finishes Available 605 606 626 </div> <div> Matching Lock Finish 605, 611 606, 612, 613, 613L, 722 613E, 618, 619, 625, 625, BSP, WSP </div> </div>	M16	Add \$100.00 per lockset
ANSI wrought strike box	M17	No Charge
Knurling outside and inside	M20*	Add \$196.00 per lockset
Knurling outside only	M21*	Add \$98.00 per lockset
Knurling inside only	M22*	Add \$98.00 per lockset
Abrasive coat outside and inside	M23	Add \$124.00 per lockset
Abrasive coat inside only	M24	Add \$62.00 per lockset
Abrasive coat outside only	M25	Add \$62.00 per lockset
Lead lining (roses)	M28	Add \$223.00 per lockset
Lever to accept Schlage® LFIC ^{2,3} (FZD, NZD and PZD designs only)	M69	No Charge
Request to Exit (REX) Switch (CL33900 only)	M92	\$276.00
CL33900 Series electrified options		
12VAC/DC ¹	12AD	No Charge
24VAC/DC	24AD	

Notes:

* All levers provided in a powder coat finish will be supplied with an abrasive coating.

1. Voltage is universal for AC or DC current.

2. Not available in CL3329 function.

3. Not available in CL3375 function.

Standard Features

Handing

Non-handed

Door Thickness

1-3/4"

Backset

2-3/4"

Strike

ANSI curved lip
4-7/8" x 1-1/4" x 1-1/4" lip to center

Cylinder

Brass, 6-pin, L4 keyway
0-bitted

Keys

Two nickel silver keys

Case Quantity

6

Case Weight

26 lbs

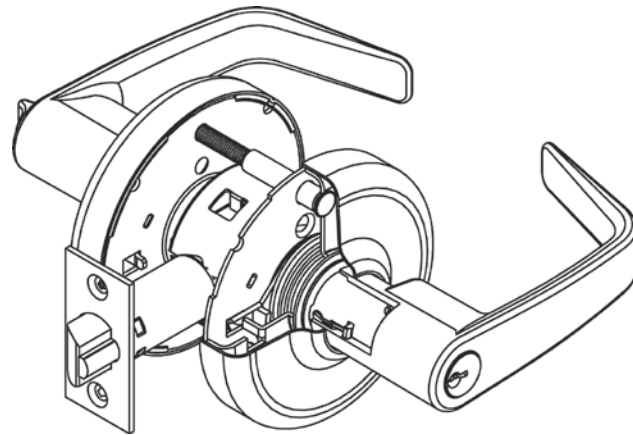

The CL3500 series is designed to meet ANSI/BHMA Grade 1 Certification.

Ordering Examples

Stock Order

Quantity	Series/Function	Trim	Finish	Hand
100	CL3555	NZD	626	RH

Split Trim/Split Finish Order

Quantity	Series/Function	Trim		Finish		Hand
		Outside	Inside	Outside	Inside	
12	CL3555	NZD	AZD	626	625	RH

Contract/Detailed Order

Quantity	Keyset	Series/Function	Trim	Finish	Hand	Strike	Misc. Options	Cylinder and Keying
24	AA1	CL3555	NZD	626	RH	SA112	M17	C6-VKC3

Lever Designs: AZD



Lever:
Solid Cast Zinc

Rose:
Wrought Brass



AZD

Armstrong

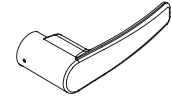

Lever Designs: NZD



Lever:
Solid Cast Zinc

Rose:
Wrought Brass



NZD

Newport

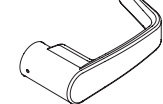

Princeton



Lever Designs: PZD



Lever:
Solid Cast Zinc

Rose:
Wrought Brass



PZD

Function	Description		AZD, NZD, PZD	
			Finish: 613E, 626, BSP, WSP	Finish: 605, 606, 611, 612, 613, 613L, 618, 619, 625, 722
CL3510	Non-Keyed	Passage	\$631.00	\$647.00
CL3580		Passage x Blank Plate	\$752.00	\$768.00
CL3520		Privacy		
CL3550		Half Dummy	\$273.00	\$281.00
CL3570		Full Dummy	\$548.00	\$564.00
CL3551	Single Cylinder	Entrance	\$881.00	\$897.00
CL3555		Classroom		
CL3557		Storeroom		
CL3561		Office or Entrance		
CL3581		Keyed x Blank Plate		
CL3582	Double Cylinder	Store Door	\$1,012.00	\$1,028.00

Cylinder Options

Description	Specify Quick Code	Add or Deduct
Conventional 6-pin	(standard)	No Charge
Conventional 7-pin	7P	Add \$2.00 per cylinder
Less Cylinder	LC	Deduct \$111.00 per cylinder
LFIC		
LFIC 6-pin	C6	Add \$104.00 per cylinder
LFIC 6-pin Less Core	CL6	No Charge
LFIC 6-pin with Temporary Construction Core (Red)	CT6R	Add \$104.00 per cylinder
LFIC 6-pin with Temporary Construction Core (Blue)	CT6B	Add \$104.00 per cylinder
LFIC 6-pin with Temporary Construction Core (Green)	CT6G	Add \$104.00 per cylinder
LFIC 6-pin with Temporary Disposable Core	CT6D	No Charge
LFIC 7-pin	C7	Add \$106.00 per cylinder
LFIC 7-pin Less Core	CL7	No Charge
LFIC 7-pin with Temporary Construction Core (Red)	CT7R	Add \$106.00 per cylinder
LFIC 7-pin with Temporary Construction Core (Blue)	CT7B	Add \$106.00 per cylinder
LFIC 7-pin with Temporary Construction Core (Green)	CT7G	Add \$106.00 per cylinder
LFIC 7-pin with Temporary Disposable Core	CT7D	No Charge
SFIC (all lever designs)		
SFIC 6-pin	C6S	Add \$93.00 per cylinder
SFIC 6-pin with Temporary Construction Core (Blue)	CT6SB	Add \$93.00 per cylinder
SFIC 6-pin or 7-pin Temporary Disposable core	CTSD	No Charge
SFIC 7-pin	C7S	Add \$93.00 per cylinder
SFIC 7-pin with Temporary Construction Core (Blue)	CT7SB	Add \$93.00 per cylinder
Security		
Security	HS	Add \$154.00 per cylinder
Security LFIC	CHS	Add \$258.00 per cylinder
Access 3		
Access 3 Patented	AP	No Charge
Access 3 Security	AS	Add \$78.00 per cylinder
Access 3 High Security, UL 437	AHS	Add \$111.00 per cylinder
Access 3 LFIC Patented	ACP	Add \$104.00 per cylinder
Access 3 LFIC Security	ACS	Add \$182.00 per cylinder
Access 3 LFIC High Security, UL 437	ACHS	Add \$215.00 per cylinder
Pyramid		
Pyramid Security Fixed Core	PS	Add \$83.00 per cylinder
Pyramid Security LFIC	PCS	Add \$181.00 per cylinder
Pyramid High Security Fixed Core	PHS	Add \$121.00 per cylinder
Pyramid High Security LFIC	PCHS	Add \$223.00 per cylinder
Pyramid LFIC with Temporary Construction Core	CTP	Add \$104.00 per cylinder
Pyramid LFIC with Temporary Disposable Core	CTPD	No Charge
Pyramid LFIC Less Core	CLP	No Charge
Other		
Lockset furnished in Schlage® C Keyway ¹	C	No Charge
Lockset furnished in Sargent® LA Keyway ²	LA	No Charge

Notes:

1. Available 0-bitted & key random (KR) only.
2. Available 0-bitted only.

Continued on next page

Cylinder Options (continued) & Keying Options*

Description	Specify Quick Code	Add or Deduct
Keying and Keys		
0-bitted with 2 Blank Keys	(standard)	No Charge
Keyed Random	KR	
Construction master keyed ^{1,2}	CMK	Add \$16.00 per cylinder
More than 2 Keys	KY# (e.g., KY6)	See page 33 - Cut Keys Section
Master Keying		
Master keyed (all cylinders except CR8000, CR8020, CR8027, CR8200, CR8500, CR8600, CR8700)	MK	Add \$16.00 per cylinder
Master keyed Pyramid (except CR8020, CR8027 LFIC cores)	MK	
Master keyed Security (including LFIC cylinder and core)	MK	
Master keyed Access 3 (except CR8500, CR8600, CR8700 LFIC cores)	MK	
Master keyed (CR8000, CR8020, CR8027, CR8200, CR8500, CR8600, CR8700)	MK-IC	No Charge
Master keyed to customer bittings or sample key	MK-CB	Add \$16.00 per cylinder
Visual Key Control (VKC)		
No bitting or keyset stamping on keys	VKC0	\$4.50
Keys only	VKC1	No Charge
Cylinder and Keys ³ (not for AS, AHS, ACS, ACHS, HS, CHS, PHS or PCHS)	VKC2	\$8.00
Cylinders only ³ (not for AS, AHS, HS, ACS, ACHS, CHS, PHS or PCHS)	VKC3	
Concealed Key Control (CKC)		
CKC cylinders with VKC keys	CKC2	\$8.00
CKC cylinders only (not for AS, AHS, ACS, ACHS, PHS, PCHS)	CKC3	

Notes:

1. CMK Construction master keying charge is in addition to master keying charge.
2. CMK Construction master keying is not available in interchangeable core, Access 3, Pyramid, or Security series.
3. VKC2, VKC3, CKC3 are not available in Access 3, Pyramid or Security series.

*Double cylinder keying: unless otherwise specified, both cylinders of 32 and 82 functions will be keyed alike. The inside cylinder of 72 function will be keyed to the master key(s) only, while the outside cylinder will include the change key.
 If different keying is required, specify outside cylinder first, then inside cylinder.
 For key bows other than 10 and 90, specify 'KB' + bow number as Quick Code, e.g. KB12.

Door Thickness Options

Description	Specify Quick Code	Add or Deduct
1-3/4"	(standard)	No Charge
1-3/8"	D138**1	

Backset Options

Description	Specify Quick Code	Add or Deduct
2-3/8"	B238 ¹	No Charge
2-3/4"	B234 (standard)	
3-3/4"	B334	Add \$15.00 per lockset
5"	B500	Add \$24.00 per lockset

Strike Options* (to purchase strike separately, see catalog or parts manual for part no.)

Lip Length	ANSI Curved Lip Specify Quick Code	Curved Lip Box Specify Quick Code	Full Lip Specify Quick Code	Add or Deduct
1"	SA100	SC100	SF118	No Charge
1-1/8"	SA118	SC118		
1-1/4"	SA114 (standard)	SC114		
1-3/8"	SA138	SC138		
1-1/2"	SA112	SC112		
1-3/4"	SA134	SC134	Add \$17.00 per lock	
2"	SA200	SC200		
2-1/4"	SA214	SC214		
2-1/2"	SA212	SC212		
2-3/4"	SA234	SC234		
3"	SA300	SC300		

Description	Specify Quick Code	Add or Deduct
Rabbeted front and strike	SR118	Add \$118.00 per lockset

*If door thickness is standard or has been specified and no special door or frame condition exist, then only the first two characters of the optional strike Quick Code must be specified (e.g. "SC").

The correct lip length will be determined by our order entry system based on the standard or specified door thickness.

**If D138 is specified, 2-3/8" backset latch will be supplied unless B234 option is also specified.

1. M14 and B238 (2-3/8" backset) standard with D138 (1-3/8" door thickness) option.

Miscellaneous Options

Description	Specify Quick Code	Add or Deduct
Split designs and split finishes	Outside Trim x Inside Trim	Higher set price prevails
Spanner head screws	M02	Add \$28.00 per lockset
Torx® head screws	M04	Add \$34.00 per lockset
Less cylinder and with tailpiece for Schlage® fixed core cylinder (all designs)	M06	No Charge
Lever to accept 6 or 7-pin SFIC (all designs)	M08	No Charge
Lever to accept Sargent® fixed core cylinder (NZD & PZD designs only)	M09	No Charge
Lever to accept Schlage® LFIC (NZD & PZD designs only)	M69	No Charge
1-1/8" latch front, rounded corners	M13	Add \$2.50 per latch
1" latch front, square corners ¹	M14	Add \$6.00 per lockset
1" latch front, rounded corners	M15	Add \$2.50 per latch
ANSI wrought strike box	M17	No Charge
Knurling outside and inside	M20*	Add \$196.00 per lockset
Knurling outside only	M21*	Add \$98.00 per lockset
Knurling inside only	M22*	Add \$98.00 per lockset
Abrasive coat outside and inside only	M23	Add \$124.00 per lockset
Abrasive coat inside only	M24	Add \$62.00 per lockset
Abrasive coat outside only	M25	Add \$62.00 per lockset
1-1/8" latch front, square corners (standard for 2-3/4" and 5" backsets)	M32	No Charge

Note:

- * All levers provided in a powder coat finish will be supplied with an abrasive coating.
- 1. M14 and B238 (2-3/4" backset) standard with D138 (1-3/8" door thickness) option.

Standard Features

Handing

Non-handed

Door Thickness

1-3/8" - 1-7/8"

Available in 2" - 2-1/4" upon request

Backset

2-3/4" standard

Strike

ANSI curved lip
4-7/8" x 1-1/4" x 1-1/4" lip to center

Cylinder

Brass, 6-pin, L4 keyway
0-bitted

Keys

Two nickel silver keys

Case Quantity

6

Case Weight

32 lbs

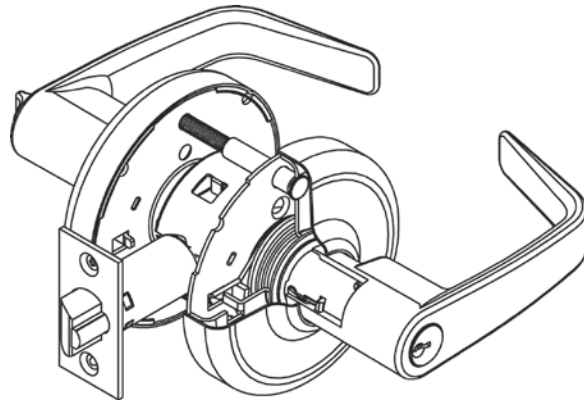

Ordering Examples

Stock Order

Quantity	Series/Function	Trim	Finish	Hand
100	CL3855	NZD	626	RHR

Split Trim/Split Finish Order

Quantity	Series/Function	Trim		Finish		Hand
		Outside	Inside	Outside	Inside	
12	CL3855	NZD	AZD	626	625	RHR

Contract/Detailed Order

Quantity	Keyset	Series/Function	Trim	Finish	Hand	Strike	Misc. Options	Cylinder and Keying
24	AA1	CL3855	NZD	626	RHR	SA112	M02	C6-VKC3

Lever Designs: AZD, NZD, PZD



Lever: Solid Cast Zinc
Rose: Wrought Brass

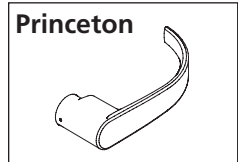
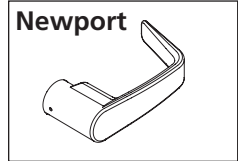
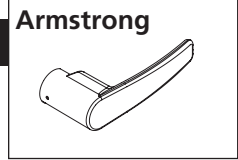

Function	Description		AZD, NZD, PZD	
			Finish: 613E, 626, BSP, WSP	Finish: 605, 606, 611, 612, 613, 613L, 618, 619, 625, 722
CL3810	Non-Keyed	Passage	\$302.00	\$318.00
CL3880		Passage x Blank Plate	\$325.00	\$341.00
CL3820		Privacy		
CL3850		Half Dummy		
CL3870		Full Dummy	\$316.00	\$332.00
CL3851	Single Cylinder	Entrance	\$388.00	\$404.00
CL3855		Classroom		
CL3857		Storeroom		
CL3861		Office		

Cylinder & Keying Options

Description	Specify Quick Code	Add or Deduct
Conventional 6-pin	(standard)	No Charge
Conventional 7-Pin	7P	Add \$2.00 per cylinder
Less Standard Cylinder	LC	Deduct \$111.00 per cylinder
LFIC		
LFIC 6-pin	C6	Add \$104.00 per cylinder
LFIC 6-pin Less Core	CL6	No Charge
LFIC 6-pin with Temporary Construction Core (Red)	CT6R	Add \$104.00 per cylinder
LFIC 6-pin with Temporary Construction Core (Blue)	CT6B	Add \$104.00 per cylinder
LFIC 6-pin with Temporary Construction Core (Green)	CT6G	Add \$104.00 per cylinder
LFIC 6-pin with Temporary Disposable Core	CT6D	No Charge
LFIC 7-Pin	C7	Add \$106.00 per cylinder
LFIC 7-Pin Less Core	CL7	No Charge
LFIC 7-Pin with Temporary Construction Core (Red)	CT7R	Add \$106.00 per cylinder
LFIC 7-Pin with Temporary Construction Core (Blue)	CT7B	Add \$106.00 per cylinder
LFIC 7-Pin with Temporary Construction Core (Green)	CT7G	Add \$106.00 per cylinder
LFIC 7-Pin with Temporary Disposable Core	CT7D	No Charge
SFIC (all lever designs)		
SFIC 6-pin	C6S	Add \$93.00 per cylinder
SFIC 6-pin with Temporary Construction Core (Blue)	CT6SB	Add \$93.00 per cylinder
SFIC 6-pin or 7-pin Temporary Disposable core	CTSD	No Charge
SFIC 7-pin	C7S	Add \$93.00 per cylinder
SFIC 7-pin with Temporary Construction Core (Blue)	CT7SB	Add \$93.00 per cylinder
Security		
Security	HS	Add \$154.00 per cylinder
Security LFIC	CHS	Add \$258.00 per cylinder
Access 3		
Access 3 Patented	AP	No Charge
Access 3 Security	AS	Add \$78.00 per cylinder
Access 3 High Security, UL 437	AHS	Add \$111.00 per cylinder
Access 3 LFIC Patented	ACP	Add \$104.00 per cylinder
Access 3 LFIC Security	ACS	Add \$182.00 per cylinder
Access 3 LFIC High Security, UL 437	ACHS	Add \$215.00 per cylinder
Pyramid		
Pyramid Security Fixed Core ³	PS	Add \$83.00 per cylinder
Pyramid Security LFIC ³	PCS	Add \$181.00 per cylinder
Pyramid High Security Fixed Core ³	PHS	Add \$121.00 per cylinder
Pyramid High Security LFIC ³	PCHS	Add \$223.00 per cylinder
Pyramid LFIC with Temporary Construction Core	CTP	Add \$104.00 per cylinder
Pyramid LFIC with Temporary Disposable Core	CTPD	No Charge
Pyramid LFIC Less Core	CLP	No Charge
Other		
Lockset furnished in Schlage® C Keyway ¹	C	No Charge
Lockset furnished in SARGENT® LA Keyway ²	LA	No Charge
Keying and Keys		
0-bitted with 2 Blank Keys	(standard)	No Charge
Keyed Random	KR	
Construction master keyed ^{1, 2}	CMK	Add \$16.00 per cylinder
More than 2 Keys	KY# (e.g., KY6)	See page 33 - Cut Keys Section
Master Keying		
Master keyed (all cylinders except CR8000, CR8020, CR8027, CR8200, CR8500, CR8600, CR8700 LFIC cores)	MK	Add \$16.00 per cylinder
Master keyed Pyramid (except CR8020, CR8027 LFIC cores)	MK	
Master keyed Security (including LFIC cylinder and core)	MK	
Master keyed Access 3 (except CR8500, CR8600, CR8700 LFIC cores)	MK	
Master keyed (CR8000, CR8020, CR8027, CR8200, CR8500, CR8600, CR8700 LFIC cores)	MK-IC	No Charge
Master keyed to customer bittings or sample key	MK-CB	Add \$16.00 per cylinder

Notes:

1. Available 0-bitted & key random (KR) only.
 2. Available 0-bitted only.
 3. CMK Construction master keying charge is in addition to master keying charge.
 4. CMK Construction master keying is not available in interchangeable core, Access 3, Pyramid, or Security series.
 5. VKC2, VKC3, CKC3 are not available in Access 3, Pyramid or Security series.
- For key bows other than 10 and 90, specify "KB" + bow number as Quick Code, e.g. KB12. No extra charge.

Continued on next page.

Cylinder Options (continued) & Keying Options*

Description	Specify Quick Code	Add or Deduct
Visual Key Control (VKC)		
No biting or keyset stamping on keys	VKC0	\$4.50
Keys only	VKC1	No Charge
Cylinder and Keys ³ (not for AS, AHS, ACS, ACHS, HS, CHS, PHS or PCHS)	VKC2	\$8.00
Cylinders only ³ (not for AS, AHS, HS, ACS, ACHS, CHS, PHS or PCHS)	VKC3	
Concealed Key Control (CKC)		
CKC cylinders with VKC keys	CKC2	\$8.00
CKC cylinders only (not for AS, AHS, ACS, ACHS, PHS, PCHS)	CKC3	

Notes:

3. VKC2, VKC3, CKC3 are not available in Access 3, Pyramid or Security series.

*Double cylinder keying: unless otherwise specified, both cylinders of 32 and 82 functions will be keyed alike. The inside cylinder of 72 function will be keyed to the master key(s) only, while the outside cylinder will include the change key.

If different keying is required, specify outside cylinder first, then inside cylinder.

For key bows other than 10 and 90, specify 'KB' + bow number as Quick Code, e.g. KB12.

Backset Options

Description	Specify Quick Code	Add or Deduct
2-3/8"	B238 ¹	No Charge
2-3/4"	B324 (standard)	
3-3/4"	B334	Add \$12.00 per lockset
5"	B500	Add \$14.00 per lockset

Door Thickness Options

Description	Specify Quick Code	Add or Deduct
1-3/8" — 1-7/8"	(standard)	No Charge
2" — 2-1/4"	D214	No Charge

Strike Options* (to purchase strike separately, see catalog or parts manual for part no.)

Lip Length	ANSI Curved Lip Specify Quick Code	Curved Lip Box Specify Quick Code	Full Lip Specify Quick Code	Full Lip Radius Corner Specify Quick Code	Add or Deduct
1"	SA100	SC100			No Charge
1-1/8"	SA118	SC118			
1-1/4"	SA114 (standard)	SC114	SF114	SFR114	
1-3/8"	SA138	SC138			
1-1/2"	SA112	SC112			Add \$17.00 per lock
1-3/4"	SA134	SC134			
2"	SA200	SC200			
2-1/4"	SA214	SC214			
2-1/2"	SA212	SC212			
2-3/4"	SA234	SC234			
3"	SA300	SC300			

*If door thickness is standard or has been specified and no special door or frame condition exist, then only the first two characters of the optional strike Quick Code must be specified (e.g. "SC"). The correct lip length will be determined by our order entry system based on the standard or specified door thickness.

Miscellaneous Options

Description	Specify Quick Code	Add or Deduct
Split designs and split finishes	Outside Trim x Inside Trim	Higher set price prevails
Spanner head screws	M02	Add \$28.00 per lockset
Torx® head screws	M04	Add \$34.00 per lockset
Less cylinder and with tailpiece for Schlage® fixed core cylinder (all designs)	M06	No Charge
Lever to accept 6 or 7-pin SFIC (all designs)	M08	No Charge
Lever to accept Sargent® fixed core cylinder (NZD & PZD designs only)	M09	No Charge
1-1/8" latch front, rounded corners	M13	Add \$2.50 per latch
1" latch front, square corners ¹	M14	Add \$6.00 per lockset
1" latch front, rounded corners	M15	Add \$2.50 per latch
ANSI wrought strike box	M17	No Charge
Knurling outside and inside	M20*	Add \$196.00 per lockset
Knurling outside only	M21*	Add \$98.00 per lockset
Knurling inside only	M22*	Add \$98.00 per lockset
Abrasive coat outside and inside only	M23	Add \$124.00 per lockset
Abrasive coat inside only	M24	Add \$62.00 per lockset
Abrasive coat outside only	M25	Add \$62.00 per lockset
1-1/8" latch front, square corners (standard for 2-3/4" and 5" backsets)	M32	No Charge
Lever to accept Schlage® LFIC (NZD & PZD designs only)	M69	No Charge

Note:

* All levers provided in a powder coat finish will be supplied with an abrasive coating.

1. M14 and B238 (2-3/8" backset) standard with D138 (1-3/8" door thickness) option.

Standard Features

Handing

Field reversible

Door Thickness

1-3/4" - 2"

Backset

2-3/4"

Strike

ANSI curved lip 4-7/8" - 1-1/4" x
1-1/4" lip to center

Cylinder

Brass, 6-pin, L4 keyway
0-bitted

Keys

Two nickel silver keys

Case Quantity

10

Case Weight

32 lbs

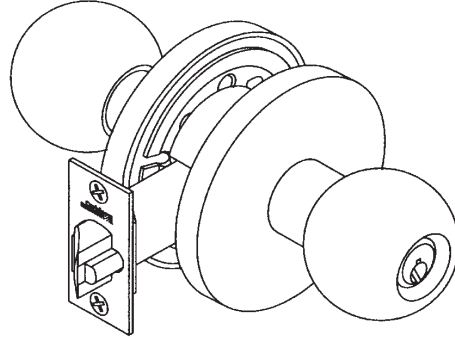

Ordering Example

Stock Order

Quantity	Series/Function	Trim	Finish	Hand
100	CK4355	GRD	630	RHR

Contract/Detailed Order

Quantity	Keyset	Series/Function	Trim	Finish	Hand	Strike	Misc. Options	Cylinder and Keying
24	AA1	CK4355	GRD	630	RHR	SA112	M02	VKC3

Knob Designs: GRD

Knob:
Wrought
Reinforced

Rose:
Wrought
Reinforced

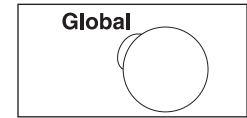

Function	Description		GRD
			Finish: 605, 613E, 630
CK4310	Non-Keyed	Passage	\$836.00
CK4320		Privacy	\$937.00
CK4350		Half Dummy	\$358.00
CK4351	Single Cylinder	Entrance	\$1,037.00
CK4355		Classroom	
CK4357		Storeroom	
CK4332	Double Cylinder	Institution	\$1,129.00

Cylinder Options

Description	Specify Quick Code	Add or Deduct
Conventional 6-pin	(standard)	No Charge
Less (1) Cylinder	LC	Deduct \$111.00 per cylinder
Access 3 Patented	AP	No Charge
Access 3 Security	AS	Add \$78.00 per cylinder
Access 3 High Security, UL 437	AHS	Add \$111.00 per cylinder
Pyramid Security Fixed Core	PS	Add \$83.00 per cylinder
Pyramid High Security Fixed Core	PHS	Add \$121.00 per cylinder
Security	HS	Add \$154.00 per cylinder

Keying Options*

Description	Specify Quick Code	Add or Deduct
0-Bitted with 2 blank keys	(standard)	No Charge
Keyed random	KR	
Master keyed	Specify keyset	Add \$16.00 per cylinder
Master keyed Pyramid	Specify keyset	Add \$16.00 per cylinder
Master keyed Security	Specify keyset	Add \$16.00 per cylinder
Master keyed	Specify keyset	No Charge
Master keyed to customer bittings or sample key	Specify keyset	Add \$16.00 per cylinder
Construction master keyed ^{1,2}	CMK	Add \$16.00 per cylinder
Visual key control (VKC)		
-No stamping	VKC0	\$4.50
-Keys only	VKC1	No Charge
-Cylinder and Keys ³	VKC2	\$8.00
-Cylinders only ³	VKC3	\$8.00
Concealed key control (CKC)		
-CKC cylinders with VKC keys	CKC2	\$8.00
-CKC cylinders only ³	CKC3	\$8.00
More than 2 keys per lock	KY# (e.g., KY6)	See page 33 - Cut Keys Section

Notes:

1. CMK Construction master keying charge is in addition to master keying charge.
2. CMK Construction master keying is not available in interchangeable core, Access 3, Pyramid, or Security series.
3. VKC2, VKC3, CKC3 are not available in Access 3, Pyramid or Security series.

*Double cylinder keying: unless otherwise specified, both cylinders of 32 functions will be keyed alike.
If different keying is required, specify outside cylinder first, then inside cylinder.
For key bows other than 10 and 90, specify "KB" + bow number as Quick Code, e.g. KB12. No extra charge.

Strike Options*

To purchase strike separately, see catalog or parts manual for part number.

Lip Length	ANSI Curved Lip - Specify Quick Code	Curved Lip Box - Specify Quick Code	Add or Deduct
1 "	SA100	SC100	No Charge
1-1/8 "	SA118	SC118	
1-1/4 "	SA114 (standard)	SC114	
1-3/8 "	SA138	SC138	
1-1/2 "	SA112	SC112	
1-3/4 "	SA134	SC134	Add \$17.00 per lock
2 "	SA200	SC200	
2-1/4 "	SA214	SC214	
2-1/2 "	SA212	SC212	
2-3/4 "	SA234	SC234	
3 "	SA300	SC300	

*If door thickness is standard or has been specified and no special door or frame condition exist, then only the first two characters of the optional strike Quick code must be specified(e.g. "SC").
The correct lip length will be determined by our order entry system based on the standard or specified door thickness.

Backset Options

Description	Specify Quick Code	Add or Deduct
2-3/4 "	B324 (standard)	No Charge

Door Thickness Options

Description	Specify Quick Code	Add or Deduct
1-3/4 " - 2 "	(standard)	No Charge

Miscellaneous Options

Description	Specify Quick Code	Add or Deduct
Spanner head screws	M02	Add \$28.00 per lockset
Torx® head screws	M04	Add \$34.00 per lockset
ANSI wrought strike box	M17	No Charge

Standard Features

Handing

Field reversible

Door Thickness

1-3/8" - 1-3/4"

Backset

2-3/4"

Strike

ANSI curved Lip 4-7/8" x 1-1/4"
x 1-1/4" lip to center

Cylinder

Brass, 6-pin, L4 keyway,
0-bitted

Keys

Two nickel silver keys

Case Quantity

12

Case Weight

18 lbs

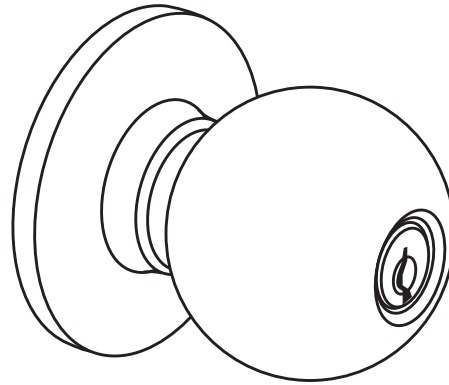

Ordering Example

Stock Order

Quantity	Series/Function	Trim	Finish	Hand
100	CK4851	GWC	626	RHR

Contract/Detailed Order

Quantity	Keyset	Series/Function	Trim	Finish	Hand	Strike	Misc. Options	Cylinder and Keying
24	AA1	CK4851	GWC	626	RHR	SA200	M17	VKC1

Knob Designs: GWC

Knob:
Wrought

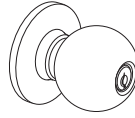
Rose:
Wrought

GWC

Function	Description		GWC
			Finish: 605, 613E, 626
CK4810	Non-Keyed	Passage	\$258.00
CK4820		Privacy	\$279.00
CK4850		Half Dummy	\$197.00
CK4851	Single Cylinder	Entrance	\$383.00
CK4855		Classroom	
CK4857		Storeroom	

Cylinder & Keying Options

Description	Specify Quick Code	Add or Deduct
Conventional 6-pin	(standard)	No Charge
Less cylinder	LC	Deduct \$111.00 per cylinder
Security		
Security	HS	Add \$154.00 per cylinder
Access 3®		
Access 3 Patented	AP	No Charge
Access 3 Security	AS	Add \$78.00 per cylinder
Access 3 High Security, UL 437	AHS	Add \$111.00 per cylinder
Pyramid		
Pyramid Security Fixed Core	PS	Add \$83.00 per cylinder
Pyramid High Security Fixed Core	PHS	Add \$121.00 per cylinder
Keying and Keys		
0-Bitted with 2 blank keys	(standard)	No Charge
Keyed random	KR	No Charge
Construction master keyed ¹	CMK	Add \$16.00 per cylinder
More than 2 keys per lock	KY# (e.g., KY6)	See page 33 - Cut Keys Section
Master Keying		
Master keyed to customer bittings or sample key	MK-CB	Add \$16.00 per cylinder
Conventional, Security, Pyramid and Access 3 cylinders	MK	
Visual Key Control (VKC)		
No bitting or keyset stamping on keys	VKC0	\$4.50
Keys only	VKC1	No Charge
Cylinders and keys (not for AS, AHS, HS, PHS)	VKC2	\$8.00
Cylinders only (not for AS, AHS, HS, PHS)	VKC3	
Concealed Key Control (CKC)		
CKC cylinders with VKC keys	CKC2	\$8.00
CKC cylinders only (not for AS, AHS, PHS)	CKC3	

Backset Options

Notes:

1. CMK Construction master keying charge is in addition to master keying charge.

For key bows other than 10 and 90, specify "KB" + bow number as Quick Code, e.g. KB12. No extra charge.

Description	Specify Quick Code	Add or Deduct
2-3/8"	B238	No Charge
2-3/4"	B234 (standard)	

Strike Options*

To purchase strike separately, see catalog or parts manual for part no.

Lip Length	ANSI Curved Lip Specify Quick Code	Curved Lip Box Specify Quick Code	Full Lip Specify Quick Code	Add or Deduct
1"	SA100	SC100		No Charge
1-1/8"	SA118	SC118		
1-1/4"	SA114 (standard)	SC114	SF114	
1-3/8"	SA138	SC138		
1-1/2"	SA112	SC112		
1-3/4"	SA134	SC134		Add \$17.00 per lock
2"	SA200	SC200		
2-1/4"	SA214	SC214		
2-1/2"	SA212	SC212		
2-3/4"	SA234	SC234		
3"	SA300	SC300		

*If door thickness is standard or has been specified and no special door or frame condition exist, then only the first two characters of the optional strike Quick Code must be specified (e.g. "SC").

Miscellaneous Options

Description	Specify Quick Code	Add or Deduct
ANSI wrought strike box	M17	No Charge

Standard Features

Handing

Field reversible

Door Thickness

1-3/8" - 1-3/4"

Backset

2-3/4"

Strike

ANSI curved Lip 4-7/8" x 1-1/4"
x 1-1/4" lip to center

Cylinder

Brass, 6-pin, L4 keyway,
0-bitted

Keys

Two nickel silver keys

Case Quantity

20

Case Weight

40 lbs

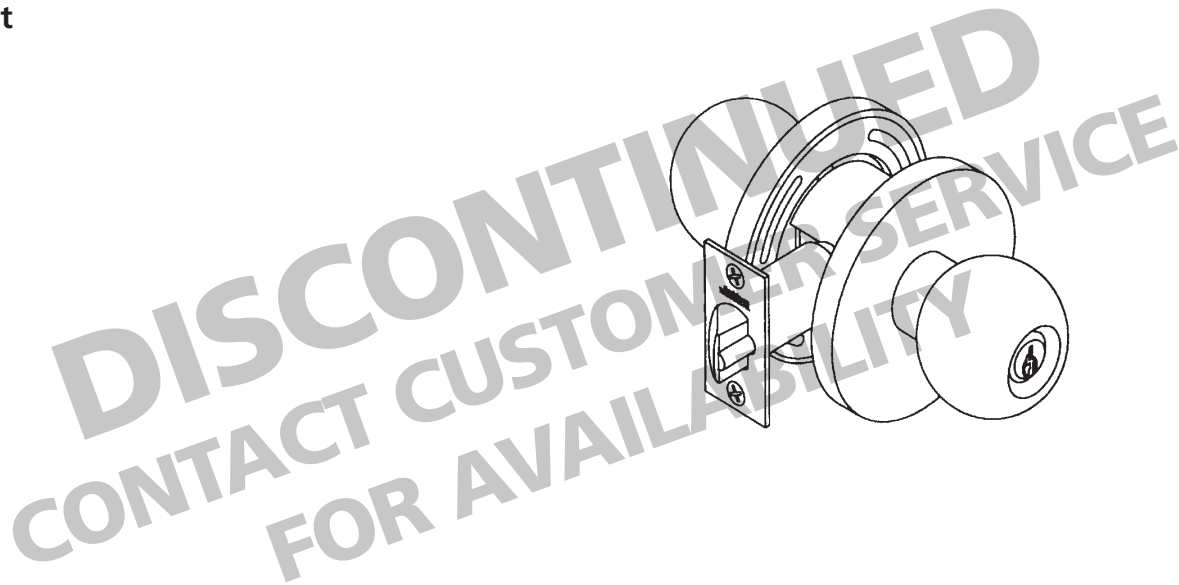

Ordering Example

Stock Order

Quantity	Series/Function	Trim	Finish	Hand
100	CK4451	GWC	630	RHR

Contract/Detailed Order

Quantity	Keyset	Series/Function	Trim	Finish	Hand	Strike	Misc. Options	Cylinder and Keying
24	AA1	CK4451	GWC	630	RHR	SA200	M17	VKC1

Knob Designs: GWC

Knob:
Wrought

Rose:
Wrought
Reinforced

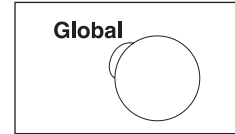

Function	Description		GWC
			Finish: 605, 613, 630
CK4410	Non-Keyed	Passage	\$258.00
CK4430		Privacy	\$279.00
CK4450		Half Dummy	\$197.00
CK4451	Single Cylinder	Entrance	\$383.00
CK4455		Classroom	
CK4457		Storeroom	

Cylinder & Keying Options

Description	Specify Quick Code	Add or Deduct
Conventional 6-pin	(standard)	No Charge
Less cylinder	LC	Deduct \$111.00 per cylinder
0-Bitted with 2 blank keys	(standard)	No Charge
Keyed random	KR	No Charge
Master keyed	MK	Add \$16.00 per cylinder
Master keyed Pyramid	MK	Add \$16.00 per cylinder
Master keyed Security	MK	Add \$16.00 per cylinder
Master keyed to customer bittings or sample key	MK-CB	Add \$16.00 per cylinder
Construction master keyed 1	CMK	Add \$16.00 per cylinder
Visual key control (VKC)		
-No stamping	VKC0	\$4.50
-Keys only	VKC1	No Charge
Concealed key control (CKC)		
-CKC cylinders with VKC keys	CKC2	\$8.00
-CKC cylinders only	CKC3	\$8.00
More than 2 keys per lock	KY# (e.g., KY6)	See page 33 - Cut Keys Section

Notes:

1. CMK Construction master keying charge is in addition to master keying charge.
For key bows other than 10 and 90, specify "KB" + bow number as Quick Code, e.g. KB12. No extra charge.

Backset Options

Description	Specify Quick Code	Add or Deduct
2-3/8"	B238	No Charge
2-3/4"	B234 (standard)	
3-3/4"	B334	Add \$12.00 per lockset
5"	B500	Add \$14.00 per lockset

Strike Options*

To purchase strike separately, see catalog or parts manual for part no.

Lip Length	ANSI Curved Lip Specify Quick Code	Curved Lip Box Specify Quick Code	Full Lip Specify Quick Code	Full Lip Radius Corner Specify Quick Code	Add or Deduct
1"	SA100	SC100			No Charge
1-1/8"	SA118	SC118			
1-1/4"	SA114 (standard)	SC114	SF114	SFR114	
1-3/8"	SA138	SC138			
1-1/2"	SA112	SC112			
1-3/4"	SA134	SC134			Add \$17.00 per lock
2"	SA200	SC200			
2-1/4"	SA214	SC214			
2-1/2"	SA212	SC212			
2-3/4"	SA234	SC234			
3"	SA300	SC300			

*If door thickness is standard or has been specified and no special door or frame condition exist, then only the first two characters of the optional strike Quick Code must be specified (e.g. "SC").

Miscellaneous Options

Description	Specify Quick Code	Add or Deduct
1" latch front, square corners (for 2-3/8" backset only)	M14	Add \$6.00 per lockset
ANSI wrought strike box	M17	No Charge
Abrasive coat outside and inside	M23	Add \$124.00 per lockset
Abrasive coat inside only	M24	Add \$62.00 per lockset
Abrasive coat outside only	M25	Add \$62.00 per lockset

Pre-Assembled Unit Locksets:

UT5200 Series Standard Features & Ordering Examples	180
UT5200 Series Lever Designs	181
UT5200 Series Cylinder Options	182
UT5200 Series Keying Options	183
UT5200 Series Strike, Miscellaneous Options	184

PL5000 Series Padlocks:

PL5000 Series Standard Features & Ordering Example	185
PL5000 Series Cylinder & Keying, Miscellaneous Options	186

DL2200 Series Cylindrical Deadlocks:

DL2200 Series Standard Features & Ordering Example	187
DL2200 Series Cylinder & Keying Options	188
DL2200 Series Strike, Door Thickness, Miscellaneous Options	189

DL3000 Series Cylindrical Deadlocks:

DL3000 Series Standard Features & Ordering Example	190
DL3000 Series Cylinder & Keying Options	191
DL3000 Series Strike, Door Thickness, Miscellaneous Options	192

DL3200 Series Cylindrical Deadlocks:

DL3200 Series Standard Features & Ordering Example	193
DL3200 Series Cylinder & Keying Options	194
DL3200 Series Strike, Door Thickness, Miscellaneous Options	195

DL4100 Series Mortise Deadlocks:

DL4100 Series Standard Features & Ordering Example	196
DL4100 Series Cylinder & Keying Options	197
DL4100 Series Strike, Door Thickness, Miscellaneous Options	198

Standard Features

Handing

Specify hand

Door Thickness

1-3/4" only

Backset

2-3/4" only

Strike

ANSI curved lip 4-7/8" x 1-1/4"
x 1-1/4" lip to center

Cylinder

Brass, 6-pin, L4 keyway,
0-bitted

Keys

Two nickel silver keys

Case Quantity

6
9

Case Weight

32 lbs

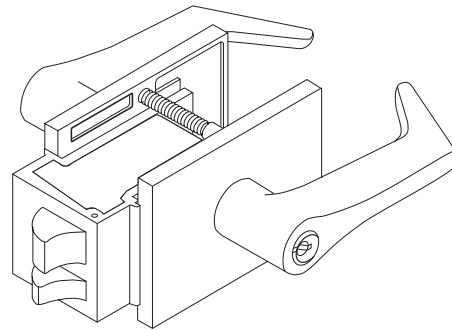

Now available with MicroShield® antimicrobial finish. Specify 626C finish (\$50.00 upcharge per lockset)

Ordering Example

Stock Order

Quantity	Series/Function	Trim	Finish	Hand
100	UT5251	ESE	626	RH

Split Trim/Split Finish Order

Quantity	Series/Function	Trim	Finish		Hand
			Outside	Inside	
12	UT5251	ESE	626	625	RHR

Contract/Detailed Order

Quantity	Keyset	Series/Function	Trim	Finish	Hand	Strike	Misc. Options	Cylinder and Keying
24	AA1	UT5251	ESE	626	RHR	SC200	M21	MR-VKC3

Lever Designs: ESE



Essex

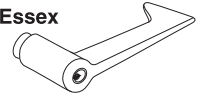

Lever:
Forged

Escutcheon:
Forged

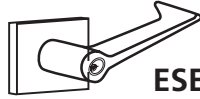

ESE

Function	Description		ESE
			Finish: 612, 613, 613E, 625, 626
UT5210	Non-keyed	Passage or Closet	\$1,837.00
UT5220		Privacy	\$1,930.00
UT5251	Single Cylinder	Entrance	\$2,029.00
UT5255		Classroom	
UT5257		Storeroom	
UT5282	Double Cylinder	Store Door	\$2,140.00

Cylinder Options		
Description	Specify Quick Code	Add or Deduct
Conventional 6-pin	(standard)	No Charge
Less Standard Cylinder	LC	Deduct \$111.00 per cylinder
LFIC		
LFIC 6-pin	C6	Add \$104.00 per cylinder
LFIC 6-pin Less Core	CL6	No Charge
LFIC 6-pin with Temporary Construction Core (Red)	CT6R	Add \$104.00 per cylinder
LFIC 6-pin with Temporary Construction Core (Blue)	CT6B	Add \$104.00 per cylinder
LFIC 6-pin with Temporary Construction Core (Green)	CT6G	Add \$104.00 per cylinder
LFIC 6-pin with Temporary Disposable Core	CT6D	No Charge
LFIC 7-pin	C7	Add \$106.00 per cylinder
LFIC 7-pin Less Core	CL7	No Charge
LFIC 7-pin with Temporary Construction Core (Red)	CT7R	Add \$106.00 per cylinder
LFIC 7-pin with Temporary Construction Core (Blue)	CT7B	Add \$106.00 per cylinder
LFIC 7-pin with Temporary Construction Core (Green)	CT7G	Add \$106.00 per cylinder
LFIC 7-pin with temporary Disposable Core	CT7D	No Charge
SFIC		
SFIC 6-pin	C6S	Add \$93.00 per cylinder
SFIC 6-pin with Temporary Construction Core (Blue)	CT6SB	Add \$93.00 per cylinder
SFIC 6-pin or 7-pin with Temporary Disposable Core	CTSD	No Charge
SFIC 7-pin	C7S	Add \$93.00 per cylinder
SFIC 7-pin with Temporary Construction Core (Blue)	CT7SB	Add \$93.00 per cylinder
Security		
Security	HS	Add \$154.00 per cylinder
Security LFIC	CHS	Add \$258.00 per cylinder
Access 3		
Access 3 Patented	AP	No Charge
Access 3 Security	AS	Add \$78.00 per cylinder
Access 3 High Security, UL 437	AHS	Add \$111.00 per cylinder
Access 3 LFIC Patented	ACP	Add \$104.00 per cylinder
Access 3 LFIC Security	ACS	Add \$182.00 per cylinder
Access 3 LFIC High Security, UL 437	ACHS	Add \$215.00 per cylinder
Pyramid		
Pyramid Security Fixed Core	PS	Add \$83.00 per cylinder
Pyramid Security LFIC	PCS	Add \$181.00 per cylinder
Pyramid High Security Fixed Core	PHS	Add \$121.00 per cylinder
Pyramid High Security LFIC	PCHS	Add \$223.00 per cylinder
Pyramid LFIC with Temporary Construction Core	CTP	Add \$104.00 per cylinder
Pyramid LFIC with Temporary Disposable Core	CTPD	No Charge
Pyramid LFIC Less Core	CLP	No Charge
Other		
Master Ring	MR	\$65.00

Continued on next page

Cylinder Options (continued) & Keying Options*		
Description	Specify Quick Code	Add or Deduct
Keying and Keys		
0-bitted with 2 Blank Keys	(standard)	No Charge
Keyed Random	KR	
Construction master keyed ^{1,2}	CMK	Add \$16.00 per cylinder
More than 2 Keys	KY# (e.g., KY6)	See page 33 - Cut Keys Section
Master Keying		
Master keyed (all cylinders except CR8000, CR8020, CR8027, CR8200, CR8500, CR8600, CR8700)	MK	Add \$16.00 per cylinder
Master keyed Pyramid (except CR8020, CR8027)	MK	
Master keyed Security (including LFIC cylinder and core)	MK	
Master keyed Access 3 (except CR8500, CR8600, CR8700 LFIC cores)	MK	
Master keyed (CR8000, CR8020, CR8027, CR8200, CR8500, CR8600, CR8700)	MK-IC	No Charge
Master keyed to customer bittings or sample key	MK-CB	Add \$16.00 per cylinder
Visual Key Control (VKC)		
No bitting or keyset stamping on keys	VKC0	\$4.50
Keys only	VKC1	No Charge
Cylinder and Keys ³ (not for AS, AHS, ACS, ACHS, HS, CHS, PHS or PCHS)	VKC2	\$8.00
Cylinders only ³ (not for AS, AHS, HS, ACS, ACHS, CHS, PHS or PCHS)	VKC3	
Concealed Key Control (CKC)		
CKC cylinders with VKC keys	CKC2	\$8.00
CKC cylinders only ³ (not for AS, AHS, ACS, ACHS, PHS, PCHS)	CKC3	

Notes:

1. CMK Construction master keying charge is in addition to master keying charge.
2. CMK Construction master keying is not available in interchangeable core, Access 3, Pyramid, or Security series.
3. VKC2, VKC3, CKC3 are not available in Access 3, Pyramid or Security series.

*Double cylinder keying: unless otherwise specified, both cylinders of 32, 62, 72 and 82 functions will be keyed alike. The inside cylinder of 52 function will be keyed to the master key(s) only, while the outside cylinder will include the change key. If different keying is required, specify outside cylinder first, then inside cylinder. For key bows other than 10 and 90, specify 'KB' + bow number as Quick Code, e.g. KB12.

Strike Options*

To purchase strike separately, see catalog for part no.

Lip Length	ANSI Curved Lip Specify Quick Code	T-Strike Curved Lip Box Specify Quick Code	Add or Deduct
1-1/4"	SA114 Standard	NA	No Charge
1-3/4"	N/A	SC134	Add \$17.00 per lock
2"	N/A	SC200	
2-1/8"	N/A	SC218	
2-1/4"	N/A	SC214	
2-1/2"	N/A	SC212	
2-3/4"	N/A	SC234	
3"	N/A	SC300	

Lip Length	ANSI Straight Lip For Door Pair** Quick Code	For Door Pair** Quick Code	Add or Deduct
1-13/16"	SA136	SP136	No Charge

Lip length	ANSI Straight Lip For Extended Lip Escutcheon Quick Code	For Extended Lip Escutcheon Quick Code	Add or Deduct
15/16"	Standard when Extended Lip Option is Specified	SX156	No Charge

*If door thickness is standard or has been specified and no special door or frame condition exist, then only the first two characters of the optional strike Quick code must be specified (e.g. "SC").

The correct lip length will be determined by our order entry system based on the standard or specified door thickness.

** Lip is measured from back of strike.

Miscellaneous Options

Description	Specify Quick Code	Add or Deduct
Split designs and split finishes	Outside Trim x Inside Trim	Higher set price prevails
Spanner head screws	M02	Add \$28.00 per lockset
Torx® head screws (on strike)	M04	Add \$34.00 per lockset
Lever to accept 6 or 7-pin SFIC (ESE only)	M08	Deduct \$20.00 per lockset
Extended lip escutcheon (for single door reverse bevel; 630 finish to match 626 only)	M11	Add \$68.00 per lockset
Knurling outside and inside	M20*	Add \$196.00 per lockset
Knurling outside only	M21*	Add \$98.00 per lockset
Knurling Inside only	M22*	
Abrasive coat outside and inside	M23	Add \$124.00 per lockset
Abrasive coat inside only	M24	Add \$62.00 per lockset
Abrasive coat outside only	M25	
Lead lining escutcheon	M28	Add \$131.00 per Escutcheon
Unstaked lever retainer	M33	No Charge

*All levers provided in a powder coat finish will be supplied with an abrasive coating.

Standard Features
Case

Extruded Brass

Shackle

11/32" (8.7mm) diameter hardened steel (PL5000 Series), brass (PL5100 Series) or stainless steel (PL5200 Series)

Locking

Ball-bearing locking heel and toe

Cylinder

 RFC model: 6-pin Fixed Core (2300)
 IC model: 6-pin & Pyramid IC (8000 series)
 L4 keyway standard

Case Quantity

36

Case Weight

27 lbs

Ordering Example
Stock Order

Quantity	Series/Function
10	PL5000R

Access 3 Order

Quantity	Series/Function	Misc. Options
8	PL5070	ACP M44

Contract Order

Quantity	Keyset	Series/Function	Shackle Length	Misc. Options
10	AA1	PL5080	258	M45

Padlocks

Hardened Steel Shackle	Brass Shackle	Description	List Price
PL5000R	PL5100R	Rekeyable Fixed Core (RFC)	\$143.00
PL5070*	PL5170*	Interchangeable core (IC), less core	\$149.00
PL5080	PL5180	IC 6-pin	\$253.00
PL5090	PL5190	IC security	\$407.00
PL5030	PL5130	Pyramid High Security (IC)	\$372.00
PL5037	PL5137	Pyramid Security (IC)	\$330.00

Stainless Steel Shackle	Description	List Price
PL5200R	Rekeyable Fixed Core (RFC)	\$148.00
PL5270*	Interchangeable core (IC), less core	\$154.00
PL5280	IC 6-pin	\$258.00
PL5290	IC security	\$412.00
PL5230	Pyramid High Security (IC)	\$377.00
PL5237	Pyramid Security (IC)	\$335.00

Shackle Length Options with Padlocks

Description	Specify Quick Code	Add or Deduct
7/8"	(standard)	No Charge
2-5/8"	258	Add \$5.00 to padlock

* Access 3 is only available with Less Core.

Cylinder Options (continued) & Keying Options*

Description	Specify Quick Code	Add or Deduct
Access 3		
Access 3 LFIC Patented	ACP	Add \$104.00 per cylinder
Access 3 LFIC Security	ACS	Add \$182.00 per cylinder
Access 3 LFIC High Security, UL 437	ACHS	Add \$215.00 per cylinder
LFIC		
LFIC 6-pin with Temporary Construction Core (Red)	CT6R	No Charge
LFIC 6-pin with Temporary Construction Core (Blue)	CT6B	No Charge
LFIC 6-pin with Temporary Construction Core (Green)	CT6G	No Charge
Keying and Keys		
0-bitted with 2 Blank Keys	(standard)	No Charge
Keyed Random	KR	
Construction master keyed ^{1,2}	CMK	Add \$16.00 per cylinder
More than 2 Keys	KY# (e.g., KY6)	See page 33 - Cut Keys Section
Master Keying		
Master keyed (all cylinders except CR8000, CR8020, CR8027, CR8200, CR8500, CR8600, CR8700 LFIC cores)	MK	Add \$16.00 per cylinder
Master keyed Pyramid (except CR8020, CR8027 LFIC cores)	MK	
Master keyed Security (including LFIC cylinder and core)	MK	
Master keyed Access 3 (except CR8500, CR8600, CR8700 LFIC cores)	MK	
Master keyed (CR8000, CR8020, CR8027, CR8200, CR8500, CR8600, CR8700 LFIC cores)	MK-IC	No Charge
Master keyed to customer bittings or sample key	MK-CB	Add \$16.00 per cylinder
Visual Key Control (VKC)		
No bitting or keyset stamping on keys	VKC0	\$4.50
Keys only	VKC1	No Charge
Cylinder and Keys ³ (not for AS, AHS, ACS, ACHS, HS, CHS, PHS or PCHS)	VKC2	\$8.00
Cylinders only ³ (not for AS, AHS, HS, ACS, ACHS, CHS, PHS or PCHS)	VKC3	
Concealed Key Control (CKC)		
CKC cylinders with VKC keys	CKC2	\$8.00
CKC cylinders only ³ (not for AS, AHS, ACS, ACHS, PHS, PCHS)	CKC3	
More than 2 keys per lock	KY# (e.g., KY6)	See page 31 - Cut Keys Section
Rekeybale FC (RFC) Less Cylinder	LC	Deduct \$28.00 per cylinder

- Notes:
1. CMK Construction master keying charge is in addition to master keying charge.
 2. CMK Construction master keying is not available in interchangeable core, Access 3, Pyramid, or Security series.
 3. VKC2, VKC3, CKC3 are not available in Access 3, Pyramid or Security series.

*Double cylinder keying: unless otherwise specified, both cylinders of 32, 62, 72 and 82 functions will be keyed alike. The inside cylinder of 52 function will be keyed to the master key(s) only, while the outside cylinder will include the change key. If different keying is required, specify outside cylinder first, then inside cylinder. For key bows other than 10 and 90, specify 'KB' + bow number as Quick Code, e.g. KB12.

Miscellaneous Options

Description	Specify Quick Code	Add or Deduct
Chain and clevis attached	M44	Add \$4.00 to padlock
Custom die stamped case* (specify existing die number or lettering specifications for artwork)	M45	Add \$5.50 to padlock

*To create new die stamp, contact factory. Provide artwork with request for quotation.
Die stamps remain the property of Corbin Russwin.

**ANSI/BHMA A156.36
Grade 2**

Standard Features

Handing

Non-handed

Door Thickness

1-3/8" - 2-1/4"

Backset

2-3/4" (standard)
2-3/8" available

Strike

2-3/4" x 1-1/8"

Cylinder

Brass 6-pin,
0-bitted, L4 keyway

Keys

Two nickel silver keys

Case Quantity

12

Case Weight

24 lbs

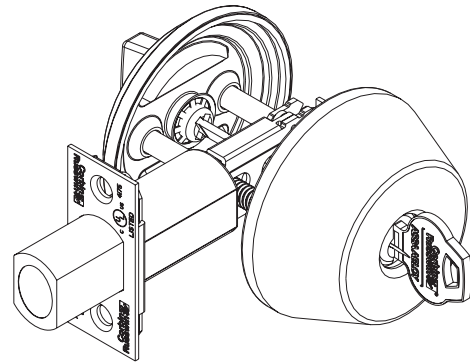

Ordering Example

Stock Order

Quantity	Series/Function	Finish
30	DL2213	626

Contract Order

Quantity	Series/Function	Finish	Keyset	Optional Strike
30	DL2213	626	AA1	SS134

Function	Description	Finish: 613E, 626, BSP, WSP	Finish: 605, 606, 612, 613, 625
DL2213	Single Cylinder	\$152.00	\$159.00
DL2212	Double Cylinder	\$195.00	\$202.00
DL2217	Classroom	\$152.00	\$159.00
DL2211	Cylinder x Blank		
DL2260	Thumbturn x Blank	\$110.00	\$114.00
DL2261	Thumbturn x Indicator*	\$122.00	\$126.00

Notes:

Both cylinders of double cylinder deadlocks are keyed alike, unless otherwise specified. If different keying is required, specify outside cylinder first, then inside cylinder.

*Indicator option code MUST be specified when ordering DL2261. If none specified, V21 will be provided as default.

Cylinder Options		
Description	Specify Quick Code	Add or Deduct
Conventional 6-pin	(standard)	No Charge
Conventional 7-pin	7P	Add \$2.00 per cylinder
Less Standard Cylinder	LC	No Deduct
LFIC		
LFIC 6-pin	C6	Add \$104.00 per cylinder
LFIC 6-pin Less Core	CL6	No Charge
LFIC 6-pin with Temporary Construction Core (Red)	CT6R	Add \$104.00 per cylinder
LFIC 6-pin with Temporary Construction Core (Blue)	CT6B	Add \$104.00 per cylinder
LFIC 6-pin with Temporary Construction Core (Green)	CT6G	Add \$104.00 per cylinder
LFIC 6-pin with Temporary Disposable Core	CT6D	No Charge
LFIC 7-pin	C7	Add \$106.00 per cylinder
LFIC 7-pin Less Core	CL7	No Charge
LFIC 7-pin with Temporary Construction Core (Red)	CT7R	Add \$106.00 per cylinder
LFIC 7-pin with Temporary Construction Core (Blue)	CT7B	Add \$106.00 per cylinder
LFIC 7-pin with Temporary Construction Core (Green)	CT7G	Add \$106.00 per cylinder
LFIC 7-pin with temporary Disposable Core	CT7D	No Charge
SFIC		
SFIC 6-pin	C6S	Add \$93.00 per cylinder
SFIC 6-pin with Temporary Construction Core (Blue)	CT6SB	Add \$93.00 per cylinder
SFIC 6-pin or 7-pin with Temporary Disposable Core	CTSD	No Charge
SFIC 7-pin	C7S	Add \$93.00 per cylinder
SFIC 7-pin with Temporary Construction Core (Blue)	CT7SB	Add \$93.00 per cylinder
Security		
Security	HS	Add \$154.00 per cylinder
Security LFIC	CHS	Add \$258.00 per cylinder
Access 3		
Access 3 Patented	AP	No Charge
Access 3 Security	AS	Add \$78.00 per cylinder
Access 3 High Security, UL 437	AHS	Add \$111.00 per cylinder
Access 3 LFIC Patented	ACP	Add \$104.00 per cylinder
Access 3 LFIC Security	ACS	Add \$182.00 per cylinder
Access 3 LFIC High Security, UL 437	ACHS	Add \$215.00 per cylinder
Pyramid		
Pyramid Security Fixed Core	PS	Add \$83.00 per cylinder
Pyramid Security LFIC	PCS	Add \$181.00 per cylinder
Pyramid High Security Fixed Core	PHS	Add \$121.00 per cylinder
Pyramid High Security LFIC	PCHS	Add \$223.00 per cylinder
Pyramid LFIC with Temporary Construction Core	CTP	Add \$104.00 per cylinder
Pyramid LFIC with Temporary Disposable Core	CTPD	No Charge
Pyramid LFIC Less Core	CLP	No Charge
Keying and Keys		
0-bitted with 2 Blank Keys	(standard)	No Charge
Keyed Random	KR	
Construction master keyed ^{1,2}	CMK	Add \$16.00 per cylinder
More than 2 Keys	KY# (e.g., KY6)	See page 33 - Cut Keys Section
Master Keying		
Master keyed (all cylinders except CR8000, CR8020, CR8027, CR8200, CR8500, CR8600, CR8700)	MK	Add \$16.00 per cylinder
Master keyed Pyramid (except CR8020, CR8027 LFIC cores)	MK	
Master keyed Security (including LFIC cylinder and core)	MK	
Master keyed Access 3 (except CR8500, CR8600, CR8700 LFIC cores)	MK	
Master keyed (CR8000, CR8020, CR8027, CR8200, CR8500, CR8600, CR8700)	MK-IC	No Charge
Master keyed to customer bittings or sample key	MK-CB	Add \$16.00 per cylinder

Cylinder Options (continued) & Keying Options*

Description	Specify Quick Code	Add or Deduct
Visual Key Control (VKC)		
No biting or keyset stamping on keys	VKC0	\$4.50
Keys only	VKC1	No Charge
Cylinder and Keys ³ (not for AS, AHS, ACS, ACHS, HS, CHS, PHS or PCHS)	VKC2	\$8.00
Cylinders only ³ (not for AS, AHS, HS, ACS, ACHS, CHS, PHS or PCHS)	VKC3	
Concealed Key Control (CKC)		
CKC cylinders with VKC keys	CKC2	\$8.00
CKC cylinders only ³ (not for AS, AHS, ACS, ACHS, PHS, PCHS)	CKC3	

Notes: 1. CMK Construction master keying charge is in addition to master keying charge.
 2. CMK Construction master keying is not available in interchangeable core, Access 3, Pyramid, or Security series.
 3. VKC2, VKC3, CKC3 are not available in Access 3, Pyramid or Security series.
 * For key bows other than 10 and 90, specify 'KB' + bow number as Quick Code, e.g. KB12.

Strike Options

To purchase strike separately, see catalog or parts manual for part no.

Lip Length	ANSI Straight Lip - Specify Quick Code	Add or Deduct
7/8"	SS078	No Charge
1-1/8"	SS118	
1-1/4"	SS114	
1-3/8"	SS138	
1-1/2"	SS112	
1-3/4"	SS134	Add \$17.00 per lock
2"	SS200	
2-1/4"	SS214	
2-1/2"	SS212	
2-3/4"	SS234	
3"	SS300	

Door Thickness Options

Description	Specify Quick Code	Add or Deduct
1-3/8"	D138	No Charge
1-3/4"	(standard)	No Charge
2"	D200	No Charge
2-1/4"	D214	No Charge

Indicator Options

Description	Specify Quick Code	Add or Deduct
Indicator inside only "Unlocked/Locked" in green/red	V01	Add \$32.00 per lock
Indicator inside only "Unlocked/Locked" in white/red	V04	
Indicator inside only, French "Ouvert/Fermé" in green/red	V01F	
Indicator both sides "Unlocked/Locked" x "Vacant/Occupied" in green/red (Std for DL2261)	V21	No Charge
Indicator both sides "Unlocked/Locked" x "Vacant/Occupied" in white/red	V54	
Indicator both sides, French "Ouvert/Fermé" x "Libre/Occupée" in green/red	V21F	

Miscellaneous Options

Description	Specify Quick Code	Add or Deduct
1" (25mm) bolt front, square corners	M14	Add \$6.00 per lockset
ANSI wrought strike box	M17	No Charge
Plastic box for standard strike	(standard)	No Charge
2-3/8" (60mm) backset bolt	B238	No Charge

**Standard Features
Handing**

Non-handed, except DL3017 function

Door Thickness

1-3/4" - 2-1/4"

Backset

2-3/4" (standard)

Strike

Wrought brass or bronze
2-3/4" x 1-1/8" with
wrought box

Cylinder

Brass 6-pin,
0-bitted, L4 keyway

Keys

Two nickel silver keys

Weight

2.5 lbs each

Case Quantity

12

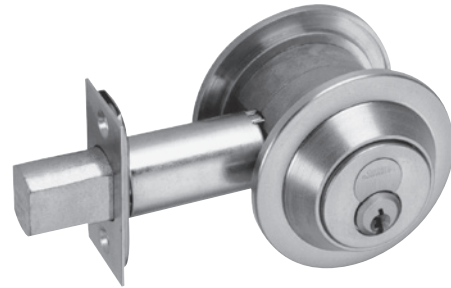

Ordering Example

Stock Order

Quantity	Series/Function	Finish
30	DL3013	626

Contract Order

Quantity	Series/Function	Finish	Keypad	Optional Strike
30	DL3013	626	AA1	SD001

Function	Description	Finish: 605, 606, 612 613 613E, 618, 619, 625, 626, 722, BSP, WSP
DL3013	Single Cylinder	\$353.00
DL3012	Double Cylinder	\$473.00
DL3017	Classroom*	\$361.00
DL3011	Cylinder x Blank	\$353.00
DL3060	Thumbturn x Blank	

*Thumbturn will not project deadbolt. Specify hand.

Cylinder Options		
Description	Specify Quick Code	Add or Deduct
Conventional 6-pin	(standard)	No Charge
Conventional 7-pin	7P	Add \$2.00 per cylinder
Less Standard Cylinder	LC	Deduct \$120.00 per cylinder
LFIC		
LFIC 6-pin	C6	Add \$104.00 per cylinder
LFIC 6-pin Less Core	CL6	No Charge
LFIC 6-pin with Temporary Construction Core (Red)	CT6R	Add \$104.00 per cylinder
LFIC 6-pin with Temporary Construction Core (Blue)	CT6B	Add \$104.00 per cylinder
LFIC 6-pin with Temporary Construction Core (Green)	CT6G	Add \$104.00 per cylinder
LFIC 6-pin with Temporary Disposable Core	CT6D	No Charge
LFIC 7-pin	C7	Add \$106.00 per cylinder
LFIC 7-pin Less Core	CL7	Add \$2.00 per cylinder
LFIC 7-pin with Temporary Construction Core (Red)	CT7R	Add \$106.00 per cylinder
LFIC 7-pin with Temporary Construction Core (Blue)	CT7B	Add \$106.00 per cylinder
LFIC 7-pin with Temporary Construction Core (Green)	CT7G	Add \$106.00 per cylinder
LFIC 7-pin with temporary Disposable Core	CT7D	Add \$2.00 per cylinder
UL LFIC 6-Pin Housing Less Core	CL6AH	Add \$104.00 per cylinder
UL LFIC 6-Pin Housing with Disposable Core	CTAHD	Add \$104.00 per cylinder
UL LFIC 6-Pin Housing with Temp Construction Core	CT6AH(R/B/G)	Add \$224.00 per cylinder
SFIC		
SFIC 6-pin	C6S	Add \$93.00 per cylinder
SFIC 6-pin with Temporary Construction Core (Blue)	CT6SB	Add \$93.00 per cylinder
SFIC 6-pin with SFIC Disposable Temporary Core	CT6SD	No Charge
SFIC 6-pin Less Core	CLS6	No Charge
SFIC 7-pin	C7S	Add \$93.00 per cylinder
SFIC 7-pin with Temporary Construction Core (Blue)	CT7SB	Add \$93.00 per cylinder
SFIC 7-pin with SFIC Disposable Temporary Core	CT7SD	No Charge
SFIC 7-pin Less Core	CLS7	No Charge
Security		
Security	HS	Add \$158.00 per cylinder
Security LFIC	CHS	Add \$258.00 per cylinder
Access 3		
Access 3 Patented	AP	No Charge
Access 3 Security	AS	Add \$78.00 per cylinder
Access 3 High Security, UL 437	AHS	Add \$111.00 per cylinder
Access 3 LFIC Patented	ACP	Add \$104.00 per cylinder
Access 3 LFIC Security	ACS	Add \$182.00 per cylinder
Access 3 LFIC High Security, UL 437	ACHS	Add \$215.00 per cylinder
Pyramid		
Pyramid Security Fixed Core	PS	Add \$84.00 per cylinder
Pyramid Security LFIC	PCS	Add \$181.00 per cylinder
Pyramid High Security Fixed Core	PHS	Add \$125.00 per cylinder
Pyramid High Security LFIC	PCHS	Add \$223.00 per cylinder
Pyramid LFIC with Temporary Construction Core	CTP	Add \$104.00 per cylinder
Pyramid LFIC with Temporary Disposable Core	CTPD	No Charge
Pyramid LFIC Less Core	CLP	No Charge

Notes:

1. CMK Construction master keying charge is in addition to master keying charge.

*Both cylinders of double cylinder deadlocks are keyed alike, unless otherwise specified. If different keying is required, specify outside cylinder first, then inside cylinder.

For key bows other than 10 and 90, specify 'KB' + bow number as Quick Code, e.g. KB12.

Note: KB92 cannot be furnished with VKC or other markings.

Cylinder Options (continued) & Keying Options*

Description	Specify Quick Code	Add or Deduct
Keying and Keys		
0-bitted with 2 Blank Keys	(standard)	No Charge
Keyed Random	KR	
Construction master keyed ^{1,2}	CMK	Add \$16.00 per cylinder
More than 2 Keys	KY# (e.g., KY6)	See page 33 - Cut Keys Section
Master Keying		
Master keyed (all cylinders except CR8000, CR8020, CR8027, CR8200, CR8500, CR8600, CR8700)	MK	Add \$16.00 per cylinder
Master keyed Pyramid (except CR8020, CR8027 LFIC cores)	MK	
Master keyed Security (including LFIC cylinder and core)	MK	
Master keyed Access 3 (except CR8500, CR8600, CR8700 LFIC cores)	MK	
Master keyed (CR8000, CR8020, CR8027, CR8200, CR8500, CR8600, CR8700)	MK-IC	No Charge
Master keyed to customer bittings or sample key	MK-CB	Add \$16.00 per cylinder
Visual Key Control (VKC)		
No bitting or keyset stamping on keys	VKC0	\$4.50
Keys only	VKC1	No Charge
Cylinder and Keys ³ (not for AS, AHS, ACS, ACHS, HS, CHS, PHS or PCHS)	VKC2	\$8.00
Cylinders only ³ (not for AS, AHS, HS, ACS, ACHS, CHS, PHS or PCHS)	VKC3	
Concealed Key Control (CKC)		
CKC cylinders with VKC keys	CKC2	\$8.00
CKC cylinders only ³ (not for AS, AHS, ACS, ACHS, PHS, PCHS)	CKC3	

- Notes: 1. CMK Construction master keying charge is in addition to master keying charge.
 2. CMK Construction master keying is not available in interchangeable core, Access 3, Pyramid, or Security series.
 3. VKC2, VKC3, CKC3 are not available in Access 3, Pyramid or Security series.

*For key bows other than 10 and 90, specify 'KB' + bow number as Quick Code, e.g. KB12.

Strike Options*

To purchase strike separately, see catalog or parts manual for part no.

Lip Length	ANSI Straight Lip - Specify Quick Code	Add or Deduct
7/8"	SS078	No Charge
1-1/8"	SS118	
1-1/4"	SS114	
1-3/8"	SS138	
1-1/2"	SS112	
1-3/4"	SS134	Add \$17.00 per lock
2"	SS200	
2-1/4"	SS214	
2-1/2"	SS212	
2-3/4"	SS234	
3"	SS300	

Strike Options (No lip)

Description	Specify Quick Code	Add or Deduct
2-3/4" x 1-1/8"	(standard)	No Charge
3-1/2" x 1-1/8"	SD001	

Door Thickness Options

Description	Specify Quick Code	Add or Deduct
1-3/8" (Not available in IC option)	D138	No Charge
1-3/4" - 2"	(standard)	
2-1/4"	D214	Add \$6.00 per lockset

Miscellaneous Options

Description	Specify Quick Code	Add or Deduct
ANSI wrought box	M17	No Charge
Ergonomic Thumbturn	M34	Add \$20.00 per TT
Plastic box for standard strike	PStdStrike	No Charge
2-3/8" backset	B238	

Standard Features

Handing

Non-handed

Door Thickness

1-3/8" - 2-1/4"

Backset

2-3/4" (standard)
2-3/8" available

Strike

2-3/4" x 1-1/8"

Cylinder

Brass 6-pin,
0-bitted, L4 keyway

Keys

Two nickel silver keys

Case Quantity

12

Case Weight

24 lbs

ANSI/BHMA 156.36

Grade 1

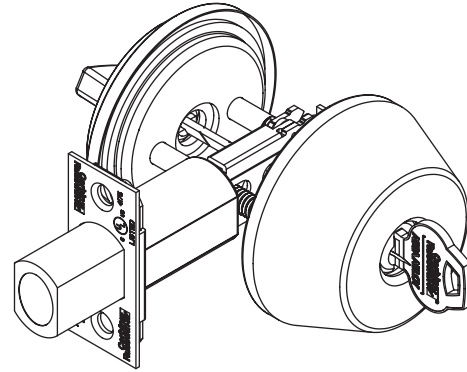

Ordering Example

Stock Order

Quantity	Series/Function	Finish
30	DL3213	626

Contract Order

Quantity	Series/Function	Finish	Keyset	Optional Strike
30	DL3213	626	AA1	SS134

Function	Description	Finish: 613E, 626, BSP, WSP	Finish: 605, 606, 612, 613, 625
DL3213	Single Cylinder	\$276.00	\$283.00
DL3212	Double Cylinder	\$387.00	\$394.00
DL3217	Classroom	\$276.00	\$283.00
DL3211	Cylinder x Blank		
DL3260	Thumbturn x Blank	\$234.00	\$238.00

Cylinder Options		
Description	Specify Quick Code	Add or Deduct
Conventional 6-pin	(standard)	No Charge
Conventional 7-pin	7P	Add \$2.00 per cylinder
Less Standard Cylinder	LC	Deduct \$111.00 per cylinder
LFIC		
LFIC 6-pin	C6	Add \$104.00 per cylinder
LFIC 6-pin Less Core	CL6	No Charge
LFIC 6-pin with Temporary Construction Core (Red)	CT6R	Add \$104.00 per cylinder
LFIC 6-pin with Temporary Construction Core (Blue)	CT6B	Add \$104.00 per cylinder
LFIC 6-pin with Temporary Construction Core (Green)	CT6G	Add \$104.00 per cylinder
LFIC 6-pin with Temporary Disposable Core	CT6D	No Charge
LFIC 7-pin	C7	Add \$106.00 per cylinder
LFIC 7-pin Less Core	CL7	No Charge
LFIC 7-pin with Temporary Construction Core (Red)	CT7R	Add \$106.00 per cylinder
LFIC 7-pin with Temporary Construction Core (Blue)	CT7B	Add \$106.00 per cylinder
LFIC 7-pin with Temporary Construction Core (Green)	CT7G	Add \$106.00 per cylinder
LFIC 7-pin with temporary Disposable Core	CT7D	No Charge
SFIC		
SFIC 6-pin	C6S	Add \$93.00 per cylinder
SFIC 6-pin with Temporary Construction Core (Blue)	CT6SB	Add \$93.00 per cylinder
SFIC 6-pin or 7-pin with Temporary Disposable Core	CTSD	No Charge
SFIC 7-pin	C7S	Add \$93.00 per cylinder
SFIC 7-pin with Temporary Construction Core (Blue)	CT7SB	Add \$93.00 per cylinder
Security		
Security	HS	Add \$154.00 per cylinder
Security LFIC	CHS	Add \$258.00 per cylinder
Access 3		
Access 3 Patented	AP	No Charge
Access 3 Security	AS	Add \$78.00 per cylinder
Access 3 High Security, UL 437	AHS	Add \$111.00 per cylinder
Access 3 LFIC Patented	ACP	Add \$104.00 per cylinder
Access 3 LFIC Security	ACS	Add \$182.00 per cylinder
Access 3 LFIC High Security, UL 437	ACHS	Add \$215.00 per cylinder
Pyramid		
Pyramid Security Fixed Core	PS	Add \$83.00 per cylinder
Pyramid Security LFIC	PCS	Add \$181.00 per cylinder
Pyramid High Security Fixed Core	PHS	Add \$121.00 per cylinder
Pyramid High Security LFIC	PCHS	Add \$223.00 per cylinder
Pyramid LFIC with Temporary Construction Core	CTP	Add \$104.00 per cylinder
Pyramid LFIC with Temporary Disposable Core	CTPD	No Charge
Pyramid LFIC Less Core	CLP	No Charge

Notes:

1. CMK Construction master keying charge is in addition to master keying charge.

*Both cylinders of double cylinder deadlocks are keyed alike, unless otherwise specified. If different keying is required, specify outside cylinder first, then inside cylinder.

For key bows other than 10 and 90, specify 'KB' + bow number as Quick Code, e.g. KB12.

Note: KB92 cannot be furnished with VKC or other markings.

Cylinder Options (continued) & Keying Options*

Description	Specify Quick Code	Add or Deduct
Keying and Keys		
0-bitted with 2 Blank Keys	(standard)	No Charge
Keyed Random	KR	
Construction master keyed ^{1,2}	CMK	Add \$16.00 per cylinder
More than 2 Keys	KY# (e.g., KY6)	See page 33 - Cut Keys Section
Master Keying		
Master keyed (all cylinders except CR8000, CR8020, CR8027, CR8200, CR8500, CR8600, CR8700)	MK	Add \$16.00 per cylinder
Master keyed Pyramid (except CR8020, CR8027 LFIC cores)	MK	
Master keyed Security (including LFIC cylinder and core)	MK	
Master keyed Access 3 (except CR8500, CR8600, CR8700 LFIC cores)	MK	
Master keyed (CR8000, CR8020, CR8027, CR8200, CR8500, CR8600, CR8700)	MK-IC	No Charge
Master keyed to customer bittings or sample key	MK-CB	Add \$16.00 per cylinder
Visual Key Control (VKC)		
No bitting or keyset stamping on keys	VKC0	\$4.50
Keys only	VKC1	No Charge
Cylinder and Keys ³ (not for AS, AHS, ACS, ACHS, HS, CHS, PHS or PCHS)	VKC2	\$8.00
Cylinders only ³ (not for AS, AHS, HS, ACS, ACHS, CHS, PHS or PCHS)	VKC3	
Concealed Key Control (CKC)		
CKC cylinders with VKC keys	CKC2	\$8.00
CKC cylinders only ³ (not for AS, AHS, ACS, ACHS, PHS, PCHS)	CKC3	

Notes: 1. CMK Construction master keying charge is in addition to master keying charge.
 2. CMK Construction master keying is not available in interchangeable core, Access 3, Pyramid, or Security series.
 3. VKC2, VKC3, CKC3 are not available in Access 3, Pyramid or Security series.
 * For key bows other than 10 and 90, specify 'KB' + bow number as Quick Code, e.g. KB12.

Strike Options

To purchase strike separately, see catalog or parts manual for part no.

Lip Length	ANSI Straight Lip - Specify Quick Code	Add or Deduct
7/8"	SS078	No Charge
1-1/8"	SS118	
1-1/4"	SS114	
1-3/8"	SS138	
1-1/2"	SS112	
1-3/4"	SS134	Add \$17.00 per lock
2"	SS200	
2-1/4"	SS214	
2-1/2"	SS212	
2-3/4"	SS234	
3"	SS300	

Door Thickness Options

Description	Specify Quick Code	Add or Deduct
1-3/8"	D138	No Charge
1-3/4"	(standard)	
2"	D200	
2-1/4"	D214	

Miscellaneous Options

Description	Specify Quick Code	Add or Deduct
1" (25mm) bolt front, square corners	M14	Add \$6.00 per dead lock
ANSI wrought strike box	M17	No Charge
Plastic box for standard strike	(standard)	
2-3/8" (60mm) backset bolt	B238	

Standard Features

Handing

Non-handed

Door Thickness

1-3/4"

Backset

2-3/4"

Strike

Wrought brass or bronze
3-1/2" x 1-1/8"

Cylinder

6-pin, L4 keyway, 0-bitted

Keys

Two nickel silver keys

Weight

2.25 lbs each

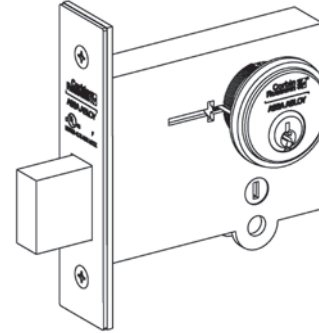

Ordering Example

Stock Order

Quantity	Series/Function	Finish
30	DL4113	626

Contract Order

Quantity	Series/Function	Finish	Keyset	Optional Strike
30	DL4113	626	AA1	SS118

Function	Description	Finish: 613E, 626, BSP	Finish: 605, 606, 611, 612, 613, 618, 619 ,625
DL4113	Single Cylinder	\$479.00	\$484.00
DL4112	Double Cylinder	\$526.00	\$531.00
DL4117	Classroom*	\$479.00	\$484.00
DL4111	Cylinder x Blank	\$403.00	\$408.00
DL4122	Double Cylinder x Thumbturn*	\$601.00	\$606.00
DL4160	Thumbturn x Blank	\$356.00	\$361.00

*Thumbturn will not project deadbolt.

Cylinder Options		
Description	Specify Quick Code	Add or Deduct
Conventional 6-pin	(standard)	No Charge
Conventional 7-pin	7P	Add \$2.00 per cylinder
Less Standard Cylinder	LC	Deduct \$120.00 per cylinder
LFIC		
LFIC 6-pin	C6	Add \$104.00 per cylinder
LFIC 6-pin Less Core	CL6	No Charge
LFIC 6-pin with Temporary Construction Core (Red)	CT6R	Add \$104.00 per cylinder
LFIC 6-pin with Temporary Construction Core (Blue)	CT6B	Add \$104.00 per cylinder
LFIC 6-pin with Temporary Construction Core (Green)	CT6G	Add \$104.00 per cylinder
LFIC 6-pin with Temporary Disposable Core	CT6D	No Charge
LFIC 7-pin	C7	Add \$106.00 per cylinder
LFIC 7-pin Less Core	CL7	Add \$2.00 per cylinder
LFIC 7-pin with Temporary Construction Core (Red)	CT7R	Add \$106.00 per cylinder
LFIC 7-pin with Temporary Construction Core (Blue)	CT7B	Add \$106.00 per cylinder
LFIC 7-pin with Temporary Construction Core (Green)	CT7G	Add \$106.00 per cylinder
LFIC 7-pin with temporary Disposable Core	CT7D	Add \$2.00 per cylinder
UL LFIC 6-Pin Housing Less Core	CL6AH	Add \$104.00 per cylinder
UL LFIC 6-Pin Housing with Disposable Core	CTAHD	Add \$104.00 per cylinder
UL LFIC 6-Pin Housing with Temp Construction Core	CT6AH(R/B/G)	Add \$224.00 per cylinder
SFIC		
SFIC 6-pin	C6S	Add \$93.00 per cylinder
SFIC 6-pin with Temporary Construction Core (Blue)	CT6SB	Add \$93.00 per cylinder
SFIC 6-pin with SFIC Disposable Temporary Core	CT6SD	No Charge
SFIC 6-pin with Less Core	CLS6	No Charge
SFIC 7-pin	C7S	Add \$93.00 per cylinder
SFIC 7-pin with Temporary Construction Core (Blue)	CT7SB	Add \$93.00 per cylinder
SFIC 7-pin with SFIC Disposable Temporary Core	CT7SD	No Charge
SFIC 7-pin with Less Core	CLS7	No Charge
Security		
Security	HS	Add \$158.00 per cylinder
Security LFIC	CHS	Add \$258.00 per cylinder
Access 3		
Access 3 Patented	AP	No Charge
Access 3 Security	AS	Add \$78.00 per cylinder
Access 3 High Security, UL 437	AHS	Add \$111.00 per cylinder
Access 3 LFIC Patented	ACP	Add \$104.00 per cylinder
Access 3 LFIC Security	ACS	Add \$182.00 per cylinder
Access 3 LFIC High Security, UL 437	ACHS	Add \$215.00 per cylinder
Pyramid		
Pyramid Security Fixed Core	PS	Add \$84.00 per cylinder
Pyramid Security LFIC	PCS	Add \$181.00 per cylinder
Pyramid High Security Fixed Core	PHS	Add \$125.00 per cylinder
Pyramid High Security LFIC	PCHS	Add \$223.00 per cylinder
Pyramid LFIC with Temporary Construction Core	CTP	Add \$104.00 per cylinder
Pyramid LFIC with Temporary Disposable Core	CTPD	No Charge
Pyramid LFIC Less Core	CLP	No Charge

Notes:

1. CMK Construction master keying charge is in addition to master keying charge.

*Both cylinders of double cylinder deadlocks are keyed alike, unless otherwise specified. If different keying is required, specify outside cylinder first, then inside cylinder.

For key bows other than 10 and 90, specify 'KB' + bow number as Quick Code, e.g. KB12.

Note: KB92 cannot be furnished with VKC or other markings.

Cylinder Options (continued) & Keying Options*

Description	Specify Quick Code	Add or Deduct
Keying and Keys		
0-bitted with 2 Blank Keys	(standard)	No Charge
Keyed Random	KR	
Construction master keyed ^{1,2}	CMK	Add \$16.00 per cylinder
More than 2 Keys	KY# (e.g., KY6)	See page 33 - Cut Keys Section
Master Keying		
Master keyed (all cylinders except CR8000, CR8020, CR8027, CR8200, CR8500, CR8600, CR8700)	MK	Add \$16.00 per cylinder
Master keyed Pyramid (except CR8020, CR8027 LFIC cores)	MK	
Master keyed Security (including LFIC cylinder and core)	MK	
Master keyed Access 3 (except CR8500, CR8600, CR8700 LFIC cores)	MK	
Master keyed (CR8000, CR8020, CR8027, CR8200, CR8500, CR8600, CR8700)	MK-IC	No Charge
Master keyed to customer bittings or sample key	MK-CB	Add \$16.00 per cylinder
Visual Key Control (VKC)		
No bitting or keyset stamping on keys	VKC0	\$4.50
Keys only	VKC1	No Charge
Cylinder and Keys ³ (not for AS, AHS, ACS, ACHS, HS, CHS, PHS or PCHS)	VKC2	\$8.00
Cylinders only ³ (not for AS, AHS, HS, ACS, ACHS, CHS, PHS or PCHS)	VKC3	
Concealed Key Control (CKC)		
CKC cylinders with VKC keys	CKC2	\$8.00
CKC cylinders only ³ (not for AS, AHS, ACS, ACHS, PHS, PCHS)	CKC3	

Notes: 1. CMK Construction master keying charge is in addition to master keying charge.
2. CMK Construction master keying is not available in interchangeable core, Access 3, Pyramid, or Security series.
3. VKC2, VKC3, CKC3 are not available in Access 3, Pyramid or Security series.

* For key bows other than 10 and 90, specify 'KB' + bow number as Quick Code, e.g. KB12.

Strike Options

To purchase strike separately, see catalog for part no.

Lip length	ANSI Straight Lip Specify Quick Code	Add or Deduct
7/8"	SS078	Add \$17.00 per lock
1-1/8"	SS118	
1-1/4"	SS114	
1-3/8"	SS138	
1-1/2"	SS112	
1-3/4"	SS134	
2"	SS200	
2-1/4"	SS214	
2-1/2"	SS212	
2-3/4"	SS234	
3"	SS300	

Door Thickness Options

Description	Specify Quick Code	Add or Deduct
1-3/4" - 2"	(standard)	No Charge
2-1/4"	D214	

Miscellaneous Options

Description	Specify Quick Code	Add or Deduct
Spanner head screws	M02	Add \$28.00 per lockset
Torx head screws	M04	Add \$34.00 per lockset
ANSI wrought box	M17	No Charge
Lead wrapped case	M29	Add \$373.00 per lockset
Ergonomic Thumbturn (specify door thickness)	M34	Add \$20.00 per TT
Box for standard strike	M40	No Charge

Table of Contents

Multi-Point Exit Device Latching System



USA & Canada Prices Effective April 17, 2023

FE5400S Series Multi-Point Exit Device Latching System:

FE5400S Series Standard Features, Ordering Examples, Pricing	201
FE5400S Series Heavy-Duty Trim Designs: A9 Armstrong, C9 Citation, D9 Dirke, E9 Essex	202
FE5400S Series Heavy-Duty Trim Designs: L9 Lustra, N9 Newport, R9 Regis, PR9 Princeton	203
FE5400S Series Heavy-Duty Trim Designs: TH900 Pull/Thumbpiece, P9 Pull	204
FE5400S Series Heavy-Duty Trim Designs: FR9 Frascati, M9 Merlot, Z9 Zinfandel	205
FE5400S Series Heavy-Duty Trim Designs: Museo® Georgia, Jackson, Laszlo, Marc, Salvador, Piet	206
FE5400S Series Electrically Controlled Trim Designs: A9 Armstrong, C9 Citation, D9 Dirke, E9 Essex	207
FE5400S Series Electrically Controlled Trim Designs: L9 Lustra, N9 Newport, R9 Regis, PR9 Princeton	208
FE5400S Series Electrically Controlled Trim Designs: FR9 Frascati, M9 Merlot, Z9 Zinfandel	209
FE5400S Series Electrically Controlled Trim Designs: Museo® Georgia, Jackson, Laszlo, Marc, Salvador, Piet	210
FE5400S Series Electrified Options & Accessories	211
FE5400S Series Cylinder & Keying Options	212
FE5400S Series Cylinder & Keying Options (Con't), Door Height, Door Width, Door Thickness, Miscellaneous Options	213
FE5400S Series Removable Mullions & Options	214

MP6600 Series Multi-Point Latching System:

MP6600 Series Standard Features	215
MP6600 Series: Single Cylinder, Double Cylinder with Deadbolt, Non-Keyed, EAC: ASA, CSA, LSA, NSA, PSA, RSA, NSM, NSN, NSR Levers	216
MP6600 Series Designs: Escutcheons with Single, Double Cylinder with Deadbolt, Non-Keyed, EAC, Georgia, Jackson, Josef, Laszlo, Marc, Salvador Levers	217
MP6600 Series Designs: Roses with Single, Double Cylinder with Deadbolt, Non-Keyed, EAC, Georgia, Jackson, Josef, Laszlo, Marc, Salvador Levers	218
MP6600 Series Designs: Escutcheons with Single, Double Cylinder with Deadbolt, Non-Keyed, EAC, Josef, Georges Levers	219
MP6600 Series Designs: Roses with Single, Double Cylinder with Deadbolt, Non-Keyed, EAC, Josef, Georges Levers	220
MP6600 Series Designs: Escutcheons with Single, Double Cylinder with Deadbolt, Non-Keyed, EAC, Piet Levers	221
MP6600 Series Designs: Roses with Single, Double Cylinder with Deadbolt, Non-Keyed, EAC, Piet Levers	222
MP6600 Series Designs: Escutcheons with Single, Double Cylinder with Deadbolt, Non-Keyed, EAC, Piet Levers	223
MP6600 Series Designs: Roses with Single, Double Cylinder with Deadbolt, Non-Keyed, EAC, Piet Levers	224
MP6600 Series Cylinder & Keying Options	225
MP6600 Series Cylinder & Keying Options (Con't), Strike Options	226
MP6600 Series Door Thickness, Options, Thumbturn Options, Strike Options	227

FE6600 Series Multi-Point Latching System:

FE6600 Series Standard Features	228
FE6600 Series: Single Cylinder, Double Cylinder with Deadbolt, Non-Keyed, EAC: ASA, CSA, LSA, NSA, PSA, RSA, NSM, NSN, NSR Levers	229
FE6600 Series Designs: Escutcheons with Single, Double Cylinder with Deadbolt, Non-Keyed, EAC, Georgia, Jackson, Josef, Laszlo, Marc, Salvador Levers	230
FE6600 Series Designs: Roses with Single, Double Cylinder with Deadbolt, Non-Keyed, EAC, Georgia, Jackson, Josef, Laszlo, Marc, Salvador Levers	231
FE6600 Series Designs: Escutcheons with Single, Double Cylinder with Deadbolt, Non-Keyed, EAC, Josef, Georges Levers	232
FE6600 Series Designs: Roses with Single, Double Cylinder with Deadbolt, Non-Keyed, EAC, Josef, Georges Levers	233
FE6600 Series Designs: Escutcheons with Single, Double Cylinder with Deadbolt, Non-Keyed, EAC, Piet Levers	234
FE6600 Series Designs: Roses with Single, Double Cylinder with Deadbolt, Non-Keyed, EAC, Piet Levers	235
FE6600 Series Designs: Escutcheons with Single, Double Cylinder with Deadbolt, Non-Keyed, EAC, Piet Levers	236
FE6600 Series Designs: Roses with Single, Double Cylinder with Deadbolt, Non-Keyed, EAC, Piet Levers	237
FE6600 Series Cylinder & Keying Options	238
FE6600 Series Cylinder & Keying Options (Con't), Strike Options	239
FE6600 Series Door Thickness, Options, Thumbturn Options, Strike Options	240

Continued on next page.

Table of Contents

Multi-Point Exit Device Latching System



USA & Canada Prices Effective April 17, 2023

BL6600 Series Multi-Point Latching System:

BL6600 Series Standard Features	241
BL6600 Series: Single Cylinder, Double Cylinder with Deadbolt, Non-Keyed, EAC: ASA, CSA, LSA, NSA, PSA, RSA, NSM, NSN, NSR Levers	242
BL6600 Series Designs: Escutcheons with Single, Double Cylinder with Deadbolt, Non-Keyed, EAC, Georgia, Jackson, Josef, Laszlo, Marc, Salvador Levers	243
BL6600 Series Designs: Roses with Single, Double Cylinder with Deadbolt, Non-Keyed, EAC, Georgia, Jackson, Josef, Laszlo, Marc, Salvador Levers	244
BL6600 Series Designs: Escutcheons with Single, Double Cylinder with Deadbolt, Non-Keyed, EAC, Josef, Georges Levers	245
BL6600 Series Designs: Roses with Single, Double Cylinder with Deadbolt, Non-Keyed, EAC, Josef, Georges Levers	246
BL6600 Series Designs: Escutcheons with Single, Double Cylinder with Deadbolt, Non-Keyed, EAC, Piet Levers	247
BL6600 Series Designs: Roses with Single, Double Cylinder with Deadbolt, Non-Keyed, EAC, Piet Levers	248
BL6600 Series Designs: Escutcheons with Single, Double Cylinder with Deadbolt, Non-Keyed, EAC, Piet Levers	249
BL6600 Series Designs: Roses with Single, Double Cylinder with Deadbolt, Non-Keyed, EAC, Piet Levers	250
BL6600 Series Cylinder & Keying Options	251
BL6600 Series Cylinder & Keying Options (Con't), Strike Options	252
BL6600 Series Door Thickness, Options, Thumbturn Options, Strike Options	253

FE6700 Series Storm Shutter Multi-Point Latching System:

FE6700 Series Standard Features, Ordering Example	254
FE6700 Series Designs	255
FE6700 Series Cylinder & Keying Options	256
FE6700 Series Cylinder & Keying Options (Con't), Shutter Thickness, Shutter Height, Miscellaneous Options	257

MP9800 Series Multi-Point Vertical Rod Lock:

MP9800 Series Standard Features	258
MP9800 Series Levers: Armstrong, Citation, Dirke, Essex, Lustra, Newport, Regis, Princeton, Georgia, Jackson, Josef, Laszlo, Marc, Salvador Levers	259
MP9800 Series Levers: Armstrong, Citation, Dirke, Essex, Lustra, Newport, Regis, Princeton, Georgia, Jackson, Josef, Laszlo, Marc, Salvador Freewheeling Trim, Electromechanical	260
MP9800A Series Levers: Armstrong, Citation, Dirke, Essex, Lustra, Newport, Regis, Princeton, Georgia, Jackson, Josef, Laszlo, Marc, Salvador Levers	261
MP9800A Series Levers: Armstrong, Citation, Dirke, Essex, Lustra, Newport, Regis, Princeton, Georgia, Jackson, Josef, Laszlo, Marc, Salvador Freewheeling Trim, Electromechanical	262
MP9800 Series Piet Levers, Freewheeling Trim, Electromechanical	263
MP9800A Series Piet Levers, Freewheeling Trim, Electromechanical	264
MP9800 Series Josef, Georges Levers, Freewheeling Trim, Electromechanical	265
MP9800A Series Josef, Georges Levers, Freewheeling Trim, Electromechanical	266
MP9800 Series Cylinder Options, Keying Options	267
MP9800 Series Cylinder & Keying Options (Con't) Door Height Options, Door Width Options, Door Thickness, Motorized Electric Latch Retraction	268
MP9800 Series Miscellaneous Options	269
Blank Page	270

FE5400S

Multi-Point Exit Device Latching System

USA & Canada Prices Effective April 17, 2023

Standard Features

Handing

Device is non-handed. Lever trim is handed.

Bar Length

Standard: 36" (914mm) bar fits 30" - 36" (762mm-914mm) door

Door Height

7'0" (2134mm) standard

Door Thickness

1-3/4" (44mm) standard

Stile

Minimum width 4-1/2" (114mm).

Projection

3-1/4" (83mm) active, 2-3/4" (70mm) dogged.

Cylinders

Cylinder not included unless specified.

Warranty

Seven-year limited



Ordering Examples:

Exit Device Only

Quantity	Series/ Function	Finish	Hand	Misc. Options
65	FE5400S	626	RHR	M51

Trim Only

Quantity	Trim/ Function	Finish	Hand	Door Thickness
24	N955ET	625	RHR	D214

Exit Device with Trim

Qty	Exit Device	Trim/ Function	Finish	Hand	Door Thickness	Door Width	Misc. Options
65	FE5400S	N955ET	605	LHR	D214	W048	M51

Contract/Detailed Order — Exit Device with Trim

Qty	Keyset	Exit Device	Trim/Function	Finish	Hand	Door Height	Door Width	Misc. Options	Cylinder Option
36	AA1	FE5400S	C955ET	626	LHR	HO800	W048	M52	7P

Pricing: 36" Device Only

Includes device, strike(s) and screw pack. No cylinder or trim.

FE5400S Series			
Function	Description	Finish: 613E, 630 ¹ , BSP, WSP	Finish: 605, 606, 611, 612, 613, 618, 619, 625, 626, 629, 722
FE5400S	Panic	\$4,929.00	\$5,009.00
FE5400SA	3 Hour Fire Rated	\$5,159.00	\$5,239.00

Caution: Be sure of your measurements. Exit devices are NOT returnable.



FE5400S

Multi-Point Exit Device Latching System

FE5400S Series Heavy-Duty Trim

USA & Canada Prices Effective April 17, 2023

Cylinder is not included.

Escutcheon Trim Design: A9 Armstrong



Lever: Cast

Escutcheon: Forged

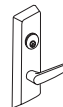

Function	Description	Finish: 605, 606, 611, 612, 613, 613E, 618, 619, 625, 626, 629 ² , 630 ¹ , 722, BSP, WSP
A910ET	Passage	\$917.00
A950ET	Dummy	
A955ET	Classroom ³	
A959ET	Storeroom	

Escutcheon Trim Design: C9 Citation



Lever: Cast

Escutcheon: Forged

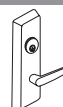

Function	Description	Finish: 605, 606, 611, 612, 613, 613E, 618, 619, 625, 626, 629 ² , 630 ¹ , 722, BSP, WSP
C910ET	Passage	\$917.00
C950ET	Dummy	
C955ET	Classroom ³	
C959ET	Storeroom	

Escutcheon Trim Design: D9 Dirke



Lever: Cast

Escutcheon: Forged



Function	Description	Finish: 605, 606, 611, 612, 613, 613E, 618, 619, 625, 626, 629 ² , 630 ¹ , 722, BSP, WSP
D910ET	Passage	\$917.00
D950ET	Dummy	
D955ET	Classroom ³	
D959ET	Storeroom	

Escutcheon Trim Design: E9 Essex



Lever: Cast

Escutcheon: Forged

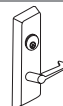

Function	Description	Finish: 605, 606, 611, 612, 613, 613E, 618, 619, 625, 626, 629 ² , 630 ¹ , 722, BSP, WSP
E910ET	Passage	\$917.00
E950ET	Dummy	
E955ET	Classroom ³	
E959ET	Storeroom	

Notes:

1. 619 finish provided to match 630 finish
2. 618 finish provided to match 629 finish.
3. Classroom function trim may be converted to storeroom function by a simple field adjustment. No additional parts required.

FE5400S

Multi-Point Exit Device Latching System

FE5400S Series Heavy-Duty Trim

USA & Canada Prices Effective April 17, 2023

Cylinder is not included.

Escutcheon Trim Design: L9 Lustra

Lever: Cast **Escutcheon:** Forged

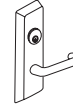

Function	Description	Finish: 605, 606, 611, 612, 613, 613E, 618, 619, 625, 626, 629 ² , 630 ¹ , 722, BSP, WSP
L910ET	Passage	\$917.00
L950ET	Dummy	
L955ET	Classroom ³	
L959ET	Storeroom	

Escutcheon Trim Design: N9 Newport

Lever: Cast **Escutcheon:** Forged

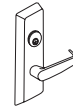

Function	Description	Finish: 605, 606, 611, 612, 613, 613E, 618, 619, 625, 626, 629 ² , 630 ¹ , 722, BSP, WSP
N910ET	Passage	\$917.00
N950ET	Dummy	
N955ET	Classroom ³	
N959ET	Storeroom	

Escutcheon Trim Design: R9 Regis

Lever: Cast **Escutcheon:** Forged

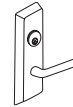

Function	Description	Finish: 605, 606, 611, 612, 613, 613E, 618, 619, 625, 626, 629 ² , 630 ¹ , 722, BSP, WSP
R910ET	Passage	\$917.00
R950ET	Dummy	
R955ET	Classroom ³	
R959ET	Storeroom	

Escutcheon Trim Design: PR9 Princeton

Lever: Cast **Escutcheon:** Forged

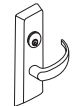

Function	Description	Finish: 605, 606, 611, 612, 613, 613E, 618, 619, 625, 626, 629 ² , 630 ¹ , 722, BSP, WSP
PR910ET	Passage	\$917.00
PR950ET	Dummy	
PR955ET	Classroom ³	
PR959ET	Storeroom	

Notes:

1. 619 finish provided to match 630 finish. - Escutcheons only
2. 618 finish provided to match 629 finish. - Escutcheons only
3. Classroom function trim may be converted to storeroom function by a simple field adjustment. No additional parts required.

FE5400S Multi-Point Exit Device Latching System



FE5400S Series Heavy-Duty Trim

USA & Canada Prices Effective April 17, 2023

Cylinder is not included.

Escutcheon Trim Design: TH900 Pull/Thumbpiece

Grip: Extruded **Escutcheon:** Forged



Function	Description	Finish: 605, 606, 611, 612, 613, 613E, 618, 619, 625, 626, 629 ² , 630 ¹ , 722, BSP
TH910ET	Passage	\$698.00
TH950ET	Dummy (No thumbpiece)	\$663.00
TH955ET	Classroom ³	\$698.00
TH959ET	Storeroom	\$698.00

Escutcheon Trim Design: P9 Pull

Pull: Extruded **Escutcheon:** Forged

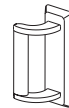

Function	Description	Finish: 605, 606, 611, 612, 613, 613E, 618, 619, 625, 626, 629 ² , 630 ¹ , 722, BSP
P950ET*	Dummy	\$601.00

* Specify Hand. Field Reversible.

FE5400S

Multi-Point Exit Device Latching System

FE5400S Series Heavy-Duty Trim

USA & Canada Prices Effective April 17, 2023

Cylinder is not included.

Escutcheon Trim Design: FR9 Frascati*



Escutcheon: Forged

* Handed Lever. Handing cannot be changed in the field.

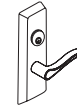

Function	Description	Finish: 605, 606, 611, 612, 613, 613E, 618, 619, 625, 626, 629 ² , 630 ¹ , 722, BSP
FR910ET	Passage	\$917.00
FR950ET	Dummy	
FR955ET	Classroom ³	
FR959ET	Storeroom	

Escutcheon Trim Design: M9 Merlot



Escutcheon: Forged

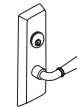

Function	Description	Finish: 605, 606, 611, 612, 613, 613E, 618, 619, 625, 626, 629 ² , 630 ¹ , 722, BSP
M910ET	Passage	\$917.00
M950ET	Dummy	
M955ET	Classroom ³	
M959ET	Storeroom	

Escutcheon Trim Design: Z9 Zinfandel*



Escutcheon: Forged

* Handed Lever. Handing cannot be changed in the field.

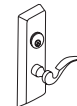

Function	Description	Finish: 605, 606, 611, 612, 613, 613E, 618, 619, 625, 626, 629 ² , 630 ¹ , 722, BSP
Z910ET	Passage	\$917.00
Z950ET	Dummy	
Z955ET	Classroom ³	
Z959ET	Storeroom	

Notes:

3. Classroom function trim may be converted to storeroom function by a simple field adjustment. No additional parts required.

FE5400S

Multi-Point Exit Device Latching System

FE5400S Series Heavy-Duty Trim

USA & Canada Prices Effective April 17, 2023

Cylinder is not included.

Escutcheon Trim Design: Muséo®

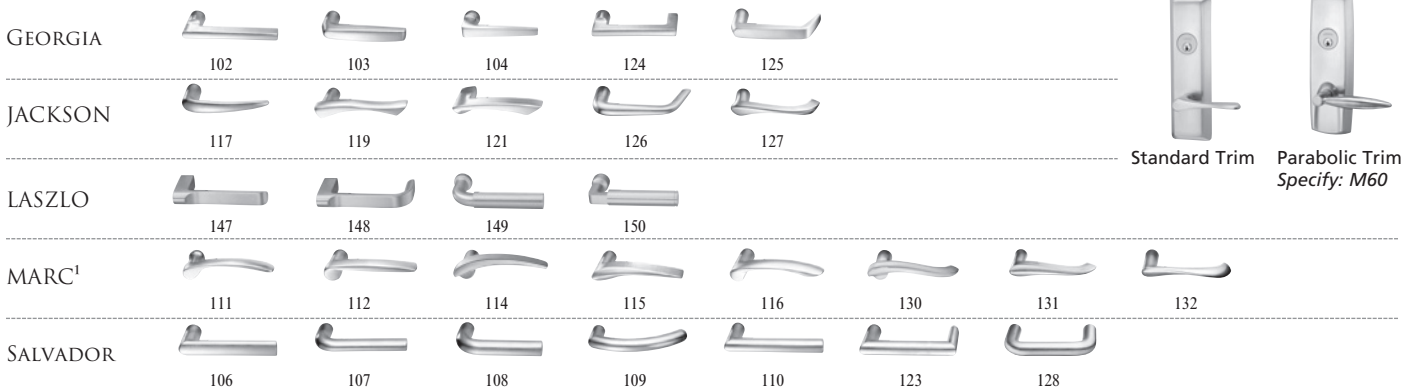

Function	Description	Finish: 605, 606, 611, 612, 613, 613E, 618, 619, 625, 626, 629², 630¹, 722, BSP
910ET	Passage	\$917.00
950ET	Dummy	
955ET	Classroom	
959ET	Storeroom	

*629 and *630 finish options are Not available for all Muséo levers. Please refer to page 20 for availability.

Escutcheon Trim Design: Muséo®

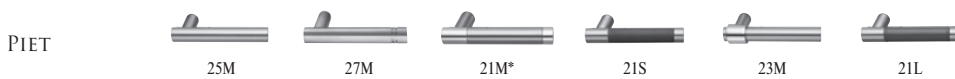

*613E, BSP, WSP finishes are not available with 21M levers.

Function	Description	Finish: 613E, 629, 630, BSP, WSP
910ET	Passage	\$988.00
950ET	Dummy	
955ET	Classroom	
959ET	Storeroom	

FE5400S

Multi-Point Exit Device Latching System

FE5400S Series Electrically Controlled Trim

USA & Canada Prices Effective April 17, 2023

Cylinder is not included.

Escutcheon Trim Design: A9 Armstrong



Lever: Cast **Escutcheon:** Forged

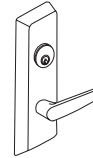

Function	Description	Finish: 605, 606, 611, 612, 613, 613E, 618, 619, 625, 626, 629 ² , 630 ¹ , 722, BSP, WSP
A9903ET*	Fail Safe	\$1,480.00
A9905ET*	Fail Secure	

Escutcheon Trim Design: C9 Citation



Lever: Cast **Escutcheon:** Forged

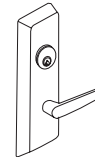

Function	Description	Finish: 605, 606, 611, 612, 613, 613E, 618, 619, 625, 626, 629 ² , 630 ¹ , 722, BSP, WSP
C9903ET*	Fail Safe	\$1,480.00
C9905ET*	Fail Secure	

Escutcheon Trim Design: D9 Dirke*



Lever: Cast **Escutcheon:** Forged

* Handed Lever. Handing cannot be changed in the field.

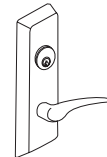

Function	Description	Finish: 605, 606, 611, 612, 613, 613E, 618, 619, 625, 626, 629 ² , 630 ¹ , 722, BSP, WSP
D9903ET*	Fail Safe	\$1,480.00
D9905ET*	Fail Secure	

Escutcheon Trim Design: E9 Essex



Lever: Cast **Escutcheon:** Forged

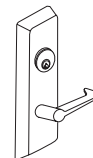

Function	Description	Finish: 605, 606, 611, 612, 613, 613E, 618, 619, 625, 626, 629 ² , 630 ¹ , 722, BSP, WSP
E9903ET*	Fail Safe	\$1,480.00
E9905ET*	Fail Secure	

Notes:

- 619 finish provided to match 630 finish. - Escutcheons only
- 618 finish provided to match 629 finish. - Escutcheons only

***ElectroLynx®**

As part of their promise to provide innovative, fast and effective high security solutions to their customers, certain ASSA ABLOY Group brands offer *ElectroLynx®*, a universal quick-connect system that simplifies the electrification of the door opening.

FE5400S

Multi-Point Exit Device Latching System

FE5400S Series Electrically Controlled Trim

USA & Canada Prices Effective April 17, 2023

Cylinder is not included.

Escutcheon Trim Design: L9 Lustra



Lever: Cast **Escutcheon:** Forged

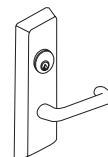

Function	Description	Finish: 605, 606, 611, 612, 613, 613E, 618, 619, 625, 626, 629 ² , 630 ¹ , 722, BSP, WSP
L9903ET*	Fail Safe	\$1,480.00
L9905ET*	Fail Secure	

Escutcheon Trim Design: N9 Newport



Lever: Cast **Escutcheon:** Forged

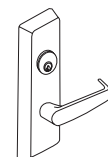

Function	Description	Finish: 605, 606, 611, 612, 613, 613E, 618, 619, 625, 626, 629 ² , 630 ¹ , 722, BSP, WSP
N9903ET*	Fail Safe	\$1,480.00
N9905ET*	Fail Secure	

Escutcheon Trim Design: R9 Regis



Lever: Cast **Escutcheon:** Forged

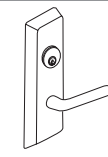

Function	Description	Finish: 605, 606, 611, 612, 613, 613E, 618, 619, 625, 626, 629 ² , 630 ¹ , 722, BSP, WSP
R9903ET*	Fail Safe	\$1,480.00
R9905ET*	Fail Secure	

Escutcheon Trim Design: PR9 Princeton



Lever: Cast **Escutcheon:** Forged

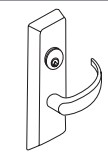

Function	Description	Finish: 605, 606, 611, 612, 613, 613E, 618, 619, 625, 626, 629 ² , 630 ¹ , 722, BSP, WSP
PR9903ET*	Fail Safe	\$1,480.00
PR9905ET*	Fail Secure	

Notes:

- 619 finish provided to match 630 finish. - Escutcheons only
- 618 finish provided to match 629 finish. - Escutcheons only

***ElectroLynx®**

As part of their promise to provide innovative, fast and effective high security solutions to their customers, certain ASSA ABLOY Group brands offer *ElectroLynx®*, a universal quick-connect system that simplifies the electrification of the door opening.

FE5400S

Multi-Point Exit Device Latching System

FE5400S Series Electrically Controlled Trim

USA & Canada Prices Effective April 17, 2023

Cylinder is not included.

Escutcheon Trim Design: FR9 Frascati

Lever: Cast **Escutcheon:** Forged

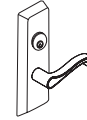

Function	Description	Finish: 605, 606, 611, 612, 613, 613E, 618, 619, 625, 626, 629 ² , 630 ¹ , 722, BSP, WSP
FR9903ET*	Fail Safe	\$1,480.00
FR9905ET*	Fail Secure	

Escutcheon Trim Design: M9 Merlot

Lever: Cast **Escutcheon:** Forged

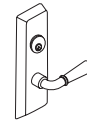

Function	Description	Finish: 605, 606, 611, 612, 613, 613E, 618, 619, 625, 626, 629 ² , 630 ¹ , 722, BSP, WSP
M9903ET*	Fail Safe	\$1,480.00
M9905ET*	Fail Secure	

Escutcheon Trim Design: Z9 Zinfandel

Lever: Cast **Escutcheon:** Forged

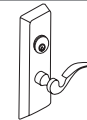

Function	Description	Finish: 605, 606, 611, 612, 613, 613E, 618, 619, 625, 626, 629 ² , 630 ¹ , 722, BSP, WSP
Z9903ET*	Fail Safe	\$1,480.00
Z9905ET*	Fail Secure	

*ElectroLynx®

As part of their promise to provide innovative, fast and effective high security solutions to their customers, certain ASSA ABLOY Group brands offer *ElectroLynx*®, a universal quick-connect system that simplifies the electrification of the door opening.

FE5400S































Multi-Point Exit Device Latching System

FE5400S Series Electrically Controlled Trim

USA & Canada Prices Effective April 17, 2023

Cylinder is not included.







Escutcheon Trim Design: Muséo® 

GEORGIA						  Standard Trim Parabolic Trim Specify: M60		
	102	103	104	124	125			
JACKSON								
	117	119	121	126	127			
LASZLO								
	147	148	149	150				
MARC ¹								
	111	112	114	115	116	130	131	132
SALVADOR								
	106	107	108	109	110	123	128	

Function	Description	Finish: 605, 606, 611, 612, 613, 613E, 618, 619, 625, 626, 629 ² , 630 ¹ , 722, BSP, WSP
9903ET**	Fail Safe	\$1,480.00
9905ET**	Fail Secure	

*629 and *630 finish options are Not available for all Muséo levers. Please refer to page 20 for availability.

Escutcheon Trim Design: Muséo® 

PIET						
	25M	27M	21M*	21S	23M	21L

*613E, BSP, WSP finishes are not available with 21M levers.

Function	Description	Finish: 629, 630
9903ET**	Fail Safe	\$1,592.00
9905ET**	Fail Secure	

**ElectroLynx®

As part of their promise to provide innovative, fast and effective high security solutions to their customers, certain ASSA ABLOY Group brands offer *ElectroLynx*®, a universal quick-connect system that simplifies the electrification of the door opening.

FE5400S Electrically Controlled Trim



Electrified Options

USA & Canada Prices Effective April 17, 2023

Description	Specify Quick Code	Add or Deduct
Touchbar Monitoring or Signaling/Request to Exit (REX)	M92*	Add \$291.00
Outside Trim Monitoring or Signaling	M93*	Add \$291.00
SPDT Lock and Unlock security monitor switch (Electric Trim Only)	M98*	Add \$280.00
Trim gasket for exterior applications (Electric Trim Only)	M99	Add \$31.00

Electrified Accessories

Part Number	Description	Specify	Price
709F649	Power Supply 1 Amp @ 12VDC Output	BPS-12-1	\$485.00
709F659	Power Supply 3 Amp @ 12VDC Output	BPS-12-3	\$985.00
709F609	Power Supply 2 Amp @ 24VDC Output	BPS-24-1	\$485.00
709F619	Power Supply 2 Amp @ 24VDC Output	BPS-24-2	\$985.00
709F629	Power Supply 4 Amp @ 24VDC Output	BPS-24-4	\$1,670.00
704F288	Concealed transfer (for over 120-degree swing door)	EPTL	\$191.00
709F689	(1) SPDT Maintained Switch (Includes LED)	MKA	\$191.00
709F709	(1) SPDT Momentary Switch (Includes LED)	MK	\$292.00
709F759	(1) SPDT Maintained (Alternating Action) Switch	PB3EA	\$172.00
709F729	DPDT Momentary Key Switch	2' MK2	\$337.00
704F719	Narrow Stile Momentary Key Switch	MKN	\$292.00
709F789	Sonalert 90db @ 2 ft. 12-24VDC Mounted on one gang stainless steel plate.	PZ1	\$146.00

*ElectroLynx®

As part of their promise to provide innovative, fast and effective high security solutions to their customers, certain ASSA ABLOY Group brands offer *ElectroLynx*®, a universal quick-connect system that simplifies the electrification of the door opening.

FE5400S Electrically Controlled Trim Multi-Point Exit Device Latching System



USA & Canada Prices Effective April 17, 2023

Cylinder Options*		
Description	Specify Quick Code	Add or Deduct
Conventional 6-pin	6P**	Add \$120.00 per cylinder
Conventional 7-pin	7P	Add \$122.00 per cylinder
LFIC		
LFIC 6-pin	C6	Add \$224.00 per cylinder
LFIC 6-pin less core	CL6	Add \$120.00 per cylinder
LFIC 6-pin with temporary construction core (Red)	CT6R	Add \$224.00 per cylinder
LFIC 6-pin with temporary construction core (Blue)	CT6B	Add \$224.00 per cylinder
LFIC 6-pin with temporary construction core (Green)	CT6G	Add \$224.00 per cylinder
LFIC 6-pin with temporary disposable core	CT6D	Add \$120.00 per cylinder
LFIC 7-pin	C7	Add \$228.00 per cylinder
LFIC 7-pin less core	CL7	Add \$122.00 per cylinder
LFIC 7-pin with temporary construction core (Red)	CT7R	Add \$228.00 per cylinder
LFIC 7-pin with temporary construction core (Blue)	CT7B	Add \$228.00 per cylinder
LFIC 7-pin with temporary construction core (Green)	CT7G	Add \$228.00 per cylinder
LFIC 7-pin with temporary disposable core	CT7D	Add \$122.00 per cylinder
SFIC		
SFIC 6-pin	C6S	Add \$213.00 per cylinder
SFIC 6-pin with temporary construction core (Blue)	CT6SB	Add \$213.00 per cylinder
SFIC 6-pin with SFIC disposable temporary core	CT6SD	Add \$120.00 per cylinder
SFIC 6-pin with Less Core	CLS6	Add \$120.00 per cylinder
SFIC 7-pin	C7S	Add \$213.00 per cylinder
SFIC 7-pin with temporary construction core (Blue)	CT7SB	Add \$213.00 per cylinder
SFIC 7-pin with SFIC disposable temporary core	CT7SD	Add \$120.00 per cylinder
SFIC 6-pin with Less Core	CLS7	Add \$120.00 per cylinder
Security		
Security	HS	Add \$278.00 per cylinder
Security LFIC	CHS	Add \$378.00 per cylinder
Access 3		
Access 3 Patented	AP	Add \$120.00 per cylinder
Access 3 Security	AS	Add \$198.00 per cylinder
Access 3 High Security, UL 437	AHS	Add \$231.00 per cylinder
Access 3 LFIC Patented	ACP	Add \$224.00 per cylinder
Access 3 LFIC Security	ACS	Add \$302.00 per cylinder
Access 3 LFIC High Security, UL 437	ACHS	Add \$335.00 per cylinder
Pyramid		
Pyramid Security fixed core	PS	Add \$204.00 per cylinder
Pyramid Security LFIC	PCS	Add \$301.00 per cylinder
Pyramid High Security fixed core	PHS	Add \$245.00 per cylinder
Pyramid High Security LFIC	PCHS	Add \$343.00 per cylinder
Pyramid LFIC with temporary construction core	CTP	Add \$224.00 per cylinder
Pyramid LFIC with temporary disposable core	CTPD	Add \$120.00 per cylinder
Pyramid LFIC less core	CLP	Add \$120.00 per cylinder
Keying and Keys		
0-bitted with 2 Blank Keys	(standard)	No Charge
Keyed Random	KR	No Charge
Construction Master Keyed ²	CMK	Add \$16.00 per cylinder
More than 2 Keys	KY# (e.g., KY6)	See page 33 - Cut Keys Section
Master Keying		
Master keyed (all cylinders except CR8000, CR8020, CR8027, CR8200, CR8500, CR8600, CR8700)	MK	Add \$16.00 per cylinder
Master keyed Pyramid (except CR8020, CR8027 LFIC cores)	MK	
Master keyed Security (including LFIC cylinder and core)	MK	
Master keyed Access 3 (except CR8500, CR8600, CR8700 LFIC cores)	MK	No Charge
Master keyed (CR8000, CR8020, CR8027, CR8200, CR8500, CR8600, CR8700)	MK-IC	
Master keyed to customer bittings or sample key	MK-CB	Add \$16.00 per cylinder

Continued on next page

*Optional dogging cylinder will be furnished with the same mechanism and keyed alike with the trim cylinder, unless otherwise specified.

If different keying or cylinder type is required, specify outside (trim) first, then inside (dogging) cylinder.

**6P cylinder option is supplied in 6-pin, L4 keyway, 0-bitted with two nickel silver keys.

*For key bows other than 10 and 90, specify "KB" + bow number as Quick Code, e.g. KB12.

- Notes:
1. CMK Construction master keying charge is in addition to master keying charge.
 2. CMK Construction master keying is not available in interchangeable core, Access 3, Pyramid, or Security series.
 3. VKC2, VKC3, CKC3 are not available in Pyramid or Security series.

FE5400S Electrically Controlled Trim Multi-Point Exit Device Latching System



USA & Canada Prices Effective April 17, 2023

Cylinder Options (continued) & Keying Options*		
Description	Specify Quick Code	Add or Deduct
Visual Key Control (VKC)		
No bitting or keyset stamping on keys	VKC0	\$4.50
Keys only	VKC1	No Charge
Cylinders and keys (not for AS, AHS, ACS, ACHS, HS, CHS, PHS or PCHS)	VKC2	\$8.00
Cylinders only (not for AS, AHS, HS, ACS, ACHS, CHS, PHS or PCHS)	VKC3	
Concealed Key Control (CKC)		
CKC cylinders with VKC keys	CKC2	\$8.00
CKC cylinders only (not for AS, AHS, ACS, ACHS, PHS, PCHS)	CKC3	

Notes:

1. Not available in CLX3329 function.
2. CMK Construction master keying charge is in addition to master keying charge and is not available in interchangeable core, Access 3, Pyramid, or Security series.

*Double cylinder keying: unless otherwise specified, both cylinders of 32, 62, 72 and 82 functions will be keyed alike. The inside cylinder of 52 function will be keyed to the master key(s) only, while the outside cylinder will include the change key. If different keying is required, specify outside cylinder first, then inside cylinder. For key bows other than 10 and 90, specify 'KB' + bow number as Quick Code, e.g. KB12.

Door Height Options

Door Height	Specify Quick Code	Add or Deduct
7'0"	(standard)	No Charge
7'2"	H0702	No Charge
7'6"	H0706	No Charge
8'0"	H0800	No Charge

Door Width Options

Door Width	Specify Quick Code	Add or Deduct
32"	W032	No Charge
36"	(standard)	No Charge
42"	W042	No Charge
48"	W048	Add \$49.00 per device

Door Thickness Options

Door Thickness	Specify Quick Code	Add or Deduct
1-3/4"	(standard)	No Charge
2"	D200	No Charge
2-1/4"	D214	No Charge

Miscellaneous Options

Description	Specify	Add or Deduct
Knurling outside and inside (Embossed Touchbar - device side)	M20*	Add \$199.00 per device
Knurling outside only (trim side) ¹	M21*	Add \$93.00 per device
Knurling inside only (Embossed Touchbar - device side)	M22*	Add \$106.00 per device
Abrasive coat outside and inside (trim and device)	M23	Add \$126.00 per device
Abrasive coat inside only (device side)	M24	Add \$66.00 per device
Abrasive coat outside only (trim side)	M25	Add \$60.00 per device
PathLite™ Photoluminescent Touchbar cover	M49	Add \$475.00 per device
Less dogging	M51	No Charge
Cylinder dogging (less cylinder)	M52	Add \$107.00 per device
Mullion stabilizer	M57	Add \$67.00 per mullion
Parabolic Design Exit Trim	M60	Add \$107.00 per device
MicroShield® Antimicrobial finish coating	626C	Add \$90.00 (Exit Devices & Trims (ordered separately) Add \$111.00 (Exit Devices & Outside Trims (ordered together)
MicroShield® Antimicrobial finish coating	630C	

1. Not available with Vineyard™ or Muséo® levers.

*All levers provided in a powder coat finish will be supplied with an abrasive coating.

FE5400S

Multi-Point Exit Device Latching System



Removable Mullions

USA & Canada Prices Effective April 17, 2023

Door Height	Description	Specify	Price
Up to 7'0"	Steel Mullion - 3 Hour Fire Rated, Windstorm Certified	CRFE772A ⁴	\$1,634.00
Up to 8'0"	Steel Mullion - 3 Hour Fire Rated, Windstorm Certified	CRFE708A ⁴	\$1,644.00

Note:

- 4. For use with UL listed door assemblies that comply to FEMA 361 and ICC 500.
For the latest listings on compliant door assemblies visit our website at corbinrusswin.com

Options

Description	Specify Quick Code	Add or Deduct
Door frame filler block for double rabbetted frames	M95	Add \$45.00 per mullion
Door frame angle bracket for aluminum frames	M96	Add \$45.00 per mullion

MP6600 Series Multi-Point Locks

USA & Canada Prices Effective April 17, 2023

Door	1-3/4" thick door only – MP6600 Series requires utilizing Ceco Door and Curries doors and frames. McKINNEY® hinges
Mounting	Supplied fasteners are for metal doors with thru-bolts for trim
Hand	Handed; specify RHR, LHR, RH or LH
Lockbody	Unique mortise lockbody assembly used for a variety of applications
Top Bolt	Adjustable stainless steel 3/4" square bolt with 11/16" engagement; 5/16" steel reinforcement plate
Bottom Bolt	Adjustable stainless steel 3/4" square bolt with 5/8" engagement; 1/4" steel reinforcement plate
Center Bolts	Latchbolt is stainless steel with 3/4" projection. One piece, anti-friction reversible catch. Deadbolt is one piece hardened stainless steel with 1" projection
Lock Front	1/8" steel mortise front reinforced with 13/64" thick lock edge stiffener
Center Bolt Strike	1/4" thick stainless steel
Backset	Lever: 2-3/4" standard; Rods: 5-1/4"
Door Thickness	1-3/4" standard
Maximum Opening	Single door 2'8" x 6'8" up to 4'0" x 10'0" and double doors 6'0" x 6'8" up to 8'0" x 10'0" (Double doors require 2-988CR surface bolts)
UL Fire Listed	UL 3-hour fire rating
Trim	Multiple sectional and escutcheon mortise trim with Standard or Muséo levers
Cylinder	Multiple mortise cylinders

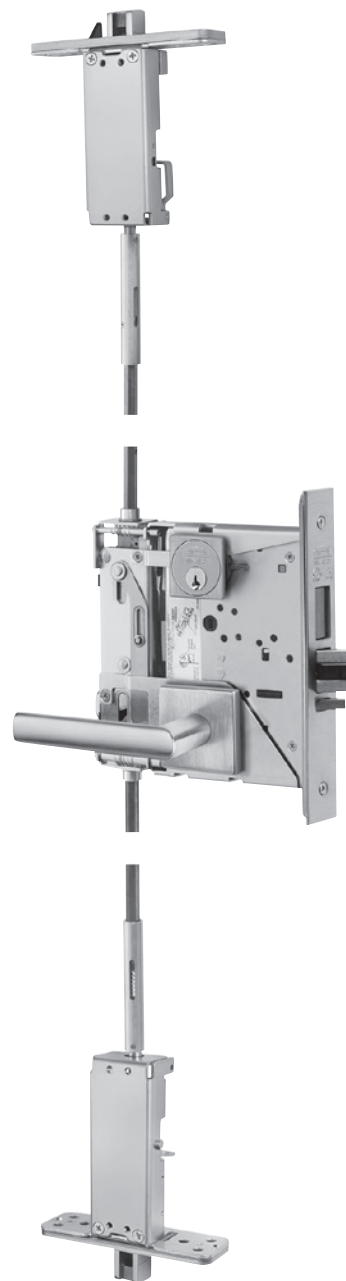

How to Order Ordering Example

Quantity	Series/ Function	Trim	Finish	Hand
100	MP6618	ASM	626	RHR

Note: Concealed vertical rods, top & bottom latches, and the lockbody cassette will be factory installed. All other hardware components are shipped directly to the customer and must be installed by a factory trained installer. Invoices for the door will be separate from the hardware invoice. The hardware invoice will include the concealed vertical assembly and the trim components.

MP6600 Series Multi-Point Locks



USA & Canada Prices Effective April 17, 2023

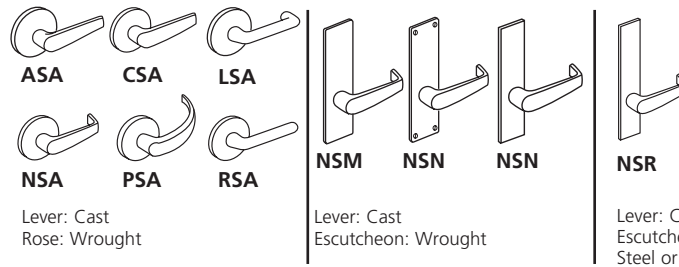

Available Functions	Description	Levers: AS, CS, ES, LS, NS, PS, RS Roses: A, G		Levers: AS, CS, ES, LS, NS, PS, RS Escutcheons: M, N, LW1		Levers: AS, CS, ES, LS, NS, PS, RS Escutcheons: RE1/RE2, RE3/RE4	
		613E, 626, BSP, WSP	605, 606, 611, 612, 613, 618, 619, 625, 629, 630, 722	613E, 626, BSP, WSP	605, 606, 611, 612, 613, 618, 619, 625, 629, 630, 722	613E, 626, BSP, WSP	605, 606, 611, 612, 613, 618, 619, 625, 629, 630, 722
Single Cylinder without Deadbolt							
MP6654 MP6655 MP6666 MP6656	Office/Entry Classroom Office & Inner Entry Lock Holdback	\$4,345.00	\$4,369.00	\$4,365.00	\$4,389.00	\$4,419.00	\$4,443.00
Single Cylinder with Deadbolt							
MP6618 MP6624 MP6665 MP6627	Classroom Storeroom Exit/Dormitory Closet or Storeroom	\$4,345.00	\$4,369.00	\$4,365.00	\$4,389.00	\$4,419.00	\$4,443.00
Non-Keyed							
MP6680 MP6609 MP6630 MP6620 MP6610 MP6660	Inside Passage Passage Privacy Bath Privacy Bedroom Passage or Closet Privacy Bath/Bedroom	\$4,345.00	\$4,369.00	\$4,365.00	\$4,389.00	\$4,419.00	\$4,443.00
Double Cylinder with Deadbolt							
MP6622 MP6662 MP6672 MP6673 MP6675	Store Door Classroom Security Intruder Deadbolt Classroom Security Intruder Aux. Deadbolt Classroom Security Intruder Deadlatch Security Deadbolt	\$4,345.00	\$4,369.00	\$4,365.00	\$4,389.00	\$4,419.00	\$4,443.00
Double Cylinder without Deadbolt							
MP6652 MP6691	Classroom Security Intruder Latchbolt Classroom Security Holdback	\$4,345.00	\$4,369.00	\$4,365.00	\$4,389.00	\$4,419.00	\$4,443.00
EAC							
MP66609 x NAC SAF / SEC	No Key Override With Deadbolt Fail Safe/Secure 12V/24V	\$4,813.00	\$4,837.00	\$4,833.00	\$4,857.00	\$4,887.00	\$4,911.00
MP66608 x NAC SAF / SEC	Key Override With Deadbolt Fail Safe/Secure 12V/24V	\$4,998.00	\$5,022.00	\$5,018.00	\$5,042.00	\$5,072.00	\$5,096.00
MP66932 SAF / SEC	NAC Fail Safe/Secure Lock, 12/24 Volt	\$4,813.00	\$4,837.00	\$4,833.00	\$4,857.00	\$4,887.00	\$4,911.00
MP66606 SAF / SEC	NAC Key Override And No Deadbolt Fail Safe/Secure 12V/24V	\$4,885.00	\$4,909.00	\$4,905.00	\$4,929.00	\$4,959.00	\$4,983.00
MP66934	NAC No Deadbolt And Key Override	\$4,998.00	\$5,022.00	\$5,018.00	\$5,042.00	\$5,072.00	\$5,096.00
MP66733	NAC No Deadbolt And No Key Override	\$4,926.00	\$4,950.00	\$4,946.00	\$4,970.00	\$5,000.00	\$5,024.00

MP6600 Series Multi-Point Locks



USA & Canada Prices Effective April 17, 2023

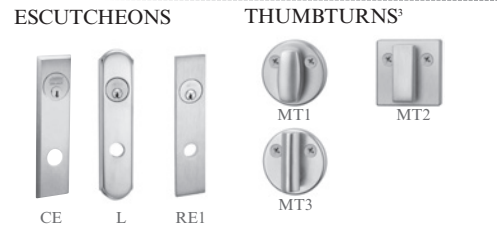
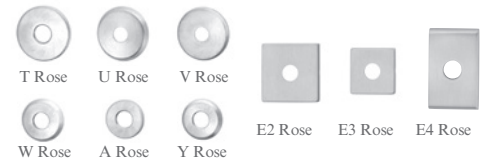
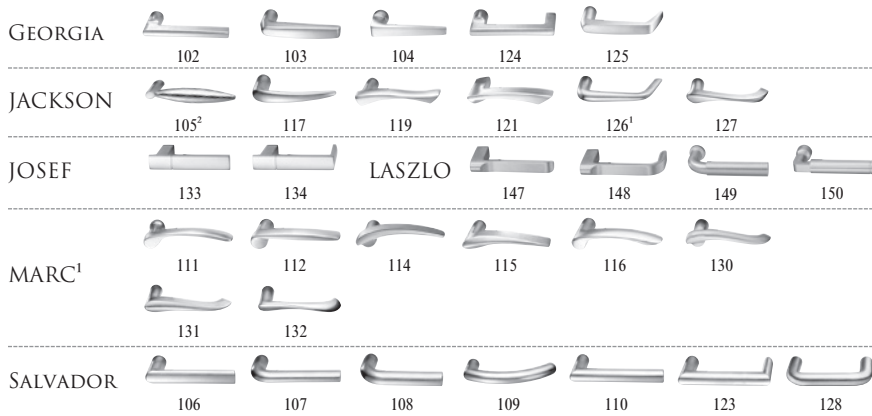

1. Handed: specify hand when ordering
2. Contact factory for current lead time
3. Specify thumbturn as quick code. Thumbturn backplate will match shape of rose chosen (i.e. round or square). Not available with escutcheons.

*629 and *630 finish options are Not available for all Muséo levers. Please refer to page 26 for availability.

613E	Dark Oxidized Satin Bronze - Equivalent	605	Bright Brass, Clear Coated	618	Bright Nickel Plated
626	Satin Chromium Plated	606	Satin Brass, Clear Coated	619	Satin Nickel Plated
BSP	Black Suede Powder Coat	611	Bright Bronze, Clear Coated	625	Bright Chromium Plated
WSP	White Suede Powder Coat	612	Satin Bronze, Clear Coated	629*	Bright Stainless Steel
		613	Dark Oxidized Satin Bronze, Oil Rubbed	630*	Satin Stainless Steel
		613L	Dark Oxidized Satin Bronze, Clear Coated	722	Black Oxidized Bronze, Oil Rubbed

Functions	Description		
Single Cylinder without Deadbolt ESCUTCHEONS: L, CE, RE1			
MP6654 MP6655 MP6666 MP6656	Office/Entry Classroom Office & Inner Entry Lock Holdback	\$4,395.00	\$4,419.00
Single Cylinder with Deadbolt ESCUTCHEONS: L, CE, RE1			
MP6618 MP6624 MP6665 MP6627	Classroom Storeroom Exit/Dormitory Closet or Storeroom	\$4,395.00	\$4,419.00
Non-Keyed ESCUTCHEONS: L, CE, RE1			
MP6680 MP6609 MP6630 MP6620 MP6610 MP6660	Inside Passage Passage Privacy Bath Privacy Bedroom Passage or Closet Privacy Bath/Bedroom	\$4,395.00	\$4,419.00
Double Cylinder with Deadbolt ESCUTCHEONS: L, CE, RE1			
MP6622 MP6662 MP6672 MP6673 MP6675	Store Door Classroom Security Intruder Deadbolt Classroom Security Intruder Auxiliary Deadbolt Classroom Security Intruder Deadlatch Security Deadbolt	\$4,395.00	\$4,419.00
Double Cylinder without Deadbolt ESCUTCHEONS: L, CE, RE1			
MP6652 MP6691	Classroom Security Intruder Latchbolt Classroom Security Holdback	\$4,395.00	\$4,419.00
EAC ESCUTCHEONS: L, CE, RE1			
MP66609 x NAC SAF / SEC	No Key Override With Deadbolt Fail Safe/Secure 12V/24V	\$4,863.00	\$4,887.00
MP66608 x NAC SAF / SEC	Key Override With Deadbolt Fail Safe/Secure 12V/24V	\$5,048.00	\$5,072.00
MP66932 SAF / SEC	NAC Fail Safe/Secure Lock, 12/24 Volt	\$4,863.00	\$4,887.00
MP66606 SAF / SEC	NAC Key Override And No Deadbolt Fail Safe/Secure 12V/24V	\$4,935.00	\$4,959.00
MP66934	NAC No Deadbolt And Key Override	\$5,048.00	\$5,072.00
MP66733	NAC No Deadbolt And No Key Override	\$4,976.00	\$5,000.00

**MP6600 Series
Multi-Point Locks**

USA & Canada Prices Effective April 17, 2023

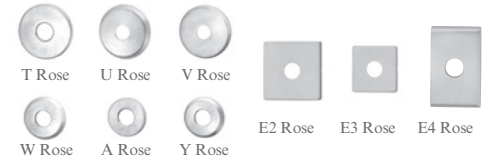
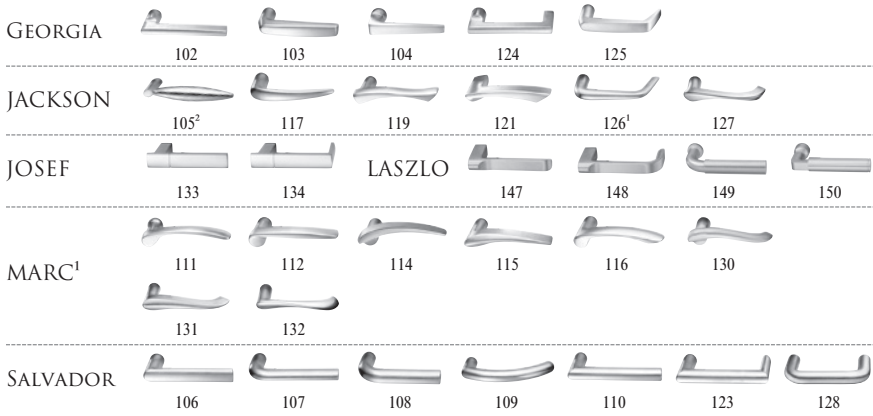

ESCUTCHEONS

THUMBTURNS³



1. Handed: specify hand when ordering
2. Contact factory for current lead time
3. Specify thumbturn as quick code. Thumbturn backplate will match shape of rose chosen (i.e. round or square). Not available with escutcheons.

*629 and *630 finish options are Not available for all Muséo levers. Please refer to page 26 for availability.

613E Dark Oxidized Satin Bronze - Equivalent	605 Bright Brass, Clear Coated	618 Bright Nickel Plated
626 Satin Chromium Plated	606 Satin Brass, Clear Coated	619 Satin Nickel Plated
BSP Black Suede Powder Coat	611 Bright Bronze, Clear Coated	625 Bright Chromium Plated
WSP White Suede Powder Coat	612 Satin Bronze, Clear Coated	629* Bright Stainless Steel
	613 Dark Oxidized Satin Bronze, Oil Rubbed	630* Satin Stainless Steel
	613L Dark Oxidized Satin Bronze, Clear Coated	722 Black Oxidized Bronze, Oil Rubbed

Functions	Description		
Single Cylinder without Deadbolt ROSES: A, T, U, V, W, Y, E2, E3, E4			
MP6654 MP6655 MP6666 MP6656	Office/Entry Classroom Office & Inner Entry Lock Holdback	\$4,345.00	\$4,369.00
Single Cylinder with Deadbolt ROSES: A, T, U, V, W, Y, E2, E3, E4			
MP6618 MP6624 MP6665 MP6627	Classroom Storeroom Exit/Dormitory Closet or Storeroom	\$4,345.00	\$4,369.00
Non-Keyed ROSES ROSES: A, T, U, V, W, Y, E2, E3, E4			
MP6680 MP6609 MP6630 MP6620 MP6610 MP6660	Inside Passage Passage Privacy Bath Privacy Bedroom Passage or Closet Privacy Bath/Bedroom	\$4,345.00	\$4,369.00
Double Cylinder with Deadbolt ROSES: A, T, U, V, W, Y, E2, E3, E4			
MP6622 MP6662 MP6672 MP6673 MP6675	Store Door Classroom Security Intruder Deadbolt Classroom Security Intruder Auxiliary Deadbolt Classroom Security Intruder Deadlatch Security Deadbolt	\$4,345.00	\$4,369.00
Double Cylinder without Deadbolt ROSES: A, T, U, V, W, Y, E2, E3, E4			
MP6652 MP6691	Classroom Security Intruder Latchbolt Classroom Security Holdback	\$4,345.00	\$4,369.00
EAC ROSES: A, T, U, V, W, Y, E2, E3, E4			
MP66609 x NAC SAF / SEC	No Key Override With Deadbolt Fail Safe/Secure 12V/24V	\$4,813.00	\$4,837.00
MP66608 x NAC SAF / SEC	Key Override With Deadbolt Fail Safe/Secure 12V/24V	\$4,998.00	\$5,022.00
MP66932 SAF / SEC	NAC Fail Safe/Secure Lock, 12/24 Volt	\$4,813.00	\$4,837.00
MP66606 SAF / SEC	NAC Key Override And No Deadbolt Fail Safe/Secure 12V/24V	\$4,885.00	\$4,909.00
MP66934	NAC No Deadbolt And Key Override	\$4,998.00	\$5,022.00
MP66733	NAC No Deadbolt And No Key Override	\$4,926.00	\$4,950.00

MP6600 Series Multi-Point Locks



USA & Canada Prices Effective April 17, 2023

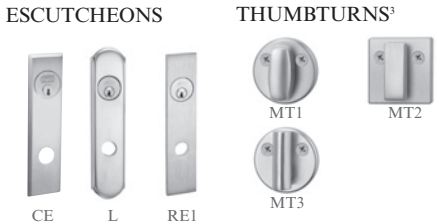
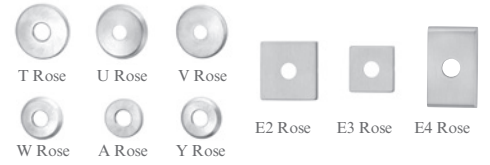
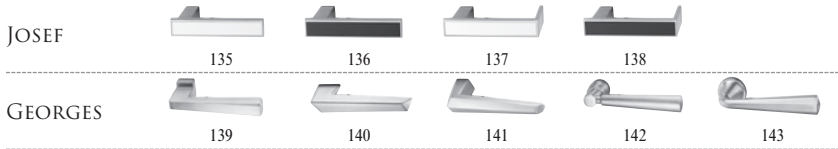

1. Handed: specify hand when ordering
2. Contact factory for current lead time
3. Specify thumbturn as quick code. Thumbturn backplate will match shape of rose chosen (i.e. round or square). Not available with escutcheons.

613E	Dark Oxidized Satin Bronze	605	Bright Brass, Clear Coated	618	Bright Nickel Plated
	- Equivalent	606	Satin Brass, Clear Coated	619	Satin Nickel Plated
626	Satin Chromium Plated	611	Bright Bronze, Clear Coated	625	Bright Chromium Plated
BSP	Black Suede Powder Coat	612	Satin Bronze, Clear Coated	629	Bright Stainless Steel
WSP	White Suede Powder Coat	613	Dark Oxidized Satin Bronze, Oil Rubbed	630	Satin Stainless Steel
		613L	Dark Oxidized Satin Bronze, Clear Coated	722	Black Oxidized Bronze, Oil Rubbed

Functions	Description		
Single Cylinder without Deadbolt ESCUTCHEONS: L, CE, RE1			
MP6654 MP6655 MP6666 MP6656	Office/Entry Classroom Office & Inner Entry Lock Holdback	\$4,509.00	\$4,533.00
Single Cylinder with Deadbolt ESCUTCHEONS: L, CE, RE1			
MP6618 MP6624 MP6665 MP6627	Classroom Storeroom Exit/Dormitory Closet or Storeroom	\$4,509.00	\$4,533.00
Non-Keyed ESCUTCHEONS: L, CE, RE1			
MP6680 MP6609 MP6630 MP6620 MP6610 MP6660	Inside Passage Passage Privacy Bath Privacy Bedroom Passage or Closet Privacy Bath/Bedroom	\$4,509.00	\$4,533.00
Double Cylinder with Deadbolt ESCUTCHEONS: L, CE, RE1			
MP6622 MP6662 MP6672 MP6673 MP6675	Store Door Classroom Security Intruder Deadbolt Classroom Security Intruder Auxiliary Deadbolt Classroom Security Intruder Deadlatch Security Deadbolt	\$4,509.00	\$4,533.00
Double Cylinder without Deadbolt ESCUTCHEONS: L, CE, RE1			
MP6652 MP6691	Classroom Security Intruder Latchbolt Classroom Security Holdback	\$4,509.00	\$4,533.00
EAC ESCUTCHEONS: L, CE, RE1			
MP66609 x NAC SAF / SEC	No Key Override With Deadbolt Fail Safe/Secure 12V/24V	\$4,977.00	\$5,001.00
MP66608 x NAC SAF / SEC	Key Override With Deadbolt Fail Safe/Secure 12V/24V	\$5,162.00	\$5,186.00
MP66932 SAF / SEC	NAC Fail Safe/Secure Lock, 12/24 Volt	\$4,977.00	\$5,001.00
MP66606 SAF / SEC	NAC Key Override And No Deadbolt Fail Safe/Secure 12V/24V	\$5,049.00	\$5,073.00
MP66934	NAC No Deadbolt And Key Override	\$5,162.00	\$5,186.00
MP66733	NAC No Deadbolt And No Key Override	\$5,090.00	\$5,114.00

MP6600 Series Multi-Point Locks

USA & Canada Prices Effective April 17, 2023

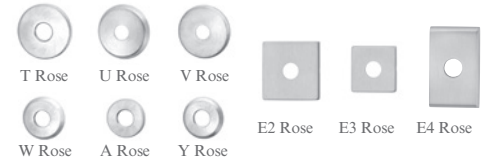
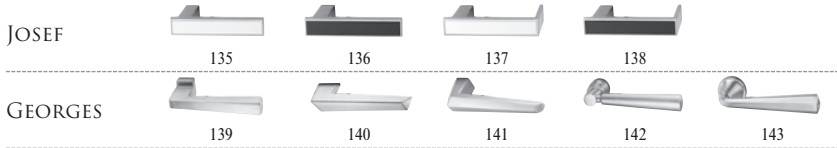

ESCUTCHEONS **THUMBTURNS¹**



1. Handed: specify hand when ordering
2. Contact factory for current lead time
3. Specify thumbturn as quick code. Thumbturn backplate will match shape of rose chosen (i.e. round or square). Not available with escutcheons.

613E	Dark Oxidized Satin Bronze	605	Bright Brass, Clear Coated	618	Bright Nickel Plated
	- Equivalent	606	Satin Brass, Clear Coated	619	Satin Nickel Plated
626	Satin Chromium Plated	611	Bright Bronze, Clear Coated	625	Bright Chromium Plated
BSP	Black Suede Powder Coat	612	Satin Bronze, Clear Coated	629	Bright Stainless Steel
WSP	White Suede Powder Coat	613	Dark Oxidized Satin Bronze, Oil Rubbed	630	Satin Stainless Steel
		613L	Dark Oxidized Satin Bronze, Clear Coated	722	Black Oxidized Bronze, Oil Rubbed

Functions	Description		
Single Cylinder without Deadbolt ROSES: A, T, U, V, W, Y, E2, E3, E4			
MP6654 MP6655 MP6666 MP6656	Office/Entry Classroom Office & Inner Entry Lock Holdback	\$4,459.00	\$4,483.00
Single Cylinder with Deadbolt ROSES: A, T, U, V, W, Y, E2, E3, E4			
MP6618 MP6624 MP6665 MP6627	Classroom Storeroom Exit/Dormitory Closet or Storeroom	\$4,459.00	\$4,483.00
Non-Keyed ROSES: A, T, U, V, W, Y, E2, E3, E4			
MP6680 MP6609 MP6630 MP6620 MP6610 MP6660	Inside Passage Passage Privacy Bath Privacy Bedroom Passage or Closet Privacy Bath/Bedroom	\$4,459.00	\$4,483.00
Double Cylinder with Deadbolt ROSES: A, T, U, V, W, Y, E2, E3, E4			
MP6622 MP6662 MP6672 MP6673 MP6675	Store Door Classroom Security Intruder Deadbolt Classroom Security Intruder Auxiliary Deadbolt Classroom Security Intruder Deadlatch Security Deadbolt	\$4,459.00	\$4,483.00
Double Cylinder without Deadbolt ROSES: A, T, U, V, W, Y, E2, E3, E4			
MP6652 MP6691	Classroom Security Intruder Latchbolt Classroom Security Holdback	\$4,459.00	\$4,483.00
EAC ROSES: A, T, U, V, W, Y, E2, E3, E4			
MP66609 x NAC SAF / SEC	No Key Override With Deadbolt Fail Safe/Secure 12V/24V	\$4,927.00	\$4,951.00
MP66608 x NAC SAF / SEC	Key Override With Deadbolt Fail Safe/Secure 12V/24V	\$5,112.00	\$5,136.00
MP66932 SAF / SEC	NAC Fail Safe/Secure Lock, 12/24 Volt	\$4,927.00	\$4,951.00
MP66606 SAF / SEC	NAC Key Override And No Deadbolt Fail Safe/Secure 12V/24V	\$4,999.00	\$5,023.00
MP66934	NAC No Deadbolt And Key Override	\$5,112.00	\$5,136.00
MP66733	NAC No Deadbolt And No Key Override	\$5,040.00	\$5,064.00

MP6600 Series Multi-Point Locks



USA & Canada Prices Effective April 17, 2023



*613E, BSP, WSP finishes are not available with 21M levers.

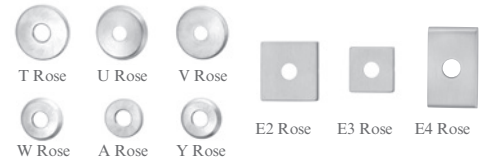

ESCUTCHEONS THUMBTURNS³



Specify thumbturn as quick code. Thumbturn backplate will match shape of rose chosen (i.e. round or square)

- 613E Dark Oxidized Satin Bronze – Equivalent
- 629 Bright Stainless Steel
- 630 Satin Stainless Steel
- BSP Black Suede Powder Coat
- WSP White Suede Powder Coat

Functions	Description	
Single Cylinder without Deadbolt ESCUTCHEONS: L, CE, RE1		
MP6654 MP6655 MP6666 MP6656	Office/Entry Classroom Office & Inner Entry Lock Holdback	\$4,507.00
Single Cylinder with Deadbolt ESCUTCHEONS: L, CE, RE1		
MP6618 MP6624 MP6665 MP6627	Classroom Storeroom Exit/Dormitory Closet or Storeroom	\$4,507.00
Non-Keyed ESCUTCHEONS: L, CE, RE1		
MP6680 MP6609 MP6630 MP6620 MP6610 MP6660	Inside Passage Passage Privacy Bath Privacy Bedroom Passage or Closet Privacy Bath/Bedroom	\$4,507.00
Double Cylinder with Deadbolt ESCUTCHEONS: L, CE, RE1		
MP6622 MP6662 MP6672 MP6673 MP6675	Store Door Classroom Security Intruder Deadbolt Classroom Security Intruder Auxiliary Deadbolt Classroom Security Intruder Deadlatch Security Deadbolt	\$4,507.00
Double Cylinder without Deadbolt ESCUTCHEONS: L, CE, RE1		
MP6652 MP6691	Classroom Security Intruder Latchbolt Classroom Security Holdback	\$4,507.00
EAC ESCUTCHEONS: L, CE, RE1		
MP66609 x NAC SAF / SEC	No Key Override With Deadbolt Fail Safe/Secure 12V/24V	\$4,975.00
MP66608 x NAC SAF / SEC	Key Override With Deadbolt Fail Safe/Secure 12V/24V	\$5,160.00
MP66932 SAF / SEC	NAC Fail Safe/Secure Lock, 12/24 Volt	\$4,975.00
MP66606 SAF / SEC	NAC Key Override And No Deadbolt Fail Safe/Secure 12V/24V	\$5,047.00
MP66934	NAC No Deadbolt And Key Override	\$5,160.00
MP66733	NAC No Deadbolt And No Key Override	\$5,088.00

MP6600 Series Multi-Point Locks

USA & Canada Prices Effective April 17, 2023



*613E, BSP, WSP finishes are not available with 21M levers.

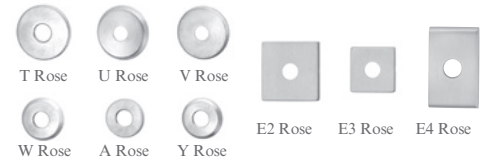

ESCUTCHEONS

THUMBTURNS³



Specify thumbturn as quick code. Thumbturn backplate will match shape of rose chosen (i.e. round or square)

- 613E Dark Oxidized Satin Bronze – Equivalent
- 629 Bright Stainless Steel
- 630 Satin Stainless Steel
- BSP Black Suede Powder Coat
- WSP White Suede Powder Coat

Functions	Description	
Single Cylinder without Deadbolt ROSES: A, T, U, V, W, Y, E2, E3, E4		
MP6654 MP6655 MP6666 MP6656	Office/Entry Classroom Office & Inner Entry Lock Holdback	\$4,457.00
Single Cylinder with Deadbolt ROSES: A, T, U, V, W, Y, E2, E3, E4		
MP6618 MP6624 MP6665 MP6627	Classroom Storeroom Exit/Dormitory Closet or Storeroom	\$4,457.00
Non-Keyed ROSES: A, T, U, V, W, Y, E2, E3, E4		
MP6680 MP6609 MP6630 MP6620 MP6610 MP6660	Inside Passage Passage Privacy Bath Privacy Bedroom Passage or Closet Privacy Bath/Bedroom	\$4,457.00
Double Cylinder with Deadbolt ROSES: A, T, U, V, W, Y, E2, E3, E4		
MP6622 MP6662 MP6672 MP6673 MP6675	Store Door Classroom Security Intruder Deadbolt Classroom Security Intruder Auxiliary Deadbolt Classroom Security Intruder Deadlatch Security Deadbolt	\$4,457.00
Double Cylinder without Deadbolt ROSES: A, T, U, V, W, Y, E2, E3, E4		
MP6652 MP6691	Classroom Security Intruder Latchbolt Classroom Security Holdback	\$4,457.00
EAC ROSES: A, T, U, V, W, Y, E2, E3, E4		
MP66609 x NAC SAF / SEC	No Key Override With Deadbolt Fail Safe/Secure 12V/24V	\$4,925.00
MP66608 x NAC SAF / SEC	Key Override With Deadbolt Fail Safe/Secure 12V/24V	\$5,110.00
MP66932 SAF / SEC	NAC Fail Safe/Secure Lock, 12/24 Volt	\$4,925.00
MP66606 SAF / SEC	NAC Key Override And No Deadbolt Fail Safe/Secure 12V/24V	\$4,997.00
MP66934	NAC No Deadbolt And Key Override	\$5,110.00
MP66733	NAC No Deadbolt And No Key Override	\$5,038.00

MP6600 Series Multi-Point Locks



USA & Canada Prices Effective April 17, 2023

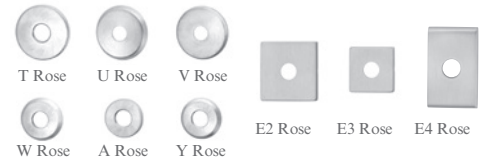
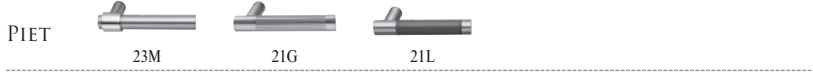

ESCUTCHEONS THUMBTURNS³



Specify thumbturn as quick code. Thumbturn backplate will match shape of rose chosen (i.e. round or square)

- 613E Dark Oxidized Satin Bronze – Equivalent
- 629 Bright Stainless Steel
- 630 Satin Stainless Steel
- BSP Black Suede Powder Coat
- WSP White Suede Powder Coat

Functions	Description	
Single Cylinder without Deadbolt ESCUTCHEONS: L, CE, RE1		
MP6654 MP6655 MP6666 MP6656	Office/Entry Classroom Office & Inner Entry Lock Holdback	\$4,533.00
Single Cylinder with Deadbolt ESCUTCHEONS: L, CE, RE1		
MP6618 MP6624 MP6665 MP6627	Classroom Storeroom Exit/Dormitory Closet or Storeroom	\$4,533.00
Non-Keyed ESCUTCHEONS: L, CE, RE1		
MP6680 MP6609 MP6630 MP6620 MP6610 MP6660	Inside Passage Passage Privacy Bath Privacy Bedroom Passage or Closet Privacy Bath/Bedroom	\$4,533.00
Double Cylinder with Deadbolt ESCUTCHEONS: L, CE, RE1		
MP6622 MP6662 MP6672 MP6673 MP6675	Store Door Classroom Security Intruder Deadbolt Classroom Security Intruder Auxiliary Deadbolt Classroom Security Intruder Deadlatch Security Deadbolt	\$4,533.00
Double Cylinder without Deadbolt ESCUTCHEONS: L, CE, RE1		
MP6652 MP6691	Classroom Security Intruder Latchbolt Classroom Security Holdback	\$4,533.00
EAC ESCUTCHEONS: L, CE, RE1		
MP66609 x NAC SAF / SEC	No Key Override With Deadbolt Fail Safe/Secure 12V/24V	\$5,001.00
MP66608 x NAC SAF / SEC	Key Override With Deadbolt Fail Safe/Secure 12V/24V	\$5,186.00
MP66932 SAF / SEC	NAC Fail Safe/Secure Lock, 12/24 Volt	\$5,001.00
MP66606 SAF / SEC	NAC Key Override And No Deadbolt Fail Safe/Secure 12V/24V	\$5,073.00
MP66934	NAC No Deadbolt And Key Override	\$5,186.00
MP66733	NAC No Deadbolt And No Key Override	\$5,114.00

**MP6600 Series
Multi-Point Locks**

USA & Canada Prices Effective April 17, 2023

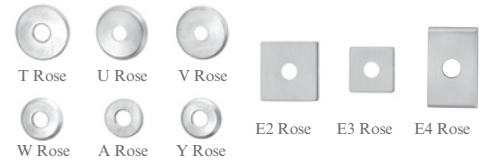
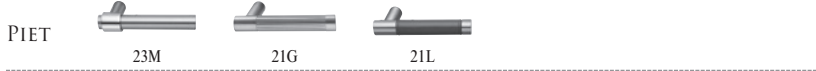

ESCUTCHEONS THUMBTURNS³



Specify thumbturn as quick code. Thumbturn backplate will match shape of rose chosen (i.e. round or square)

613E	Dark Oxidized Satin Bronze – Equivalent
629	Bright Stainless Steel
630	Satin Stainless Steel
BSP	Black Suede Powder Coat
WSP	White Suede Powder Coat

Functions	Description	
Single Cylinder without Deadbolt ROSES: A, T, U, V, W, Y, E2, E3, E4		
MP6654 MP6655 MP6666 MP6656	Office/Entry Classroom Office & Inner Entry Lock Holdback	\$4,483.00
Single Cylinder with Deadbolt ROSES: A, T, U, V, W, Y, E2, E3, E4		
MP6618 MP6624 MP6665 MP6627	Classroom Storeroom Exit/Dormitory Closet or Storeroom	\$4,483.00
Non-Keyed ROSES: A, T, U, V, W, Y, E2, E3, E4		
MP6680 MP6609 MP6630 MP6620 MP6610 MP6660	Inside Passage Passage Privacy Bath Privacy Bedroom Passage or Closet Privacy Bath/Bedroom	\$4,483.00
Double Cylinder with Deadbolt ROSES: A, T, U, V, W, Y, E2, E3, E4		
MP6622 MP6662 MP6672 MP6673 MP6675	Store Door Classroom Security Intruder Deadbolt Classroom Security Intruder Auxiliary Deadbolt Classroom Security Intruder Deadlatch Security Deadbolt	\$4,483.00
Double Cylinder without Deadbolt ROSES: A, T, U, V, W, Y, E2, E3, E4		
MP6652 MP6691	Classroom Security Intruder Latchbolt Classroom Security Holdback	\$4,483.00
EAC ROSES: A, T, U, V, W, Y, E2, E3, E4		
MP66609 x NAC SAF / SEC	No Key Override With Deadbolt Fail Safe/Secure 12V/24V	\$4,951.00
MP66608 x NAC SAF / SEC	Key Override With Deadbolt Fail Safe/Secure 12V/24V	\$5,136.00
MP66932 SAF / SEC	NAC Fail Safe/Secure Lock, 12/24 Volt	\$4,951.00
MP66606 SAF / SEC	NAC Key Override And No Deadbolt Fail Safe/Secure 12V/24V	\$5,023.00
MP66934	NAC No Deadbolt And Key Override	\$5,136.00
MP66733	NAC No Deadbolt And No Key Override	\$5,064.00

MP6600 Series Multi-Point Locks



USA & Canada Prices Effective April 17, 2023

Cylinder Options		
Description	Specify Quick Code	Add or Deduct
Conventional 6-pin	(standard)	No Charge
Conventional 7-pin	7P	Add \$2.00 per cylinder
Less Standard Cylinder	LC	Deduct \$120.00 per cylinder
Less Concealed Shell Cylinder	PO-LC	Add \$5.00 per lockset
LFIC		
LFIC 6-pin	C6	Add \$104.00 per cylinder
LFIC 6-pin Less Core	CL6	No Charge
LFIC 6-pin with Temporary Construction Core (Red)	CT6R	Add \$104.00 per cylinder
LFIC 6-pin with Temporary Construction Core (Blue)	CT6B	Add \$104.00 per cylinder
LFIC 6-pin with Temporary Construction Core (Green)	CT6G	Add \$104.00 per cylinder
LFIC 6-pin with Temporary Disposable Core	CT6D	No Charge
LFIC 7-pin	C7	Add \$106.00 per cylinder
LFIC 7-pin Less Core	CL7	Add \$2.00 per cylinder
LFIC 7-pin with Temporary Construction Core (Red)	CT7R	Add \$106.00 per cylinder
LFIC 7-pin with Temporary Construction Core (Blue)	CT7B	Add \$106.00 per cylinder
LFIC 7-pin with Temporary Construction Core (Green)	CT7G	Add \$106.00 per cylinder
LFIC 7-pin with Temporary Disposable Core	CT7D	Add \$2.00 per cylinder
SFIC		
SFIC 6-pin	C6S	Add \$93.00 per cylinder
SFIC 6-pin with Temporary Construction Core (Blue)	CT6SB	Add \$93.00 per cylinder
SFIC 6-pin with SFIC Disposable Temporary Core	CT6SD	No Charge
SFIC 6-pin with Less Core	CLS6	No Charge
SFIC 7-pin	C7S	Add \$93.00 per cylinder
SFIC 7-pin with Temporary Construction Core (Blue)	CT7SB	Add \$93.00 per cylinder
SFIC 7-pin with SFIC Disposable Temporary Core	CT7SD	No Charge
SFIC 6-pin with Less Core	CLS7	No Charge
Security		
Security ⁴	HS	Add \$158.00 per cylinder
Security LFIC ^{1,4}	CHS	Add \$258.00 per cylinder
Access 3		
Access 3 Patented	AP	No Charge
Access 3 Security	AS	Add \$78.00 per cylinder
Access 3 High Security, UL 437	AHS	Add \$111.00 per cylinder
Access 3 LFIC Patented	ACP	Add \$104.00 per cylinder
Access 3 LFIC Security	ACS	Add \$182.00 per cylinder
Access 3 LFIC High Security, UL 437	ACHS	Add \$215.00 per cylinder
Pyramid		
Pyramid Security Fixed Core	PS	Add \$84.00 per cylinder
Pyramid Security LFIC	PCS	Add \$181.00 per cylinder
Pyramid High Security Fixed Core	PHS	Add \$125.00 per cylinder
Pyramid High Security LFIC	PCHS	Add \$223.00 per cylinder
Pyramid LFIC with Temporary Construction Core ³	CTP	Add \$104.00 per cylinder
Pyramid LFIC with Temporary Disposable Core ³	CTPD	No Charge
Pyramid LFIC Less Core	CLP	No Charge
Other		
Master Ring ²	MR	Add \$87.00 per cylinder
Flex Head Cylinder, 6-pin (sectional trim)	FX6	Add \$108.00 per cylinder
Flex Head Cylinder, 7-pin (sectional trim)	FX7	Add \$110.00 per cylinder
Flex Head Master Ring (sectional trim)	FXM	Add \$175.00 per cylinder
Plug only to show, 6-pin (concealed shell) (available for M and R escutcheons and single cylinder functions only)	P06	Add \$120.00 per lockset
Plug only to show, 7-pin (concealed shell) (available for M and R escutcheons and single cylinder functions only)	P07	Add \$122.00 per lockset

Notes:

1. CHS ordered with CT6 option no charge.
3. Refer to Key construction core program, pg. 63 for example of CTP option pricing.
4. For existing systems only.

Continued on next page

MP6600 Series Multi-Point Locks

USA & Canada Prices Effective April 17, 2023

Cylinder Options (continued) & Keying Options*

Description	Specify Quick Code	Add or Deduct
Keying and Keys		
0-bitted with 2 Blank Keys	(standard)	No Charge
Keyed Random	KR	
Construction Master Keyed ²	CMK	Add \$16.00 per cylinder
More than 2 Keys	KY# (e.g., KY6)	See page 33 - Cut Keys Section
Master Keying		
Master keyed (all cylinders except CR8000, CR8020, CR8027, CR8200, CR8500, CR8600, CR8700)	MK	Add \$16.00 per cylinder
Master keyed Pyramid (except CR8020, CR8027 LFIC cores)	MK	
Master keyed Security (including LFIC cylinder and core)	MK	
Master keyed Access 3 (except CR8500, CR8600, CR8700 LFIC cores)	MK	
Master keyed (CR8000, CR8020, CR8027, CR8200, CR8500, CR8600, CR8700)	MK-IC	No Charge
Master keyed to customer bittings or sample key	MK-CB	Add \$16.00 per cylinder
Visual Key Control (VKC)		
No bitting or keyset stamping on keys	VKC0	\$4.50
Keys only	VKC1	No Charge
Cylinders and keys (not for AS, AHS, ACS, ACHS, HS, CHS, PHS or PCHS)	VKC2	\$8.00
Cylinders only (not for AS, AHS, HS, ACS, ACHS, CHS, PHS or PCHS)	VKC3	
Concealed Key Control (CKC)		
CKC cylinders with VKC keys	CKC2	\$8.00
CKC cylinders only (not for AS, AHS, ACS, ACHS, PHS, PCHS)	CKC3	

Notes:

1. CMK Construction master keying charge is in addition to master keying charge.
2. CMK Construction master keying is not available in interchangeable core, Access 3, Pyramid, or Security series.
3. VKC2, VKC3, CKC3 are not available in Pyramid or Security series.
4. Pyramid series is not available keyed random.
5. Security series is not available 0-bitted.

*Double cylinder keying: unless otherwise specified, both cylinders of 32, 62, 72 and 82 functions will be keyed alike. The inside cylinder of 52 function will be keyed to the master key(s) only, while the outside cylinder will include the change key. If different keying is required, specify outside cylinder first, then inside cylinder. For key bows other than 10 and 90, specify 'KB' + bow number as Quick Code, e.g. KB12.

Strike Options*

Lip Length	ANSI Straight Lip - Specify Quick Code	ANSI Curved Lip - Specify Quick Code	Add or Deduct
7/8"	SS078	N/A	No Charge

* If door thickness is standard or has been specified and no special door or frame condition exist, then only the first two characters of the optional strike Quick Code must be specified (e.g. "SA").

The correct lip length will be determined by our order entry system based on the standard or specified door thickness.

MP6600 Series Multi-Point Locks



USA & Canada Prices Effective April 17, 2023

Door Thickness with Locksets Mortised on Center

Door Thickness	Sectional Rose Trim Specify Quick Code	Escutcheon ^{1,2} Trim Specify Quick Code	Add or Deduct
1-3/4" (standard)	—	—	No Charge

Options

Description	Specify Quick Code	Add or Deduct
Split designs and split finishes	Outside Trim x Inside Trim	Higher set price prevails
Spanner head screws	M02	Add \$28.00 per lockset
Torx® head screws (n/a with N escutcheon)	M04	Add \$34.00 per lockset
Single Occupancy Indicator - Secure/Unsecure (Outside)	M19S*	Add \$175.00 per lockset
Single Occupancy Indicator - Vacant/Occupied (Outside)	M19V*	Add \$175.00 per lockset
Double Occupancy Indicator - Secure/Unsecure (Outside) Secure/Unsecure (Inside)	M19SN*	Add \$350.00 per lockset
Double Indicator Vacant/Occupied (Outside) Secure/Unsecure (Inside)	M19VN*	Add \$350.00 per lockset
Knurling outside and inside	M20**	Add \$196.00 per lockset
Knurling outside only	M21**	Add \$98.00 per lockset
Knurling inside only	M22**	Add \$98.00 per lockset
Abrasive coat outside and inside	M23 ¹	Add \$124.00 per lockset
Abrasive coat inside only	M24 ¹	Add \$62.00 per lockset
Abrasive coat outside only	M25 ¹	Add \$62.00 per lockset

** All levers provided in a powder coat finish will be supplied with an abrasive coating.

Thumbturn Options

Specify door thickness	Specify Quick Code	Add or Deduct
Ergonomic	M34 ²	Add \$20.00 per TT
Decorative	MT1	No Charge
Decorative square	MT2	No Charge
Decorative cylinder	MT3	No Charge



MT1



MT2



MT3

Notes:

1. Not available with Vineyard™ or Muséo® levers.
2. M34 is not available with M19N, M19VN or M19SN.

Note: Thumbturn backplate will match shape of rose chosen (i.e. round or square)

Strike Options

Part Number	Description
726F577	Top Strike Pack
726F587	Bottom Strike Pack
726F607	Center Strike Pack

Dogging Indicator Kit

AUX188 x FIN -Dogging Indicator kit if ordered separately.

Price
\$673.00

Note: Concealed vertical rods, top & bottom latches, and the lockbody cassette will be factory installed. All other hardware components are shipped directly to the customer and must be installed by a factory trained installer. Invoices for the door will be separate from the hardware invoice. The hardware invoice will include the concealed vertical assembly and the trim components.

FE6600 Series

Series Multi-Point Locks



USA & Canada Prices Effective April 17, 2023

Door	1-3/4" thick door only - FE6600 Series requires utilizing Ceco Door StormPro 361 and Curries StormPro 361 doors and frames. McKINNEY StormPro hinges are required when used as a certified tornado solution
Mounting	Supplied fasteners are for metal doors with throughbolts for trim
Hand	Handed; specify RHR, LHR, RH or LH
Lockbody	Unique mortise lockbody assembly used for a variety of applications
Top Bolt	Adjustable stainless steel 3/4" square bolt with 11/16" engagement; 5/16" steel reinforcement plate
Bottom Bolt	Adjustable stainless steel 3/4" square bolt with 5/8" engagement; 1/4" steel reinforcement plate
Center Bolts	Latchbolt is stainless steel with 3/4" projection. One piece, anti-friction reversible catch. Deadbolt is one piece hardened stainless steel with 1" projection
Lock Front	1/8" steel mortise front reinforced with 13/64" thick lock edge stiffener
Center Bolt Strike	1/4" thick stainless steel
Backset	2-3/4" standard
Door Thickness	1-3/4" standard
Door Height	7'0" - 8'0"
Maximum Opening	Single door 4'0" x 8'0" and double doors 8'0" x 8'0".
UL Fire Listed	UL 3-hour fire rating
Trim	Multiple sectional and escutcheon mortise trim with Standard or Muséo levers
Cylinder	Multiple mortise cylinders

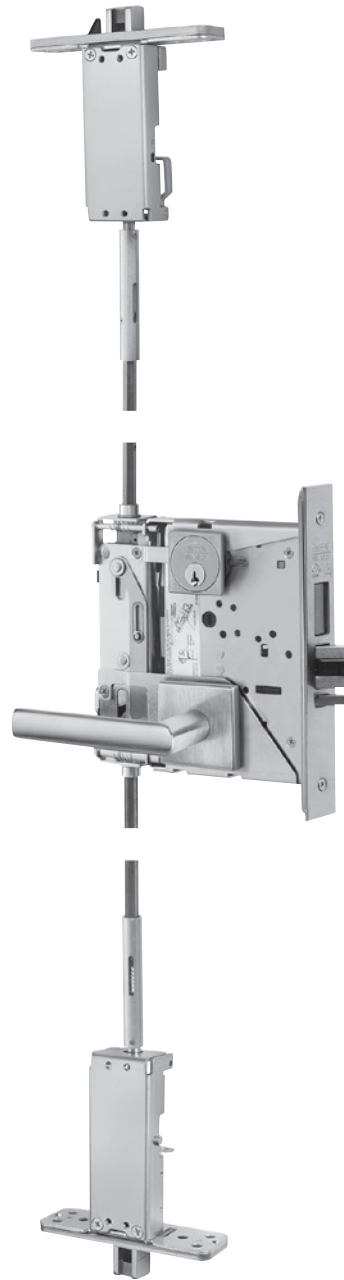

How to Order

Ordering Example

Quantity	Series/Function	Trim	Finish	Hand
100	FE6618	ASM	626	RHR

Note: Concealed vertical rods, top & bottom latches, and the lockbody cassette will be factory installed. All other hardware components are shipped directly to the customer and must be installed by a factory trained installer. Invoices for the door will be separate from the hardware invoice. The hardware invoice will include the concealed vertical assembly and the trim components.

FE6600 Series Multi-Point Locks



USA & Canada Prices Effective April 17, 2023

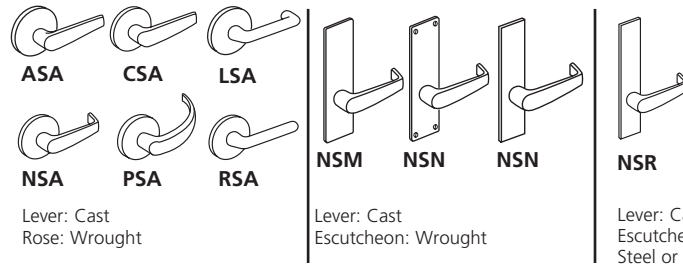

Available Functions	Description	Levers: AS, CS, ES, LS, NS, PS, RS Roses: A, G		Levers: AS, CS, ES, LS, NS, PS, RS Escutcheons: M, N, LW1		Levers: AS, CS, ES, LS, NS, PS, RS Escutcheons: RE1/RE2, RE3/RE4	
		613E, 626, BSP, WSP	605, 606, 611, 612, 613, 618, 619, 625, 629, 630, 722	613E, 626, BSP, WSP	605, 606, 611, 612, 613, 618, 619, 625, 629, 630, 722	613E, 626, BSP, WSP	605, 606, 611, 612, 613, 618, 619, 625, 629, 630, 722
Single Cylinder with Deadbolt							
FE6618 FE6624 FE6665	Classroom Storeroom Exit/Dormitory	\$4,848.00	\$4,872.00	\$4,868.00	\$4,892.00	\$4,922.00	\$4,946.00
Non-Keyed							
FE6680 FE6630 FE6620	Inside Passage Privacy Bath Privacy Bedroom	\$4,848.00	\$4,872.00	\$4,868.00	\$4,892.00	\$4,922.00	\$4,946.00
Double Cylinder with Deadbolt							
FE6622 FE6662 FE6672 FE6673 FE6675	Store Door Classroom Security Intruder Deadbolt Classroom Security Intruder Aux. Deadbolt Classroom Security Intruder Deadlatch Security Deadbolt	\$4,848.00	\$4,872.00	\$4,868.00	\$4,892.00	\$4,922.00	\$4,946.00
EAC							
FE66609 x NAC SAF / SEC	No Key Override With Deadbolt Fail Safe/Secure 12V/24V	\$5,316.00	\$5,340.00	\$5,336.00	\$5,360.00	\$5,390.00	\$5,414.00
FE66608 x NAC SAF / SEC	Key Override With Deadbolt Fail Safe/Secure 12V/24V	\$5,501.00	\$5,525.00	\$5,521.00	\$5,545.00	\$5,575.00	\$5,599.00

FE6600 Series Multi-Point Locks

USA & Canada Prices Effective April 17, 2023

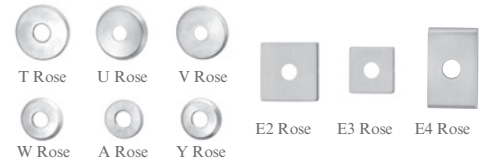
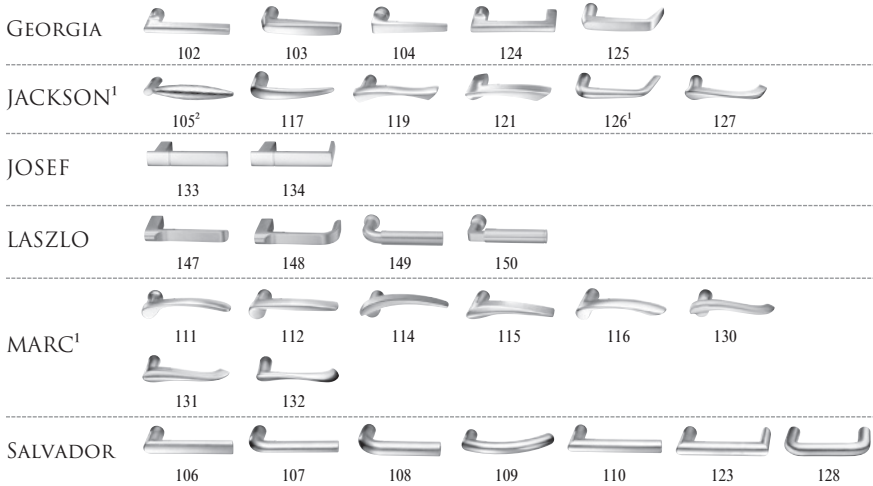

ESCUTCHEONS



THUMBTURNS³



1. Handed: specify hand when ordering
2. Contact factory for current lead time
3. Specify thumbturn as quick code. Thumbturn backplate will match shape of rose chosen (i.e. round or square). Not available with escutcheons.

*629 and *630 finish options are Not available for all Muséo levers. Please refer to page 26 for availability.

613E	Dark Oxidized Satin Bronze	- Equivalent	605	Bright Brass, Clear Coated	618	Bright Nickel Plated
626	Satin Chromium Plated		606	Satin Brass, Clear Coated	619	Satin Nickel Plated
BSP	Black Suede Powder Coat		611	Bright Bronze, Clear Coated	625	Bright Chromium Plated
WSP	White Suede Powder Coat		612	Satin Bronze, Clear Coated	629*	Bright Stainless Steel
			613	Dark Oxidized Satin Bronze, Oil Rubbed	630*	Satin Stainless Steel
			613L	Dark Oxidized Satin Bronze, Clear Coated	722	Black Oxidized Bronze, Oil Rubbed

Functions	Description		
Single Cylinder with Deadbolt ESCUTCHEONS L, CE, RE1			
FE6618 FE6624 FE6665	Classroom Storeroom Exit/Dormitory	\$4,898.00	\$4,922.00
Non-Keyed ESCUTCHEONS L, CE, RE1			
FE6680 FE6630 FE6620	Inside Passage Privacy Bath Privacy Bedroom	\$4,898.00	\$4,922.00
Double Cylinder with Deadbolt ESCUTCHEONS L, CE, RE1			
FE6622 FE6662 FE6672 FE6673 FE6675	Store Door Classroom Security Intruder Deadbolt Classroom Security Intruder Aux. Deadbolt Classroom Security Intruder Deadlatch Security Deadbolt	\$4,898.00	\$4,922.00
EAC ESCUTCHEONS L, CE, RE1			
FE66609 x NAC SAF / SEC	No Key Override With Deadbolt Fail Safe/Secure 12V/24V	\$5,366.00	\$5,390.00
FE66608 x NAC SAF / SEC	Key Override With Deadbolt Fail Safe/Secure 12V/24V	\$5,551.00	\$5,575.00

FE6600 Series Multi-Point Locks

USA & Canada Prices Effective April 17, 2023

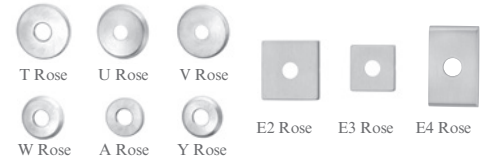
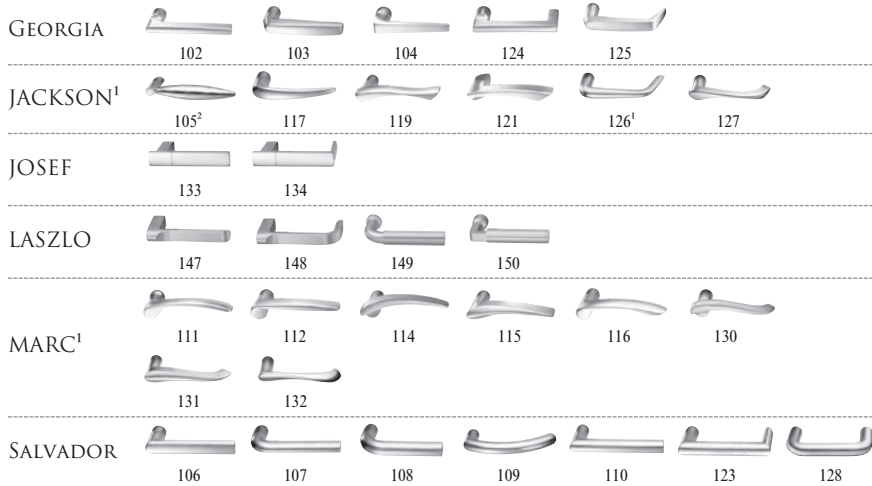

ESCUTCHEONS



THUMBTURNS³



1. Handed: specify hand when ordering
2. Contact factory for current lead time
3. Specify thumbturn as quick code. Thumbturn backplate will match shape of rose chosen (i.e. round or square). Not available with escutcheons.

*629 and *630 finish options are Not available for all Muséo levers. Please refer to page 26 for availability.

613E Dark Oxidized Satin Bronze - Equivalent	605 Bright Brass, Clear Coated	618 Bright Nickel Plated
626 Satin Chromium Plated	606 Satin Brass, Clear Coated	619 Satin Nickel Plated
BSP Black Suede Powder Coat	611 Bright Bronze, Clear Coated	625 Bright Chromium Plated
WSP White Suede Powder Coat	612 Satin Bronze, Clear Coated	629* Bright Stainless Steel
	613 Dark Oxidized Satin Bronze, Oil Rubbed	630* Satin Stainless Steel
	613L Dark Oxidized Satin Bronze, Clear Coated	722 Black Oxidized Bronze, Oil Rubbed

Functions	Description		
Single Cylinder with Deadbolt ROSES: A, T, U, V, W, Y, E2, E3, E4			
FE6618 FE6624 FE6665	Classroom Storeroom Exit/Dormitory	\$4,848.00	\$4,872.00
Non-Keyed ROSES: A, T, U, V, W, Y, E2, E3, E4			
FE6680 FE6630 FE6620	Inside Passage Privacy Bath Privacy Bedroom	\$4,848.00	\$4,872.00
Double Cylinder with Deadbolt ROSES: A, T, U, V, W, Y, E2, E3, E4			
FE6622 FE6662 FE6672 FE6673 FE6675	Store Door Classroom Security Intruder Deadbolt Classroom Security Intruder Aux. Deadbolt Classroom Security Intruder Deadlatch Security Deadbolt	\$4,848.00	\$4,872.00
EAC ROSES: A, T, U, V, W, Y, E2, E3, E4			
FE66609 x NAC SAF / SEC	No Key Override With Deadbolt Fail Safe/Secure 12V/24V	\$5,316.00	\$5,340.00
FE66608 x NAC SAF / SEC	Key Override With Deadbolt Fail Safe/Secure 12V/24V	\$5,501.00	\$5,525.00

FE6600 Series Multi-Point Locks

USA & Canada Prices Effective April 17, 2023

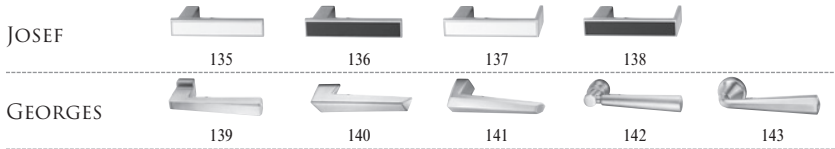

ROSES

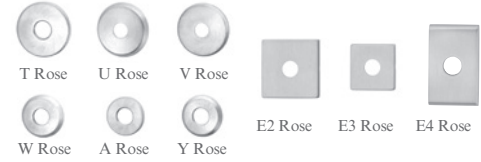

ESCUTCHEONS



THUMBTURNS³



1. Handed: specify hand when ordering
2. Contact factory for current lead time
3. Specify thumbturn as quick code. Thumbturn backplate will match shape of rose chosen (i.e. round or square). Not available with escutcheons.

613E	Dark Oxidized Satin Bronze	- Equivalent	605	Bright Brass, Clear Coated	618	Bright Nickel Plated
626	Satin Chromium Plated		606	Satin Brass, Clear Coated	619	Satin Nickel Plated
BSP	Black Suede Powder Coat		611	Bright Bronze, Clear Coated	625	Bright Chromium Plated
WSP	White Suede Powder Coat		612	Satin Bronze, Clear Coated	629	Bright Stainless Steel
			613	Dark Oxidized Satin Bronze, Oil Rubbed	630	Satin Stainless Steel
			613L	Dark Oxidized Satin Bronze, Clear Coated	722	Black Oxidized Bronze, Oil Rubbed

Functions	Description		
Single Cylinder with Deadbolt ESCUTCHEONS L, CE, RE1			
FE6618	Classroom	\$5,012.00	\$5,036.00
FE6624	Storeroom		
FE6665	Exit/Dormitory		
Non-Keyed ESCUTCHEONS L, CE, RE1			
FE6680	Inside Passage	\$5,012.00	\$5,036.00
FE6630	Privacy Bath		
FE6620	Privacy Bedroom		
Double Cylinder with Deadbolt ESCUTCHEONS L, CE, RE1			
FE6622	Store Door	\$5,012.00	\$5,036.00
FE6662	Classroom Security Intruder Deadbolt		
FE6672	Classroom Security Intruder Aux. Deadbolt		
FE6673	Classroom Security Intruder Deadlatch		
FE6675	Security Deadbolt		
EAC ESCUTCHEONS L, CE, RE1			
FE66609 x NAC SAF / SEC	No Key Override With Deadbolt Fail Safe/Secure 12V/24V	\$5,480.00	\$5,504.00
FE66608 x NAC SAF / SEC	Key Override With Deadbolt Fail Safe/Secure 12V/24V	\$5,665.00	\$5,689.00

FE6600 Series Multi-Point Locks



USA & Canada Prices Effective April 17, 2023

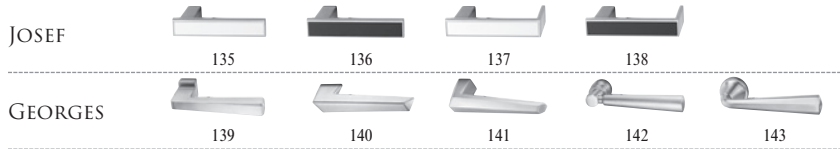

ROSES

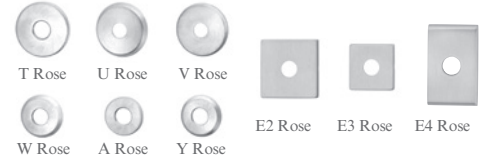

ESCUTCHEONS



THUMBTURNS³



1. Handed: specify hand when ordering
2. Contact factory for current lead time
3. Specify thumbturn as quick code. Thumbturn backplate will match shape of rose chosen (i.e. round or square). Not available with escutcheons.

613E	Dark Oxidized Satin Bronze	605	Bright Brass, Clear Coated	618	Bright Nickel Plated
	- Equivalent	606	Satin Brass, Clear Coated	619	Satin Nickel Plated
626	Satin Chromium Plated	611	Bright Bronze, Clear Coated	625	Bright Chromium Plated
BSP	Black Suede Powder Coat	612	Satin Bronze, Clear Coated	629	Bright Stainless Steel
WSP	White Suede Powder Coat	613	Dark Oxidized Satin Bronze, Oil Rubbed	630	Satin Stainless Steel
		613L	Dark Oxidized Satin Bronze, Clear Coated	722	Black Oxidized Bronze, Oil Rubbed

Functions	Description		
Single Cylinder with Deadbolt ROSES: A, T, U, V, W, Y, E2, E3, E4			
FE6618	Classroom		
FE6624	Storeroom	\$4,962.00	\$4,986.00
FE6665	Exit/Dormitory		
Non-Keyed ROSES: A, T, U, V, W, Y, E2, E3, E4			
FE6680	Inside Passage		
FE6630	Privacy Bath	\$4,962.00	\$4,986.00
FE6620	Privacy Bedroom		
Double Cylinder with Deadbolt ROSES: A, T, U, V, W, Y, E2, E3, E4			
FE6622	Store Door		
FE6662	Classroom Security Intruder Deadbolt	\$4,962.00	\$4,986.00
FE6672	Classroom Security Intruder Aux. Deadbolt		
FE6673	Classroom Security Intruder Deadlatch		
FE6675	Security Deadbolt		
EAC ROSES: A, T, U, V, W, Y, E2, E3, E4			
FE66609 x NAC SAF / SEC	No Key Override With Deadbolt Fail Safe/Secure 12V/24V	\$5,430.00	\$5,454.00
FE66608 x NAC SAF / SEC	Key Override With Deadbolt Fail Safe/Secure 12V/24V	\$5,615.00	\$5,639.00

FE6600 Series Multi-Point Locks

USA & Canada Prices Effective April 17, 2023



*613E, BSP, WSP finishes are not available with 21M levers.

ROSES



ESCUTCHEONS

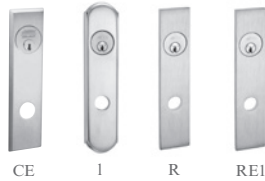

THUMBTURNS



Specify thumbturn as quick code. Thumbturn backplate will match shape of rose chosen (i.e. round or square)

613E Dark Oxidized Satin Bronze – Equivalent
629 Bright Stainless Steel
630 Satin Stainless Steel
BSP Black Suede Powder Coat
WSP White Suede Powder Coat

Functions	Description	
Single Cylinder with Deadbolt ESCUTCHEONS L, CE, RE1		
FE6618 FE6624 FE6665	Classroom Storeroom Exit/Dormitory	\$5,010.00
Non-Keyed ESCUTCHEONS L, CE, RE1		
FE6680 FE6630 FE6620	Inside Passage Privacy Bath Privacy Bedroom	\$5,010.00
Double Cylinder with Deadbolt ESCUTCHEONS L, CE, RE1		
FE6622 FE6662 FE6672 FE6673 FE6675	Store Door Classroom Security Intruder Deadbolt Classroom Security Intruder Aux. Deadbolt Classroom Security Intruder Deadlatch Security Deadbolt	\$5,010.00
EAC ESCUTCHEONS L, CE, RE1		
FE66609 x NAC SAF / SEC	No Key Override With Deadbolt Fail Safe/Secure 12V/24V	\$5,478.00
FE66608 x NAC SAF / SEC	Key Override With Deadbolt Fail Safe/Secure 12V/24V	\$5,663.00

FE6600 Series Multi-Point Locks

USA & Canada Prices Effective April 17, 2023



*613E, BSP, WSP finishes are not available with 21M levers.

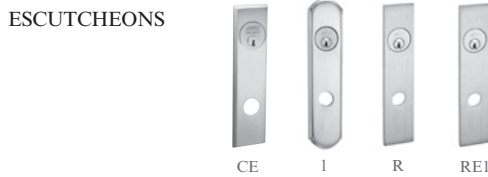
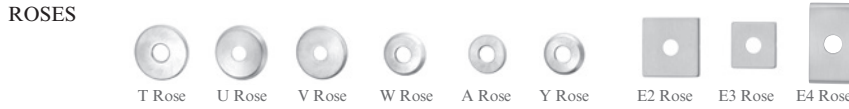

Specify thumbturn as quick code. Thumbturn backplate will match shape of rose chosen (i.e. round or square)

613E	Dark Oxidized Satin Bronze – Equivalent
629	Bright Stainless Steel
630	Satin Stainless Steel
BSP	Black Suede Powder Coat
WSP	White Suede Powder Coat

Functions	Description	
Single Cylinder with Deadbolt ROSES: A, T, U, V, W, Y, E2, E3, E4		
FE6618 FE6624 FE6665	Classroom Storeroom Exit/Dormitory	\$4,960.00
Non-Keyed ROSES: A, T, U, V, W, Y, E2, E3, E4		
FE6680 FE6630 FE6620	Inside Passage Privacy Bath Privacy Bedroom	\$4,960.00
Double Cylinder with Deadbolt ROSES: A, T, U, V, W, Y, E2, E3, E4		
FE6622 FE6662 FE6672 FE6673 FE6675	Store Door Classroom Security Intruder Deadbolt Classroom Security Intruder Aux. Deadbolt Classroom Security Intruder Deadlatch Security Deadbolt	\$4,960.00
EAC ROSES: A, T, U, V, W, Y, E2, E3, E4		
FE66609 x NAC SAF / SEC	No Key Override With Deadbolt Fail Safe/Secure 12V/24V	\$5,428.00
FE66608 x NAC SAF / SEC	Key Override With Deadbolt Fail Safe/Secure 12V/24V	\$5,613.00

FE6600 Series Multi-Point Locks

USA & Canada Prices Effective April 17, 2023

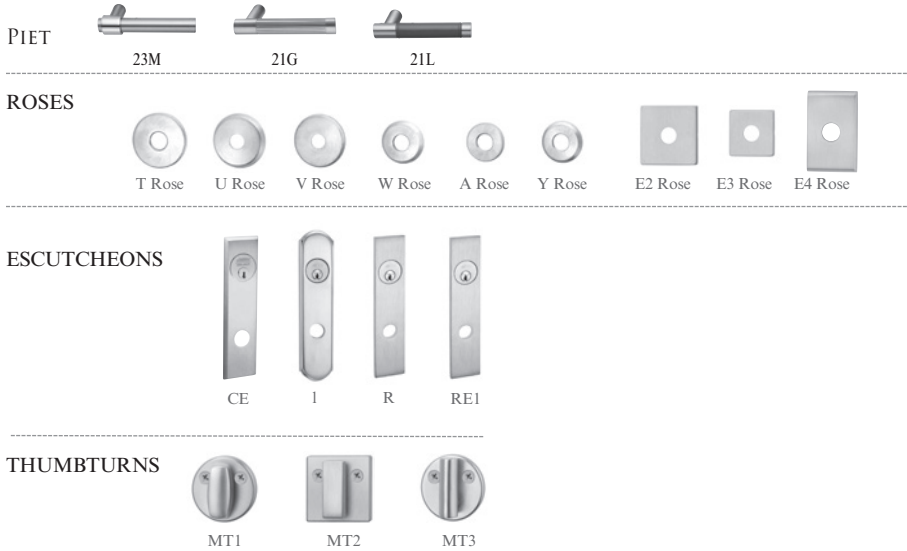

Specify thumbturn as quick code. Thumbturn backplate will match shape of rose chosen (i.e. round or square)

613E	Dark Oxidized Satin Bronze – Equivalent
629	Bright Stainless Steel
630	Satin Stainless Steel
BSP	Black Suede Powder Coat
WSP	White Suede Powder Coat

Functions	Description	
Single Cylinder with Deadbolt ESCUTCHEONS L, CE, RE1		
FE6618 FE6624 FE6665	Classroom Storeroom Exit/Dormitory	\$5,036.00
Non-Keyed ESCUTCHEONS L, CE, RE1		
FE6680 FE6630 FE6620	Inside Passage Privacy Bath Privacy Bedroom	\$5,036.00
Double Cylinder with Deadbolt ESCUTCHEONS L, CE, RE1		
FE6622 FE6662 FE6672 FE6673 FE6675	Store Door Classroom Security Intruder Deadbolt Classroom Security Intruder Aux. Deadbolt Classroom Security Intruder Deadlatch Security Deadbolt	\$5,036.00
EAC ESCUTCHEONS L, CE, RE1		
FE66609 x NAC SAF / SEC	No Key Override With Deadbolt Fail Safe/Secure 12V/24V	\$5,504.00
FE66608 x NAC SAF / SEC	Key Override With Deadbolt Fail Safe/Secure 12V/24V	\$5,689.00

FE6600 Series Multi-Point Locks

USA & Canada Prices Effective April 17, 2023

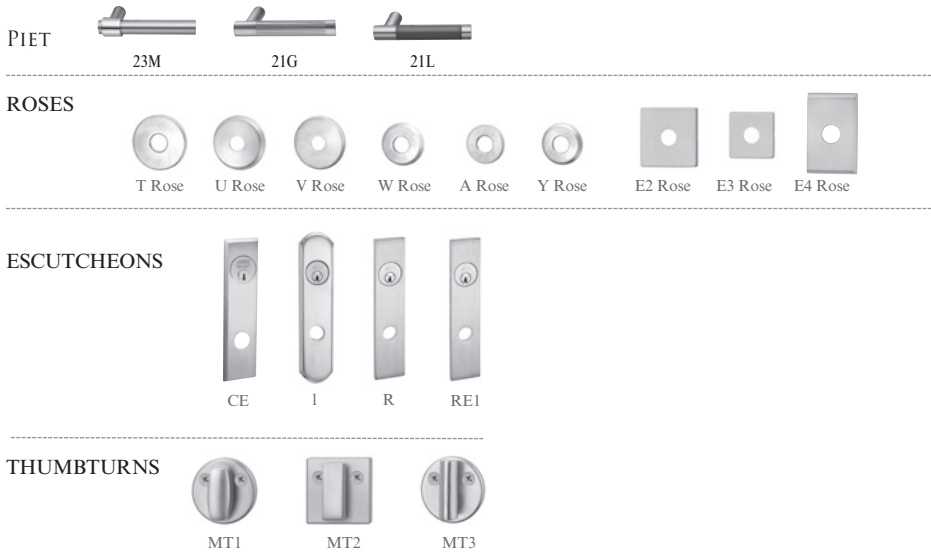

Specify thumbturn as quick code. Thumbturn backplate will match shape of rose chosen (i.e. round or square)

613E	Dark Oxidized Satin Bronze – Equivalent
629	Bright Stainless Steel
630	Satin Stainless Steel
BSP	Black Suede Powder Coat
WSP	White Suede Powder Coat

Functions	Description	
Single Cylinder with Deadbolt ROSES: A, T, U, V, W, Y, E2, E3, E4		
FE6618 FE6624 FE6665	Classroom Storeroom Exit/Dormitory	\$4,986.00
Non-Keyed ROSES: A, T, U, V, W, Y, E2, E3, E4		
FE6680 FE6630 FE6620	Inside Passage Privacy Bath Privacy Bedroom	\$4,986.00
Double Cylinder with Deadbolt ROSES: A, T, U, V, W, Y, E2, E3, E4		
FE6622 FE6662 FE6672 FE6673 FE6675	Store Door Classroom Security Intruder Deadbolt Classroom Security Intruder Aux. Deadbolt Classroom Security Intruder Deadlatch Security Deadbolt	\$4,986.00
ROSES: A, T, U, V, W, Y, E2, E3, E4		
FE66609 x NAC SAF / SEC	No Key Override With Deadbolt Fail Safe/Secure 12V/24V	\$5,454.00
FE66608 x NAC SAF / SEC	Key Override With Deadbolt Fail Safe/Secure 12V/24V	\$5,639.00

FE6600 Series Multi-Point Locks



USA & Canada Prices Effective April 17, 2023

Cylinder Options		
Description	Specify Quick Code	Add or Deduct
Conventional 6-pin	(standard)	No Charge
Conventional 7-pin	7P	Add \$2.00 per cylinder
Less Standard Cylinder	LC	Deduct \$120.00 per cylinder
Less Concealed Shell Cylinder	PO-LC	Add \$5.00 per lockset
LFIC		
LFIC 6-pin	C6	Add \$104.00 per cylinder
LFIC 6-pin Less Core	CL6	No Charge
LFIC 6-pin with Temporary Construction Core (Red)	CT6R	Add \$104.00 per cylinder
LFIC 6-pin with Temporary Construction Core (Blue)	CT6B	Add \$104.00 per cylinder
LFIC 6-pin with Temporary Construction Core (Green)	CT6G	Add \$104.00 per cylinder
LFIC 6-pin with Temporary Disposable Core	CT6D	No Charge
LFIC 7-pin	C7	Add \$106.00 per cylinder
LFIC 7-pin Less Core	CL7	Add \$2.00 per cylinder
LFIC 7-pin with Temporary Construction Core (Red)	CT7R	Add \$106.00 per cylinder
LFIC 7-pin with Temporary Construction Core (Blue)	CT7B	Add \$106.00 per cylinder
LFIC 7-pin with Temporary Construction Core (Green)	CT7G	Add \$106.00 per cylinder
LFIC 7-pin with Temporary Disposable Core	CT7D	Add \$2.00 per cylinder
SFIC		
SFIC 6-pin	C6S	Add \$93.00 per cylinder
SFIC 6-pin with Temporary Construction Core (Blue)	CT6SB	Add \$93.00 per cylinder
SFIC 6-pin with SFIC disposable temporary core	CT6SD	No Charge
SFIC 6-pin with Less Core	CLS6	No Charge
SFIC 7-pin	C7S	Add \$93.00 per cylinder
SFIC 7-pin with Temporary Construction Core (Blue)	CT7SB	Add \$93.00 per cylinder
SFIC 7-pin with SFIC disposable temporary core	CT7SD	No Charge
SFIC 7-pin with Less Core	CLS7	No Charge
Security		
Security ⁴	HS	Add \$158.00 per cylinder
Security LFIC ^{1,4}	CHS	Add \$258.00 per cylinder
Access 3		
Access 3 Patented	AP	No Charge
Access 3 Security	AS	Add \$78.00 per cylinder
Access 3 High Security, UL 437	AHS	Add \$111.00 per cylinder
Access 3 LFIC Patented	ACP	Add \$104.00 per cylinder
Access 3 LFIC Security	ACS	Add \$182.00 per cylinder
Access 3 LFIC High Security, UL 437	ACHS	Add \$215.00 per cylinder
Pyramid		
Pyramid Security Fixed Core	PS	Add \$84.00 per cylinder
Pyramid Security LFIC	PCS	Add \$181.00 per cylinder
Pyramid High Security Fixed Core	PHS	Add \$125.00 per cylinder
Pyramid High Security LFIC	PCHS	Add \$223.00 per cylinder
Pyramid LFIC with Temporary Construction Core ³	CTP	Add \$104.00 per cylinder
Pyramid LFIC with Temporary Disposable Core ³	CTPD	No Charge
Pyramid LFIC Less Core	CLP	No Charge
Other		
Master Ring ²	MR	Add \$87.00 per cylinder
Flex Head Cylinder, 6-pin (sectional trim)	FX6	Add \$108.00 per cylinder
Flex Head Cylinder, 7-pin (sectional trim)	FX7	Add \$110.00 per cylinder
Flex Head Master Ring (sectional trim)	FXM	Add \$175.00 per cylinder
Plug only to show, 6-pin (concealed shell) (available for M and R escutcheons and single cylinder functions only)	P06	Add \$120.00 per lockset
Plug only to show, 7-pin (concealed shell) (available for M and R escutcheons and single cylinder functions only)	P07	Add \$122.00 per lockset

Notes:

1. CHS ordered with CT6 option no charge.
3. Refer to Key construction core program, pg. 63 for example of CTP option pricing.
4. For existing systems only.

Continued on next page

FE6600 Series Multi-Point Locks



USA & Canada Prices Effective April 17, 2023

Cylinder Options (continued) & Keying Options*		
Description	Specify Quick Code	Add or Deduct
Keying and Keys		
0-bitted with 2 Blank Keys	(standard)	No Charge
Keyed Random	KR	
Construction Master Keyed ²	CMK	Add \$16.00 per cylinder
More than 2 Keys	KY# (e.g., KY6)	See page 33 - Cut Keys Section
Master Keying		
Master keyed (all cylinders except CR8000, CR8020, CR8027, CR8200, CR8500, CR8600, CR8700)	MK	Add \$16.00 per cylinder
Master keyed Pyramid (except CR8020, CR8027 LFIC cores)	MK	
Master keyed Security (including LFIC cylinder and core)	MK	
Master keyed Access 3 (except CR8500, CR8600, CR8700 LFIC cores)	MK	
Master keyed (CR8000, CR8020, CR8027, CR8200, CR8500, CR8600, CR8700)	MK-IC	No Charge
Master keyed to customer bittings or sample key	MK-CB	Add \$16.00 per cylinder
Visual Key Control (VKC)		
No bitting or keyset stamping on keys	VKC0	\$4.50
Keys only	VKC1	No Charge
Cylinders and keys (not for AS, AHS, ACS, ACHS, HS, CHS, PHS or PCHS)	VKC2	\$8.00
Cylinders only (not for AS, AHS, HS, ACS, ACHS, CHS, PHS or PCHS)	VKC3	
Concealed Key Control (CKC)		
CKC cylinders with VKC keys	CKC2	\$8.00
CKC cylinders only (not for AS, AHS, ACS, ACHS, PHS, PCHS)	CKC3	

Notes:

1. CMK Construction master keying charge is in addition to master keying charge.
2. CMK Construction master keying is not available in interchangeable core, Access 3, Pyramid, or Security series.
3. VKC2, VKC3, CKC3 are not available in Pyramid or Security series.
4. Pyramid series is not available keyed random.
5. Security series is not available 0-bitted.

Strike Options*

Lip Length	ANSI Straight Lip - Specify Quick Code	ANSI Curved Lip - Specify Quick Code	Add or Deduct
7/8"	SS078	N/A	No Charge

* If door thickness is standard or has been specified and no special door or frame condition exist, then only the first two characters of the optional strike Quick Code must be specified (e.g. "SA").

The correct lip length will be determined by our order entry system based on the standard or specified door thickness.

**FE6600 Series
Multi-Point Locks**

USA & Canada Prices Effective April 17, 2023

Door Thickness with Locksets Mortised on Center

Door Thickness	Sectional Rose Trim Specify Quick Code	Escutcheon ^{1,2} Trim Specify Quick Code	Add or Deduct
1-3/4" (standard)	—	—	No Charge

Options

Description	Specify Quick Code	Add or Deduct
Split designs and split finishes	Outside Trim x Inside Trim	Higher set price prevails
Spanner head screws	M02	Add \$28.00 per lockset
Torx® head screws (n/a with N escutcheon)	M04	Add \$34.00 per lockset
Single Occupancy Indicator - Secure/Unsecure (Outside)	M19S*	Add \$175.00 per lockset
Single Occupancy Indicator - Vacant/Occupied (Outside)	M19V*	Add \$175.00 per lockset
Double Occupancy Indicator - Secure/Unsecure (Outside) Secure/Unsecure (Inside)	M19SN*	Add \$350.00 per lockset
Double Indicator Vacant/Occupied (Outside) Secure/Unsecure (Inside)	M19VN*	Add \$350.00 per lockset
Knurling outside and inside	M20**	Add \$196.00 per lockset
Knurling outside only	M21**	Add \$98.00 per lockset
Knurling inside only	M22**	Add \$98.00 per lockset
Abrasive coat outside and inside	M23 ¹	Add \$124.00 per lockset
Abrasive coat inside only	M24 ¹	Add \$62.00 per lockset
Abrasive coat outside only	M25 ¹	Add \$62.00 per lockset

** All levers provided in a powder coat finish will be supplied with an abrasive coating.

Thumbturn Options

Specify door thickness	Specify Quick Code	Add or Deduct
Ergonomic	M34 ²	Add \$20.00 per TT
Decorative	MT1	No Charge
Decorative square	MT2	No Charge
Decorative cylinder	MT3	No Charge



MT1



MT2



MT3

Notes:

1. Not available with Vineyard™ or Muséo® levers.
2. M34 is not available with M19N, M19VN or M19SN.

Note: Thumbturn backplate will match shape of rose chosen (i.e. round or square)

Strike Options

Part Number	Description
726F577	Top Strike Pack
726F587	Bottom Strike Pack
726F607	Center Strike Pack

Dogging Indicator Kit

AUX188 x FIN -Dogging Indicator kit if ordered separately.

**Price
\$673.00**

BL6600 Series

Series Multi-Point Locks

USA & Canada Prices Effective April 17, 2023

Door	1-3/4" thick door only – BL6600 Series requires utilizing Ceco Door and Curries Multi-Solution Opening doors and frames. McKINNEY® StormPro® hinges
Mounting	Supplied fasteners are for metal doors with thru-bolts for trim
Hand	Handed; specify RHR, LHR, RH or LH
Lockbody	Unique mortise lockbody assembly used specifically for blast applications
Top Bolt	Adjustable stainless steel 3/4" square bolt with 11/16" engagement; 5/16" steel reinforcement plate
Bottom Bolt	Adjustable stainless steel 3/4" square bolt with 5/8" engagement; 1/4" steel reinforcement plate
Center Bolts	Latchbolt is stainless steel with 3/4" projection. One piece, anti-friction reversible catch. Deadbolt is one piece hardened stainless steel with 1" projection
Lock Front	1/8" steel mortise front reinforced with 13/64" thick lock edge stiffener
Center Bolt Strike	1/4" thick stainless steel
Backset	Lever: 2-3/4" standard; Rods: 5-1/4"
Door Thickness	1-3/4" standard
Maximum Opening	Single door 2'8" x 6'8" up to 4'0" x 8'0" (only available as single door)
UL Fire Listed	UL 3-hour fire rating
Trim	Multiple sectional and escutcheon mortise trim with Standard or Muséo levers
Cylinder	Multiple mortise cylinders

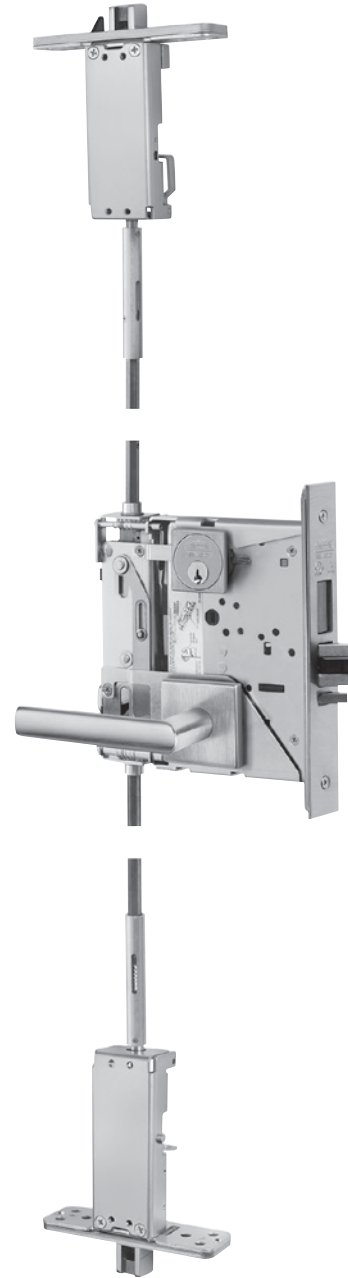

How to Order

Ordering Example

Quantity	Series/ Function	Trim	Finish	Hand
100	BL6618	ASM	626	RHR

Note: Concealed vertical rods, top & bottom latches, and the lockbody cassette will be factory installed. All other hardware components are shipped directly to the customer and must be installed by a factory trained installer. Invoices for the door will be separate from the hardware invoice. The hardware invoice will include the concealed vertical assembly and the trim components.

BL6600 Series Multi-Point Locks



USA & Canada Prices Effective April 17, 2023

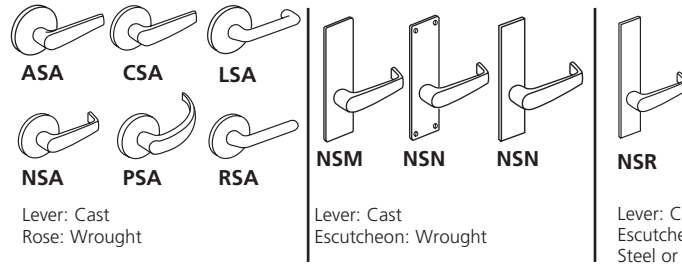

Available Functions	Description	Levers: AS, CS, ES, LS, NS, PS, RS Roses: A, G		Levers: AS, CS, ES, LS, NS, PS, RS Escutcheons: M, N, LW1		Levers: AS, CS, ES, LS, NS, PS, RS Escutcheons: RE1/RE2, RE3/RE4	
		613E, 626, BSP, WSP	605, 606, 611, 612, 613, 618, 619, 625, 629, 630, 722	613E, 626, BSP, WSP	605, 606, 611, 612, 613, 618, 619, 625, 629, 630, 722	613E, 626, BSP, WSP	605, 606, 611, 612, 613, 618, 619, 625, 629, 630, 722
Single Cylinder with Deadbolt							
BL6618 BL6624 BL6665	Classroom Storeroom Exit/Dormitory	\$5,351.00	\$5,375.00	\$5,371.00	\$5,395.00	\$5,425.00	\$5,449.00
Non-Keyed							
BL6680 BL6630 BL6620	Inside Passage Privacy Bath Privacy Bedroom	\$5,351.00	\$5,375.00	\$5,371.00	\$5,395.00	\$5,425.00	\$5,449.00
Double Cylinder with Deadbolt							
BL6622 BL6662 BL6672 BL6673 BL6675	Store Door Classroom Security Intruder Deadbolt Classroom Security Intruder Aux. Deadbolt Classroom Security Intruder Deadlatch Security Deadbolt	\$5,351.00	\$5,375.00	\$5,371.00	\$5,395.00	\$5,425.00	\$5,449.00
EAC							
BL66609 x NAC SAF / SEC	No Key Override With Deadbolt Fail Safe/Secure 12V/24V	\$5,819.00	\$5,843.00	\$5,839.00	\$5,863.00	\$5,893.00	\$5,917.00
BL66608 x NAC SAF / SEC	Key Override With Deadbolt Fail Safe/Secure 12V/24V	\$6,004.00	\$6,028.00	\$6,024.00	\$6,048.00	\$6,078.00	\$6,102.00

BL6600 Series Multi-Point Locks



USA & Canada Prices Effective April 17, 2023

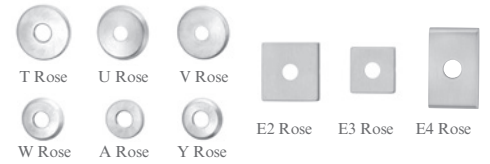
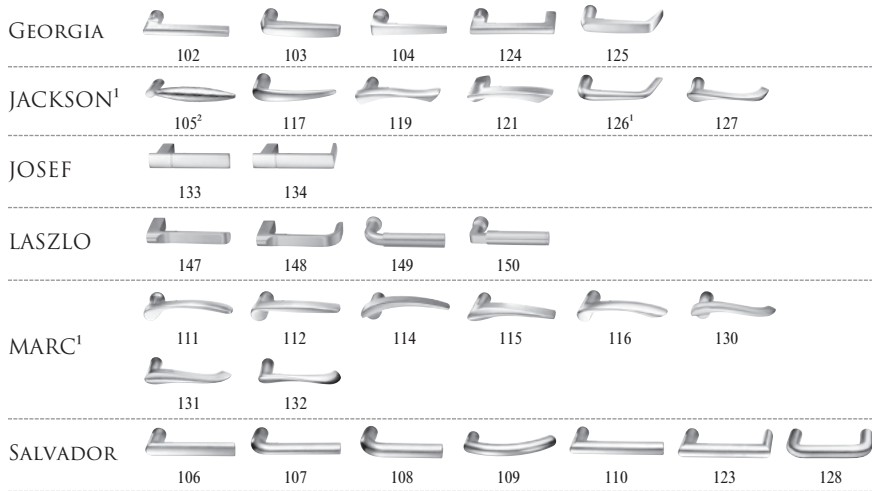

ESCUTCHEONS



THUMBTURNS³



1. Handed: specify hand when ordering
2. Contact factory for current lead time
3. Specify thumbturn as quick code. Thumbturn backplate will match shape of rose chosen (i.e. round or square). Not available with escutcheons.

*629 and *630 finish options are Not available for all Muséo levers. Please refer to page 26 for availability.

613E	Dark Oxidized Satin Bronze	605	Bright Brass, Clear Coated	618	Bright Nickel Plated
	- Equivalent	606	Satin Brass, Clear Coated	619	Satin Nickel Plated
626	Satin Chromium Plated	611	Bright Bronze, Clear Coated	625	Bright Chromium Plated
BSP	Black Suede Powder Coat	612	Satin Bronze, Clear Coated	629*	Bright Stainless Steel
WSP	White Suede Powder Coat	613	Dark Oxidized Satin Bronze, Oil Rubbed	630*	Satin Stainless Steel
		613L	Dark Oxidized Satin Bronze, Clear Coated	722	Black Oxidized Bronze, Oil Rubbed

Functions	Description		
Single Cylinder with Deadbolt ESCUTCHEONS: L, CE, RE1			
BL6618 BL6624 BL6665	Classroom Storeroom Exit/Dormitory	\$5,401.00	\$5,425.00
Non-Keyed ESCUTCHEONS: L, CE, RE1			
BL6680 BL6630 BL6620	Inside Passage Privacy Bath Privacy Bedroom	\$5,401.00	\$5,425.00
Double Cylinder with Deadbolt ESCUTCHEONS: L, CE, RE1			
BL6622 BL6662 BL6672 BL6673 BL6675	Store Door Classroom Security Intruder Deadbolt Classroom Security Intruder Aux. Deadbolt Classroom Security Intruder Deadlatch Security Deadbolt	\$5,401.00	\$5,425.00
EAC ESCUTCHEONS: L, CE, RE1			
BL66609 x NAC SAF / SEC	No Key Override With Deadbolt Fail Safe/Secure 12V/24V	\$5,869.00	\$5,893.00
BL66608 x NAC SAF / SEC	Key Override With Deadbolt Fail Safe/Secure 12V/24V	\$6,054.00	\$6,078.00

BL6600 Series Multi-Point Locks

USA & Canada Prices Effective April 17, 2023

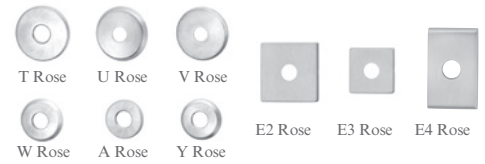
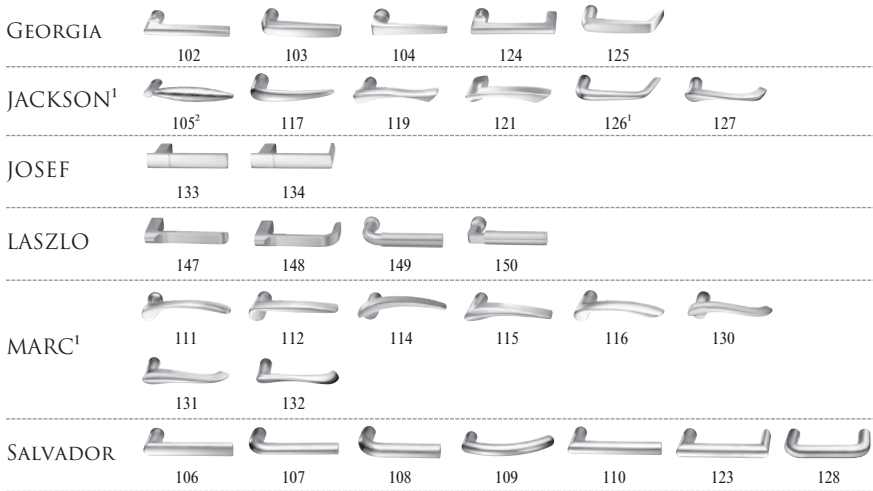

ESCUTCHEONS



THUMBTURNS³



1. Handed: specify hand when ordering
2. Contact factory for current lead time
3. Specify thumbturn as quick code. Thumbturn backplate will match shape of rose chosen (i.e. round or square). Not available with escutcheons.

*629 and *630 finish options are Not available for all Muséo levers. Please refer to page 26 for availability.

613E Dark Oxidized Satin Bronze - Equivalent	605 Bright Brass, Clear Coated	618 Bright Nickel Plated
626 Satin Chromium Plated	606 Satin Brass, Clear Coated	619 Satin Nickel Plated
BSP Black Suede Powder Coat	611 Bright Bronze, Clear Coated	625 Bright Chromium Plated
WSP White Suede Powder Coat	612 Satin Bronze, Clear Coated	629* Bright Stainless Steel
	613 Dark Oxidized Satin Bronze, Oil Rubbed	630* Satin Stainless Steel
	613L Dark Oxidized Satin Bronze, Clear Coated	722 Black Oxidized Bronze, Oil Rubbed

Functions	Description		
Single Cylinder with Deadbolt ROSES: A, T, U, V, W, Y, E2, E3, E4			
BL6618	Classroom	\$5,351.00	\$5,375.00
BL6624	Storeroom		
BL6665	Exit/Dormitory		
Non-Keyed ROSES: A, T, U, V, W, Y, E2, E3, E4			
BL6680	Inside Passage	\$5,351.00	\$5,375.00
BL6630	Privacy Bath		
BL6620	Privacy Bedroom		
Double Cylinder with Deadbolt ROSES: A, T, U, V, W, Y, E2, E3, E4			
BL6622	Store Door	\$5,351.00	\$5,375.00
BL6662	Classroom Security Intruder Deadbolt		
BL6672	Classroom Security Intruder Aux. Deadbolt		
BL6673	Classroom Security Intruder Deadlatch		
BL6675	Security Deadbolt		
EAC ROSES: A, T, U, V, W, Y, E2, E3, E4			
BL66609 x NAC SAF / SEC	No Key Override With Deadbolt Fail Safe/Secure 12V/24V	\$5,819.00	\$5,843.00
BL66608 x NAC SAF / SEC	Key Override With Deadbolt Fail Safe/Secure 12V/24V	\$6,004.00	\$6,028.00

BL6600 Series Multi-Point Locks



USA & Canada Prices Effective April 17, 2023

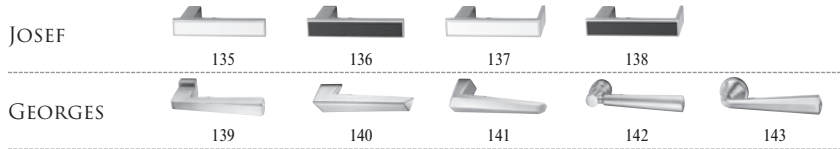

ROSES

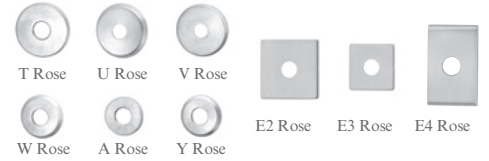

ESCUTCHEONS



THUMBTURNS³



1. Handed: specify hand when ordering
2. Contact factory for current lead time
3. Specify thumbturn as quick code. Thumbturn backplate will match shape of rose chosen (i.e. round or square). Not available with escutcheons.

613E	Dark Oxidized Satin Bronze	605	Bright Brass, Clear Coated	618	Bright Nickel Plated
606	Satin Brass, Clear Coated	606	Satin Brass, Clear Coated	619	Satin Nickel Plated
-	Equivalent	611	Bright Bronze, Clear Coated	625	Bright Chromium Plated
626	Satin Chromium Plated	612	Satin Bronze, Clear Coated	629	Bright Stainless Steel
BSP	Black Suede Powder Coat	613	Dark Oxidized Satin Bronze, Oil Rubbed	630	Satin Stainless Steel
WSP	White Suede Powder Coat	613L	Dark Oxidized Satin Bronze, Clear Coated	722	Black Oxidized Bronze, Oil Rubbed

Functions	Description		
Single Cylinder with Deadbolt ESCUTCHEONS: L, CE, RE1			
BL6618 BL6624 BL6665	Classroom Storeroom Exit/Dormitory	\$5,515.00	\$5,539.00
Non-Keyed ESCUTCHEONS: L, CE, RE1			
BL6680 BL6630 BL6620	Inside Passage Privacy Bath Privacy Bedroom	\$5,515.00	\$5,539.00
Double Cylinder with Deadbolt ESCUTCHEONS: L, CE, RE1			
BL6622 BL6662 BL6672 BL6673 BL6675	Store Door Classroom Security Intruder Deadbolt Classroom Security Intruder Aux. Deadbolt Classroom Security Intruder Deadlatch Security Deadbolt	\$5,515.00	\$5,539.00
EAC ESCUTCHEONS: L, CE, RE1			
BL66609 x NAC SAF / SEC	No Key Override With Deadbolt Fail Safe/Secure 12V/24V	\$5,983.00	\$6,007.00
BL66608 x NAC SAF / SEC	Key Override With Deadbolt Fail Safe/Secure 12V/24V	\$6,168.00	\$6,192.00

BL6600 Series Multi-Point Locks

USA & Canada Prices Effective April 17, 2023

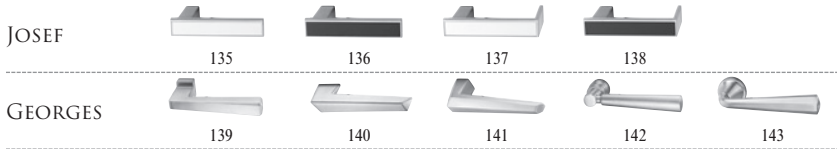

ROSES

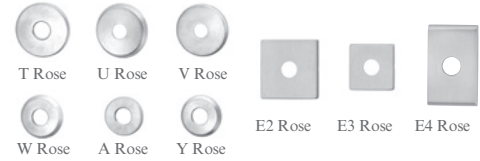

ESCUTCHEONS



THUMBTURNS³



1. Handed: specify hand when ordering
2. Contact factory for current lead time
3. Specify thumbturn as quick code. Thumbturn backplate will match shape of rose chosen (i.e. round or square). Not available with escutcheons.

613E	Dark Oxidized Satin Bronze	605	Bright Brass, Clear Coated	618	Bright Nickel Plated
626	Satin Chromium Plated	606	Satin Brass, Clear Coated	619	Satin Nickel Plated
BSP	Black Suede Powder Coat	611	Bright Bronze, Clear Coated	625	Bright Chromium Plated
WSP	White Suede Powder Coat	612	Satin Bronze, Clear Coated	629	Bright Stainless Steel
		613	Dark Oxidized Satin Bronze, Oil Rubbed	630	Satin Stainless Steel
		613L	Dark Oxidized Satin Bronze, Clear Coated	722	Black Oxidized Bronze, Oil Rubbed

Functions	Description		
Single Cylinder with Deadbolt ROSES: A, T, U, V, W, Y, E2, E3, E4			
BL6618 BL6624 BL6665	Classroom Storeroom Exit/Dormitory	\$5,465.00	\$5,489.00
Non-Keyed ROSES: A, T, U, V, W, Y, E2, E3, E4			
BL6680 BL6630 BL6620	Inside Passage Privacy Bath Privacy Bedroom	\$5,465.00	\$5,489.00
Double Cylinder with Deadbolt ROSES: A, T, U, V, W, Y, E2, E3, E4			
BL6622 BL6662 BL6672 BL6673 BL6675	Store Door Classroom Security Intruder Deadbolt Classroom Security Intruder Aux. Deadbolt Classroom Security Intruder Deadlatch Security Deadbolt	\$5,465.00	\$5,489.00
EAC ROSES: A, T, U, V, W, Y, E2, E3, E4			
BL66609 x NAC SAF / SEC	No Key Override With Deadbolt Fail Safe/Secure 12V/24V	\$5,933.00	\$5,957.00
BL66608 x NAC SAF / SEC	Key Override With Deadbolt Fail Safe/Secure 12V/24V	\$6,118.00	\$6,142.00

BL6600 Series Multi-Point Locks

USA & Canada Prices Effective April 17, 2023



*613E, BSP, WSP finishes are not available with 21M levers.

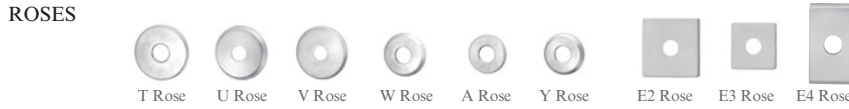

Specify thumbturn as quick code. Thumbturn backplate will match shape of rose chosen (i.e. round or square)

613E	Dark Oxidized Satin Bronze – Equivalent
629	Bright Stainless Steel
630	Satin Stainless Steel
BSP	Black Suede Powder Coat
WSP	White Suede Powder Coat

Functions	Description	
Single Cylinder with Deadbolt ESCUTCHEONS: L, CE, RE1		
BL6618 BL6624 BL6665	Classroom Storeroom Exit/Dormitory	\$5,513.00
Non-Keyed ESCUTCHEONS: L, CE, RE1		
BL6680 BL6630 BL6620	Inside Passage Privacy Bath Privacy Bedroom	\$5,513.00
Double Cylinder with Deadbolt ESCUTCHEONS: L, CE, RE1		
BL6622 BL6662 BL6672 BL6673 BL6675	Store Door Classroom Security Intruder Deadbolt Classroom Security Intruder Aux. Deadbolt Classroom Security Intruder Deadlatch Security Deadbolt	\$5,513.00
EAC ESCUTCHEONS: L, CE, RE1		
BL66609 x NAC SAF / SEC	No Key Override With Deadbolt Fail Safe/Secure 12V/24V	\$5,981.00
BL66608 x NAC SAF / SEC	Key Override With Deadbolt Fail Safe/Secure 12V/24V	\$6,166.00

BL6600 Series Multi-Point Locks

USA & Canada Prices Effective April 17, 2023



*613E, BSP, WSP finishes are not available with 21M levers.

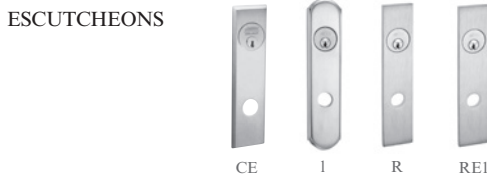

Specify thumbturn as quick code. Thumbturn backplate will match shape of rose chosen (i.e. round or square)

613E Dark Oxidized Satin Bronze – Equivalent
629 Bright Stainless Steel
630 Satin Stainless Steel
BSP Black Suede Powder Coat
WSP White Suede Powder Coat

Functions	Description	
Single Cylinder with Deadbolt ROSES: A, T, U, V, W, Y, E2, E3, E4		
BL6618 BL6624 BL6665	Classroom Storeroom Exit/Dormitory	\$5,463.00
Non-Keyed ROSES: A, T, U, V, W, Y, E2, E3, E4		
BL6680 BL6630 BL6620	Inside Passage Privacy Bath Privacy Bedroom	\$5,463.00
Double Cylinder with Deadbolt ROSES: A, T, U, V, W, Y, E2, E3, E4		
BL6622 BL6662 BL6672 BL6673 BL6675	Store Door Classroom Security Intruder Deadbolt Classroom Security Intruder Aux. Deadbolt Classroom Security Intruder Deadlatch Security Deadbolt	\$5,463.00
EAC ROSES: A, T, U, V, W, Y, E2, E3, E4		
BL66609 x NAC SAF / SEC	No Key Override With Deadbolt Fail Safe/Secure 12V/24V	\$5,931.00
BL66608 x NAC SAF / SEC	Key Override With Deadbolt Fail Safe/Secure 12V/24V	\$6,116.00

BL6600 Series Multi-Point Locks

USA & Canada Prices Effective April 17, 2023

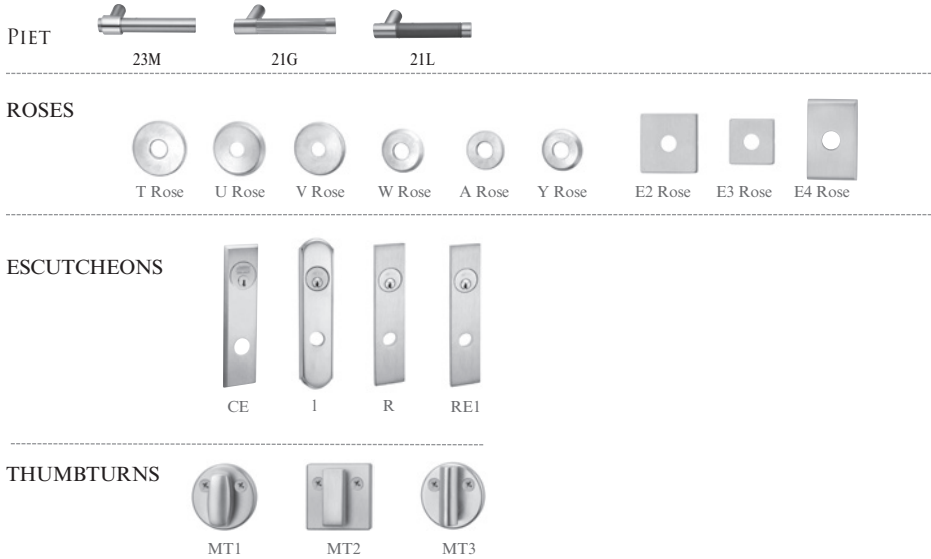

Specify thumbturn as quick code. Thumbturn backplate will match shape of rose chosen (i.e. round or square)

613E	Dark Oxidized Satin Bronze – Equivalent
629	Bright Stainless Steel
630	Satin Stainless Steel
BSP	Black Suede Powder Coat
WSP	White Suede Powder Coat

Functions	Description	
Single Cylinder with Deadbolt ESCUTCHEONS: L, CE, RE1		
BL6618 BL6624 BL6665	Classroom Storeroom Exit/Dormitory	\$5,539.00
Non-Keyed ESCUTCHEONS: L, CE, RE1		
BL6680 BL6630 BL6620	Inside Passage Privacy Bath Privacy Bedroom	\$5,539.00
Double Cylinder with Deadbolt ESCUTCHEONS: L, CE, RE1		
BL6622 BL6662 BL6672 BL6673 BL6675	Store Door Classroom Security Intruder Deadbolt Classroom Security Intruder Aux. Deadbolt Classroom Security Intruder Deadlatch Security Deadbolt	\$5,539.00
EAC ESCUTCHEONS: L, CE, RE1		
BL66609 x NAC SAF / SEC	No Key Override With Deadbolt Fail Safe/Secure 12V/24V	\$6,007.00
BL66608 x NAC SAF / SEC	Key Override With Deadbolt Fail Safe/Secure 12V/24V	\$6,192.00

BL6600 Series Multi-Point Locks

USA & Canada Prices Effective April 17, 2023

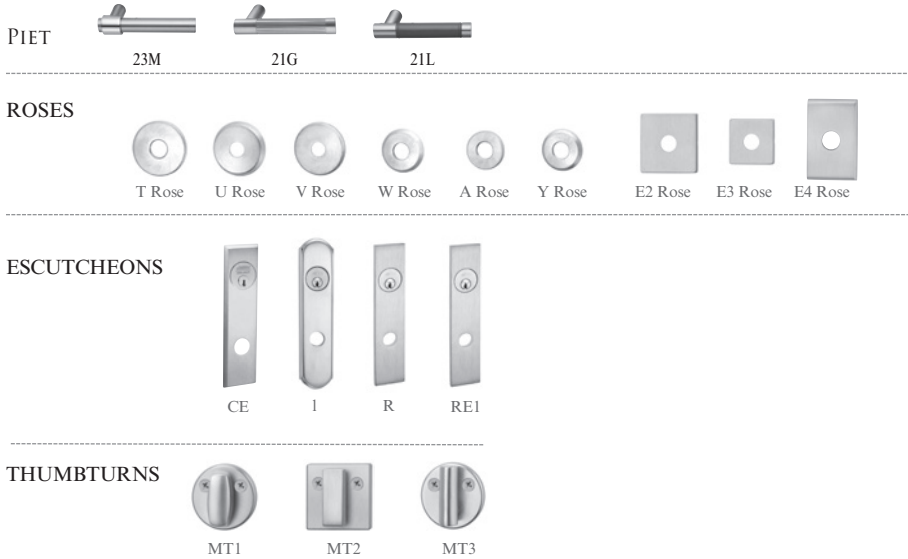

Specify thumbturn as quick code. Thumbturn backplate will match shape of rose chosen (i.e. round or square)

613E	Dark Oxidized Satin Bronze – Equivalent
629	Bright Stainless Steel
630	Satin Stainless Steel
BSP	Black Suede Powder Coat
WSP	White Suede Powder Coat

Functions	Description	
Single Cylinder with Deadbolt ROSES: A, T, U, V, W, Y, E2, E3, E4		
BL6618 BL6624 BL6665	Classroom Storeroom Exit/Dormitory	\$5,489.00
Non-Keyed ROSES: A, T, U, V, W, Y, E2, E3, E4		
BL6680 BL6630 BL6620	Inside Passage Privacy Bath Privacy Bedroom	\$5,489.00
Double Cylinder with Deadbolt ROSES: A, T, U, V, W, Y, E2, E3, E4		
BL6622 BL6662 BL6672 BL6673 BL6675	Store Door Classroom Security Intruder Deadbolt Classroom Security Intruder Aux. Deadbolt Classroom Security Intruder Deadlatch Security Deadbolt	\$5,489.00
EAC ROSES: A, T, U, V, W, Y, E2, E3, E4		
BL66609 x NAC SAF / SEC	No Key Override With Deadbolt Fail Safe/Secure 12V/24V	\$5,957.00
BL66608 x NAC SAF / SEC	Key Override With Deadbolt Fail Safe/Secure 12V/24V	\$6,142.00

BL6600 Series Multi-Point Locks



USA & Canada Prices Effective April 17, 2023

Cylinder Options		
Description	Specify Quick Code	Add or Deduct
Conventional 6-pin	(standard)	No Charge
Conventional 7-pin	7P	Add \$2.00 per cylinder
Less Standard Cylinder	LC	Deduct \$120.00 per cylinder
Less Concealed Shell Cylinder	PO-LC	Add \$5.00 per lockset
LFIC		
LFIC 6-pin	C6	Add \$104.00 per cylinder
LFIC 6-pin Less Core	CL6	No Charge
LFIC 6-pin with Temporary Construction Core (Red)	CT6R	Add \$104.00 per cylinder
LFIC 6-pin with Temporary Construction Core (Blue)	CT6B	Add \$104.00 per cylinder
LFIC 6-pin with Temporary Construction Core (Green)	CT6G	Add \$104.00 per cylinder
LFIC 6-pin with Temporary Disposable Core	CT6D	No Charge
LFIC 7-pin	C7	Add \$106.00 per cylinder
LFIC 7-pin Less Core	CL7	Add \$2.00 per cylinder
LFIC 7-pin with Temporary Construction Core (Red)	CT7R	Add \$106.00 per cylinder
LFIC 7-pin with Temporary Construction Core (Blue)	CT7B	Add \$106.00 per cylinder
LFIC 7-pin with Temporary Construction Core (Green)	CT7G	Add \$106.00 per cylinder
LFIC 7-pin with Temporary Disposable Core	CT7D	Add \$2.00 per cylinder
SFIC		
SFIC 6-pin	C6S	Add \$93.00 per cylinder
SFIC 6-pin with Temporary Construction Core (Blue)	CT6SB	Add \$93.00 per cylinder
SFIC 6-pin with SFIC disposable temporary core	CT6SD	No Charge
SFIC 6-pin with Less Core	CLS6	No Charge
SFIC 7-pin	C7S	Add \$93.00 per cylinder
SFIC 7-pin with Temporary Construction Core (Blue)	CT7SB	Add \$93.00 per cylinder
SFIC 7-pin with SFIC disposable temporary core	CT7SD	No Charge
SFIC 7-pin with Less Core	CLS7	No Charge
Security		
Security ⁴	HS	Add \$158.00 per cylinder
Security LFIC ^{1,4}	CHS	Add \$258.00 per cylinder
Access 3		
Access 3 Patented	AP	No Charge
Access 3 Security	AS	Add \$78.00 per cylinder
Access 3 High Security, UL 437	AHS	Add \$111.00 per cylinder
Access 3 LFIC Patented	ACP	Add \$104.00 per cylinder
Access 3 LFIC Security	ACS	Add \$182.00 per cylinder
Access 3 LFIC High Security, UL 437	ACHS	Add \$215.00 per cylinder
Pyramid		
Pyramid Security Fixed Core	PS	Add \$84.00 per cylinder
Pyramid Security LFIC	PCS	Add \$181.00 per cylinder
Pyramid High Security Fixed Core	PHS	Add \$125.00 per cylinder
Pyramid High Security LFIC	PCHS	Add \$223.00 per cylinder
Pyramid LFIC with Temporary Construction Core ³	CTP	Add \$104.00 per cylinder
Pyramid LFIC with Temporary Disposable Core ³	CTPD	No Charge
Pyramid LFIC Less Core	CLP	No Charge
Other		
Master Ring ²	MR	Add \$87.00 per cylinder
Flex Head Cylinder, 6-pin (sectional trim)	FX6	Add \$108.00 per cylinder
Flex Head Cylinder, 7-pin (sectional trim)	FX7	Add \$110.00 per cylinder
Flex Head Master Ring (sectional trim)	FXM	Add \$175.00 per cylinder
Plug only to show, 6-pin (concealed shell) (available for M and R escutcheons and single cylinder functions only)	P06	Add \$120.00 per lockset
Plug only to show, 7-pin (concealed shell) (available for M and R escutcheons and single cylinder functions only)	P07	Add \$122.00 per lockset

Notes:

1. CHS ordered with CT6 option no charge.
2. Refer to Key construction core program, pg. 63 for example of CTP option pricing.
3. For existing systems only.

Continued on next page

BL6600 Series Multi-Point Locks

USA & Canada Prices Effective April 17, 2023

Cylinder Options (continued) & Keying Options*

Description	Specify Quick Code	Add or Deduct
Keying and Keys		
0-bitted with 2 Blank Keys	(standard)	No Charge
Keyed Random	KR	
Construction Master Keyed ²	CMK	Add \$16.00 per cylinder
More than 2 Keys	KY# (e.g., KY6)	See page 33 - Cut Keys Section
Master Keying		
Master keyed (all cylinders except CR8000, CR8020, CR8027, CR8200, CR8500, CR8600, CR8700)	MK	Add \$16.00 per cylinder
Master keyed Pyramid (except CR8020, CR8027 LFIC cores)	MK	
Master keyed Security (including LFIC cylinder and core)	MK	
Master keyed Access 3 (except CR8500, CR8600, CR8700 LFIC cores)	MK	
Master keyed (CR8000, CR8020, CR8027, CR8200, CR8500, CR8600, CR8700)	MK-IC	No Charge
Master keyed to customer bittings or sample key	MK-CB	Add \$16.00 per cylinder
Visual Key Control (VKC)		
No bitting or keyset stamping on keys	VKC0	\$4.50
Keys only	VKC1	No Charge
Cylinders and keys (not for AS, AHS, ACS, ACHS, HS, CHS, PHS or PCHS)	VKC2	\$8.00
Cylinders only (not for AS, AHS, HS, ACS, ACHS, CHS, PHS or PCHS)	VKC3	
Concealed Key Control (CKC)		
CKC cylinders with VKC keys	CKC2	\$8.00
CKC cylinders only (not for AS, AHS, ACS, ACHS, PHS, PCHS)	CKC3	

Notes:

1. CMK Construction master keying charge is in addition to master keying charge.
2. CMK Construction master keying is not available in interchangeable core, Access 3, Pyramid, or Security series.
3. VKC2, VKC3, CKC3 are not available in Pyramid or Security series.
4. Pyramid series is not available keyed random.
5. Security series is not available 0-bitted.

Strike Options*

Lip Length	ANSI Straight Lip - Specify Quick Code	ANSI Curved Lip - Specify Quick Code	Add or Deduct
7/8"	SS078	N/A	No Charge

* If door thickness is standard or has been specified and no special door or frame condition exist, then only the first two characters of the optional strike Quick Code must be specified (e.g. "SA").

The correct lip length will be determined by our order entry system based on the standard or specified door thickness.

BL6600 Series Multi-Point Locks



USA & Canada Prices Effective April 17, 2023

Door Thickness with Locksets Mortised on Center

Door Thickness	Sectional Rose Trim Specify Quick Code	Escutcheon ^{1,2} Trim Specify Quick Code	Add or Deduct
1-3/4" (standard)	—	—	No Charge

Options

Description	Specify Quick Code	Add or Deduct
Split designs and split finishes	Outside Trim x Inside Trim	Higher set price prevails
Spanner head screws	M02	Add \$28.00 per lockset
Torx® head screws (n/a with N escutcheon)	M04	Add \$34.00 per lockset
Single Occupancy Indicator - Secure/Unsecure (Outside)	M19S*	Add \$175.00 per lockset
Single Occupancy Indicator - Vacant/Occupied (Outside)	M19V*	Add \$175.00 per lockset
Double Occupancy Indicator - Secure/Unsecure (Outside) Secure/Unsecure (Inside)	M19SN*	Add \$350.00 per lockset
Double Indicator Vacant/Occupied (Outside) Secure/Unsecure (Inside)	M19VN*	Add \$350.00 per lockset
Knurling outside and inside	M20**	Add \$196.00 per lockset
Knurling outside only	M21**	Add \$98.00 per lockset
Knurling inside only	M22**	Add \$98.00 per lockset
Abrasive coat outside and inside	M23 ¹	Add \$124.00 per lockset
Abrasive coat inside only	M24 ¹	Add \$62.00 per lockset
Abrasive coat outside only	M25 ¹	Add \$62.00 per lockset

** All levers provided in a powder coat finish will be supplied with an abrasive coating.

Thumbturn Options

Specify door thickness	Specify Quick Code	Add or Deduct
Ergonomic	M34 ²	Add \$20.00 per TT
Decorative	MT1	No Charge
Decorative square	MT2	No Charge
Decorative cylinder	MT3	No Charge



MT1



MT2



MT3

Notes:

1. Not available with Vineyard™ or Muséo® levers.
2. M34 is not available with M19N, M19VN or M19SN.

Note: Thumbturn backplate will match shape of rose chosen (i.e. round or square)

Strike Options

Part Number	Description
726F577	Top Strike Pack
726F587	Bottom Strike Pack
726F607	Center Strike Pack

Note: Concealed vertical rods, top & bottom latches, and the lockbody cassette will be factory installed. All other hardware components are shipped directly to the customer and must be installed by a factory trained installer. Invoices for the door will be separate from the hardware invoice. The hardware invoice will include the concealed vertical assembly and the trim components.

FE6700

Storm Shutter Multi-Point Latching System

USA & Canada Prices Effective April 17, 2023

Standard Features

Handing
Device is handed

Shutter Thickness
FE6700 is for use with standard 1-3/4" thick shutters

Cylinder Furnished with:
Brass, 6-pin, L4 keyway, 0-bitted, 1-1/8" standard for FE6755 Classroom Function. Optional cylinders available; see Quick Codes

Warranty
Seven-year limited

UL Approved
Meets FEMA P320 (2014), P361 (2015) and ICC 500-2014 for inswing shutters 2'8" w x 3'00" h min to 4'0" w x 6'8" h max.

Solid brass lever and heavy duty escutcheon

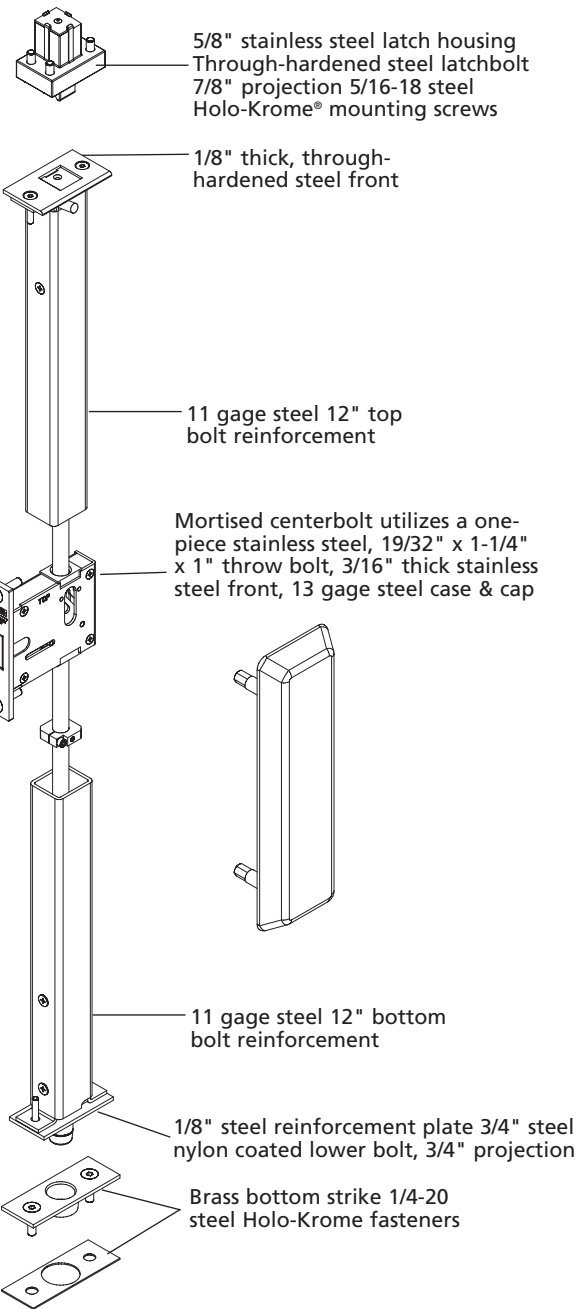
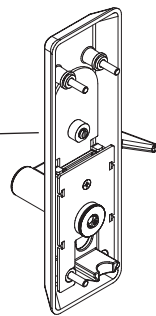

Ordering Example

Stock Order

Quantity	Series/ Function	Trim	Finish	Hand	Shutter Height
100	FE6780	FSH	626	RH	H0400

FE6700

Storm Shutter Multi-Point Latching System

USA & Canada Prices Effective April 17, 2023

Lever: Solid cast
Escutcheon: Forged

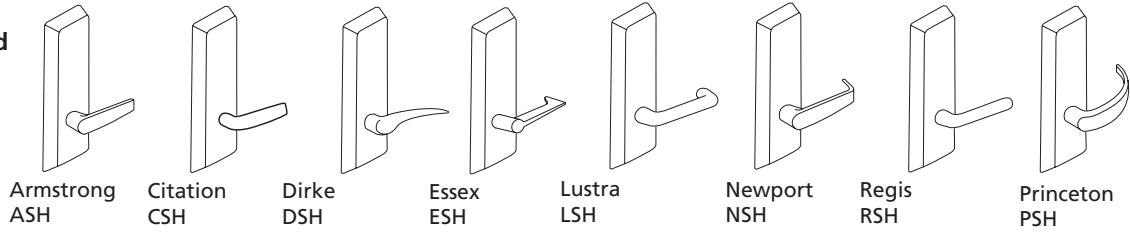

FE6700 Series

Function	Description	ASH, CSH, DSH, ESH, LSH, NSH, PSH, RSH					
		Finish Group 1		Finish Group 2			
		613E	Dark Oxidized Satin Bronze	605	Polished Brass	619	Satin Nickel
		630	Satin Stainless Steel(1)	606	Satin Brass	625	Polished Chrome
		BSP	Black Suede Powder Coat	611	Polished Bronze	629	Polished Stainless Steel(1)
		WSP	White Suede Powder Coat	612	Satin Bronze	626	Satin Chrome
				613	Oil Rubbed Bronze	722	Black Oil Rubbed Bronze
				618	Polished Nickel		
For Typical Shutter Applications							
FE6780	Passage Lever x Blank Plate						
Optional Functions							
FE6710	Passage or Closet						
FE6755	Classroom ³						
				\$4,917.00		\$4,927.00	

1. H escutcheon is a brass forging finished to match 629 and 630 finishes
3. Collar is required depending on length and type of cylinder. See Miscellaneous Options section on page 257.

Lever: Solid Cast
Escutcheon: Forged



FE6700 Series

Function	Description	FSH, MSH, ZSH					
		Finish Group 1		Finish Group 2			
		613E	Dark Oxidized Satin Bronze	605	Polished Brass	619	Satin Nickel
		630	Satin Stainless Steel(1)	606	Satin Brass	625	Polished Chrome
		BSP	Black Suede Powder Coat	611	Polished Bronze	722	Black Oil Rubbed Bronze
		WSP	White Suede Powder Coat	612	Satin Bronze		
				613	Oil Rubbed Bronze		
				618	Polished Nickel		
For Typical Shutter Applications							
FE6780	Passage Lever x Blank Plate						
Optional Functions							
FE6710	Passage or Closet						
FE6755	Classroom ³						
				\$4,917.00		\$4,927.00	

3. Collar is required depending on length and type of cylinder. See Miscellaneous Options section on page 257.

FE6700

Storm Shutter Multi-Point Latching System

USA & Canada Prices Effective April 17, 2023

Cylinder Options*

Description	Specify Quick Code	Add or Deduct
Conventional 6-pin	6P**	No Charge
Conventional 7-pin	7P	Add \$2.00 per cylinder
Less Standard Cylinder	LC	Deduct \$120.00 per cylinder
Less Concealed Shell Cylinder	PO-LC	Add \$5.00 per lockset
LFIC		
LFIC 6-pin	C6	Add \$104.00 per cylinder
LFIC 6-pin less core	CL6	No Charge
LFIC 6-pin with temporary construction core (Red)	CT6R	Add \$104.00 per cylinder
LFIC 6-pin with temporary construction core (Blue)	CT6B	Add \$104.00 per cylinder
LFIC 6-pin with temporary construction core (Green)	CT6G	Add \$104.00 per cylinder
LFIC 6-pin with temporary disposable core	CT6D	No Charge
LFIC 7-pin	C7	Add \$106.00 per cylinder
LFIC 7-pin less core	CL7	Add \$2.00 per cylinder
LFIC 7-pin with temporary construction core (Red)	CT7R	Add \$106.00 per cylinder
LFIC 7-pin with temporary construction core (Blue)	CT7B	Add \$106.00 per cylinder
LFIC 7-pin with temporary construction core (Green)	CT7G	Add \$106.00 per cylinder
LFIC 7-pin with temporary disposable core	CT7D	Add \$2.00 per cylinder
SFIC		
SFIC 6-pin	C6S	Add \$93.00 per cylinder
LFIC 6-pin with temporary construction core (Blue)	CT6SB	Add \$93.00 per cylinder
SFIC 6-pin with SFIC disposable temporary core	CT6SD	No Charge
SFIC 6-pin with Less Core	CLS6	No Charge
SFIC 7-pin	C7S	Add \$93.00 per cylinder
LFIC 6-pin with temporary construction core (Blue)	CT7SB	Add \$93.00 per cylinder
SFIC 7-pin with SFIC disposable temporary core	CT7SD	No Charge
SFIC 7-pin with Less Core	CLS7	No Charge
Security		
Security ⁴	HS	Add \$158.00 per cylinder
Security LFIC ⁴	CHS	Add \$258.00 per cylinder
Access 3		
Access 3 Patented	AP	No Charge
Access 3 Security	AS	Add \$78.00 per cylinder
Access 3 High Security, UL 437	AHS	Add \$111.00 per cylinder
Access 3 LFIC Patented	ACP	Add \$104.00 per cylinder
Access 3 LFIC Security	ACS	Add \$182.00 per cylinder
Access 3 LFIC High Security, UL 437	ACHS	Add \$215.00 per cylinder
Pyramid		
Pyramid Security fixed core	PS	Add \$84.00 per cylinder
Pyramid Security LFIC	PCS	Add \$181.00 per cylinder
Pyramid High Security fixed core	PHS	Add \$125.00 per cylinder
Pyramid High Security LFIC	PCHS	Add \$223.00 per cylinder
Pyramid LFIC with temporary construction core ³	CTP	Add \$104.00 per cylinder
Pyramid LFIC with temporary disposable core ³	CTPD	No Charge
Pyramid LFIC less core	CLP	No Charge

Notes:

1. CMK Construction master keying charge is in addition to master keying charge.
2. CMK Construction master keying is not available in interchangeable core, Access 3, Pyramid, or Security series.
3. VKC2, VKC3, CKC3 are not available in Pyramid or Security series.
4. Pyramid series is not available keyed random.
5. Security series is not available 0-bitted.

*Optional dogging cylinder will be furnished with the same mechanism and keyed alike with the trim cylinder, unless otherwise specified.
If different keying or cylinder type is required, specify outside (trim) first, then inside (dogging) cylinder.

**6P cylinder option is supplied in 6-pin, L4 keyway, 0-bitted with two nickel silver keys.

FE6700

Storm Shutter Multi-Point Latching System



USA & Canada Prices Effective April 17, 2023

Cylinder Options (continued) & Keying Options*		
Description	Specify Quick Code	Add or Deduct
Keying and Keys		
0-bitted with 2 Blank Keys	(standard)	No Charge
Keyed Random	KR	
Construction Master Keyed ²	CMK	Add \$16.00 per cylinder
More than 2 Keys	KY# (e.g., KY6)	See page 33 - Cut Keys Section
Master Keying		
Master keyed (all cylinders except CR8000, CR8020, CR8027, CR8200, CR8500, CR8600, CR8700)	MK	Add \$16.00 per cylinder
Master keyed Pyramid (except CR8020, CR8027 LFIC cores)	MK	
Master keyed Security (including LFIC cylinder and core)	MK	
Master keyed Access 3 (except CR8500, CR8600, CR8700 LFIC cores)	MK	
Master keyed (CR8000, CR8020, CR8027, CR8200, CR8500, CR8600, CR8700)	MK-IC	No Charge
Master keyed to customer bittings or sample key	MK-CB	Add \$16.00 per cylinder
Visual Key Control (VKC)		
No bitting or keyset stamping on keys	VKC0	\$4.50
Keys only	VKC1	No Charge
Cylinders and keys (not for AS, AHS, ACS, ACHS, HS, CHS, PHS or PCHS)	VKC2	\$8.00
Cylinders only (not for AS, AHS, HS, ACS, ACHS, CHS, PHS or PCHS)	VKC3	
Concealed Key Control (CKC)		
CKC cylinders with VKC keys	CKC2	\$8.00
CKC cylinders only (not for AS, AHS, ACS, ACHS, PHS, PCHS)	CKC3	

Notes:

1. Not available in CLX3329 function.
2. CMK Construction master keying charge is in addition to master keying charge and is not available in interchangeable core, Access 3, Pyramid, or Security series.

*Double cylinder keying: unless otherwise specified, both cylinders of 32, 62, 72 and 82 functions will be keyed alike. The inside cylinder of 52 function will be keyed to the master key(s) only, while the outside cylinder will include the change key. If different keying is required, specify outside cylinder first, then inside cylinder. For key bows other than 10 and 90, specify 'KB' + bow number as Quick Code, e.g. KB12.

Shutter Thickness

Description	Specify
1-3/4"	(standard)

Shutter Height Options

Description	Specify
2'8" - 4'6"	H0400
4'6" - 6'8"	H0500

Miscellaneous Options

Description	Specify	Add or Deduct
Torx Screws	M04	Add \$34.00 per lockset
1-1/8" cylinder collar (for 6-pin mortise cylinder) ¹²	721F36	No Charge
1-1/4" cylinder collar (for 7-pin mortise cylinder) ¹²	721F37	No Charge
1-1/2" cylinder collar (for 7-pin IC mortise cylinder) ¹²	721F38	No Charge
MicroShield® Antimicrobial finish coating	630C	Add \$111.00 per lockset
MicroShield Antimicrobial finish coating	626C	Add \$111.00 per lockset

Notes:

1. For optional FE6755 classroom function, collar is required depending on length and type of cylinder.
2. Specify as optional collar when ordering cylinders only.

MP9800 Series Multi-Point Vertical Rod Lock

Standard Features

Handing

Field Reversible.

Doors

1-3/4" (44mm) door thickness standard,
2-1/4" backset standard.

Mounting

Supplied fasteners are for metal doors with through-bolts for trim.

Rods

Steel. Top and bottom bolt travels 7/16" (11mm)
Projection adjustable up to 3/4" (19mm).

Latching

Top and Bottom or Top only (M55).

Trim

Available with all lever designs.

Cylinder

See cylinders page 12.

Applications

Single or Double Door.

Thermal Pins

MP9800A x M55: devices are supplied with ONE thermal pin per
fire-rated device, for installation on pairs of fire-rated doors.

Warranty

5 year.



Featuring Ecoflex Technology

Available Function Combinations:

	Outside Function (E)	Inside Function (N)								
		10	45*	49*	50	52	55*	59*	903*	905*
Blank Escutcheon Plate	01	X	X	X			X	X	X	X
Passage only (No cylinder)	10	X	X	X			X	X		
No outside Operation (No Cylinder); Pull Only	40+	X	X	X					X	X
Class Room Key Outside Unlocks/locks Trim	45	X	X	X						
Key unlocks Trim; Trim retracts latch; Trim relocks when key is removed	49	X	X	X					X	X
Freewheeling Trim; No Outside Operation	50						X	X		
Key outside unlocks/locks O/S trim; Key inside unlocks/locks O/S trim	52					X				
Freewheeling Trim; Key Outside Unlocks/locks Trim	55	X			X		X	X		
Freewheeling Trim; Key unlocks Trim;	59	X			X		X	X		
Trim retracts latch/Trim relocks when key is removed	903	X	X	X					X	X
Electrified Trim - Fail Safe	905	X	X	X					X	X

* Not recommended for use on any door used for Life Safety egress + Rigid lever

*Specify voltage desired for 903 and 905 functions (12VDC/24VDC)

Ordering Examples

Qty	Device	Exterior Trim/Function			Interior Trim/Function			Finish	Hand	Door Thickness	Door Height	Misc. Options	Voltage for Electrified Trim
		Lever	Exterior	Function	Lever	Interior	Function						
65	MP9800	D	E	49	D	N	10	605	LHR	D214	H0800	M55	12V

Contract/Detailed Order

Qty	Keyset	Series	Exterior Trim/Function			Interior Trim/Function			Finish	Hand	Door Thickness	Door Hght	Misc. Opts	Cyl Opts	Voltage for Electrified Trim
			Lever	Exterior	Function	Lever	Interior	Function							
36	AA1	MP9800A	102	E	50	102	N	55	626	LHR	D214	H1000	M93	7P	12V

Experience a safer
and more open world

MP9800 Series

Multi-Point Vertical Rod Lock

USA & Canada Prices Effective April 17, 2023

Lever: Solid Cast
Escutcheon: Forged

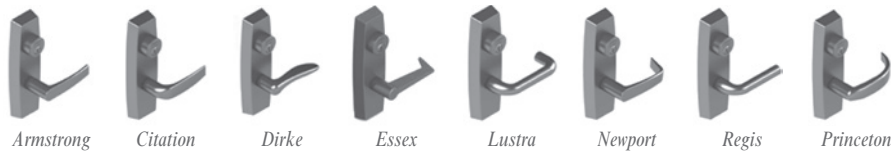

GEORGIA									
JACKSON									
JOSEF									
LASZLO									
MARC									
SALVADOR									

Note: Must designate E for exterior function or N for interior function when specifying order.

MP9800		613E, 626, BSP, WSP	605 606 611 612 613 618 625
Lever (E) x 01 x Lever (N) x *49	Blank Escutcheon Plate		
Lever (E) x 01 x Lever (N) x *45	Blank Escutcheon Plate		
Lever (E) x 01 x Lever (N) x 10	Blank Escutcheon Plate		
Lever (E) x 01 x Lever (N) x *55	Blank Escutcheon Plate		
Lever (E) x 01 x Lever (N) x 59	Blank Escutcheon Plate		
Lever (E) x 10 x Lever (N) x *49	Passage only (No cylinder)		
Lever (E) x 10 x Lever (N) x *45	Passage only (No cylinder)		
Lever (E) x 10 x Lever (N) x 10	Passage only (No cylinder)		
Lever (E) x 10 x Lever (N) x *55	Passage only (No cylinder)		
Lever (E) x 10 x Lever (N) x *59	Passage only (No cylinder)	\$2,832.00	\$2,912.00
Lever (E) x 40 x Lever (N) x *49	No outside Operation (No Cylinder); Pull Only		
Lever (E) x 40 x Lever (N) x *45	No outside Operation (No Cylinder); Pull Only		
Lever (E) x 40 x Lever (N) x 10	No outside Operation (No Cylinder); Pull Only		
Lever (E) x 45 x Lever (N) x *49	Class Room Key Outside Unlocks/locks Trim		
Lever (E) x 45 x Lever (N) x *45	Class Room Key Outside Unlocks/locks Trim		
Lever (E) x 45 x Lever (N) x 10	Class Room Key Outside Unlocks/locks Trim		
Lever (E) x 49 x Lever (N) x *10	Key unlocks Trim; Trim retracts latch; Trim relocks when key is removed		
Lever (E) x 49 x Lever (N) x *45	Key unlocks Trim; Trim retracts latch; Trim relocks when key is removed		
Lever (E) x 49 x Lever (N) x *49	Key unlocks Trim; Trim retracts latch; Trim relocks when key is removed		

* Not recommended for use on any door used for Life Safety egress.

MP9800 Series
Multi-Point Vertical Rod Lock

USA & Canada Prices Effective April 17, 2023

MP9800 Freewheeling Trim		613E, 626, BSP, WSP	605 606 611 612 613 618 625
Lever (E) x 50 x Lever (N) x *55	Freewheeling Trim; No Outside Operation		
Lever (E) x 50 x Lever (N) x *59	Freewheeling Trim; No Outside Operation		
Lever (E) x 52 x Lever (N) x 52	Key outside unlocks/locks O/S trim; Key inside unlocks/locks O/S trim		
Lever (E) x 55 x Lever (N) x *10	Freewheeling Trim; Key Outside Unlocks/locks Trim		
Lever (E) x 55 x Lever (N) x 50	Freewheeling Trim; Key Outside Unlocks/locks Trim		
Lever (E) x 55 x Lever (N) x *55	Freewheeling Trim; Key Outside Unlocks/locks Trim	\$2,832.00	\$2,912.00
Lever (E) x 55 x Lever (N) x *59	Freewheeling Trim; Key Outside Unlocks/locks Trim		
Lever (E) x 59 x Lever (N) x *10	Freewheeling Trim; Key unlocks Trim; Trim retracts latch/Trim relocks when key is removed		
Lever (E) x 59 x Lever (N) x 50	Freewheeling Trim; Key unlocks Trim; Trim retracts latch/Trim relocks when key is removed		
Lever (E) x 59 x Lever (N) x *55	Freewheeling Trim; Key unlocks Trim; Trim retracts latch/Trim relocks when key is removed		
Lever (E) x 59 x Lever (N) x *59	Freewheeling Trim; Key unlocks Trim; Trim retracts latch/Trim relocks when key is removed		
MP9800 Electromechanical			
Lever (E) x 01 x Lever (N) x *903	Blank Escutcheon Plate		
Lever (E) x 01 x Lever (N) x *905	Blank Escutcheon Plate		
Lever (E) x 40 x Lever (N) x *903	No outside Operation (No Cylinder); Pull Only		
Lever (E) x 40 x Lever (N) x *905	No outside Operation (No Cylinder); Pull Only		
Lever (E) x 49 x Lever (N) x *903	Key unlocks Trim; Trim retracts latch; Trim relocks when key is removed	\$3,165.00	\$3,245.00
Lever (E) x 49 x Lever (N) x *905	Key unlocks Trim; Trim retracts latch; Trim relocks when key is removed		
Lever (E) x 903 x Lever (N) x 10	Electrified Trim - Fail Safe		
Lever (E) x 903 x Lever (N) x *45	Electrified Trim - Fail Safe		
Lever (E) x 905 x Lever (N) x 10	Electrified Trim - Fail Secure		
Lever (E) x 905 x Lever (N) x *45	Electrified Trim - Fail Secure		
Lever (E) x 905 x Lever (N) x *903	Electrified Trim - Fail Secure		
Lever (E) x 905 x Lever (N) x *905	Electrified Trim - Fail Secure	\$3,365.00	\$3,445.00
Lever (E) x 903 x Lever (N) x *903	Electrified Trim - Fail Safe		
Lever (E) x 903 x Lever (N) x *905	Electrified Trim - Fail Safe		

* Not recommended for use on any door used for Life Safety egress.

MP9800 Series

Multi-Point Vertical Rod Lock

USA & Canada Prices Effective April 17, 2023

Lever: Solid Cast
Escutcheon: Forged

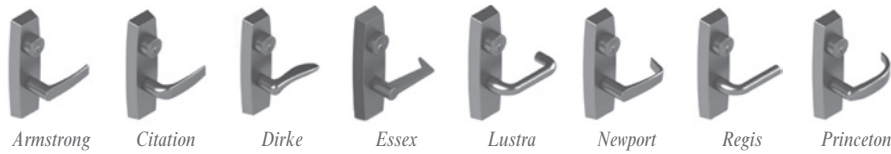

GEORGIA									
JACKSON									
JOSEF									
LASZLO									
MARC									
SALVADOR									

Note: Must designate E for exterior function or N for interior function when specifying order.

MP9800A/B		613E, 626, BSP, WSP	605 606 611 612 613 618 625
Lever (E) x 01 x Lever (N) x *49	Blank Escutcheon Plate		
Lever (E) x 01 x Lever (N) x *45	Blank Escutcheon Plate		
Lever (E) x 01 x Lever (N) x 10	Blank Escutcheon Plate		
Lever (E) x 01 x Lever (N) x *55	Blank Escutcheon Plate		
Lever (E) x 01 x Lever (N) x *59	Blank Escutcheon Plate		
Lever (E) x 10 x Lever (N) x *49	Passage only (No cylinder)		
Lever (E) x 10 x Lever (N) x *45	Passage only (No cylinder)		
Lever (E) x 10 x Lever (N) x 10	Passage only (No cylinder)		
Lever (E) x 10 x Lever (N) x *55	Passage only (No cylinder)		
Lever (E) x 10 x Lever (N) x *59	Passage only (No cylinder)	\$3,062.00	\$3,142.00
Lever (E) x 40 x Lever (N) x *49	No outside Operation (No Cylinder); Pull Only		
Lever (E) x 40 x Lever (N) x *45	No outside Operation (No Cylinder); Pull Only		
Lever (E) x 40 x Lever (N) x 10	No outside Operation (No Cylinder); Pull Only		
Lever (E) x 45 x Lever (N) x *49	Class Room Key Outside Unlocks/locks Trim		
Lever (E) x 45 x Lever (N) x *45	Class Room Key Outside Unlocks/locks Trim		
Lever (E) x 45 x Lever (N) x 10	Class Room Key Outside Unlocks/locks Trim		
Lever (E) x 49 x Lever (N) x *10	Key unlocks Trim; Trim retracts latch; Trim relocks when key is removed		
Lever (E) x 49 x Lever (N) x *45	Key unlocks Trim; Trim retracts latch; Trim relocks when key is removed		
Lever (E) x 49 x Lever (N) x *49	Key unlocks Trim; Trim retracts latch; Trim relocks when key is removed		

* Not recommended for use on any door used for Life Safety egress.

MP9800 Series
Multi-Point Vertical Rod Lock

USA & Canada Prices Effective April 17, 2023

MP9800A/B Freewheeling Trim		613E, 626, BSP, WSP	605 606 611 612 613 618 625
Lever (E) x 50 x Lever (N) x *55	Freewheeling Trim; No Outside Operation		
Lever (E) x 50 x Lever (N) x *59	Freewheeling Trim; No Outside Operation		
Lever (E) x 52 x Lever (N) x 52	Key outside unlocks/locks O/S trim; Key inside unlocks/locks O/S trim		
Lever (E) x 55 x Lever (N) x *10	Freewheeling Trim; Key Outside Unlocks/locks Trim		
Lever (E) x 55 x Lever (N) x 50	Freewheeling Trim; Key Outside Unlocks/locks Trim		
Lever (E) x 55 x Lever (N) x *55	Freewheeling Trim; Key Outside Unlocks/locks Trim	\$3,062.00	\$3,142.00
Lever (E) x 55 x Lever (N) x *59	Freewheeling Trim; Key Outside Unlocks/locks Trim		
Lever (E) x 59 x Lever (N) x *10	Freewheeling Trim; Key unlocks Trim; Trim retracts latch/Trim relocks when key is removed		
Lever (E) x 59 x Lever (N) x 50	Freewheeling Trim; Key unlocks Trim; Trim retracts latch/Trim relocks when key is removed		
Lever (E) x 59 x Lever (N) x *55	Freewheeling Trim; Key unlocks Trim; Trim retracts latch/Trim relocks when key is removed		
Lever (E) x 59 x Lever (N) x *59	Freewheeling Trim; Key unlocks Trim; Trim retracts latch/Trim relocks when key is removed		
MP9800A/B Electromechanical			
Lever (E) x 01 x Lever (N) x *903	Blank Escutcheon Plate		
Lever (E) x 01 x Lever (N) x *905	Blank Escutcheon Plate		
Lever (E) x 40 x Lever (N) x *903	No outside Operation (No Cylinder); Pull Only		
Lever (E) x 40 x Lever (N) x *905	No outside Operation (No Cylinder); Pull Only		
Lever (E) x 49 x Lever (N) x *903	Key unlocks Trim; Trim retracts latch; Trim relocks when key is removed	\$3,406.00	\$3,486.00
Lever (E) x 49 x Lever (N) x *905	Key unlocks Trim; Trim retracts latch; Trim relocks when key is removed		
Lever (E) x 903 x Lever (N) x 10	Electrified Trim - Fail Safe		
Lever (E) x 903 x Lever (N) x *45	Electrified Trim - Fail Safe		
Lever (E) x 905 x Lever (N) x 10	Electrified Trim - Fail Secure		
Lever (E) x 905 x Lever (N) x *45	Electrified Trim - Fail Secure		
Lever (E) x 905 x Lever (N) x *903	Electrified Trim - Fail Secure	\$3,606.00	\$3,686.00
Lever (E) x 905 x Lever (N) x *905	Electrified Trim - Fail Secure		
Lever (E) x 903 x Lever (N) x *903	Electrified Trim - Fail Safe		
Lever (E) x 903 x Lever (N) x *905	Electrified Trim - Fail Safe		

* Not recommended for use on any door used for Life Safety egress.

MP9800 Series

Multi-Point Vertical Rod Lock

USA & Canada Prices Effective April 17, 2023

PIET*



**613E, BSP, WSP finishes are not available with 21M levers.

MP9800		613E, 629, 630, BSP, WSP
	Piet 21G, 21L, 21M, 21S, 23M, 25M, 27M	
Lever (E) x 01 x Lever (N) x *49	Blank Escutcheon Plate	\$3,016.00
Lever (E) x 01 x Lever (N) x *45	Blank Escutcheon Plate	
Lever (E) x 01 x Lever (N) x 10	Blank Escutcheon Plate	
Lever (E) x 01 x Lever (N) x *55	Blank Escutcheon Plate	
Lever (E) x 01 x Lever (N) x 59	Blank Escutcheon Plate	
Lever (E) x 10 x Lever (N) x *49	Passage only (No cylinder)	
Lever (E) x 10 x Lever (N) x *45	Passage only (No cylinder)	
Lever (E) x 10 x Lever (N) x 10	Passage only (No cylinder)	
Lever (E) x 10 x Lever (N) x *55	Passage only (No cylinder)	
Lever (E) x 10 x Lever (N) x *59	Passage only (No cylinder)	
Lever (E) x 40 x Lever (N) x *49	No outside Operation (No Cylinder); Pull Only	
Lever (E) x 40 x Lever (N) x *45	No outside Operation (No Cylinder); Pull Only	
Lever (E) x 40 x Lever (N) x 10	No outside Operation (No Cylinder); Pull Only	
Lever (E) x 45 x Lever (N) x *49	Class Room Key Outside Unlocks/locks Trim	
Lever (E) x 45 x Lever (N) x *45	Class Room Key Outside Unlocks/locks Trim	
Lever (E) x 45 x Lever (N) x 10	Class Room Key Outside Unlocks/locks Trim	
Lever (E) x 49 x Lever (N) x *10	Key unlocks Trim; Trim retracts latch; Trim relocks when key is removed	
Lever (E) x 49 x Lever (N) x *45	Key unlocks Trim; Trim retracts latch; Trim relocks when key is removed	
Lever (E) x 49 x Lever (N) x *49	Key unlocks Trim; Trim retracts latch; Trim relocks when key is removed	
MP9800 Freewheeling Trim		
Lever (E) x 50 x Lever (N) x *55	Freewheeling Trim; No Outside Operation	\$3,016.00
Lever (E) x 50 x Lever (N) x *59	Freewheeling Trim; No Outside Operation	
Lever (E) x 52 x Lever (N) x 52	Key outside unlocks/locks O/S trim; Key inside unlocks/locks O/S trim	
Lever (E) x 55 x Lever (N) x *10	Freewheeling Trim; Key Outside Unlocks/locks Trim	
Lever (E) x 55 x Lever (N) x 50	Freewheeling Trim; Key Outside Unlocks/locks Trim	
Lever (E) x 55 x Lever (N) x *55	Freewheeling Trim; Key Outside Unlocks/locks Trim	
Lever (E) x 55 x Lever (N) x *59	Freewheeling Trim; Key Outside Unlocks/locks Trim	
Lever (E) x 59 x Lever (N) x *10	Freewheeling Trim; Key unlocks Trim; Trim retracts latch/Trim relocks when key is removed	
Lever (E) x 59 x Lever (N) x 50	Freewheeling Trim; Key unlocks Trim; Trim retracts latch/Trim relocks when key is removed	
Lever (E) x 59 x Lever (N) x *55	Freewheeling Trim; Key unlocks Trim; Trim retracts latch/Trim relocks when key is removed	
Lever (E) x 59 x Lever (N) x *59	Freewheeling Trim; Key unlocks Trim; Trim retracts latch/Trim relocks when key is removed	
MP9800 Electromechanical		
Lever (E) x 01 x Lever (N) x *903	Blank Escutcheon Plate	\$3,384.00
Lever (E) x 01 x Lever (N) x *905	Blank Escutcheon Plate	
Lever (E) x 40 x Lever (N) x *903	No outside Operation (No Cylinder); Pull Only	
Lever (E) x 40 x Lever (N) x *905	No outside Operation (No Cylinder); Pull Only	
Lever (E) x 49 x Lever (N) x *903	Key unlocks Trim; Trim retracts latch; Trim relocks when key is removed	
Lever (E) x 49 x Lever (N) x *905	Key unlocks Trim; Trim retracts latch; Trim relocks when key is removed	
Lever (E) x 903 x Lever (N) x 10	Electrified Trim - Fail Safe	
Lever (E) x 903 x Lever (N) x *45	Electrified Trim - Fail Safe	
Lever (E) x 905 x Lever (N) x 10	Electrified Trim - Fail Secure	
Lever (E) x 905 x Lever (N) x *45	Electrified Trim - Fail Secure	
Lever (E) x 905 x Lever (N) x *903	Electrified Trim - Fail Secure	\$3,584.00
Lever (E) x 905 x Lever (N) x *905	Electrified Trim - Fail Secure	
Lever (E) x 903 x Lever (N) x *903	Electrified Trim - Fail Safe	
Lever (E) x 903 x Lever (N) x *905	Electrified Trim - Fail Safe	

* Not recommended for use on any door used for Life Safety egress.

MP9800 Series

Multi-Point Vertical Rod Lock

USA & Canada Prices Effective April 17, 2023

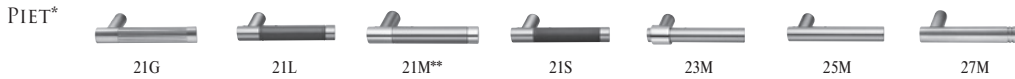

**613E, BSP, WSP finishes are not available with 21M levers.

MP9800A/B		613E, 629, 630, BSP, WSP
	Piet 21G, 21L, 21M, 21S, 23M, 25M, 27M	
Lever (E) x 01 x Lever (N) x *49	Blank Escutcheon Plate	\$3,246.00
Lever (E) x 01 x Lever (N) x *45	Blank Escutcheon Plate	
Lever (E) x 01 x Lever (N) x 10	Blank Escutcheon Plate	
Lever (E) x 01 x Lever (N) x *55	Blank Escutcheon Plate	
Lever (E) x 01 x Lever (N) x 59	Blank Escutcheon Plate	
Lever (E) x 10 x Lever (N) x *49	Passage only (No cylinder)	
Lever (E) x 10 x Lever (N) x *45	Passage only (No cylinder)	
Lever (E) x 10 x Lever (N) x 10	Passage only (No cylinder)	
Lever (E) x 10 x Lever (N) x *55	Passage only (No cylinder)	
Lever (E) x 10 x Lever (N) x *59	Passage only (No cylinder)	
Lever (E) x 40 x Lever (N) x *49	No outside Operation (No Cylinder); Pull Only	
Lever (E) x 40 x Lever (N) x *45	No outside Operation (No Cylinder); Pull Only	
Lever (E) x 40 x Lever (N) x 10	No outside Operation (No Cylinder); Pull Only	
Lever (E) x 45 x Lever (N) x *49	Class Room Key Outside Unlocks/locks Trim	
Lever (E) x 45 x Lever (N) x *45	Class Room Key Outside Unlocks/locks Trim	
Lever (E) x 45 x Lever (N) x 10	Class Room Key Outside Unlocks/locks Trim	
Lever (E) x 49 x Lever (N) x *10	Key unlocks Trim; Trim retracts latch; Trim relocks when key is removed	
Lever (E) x 49 x Lever (N) x *45	Key unlocks Trim; Trim retracts latch; Trim relocks when key is removed	
Lever (E) x 49 x Lever (N) x *49	Key unlocks Trim; Trim retracts latch; Trim relocks when key is removed	
MP9800A/B Freewheeling Trim		
Lever (E) x 50 x Lever (N) x *55	Freewheeling Trim; No Outside Operation	\$3,246.00
Lever (E) x 50 x Lever (N) x *59	Freewheeling Trim; No Outside Operation	
Lever (E) x 52 x Lever (N) x 52	Key outside unlocks/locks O/S trim; Key inside unlocks/locks O/S trim	
Lever (E) x 55 x Lever (N) x *10	Freewheeling Trim; Key Outside Unlocks/locks Trim	
Lever (E) x 55 x Lever (N) x 50	Freewheeling Trim; Key Outside Unlocks/locks Trim	
Lever (E) x 55 x Lever (N) x *55	Freewheeling Trim; Key Outside Unlocks/locks Trim	
Lever (E) x 55 x Lever (N) x *59	Freewheeling Trim; Key Outside Unlocks/locks Trim	
Lever (E) x 59 x Lever (N) x *10	Freewheeling Trim; Key unlocks Trim; Trim retracts latch/Trim relocks when key is removed	
Lever (E) x 59 x Lever (N) x 50	Freewheeling Trim; Key unlocks Trim; Trim retracts latch/Trim relocks when key is removed	
Lever (E) x 59 x Lever (N) x *55	Freewheeling Trim; Key unlocks Trim; Trim retracts latch/Trim relocks when key is removed	
Lever (E) x 59 x Lever (N) x *59	Freewheeling Trim; Key unlocks Trim; Trim retracts latch/Trim relocks when key is removed	
MP9800A/B Electromechanical		
Lever (E) x 01 x Lever (N) x *903	Blank Escutcheon Plate	\$3,626.00
Lever (E) x 01 x Lever (N) x *905	Blank Escutcheon Plate	
Lever (E) x 40 x Lever (N) x *903	No outside Operation (No Cylinder); Pull Only	
Lever (E) x 40 x Lever (N) x *905	No outside Operation (No Cylinder); Pull Only	
Lever (E) x 49 x Lever (N) x *903	Key unlocks Trim; Trim retracts latch; Trim relocks when key is removed	
Lever (E) x 49 x Lever (N) x *905	Key unlocks Trim; Trim retracts latch; Trim relocks when key is removed	
Lever (E) x 903 x Lever (N) x 10	Electrified Trim - Fail Safe	
Lever (E) x 903 x Lever (N) x *45	Electrified Trim - Fail Safe	
Lever (E) x 905 x Lever (N) x 10	Electrified Trim - Fail Secure	
Lever (E) x 905 x Lever (N) x *45	Electrified Trim - Fail Secure	
Lever (E) x 905 x Lever (N) x *903	Electrified Trim - Fail Secure	\$3,825.00
Lever (E) x 905 x Lever (N) x *905	Electrified Trim - Fail Secure	
Lever (E) x 903 x Lever (N) x *903	Electrified Trim - Fail Safe	
Lever (E) x 903 x Lever (N) x *905	Electrified Trim - Fail Safe	

* Not recommended for use on any door used for Life Safety egress.

MP9800 Series Multi-Point Vertical Rod Lock

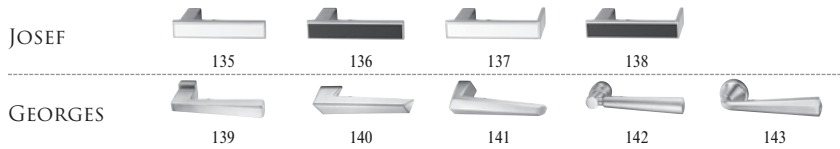

USA & Canada Prices Effective April 17, 2023

MP9800		613E, 626, BSP, WSP	605 606 611 612 613 618 625		
	Josef, Georges Levers				
Lever (E) x 01 x Lever (N) x *49	Blank Escutcheon Plate				
Lever (E) x 01 x Lever (N) x *45	Blank Escutcheon Plate				
Lever (E) x 01 x Lever (N) x 10	Blank Escutcheon Plate				
Lever (E) x 01 x Lever (N) x *55	Blank Escutcheon Plate				
Lever (E) x 01 x Lever (N) x 59	Blank Escutcheon Plate				
Lever (E) x 10 x Lever (N) x *49	Passage only (No cylinder)				
Lever (E) x 10 x Lever (N) x *45	Passage only (No cylinder)				
Lever (E) x 10 x Lever (N) x 10	Passage only (No cylinder)				
Lever (E) x 10 x Lever (N) x *55	Passage only (No cylinder)				
Lever (E) x 10 x Lever (N) x *59	Passage only (No cylinder)				
Lever (E) x 40 x Lever (N) x *49	No outside Operation (No Cylinder); Pull Only	\$2,939.00	\$3,016.00		
Lever (E) x 40 x Lever (N) x *45	No outside Operation (No Cylinder); Pull Only				
Lever (E) x 40 x Lever (N) x 10	No outside Operation (No Cylinder); Pull Only				
Lever (E) x 45 x Lever (N) x *49	Class Room Key Outside Unlocks/locks Trim				
Lever (E) x 45 x Lever (N) x *45	Class Room Key Outside Unlocks/locks Trim				
Lever (E) x 45 x Lever (N) x 10	Class Room Key Outside Unlocks/locks Trim				
Lever (E) x 49 x Lever (N) x *10	Key unlocks Trim; Trim retracts latch; Trim relocks when key is removed				
Lever (E) x 49 x Lever (N) x *45	Key unlocks Trim; Trim retracts latch; Trim relocks when key is removed				
Lever (E) x 49 x Lever (N) x *49	Key unlocks Trim; Trim retracts latch; Trim relocks when key is removed				
MP9800 Freewheeling Trim					
Lever (E) x 50 x Lever (N) x *55	Freewheeling Trim; No Outside Operation				
Lever (E) x 50 x Lever (N) x *59	Freewheeling Trim; No Outside Operation				
Lever (E) x 52 x Lever (N) x 52	Key outside unlocks/locks O/S trim; Key inside unlocks/locks O/S trim				
Lever (E) x 55 x Lever (N) x *10	Freewheeling Trim; Key Outside Unlocks/locks Trim				
Lever (E) x 55 x Lever (N) x 50	Freewheeling Trim; Key Outside Unlocks/locks Trim				
Lever (E) x 55 x Lever (N) x *55	Freewheeling Trim; Key Outside Unlocks/locks Trim			\$2,939.00	\$3,016.00
Lever (E) x 55 x Lever (N) x *59	Freewheeling Trim; Key Outside Unlocks/locks Trim				
Lever (E) x 59 x Lever (N) x *10	Freewheeling Trim; Key unlocks Trim; Trim retracts latch/Trim relocks when key is removed				
Lever (E) x 59 x Lever (N) x 50	Freewheeling Trim; Key unlocks Trim; Trim retracts latch/Trim relocks when key is removed				
Lever (E) x 59 x Lever (N) x *55	Freewheeling Trim; Key unlocks Trim; Trim retracts latch/Trim relocks when key is removed				
Lever (E) x 59 x Lever (N) x *59	Freewheeling Trim; Key unlocks Trim; Trim retracts latch/Trim relocks when key is removed				
MP9800 Electromechanical					
Lever (E) x 01 x Lever (N) x *903	Blank Escutcheon Plate				
Lever (E) x 01 x Lever (N) x *905	Blank Escutcheon Plate				
Lever (E) x 40 x Lever (N) x *903	No outside Operation (No Cylinder); Pull Only				
Lever (E) x 40 x Lever (N) x *905	No outside Operation (No Cylinder); Pull Only				
Lever (E) x 49 x Lever (N) x *903	Key unlocks Trim; Trim retracts latch; Trim relocks when key is removed	\$3,307.00	\$3,384.00		
Lever (E) x 49 x Lever (N) x *905	Key unlocks Trim; Trim retracts latch; Trim relocks when key is removed				
Lever (E) x 903 x Lever (N) x 10	Electrified Trim - Fail Safe				
Lever (E) x 903 x Lever (N) x *45	Electrified Trim - Fail Safe				
Lever (E) x 905 x Lever (N) x 10	Electrified Trim - Fail Secure				
Lever (E) x 905 x Lever (N) x *45	Electrified Trim - Fail Secure				
Lever (E) x 905 x Lever (N) x *903	Electrified Trim - Fail Secure				
Lever (E) x 905 x Lever (N) x *905	Electrified Trim - Fail Secure				
Lever (E) x 903 x Lever (N) x *903	Electrified Trim - Fail Safe	\$3,507.00	\$3,584.00		
Lever (E) x 903 x Lever (N) x *905	Electrified Trim - Fail Safe				

MP9800 Series
Multi-Point Vertical Rod Lock

JOSEF



135 136 137 138

GEORGES



139 140 141 142 143

USA & Canada Prices Effective April 17, 2023

MP9800A/B		613E, 626, BSP, WSP	605 606 611 612 613 618 625
	Josef, Georges Levers		
Lever (E) x 01 x Lever (N) x *49	Blank Escutcheon Plate		
Lever (E) x 01 x Lever (N) x *45	Blank Escutcheon Plate		
Lever (E) x 01 x Lever (N) x 10	Blank Escutcheon Plate		
Lever (E) x 01 x Lever (N) x *55	Blank Escutcheon Plate		
Lever (E) x 01 x Lever (N) x 59	Blank Escutcheon Plate		
Lever (E) x 10 x Lever (N) x *49	Passage only (No cylinder)		
Lever (E) x 10 x Lever (N) x *45	Passage only (No cylinder)		
Lever (E) x 10 x Lever (N) x 10	Passage only (No cylinder)		
Lever (E) x 10 x Lever (N) x *55	Passage only (No cylinder)		
Lever (E) x 10 x Lever (N) x *59	Passage only (No cylinder)	\$3,169.00	\$3,179.00
Lever (E) x 40 x Lever (N) x *49	No outside Operation (No Cylinder); Pull Only		
Lever (E) x 40 x Lever (N) x *45	No outside Operation (No Cylinder); Pull Only		
Lever (E) x 40 x Lever (N) x 10	No outside Operation (No Cylinder); Pull Only		
Lever (E) x 45 x Lever (N) x *49	Class Room Key Outside Unlocks/locks Trim		
Lever (E) x 45 x Lever (N) x *45	Class Room Key Outside Unlocks/locks Trim		
Lever (E) x 45 x Lever (N) x 10	Class Room Key Outside Unlocks/locks Trim		
Lever (E) x 49 x Lever (N) x *10	Key unlocks Trim; Trim retracts latch; Trim relocks when key is removed		
Lever (E) x 49 x Lever (N) x *45	Key unlocks Trim; Trim retracts latch; Trim relocks when key is removed		
Lever (E) x 49 x Lever (N) x *49	Key unlocks Trim; Trim retracts latch; Trim relocks when key is removed		
MP9800A/B Freewheeling Trim			
Lever (E) x 50 x Lever (N) x *55	Freewheeling Trim; No Outside Operation		
Lever (E) x 50 x Lever (N) x *59	Freewheeling Trim; No Outside Operation		
Lever (E) x 52 x Lever (N) x 52	Key outside unlocks/locks O/S trim; Key inside unlocks/locks O/S trim		
Lever (E) x 55 x Lever (N) x *10	Freewheeling Trim; Key Outside Unlocks/locks Trim		
Lever (E) x 55 x Lever (N) x 50	Freewheeling Trim; Key Outside Unlocks/locks Trim		
Lever (E) x 55 x Lever (N) x *55	Freewheeling Trim; Key Outside Unlocks/locks Trim	\$3,169.00	\$3,179.00
Lever (E) x 55 x Lever (N) x *59	Freewheeling Trim; Key Outside Unlocks/locks Trim		
Lever (E) x 59 x Lever (N) x *10	Freewheeling Trim; Key unlocks Trim; Trim retracts latch/Trim relocks when key is removed		
Lever (E) x 59 x Lever (N) x 50	Freewheeling Trim; Key unlocks Trim; Trim retracts latch/Trim relocks when key is removed		
Lever (E) x 59 x Lever (N) x *55	Freewheeling Trim; Key unlocks Trim; Trim retracts latch/Trim relocks when key is removed		
Lever (E) x 59 x Lever (N) x *59	Freewheeling Trim; Key unlocks Trim; Trim retracts latch/Trim relocks when key is removed		
MP9800A/B Electromechanical			
Lever (E) x 01 x Lever (N) x *903	Blank Escutcheon Plate		
Lever (E) x 01 x Lever (N) x *905	Blank Escutcheon Plate		
Lever (E) x 40 x Lever (N) x *903	No outside Operation (No Cylinder); Pull Only		
Lever (E) x 40 x Lever (N) x *905	No outside Operation (No Cylinder); Pull Only		
Lever (E) x 49 x Lever (N) x *903	Key unlocks Trim; Trim retracts latch; Trim relocks when key is removed	\$3,549.00	\$3,626.00
Lever (E) x 49 x Lever (N) x *905	Key unlocks Trim; Trim retracts latch; Trim relocks when key is removed		
Lever (E) x 903 x Lever (N) x 10	Electrified Trim - Fail Safe		
Lever (E) x 903 x Lever (N) x *45	Electrified Trim - Fail Safe		
Lever (E) x 905 x Lever (N) x 10	Electrified Trim - Fail Secure		
Lever (E) x 905 x Lever (N) x *45	Electrified Trim - Fail Secure		
Lever (E) x 905 x Lever (N) x *903	Electrified Trim - Fail Secure		
Lever (E) x 905 x Lever (N) x *905	Electrified Trim - Fail Secure	\$3,748.00	\$3,825.00
Lever (E) x 903 x Lever (N) x *903	Electrified Trim - Fail Safe		
Lever (E) x 903 x Lever (N) x *905	Electrified Trim - Fail Safe		

* Not recommended for use on any door used for Life Safety egress.

MP9800 Series

Multi-Point Vertical Rod Lock



USA & Canada Prices Effective April 17, 2023

Cylinder Options*		
Description	Specify Quick Code	Add or Deduct
Conventional 6-pin	6P**	Add \$120.00 per cylinder
Conventional 7-pin	7P	Add \$122.00 per cylinder
LFIC		
LFIC 6-pin	C6	Add \$224.00 per cylinder
LFIC 6-pin less core	CL6	Add \$120.00 per cylinder
LFIC 6-pin with temporary construction core (Red)	CT6R	Add \$224.00 per cylinder
LFIC 6-pin with temporary construction core (Blue)	CT6B	Add \$224.00 per cylinder
LFIC 6-pin with temporary construction core (Green)	CT6G	Add \$224.00 per cylinder
LFIC 6-pin with temporary disposable core	CT6D	Add \$120.00 per cylinder
LFIC 7-pin	C7	Add \$228.00 per cylinder
LFIC 7-pin less core	CL7	Add \$122.00 per cylinder
LFIC 7-pin with temporary construction core (Red)	CT7R	Add \$228.00 per cylinder
LFIC 7-pin with temporary construction core (Blue)	CT7B	Add \$228.00 per cylinder
LFIC 7-pin with temporary construction core (Green)	CT7G	Add \$228.00 per cylinder
LFIC 7-pin with temporary disposable core	CT7D	Add \$122.00 per cylinder
SFIC		
SFIC 6-pin	C6S	Add \$213.00 per cylinder
SFIC 6-pin with temporary construction core (Blue)	CT6SB	Add \$213.00 per cylinder
SFIC 6-pin with SFIC disposable temporary core	CT6SD	Add \$120.00 per cylinder
SFIC 6-pin with Less Core	CLS6	Add \$120.00 per cylinder
SFIC 7-pin	C7S	Add \$213.00 per cylinder
SFIC 7-pin with temporary construction core (Blue)	CT7SB	Add \$213.00 per cylinder
SFIC 7-pin with SFIC disposable temporary core	CT7SD	Add \$120.00 per cylinder
SFIC 7-pin with Less Core	CLS7	Add \$120.00 per cylinder
Security		
Security ⁴	HS	Add \$278.00 per cylinder
Security LFIC ⁴	CHS	Add \$378.00 per cylinder
Access 3		
Access 3 Patented	AP	Add \$120.00 per cylinder
Access 3 Security	AS	Add \$198.00 per cylinder
Access 3 High Security, UL 437	AHS	Add \$231.00 per cylinder
Access 3 LFIC Patented	ACP	Add \$224.00 per cylinder
Access 3 LFIC Security	ACS	Add \$302.00 per cylinder
Access 3 LFIC High Security, UL 437	ACHS	Add \$335.00 per cylinder
Pyramid		
Pyramid Security fixed core	PS	Add \$204.00 per cylinder
Pyramid Security LFIC	PCS	Add \$301.00 per cylinder
Pyramid High Security fixed core	PHS	Add \$245.00 per cylinder
Pyramid High Security LFIC	PCHS	Add \$343.00 per cylinder
Pyramid LFIC with temporary construction core ³	CTP	Add \$224.00 per cylinder
Pyramid LFIC with temporary disposable core ³	CTPD	Add \$120.00 per cylinder
Pyramid LFIC less core	CLP	Add \$120.00 per cylinder

Notes:

1. CMK Construction master keying charge is in addition to master keying charge.
2. CMK Construction master keying is not available in interchangeable core, Access 3, Pyramid, or Security series.
3. VKC2, VKC3, CKC3 are not available in Pyramid or Security series.
4. Pyramid series is not available keyed random.
5. Security series is not available 0-bitted.

*Optional dogging cylinder will be furnished with the same mechanism and keyed alike with the trim cylinder, unless otherwise specified.
If different keying or cylinder type is required, specify outside (trim) first, then inside (dogging) cylinder.

**6P cylinder option is supplied in 6-pin, L4 keyway, 0-bitted with two nickel silver keys.

MP9800 Series

Multi-Point Vertical Rod Lock

USA & Canada Prices Effective April 17, 2023

Cylinder Options (continued) & Keying Options*

Description	Specify Quick Code	Add or Deduct
Keying and Keys		
0-bitted with 2 Blank Keys	(standard)	No Charge
Keyed Random	KR	
Construction Master Keyed ²	CMK	Add \$16.00 per cylinder
More than 2 Keys	KY# (e.g., KY6)	See page 33 - Cut Keys Section
Master Keying		
Master keyed (all cylinders except CR8000, CR8020, CR8027, CR8200, CR8500, CR8600, CR8700)	MK	Add \$16.00 per cylinder
Master keyed Pyramid (except CR8020, CR8027 LFIC cores)	MK	
Master keyed Security (including LFIC cylinder and core)	MK	
Master keyed Access 3 (except CR8500, CR8600, CR8700 LFIC cores)	MK	
Master keyed (CR8000, CR8020, CR8027, CR8200, CR8500, CR8600, CR8700)	MK-IC	No Charge
Master keyed to customer bittings or sample key	MK-CB	Add \$16.00 per cylinder
Visual Key Control (VKC)		
No bitting or keyset stamping on keys	VKC0	\$4.50
Keys only	VKC1	No Charge
Cylinders and keys (not for AS, AHS, ACS, ACHS, HS, CHS, PHS or PCHS)	VKC2	\$8.00
Cylinders only (not for AS, AHS, HS, ACS, ACHS, CHS, PHS or PCHS)	VKC3	
Concealed Key Control (CKC)		
CKC cylinders with VKC keys	CKC2	\$8.00
CKC cylinders only (not for AS, AHS, ACS, ACHS, PHS, PCHS)	CKC3	

Notes:

1. Not available in CLX3329 function.
2. CMK Construction master keying charge is in addition to master keying charge and is not available in interchangeable core, Access 3, Pyramid, or Security series.

*Double cylinder keying: unless otherwise specified, both cylinders of 32, 62, 72 and 82 functions will be keyed alike. The inside cylinder of 52 function will be keyed to the master key(s) only, while the outside cylinder will include the change key. If different keying is required, specify outside cylinder first, then inside cylinder. For key bows other than 10 and 90, specify 'KB' + bow number as Quick Code, e.g. KB12.

MP9800 Series

Multi-Point Vertical Rod Lock



USA & Canada Prices Effective April 17, 2023

Door Height Options	Specify	Add or Deduct
7'0"	Standard	No Charge
7'2"	H702	
7'6"	H706	
8'0"	H0800	
9'0"	H0900	
10'0"	H1000	
Door Thickness	Specify	Add or Deduct
1-3/4" (44mm)	Standard	No Charge
2" (51mm)	D200	No Charge
2-1/4" (57mm)	D214	No Charge
Motorized Electric Latch Retraction	Specify	Add or Deduct
Electric Latch Retraction	MELR	Add \$1116.00
Miscellaneous Options	Specify	Add or Deduct
Spanner Head Screw	M02	Add \$47.00 per device
Torx® head screws	M04	Add \$63.00 per device
Knurling outside and inside	M20*	Add \$199.00 per device
Knurling outside only ¹	M21*	Add \$93.00 per device
Knurling inside only	M22*	Add \$106.00 per device
Abrasive coat outside and inside (trim and device)	M23	Add \$126.00 per device
Abrasive coat inside only (device side)	M24	Add \$66.00 per device
Abrasive coat outside only (trim side)	M25	Add \$60.00 per device
Less bottom vertical rod	M55	No Charge
Latchbolt Monitoring	M91	Add \$311.00
O/S Lever Monitoring	M93	Add \$291.00
I/S Lever Monitoring	M92	Add \$291.00
Windstorm	M107	Add \$117.00 per device
Aluminum Door	MPAD	No Charge
Rectangular Back Plate (Required for Wood Door - MPWD)	MPER	
Back Plate (Required for Wood Door - MPWD)	MPES	
Lever Hold Back	MPHB	Add \$28.00 per device
Fire Rated Wood Door	MPWD	No Charge
aux control (classroom)	AUX155	Add \$850.00 per device
aux control (storeroom)	AUX159	Add \$850.00 per device
MicroShield® Antimicrobial finish coating	626C	Add \$90.00 (Exit Devices & Trims (ordered separately) Add \$111.00 (Exit Devices & Outside Trims (ordered together)
MicroShield® Antimicrobial finish coating	630C	Add \$90.00 (Exit Devices & Trims (ordered separately) Add \$111.00 (Exit Devices & Outside Trims (ordered together)

1. Not available with Vineyard™ or Muséo® levers.

*All levers provided in a powder coat finish will be supplied with an abrasive coating.

Blank Page

MicroShield® How to Order, Pricing	273
ED2000 Pushpad Series:	
ED2000 Series Standard Features	274
ED2000 Series Ordering Example	275
ED2000 Series: Rim ED2000, Vertical Rod ED2400	276
ED2000 Series Rose Trim Designs: A5 Armstrong, N5 Newport, PR5 Princeton	277
ED2000 Series Rose Trim Flat Plate Trim F1 Flat Plate, Pull Trim Design P8 Wing Pull, Trim Design K1 Key Only	278
ED2000 Series Cylinder Options, Rim Cylinder Trim	279
ED2000 Series Cylinder Options (continued) & Keying Options	280
ED2000 Series Keying, Door Width, Door Thickness, Door Height Options, Miscellaneous & Strike Options	281
ED2000 Series Alarm Kit, Mullions, Door Height Options, Mullions Cylinder Options	282
ED3000 Crossbar Series:	
ED3000 Series Standard Features	283
ED3000 Series Ordering Examples	284
ED3000 Series: Rim ED3200	285
ED3000 Series: Surface Vertical Rod ED3400 Series, Mortise ED3600 Series	286
ED3000 Series Escutcheon Trim Designs: A33 Armstrong, C33 Citation, D33 Dirke, L33 Lustra	287
ED3000 Series Escutcheon Trim Designs: N33 Newport, PR33 Princeton, R33 Regis	288
ED3000 Series Escutcheon Trim Designs: T33 D Grip, T34 Round Grip, T35 Sectional Grip, Auxiliary Control/Inside Lever Assembly: 3357T Nightlatch	289
ED3000 Series Offset Pull Trim & Cylinder Options	290
ED3000 Series Keying Options	291
ED3000 Series Strike Options	292
ED3000 Series Miscellaneous, Door Width, Door Thickness, Door Height Options	293
ED3000 Series Mullions, Removable Mullions, Key Removable Mullions, Mullion Cylinder Options, Ordering Examples	294
ED4000 Narrow Stile Pushpad Series:	
ED4000 Series How to Order	295
ED4000 Series Standard Features	296
ED4000 Series Ordering Example	297
ED4000 Series: ED4200S, ED4200, ED4400, ED4800	298
ED4000 Series Museo Pushpad Exit Devices:	
ED4000 Series: Museo Levers with 800 Series Escutcheon: Georgia, Pablo, Jackson, Salvador, Josef Marc Levers	299
ED4000 Series: Museo Levers with 800 Series Escutcheon: Piet Levers	300
ED4000 Narrow Stile Pushpad Series:	
ED4000 Series Escutcheon Trim Designs: A8 Armstrong, C8 Citation, D8 Dirke	301
ED4000 Series Escutcheon Trim Designs: E8 Essex, L8 Lustra, N8 Newport, R8 Regis	302
ED4000 Series Escutcheon Trim Designs: PR8 Princeton, F4 Plate, O8 Plate x Thumbturn	303
ED4000 Series Escutcheon Trim Designs: O14 Plate x Thumbturn, T14 Pull/Thumbpiece, P10 Pull, K1 Key Only	304
ED4000 Series Pull Trim & Accessories	305
ED4000 Series Cylinder & Keying Options	306
ED4000 Series Door Height Options for ED4400, ED4800 Series, Width, Thickness, Strike Options	307
ED4000 Series Miscellaneous Options, Removable Mullion	308

Continued on next page.

ED5000 Pushpad Series:

ED5000 Series How to Order	309
ED5000 Series Standard Features	310
ED5000 Series Ordering Examples	311
ED5000 Series: ED5200S, ED5200, ED5400, ED5600, ED5800, ED5000DB	312

ED5000 Series: Museo Levers with 900 Series Escutcheon:

ED5000 Series: Museo Georgia, Pablo, Jackson, Salvador, Marc Josef Levers with 900 Series Escutcheon	313
ED5000 Series: Museo Georges Levers with 900 Series Escutcheon	314
ED5000 Series: Museo Piet Levers with 900 Series Escutcheon	315

ED5000 Pushpad Series:

ED5000 Series Escutcheon Trim Designs: A9 Armstrong, C9 Citation, D9 Dirke	316
ED5000 Series Escutcheon Trim Designs: E9 Essex, L9 Lustra, N9 Newport, R9 Regis	317
ED5000 Series Escutcheon Trim Designs: PR9 Princeton, F9, VT9	318
ED5000 Series Escutcheon Trim Designs: FR9 Frascati, M9 Merlot, Z9 Zinfandel	319
ED5000 Series Escutcheon Trim Designs: TH900 Pull/Thumbpiece, P9 Pull, K1 Key Only	320
ED5000 Series Escutcheon Trim Designs: A4M Armstrong, C9M Citation, D9M Dirke	321
ED5000 Series Escutcheon Trim Designs: E9M Essex, L9M Lustra, N9M Newport	322
ED5000 Series Escutcheon Trim Designs: R9M Regis, PR9M Princeton, F9	323
ED5000 Series Escutcheon Trim Designs: FR9M Frascati, M9M Merlot, Z9M Zinfandel	324
ED5000 Series Escutcheon Trim Designs: TH900, TH9M00 Pull/Thumbpiece, P9M Pull, VT9M, K1M Key Only	325
ED5000 Series Escutcheon Trim Designs: A4M Armstrong, C9M Citation, D9M Dirke, E9 Essex	326
ED5000 Series Escutcheon Trim Designs: L9 Lustra, N9 Newport, R9 Regis, PR9 Princeton	327
ED5000 Series Escutcheon Trim Designs: FR9 Frascati, M9 Merlot, Z9 Zinfandel	328
ED5000 Series Offset Pull Trim P12, P13, P14, Electrified Options, Delayed Egress Device, Retrofit MELR Kit:	329
ED5000 Series Electrified Accessories	330
ED5000 Series Cylinder & Keying Options	331
ED5000 Series Door Height, Door Width, Door Thickness, Strike Options	332
ED5000 Series Miscellaneous Options, Surface Bolt	333
ED5000 Series Mullions, Removable Mullions, Key Removable Mullions, Mullions Cylinder Options	334

ED7000 Narrow Stile Crossbar Series:

ED7000 Series Standard Features	335
ED7000 Series Ordering Example	336
ED7000 Series: ED7200, ED7400, ED7600, ED7800	337
ED7000 Series Pull Trim Designs: P4 D Grip Pull, P5 Round Grip Pull, P6 Pull, P7 Plate	338
ED7000 Series Escutcheon Trim Designs: C4 Citation, D4 Dirke, O3 D Grip Operator, O4 Round Grip Operator	339
ED7000 Series Escutcheon Trim Designs: O5 Operator, Offset Pull Trim: P12, P13, P14	340
ED7000 Series Cylinder & Keying Options	341
ED7000 Series Cylinder & Keying Options	342
ED7000 Series Strike Options	343
ED7000 Series Door Width, Door Thickness, Door Height, Miscellaneous Options	344
ED7000 Series Mortise Lock Only, Removable Mullion Ordering Example	344

MicroShield®

Look for the *MicroShield* icon.

ED3000
ED4000
ED5000
ED7000

MicroShield®

As part of their promise to provide innovative solutions to their customers, certain ASSA ABLOY Group brands offer the MicroShield® technology, a silver-based antimicrobial coating designed to inhibit the growth of bacteria.

MicroShield® is a registered trademark of Yale Security Inc., an ASSA ABLOY Group company.

Product	Series	MicroShield® Coated Components
Exit Devices	ED4000 and ED5000 Series	Inside rail, push rail, head cover, end cap* Outside trim: levers/pull* and escutcheons
	ED3000 and ED7000 Series	Active/Inactive case covers, cross bar, arms Outside trim: levers/pull* and escutcheons

AVAILABLE FINISHES

- MicroShield® is available on 626 and 630. Other finishes available by Special Product Application Request Form only.
- Specify 626C (satin chrome plated) or 630C (satin stainless steel) when ordering.
- MicroShield® coating will be applied over 626 and 630 finishes. All components will match 626.

Note: MicroShield® coating will only be applied to "high touch" components.

HOW TO ORDER

Product	How to Order
Exit Devices & Outside Trims (ordered together)	ED5200 x C955ET x 630C x LHR
Exit Devices & Trims (ordered separately)	N955ET x 630C x RHR

Description	Add
Exit Devices & Outside Trims (ordered together)	Add \$111.00 (when ordered together)
Exit Devices & Trims (ordered separately)	Add \$90.00

Standard Features

Handing

ED2200 Non-handed
ED2400 Handed; specify hand

Door Thickness

1-3/4"

Backset

2-3/4"

Bar Length

36 standard; 42" and 48"
available. Easily field cut to
size.

Projection

2-1/2"

Trim

Cylinder is not included.
See page 275 for
cylinder options.

RIM

ED2200
ED2200A

Panic
3 Hour Fire Rated

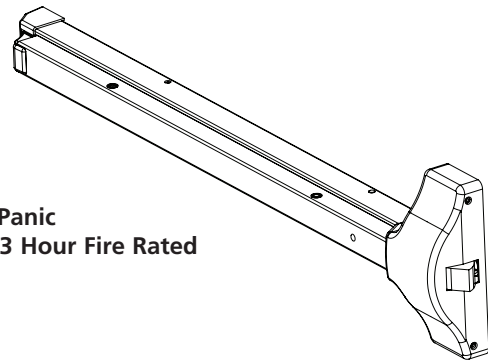

VERTICAL ROD

ED2400
ED2400A

Panic
3 Hour Fire Rated

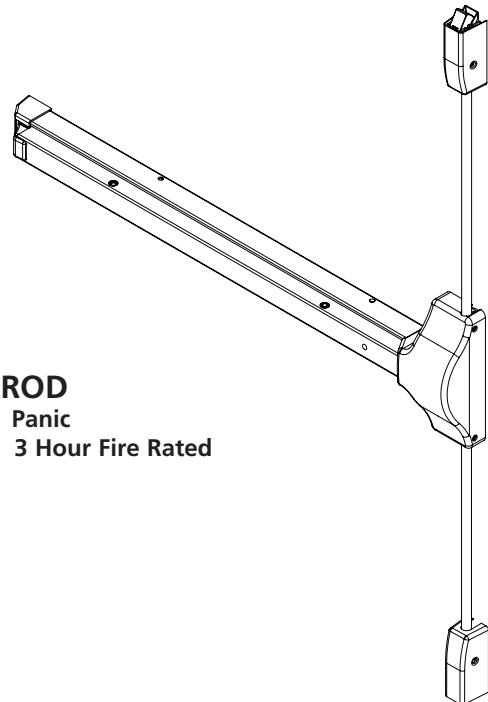

Ordering Example

Rim Exit Device

Quantity	Exit Device	Finish
20	ED2200	689

Rim Exit Device with Trim

Quantity	Exit Device	Trim/Function	Finish		Hand	Door Thickness	Door Width	Misc. Options
			Trim	Device				
50	ED2200A	A557ET	613	690	RHR	D200	W048	M58

Trim Only (Rim or Vertical Rod)

Quantity	Trim/Function	Finish	Hand
10	N555ET	606	RHR

Vertical Rod Exit Device with Trim

Quantity	Exit Device	Trim/Function	Finish		Hand	Optional Strike	Door Width	Height
			Trim	Device				
50	ED2400	PR510ET	626	689	RHR	S03	W048	H0700

Contract/Detailed Order - Rim Exit Device with Trim

Quantity	Keypad	Exit Device	Trim/Function	Finish		Hand	Door Thickness	Door Width	Optional Cylinder	Keying
				Trim	Device					
50	AA1	ED2200	N555ET	626	689	LHR	D200	W048	C6	VKC3

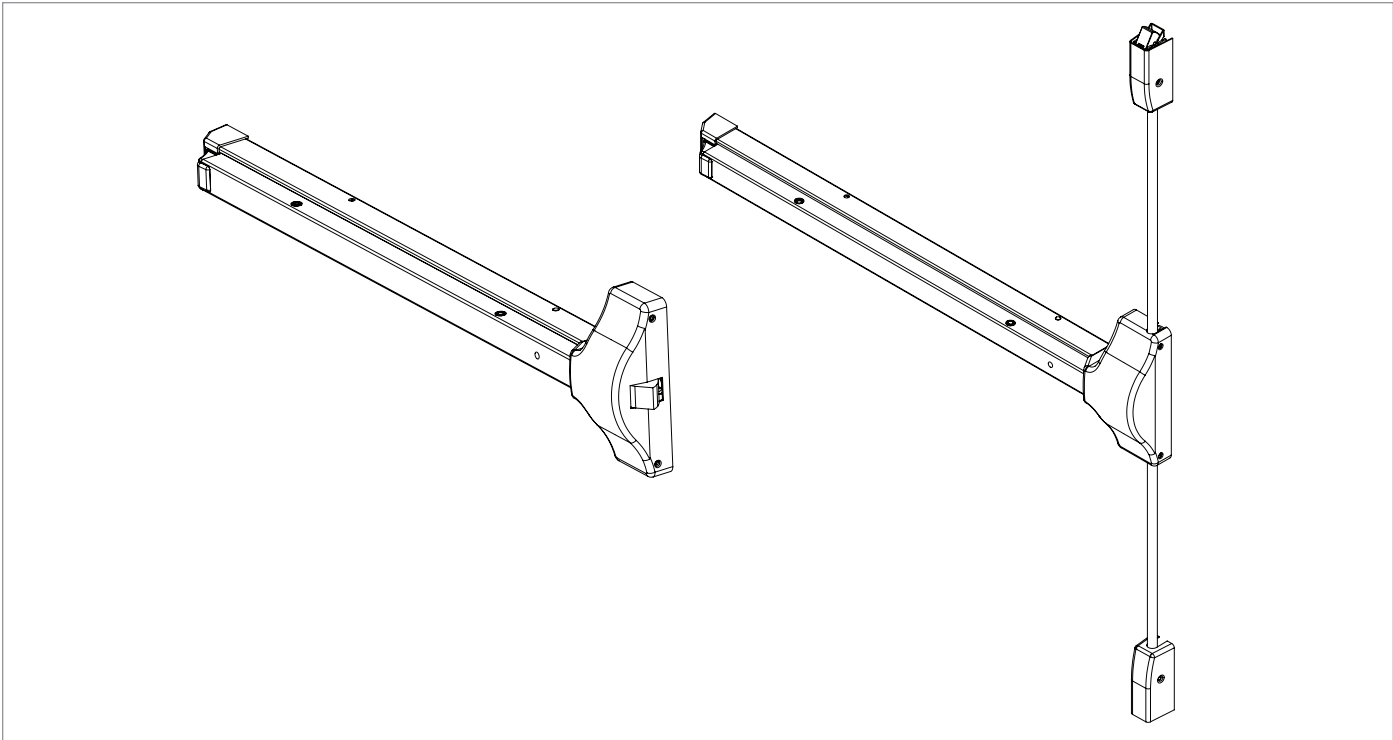

36", 42" and 48" Exit Devices

Includes device, strike(s) and screw pack. No cylinder or trim.

Rim ED2000 Series

Function	Description	Finish: 689, 690, 691
ED2200	Panic	\$317.00
ED2200A	3 Hour Fire Rated	\$418.00

Vertical Rod ED2400 Series

Function	Description	Finish: 689, 690, 691
ED2400	Panic	\$456.00
ED2400A	3 Hour Fire Rated	\$557.00

Caution: Be sure of your measurements. Exit devices are NOT returnable.

ED2200/ED2400 Rim and Surface Vertical Rod Trim

Cylinder is not included, except where noted.

Rose Trim Design: A5 Armstrong



Lever: Die cast zinc
Cylinder included

Rose: Wrought brass or bronze

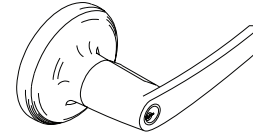

Function	Description	Finish: 605, 606, 611, 612, 613, 613E, 619, 625, 626, 722 BSP
A510ET	Passage	\$166.00
A550ET	Dummy	
A555ET	Classroom	\$207.00
A557ET	Nightlatch ¹	

Rose Trim Design: N5 Newport



Lever: Die cast zinc
Cylinder included

Rose: Wrought brass or bronze

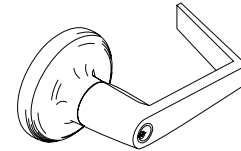

Function	Description	Finish: 605, 606, 611, 612, 613, 613E, 619, 625, 626, 722 BSP
N510ET	Passage	\$166.00
N550ET	Dummy	
N555ET	Classroom	\$207.00
N557ET	Nightlatch ¹	

Rose Trim Design: PR5 Princeton



Lever: Die cast zinc
Cylinder included

Rose: Wrought brass or bronze

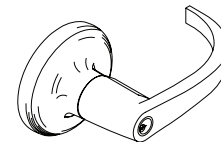

Function	Description	Finish: 605, 606, 611, 612, 613, 613E, 619, 625, 626, 722 BSP
PR510ET	Passage	\$166.00
PR550ET	Dummy	
PR555ET	Classroom	\$207.00
PR557ET	Nightlatch ¹	

Note:

1. Not recommended for use with ED2400 and ED2400A surface vertical rod exit devices.

ED2200/ED2400 Rim and Surface Vertical Rod Trim

Cylinder is not included, except where noted.

Flat Plate Trim Design: F1 Flat Plate

Plate: Steel

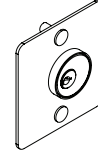

Function	Description	Finish: 605, 606, 611, 612, 613, 613E, 619, 625, 626, 722 BSP
F1857ET	Nightlatch ¹	\$93.00

Note:

1. Not recommended for use with ED2400 and ED2400A surface vertical rod exit devices.

Pull Trim Design: P8 Wing Pull



Pull: Extruded Aluminum

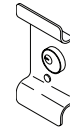

Function	Description	Finish: 689, 690, 691
P1850ET	Dummy	\$93.00
P1857ET	Nightlatch ¹	

Trim Design: K1 Key Only

Note: Available with cylinder option only.

Example: K157 x 6P

Cylinder option pricing applies.



Function	Description	Finish: 605, 606, 611, 612, 613, 619, 622, 625, 626, 722
K157ET	Nightlatch ¹	\$81.00

Cylinder Options*		
Rim Cylinder Trim		
Description	Specify Quick Code	Add or Deduct
Conventional 6-pin	6P**	Add \$120.00 per cylinder
Conventional 7-pin	7P	Add \$122.00 per cylinder
LFIC		
LFIC 6-pin	C6	Add \$224.00 per cylinder
LFIC 6-pin less core	CL6	Add \$120.00 per cylinder
LFIC 6-pin with temporary construction core (Red)	CT6R	Add \$224.00 per cylinder
LFIC 6-pin with temporary construction core (Blue)	CT6B	Add \$224.00 per cylinder
LFIC 6-pin with temporary construction core (Green)	CT6G	Add \$224.00 per cylinder
LFIC 6-pin with temporary disposable core	CT6D	Add \$120.00 per cylinder
LFIC 7-pin	C7	Add \$228.00 per cylinder
LFIC 7-pin less core	CL7	Add \$122.00 per cylinder
LFIC 7-pin with temporary construction core (Red)	CT7R	Add \$228.00 per cylinder
LFIC 7-pin with temporary construction core (Blue)	CT7B	Add \$228.00 per cylinder
LFIC 7-pin with temporary construction core (Green)	CT7G	Add \$228.00 per cylinder
LFIC 7-pin with temporary disposable core	CT7D	Add \$122.00 per cylinder
SFIC		
SFIC 6-pin	C6S	Add \$213.00 per cylinder
SFIC 6-pin with Temporary Construction Core (Blue)	CT6SB	Add \$213.00 per cylinder
SFIC 6-pin Disposable Temporary Core	CT6SD	Add \$120.00 per cylinder
SFIC 6-pin with Less Core	CLS6	Add \$120.00 per cylinder
SFIC 7-pin	C7S	Add \$213.00 per cylinder
SFIC 7-pin with Temporary Construction Core (Blue)	CT7SB	Add \$213.00 per cylinder
SFIC 7-pin Disposable Temporary Core	CT7SD	Add \$120.00 per cylinder
SFIC 7-pin with Less Core	CLS7	Add \$120.00 per cylinder
Security		
Security ⁴	HS	Add \$278.00 per cylinder
Security LFIC ⁴	CHS	Add \$378.00 per cylinder
Pyramid		
Pyramid Security fixed core	PS	Add \$204.00 per cylinder
Pyramid Security LFIC	PCS	Add \$301.00 per cylinder
Pyramid High Security fixed core	PHS	Add \$245.00 per cylinder
Pyramid High Security LFIC	PCHS	Add \$343.00 per cylinder
Pyramid LFIC with temporary construction core ³	CTP	Add \$224.00 per cylinder
Pyramid LFIC with temporary disposable core ³	CTPD	Add \$120.00 per cylinder
Pyramid LFIC less core	CLP	Add \$120.00 per cylinder

*Optional alarm unit cylinder and trim are keyed alike unless otherwise specified. If different keying is required, specify outside cylinder, then inside cylinder.

**6P cylinder option is supplied in 6-pin, L4 keyway, 0-bitted with two nickel silver keys.

Cylinder Options (continued) & Keying Options*

Description	Specify Quick Code	Add or Deduct
Keying and Keys		
0-bitted with 2 Blank Keys	(standard)	No Charge
Keyed Random	KR	
Construction Master Keyed ²	CMK	Add \$16.00 per cylinder
More than 2 Keys	KY# (e.g., KY6)	See page 33 - Cut Keys Section
Master Keying		
Master keyed (all cylinders except CR8000, CR8020, CR8027, CR8200, CR8500, CR8600, CR8700)	MK	Add \$16.00 per cylinder
Master keyed Pyramid (except CR8020, CR8027 LFIC cores)	MK	
Master keyed Security (including LFIC cylinder and core)	MK	
Master keyed Access 3 (except CR8500, CR8600, CR8700 LFIC cores)	MK	
Master keyed (CR8000, CR8020, CR8027, CR8200, CR8500, CR8600, CR8700)	MK-IC	No Charge
Master keyed to customer bittings or sample key	MK-CB	Add \$16.00 per cylinder
Visual Key Control (VKC)		
No bitting or keyset stamping on keys	VKC0	\$4.50
Keys only	VKC1	No Charge
Cylinders and keys (not for AS, AHS, ACS, ACHS, HS, CHS, PHS or PCHS)	VKC2	\$8.00
Cylinders only (not for AS, AHS, HS, ACS, ACHS, CHS, PHS or PCHS)	VKC3	
Concealed Key Control (CKC)		
CKC cylinders with VKC keys	CKC2	\$8.00
CKC cylinders only (not for AS, AHS, ACS, ACHS, PHS, PCHS)	CKC3	

Notes:

1. CMK Construction master keying charge is in addition to master keying charge.
 2. CMK construction master keying is not available in interchangeable core, Access 3, Pyramid, or Security series.
 3. VKC2, VKC3, CKC3 are not available in Pyramid or Security series.
- *For key bows other than 10 and 90, specify 'KB' + bow number as Quick Code, e.g. KB12. No extra charge.

Door Width Options		
Door Width	Specify	Add or Deduct
36"	(standard)	No Charge
42"	W042	
48"	W048	Add \$49.00 per device
Door Thickness Options		
Door Thickness	Specify	Add or Deduct
1-3/4"	(standard)	No Charge
2"	D200	
2-1/4"	D214	
Door Height Options		
Door Height	Specify	Add or Deduct
7'0" (ED2400 devices)	(standard)	No Charge
7'2"	H0702	
7'6"	H0706	
8'0" (ED2400A devices)	H0800	
Miscellaneous Options		
Description	Specify	Add or Deduct
Bottom Pullman Latch	BPL	Add \$43.00 per device
Lever to accept 6- or 7-pin Best-type IC core (SFIC) – (N5, PR5 design only)	M08	No Charge
Lever to accept Sargent® cylinder – (N5, PR5 design only)	M09	
Trim Lever to accept <i>Schlage</i> IC core – (N5, PR5 design only)	M69	
Less dogging	M51	
Sex nuts and bolts (SNBs)	M54	Add \$67.00 per mullion
Mullion Stabilizer	M57	
Shim kit (for vision light)		
- Rim device	M58	Add \$98.00 per device
- Vertical Rod device	M58	Add \$129.00 per device
Strike Options*		
Description	Specify	Add or Deduct
Rim strike on ED2200 device	(standard)	No Charge
Fire rated Rim strike on ED2200A devices		
Rim x Vertical Rod strike for pairs of doors	S02	Add \$50.00 per device
Vertical Rod top strike on ED2400 device	(standard)	No Charge
Vertical Rod surface projecting bottom strike on ED2400 device		
Vertical Rod flush bottom strike on ED2400 device	S09	No Charge
Fire rated Vertical Rod top strike on ED2400A device	(standard)	No Charge
Fire rated Vertical Rod bottom strike on ED2400A device	(standard)	No Charge

*To purchase strike separately, see catalog or parts manual for part no.

Removable Mullion (Cylinder not included)

Cylinder not included

Ordering Example

Quantity	Mullion Number
10	CR972

Door Height Options

Door Height	Specify	Price
Up to 7'2", Steel Mullion – Panic Rated	CR972	\$943.00
Up to 7'2", Steel Mullion – 3 Hour Fire Rated	CR972A	\$1,311.00
Up to 10'0", Steel Mullion – 3 Hour Fire Rated up to 8'	CR910A	\$1,321.00

Options

Description	Specify	Price
Up to 7'2", key removable mullion, 1-1/2 Hour Fire Rated	CR972BKM ¹	\$2,018.00
Up to 10'0", key removable mullion, 1-1/2 Hour Fire Rated up to 8'	CR910BKM ¹	\$2,028.00
Door frame filler block for double rabbeted frames	M95	Add \$45.00 per mullion
Door frame angle bracket for aluminum frames	M96	Add \$45.00 per mullion

Note 1: Cylinder and collars not included, specify separately

Mullions Cylinder Options

Description	Specify	Add or Deduct
Conventional 6-pin	6P	Add \$120.00 per cylinder
Conventional 7-pin	7P	Add \$122.00 per cylinder
LFIC 6-pin	C6	Add \$224.00 per cylinder
LFIC 7-pin	C7	Add \$228.00 per cylinder
Pyramid High Security Fixed Core	PHS	Add \$245.00 per cylinder
Pyramid Security Fixed Core	PS	Add \$204.00 per cylinder
Pyramid High Security IC	PCHS	Add \$343.00 per cylinder
Pyramid Security IC	PCS	Add \$301.00 per cylinder
Security	HS	Add \$278.00 per cylinder
Security IC	CHS	Add \$378.00 per cylinder
LFIC 6-pin with temporary construction core (Red)	CT6R	Add \$224.00 per cylinder
LFIC 6-pin with temporary construction core (Blue)	CT6B	Add \$224.00 per cylinder
LFIC 6-pin with temporary construction core (Green)	CT6G	Add \$224.00 per cylinder
LFIC 6-Pin with temporary disposable core	CT6D	Add \$120.00 per cylinder
LFIC 6-pin less core	CL6	Add \$120.00 per cylinder
LFIC 7-pin with temporary construction core (Red)	CT7R	Add \$228.00 per cylinder
LFIC 7-pin with temporary construction core (Blue)	CT7B	Add \$228.00 per cylinder
LFIC 7-pin with temporary construction core (Green)	CT7G	Add \$228.00 per cylinder
LFIC 7-Pin with temporary disposable core	CT7D	Add \$122.00 per cylinder
LFIC 7-pin less core	CL7	Add \$122.00 per cylinder

Standard Features

Handing

Handed, specify hand

Door Thickness

1-3/4"

Backset

2-3/4"

Projection

4" (102mm); 2 7/8" (74mm) depressed

Trim

Cylinder is not included.

See page 286 for cylinder options.

Rim

ED3200
ED3200A

Panic

3 Hour Fire Rated

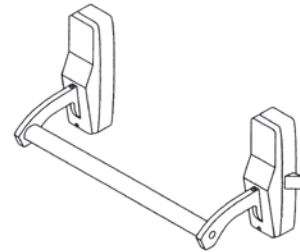

Surface Vertical Rod

ED3400
ED3400A

Panic

3 Hour Fire Rated

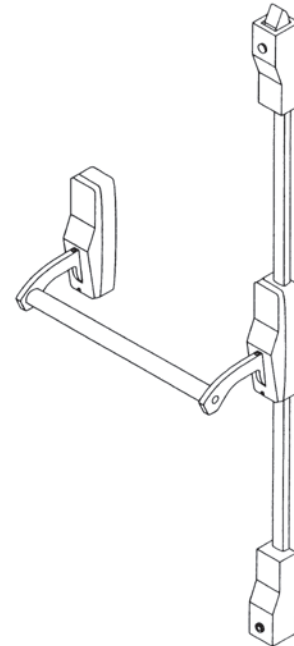

Mortise

ED3600
ED3600A

Panic

3 Hour Fire Rated

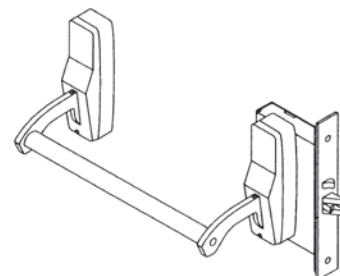

Ordering Examples
Rim Exit Device

Quantity	Exit Device	Finish	Hand	Misc. Options
20	ED3250	630	RHR	M51-M54

Rim Exit Device with Trim

Quantity	Exit Device	Trim	Finish	Hand	Door Thickness	Door Width	Misc. Options
50	ED3255A	A3355ET	630	RHR	D200	W048	M53

Trim Only (Rim Exit Device or Vertical Rod)

Quantity	Exit Device	Finish	Hand
10	L3310ET	606	RHR

Surface Vertical Rod Exit Device with Trim

Quantity	Exit Device	Trim	Finish	Hand	Door Thickness	Door Width	Misc. Options
50	ED3410	R3310ET	606	RHR	D214	W048	H1000

Mortise Exit Device with Trim

Quantity	Exit Device	Trim	Finish	Hand	Door Thickness	Strike	Door Width
50	ED3657	L3357ET	630	LHR	D200	SB200	W048

Contract/Detailed Order - Rim Exit Device with Trim

Quantity	Keyset	Exit Device	Trim	Finish	Hand	Door Thickness	Door Width	Optional Cylinders	Keying
50	AA1	ED3255	N3355ET	630	LHR	D200	W048	C6	VKC3

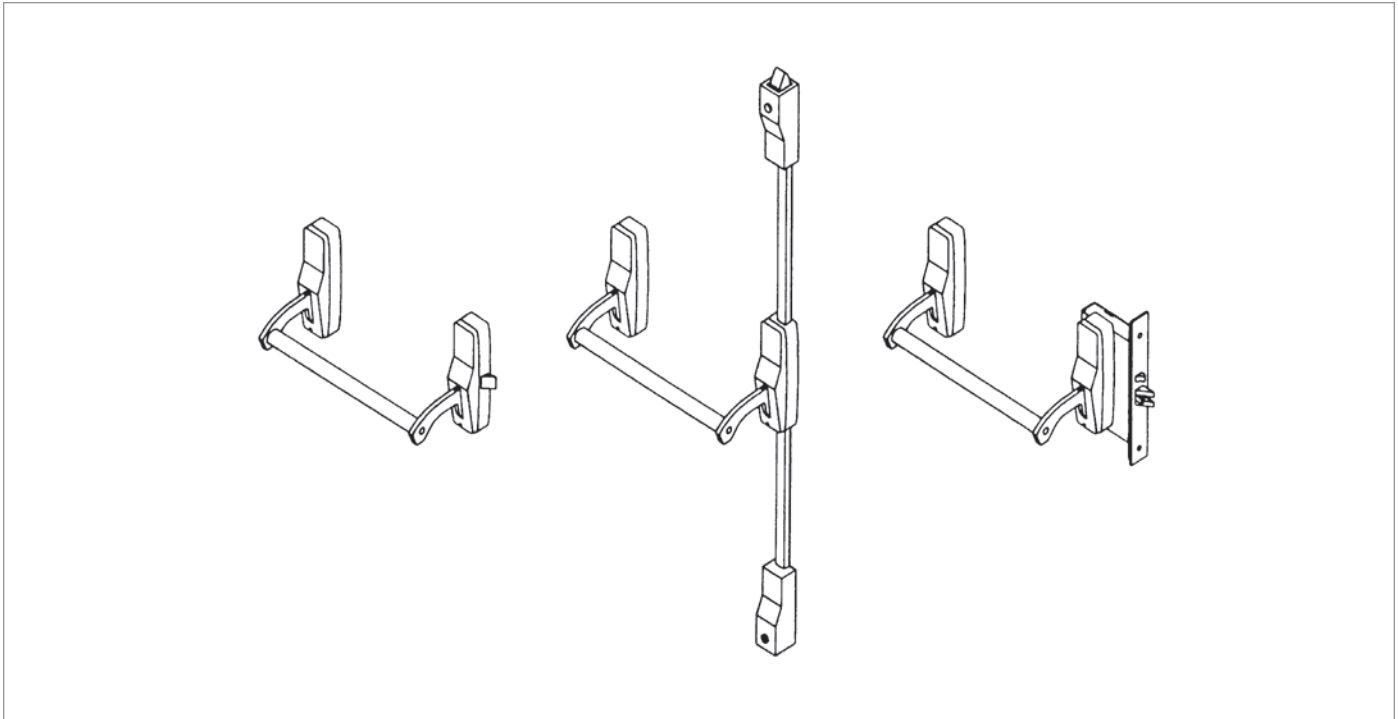

36" Device Only

Includes device, strike(s) and screw pack. No cylinder or trim.

Rim ED3200 Series

Function	Description	Finish: 613E	Finish: 605, 606, 611, 612, 613, 629, 630
ED3210	Panic device only (Passage)	\$2,614.00	\$2,784.00
ED3250	Panic device only (Dummy)		
ED3255	Panic (Classroom)		
ED3257	Panic (Nightlatch)		
ED3210T	Thumb Piece (Passage)		
ED3255T	Thumb Piece (Classroom)	\$2,844.00	\$3,014.00
ED3210A	3 Hour Fire Rated (Passage)		
ED3250A	3 Hour Fire Rated (Dummy)		
ED3255A	3 Hour Fire Rated (Classroom)		
ED3257A	3 Hour Fire Rated (Nightlatch)		
ED3210AT	Thumb Piece – 3 Hour Fire Rated (Passage)		
ED3255AT	Thumb Piece – 3 Hour Fire Rated (Classroom)		

Caution: Be sure of your measurements. Exit devices are NOT returnable.

Notes:

For doors over 1-3/4" thick, a Special Application Request must be submitted to the factory prior to approval and pricing.

Surface Vertical Rod ED3400 Series

Function	Description	Finish: 613E	Finish: 605, 606, 611, 612, 613, 629, 630
ED3410	Panic (Passage)	\$3,250.00	\$3,420.00
ED3450	Panic (Dummy)		
ED3455	Panic (Classroom)		
ED3457	Panic (Nightlatch)		
ED3410T	Thumb Piece (Passage)		
ED3455T	Thumb Piece (Classroom)		
ED3410A	3 Hour fire rated (Passage)	\$3,480.00	\$3,650.00
ED3450A	3 Hour fire rated (Dummy)		
ED3455A	3 Hour Fire Rated (Classroom)		
ED3457A	3 Hour Fire Rated (Nightlatch)		
ED3410AT	Thumb Piece – 3 Hour Fire Rated (Passage)		
ED3455AT	Thumb Piece – 3 Hour Fire Rated (Classroom)		

Mortise ED3600 Series

Function	Description	Finish: 613E	Finish: 605, 606, 611, 612, 613, 629, 630
ED3610	Panic (Passage)	\$2,966.00	\$3,136.00
ED3650	Panic (Dummy)		
ED3655	Panic (Classroom)		
ED3657	Panic (Nightlatch)		
ED3610T	Thumb Piece (Passage)		
ED3655T	Thumb Piece (Classroom)		
ED3610A	3 Hour fire rated (Passage)		
ED3650A	3 Hour fire rated (Dummy)		
ED3655A	3 Hour Fire Rated (Classroom)		
ED3657A	3 Hour Fire Rated (Nightlatch)		
ED3610AT	Thumb Piece – 3 Hour Fire Rated (Passage)		
ED3655AT	Thumb Piece – 3 Hour Fire Rated (Classroom)		

Caution: Be sure of your measurements. Exit devices are NOT returnable.

Notes:

For doors over 1-3/4" thick, a Special Application Request must be submitted to the factory prior to approval and pricing.

ED3200/ED3200A/ED3400/ED3400A/ED3600/ED3600A Rim, Surface Vertical Rod, and Mortise Trim

Cylinder is not included.

Escutcheon Trim Design: A33 Armstrong



Lever: Cast **Escutcheon:** Cast

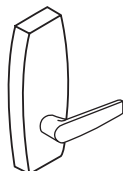

Function	Description	Finish: 605, 606, 611, 612, 613, 613E, 618, 619, 625, 626
A3310ET	Passage	\$783.00
A3350ET	Dummy	
A3355ET	Classroom	
A3357ET	Nightlatch – Rim	
A33V57ET	Nightlatch – SVR	
A33M57ET	Nightlatch – Mortise	

Escutcheon Trim Design: C33 Citation



Lever: Cast **Escutcheon:** Cast



Function	Description	Finish: 605, 606, 611, 612, 613, 613E, 618, 619, 625, 626
C3310ET	Passage	\$783.00
C3350ET	Dummy	
C3355ET	Classroom	
C3357ET	Nightlatch – Rim	
C33V57ET	Nightlatch – SVR	
C33M57ET	Nightlatch – Mortise	

Escutcheon Trim Design: D33 Dirke



Lever: Cast **Escutcheon:** Cast

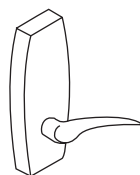

Function	Description	Finish: 605, 606, 611, 612, 613, 613E, 618, 619, 625, 626
D3310ET	Passage	\$783.00
D3350ET	Dummy	
D3355ET	Classroom	
D3357ET	Nightlatch – Rim	
D33V57ET	Nightlatch – SVR	
D33M57ET	Nightlatch – Mortise	

Escutcheon Trim Design: L33 Lustra



Lever: Cast **Escutcheon:** Cast

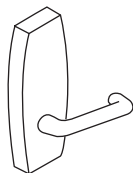

Function	Description	Finish: 605, 606, 611, 612, 613, 613E, 618, 619, 625, 626
L3310ET	Passage	\$783.00
L3350ET	Dummy	
L3355ET	Classroom	
L3357ET	Nightlatch – Rim	
L33V57ET	Nightlatch – SVR	
L33M57ET	Nightlatch – Mortise	

ED3200/ED3200A/ED3400/ED3400A/ED3600/ED3600A Rim, Surface Vertical Rod, and Mortise Trim

Cylinder is not included.

Escutcheon Trim Design: N33 Newport



Lever: Cast **Escutcheon:** Cast

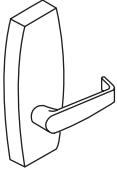

Function	Description	Finish: 605, 606, 611, 612, 613, 613E, 618, 619, 625, 626
N3310ET	Passage	\$783.00
N3350ET	Dummy	
N3355ET	Classroom	
N3357ET	Nightlatch – Rim	
N33V57ET	Nightlatch – SVR	
N33M57ET	Nightlatch – Mortise	

Escutcheon Trim Design: PR33 Princeton



Lever: Cast **Escutcheon:** Cast



Function	Description	Finish: 605, 606, 611, 612, 613, 613E, 618, 619, 625, 626
PR3310ET	Passage	\$783.00
PR3350ET	Dummy	
PR3355ET	Classroom	
PR3357ET	Nightlatch – Rim	
PR33V57ET	Nightlatch – SVR	
PR33M57ET	Nightlatch – Mortise	

Escutcheon Trim Design: R33 Regis



Lever: Cast **Escutcheon:** Cast

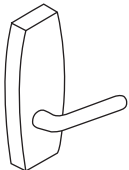

Function	Description	Finish: 605, 606, 611, 612, 613, 613E, 618, 619, 625, 626
R3310ET	Passage	\$783.00
R3350ET	Dummy	
R3355ET	Classroom	
R3357ET	Nightlatch – Rim	
R33V57ET	Nightlatch – SVR	
R33M57ET	Nightlatch – Mortise	

ED3200/ED3200A/ED3400/ED3400A/ED3600/ED3600A Rim, Surface Vertical Rod, and Mortise Trim

Cylinder is not included.

Escutcheon Trim Design: T33 D Grip

Grip: Extruded **Escutcheon:** Wrought



Function	Description	Finish: 629, 630
T3310ET	Passage	\$513.00
T3350ET	Dummy	
T3355ET	Classroom	
T3357ET	Nightlatch – Rim	
T33M55ET	Classroom – Mortise	
T33M57ET	Nightlatch – Mortise	

Escutcheon Trim Design: T34 Round Grip

Grip: Extruded **Escutcheon:** Wrought



Function	Description	Finish: 629, 630
T3410ET	Passage	\$513.00
T3450ET	Dummy	
T3455ET	Classroom	
T3457ET	Nightlatch – Rim	
T34M55ET	Classroom – Mortise	
T34M57ET	Nightlatch – Mortise	

Escutcheon Trim Design: T35 Sectional Grip

Grip: Extruded



Function	Description	Finish: 629, 630
T3510ET	Passage	\$547.00
T3550ET	Dummy	
T3555ET	Classroom	
T3557ET	Nightlatch – Rim	
T35M55ET	Classroom – Mortise	
T35M57ET	Nightlatch – Mortise	

Auxiliary Control/Inside Lever Assembly: 3357T Nightlatch

Auxiliary Control



Function	Description	Finish: 605, 606, 611, 612, 613, 613E, 618, 619, 625, 626
3357T	Auxiliary Control/Inside Lever Assembly	\$950.00

Inside Lever Assembly



Offset Pull Trim: P12, P13, P14

Offset Pull Trim	Part Number	Finish: 605, 606, 612, 613, 613E, 626, 629, 630, BSP
P12	716F50M X Finish	\$397.00
P13	716F51M X Finish	\$484.00
P14	716F52M X Finish	\$340.00

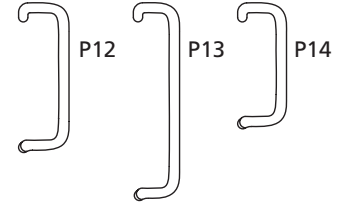
Cylinder Options*

Description	Specify Quick Code	Add or Deduct
Conventional 6-pin	6P*	Add \$120.00 per cylinder
Conventional 7-pin	7P	Add \$122.00 per cylinder
LFIC		
LFIC 6-pin	C6	Add \$224.00 per cylinder
LFIC 6-pin less core	CL6	Add \$120.00 per cylinder
LFIC 6-pin with temporary construction core (Red)	CT6R	Add \$224.00 per cylinder
LFIC 6-pin with temporary construction core (Blue)	CT6B	Add \$224.00 per cylinder
LFIC 6-pin with temporary construction core (Green)	CT6G	Add \$224.00 per cylinder
LFIC 6-pin with temporary disposable core	CT6D	Add \$120.00 per cylinder
LFIC 7-pin	C7	Add \$228.00 per cylinder
LFIC 7-pin less core	CL7	Add \$122.00 per cylinder
LFIC 7-pin with temporary construction core (Red)	CT7R	Add \$228.00 per cylinder
LFIC 7-pin with temporary construction core (Blue)	CT7B	Add \$228.00 per cylinder
LFIC 7-pin with temporary construction core (Green)	CT7G	Add \$228.00 per cylinder
LFIC 7-pin with temporary disposable core	CT7D	Add \$122.00 per cylinder
SFIC		
SFIC 6-pin	C6S	Add \$213.00 per cylinder
SFIC 6-pin with temporary construction core (Blue)	CT6SB	Add \$213.00 per cylinder
SFIC 6-pin with SFIC disposable temporary core	CT6SD	Add \$120.00 per cylinder
SFIC 6-pin with Less Core	CLS6	Add \$120.00 per cylinder
SFIC 7-pin	C7S	Add \$213.00 per cylinder
SFIC 7-pin with temporary construction core (Blue)	CT7SB	Add \$213.00 per cylinder
SFIC 7-pin with SFIC disposable temporary core	CT7SD	Add \$120.00 per cylinder
SFIC 7-pin with Less Core	CLS7	Add \$120.00 per cylinder
Security		
Security ⁴	HS	Add \$278.00 per cylinder
Security LFIC ⁴	CHS	Add \$378.00 per cylinder
Access 3		
Access 3 Patented	AP	Add \$120.00 per cylinder
Access 3 Security	AS	Add \$198.00 per cylinder
Access 3 High Security, UL 437	AHS	Add \$231.00 per cylinder
Access 3 LFIC Patented	ACP	Add \$224.00 per cylinder
Access 3 LFIC Security	ACS	Add \$302.00 per cylinder
Access 3 LFIC High Security, UL 437	ACHS	Add \$335.00 per cylinder
Pyramid		
Pyramid Security fixed core	PS	Add \$204.00 per cylinder
Pyramid Security LFIC	PCS	Add \$301.00 per cylinder
Pyramid High Security fixed core	PHS	Add \$245.00 per cylinder
Pyramid High Security LFIC	PCHS	Add \$343.00 per cylinder
Pyramid LFIC with temporary construction core ³	CTP	Add \$224.00 per cylinder
Pyramid LFIC with temporary disposable core ³	CTPD	Add \$120.00 per cylinder
Pyramid LFIC less core	CLP	Add \$120.00 per cylinder

*6P cylinder option is supplied in 6-pin, L4 keyway 0-bitted with two nickel silver keys.

IC 6-pin with temporary construction core CT6.

IC 7-pin with temporary construction core CT7.

**Not available with Rim or SVR Lever Trim – Classroom Function.
or SVR Lever Trim – Night Latch Function.

Cylinder Options (continued) & Keying Options*		
Description	Specify Quick Code	Add or Deduct
Keying and Keys		
0-bitted with 2 Blank Keys	(standard)	No Charge
Keyed Random	KR	
Construction Master Keyed ²	CMK	Add \$16.00 per cylinder
More than 2 Keys	KY# (e.g., KY6)	See page 33 - Cut Keys Section
Master Keying		
Master keyed (all cylinders except CR8000, CR8020, CR8027, CR8200, CR8500, CR8600, CR8700)	MK	Add \$16.00 per cylinder
Master keyed Pyramid (except CR8020, CR8027 LFIC cores)	MK	
Master keyed Security (including LFIC cylinder and core)	MK	
Master keyed Access 3 (except CR8500, CR8600, CR8700 LFIC cores)	MK	
Master keyed (CR8000, CR8020, CR8027, CR8200, CR8500, CR8600, CR8700)	MK-IC	No Charge
Master keyed to customer bittings or sample key	MK-CB	Add \$16.00 per cylinder
Visual Key Control (VKC)		
No bitting or keyset stamping on keys	VKC0	\$4.50
Keys only	VKC1	No Charge
Cylinders and keys (not for AS, AHS, ACS, ACHS, HS, CHS, PHS or PCHS)	VKC2	\$8.00
Cylinders only (not for AS, AHS, HS, ACS, ACHS, CHS, PHS or PCHS)	VKC3	
Concealed Key Control (CKC)		
CKC cylinders with VKC keys	CKC2	\$8.00
CKC cylinders only (not for AS, AHS, ACS, ACHS, PHS, PCHS)	CKC3	

Notes:

1. CMK Construction master keying charge is in addition to master keying charge.
2. CMK Construction master keying is not available in interchangeable core, Access 3, Pyramid, or Security series.
3. VKC2, VKC3, CKC3 are not available in Pyramid or Security series.

Custom Laser Engraving- LASER

Laser engraving processing charge (all engraving types)

- \$250.00 net per order. Charge will be applied to production order when placed.

Single Vanity, Logo or Other (same engraving on all parts)

- Lever - \$10.00 net add each
- Mortise Escutcheon - \$10.00 net add each
- HPSK Paddle - \$10.00 net add each

Unique laser engraving (i.e. Room Number, Apartment Number, etc)

- \$12.00 net add each (per piece)

Strike Options

To purchase strike separately see catalog for part no.

Description	Specify Quick Code	Add or Deduct
Fire rated rim strike on ED3200	(standard)	No Charge
Mortised adjustable rim strike	S04	
Rim x vertical rod strike for pairs of doors	S02	Add \$50.00 per device
Vertical rod flush bottom strike (ED3400 only)	S03	No Charge
Vertical rod surface projecting bottom strike on ED3400 device	(standard)	
Fire rated vertical rod bottom strike on ED3400A device	(standard)	
Fire rated vertical rod bottom strike for threshold	S06	

Description	Door Thickness	Specify	Add or Deduct
Curved lip ANSI strike	1-3/4"	SA114 (standard)	No Charge
	2"	SA138	
	2-1/4"	SA158	

Description	Door Thickness	Specify	Add or Deduct
Mortise straight lip ANSI strike on ED3600, ED3600A	1-3/4"	SS118	No Charge
	2"	SS138	
	2-1/4"	SS158	

Description	Door Thickness	Specify	Add or Deduct
Mortise open back strike	1-3/4"	SB134	Add \$114.00 per device
	2"	SB200	\$182.00
	2-1/4"	SB214	\$182.00

Miscellaneous Options

Description	Specify	Add or Deduct
Spanner head screws	M02	Add \$47.00 per device
Torx® screws for rim, mortise	M04	Add \$63.00 per device
Torx® screws for surface vertical rod		Add \$118.00 per device
Abrasive coat outside and inside (trim and device)	M23	Add \$126.00 per device
Abrasive coat inside only (device side)	M24	Add \$66.00 per device
Abrasive coat outside only (trim side)	M25	Add \$60.00 per device
Steel reinforced crossbar	M53	Add \$93.00 per device
Sex nuts and bolts (SNBs)	M54	No Charge
Mullion stabilizer	M57	Add \$67.00 per mullion
Shim for 2-3/4" backset on doors with 1/2" stop (rim devices only)	M59	No Charge
Flush transom bracket	M67	Add \$40.00 per device

Door Width Options

Description	Specify	Add or Deduct
36"	(standard)	No Charge
48"	W048	Add \$49.00 per device

Door Thickness Options

Description	Specify	Add or Deduct
1-3/4"	(standard)	No Charge
2"	D200	
2-1/4"	D214	

Door Height Options

Description	Specify	Add or Deduct
7'0" H0700	H0700	No Charge
7'2" H0702	H0702	
7'6" H0706	H0706	
8' (Standard)	(standard)	
8'6" H0806 (ED3400 device only)	H0806	Add \$112.00 per device
9' H0900 (ED3400 device only)	H0900	
10' H01000 (ED3400 device only)	H1000	

Mullions

Cylinder not included

Ordering Example

Quantity	Mullion Number
10	CR972

Removable Mullion

Description	Specify	Price
Up to 7'2" Steel Mullion - Panic Rated	CR972	\$943.00
Up to 7'2", Steel Mullion - 3 Hour Fire Rated	CR972A	\$1,311.00
Up to 10' (Only Fire rated up to 8'), Steel Mullion - 3 Hour Fire up to 8' size	CR910A	\$1,321.00

Key Removable Mullion

Description	Specify	Price
Up to 7'2", key removable mullion, 1-1/2 Hour Fire Rated	CR972BKM ¹	\$2,018.00
Up to 10' (only fire rated up to 8'), key removable mullion, 1-1/2 Hour Fire Rated	CR908BKM ^{1,2}	\$2,028.00
Door frame filler block for double rabbeted frames	M95	Add \$45.00 per mullion
Door frame angle bracket for aluminum frames	M96	Add \$45.00 per mullion

Notes: 1. Cylinder and collars not included, specify separately.

2. Mullions longer than 8" must be ordered as fire rated option x 10' length. Fire rating is valid only up to 96".

Mullions Cylinder Options

Description	Specify Quick Code	Add or Deduct
Conventional 6-pin	6P	Add \$120.00 per cylinder
Conventional 7-pin	7P	Add \$122.00 per cylinder
LFIC		
LFIC 6-pin	C6	Add \$224.00 per cylinder
LFIC 6-pin less core	CL6	Add \$120.00 per cylinder
LFIC 6-pin with temporary construction core (Red)	CT6R	Add \$224.00 per cylinder
LFIC 6-pin with temporary construction core (Blue)	CT6B	Add \$224.00 per cylinder
LFIC 6-pin with temporary construction core (Green)	CT6G	Add \$224.00 per cylinder
LFIC 6-pin with temporary disposable core	CT6D	Add \$120.00 per cylinder
LFIC 7-pin	C7**	Add \$228.00 per cylinder
LFIC 7-pin less core	CL7	Add \$122.00 per cylinder
LFIC 7-pin with temporary construction core (Red)	CT7R**	Add \$228.00 per cylinder
LFIC 7-pin with temporary construction core (Blue)	CT7B**	Add \$228.00 per cylinder
LFIC 7-pin with temporary construction core (Green)	CT7G**	Add \$228.00 per cylinder
LFIC 7-pin with temporary disposable core	CT7D**	Add \$122.00 per cylinder
Security		
Security	HS	Add \$278.00 per cylinder
Security LFIC	CHS	Add \$378.00 per cylinder
Pyramid		
Pyramid Security fixed core	PS	Add \$204.00 per cylinder
Pyramid Security LFIC	PCS	Add \$301.00 per cylinder
Pyramid High Security fixed core	PHS	Add \$245.00 per cylinder
Pyramid High Security LFIC	PCHS	Add \$343.00 per cylinder

IC 7-pin with temporary construction core CT7.

**Not available with Rim or SVR Lever Trim – Classroom Function. or SVR Lever Trim – Night Latch Function.

Mortise Lock Only

Lock Number	Description	Finish: 605, 606, 611, 612, 613, 613E, 625, 626
MLE012	Lockbody for Nightlatch/Dummy function	\$873.00
MLE013	Lockbody for Classroom function	
MLE014	Lockbody for Passage function	
MLE015	Lockbody for Passage Thumbpiece function	
MLE016	Lockbody for Classroom Thumbpiece function	

Ordering Example

Mortise Lock Only

Quantity	Lock Number	Finish	Hand
2	MLE013	630	LHR



The PathLite™ patent pending technology offers a number of benefits:

- Requires no wiring or maintenance
- Recharges with exposure to ambient light
- Unaffected by heat or cold
- Non-toxic, will not rub or fade
- Vandal resistant
- Fire resistant and non-radioactive
- Green contrasting word "EXIT" centered on touchbar in 1-1/4" high lettering
- Cost effective; especially suited for existing buildings

PathLite™ photoluminescent exit devices meet New York City's newly adopted standards for requirement of photoluminescent signage and stairwell markings in all office buildings in excess of 75 feet in height.

How To Order Complete Device

Exit Device	Trim/Function	Finish	Hand	Misc. Options
ED4200	A810	630	RHR	M49

ED4200 x A810 x 630 x RHR x M49

Options	Specify	Price
24", 36" , and 48" PathLite™ Photoluminescent Touchbar Cover	M49	Add \$475.00 per device

How to Order Touchbar Cover Only

Options	Part Number	Price
24" PathLite™ Photoluminescent Touchbar cover	710F797	\$469.00
36" PathLite™ Photoluminescent Touchbar cover	710F737	
48" PathLite™ Photoluminescent Touchbar cover	710F747	

**Standard Features
Handing**

Devices are field reversible;
specify hand. Lever trims are
handed; specify hand

Door Thickness

1-3/4"

Projection

3-1/4"; 2-3/4" dogged

Trim

Cylinder is not included.
See page 302 for
cylinder options

Door Width

36"

Product	Minimum Stile
ED4200S	2"
ED4200SM	3 1/2"
ED4200SMA	3 1/2"
ED4200	2"
ED4200M	3 1/2"
ED4200MA	3 1/2"
ED4400	2"
ED4400M	3 1/2"
ED4400MA	3 1/2"
ED4800	2"
ED4800M	3 1/2"
ED4800MA	3 1/2"

SecureBolt®

ED4200S Panic
ED4200SM Panic
ED4200SMA 3 Hour Fire Rated

Rim

ED4200 Panic
ED4200M Panic
ED4200MA 3 Hour Fire Rated

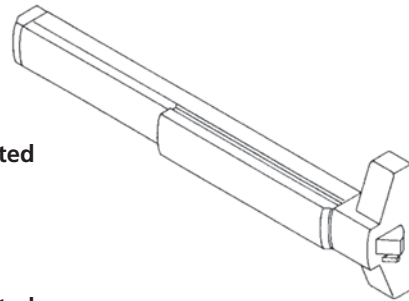

Surface Vertical Rod

ED4400 Panic
ED4400M Panic
ED4400MA 3 Hour Fire Rated

Concealed Vertical Rod

ED4800 Panic
ED4800M Panic
ED4800MA 3 Hour Fire Rated

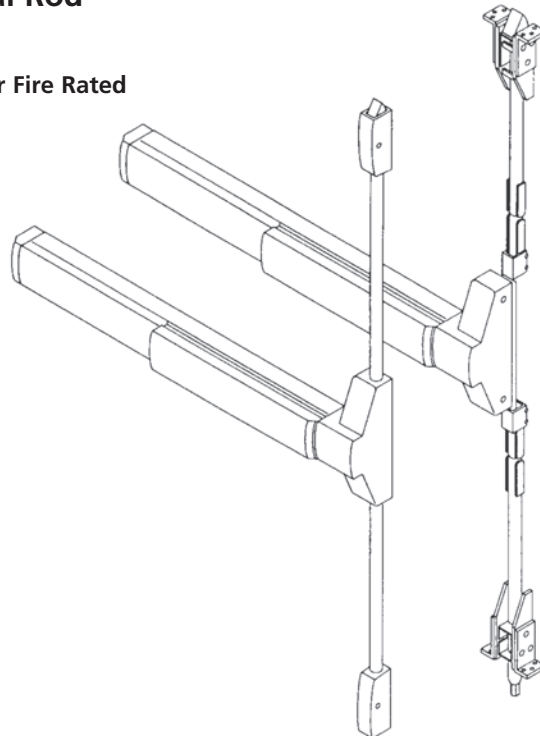

Ordering Example

Exit Device Only

Quantity	Exit Device	Finish	Hand	Misc. Options
20	ED4200	606	RHR	M51-M54

Removable Mullions

Quantity	Mullion	Finish	Misc. Options
12	CR808	695	M57

Exit Device with Trim

Quantity	Exit Device	Trim/Function	Finish	Hand	Door Thickness	Door Width	Door Height	Misc. Options
10	ED4400	N855ET	605	LHR	D200	W048	H0706	M51-M54

Trim Only

Quantity	Trim/Function	Finish	Hand	Door Thickness
24	N855ET	625	RHR	D214

Contract/Detailed Order - Rim Exit Device with Trim

Quantity	Keypad	Exit Device	Trim/Function	Finish	Hand	Door Height	Optional Strike	Door Width	Misc. Options	Optional Cylinder
36	AA1	ED4400	C855ET	626	LHR	H0800	S09	W048	M52-M54	7P

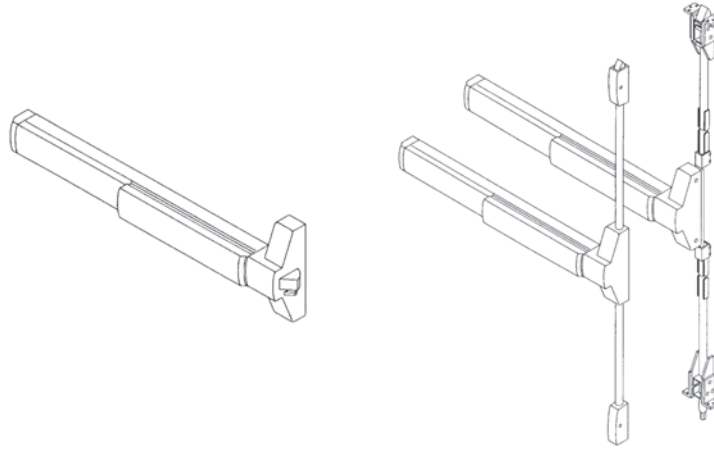

36" Device Only, See Quick Code section for 24" and 48" door width options

Includes device, strike(s) and screw pack. No cylinder or trim.

SecureBolt® ED4200S Series

Function	Description	Finish: 613E, 630, BSP, WSP	Finish: 605, 606, 611, 612, 613, 618, 619, 625, 629, 722
ED4200S	Panic	\$2,885.00	\$2,965.00
ED4200SM	Panic	\$2,885.00	\$2,965.00
ED4200SMA	3 Hour Fire Rated	\$3,115.00	\$3,195.00

Rim ED4200 Series

Function	Description	Finish: 613E, 630, BSP, WSP	Finish: 605, 606, 611, 612, 613, 618, 619, 625, 629, 722
ED4200	Panic	\$2,799.00	\$2,879.00
ED4200M	Panic	\$2,799.00	\$2,879.00
ED4200MA	3 Hour Fire Rated	\$3,029.00	\$3,109.00

Vertical Rod ED4400 Series

Function	Description	Finish: 613E, 630, BSP, WSP	Finish: 605, 606, 611, 612, 613, 618, 619, 625, 629, 722
ED4400	Panic	\$3,186.00	\$3,266.00
ED4400M	Panic	\$3,186.00	\$3,266.00
ED4400MA	3 Hour Fire Rated	\$3,416.00	\$3,496.00

Concealed V.R. ED4800 Series

Function	Description	Finish: 613E, 630, BSP, WSP	Finish: 605, 606, 611, 612, 613, 618, 619, 625, 629, 722
ED4800	Panic	\$3,514.00	\$3,594.00
ED4800M	Panic	\$3,514.00	\$3,594.00
ED4800MA	3 Hour Fire Rated	\$3,744.00	\$3,824.00

Caution: Be sure of your measurements. Exit devices are NOT returnable.

Pushpad Exit Devices

ED4000 Series: Muséo Levers with 800 Series Escutcheon

USA & Canada Prices Effective April 17, 2023



contemporary levers to complement the interior design of your next project

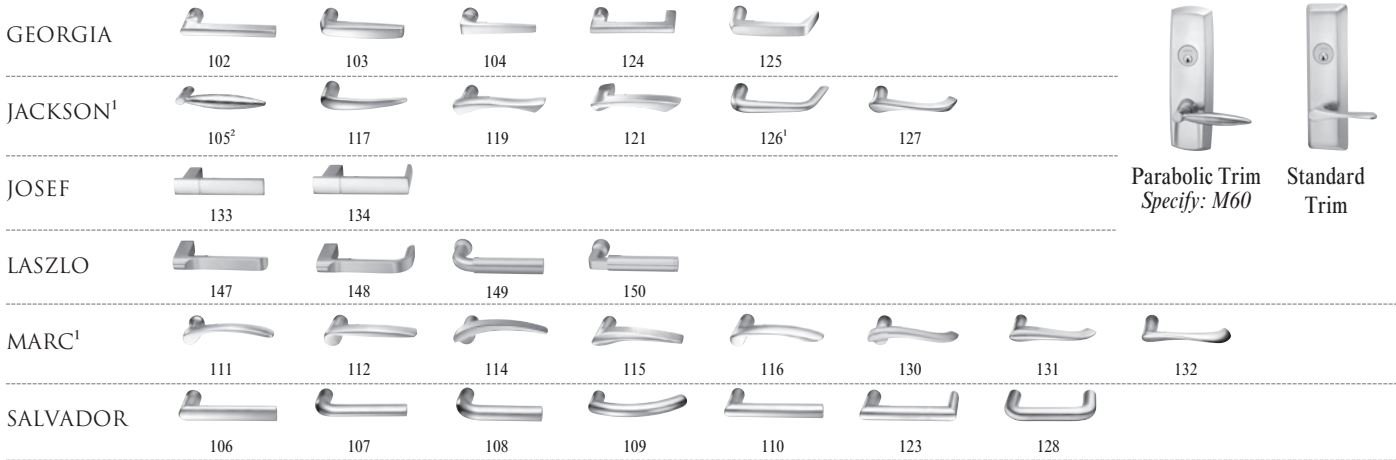

- 1. Handed: specify hand when ordering
- 2. Contact factory for current lead time

*629 and *630 finish options are Not available for all Muséo levers. Please refer to page 26 for availability.

605	Bright Brass, Clear Coated	613L	Dark Oxidized Satin Bronze, Clear Coated	BSP	Black Suede Powder Coat
606	Satin Brass, Clear Coated	618	Bright Nickel Plated	WSP	White Suede Powder Coat
611	Bright Bronze, Clear Coated	619	Satin Nickel Plated	722	Black Oxidized Bronze, Oil Rubbed
612	Satin Bronze, Clear Coated	625	Bright Chromium Plated		
613	Dark Oxidized Satin Bronze, Oil Rubbed	626	Satin Chromium Plated		
613E	Dark Oxidized Satin Bronze - Equivalent	629*	Bright Stainless Steel		
		630*	Satin Stainless Steel		

Function

Rim/SVR/CVR	810 850 855 859	Passage Dummy Classroom Storeroom	\$917.00
Options	M60	Parabolic Escutcheon	Add \$107.00 per device

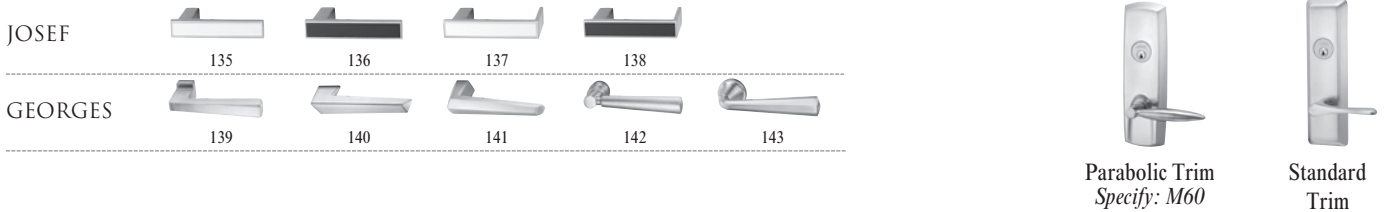

- 1. Handed: specify hand when ordering
- 2. Contact factory for current lead time

605	Bright Brass, Clear Coated	613L	Dark Oxidized Satin Bronze, Clear Coated	BSP	Black Suede Powder Coat
606	Satin Brass, Clear Coated	618	Bright Nickel Plated	WSP	White Suede Powder Coat
611	Bright Bronze, Clear Coated	619	Satin Nickel Plated	722	Black Oxidized Bronze, Oil Rubbed
612	Satin Bronze, Clear Coated	625	Bright Chromium Plated		
613	Dark Oxidized Satin Bronze, Oil Rubbed	626	Satin Chromium Plated		
613E	Dark Oxidized Satin Bronze - Equivalent	629*	Bright Stainless Steel		
		630*	Satin Stainless Steel		

Rim/SVR/CVR	810 850 855 859	Passage Dummy Classroom Storeroom	\$988.00
Options	M60	Parabolic Escutcheon	Add \$107.00 per device



Experience a safer and more open world

Pushpad Exit Devices

ED4000 Series: Muséo Levers with 800 Series Escutcheon

USA & Canada Prices Effective April 17, 2023

contemporary levers to complement the interior design of your next project



*613E, BSP, WSP finishes are not available with 21M levers.



Parabolic Trim
Specify: M60

Standard Trim

613E	Dark Oxidized Satin Bronze – Equivalent
629	Bright Stainless Steel
630	Satin Stainless Steel
BSP	Black Suede Powder Coat
WSP	White Suede Powder Coat

Function

Rim/SVR/CVR	810	Passage		\$988.00
	850	Dummy		
	855	Classroom		
	859	Storeroom		
Options	M60	Parabolic Escutcheon		Add \$107.00 per device



Experience a safer
and more open world

ED4200S/ED4200/ED4400/ED4800 SecureBolt®, Rim, Surface and Concealed V.R. Trim

Cylinder is not included.

Escutcheon Trim Design: A8 Armstrong



Lever: Cast

Escutcheon: Wrought

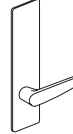

Function	Description	Finish: 605, 606, 611, 612, 613, 613E, 618, 619, 625, 626, 629, 630, 722, BSP
A810ET	Passage	\$890.00
A850ET	Dummy	
A855ET	Classroom ¹	
A859ET	Storeroom	

Escutcheon Trim Design: C8 Citation



Lever: Cast

Escutcheon: Wrought

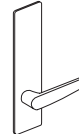

Function	Description	Finish: 605, 606, 611, 612, 613, 613E, 618, 619, 625, 626, 629, 630, 722, BSP
C810ET	Passage	\$890.00
C850ET	Dummy	
C855ET	Classroom ¹	
C859ET	Storeroom	

Escutcheon Trim Design: D8 Dirke



Lever: Cast

Escutcheon: Wrought

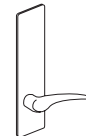

Function	Description	Finish: 605, 606, 611, 612, 613, 613E, 618, 619, 625, 626, 629, 630, 722, BSP
D810ET	Passage	\$890.00
D850ET	Dummy	
D855ET	Classroom ¹	
D859ET	Storeroom	

Note:

1. Classroom function trim may be converted to storeroom function by a simple field adjustment. No additional parts required.

ED4200S/ED4200/ED4400/ED4800 SecureBolt® , Rim, Surface and Concealed V.R. Trim

Cylinder is not included.

Escutcheon Trim Design: E8 Essex



Lever: Cast

Escutcheon: Wrought

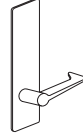

Function	Description	Finish: 605, 606, 611, 612, 613, 613E, 618, 619, 625, 626, 629, 630, 722, BSP
E810ET	Passage	\$890.00
E850ET	Dummy	
E855ET	Classroom ¹	
E859ET	Storeroom	

Escutcheon Trim Design: L8 Lustra



Lever: Cast

Escutcheon: Wrought

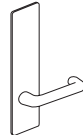

Function	Description	Finish: 605, 606, 611, 612, 613, 613E, 618, 619, 625, 626, 629, 630, 722, BSP
L810ET	Passage	\$890.00
L850ET	Dummy	
L855ET	Classroom ¹	
L859ET	Storeroom	

Escutcheon Trim Design: N8 Newport



Lever: Cast

Escutcheon: Wrought

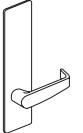

Function	Description	Finish: 605, 606, 611, 612, 613, 613E, 618, 619, 625, 626, 629, 630, 722, BSP
N810ET	Passage	\$890.00
N850ET	Dummy	
N855ET	Classroom ¹	
N859ET	Storeroom	

Escutcheon Trim Design: R8 Regis



Lever: Cast

Escutcheon: Wrought

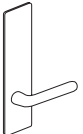

Function	Description	Finish: 605, 606, 611, 612, 613, 613E, 618, 619, 625, 626, 629, 630, 722, BSP
R810ET	Passage	\$890.00
R850ET	Dummy	
R855ET	Classroom ¹	
R859ET	Storeroom	

Note: 1. Classroom function trim may be converted to storeroom function by a simple field adjustment. No additional parts required.

ED4200S/ED4200/ED4400/ED4800 SecureBolt® , Rim, Surface and Concealed V.R. Trim

Cylinder is not included.

Escutcheon Trim Design: PR8 Princeton



Lever: Cast

Escutcheon: Wrought



Function	Description	Finish: 605, 606, 611, 612, 613, 613E, 618, 619, 625, 626, 629, 630, 722, BSP
PR810ET	Passage	\$890.00
PR850ET	Dummy	
PR855ET	Classroom ¹	
PR859ET	Storeroom	

Escutcheon Trim Design: F4 Plate

Plate: Wrought



Function	Description	Finish: 605, 606, 611, 612, 613, 613E, 618, 619, 625, 626, 629, 630, 722, BSP
F450ET	Dummy	\$353.00
F457ET	Nightlatch	

Escutcheon Trim Design: O8 Plate x Thumbturn

Plate: Wrought

Thumbturn: Cast



Function	Description	Finish: 605, 606, 612, 613, 613E, 630, 722, BSP
O810	Passage	\$720.00
O855 ¹	Classroom	
O859	Storeroom	

Note:

1. Classroom function trim may be converted to storeroom function by a simple field adjustment. No additional parts required.

ED4200S/ED4200/ED4400/ED4800 SecureBolt® , Rim, Surface and Concealed V.R. Trim

Cylinder is not included.

Escutcheon Trim Design: O14 Plate x Thumbturn

Pull: Cast **Escutcheon:** Wrought **Thumbturn:** Cast



Function	Description	Finish: 605, 606, 611, 612, 613, 613E, 618, 619, 625, 626, 629, 630, 722, BSP
O1410ET	Passage	\$880.00
O1455ET ¹	Classroom	
O1459ET	Storeroom	

Escutcheon Trim Design: T14 Pull/Thumbpiece

Grip: Cast **Escutcheon:** Wrought

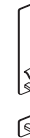

Function	Description	Finish: 605, 606, 611, 612, 613, 613E, 618, 619, 625, 626, 629, 630, 722, BSP
T1410ET	Passage	\$850.00
T1450ET	Dummy	\$770.00
T1455ET ¹	Classroom	\$850.00
T1457ET	Nightlatch (see note 2)	\$770.00

Escutcheon Trim Design: P10 Pull



Pull: Extruded **Escutcheon:** Wrought



Function	Description	Finish: 605, 606, 611, 612, 613, 613E, 618, 619, 625, 626, 629, 630, 722, BSP
P1050ET	Dummy	\$856.00
P1057ET	Nightlatch (see note 2)	

Escutcheon Trim Design: K1 Key Only

Note: Available with cylinder option only. Example: K157 x 6P
Cylinder option pricing applies.



Function	Description	Finish: 605, 606, 611, 612, 613, 618, 619, 622, 625, 626, 722
K157ET	Nightlatch ²	\$81.00

Notes:

- Classroom function trim may be converted to storeroom function by a simple field adjustment. No additional parts required.
- Not recommended for use on surface or concealed vertical rod exit devices.

Offset Pull Trim: P12, P13, P14

Offset Pull Trim	Part Number	Finish: 605, 606, 611, 612, 613, 613E, 618, 619, 625, 626, 629, 630, 722, BSP
P12	716F50M X Finish	\$397.00
P13	716F51M X Finish	\$484.00
P14	716F52M X Finish	\$340.00

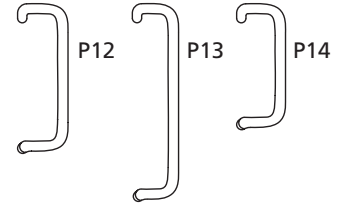

Electrified Options for Exit Devices

Description	Specify	Add or Deduct
Exit Alarm Device (cylinder is not included)	M61	\$1,054.00
Bolt Position Monitoring	M91*	Add \$311.00
Touchbar Monitoring or Signaling/Request to Exit (REX)	M92*	Add \$291.00
Outside Trim Monitoring or Signaling	M93*	
Motor Latch Retraction	MELR	Add \$1116.00
Electric Dogging	M97	Add \$594.00

Delayed Egress Device

Description	Specify	Add or Deduct
Delayed Egress (Suffix the letter D to device. Ex: ED4200)	D	Add \$2288.00
30-Second Delay	M88*	\$159.00
BOCA 15-Second Delay	M89*	
BOCA 30-Second Delay	M90*	

Electrified Accessories

Part Number	Description	Specify	Price
709F609	Power Supply 1 Amp (controls 1 'D' device)	BPS-24-1	\$485.00
709F619	Power Supply 2 Amp (controls 2 'D' devices or 1 "D" with SAF or SEC)	BPS-24-2	\$985.00
709F269	Power Supply 4 amp 24VDC	BPS-24-4	\$1,670.00
704F288	Concealed transfer (for over 120-degree swing door)	EPTL	\$191.00
709F689	(1) SPDT Maintained Switch (Includes LED)	MKA	\$191.00
709F709	(1) SPDT Momentary Switch (Includes LED)	MK	\$292.00
709F749	(1) SPDT Momentary Switch (Illuminated)	PB2	\$225.00
709F759	(1) SPDT Maintained (Alternating Action) Switch	PB3EA	\$172.00
709F769	(1) SPDT Momentary Switch (Illuminated)	PB3	\$217.00
709F779	(1) SPDT Momentary Switch	PB3ER	\$146.00
709F729	DPDT Momentary Key Switch	MK2	\$337.00
709F699	Narrow Stile Key Switch (Alt. action)	MKAN	\$292.00
709F719	Narrow Stile Momentary Key Switch	MKN	\$292.00
709F789	Sonalert 90db @ 2 ft. 12-24VDC. Mounted on one gang stainless steel plate.	PZ1	\$146.00
	Alarm Kit (cylinder is not included) ^{1,2}	ED40AK	\$1,198.00
709F679	Door Cord	TSB-C	\$62.00
741F739	Digital Entry System (4 users)	DK-12	\$313.00
709F809	Digital Entry System (59 users) ST finish	FADK-26SS	\$1,030.00
709F819	Digital Entry System (59 users) Black finish	DK-26BK	\$1,030.00

Notes:

1. Alarm kit cannot be installed in the field to surface vertical rod exit device. Any attempt to do so voids all warranties.
2. Specify Finish and Length.

***ElectroLynx®**

As part of their promise to provide innovative, fast and effective high security solutions to their customers, certain ASSA ABLOY Group brands offer *ElectroLynx®*, a universal quick-connect system that simplifies the electrification of the door opening.

Cylinder Options*

Description	Specify Quick Code	Add or Deduct
Conventional 6-pin	6P*	Add \$120.00 per cylinder
Conventional 7-pin	7P	Add \$122.00 per cylinder
LFIC		
LFIC 6-pin	C6	Add \$224.00 per cylinder
LFIC 6-pin less core	CL6	Add \$120.00 per cylinder
LFIC 6-pin with temporary construction core (Red)	CT6R	Add \$224.00 per cylinder
LFIC 6-pin with temporary construction core (Blue)	CT6B	Add \$224.00 per cylinder
LFIC 6-pin with temporary construction core (Green)	CT6G	Add \$224.00 per cylinder
LFIC 6-pin with temporary disposable core	CT6D	Add \$120.00 per cylinder
LFIC 7-pin	C7	Add \$228.00 per cylinder
LFIC 7-pin less core	CL7	Add \$122.00 per cylinder
LFIC 7-pin with temporary construction core (Red)	CT7R	Add \$228.00 per cylinder
LFIC 7-pin with temporary construction core (Blue)	CT7B	Add \$228.00 per cylinder
LFIC 7-pin with temporary construction core (Green)	CT7G	Add \$228.00 per cylinder
LFIC 7-pin with temporary disposable core	CT7D	Add \$122.00 per cylinder
SFIC		
SFIC 6-pin	C6S	Add \$213.00 per cylinder
SFIC 6-pin with temporary construction core (Blue)	CT6SB	Add \$213.00 per cylinder
SFIC 6-pin with SFIC disposable temporary core	CT6SD	Add \$120.00 per cylinder
SFIC 6-pin with Less Core	CLS6	Add \$120.00 per cylinder
SFIC 7-pin	C7S	Add \$213.00 per cylinder
SFIC 7-pin with temporary construction core (Blue)	CT7SB	Add \$213.00 per cylinder
SFIC 7-pin with SFIC disposable temporary core	CT7SD	Add \$120.00 per cylinder
SFIC 7-pin with Less Core	CLS7	Add \$120.00 per cylinder
Security		
Security ⁴	HS	Add \$278.00 per cylinder
Security LFIC ⁴	CHS	Add \$378.00 per cylinder
Access 3		
Access 3 Patented	AP	Add \$120.00 per cylinder
Access 3 Security	AS	Add \$198.00 per cylinder
Access 3 High Security, UL 437	AHS	Add \$231.00 per cylinder
Access 3 LFIC Patented	ACP	Add \$224.00 per cylinder
Access 3 LFIC Security	ACS	Add \$302.00 per cylinder
Access 3 LFIC High Security, UL 437	ACHS	Add \$335.00 per cylinder
Pyramid		
Pyramid Security fixed core	PS	Add \$204.00 per cylinder
Pyramid Security LFIC	PCS	Add \$301.00 per cylinder
Pyramid High Security fixed core	PHS	Add \$245.00 per cylinder
Pyramid High Security LFIC	PCHS	Add \$343.00 per cylinder
Pyramid LFIC with temporary construction core ³	CTP	Add \$224.00 per cylinder
Pyramid LFIC with temporary disposable core ³	CTPD	Add \$120.00 per cylinder
Pyramid LFIC less core	CLP	Add \$120.00 per cylinder

*Optional dogging cylinder will be furnished with the same mechanism and keyed alike with the trim cylinder, unless otherwise specified. If different keying or cylinder type is required, specify outside (trim) first, then inside (dogging) cylinder.

**6P cylinder option is supplied in 6-pin, L4 keyway, 0-bitted with two nickel silver keys.

*For key bows other than 10 and 90, specify "KB" + bow number as Quick Code, e.g. KB12.

Notes:

1. CMK Construction master keying charge is in addition to master keying charge.
2. CMK Construction master keying is not available in interchangeable core, Access 3, Pyramid, or Security series.
3. VKC2, VKC3, CKC3 are not available in Pyramid or Security series.

Cylinder Options (continued) & Keying Options*		
Description	Specify Quick Code	Add or Deduct
Keying and Keys		
0-bitted with 2 Blank Keys	(standard)	No Charge
Keyed Random	KR	
Construction Master Keyed ²	CMK	Add \$16.00 per cylinder
More than 2 Keys	KY# (e.g., KY6)	See page 33 - Cut Keys Section
Master Keying		
Master keyed (all cylinders except CR8000, CR8020, CR8027, CR8200, CR8500, CR8600, CR8700)	MK	Add \$16.00 per cylinder
Master keyed Pyramid (except CR8020, CR8027 LFIC cores)	MK	
Master keyed Security (including LFIC cylinder and core)	MK	
Master keyed Access 3 (except CR8500, CR8600, CR8700 LFIC cores)	MK	
Master keyed (CR8000, CR8020, CR8027, CR8200, CR8500, CR8600, CR8700)	MK-IC	No Charge
Master keyed to customer bittings or sample key	MK-CB	Add \$16.00 per cylinder
Visual Key Control (VKC)		
No bitting or keyset stamping on keys	VKC0	\$4.50
Keys only	VKC1	No Charge
Cylinders and keys (not for AS, AHS, ACS, ACHS, HS, CHS, PHS or PCHS)	VKC2	\$8.00
Cylinders only (not for AS, AHS, HS, ACS, ACHS, CHS, PHS or PCHS)	VKC3	
Concealed Key Control (CKC)		
CKC cylinders with VKC keys	CKC2	\$8.00
CKC cylinders only (not for AS, AHS, ACS, ACHS, PHS, PCHS)	CKC3	

*Optional dogging cylinder will be furnished with the same mechanism and keyed alike with the trim cylinder, unless otherwise specified. If different keying or cylinder type is required, specify outside (trim) first, then inside (dogging) cylinder.

**6P cylinder option is supplied in 6-pin, L4 keyway, 0-bitted with two nickel silver keys.

*For key bows other than 10 and 90, specify "KB" + bow number as Quick Code, e.g. KB12.

- Notes:
1. CMK Construction master keying charge is in addition to master keying charge.
 2. CMK Construction master keying is not available in interchangeable core, Access 3, Pyramid, or Security series.
 3. VKC2, VKC3, CKC3 are not available in Pyramid or Security series.

Door Height Options

ED4400 Device

Door Height	Specify	Add or Deduct
7'0"	(standard)	No Charge
7'2"	H0702	
7'6"	H0706	
8'0"	H0800	
9'0"	H0900	Add \$112.00 per device
10'0"	H1000	

ED4800 Device

Door Height	Specify	Add or Deduct
8'0"	(standard)	No Charge
8'2"	H0802	
8'6"	H0806	
9'0"	H0900	
10'0"	H1000	Add \$112.00 per device

Door Width Options

Door Width	Specify	Add or Deduct
24"	W024	Add \$398.00 per device
36"	(standard)	No Charge
48"	W048	Add \$49.00 per device

Door Thickness Options

Door Thickness	Specify	Add or Deduct
1-3/4"	(standard)	No Charge
2"	D200	
2-1/4"	D214	

Strike Options

Description	Specify	Add or Deduct
Surface or concealed vertical rod	S09	No Charge
Bottom strike for 1/2" threshold		
Flush transom top strike bracket	M67	Add \$40.00 per device

Miscellaneous Options

Description	Specify	Add or Deduct
Torx® screws for rim, concealed vertical rod, mortise	M04	Add \$63.00 per device
Torx® screws for surface vertical rod	M04	Add \$118.00 per device
Knurling outside and inside (Embossed Touchbar - device side)	M20*	Add \$199.00 per device
Knurling outside only (trim side) ¹	M21*	Add \$93.00 per device
Knurling inside only (Embossed Touchbar - device side)	M22*	Add \$106.00 per device
Abrasive coat outside and inside (trim and device)	M23	Add \$126.00 per device
Abrasive coat inside only (device side)	M24	Add \$66.00 per device
Abrasive coat outside only (trim side)	M25	Add \$60.00 per device
Pathlite™ Photoluminescent Touchbar cover	M49	Add \$475.00 per device
Less dogging	M51	No Charge
Cylinder dogging (less cylinder)	M52	Add \$107.00 per device
Sex nuts and bolts (SNBs)	M54	No Charge
Mullion stabilizer*	M57	Add \$67.00 per mullion
Shim kit (for vision light)		
- All rim and concealed vertical rod	M58	Add \$98.00 per device
- All surface vertical rod	M58	Add \$129.00 per device
End Cap Reinforcement (used with standard end cap only)	M109	Add \$107.00 per device
Flush End Cap	M110	No Charge

1. Not available with Vineyard™ or Muséo® levers.

*All levers provided in a powder coat finish will be supplied with an abrasive coating.

Removable Mullion

Ordering Example

Quantity	Mullion Number	Finish
10	CR808	628

Door Height	Specify	Finish	Price
Up to 8'0"	CR808	628	\$2,042.00
Up to 8'0"	CR808	695	\$2,345.00

*Standard with all 808 mullions.

Custom Laser Engraving- LASER

Laser engraving processing charge (all engraving types)

- \$250.00 net per order. Charge will be applied to production order when placed.

Single Vanity, Logo or Other (same engraving on all parts)

- \$10.00 net add each
- Mortise Escutcheon - \$10.00 net add each
- HPSK Paddle - \$10.00 net add each

Unique laser engraving (i.e. Room Number, Apartment Number, etc)

- \$12.00 net add each (per piece)

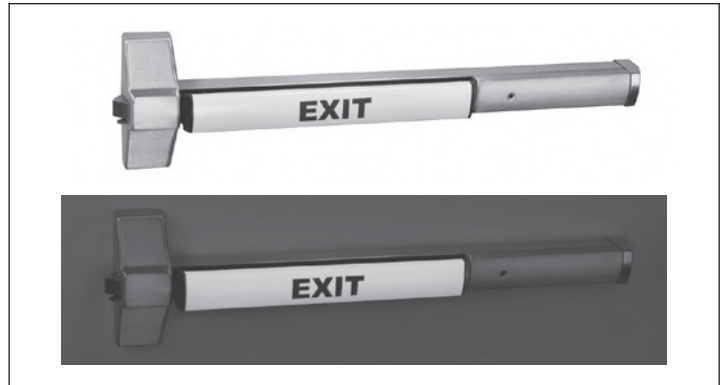
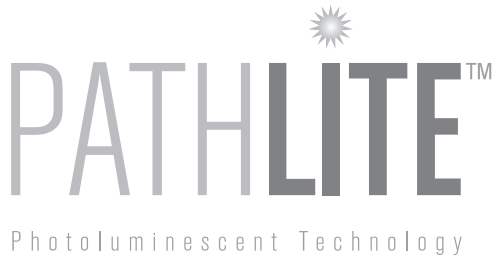

The PathLite™ patent pending technology offers a number of benefits:

- Requires no wiring or maintenance
- Recharges with exposure to ambient light
- Unaffected by heat or cold
- Non-toxic, will not rub off or fade
- Vandal resistant
- Fire resistant and non-radioactive
- Green contrasting word "EXIT" centered on touchbar in 1-1/4" high lettering
- Cost effective; especially suited for existing buildings

PathLite™ photoluminescent exit devices meet New York City's newly adopted standards for requirement of photoluminescent signage and stairwell markings in all office buildings in excess of 75 feet in height.

How To Order Complete Device

Exit Device	Trim/Function	Finish	Hand	Misc. Options
ED5200	N910ET	630	RHR	M49

ED5200 x N910 x 630 x RHR x M49

Options	Specify	Price
24", 36", and 48" PathLite™ Photoluminescent Touchbar Cover	M49	Add \$475.00 per device

How to Order Touchbar Cover Only

Options	Part Number	Price
24" PathLite™ Photoluminescent Touchbar cover	710F797	\$469.00
36" PathLite™ Photoluminescent Touchbar cover	710F737	
48" PathLite™ Photoluminescent Touchbar cover	710F747	

**Standard Features
Handing**

Devices are field reversible;
specify hand. Lever trims are
handed; specify hand.

Note:
Specify hand for all double cylinder
exit devices

Door Thickness
1-3/4"

Door Width
36"

Projection
3-1/4"; 2-3/4" dogged

Trim
Cylinder is not included.
See page 327 for
cylinder options.

SecureBolt®
ED5200S Panic
ED5200SA 3 Hour Fire Rated
ED5202S Double Cylinder Panic,
SecureBolt®
ED5202SA Double Cylinder, Secure Bolt,
3 Hour Fire Rated

RIM
ED5200 Panic
ED5200A 3 Hour Fire Rated
ED5202 Double Cylinder Panic
ED5202A Double Cylinder; 3 Hour fire rated

Vertical Rod
ED5400 Panic
ED5470 Panic
ED5400A 3 Hour Fire Rated
ED5470B 1-1/2 Hour Fire Rated

Concealed Vertical Rod
ED5800 Panic
ED5860 Panic
ED5800A 3 Hour Fire Rated
ED5860B 1-1/2 Hour Fire Rated

Mortise
ED5600 Panic
ED5600A 3 Hour Fire Rated
ED5602L Double Cylinder Panic
(Classroom Function)
ED5602AL Double Cylinder
(Classroom Function);
3 Hour Fire Rated

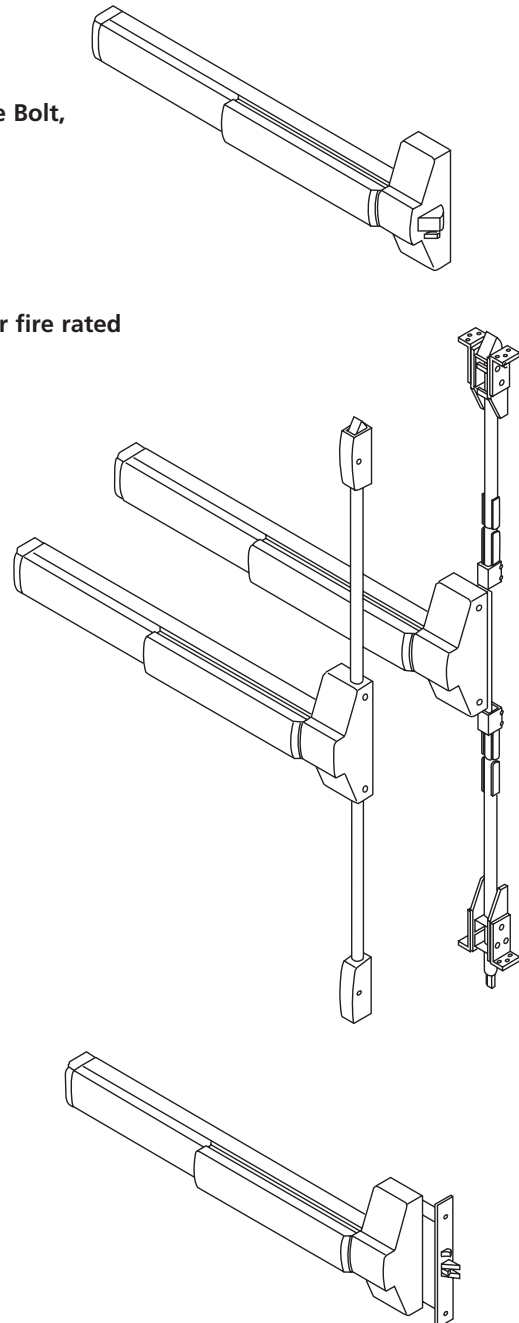

Ordering Examples
Exit Device with Trim

Quantity	Exit Device	Trim/Function	Finish	Hand	Door Thickness	Optional Strike	Door Width	Misc. Options
36	ED5600L	N9M55ET	605	LHR	D200	SB134	W048	M51-M54

Trim Only

Quantity	Trim/Function	Finish	Hand	Door Thickness
24	N955ET	625	RHR	D214

Contract/Detailed Order - Rim Exit Device with Trim

Quantity	Keypad	Exit Device	Trim/Function	Finish	Hand	Door Thickness	Door Width	Misc. Options	Optional Cylinder
36	AA1	ED5200	C955ET	613E	LHR	D200	W048	M52-M54	6P

Notes:

M55 less bottom rod option is available on ED5470(B) and ED5860(B) devices only.
H0900 and H1000 options are available on ED5470(B) and ED5860(B) devices only.
Non fire rated devices do not have a door size limitation set by UL.

36" Device Only

Includes device, strike(s) and screw pack. No cylinder or trim.

SecureBolt® ED5200S Series

Function	Description	Finish: 613E, 630, BSP, WSP	Finish: 605, 606, 611, 612, 613, 618, 619, 625, 629, 722
ED5200S	Panic	\$2,290.00	\$2,386.00
ED5202S ¹	Double Cylinder Panic <i>Classroom function Trim only</i>	\$2,568.00	\$2,664.00
ED5200SA	3 Hour Fire Rated	\$2,520.00	\$2,616.00
ED5202SA ¹	Double Cylinder 3 Hour Fire Rated <i>Classroom function Trim only</i>	\$2,798.00	\$2,894.00

Rim ED5200 Series

Function	Description	Finish: 613E, 630, BSP, WSP	Finish: 605, 606, 611, 612, 613, 618, 619, 625, 629, 722
ED5200	Panic	\$2,204.00	\$2,300.00
ED5202 ¹	Double Cylinder Panic <i>Classroom function Trim only</i>	\$2,482.00	\$2,578.00
ED5200A	3 Hour Fire Rated	\$2,434.00	\$2,530.00
ED5202A ¹	Double Cylinder 3 Hour Fire Rated <i>Classroom function Trim only</i>	\$2,712.00	\$2,808.00

Vertical Rod ED5400 Series

Function	Description	Finish: 613E, 630, BSP, WSP	Finish: 605, 606, 611, 612, 613, 618, 619, 625, 629, 722
ED5400	Panic	\$2,888.00	\$2,984.00
ED5470	Panic	\$2,970.00	\$3,066.00
ED5400A	3 Hour Fire Rated	\$3,118.00	\$3,214.00
ED5470B	1-1/2 Hour Fire Rated	\$3,200.00	\$3,296.00

Mortise ED5600 Series

Function	Description	Finish: 613E, 630, BSP, WSP	Finish: 605, 606, 611, 612, 613, 618, 619, 625, 629, 722
ED5600L	Panic	\$2,847.00	\$2,943.00
ED5657L			
ED5600T			
ED5657T			
ED5602L ¹	Double Cylinder Panic <i>Classroom function Trim only</i>	\$3,125.00	\$3,221.00
ED5600AL	3 Hour Fire Rated	\$3,077.00	\$3,173.00
ED5657AL			
ED5600AT			
ED5657AT			
ED5602AL ¹	Double Cylinder 3 Hour Fire Rated <i>Classroom function Trim only</i>	\$3,355.00	\$3,451.00

Concealed V.R. ED5800 Series

Function	Description	Finish: 613E, 630, BSP, WSP	Finish: 605, 606, 611, 612, 613, 619, 625, 629, 722
ED5800	Panic	\$3,209.00	\$3,305.00
ED5860	Panic	\$3,374.00	\$3,470.00
ED5800A	3 Hour Fire Rated	\$3,439.00	\$3,535.00
ED5860B	1-1/2 Hour Fire Rated	\$3,604.00	\$3,700.00

Inactive Bar ED5000DB Series

Function	Description	Finish: 613E, 630, BSP, WSP	Finish: 605, 606, 611, 612, 613, 619, 625, 629, 722
ED5000DB	Inactive Bar	\$1,065.00	\$1,161.00

1.Specify handing for double cylinder devices
Only classroom function trim can be used with double cylinder devices.
Caution: Be sure of your measurements. Exit devices are NOT returnable.

Pushpad Exit Devices

ED5000 Series: Muséo Levers with 900 Series Escutcheon

USA & Canada Prices Effective April 17, 2023



contemporary levers to complement the interior design of your next project

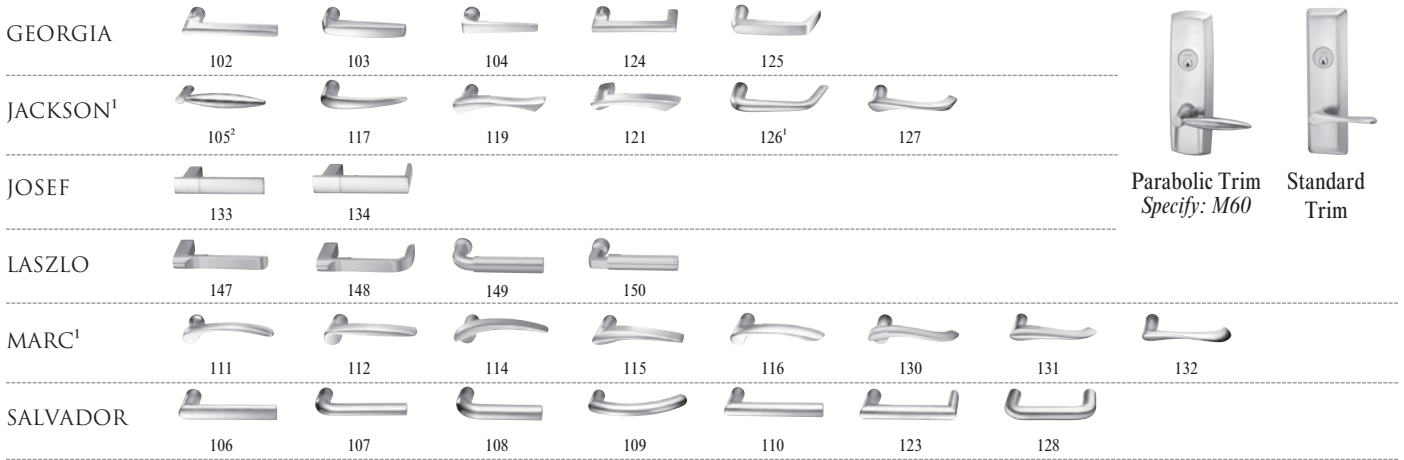

1. Handed: specify hand when ordering
2. Contact factory for current lead time

*629 and *630 finish options are Not available for all Muséo levers. Please refer to page 26 for availability.

605	Bright Brass, Clear Coated	613L	Dark Oxidized Satin Bronze, Clear Coated	BSP	Black Suede Powder Coat
606	Satin Brass, Clear Coated	618	Bright Nickel Plated	WSP	White Suede Powder Coat
611	Bright Bronze, Clear Coated	619	Satin Nickel Plated	722	Black Oxidized Bronze, Oil Rubbed
612	Satin Bronze, Clear Coated	625	Bright Chromium Plated		
613	Dark Oxidized Satin Bronze, Oil Rubbed	626	Satin Chromium Plated		
613E	Dark Oxidized Satin Bronze - Equivalent	629*	Bright Stainless Steel		
		630*	Satin Stainless Steel		

Function

Rim/SVR/CVR	910	Passage	\$917.00
	950	Dummy	
	955	Classroom	
	957	Nightlatch	
	959	Storeroom	
Mortise	9M10	Passage	\$917.00
	9M50	Dummy	
	9M55	Classroom	
	9M57	Nightlatch	
Electrified	9903	Fail Safe	\$1,480.00
	9905	Fail Secure	
Options	M60	Parabolic Escutcheon	Add \$107.00 per device

Ordering Example Details

- 111 Marc family lever
- 9M50 Dummy Trim; Mortise
- 625 Bright Chrome finish
- RHR Right Hand Reverse
- D214 2-1/4" Door Thickness
- M60 Parabolic Escutcheon Design (mechanical)



Trim Only					
Quantity	Trim/Function	Finish	Hand	Door Thickness	Option
24	1119M50	625	RHR	D214	M60



Experience a safer and more open world

Pushpad Exit Devices

ED5000 Series: Muséo Levers with 900 Series Escutcheon

USA & Canada Prices Effective April 17, 2023

contemporary levers to complement the interior design of your next project



JOSEF



GEORGES



Parabolic Trim
Specify: M60



Standard Trim

1. Handed: specify hand when ordering
2. Contact factory for current lead time

605	Bright Brass, Clear Coated	613L	Dark Oxidized Satin Bronze, Clear Coated	BSP	Black Suede Powder Coat
606	Satin Brass, Clear Coated	618	Bright Nickel Plated	WSP	White Suede Powder Coat
611	Bright Bronze, Clear Coated	619	Satin Nickel Plated	722	Black Oxidized Bronze, Oil Rubbed
612	Satin Bronze, Clear Coated	625	Bright Chromium Plated		
613	Dark Oxidized Satin Bronze, Oil Rubbed	626	Satin Chromium Plated		
613E	Dark Oxidized Satin Bronze - Equivalent	629*	Bright Stainless Steel		
		630*	Satin Stainless Steel		

Function

Rim/SVR/CVR	910	Passage	\$988.00
	950	Dummy	
	955	Classroom	
	957	Nightlatch	
	959	Storeroom	
Mortise	9M10	Passage	\$988.00
	9M50	Dummy	
	9M55	Classroom	
	9M57	Nightlatch	
Electrified	9903	Fail Safe	\$1,592.00
	9905	Fail Secure	
Options	M60	Parabolic Escutcheon	Add \$107.00 per device

Ordering Example Details

- 133 Josef family lever
- 9M50 Dummy Trim; Mortise
- 625 Bright Chrome finish
- RHR Right Hand Reverse
- D214 2-1/4" Door Thickness
- M60 Parabolic Escutcheon Design (mechanical)



Trim Only						
Quantity	Trim/Function	Finish	Hand	Door Thickness	Option	
24	1339M50	625	RHR	D214	M60	



Experience a safer and more open world

Pushpad Exit Devices

ED5000 Series: Muséo Levers with 900 Series Escutcheon

USA & Canada Prices Effective April 17, 2023

contemporary levers to complement the interior design of your next project

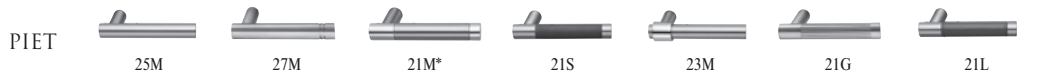

*613E, BSP, WSP finishes are not available with 21M levers.



Parabolic Trim
Specify: M60
Standard Trim

613E	Dark Oxidized Satin Bronze – Equivalent
629	Bright Stainless Steel
630	Satin Stainless Steel
BSP	Black Suede Powder Coat
WSP	White Suede Powder Coat

Function

Rim/SVR/CVR	910	Passage	\$988.00
	950	Dummy	
	955	Classroom	
	957	Nightlatch	
	959	Storeroom	
Mortise	9M10	Passage	\$988.00
	9M50	Dummy	
	9M55	Classroom	
	9M57	Nightlatch	
Electrified	9903	Fail Safe	\$1,592.00
	9905	Fail Secure	
Options	M60	Parabolic Escutcheon	Add \$107.00 per device



Ordering Example Details

- 21M Piet Family Lever - Polished with Satin Insert
- 9M50 Dummy Trim; Mortise
- 293029 Lever Finish
- Polished with satin stainless steel insert (630), polished stainless steel (629) shank and polished stainless steel (629) grip
- 629 Lock Finish
- D214 2-1/4" Door Thickness
- M60 Parabolic Escutcheon Design (mechanical)

Trim Only						
Quantity	Trim/Function	Lever Finish	Lock Finish	Hand	Door Thickness	Option
2	21M9M50	293029	629	RHR	D214	M60



Experience a safer and more open world

ED5200S/ED5200/ED5400/ED5800 SecureBolt® , Rim, Surface and CVR Heavy-Duty Trim

Cylinder is not included.

Escutcheon Trim Design: A9 Armstrong



Lever: Cast

Escutcheon: Forged

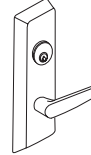

Function	Description	Finish: 605, 606, 611, 612, 613, 613E, 618, 619, 625, 626, 629 ² , 630 ¹ , 722, BSP
A910ET	Passage	\$917.00
A950ET	Dummy	
A955ET	Classroom ^{3,4}	
A957ET	Nightlatch ⁵	
A959ET	Storeroom	

Escutcheon Trim Design: C9 Citation



Lever: Cast

Escutcheon: Forged

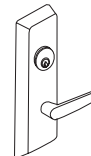

Function	Description	Finish: 605, 606, 611, 612, 613, 613E, 618, 619, 625, 626, 629 ² , 630 ¹ , 722, BSP
C910ET	Passage	\$917.00
C950ET	Dummy	
C955ET	Classroom ^{3,4}	
C957ET	Nightlatch ⁵	
C959ET	Storeroom	

Escutcheon Trim Design: D9 Dirke



Lever: Cast

Escutcheon: Forged

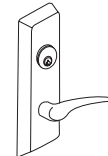

Function	Description	Finish: 605, 606, 611, 612, 613, 613E, 618, 619, 625, 626, 629 ² , 630 ¹ , 722, BSP
D910ET	Passage	\$917.00
D950ET	Dummy	
D955ET	Classroom ^{3,4}	
D957ET	Nightlatch ⁵	
D959ET	Storeroom	

Notes:

1. 619 finish provided to match 630 finish
2. 618 finish provided to match 629 finish.
3. Classroom function trim may be converted to storeroom function by a simple field adjustment. No additional parts required.
4. Only Classroom function may be used with Double Cylinder exit devices.
5. Not recommended for use with surface or concealed vertical rod exit devices (ED5400, ED5800)

ED5200S/ED5200/ED5400/ED5800 SecureBolt® , Rim, Surface and CVR Heavy-Duty Trim

Cylinder is not included.

Escutcheon Trim Design: E9 Essex



Lever: Cast

Escutcheon: Forged

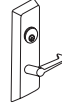

Function	Description	Finish: 605, 606, 611, 612, 613, 613E, 618, 619, 625, 626, 629 ² , 630 ¹ , 722, BSP
E910ET	Passage	\$917.00
E950ET	Dummy	
E955ET	Classroom ^{3,4}	
E957ET	Nightlatch ⁵	
E959ET	Storeroom	

Escutcheon Trim Design: L9 Lustra



Lever: Cast

Escutcheon: Forged



Function	Description	Finish: 605, 606, 611, 612, 613, 613E, 618, 619, 625, 626, 629 ² , 630 ¹ , 722, BSP
L910ET	Passage	\$917.00
L950ET	Dummy	
L955ET	Classroom ^{3,4}	
L957ET	Nightlatch ⁵	
L959ET	Storeroom	

Escutcheon Trim Design: N9 Newport



Lever: Cast

Escutcheon: Forged

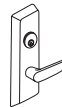

Function	Description	Finish: 605, 606, 611, 612, 613, 613E, 618, 619, 625, 626, 629 ² , 630 ¹ , 722, BSP
N910ET	Passage	\$917.00
N950ET	Dummy	
N955ET	Classroom ^{3,4}	
N957ET	Nightlatch ⁵	
N959ET	Storeroom	

Escutcheon Trim Design: R9 Regis



Lever: Cast

Escutcheon: Forged



Function	Description	Finish: 605, 606, 611, 612, 613, 613E, 618, 619, 625, 626, 629 ² , 630 ¹ , 722, BSP
R910ET	Passage	\$917.00
R950ET	Dummy	
R955ET	Classroom ^{3,4}	
R957ET	Nightlatch ⁵	
R959ET	Storeroom	

Notes:

1. 619 finish provided to match 630 finish. - Escutcheons only
2. 618 finish provided to match 629 finish. - Escutcheons only
3. Classroom function trim may be converted to storeroom function by a simple field adjustment. No additional parts required.

4. Only Classroom function trim may be used with Double Cylinder exit devices.
5. Not recommended for use with surface or concealed vertical rod exit devices (ED5400, ED5800)

ED5200S/ED5200/ED5400/ED5800 SecureBolt® , Rim, Surface and CVR Heavy-Duty Trim

Cylinder is not included.

Escutcheon Trim Design: PR9 Princeton



Lever: Cast

Escutcheon: Forged



Function	Description	Finish: 605, 606, 611, 612, 613, 613E, 618, 619, 625, 626, 629 ² , 630 ¹ , 722, BSP
PR910ET	Passage	\$917.00
PR950ET	Dummy	
PR955ET	Classroom ^{3,4}	
PR957ET	Nightlatch ⁵	
PR959ET	Storeroom	

Escutcheon Trim Design: F9

Lever: Cast

Escutcheon: Forged



Function	Description	Finish: 605, 606, 611, 612, 613, 613E, 618, 619, 625, 626, 629 ² , 630 ¹ , 722, BSP
F950ET	Dummy	\$423.00
F957ET	Nightlatch ⁵	

Escutcheon Trim Design: VT9

Plate: Stamped or Formed Stainless Steel



Function	Description	Finish: 630 ¹
VT957ET	Nightlatch ⁶	\$842.00
VTL957ET	Nightlatch with Lip ⁶	
VT950ET	Pull	
VTL950ET	Pull with Lip	

Notes:

- | | |
|---|--|
| <ol style="list-style-type: none"> 1. 619 finish provided to match 630 finish. - Escutcheons only 2. 618 finish provided to match 629 finish. - Escutcheons only 3. Classroom function trim may be converted to storeroom function by a simple field adjustment. No additional parts required. | <ol style="list-style-type: none"> 4. Only Classroom function trim may be used with Double Cylinder exit devices. 5. Not recommended for use with surface or concealed vertical rod exit devices (ED5400, ED5800) 6. VT957 and VTL957 trims are handed and not reversible |
|---|--|

ED5200S/ED5200/ED5400/ED5800 SecureBolt®, Rim, Surface and CVR Heavy-Duty Trim

Cylinder is not included.

Escutcheon Trim Design: FR9 Frascati*



Escutcheon: Forged

* Handed Lever. Handing cannot be changed in the field.

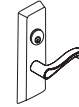

Function	Description	Finish: 605, 606, 611, 612, 613, 613E, 618, 619, 625, 626, 629 ² , 630 ¹ , 722, BSP
FR910ET	Passage	\$917.00
FR950ET	Dummy	
FR955ET	Classroom ^{3, 4}	
FR957ET	Nightlatch ⁵	
FR959ET	Storeroom	

Escutcheon Trim Design: M9 Merlot



Escutcheon: Forged

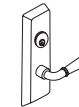

Function	Description	Finish: 605, 606, 611, 612, 613, 613E, 618, 619, 625, 626, 629 ² , 630 ¹ , 722, BSP
M910ET	Passage	\$917.00
M950ET	Dummy	
M955ET	Classroom ^{3, 4}	
M957ET	Nightlatch ⁵	
M959ET	Storeroom	

Escutcheon Trim Design: Z9 Zinfandel*



Escutcheon: Forged

* Handed Lever. Handing cannot be changed in the field.

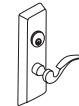

Function	Description	Finish: 605, 606, 611, 612, 613, 613E, 618, 619, 625, 626, 629 ² , 630 ¹ , 722, BSP
Z910ET	Passage	\$917.00
Z950ET	Dummy	
Z955ET	Classroom ^{3, 4}	
Z957ET	Nightlatch ⁵	
Z959ET	Storeroom	

Notes:

- 3. Classroom function trim may be converted to storeroom function by a simple field adjustment. No additional parts required.
- 4. Only Classroom function trim may be used with Double Cylinder exit devices.
- 5. Not recommended for use with surface or concealed vertical rod exit devices.

ED5200S/ED5200/ED5400/ED5800 SecureBolt® , Rim, Surface and CVR Trim

Cylinder is not included.

Escutcheon Trim Design: TH900 Pull/Thumbpiece

Grip: Extruded **Escutcheon:** Forged



Function	Description	Finish: 605, 606, 611, 612, 613, 613E, 618, 619, 625, 626, 629 ² , 630 ¹ , 722, BSP
TH910ET	Passage	\$698.00
TH950ET	Dummy (No thumbpiece)	\$663.00
TH955ET	Classroom ^{3,4}	\$698.00
TH957ET	Nightlatch ⁵ (No thumbpiece)	\$663.00
TH959ET	Storeroom	\$698.00

Escutcheon Trim Design: P9 Pull



Pull: Extruded **Escutcheon:** Forged

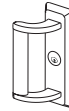

Function	Description	Finish: 605, 606, 611, 612, 613, 613E, 618, 619, 625, 626, 629 ² , 630 ¹ , 722, BSP
P950ET*	Dummy	\$601.00
P957ET*	Nightlatch ⁵	

* Specify Hand. Field Reversible.

Escutcheon Trim Design: K1 Key Only

Note: Only available with cylinder option. Example K157 x 6P
Cylinder option pricing applies.



Function	Description	Finish: 605, 606, 611, 612, 613, 618, 619, 622, 625, 626, 722
K157ET	Nightlatch ⁵	\$81.00

- Note:
1. 619 finish provided to match 630 finish. - Escutcheons only
 2. 618 finish provided to match 629 finish. - Escutcheons only
 3. Classroom function trim may be converted to storeroom function by a simple field adjustment. No additional parts required.
 4. Only Classroom function trim may be used with Double Cylinder exit devices.
 5. Not recommended for use on surface or concealed vertical rod exit devices.

ED5600 Mortise Heavy-Duty Trim

Cylinder is not included.

Escutcheon Trim Design: A4M Armstrong



Lever: Cast

Escutcheon: Forged

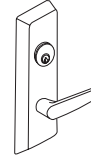

Function	Description	Finish: 605, 606, 611, 612, 613, 613E, 618, 619, 625, 626, 629 ² , 630 ¹ , 722, BSP
A9M10ET	Passage ³	\$917.00
A9M50ET	Dummy ³	
A9M55ET	Classroom ^{4, 5}	
A9M57ET	Nightlatch ⁴	

Escutcheon Trim Design: C9M Citation



Lever: Cast

Escutcheon: Forged

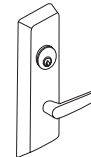

Function	Description	Finish: 605, 606, 611, 612, 613, 613E, 618, 619, 625, 626, 629 ² , 630 ¹ , 722, BSP
C9M10ET	Passage ³	\$917.00
C9M50ET	Dummy ³	
C9M55ET	Classroom ^{4, 5}	
C9M57ET	Nightlatch ⁴	

Escutcheon Trim Design: D9M Dirke*



Lever: Cast

Escutcheon: Forged

* Handed Lever. Handing cannot be changed in the field.

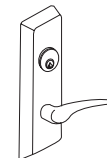

Function	Description	Finish: 605, 606, 611, 612, 613, 613E, 618, 619, 625, 626, 629 ² , 630 ¹ , 722, BSP
D9M10ET	Passage ³	\$917.00
D9M50ET	Dummy ³	
D9M55ET	Classroom ^{4, 5}	
D9M57ET	Nightlatch ⁴	

Notes:

1. 619 finish provided to match 630 finish. - Escutcheons only
2. 618 finish provided to match 629 finish. - Escutcheons only
3. Dummy and passage functions are the same. For dummy function, mortise lock body must be installed in the locked mode. No additional parts required.
4. Classroom and nightlatch function trims are the same. Trim function must be specified when ordered with an exit device to ensure that the correct lock body is supplied.
5. Only Classroom function trim may be used with Double Cylinder exit devices.

ED5600 Mortise Heavy-Duty Trim

Cylinder is not included.

Escutcheon Trim Design: E9M Essex



Lever: Cast

Escutcheon: Forged

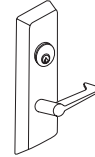

Function	Description	Finish: 605, 606, 611, 612, 613, 613E, 618, 619, 625, 626, 629 ² , 630 ¹ , 722, BSP
E9M10ET	Passage ³	\$917.00
E9M50ET	Dummy ³	
E9M55ET	Classroom ^{4, 5}	
E9M57ET	Nightlatch ⁴	

Escutcheon Trim Design: L9M Lustra



Lever: Cast

Escutcheon: Forged

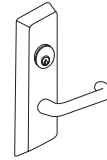

Function	Description	Finish: 605, 606, 611, 612, 613, 613E, 618, 619, 625, 626, 629 ² , 630 ¹ , 722, BSP
L9M10ET	Passage ³	\$917.00
L9M50ET	Dummy ³	
L9M55ET	Classroom ^{4, 5}	
L9M57ET	Nightlatch ⁴	

Escutcheon Trim Design: N9M Newport



Lever: Cast

Escutcheon: Forged

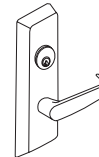

Function	Description	Finish: 605, 606, 611, 612, 613, 613E, 618, 619, 625, 626, 629 ² , 630 ¹ , 722, BSP
N9M10ET	Passage ³	\$917.00
N9M50ET	Dummy ³	
N9M55ET	Classroom ^{4, 5}	
N9M57ET	Nightlatch ⁴	

Notes:

1. 619 finish provided to match 630 finish. - Escutcheons only
2. 618 finish provided to match 629 finish. - Escutcheons only
3. Dummy and passage functions are the same. For dummy function, mortise lock body must be installed in the locked mode. No additional parts required.
4. Classroom and nightlatch function trims are the same. Trim function must be specified when ordered with an exit device to ensure that the correct lock body is supplied.
5. Only Classroom function trim may be used with Double Cylinder exit devices.

ED5600 Mortise Heavy-Duty Trim

Cylinder is not included.

Escutcheon Trim Design: R9M Regis



Lever: Cast

Escutcheon: Forged

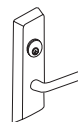

Function	Description	Finish: 605, 606, 611, 612, 613, 613E, 618, 619, 625, 626, 629 ² , 630 ¹ , 722, BSP
R9M10ET	Passage ³	\$917.00
R9M50ET	Dummy ³	
R9M55ET	Classroom ^{4, 5}	
R9M57ET	Nightlatch ⁴	

Escutcheon Trim Design: PR9M Princeton



Lever: Cast

Escutcheon: Forged



Function	Description	Finish: 605, 606, 611, 612, 613, 613E, 618, 619, 625, 626, 629 ² , 630 ¹ , 722, BSP
PR9M10ET	Passage ³	\$917.00
PR9M50ET	Dummy ³	
PR9M55ET	Classroom ^{4, 5}	
PR9M57ET	Nightlatch ⁴	

Escutcheon Trim Design: F9

Escutcheon: Forged



Function	Description	Finish: 605, 606, 611, 612, 613, 613E, 618, 619, 625, 626, 629 ² , 630 ¹ , 722, BSP
F950ET	Dummy	\$423.00
F9M57ET	Nightlatch ⁴	

Notes:

1. 619 finish provided to match 630 finish. - Escutcheons only
2. 618 finish provided to match 629 finish. - Escutcheons only
3. Dummy and passage functions are the same. For dummy function, mortise lock body must be installed in the locked mode. No additional parts required.
4. Classroom and nightlatch function trims are the same. Trim function must be specified when ordered with an exit device to ensure that the correct lock body is supplied.
5. Only Classroom function trim may be used with Double Cylinder exit devices.

ED5600 Mortise Heavy-Duty Trim

Cylinder is not included.

Escutcheon Trim Design: FR9M Frascati*



Lever: Cast

Escutcheon: Forged



* Handed Lever. Handing cannot be changed in the field.

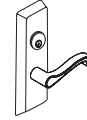

Function	Description	Finish: 605, 606, 611, 612, 613, 613E, 618, 619, 625, 626, 629 ² , 630 ¹ , 722, BSP
FR9M10ET	Passage ¹	\$917.00
FR9M50ET	Dummy ¹	
FR9M55ET	Classroom ^{2, 3}	
FR9M57ET	Nightlatch ²	

Escutcheon Trim Design: M9M Merlot



Lever: Cast

Escutcheon: Forged

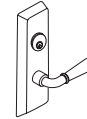

Function	Description	Finish: 605, 606, 611, 612, 613, 613E, 618, 619, 625, 626, 629 ² , 630 ¹ , 722, BSP
M9M10ET	Passage ¹	\$917.00
M9M50ET	Dummy ¹	
M9M55ET	Classroom ^{2, 3}	
M9M57ET	Nightlatch ²	

Escutcheon Trim Design: Z9M Zinfandel*



Lever: Cast

Escutcheon: Forged



* Handed Lever. Handing cannot be changed in the field.

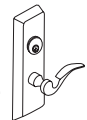

Function	Description	Finish: 605, 606, 611, 612, 613, 613E, 618, 619, 625, 626, 629 ² , 630 ¹ , 722, BSP
Z9M10ET	Passage ¹	\$917.00
Z9M50ET	Dummy ¹	
Z9M55ET	Classroom ^{2, 3}	
Z9M57ET	Nightlatch ²	

Notes:

- Dummy and passage functions are the same. For dummy function, mortise lock body must be installed in the locked mode. No additional parts required.
- Classroom and nightlatch function trims are the same. Trim function must be specified when ordered with an exit device to ensure that the correct lock body is supplied.
- Only Classroom function trim may be used with Double Cylinder exit devices.

Mortise Trim Design: ED5600

Cylinder is not included.

Escutcheon Trim Design: TH900, TH9M00 Pull/Thumbpiece

Grip: Extruded

Escutcheon: Forged



Function	Description	Finish: 605, 606, 611, 612, 613, 613E, 618, 619, 625, 626, 629 ² , 630 ¹ , 722, BSP
TH9M10ET	Passage	\$698.00
TH950ET	Dummy (No Thumbpiece)	\$663.00
TH9M55ET	Classroom ³	\$698.00
TH9M57ET	Nightlatch (No Thumbpiece)	\$663.00

Escutcheon Trim Design: P9M Pull



Pull: Extruded

Escutcheon: Forged

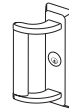

Function	Description	Finish: 605, 606, 611, 612, 613, 613E, 618, 619, 625, 626, 629 ² , 630 ¹ , 722, BSP
P950ET*	Dummy	\$601.00
P9M57ET*	Nightlatch	

*Specify Hand. Field Reversible.

Escutcheon Trim Design: VT9M

Plate: Stamped or Formed Stainless Steel



Function	Description	Finish: 630
VT9M57ET	Nightlatch	\$842.00
VTL9M57ET	Nightlatch with Lip	

Note: For mortise exit dummy functions, specify VT950 and VTL950

Escutcheon Trim Design: K1M Key Only

Note: Available with cylinder option only. Example: K1M57 x 6P
Cylinder option pricing applies.



Function	Description	Finish: 605, 606, 611, 612, 613, 618, 619, 622, 625, 626, 722
K1M57ET	Nightlatch	\$81.00

Note:
1. 619 finish provided to match 630 finish. - Escutcheons only
2. 618 finish provided to match 629 finish. - Escutcheons only
3. Only Classroom function trim may be used with Double Cylinder exit devices.

ED5200S/ED5200/ED5400/ED5800 SecureBolt® , Rim, Surface & CVR Heavy-Duty Trim

Cylinder is not included.

Escutcheon Trim Design: A9 Armstrong



Lever: Cast **Escutcheon:** Forged

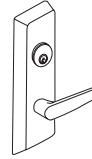

Function	Description	Finish: 605, 606, 611, 612, 613, 613E, 618, 619, 625, 626, 629 ² , 630 ¹ , 722, BSP
A9903ET*	Fail Safe	\$1,480.00
A9905ET*	Fail Secure	

Escutcheon Trim Design: C9 Citation



Lever: Cast **Escutcheon:** Forged

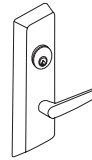

Function	Description	Finish: 605, 606, 611, 612, 613, 613E, 618, 619, 625, 626, 629 ² , 630 ¹ , 722, BSP
C9903ET*	Fail Safe	\$1,480.00
C9905ET*	Fail Secure	

Escutcheon Trim Design: D9 Dirke*



Lever: Cast **Escutcheon:** Forged
* Handed Lever. Handing cannot be changed in the field.

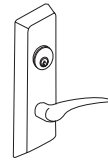

Function	Description	Finish: 605, 606, 611, 612, 613, 613E, 618, 619, 625, 626, 629 ² , 630 ¹ , 722, BSP
D9903ET*	Fail Safe	\$1,480.00
D9905ET*	Fail Secure	

Escutcheon Trim Design: E9 Essex



Lever: Cast **Escutcheon:** Forged

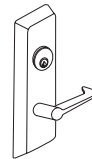

Function	Description	Finish: 605, 606, 611, 612, 613, 613E, 618, 619, 625, 626, 629 ² , 630 ¹ , 722, BSP
E9903ET*	Fail Safe	\$1,480.00
E9905ET*	Fail Secure	

Notes:
1. 619 finish provided to match 630 finish. - Escutcheons only
2. 618 finish provided to match 629 finish. - Escutcheons only

***ElectroLynx®**
As part of their promise to provide innovative, fast and effective high security solutions to their customers, certain ASSA ABLOY Group brands offer *ElectroLynx®*, a universal quick-connect system that simplifies the electrification of the door opening.

ED5200S/ED5200/ED5400/ED5800 SecureBolt®, Rim, Surface & CVR Heavy-Duty Trim

Cylinder is not included.

Escutcheon Trim Design: L9 Lustra



Lever: Cast **Escutcheon:** Forged

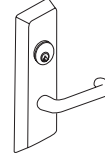

Function	Description	Finish: 605, 606, 611, 612, 613, 613E, 618, 619, 625, 626, 629 ² , 630 ¹ , 722, BSP
L9903ET*	Fail Safe	\$1,480.00
L9905ET*	Fail Secure	

Escutcheon Trim Design: N9 Newport



Lever: Cast **Escutcheon:** Forged

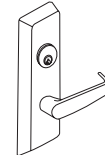

Function	Description	Finish: 605, 606, 611, 612, 613, 613E, 618, 619, 625, 626, 629 ² , 630 ¹ , 722, BSP
N9903ET*	Fail Safe	\$1,480.00
N9905ET*	Fail Secure	

Escutcheon Trim Design: R9 Regis



Lever: Cast **Escutcheon:** Forged

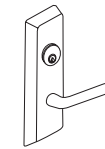

Function	Description	Finish: 605, 606, 611, 612, 613, 613E, 618, 619, 625, 626, 629 ² , 630 ¹ , 722, BSP
R9903ET*	Fail Safe	\$1,480.00
R9905ET*	Fail Secure	

Escutcheon Trim Design: PR9 Princeton



Lever: Cast **Escutcheon:** Forged

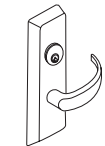

Function	Description	Finish: 605, 606, 611, 612, 613, 613E, 618, 619, 625, 626, 629 ² , 630 ¹ , 722, BSP
PR9903ET*	Fail Safe	\$1,480.00
PR9905ET*	Fail Secure	

Notes:

1. 619 finish provided to match 630 finish. - Escutcheons only
2. 618 finish provided to match 629 finish. - Escutcheons only

***ElectroLynx®**

As part of their promise to provide innovative, fast and effective high security solutions to their customers, certain ASSA ABLOY Group brands offer *ElectroLynx®*, a universal quick-connect system that simplifies the electrification of the door opening.

ED5200S/ED5200/ED5400/ED5800 SecureBolt® , Rim, Surface & CVR Heavy-Duty Trim

Cylinder is not included.

Escutcheon Trim Design: FR9 Frascati



Lever: Cast **Escutcheon:** Forged



Function	Description	Finish: 605, 606, 611, 612, 613, 613E, 618, 619, 625, 626, 629 ² , 630 ¹ , 722, BSP
FR9903ET*	Fail Safe	\$1,480.00
FR9905ET*	Fail Secure	

Escutcheon Trim Design: M9 Merlot



Lever: Cast **Escutcheon:** Forged

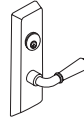

Function	Description	Finish: 605, 606, 611, 612, 613, 613E, 618, 619, 625, 626, 629 ² , 630 ¹ , 722, BSP
M9903ET*	Fail Safe	\$1,480.00
M9905ET*	Fail Secure	

Escutcheon Trim Design: Z9 Zinfandel



Lever: Cast **Escutcheon:** Forged

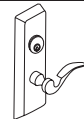

Function	Description	Finish: 605, 606, 611, 612, 613, 613E, 618, 619, 625, 626, 629 ² , 630 ¹ , 722, BSP
Z9903ET*	Fail Safe	\$1,480.00
Z9905ET*	Fail Secure	

***ElectroLynx®**

As part of their promise to provide innovative, fast and effective high security solutions to their customers, certain ASSA ABLOY Group brands offer *ElectroLynx*®, a universal quick-connect system that simplifies the electrification of the door opening.

Offset Pull Trim: P12, P13, P14

Offset Pull Trim	Part Number	Finish: 605, 606, 612, 613, 613E, 630, 626, 629, BSP, WSP
P12	716F50M X Finish	\$397.00
P13	716F51M X Finish	\$484.00
P14	716F52M X Finish	\$340.00

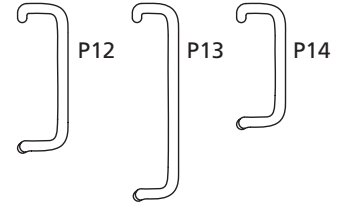
Electrified Options for Exit Devices

Description	Specify	Add or Deduct
Exit Alarm Device (cylinder is not included)	M61	\$1,054.00
Bolt Position Monitoring	M91*	Add \$311.00
Touchbar Monitoring or Signaling/Request to Exit (REX)	M92*	Add \$291.00
Outside Trim Monitoring or Signaling	M93*	
Motor Latch Retraction	MELR	Add \$1116.00
Electric Dogging	M97*	Add \$594.00
SPDT Lock and Unlock security monitor switch (Electric Trim Only)	M98*	Add \$280.00
Trim gasket for exterior applications (Electric Trim Only)	M99	Add \$31.00
Mortise device lock with Outside Trim Control (Fail Safe)	SAF2*	\$1,059.00
Mortise device lock with Outside Trim Control (Fail Secure)	SEC2*	

Delayed Egress Device

Description	Suffix	Add or Deduct
Delayed Egress (Suffix the letter D to device. Ex: ED4200)	D	Add \$2288.00
30-Second Delay	M88*	\$159.00
BOCA 15-Second Delay	M89*	
BOCA 30-Second Delay	M90*	

Notes:

- Alarm kit cannot be installed in the field to surface vertical rod exit device. Any attempt to do so voids all warranties.
- Only available with ED5600(A) (Except knob trim)
- M88, M89 and M90 are available only as options for suffix "D" Delayed Egress Exit Devices.
- The following options cannot be ordered together on the same device: a) M97 & D; b) M52 x M97; d) M97 x M107; e) M61 or M92 & D; f) M61 x M92; g) M61x M52; h) M52 & D; i) ED5600 x M91 & M93; j) ED5600 SAF or SEC x M91 or M93; k) Surface vertical rod exit devices with M61 x M91, M92 or M93.

***ElectroLynx®**

As part of their promise to provide innovative, fast and effective high security solutions to their customers, certain ASSA ABLOY Group brands offer *ElectroLynx®*, a universal quick-connect system that simplifies the electrification of the door opening.

Retrofit Kit: MELR rail assy, no switches, no latch, with controller, touchbar end cap

Description	Specify	Price	Available Options		
			M93	M107	M93 & M107
ED5000 MELR 36" Device ASSY	CRMELR-36	\$1,116.00	\$291.00	\$117.00	\$408.00
ED5000 MELR 36" NS Device ASSY (Narrow Stile)	CRMELR-38	\$1,116.00	\$291.00	N/A	N/A
ED5000 MELR 48" Device ASSY,	CRMELR-48	\$1,116.00	\$291.00	\$117.00	\$408.00

Electrified Accessories

Part Number	Description	Specify	Price
709F609	Power Supply 1 Amp (controls 1 "D" device)	BPS-24-1	\$485.00
709F619	Power Supply 2 Amp (controls 2 "D" devices or 1 "D" with SAF or SEC)	BPS-24-2	\$985.00
709F629	Power Supply 4 amp 24VDC	BPS-24-4	\$1,670.00
704F288	Concealed transfer (for over 120-degree swing door)	EPTL	\$191.00
709F689	(1) SPDT Maintained Switch (Includes LED)	MKA	\$191.00
709F709	(1) SPDT Momentary Switch (Includes LED)	MK	\$292.00
709F749	(1) SPDT Momentary Switch (Illuminated)	PB2	\$225.00
709F759	(1) SPDT Maintained (Alternating Action) Switch	PB3EA	\$172.00
709F769	(1) SPDT Momentary Switch (Illuminated)	PB3	\$217.00
709F779	(1) SPDT Momentary Switch	2' PB3ER	\$146.00
709F729	DPDT Momentary Key Switch	2' MK2	\$337.00
709F699	Narrow Stile Key Switch (Alt. action)	MKAN	\$292.00
704F719	Narrow Stile Momentary Key Switch	MKN	\$292.00
709F789	Sonalert 90db @ 2 ft. 12-24VDC Mounted on one gang stainless steel plate.	PZ1	\$146.00
	Alarm Kit (cylinder is not included) ^{1,2}	ED50AK	\$1,198.00
709F679	Door Cord	TSB-C	\$62.00
741F739	Digital Entry System (4 users)	DK-12	\$313.00
709F809	Digital Entry System (59 users) SS finish	FADK-26SS	\$1,030.00
709F819	Digital Entry System (59 users) Black finish	DK-26BK	\$1,030.00
709F989	Remote Power Harness – 36"		\$191.00
709F999	Remote Power Harness – 48"		\$213.00

Notes:

1. Alarm kit cannot be installed in the field to surface vertical rod exit device. Any attempt to do so voids all warranties.
2. Specify Finish and Length.

Custom Laser Engraving- LASER
Laser engraving processing charge (all engraving types)

- \$250.00 net per order. Charge will be applied to production order when placed.

Single Vanity, Logo or Other (same engraving on all parts)

- Lever - \$10.00 net add each
- Mortise Escutcheon - \$10.00 net add each
- HPSK Paddle - \$10.00 net add each

Unique laser engraving (i.e. Room Number, Apartment Number, etc)

- \$12.00 net add each (per piece)

Cylinder Options*		
Description	Specify Quick Code	Add or Deduct
Conventional 6-pin	6P*	Add \$120.00 per cylinder
Conventional 7-pin	7P	Add \$122.00 per cylinder
LFIC		
LFIC 6-pin	C6	Add \$224.00 per cylinder
LFIC 6-pin less core	CL6	Add \$120.00 per cylinder
LFIC 6-pin with temporary construction core (Red)	CT6R	Add \$224.00 per cylinder
LFIC 6-pin with temporary construction core (Blue)	CT6B	Add \$224.00 per cylinder
LFIC 6-pin with temporary construction core (Green)	CT6G	Add \$224.00 per cylinder
LFIC 6-pin with temporary disposable core	CT6D	Add \$120.00 per cylinder
LFIC 7-pin	C7	Add \$228.00 per cylinder
LFIC 7-pin less core	CL7	Add \$122.00 per cylinder
LFIC 7-pin with temporary construction core (Red)	CT7R	Add \$228.00 per cylinder
LFIC 7-pin with temporary construction core (Blue)	CT7B	Add \$228.00 per cylinder
LFIC 7-pin with temporary construction core (Green)	CT7G	Add \$228.00 per cylinder
LFIC 7-pin with temporary disposable core	CT7D	Add \$122.00 per cylinder
SFIC		
SFIC 6-pin	C6S	Add \$213.00 per cylinder
SFIC 6-pin with temporary construction core (Blue)	CT6SB	Add \$213.00 per cylinder
SFIC 6-pin with SFIC disposable temporary core	CT6SD	Add \$120.00 per cylinder
SFIC 6-pin with Less Core	CLS6	Add \$120.00 per cylinder
SFIC 7-pin	C7S	Add \$213.00 per cylinder
SFIC 7-pin with temporary construction core (Blue)	CT7SB	Add \$213.00 per cylinder
SFIC 7-pin with SFIC disposable temporary core	CT7SD	Add \$120.00 per cylinder
SFIC 7-pin with Less Core	CLS7	Add \$120.00 per cylinder
Security		
Security ⁴	HS	Add \$278.00 per cylinder
Security LFIC ⁴	CHS	Add \$378.00 per cylinder
Access 3		
Access 3 Patented	AP	Add \$120.00 per cylinder
Access 3 Security	AS	Add \$198.00 per cylinder
Access 3 High Security, UL 437	AHS	Add \$231.00 per cylinder
Access 3 LFIC Patented	ACP	Add \$224.00 per cylinder
Access 3 LFIC Security	ACS	Add \$302.00 per cylinder
Access 3 LFIC High Security, UL 437	ACHS	Add \$335.00 per cylinder
Pyramid		
Pyramid Security fixed core	PS	Add \$204.00 per cylinder
Pyramid Security LFIC	PCS	Add \$301.00 per cylinder
Pyramid High Security fixed core	PHS	Add \$245.00 per cylinder
Pyramid High Security LFIC	PCHS	Add \$343.00 per cylinder
Pyramid LFIC with temporary construction core ³	CTP	Add \$224.00 per cylinder
Pyramid LFIC with temporary disposable core ³	CTPD	Add \$120.00 per cylinder
Pyramid LFIC less core	CLP	Add \$120.00 per cylinder

*For key bows other than 10 and 90, specify "KB" + bow number as Quick Code, e.g. KB12.

Notes:

1. CMK Construction master keying charge is in addition to master keying charge.
2. CMK Construction master keying is not available in interchangeable core, Access 3, Pyramid, or Security series.
3. VKC2, VKC3, CKC3 are not available in Pyramid or Security series.

Cylinder Options (continued) & Keying Options*		
Description	Specify Quick Code	Add or Deduct
Keying and Keys		
0-bitted with 2 Blank Keys	(standard)	No Charge
Keyed Random	KR	
Construction Master Keyed ²	CMK	Add \$16.00 per cylinder
More than 2 Keys	KY# (e.g., KY6)	See page 33 - Cut Keys Section
Master Keying		
Master keyed (all cylinders except CR8000, CR8020, CR8027, CR8200, CR8500, CR8600, CR8700)	MK	Add \$16.00 per cylinder
Master keyed Pyramid (except CR8020, CR8027 LFIC cores)	MK	
Master keyed Security (including LFIC cylinder and core)	MK	
Master keyed Access 3 (except CR8500, CR8600, CR8700 LFIC cores)	MK	
Master keyed (CR8000, CR8020, CR8027, CR8200, CR8500, CR8600, CR8700)	MK-IC	No Charge
Master keyed to customer bittings or sample key	MK-CB	Add \$16.00 per cylinder
Visual Key Control (VKC)		
No bitting or keyset stamping on keys	VKC0	\$4.50
Keys only	VKC1	No Charge
Cylinders and keys (not for AS, AHS, ACS, ACHS, HS, CHS, PHS or PCHS)	VKC2	\$8.00
Cylinders only (not for AS, AHS, HS, ACS, ACHS, CHS, PHS or PCHS)	VKC3	
Concealed Key Control (CKC)		
CKC cylinders with VKC keys	CKC2	\$8.00
CKC cylinders only (not for AS, AHS, ACS, ACHS, PHS, PCHS)	CKC3	

*Optional dogging cylinder will be furnished with the same mechanism and keyed alike with the trim cylinder, unless otherwise specified. If different keying or cylinder type is required, specify outside (trim) first, then inside (dogging) cylinder.
 **6P cylinder option is supplied in 6-pin, L4 keyway, 0-bitted with two nickel silver keys.
 *For key bows other than 10 and 90, specify "KB" + bow number as Quick Code, e.g. KB12.

Notes:

1. CMK Construction master keying charge is in addition to master keying charge.
2. CMK Construction master keying is not available in interchangeable core, Access 3, Pyramid, or Security series.
3. VKC2, VKC3, CKC3 are not available in Pyramid or Security series.

Door Height Options

ED5400, ED5400A, ED5470(B) Devices

Door Height	Specify	Add or Deduct
7'0"	(standard)	No Charge
7'2"	H0702	
7'6"	H0706	
8'0"	H0800	

ED5800, ED5800A, ED5860(B) Devices

Door Height	Specify	Add or Deduct
8'0"	(standard)	No Charge

ED5470(B), ED5860(B) Devices

Door Height	Specify	Add or Deduct
9'0" ¹	H0900	Add \$112.00 per device
10'0" ¹	H1000	

Note:

1. H0900 and H1000 options for ED5470(B), ED5860(B) devices only

Door Height Options (continued)

Door Width Options

Door Width	Specify	Add or Deduct
24"	W024	Add \$398.00 per device
36"	(standard)	No Charge
48"	W048	Add \$49.00 per device

Door Thickness Options

Door Thickness	Specify	Add or Deduct
1-3/4"	(standard)	No Charge
2"	D200	
2-1/4"	D214	

Strike Options

Description	Specify	Add or Deduct
Rim x Vertical Rod on pairs of doors	S02	Add \$50.00 per device
Surface or Concealed Vertical Rod device bottom strike for 1/2" threshold	S09	No Charge
Flush transom top strike bracket	M67	Add \$40.00 per device
Mortise Device		
-ANSI wrought strike box	M17	No Charge
-ANSI strike for pair of doors w/astragal (7/8" L to C)	SS078	
-Open back strike for 1-3/4" door	SB134	Add \$114.00 per device
-Open back strike for 2-1/4" door	SB214	\$182.00

Miscellaneous Options

Description	Specify	Add or Deduct
Torx® screws for rim, concealed vertical rod, mortise	M04	Add \$63.00 per device
Torx® screws for surface vertical rod	M04	Add \$118.00 per device
Knurling outside and inside (Embossed Touchbar - device side) ¹	M20*	Add \$199.00 per device
Knurling outside only (trim side) ¹	M21*	Add \$93.00 per device
Knurling inside only (Embossed Touchbar - device side)	M22*	Add \$106.00 per device
Abrasive coat outside and inside (trim and device)	M23	Add \$126.00 per device
Abrasive coat inside only (device side)	M24	Add \$66.00 per device
Abrasive coat outside only (trim side)	M25	Add \$60.00 per device
Pathlite™ Photoluminescent Touchbar cover	M49	Add \$475.00 per device
Less dogging	M51	No Charge
Cylinder dogging (less cylinder)	M52	Add \$107.00 per device
Sex nuts and bolts (SNBs)	M54	No Charge
Less bottom vertical rod ²	M55	
Narrow stile cover	M56	No Charge
Shim kit (for vision light)		
- All rim and concealed vertical rod	M58	Add \$98.00 per device
- All surface vertical rod	M58	Add \$129.00 per device
- All mortise exit devices	M58	Add \$129.00 per device
Parabolic Design Exit Trim	M60	Add \$107.00 per device
Wood screws For use on fire rated solid wood or wood core doors	M64	No Charge
Trim to accept Schlage® interchangeable core (950 series trim only)	M69	No Charge
Windstorm Certified products for ED5200S(A) and ED5470(B) Only ^{3,4,5}	M107	Add \$117.00 per device
End Cap Reinforcement (used with standard end cap only)	M109	Add \$107.00 per device
Flush End Cap	M110	No Charge
5 lbs Pressure Release (Only available with RIM devices)	5CH	Add \$37.00

- Notes: 1. Not available with VT9, VTL9, VT9M and VTL9M trim, Vineyard™ or Muséo® levers.
 2. Available with ED5470 and ED5860 series only.
 3. ED5200S(A) x M107 requires through bolts.
 4. ED5470(B) maximum opening height is 8'0".
 5. Contact Ceco, Curries® or Fleming for detailed frame/door requirements and limitations.

*All levers provided in a powder coat finish will be supplied with an abrasive coating.

Surface Bolt™

Description	Specify	Price
Surface Bolt Kit – For Approved Windstorm Code Applications - bright zinc plated finish	988CR	\$202.00

Mullions
Ordering Example

Quantity	Mullion Number
10	CR972

Removable Mullions

Door Height	Description	Specify	Price
Up to 7'2"	Steel Mullion - Panic Rated	CR972	\$943.00
Up to 7'2"	Steel Mullion - 3 Hour Fire Rated	CR972A	\$1,311.00
Up to 10'	Steel Mullion - 3 Hour Fire Rated up to 8' size	CR910A ³	\$1,321.00
Up to 7'2"	Steel Mullion - 3 Hour Fire Rated, Windstorm Certified	CRFE772A ¹	\$1,634.00
Up to 8'0"	Steel Mullion - 3 Hour Fire Rated, Windstorm Certified	CRFE708A ¹	\$1,644.00

Key Removable Mullions

Door Height	Description	Specify	Price
Up to 7'2"	Steel Mullion - 1-1/2 Hour Fire Rated	CR972BKM ²	\$2,018.00
Up to 10'	Steel Mullion - 1-1/2 Hour Fire Rated up to 8' size	CR910BKM ²	\$2,028.00
Up to 7'2"	Steel Mullion - 3 Hour Fire Rated, Windstorm Certified	CRWS772AKM ²	\$2,293.00
Up to 8'0"	Steel Mullion - 3 Hour Fire Rated, Windstorm Certified	CRWS708AKM ²	\$2,303.00

Notes:

- For use with UL approved door assemblies that comply to FEMA 361 and FEMA 320 guidelines. For the latest listings on compliant door assemblies visit our website at corbinrusswin.com.
- Cylinder and collars not included, specify separately.
- Mullions longer than 8" must be ordered as fire rated option x 10' length. Fire rating is valid only up to 96".

Mullions Cylinder Options

Description	Specify	Add or Deduct
Conventional 6-pin	6P	Add \$120.00 per cylinder
Conventional 7-pin	7P	Add \$122.00 per cylinder
LFIC 6-pin	C6	Add \$224.00 per cylinder
LFIC 7-pin	C7	Add \$228.00 per cylinder
Pyramid High Security Fixed Core	PHS	Add \$245.00 per cylinder
Pyramid Security Fixed Core	PS	Add \$204.00 per cylinder
Pyramid High Security IC	PCHS	Add \$343.00 per cylinder
Pyramid Security IC	PCS	Add \$301.00 per cylinder
Security	HS	Add \$278.00 per cylinder
Security IC	CHS	Add \$378.00 per cylinder
LFIC 6-pin with temporary construction core (Red)	CT6R	Add \$224.00 per cylinder
LFIC 6-pin with temporary construction core (Blue)	CT6B	Add \$224.00 per cylinder
LFIC 6-pin with temporary construction core (Green)	CT6G	Add \$224.00 per cylinder
LFIC 6-pin with temporary disposable core	CT6D	Add \$120.00 per cylinder
LFIC 6-pin less core	CL6	Add \$120.00 per cylinder
LFIC 7-pin with temporary construction core (Red)	CT7R	Add \$228.00 per cylinder
LFIC 7-pin with temporary construction core (Blue)	CT7B	Add \$228.00 per cylinder
LFIC 7-pin with temporary construction core (Green)	CT7G	Add \$228.00 per cylinder
LFIC 7-pin with temporary disposable core	CT7D	Add \$122.00 per cylinder
LFIC 7-pin less core	CL7	Add \$122.00 per cylinder

Options

Description	Specify	Add or Deduct
Door frame filler block for double rabbeted frames	M95	Add \$45.00 per mullion
Door frame angle bracket for aluminum frames	M96	Add \$45.00 per mullion
Mullion stabilizer	M57	Add \$67.00 per mullion

Standard Features

Handing

Handed, specify hand

Door Thickness

1-3/4"

Backset

2-3/4"

Projection

4" (102mm); 2 3/4" (70mm) depressed

Trim

Cylinder is not included.

See page 337 for
cylinder options.

Rim

ED7200

Panic

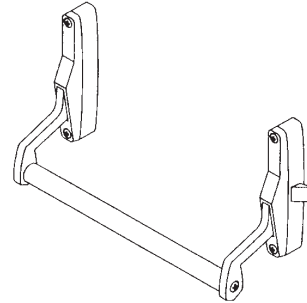

Vertical Rod

ED7400

Panic

Concealed Vertical Rod

ED7800

Panic

ED7800A

3 Hour Fire Rated

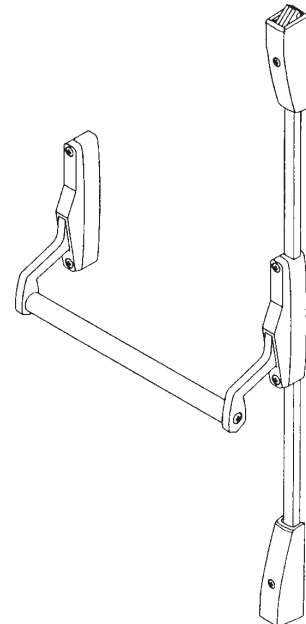

Ordering Example

Rim Exit Device

Quantity	Exit Device	Finish	Hand	Misc. Options
20	ED7200	606	RHR	M51-M54

Rim Exit Device with Trim

Quantity	Exit Device	Trim/Function	Finish	Hand	Door Thickness	Door Width	Misc. Options
50	ED7200	P557ET	630	LHR	D214	W048	M53

Trim Only (Rim Device)

Quantity	Exit Device	Finish
10	P457ET	630

Vertical Rod Exit Device with Trim

Quantity	Exit Device	Trim/Function	Finish	Hand	Door Thickness	Door Width	Misc. Options
50	ED7401	C455ET	613	RHR	D214	W048	H1000

Contract/Detailed Order - Rim Exit Device with Trim

Quantity	Keypad	Exit Device	Trim/Function	Finish	Hand	Door Thickness	Door Width	Optional Cylinders	Keying
50	AA1	ED7200	P457ET	626	LHR	D200	W048	C6	VKC3

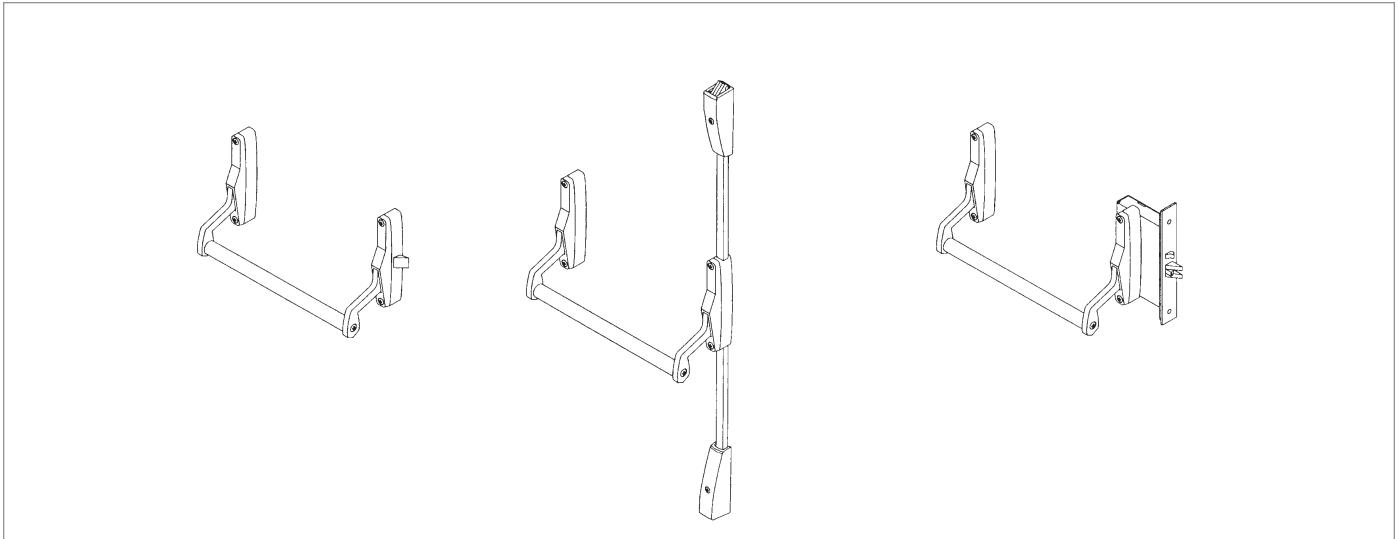

36" Device Only

Includes device, strike(s) and screw pack. No cylinder or trim.

Rim ED7200 Series

Function	Description	Finish: 613E, 626	Finish: 605, 606, 611, 612, 613, 618, 619, 625, 629, 630, 722
ED7200	Panic	\$3,941.00	\$4,018.00

Vertical Rod ED7400 Series

Function	Description	Finish: 613E, 626	Finish: 605, 606, 611, 612, 613, 618, 619, 625, 629, 630, 722
ED7400	Panic Exit Trim Only (accepts operator trim)	\$4,503.00	\$4,580.00
ED7401	Panic Exit Trim Only (accepts lever trim)		

Concealed V.R. ED7800 Series

Function	Description	Finish: 613E, 626	Finish: 605, 606, 611, 612, 613, 618, 619, 625, 629, 630, 722
ED7800	Panic	\$4,364.00	\$4,441.00
ED7800A	3 Hour Fire Rated	\$4,594.00	\$4,671.00

Caution: Be sure of your measurements. Exit devices are NOT returnable.

ED7200 Rim Trim

Cylinder is not included.

Pull Trim Design: P4 D Grip Pull



Grip: Extruded **Escutcheon:** Wrought



Function	Description	Finish: 605, 606, 611, 612, 613, 613E, 618, 619, 625, 626, 629, 630, 722
P450ET	Dummy	\$555.00
P457ET	Nightlatch	

Pull Trim Design: P5 Round Grip Pull



Grip: Extruded **Escutcheon:** Wrought



Function	Description	Finish: 605, 606, 611, 612, 613, 613E, 618, 619, 625, 626, 629, 630, 722
P550ET	Dummy	\$555.00
P557ET	Nightlatch	

Pull Trim Design: P6 Pull



Grip: Wrought
MR option available **Escutcheon:** Wrought



Function	Description	Finish: 605, 606, 611, 612, 613, 613E, 618, 619, 625, 626, 629, 630, 722
P650ET	Dummy	\$555.00
P657ET	Nightlatch	

Pull Trim Design: P7 Plate

Escutcheon: Wrought
MR option available



Function	Description	Finish: 605, 606, 611, 612, 613, 613E, 618, 619, 625, 626, 629, 630, 722
P757ET	Nightlatch	\$546.00

ED7400 Surface Vertical Rod Trim

Cylinder is not included.

Escutcheon Trim Design: C4 Citation



Lever: Cast
MR option available

Escutcheon: Wrought
Available with ED7401 device only.



Function	Description	Finish: 605, 606, 611, 612, 613, 613E, 618, 619, 625, 626, 629, 630, 722
C455ET*	Classroom	\$1,136.00
C457ET*	Nightlatch	

*1-3/4 doors only

Escutcheon Trim Design: D4 Dirke



Lever: Cast
MR option available

Escutcheon: Wrought
Available with ED7401 device only.

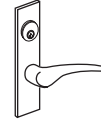

Function	Description	Finish: 605, 606, 611, 612, 613, 613E, 618, 619, 625, 626, 629, 630, 722
D455ET*	Classroom	\$1,136.00
D457ET*	Nightlatch	

*1-3/4 doors only

Escutcheon Trim Design: O3 D Grip Operator



Pull: Extruded
MR option available

Escutcheon: Cast
Available with ED7400 only.



Function	Description	Finish: 605, 606, 611, 612, 613, 613E, 618, 619, 625, 626, 629, 630, 722
O355ET	Classroom	\$1,136.00
O356ET**	Nightlatch	
O357ET	Nightlatch	

Escutcheon Trim Design: O4 Round Grip Operator



Pull: Extruded
MR option available

Escutcheon: Cast
Available with ED7400 only.



Function	Description	Finish: 605, 606, 611, 612, 613, 613E, 618, 619, 625, 626, 629, 630, 722
O455ET	Classroom	\$1,136.00
O456ET**	Nightlatch	
O457ET	Nightlatch	

**Key also used to hold top and bottom latchbolts in retracted position.

ED7800 Concealed Vertical Rod Trim

Cylinder is not included.

Trim Design: O5 Operator

Escutcheon: Cast



Function	Description	Finish: 605, 606, 611, 612, 613, 613E, 618, 619, 625, 626, 629, 630, 722
O557ET	Nightlatch	\$432.00

Offset Pull Trim: P12, P13, P14

Offset Pull Trim	Part Number	Finish: 605, 606, 612, 613, 613E, 626, 629, 630
P12	716F50M X Finish	\$397.00
P13	716F51M X Finish	\$484.00
P14	716F52M X Finish	\$340.00

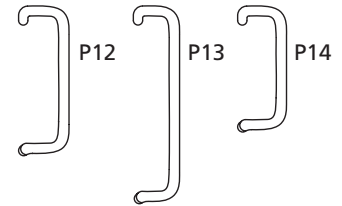

Cylinder Options*		
Description	Specify Quick Code	Add or Deduct
Conventional 6-pin	6P*	Add \$120.00 per cylinder
Conventional 7-pin	7P	Add \$122.00 per cylinder
LFIC		
LFIC 6-pin	C6	Add \$224.00 per cylinder
LFIC 6-pin less core	CL6	Add \$120.00 per cylinder
LFIC 6-pin with temporary construction core (Red)	CT6R	Add \$224.00 per cylinder
LFIC 6-pin with temporary construction core (Blue)	CT6B	Add \$224.00 per cylinder
LFIC 6-pin with temporary construction core (Green)	CT6G	Add \$224.00 per cylinder
LFIC 6-pin with temporary disposable core	CT6D	Add \$120.00 per cylinder
LFIC 7-pin	C7	Add \$228.00 per cylinder
LFIC 7-pin less core	CL7	Add \$122.00 per cylinder
LFIC 7-pin with temporary construction core (Red)	CT7R	Add \$228.00 per cylinder
LFIC 7-pin with temporary construction core (Blue)	CT7B	Add \$228.00 per cylinder
LFIC 7-pin with temporary construction core (Green)	CT7G	Add \$228.00 per cylinder
LFIC 7-pin with temporary disposable core	CT7D	Add \$122.00 per cylinder
SFIC		
SFIC 6-pin	C6S	Add \$213.00 per cylinder
SFIC 6-pin with temporary construction core (Blue)	CT6SB	Add \$213.00 per cylinder
SFIC 6-pin with SFIC disposable temporary core	CT6SD	Add \$120.00 per cylinder
SFIC 6-pin with Less Core	CLS6	Add \$120.00 per cylinder
SFIC 7-pin	C7S	Add \$213.00 per cylinder
SFIC 7-pin with temporary construction core (Blue)	CT7SB	Add \$213.00 per cylinder
SFIC 7-pin with SFIC disposable temporary core	CT7SD	Add \$120.00 per cylinder
SFIC 7-pin with Less Core	CLS7	Add \$120.00 per cylinder
Security		
Security ⁴	HS	Add \$278.00 per cylinder
Security LFIC ⁴	CHS	Add \$378.00 per cylinder
Access 3		
Access 3 Patented	AP	Add \$120.00 per cylinder
Access 3 Security	AS	Add \$198.00 per cylinder
Access 3 High Security, UL 437	AHS	Add \$231.00 per cylinder
Access 3 LFIC Patented	ACP	Add \$224.00 per cylinder
Access 3 LFIC Security	ACS	Add \$302.00 per cylinder
Access 3 LFIC High Security, UL 437	ACHS	Add \$335.00 per cylinder
Pyramid		
Pyramid Security fixed core	PS	Add \$204.00 per cylinder
Pyramid Security LFIC	PCS	Add \$301.00 per cylinder
Pyramid High Security fixed core	PHS	Add \$245.00 per cylinder
Pyramid High Security LFIC	PCHS	Add \$343.00 per cylinder
Pyramid LFIC with temporary construction core ³	CTP	Add \$224.00 per cylinder
Pyramid LFIC with temporary disposable core ³	CTPD	Add \$120.00 per cylinder
Pyramid LFIC less core	CLP	Add \$120.00 per cylinder
Other		
Less master ring cylinder ⁴	MR-LC	No Charge
Master Ring ⁴	MR	Add \$187.00 per cylinder

*6P cylinder option is supplied in 6-pin, L4 keyway, 0-bitted with two nickel silver keys.

Notes:

1. Available on outside trim only.
2. Not available on O5 trim.
3. Rim only. 4. Available on C4, D4, OBS, O3, O4 trims only.
5. Not available on ED7600 C4M, D4M, E4M B5M, G6M trims.
6. Pyramid is not available on ED7600 with door thicknesses over 2-1/4".
7. Not available on P4, P5, P5, P7 trims.

Cylinder Options (continued) & Keying Options*

Description	Specify Quick Code	Add or Deduct
Keying and Keys		
0-bitted with 2 Blank Keys	(standard)	No Charge
Keyed Random	KR	
Construction Master Keyed ²	CMK	Add \$16.00 per cylinder
More than 2 Keys	KY# (e.g., KY6)	See page 33 - Cut Keys Section
Master Keying		
Master keyed (all cylinders except CR8000, CR8020, CR8027, CR8200, CR8500, CR8600, CR8700)	MK	Add \$16.00 per cylinder
Master keyed Pyramid (except CR8020, CR8027 LFIC cores)	MK	
Master keyed Security (including LFIC cylinder and core)	MK	
Master keyed Access 3 (except CR8500, CR8600, CR8700 LFIC cores)	MK	
Master keyed (CR8000, CR8020, CR8027, CR8200, CR8500, CR8600, CR8700)	MK-IC	No Charge
Master keyed to customer bittings or sample key	MK-CB	Add \$16.00 per cylinder
Visual Key Control (VKC)		
No bitting or keyset stamping on keys	VKC0	\$4.50
Keys only	VKC1	No Charge
Cylinders and keys (not for AS, AHS, ACS, ACHS, HS, CHS, PHS or PCHS)	VKC2	\$8.00
Cylinders only (not for AS, AHS, HS, ACS, ACHS, CHS, PHS or PCHS)	VKC3	
Concealed Key Control (CKC)		
CKC cylinders with VKC keys	CKC2	\$8.00
CKC cylinders only (not for AS, AHS, ACS, ACHS, PHS, PCHS)	CKC3	

- Notes:
1. CMK Construction master keying charge is in addition to master keying charge.
 2. CMK Construction master keying is not available in interchangeable core, Access 3, Pyramid, or Security series.
 3. VKC2, VKC3, CKC3 are not available in Pyramid or Security series.

Strike Options

To purchase strike separately, see catalog for part no.

Description	Specify	Add or Deduct
Open rim strike on ED7200	(standard)	No Charge
Rim strike	S07	
Rim strike for aluminum frames with blade stops	S08	
Mortised adjustable rim strike	S04	
Vertical rod top strike on ED7400 device	(standard)	
Vertical rod bottom strike on ED7400		
Vertical rod flush bottom strike on ED7400 device	S03	
Concealed vertical rod top strike on ED7800 device	(standard)	
Fire rated concealed vertical rod top strike on ED7800A device	(standard)	
Fire rated concealed vertical rod bottom strike on ED7800 and ED7800A devices	(standard)	

Description	Lip Length	Specify	Add or Deduct
Mortise straight lip ANSI strike on ED7600, ED7600A	1-1/8"	(standard)	No Charge
	1-1/4"	SS114	
	1-3/8"	SS138	
Mortise open back strike	1-3/4"	SB134	Add \$114.00 per device
	2"	SB200	\$182.00
	2-1/4"	SB214	

Custom Laser Engraving- LASER

Laser engraving processing charge (all engraving types)

- \$250.00 net per order. Charge will be applied to production order when placed.

Single Vanity, Logo or Other (same engraving on all parts)

- Lever - \$10.00 net add each
- Mortise Escutcheon - \$10.00 net add each
- HPSK Paddle - \$10.00 net add each

Unique laser engraving (i.e. Room Number, Apartment Number, etc)

- \$12.00 net add each (per piece)

Door Width Options

Description	Specify	Add or Deduct
36"	(standard)	No Charge
48"	W048	Add \$49.00 per device

Door Thickness Options

Description	Specify	Add or Deduct
1-3/4"	(standard)	No Charge
2" (Not available for ED7800 Series)	D200	
2-1/4" (Not available for ED7800 Series)	D214	

Door Height Options

Description	Specify	Add or Deduct
7'6" (ED7400 devices)	(standard)	No Charge
7'2" (ED7400A & 7800A devices)	(standard)	
8'6" (ED7800 devices)	(standard)	
10'0" (ED7400 devices only)	H1000	Add \$112.00 per device
10'8" (ED7800 devices only)	H1008	

Miscellaneous Options

Description	Specify	Add or Deduct
Spanner head screws	M02	Add \$47.00 per device
ANSI wrought strike box (for mortise only)	M17	No Charge
Knurling outside and inside (trim and device)	M20*	Add \$199.00 per device
Knurling outside only (trim side)	M21*	Add \$93.00 per device
Knurling inside only (device side)	M22*	Add \$106.00 per device
Abrasive coat outside and inside (trim and device)	M23	Add \$126.00 per device
Abrasive coat inside only (device side)	M24	Add \$66.00 per device
Abrasive coat outside only (trim side)	M25	Add \$60.00 per device
Stainless Steel Crossbar ¹		
- When ordered with 626 or 630 finish	M50	No Charge
- All other finishes	M50	Add \$102.00 per device
Less dogging	M51	No Charge
Steel reinforced crossbar	M53	Add \$93.00 per device
Sex nuts and bolts (SNBs)	M54	No Charge
Shim for 2-3/4" backset on doors with 1/2" stop (for ED7200 only)	M59	Add \$30.00 per device
Less latch hold-back (for ED7200 and ED7600 devices only)	M66	No Charge

Note:

1. Not available with M22 or M20 option.

*All levers provided in a powder coat finish will be supplied with an abrasive coating.

Removable Mullion

Ordering Example

Quantity	Mullion Number
10	CR507

Mullion Number	Description	Price
CR510	For doors up to 10'	\$1,137.00

DC3000 Series:

DC3000 Series Standard Features	346
---------------------------------	-----

DC3000 Series Arm Options, Miscellaneous Options, Brackets, Door Thickness, Drop Plates, Finish Options	347
---	-----

DC5000 Series (Cam Action Door Closer):

DC5000 Series Standard Features	348
---------------------------------	-----

DC5000 Series Arm Options, Door Thickness, Handing, Finish Options, Miscellaneous Options, Drop Plate	349
---	-----

DC6000 Series:

DC6000 Series Standard Features	350
---------------------------------	-----

DC6200 Series, DC6400 Series	351
------------------------------	-----

DC6000 Series Arm Options, Door Width Options, Finish Options, Door Thickness, Handing	352
--	-----

DC6000 Series Miscellaneous Options, Blade Stop Spacer, Miscellaneous Brackets, Drop Plates	353
---	-----

DC8000 Series:

DC8000 Series Standard Features	354
---------------------------------	-----

DC8200 Series (Factory Pre-Sized)	355
-----------------------------------	-----

DC8000 Series Arm Options, Door Width Options, Finish Options	356
---	-----

DC8000 Series Miscellaneous Options, Blade Stop Spacer, Miscellaneous Brackets, Drop Plates	357
---	-----

DC62900 Series:

DC62900 Series Electromechanical Door Controls: Ordering Example, DC62900 Series, Miscellaneous Options, Voltage	358
--	-----

Standard Features

Handing

Non-handed

Spring Power

DC3200 Series: Non-sized
fully adjustable 1 thru 6.

Degree of Opening

Up to 180° opening standard for
regular, top jamb and
parallel arm mounting.

Case Quantity

4

Case Weight

42 lbs

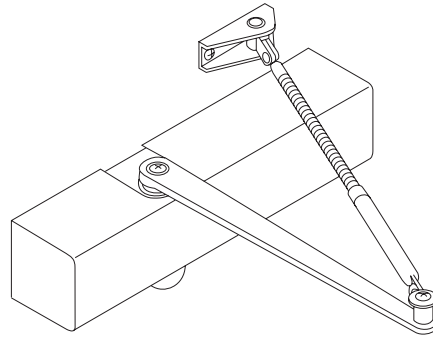

Ordering Examples

Stock Order

Quantity	Series/Mounting	Finish
48	DC3210	689

Contract Order

Quantity	Series/Mounting	Arm	Finish	Option
100	DC3210	A4	689	M54

DC3200 Series

Non-sized: full adjustability from sizes 1-6

Function	Description	Finish: 600, 689, 690, 691, 693, 696
DC3200	Regular arm	\$567.00
DC3210	Parallel arm	
DC3220	Top jamb	

DC3210 closers are tri-packed standard (for regular arm, top jamb or parallel arm mounting) unless specialty arm is requested.

Arm Options

Description	Specify Quick Code	Add or Deduct
Hold open arm	A1	Add \$101.00 per closer
Heavy-duty parallel arm with hold open	A2	Add \$128.00 per closer
Heavy-duty parallel arm	A3	Add \$64.00 per closer
Heavy-duty parallel arm with backstop	A4	Add \$120.00 per closer
Heavy-duty parallel arm with backstop & hold open	A5	Add \$226.00 per closer
Heavy-duty regular arm	A10	Add \$64.00 per closer

Miscellaneous Options

Description	Specify Quick Code	Add or Deduct
Sex nuts and bolts (SNB)	M54	No Charge
Backcheck intensity	(standard)	No Charge
Delayed Action	M71	Add \$60.00 per closer
Full ABS Cover	(standard)	No Charge
Corrosion protection	M75	Add \$57.00 per closer
Heavy-duty parallel arm flush transom bracket (499F30). Used with A2, A3, A4 & A5 arms)	M79	Add \$21.00 per closer

Miscellaneous Brackets

Description	Specify Quick Code	Add or Deduct
Parallel arm flush transom bracket	M82	Add \$41.00 per closer
Parallel arm offset bracket	M83	Add \$41.00 per closer
Mortise arm bracket for regular arm mounting	M84	Add \$41.00 per closer
Angle Support bracket	M85	Add \$41.00 per closer

Door Thickness

Description	Specify
1-3/4"	(standard)

Drop Plates

Closer Plates	Old Quick Ship #	Full Cover	List price
DC3210	M80	597F58	\$102.00
DC3220	M80	188F65	\$102.00

Finish Options

Description	Add or Deduct
600, 613E, 689, 690, 691, 693, 696, BSP, WSP	(standard)

Standard Features

Handing

Non-handed

Spring Power

DC5000 Series: sizes 1 thru 6 fully adjustable.

Degree of Opening

110° opening range for Push Side and Pull Side installations.

Slide Track

Standard

Case Weight

DC5230 8 lbs.
DC5240 8 lbs.



Ordering Example

Stock Order

Quantity	Series/Mounting	Finish
100	DC5230	689

Contract Order

Quantity	Series/Mounting	Arm	Finish
100	DC5240	A1	689

DC5000 Series

Non-sized: full adjustability from sizes 1-6

Function	Description	Finish: 689, 690, 691, 693, 696
DC5230	Pull Side Track	\$825.00
DC5240	Push Side Track	

Arm Options

Description	Specify Quick Code	Add or Deduct
Hold open arm	A1	\$38.00

Door Thickness

Description	Specify
1-3/4"	(standard)

Handing

Description	Specify
Left Hand	LH
Right Hand	RH
Left Hand USA & Canada Prices Effective April 17, 2023	RH
Right Hand Reverse	LH

Finish Options

Description	Add or Deduct
Painted finishes: 689, 690, 691, 693, 696	(standard)

Miscellaneous Options

Description	Specify Quick Code	Add or Deduct
Sex nuts and bolts (SNB)	M54	No Charge

Drop Plate

Description	Part Number	Add or Deduct
Drop Plate (Push side)	754F80	\$70.00

Standard Features
Handing

Non-handed

Spring Power

DC6200 Series: sizes 1 thru 6
non-sized fully adjustable.

DC6400 Series: sizes 1 thru 6
half-size adjustability.

Degree of Opening

Up to full 180° opening
standard for regular, top jamb
and parallel arm applications.

Case Quantity

4

Case Weight

DC6200 42 lbs

DC6400 42 lbs



Ordering Example

Stock Order

Quantity	Series/Mounting	Finish
100	DC6210	689

Contract Order

Quantity	Series/Mounting	Arm	Finish	Door Thickness
100	DC6406	A6	689	D138

DC6200 Series

Non-sized: full adjustability from sizes 1-6

Function	Description	Finish: 600, 613E, 689, 690, 691, 693, 696, BSP, WSP
DC6200	Regular arm	\$626.00
DC6210	Parallel arm	
DC6220	Top jamb	
DC6230	Pull side track**	\$720.00
DC6240	Push side track	

DC6210 closers are tri-packed standard (for regular arm, top jamb or parallel arm mounting) unless specialty arm is requested.
 **Minimum 3" top jamb required.

DC6400 Series

Sized: 1/2-size adjustability

Function	Description	Finish: 600, 613E, 689, 690, 691, 693, 696, BSP, WSP
DC6401	Regular arm	Size 1
DC6402		Size 2
DC6403		Size 3
DC6404		Size 4
DC6405		Size 5
DC6406		Size 6
DC6411	Parallel arm	Size 1
DC6412		Size 2
DC6413		Size 3
DC6414		Size 4
DC6415		Size 5
DC6416		Size 6
DC6421	Top jamb	Size 1
DC6422		Size 2
DC6423		Size 3
DC6424		Size 4
DC6425		Size 5
DC6426		Size 6
DC6433	Pull side track	Size 3
DC6434		Size 4
DC6435		Size 5
DC6436		Size 6
DC6443	Push side track	Size 3
DC6444		Size 4
DC6445		Size 5
DC6446		Size 6

Note: See page 352 for plated finishes.
 DC641X closers are tri-packed standard (for regular arm, top jamb or parallel arm mounting) unless specialty arm is requested.

Arm Options

Description	Specify Quick Code	Add or Deduct
Hold open arm	A1	Add \$101.00 per closer
Heavy-duty parallel arm with hold open	A2	Add \$128.00 per closer
Heavy-duty parallel arm	A3	Add \$64.00 per closer
Heavy-duty parallel arm with backstop	A4	Add \$120.00 per closer
Heavy-duty parallel arm with backstop & hold open	A5	Add \$226.00 per closer
Deep reveal (3-1/4" - 7-1/4")	A6	No Charge
Deep reveal with hold open	A8	Add \$101.00 per closer
Heavy-duty regular arm	A10	Add \$64.00 per closer
Heavy-duty Unitrol®	A11*	Add \$325.00 per closer
Heavy-duty Unitrol® with hold open	A12*	Add \$426.00 per closer
Heavy-duty parallel arm with extra clearance	A13	Add \$54.00 per closer
Heavy-duty friction hold open arm	A14	Add \$127.00 per closer
Push side track with hold open	A1	Add \$101.00 per closer

* Specify door width

Door Width Options

Description	Specify Quick Code	Add or Deduct
A11, A12 door width 28" - 32"	W28	No Charge
A11, A12 door width 33" - 41"	W33	
A11, A12 door width 42" - 48"	W42	

Finish Options*

Description	Add or Deduct
	605, 606, 611, 612, 625, 626
Painted finishes: 600, 613E, 689, 690, 691, 693, 696, BSP, WSP	(standard)
Plated finishes: specify 605, 606, 611, 612, 625, 626	
Regular, parallel, hold open:	
- Plated arm & cover*	Add \$744.00 per closer
- Plated cover (metal)	Add \$303.00 per closer
- Plated arm*	Add \$441.00 per closer

Heavy-Duty arms (A2, A3, A4, A5, A10, A11, A12, A13, A14) are not available plated.

Track & arm for track-type closers are not available plated.

*For split finish of closer cover and arm, specify cover first, then arm finish; e.g. DC6200 x 625 x 689.

Special Finishes

<ul style="list-style-type: none"> Contact factory for availability 50 piece minimum order for non-standard sprayed or powder coat finishes 	Net add \$50.00 per closer
Additional charge per closer will be added to net/net charge	

Door Thickness

Description	Specify
1- 3/4"	(standard)
2"	D200

Handing

Description	Specify
Left Hand	LH
Right Hand	RH
Left Hand Reverse	RH
Right Hand Reverse	LH

Miscellaneous Options

Description	Specify Quick Code	Add or Deduct
Torx® Screws	M04	Add \$47.00 per closer
Sex nuts and bolts (SNB)	M54	No Charge
Backcheck intensity and location valves	(standard)	No Charge
Delayed Action	M71	Add \$60.00 per closer
Full ABS Cover	(standard)	No Charge
Full Metal Cover	M73	Add \$24.00 per closer
Extreme temperature fluid	(standard)	No Charge
Corrosion protection	M75	Add \$57.00 per closer
Security package*	M87	A2-Arm - Add \$199.00 per closer
		A3-Arm - Add \$135.00 per closer
		A4-Arm - Add \$191.00 per closer
		A5-Arm - Add \$297.00 per closer
		A10-Arm - Add \$135.00 per closer

*M87 includes full metal cover, Torx® fasteners and A2, A3, A4, A5, or A10 arm. Specify arm when ordering.

Blade Stop Spacer

Description	Specify Quick Code	Add or Deduct
1/2" spacer (597F92)	M77	Add \$31.00 per closer
5/8" spacer (597F93)	M78	Add \$50.00 per closer

Miscellaneous Brackets

Description	Specify Quick Code	Add or Deduct
HD PA flush transom bracket (used with all parallel arms except the Unicontrol®)	M79	Add \$54.00 per closer
Parallel arm flush transom bracket	M82	Add \$41.00 per closer
Parallel arm offset bracket	M83	Add \$41.00 per closer
Mortise arm bracket for regular arm mounting	M84	Add \$41.00 per closer
Angle support bracket	M85	Add \$41.00 per closer
Deep Reveal Reinforcement Kit	M103	Add \$41.00 per closer
Flush partition bracket	M104	Add \$34.00 per closer
Lead lined cover (metal cover only)	M108	Add \$248.00 per closer

Drop Plates

Closer Plates	Old Quick Ship #	Full Cover	List Price
DC6210, DC6410 (Parallel)	M80	597F58	\$102.00
DC6220, DC6420 (Top Jamb)	M80	188F65	
DC6230, DC6430 (Pull Side)	M81	597F59	
DC6240, DC6440 (Push Side)	M102	597F59	

Standard Features
Handing

Non-handed

Spring Power

DC8200 Series: sizes 1 thru 6 non-sized fully adjustable.

DC8200 Series: sizes 1 thru 6 half-size adjustability.

Degree of Opening

Up to full 180° opening standard for regular, top jamb and parallel arm applications.

Case Quantity

4

Case Weight

DC8200 54 lbs



Ordering Example

Stock Order

Quantity	Series/Mounting	Finish
100	DC8210	689

Contract Order

Quantity	Series/Mounting	Arm	Finish	Door Thickness
100	DC8206	A6	689	D138

DC8200 Series			
Non-sized full adjustability from sizes 1-6			
Function	Description	Finish: 600, 613E, 689, 690, 691, 693, 696, BSP, WSP	
DC8200	Regular arm	\$807.00	
DC8210	Parallel arm		
DC8220	Top Jamb		
DC8230	Pull side track**	\$895.00	
DC8240	Push side track		
DC8210 closers are tri-packed standard (for regular arm, top jamb or parallel arm mounting) unless specialty arm is requested. *Minimum 3" top jamb required.			
Factory Pre-Sized (available upon request)			
Function	Description	Finish: 600, 613E, 689, 690, 691, 693, 696, BSP, WSP	
DC8201	Regular arm	Size 1	\$807.00
DC8202		Size 2	
DC8203		Size 3	
DC8204		Size 4	
DC8205		Size 5	
DC8206		Size 6	
DC8211	Parallel arm	Size 1	
DC8212		Size 2	
DC8213		Size 3	
DC8214		Size 4	
DC8215		Size 5	
DC8216		Size 6	
DC8221	Top Jamb	Size 1	
DC8222		Size 2	
DC8223		Size 3	
DC8224		Size 4	
DC8225		Size 5	
DC8226		Size 6	
DC8233	Pull side track	Size 3	\$895.00
DC8234		Size 4	
DC8235		Size 5	
DC8236		Size 6	
DC8243	Push side track	Size 3	
DC8244		Size 4	
DC8245		Size 5	
DC8246		Size 6	
DC821X closers are tri-packed standard (for regular arm, top jamb or parallel arm mounting) unless specialty arm is requested.			

Arm Options

Description	Specify Quick Code	Add or Deduct
Hold open arm	A1	Add \$101.00 per closer
Heavy-duty parallel arm with hold open	A2	Add \$128.00 per closer
Heavy-duty parallel arm	A3	Add \$64.00 per closer
Heavy-duty parallel arm with backstop	A4	Add \$120.00 per closer
Heavy-duty parallel arm with backstop & hold open	A5	Add \$226.00 per closer
Deep reveal (3-1/4" - 7-1/4")	A6	No Charge
Deep reveal with hold open	A8	Add \$101.00 per closer
Heavy-duty regular arm	A10	Add \$64.00 per closer
Unitrol® arm	A11*	Add \$325.00 per closer
Unitrol arm x hold open	A12*	Add \$426.00 per closer
Heavy-duty parallel arm with extra clearance	A13	Add \$54.00 per closer
Heavy-duty friction hold open	A14	Add \$127.00 per closer
Push side track with hold open	A1	Add \$101.00 per closer

*Specify door width

Door Width Options

Description	Specify Quick Code	Add or Deduct
A11, A12 - door width 28" - 32"	W28	No Charge
A11, A12 - door width 33" - 41"	W33	
A11, A12 - door width 42" - 48"	W42	

Finish Options*

Description	Add or Deduct
	605, 606, 611, 612, 625, 626
Painted finishes: 600, 613E, 689, 690, 691, 693, 696, BSP, WSP	(standard)
Plated finishes: specify 605, 606, 611, 612, 625, 626	
Regular, parallel, hold open:	
- Plated arm & cover*	Add \$744.00 per closer
- Plated cover (metal)**	Add \$303.00 per closer
- Plated arm*	Add \$441.00 per closer

Heavy-Duty arms (A2, A3, A4, A5, A10, A11, A12, A13, A14) are not available plated.
 Track & arm for track-type closers are not available plated.

*For split finish of closer cover and arm, specify cover first, then arm finish; e.g. DC6200 x 625 x 689.

**Price of M73 option is not included.

Special Finishes

<ul style="list-style-type: none"> Contact factory for availability 50 piece minimum order for non-standard sprayed or powder coat finishes 	Net add \$50.00 per closer
Additional charge per closer will be added to net/net charge	

Miscellaneous Options		
Description	Specify Quick Code	Add or Deduct
Torx® Screws	M04	Add \$47.00 per closer
Sex nuts and bolts (SNB)	M54	No Charge
Backcheck valve	(standard)	No Charge
Delayed Action	M71	Add \$60.00 per closer
Full ABS Cover	(standard)	No Charge
Full Metal Cover	M73	Add \$24.00 per closer
Extreme Temperature Fluid	(standard)	No Charge
Corrosion Protection	M75	Add \$57.00 per closer
Security Package*	M87	A2-Arm - Add \$199.00 per closer
		A3-Arm - Add \$135.00 per closer
		A4-Arm - Add \$191.00 per closer
		A5-Arm - Add \$297.00 per closer
		A10-Arm - Add \$135.00 per closer
*M87 includes full metal cover, Torx® fasteners and A2, A3, A4, A5, A10 or A13. Specify arm when ordering		
Blade Stop Spacer		
Description	Specify Quick Code	Add or Deduct
1/2" spacer (597F92)	M77	Add \$31.00 per closer
5/8" spacer (597F93)	M78	Add \$50.00 per closer
Miscellaneous Brackets		
Description	Specify Quick Code	Add or Deduct
HD PA flush transom bracket (used with all parallel arms except the Unitrol®)	M79	Add \$54.00 per closer
Parallel arm flush transom bracket	M82	Add \$41.00 per closer
Parallel arm offset bracket	M83	Add \$41.00 per closer
Mortise arm bracket for regular arm mounting	M84	Add \$41.00 per closer
Angle support bracket	M85	Add \$41.00 per closer
Deep reveal reinforcement kit	M103	Add \$41.00 per closer
Flush partition bracket (used with Unitrol® arm)	M104	Add \$34.00 per closer
Lead lined cover	M108	Add \$248.00 per closer
Drop Plates		
Closer Series	Part Number	List Price
DC8200 (regular)	754F20	\$125.00
DC8200 (with concealed holder)	754F24	\$125.00
DC8210 (parallel)	754F25	\$125.00
DC8220 (top jamb)	754F24	\$125.00
DC8230 (pull side track)	754F20	\$125.00

Electromechanical Door Controls

Sex nuts and bolts are furnished standard.
 689 Finish.

Ordering Example

Quantity	Series/Mounting	Finish	Voltage	Options
24	DC62930	689	24A	M54

DC62900 Series

Model	Quick Code	Description		Finish: 689, 690, 691, 693, 696
DC62930	ET	Pull Side	Support Unit	\$1,608.00
DC62940	ET	Push Side	Support Unit	\$1,608.00

Miscellaneous Options

Description	Specify Quick Code	Add or Deduct
Torx® machine screws	M04	Add \$47.00 per closer
Sex nuts and bolts		
- DC62930	(standard)	(standard)
- DC62940	(standard)	(standard)
Backcheck intensity valve	M70	Add \$46.00 per closer

Voltage*

Description	Specify Quick Code
24VAC	24A
24VDC	24D
120VAC	120A

Parts Price List

Number 38
USA & Canada Prices Effective
April 17, 2023



PLUGS AND SHELLS

6-PIN PLUGS, BULK PACKS			606, 626
PART NO.	DESCRIPTION	LIST PRICE	
These packages are priced at a savings over individual plug prices. Keyway availability is limited to L4, D1, H1, 60, 59A1 and 981.			
492K90	25 Pack for 1-1/8" Mortise	\$1,031.00	
492K91	25 Pack for 3000 Rim		
492K92	50 Pack for CK4200, UT5200		
610K48	50 Pack for CL3300		
5- AND 6-PIN INDIVIDUAL PLUGS			
X CLASS	STANDARD	USED IN	LIST PRICE
487K10	121K10	1" Mortise (5-pin)	\$52.00
487K11	121K11	1-1/8" Mortise	
606K73	193K09	3-1/4" Mortise	\$92.00
606K74	193K10	3-1/2" Mortise	\$94.00
606K75	193K11	3-3/4" Mortise	\$100.00
487K38	197K51*	1001 Hotel Mortise	\$56.00
488K99	488K98	CK4200, UT5200 (.552") and 2000051	\$52.00
564K53	574K05	CK4400, except below	
564K60	564K52	CK4429 Hotel, old tailpiece	
564K59	579K14	CK4429, new tailpiece	\$65.00
580K99	574K07	CK4455, CK4482, before 8/93	
596K29	585K24	CL3300, CL3500, CL3600, CL3700, CL3800	\$52.00
596K31	585K26	CL3329, CL3629 Hotel	\$67.00
489K49	186K75	2001051 (1429/3433EM)	
534K25	245K37	2100/2160 (large head)	\$65.00
612K90	444K87	2200001 and 009	
612K91	444K89	2200002	
612K88	444K94	2200008	
612K93	444K88	2200054	
612K94	523K21	2200076	\$52.00
488K84	253K66	3000 Rim Cylinder	
610K46	146K80	4200002 for AR Pull	\$65.00
	195K68	4266 for MR Exit Operators	\$78.00
334K01	334K00	80006 Interchangeable Core	\$52.00
n/a	378K18	Fox Police Rim Cyl. (5-pin)	\$78.00
7-PIN PLUGS			606, 626
X CLASS	STANDARD	USED IN	LIST PRICE
487K13	292K95	1-1/4" Mortise	\$56.00
487K15	292K96	1-3/8" Mortise	
487K17	292K97	1-1/2" Mortise	
487K19	292K98	1-3/4" Mortise	\$72.00
487K21	292K99	2" Mortise	\$77.00
606K76	293K00	2-1/4" Mortise	
606K77	293K01	2-1/2" Mortise	
606K78	293K02	2-3/4" Mortise	
606K79	293K03	3" Mortise	\$80.00
596K30	585K25	CL3300 Non-Hotel	\$66.00
596K32	585K27	CL3329 Hotel	\$72.00
488K85	253K67	3000-7 Rim Cylinder	\$56.00
416K08	416K07	8000-7 Core	\$66.00

SECURITY PLUGS (USE IN SECURITY SHELLS ONLY)			
PART NO.	DESCRIPTION	LIST PRICE	
407K63	1-1/8" Mortise	\$80.00	
407K64	1-1/4" Mortise		
415K73	1-3/8" Mortise	\$89.00	
415K74	1-1/2" Mortise		
518K73	1-3/4" Mortise	\$103.00	
518K74	2" Mortise		
518K75	2-1/4" Mortise	\$106.00	
518K76	2-1/2" Mortise		
518K77	2-3/4" Mortise		
409K12*	1011 Mortise Hotel	\$80.00	
408K45	CK4200, UT5200	\$72.00	
585K46	CL3300 Non-Hotel	\$89.00	
444K97	2210001 and 009		
444K98	2210002	\$80.00	
444K96	2210008	\$89.00	
444K99	2210054	\$80.00	
407K65	3010 Rim Cylinder	\$72.00	
483K01	3012 Rim	\$87.00	
446K68	8010 Interchangeable Core	\$66.00	
PYRAMID STANDARD PLUGS			
696K43	Used with 1020	†Order 10-	\$72.00
798K912 x Fin	Used with 1020112	†Order 10-	
696K45	Used with 3020	†Order 10-	
696K46	Used with 2020	†Order 10-	
696K48	Used with 2020	†Order 10-	
696K52	Used with 8020, 8027	†Order 10-	
715K14	Used with 2220	†Order 10-	
PYRAMID SECURITY PLUGS			
716K43	Used with 1027	†Order 10-	\$72.00
798K922 x Fin	Used with 1027112	†Order 10-	
716K45	Used with 3027	†Order 10-	
716K46	Used with 2027 KIL	†Order 10-	
716K48	Used with 2027 KIK	†Order 10-	
716K16	Used with 2227	†Order 10-	
PYRAMID SIDE PIN PLUGS			
628K852 x Fin	Used with 1020114	†Order 10-	\$72.00
628K972 x Fin	Used with 1020112	†Order 10-	
628K872 x Fin	Used with 3020	†Order 10-	
628K902 x Fin	Used with 2020052	†Order 10-	
628K882 x Fin	Used with 202003x	†Order 10-	
628K952 x Fin	Used with 2220	†Order 10-	
629K032 x Fin	Used with 8020, 8027	†Order 10-	
628K992 x Fin	Used with 1027114	†Order 10-	
630K472 x Fin	Used with 1027112	†Order 10-	
629K002 x Fin	Used with 3027	†Order 10-	
629K022 x Fin	Used with 2027052	†Order 10-	
629K012 x Fin	Used with 202703x	†Order 10-	
629K042 x Fin	Used with 2227	†Order 10-	
6-PIN LOADED SHELLS, BULK PACKS			
Finishes available for rim and mortise shells: 605, 606, 612, 613, 625, 626			
493F76	25 Pack for 1000118 Mortise	\$1,924.00	
677F42	25 Pack for 1000114 Mortise		
493F77	25 Pack for 3000 Rim		
493F78	50 Pack for CK4200, UT5200		
610F49	50 Pack for CL3300, CL3700		

*Not available in D1, D2, L1, L2, 752, 852 or A class keyways.
†Sold only in multiples of the number indicated. Price is each.

CYLINDER PARTS

PART NO.	DESCRIPTION	LIST PRICE	SOLD IN MULT. OF	PART NO.	DESCRIPTION	LIST PRICE	SOLD IN MULT. OF			
PYRAMID SHELLS				SECURITY MASTER PINS						
695F042 x Fin	Used with 1020114, 1027114, 3020058, 3027058	\$93.00	10†	407T314097	2L	\$6.80	20†			
695F052 x Fin	Used with 3020, 3027 (Slotted)									
696F502 x Fin	Used with 8020, 8027									
696F472	Used with 2020, 2027 (KIL)	\$85.00								
696F499	Used with 2020, 2027 (KIK)									
715F152	Used with 2220, 2227									
PYRAMID SHELLS - SIDE PINS				SECURITY TOP PINS						
628F922 x Fin	Used with 8020, 8027	\$85.00		10†	407T434193			Size 1 Long	\$6.80	20†
629F062 x Fin	Used with 1020114, 1027114, 3020058, 3027058									
630F482 x Fin	Used with 1020112, 1027112									
628F912	Used with 2020, 2027 (Levers)									
628F892	Used with 2020, 2027 (Levers)									
628F962	Used with 2220, 2227 (Competitors)									
629F072 x Fin	Used with 3020, 3027 (Slotted)									
PYRAMID SIDE PINS (VIAL OF 20 PINS)					BUMP-RESISTANT TOP SPOOL PINS (VIAL OF 100 PINS)					
630F494	Pyramid Side Pins - Vial Of 20 Pins	\$25.00			628F107171	Conventional	\$64.00	1		
PYRAMID HIGH SECURITY PINS (VIAL OF 100 PINS)					SPRINGS AND SPRING COVERS					
TOP PINS				ACCESS 3 PINS (VIAL OF 100 PINS)						
695F257031 - .031"	695F257173 - .173"	\$65.00	1	Bottom Pins (BP)						
695F257047 - .047"	695F257189 - .189"			763F002213	Bottom AP-0	\$34.00	1			
695F257063 - .063"	695F257204 - .204"			763F002243	Bottom AP-1					
695F257078 - .078"	695F257220 - .220"			763F002273	Bottom AP-2					
695F257094 - .094"	695F257236 - .236"			763F002303	Bottom AP-3					
695F257110 - .110"	695F257252 - .252"			763F002333	Bottom AP-4					
695F257126 - .126"	695F257267 - .267"			763F002363	Bottom AP-5					
695F257141 - .141"	695F257283 - .283"			763F002393	Bottom AP-6					
695F257157 - .157"	695F257299 - .299"			Master Pins (MP)						
BOTTOM PINS				763F012030	Master AP&AS-1	\$34.00	1			
695F247139 - .139"	695F247218 - .218"	763F012060	Master AP&AS-2							
695F247155 - .155"	695F247234 - .234"	763F012090	Master AP&AS-3							
695F247171 - .171"	695F247250 - .250"	763F012120	Master AP&AS-4							
695F247187 - .187"	695F247265 - .265"	763F012150	Master AP&AS-5							
695F247202 - .202"	695F247281 - .281"	Top Pin - Bump Resistant								
PYRAMID SECURITY PINS (VIAL OF 100 PINS)				Top Pin						
TOP PINS				Build Up Pins (BU)						
695F252031 - .031"	695F252173 - .173"	\$65.00	1	763F012180	Top AP-6	\$34.00	1			
695F252047 - .047"	695F252189 - .189"			763F012210	Top AP/BU-7					
695F252063 - .063"	695F252204 - .204"			763F012240	Top AP/BU-8					
695F252078 - .078"	695F252220 - .220"			763F012270	Top AP/BU-9					
695F252094 - .094"	695F252236 - .236"			CMK Wafer						
695F252110 - .110"	695F252252 - .252"			763F072	CMK Wafer	\$60.00	1			
695F252126 - .126"	695F252267 - .267"			SECURITY BOTTOM PINS						
695F252141 - .141"	695F252283 - .283"			407T414242	2L	\$6.80	20†			
695F252157 - .157"	695F252299 - .299"			407T424242	2R					
BOTTOM PINS										
695F244139 - .139"	695F244218 - .218"	407T414270	3L							
695F244155 - .155"	695F244234 - .234"	407T424270	3R							
695F244171 - .171"	695F244250 - .250"	407T414298	4L							
695F244187 - .187"	695F244265 - .265"	407T424298	4R							
695F244202 - .202"	695F244281 - .281"	407T414326	5L							
PINS (SPECIFY SIZE WHERE APPROPRIATE)										
553F482 x length	Vial of 100 bottom pins (L Pins)	\$34.00	1	407T424326	5R					
553F502 x length	Vial of 100 spool top pins (J Pins)									
553F492 x length	Vial of 100 top pins (= master & Bu) (M Pins)									
546F978	Vial of 1500 construction balls	\$29.00	1	407T414354	6L					
197F527	Pin, blocking of 1001, 1011 (hotel)	\$2.90	50†	407T424354	6R					

†Sold only in multiples of the number indicated. Price is each.

CYLINDER PARTS (CONT'D)

PART NO.	DESCRIPTION	LIST PRICE	SOLD IN MULT. OF	
CAMS – CONVENTIONAL AND SECURITY				
756F507	A01 Cloverleaf	\$8.50	10†	
756F517	A02 Straight		10†	
756F527	A03		10†	
756F537	A04		10†	
756F542	A05 AR4070		5†	
756F557	A06		10†	
756F567	A07		\$9.80	10†
756F582	A62		\$25.00	10†
756F622	A92		\$6.80	10†
281F272	A93		\$11.00	10†
406F438	Cam for O5 Exit trim	\$17.00	1	
CAMS - LFIC VERSION				
756F507	A01 Cloverleaf	\$8.50	10†	
756F517	A02 Straight	\$8.50		
756F527	A03			
756F537	A04			
756F542	A05 AR4070			\$8.50
756F557	A06	\$8.50		
756F567	A07	\$9.80		
756F582	A62 Straight	\$25.00		
756F622	A92	\$6.80		
362F432	A93	\$13.00		
MASTER RING				
562F402	A61 New Cloverleaf (locks after 5/93)	\$6.80	10†	
756F582	A62 Straight	\$25.00	10†	
121F012	A63	\$6.80	5†	
135F192	A64	\$11.00	5†	
025F722	A65 Old Cloverleaf (was 11A)	\$8.50	5†	
TAILPIECES				
444F748	A21	\$4.10	20†	
461F108	A22	\$4.10	10†	
520F358	A23	\$6.80	10†	
444F758	A24	\$4.10	10†	
365F968	A38 (Fox square)	\$5.60	5†	
329F998	A39 (Fox round)	\$9.80	5†	
484F958	A41	\$4.10	10†	
484F928	A42			
484F918	A43	\$4.10	20†	
484F968	A44	\$6.80	10†	
484F938	A45	\$5.60	10†	
484F948	A46	\$6.80	10†	
146F788	A47	\$22.00	1	
585F337	For 20010346	\$4.10	20†	
585F358	For 20010347	\$5.60	10†	
622F298	For 20000346	\$5.60	10†	
596F898	For 2000038			
622F308	For 20000336, 20000347			
489F028	For 2000051			
682F298	For 20000337	\$4.10	20†	
186F748	For 2001051	\$9.80	1	
622F328	For 2400033			
682F398	For 2400034	\$26.00	1	
685F098	For 2400037	\$9.80	1	
616F208	For 2400039	\$11.00	1	
616F218	For 2400039L			
490F558	For 3000138			
253F768	For 3000200	\$4.10	20†	
413F488	For 3000200V	\$5.60	10†	
253F778	For 3000312	\$4.10	20†	
413F498	For 3000312V	\$5.60	10†	
582F298	For 3080114 for exit alarm options M61 & M62	\$6.80	10†	
253F858	For 3080178	\$6.80	10†	
284F138	For 3080318	\$5.60	10†	
599F389	Kit for Sargent® in CL3600	\$14.00	1	
601F229	Kit for Sargent® in CL3400	\$15.00	1	
622F328	For Schlage® cyl. in CL3400/CL3600	\$9.80	5†	
715F108	P21	\$8.50	10†	
715F118	P22			
715F128	P23			

PART NO.	DESCRIPTION	LIST PRICE	SOLD IN MULT. OF	
RETAINERS				
173F798	.020" Plug Retainer-3300/5600,1400/4300	\$4.10	50†	
368F918	.030" Plug Retainer-3000 and 3010 rim cylinders	\$4.10	20†	
488F928	.032" Plug Retainer-2000052, 044 and 051	\$4.10	20†	
333F998	Plug Retainer, LFIC, CK4400, 2200008, 2020 KIK	\$4.10	100†	
655F415	Retainer, LFIC rim tailpiece	\$6.80	10†	
365F958	Retainer, Fox Police rim cylinder	\$8.50	10†	
250F088	Retainer for flex head cylinder	\$4.10	100†	
680F645	Cap for 2000033, 034	\$6.80	10†	
585F312	Cap Pin for 2000034	\$4.10	100†	
219F888	Plug Retainer for 2060052	\$4.10	100†	
LFIC THROW MEMBERS				
715F892	CK4200, UT5200	\$6.80	1	
320F442	CK4200, UT5200 Best® knob	\$9.80	1	
631F248	CL3400, CL3600 Series packet (before 6/2000) straight	\$9.80	10†	
379F805	Used with 1030134, 1037134	\$60.00	1	
628F825	Used with 1030114, 1037114, 1030138, 1037138, 3030, 3037	\$20.00	1	
628F835	Used with 1030112, 1037112	\$24.00	1	
362F153	Padlock	\$13.00	10†	
OTHER LFIC PARTS				
353F868	Inner cam for 1071 (hotel)	\$13.00	5†	
446F572	Control Sleeve for 8000 core	\$22.00	5†	
446F582	Control Sleeve for 8010 core	\$26.00	5†	
438F428	Mortise Cylinder Cam Screw	\$4.10	100†	
334F128	Mortise Cylinder Cam Plate	\$4.10	20†	
622F698	Security disk for CL3400, CL3600			
607F919	Spacer for 6-pin Best type core			
OTHER MASTER RING CYLINDER PARTS				
522F932	Adapter Bushing for MR	\$107.00	1	
135F108	Backplate, MR rim	\$6.80	10†	
158F062	Cam Spacer for A61, A62, A65	\$4.10	20†	
700F575	Thumbturn Hub for A61 MR cam	\$48.00	1	
562F422	Kit, A61 cam / hub conversion			
488F108	Mortise Cylinder Set Screw Pkt	\$4.10	20†	
354F198	Thumbturn disk, A64 cam	\$127.00	1	
197F357	Wave Washer for collar	\$6.80	10†	
OTHER MORTISE/RIM CYLINDER PARTS				
253F758	Backplate, rim cylinder	\$4.10	20†	
438F418	Cam Screw		100†	
488F088	Mortise Cylinder Set Screw Pkt		20†	
021F688	Screw, rim cyl. mounting, 2-9/32"		20†	
021F718	Screw, rim cyl. mounting, 3-1/8"		\$6.80	10†
197F347	Wave Washer for collar		\$5.60	20†
129F848	Cylinder Nut		\$11.00	1
310F488	Thumbturn Disk, A02 cam		\$55.00	1
OTHER KNOB/LEVER CYLINDER PARTS				
596F879	Obsolete by new design	\$4.10	20†	
585F387	2001034 Indicator fork			
585F377	2001034 Stabilizer Pin			
314F997	20010346 Indicator Pin			
585F407	20010347 Indicator Pin			
585F367	Tailpiece Anchor, 2001034			
041F478	Key, hotel shut-out			
PYRAMID CYLINDER PARTS				
696F42	Blocking plate	\$6.80	20†	
697F50	Tumbler spring	\$4.10	100†	
217F43	Spring cover		100†	
217F44	LFIC Spring cover		100†	
696F51	Control sleeve		\$40.00	10†
628F932	Control sleeve - Used with 8020, 8027	\$42.00	10	

†Sold only in multiples of the number indicated. Price is each.

STANDARD DIAMETER CYLINDER COLLARS

PART NO.	DESCRIPTION	LIST PRICE	SOLD IN MULT. OF
STAMPED COLLARS			
253F97	Spring collar 605, 606, 612, 613, 618, 619, 622, 625, 626	\$11.00	10†
428F66	2-Piece (was 574 1/2, H) 605, 606, 612, 613, 618, 619, 622, 625, 626	\$17.00	5† 1
549F52	.219" Straight (was 154 1/2, H1) 605, 606, 612, 613, 618, 619, 622, 625, 626	\$11.00	10†
605F43	.350 Tapered spring collar 605, 606, 612, 613, 618, 619, 622, 625, 626	\$11.00	
SPACER FOR FLEXIBLE HEAD CYLINDER			
370F29	.125" (1/8")	\$56.00	1
370F31	.250" (1/4")	\$56.00	1
252F82	.312" (5/16")	\$56.00	1
SOLID, RECESSED FOR CYLINDER HEAD			
447F41	.031" (was 575 1/4, 910) 605, 606, 612, 613, 618, 619, 622, 625, 626	\$26.00	1
270F15	.156" 605, 606, 612, 613, 618, 619, 622, 625, 626	\$35.00	1
447F42	.172" (was 575 3/8, 9106) 605, 606, 612, 613, 618, 619, 622, 625, 626	\$26.00	1
610F01	.221" (was 5574 3/4, C) 605, 606, 612, 613, 618, 619, 622, 625, 626	\$43.00	1
610F02	.289" (was 5574 1/4, L) 605, 606, 611, 612, 613, 618, 619, 625, 626	\$43.00	1
654F07	.356" for ED4000/ED5000 605, 606, 611, 612, 613, 622, 625, 626, 629, 630	\$35.00	1
447F43	.375" (was 575 9/16, 9109) 605, 606, 611, 612, 613, 618, 619, 625, 626	\$26.00	1
609F36	.500" 605, 606, 611, 612, 613, 618, 619, 625, 626	\$50.00	1

PART NO.	DESCRIPTION	LIST PRICE	SOLD IN MULT. OF
SOLID, RECESSED FOR CYLINDER HEAD (Cont'd)			
654F08	.556" for ED4000/ED5000 605, 606, 611, 612, 613, 622, 625, 626, 629, 630	\$35.00	1
609F37	.650" 605, 606, 611, 612, 613, 618, 619, 625, 626	\$50.00	1
609F38	.850" 605, 606, 611, 612, 613, 618, 619, 625, 626	\$50.00	1
134F05	With lip, .510" ED7400, ED7800 605, 606, 611, 612, 613, 618, 619, 622, 625, 626	\$50.00	1
267F97	With lip, .635" 605, 606, 611, 612, 613, 618, 619, 622, 625, 626	\$51.00	1
OTHER CYLINDER COLLARS			
416F39	Security .172" (was 95) 605, 606, 611, 612, 613, 618, 619, 625, 626	\$35.00	1
303F25	Solid .312" (was 571/J) 605, 606, 611, 612, 613, 618, 619, 625, 626	\$48.00	1
RIM CYLINDER COLLARS			
255F53	Flush Mount (was 151/ R1290)		10†
	605, 606, 611, 612, 613, 618, 619, 622, 625, 626	\$26.00	10†
			1
422F88	Surface Mount		5†
	605, 606, 611, 612, 613, 618, 619, 622, 626, 625	\$26.00	1

†Sold only in multiples of the number indicated. Price is each.

MASTER RING CYLINDER COLLARS

PART NO.	DESCRIPTION	LIST PRICE	SOLD IN MULT. OF
SOLID, RECESSED FOR CYLINDER HEAD			
447F44	.031" (was 576 1/4, MR910)	\$35.00	1
	605, 606, 611, 612, 613, 618, 619, 625, 626		
447F45	.172" (was 576 3/8, MR9106)	\$41.00	1
	605, 606, 611, 612, 613, 618, 619, 625, 626		
447F46	.375" (was 576 9/16, MR9109)	\$44.00	1
	605, 606, 611, 612, 613, 618, 619, 625, 626		
SPACERS FOR FLEXIBLE HEAD CYLINDERS			
366F70	.090" tapered	\$17.00	5
370F33	.094"		
370F35	.281"	\$17.00	1
RIM CYLINDER COLLARS			
255F54	(was 151 3/4, T)	\$26.00	1
	605, 606, 612, 613, 619, 625, 626		

PART NO.	DESCRIPTION	LIST PRICE
CYLINDER SERVICE TOOLS		
See main price book		
LOCKSET INSTALLATION TOOLS		
574F158	CK4400 Series Knob Removal Tool	\$4.10
506F57	CK4400 Series Knob Cover Removal Tool	\$11.00
391F658	Knob Release Tool, CK4200, ML2200 †Order 100-	\$4.10

PART NO.	DESCRIPTION	LIST PRICE	PART NO.	DESCRIPTION	LIST PRICE
ARMORED FRONT			AUXILIARY LATCH		
Finish: 605, 606, 611, 612, 612, 613, 619, 625, 626, 629**, 630**, BSP, WSP			403F677	Auxiliary latch	\$24.00
Deadbolt			AUXILIARY LATCH LEVER		
079F00	Armored front, 1-1/4" standard	\$51.00	678F548	Auxiliary latch lever	\$8.50
079F02	Armored front, 1-1/16"		Auxiliary Latch Lever Spring		
Deadbolt, latchbolt, aux. latch, toggle			678F677	Auxiliary latch lever spring. †Order 100-	\$4.10
402F29	Armored front, 1-1/4" standard	\$51.00	CAP		
402F33	Armored front, 1-1/16"		700F278	Cap	\$35.00
Deadbolt, latchbolt, auxiliary latch			CYLINDER LATCH LEVER SA		
402F30	Armored front, 1-1/4" standard	\$51.00	701F748	Cylinder latch lever	\$4.10
402F34	Armored front, 1-1/16"		753F098	Cylinder latch lever (functions 72, 73, 75)	
Deadbolt, latchbolt, toggle			CYLINDER LATCH LEVER STOP		
402F31	Armored front, 1-1/4" standard	\$51.00	705F949	Cylinder latch lever stop	\$4.10
402F35	Armored front, 1-1/16"		CYLINDER SET SCREW BRACKET		
Latchbolt, auxiliary latch, toggle			402F738	Cylinder set screw bracket	\$8.50
681F31	Armored front, 1-1/4" standard	\$51.00	DEADBOLT		
681F30	Armored front, 1-1/16"		702F987	Deadbolt	\$60.00
681F41	LHB, 1-1/4"		753F697	Deadbolt ML2072	
681F40	LHB, 1-1/16"		DEADBOLT SPRING		
Blank Front			701F228	Deadbolt spring †Order 50-	\$4.10
720F43	Armored front, 1-1/4"	\$51.00	DEADLOCKING LEVER		
720F46	Armored front, 1-1/16"		602F198	Toggle Functions	\$6.80
Filler Plate			624F488	Non-Toggle Functions	
334F998	USP Filler, 8" x 1-1/4"	DEADLOCKING LEVER SPRING			
Deadbolt, latchbolt			700F907	Deadlocking lever spring	\$4.10
423F54	Armored front, 1-1/4" standard	\$51.00	FIXED STOP		
423F57	Armored front, 1-1/16"		684F559	Fixed stop	\$6.80
Latchbolt only			HUB ALIGNMENT BRACKET		
423F55	Armored front, 1-1/4" standard	\$51.00	404F868	Hub alignment bracket	\$9.80
423F58	Armored front, 1-1/16"		HUB ALIGNMENT BRACKET SCREW		
Latchbolt, auxiliary latch			269F088	FHUM-PH #8-32 X 3/8" Screw †Order 20-	\$4.10
624F49	Armored front, 1-1/4" standard	\$51.00	HUB LEVER		
624F53	Armored front, 1-1/16"		820F008	Non Panic Egress	\$8.50
			820F148	Panic Egress	

†Sold only in multiples of the number indicated. Price is each.

**618, 619 finish provided to match 629, 630.

PART NO.	DESCRIPTION	LIST PRICE
HUB LEVER SPRING		
820F048	Hub lever spring †Order 10-	\$4.10
HUB SPACER		
684F119	Hub spacer	\$4.10
KNOB HUB		
820F088	Cap Side	\$30.00
820F168	Case Side	
LATCHBOLT		
864F107	Latchbolt Assembly (All functions except ML2080 & ML2090)	\$67.00
864F117	Latchbolt Assembly (ML2080 & ML2090 function only)	\$67.00
LATCH LEVER SPRING		
700F957	Latch lever spring	\$4.10
LEVER HUB		
820F068	Cap side	\$20.00
820F078	Case side	
LEVER RETURN SPRING		
404F858	Lever return spring †Order 20-	\$4.10
LOCKING LEVER		
852F307	ML2017 Locking Lever	\$34.00
852F318	ML2017 Spring	
RETAINING RING		
436F177	Retaining ring †Order 100-	\$4.10
SCREW PACKETS		
Finish: 606, 612, 613, 619		
429F41	Mounting screw pack, standard	\$6.80
488F09	Mounting screw pack, MR option	\$11.00
465F57	Mounting screw pack, M04 (VR)	\$35.00
616F12	Mounting screw pack, MR x M04	
SPACER		
466F229	Spacer	\$4.10
624F439	Spacer	
624F449	Spacer	
SPACER SPRING		
684F129	Spacer spring	\$2.90
SPRINGS		
403F568	Spring	\$13.00
688F017	Spring, kickoff	\$4.10
624F427	Spring	\$5.60

†Sold only in multiples of the number indicated. Price is each.

**618, 619 finish provided to match 629, 630

PART NO.	DESCRIPTION	LIST PRICE
STOP		
684F055	Stop	\$6.80
STOP LEVERS		
700F708	Stop lever	\$4.10
624F478	Stop lever	\$8.50
681F448	Stop lever	\$4.10
682F018	Stop lever	\$8.50
700F748	Stop lever	\$4.10
753F078	Stop lever	
STOP SCREW		
684F067	Stop screw	\$4.10
STOP SPRING		
685F387	Stop spring	\$4.10
703F997	Stop spring	\$4.10
790F047	Aux Stop Spring	
THUMBTURN LEVER HUB		
624F455	Thumbturn lever hub	\$13.00
TURNPIECE HUB – STANDARD		
813F505	Turnpiece Hub, Standard	\$5.60
TURNPIECE HUB – LARGE		
701F705	Turnpiece Hub, Large	\$11.00
853F865	Turnpiece hub, large (ML2087 RH/RHR)	
853F875	Turnpiece hub, large (ML2087 LH/LHR)	
STRIKES		
605, 606, 611, 612, 613, 619, 625, 626, 629**, 630**		
Latchbolt & Deadbolt - Straight Lip		
236L72M014FIN	7/8" Lip Length	\$50.00
236L72M016FIN	1" Lip Length	
236L72M018FIN	1-1/8" Lip Length	
236L72M020FIN	1-1/4" Lip Length	
236L72M022FIN	1-3/8" Lip Length	
236L72M024FIN	1-1/2" Lip Length	
236L72M028FIN	1-3/4" Lip Length	
236L72M032FIN	2" Lip Length	
236L72M036FIN	2-1/4" Lip Length	
236L720M40FIN	2-1/2" Lip Length	
236L720M44FIN	2-3/4" Lip Length	
236L720M48FIN	3" Lip Length	

PART NO.	DESCRIPTION	LIST PRICE	PART NO.	DESCRIPTION	LIST PRICE	
STRIKES (Cont'd)			STRIKE - OPEN BACK			
605, 606, 611, 612, 619, 613, 625, 626, 629**, 630**			605, 606, 611, 612, 613, 619, 625, 626, 629**, 630**			
Latchbolt & Deadbolt - Curved Lip (RH)			Latchbolt & Deadbolt - Curved Lip (RH)			
340L60M018FIN	1-1/8" Lip Length	RH	\$50.00	411L63M016FIN	1-3/4" (016) Door RHR	\$158.00
340L60M020FIN	1-1/4" Lip Length	RH		411L63M018FIN	2" (018) Door LHR	
340L60M022FIN	1-3/8" Lip Length	RH		411L63M020FIN	2-1/4" (020) Door RHR	
340L60M024FIN	1-1/2" Lip Length	RH		411L62M016FIN	1-3/4" (016) Door LHR	\$238.00
340L60M024FIN	1-1/2" Lip Length	RH		411L62M018FIN	2" (018) Door RHR	
340L60M028FIN	1-3/4" Lip Length	RH		411L62M020FIN	2-1/4" (020) Door LHR	
340L60M032FIN	2" Lip Length	RH		STRIKE - RABBETED FRONT		
340L60M036FIN	2-1/4" Lip Length	RH		605, 606, 611, 612, 613, 619, 625, 626, 629, 630		
340L60M040FIN	2-1/2" Lip Length	RH		318F66	All Functions and Handing	\$273.00
340L60M044FIN	2-3/4" Lip Length	RH				
340L60M048FIN	3" Lip Length	RH				
Latchbolt & Deadbolt - Curved Lip (LH)				Latchbolt & Deadbolt - Curved Lip (LH)		
340L61M018FIN	1-1/8" Lip Length	LH	\$50.00			
340L617020FIN	1-1/4" Lip Length	LH				
340L61M022FIN	1-3/8" Lip Length	LH				
340L61M024FIN	1-1/2" Lip Length	LH				
340L61M028FIN	1-3/4" Lip Length	LH				
340L61M032FIN	2" Lip Length	LH				
340L61M036FIN	2-1/4" Lip Length	LH				
340L61M040FIN	2-1/2" Lip Length	LH				
340L61M044FIN	2-3/4" Lip Length	LH				
340L61M048FIN	3" Lip Length	LH				

†Sold only in multiples of the number indicated. Price is each.

**618, 619 finish provided to match 629, 630, except on 1-1/4" length curved lip strike

PART NO.	DESCRIPTION	LIST PRICE
TRIM ALIGNMENT (ADAPTER) PACKETS		
Finish: 605, 606, 611, 612, 613, 619, 625, 626, 629**, 630**		
"P" Escutcheon		
Knob or Lever Trim		
466F73	1-3/8" door	\$82.00
466F74	1-3/4" door	
466F75	2-1/4" door	\$92.00
Half Working Trim		
439F25	1-3/8" door	\$51.00
439F26	1-3/4" door	
439F27	2-1/4" door	
Lever/Knob (GZ/YZ) Half Dummy Trim		
488F31	"P" Escutcheon	\$104.00
Lever/Knob (GZ/YZ) Full Dummy Trim		
854F19	"P" Escutcheon	\$104.00
Knob Half Dummy Trim		
437F28	"P" Escutcheon*	\$104.00
Wrought Knob Half Dummy Trim		
511F52	"P" Escutcheon*	\$92.00
"M" and "N" Escutcheons		
Regularly Furnished with Working Trim		
466F50	1-3/8" door	\$78.00
466F51	1-3/4" door	
466F52	2-1/4" door	
Half Working Trim		
428F32	1-3/8" door	\$50.00
428F33	1-3/4" door	
428F34	2-1/4" door	
Half Dummy Trim		
437F26	Knob*	\$89.00
438F37	Cast Knob*	\$98.00
854F27	Lever/Knob (GZ/YZ)	\$89.00
Full Dummy Trim		
854F15	Lever/Knob (GZ/YZ)	\$89.00

PART NO.	DESCRIPTION	LIST PRICE
TRIM ALIGNMENT (ADAPTER) PACKETS (Cont'd)		
Knob or Lever Trim Outside & Blank Escutcheon Inside		
466F45	1-3/8" door	\$60.00
466F46	1-3/4" door	
466F47	2-1/4" door	
Sectional Trim		
Regularly Furnished with Working Trim		No Finish
466F40	1-3/8" door	\$40.00
466F41	1-3/4" door	
466F42	2-1/4" door	
Half Working Trim		
437F40	1-3/8" door	\$40.00
437F41	1-3/4" door	
437F42	2-1/4" door	
Half Dummy Trim		
438F38	Cast Knob*	\$102.00
854F23	Lever/Knob (GZ/YZ)	\$63.00
511F51	Wrought Knob*	\$78.00
Full Dummy Trim		
854F11	Lever/Knob (GZ/YZ)	\$21.00
Inside Adapter Only - Lockbody		
427F06	Knob Half Working Trim*	\$40.00
488F27	Lever/Knob (GZ/YZ) Half Working Trim	\$72.00
Adjustable Locknut Assembly*		No Finish
482F37	Adjustable Locknut Assembly	\$14.00
Adjusting Bolt for Half Lever Trim		No Finish
483F34	1-3/8" door	\$14.00
483F35	1-3/4" door	
483F36	2-1/4" door	
Cylinder Set Screw Packet		No Finish
488F088	Standard †Order 20	\$4.10
488F108	Master Ring	\$4.10
Dowel Screw		No Finish
483F30	for Inside Lever/Knob (GZ/YZ)	\$5.60
Emergency Key		Finish: 619
605F42	for ML2020, ML2030, ML2060	\$8.50
E-Ring		No Finish
427F078	for working half trim adapter. †Order 100-	\$4.10

†Sold only in multiples of the number indicated. Price is each.

**618, 619 finish provided to match 629, 630.

*Discontinued product, only available as inventory allows.

PART NO.	DESCRIPTION	605, 606, 611, 612, 613, 613E, 618, 619, 625, 626, 629, 630, 722
"R" ESCUTCHEON - CAST		
Blank		
426F52	Outside	
545F79	Inside	
For Cylinder only		
427F45	Outside	
545F88	Inside	
For Grip only		
427F43	Outside	
545F87	Inside	
For Cylinder & Grip		
427F39	Outside	
545F80	Inside	\$321.00
For Thumbturn Lever only		
545F84	Inside-1-3/8" door	
545F86	Inside-2-1/4" door	
545F85	Inside-1-3/4" door	
For Thumbturn Lever & Grip		
545F81	Inside-1-3/8" door	
545F83	Inside-2-1/4" door	
545F82	Inside-1-3/4" door	
For Grip & Emergency Key		
427F47	Outside	
PART NO.	DESCRIPTION	605, 606, 611, 612, 613, 613E, 618, 619, 625, 626, 629, 630, 722
"N" ESCUTCHEON - WROUGHT		
Blank		
544F93	Inside or Outside	
For Cylinder only		
544F80	Inside or Outside	
For Grip only		
544F76	Inside or Outside	
For Cylinder & Grip		
544F77	Inside or Outside	
For Thumbturn Lever only		
544F89	Inside-1-3/4" door	
544F92	Inside-1-3/8" door	
544F91	Inside-2-1/4" door	
For Thumbturn Lever & Grip		
544F85	Inside-1-3/4" door	
544F87	Inside-2-1/4" door	
544F88	Inside-1-3/8" door	
For Grip & Emergency Key		
544F79	Outside	\$178.00

PART NO.	DESCRIPTION	605, 606, 611, 612, 613, 613E, 618, 619, 625, 626, 629, 630, 722
"M" ESCUTCHEON - WROUGHT		
Blank		
383F82	Outside	
545F45	Inside	
For Cylinder only		
488F07	Outside	
751F16	Outside - Master Ring	
545F00	Inside	
751F17	Inside - Master Ring	
For Grip only		
488F04	Outside	
544F95	Inside	
For Cylinder & Grip		
488F05	Outside - Conventional	\$178.00
557F29	Outside - Master Ring	
544F96	Inside - Conventional	
377F80	Inside - Master Ring	
For Thumbturn Lever only		
545F42	Inside-1-3/8" door	
545F43	Inside-1-3/4" door	
545F44	Inside-2-1/4" door	
For Thumbturn Lever & Grip		
544F97	Inside-1-3/8" door	
544F98	Inside-1-3/4" door	
544F99	Inside-2-1/4" door	
For Grip & Emergency Key		
544F94	Outside	
"P" ESCUTCHEON - WROUGHT		
Blank		
544F46	Inside	
384F11	Outside	\$178.00
For Cylinder only		
488F03	Outside	
544F43	Inside	

PART NO.	DESCRIPTION	605, 606, 611, 612, 613, 613E, 618, 619, 626, 625, 629, 630, 722
"P" ESCUTCHEON - WROUGHT		
For Grip only		
488F00	Outside	
544F39	Inside	
For Cylinder & Grip		
488F01	Outside	
544F40	Inside	
For Thumbturn Lever only		
544F14	Inside-1-3/8" door	
544F44	Inside-2-1/4" door	\$178.00
544F45	Inside-1-3/4" door	
For Thumbturn Lever & Grp		
544F13	Inside-1-3/8" door	
544F41	Inside-2-1/4" door	
544F42	Inside-1-3/4" door	
For Grp & Emergency Key		
544F38	Outside	
PART NO.	DESCRIPTION	613E, 630
"V" ESCUTCHEON - CAST		
Blank		
700F80	Outside	
700F40	Inside	
For Cylinder only		
700F83	Outside	
700F43	Inside	
For Grip only		
700F81	Outside	
700F41	Inside	
For Cylinder & Grip		
700F82	Outside	
700F87	Outside - 7P & C6 (Use when collar is required)	\$363.00
700F42	Inside	
700F47	Inside - 7P & C6 (Use when collar is required)	
For Thumbturn Lever only		
700F45	Inside	
For Thumbturn Lever & Grip		
700F44	Inside	
For Grp & Emergency Key		
700F84	Outside	
For Cylinder, Grip & Indicator		
700F86	Outside	
700F46	Inside	
PART NO.	DESCRIPTION	LIST PRICE
Hex Wrench		
No Finish		
264F698	Hex Wrench	\$4.10
Key Plate Packet		
438F90	Key Plate Packet: 605, 606, 611, 612, 613, 619, 625, 626, 629**, 630**	\$36.00

**618, 619 finish provided to match 629, 630.

PART NO.	DESCRIPTION	605, 606, 611, 612, 613, 613E, 625, 626	PART NO.	DESCRIPTION	605, 606, 611, 612, 613, 613E, 625, 626
"GZ" KNOB - CAST*			"YZ" KNOB - CAST*		
Inside Knob			Inside Knob		
854F04		\$261.00	854F09		\$261.00
Outside Knob & Spindle Assembly			Outside Knob & Spindle Assembly		
854F01	for 1-3/4" door	\$261.00	854F06	for 1-3/4" door	\$261.00
854F00	for 1-3/8" door		854F05	for 1-3/8" door	
854F03	for 2-1/4" door		854F08	for 2-1/4" door	

MISCELLANEOUS PARTS		
PART NO.	DESCRIPTION	LIST PRICE
Knob Release Tool		No Finish
391F658	Knob Release Tool	\$4.10
Knob Shank Adapter		No Finish
483F118	Knob Shank Adapter	\$11.00
Spring Clip		
377F308	Spring Clip	\$4.10

MORTISE INDICATOR PARTS		
PART NO.	DESCRIPTION	LIST PRICE
855F649	Indicator Mechanism Retaining Pad (sectional)	\$5.00
856F049	Indicator Window	
855F619	Indicator Spindle Cam - Thumbturn	\$16.00
855F707	Indicator Spindle Cam - Cylinder / No Input-Blank (1-3/4" door thickness)	
855F697	Indicator Spindle Cam - Cylinder / No Input-Blank (1-3/8" door thickness)	
855F717	Indicator Spindle Cam - Cylinder / No Input-Blank (2-1/4" door thickness)	\$16.00
855F727	Indicator Spindle Cam - Cylinder / No Input-Blank - (door thickness greater than 2-1/4", must specify)	
855F747 x Finish	Indicator Spindle Cam - Coin Turn (1-3/4" door thickness)	\$19.00
855F737 x Finish	Indicator Spindle Cam - Coin Turn (1-3/8" door thickness)	
855F757 x Finish	Indicator Spindle Cam - Coin Turn (2-1/4" door thickness)	
855F767 x Finish	Indicator Spindle Cam - Coin Turn (door thickness greater than 2-1/4", must specify)	\$77.00
858F241	Indicator Display Assembly - Unlocked/Locked, Green/Red	
858F251	Indicator Display Assembly - Vacant/Occupied, Green/Red	
858F261	Indicator Display Assembly - Unlocked Icon/Locked Icon, Green/Red	
858F271	Indicator Display Assembly - Unlocked/Locked, White/Red	
858F281	Indicator Display Assembly - Vacant/Occupied, White/Red	
858F291	Indicator Display Assembly - Unlocked Icon/Locked Icon, White/Red	
865F241	Indicator Display Assembly - Ouvert/Ferme, Green/Red	
865F251	Indicator Display Assembly - Libre/Occupee, Green/Red	
855F638	Escutcheon Indicator Backing Plate	
855F658	Sectional Indicator Surface Mount Backing Plate	\$15.00
858F517 x Finish	Escutcheon Indicator Screw Pack - Phillips, 1-3/4" Door	\$12.00
858F50M x Finish	Escutcheon Indicator Screw Pack - Phillips, 1-3/8" Door	
858F52M x Finish	Escutcheon Indicator Screw Pack - Phillips, 2" Door	
858F53M x Finish	Escutcheon Indicator Screw Pack - Phillips, 2-1/4" Door	
858F55M x Finish	Escutcheon Indicator Screw Pack - Phillips, 2-1/2" Door	
858F497 x Finish	Sectional Indicator Screw Pack - Phillips & Torx	\$17.00
858F549	Sectional Indicator Template Kit	
855F592 x Finish	Cylinder Plate Only - ML190 (Cylinder not included)	\$113.00
855F582 x Finish	CoinTurn Plate Only - ML193 (Assembly that includes cointurn)	\$110.00
859F052 x Finish	Thumbturn Plate Only - ML194 (Assembly that includes standard thumbturn)	\$113.00
859F062 x Finish	Sectional Thumbturn Plate Only (Assembly that includes ADA thumbturn)	\$136.00
859F072 x Finish	Sectional Thumbturn Plate Only (Assembly that includes T1 thumbturn)	\$113.00
859F082 x Finish	Sectional Thumbturn Plate Only (Assembly that includes T2 thumbturn)	
859F092 x Finish	Sectional Thumbturn Plate Only (Assembly that includes T3 thumbturn)	
855F602 x Finish	Sectional Blank/No Input Plate Only	

PART NO.	DESCRIPTION	605, 606, 611, 612, 613, 613E, 618, 619, 625, 626, 629, 630, 722
"AS" LEVER - CAST		
Inside Lever		
670F37		
Outside Lever & Spindle Assembly		
670F64	for 1-3/8" door	\$281.00
670F73	for 1-3/4" door	
671F09	for 2-1/4" door	
"CS" LEVER - CAST		
Inside Lever		
670F30		
Outside Lever & Spindle Assembly		
670F57	for 1-3/8" door	\$281.00
670F66	for 1-3/4" door	
671F02	for 2-1/4" door	
"DS" LEVER - CAST		
Inside Lever		
670F32	LH/LHR	
670F31	RH/RHR	
Outside Lever & Spindle Assembly		
670F59	for 1-3/8" door	RH/RHR
670F68	for 1-3/4" door	RH/RHR
671F04	for 2-1/4" door	RH/RHR
670F58	for 1-3/8" door	LH/LHR
670F67	for 1-3/4" door	LH/LHR
671F03	for 2-1/4" door	LH/LHR
"ES" LEVER - CAST		
Inside Lever		
670F33		
Outside Lever & Spindle Assembly		
670F60	for 1-3/8" door	\$281.00
670F69	for 1-3/4" door	
671F05	for 2-1/4" door	
"LS" LEVER - CAST		
Inside Lever		
670F34		
Outside Lever & Spindle Assembly		
670F61	for 1-3/8" door	\$281.00
670F70	for 1-3/4" door	
671F06	for 2-1/4" door	
"NS" LEVER - CAST		
Inside Lever		
670F36		
Outside Lever & Spindle Assembly		
670F63	for 1-3/8" door	\$281.00
670F72	for 1-3/4" door	
671F08	for 2-1/4" door	
"PS" LEVER - CAST		
Inside Lever		
670F38		
Outside Lever & Spindle Assembly		
670F65	for 1-3/8" door	\$281.00
670F74	for 1-3/4" door	
671F10	for 2-1/4" door	
"RS" LEVER - CAST		
Inside Lever		
670F35		
Outside Lever & Spindle Assembly		
670F62	for 1-3/8" door	\$281.00
670F71	for 1-3/4" door	
671F07	for 2-1/4" door	

PART NO.	DESCRIPTION	605, 606, 611, 612, 613, 613E, 618, 619, 625, 626, 629, 630, 722
"LW" LEVER - WROUGHT		
Inside Lever		
493F31		\$238.00
Outside Lever & Spindle Assembly		
483F79	for 1-3/8" door	\$238.00
483F80	for 1-3/4" door	
483F81	for 2-1/4" door	
"RW" LEVER - WROUGHT		
Inside Lever		
493F34		\$238.00
Outside Lever & Spindle Assembly		
483F82	for 1-3/8" door	\$238.00
483F83	for 1-3/4" door	
483F84	for 2-1/4" door	

PART NO.	DESCRIPTION	LIST PRICE
NYLON BUSHING NO FINISH		
698F22	Nylon Bushing †Order 100-	\$4.10
ROSE PACKET		
445F82	Wrought Rose Packet- (Qty 2) 2-7/8" dia. (C)* 605, 606, 611, 612, 613, 613E, 618, 619, 625, 626, 722	\$103.00
445F83	Wrought Rose Packet- (Qty 2) 3-1/2" dia. (D)* 605, 606, 611, 612, 613, 613E, 618, 619, 625, 626, 722	\$103.00
445F84	Wrought Rose Packet- (Qty 2) 3" square (E)* 605, 606, 611, 612, 613, 613E, 618, 619, 625, 626, 722	\$103.00
447F24	Cast Rose Packet - (Qty 2) 2-7/8" dia. (F) 605, 606, 611, 612, 613E, 618, 619, 625, 626, 629, 630, 722	\$251.00
447F25	Cast Rose Packet- (Qty 2) 2-1/4" dia. (B) 605, 606, 611, 612, 613E, 618, 619, 625, 626, 629, 630, 722	\$129.00
487F08	Wrought Rose Packet- (Qty 2) 2-1/4" dia. (A) 605, 606, 611, 612, 613E, 618, 619, 625, 626, 629, 630, 722	\$103.00
853F05	Wrought Rose Packet- (Qty 2) 2-7/8" dia. (H) 605, 606, 611, 612, 613E, 618, 619, 625, 626, 629, 630, 722	\$103.00

PART NO.	DESCRIPTION	LIST PRICE
ROSE REINFORCEMENT PACKET NO FINISH		
445F869	Rose Reinforcement Packet*	\$9.80
SCREW PACKET		
605, 606, 611, 612, 613, 619, 625, 626, 629, 630		
569F45	For M & P half dummy trim*	\$11.00
429F317	Screw Packet for "N" Surface Mounted Escutcheon	\$14.00
616F088	Lock mounting, spanner	\$14.00
584F46	Escutcheon for 1-3/4" door, spanner	\$8.50
384F03	Escutcheon for 2" - 2-1/4" door, spanner	
616F078	T20 Torx® bit	\$20.00
269F098	Screw 1-32 x 1/4" OHMS-PH †Order 100-	\$4.10
SPACER NO FINISH		
497F528	Spacer for Cast Knob*	\$5.60
SPINDLES NO FINISH		
LxL, KxK, LxK, KxL Spindle		
499F828	1-3/8" door	\$51.00
499F838	1-3/4" door	
499F848	2-1/4" door	\$51.00

†Sold only in multiples of the number indicated. Price is each.

*Discontinued product, only available as inventory allows.

PART NO.	DESCRIPTION	LIST PRICE
INSIDE SPINDLE FOR HALF LEVER TRIM*		
	(Knob x Knob) Spindle*	
680F348	1-3/8" door	\$26.00
680F358	1-3/4" door	\$8.50
680F368	2-1/4" door	\$18.00
VANDAL RESISTANT SPINDLE & SCREW PACK		
700F65	1-3/4" door	\$24.00
700F66	2" door	
700F67	2 -1/4" door	
THIMBLE PACKET		
432F86	(Qty 2) for wrought escutcheon knob trim designs* 605, 606, 611, 612, 613, 619, 625, 626, 629, 630	\$50.00
445F85	(Qty 2) for sectional knob trim designs* 605, 606, 611, 612, 613, 619, 625, 626	\$62.00
THIMBLE WRENCH NO FINISH		
300F688	Thimble Wrench	\$6.30
THROUGHBOLT PACKET		
	605, 606, 611, 612, 613, 619, 625, 626, 629, 630	
	"M" and "P" Escutcheons	
433F76	1-3/8" door	\$11.00
433F77	1-3/4" door	
433F78	2-1/4" door	
	"R" Escutcheon	
439F33	1-3/8" door	\$11.00
439F34	1-3/4" door	
439F35	2-1/4" door	
	"T" Escutcheon (spanner head)*	
445F318	1-3/4" door	\$22.00
498F928	2" to 2-1/4" door	
THUMBTURN LEVER PACKET		
	605, 606, 611, 612, 613, 625, 626, 629, 630	
519F09	for 1-3/8" door	\$67.00
519F10	for 1-3/4" door	
519F11	for 2-1/4" door	
519F12	for up to 3" door	\$88.00
581F96	for up to 3-1/2" door	
696F39	Blank Plate	
ERGONOMIC THUMBTURN LEVER PACKET FOR SECTIONAL TRIM		
	605, 606, 611, 612, 613, 619, 625, 626, 629, 630	
707F57	for 1-3/8" door	\$100.00
707F58	for 1-3/4" to 2" doors	
707F59	for 2-1/4" door	
707F60	for up to 3" door	
706F70	for up to 4" door	

*Discontinued product, only available as inventory allows.

PART NO.	DESCRIPTION	LIST PRICE
ERGONOMIC THUMBTURN KIT FOR ESCUTCHEON TRIM		
	605, 606, 611, 612, 613, 619, 625, 626, 629, 630	
711F002	for up to 4" door (must be field cut to size)	\$100.00
WASHER FOR VANDAL RESISTANT TRIM		
700F378	Washer	\$5.60
RETAINING RING FOR VANDAL RESISTANT TRIM		
700F168	Retaining ring	\$4.10
LEVER SPINDLE SPRING FOR VANDAL RESISTANT TRIM		
700F367	Lever spindle spring	\$4.10

PART NO. X FINISH	DESCRIPTION	605, 606, 611, 612, 613, 613E, 618, 619, 625, 626, 629, 630, 722
M19 OPTION INDICATORS – KEYED FUNCTION (SECURE)		
720F21	for 1-3/8" (35mm) door	\$169.00
720F22	for 1-3/4" (44mm) – 2" (51mm) door	
720F24	for 2-1/4" (57mm) door	
720F25	for over 2-1/4" (57mm) door	
M19 OPTION INDICATORS – KEYED FUNCTION (VACANT)		
741F21	for 1-3/8" door	\$169.00
741F22	for 1-3/4" to 2" doors	
741F23	for 2-1/4" door	
741F24	for up to 3" door	
M19 OPTION INDICATORS – NON-KEYED FUNCTION (SECURE)		
721F16	for 1-3/8" (35mm) door	\$165.00
721F17	for 1-3/4" (44mm) – 2" (51mm) door	
721F18	for 2-1/4" (57mm) door	
721F19	for over 2-1/4" (57mm) door	
M19 OPTION INDICATORS – NON-KEYED FUNCTION (VACANT)		
720F61	for 1-3/8" (35mm) door	\$165.00
720F62	for 1-3/4" (44mm) – 2" (51mm) door	
720F64	for 2-1/4" (57mm) door	
720F65	for over 2-1/4" (57mm) door	
M19 OPTION THUMBTURN INDICATOR		
723F69	for 1-3/8" (35mm) door	\$293.00
723F26	for 1-3/4" (44mm) – 2" (51mm) door	
791F59	for 2-1/4" (57mm) door	
791F60	for over 2-1/4" (57mm) door	

VINEYARD™ COLLECTION TRIM

PART NO.	DESCRIPTION	605 , 606, 613E, 619, 625, 626
INSIDE LEVERS		
692F632	Frascati LH/LHR	\$369.00
692F642	Frascati RH/RHR	
692F662	Zinfandel LH/LHR	
692F672	Zinfandel RH/RHR	
692F652	Merlot	
OUTSIDE LEVERS		
692F762	Frascati for 1 3/4" door LH/LHR	\$369.00
692F752	Frascati for 1 3/4" door RH/RHR	
692F952	Zinfandel for 1 3/4" door LH/LHR	
692F942	Zinfandel for 1 3/4" door RH/RHR	
692F932	Merlot for 1 3/4" door	
L ESCUTCHEON - CAST		
Blank		
692F862	Inside	\$304.00
For Cylinder Only		
694F322	Inside	
694F522	Outside	
For Grip Only		
694F312	Inside	
694F442	Outside	
For Cylinder & Grip		
694F332	Inside	
694F562	Outside	
For Thumbturn Lever Only		
694F352	Inside	
For Thumbturn Lever & Grip		
694F392	Inside	
For Grip & Emergency Key		
694F482	Outside	
For Grip x Plug Only		
694F682	Outside	
ROSES (PAIR)		
694F802	G-Rose (All functions)	\$345.00

LOCKSET PARTS

PART NO.	DESCRIPTION	LIST PRICE
LEVERS-Finish: 605,606,611,612,613,613E,613L,618,619,625,626,722,BSP,WSP		
790F215	NZ - Plain	\$120.00
790F225	NZ - Cylinder or Button	
790F235	NZ - Emergency Key Hole	
790F245	NZ - Intruder	
790F335	NZ - Sargent® Cylinder Cutout	
790F345	NZ - Sargent Cylinder Cutout - Intruder	
790F395	NZ - Corbin Russwin LFIC - 6 Pin	
790F405	NZ - Corbin Russwin LFIC - 6 Pin Intruder	
790F415	NZ - Corbin Russwin LFIC - 7 Pin	
790F425	NZ - Corbin Russwin LFIC - 7 Pin Intruder	
790F515	NZ - SFIC Cutout	
790F525	NZ - SFIC Cutout Intruder	
790F575	NZ - Schlage® LFIC Cutout	
790F585	NZ - Schlage® LFIC Cutout - Intruder	
790F225	NZ - Yale® Cylinder Cutout 6/7 Pin	
790F245	NZ - Yale® Cylinder Cutout 6/7 Pin - Intruder	
774F925	NZ - Yale® LFIC Cutout 6 Pin	
798F295	NZ - Yale® LFIC Cutout 6 Pin - Intruder	
774F945	NZ - Yale® LFIC Cutout 7 Pin	
798F305	NZ - Yale® LFIC Cutout 7 Pin - Intruder	
780F215	NZ - Security - Plain	
780F225	NZ - Security -Cylinder or Button	
780F235	NZ - Security - Emergency Key Hole	
780F245	NZ - Security - Intruder	
780F335	NZ - Security - Sargent Cylinder Cutout	
780F345	NZ - Security - Sargent Cylinder Cutout - Intruder	
780F395	NZ - Security - Corbin Russwin LFIC - 6 Pin	
780F405	NZ - Security - Corbin Russwin LFIC - 6 Pin Intruder	
780F415	NZ - Security - Corbin Russwin LFIC - 7 Pin	
780F425	NZ - Security - Corbin Russwin LFIC - 7 Pin Intruder	
780F515	NZ - Security - SFIC Cutout	
780F525	NZ - Security - SFIC Cutout Intruder	
780F575	NZ - Security - Schlage® LFIC Cutout	
780F585	NZ - Security - Schlage® LFIC Cutout - Intruder	
776F215	AZ - Plain	
776F225	AZ - Cylinder or Button	
776F235	AZ - Emergency Key Hole	
776F245	AZ - Intruder	
776F335	AZ - Sargent® Cylinder Cutout	
776F345	AZ - Sargent Cylinder Cutout - Intruder	
776F395	AZ - Corbin Russwin LFIC - 6 Pin	
776F405	AZ - Corbin Russwin LFIC - 6 Pin Intruder	
776F415	AZ - Corbin Russwin LFIC - 7 Pin	
776F425	AZ - Corbin Russwin LFIC - 7 Pin Intruder	
776F515	AZ - SFIC Cutout	
776F525	AZ - SFIC Cutout Intruder	
776F575	AZ - Schlage® LFIC Cutout	
776F585	AZ - Schlage® LFIC Cutout - Intruder	
777F215	AZ Security - Plain	
777F225	AZ Security -Cylinder or Button	
777F235	AZ Security - Emergency Key Hole	
777F245	AZ Security - Intruder	
777F335	AZ Security - Sargent Cylinder Cutout	
777F345	AZ Security - Sargent Cylinder Cutout - Intruder	
777F395	AZ Security - Corbin Russwin LFIC - 6 Pin	
777F405	AZ Security - Corbin Russwin LFIC - 6 Pin Intruder	
777F415	AZ Security - Corbin Russwin LFIC - 7 Pin	
777F425	AZ Security - Corbin Russwin LFIC - 7 Pin Intruder	
777F515	AZ Security - SFIC Cutout	
777F525	AZ Security - SFIC Cutout Intruder	
777F575	AZ Security - Schlage® LFIC Cutout	
777F585	AZ Security - Schlage® LFIC Cutout - Intruder	

PART NO.	DESCRIPTION	LIST PRICE
LEVERS-Finish: 605,606,611,612,613,613E,613L,618,619,625,626,722,BSP,WSP		
778F215	PZ - Plain	\$120.00
778F225	PZ - Cylinder or Button	
778F235	PZ - Emergency Key Hole	
778F245	PZ - Intruder	
778F335	PZ - Sargent® Cylinder Cutout	
778F345	PZ - Sargent Cylinder Cutout - Intruder	
778F395	PZ - Corbin Russwin LFIC - 6 Pin	
778F405	PZ - Corbin Russwin LFIC - 6 Pin Intruder	
778F415	PZ - Corbin Russwin LFIC - 7 Pin	
778F425	PZ - Corbin Russwin LFIC - 7 Pin Intruder	
778F515	PZ - SFIC Cutout	
778F525	PZ - SFIC Cutout Intruder	
778F575	PZ - Schlage® LFIC Cutout	
778F585	PZ - Schlage® LFIC Cutout - Intruder	
778F225	PZ - Yale® Cylinder Cutout 6/7 Pin	
778F245	PZ - Yale® Cylinder Cutout 6/7 Pin - Intruder	
774F965	PZ - Yale® LFIC Cutout 6 Pin	
798F395	PZ - Yale® LFIC Cutout 6 Pin - Intruder	
774F985	PZ - Yale® LFIC Cutout 7 Pin	
798F405	PZ - Yale® LFIC Cutout 7 Pin - Intruder	
779F215	PZ Security - Plain	
779F225	PZ Security -Cylinder or Button	
779F235	PZ Security - Emergency Key Hole	
779F245	PZ Security - Intruder	
779F335	PZ Security - Sargent Cylinder Cutout	
779F345	PZ Security - Sargent Cylinder Cutout - Intruder	
779F395	PZ Security - Corbin Russwin LFIC - 6 Pin	
779F405	PZ Security - Corbin Russwin LFIC - 6 Pin Intruder	
779F415	PZ Security - Corbin Russwin LFIC - 7 Pin	
779F425	PZ Security - Corbin Russwin LFIC - 7 Pin Intruder	
779F515	PZ Security - SFIC Cutout	
779F525	PZ Security - SFIC Cutout Intruder	
779F575	PZ Security - Schlage® LFIC Cutout	
779F585	PZ Security - Schlage® LFIC Cutout - Intruder	

PART NO.	DESCRIPTION	LIST PRICE
ROSES		
D ROSE		
678F252 Fin	626/613E, BSP, WSP	\$67.00
	605,606,611,612,613,613L,618,619,625,722	
C ROSE		
779F97 Fin	626/613E, BSP, WSP	\$67.00
	605,606,611,612,613,613L,618,619,625,722	
ROSETTE FOR C & K ROSE		
778F90 Fin	626/613E, BSP, WSP	\$67.00
	605,606,611,612,613,613L,618,619,625,722	
E ROSE		
779F98 Fin	626/613E, BSP, WSP	\$67.00
	605,606,611,612,613,613L,618,619,625,722	
ROSETTE FOR E ROSE		
778F97 Fin	626/613E, BSP, WSP	\$67.00
	605,606,611,612,613,613L,618,619,625,722	
K ROSE		
779F99 Fin	626/613E, BSP, WSP	\$67.00
	605,606,611,612,613,613L,618,619,625,722	

LOCKSET PARTS

PART NO.	DESCRIPTION	LIST PRICE
LATCH ASSEMBLIES		
Standard		
780F81 Fin	10 Function	\$218.00
780F82 Fin	32, 40NT, 51, 52, 55, 57, 62, 72, and 80 Functions	
780F83 Fin	20 and 20H Functions	
780F84 Fin	29, 75, and 93 Functions	
780F85 Fin	61 Function	
3-3/4" Backset		
780F86 Fin	10 Function	\$218.00
780F87 Fin	32, 40NT, 51, 52, 55, 57, 62, 72, and 80 Functions	
780F88 Fin	20 and 20H Functions	
780F89 Fin	29, 75, and 93 Functions	
780F90 Fin	61 Function	
5" Backset		
780F91 Fin	10 Function	\$218.00
780F92 Fin	32, 40NT, 51, 52, 55, 57, 62, 72, and 80 Functions	
780F93 Fin	20 and 20H Functions	
780F94 Fin	29, 75, and 93 Functions	
780F95 Fin	61 Function	
3/4" Throw Fire Latch		
780F96 Fin	10, 51, 55, 57, 72, and 80 Functions	\$282.00

PART NO.	DESCRIPTION	LIST PRICE
STRIKES		
586L19	Curved Lip "T" Strike	\$35.00

PART NO.	DESCRIPTION	LIST PRICE
SLEEVE ASSEMBLIES		
STANDARD		
775F808	Outside Sleeve - 61 Function	\$233.00
776F002 Fin	Inside Sleeve - 51 Function	\$123.00
776F012 Fin	Inside Sleeve - 93 Function	
776F022 Fin	Inside Sleeve - 61 Function	
776F032 Fin	Inside Sleeve - 29 Function	\$233.00
776F042 Fin	Inside Sleeve - 20, 20H and 75 Functions	\$303.00
776F638	Outside Sleeve - 51,57,61,72, and 93 Functions	\$233.00
776F648	Outside Sleeve - 40NT Function	\$123.00
776F658	Outside Sleeve - 32 Function	\$218.00
776F668	Outside Sleeve - 55 and 62 Functions	
776F678	Outside Sleeve - 29 Function	\$233.00
776F688	Outside Sleeve - 52 and 75 Functions	\$259.00
776F698	Outside Sleeve - 20 and 20H Functions	\$197.00
776F708	Inside Sleeve - 10, 55, and 80 Functions	\$107.00
	Outside Sleeve - 10 Function	
776F848	Inside Sleeve - 52 and 72 Functions	\$303.00
776F858	Inside Sleeve - 32 Function	\$218.00
776F868	Inside Sleeve - 62 Function	
776F878	Inside Sleeve - 40NT and 57 Functions	

PART NO.	DESCRIPTION	LIST PRICE
SLEEVE ASSEMBLIES		
INTERCHANGEABLE CORE		
775F818	Outside Sleeve - 61 Function	\$233.00
776F718	Outside Sleeve - 51, 57, 72, 93 Functions	
776F728	Outside Sleeve - 32 Function	\$218.00
776F738	Outside Sleeve - 55, 62 Functions	
776F748	Outside Sleeve - 52, 75 Functions	\$259.00
776F918	Inside Sleeve - 61, 75 Functions	\$233.00
776F928	Inside Sleeve - 52, 72 Functions	\$218.00
776F938	Inside Sleeve - 32 Function	
776F948	Inside Sleeve - 62 Function	\$214.00
3/4" THROW FIRE LATCH - STANDARD		
779F638	Outside Sleeve - 51, 57, 72 Functions	\$218.00
779F648	Outside Sleeve - 55 Function	
779F658	Inside Sleeve - 72 Function	\$112.00
	Inside Sleeve - 57 Function	
779F728	Inside Sleeve - 72 Function	\$303.00
779F738	Inside Sleeve - 57 Function	\$107.00
779F748	Inside Sleeve - 51 Function	\$218.00
3/4" THROW FIRE LATCH - INTERCHANGEABLE CORE		
779F758	Inside Sleeve - 72 Function	\$233.00
M111 SLEEVE ASSEMBLIES - STANDARD		
775F828	Outside Sleeve - 61 Function	\$233.00
776F758	Outside Sleeve - 51, 57, 72, 93 Functions	
776F768	Outside Sleeve - 32 Function	\$218.00
776F778	Outside Sleeve - 55, 62 Functions	
776F788	Outside Sleeve - 29 Function	\$233.00
776F798	Outside Sleeve - 52, 75 Functions	\$259.00
776F958	Inside Sleeve - 52, 72 Functions	\$303.00
776F968	Inside Sleeve - 32 Function	\$218.00
776F978	Inside Sleeve - 62 Function	
M111 SLEEVE ASSEMBLIES - INTERCHANGEABLE CORE		
775F838	Outside Sleeve - 61 Function	\$233.00
776F808	Outside Sleeve - 51,57,61,72,93 Functions	
776F818	Outside Sleeve - 32 Function	\$218.00
776F828	Outside Sleeve - 55, 62 Functions	
776F838	Outside Sleeve - 52, 75 Functions	\$259.00
776F988	Inside Sleeve - 52, 72 Functions	\$218.00
776F998	Inside Sleeve - 32 Function	
777F208	Inside Sleeve - 62 Function	

PART NO.	DESCRIPTION	LIST PRICE
COLLARS		
778F888	Inside Collar	\$13.00
778F898	Outside Collar	\$13.00

PART NO.	DESCRIPTION	LIST PRICE
TAILPIECES		
778F788	Schlage® Fixed Core	\$26.00
780F658	SFIC Core	\$8.50
775F948	SARGENT Fixed Core	\$26.00
780F662	Schlage® LFIC	\$35.00
631F288	Corbin Russwin LFIC	\$8.50
774F878	Yale® LFIC 6-Pin	\$2.90
774F888	Yale® LFIC 7-Pin	
780F808	Tail, Cylinder, 20H	\$4.10

LOCKSET PARTS

PART NO.	DESCRIPTION	LIST PRICE
MISCELLANEOUS		
778F638	Collar/Rosette Installation Wrench	\$13.00
780F638	Allen Key Wrench	
780F208	M111 Screwdriver	\$8.50
604F228 Fin	Screw Packet	\$9.80
775F908 Fin	Mounting Kit Packet (CL3150)	\$34.00
775F918 Fin	Mounting Kit Packet (CL3170)	
753F598	Rose Installation Tool	\$11.00
778F868	Aligning Pin	\$4.10
779F787	Bearing Assembly	\$295.00
778F812	Emergency Release Cylinder	\$67.00
206F578	Screw, combo #8 PH	\$4.10
790F988	Inside Mounting Flange Assembly	\$170.00
790F998	Outside Mounting Flange Assembly	
403F302 Fin	Cup Washer	\$5.60
305F318 Fin	Machine Screw 1/4-20 x 2-3/4"	\$6.80
269F808	Countersunk Flat Head Screw 10-24x3/8" (1-3/4" Door)	\$4.10
778F968	Anchor Plate	\$4.10
778F91 Fin	Rosette Plug	\$59.00
790F988	Flange SA, Mounting I/S	\$170.00
790F998	Flange SA, Mounting O/S	
220F718	Screw, FHM-PH, 10-24X1/2"	\$4.10
779F797	Bearing SA, D200	\$295.00
779F807	Bearing SA, M16	\$261.00
790F208	Screw, FHM-PH, #4-40X1/2"	\$6.80
679F818	Emergency Release Tool	\$4.10
778F759	Cylinder Spacer for 6-Pin Fixed Core Corbin Russwin or Yale® Cylinder	

CLX3300 Cylindrical Lock Series Extra Heavy-Duty Lever Lockset

USA & Canada Prices Effective April 17, 2023

LOCKSET PARTS

MECHANICAL LOCKBODY ASSEMBLY, FREEWHEELING LEVER – ALL CYLINDER/CORE PREPS (ALL BACKSETS EXCEPT 2-3/8")			MECHANICAL LOCKBODY ASSEMBLY, FREEWHEELING LEVER – ALL CYLINDER/CORE PREPS (2-3/8" BACKSET ONLY)		
STANDARD/ FREEWHEELING	FUNCTION	LIST PRICE	STANDARD/ FREEWHEELING (B238 ONLY)	FUNCTION	LIST PRICE
861F708	CLX3310	\$273.00	866F028	CLX3310	\$273.00
861F748 Fin	CLX3320, CLX3320H, CLX3330, CLX3340		866F068 Fin	CLX3320, CLX3320H, CLX3330, CLX3340	
861F728 Fin	CLX3320TO		866F048 Fin	CLX3320TO	
861F768 Fin	CLX3329		866F088 Fin	CLX3329	
861F968	CLX3332		866F268	CLX3332	
861F358	CLX3340NT, CLX3357		861F378	CLX3340NT, CLX3357	
861F828 Fin	CLX3351, CLX3393		866F128 Fin	CLX3351, CLX3393	
861F848	CLX3352, CLX3355		866F148	CLX3352, CLX3355	
861F868	CLX3359		866F168	CLX3359	
861F788 Fin	CLX3361		866F108 Fin	CLX3361	
861F988	CLX3362		866F288	CLX3362	
862F008	CLX3372		866F308	CLX3372	
861F888 Fin	CLX3375		866F188 Fin	CLX3375	
861F908 Fin	CLX3376		866F208 Fin	CLX3376	
861F718	CLX3380, CLX3390		866F038	CLX3380, CLX3390	
861F928	CLX3381		866F228	CLX3381	
862F028	CLX3382	866F328	CLX3382		
861F948	CLX3383	866F248	CLX3383		
MECHANICAL LOCKBODY ASSEMBLY – RIGID LEVER, ALL CYLINDER/CORE PREPS (ALL BACKSETS EXCEPT 2-3/8")			MECHANICAL LOCKBODY ASSEMBLY – RIGID LEVER, ALL CYLINDER/CORE PREPS (2-3/8" BACKSET ONLY)		
RIGID LEVER	FUNCTION	LIST PRICE	RIGID LEVER (B238 ONLY)	FUNCTION	LIST PRICE
861F758 Fin	CLX3320, CLX3320H, CLX3330, CLX3340	\$273.00	866F078 Fin	CLX3320, CLX3320H, CLX3330, CLX3340	\$273.00
861F738 Fin	CLX3320TO		866F058 Fin	CLX3320TO	
861F778 Fin	CLX3329		866F098 Fin	CLX3329	
861F978	CLX3332		866F278	CLX3332	
861F368	CLX3340NT, CLX3357		861F388	CLX3340NT, CLX3357	
861F838 Fin	CLX3351, CLX3393		866F138 Fin	CLX3351, CLX3393	
861F858	CLX3352, CLX3355		866F158	CLX3352, CLX3355	
861F878	CLX3359		866F178	CLX3359	
861F798 Fin	CLX3361		866F118 Fin	CLX3361	
861F998	CLX3362		866F298	CLX3362	
862F018	CLX3372		866F318	CLX3372	
861F898 Fin	CLX3375		866F198 Fin	CLX3375	
861F918 Fin	CLX3376		866F218 Fin	CLX3376	
861F938	CLX3381		866F238	CLX3381	
862F038	CLX3382		866F338	CLX3382	
861F958	CLX3383		866F258	CLX3383	
ELECTRIFIED LOCKBODY ASSEMBLY (1-3/8" – 2-1/4" DOOR)					
PART NO.	FUNCTION	LIST PRICE			
886F000	Std/Freewheeling – CLX33903, CLX33905	\$666.00			
886F010	Rigid Lever – CLX33903, CLX33905				

LOCKSET PARTS

TAILPIECE PACKS – USED WITH MECHANICAL FUNCTIONS		
PART NUMBER	DESCRIPTION	LIST PRICE
862F998	Corbin Russwin & Yale® fixed core cylinder tailpiece pack, 6-pin, 1-3/8" - 2" door	\$35.00
863F008	Corbin Russwin & Yale® fixed core cylinder tailpiece pack, 6-pin, 2-1/4" door	
863F018	Corbin Russwin & Yale® fixed core cylinder tailpiece pack, 7-pin, 1-3/8" - 2" door	
863F028	Corbin Russwin & Yale® fixed core cylinder tailpiece pack, 7-pin, 2-1/4" door	
864F568	Hotel cylinder tailpiece, 6-pin, all doors	
864F578	Hotel cylinder tailpiece, 7-pin, all doors	
863F038	Schlage® & SARGENT keyway fixed core cylinder tailpiece pack, 1-3/8" - 2" door	\$10.10
863F048	Schlage® & SARGENT keyway fixed core cylinder tailpiece pack, 2-1/4" door	
863F058	Corbin Russwin LFIC tailpiece pack, 6- or 7-pin, 1-3/8" - 2" door	\$35.00
863F068	Corbin Russwin LFIC tailpiece pack, 6- or 7-pin, 2-1/4" door	
864F568	Hotel LFIC tailpiece pack, 6-pin, all doors	\$10.10
864F578	Hotel LFIC tailpiece pack, 7-pin, all doors	
863F078	SFIC tailpiece pack, 6-or7-pin, 1-3/8" - 2" door	\$26.00
863F088	SFIC tailpiece pack, 6-or7-pin, 2-1/4" door	
862F978	SARGENT fixed core tailpiece pack, 6-pin, 1-3/8" - 2" door	\$35.00
862F988	SARGENT fixed core tailpiece pack, 6-pin, 2-1/4" door	
863F038	Schlage® fixed core tailpiece pack, 6-pin, 1-3/8" - 2" door	\$35.00
863F048	Schlage® fixed core tailpiece pack, 6-pin, 2-1/4" door	
862F472	Schlage® LFIC tailpiece pack, 6-pin, 1-3/8" - 2" door	
862F482	Schlage® LFIC tailpiece pack, 6-pin, 2-1/4" door	
862F402	Yale® LFIC tailpiece pack, 6-pin, 1-3/8" - 2" door	
862F412	Yale® LFIC tailpiece pack, 6-pin, 2-1/4" door	

TAILPIECE PACKS – USED WITH ELECTRIFIED FUNCTIONS		
PART NUMBER	DESCRIPTION	LIST PRICE
886F148	Corbin Russwin & Yale® fixed core cylinder tailpiece pack, 6-pin, 1-3/8" - 2" door	\$35.00
886F158	Corbin Russwin & Yale® fixed core cylinder tailpiece pack, 6-pin, 2-1/4" door	
886F168	Corbin Russwin & Yale® fixed core cylinder tailpiece pack, 7-pin, 1-3/8" - 2" door	
886F178	Corbin Russwin & Yale® fixed core cylinder tailpiece pack, 7-pin, 2-1/4" door	
886F188	Schlage® & SARGENT keyway fixed core cylinder tailpiece pack, 1-3/8" - 2" door	
886F198	Schlage® & SARGENT keyway fixed core cylinder tailpiece pack, 2-1/4" door	
886F208	Corbin Russwin LFIC tailpiece pack, 6- or 7-pin, 1-3/8" - 2" door	\$10.10
886F218	Corbin Russwin LFIC tailpiece pack, 6- or 7-pin, 2-1/4" door	
886F228	SFIC tailpiece pack, 6-or7-pin, 1-3/8" - 2" door	\$10.10
886F238	SFIC tailpiece pack, 6-or7-pin, 2-1/4" door	
886F128	SARGENT fixed core tailpiece pack, 6-pin, 1-3/8" - 2" door	\$26.00
886F138	SARGENT fixed core tailpiece pack, 6-pin, 2-1/4" door	
886F188	Schlage® fixed core tailpiece pack, 6-pin, 1-3/8" - 2" door	\$35.00
886F198	Schlage® fixed core tailpiece pack, 6-pin, 2-1/4" door	
886F268	Schlage® LFIC tailpiece pack, 6-pin, 1-3/8" - 2" door	
886F278	Schlage® LFIC tailpiece pack, 6-pin, 2-1/4" door	
886F248	Yale® LFIC tailpiece pack, 6-pin, 1-3/8" - 2" door	
886F258	Yale® LFIC tailpiece pack, 6-pin, 2-1/4" door	

OUTSIDE SPRING HOUSING ASSEMBLIES (1-3/8" - 2-1/4" DOOR)		
PART NO.	DESCRIPTION	LIST PRICE
860F608	All Functions except CLX3380, CLX3381, CLX3383, CLX3350, CLX3370	\$273.00
860F638	All Functions for Yale® LFIC	
DUMMY SPRING HOUSING ASSEMBLIES		
863F108	Outside CLX3350, CLX3370	\$273.00
863F118	Inside CLX3370	
MISCELLANEOUS CYLINDER PARTS		
862F049	Spacer only - fixed core cylinder	\$4.10
627F009	Disposable cores, Corbin Russwin LFIC (10 pack)	\$70.00
707F299	Disposable cores, SFIC (10 pack)	\$62.00

INSIDE SPRING HOUSING ASSEMBLIES (1-3/8" - 2" DOOR)		
PART NO.	DESCRIPTION	LIST PRICE
860F618	All Functions except CLX3332, CLX3352, CLX3362, CLX3372, CLX3381, CLX3382, CLX3383, CLX3390, CLX3350, CLX3370	\$273.00
860F628	Functions CLX3332, CLX3352, CLX3362, CLX3372, CLX3381, CLX3382, CLX3383	
860F648	All Functions for Yale® LFIC CLX3332, CLX3352, CLX3362, CLX3372, CLX3381, CLX3382, CLX3383	
885F860	All functions with Request to Exit Option (M92)	

LOCKSET PARTS

LEVERS 1-3/8" TO 2-1/4" DOORS

PART NO.	DESCRIPTION	LIST PRICE	PART NO.	DESCRIPTION	LIST PRICE
860F005	AZ - Passage/plain	\$162.00	860F465	PZ - LFIC (Corbin Russwin 6-pin)	\$162.00
860F055	AZ - Emergency key hole		860F475	PZ - LFIC (Corbin Russwin 6-pin inside CLX3352)	
860F015	AZ - Fixed core cylinder (Corbin Russwin 6/7-pin, Yale® 6/7-pin, Schlage® 6-pin)		860F485	PZ - LFIC (Corbin Russwin 7-pin)	
860F025	AZ - Fixed core cylinder (Corbin Russwin 6/7-pin, Yale® 6/7-pin, Schlage® 6-pin inside CLX3352)		860F495	PZ - LFIC (Corbin Russwin 7-pin inside CLX3352)	
860F035	AZ - Push/turn button or fixed core cylinder (SARGENT® 6-pin)		860F525	PZ - LFIC (Schlage® 6-pin)	
860F045	AZ - Fixed core cylinder (SARGENT® inside CLX3352)		860F535	PZ - LFIC (Schlage® 6-pin inside CLX3352)	
860F065	AZ - LFIC (Corbin Russwin 6-pin)		860F545	PZ - LFIC (Yale® 6-pin)	
860F075	AZ - LFIC (Corbin Russwin 6-pin inside CLX3352)		860F555	PZ - LFIC (Yale® 6-pin inside CLX3352)	
860F085	AZ - LFIC (Corbin Russwin 7-pin)		860F505	PZ - SFIC 6/7-pin	
860F095	AZ - LFIC (Corbin Russwin 7-pin inside CLX3352)		860F515	PZ - SFIC 6/7-pin (inside CLX3352)	
860F125	AZ - LFIC (Schlage® 6-pin)		860F655	102 - Passage/plain	
860F135	AZ - LFIC (Schlage® 6-pin inside CLX3352)		860F705	102 - Emergency key hole	
860F145	AZ - LFIC (Yale® 6-pin)		860F665	102 - Fixed core cylinder (Corbin Russwin 6/7-pin, Yale® 6/7-pin, Schlage® 6-pin)	
860F155	AZ - LFIC (Yale® 6-pin inside CLX3352)		860F685	102 - Push/turn button or fixed core cylinder (SARGENT® 6-pin)	
860F105	AZ - SFIC 6/7-pin		860F715	102 - LFIC (Corbin Russwin 6-pin)	
860F115	AZ - SFIC 6/7-pin (inside CLX3352)		860F735	102 - LFIC (Corbin Russwin 7-pin)	
860F205	NZ - Passage/plain		860F755	102 - SFIC 6/7-pin	
860F255	NZ - Emergency key hole		860F905	106 - Passage/plain	
860F215	NZ - Fixed core cylinder (Corbin Russwin 6/7-pin, Yale® 6/7-pin, Schlage® 6-pin)		860F955	106 - Emergency key hole	
860F225	NZ - Fixed core cylinder (Corbin Russwin 6/7-pin, Yale® 6/7-pin, Schlage® 6-pin inside CLX3352)		860F915	106 - Fixed core cylinder (Corbin Russwin 6/7-pin, Yale® 6/7-pin, Schlage® 6-pin)	
860F235	NZ - Push/turn button or fixed core cylinder (SARGENT® 6-pin)		860F935	106 - Push/turn button or fixed core cylinder (SARGENT® 6-pin)	
860F245	NZ - Fixed core cylinder (SARGENT® inside CLX3352)		860F965	106 - LFIC (Corbin Russwin 6-pin)	
860F265	NZ - LFIC (Corbin Russwin 6-pin)		860F985	106 - LFIC (Corbin Russwin 7-pin)	
860F275	NZ - LFIC (Corbin Russwin 6-pin inside CLX3352)		861F015	106 - SFIC 6/7-pin	
860F285	NZ - LFIC (Corbin Russwin 7-pin)		861F035	123 - Passage/plain	
860F295	NZ - LFIC (Corbin Russwin 7-pin inside CLX3352)		861F085	123 - Emergency key hole	
860F325	NZ - LFIC (Schlage® 6-pin)		861F045	123 - Fixed core cylinder (Corbin Russwin 6/7-pin, Yale® 6/7-pin, Schlage® 6-pin)	
860F335	NZ - LFIC (Schlage® 6-pin inside CLX3352)		861F065	123 - Push/turn button or fixed core cylinder (SARGENT® 6-pin)	
860F345	NZ - LFIC (Yale® 6-pin)		861F095	123 - LFIC (Corbin Russwin 6-pin)	
860F355	NZ - LFIC (Yale® 6-pin inside CLX3352)		861F115	123 - LFIC (Corbin Russwin 7-pin)	
860F305	NZ - SFIC 6/7-pin		861F135	123 - SFIC 6/7-pin	
860F315	NZ - SFIC 6/7-pin (inside CLX3352)		860F775	124 - Passage/plain	
860F405	PZ - Passage/plain		860F825	124 - Emergency key hole	
860F455	PZ - Emergency key hole		860F785	124 - Fixed core cylinder (Corbin Russwin 6/7-pin, Yale® 6/7-pin, Schlage® 6-pin)	
860F415	PZ - Fixed core cylinder (Corbin Russwin 6/7-pin, Yale® 6/7-pin, Schlage® 6-pin)		860F805	124 - Push/turn button or fixed core cylinder (SARGENT® 6-pin)	
860F425	PZ - Fixed core cylinder (Corbin Russwin 6/7-pin, Yale® 6/7-pin, Schlage® 6-pin inside CLX3352)		860F835	124 - LFIC (Corbin Russwin 6-pin)	
860F435	PZ - Push/turn button or fixed core cylinder (SARGENT® 6-pin)		860F855	124 - LFIC (Corbin Russwin 7-pin)	
860F445	PZ - Fixed core cylinder (SARGENT® inside CLX3352)		860F875	124 - SFIC 6/7-pin	

LOCKSET PARTS

PART NO.	DESCRIPTION	LIST PRICE	PART NO.	DESCRIPTION	LIST PRICE
LEVERS 1-3/8" TO 2-1/4" DOORS WITH KNURLING			LEVERS 1-3/8" TO 2-1/4" DOORS WITH ABRASIVE COAT		
860N005	AZ - Passage/plain	\$162.00	860R005	AZ - Passage/plain	\$162.00
860N055	AZ - Emergency key hole		860R055	AZ - Emergency key hole	
860N015	AZ - Fixed core cylinder (Corbin Russwin 6/7-pin, Yale® 6/7-pin, Schlage® 6-pin)		860R015	AZ - Fixed core cylinder (Corbin Russwin 6/7-pin, Yale® 6/7-pin, Schlage® 6-pin)	
860N025	AZ - Fixed core cylinder (Corbin Russwin 6/7-pin, Yale® 6/7-pin, Schlage® 6-pin inside CLX3352)		860R025	AZ - Fixed core cylinder (Corbin Russwin 6/7-pin, Yale® 6/7-pin, Schlage® 6-pin inside CLX3352)	
860N035	AZ - Push/turn button or fixed core cylinder (SARGENT® 6-pin)		860R035	AZ - Push/turn button or fixed core cylinder (SARGENT® 6-pin)	
860N045	AZ - Fixed core cylinder (SARGENT® inside CLX3352)		860R045	AZ - Fixed core cylinder (SARGENT® inside CLX3352)	
860N065	AZ - LFIC (Corbin Russwin 6-pin)		860R065	AZ - LFIC (Corbin Russwin 6-pin)	
860N075	AZ - LFIC (Corbin Russwin 6-pin inside CLX3352)		860R075	AZ - LFIC (Corbin Russwin 6-pin inside CLX3352)	
860N085	AZ - LFIC (Corbin Russwin 7-pin)		860R085	AZ - LFIC (Corbin Russwin 7-pin)	
860N095	AZ - LFIC (Corbin Russwin 7-pin inside CLX3352)		860R095	AZ - LFIC (Corbin Russwin 7-pin inside CLX3352)	
860N125	AZ - LFIC (Schlage® 6-pin)		860R125	AZ - LFIC (Schlage® 6-pin)	
860N135	AZ - LFIC (Schlage® 6-pin inside CLX3352)		860R135	AZ - LFIC (Schlage® 6-pin inside CLX3352)	
860N145	AZ - LFIC (Yale® 6-pin)		860R145	AZ - LFIC (Yale® 6-pin)	
860N155	AZ - LFIC (Yale® 6-pin inside CLX3352)		860R155	AZ - LFIC (Yale® 6-pin inside CLX3352)	
860N105	AZ - SFIC 6/7-pin		860R105	AZ - SFIC 6/7-pin	
860N115	AZ - SFIC 6/7-pin (inside CLX3352)		860R115	AZ - SFIC 6/7-pin (inside CLX3352)	
860N205	NZ - Passage/plain		860R205	NZ - Passage/plain	
860N255	NZ - Emergency key hole		860R255	NZ - Emergency key hole	
860N215	NZ - Fixed core cylinder (Corbin Russwin 6/7-pin, Yale® 6/7-pin, Schlage® 6-pin)		860R215	NZ - Fixed core cylinder (Corbin Russwin 6/7-pin, Yale® 6/7-pin, Schlage® 6-pin)	
860N225	NZ - Fixed core cylinder (Corbin Russwin 6/7-pin, Yale® 6/7-pin, Schlage® 6-pin inside CLX3352)		860R225	NZ - Fixed core cylinder (Corbin Russwin 6/7-pin, Yale® 6/7-pin, Schlage® 6-pin inside CLX3352)	
860N235	NZ - Push/turn button or fixed core cylinder (SARGENT® 6-pin)		860R235	NZ - Push/turn button or fixed core cylinder (SARGENT® 6-pin)	
860N245	NZ - Fixed core cylinder (SARGENT® inside CLX3352)		860R245	NZ - Fixed core cylinder (SARGENT® inside CLX3352)	
860N265	NZ - LFIC (Corbin Russwin 6-pin)		860R265	NZ - LFIC (Corbin Russwin 6-pin)	
860N275	NZ - LFIC (Corbin Russwin 6-pin inside CLX3352)		860R275	NZ - LFIC (Corbin Russwin 6-pin inside CLX3352)	
860N285	NZ - LFIC (Corbin Russwin 7-pin)		860R285	NZ - LFIC (Corbin Russwin 7-pin)	
860N295	NZ - LFIC (Corbin Russwin 7-pin inside CLX3352)		860R295	NZ - LFIC (Corbin Russwin 7-pin inside CLX3352)	
860N325	NZ - LFIC (Schlage® 6-pin)		860R325	NZ - LFIC (Schlage® 6-pin)	
860N335	NZ - LFIC (Schlage® 6-pin inside CLX3352)		860R335	NZ - LFIC (Schlage® 6-pin inside CLX3352)	
860N345	NZ - LFIC (Yale® 6-pin)		860R345	NZ - LFIC (Yale® 6-pin)	
860N355	NZ - LFIC (Yale® 6-pin inside CLX3352)		860R355	NZ - LFIC (Yale® 6-pin inside CLX3352)	
860N305	NZ - SFIC 6/7-pin	860R305	NZ - SFIC 6/7-pin		
860N315	NZ - SFIC 6/7-pin (inside CLX3352)	860R315	NZ - SFIC 6/7-pin (inside CLX3352)		
860N405	PZ - Passage/plain	860R405	PZ - Passage/plain		
860N455	PZ - Emergency key hole	860R415	PZ - Emergency key hole		
860N415	PZ - Fixed core cylinder (Corbin Russwin 6/7-pin, Yale® 6/7-pin, Schlage® 6-pin)	860R425	PZ - Fixed core cylinder (Corbin Russwin 6/7-pin, Yale® 6/7-pin, Schlage® 6-pin)		
860N425	PZ - Fixed core cylinder (Corbin Russwin 6/7-pin, Yale® 6/7-pin, Schlage® 6-pin inside CLX3352)	860R435	PZ - Fixed core cylinder (Corbin Russwin 6/7-pin, Yale® 6/7-pin, Schlage® 6-pin inside CLX3352)		
860N435	PZ - Push/turn button or fixed core cylinder (SARGENT® 6-pin)	860R445	PZ - Push/turn button or fixed core cylinder (SARGENT® 6-pin)		
860N445	PZ - Fixed core cylinder (SARGENT® inside CLX3352)	860R455	PZ - Fixed core cylinder (SARGENT® inside CLX3352)		
860N465	PZ - LFIC (Corbin Russwin 6-pin)	860R465	PZ - LFIC (Corbin Russwin 6-pin)		
860N475	PZ - LFIC (Corbin Russwin 6-pin inside CLX3352)	860R475	PZ - LFIC (Corbin Russwin 6-pin inside CLX3352)		
860N485	PZ - LFIC (Corbin Russwin 7-pin)	860R485	PZ - LFIC (Corbin Russwin 7-pin)		
860N495	PZ - LFIC (Corbin Russwin 7-pin inside CLX3352)	860R495	PZ - LFIC (Corbin Russwin 7-pin inside CLX3352)		
860N525	PZ - LFIC (Schlage® 6-pin)	860R525	PZ - LFIC (Schlage® 6-pin)		
860N535	PZ - LFIC (Schlage® 6-pin inside CLX3352)	860R535	PZ - LFIC (Schlage® 6-pin inside CLX3352)		
860N545	PZ - LFIC (Yale® 6-pin)	860R545	PZ - LFIC (Yale® 6-pin)		
860N555	PZ - LFIC (Yale® 6-pin inside CLX3352)	860R555	PZ - LFIC (Yale® 6-pin inside CLX3352)		
860N505	PZ - SFIC 6/7-pin	860R505	PZ - SFIC 6/7-pin		
860N515	PZ - SFIC 6/7-pin (inside CLX3352)	860R515	PZ - SFIC 6/7-pin (inside CLX3352)		

LOCKSET PARTS

PART NO.	DESCRIPTION	LIST PRICE
MISCELLANEOUS		
865F298	Emergency Release Tool (CLX3320)	\$4.10
867F388	1-3/8" Door Adapter Plates Pack (D138)	\$63.00
865F199	Hotel Adjustment Tool	\$15.02
041F478	Hotel Shut-out Key	\$4.10
LATCH ASSEMBLY		
2 3/4" Backsets		
867F20	Plain, square corner	\$107.00
867F26	Plain, rounded corner	
867F21	Deadlocking square corner mechanical functions	\$122.00
867F27	Deadlocking rounded corner mechanical functions	
867F32	Deadlocking square corner electrified functions	
867F35	Deadlocking rounded corner electrified functions	
601F69	3/4" Throw deadlocking fire latch square corner	\$156.00
2 3/8" Backsets		
599F91	Plain, square corner 1" front	\$93.00
599F97	Plain, square corner 1-1/8" front	
599F94	Plain, rounded corner 1" front	
600F00	Plain, rounded corner 1-1/8" front	
599F92	Deadlocking, square corner 1" front	
599F98	Deadlocking, square corner 1-1/8" front	
599F95	Deadlocking, rounded corner 1" front	
600F01	Deadlocking, rounded corner 1-1/8" front	
3 3/4" Backsets		
867F22	Plain, square corner	\$205.00
867F28	Plain, round corner	
867F23	Deadlocking square corner mechanical functions	\$216.00
867F29	Deadlocking rounded corner mechanical functions	
867F33	Deadlocking square corner electrified functions	
867F36	Deadlocking rounded corner electrified functions	
5" Backsets		
867F24	Plain, square corner	\$148.00
867F30	Plain, rounded corner	
867F25	Deadlocking square corner mechanical functions	\$156.00
867F31	Deadlocking rounded corner mechanical functions	
867F34	Deadlocking square corner electrified functions	
867F37	Deadlocking rounded corner electrified functions	

PART NO.	DESCRIPTION	LIST PRICE
LATCH & STRIKE SCREW PACKS		
604F228 Fin	Latch & ANSI (4 7/8") strike – phillips head	\$9.80
604F238 Fin	Latch & ANSI (4 7/8") strike – spanner head	\$21.00
604F248 Fin	Latch & ANSI (4 7/8") strike – Torx head	\$21.00
604F268 Fin	Latch & T (2 3/4") strike – phillips head	\$9.80
604F278 Fin	Latch & T (2 3/4") strike – spanner head	\$21.00
604F288 Fin	Latch & T (2 3/4") strike – Torx head	\$21.00
MOUNTING SCREW PACKS		
865F308	1 3/8" – 2" doors	\$9.80
865F398	Over 2"	\$14.00
867F73 Fin	CLX3390 1 3/8" – 2 1/4" phillips head	\$11.00
867F74 Fin	CLX3390 1 3/8" – 2 1/4" spanner head	\$21.00
867F75 Fin	CLX3390 1 3/8" – 2 1/4" Torx head	\$21.00
867F70 Fin	CLX3350 Half Dummy Trim - phillips head	\$14.00
867F71 Fin	CLX3350 Half Dummy Trim - spanner head	\$66.00
867F72 Fin	CLX3350 Half Dummy Trim - Torx head	\$66.00
ROSES/ROSE LINERS		
678F25 Fin	Rose	\$67.00
598F59 Fin	Blank Rose/Plate CLX3380, CLX3381, CLX3383	\$42.00
789F018	Rose liner I/S 1 3/4" – 2"	\$9.80
789F028	Rose liner I/S over 2"	\$9.80
789F058	Rose liner O/S 1 3/4" – 2"	
789F068	Rose liner O/S over 2"	\$9.80
865F32 x Fin	Thumbturn ass'y 1 3/4" – 2" (CLX3390)	\$129.00
865F33 x Fin	Thumbturn ass'y over 2" (CLX3390)	
789F228	Rose liner ass'y O/S CLX3380, CLX3381, CLX3383	\$40.00
STRIKES – 4 7/8" ANSI CURVED LIP		
217L13M016	1" Lip Length	\$35.00
217L13M018	1 1/8" Lip Length	
217L13M020	1 1/4" Lip Length	
217L13M022	1 3/8" Lip Length	
217L13M024	1 1/2" Lip Length	
217L13M028	1 3/4" Lip Length	
217L13M032	2" Lip Length	
217L13M036	2 1/4" Lip Length	
217L13M040	2 1/2" Lip Length	
217L13M044	2 3/4" Lip Length	
217L13M048	3" Lip Length	
120F768	4 7/8" strike box	
STRIKES – 2 3/4" T- CURVED LIP		
586L19M016	1" Lip Length	\$35.00
586L19M018	1 1/8" Lip Length	
586L19M020	1 1/4" Lip Length	
586L19M022	1 3/8" Lip Length	
586L19M024	1 1/2" Lip Length	
586L19M028	1 3/4" Lip Length	
586L19M032	2" Lip Length	
586L19M036	2 1/4" Lip Length	
586L19M040	2 1/2" Lip Length	
586L19M044	2 3/4" Lip Length	
586L19M048	3" Lip Length	
STRIKE - 2 3/4" FULL LIP		
607F76	1-1/8" Lip Length	\$13.00

LOCKSET PARTS

PART NO.	DESCRIPTION	LIST PRICE
CHASSIS ASSEMBLY STANDARD		
785F008	CL3310	\$243.00
785F118 Fin	CL3320, CL3361	\$256.00
785F138 Fin	CL3320TO	\$243.00
785F078 Fin	CL3329	\$300.00
785F068	CL3332	\$290.00
785F028 Fin	CL3340	\$282.00
785F038	CL3340NT	\$258.00
785F018 Fin	CL3351, CL3357	
785F048	CL3352, CL3355	\$300.00
785F148	CL3359	\$258.00
785F058	CL3362	\$290.00
785F088	CL3372	
785F158 Fin	CL3375	\$274.00
785F098	CL3380, CL3390	\$274.00
785F108	CL3381, CL3391	\$274.00
785F378 Fin	CL3393	\$274.00
785F188	CL33903-12AD	\$666.00
785F168	CL33903-24AD	
785F198	CL33905-12AD	
785F178	CL33905-24AD	
CHASSIS ASSEMBLY, LFIC		
785F298	CL3361	\$290.00
785F268 Fin	CL3329	\$317.00
785F258	CL3332	\$309.00
785F218 Fin	CL3351, CL3357, CL3393	\$282.00
785F238	CL3352	\$309.00
785F228	CL3355	
785F308	CL3359	\$282.00
785F248	CL3362	\$309.00
785F278	CL3372	
785F318 Fin	CL3375	\$262.00
785F288	CL3381, CL3391	\$294.00
785F388 Fin	CL3393	\$262.00
785F348	CL33903-12AD	\$666.00
785F328	CL33903-24AD	
785F358	CL33905-12AD	
785F338	CL33905-24AD	

PART NO.	DESCRIPTION	LIST PRICE
CYLINDER PARTS		
622F308	Tailpiece 6-pin	\$4.10
682F298	Tailpiece 7-pin	
631F248	Corbin Russwin LFIC core kit	\$9.80
682F958	SFIC tailpiece kit	
682F969	Sargent® tailpiece kit	\$26.00
697F942	Schlage® LFIC tailpiece kit	\$35.00
682F398	Schlage® tailpiece kit	\$26.00
HOUSING ASSEMBLIES		
783F208	Spring housing O/S	\$51.00
783F308	Spring housing I/S 1 3/4"-2"	\$42.00
783F408	Spring housing I/S 2 1/4"	
686F858	Dummy housing I/S	\$156.00
686F868	Dummy housing O/S	\$142.00
EMERGENCY RELEASE TOOL		
679F818	Emergency Release Tool (CL3320)	\$4.10
LEVER INSERT		
585F729	Lever insert (black)	\$4.10
LATCH ASSEMBLY		
2 3/4" Backsets		
586F16	Plain, square corner	\$107.00
596F66	Plain, rounded corner	
586F17	Deadlocking square corner	\$122.00
596F67	Deadlocking rounded corner	
586F18	Throw-Off square corner	
596F68	Throw-Off rounded corner	
601F69	3/4" Throw deadlocking fire latch square corner	\$156.00
3 3/4" Backsets		
586F80	Plain, square corner	\$205.00
586F86	Plain, rounded corner	
586F81	Deadlocking square corner	\$216.00
586F87	Deadlocking rounded corner	
586F82	Throw-Off square corner	
586F88	Throw-Off rounded corner	
5" Backsets		
598F20	Plain, square corner	\$148.00
601F24	Plain, rounded corner	
598F21	Deadlocking square corner	\$156.00
601F25	Deadlocking rounded corner	
598F22	Throw-Off square corner	
601F26	Throw-Off rounded corner	

LOCKSET PARTS

PART NO.	DESCRIPTION	LIST PRICE	PART NO.	DESCRIPTION	LIST PRICE
LEVERS 1-3/4" TO 2" DOORS			LEVERS 1-3/4" TO 2" DOORS (Cont'd)		
563F945	NZD - Plain	\$156.00	799F805	PZD - SFIC	\$156.00
563F955	NZD - Cylinder button		799F815	PZD - SFIC CL3352 inside	
714F065	NZD - CL3352 inside		799F825	PZD - Schlage® LFIC	
563F965	NZD - Emergency key hole		799F835	PZD - Schlage® LFIC CL3352 inside	
585F715	NZD - LFIC cylinder - 6 pin		799F545	PZD - Sargent Fixed Core Cylinder	
714F365	NZD - LFIC cylinder - 6 pin CL3352 inside		799F555	PZD - Sargent Fixed Core Cylinder CL3352 Inside	
600F415	NZD - LFIC cylinder - 7 pin		712F205	FZD - LH plain	
714F375	NZD - LFIC cylinder - 7 pin CL3352 inside		712F215	FZD - LH cylinder or button	
596F825	NZD - SFIC		712F385	FZD - LH CL3352 inside	
714F425	NZD - SFIC CL3352 inside		712F225	FZD - LH emergency key hole	
690F975	NZD - Schlage® LFIC		715F245	FZD - LH Corbin Russwin LFIC - 6 pin	
714F455	NZD - Schlage® LFIC CL3352 inside		712F405	FZD - LH Corbin Russwin LFIC - 6 pin CL3352 inside	
578F435	NZD - Sargent Fixed Core Cylinder		714F255	FZD - LH Corbin Russwin LFIC - 7 pin	
714F125	NZD - Sargent Fixed Core Cylinder CL3352 Inside		712F415	FZD - LH Corbin Russwin LFIC - 7 pin CL3352 inside	
563F885	AZD - Plain		712F265	FZD - LH SFIC	
563F895	AZD - Cylinder or button		712F425	FZD - LH SFIC CL3352 inside	
714F005	AZD - CL3352 inside		712F275	FZD - LH Schlage® LFIC	
563F905	AZD - Emergency key hole		712F435	FZD - LH Schlage® LFIC CL3352 inside	
585F705	AZD - Corbin Russwin LFIC - 6 pin		712F235	FZD - LH Sargent Fixed Core Cylinder	
714F305	AZD - Corbin Russwin LFIC - 6 pin CL3352 inside		712F395	FZD - LH Sargent Fixed Core Cylinder CL3352 Inside	
600F425	AZD - Corbin Russwin LFIC - 7 pin inside		712F505	FZD - RH plain	
714F315	AZD - Corbin Russwin LFIC - 7 pin CL3352 inside		712F515	FZD - RH cylinder or button	
409F865	AZD - SFIC		712F685	FZD - RH CL3352 inside	
540F625	AZD - SFIC CL3352 inside		712F525	FZD - RH emergency key hole	
695F075	AZD - Sargent Fixed Core Cylinder		712F545	FZD - RH Corbin Russwin LFIC - 6 pin	
714F035	AZD - Sargent Fixed Core Cylinder CL3352 Inside		712F705	FZD - RH Corbin Russwin LFIC - 6 pin CL3352 inside	
799F505	PZD - Plain		712F555	FZD - RH Corbin Russwin LFIC - 7 pin CL3352 inside	
799F515	PZD - Cylinder or button		712F715	FZD - RH Corbin Russwin LFIC - 7 pin CL3352 inside	
799F535	PZD - CL3352 inside		712F565	FZD - RH SFIC	
799F525	PZD - Emergency key hole		712F725	FZD - RH SFIC CL3352 inside	
799F565	PZD - Corbin Russwin LFIC - 6 pin		712F575	FZD - Schlage® LFIC	
799F575	PZD - Corbin Russwin LFIC - 6 pin CL3352 inside		712F735	FZD - Schlage® LFIC CL3352 inside	
799F585	PZD - Corbin Russwin LFIC - 7 pin	712F535	FZD - RH Sargent Fixed Core Cylinder		
799F595	PZD - Corbin Russwin LFIC - 7 pin CL3352 inside	712F695	FZD - RH Sargent Fixed Core Cylinder CL3352 Inside		

LOCKSET PARTS

PART NO.	DESCRIPTION	LIST PRICE	PART NO.	DESCRIPTION	LIST PRICE
LEVERS 2 1/4" DOORS			LEVERS 2 1/4" DOORS (Cont'd)		
684F825	NZD - Plain	\$156.00	799F845	PZD - SFIC	\$156.00
684F835	NZD - Cylinder or button		799F855	PZD - SFIC CL3352 inside	
714F215	NZD - CL3352 inside		799F865	PZD - Schlage® LFIC	
684F845	NZD - Emergency key hole		799F875	PZD - Schlage LFIC CL3352 inside	
684F865	NZD - Corbin Russwin LFIC - 6 pin		799F645	PZD - Sargent Fixed Core Cylinder	
714F545	NZD - Corbin Russwin LFIC - 6 pin CL3352 inside		799F655	PZD - Sargent Fixed Core Cylinder CL3352 Inside	
685F875	NZD - Corbin Russwin LFIC - 7 pin		712F305	FZD - LH plain	
714F555	NZD - Corbin Russwin LFIC - 7 pin CL3352 inside		712F315	FZD - LH cylinder or botton	
684F885	NZD - SFIC		712F445	FZD - LH CL3352 inside	
714F605	NZD - SFIC CL3352 inside		712F325	FZD - LH emergency key hole	
690F985	NZD - Schlage® LFIC		712F345	FZD - Corbin Russwin LFIC - 6 pin	
714F635	NZD - Schlage® LFIC CL3352 inside		712F465	FZD - Corbin Russwin LFIC - 6 pin CL3352 inside	
684F855	NZD - Sargent Fixed Core Cylinder		712F355	FZD - Corbin Russwin LFIC - 7 pin	
714F275	NZD - Sargent Fixed Core Cylinder CL3352 Inside		712F475	FZD - Corbin Russwin LFIC - 7 pin CL3352 inside	
684F775	AZD - Plain		712F365	FZD - LH SFIC	
684F785	AZD - Cylinder or button		712F485	FZD - LH SFIC CL3352 inside	
714F155	AZD - CL3352 inside		712F375	FZD - LH Schlage® LFIC	
684F795	AZD - Emergency key hole		712F495	FZD - LH Schlage® LFIC CL3352 inside	
684F805	AZD - Corbin Russwin LFIC - 6 pin		712F335	FZD - LH Sargent Fixed Core Cylinder	
714F485	AZD - Corbin Russwin LFIC - 6 pin CL3352 inside		712F455	FZD - LH Sargent Fixed Core Cylinder CL3352 Inside	
684F815	AZD - Corbin Russwin LFIC - 7 pin		712F605	FZD - RH plain	
714F495	AZD - Corbin Russwin LFIC - 7 pin CL3352 inside		712F615	FZD - RH cylinder or button	
409F875	AZD - SFIC		712F745	FZD - RH CL3352 inside	
540F685	AZD - SFIC CL3352 inside		712F625	FZD - RH emergency key hole	
697F995	AZD - Sargent Fixed Core Cylinder		712F645	FZD - RH Corbin Russwin LFIC - 6 pin	
714F185	AZD - Sargent Fixed Core Cylinder CL3352 Inside		712F765	FZD - RH Corbin Russwin LFIC - 6 pin CL3352 inside	
799F605	PZD - Plain		712F655	FZD - RH Corbin Russwin LFIC - 7 pin	
799F615	PZD - Cylinder or button		712F775	FZD - RH Corbin Russwin LFIC - 7 pin CL3352 inside	
799F635	PZD - CL3352 inside		712F665	FZD - RH SFIC	
799F625	PZD - Emergency key hole		712F785	FZD - RH SFIC CL3352 inside	
799F665	PZD - Corbin Russwin LFIC - 6 pin		712F675	FZD - RH Schlage® LFIC	
799F675	PZD - Corbin Russwin LFIC - 6 pin CL3352 inside		712F795	FZD - RH Schlage® LFIC CL3352 inside	
799F685	PZD - Corbin Russwin LFIC - 7 pin		712F635	FZD - RH Sargent Fixed Core Cylinder	
799F695	PZD - Corbin Russwin LFIC - 7 pin CL3352 inside	712F755	FZD - RH Sargent Fixed Core Cylinder CL3352 Inside		

CL3300 Cylindrical Lock Series Extra Heavy-Duty Lever Lockset

USA & Canada Prices Effective April 17, 2023

LOCKSET PARTS

PART NO.	DESCRIPTION	LIST PRICE
LATCH & STRIKE SCREW PACKS		
604F228 Fin	Latch & ANSI (4 7/8") strike - phillips head	\$9.80
604F238 Fin	Latch & ANSI (4 7/8") strike - spanner head	\$21.00
604F248 Fin	Latch & ANSI (4 7/8") strike - Torx head	
604F268 Fin	Latch & T (2 3/4") strike - phillips head	\$9.80
604F278 Fin	Latch & T (2 3/4") strike - spanner head	\$21.00
604F288 Fin	Latch & T (2 3/4") strike - Torx head	
480F688 Fin	Rabbetted Strike - phillips head	\$9.80
596F618 Fin	Rabbetted Strike - spanner head	\$21.00
596F628 Fin	Rabbetted Strike - Torx head	
MOUNTING SCREW PACKS		
682F608	1 3/4" - 2" doors (pre June 2004)	\$9.80
710F658	1 3/4" - 2" doors (after June 2004)	
682F618	Over 2" (pre June 2004)	\$14.00
710F668	Over 2" (after June 2004)	
682F628	CL3380, CL3381 1 3/4" - 2" doors	\$9.80
682F638	CL3380, CL3381 over 2" doors	\$14.00
682F64 Fin	CL3390, CL3391 1 3/4" - 2" phillips head	\$11.00
682F67 Fin	CL3390, CL3391 1 3/4" - 2" spanner head	\$21.00
682F68 Fin	CL3390, CL3391 1 3/4" - 2" Torx head	
682F65 Fin	CL3390, CL3391 over 2" phillips head	\$66.00
682F86 Fin	CL3390, CL3391 over 2" spanner head	
682F87 Fin	CL3390, CL3391 over 2" Torx head	\$14.00
684F44 Fin	CL3350 Half Dummy Trim - phillips head	
684F45 Fin	CL3350 Half Dummy Trim - spanner head	\$66.00
684F46 Fin	CL3350 Half Dummy Trim - Torx head	
684F528	CL3370 Half Dummy Trim	\$9.80
BUTTONS		
585F76 Fin	Turnbutton CL3351	\$30.00
585F77 Fin	Pushbutton CL3320, CL3320H, CL3320TO, CL3340, CL3361, CL3375	
585F78 Fin	Hotel button CL3329	
585F79 Fin	Slotted button CL3393	

PART NO.	DESCRIPTION	LIST PRICE
FRONT PLATE RABBETTED STRIKE		
315F93 Fin*	606, 612, 619, 626, 605, 611, 613, 625	\$86.00
RABBETTED STRIKE		
315F94 Fin*	606, 612, 619, 626, 605, 611, 613, 625	\$86.00
601F283 Fin*	Rabbetted Strike & Front	\$131.00

ROSES		
678F25 Fin	Rose	\$67.00
598F59 Fin	Blank Rose	\$42.00
710F618	Rose liner I/S 1 3/4" - 2" after June 2004	\$9.80
710F628	Rose liner I/S over 2" after June 2004	
678F248	Rose liner O/S 1 3/4" - 2"	
678F498	Rose liner O/S over 2"	
586F51 Fin	Thumbturn ass'y 1 3/4" - 2"	\$129.00
686F88 Fin	Thumbturn ass'y over 2"	
682F788	Rose liner CL3380, CL3381	\$40.00

STRIKES - 4 7/8" ANSI CURVED LIP		
217L13M016	1" Lip Length	\$35.00
217L13M018	1 1/8" Lip Length	
217L13M020	1 1/4" Lip Length	
217L13M022	1 3/8" Lip Length	
217L13M024	1 1/2" Lip Length	
217L13M028	1 3/4" Lip Length	
217L13M032	2" Lip Length	
217L13M036	2 1/4" Lip Length	
217L13M040	2 1/2" Lip Length	
217L13M044	2 3/4" Lip Length	
217L13M048	3" Lip Length	

STRIKES - 2 3/4" T- CURVED LIP		
586L19M016	1" Lip Length	\$35.00
586L19M018	1 1/8" Lip Length	
586L19M020	1 1/4" Lip Length	
586L19M022	1 3/8" Lip Length	
586L19M024	1 1/2" Lip Length	
586L19M028	1 3/4" Lip Length	
586L19M032	2" Lip Length	
586L19M036	2 1/4" Lip Length	
586L19M040	2 1/2" Lip Length	
586L19M044	2 3/4" Lip Length	
586L19M048	3" Lip Length	

PART NO.	DESCRIPTION	LIST PRICE
BUTTONS		ALL FINISH
585F762	CL3551 (Turn Button)	\$30.00
585F772	CL3520, 61 (Push Button)	
CASSETTE HOUSING O/S		NO FINISH
796F378	Standard	\$43.00
686F858	CL3550, 70	\$156.00
CASSETTE HOUSING I/S		NO FINISH
796F408	CL3580, 81	\$30.00
686F868	CL3570	\$142.00
796F398	Standard I/S Spring Housing	\$24.00
CHASSIS ASSEMBLY, STANDARD		NO FINISH
796F208	CL3510	\$134.00
796F218	CL3520, 61	\$187.00
796F248	CL3580	
796F228	CL3551, 57	
796F238	CL3555	
796F258	CL3581	
796F268	CL3582	\$253.00
CHASSIS ASSEMBLY, LFIC		NO FINISH
796F318	CL3561	\$187.00
796F328	CL3551, 57	
796F338	CL3555	\$200.00
796F358	CL3581	\$223.00
796F368	CL3582	\$262.00
CYLINDER PARTS		NO FINISH
622F308	Tailpiece 6-Pin	\$4.10
682F298	Tailpiece 7-pin	
682F398	M06 - Schlage® tailpiece kit	\$26.00
682F969	M09 - Sargent® tailpiece kit	
631F248	C6/C7 - LFIC tailpiece kit	\$9.80
682F958	M08 - SFIC kit	
697F942	M69 - Schlage® IC tailpiece kit	\$35.00
HOUSING ASSEMBLIES		
796F388	Housing Assembly, I/S, D134	\$23.00
796F398	Housing Assembly, I/S, D138	\$24.00

PART NO.	DESCRIPTION	LIST PRICE
LATCH ASSEMBLY		ALL FINISH
Deadlocking Latches		
599F92	2-3/8" backset x 1" front	\$93.00
599F95	2-3/8" backset x 1" round corner	
599F98	2-3/8" backset x 1-1/8" front	
600F01	2-3/8" backset x 1-1/8" round corner	
600F04	2-3/4" backset x 1" front	
600F07	2-3/4" backset x 1" round corner	
600F10	2-3/4" backset x 1-1/8" front	
600F13	2-3/4" backset x 1-1/8" round corner	
600F63	3-3/4" backset x 1-1/8" front	
600F66	3-3/4" backset x 1-1/8" round corner	
600F69	5" backset x 1-1/8" front	\$129.00
600F72	5" backset x 1-1/8" round corner	
Deadlocking Latches with Release (CL3520)		
599F93	2-3/8" backset x 1" front	\$93.00
599F96	2-3/8" backset x 1" round corner	
599F99	2-3/8" backset x 1-1/8" front	
600F02	2-3/8" backset x 1-1/8" round corner	
600F05	2-3/4" backset x 1" front	
600F08	2-3/4" backset x 1" round corner	
600F11	2-3/4" backset x 1-1/8" front	
600F14	2-3/4" backset x 1-1/8" round corner	
600F64	3 3/4" backset x 1 1/8" front	\$129.00
600F67	3-3/4" backset x 1-1/8" round corner	
600F70	5" backset x 1 1/8" front	
600F73	5" backset x 1-1/8" round corner	
Plain Spring Latches (CL3510)		
599F91	2-3/8" backset x 1" front	\$93.00
599F94	2-3/8" backset x 1" rounded corner	
599F97	2-3/8" backset x 1-1/8" front	
600F00	2-3/8" backset x 1-1/8" rounded corner	
600F03	2-3/4" backset x 1" front	
600F06	2-3/4" backset x 1" rounded corner	
600F09	2-3/4" backset x 1-1/8" front	
600F12	2-3/4" backset x 1-1/8" rounded corner	
600F62	3-3/4" backset x 1-1/8" front	\$129.00
600F65	3-3/4" backset x 1-1/8" rounded corner	
600F68	5" backset x 1-1/8" front	
600F71	5" backset x 1-1/8" rounded corner	

CL3500 Cylindrical Lock Series Heavy-Duty Lever Lockset

USA & Canada Prices Effective April 17, 2023

PART NO.	DESCRIPTION	LIST PRICE
LEVERS		ALL FINISH
598F815	AZD x plain	\$128.00
598F825	AZD x cylinder or button	
598F835	AZD x emergency hole	
598F905	AZD x C6 LFIC 6-pin	
599F275	AZD x C7 LFIC 7-pin	
409F905	AZD x M08 SFIC	
797F845	NZD x plain	
797F855	NZD x cylinder or button	
797F865	NZD x emergency hole	
797F875	NZD x M09 Sargent® cylinder	
797F915	NZD x C6 LFIC 6-pin	
797F925	NZD x C7 LFIC 7-pin	
797F935	NZD x M69 Schlage LFIC	
797F945	NZD x M08 SFIC	
798F115	PZD x plain	
798F125	PZD x cylinder or button	
798F135	PZD x emergency hole	
798F145	PZD x M09 Sargent® cylinder	
798F155	PZD x C6 LFIC 6-pin	
798F165	PZD x C7 LFIC 7-pin	
798F175	PZD x M69 Schlage® LFIC	
798F185	PZD x M08 SFIC	
LEVER INSERT		ALL FINISH
598F809	Standard	\$4.10
MOUNTING SCREW PACK		
796F118	Standard	\$6.80
797F828	Standard - CL3580, 81	\$18.00
684F448	CL3550 (ALL FINISH)	\$14.00
684F528	CL3570	\$9.80

PART NO.	DESCRIPTION	LIST PRICE
ROSES		ALL FINISH
678F252	Standard	\$67.00
598F592	Blank - CL3580, 81	\$42.00
ROSE LINER O/S		NO FINISH
678F248	Standard	\$9.80
682F788	CL3580, 81	\$40.00
SCREW PACKS FOR LATCH & STRIKE		
604F228	For Latch & ANSI Strike	\$9.80
604F268	For Latch & (T strike)	
STRIKES		NO FINISH
ANSI Curved Lip Strike		
217L13M016	1" Lip Length	\$35.00
217L13M018	1-1/8" Lip Length	
217L13M020	1-1/4" Lip Length	
217L13M022	1-3/8" Lip Length	
217L13M024	1-1/2" Lip Length	
217L13M028	1-3/4" Lip Length	
217L13M032	2" Lip Length	
217L13M036	2-1/4" Lip Length	
217L13M040	2-1/2" Lip Length	
217L13M044	2-3/4" Lip Length	
217L13M048	3" Lip Length	
STRIKE BOX		NO FINISH
025F858	Curved lip (T strike)	\$5.60

CL3800 PARTS

PART NO.	DESCRIPTION	LIST PRICE
BUTTONS		ALL FINISH
585F762	CL3851 (Turn Button)	\$30.00
585F772	CL3820, 40, 61 (Push Button)	
CASSETTE HOUSING O/S		NO FINISH
796F378	Standard	\$43.00
686F858	CL3850, 70	\$156.00
CASSETTE HOUSING I/S		NO FINISH
796F398	Standard - 1-3/8" to 1-7/8" door	\$24.00
797F808	D214 - 2" to 2-1/4" door	\$30.00
796F408	CL3880, 81	\$30.00
686F868	CL3870	\$142.00
CHASSIS ASSEMBLY, STANDARD		NO FINISH
797F618	CL3810	\$75.00
797F628	CL3820, 61	\$86.00
797F658	CL3880	\$75.00
797F668	CL3851, 57	\$90.00
797F688	CL3855	
CHASSIS ASSEMBLY, IC		NO FINISH
797F638	CL3861	\$88.00
797F678	CL3851, 57	\$92.00
797F698	CL3855	

PART NO.	DESCRIPTION	LIST PRICE	
CYLINDER PARTS		NO FINISH	
622F308	Tailpiece 6-Pin	\$4.10	
682F298	Tailpiece 7-pin	\$4.10	
682F398	M06 - Schlage® tailpiece kit	\$26.00	
682F969	M09 - SARGENT® tailpiece kit		
631F248	C6/C7 - LFIC tailpiece kit	\$9.80	
682F958	M08 - SFIC kit	\$9.80	
697F942	M69 - Schlage® LFIC tailpiece kit	\$35.00	
LATCH ASSEMBLY		ALL FINISH	
Deadlocking Latches			
599F92	2-3/8" backset x 1" front	\$93.00	
599F95	2-3/8" backset x 1" rounded corner		
599F98	2-3/8" backset x 1-1/8" front		
600F01	2-3/8" backset x 1-1/8" rounded corner		
600F04	2-3/4" backset x 1" front		
600F07	2-3/4" backset x 1" rounded corner		
600F10	2-3/4" backset x 1-1/8" front		
600F13	2-3/4" backset x 1-1/8" rounded corner		
600F63	3-3/4" backset x 1-1/8" front		\$129.00
600F66	3-3/4" backset x 1-1/8" rounded corner		
600F69	5" backset x 1-1/8" front		
600F72	5" backset x 1-1/8" rounded corner		
Deadlocking Latches with Release (CL3810)			
599F93	2-3/8" backset x 1" front	\$93.00	
599F96	2-3/8" backset x 1" rounded corner		
599F99	2-3/8" backset x 1-1/8" front		
600F02	2-3/8" backset x 1-1/8" rounded corner		
600F05	2-3/4" backset x 1" front		
600F08	2-3/4" backset x 1" rounded corner		
600F11	2-3/4" backset x 1-1/8" front		
600F14	2-3/4" backset x 1-1/8" rounded corner		
600F64	3 3/4" backset x 1 1/8" front	\$129.00	
600F67	3-3/4" backset x 1-1/8" rounded corner		
600F70	5" backset x 1 1/8" front		
600F73	5" backset x 1-1/8" rounded corner		
Plain Spring Latches (CL3810)			
599F91	2-3/8" backset x 1" front	\$93.00	
599F94	2-3/8" backset x 1" rounded corner		
599F97	2-3/8" backset x 1-1/8" front		
600F00	2-3/8" backset x 1-1/8" rounded corner		
600F03	2-3/4" backset x 1" front		
600F06	2-3/4" backset x 1" rounded corner		
600F09	2-3/4" backset x 1-1/8" front		
600F12	2-3/4" backset x 1-1/8" rounded corner		
600F62	3-3/4" backset x 1-1/8" front		\$129.00
600F65	3-3/4" backset x 1-1/8" rounded corner		
600F68	5" backset x 1-1/8" front		
600F71	5" backset x 1-1/8" rounded corner		

CL3800 Cylindrical Lock Series Grade 2 Key-In-Lever Lockset

USA & Canada Prices Effective April 17, 2023

CL3800 PARTS						
PART NO.	DESCRIPTION	LIST PRICE	PART NO.	DESCRIPTION	LIST PRICE	
LEVERS 1-3/8" to 1-7/8" Doors			ALL FINISH			
598F815	AZD x plain	\$128.00	598F809	Standard - 1-3/8" to 1-7/8" door	\$4.10	
598F825	AZD x cylinder or button		684F539	D214 - 2" to 2-1/4" door	\$62.00	
598F835	AZD x emergency hole		MOUNTING SCREW PACK			
598F905	AZD x C6 LFIC 6-pin		796F118	Standard - 1-3/8" to 1-7/8" door	\$6.80	
599F275	AZD x C7 LFIC 7-pin		797F818	D214 - 2" to 2-1/4" door	\$24.00	
409F905	AZD x M08 SFIC		797F828	Standard - CL3880, 81, 90, 91	\$18.00	
797F845	NZD x plain		797F838	D214 - CL3880, 81, 90, 91	\$24.00	
797F855	NZD x cylinder or button		684F448	CL3850 (ALL FINISH)	\$14.00	
797F865	NZD x emergency hole		684F528	CL3870	\$9.80	
797F875	NZD x M09 Sargent® cylinder		ROSES			ALL FINISH
797F915	NZD x C6 LFIC 6-pin		678F252	Standard	\$67.00	
797F925	NZD x C7 LFIC 7-pin		598F592	Blank - CL3880, 81	\$42.00	
797F935	NZD x M69 Schlage LFIC		ROSE LINER O/S			NO FINISH
797F945	NZD x M08 SFIC		678F248	Standard - 1-3/8" to 1-7/8" door	\$9.80	
798F115	PZD x plain		678F498	D214 - 2" to 2-1/4" door		
798F125	PZD x cylinder or button		682F788	CL3880, 81	\$40.00	
798F135	PZD x emergency hole		SCREW PACK FOR LATCH & STRIKE			ALL FINISH
798F145	PZD x M09 Sargent® cylinder		604F228	For Latch & ANSI Strike	\$9.80	
798F155	PZD x C6 LFIC 6-pin		604F268	For Latch & 'T' or Full Lip Strike	\$9.80	
798F165	PZD x C7 LFIC 7-pin		STRIKES*			ALL FINISH
798F175	PZD x M69 Schlage® LFIC	680L52	ANSI Curved Lip Blank Strike	\$35.00		
798F185	PZD x M08 SFIC	586L19	T-Strike			
LEVERS 2" to 2-1/4" Doors - D214			680L50		Full Lip Strike	
684F775	AZD x plain	\$156.00	680L51	Full Lip Strike 1/4" Radius (Available Only 1-1/4" Lip)	\$22.00	
684F785	AZD x cylinder or button		STRIKE BOX			NO FINISH
684F795	AZD x emergency hole		025F858	Curved lip (T strike)	\$5.60	
684F805	AZD x C6 LFIC 6-pin		THUMBURNS			ALL FINISH
684F815	AZD x C7 LFIC 7-pin		586F512	Standard - 91	\$129.00	
409F875	AZD x M08 SFIC		686F882	D214 - 91		
684F825	NZD x plain					
684F835	NZD x cylinder or button					
684F845	NZD x emergency hole					
684F855	NZD x M09 Sargent® cylinder					
684F865	NZD x C6 LFIC 6-pin					
684F875	NZD x C7 LFIC 7-pin					
690F985	NZD x M69 Schlage® LFIC					
684F885	NZD x M08 SFIC					
798F215	PZD x plain					
798F225	PZD x cylinder or button					
798F235	PZD x emergency hole					
798F245	PZD x M09 Sargent® cylinder					
798F255	PZD x C6 LFIC 6-pin					
798F265	PZD x C7 LFIC 7-pin					
798F275	PZD x M69 Schlage® LFIC					
798F285	PZD x M08 SFIC					

*Specify length and finish

LOCKSET PARTS			
PART NO.	DESCRIPTION	LIST PRICE	
SCREW PACKET			
605, 613E, 630			
556F558	for CK4350 †Order 50-	\$4.10	
604F268	for curved lip strike	\$9.80	
604F278	for curved lip strike x spanner head (M02)	\$21.00	
604F288	for curved lip strike x Torx® head (M04)		
604F238	for spanner head (M02)		
480F68	for SR118	\$8.50	
596F618	for SR118 & spanner head (M02)	\$21.00	
596F628	for SR118 & Torx head (M04)		
604F228	standard	\$9.80	
604F248	for Torx head (M04)	\$21.00	
224F008*	Screw, Sems Assembly #8 -32 X 1-1/4" †Order 100-	\$4.10	
STRIKE			
605, 613E, 630			
ANSI Curved Lip Strike			
217L13M016	1" Lip Length	\$35.00	
217L13M018	1-1/8" Lip Length		
217L13M020	1-1/4" Lip Length		
217L13M022	1-3/8" Lip Length		
217L13M024	1-1/2" Lip Length		
217L13M028	1-3/4" Lip Length		
217L13M032	2" Lip Length		
217L13M036	2-1/4" Lip Length		
217L13M040	2-1/2" Lip Length		
217L13M044	2-3/4" Lip Length		
217L13M048	3" Lip Length		

PART NO.	DESCRIPTION	LIST PRICE
STRIKE (Cont'd)		
Curved Lip Box Strike		
586L19M016	1" Lip Length	\$35.00
586L19M018	1-1/8" Lip Length	
586L19M020	1-1/4" Lip Length	
586L19M022	1-3/8" Lip Length	
586L19M024	1-1/2" Lip Length	
586L19M028	1-3/4" Lip Length	
586L19M032	2" Lip Length	
586L19M036	2-1/4" Lip Length	
586L19M040	2-1/2" Lip Length	
586L19M044	2-3/4" Lip Length	
586L19M048	3" Lip Length	

†Sold only in multiples of the number indicated. Price is each.

CK4800 Series Standard Cylindrical Locksets

USA & Canada Prices Effective April 17, 2023 – Added 12/20/22

CK4800 SERIES

PART NO.	DESCRIPTION	LIST PRICE
STRIKES AND WROUGHT BOX		
ANSI TYPE		ALL FINISHES
217L13M016	1" Lip to Center	\$35.00
217L13M018	1-1/8" Lip to Center	
217L13M020	1-1/4" Lip to Center (standard)	
217L13M022	1-3/8" Lip to Center	
217L13M024	1-1/2" Lip to Center	
217L13M028	1-3/4" Lip to Center	
217L13M032	2" Lip to Center	
217L13M036	2-1/4" Lip to Center	
217L13M040	2-1/2" Lip to center	
217L13M044	2-3/4" Lip to Center	
217L13M048	3" Lip to Center	
CURVED LIP BOX TYPE STRIKE		
586L19M016	1" Lip Length	\$35.00
586L19M018	1-1/8" Lip Length	
586L19M020	1-1/4" Lip Length	
586L19M022	1-3/8" Lip Length	
586L19M024	1-1/2" Lip Length	
586L19M028	1-3/4" Lip Length	
586L19M032	2" Lip Length	
586L19M036	2-1/4" Lip Length	
586L19M040	2-1/2" Lip Length	
586L19M044	2-3/4" Lip Length	
586L19M048	3" Lip Length	
STRIKE		
680L50	Full Lip Strike	\$22.00

PART NO.	DESCRIPTION	LIST PRICE
ROSE		NO FINISH
579F11	Screw Packet & Strike Box	\$8.50
LATCH ASSEMBLY		ALL FINISHES
2-3/8" Backset		\$56.00
881F490	Plain, square corner	
881F480	Deadlocking, square corner	
2-3/4" Backset		
881F470	Plain, square corner	
881F460	Deadlocking, square corner	

CK4400 Series Standard Cylindrical Locksets

USA & Canada Prices Effective April 17, 2023

CK4400 SERIES

PART NO.	DESCRIPTION	LIST PRICE
STRIKES AND WROUGHT BOX		
ANSI TYPE		ALL FINISHES
217L13M016	1" Lip to Center	\$35.00
217L13M018	1-1/8" Lip to Center	
217L13M020	1-1/4" Lip to Center (standard)	
217L13M022	1-3/8" Lip to Center	
217L13M024	1-1/2" Lip to Center	
217L13M028	1-3/4" Lip to Center	
217L13M032	2" Lip to Center	
217L13M036	2-1/4" Lip to Center	
217L13M040	2-1/2" Lip to center	
217L13M044	2-3/4" Lip to Center	
217L13M048	3" Lip to Center	
CURVED LIP BOX TYPE STRIKE		
586L19M016	1" Lip Length	\$35.00
586L19M018	1-1/8" Lip Length	
586L19M020	1-1/4" Lip Length	
586L19M022	1-3/8" Lip Length	
586L19M024	1-1/2" Lip Length	
586L19M028	1-3/4" Lip Length	
586L19M032	2" Lip Length	
586L19M036	2-1/4" Lip Length	
586L19M040	2-1/2" Lip Length	
586L19M044	2-3/4" Lip Length	
586L19M048	3" Lip Length	

PART NO.	DESCRIPTION	LIST PRICE
ROSE		NO FINISH
579F11	Screw Packet & Strike Box	\$8.50
LATCH ASSEMBLY		ALL FINISHES
574F29	2-3/8" Deadlatch	\$56.00
574F30	2-3/8" Deadlatch With Throw-Off	
574F55	2-3/4" Deadlatch	
574F56	2-3/4" Deadlatch With Throw-Off	
574F29 x574F25	3-3/4" Deadlatch	\$98.00
574F30 x574F25	3-3/4" Deadlatch With Throw-Off	
574F29 x574F26	5" Deadlatch	
574F30 x574F26	5" Deadlatch With Throw-Off	
BACKSET EXTENDER KIT		
574F258	Extender ONLY (No Latch Unit) - Must be added to 2-3/8" Latch Unit	\$43.00
574F268	Extender ONLY (No Latch Unit) - Must be added to 2-3/8" Latch Unit	

LOCKSET PARTS						
PART NO.	DESCRIPTION	LIST PRICE	PART NO.	DESCRIPTION	LIST PRICE	
BUSHING			HUB SPACER			
NO FINISH			NO FINISH			
194F228	Bushing	\$5.60	060F338	for UT5210, 61	†Order 50- \$4.10	
BUTTON ASSEMBLY			NO FINISH			
612, 613, 619, 625, 626			070F428	for UT5220	†Order 50- \$4.10	
022F80	for UT5220	\$78.00	070F438	for UT5220	†Order 50- \$6.80	
157F11	for UT5251		606F038	for UT5255	\$4.10	
156F43	for UT5261		067F428	for UT5257	\$5.60	
CHASSIS COVER			LEVER			
NO FINISH			612, 613, 619, 625, 626			
138F888	Chassis Cover	\$9.80	582F122	cyl/button LH	\$285.00	
CHASSIS			582F112	cyl/button RH		
612, 613, 619, 625, 626			582F142	cyl/button LH tactile		
496F33	for UT5210	\$458.00	582F132	cyl/button RH tactile		
496F34	for UT5220		489F892	LFIC 6-pin LH		
496F32	for UT5251, 55, 57, 72		489F882	LFIC 6-pin RH		
198F71	for UT5261		549F362	LFIC 6-pin LH tactile	\$295.00	
381F30	for UT5282		549F352	LFIC 6-pin RH tactile	\$285.00	
CORE HOUSING			NO FINISH			
342F052	for 6-pin LFIC	\$17.00	613F232	LFIC 7-pin LH	\$285.00	
442F952	for 7-pin LFIC	\$14.00	613F222	LFIC 7-pin RH		
613F352	for 6/7 pin Best-type LFIC	\$14.00	613F252	LFIC 7-pin LH tactile	\$295.00	
COUPLING			NO FINISH			
131F278	Coupling	\$77.00	613F242	LFIC 7-pin RH tactile	\$285.00	
EMERGENCY KEY			NO FINISH			
679F818	for UT5220	\$4.10	613F112	plain LH		
ESCUTCHEON			612, 613, 619, 625, 626			
144F33	for inside lever	\$221.00	613F102	plain RH		
415F16	for outside knob		613F152	plain LH tactile		
144F34	for outside lever		613F142	plain RH tactile		
605F90	for inside lever, lead lined		613F132	priv. key hole LH		
301F567	for outside lever, ext. lip 630 only		613F122	priv. key hole RH		
GRIP RETAINER			NO FINISH			
078F078	Grip Retainer	†Order 50- \$4.10	613F172	priv. key hole LH tactile	\$315.00	
HUB			NO FINISH			
060F428	for all but UT5255	\$5.60	613F162	priv. key hole RH tactile		
071F628	for UT5210	\$6.80	613F432	SFIC prep LH		
081F778	for UT5220	\$8.50	613F422	SFIC prep RH		
147F078	for UT5251, 55, 72	\$5.60	LEVER INSERT			
140F978	for UT5251, 57, 72		NO FINISH			
071F638	for UT5257		NO FINISH			
			613F029	Lever Insert	†Order 50- \$4.10	
			LEVER SPRING ANCHOR			
			NO FINISH			
			171F798	Lever Spring Anchor	\$24.00	
			PIN			
			NO FINISH			
			019F137	Pin, Spindle Drive	†Order 50-	
			156F837	Pin, UT5261 shank	†Order 50- \$4.10	
			286F507	Pin, UT5282 spindle	†Order 50-	

†Sold only in multiples of the number indicated. Price is each.

UT5200 Series Pre-Assembled Unit Locksets

USA & Canada Prices Effective April 17, 2023

PART NO.	DESCRIPTION	LIST PRICE
PLUG DRIVER NO FINISH		
144F888	Plug Driver & Spindle Assembly UT5282	\$58.00
168F818	Plug Driver Assembly	\$36.00
144F298	Plug Driver UT5251, 57, 72	\$22.00
606F018	Plug Driver UT5255	\$21.00
145F328	Plug Driver UT5282	\$58.00
RETAINING RING NO FINISH		
251F198	Retaining Ring for UT5282 Spindle †Order 100-	\$4.10
SCREW 612, 619, 626, 613, 625		
480F70	Screw Pkt. (strike mount'g) †Order 20-	\$4.10
No Finish		
249F768	Screw, Fixed Escutcheon †Order 50-	\$4.10
092F789	Screw, Strike Adjustment (nylon) †Order 50-	
SHANK, LEVER NO FINISH		
102F198	for UT5210, 57 outside	\$67.00
102F378	for UT5220 inside	
114F678	for UT5220 outside	
188F758	for UT5251, 57, 72 outside	
188F738	for UT5251, 72 inside	\$77.00
605F768	for UT5255 inside	\$70.00
605F778	for UT5255 outside	\$70.00
156F658	for UT5261 inside	\$124.00
156F648	for UT5261 outside	\$85.00
102F278	for UT5282 inside	\$70.00
287F608	for UT5282 outside	\$104.00
SHANK RETAINER NO FINISH		
242F508	for lever †Order 50-	\$4.10

PART NO.	DESCRIPTION	LIST PRICE
SPINDLE NO FINISH		
201F188	for UT5220	\$11.00
144F308	for UT5251, 72	\$11.00
606F028	for UT5255	\$11.00
335F988	for UT5257	\$15.00
SPRING NO FINISH		
022F723	Spring, Button UT5220, 61 †Order 50-	\$4.10
103F458	Spring, Lever Return LH	\$14.00
103F448	Spring, Lever Return RH	\$14.00
060F053	Spring, Shoe UT5220, 61 †Order 100-	\$4.10
071F673	Spring, Spindle for UT5220 †Order 100-	\$4.10
249F773	Spring, Spindle for UT5251, 55, 57, 72 †Order 100-	\$4.10
261F118	Spring, Spindle for UT5282 †Order 100-	\$4.10
STRIKE 612, 613, 625, 626		
236L75M020	ANSI curved lip	\$34.00
610L44	ANSI straight lip	
610L43	ANSI straight lip for ext. esc.	
083L96M032	curved lip box, 2"	
083L96M036	curved lip box, 2-1/4"	
083L96M034	curved lip box, 2-1/8" (std)	
083L96M040	curved lip box, 2-1/2"	
083L96M048	curved lip box, 3"	
293L14	curved lip box for ext. lip esc.	
082L67	pairs of doors	
THROUGHBOLT		
222F85	Regular	\$8.50
223F29	Spanner head	\$8.50
THROW MEMBER NO FINISH		
320F442	for SFIC core	\$9.80
342F032	for Corbin Russwin core	\$9.80

† Sold only in multiples of the number indicated. Price is each.

Padlocks and Deadlocks

PADLOCKS			
PART NO.	DESCRIPTION	LIST PRICE	SOLD IN MULT. OF
422L842144	Chain & clevis, 9" brass	\$30.00	1
422L848144	Chain & clevis, 9" steel	\$28.00	1
303F242	Pin chamber cap	\$4.10	100
228F348	Plug retainer, oversize Spirol pin		100
244F647	Plug retainer, standard solid pin		20
405F772	Security disc		50
756F963	Throw member, LFIC models		\$13.00
DL4100 SERIES DEADLOCK PARTS			
PART NO.	DESCRIPTION	LIST PRICE	SOLD IN MULT. OF
796F46 x Fin	Outside Front	\$124.00	
796F30 x Fin	Thumbturn Assembly	\$103.00	
791F51 x Fin	Ergonomic Thumbturn Assembly	\$93.00	
Mouting Packs:			
791F82 Fin	Screw Pack - Standard Strike	\$30.00	
791F83 Fin	Spanner Head crew Pack - Standard Strike	\$21.00	
791F84 Fin	Torx Head Screw Pack - Standard Strike		
791F85 Fin	Screw Pack - ANSI Strike	\$6.80	
791F86 Fin	Spanner Head crew Pack - ANSI Strike	\$21.00	
791F87 Fin	Torx Head Screw Pack - ANSI Strike		
Strikes:			
796F43	Standard Strike	\$20.00	
240L08018	ANSI Strike 1-3/4" Door	\$30.00	
240L08020	ANSI Strike 2" Door		
240L08022	ANSI Strike 2-1/4" Door		
466F279	Strike Box	\$15.00	

DL3000 SERIES DEADLOCKS			
PART NO.	DESCRIPTION	LIST PRICE	SOLD IN MULT. OF
261F298	Allen wrench 5/64"	\$5.60	10
467F36	Bolt front	\$24.00	1
467F345	Cylinder housing	\$72.00	1
467F338	Cylinder housing screw	\$4.10	20
480F708	Screw pack for ANSI strike	\$4.10	20
480F69	Screw pack for strikes 424F83 and 394F19	\$5.60	20
283F81	Collar Base / Rose	\$66.00	1
424F838	Strike, 2-3/4" x 1-1/8"	\$34.00	1
394F198	Strike, 3-1/2" x 1-1/8"	\$29.00	1
423L71	Strike, ANSI 611,613, and all other finishes	\$40.00	1
416F38	Security collar	\$60.00	1
467F358	Bolt, less front -2-3/4" B.S.	\$62.00	1
693F208	Bolt, less front -2-3/8" B.S.		1
467F378	Strike box	\$9.80	1
496F718	Strike box	\$8.50	1

DEVICE PARTS			DEVICE PARTS			
PART NO.	DESCRIPTION	LIST PRICE	PART NO.	DESCRIPTION	LIST PRICE	
ACTIVE HEAD (FIELD REVERSIBLE, WHERE HANDED)			DELAYED EGRESS PC BOARDS			
NO FINISH						
650F378	ED4200	\$349.00	704F269	DEED PC BD SA 36"NFFPA-15	\$2,049.00	
681F618	ED4200S	\$371.00	704F279	DEED PC BD SA 36"NFFPA-30		
650F418	ED4400 LHR	\$367.00	704F479	DEED PC BD SA 36"BOCA-15		
650F408	ED4400 RHR		704F489	DEED PC BD SA 36"BOCA-30		
650F468	ED4800 LHR	\$383.00	704F569	DEED PC BD SA 48"NFFPA-15		
650F458	ED4800 RHR		704F579	DEED PC BD SA 48"NFFPA-30		
650F358	ED5200	\$349.00	704F589	DEED PC BD SA 48"BOCA-15		
650F368	ED5200A	\$367.00	704F599	DEED PC BD SA 48"BOCA-30		
706F038	ED5202 RHR	\$410.00	COVER, BAR 605, 606, 611, 612, 613, 619, 625, 626, 629, 630			
706F048	ED5202 LHR		650F07	36"		\$77.00
706F058	ED5202A RHR	\$426.00	650F08	48"		
706F068	ED5202A LHR			COVER, END		
681F608	ED5200S(A)	\$371.00				
706F078	ED5202S(A) RHR	\$432.00	ED5000DB			
706F088	ED5202S(A) LHR		605, 606, 611, 612, 613, 619, 625, 626, 629, 630	\$503.00		
650F398	ED5400(A) LHR	\$367.00	ED4000 36" cyl. dogging			
650F388	ED5400(A) RHR		605, 606, 611, 612, 613, 619, 625, 626, 629, 630	\$215.00		
650F428	ED5600(A)	\$349.00	ED4000 36" standard			
706F098	ED5602(A) RHR	\$410.00	605, 606, 611, 612, 613, 619, 625, 626, 629, 630	\$213.00		
706F108	ED5602(A) LHR					
650F448	ED5800(A) LHR	\$383.00	ED5000 36" cyl. dogging			
650F438	ED5800(A) RHR		605, 606, 611, 612, 613, 619, 625, 626, 629, 630	\$215.00		
ARMORED FRONT 605, 606, 611, 612, 613, 619, 625, 626, 629, 630			ED5000(A) 36" standard			
650F06	ED5600	\$25.00	605, 606, 611, 612, 613, 619, 625, 626, 629, 630	\$213.00		
BAR & CARRIER ASSEMBLY			ED5000 36" cyl. dogging			
NO FINISH						
650F248	All 48"	\$404.00	605, 606, 611, 612, 613, 619, 625, 626, 629, 630	\$215.00		
650F238	ED4000 36"	\$384.00	ED5000(A) 36" standard			
650F228	ED5000 36"		605, 606, 611, 612, 613, 619, 625, 626, 629, 630	\$213.00		
BAR CAP			NO FINISH			
650F189	Black nylon	†Order 10-	\$6.80			
BOTTOM BOLT CASE			NO FINISH			
650F588	ED4400, ED5400	\$63.00				
650F598	ED5400A	\$67.00				
BOTTOM BOLT PACKET			NO FINISH			
650F778	ED4800	\$188.00				
698F038	ED5800(A)	\$165.00				
BOTTOM RAIL						
650F21	48"	\$242.00				
	606, 612, 630					
	605, 613					
	611, 625, 626, 629					
BOTTOM ROD & COUPLER ASSEMBLY			NO FINISH			
650F798	ED4800, ED5800(A)	\$140.00				
BOTTOM ROD & END PIN ASSEMBLY 605, 606, 611, 612, 613, 618, 619, 625, 626, 629, 630, 722						
649F99 fin	Surface devices	\$226.00				
CARRIER BAR NO FINISH						
650F998	Internal	\$22.00				
COVER, ACTIVE HEAD 605, 606, 611, 612, 613, 619, 625, 626, 629, 630						
650F00	ED5200	\$282.00	COVER, TOP & BOTTOM LATCH			
650F03	ED4200					
681F63	ED4200S		ED4400, ED5400(A)			
650F04	ED4400		605, 606, 611, 612, 613, 619, 625, 626, 629, 630	\$119.00		
650F05	ED4800		CYLINDER DOGGING KIT			
681F62	ED5200S					
706F15	ED5602 RHR					
706F16	ED5602 LHR					
			ED4000 36" bar			
			605, 606, 611, 612, 613, 619, 625, 626, 629, 630	\$209.00		
			ED5000 36" bar			
			605, 606, 611, 612, 613, 619, 625, 626, 629, 630	\$209.00		
			All 48" bar			
			605, 606, 611, 612, 613, 619, 625, 626, 629, 630	\$221.00		
			DOGGING ASSEMBLY			
			NO FINISH			
650F968	Cylinder type	\$56.00				
650F528	Hex Key type					
			DOGGING CYLINDER NUT			
			NO FINISH			
697F862	Dogging Cylinder Nut	\$22.00				

†Sold only in multiples of the number indicated. Price is each.

ED4000/ED5000 Series Pushpad Exit Devices

USA & Canada Prices Effective April 17, 2023

DEVICE PARTS (Cont'd)

PART NO.	DESCRIPTION	LIST PRICE
DOGGING CYLINDER SLEEVE		
650F959	Dogging Cylinder Sleeve	\$13.00
DOGGING HOLE PLUG		
650F279	Dogging Hole Plug †Order 50-	\$4.10
DOGGING KEY, HEX		
656F408	5/32"	\$5.60
END CAP RETROFIT KIT		
704F66	End Cap Retrofit Kit	\$119.00
END CAP		
704F62	End Cap	\$88.00
710F00M	Flush End Cap Retrofit Kit (M110)	\$110.00
END CLAMP PACKET		
592F338	ED4000, ED5000-D214	\$20.00
704F658	ED4200(S), ED5200S(A)	
704F648	ED4000, ED5000(A)	
FLUSH STRIKE TRANSOM BRACKET		
650F878	Flush strike transom brkt., ED5400(A)	\$77.00
LATCH PACKET		
654F218	Latch pkt, ED4400, ED5400 †Order 10-	\$6.80
MORTISE LOCK BODY		
655F488RR	ED5610 knob - RHR	\$477.00
655F488LR	ED5610 knob - LHR	
650F698RR	ED5602, ED5610, ED5655 lever - RHR	
650F698LR	ED5602, ED5610, ED5655 lever - LHR	
678F008RR	ED5610, ED5655 thumbpiece - RHR	
678F008LR	ED5610, ED5655 thumbpiece - LHR	
650F678RR	ED5650,57 knob, lever/thumbpiece - RHR	
650F678LR	ED5650,57 knob, lever/thumbpiece - LHR	
710F318LR	ED5634L - LHR	
710F318RR	ED5634L - RHR	
710F328LR	ED5634L - LHR - M91	\$819.00
710F328RR	ED5634L - RHR - M91	
710F338LR	ED5634L - LHR - M93	\$795.00
710F338RR	ED5634L - RHR - M93	
ADAPTER ASSEMBLY, MORTISE		
706F462	ED5602(A)	\$42.00
MOUNTING PACKET		
650F578	ED4400, ED5400(A)	\$126.00
654F208	Non-rated, wood door †Order 20-	\$5.60
900, WS700 & FE700 SERIES MULLION PACKETS		
TOP RETAINER AND SCREW PACKET		
713F518	972, 972A, 910A	\$296.00
713F938	FE772A, FE710A	\$306.00
713F948	972BKM, 910BKM	\$296.00
713F958	WS772AKM, WS708AKM	\$306.00
BOTTOM RETAINER AND SCREW PACKET		
713F528	972, 972A, 910A	\$195.00
713F998	FE772A, FE708A	\$306.00
713F988	972BKM, 910BKM	\$195.00
713F908	WS772AKM, WS708AKM	\$306.00
LOCKING MECHANISM PACKET		
744F258	972BKM, 910BKM	\$639.00
744F208	WS772AKM, WS708AKM	\$663.00
1-1/4" CYLINDER COLLAR PACKET¹		
447F43	972BKM ² , 910BKM ²	\$26.00
610F01	WS772AKM ² , WS708AKM ²	\$43.00
1-1/2" LFIC CYLINDER COLLAR PACKET¹		
609F37	972BKM ² , 910BKM ²	\$50.00
609F36	WS772AKM ² , WS708AKM ²	
Notes: 1. Cylinder collar packets contain a collar & spring washer. 2. Specify finish when ordering packets.		
PILLOW BLOCK PACKET		
650F978	Pillow Block packet, ED4400	\$67.00
POPPER KIT		
744F688	for ED5470, ED5860 M55	\$129.00
ROD & YOKE ASSEMBLY		
650F828	Rod & Yoke Assembly, concealed	\$164.00

PART NO.	DESCRIPTION	LIST PRICE
ROD EXTENSION KIT (CONCEALED VERTICAL)		
684F427	Rod Extension Kit, 24"	\$124.00
ROD EXTENSION KIT (SURFACE VERTICAL)		
Rod Extension Kit, 2"		
655F15	605, 606, 612, 613, 619, 625, 626, 629, 630	\$123.00
Rod Extension Kit, 6"		
655F16	605, 606, 612, 613, 619, 625, 626, 629, 630	\$140.00
Rod Extension Kit, 12"		
655F17	605, 606, 612, 613, 619, 625, 626, 629, 630	\$148.00
Rod Extension Kit, 24"		
684F42	605, 606, 612, 613, 619, 625, 626, 629, 630	\$151.00
ROD GUIDE COVER		
Rod Guide Cover		
650F63	605, 606, 612, 613, 619, 625, 626, 629, 630	\$48.00
ROD GUIDE PACKET		
Rod Guide Packet		
650F62	606, 612, 613, 626	\$29.00
SCREWS		
605, 606, 611, 612, 613, 619, 625, 626, 629, 630		
429F41	Pack, Armored Front †Order 20- 606, 612, 613, 619	\$6.80
704F63	Packet, Cover 606,612,613,630 finish	
656F668	#10-24 x 1/4" PH †Order 100-	\$4.10
650F538	Dogging Assembly †Order 50-	
650F518	Latch head to carrier †Order 50-	
650F288	Touch bar caps (622 only) †Order 50-	
650F508	Trim slide †Order 100-	
SCREW PACK, TORX® PIN		
701F60	ED4200(S), ED4800, ED5200(S), ED5800	\$25.00
701F61	ED4400, ED5400, ED5470	
701F62	ED5600	\$26.00
701F63	ED5860	\$25.00
SEX NUT PACKET		
652F298	Sex Nut Packet (4 sex nuts)	\$29.00
SHIM KIT		
697F338	ED5200(S)(A), ED5600(A), ED5800(A)	\$162.00
697F348	ED5400(A)	\$192.00
697F358	ED4200(S), ED4800	\$162.00
697F368	ED4400	\$192.00
SPRING, TOUCH PAD		
656F41	Spring, Touch Pad	\$5.60
STRIKE PACKET 622 FINISH ONLY		
650F888	bottom for 1/2" threshold (509)	\$88.00
650F318	ED4200(S), ED4800	\$86.00
730F778	ED5200(S)(A), ED5202(S)(A)	\$122.00
650L65	ED5600	\$55.00
650L657020	Mortise strike for ED5602(A)	
653L157014	Mortise strike for doors with astragal	\$48.00
655F718	ED5200 x S02	\$88.00
653L163016	open back straight lip for 1-3/4" door	\$133.00
653L163020	open back straight lip for 2-1/4" door	\$177.00
653L183016	open back curved lip for 1-3/4" door	\$133.00
653L183020	open back curved lip for 2-1/4" door	\$177.00

†Sold only in multiples of the number indicated. Price is each.

Experience a safer
and more open world

DEVICE PARTS (Cont'd)

PART NO.	DESCRIPTION	LIST PRICE
TOP LATCH		
650F738	Top Latch & Bracket Assembly, ED4800	\$271.00
650F718	Top Latch & Bracket Assembly, ED5800	\$274.00
650F728	Top Latch & Bracket Assembly, ED5800A	\$294.00
650F558	Top Latch, ED4400, ED5400, ED5470	\$256.00
650F568	Top Latch, ED5400A, ED5470B	\$269.00
681F768	Top Latch, ED5860B	\$306.00
681F718	Top Mtg. Plate for ED5470B	\$77.00
TOP ROD NO FINISH		
650F818	Top Rod Tube, concealed	\$139.00
650F808	Top Rod, concealed	\$119.00
Top Rod, surface		
650F60 fin	605, 606, 611, 612, 613, 619, 625, 626, 629, 630	\$186.00

PART NO.	DESCRIPTION	LIST PRICE
TOP STRIKE PACKET		
650F548	Top strike packet	\$116.00
681F708	Top strike packet for ED5470B	\$43.00
681F778	Top strike for ED5860B	\$50.00
TOUCH PAD CAP 622 ONLY		
724F278	Touch Pad Cap, front	\$50.00
650F095	Touch Pad Cap, rear	\$41.00
TRIM SLIDE NO FINISH		
650F498	Trim Slide Retainer †Order 10-	\$6.80
650F489	Trim Slide, ED4000	\$9.80

TRIM PARTS, GRIPS

DESIGN	STANDARD PART NO.	STANDARD PRICE 605, 606, 611, 612, 613, 619, 625, 626, 629, 630	KNURLED PART NO.	KNURLED PART PRICE	ABRASIVE PART NO.	ABRASIVE PART PRICE
A7	652F78	\$241.00	652F79	\$332.00	652F80	\$299.00
C7	652F66		652F67		652F68	
D7 RHR	652F69		652F70		652F71	
D7 LHR	652F72		652F73		652F74	
E7	652F57		652F58		652F59	
L7	652F60		652F61		652F62	
N7	652F75		652F76		652F77	
PR7	652F81		652F82		652F83	
R7	652F63		652F64		652F65	
A7M	653F71		653F72		653F73	
C7M	653F59		653F60		653F61	
D7M RHR	653F62		653F63			
D7M LHR	653F65		653F66			
E7M	653F50					
L7M	653F53		653F54		653F55	
N7M	653F68		653F69		653F70	
PR7M	653F74		653F75		653F76	
R7M	653F56		653F57			
A8	653F05					
C8	652F93				652F95	
D8 RHR	652F96					
D8 LHR	652F99					
E8	652F84	652F85	652F86			
L8	652F87	652F88	652F89			
N8	653F02	653F03	653F04			
PR8	653F08	653F09	653F10			
R8	652F90		652F92			
08, 014	656F53		n/a		n/a	

†Sold only in multiples of the number indicated. Price is each.

TRIM PARTS, GRIPS, ESCUTCHEONS (Cont'd)

DESIGN	STANDARD PART NO.	STANDARD PRICE 605, 606, 611, 612, 613, 619, 625, 626, 629, 630	KNURLED PART NO.	KNURLED PART PRICE	ABRASIVE PART NO.	ABRASIVE PART PRICE
A9	677F16	\$241.00	652F79	\$332.00	652F80	\$299.00
C9	677F15		652F67		652F68	
D9 RHR	677F26		652F70		652F71	
D9 LHR	677F27		652F73		652F74	
E9	677F13		652F58		652F59	
L9	677F04		652F61		652F62	
N9	677F05		652F76		652F77	
PR9	677F28		652F82		652F83	
R9	677F14		652F64		652F65	
A9M	653F71		653F72		653F73	
C9M	653F59		653F60		653F61	
D9M RHR	653F62		653F63			
D9M LHR	653F65		653F66			
E9M	653F50					
L9M	653F53		653F54		653F55	
N9M	653F68		653F69		653F70	
PR9M	653F74		653F75		653F76	
R9M	653F56		653F57			

DESIGN	PART NO.	LIST PRICE 605, 606, 613, 625, 626
FR9 RHR	698F64	\$271.00
FR9 LHR	698F66	
TS9	698F31	
Z9 RHR	698F68	
Z9 LHR	698F70	
M9	698F33	\$247.00
FR9M RHR	698F65	\$271.00
FR9M LHR	698F67	
TS9M	698F32	
Z9M RHR	698F69	
Z9M LHR	698F71	
M9M	698F34	\$247.00

PART NO.	DESCRIPTION	605, 606, 611, 612, 613, 613E, 619, 625, 626, 629, 630
656F58	x8 cyl. x thumbturn	\$197.00
656F59	x8 cyl. x lever	\$209.00
656F60	x8 plain x thumbturn	\$197.00
656F61	x8 plain x lever	\$209.00
651F00	F450	\$189.00
651F01	F457	
651F10	O14, T14 bottom	\$88.00
656F62	O1410 top	\$189.00
656F63	O1455/59 top	
651F09	T1410 top	\$171.00
651F06	T1450 top	\$165.00
651F08	T1455, T1459 top	\$171.00
651F04	T1457 top	\$165.00
733F41	F950	\$271.00
733F42	F957	
733F43	9M10, M50	
733F05	L910	
733F44	L950	
733F45	L955	
783F06*	L955 L959	
733F46	F9M57	
733F47	L957	
733F48	DL910	
733F49	DL9M10, DL9M50	
733F50	DL955, DL959	
733F51	DL9M55, DL9M57	
733F52	DL957	
733F53	DL950	

†Sold only in multiples of the number indicated. Price is each.
*Not available in 630 Finish.

TRIM PARTS (Cont'd)

PART NO.	DESCRIPTION	LIST PRICE
BUSHING, NYLON NO FINISH		
652F239	Bushing, Nylon †Order 20-	\$6.80
CLUTCH LEVER NO FINISH		
651F538	Clutch Lever †Order 20-	\$6.80
COTTER PIN NO FINISH		
677F098	Cotter Pin †Order 100-	\$4.10
COVER PLATE NO FINISH		
651F858	Cover Plate, x8, O14, T14	\$21.00
CYLINDER COLLAR		
	various	see page 359
GEAR & BLACK HOUSING ASSEMBLY NO FINISH		
651F638	Gear & Black Housing Assembly (all but x750)	\$24.00
651F648	Gear, levers	\$9.80
655F548	Gear, dummy lever	
HEX NUT/BUSHING NO FINISH		
651F398	Hex Nut/Bushing for spring	\$8.50
HOUSING NO FINISH		
651F675	Housing & Cam Assembly, x755, T1355	\$64.00
651F965	Housing & Cam Assembly, x855, x859, O/T1455/59	\$52.00
651F425	Housing, Cylinder, F2, F3, T1357, O/T1457	\$11.00
651F545	Housing, Tailpiece Assembly	\$43.00
706F015	Housing, Cylinder ED5202(S)(A), ED5602(A)	\$13.00
706F005	Housing, Cylinder, Trim, ED5202(S)(A), ED5602(A)	\$63.00
HUB NO FINISH		
652F228	Hub	\$36.00
651F655	Hub, lever	\$11.00
656F64	Hub, G knob	
LOCK WASHER NO FINISH		
651F448	for screw post †Order 50-	\$4.10
NUT NO FINISH		
651F888	Nut, Cover Plate †Order 50-	\$4.10
651F928	Nut, Spring Post	\$8.50
PIN NO FINISH		
651F838	Pin, Clutch Lever †Order 50-	\$4.10
651F988	Pin, Groove, 5/32" x 1-1/8" for T1410, T1455, T145 †Order 50-	
651F587	Pin, Thumbpiece, T13M †Order 20-	
PULL		
651F372	Pull, Offset - 605, 606, 611, 612, 613, 619, 625, 626, 629, 630	\$202.00
651F362	Pull, Straight - 605, 606, 611, 612, 613, 619, 625, 626, 629, 630	\$165.00
RACK & TAILPIECE ASSEMBLY NO FINISH		
651F828	x810, x855, x859, O14, T14	\$128.00
652F218	x850	\$111.00
RETAINER, CLUTCH LEVER PIN NO FINISH		
651F898	Retainer, Clutch Lever Pin †Order 100-	\$4.10
RETAINING RING NO FINISH		
651F608	Retaining Ring, T13M †Order 50-	\$4.10
ELECTRIFIED LOCKBODY USED WITH "SAF" & "SEC" ED5600L DEVICES:		
677F768LR 626	LOCK SA-L5 MORT.SAFE LHR	\$1,153.00
677F768RR 626	LOCK SA-L5 MORT.SAFE RHR	
677F778LR 626	LOCK SA-L5 MORT.SEC. LHR	
677F778RR 626	LOCK SA-L5 MORT.SEC. RHR	
SCREW NO FINISH		
655F028	Screw, Cylinder Mounting †Order 100-	\$4.10
651F878	Screw, FHM-PH #8-32 x 7/16" †Order 50-	

PART NO.	DESCRIPTION	LIST PRICE
SCREW (CONT'D) NO FINISH		
656F658	Screw, Function	\$4.10
651F418	Screw, RHM-PH #1/4-20 x 5/8" †Order 50-	
651F508	Screw, Tailpiece Plate, PHT-T-PH #6 x 3/8 †Order 50-	
SCREW PACKET, MOUNTING		
652F128	1-3/4" - 2" door - 606, 612, 613, 619, 626	\$13.00
652F108	1-3/4" - 2" door - 606, 612, 613, 619, 626	\$9.80
652F118	2-1/4" door - 606, 612, 613, 619, 626	
652F138	2-1/4" door - 606, 612, 613, 619, 626	\$13.00
652F148	F3, T13 for 1-3/4" - 2" door - 606, 612, 613, 619, 626	\$17.00
652F158	F3, T13 for 2-1/4" door - 606, 612, 613, 619, 626	
SCREW POST NO FINISH		
783F048	Screw Post	\$9.80
SLIDER, THUMBPIECE NO FINISH		
651F498	Slider, Thumbpiece	\$9.80
SPINDLE BRACKET NO FINISH		
652F048	Spindle Bracket, lever	\$9.80
SPINDLE NUT NO FINISH		
651F738	Spindle Nut, x7 †Order 20-	\$4.10
652F098	Spindle Nut, x7M lever †Order 50-	
SPINDLE WASHER NO FINISH		
652F068	Spindle washer, G Knob	\$6.80
652F058	Spindle Washer, Levers	\$6.80
SPRING NO FINISH		
651F948	Spring, Extension	\$4.10
651F758	Spring, Grip Return, knob †Order 10-	\$6.80
651F618	Spring, Grip Return, lever, LHR (red)	
651F628	Spring, Grip Return, lever, RHR (blue)	
651F938	Spring, Rack, lever †Order 50-	\$4.10
651F478	Spring, Thumbpiece, T13	\$8.50
678F028	Spring, Thumbpiece T13M	\$11.00
651F408	Spring, various trim †Order 20-	\$4.10
651F868	Spring, various trim †Order 50-	
TAILPIECE ASSEMBLY NO FINISH		
677F068	1-3/4" door without shim kit	\$58.00
655F698	2" - 2-1/4" door or 1 3/4" door with shim kit - TH9 series trims	
655F708	2" - 2-1/4" door or std. door with shim kit - All trims except TH9 series	
THIMBLE INSERT		
651F389	Knob & thumbturn †Order 50-	\$4.10
118F299	Lever †Order 100-	
THUMBPIECE BRACKET		
651F578	Thumbpiece Bracket, T13M	\$29.00
THUMBPIECE TAB NO FINISH		
651F568	Thumbpiece Tab, T13M	\$5.60
THUMBPIECE 605, 606, 611, 612, 613, 619, 625, 626, 629, 630		
566F50	Thumbpiece, T13, T14	\$67.00
566F51	Thumbpiece, T13M	\$78.00
WASHER NO FINISH		
651F708	Washer under tailpiece †Order 50-	\$4.10
651F848	Washer, Grip †Order 20-	

ED7000 Series Crossbar Exit Devices

USA & Canada Prices Effective April 17, 2023

STRIKES FOR CROSSBAR EXIT DEVICES

PART NO.	DESCRIPTION	LIST PRICE
269F73	ED7000 LHR with dogging	\$1,237.00
269F74	ED7000 RHR with dogging	
269F75	ED7000 LHR less dogging	\$1,167.00
269F76	ED7000 RHR less dogging	
VERTICAL ROD STRIKES 605, 606, 612, 613, 622, 626, 629		
392F24	Top	\$134.00
392F22	Top	\$106.00
392F28	Bottom flush	\$87.00
392F29	Bottom surface	\$72.00
176F653	Top bracket	
304F337	Bottom 630 only	\$48.00
304F347	Bottom 630 only	\$72.00
352F042	Bottom	\$48.00
352F05	Top	\$87.00
361F913	Bottom flush	
123F22	Bottom	
183F857	Top 630 only	
502F75	Bottom mortised	\$51.00
502F96	Surface	\$65.00

STRIKES FOR CROSSBAR EXIT DEVICES (Cont'd)

PART NO.	DESCRIPTION	LIST PRICE
CONCEALED VERTICAL ROD STRIKES 605, 606, 612, 613, 622, 626		
503F52	Bottom Strike	\$88.00
503F533	Fire Rated Bottom Strike	
RIM EXIT DEVICE STRIKES 605, 606, 612, 613, 622, 626		
142F43	Adj. Packet	\$199.00
467F733	Pack, rim vert. rod	\$134.00
300F71	Packet	\$170.00
499F598	Adj.	\$126.00
MORTISE STRIKES 605, 606, 612, 613, 619, 622, 625, 626		
240L50	Stainless Mortise - LHR 629, 630 only	\$70.00
240L51	Stainless Mortise - RHR 629, 630 only	
411L63	Open Back - RHR	\$158.00
411L62	Open Back - LHR	
LOW PROFILE EXIT DEVICE STRIKES		
416F355	Strike 622 689, 690, 691	\$65.00
436F038	Strike, bottom	\$26.00
487M048589	Top Rod (for 10' Doors)	\$189.00
463F918	Flush Bottom Strike	\$30.00

DEVICE PARTS					
PART NO.	DESCRIPTION	LIST PRICE	PART NO.	DESCRIPTION	LIST PRICE
122F188	Mounting Bracket	\$43.00	164F329	Nylon Washer †Order 50-	\$4.10
122F248	Washer †Order 100-	\$4.10	173F698	Stud	
122F413	Lower Rod Guide	\$18.00	173F728	Nut	\$8.50
122F508	Lower Bolt Tube Sub Assembly	\$123.00	175F518	Rod Insert	\$29.00
122F518	Bottom Guide Sub Assembly	\$117.00	183F74	Top Latch Sub Assembly (with top rod doors 6'4" to 8'6")	\$544.00
122F568	Locking Lever	\$34.00	183F75	Top Latch Sub Assembly (with top rod door 8'6" to 10'8")	\$544.00
122F578	Locking Lever	\$24.00	184F825	Shim	\$29.00
122F593	Locking Lever Spring	\$36.00	184F948	Jam Nut	\$9.80
122F608	Locking Hub	\$20.00			
122F618	Locking Hub	\$9.80			
122F639	Spacer Washer (Nylon)	\$4.10			
122F643*	Handle Lever	\$170.00			
123F538	Dogging Key, 3/16" hex	\$5.60			
129F499	Sound Deadener	\$11.00			
129F848	Cylinder Nut				
134F05	Cylinder Collar	\$50.00			
140F528	Stud †Order 20-	\$4.10			
141L548	Reinforcing Tube	\$208.00			
141L59	Crossbar				
	605, 606, 611, 612, 613, 619, 622, 625, 626, 629, 630	\$471.00			
142F44*	Adj. Strike	\$110.00			
143F248	Spring †Order 50-	\$4.10			
145F543*	Strike Plate	\$120.00			
148F367	Release Plunger Sub Assembly	\$35.00			
148F448	Mounting Wrench	\$8.50			

DEVICE PARTS (Cont'd)

PART NO.	DESCRIPTION	LIST PRICE
213F117	Top Strike S/A (reveal less 5-1/2") <i>Obsolete</i> 629, 630	\$131.00
200F168	Screw 12-24 x 1/2" FHMS <i>Obsolete</i>	\$4.10
220F498	Screw 1/4-20 x 2" FHMS <i>Obsolete</i>	
220F722	Screw 12-24 x 1/2" FHMS-PH <i>Obsolete</i> †Order 20-	
220F75	Screw 1/4-20 x 5/8" FHMS-PH 606, 619, 622, 625, 626, 630	
	605, 611, 512, 613, 629	\$5.60
220F778	Screw 622, CDC, MTD, 613	\$4.10
220F827	Screw 1/4-20 x 1" FHMS-PH	\$5.60
220F848	Screw 12-24 x 1-1/4" FHMS-PH	\$4.10
220F85*	Screw 1/4-20 x 1-1/4" FHMS-PH x Anchor <i>Obsolete</i>	\$5.60
221F948*	Mounting Screw	
222F71*	Throughbolt	
224F348	Screw 12 x 1" FHWS †Order 20- <i>Obsolete</i>	\$4.10
224F392	Screw 14 x 1-1/4" FHWS †Order 20- <i>Obsolete</i>	
224F448	Screw 14 x 1-1/2" FHWS <i>Obsolete</i>	\$5.60
224F508	Screw 14 x 2" FHWS †Order 20- <i>Obsolete</i>	\$4.10
225F998	Screw 12 x 1-1/2" OHWS-PH <i>Obsolete</i>	
228F188	Roll Pin †Order 100- <i>Obsolete</i>	
228F497	Roll Pin (79028-1250343)	
228F517	Roll Pin (79028-1250500 St'd) †Order 100-	
228F528	Roll Pin †Order 100- <i>Obsolete</i>	
228F558	Roll Pin 1/8 x 3/4" †Order 100- <i>Obsolete</i>	
228F687	Roll Pin 156 x 9/16" †Order 50-	
228F808	Roll Pin 187 x 3/4" †Order 100-	
228F817	Roll Pin 187 x 1-15/16" †Order 20-	
228F847	Roll Pin 187 x 1-3/8" †Order 20-	
243F769	Stop Nut †Order 20- <i>Obsolete</i>	
243F798	Spring Lock Washer †Order 100- <i>Obsolete</i>	
243F808	1/4-20 x 5/8" FRMS-PH <i>Obsolete</i>	\$5.60
243F85	Top Cover Sub Assembly 605, 606, 611, 612, 613, 619, 625, 626, 629, 630 <i>Obsolete</i>	\$215.00
249F33*	1/4-20 NC-2A x 1-1/4" Lg. Phillips OHMS	\$6.80
253F118	Drive Screw †Order 100-	\$4.10
254F73	Screw 8-32 x 3/8" OHMS-PH <i>Obsolete</i> 605, 606, 611, 612, 613, 619, 625, 626, 630	\$4.10
255F41*	Screw 12-24 x 2" FHMS-PH	\$8.50
261F288	Screw 8-32 x 3/8" HSS Cone-SOC <i>Obsolete</i>	\$5.60
261F318	Screw 5/16-24 x 1-1/2" FHMS-SOC 605, 611, 612, 613, 619, 625, 626, 630	\$5.60
261F54	Cylinder Collar	\$42.00
261F658	Screw 1/4-20 x 1/2" PHMS	\$5.60
262F901	River 3/32" x 5/32" †Order 100- <i>Obsolete</i>	\$4.10

PART NO.	DESCRIPTION	LIST PRICE
264F958	Screw 12-24 x 7/8" RHMS-PH <i>Obsolete</i> (Metal Doors) †Order 20-	\$4.10
268F647	Washer †Order 50-	
268F848	Screw 6-32 x 5/8" RHMS †Order 20- <i>Obsolete</i>	
268F878	Retainer Ring †Order 20-	
269F048	Cotter Pin †Order 50-	
269F058	Lockwasher †Order 100-	
269F08	Screw 8-32 x 3/8" FHMS-PH 605, 606, 611, 613, 619, 625, 626, 630	\$4.10
	Lever	
269F31	605, 606, 611, 612, 619, 613, 619, 625, 626	\$444.00
269F32	605, 606, 611, 612, 619, 613, 619, 625, 626	
COVER		
269F33	605, 606, 611, 612, 613, 619, 625, 626, 629, 630	\$459.00
269F34	605, 606, 611, 612, 613, 619, 625, 626, 629, 630	
269F35	605, 606, 611, 612, 613, 619, 625, 626, 629, 630	
269F36	Active Case Less Cover, ED7200 RHR & LHR 605, 606, 611, 612, 613, 619, 625, 626, 629, 630	\$494.00
269F378	Hub	\$60.00
269F393	Latch Retractor	\$55.00
269F403	Latch Retractor	\$60.00
269F413	Slide	\$70.00
269F42	Inactive Case S/A, all ED7000 605, 606, 611, 612, 613, 619, 625, 626, 629, 630	\$492.00
269F468	Hold Back Sleeve	\$60.00
269F479	Nyliner	\$5.60
269F488	Lever Pivot	
269F499	Bushing	\$6.80
269F528	Hub Shank	\$8.50
269F538	Latch Spring	\$5.60
269F549	Button	\$4.10
269F559	Washer †Order 50-	
269F569	Washer †Order 50-	
269F578	Spring Washer	\$9.80
269F587	Latch Pin	\$5.60
269F608	Inner Spring	\$9.80
269F91*	Screw Packet	\$136.00
269F92*	Screw Packet	\$101.00
270F01*	Screw Packet	\$136.00
270F02*	Screw Packet	\$104.00
270F11*	Through Bolt	\$6.80
282F325	Caulking Anchor <i>Obsolete</i>	
282F357	Caulking Anchor	\$5.60
284F67*	Lever RH <i>Obsolete</i>	\$174.00

*Specify Finish. Ø Subject to availability.

† Sold only in multiples of the number indicated. Price is each.

DEVICE PARTS (Cont'd)

PART NO.	DESCRIPTION	LIST PRICE	PART NO.	DESCRIPTION	LIST PRICE
284F977	Roll Pin †Order 50-	\$4.10	351F72	Bottom Latch Cover 605, 606, 611, 612, 613, 619, 625, 626, 629, 630	\$334.00
291F498	Stop Plate	\$36.00	351F73	Top Latch Cover 605, 606, 611, 612, 613, 619, 625, 626, 629, 630	\$353.00
291F578	Screw 10-31 x 1" FHM-PH †Order 50-	\$4.10	351F797	Top Latch Sub Assembly	\$80.00
293F183	Slide Assembly	\$162.00	351F807	Roll Pin †Order 50-	\$4.10
306F068	Screw 10-24 x 5/16" RHMS-PH †Order 20-	\$4.10	351F823	Top Latch Backplate	\$148.00
306F078	Spring Lockwasher †Order 100-		351F833	Top Latch Slide	
321F907	Dogging Device Sub Assembly	\$65.00	351F849	Spacer	\$14.00
333F519	Screw	\$4.10	351F85*	Top Latch Sub Assembly No Cover	\$559.00
341F318	Shim	\$30.00	351F867	Bottom Latch	\$148.00
351F50*	Active Case - less cover, ED7400 standard		351F873	Latch Link	\$142.00
	606, 612, 619, 622, 626	\$306.00	351F883	Bottom Latch Backplate	\$148.00
	605, 611, 613, 625, 629, 630		351F897	Spring †Order 20-	\$4.10
351F51*	Active Case - less cover, ED74000, ED7401, no bottom rod		351F907*	Bottom Latch Sub Assembly	\$503.00
	606, 612, 619, 622, 626	\$306.00	351F988	Rod Connector Sub Assembly	\$8.50
	605, 611, 613, 625, 629, 630		352F021	Drive Rivet †Order 20-	\$4.10
351F528	10-32 x 7/16" FHUMS-PH Screw †Order 100-	\$4.10	352F068	1/4-20 x 3/4" BHUMS-PH Screw †Order 20-	
351F553	Slide Sub Assembly	\$230.00	361F308	Anchor	\$9.80
351F56*	Active Case Sub Ass'y, ED7400 with dogging -RHR	\$1,266.00	362F498	Nut	\$35.00
351F57*	Active Case Sub Ass'y, ED7400 with dogging -LHR		362F918	Plate	\$11.00
			364F228	Washer	\$9.80
			364F272	Locking Slide	\$40.00
			364F288	Locking Lever Sub Assembly	\$52.00
			364F308	Lifting Lever	\$42.00
			364F36*	Escutcheon Assembly RHR, C4, D4, E4 - MR	\$425.00
			364F37*	Escutcheon Assembly LHR, C4, D4, E4 - MR	
			364F38*	Escutcheon Assembly RHR, C4, D4, E4 - Std	\$445.00
			364F39*	Escutcheon Assembly LHR, C4, D4, E4 - Std	
			365F003	Slide Extension S/A Door 1-3/4"	\$65.00
			365F013	Slide Extension S/A Door 2-1/4"	
			365F033	Slide Extension S/A Door 1-3/4" or Lever Trim	
			365F98*	1/4-20 x 2" OHTS-F-PH Metal Door	\$9.80
				Latch Sub Assembly	
			376F42	611, 612, 613, 619, 625, 626	\$77.00
				605, 606, 629, 630	\$91.00
			378F745	Tenon Sub Assembly	\$63.00

*Specify Finish. Subject to availability.

† Sold only in multiples of the number indicated. Price is each.

DEVICE PARTS (Cont'd)

PART NO.	DESCRIPTION	LIST PRICE	PART NO.	DESCRIPTION	LIST PRICE
392L19*	Adj. Bottom Rod Assembly	\$328.00	468F246	Active Backplate Assembly, RH	\$1,167.00
393L13-M672*	Top Rod	\$256.00	468F256	Active Backplate Assembly, LH	
399F188	Lower Bolt Assembly	\$509.00	468F266	Active Backplate Assembly, RH	
402F99*	Thumbpiece	\$66.00	468F276	Active Backplate Assembly, LH	
403F035	Slide x4M Trim	\$131.00	468F355	Cylinder housing	\$14.00
403F30*	Washer	\$5.60	480F128	Inactive Backplate Assembly	\$156.00
405F428	Anchor	\$9.80	480F13*	Lever	\$393.00
405F458	Mullion (507) 7'2" door	\$303.00	480F188	Spindle	\$64.00
Ø 405F466	Bottom Plate	\$156.00	480F198	Nut	\$14.00
405F476	Top Plate	\$139.00	480F208	Rollback	\$15.00
405F496	Bottom Plate Assembly				
Ø 409F836	Top Plate Assembly				
412F133*	Screw, 8-32 x 5/16"	\$5.60	480F28*	Lever & Spindle Assembly	\$366.00
412F157	Lever Pivot	\$18.00	480F30*	Lever & Spindle Assembly	
412F167	Deadlocking Plunger	\$30.00	480F33*	Lever & Spindle Assembly	\$370.00
412F451	Inactive Backplate Assembly	\$153.00	480F375	Slide	\$72.00
416F818	Stud	\$13.00	482F442	*Bushing	\$80.00
418F288	Dogging Screw	\$9.80	482F49*	Escutcheon	
418F308	Rivet	\$5.60	482F73*	Escutcheon & Bushing	\$370.00
418F352	Hub	\$70.00	484F418	Rollback	\$25.00
418F368	Lever, RH	\$8.50	484F898	Knob Shank Sub Assembly	\$48.00
418F378	Lever, LH				
420F128*	Screw Packet	\$65.00	492F195	Slide	\$128.00
433F978	Lever Pivot	\$63.00	BLANK PLATE FOR STOCK HOLLOW METAL DOORS		
433F988	Lever Pivot				
434F008	Lever Pivot	\$36.00	561F29	Bank Plate 14" x 3-1/2" Used on the outside of stock cut-out hollow metal doors where no trim is desired 605, 606, 612, 613, 619, 625, 626, 630	\$193.00
434F028	Screw 1/4-20 x 3/4" BUHC-SK	\$4.10	BLANK FRONTS AND STRIKES FOR STOCK HOLLOW METAL DOORS AND FRAMES		
464F028	Mullion (508) 8' door	\$336.00	Steel, USP		
464F915	Active Case Casting only	\$65.00	077F198	Front, 2-1/4" x 1-1/8"	\$13.00
467F942	Thumbpiece Lever RH	\$120.00	334F99	Front, 8" x 1-1/4"	\$30.00
467F952*	Thumbpiece Lever LH				
468F022*	Lever, inactive RH	\$178.00	Ø 236L718018	Strike, 4-7/8" x 1-1/4"	\$13.00
468F032*	Lever, inactive LH				
468F122	Thumbpiece Lever Assembly RH	\$306.00	321F24*	RHR Bracket for P3 trim	\$156.00
468F132	Thumbpiece Lever Assembly LH				
468F147	Latch Pin Assembly RH	\$120.00	393L13-M672*	Top Rod	\$256.00
468F157	Latch Pin Assembly LH				
468F162	Lever Assembly RH	\$112.00	Ø 399F168	Spindle Adapter	\$68.00
468F172	Lever Assembly LH				
468F202*	Lever Assembly RH	\$282.00	399F178	Lower Rod Assembly	\$256.00
468F212*	Lever Assembly LH				
			402F983	Extension Slide	\$51.00
			402F99*	Thumbpiece	\$66.00
			408F258	Guide Spring	\$4.10
			503F533	Bottom Strike	\$88.00
			503F557	Top Strike	\$82.00
			503F567	Top Strike - Fire Rated	
			376F37*	Sex Nut (For 1-3/4 & 2" doors)	\$9.80
			MISCELLANEOUS		
			148F228	Pin	\$4.10

*Specify Finish. Ø Subject to availability.

† Sold only in multiples of the number indicated. Price is each.

DC3000 CLOSER PARTS		
PART NO.	DESCRIPTION	LIST PRICE
TOOLS		
330F10	Hex wrench for closer valve, 3/32"	\$7.20
597F24	Torx tool kit	\$292.00
CLOSER BODIES 600, 689, 690, 691, 693, 696		
540F27	Closer body for DC3200	\$448.00
597F35	Closer body for DC3200 x M71	\$508.00
M71 = Delayed action		
ARMS 600, 689, 690, 691, 693, 696		
688F95	Regular arm	\$185.00
688F77	Regular arm with hold-open	\$273.00
688F95	Top jamb	\$185.00
688F77	Top jamb with hold-open	\$273.00
689F02	Heavy-duty parallel arm	\$278.00
689F01	Heavy-duty parallel arm with hold-open	\$311.00
597F52	Heavy-duty regular arm	\$278.00
689F03	Heavy-duty parallel arm with backstop	\$291.00
689F04	Heavy-duty parallel arm with backstop & hold-open	\$269.00
691F98	Reg. secondary arm assy.	\$65.00
691F99	Deep reveal secondary arm assembly	\$66.00
692F02	Reg. H.D. secondary arm assembly	\$245.00
692F03	Deep reveal H.D. secondary arm assembly	\$424.00
BRACKETS 600, 689, 690, 691, 693, 696		
188F03	Quik-Install™	\$28.00
188F41	Parallel arm	\$36.00
509F49	Parallel arm with hold-open	\$64.00
188F62	Parallel arm offset	\$43.00
188F63	Parallel arm for flush transom	\$64.00
244F17	Regular arm mortise	\$77.00
447F14	Angle Support Bracket and Spacer	\$64.00
DROP PLATES 600, 689, 690, 691, 693, 696		
188F65	For DC3220 x full cover	\$102.00
597F58	For DC3210 x full cover	
COVERS 600, 689, 690, 691, 693, 696		
597F78	Full cover and insert packet (standard)	\$63.00
PAINT (PER CAN)		
597F94	Silver Aluminum - 689	\$81.00
597F95	Dark Bronze - 690	
597F96	Light Bronze - 691	
597F97	Satin Brass - 696	

DC5000 CLOSER PARTS		
PART NO.	DESCRIPTION	LIST PRICE
CLOSER BODY 600, 689, 690, 691, 693, 696		
754F68	Closer Body Only	\$677.00
ARMS 600, 689, 690, 691, 693, 696		
754F95	Pull Side Slide Track & Arm Assy., Non-Hold Open	\$279.00
754F96	Pull Side Slide Track & Arm Assy., Hold Open	\$421.00
754F97	Push Side Slide Track & Arm Assy., Non-Hold Open	\$279.00
754F98	Push Side Slide Track & Arm Assy., Hold Open	\$421.00
754F92	Hold Open Assembly	\$64.00
COVER		
754F79	Plastic Cover	\$64.00
DROP PLATE		
754F80	Push side, drop plate	\$68.00
ANGLE BRACKET		
754F93	Stop Mount Track Angle Bracket	\$124.00
SCREW PACKETS		
754F69	Closer Screw Pack	\$16.00
754F70	Spline Screw Pack	\$43.00
754F94	Track Screw Pack	\$21.00
261F298	Hex Key 5/64" †Order 10-	\$5.60

† Sold only in multiples of the number indicated. Price is each.

CLOSER PARTS

PART NO.	DESCRIPTION	LIST PRICE
CLOSER BODIES 600, 689, 690, 691, 693, 696		
689F12	Closer body for DC6200	\$580.00
689F13	Closer body for DC6200 x M71	\$640.00
689F14	Closer body for DC6401	\$580.00
689F15	Closer body for DC6402	
689F16	Closer body for DC6403	
689F17	Closer body for DC6404	
689F18	Closer body for DC6405	
689F19	Closer body for DC6406	
691F52	Closer body for DC6401 x M71	\$640.00
691F53	Closer body for DC6402 x M71	
691F54	Closer body for DC6403 x M71	
691F55	Closer body for DC6404 x M71	
691F56	Closer body for DC6405 x M71	
691F57	Closer body for DC6406 x M71	
M71 = Delayed action		
ARMS 600, 689, 690, 691, 693, 696		
688F95	Regular arm, consists of:	\$185.00
	688F99 main arm & tube assembly	\$116.00
	688F98 rod & shoe assembly	\$49.00
	688F92 hex screw pkg.	\$20.00
688F77	Regular arm with hold-open (A1), consists of:	\$273.00
	691F92 main arm & rod Assy	\$108.00
	540F40 hold-open bracket assembly	\$165.00
689F02	Heavy duty parallel arm (A3)	\$278.00
689F01	Heavy duty parallel arm with hold-open (A2)	\$311.00
597F52	Heavy duty regular arm (A10)	\$278.00
689F03	Heavy duty parallel arm with backstop (A4)	\$291.00
689F04	Heavy duty parallel arm with backstop & hold-open (A5)	\$269.00
615F52	HD Spring stop for Dr. width. 28"-32" (A11)	\$278.00
615F54	Unitrol® for Dr. width. 33"-41	
615F56	Unitrol® for Dr. width. 42"-48"	
615F51	Unitrol®/HO for Dr. width. 28"-32" (A12)	
615F53	Unitrol®/HO for Dr. width. 33"-41"	\$311.00
615F55	Unitrol®/HO for Dr. width. 42"-48"	
691F96	Heavy-duty offset arm (A13)	\$182.00
754F16	DC6230, DC6430 pull side - arm only	\$141.00
754F10	DC6230, DC6430 - track only (hold-open)	\$421.00
754F09	DC6230, DC6430 - track only (non hold-open)	\$279.00
754F44	DC6230, DC6430 pull side track assembly, non-hold open	\$595.00
754F45	DC6230, DC6430 pull side track assembly, hold open	\$744.00
754F12	DC6240, DC6440 push side track & arm (non hold open)	\$415.00
754F14	DC6240, DC6440 - track only (non hold-open)	\$279.00
754F13	DC6240, DC6440 track & arm (hold-open)	\$563.00
754F15	DC6240, DC6440 - track only (hold-open)	\$421.00
754F16	DC6240, DC6440 - arm only (hold-open)	\$141.00
691F72	Deep reveal arm (7-1/4" max), consists of:	\$169.00
	688F99 main arm and arm tube Assy	\$116.00
	691F75 rod & shoe assembly	\$54.00

PART NO.	DESCRIPTION	LIST PRICE
ARMS 600, 689, 690, 691, 693, 696		
691F74	Deep reveal arm w/hold-open (7-1/4" max), consists of:	\$224.00
	691F95 main arm & rod Assy- deep reveal	\$59.00
	540F40 hold-open bracket Assy.	\$165.00
615F58	Reinforcing bracket	\$54.00
615F59	Deep reveal reinforcing kit	\$70.00
615F60	Flush partition bracket	\$52.00
692F04	Friction, Hold Open Arm RH	\$170.00
692F05	Friction, Hold Open Arm LH	
692F00	Reg. Secondary Arm Assy.	\$65.00
692F01	Top Jamb Secondary Arm Assy.	\$66.00
692F02	Reg. H.D. Secondary Arm Assy.	\$245.00
692F03	Deep Reveal HD. Secondary Arm Assy.	\$424.00
BRACKETS 600, 689, 690, 691, 693, 696		
188F03	Quik-Install™	\$28.00
188F41	Parallel arm	\$36.00
509F49	Parallel arm with hold-open	\$64.00
188F63	Parallel arm for flush transom	
188F62	Parallel arm offset	\$43.00
244F17	Regular arm mortise	\$77.00
447F14	Angle support	\$64.00
499F30	Flush transom	\$40.00
691F78	Spacer	\$8.70
COVERS 600, 689, 690, 691, 693, 696		
597F78	Full cover and insert pkt. (standard)	\$63.00
603F55	Full metal cover RH/LHR	\$68.00
603F57	Full metal cover LH/RHR	
261F95	Cover screw pack	\$8.70
DROP PLATES 600, 689, 690, 691, 693, 696		
188F65	For DC6220 x full cover	\$102.00
	For DC6420 x full cover	
597F58	For DC6210, DC6410, DC6240, DC6440 x full cover	
597F59	For DC6230, DC6240, x full cover	
	For DC6430, DC6440 x full cover	
BLADE STOP SPACER		
597F92	1/2" Spacer block	\$31.00
597F93	5/8" Spacer block	\$52.00
SCREW PACKETS 600, 689, 690, 691, 693, 696		
691F93	Standard Screw Pack	\$19.00
691F94	Standard Screw Pack w/ Sex Nuts	\$30.00
468F34	SNB for 1-3/4" door	\$18.00
691F89	Torx® Screw Pack	\$43.00
691F90	Torx Screw Pack with Sex Nuts	\$48.00
597F24	Torx® tool kit	\$292.00
754F43	Screw pack (push or pull track)	\$28.00
PAINT (PER CAN)		
597F94	Silver Aluminum - 689	\$81.00
597F95	Dark Bronze - 690	
597F96	Light Bronze - 691	
597F97	Satin Brass - 696	

CLOSER PARTS					
PART NO.	DESCRIPTION	LIST PRICE	PART NO.	DESCRIPTION	LIST PRICE
CLOSER BODIES			BRACKET		
754F21	Closer body for DC8200	\$693.00	754F18	Quik-Install™	\$30.00
754F26	Closer body for DC8200 x M71	\$758.00	188F41	Parallel arm	\$36.00
ARMS			509F49	Parallel arm with hold-open	\$64.00
688F95	Regular arm, consists of:	\$185.00	188F63	Parallel arm for flush transom	
	688F99 main arm & tube assembly	\$116.00	188F62	Parallel arm offset	\$43.00
	688F98 rod & shoe assembly	\$49.00	244F17	Regular arm mortise	\$77.00
	688F92 hex screw pkg.	\$20.00	447F14	Angle support	\$64.00
688F77	Regular arm with hold-open (A1), consists of:	\$273.00	499F30	Heavy duty parallel arm flush transom bracket	\$40.00
	691F92 main arm & rod assy	\$108.00	COVERS		
	540F40 hold open bracket assembly	\$165.00	754F84	Full ABS cover	\$40.00
689F02	Heavy-duty parallel arm (A3)	\$278.00	754F22	Full metal cover RH/LHR	\$94.00
689F01	Heavy-duty parallel arm with hold-open (A2)	\$311.00	754F23	Full metal cover LH/RHR	
597F52	Heavy-duty regular arm (A10)	\$278.00	754F17	Cover screw pack	\$8.70
689F03	Heavy-duty parallel arm with backstop (A4)	\$291.00	DROP PLATES		
689F04	Heavy-duty parallel arm with backstop & hold-open (A5)	\$269.00	754F20	For DC8200 (regular)	\$118.00
615F52	Unitrol® - Dr. width 28"-32" (A11)	\$278.00	754F24	For DC8200 (with concealed holder)	\$118.00
615F54	Unitrol® - Dr. width 33"-41" (A11)			For DC8220 (top jamb)	
615F56	Unitrol® - Dr. width 42"-48" (A11)		754F25	For DC8210 (parallel)	\$118.00
615F51	Unitrol® w/ Hold Open - Dr. width 28"-32" (A12)			For DC8230 (pull side track)	
615F53	Unitrol® w/ Hold Open - Dr. width 33"-41" (A12)	\$311.00	For DC8240 (push side track)		
615F55	Unitrol® w/ Hold Open - Dr. width 42"-48" (A12)		BLADE STOP SPACER		
691F96	Heavy-duty offset arm (A13)	\$182.00	597F92	1/2" Spacer block	\$31.00
692F04	Heavy duty friction hold open, RH (A14)	\$170.00	597F93	5/8" Spacer block	\$52.00
692F05	Heavy duty friction hold open, LH (A14)	\$170.00	SCREW PACKETS		
754F09	Pull side track only, non-hold open	\$279.00	754F37	Standard screw pack	\$20.00
754F10	Pull side track only, hold open	\$421.00	754F29	Standard screw pack (includes sex nuts)	
754F12	Push side track & arm, non-hold open	\$415.00	754F30	SNB for 1-3/4" door	\$26.00
754F13	Push side track & arm, hold open	\$563.00	754F38	Torx® screw pack	\$63.00
754F14	Push side track only, non-hold open	\$279.00	754F34	Torx screw pack (includes sex nuts)	
754F15	Push side track only, hold open	\$421.00	597F24	Torx® tool kit	\$292.00
754F16	Slide track assembly (non-hold open or hold open)	\$141.00	754F35	Main arm screw & washer	\$10.20
691F72	Deep reveal arm (7 1/4" max) consists of:	\$169.00	RETROFIT PLATES		
	688F99 main arm and arm tube assy	\$116.00	754F36	To Replace DC6000 (Reg. Arm)	\$138.00
	691F75 rod & shoe assembly	\$54.00	754F46	To Replace DC6000 (Par. Arm or Top Jamb)	\$138.00
691F74	Deep reveal arm with hold-open (7 1/4" max), consists of:	\$224.00			
	691F95 main arm & rod assy- deep reveal	\$59.00			
	540F40 hold open bracket assy.	\$165.00			
615F58	Reinforcing bracket	\$54.00			
615F59	Deep reveal reinforcing kit	\$70.00			
615F60	Flush partition bracket	\$52.00			

PART NO.	DESCRIPTION	LIST PRICE
DC62900 SERIES ELECTROMECHANICAL CLOSERS		
689F12	DC6000 Closer Body	\$580.00
188F03	Quik-Install Bracket	\$28.00
597F78	Full Cover	\$63.00
603F55	Full Metal Cover RH	\$68.00
603F57	Full Metal Cover LH	
692F24	Standard Arm Assembly	\$136.00
692F25	Adjusting Head and Tube Assembly	\$171.00
692F14	Slide Assembly	\$147.00
692F15	Arm Stud Clip	\$15.00
692F16	Track Assembly End Cap	\$12.00
692F17	Solenoid Block Assembly, 24V	\$460.00
692F19	Adjusting Rod Assembly	\$70.00
692F20	Arm Stud	\$10.20
692F21	Retaining Ring	\$5.80
692F23	Arm Length Adjusting Screw	\$4.30
754F02	Double Egress Arm, RH	\$248.00
754F03	Double Egress Arm, LH	
754F04	Adjusting Head and Tube Assembly, RH	\$169.00
754F05	Adjusting Head and Tube Assembly, LH	
754F52	Track Assy. (Hinge Side) support units	\$570.00
754F53	Track Assy. (Stop Side) support units	
754F54	Hook-Up Board, Support, 24V	\$186.00
754F55	Hook-Up Board, Support, 120V	\$279.00
754F58	Hook-Up Box, Support unit, 24V, push side	\$479.00
754F59	Hook-Up Box, Support unit, 120V, push side	
754F63	Hook-Up Box, Support unit, 24V, pull side	\$494.00
754F64	Hook-Up Box, Support unit, 120V, pull side	
754F66	Fuse	\$28.00
754F72	Hook-Up Box Cover Kit (included cover & screws), Support	\$82.00

PART NO.	DESCRIPTION	LIST PRICE
Access 800° AC2 Series		
794F509	Gaskets Exit device - Reader	\$16.00
794F519	Gaskets Exit device trim	
794F529	Gaskets Cylindrical lock	\$21.00
794F539	Gaskets Mortise lock	

PART NO.	DESCRIPTION	LIST PRICE
Motorized		
789F929	ECOFLEX, Motor SUB Assembly	\$199.00
728F709	Harness Fail Safe / Fail Secure	\$25.00
789F859	Motor Mortise ECOFLEX	\$161.00
728F759	ECOFLEX ET Harness A800 AC2	\$25.00
789F869	ECOFLEX ET Link Harness IN100	
728F799	ECOFLEX ET Link Harness A800 WI1 & IP1	
789F879	ECOFLEX ET Link Harness A700 PIP1, PWI1, IN120, IN220	
728F809	ECOFLEX ET Link Harness A700 PAC1	
728F939	ECOFLEX ET Link Harness A600 & SE LP10	
728F799	ECOFLEX ET Ground Wire A800 WI1, IP1	

Part Number	Page	Part Number	Page	Part Number	Page	Part Number	Page	Part Number	Page
019F137	395	122F639	403	184F948	403	217L13M022	384	220F722	404
021F688	362	122F643*	403	186F748	362	217L13M022	388	220F75	404
021F718	362	123F22	402	188F03	407	217L13M022	390	220F75-B	404
022F723	396	123F538	403	188F03	408	217L13M022	393	220F778	404
022F80	395	129F499	403	188F03	410	217L13M022	394	220F827	404
025F722	362	129F848	362	188F41	407	217L13M022	394	220F848	404
025F858	390	129F848	403	188F41	408	217L13M024	384	220F85*	404
025F858	392	131F278	395	188F41	409	217L13M024	388	221F948*	404
026F757	361	134F05	363	188F62	407	217L13M024	390	222F71*	404
041F478	362	134F05	403	188F62	408	217L13M024	393	222F85	396
041F478	384	135F108	362	188F62	409	217L13M024	394	223F29	396
060F053	396	135F192	362	188F63	407	217L13M024	394	224F008	393
060F338	395	138F888	395	188F63	408	217L13M028	384	224F348	404
060F428	395	140F528	403	188F63	409	217L13M028	388	224F392	404
067F428	395	140F978	395	188F65	407	217L13M028	390	224F448	404
070F428	395	141L548	403	188F65	408	217L13M028	393	224F508	404
070F438	395	141L59	403	188F738	396	217L13M028	394	225F998	404
071F628	395	142F43	402	188F758	396	217L13M028	394	228F188	404
071F638	395	142F44*	403	194F228	395	217L13M032	384	228F348	396
071F673	396	143F248	403	195K68	360	217L13M032	388	228F497	404
077F198	406	144F298	396	197F347	362	217L13M032	390	228F517	404
078F078	395	144F308	396	197F357	362	217L13M032	393	228F528	404
079F00	365	144F33	395	197F527	361	217L13M032	394	228F558	404
079F02	365	144F34	395	198F71	395	217L13M032	394	228F687	404
081F778	395	144F888	396	200F168	404	217L13M036	384	228F808	404
082L67	396	145F328	396	201F188	396	217L13M036	388	228F817	404
083L96M032	396	145F543*	403	206F578	379	217L13M036	390	228F847	404
083L96M034	396	146F788	362	213F117	404	217L13M036	393	236L720M40FIN	366
083L96M036	396	147F078	395	217F422	361	217L13M036	394	236L720M44FIN	366
083L96M040	396	148F228	406	217F43	362	217L13M036	394	236L720M48FIN	366
083L96M048	396	148F367	403	217F432	361	217L13M040	384	236L72M014FIN	366
092F789	396	148F448	403	217F44	362	217L13M040	388	236L72M016FIN	366
102F198	396	156F43	395	217F442	361	217L13M040	390	236L72M018FIN	366
102F278	396	156F648	396	217L13M016	384	217L13M040	393	236L72M020FIN	366
102F378	396	156F658	396	217L13M016	388	217L13M040	394	236L72M022FIN	366
103F448	396	156F837	395	217L13M016	390	217L13M040	394	236L72M024FIN	366
103F458	396	157F11	395	217L13M016	393	217L13M044	384	236L72M028FIN	366
114F678	396	158F062	362	217L13M016	394	217L13M044	388	236L72M032FIN	366
118F299	401	164F329	403	217L13M016	394	217L13M044	390	236L72M036FIN	366
120F768	384	168F818	396	217L13M018	384	217L13M044	393	236L75M020	396
121F012	362	171F468	361	217L13M018	388	217L13M044	394	240L08018	396
122F188	403	171F798	395	217L13M018	390	217L13M044	394	240L08020	396
122F248	403	173F698	403	217L13M018	393	217L13M048	384	240L08022	396
122F413	403	173F728	403	217L13M018	394	217L13M048	388	240L50	402
122F508	403	173F798	362	217L13M018	394	217L13M048	390	240L51	402
122F518	403	175F518	403	217L13M020	384	217L13M048	393	242F508	396
122F568	403	176F653	402	217L13M020	388	217L13M048	394	243F769	404
122F578	403	183F74	403	217L13M020	390	217L13M048	394	243F798	404
122F593	403	183F75	403	217L13M020	393	219F888	362	243F808	404
122F608	403	183F857	402	217L13M020	394	220F498	404	243F85	404
122F618	403	184F825	403	217L13M020	394	220F718	379	244F17	407

Part Number	Page	Part Number	Page	Part Number	Page	Part Number	Page	Part Number	Page
244F17	408	269F479	404	318F66	367	351F85*	405	391F658	372
244F17	409	269F488	404	320F442	362	351F867	405	392F22	402
244F647	396	269F499	404	320F442	396	351F873	405	392F24	402
249F33*	404	269F528	404	321F24*	406	351F883	405	392F28	402
249F768	396	269F538	404	321F907	405	351F897	405	392F29	402
249F773	396	269F549	404	329F998	362	351F907*	405	392L19*	406
250F088	362	269F559	404	330F10	407	351F988	405	393L13-M672*	406
251F198	396	269F569	404	333F519	405	352F021	405	393L13-M672*	406
252F82	363	269F578	404	333F998	362	352F042	402	394F198	396
253F118	404	269F587	404	334F128	362	352F05	402	399F178	406
253F758	362	269F608	404	334F238	362	352F068	405	399F188	406
253F768	362	269F73	402	334F99	406	353F868	362	402F29	365
253F778	362	269F74	402	334F998	365	354F198	362	402F30	365
253F858	362	269F75	402	334K01	360	361F308	405	402F31	365
253F97	363	269F76	402	335F988	396	361F913	402	402F33	365
254F73	404	269F808	379	340L60M018FIN	367	362F153	362	402F34	365
255F41*	404	269F91*	404	340L60M020FIN	367	362F432	362	402F35	365
255F53	363	269F92*	404	340L60M022FIN	367	362F498	405	402F738	365
255F54	364	270F01*	404	340L60M024FIN	367	362F918	405	402F983	406
261F118	396	270F02*	404	340L60M028FIN	367	364F228	405	402F99*	406
261F288	404	270F11*	404	340L60M032FIN	367	364F272	405	402F99*	406
261F298	396	270F15	363	340L60M036FIN	367	364F288	405	403F035	406
261F298	407	281F272	362	340L60M040FIN	367	364F308	405	403F30*	406
261F318	404	282F325	404	340L60M044FIN	367	364F36*	405	403F302 Fin	379
261F54	404	282F357	404	340L60M048FIN	367	364F37*	405	403F568	366
261F658	404	283F81	396	340L617020FIN	367	364F38*	405	403F677	365
261F95	408	284F138	362	340L61M018FIN	367	364F39*	405	404F858	366
262F901	404	284F67*	404	340L61M022FIN	367	365F003	405	404F868	365
264F698	371	284F977	405	340L61M024FIN	367	365F013	405	405F428	406
264F958	404	286F507	395	340L61M028FIN	367	365F033	405	405F458	406
267F97	363	287F608	396	340L61M032FIN	367	365F958	362	405F476	406
268F647	404	291F498	405	340L61M036FIN	367	365F968	362	405F496	406
268F848	404	291F578	405	340L61M040FIN	367	365F98*	405	405F772	396
268F878	404	293F183	405	340L61M044FIN	367	366F70	364	406F438	362
269F048	404	293L14	396	340L61M048FIN	367	368F918	362	407K63	360
269F058	404	300F688	375	341F318	405	370F29	363	407K64	360
269F08	404	300F71	402	342F032	396	370F31	363	407K65	360
269F088	365	301F567	395	342F052	395	370F33	364	407T314097	361
269F098	374	303F242	396	351F50*	405	370F35	364	407T314125	361
269F31	404	303F25	363	351F51*	405	376F37*	406	407T314153	361
269F32	404	304F337	402	351F528	405	376F42	405	407T324097	361
269F33	404	304F347	402	351F553	405	377F308	372	407T324125	361
269F34	404	305F318 Fin	379	351F56*	405	377F80	370	407T324153	361
269F35	404	306F068	405	351F57*	405	378F745	405	407T334097	361
269F36	404	306F078	405	351F72	405	378K18	360	407T334125	361
269F378	404	310F488	362	351F73	405	379F805	362	407T334153	361
269F393	404	314F887	361	351F797	405	381F30	395	407T414242	361
269F403	404	314F987	361	351F807	405	383F82	370	407T414270	361
269F413	404	314F997	362	351F823	405	384F03	374	407T414298	361
269F42	404	315F93 Fin	388	351F833	405	384F11	370	407T414326	361
269F468	404	315F94 Fin	388	351F849	405	391F658	364	407T414354	361

Part Number	Page	Part Number	Page	Part Number	Page	Part Number	Page	Part Number	Page
407T424242	361	426F52	369	445F85	375	468F172	406	487K15	360
407T424270	361	427F06	368	445F869	374	468F202*	406	487K17	360
407T424298	361	427F078	368	446F572	362	468F212*	406	487K19	360
407T424326	361	427F39	369	446F582	362	468F246	406	487K21	360
407T424354	361	427F43	369	446K68	360	468F256	406	487K38	360
407T434158	361	427F45	369	447F14	407	468F266	406	487M048589	402
407T434193	361	427F47	369	447F14	408	468F276	406	488F00	371
408F258	406	428F32	368	447F14	409	468F34	408	488F01	371
408K45	360	428F33	368	447F24	374	468F355	406	488F03	370
409F865	386	428F34	368	447F25	374	480F128	406	488F04	370
409F875	387	428F66	363	447F41	363	480F13*	406	488F05	370
409F875	392	429F317	374	447F42	363	480F188	406	488F07	370
409F905	392	429F41	366	447F43	363	480F198	406	488F088	362
409K12	360	429F41	398	447F43	398	480F208	406	488F088	368
411L62	402	432F86	375	447F44	364	480F28*	406	488F09	366
411L62M016FIN	367	433F76	375	447F45	364	480F30*	406	488F108	362
411L62M018FIN	367	433F77	375	447F46	364	480F33*	406	488F108	368
411L62M020FIN	367	433F78	375	461F108	362	480F375	406	488F27	368
411L63	402	433F978	406	463F918	402	480F68	393	488F31	368
411L63M016FIN	367	433F988	406	464F028	406	480F688 Fin	388	488F928	362
411L63M018FIN	367	434F008	406	464F915	406	480F69	396	488K84	360
411L63M020FIN	367	434F028	406	465F57	366	480F70	396	488K85	360
412F133*	406	436F038	402	466F229	366	480F708	396	488K99	360
412F157	406	436F177	366	466F279	396	482F37	368	489F028	362
412F167	406	437F26	368	466F40	368	482F442	406	489F882	395
412F451	406	437F28	368	466F41	368	482F49*	406	489F892	395
413F488	362	437F40	368	466F42	368	482F73*	406	489K49	360
413F498	362	437F41	368	466F45	368	483F118	372	490F558	362
415F16	395	437F42	368	466F46	368	483F30	368	492F195	406
415K73	360	438F37	368	466F47	368	483F34	368	492K90	360
415K74	360	438F38	368	466F50	368	483F35	368	492K91	360
416F355	402	438F418	362	466F51	368	483F36	368	492K92	360
416F38	396	438F428	362	466F52	368	483F79	374	493F31	374
416F39	363	438F90	371	466F73	368	483F80	374	493F34	374
416F818	406	439F25	368	466F74	368	483F81	374	493F76	360
416K08	360	439F26	368	466F75	368	483F82	374	493F77	360
418F288	406	439F27	368	467F338	396	483F83	374	493F78	360
418F308	406	439F33	375	467F345	396	483F84	374	496F32	395
418F352	406	439F34	375	467F358	396	483K01	360	496F33	395
418F368	406	439F35	375	467F36	396	484F418	406	496F34	395
418F378	406	442F952	395	467F378	396	484F898	406	496F718	396
420F128*	406	444F748	362	467F733	402	484F918	362	497F528	374
422F88	363	444F758	362	467F942	406	484F928	362	498F928	375
422L842144	396	444K96	360	467F952*	406	484F938	362	499F30	408
422L848144	396	444K97	360	468F022*	406	484F948	362	499F30	409
423F54	365	444K98	360	468F032*	406	484F958	362	499F598	402
423F55	365	444K99	360	468F122	406	484F968	362	499F828	374
423F57	365	445F318	375	468F132	406	487F08	374	499F838	374
423F58	365	445F82	374	468F147	406	487K10	360	499F848	374
423L71	396	445F83	374	468F157	406	487K11	360	502F75	402
424F838	396	445F84	374	468F162	406	487K13	360	502F96	402

Part Number	Page	Part Number	Page	Part Number	Page	Part Number	Page	Part Number	Page
503F52	402	544F97	370	574F55	394	586L19M018	384	596F618	393
503F533	402	544F98	370	574F56	394	586L19M018	388	596F618 Fin	388
503F533	406	544F99	370	578F435	386	586L19M018	393	596F628	393
503F557	406	545F00	370	579F11	394	586L19M018	394	596F628 Fin	388
503F567	406	545F42	370	580K99	360	586L19M018	394	596F66	385
506F57	364	545F43	370	581F96	375	586L19M020	384	596F67	385
509F49	407	545F44	370	582F112	395	586L19M020	388	596F68	385
509F49	408	545F45	370	582F122	395	586L19M020	393	596F825	386
509F49	409	545F79	369	582F132	395	586L19M020	394	596F879	362
511F51	368	545F80	369	582F142	395	586L19M020	394	596F898	362
511F52	368	545F81	369	582F298	362	586L19M022	384	596K29	360
518K73	360	545F82	369	584F46	374	586L19M022	388	596K30	360
518K74	360	545F83	369	585F312	362	586L19M022	393	596K31	360
518K75	360	545F84	369	585F327	361	586L19M022	394	596K32	360
518K76	360	545F85	369	585F337	362	586L19M022	394	597F24	407
518K77	360	545F86	369	585F358	362	586L19M024	384	597F24	408
519F09	375	545F87	369	585F367	362	586L19M024	388	597F24	409
519F10	375	545F88	369	585F377	362	586L19M024	393	597F35	407
519F11	375	546F978	361	585F387	362	586L19M024	394	597F52	407
519F12	375	549F352	395	585F397	361	586L19M024	394	597F52	408
520F358	362	549F362	395	585F407	362	586L19M028	384	597F52	409
522F932	362	549F52	363	585F705	386	586L19M028	388	597F58	407
534K25	360	553F482 x length	361	585F715	386	586L19M028	393	597F58	408
540F27	407	553F492 x length	361	585F729	385	586L19M028	394	597F59	408
540F625	386	553F502 x length	361	585F76 Fin	388	586L19M028	394	597F78	407
540F685	387	556F558	393	585F762	389	586L19M032	384	597F78	408
544F13	371	557F29	370	585F762	391	586L19M032	388	597F78	410
544F14	371	561F29	406	585F77 Fin	388	586L19M032	393	597F92	408
544F38	371	562F402	362	585F772	389	586L19M032	394	597F92	409
544F39	371	562F422	362	585F772	391	586L19M032	394	597F93	408
544F40	371	563F885	386	585F78 Fin	388	586L19M036	384	597F93	409
544F41	371	563F895	386	585F79 Fin	388	586L19M036	388	597F94	407
544F42	371	563F905	386	585K46	360	586L19M036	393	597F94	408
544F43	370	563F945	386	586F16	385	586L19M036	394	597F95	407
544F44	371	563F955	386	586F17	385	586L19M036	394	597F95	408
544F45	371	563F965	386	586F18	385	586L19M040	384	597F96	407
544F46	370	564K53	360	586F51 Fin	388	586L19M040	388	597F96	408
544F76	369	564K59	360	586F512	392	586L19M040	393	597F97	407
544F77	369	564K60	360	586F80	385	586L19M040	394	597F97	408
544F79	369	566F50	401	586F81	385	586L19M040	394	598F20	385
544F80	369	566F51	401	586F82	385	586L19M044	384	598F21	385
544F85	369	569F45	374	586F86	385	586L19M044	388	598F22	385
544F87	369	574F158	364	586F87	385	586L19M044	393	598F59 Fin	384
544F88	369	574F258	394	586F88	385	586L19M044	394	598F59 Fin	388
544F89	369	574F268	394	586L19	378	586L19M044	394	598F592	390
544F91	369	574F29	394	586L19	392	586L19M048	384	598F592	392
544F92	369	574F29 x574F25	394	586L19M016	384	586L19M048	388	598F809	390
544F93	369	574F29 x574F26	394	586L19M016	388	586L19M048	393	598F809	392
544F94	370	574F30	394	586L19M016	393	586L19M048	394	598F815	390
544F95	370	574F30 x574F25	394	586L19M016	394	586L19M048	394	598F815	392
544F96	370	574F30 x574F26	394	586L19M016	394	592F338	398	598F825	390

Part Number	Page	Part Number	Page	Part Number	Page	Part Number	Page	Part Number	Page
598F825	392	600F08	391	603F57	410	610K48	360	622F308	391
598F835	390	600F09	389	604F228	390	610L43	396	622F328	362
598F835	392	600F09	391	604F228	392	610L44	396	622F328	362
598F905	390	600F10	389	604F228	393	612K88	360	622F698	362
598F905	392	600F10	391	604F228 Fin	379	612K90	360	624F427	366
599F275	390	600F11	389	604F228 Fin	384	612K91	360	624F439	366
599F275	392	600F11	391	604F228 Fin	388	612K93	360	624F449	366
599F389	362	600F12	389	604F238	393	612K94	360	624F455	366
599F91	384	600F12	391	604F238 Fin	384	613F029	395	624F478	366
599F91	389	600F13	389	604F238 Fin	388	613F102	395	624F488	365
599F91	391	600F13	391	604F248	393	613F112	395	624F49	365
599F92	384	600F14	389	604F248 Fin	384	613F122	395	624F53	365
599F92	389	600F14	391	604F248 Fin	388	613F132	395	627F009	381
599F92	391	600F415	386	604F268	390	613F142	395	627F009	381
599F93	389	600F425	386	604F268	392	613F152	395	628F107142	361
599F93	391	600F62	389	604F268	393	613F162	395	628F107171	361
599F94	384	600F62	391	604F268 Fin	384	613F172	395	628F107236	361
599F94	389	600F63	389	604F268 Fin	388	613F222	395	628F825	362
599F94	391	600F63	391	604F278	393	613F232	395	628F835	362
599F95	384	600F64	389	604F278 Fin	384	613F242	395	628F892	361
599F95	389	600F64	391	604F278 Fin	388	613F252	395	628F912	361
599F95	391	600F65	389	604F288	393	613F352	395	628F922 x Fin	361
599F96	389	600F65	391	604F288 Fin	384	613F422	395	628F932	362
599F96	391	600F66	389	604F288 Fin	388	613F432	395	628F962	361
599F97	384	600F66	391	605F42	368	615F51	408	628K852 x Fin	360
599F97	389	600F67	389	605F43	363	615F51	409	628K872 x Fin	360
599F97	391	600F67	391	605F768	396	615F52	408	628K882 x Fin	360
599F98	384	600F68	389	605F778	396	615F52	409	628K902 x Fin	360
599F98	389	600F68	391	605F90	395	615F53	408	628K952 x Fin	360
599F98	391	600F69	389	606F018	396	615F53	409	628K972 x Fin	360
599F99	389	600F69	391	606F028	396	615F54	408	628K992 x Fin	360
599F99	391	600F70	389	606F038	395	615F54	409	629F062 x Fin	361
600F00	384	600F70	391	606K73	360	615F55	408	629F072 x Fin	361
600F00	389	600F71	389	606K74	360	615F55	409	629K002 x Fin	360
600F00	391	600F71	391	606K75	360	615F56	408	629K012 x Fin	360
600F01	384	600F72	389	606K76	360	615F56	409	629K022 x Fin	360
600F01	389	600F72	391	606K77	360	615F58	408	629K032 x Fin	360
600F01	391	600F73	389	606K78	360	615F58	409	629K042 x Fin	360
600F02	389	600F73	391	606K79	360	615F59	408	630F482 x Fin	361
600F02	391	601F229	362	607F76	384	615F59	409	630F494	361
600F03	389	601F24	385	607F919	362	615F60	408	630K472 x Fin	360
600F03	391	601F25	385	609F36	363	615F60	409	631F248	362
600F04	389	601F26	385	609F36	398	616F078	374	631F248	385
600F04	391	601F283 Fin	388	609F37	363	616F088	374	631F248	389
600F05	389	601F69	384	609F37	398	616F12	366	631F248	391
600F05	391	601F69	385	609F38	363	616F208	362	631F288	378
600F06	389	602F198	365	610F01	363	616F218	362	649F99 fin	397
600F06	391	603F207	361	610F01	398	622F298	362	650F00	397
600F07	389	603F55	408	610F02	363	622F308	362	650F03	397
600F07	391	603F55	410	610F49	360	622F308	385	650F04	397
600F08	389	603F57	408	610K46	360	622F308	389	650F05	397

Part Number	Page	Part Number	Page	Part Number	Page	Part Number	Page	Part Number	Page
650F06	397	650F728	399	651F848	401	652F73	399	653F56	400
650F07	397	650F738	399	651F858	401	652F73	400	653F57	399
650F08	397	650F778	397	651F868	401	652F74	399	653F57	400
650F095	399	650F798	397	651F878	401	652F74	400	653F59	399
650F11	397	650F808	399	651F888	401	652F75	399	653F59	400
650F12	397	650F818	399	651F898	401	652F76	399	653F60	399
650F13	397	650F828	398	651F928	401	652F76	400	653F60	400
650F14	397	650F878	398	651F938	401	652F77	399	653F61	399
650F15	397	650F888	398	651F948	401	652F77	400	653F61	400
650F16	397	650F93	397	651F965	401	652F78	399	653F62	399
650F189	397	650F959	398	651F988	401	652F79	399	653F62	400
650F21	397	650F968	397	652F048	401	652F79	400	653F63	399
650F228	397	650F978	398	652F058	401	652F80	399	653F63	400
650F238	397	650F998	397	652F068	401	652F80	400	653F65	399
650F248	397	650L65	398	652F098	401	652F81	399	653F65	400
650F279	398	650L657020	398	652F108	401	652F82	399	653F66	399
650F288	398	651F00	400	652F118	401	652F82	400	653F66	400
650F318	398	651F01	400	652F128	401	652F83	399	653F68	399
650F358	397	651F04	400	652F138	401	652F83	400	653F68	400
650F368	397	651F06	400	652F148	401	652F84	399	653F69	399
650F378	397	651F08	400	652F158	401	652F85	399	653F69	400
650F388	397	651F09	400	652F218	401	652F86	399	653F70	399
650F398	397	651F10	400	652F228	401	652F87	399	653F70	400
650F408	397	651F362	401	652F239	401	652F88	399	653F71	399
650F418	397	651F372	401	652F298	398	652F89	399	653F71	400
650F428	397	651F389	401	652F57	399	652F90	399	653F72	399
650F438	397	651F398	401	652F58	399	652F92	399	653F72	400
650F448	397	651F408	401	652F58	400	652F93	399	653F73	399
650F458	397	651F418	401	652F59	399	652F95	399	653F73	400
650F468	397	651F425	401	652F59	400	652F95	399	653F74	399
650F489	399	651F448	401	652F60	399	652F96	399	653F74	400
650F498	399	651F478	401	652F61	399	652F99	399	653F75	399
650F508	398	651F498	401	652F61	400	653F02	399	653F75	400
650F518	398	651F508	401	652F62	399	653F03	399	653F76	399
650F528	397	651F538	401	652F62	400	653F04	399	653F76	400
650F538	398	651F545	401	652F63	399	653F05	399	653L157014	398
650F548	399	651F568	401	652F64	399	653F08	399	653L163016	398
650F558	399	651F578	401	652F64	400	653F09	399	653L163020	398
650F568	399	651F587	401	652F65	399	653F10	399	653L183016	398
650F578	398	651F608	401	652F65	400	653F12	397	653L183020	398
650F588	397	651F618	401	652F66	399	653F13	397	654F07	363
650F598	397	651F628	401	652F67	399	653F14	397	654F08	363
650F60 fin	399	651F638	401	652F67	400	653F50	399	654F208	398
650F62	398	651F648	401	652F68	399	653F50	400	654F218	398
650F63	398	651F655	401	652F68	400	653F53	399	655F028	401
650F64	397	651F675	401	652F69	399	653F53	400	655F15	398
650F678LR	398	651F708	401	652F70	399	653F54	399	655F16	398
650F678RR	398	651F738	401	652F70	400	653F54	400	655F17	398
650F698LR	398	651F758	401	652F71	399	653F55	399	655F488LR	398
650F698RR	398	651F828	401	652F71	400	653F55	400	655F488RR	398
650F718	399	651F838	401	652F72	399	653F56	399	655F548	401

Part Number	Page	Part Number	Page	Part Number	Page	Part Number	Page	Part Number	Page
655F698	401	677F04	400	681F708	399	684F785	392	689F04	409
655F708	401	677F05	400	681F718	399	684F795	387	689F12	408
655F718	398	677F068	401	681F768	399	684F795	392	689F12	410
656F408	398	677F098	401	681F778	399	684F805	387	689F13	408
656F41	398	677F13	400	682F018	366	684F805	392	689F14	408
656F53	399	677F14	400	682F298	362	684F815	387	689F15	408
656F58	400	677F15	400	682F298	385	684F815	392	689F16	408
656F59	400	677F16	400	682F298	389	684F825	387	689F17	408
656F60	400	677F26	400	682F298	391	684F825	392	689F18	408
656F61	400	677F27	400	682F398	362	684F835	387	689F19	408
656F62	400	677F28	400	682F398	385	684F835	392	690F975	386
656F63	400	677F42	360	682F398	389	684F845	387	690F985	387
656F64	401	677F768LR 626	401	682F398	391	684F845	392	690F985	392
656F658	401	677F768RR 626	401	682F608	388	684F855	387	691F52	408
656F668	398	677F778LR 626	401	682F618	388	684F855	392	691F53	408
670F30	373	677F778RR 626	401	682F628	388	684F865	387	691F54	408
670F31	373	678F008LR	398	682F638	388	684F865	392	691F55	408
670F32	373	678F008RR	398	682F64 Fin	388	684F875	392	691F56	408
670F33	373	678F028	401	682F65 Fin	388	684F885	387	691F57	408
670F34	373	678F248	388	682F67 Fin	388	684F885	392	691F72	408
670F35	373	678F248	390	682F68 Fin	388	685F098	362	691F72	409
670F36	373	678F248	392	682F788	388	685F387	366	691F74	408
670F37	373	678F25 Fin	384	682F788	390	685F875	387	691F74	409
670F38	373	678F25 Fin	388	682F788	392	686F858	385	691F78	408
670F57	373	678F252	390	682F86 Fin	388	686F858	389	691F89	408
670F58	373	678F252	392	682F87 Fin	388	686F858	391	691F90	408
670F59	373	678F252 Fin	377	682F958	385	686F868	385	691F93	408
670F60	373	678F498	388	682F958	389	686F868	389	691F94	408
670F61	373	678F498	392	682F958	391	686F868	391	691F96	408
670F62	373	678F548	365	682F969	385	686F88 Fin	388	691F96	409
670F63	373	678F677	365	682F969	389	686F882	392	691F98	407
670F64	373	679F818	379	682F969	391	688F017	366	691F99	407
670F65	373	679F818	385	684F055	366	688F77	407	692F00	408
670F66	373	679F818	395	684F067	366	688F77	407	692F01	408
670F67	373	680F348	375	684F119	366	688F77	408	692F02	407
670F68	373	680F358	375	684F129	366	688F77	409	692F02	408
670F69	373	680F368	375	684F42	398	688F95	407	692F03	407
670F70	373	680F645	362	684F427	398	688F95	407	692F03	408
670F71	373	680L50	392	684F44 Fin	388	688F95	408	692F04	408
670F72	373	680L50	394	684F448	390	688F95	409	692F04	409
670F73	373	680L51	392	684F448	392	689F01	407	692F05	408
670F74	373	680L52	392	684F45 Fin	388	689F01	408	692F05	409
671F02	373	681F30	365	684F46 Fin	388	689F01	409	692F14	410
671F03	373	681F31	365	684F528	388	689F02	407	692F15	410
671F04	373	681F40	365	684F528	390	689F02	408	692F16	410
671F05	373	681F41	365	684F528	392	689F02	409	692F17	410
671F06	373	681F448	366	684F539	392	689F03	407	692F19	410
671F07	373	681F608	397	684F559	365	689F03	408	692F20	410
671F08	373	681F618	397	684F775	387	689F03	409	692F21	410
671F09	373	681F62	397	684F775	392	689F04	407	692F23	410
671F10	373	681F63	397	684F785	387	689F04	408	692F24	410

Part Number	Page	Part Number	Page	Part Number	Page	Part Number	Page	Part Number	Page
692F25	410	695F257110 - .110"	361	700F66	375	707F299	381	712F615	387
692F632	376	695F257126 - .126"	361	700F67	375	707F57	375	712F625	387
692F642	376	695F257141 - .141"	361	700F708	366	707F58	375	712F635	387
692F652	376	695F257157 - .157"	361	700F748	366	707F59	375	712F645	387
692F662	376	696F39	375	700F80	371	707F60	375	712F655	387
692F672	376	696F42	362	700F81	371	710F00M	398	712F665	387
692F752	376	696F472	361	700F82	371	710F318LR	398	712F675	387
692F762	376	696F499	361	700F83	371	710F318RR	398	712F685	386
692F862	376	696F502 x Fin	361	700F84	371	710F328LR	398	712F695	386
692F932	376	696F51	362	700F86	371	710F328RR	398	712F705	386
692F942	376	696K43	360	700F87	371	710F338LR	398	712F715	386
692F952	376	696K45	360	700F907	365	710F338RR	398	712F725	386
693F208	396	696K46	360	700F957	366	710F618	388	712F735	386
694F312	376	696K48	360	701F228	365	710F628	388	712F745	387
694F322	376	696K52	360	701F60	398	710F658	388	712F755	387
694F332	376	697F338	398	701F61	398	710F668	388	712F765	387
694F352	376	697F348	398	701F62	398	712F205	386	712F775	387
694F392	376	697F358	398	701F63	398	712F215	386	712F785	387
694F442	376	697F368	398	701F705	366	712F225	386	712F795	387
694F482	376	697F50	362	701F748	365	712F235	386	713F518	398
694F522	376	697F507	361	702F987	365	712F265	386	713F528	398
694F562	376	697F862	397	703F997	366	712F275	386	713F908	398
694F682	376	697F942	385	704F269	397	712F305	387	713F938	398
694F802	376	697F942	389	704F279	397	712F315	387	713F948	398
695F042 x Fin	361	697F942	391	704F479	397	712F325	387	713F958	398
695F052 x Fin	361	697F995	387	704F489	397	712F335	387	713F988	398
695F075	386	698F038	397	704F569	397	712F345	387	713F998	398
695F244139 - .139"	361	698F22	374	704F579	397	712F355	387	714F005	386
695F244155 - .155"	361	698F31	400	704F589	397	712F365	387	714F035	386
695F244171 - .171"	361	698F32	400	704F599	397	712F375	387	714F065	386
695F244187 - .187"	361	698F33	400	704F62	398	712F385	386	714F125	386
695F244202 - .202"	361	698F34	400	704F63	398	712F395	386	714F155	387
695F247139 - .139"	361	698F64	400	704F648	398	712F405	386	714F185	387
695F247155 - .155"	361	698F65	400	704F658	398	712F415	386	714F215	387
695F247171 - .171"	361	698F66	400	704F66	398	712F425	386	714F255	386
695F247187 - .187"	361	698F67	400	705F949	365	712F435	386	714F275	387
695F247202 - .202"	361	698F68	400	706F005	401	712F445	387	714F305	386
695F252031 - .031"	361	698F69	400	706F015	401	712F455	387	714F315	386
695F252047 - .047"	361	698F70	400	706F038	397	712F465	387	714F365	386
695F252063 - .063"	361	698F71	400	706F048	397	712F475	387	714F375	386
695F252078 - .078"	361	700F278	365	706F058	397	712F485	387	714F425	386
695F252094 - .094"	361	700F40	371	706F068	397	712F495	387	714F455	386
695F252110 - .110"	361	700F41	371	706F078	397	712F505	386	714F485	387
695F252126 - .126"	361	700F42	371	706F088	397	712F515	386	714F495	387
695F252141 - .141"	361	700F43	371	706F098	397	712F525	386	714F545	387
695F252157 - .157"	361	700F44	371	706F108	397	712F535	386	714F555	387
695F257031 - .031"	361	700F45	371	706F15	397	712F545	386	714F605	387
695F257047 - .047"	361	700F46	371	706F16	397	712F555	386	714F635	387
695F257063 - .063"	361	700F47	371	706F462	398	712F565	386	715F108	362
695F257078 - .078"	361	700F575	362	706F70	375	712F575	386	715F118	362
695F257094 - .094"	361	700F65	375	707F299	381	712F605	387	715F128	362

Part Number	Page	Part Number	Page	Part Number	Page	Part Number	Page	Part Number	Page
715F152	361	744F208	398	754F55	410	763F012150	361	776F668	378
715F245	386	744F258	398	754F58	410	763F012180	361	776F678	378
715F892	362	744F688	398	754F59	410	763F012210	361	776F688	378
715K14	360	751F16	370	754F63	410	763F012240	361	776F698	378
716K16	360	751F17	370	754F64	410	763F012270	361	776F708	378
716K43	360	753F078	366	754F66	410	763F012300	361	776F718	378
716K45	360	753F098	365	754F68	407	763F012330	361	776F728	378
716K46	360	753F598	379	754F69	407	763F012360	361	776F738	378
716K48	360	753F697	365	754F70	407	763F027120	361	776F748	378
720F21	375	754F02	410	754F72	410	763F027150	361	776F758	378
720F22	375	754F03	410	754F79	407	763F027180	361	776F768	378
720F24	375	754F04	410	754F80	407	763F027210	361	776F778	378
720F25	375	754F05	410	754F84	409	763F027240	361	776F788	378
720F43	365	754F09	408	754F92	407	763F027270	361	776F798	378
720F46	365	754F09	409	754F93	407	763F027300	361	776F808	378
720F61	375	754F10	408	754F94	407	763F072	361	776F818	378
720F62	375	754F10	409	754F95	407	774F225	377	776F828	378
720F64	375	754F12	408	754F96	407	774F878	378	776F838	378
720F65	375	754F12	409	754F97	407	774F888	378	776F848	378
721F16	375	754F13	408	754F98	407	774F945	377	776F858	378
721F17	375	754F13	409	756F507	362	774F965	377	776F868	378
721F18	375	754F14	408	756F507	362	774F985	377	776F878	378
721F19	375	754F14	409	756F517	362	775F808	378	776F918	378
723F26	375	754F15	408	756F517	362	775F818	378	776F928	378
723F69	375	754F15	409	756F527	362	775F828	378	776F938	378
724F278	399	754F16	408	756F527	362	775F838	378	776F948	378
728F709	410	754F16	408	756F537	362	775F908 Fin	379	776F958	378
728F759	410	754F16	409	756F537	362	775F918 Fin	379	776F968	378
728F799	410	754F17	409	756F542	362	775F948	378	776F978	378
728F799	410	754F18	409	756F542	362	776F002 Fin	378	776F988	378
728F809	410	754F20	409	756F557	362	776F012 Fin	378	776F998	378
728F939	410	754F21	409	756F557	362	776F022 Fin	378	777F208	378
730F778	398	754F22	409	756F567	362	776F032 Fin	378	777F215	377
733F05	400	754F23	409	756F567	362	776F042 Fin	378	777F225	377
733F41	400	754F24	409	756F582	362	776F215	377	777F235	377
733F42	400	754F25	409	756F582	362	776F225	377	777F245	377
733F43	400	754F26	409	756F582	362	776F235	377	777F335	377
733F44	400	754F29	409	756F622	362	776F245	377	777F345	377
733F45	400	754F30	409	756F622	362	776F335	377	777F395	377
733F46	400	754F34	409	756F963	396	776F345	377	777F405	377
733F47	400	754F35	409	763F002213	361	776F395	377	777F415	377
733F48	400	754F36	409	763F002243	361	776F405	377	777F425	377
733F49	400	754F37	409	763F002273	361	776F415	377	777F515	377
733F50	400	754F38	409	763F002303	361	776F425	377	777F525	377
733F51	400	754F43	408	763F002333	361	776F515	377	777F575	377
733F52	400	754F44	408	763F002363	361	776F525	377	777F585	377
733F53	400	754F45	408	763F002393	361	776F575	377	778F215	377
741F21	375	754F46	409	763F012030	361	776F585	377	778F225	377
741F22	375	754F52	410	763F012060	361	776F638	378	778F225	377
741F23	375	754F53	410	763F012090	361	776F648	378	778F235	377
741F24	375	754F54	410	763F012120	361	776F658	378	778F245	377

Part Number	Page	Part Number	Page	Part Number	Page	Part Number	Page	Part Number	Page
778F245	377	780F225	377	785F138 Fin	385	790F988	379	797F808	391
778F335	377	780F235	377	785F148	385	790F988	379	797F818	392
778F345	377	780F245	377	785F158 Fin	385	790F998	379	797F828	390
778F395	377	780F335	377	785F168	385	790F998	379	797F828	392
778F405	377	780F345	377	785F178	385	791F51 x Fin	396	797F838	392
778F415	377	780F395	377	785F188	385	791F59	375	797F845	390
778F425	377	780F405	377	785F198	385	791F60	375	797F845	392
778F515	377	780F415	377	785F218 Fin	385	791F82 Fin	396	797F855	390
778F525	377	780F425	377	785F228	385	791F83 Fin	396	797F855	392
778F575	377	780F515	377	785F238	385	791F84 Fin	396	797F865	390
778F585	377	780F525	377	785F248	385	791F85 Fin	396	797F865	392
778F638	379	780F575	377	785F258	385	791F86 Fin	396	797F875	390
778F759	379	780F585	377	785F268 Fin	385	791F87 Fin	396	797F875	392
778F788	378	780F638	379	785F278	385	792F997	361	797F915	390
778F812	379	780F658	378	785F288	385	794F509	410	797F915	392
778F868	379	780F662	378	785F298	385	794F519	410	797F925	390
778F888	378	780F808	378	785F308	385	794F529	410	797F925	392
778F898	378	780F81 Fin	378	785F318 Fin	385	794F539	410	797F935	390
778F90 Fin	377	780F82 Fin	378	785F328	385	796F118	390	797F935	392
778F91 Fin	379	780F83 Fin	378	785F338	385	796F118	392	797F945	390
778F968	379	780F84 Fin	378	785F348	385	796F208	389	797F945	392
778F97 Fin	377	780F85 Fin	378	785F358	385	796F218	389	798F115	390
779F215	377	780F86 Fin	378	785F378 Fin	385	796F228	389	798F115	392
779F225	377	780F87 Fin	378	785F388 Fin	385	796F238	389	798F125	390
779F235	377	780F88 Fin	378	789F018	384	796F248	389	798F125	392
779F245	377	780F89 Fin	378	789F028	384	796F258	389	798F135	390
779F335	377	780F90 Fin	378	789F058	384	796F268	389	798F135	392
779F345	377	780F91 Fin	378	789F068	384	796F30 x Fin	396	798F145	390
779F395	377	780F92 Fin	378	789F228	384	796F318	389	798F145	392
779F405	377	780F93 Fin	378	789F859	410	796F328	389	798F155	390
779F415	377	780F94 Fin	378	789F869	410	796F338	389	798F155	392
779F425	377	780F95 Fin	378	789F879	410	796F358	389	798F165	390
779F515	377	780F96 Fin	378	789F929	410	796F368	389	798F165	392
779F525	377	783F048	401	790F047	366	796F378	389	798F175	390
779F575	377	783F06	400	790F208	379	796F378	391	798F175	392
779F585	377	783F208	385	790F215	377	796F388	389	798F185	390
779F638	378	783F308	385	790F225	377	796F398	389	798F185	392
779F648	378	783F408	385	790F225	377	796F398	389	798F215	392
779F658	378	785F008	385	790F235	377	796F398	391	798F225	392
779F728	378	785F018 Fin	385	790F245	377	796F408	389	798F235	392
779F738	378	785F028 Fin	385	790F245	377	796F408	391	798F245	392
779F748	378	785F038	385	790F335	377	796F43	396	798F255	392
779F758	378	785F048	385	790F345	377	796F46 x Fin	396	798F265	392
779F787	379	785F058	385	790F395	377	797F618	391	798F275	392
779F797	379	785F068	385	790F405	377	797F628	391	798F285	392
779F807	379	785F078 Fin	385	790F415	377	797F638	391	798F295	377
779F97 Fin	377	785F088	385	790F425	377	797F658	391	798F305	377
779F98 Fin	377	785F088	385	790F515	377	797F668	391	798F395	377
779F99 Fin	377	785F098	385	790F525	377	797F678	391	798F405	377
780F208	379	785F108	385	790F575	377	797F688	391	798K912 x Fin	360
780F215	377	785F118 Fin	385	790F585	377	797F698	391	798K922 x Fin	360

Part Number	Page	Part Number	Page	Part Number	Page	Part Number	Page	Part Number	Page
799F505	386	854F19	368	860F145	382	860F855	382	860N515	383
799F515	386	854F23	368	860F155	382	860F875	382	860N525	383
799F525	386	854F27	368	860F205	382	860F905	382	860N535	383
799F535	386	855F582 x Finish	372	860F215	382	860F915	382	860N545	383
799F545	386	855F592 x Finish	372	860F225	382	860F935	382	860N555	383
799F555	386	855F602 x Finish	372	860F235	382	860F955	382	860R005	383
799F565	386	855F619	372	860F245	382	860F965	382	860R015	383
799F575	386	855F638	372	860F255	382	860F985	382	860R025	383
799F585	386	855F649	372	860F265	382	860N005	383	860R035	383
799F595	386	855F658	372	860F275	382	860N015	383	860R045	383
799F605	387	855F697	372	860F285	382	860N025	383	860R055	383
799F615	387	855F707	372	860F295	382	860N035	383	860R065	383
799F625	387	855F717	372	860F305	382	860N045	383	860R075	383
799F635	387	855F727	372	860F315	382	860N055	383	860R085	383
799F645	387	855F737 x Finish	372	860F325	382	860N065	383	860R095	383
799F655	387	855F747 x Finish	372	860F335	382	860N075	383	860R105	383
799F665	387	855F757 x Finish	372	860F345	382	860N085	383	860R115	383
799F675	387	855F767 x Finish	372	860F355	382	860N095	383	860R125	383
799F685	387	856F049	372	860F405	382	860N105	383	860R135	383
799F695	387	858F241	372	860F415	382	860N115	383	860R145	383
799F805	386	858F251	372	860F425	382	860N125	383	860R155	383
799F815	386	858F261	372	860F435	382	860N135	383	860R205	383
799F825	386	858F271	372	860F445	382	860N145	383	860R215	383
799F835	386	858F281	372	860F455	382	860N155	383	860R225	383
799F845	387	858F291	372	860F465	382	860N205	383	860R235	383
799F855	387	858F497 x Finish	372	860F475	382	860N215	383	860R245	383
799F865	387	858F50M x Finish	372	860F485	382	860N225	383	860R255	383
799F875	387	858F517 x Finish	372	860F495	382	860N235	383	860R265	383
813F505	366	858F52M x Finish	372	860F505	382	860N245	383	860R275	383
820F008	365	858F53M x Finish	372	860F515	382	860N255	383	860R285	383
820F048	366	858F549	372	860F525	382	860N265	383	860R295	383
820F068	366	858F55M x Finish	372	860F535	382	860N275	383	860R305	383
820F078	366	859F052 x Finish	372	860F545	382	860N285	383	860R315	383
820F088	366	859F062 x Finish	372	860F555	382	860N295	383	860R325	383
820F148	365	859F072 x Finish	372	860F608	381	860N305	383	860R335	383
820F168	366	859F082 x Finish	372	860F618	381	860N315	383	860R345	383
852F307	366	859F092 x Finish	372	860F628	381	860N325	383	860R355	383
852F318	366	860F005	382	860F638	381	860N335	383	860R405	383
853F05	374	860F015	382	860F648	381	860N345	383	860R415	383
853F865	366	860F025	382	860F655	382	860N355	383	860R425	383
853F875	366	860F035	382	860F665	382	860N405	383	860R435	383
854F00	372	860F045	382	860F685	382	860N415	383	860R445	383
854F01	372	860F055	382	860F705	382	860N425	383	860R455	383
854F03	372	860F065	382	860F715	382	860N435	383	860R465	383
854F04	372	860F075	382	860F735	382	860N445	383	860R475	383
854F05	372	860F085	382	860F755	382	860N455	383	860R485	383
854F06	372	860F095	382	860F775	382	860N465	383	860R495	383
854F08	372	860F105	382	860F785	382	860N475	383	860R505	383
854F09	372	860F115	382	860F805	382	860N485	383	860R515	383
854F11	368	860F125	382	860F825	382	860N495	383	860R525	383
854F15	368	860F135	382	860F835	382	860N505	383	860R535	383

Part Number	Page	Part Number	Page	Part Number	Page	Part Number	Page	Part Number	Page
860R545	383	862F482	381	866F228	380	886F188	381		
860R555	383	862F978	381	866F238	380	886F198	381		
861F015	382	862F988	381	866F248	380	886F198	381		
861F035	382	862F998	381	866F258	380	886F208	381		
861F045	382	863F008	381	866F268	380	886F218	381		
861F065	382	863F018	381	866F278	380	886F228	381		
861F085	382	863F028	381	866F288	380	886F238	381		
861F095	382	863F038	381	866F298	380	886F248	381		
861F115	382	863F038	381	866F308	380	886F258	381		
861F135	382	863F048	381	866F318	380	886F268	381		
861F358	380	863F048	381	866F328	380	886F278	381		
861F368	380	863F058	381	866F338	380				
861F378	380	863F068	381	867F20	384				
861F388	380	863F078	381	867F21	384				
861F708	380	863F088	381	867F22	384				
861F718	380	863F108	381	867F23	384				
861F728 Fin	380	863F118	381	867F24	384				
861F738 Fin	380	864F107	366	867F25	384				
861F748 Fin	380	864F117	366	867F26	384				
861F758 Fin	380	864F568	381	867F27	384				
861F768 Fin	380	864F568	381	867F28	384				
861F778 Fin	380	864F578	381	867F29	384				
861F788 Fin	380	864F578	381	867F30	384				
861F798 Fin	380	865F199	384	867F31	384				
861F828 Fin	380	865F241	372	867F32	384				
861F838 Fin	380	865F251	372	867F33	384				
861F848	380	865F298	384	867F34	384				
861F858	380	865F308	384	867F35	384				
861F868	380	865F32 x Fin	384	867F36	384				
861F878	380	865F33 x Fin	384	867F37	384				
861F888 Fin	380	865F398	384	867F388	384				
861F898 Fin	380	866F028	380	867F70 Fin	384				
861F908 Fin	380	866F038	380	867F71 Fin	384				
861F918 Fin	380	866F048 Fin	380	867F72 Fin	384				
861F928	380	866F058 Fin	380	867F73 Fin	384				
861F938	380	866F068 Fin	380	867F74 Fin	384				
861F948	380	866F078 Fin	380	867F75 Fin	384				
861F958	380	866F088 Fin	380	881F460	394				
861F968	380	866F098 Fin	380	881F470	394				
861F978	380	866F108 Fin	380	881F480	394				
861F988	380	866F118 Fin	380	881F490	394				
861F998	380	866F128 Fin	380	885F860	381				
862F008	380	866F138 Fin	380	886F000	380				
862F018	380	866F148	380	886F010	380				
862F028	380	866F158	380	886F128	381				
862F038	380	866F168	380	886F138	381				
862F049	381	866F178	380	886F148	381				
862F049	381	866F188 Fin	380	886F158	381				
862F402	381	866F198 Fin	380	886F168	381				
862F412	381	866F208 Fin	380	886F178	381				
862F472	381	866F218 Fin	380	886F188	381				

For more information regarding Corbin Russwin Locksets, Exit Devices, Door Controls and Key Systems, contact your authorized Corbin Russwin Distributor or Sales Representative.

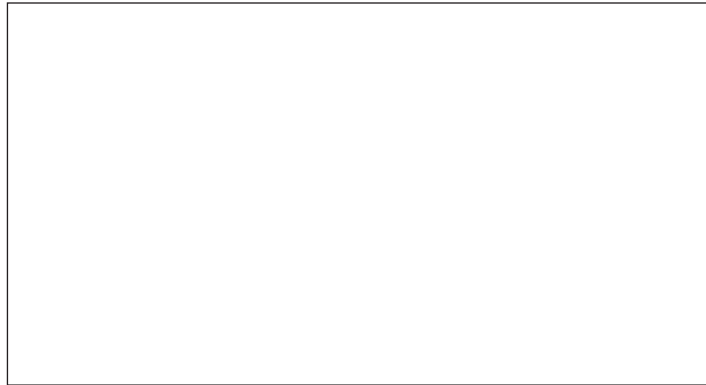

Corbin Russwin Architectural Hardware

225 Episcopal Road
Berlin, CT 06037
Phone 800-543-3658
Fax 800-447-6714
www.corbinrusswin.com

Notice: This price book takes precedence over the catalog as to the correctness and availability of items in our entire line.

Corbin Russwin and Design®, Corbin®, Russwin®, and Design® Access 800®, Muséo®, and SecureBolt® are registered trademarks of Corbin Russwin, Inc., an ASSA ABLOY Group company. Safeguard™, PathLite™ and Vineyard™ are trademarks of Corbin Russwin, Inc. an ASSA ABLOY Group company. Unitrol® is a registered trademark of Yale Security Inc., an ASSA ABLOY Group company. These materials are protected under US copyright laws. All contents current at time of publication. Corbin Russwin Inc., an ASSA ABLOY Group company reserves the right to change availability of any item in this catalog, its design, construction, and/or its materials. Other products' brand names may be trademarks or registered trademarks of their respective owners and are mentioned for reference purposes only.

Copyright © 2002-2023 Corbin Russwin, Inc., an ASSA ABLOY Group company. All rights reserved. Reproduction in whole or in part without the express written permission of Corbin Russwin, Inc. is prohibited.