

INVTMMETALS



NI 43-101 FEASIBILITY STUDY TECHNICAL REPORT

INV METALS INC.

LOMA LARGA PROJECT,
AZUAY PROVINCE, ECUADOR

Prepared For:
INV Metals Inc.

Prepared By:
DRA Americas Inc.
Effective Date: 11 January 2019
Report: J01834-PM-REP-002





CONTENTS

1	SUMMARY	16
1.1	SUMMARY AND CONCLUSIONS	16
1.2	RECOMMENDATIONS	35
2	INTRODUCTION.....	38
2.1	SOURCES OF INFORMATION	39
3	RELIANCE ON OTHER EXPERTS.....	41
4	PROPERTY DESCRIPTION AND LOCATION	42
4.1	LAND TENURE	42
5	ACCESS, CLIMATE, LOCAL RESOURCES, INFRASTRUCTURE AND PHYSIOGRAPHY	47
5.1	ACCESS, TRANSPORTATION AND LOGISTICS	47
5.2	CLIMATE	49
5.3	LOCAL RESOURCES	51
5.4	INFRASTRUCTURE	51
5.5	PHYSIOGRAPHY	52
6	HISTORY	53
7	GEOLOGICAL SETTING AND MINERALIZATION	55
7.1	REGIONAL GEOLOGY	55
7.2	LOCAL AND PROPERTY GEOLOGY	57
7.3	MINERALIZATION	60
8	DEPOSIT TYPES.....	64
9	EXPLORATION	67
10	DRILLING	68
10.1	IAMGOLD DRILLING	68
10.2	INV DRILLING	68
11	SAMPLE PREPARATION, ANALYSES AND SECURITY	75
11.1	PRE-2012 PROGRAMS	75
11.2	INV 2013 DRILL PROGRAM	77
11.3	RESULTS OF QA/QC PROGRAMS	78
12	DATA VERIFICATION	106
12.1	MANUAL DATABASE VERIFICATION	106
12.2	INDEPENDENT ASSAYS OF DRILL CORE	107
13	MINERAL PROCESSING AND METALLURGICAL TESTING.....	108
13.1	INTRODUCTION	108
13.2	HISTORICAL METALLURGICAL TESTWORK	108
13.3	TESTWORK FOR 2017 FEASIBILITY STUDY	109
13.4	SUPPLEMENTAL TESTWORK	141
13.5	RECOVERY ESTIMATES	142
13.6	METALLURGICAL VARIABILITY	145
13.7	DELETERIOUS ELEMENTS	145
14	MINERAL RESOURCE ESTIMATE.....	146
14.1	SUMMARY	146

14.2	MINERAL RESOURCE DATABASE	147
14.3	GEOLOGICAL INTERPRETATION AND 3D SOLID	147
14.4	STATISTICAL ANALYSIS	151
14.5	CAPPING HIGH GRADE VALUES	153
14.6	COMPOSITING	155
14.7	DENSITY	157
14.8	NSR CUT-OFF VALUE	160
14.9	VARIOGRAPHY AND INTERPOLATION VALUES	161
14.10	BLOCK MODEL	164
14.11	BLOCK MODEL VALIDATION	165
14.12	CLASSIFICATION	172
14.13	SUMMARY OF MINERAL RESOURCE ESTIMATE	176
14.14	SULPHUR MODEL	177
15	MINERAL RESERVE ESTIMATE	187
15.1	SUMMARY	187
15.2	DILUTION	187
15.3	ORE RECOVERY	188
15.4	GOLD EQUIVALENT CALCULATIONS	188
15.5	EQUIVALENT GOLD	189
16	MINING	190
16.1	INTRODUCTION	190
16.2	MINING METHODS	192
16.3	GEOTECHNICAL CONSIDERATIONS	195
16.4	UNDERGROUND MINE DEVELOPMENT	204
16.5	PRODUCTION SCHEDULE	211
16.6	DRILLING AND BLASTING	216
16.7	MINE EQUIPMENT	218
16.8	MINE VENTILATION	223
16.9	PASTE BACKFILL	241
16.10	UNDERGROUND HYDROGEOLOGY CONSIDERATIONS	247
16.11	UNDERGROUND SERVICE FACILITIES	248
16.12	MINE SURFACE FACILITIES	257
17	RECOVERY METHODS	260
17.1	INTRODUCTION	260
17.2	PROCESS FLOW SHEET	260
17.3	PLANT DESIGN	263
17.4	PRODUCTION SUMMARY	264
17.5	ENERGY, WATER AND PROCESS MATERIAL REQUIREMENTS	266
18	PROJECT INFRASTRUCTURE.....	268
18.1	SUMMARY	268
18.2	TRANSMISSION LINE AND SITE POWER DISTRIBUTION	270
18.3	ROADS	270
18.4	BUILDINGS	271
18.5	COMMUNICATIONS	272

18.6	FILTERED TAILINGS STORAGE FACILITY	272
18.7	WASTE ROCK	275
18.8	WATER AND OTHER LIQUID EFFLUENT HANDLING	275
18.9	WASTE WATER TREATMENT PLANT	276
18.10	GARBAGE, HAZARDOUS & OTHER WASTE	278
18.11	TRANSPORTATION AND LOGISTICS	281
19	MARKET STUDIES AND CONTRACTS.....	282
19.1	MARKETS	282
19.2	CONTRACTS	283
20	ENVIRONMENTAL STUDIES, PERMITTING, AND SOCIAL OR COMMUNITY IMPACT..	284
20.1	INTRODUCTION	284
20.2	PROJECT PERMITTING AND ENVIRONMENTAL ASSESSMENT	284
20.3	ENVIRONMENTAL STUDIES	297
20.4	SOCIAL OR COMMUNITY REQUIREMENTS	315
20.5	SOCIAL MANAGEMENT POLICIES AND PROCEDURES	321
20.6	MINE CLOSURE REQUIREMENTS	321
21	CAPITAL AND OPERATING COSTS.....	326
21.1	CAPITAL COST ESTIMATE	326
21.2	OPERATING COST ESTIMATE	344
22	ECONOMIC ANALYSIS.....	362
22.1	ECONOMIC CRITERIA	362
22.2	CASH FLOW ANALYSIS AND ECONOMIC RESULTS	367
22.3	SENSITIVITY ANALYSIS	369
23	ADJACENT PROPERTIES.....	371
24	OTHER RELEVANT DATA AND INFORMATION	372
24.1	EXECUTION PLAN	372
24.2	RISK	382
24.3	POWER LINE	384
24.4	TRANSPORTATION AND LOGISTICS	384
24.5	ACCESS ROAD	384
24.6	ENVIRONMENTAL PERMITTING	384
25	INTERPRETATION AND CONCLUSIONS	385
25.1	PROPERTY DESCRIPTION AND LOCATION	385
25.2	ACCESS, CLIMATE, LOCAL RESOURCES, INFRASTRUCTURE AND PHYSIOGRAPHY	385
25.3	GEOLOGY AND MINERAL RESOURCES	385
25.4	MINERAL RESERVE ESTIMATE AND MINING METHODS	386
25.5	MINERAL PROCESSING AND METALLURGICAL TESTING	386
25.6	RECOVERY METHODS	386
25.7	PROJECT INFRASTRUCTURE	387
25.8	ENVIRONMENTAL STUDIES, PERMITTING AND SOCIAL OR COMMUNITY IMPACT	387
25.9	CAPITAL COSTS	388
25.10	OPERATING COSTS	391
25.11	ECONOMIC ANALYSIS	392

	Document Number	J01834-PM-REP-002	Rev	0	
	Date	11 January 2019	Page	5 of 417	

26	RECOMMENDATIONS	393
26.1	PROPERTY DESCRIPTION AND LOCATION	393
26.2	ACCESS, CLIMATE, LOCAL RESOURCES, INFRASTRUCTURE AND PHYSIOGRAPHY	393
26.3	GEOLOGY AND MINERAL RESOURCES	393
26.4	MINERAL RESERVE ESTIMATE	393
26.5	MINING METHODS	394
26.6	MINERAL PROCESSING AND METALLURGICAL TESTING	395
26.7	PROJECT INFRASTRUCTURE	396
26.8	ENVIRONMENTAL STUDIES, PERMITTING AND SOCIAL OR COMMUNITY IMPACT	396
26.9	MARKET STUDIES AND CONTRACTS	396
26.10	OTHER RELEVANT DATA AND INFORMATION	396
27	REFERENCES.....	397
28	DATE AND SIGNATURE PAGE.....	405
29	CERTIFICATE OF QUALIFIED PERSONS	406

LIST OF TABLES

Table 1-1: Mineral Resource Estimate Summary – October 31, 2018	22
Table 1-2: Loma Larga Mineral Reserves estimate as of October 31, 2018	24
Table 1-3: Smelter Terms	27
Table 1-4: Capital Cost Summary	29
Table 1-5: Initial Capital Estimate Summary by Discipline	30
Table 1-6: Summary of Sustaining Capital Cost	30
Table 1-7: Project Life-of-Mine Operating Costs by Major Area	31
Table 1-8: Bulk Quantity Summary	34
Table 2-1: List of QPs	40
Table 4-1: Initial IAMGOLD Mining Concessions (INV Metals Inc. – Loma Larga Project)	42
Table 4-2: Property Size for Advanced Exploration Stage	42
Table 4-3: Current Surface Rights Agreements (INV Metals Inc. – Loma Larga Project)	45
Table 5-1: Estimated Mean Monthly and Annual Site Precipitation at Loma Larga Site (NewFields, 2018)	49
Table 5-2: Mean Monthly Potential Evaporation Estimates at Loma Larga Site (NewFields, 2018)	51
Table 10-1: Metallurgical and High-Grade Zone Drill Results	69
Table 10-2: Geotechnical and Hydrogeological Drill Holes Completed in 2016 - 2017	70
Table 10-3: Selected Drill Results from the 2017 Geotechnical and Hydrogeological Drilling	70
Table 10-4: Summary of 2017 Loma Larga Drill Program	73
Table 10-5: 2017 Selected Loma Larga Drill Program Results	74
Table 11-1: QA/QC Review Summary – 2013 Drilling Program	81
Table 11-2: CRMs Used In 2013 Drilling Program	82
Table 11-3: Summary of CRM Results	83
Table 11-4: Summary of Field Duplicate Results	86
Table 11-5: Summary of Reject Duplicate Results	88
Table 11-6: Summary of Pulp Duplicate Results	90
Table 11-7: Summary of Pulp Replicate Results	91
Table 11-8: Summary of the 2016-2017 Drilling Program	93
Table 11-9: QA/QC Review Summary – 2017 Drilling Program	93
Table 11-10: CRMs Used In 2017 Drilling Program	94
Table 11-11: Summary of CRM Results	95
Table 11-12: Summary of Reject Duplicate Results	99
Table 11-13: Summary of Pulp Duplicate Results	102
Table 12-1: Drill Hole Collar Elevation Errors	107
Table 13-1 Ore Type Categories	111
Table 13-2: Head Sample Assays and Mineralogical Data	113
Table 13-3: 2017/18 Ore Hardness Testing	114
Table 13-4: Bulk Circuit Rougher and Cleaner Variability Test Results	117
Table 13-5: Overall Bulk Cleaner Results to Copper Concentrate	119
Table 13-6: LCT # 2 Recovery to Bulk Second Cleaner Concentrate	119
Table 13-7: LCT #1 Test Conditions	128
Table 13-8: LCT #1 Stream Assays	130
Table 13-9: LCT #1 Overall Recoveries	130
Table 13-10: LCT #1 Staged Recoveries	130
Table 13-11: LCT #2 Test Conditions	132
Table 13-12: LCT #2 Stream Assays	132
Table 13-13: LCT #2 Overall Recoveries	132
Table 13-14: LCT #2 Staged Recoveries	132
Table 13-15: LCT #3 Sample Head Grade	135
Table 13-16: LCT #3 Test Conditions	135
Table 13-17: LCT #3 Stream Balanced Data	136
Table 13-18: LCT #3 Overall Recoveries Balanced Data	136
Table 13-19: LCT #3 Stage Recoveries Balanced Data	136
Table 13-20: LCT #4 Sample Head Grade – 5 Year Composite	137



	Document Number	J01834-PM-REP-002	Rev	0	
	Date	11 January 2019	Page	7 of 417	

Table 13-21: LCT #4 Test Conditions	139
Table 13-22: LCT #4 Stream Assays – Balanced Data	139
Table 13-23: LCT #4 Overall Recoveries – Balanced Data	140
Table 13-24: LCT #4 Stage Recoveries – Balanced Data	140
Table 13-25: SFR (PP-01) vs. Average Bench Flotation Performance	141
Table 13-26: Deleterious Elements Recovery to Copper Concentrate	145
Table 13-27: Deleterious Elements Recovery to Pyrite Concentrate	145
Table 14-1: Mineral Resource Estimate Summary – October 31, 2018	146
Table 14-2: Mineral Resource Database	147
Table 14-3: Rock Codes	148
Table 14-4: Descriptive Statistics of Resource Assay Values	152
Table 14-5: Capped Grade Values of Resource Assays	153
Table 14-6: Descriptive Statistics of Resource Capped Assay Values	154
Table 14-7: Descriptive Statistics of Resource Capped Composite Values	156
Table 14-8: Descriptive Statistics of Resource Density Values	157
Table 14-9: Descriptive Statistics of Composited Density Samples	160
Table 14-10: Cut-Off Value Assumptions	160
Table 14-11: Block Estimation Parameters	162
Table 14-12: Block Model Dimensions	164
Table 14-13: Block Model Field Descriptions	164
Table 14-14: Comparison of Grade Statistics for Assays, Composites and Resource Blocks	166
Table 14-15: Mineral Resource Estimate – October 31, 2018	177
Table 14-16: Sulphur Database used for Block Grade Estimation	178
Table 14-17: Descriptive Statistics of Geochemistry Resource Assay Values	180
Table 14-18: Descriptive Statistics of Sulphur Composite Values	182
Table 14-19: Sulphur Block Estimation Parameters	183
Table 14-20: Descriptive Statistics of Sulphur Block Values	184
Table 15-1: Loma Larga Mineral Reserves estimate as of October 31, 2018	187
Table 15-2: Loma Larga NSR Cut-off Parameters	189
Table 16-1: MSO Parameters for Transverse Longhole Stope Design	193
Table 16-2: Summary of Rock Mass Classification Statistics	196
Table 16-3: Summary of Joint Set Orientations (Dip/Dip Dir'n, in degrees)	196
Table 16-4: Percentage of Each Support Category (5 m Spans) by Alteration for Permanent Openings	200
Table 16-5: Ramp Development Schedule	213
Table 16-6: Pre-Production (Ramp-up) Phase	213
Table 16-7: Ore Stockpiling During Pre-Production Phase	214
Table 16-8: Detailed Mine Schedule	215
Table 16-9: Major Mine Mobile Equipment	222
Table 16-10: Auxiliary Mobile Mine Equipment	223
Table 16-11: Design Velocities and Quantities	226
Table 16-12: Friction Factors	226
Table 16-13: Leakage	227
Table 16-14: Development Ventilation	227
Table 16-15: Diesel Equipment Utilization	227
Table 16-16: Diesel Fleet	228
Table 16-17: Surface Ambient Design Conditions	228
Table 16-18: Virgin Rock Temperatures	229
Table 16-19: Thermal Criteria	229
Table 16-20: Summary of Airborne Pollutants OEL	230
Table 16-21: Maximum Time of Exposure	230
Table 16-22: Ventilation Requirement Start of Stope Development	233
Table 16-23: Ventilation Requirement, Near North Ventilation Raise Operational	234
Table 16-24: Ventilation Requirement, Near South Ventilation Raise Operational	235
Table 16-25: Ventilation Requirement, Far North Ventilation Raise Operational	236



	Document Number	J01834-PM-REP-002	Rev	0	
	Date	11 January 2019	Page	8 of 417	

Table 16-26: Ventilation Requirement, Full Ventilation System Operational	237
Table 16-27: Underground Water Supply for Ramp and Pre-Production Development	248
Table 16-28: Underground Water Supply for Full Production	248
Table 16-29: Underground Electrical Equipment List and Consumption	252
Table 17-1: Summary Process Design Criteria	263
Table 17-2:Loma Larga LOM Process Plant Production Plan	265
Table 18-1: Elevation – Tailings Storage Capacity	274
Table 18-2 Annual Contact Water Volumes Requiring Treatment (Mm ³ /year)	276
Table 18-3 Expected Water Quality and Anticipated Discharge Limits	277
Table 19-1: Smelter Terms	283
Table 20-1: Main Permitting requirements for the Loma Larga Project	287
Table 20-2 Summary of Environmental Studies Conducted on the Loma Larga Concessions (Rio Falso, Cerro Casco and Cristal) from 2003 to 2018	298
Table 21-1: Capital Cost Summary	326
Table 21-2: Initial Capital Estimate Summary by Discipline	327
Table 21-3: Summary of Sustaining Capital Cost	327
Table 21-4: Summary of Closure Costs	328
Table 21-5: Summary of Mine Capital Cost	328
Table 21-6: Summary of Process Plant Capital Cost Estimate	330
Table 21-7: Summary of Waste Management Capital Cost Estimate	330
Table 21-8: Summary of Plant Infrastructure Capital Cost Estimate	330
Table 21-9: Summary of Off-Site Infrastructure Capital Cost Estimate	331
Table 21-10: Summary of Project Indirect Capital Cost Estimate	331
Table 21-11: Capital Cost Estimate Basis	333
Table 21-12: Bulk Commodity Quantities for Process Plant	334
Table 21-13: Bulk Quantity Summary	334
Table 21-14: Pricing Source Breakdown	335
Table 21-15: Foreign Exchange Rates	335
Table 21-16: Project Life-of-Mine Operating Costs by Major Area	344
Table 21-17: Mining Labour Complement –Management	347
Table 21-18: Mining Labour Complement – Operations	347
Table 21-19: Mining Labour Complement – Maintenance	348
Table 21-20: Draw Point Development – Mining Labour Cost	348
Table 21-21: Stope Production – Mining Labour Cost	348
Table 21-22: Mining Equipment Cost Distribution	349
Table 21-23: Mining Equipment Cost – Component	350
Table 21-24: Draw Point Development – Mining Material Cost	351
Table 21-25: Stope Production – Mining Material Cost	351
Table 21-26: Mining Operating Cost Summary	353
Table 21-27: Process Plant Labour Complement and Cost	353
Table 21-28: Process Plant Electrical Consumption and Cost	355
Table 21-29: Process Plant Reagents and Cost	355
Table 21-30: Process Plant Grinding Media and Cost	356
Table 21-31: Crusher and Mill Liner Costs	357
Table 21-32: Process Plant Maintenance Costs	357
Table 21-33: Overall Process Plant Operating Cost	358
Table 21-34: Backfill Plant Operating Costs	358
Table 21-35: Tailings Disposal Costs	359
Table 21-36: Overall G&A Costs	359
Table 21-37: G&A Labour Complement and Cost	360
Table 21-38: G&A Costs – Corporate	360
Table 21-39: G&A Costs – Site Office Costs	361
Table 21-40: G&A Costs – Mine Support Costs	361
Table 22-1: Base Case Financial Results	362



	Document Number	J01834-PM-REP-002	Rev	0	
	Date	11 January 2019	Page	9 of 417	

Table 22-2: Production Rates	362
Table 22-3: Metal Prices	363
Table 22-4: Concentrate Transport	363
Table 22-5: LOM Operating Costs	363
Table 22-6: LOM Capital Expenditure	364
Table 22-7: Loma Larga Project Financial Results	367
Table 22-8: Cash Flow Statement – Base Case	368
Table 22-9: Gold Price Sensitivity	370
Table 24-1: Loma Larga Key Milestones – Project	374
Table 24-2: Loma Larga- Lead Time Long Lead Equipment	375
Table 24-3: Major Construction Contracts – Bid in Feasibility Study	379
Table 24-4: Bulk Quantity Summary	381
Table 24-5: Bulk Commodity Quantities for Process Plant	381
Table 24-6: Loma Larga – Feasibility Study Risk Register – Major Risks	383
Table 25-1: Capital Cost Summary	389
Table 25-2: Initial Capital Estimate Summary by Discipline	390
Table 25-3: Summary of Sustaining Capital Cost	390
Table 25-4: Project Life-of-Mine Operating Costs by Major Area	391

LIST OF FIGURES

Figure 1-1: Project Life-of-Mine Unit Operating Costs	31
Figure 1-2: Loma Larga Level 1 Schedule – Project	33
Figure 4-1: Loma Larga Project and Natural Protected Areas	44
Figure 5-1: Route options between Guayaquil and Girón	48
Figure 7-1: Major Terranes of Ecuador	56
Figure 7-2: Regional Geology	57
Figure 7-3: Property Geology	59
Figure 7-4: Cross Section of the Loma Larga Deposit, Looking Northeast	61
Figure 7-5: Longitudinal Section of the Loma Larga Deposit, Looking East	62
Figure 8-1: Zonation of Alteration in a High Sulphidation Deposit	65
Figure 8-2: Schematic Section of a High Sulphidation Deposit	66
Figure 10-1: Location of INV 2016-2017 Drill Holes in 3D Isometric View	71
Figure 10-2: Location of 2016-2017 Loma Larga Drill Holes in 3D Isometric View	72
Figure 11-1: Gold Control Chart for 2013 Drilling: CRM SG14	84
Figure 11-2: Gold Control Chart for 2013 drilling: CRM SI15	84
Figure 11-3: Gold Control Chart for 2013 drilling: CRM SN16	85
Figure 11-4: Gold Field Duplicate Scatterplot	87
Figure 11-5: Gold Reject Duplicate Scatterplot	89
Figure 11-6: Gold Pulp Duplicate Scatterplot	90
Figure 11-7: Gold Pulp Replicate Scatterplot	92
Figure 11-8: Gold Control Chart: CRM SG66	95
Figure 11-9: Gold Control Chart: CRM SI15	96
Figure 11-10: Gold Control Chart: CRM SJ63	96
Figure 11-11: Gold Control Chart: CRM SN16	97
Figure 11-12: Gold Control Chart: CRM SN60	97
Figure 11-13: Gold Reject Duplicate Scatterplot	100
Figure 11-14: Silver Reject Duplicate Scatterplot	100
Figure 11-15: Copper Reject Duplicate Scatterplot	101
Figure 11-16: Gold Pulp Duplicate Scatterplot	103
Figure 11-17: Silver Pulp Duplicate Scatterplot	103
Figure 11-18: Copper Pulp Duplicate Scatterplot	104
Figure 13-1: Drill Hole Locations and Ore Types	112
Figure 13-2: Bulk Cleaner Assay Reject Samples – SFR Bulk Concentrates	118
Figure 13-3: Copper Rougher Variability Results	123
Figure 13-4: Pyrite Rougher Variability Results	123
Figure 13-5: Copper Cleaner – Copper Grade vs Recovery	125
Figure 13-6: Copper Cleaner – Arsenic Grade vs Recovery	125
Figure 13-7: Copper Cleaner Gold Grade vs Recovery	126
Figure 13-8: Copper Concentrate Sulphur Grade vs Recovery	126
Figure 13-9: LCT #1 Flowsheet	129
Figure 13-10: Loma Larga 2017 Metallurgical Testing Program LCT #2 Flowsheet	131
Figure 13-11: LCT #3 Flowsheet	134
Figure 13-12: LCT #4 Flowsheet	138
Figure 13-13: Metallurgical Data and Model for Copper Recovery and Concentrate Grade	143
Figure 13-14: Gold Department to Copper Concentrates	144
Figure 14-1: 2018 versus 2016 Wireframe Domains in Plan View (3,600 m Level)	150
Figure 14-2: 3D View of 2018 High Grade (2.0 g/t Au) and Low Grade (0.8 g/t Au) Wireframe Domains, Looking Northeast.	151
Figure 14-3: 3D View of 2018 High Grade (2.0 g/t Au) and Low Grade (0.8 g/t Au) Wireframe Domains, Looking West.	151
Figure 14-4: Histogram of Resource Density Samples	158
Figure 14-5: Box Plot of Resource Density Samples by Domain	159
Figure 14-6: High Gold Grade and Classification of Selected Block in the Low Grade Lower Zone	167



	Document Number	J01834-PM-REP-002	Rev	0	
	Date	11 January 2019	Page	11 of 417	

Figure 14-7: Capped Gold Composites and Blocks on 3,600 m Level	168
Figure 14-8: Capped Silver Composites and Blocks on 3,600 m Level	169
Figure 14-9: Capped Copper Composites and Blocks on 3,600 m Level	170
Figure 14-10: High Grade Main Zone Trend Plots and Histograms of Capped Gold Assays versus Block Grades	171
Figure 14-11: Low Grade Main Zone Trend Plots and Histograms of Capped Gold Assays versus Block Grades	172
Figure 14-12: Plan View of Block Classification on the 3,600 m Level.	174
Figure 14-13: Cumulative Histogram of Distance to Nearest Sample Grouped by Class	175
Figure 14-14: 3D Isometric View of Drill Holes with Sulphur Data	179
Figure 14-15: Assay Histograms for Sulphur	181
Figure 14-16: Sulphur Composites and Blocks on 3,600 m Level	186
Figure 16-1: Loma Larga Deposit, Portal and Main Surface Infrastructure	191
Figure 16-2: Loma Larga Mine Layout	192
Figure 16-3: Primary and Secondary Transverse Longhole Stopes	194
Figure 16-4: Drift and Fill Method	195
Figure 16-5: Ground Support for 1.2 m x 1.2 m Pattern	198
Figure 16-6: Ground Support for 3 and 4-way Intersections	199
Figure 16-7: Large-Scale Structural Features	204
Figure 16-8: Portal Layout	205
Figure 16-9: Portal 3D View	206
Figure 16-10: Haulage Ramp General Arrangement with 40-ton Truck	207
Figure 16-11: Level Access General Arrangement with 40-ton Truck	208
Figure 16-12: Drawpoints and Drilling Drift General Arrangement	209
Figure 16-13: Loading Station - Plan View	210
Figure 16-14: Main Haulage Ramp and Main Haulage Drift Blast Drilling Pattern	217
Figure 16-15: Drawpoint Drift Blast Drilling Pattern	218
Figure 16-16: Main Ventilation Infrastructure	224
Figure 16-17: Extraction Profile	226
Figure 16-18: Fan Pressure Requirements Main Ramp	231
Figure 16-19: Ramp Ventilation Requirements to Meet Mine Development Schedule	232
Figure 16-20: Development of Multiple Ends as per the Mining Schedule	232
Figure 16-21: Start of Stope Development	234
Figure 16-22: Near North Ventilation Raise Operational	234
Figure 16-23: Near South Ventilation Raise Operational	235
Figure 16-24: Far North Ventilation Raise Operational	236
Figure 16-25: Full Ventilation System Operational	237
Figure 16-26: Main Fan Curve	240
Figure 16-27: Binder Estimate (28 Day Target Strength)	243
Figure 16-28: Paste Plant Site Plan (including Paste Plant and Process Plant Location)	244
Figure 16-29: Schematic Diagram of Underground Workings – Pipeline Profile (Plan View)	246
Figure 16-30: Schematic Diagram of Underground Workings – Pipeline Profile (Mine Elevation)	247
Figure 16-31: Mine Water Balance	251
Figure 16-32 : Electrical Single Line Drawing	253
Figure 16-33: Level 3,600 Power Distribution	255
Figure 16-34: Level 3,625 Power Distribution	256
Figure 16-35: Surface Facilities	259
Figure 17-1: Simplified Overall Process Flow Diagram	262
Figure 18-1: Overall Site Layout	269
Figure 18-2: FTSF Site Layout	273
Figure 18-3: Landfill Plan View and Sections and Details	279
Figure 20-1 Historical and Existing Hydro-meteorological, Air Quality and Ambient Noise Baseline and Monitoring Locations	301



	Document Number	J01834-PM-REP-002	Rev	0	
	Date	11 January 2019	Page	12 of 417	

Figure 20-2: Historical and Existing Water Quality, Effluent, Fish and Macroinvertebrate Baseline and Monitoring Locations	307
Figure 20-3: Historical and Existing Mammal, Bird, Entomological and Herpetological Baseline and Monitoring Locations	311
Figure 20-4: Historical and Existing Vegetation and Soil Quality Baseline and Monitoring Locations	313
Figure 20-5: Areas of Social Influence of the Loma Larga Project	317
Figure 21-1: Project Life-of-Mine Unit Operating Costs	345
Figure 21-2: Mining Labour Costs by Category and Activity	346
Figure 21-3: Mining Equipment Costs (Direct and Indirect Costs)	349
Figure 21-4: Mining Material Costs	350
Figure 21-5: Mining Support Equipment Maintenance and Power Costs	352
Figure 21-6: Reagent and Grinding Media Cost Contribution	356
Figure 22-1: After-Tax Cash Flow and Cumulative Cash Flow Profiles	367
Figure 22-2: Pre-Tax NPV and IRR Sensitivity	369
Figure 22-3: After-Tax NPV and IRR Sensitivity	370
Figure 24-1: Loma Larga Level 1 Schedule – Project	373
Figure 24-2: Project Management Organization Chart	377
Figure 25-1: Project Life-of-Mine Unit Operating Costs	391

LIST OF ABBREVIATIONS

Units of measurement used in this report conform to the metric system. All Currency in this report is US Dollars (US\$) unless otherwise noted.

GENERAL	
µg/m ³	microgram per cubic metre
µm	microns, micrometer
\$	Dollar
\$/m ²	Dollar per square metre
\$/m ³	Dollar per cubic metre
\$/t	Dollar per metric tonne
%	Percent Sign
% w/w	Percent solid by weight
¢/kWh	cent per Kilowatt hour
°	Degree
°C	degree celsius
2D	Two Dimensions
3D	Three Dimensions
A	
AACEI	Association for the Advancement of Cost Engineering
ABA	acid base accounting
ADI	Area of Direct Influence
Ag	Silver
AI	Abrasion Index
All	Area of Indirect Influence
AMSL	above mean sea level
ANFO	Ammonium nitrate and fuel oil
ASL	Above Sea Level
Au	Gold
AWG	American Wire Gauge
B	
BESIA	Bankable Environmental and Social Impact Assessment
BSG	Bulk Specify Gravity
BWI	Bond Ball Mill Work Index and Bond Work Index
C	
CAD\$	Canadian Dollar
CAPEX	Capital Expenditures
cfm	cubic feet per minute
CIF	Cost Insurance and Freight
CIL	Carbon in Leach
CIM	Canadian Institute of Mining, Metallurgy and Petroleum
CIP	Carbon in Pulp or Carriage and Insurance Paid
cm	Centimeter
COA	Certificate of Analysis
CofA	Certificate of Authorization
COP	Code of Practice
COPC	Constituents of potential concern
COV	Coefficient of Variation
CRM	Certified Reference Material
Cu	Copper
CWI	Crusher Work Index
D	
d	day
DCF	Discounted cash flow
DWT	Drop Weight Test



E	
E	East
EHS	Environment Health and Safety
EIA	Environmental Impact Assessment
EIS	Environmental Impact Statement
EPA	Environmental Protection Agency
EPCM	Engineering, Procurement and Construction Management
ESIA	Environmental and Social Impact Assessment
F	
Fe	Iron
FS	Feasibility Study
ft	feet
FRB	FIDIC Red Book
FTSF	Filtered tailings storage facility
G	
g	Grams
G&A	General and Administration
g/t	grams per tonne
GEMS	Global Earth-System Monitoring Using Space
GT	Geotechnical
GWH	Gigawatt hour
H	
H	Horizontal
h	Hour
HAZOP	Hazard and Operability
H ₂	Hydrogen
HCTs	Humidity cell tests
HDPE	High Density Polyethylene
HF	Hydrofluoric Acid
HP	horse power
HQ	Drill Core Size (6.4 cm diameter)
HSE	Health, Safety and Environmental
I	
I/O	Input / Output
IFC	International Finance Corporation
INVE	INV Minerales Ecuador S.A.
IRR	Internal Rate of Return
ITH Drill	In-the-Hole Drill
IUCN	International Union for Conservation of Nature
K	
kg	Kilogram
kg/t	kilogram per metric tonne
km	Kilometer
km/h	kilometre per hour
kPa	Kilopascal
kV	Kilovolt
kW	Kilowatt
kWh	kilowatt-hour
kWh/t	kilowatt-hour per metric tonne

L	
L	Litre
L/s	Litres per second
Lb(s)	Pound(s)
LCRS	Leak collection recovery system
LCT	Locked Cycle Test
LHD	Load-Haul-Dump (truck)
LOM	Life of Mine
LOTO	Lock-out and tag-out
M	
M	Million
m	Metre
m \emptyset	metre diameter
m/h	metre per hour
m/s	metre per second
m ²	square metre
m ³	cubic metre
m ³ /d	cubic metre per day
m ³ /h	cubic metre per hour
m ³ /s	Cubic metre per second
m ³ /y	cubic metre per year
MAE	Ministry of Environment and Water in Azuay
MCC	Motor Control Centre
MEL	Mechanical equipment list
MIBC	Methyl Isobutyl Carbinol
min	Minute
min/h	minute per hour
min/shift	minute per Shift
mL	Millilitre
mm	Millimetre
MOU	Memorandum of Understanding
MSO	Mining stope optimizer
Mt	Million metric tonnes
MTOP	Ministerio de Transporte y Obras Publicas (Ministry of Transportation)
MV	Medium Voltage
MVA	Mega Volt-Ampere
MW	Megawatts
N	
N	North
NAG	Non-Acid Generating
NE	Northeast
NI	National Instrument
NNP	Net neutralization potential
No.	Number
NPV	Net Present Value
NQ	Drill Core Size (4.8 cm diameter)
NSR	Net Smelter Return
NW	Northwest
O	
OCIP	Owner-controlled insurance program
OEL	Occupational exposure limits
OEM	Original Equipment Manufacturers
OK	Ordinary Kriging
OPEX	Operating Expenditures
OSA	On-stream analysis
oz	ounce (troy)

P	
Pa	Pascal
PAG	Potential Acid Generating
PAX	Potassium Amyl Xanthate
PCD	Process control diagram
PEA	Preliminary Economic Assessment
PFD	Process flow diagram
PFS	Pre-Feasibility Study
PIMA	Portable infrared mineral analyzer
pH	Measure of acidity
PLC	Programmable Logic Controllers
POF	Probability of failure
POP	Procurement Operating Plan
PP	Preproduction
ppb	part per billion
ppm	part per million
Q	
QA/QC	Quality Assurance/Quality Control
QP	Qualified Person
R	
RBH	Raisebore hole
RMR	Rock Mass Rating
ROM	Run of Mine
RWI	Bond Rod Mill Work Index
S	
S	South
S	Sulfur
SAG	Semi-Autogenous Grinding
SCADA	Supervisory Control and Data Acquisition
SE	Southeast
s	Second
SFR	Staged Flotation Reactors
SGS	SGS Lakefield Research Limited of Canada
SLIP	Supplementary lenders information package
SMC	SAG Mill Comminution
SPI	SAG Power Index
SQCP	Site Quality Control Plan
SUIA	Unique system of environmental information
SW	Southwest
T	
t or tonne	metric tonne
t/d	metric tonne per day
t/h	metric tonne per hour
t/h/m	metric tonne per hour per metre
t/h/m ²	metric tonne per hour per square metre
t/m	metric tonne per month
t/m ²	metric tonne per square metre
t/m ³	metric tonne per cubic metre
ton	Short ton
TOR	Terms of Reference
tpa	metric tonnes per annum (year)
TSF	Tailings storage facility
TWA	Time weighted average
U	
UBR	Unified basic remuneration
US\$	United States Dollar

V	
V	Volt
VAT	Value added tax
VFD	Variable Frequency Drive
VRTs	Virgin rock temperatures
VSD	Variable speed drives
W	
W	Watt
W	West
w/w	Weight per weight
WBS	Work breakdown structure

WHO	World Health Organization
WMS	Western Mining Services
wt	wet metric tonne
WTP	Water treatment plant
WWTP	Waste water treatment plant
X	
XRD	X-Ray Diffraction
Y	
y	Year

	Document Number	J01834-PM-REP-002	Rev	0	
	Date	11 January 2019	Page	16 of 417	

1 SUMMARY

INV Metals Inc. (INV) is a Canadian mineral resource company headquartered in Toronto, focused on the acquisition, exploration and development of its 100% interest in the Loma Larga gold-copper-silver project, and its regional exploration properties, located in Ecuador. INV is listed on the Toronto Stock Exchange under the symbol INV.

INV retained DRA Americas Inc. (DRA); Roscoe Postle Associates Inc. (RPA); Mine Design Engineering Inc. (MDEng); Itasca Denver Inc. (Itasca); Environmental Resources Management (ERM); NewFields; Paterson & Cooke Canada Inc. (P&C); and SGS Canada Inc. to prepare a Feasibility Study (FS or the Study) for the Loma Larga gold-copper-silver Project (the Project), located in Ecuador. This technical report was prepared for INV to summarize the results of the FS. This report was prepared in compliance with the disclosure requirements of the Canadian National Instrument 43-101 (NI 43-101) Standards of Disclosure for Mineral Projects.

The Loma Larga Project supports conventional mining methods and proven processing technologies. The regional infrastructure will reasonably support all phases of the project. INV is committed to execute all phases of the Project in a socially responsible and environmentally sustainable manner. The underground mine and related processing infrastructure have been designed to minimize the footprint with an estimated disturbance area of less than 80 hectares at the Project site. The process plant design, the use of paste backfill, and a filtered tailings disposal method will recover water for re-use in processing to minimize the use of water and reduce treated water discharge.

INV plans to break ground in early 2020, with the goal of achieving first gold concentrate production in late 2021. It is anticipated that the Project investment will provide positive social and economic impacts locally and nationally, including new employment, training, procurement and business opportunities throughout the region, from construction through to operations.

1.1 SUMMARY AND CONCLUSIONS



1.1.1 PROPERTY DESCRIPTION AND LOCATION

INV obtained 100% title to the Loma Larga property by acquiring IAMGOLD's Ecuadorian subsidiary in November 2012. INV maintains three mining concessions in good standing for a total area of 7,960 hectares. In addition to the mining concessions, INV holds two areas of surface rights that are maintained in good standing.

A strategy for land acquisition and land access for the Project's linear components, the power transmission line and access road, will be implemented. There are no land acquisition requirements for the mine infrastructure given that INV already has concession rights on the area where the mining facilities will be located.

1.1.2 ACCESS, CLIMATE, LOCAL RESOURCES, INFRASTRUCTURE AND PHYSIOGRAPHY

The current regional and national infrastructure is adequate to access the Project site through well established network of existing major ports and roadways. The road between San

	Document Number	J01834-PM-REP-002	Rev	0	
	Date	11 January 2019	Page	17 of 417	

Gerardo and the Project site will be upgraded during the early stages of the project and will be ready to support the operations phase of the project.

The analysis of the meteorological conditions of the area was based on site and regional climate data collected by PROMAS - Universidad del Azuay. The climate data analysis was completed by NewFields (2018) using data collected by the meteorological stations.

Daily data of wind speed, temperature, relative humidity and solar radiation was used between August 2005 to October 2015.

The average annual temperature ranged from a high of 7.5 °C in 2010 to a low of 5.7°C in 2012 (represent values for full years of data available between 2005-2013). The absolute minimum and absolute maximum daily air temperatures ranged from a low of –5.3°C on November 28, 2005 to a high of 24.2°C on October 3, 2008.

Average peak 24-hour precipitation values from three of the meteorological stations were of the same order of magnitude with an average from the three sites of approximately 36 mm (NewFields, 2018). The annual precipitation rate used in the design for the Project was estimated conservatively at 1.625 meters per year (a 30% increase over observed data).

Wind direction is highly variable and there is no single predominant direction (NewFields, 2018). The mean daily wind speed over the entire measurement period was 4.2 m/s, with the maximum daily wind speed of 11.9 m/s recorded on October 31, 2011. 2012 data showed that winds were recorded as predominantly from the east-northeast direction (31%) and from east (19%) and northeast (16%), with the highest wind speeds from the easterly direction. During the period of record, winds were higher than 8 m/s (28.8 km/h) 11.4% of the time and calm (less than 0.5 m/s) 8.2% of the time.

The mean relative humidity over the entire measurement period of record at the Quimsacocha 1 meteorological station was 91.7%.

Annual evaporation is estimated (NewFields, 2018) to be approximately 844 mm.



The Project could attract resources from the local communities surrounding the Project, including San Gerardo, Chumblin and Victoria del Portete.

There is currently minimal infrastructure on the property. The north-south access road, which has been deemed a public road by the government, extends all the way past the future portal entrance and up to the mine concession above the ore body.

In addition, there is a small camp at Los Pinos that can house 30 people including office space and there is electrical power from the grid. There is also good cellular and Wi-Fi service.

Electrical power is to be provided via the local utility, CENTROSUR S.A. (CENTROSUR), from the local network in Ecuador. The main 69 kV / 25 MVA supply will connect to the network running between Lentag and Victoria del Portete, with the new substation located near Girón and the transmission line up to the plant site. The incoming 69 kV will terminate into the main substation at the plant site and will be stepped down to 22 kV from where it will be distributed to site facilities.

A 2 MVA, 22 kV supply from San Fernando is proposed for construction power and emergency backup power as it is fed from a different source, on different infrastructure and overhead lines that run a different route. Diesel generators were therefore deemed not to be necessary.

	Document Number	J01834-PM-REP-002	Rev	0	
	Date	11 January 2019	Page	18 of 417	

The property of Loma Larga is located within the Western Cordillera of the Andes, which is made up of a series of narrow lands, oriented in a north-easterly direction. The Project is located in the southern part of the Chaucha continental terrain, in the physiographic province of the Western Cordillera. The terrain is composed of volcanic rocks from the Tertiary continental arc deposited on marine sedimentary rocks to fluvial from the Upper Cretaceous, which in turn were deposited on metamorphic rocks in the Paleozoic and Mesozoic bases.

The physiography at the Project consists of desert plains and rugged valleys, mainly formed by glaciers, with an altitude ranging from 3,500 m ASL to 3,960 m ASL. Vegetation is sparse and typical of the Andean region above tree line. Much of the property is covered by Andean “paramo”, a type of moorland vegetation consisting mainly of coarse grasses (*Calamagrostis* sp.), Pads (*Plantago* sp.), and upper montane forest. There are stands of small pine on hillsides adjacent to the concessions. These were planted as part of a forestation project.

1.1.3 HISTORY

Exploration activity began in the area in the late 1970s when a United Nations survey identified the Tasqui and Jordanita base metal stream sediment geochemical anomalies five kilometres south of the margin of the Quimsacocha caldera.

In 1991, the property was acquired by COGEMA, which completed 2,944 m of diamond drilling in 17 holes on vein and disseminated targets. COGEMA entered into a joint venture with Newmont Mining Corporation (Newmont) and TVX Gold Inc. in 1993. Newmont drilled 82 holes totalling 7,581 m. With the average hole being less than 100 m deep, the drill program failed to reach the Loma Larga deposit. IAMGOLD subsequently entered into the option agreement with COGEMA in 1999, however, no work was carried out for several years.

IAMGOLD discovered the Loma Larga deposit in 2004 and carried out a drill program consisting of 280 holes totalling 65,117 m. A PFS was completed in 2008.



On June 22, 2012, INV entered into a share purchase agreement with IAMGOLD and its two subsidiaries, AGEM Ltd. and Repadre Capital (BVI) Inc., to purchase a 100% interest in IAMGOLD Ecuador S.A. INV obtained 100% title to the property in November 2012.

Geotechnical, hydrological, and exploration drilling was performed by INV in 2016-2017. A total of 6,978.21 metres were drilled in 32 drill holes. As a result of this drill program, an indication of the presence of multiple feeder zones along the north-south length of the deposit were identified.

In October of 2018, RPA updated the estimated Mineral Resources for the Loma Larga Project using all the available drillhole data available.

In June of 2017, a Feasibility Study was started and progressed over 18 months to December 2018. This positive Feasibility Study was announced on November 29, 2018 and is the subject of this document.

There has been no production from the Loma Larga Project to date.

	Document Number	J01834-PM-REP-002	Rev	0	
	Date	11 January 2019	Page	19 of 417	

1.1.4 GEOLOGY AND MINERAL RESOURCES

1.1.4.1 GEOLOGICAL SETTING AND MINERALIZATION

The Loma Larga property is located within the Ecuadorian cordillera, which consists of a number of narrow, north to northeast trending terranes which were formed during the separation of the Central and South American plates and accreted onto the Amazon Craton from the Late Jurassic to Eocene. Most of the terranes extend for several hundreds of kilometres in a north-northeast direction and are only a few tens of kilometres wide. They are separated by deep north-northeast trending faults. These terranes were built upon during the Tertiary and Quaternary by subduction related continental arc magmatism and reactivation of the terrane bounding faults.



The Project lies in the southern part of the Chaucha continental terrane, in the Western Cordilleran physiographic province. The terrane consists of Tertiary continental arc volcanic rocks deposited upon Cretaceous marine to fluvial sedimentary rocks, which in turn were deposited on basement Paleozoic and Mesozoic metamorphic rocks.

The Loma Larga property is located between the Gañarin fault to the northwest and the Girón fault to the southeast. A collapsed caldera structure, four kilometres in diameter, the remnant of an eroded stratovolcano, lies along (and probably emplaced and controlled by) the Gañarin fault and 400 m west of the main Loma Larga mineralization. The caldera is underlain by late felsic domes and is cut by a multi-phase diatreme. The north-south trending Rio Falso fault, which appears to be a conjugate fault linking the Gañarin and Girón faults, is the locus for alteration and mineralizing fluids.

The property and immediate surrounding area are mostly underlain by Upper Miocene volcanic and volcanoclastic rocks of the Turi, Turupamba, Quimsacocha, and Tarqui formations. These formations are flat lying to gently dipping and usually do not outcrop on the property. The property is largely underlain by the Quimsacocha Formation which hosts the Loma Larga deposit and consists of alternating andesitic banded lava flows with phenocrysts of fresh plagioclase and andesite tuffs and breccias, distributed radially only around the outside of the caldera.

The alteration is characterized by multiphase injections of hydrothermal fluids strongly controlled by both structure and stratigraphy. It typically occurs as silica ribs mimicking fault locations and orientations. The most significant alteration zone, host to the deposit, is coincident with the north-trending Rio Falso fault, extending for over eight kilometres north-south, along the eastern edge of the collapsed caldera. This long, linear zone contains multiple large pods of silica alteration ranging up to two kilometres in east to west width. The silica alteration is surrounded by varying widths of a halo of argillic alteration, grading from higher to lower temperature mineral assemblages including pyrophyllite, alunite, dickite, kaolinite, illite, and smectite.

The mineralization is also stratigraphically controlled as it occurs at lithological contacts between Quimsacocha Formation andesitic lavas and tuffs and reaches greater thickness in the more permeable tuffs. The mineralization is a flat lying to gently western dipping (less than ten degrees), north-south striking, cigar shaped body, which has a strike length of approximately 1,600 m north-south by 120 m to 400 m east-west and up to 60 m thick, beginning approximately 120 m below surface. It also dips slightly to the north, such that the mineralized zone is closer to surface at the south end. Resources are defined as a smaller, higher-grade subset within this mineralization.

	Document Number	J01834-PM-REP-002	Rev	0	
	Date	11 January 2019	Page	20 of 417	

Mineralized zones are characterized by multiple brecciation and open-space filling events and sulphides such as pyrite, enargite, covellite, chalcopyrite, and luzonite or, at lower sulphidation states, tennantite and tetrahedrite. Higher grade intervals typically coincide with increased amounts of enargite, minor barite, and intense hydraulic brecciation that contains subrounded to rounded silicified fragments. Visible gold is rare. Gold mineralization is found, for the most part, in one of the following mineralogical assemblages: (a) vuggy silica plus fine grained pyrite and enargite; (b) massive pyrite, including a brilliant arsenical pyrite; or (c) vuggy silica with grey silica banding, sulphide space-filling and banded pyrite. Very fine grained pyrite is dominant in semi-massive to massive zones, and is interpreted to have formed earlier than coarser fracture and vug-filling pyrite.

1.1.4.2 DEPOSIT TYPES

Loma Larga is a typical high sulphidation gold-copper-silver epithermal deposit.

1.1.4.3 EXPLORATION

INV carried out exploration activities on the property in 2017 and 2018, including the following:

- Analysis of geophysical data and potential exploration targets within the Rio Falso concession.
- Analysis of diamond drillhole data, geological maps, and geophysical data for the Project to develop a targeting matrix for the Loma Larga exploration program.
- Updating of the regional geology map for the Loma Larga concessions, targeting areas with no previous geological mapping along the concession boundaries.

1.1.4.4 DRILLING

From 2002 to 2007, drilling was carried out by IAMGOLD including a total of 65,117 m in 280 holes. No drilling was carried out between 2007 and 2012, when INV acquired the Project.



INV has carried out two drilling campaigns, in 2013 and 2016-2017. INV's drill program in 2013 comprised 12 diamond drillholes totalling 3,684.7 m, including two holes drilled for metallurgical testwork, three holes to further define the High Grade Main Zone, and seven holes to test step-out targets to extend the deposit. In 2016-2017, INV completed nine geotechnical and nine hydrogeological drillholes on the Loma Larga deposit to obtain data for modelling. Various samples of the core from these holes were used for the metallurgical and geotechnical testwork programs as part of this Feasibility Study.

The current Mineral Resource incorporates drilling completed up to the end of August 2017. No further drilling has been completed since that date. The resource drillhole database consists of 365 holes, totalling 81,183 m, with 249 of the holes (58,990 m) located within the mineralization domains.

1.1.4.5 SAMPLE PREPARATION, ANALYSIS AND SECURITY

As part of the October 2018 Mineral Resource estimate, RPA compiled and reviewed all of the Loma Larga Project Quality Control (QC) sample results for INV's 2013 and 2016-2017 drilling campaigns. RPA also completed a procedural and statistical review of all historical QC data on the Project.

For the 2013 drilling campaign, all samples were collected primarily from mineralized zones and sent to internationally recognized and independent laboratories for preparation and

	Document Number	J01834-PM-REP-002	Rev	0	
	Date	11 January 2019	Page	21 of 417	

testing. Prior to September 2004, samples were prepared in Quito by ALS Chemex and analyzed by ALS Chemex laboratory in North Vancouver, Canada. From October 2004 onward (to the end of drilling by IAMGOLD in 2008), samples were prepared by Inspectorate del Ecuador S.A. in Quito and analyzed by BSI Laboratories in Lima, Peru (BSI). Both analytical laboratories are accredited to ISO/IEC 17025 for specific registered test and certified to ISO 9001 standards.

In 2016-2017, samples were collected in mineralized and altered zones. Sample preparation was carried out by Inspectorate del Ecuador S.A. (Inspectorate), part of the Bureau Veritas Group, Llano Grande-Quito, Ecuador. Inspectorate sent the prepared samples by air freight to their analytical laboratory in Callao-Lima, Peru. Inspectorate holds an international certificate for ISO 9001:2008 and fulfills NTP-ISO 17025:2006.

IAMGOLD developed an industry standard QA/QC program for the Project early on in the exploration work. From 2002 to 2008, a total of 1,015 Certified Reference Materials (CRM) and 714 blank samples were inserted into the process stream. IAMGOLD also collected 1,046 pulp replicates, 456 pulp duplicates, and 263 triplicates (replicates) for comparative analysis.

During the 2013 and 2016-2017 drilling campaigns, INV maintained a rigorous QA/QC program that incorporated the regular submission of blanks, duplicates, and standards. As part of the 2013 drilling program, 74 CRMs and 68 blank samples were inserted into the process stream. Additionally, INV collected 24 field duplicates, 77 pulp duplicates, 77 reject duplicates, and 167 pulp replicates. In 2016-2017, 84 CRMs and 94 blank samples were inserted into the process stream. INV also collected 127 pulp duplicates and 127 reject duplicates.

RPA reviewed the QA/QC results for the IAMGOLD and INV drilling campaigns and is of the opinion that the QC samples and the QA/QC procedures implemented at Loma Larga provide adequate confidence in the data collection and processing, and the assay data is suitable for Mineral Resource estimation.

1.1.4.6 DATA VERIFICATION

Sampling details for the historic drilling program by IAMGOLD were verified by RPA in 2006. In 2012, RPA verified 30 drillholes completed by IAMGOLD in 2008, which included 28 resource delineation drillholes and two drillholes for metallurgical testwork. RPA reviewed and verified 12 drillholes completed by INV in 2013 for the purpose of a NI 43-101 Technical Report completed by RPA for INV in 2016 (the 2016 Technical Report).

In 2018, RPA verified the assay results from 23 drillholes that were completed subsequent to the 2016 Technical Report. Verification included checking assay certificates against the database assay table. RPA also completed standard database validation tests of the new drilling. In addition, RPA reviewed and verified the 248 drillholes with sulphur data, including 26 drillholes that were completed by INV during the 2017 drilling campaigns on the Project.

RPA has visited the Project twice, in 2005 and 2014. Independent samples were collected during the 2005 visit which confirmed the presence of gold in the samples.

1.1.4.7 MINERAL PROCESSING AND METALLURGICAL TESTING

Three separate and distinct phases of metallurgical testwork have been conducted on the Loma Larga deposit. The first two phases of testwork were conducted in 2006 and 2014 are

referred to as historical work. The first program was managed by IAMGOLD in 2006 and the second program managed by RPA in 2014 and was used as the basis of design for the Pre-Feasibility Study (PFS). The third program (2017 metallurgical testwork program) was managed by INV with advisory input from DRA and Promet101. The 2017 metallurgical program forms the basis of the 2018 Loma Larga Feasibility Study.

A significant amount of testwork was conducted to develop a robust and fit for purpose flowsheet for the development of the Loma Larga process plant design. The merits of sequential and bulk flotation flowsheets were examined during the program and analysed. Sufficient testwork has been conducted to support the basis of the 2018 Feasibility Study.

The metallurgical programs concluded that a sequential flotation flowsheet for the recovery of separate gold bearing copper and pyrite concentrates is the preferred processing route. From the testwork, grade and recovery relationships for the copper concentrate and an understanding of the gold-pyrite concentrate recoveries was determined.

1.1.4.8 MINERAL RESOURCE ESTIMATE

RPA estimated Mineral Resources for the Loma Larga Project using all drillhole data available as of October 31, 2018. This Mineral Resource estimate was previously updated on June 30, 2016 and reported in the 2016 Technical Report. The current Mineral Resource estimate is based on an underground mining scenario and is reported inclusive of Mineral Reserves. Using a US\$60/t Net Smelter Return (NSR) cut-off value, Mineral Resources as of October 31, 2018 are summarized in **Table 1-1**. The Mineral Resources conform to Canadian Institute of Mining, Metallurgy, Petroleum (CIM) Definition Standards for Mineral Resources and Mineral Reserves (CIM (2014) definitions) as incorporated by reference in NI 43-101.

Table 1-1: Mineral Resource Estimate Summary – October 31, 2018



Resource Classification	Tonnage		Contained Au		Contained Ag		Contained Cu		Grade (g/t AuEq)	Contained Gold Equivalent (M oz AuEq)
	(Mt)	Au (g/t)	(M oz)	(g/t)	(M oz)	(%)	(M lb)			
Measured	2.9	7.31	0.67	34.9	3.2	0.44	28.2	8.45	0.78	
Indicated	17.0	3.74	2.04	26.5	14.5	0.22	81.4	4.43	2.42	
Measured + Indicated	19.8	4.25	2.71	27.8	17.7	0.25	109.5	5.01	3.20	
Inferred	4.7	2.22	0.33	29.7	4.5	0.14	14.5	2.84	0.43	

– Notes:

- CIM (2014) definitions were followed for Mineral Resources.
- Mineral Resources are reported at an NSR cut-off value of US\$60/t.
- Mineral Resources are estimated using a long-term gold price of US\$1,450 per ounce, silver price of US\$22.00 per ounce, and copper price of US\$3.50 per pound.
- The formula used to calculate gold equivalence (AuEq) is: $(Au\ g/t \times 31.31 + Ag\ g/t \times 0.44 + Cu\% \times 46.19) \div 31.31$. The formula used for calculated AuEq ounces is: $AuEq\ Oz = (Tonnage \times AuEq\ g/t) \div 31.1035$
- Mineral Resources are inclusive of Mineral Reserves.
- Mineral Resources that are not Mineral Reserves do not have demonstrated economic viability.
- Average bulk density is 2.7 t/m³.
- Numbers may not add due to rounding.

Three-dimensional (3D) grade shell wireframes were constructed at 2.0 g/t Au (High Grade Zone) and 0.8 g/t Au (Low Grade Zone). RPA used cross sections, long sections, and plan views to interpret and validate the wireframes.

The Loma Larga High Grade Zone comprises two mineralized zones: High Grade Main Zone and High Grade Upper Zone. The Low Grade Zone comprises two domains: Low Grade Main

	Document Number	J01834-PM-REP-002	Rev	0	
	Date	11 January 2019	Page	23 of 417	

Zone wireframe domain that encompasses the High Grade Main Zone, and Low Grade Lower Zone, which lies below the Low Grade Main Zone.

Variography was performed on the 2.0 m Au, Ag, Cu, S, and density composites from the High Grade Main Zone and Low Grade Main Zone. Block grade interpolation was carried out using Ordinary Kriging (OK) and the gold grade shell wireframe models were used to constrain the grade interpolations. A soft boundary was used between the Low and High Grade Main Zones for density block interpolation.

The polymetallic sulphide mineralization at the Loma Larga deposit contains significant values of Au, Ag, and Cu. Therefore, original assays were converted into NSR values (\$ per tonne). The NSR values account for parameters such as metal price, metallurgical recoveries, smelter terms and refining charges, and transportation costs. For the purposes of developing an NSR cut-off value for an underground operation, a total operating cost of US\$60/t milled was assumed, which includes mining, processing, and general and administrative (G&A) expenses.

RPA is not aware of any environmental, permitting, legal, title, taxation, socio-economic, marketing, political, or other relevant factors that could materially affect the Mineral Resource estimate.

1.1.4.9 GEOLOGY AND MINERAL RESOURCES CONCLUSIONS

Specific conclusions for the geology and resource database related items of the Loma Larga Project are summarized below.

- Loma Larga is a high sulphidation polymetallic epithermal deposit containing significant values of gold, silver, and copper.
- The Loma Larga deposit is a stratigraphically controlled, flat lying, gently westward-dipping, north-south striking, cigar-shaped body. It also dips slightly to the north, such that the mineralized zone is closer to surface at the south end.
- The results of the quality control (QC) samples, together with the quality assurance/quality control (QA/QC) procedures implemented by INV at Loma Larga, provide adequate confidence in the data collection and processing, and the assay data is suitable for Mineral Resource estimation.
- Understanding of the Project geology and mineralization, together with the deposit type, is sufficiently well established to support Mineral Resource and Mineral Reserve estimation.

1.1.5 MINERAL RESERVE ESTIMATE

The mineral reserves for Loma Larga are estimated at 13,926,000 tonnes of recoverable and diluted ore grading 4.91 g/t Au, 29.6 g/t Ag, and 0.29% Cu using an economic cut-off of US \$60/t NSR. The mineral reserves are comprised of 21% in proven category (2,924,100 tonnes grading 7.30 g/t Au, 34.80 g/t Ag and 0.44% Cu) and 79% in probable category (11,001,900 tonnes grading 4.28 g/t Au, 28.26 g/t Ag and 0.25% Cu). Reserves are inclusive of dilution and ore loss.

Table 1-2: Loma Larga Mineral Reserves estimate as of October 31, 2018

Ore Category	Tonne (M)	Au Grade (g/t)	Au Contained (M oz)	Ag Grade (g/t)	Ag Contained (M oz)	Cu Grade (%)	Cu Contained (M lb)	Cu Equivalent (M oz)	Au Equivalent Grade (g/t)
Proven	2.9	7.30	0.69	34.8	3.27	0.44%	28.5	0.80	8.53
Probable	11.0	4.28	1.51	28.3	10.00	0.25%	59.5	1.80	5.09
Proven and Probable	13.9	4.91	2.20	29.6	13.27	0.29%	88.0	2.60	5.81

– Notes:

- CIM (2014) definitions were followed for Mineral Reserves.
- Mineral Reserves include long hole and drift-and-fill stopes as well as development in ore
- Mineral Reserves are reported at an NSR cut-off value of US\$60/t.
- Mineral Reserves are estimated using average gold price of US\$1,250 per ounce, silver price of US\$18.00 per ounce, and copper price of US\$3.00 per pound.
- Average bulk density is 2.7 t/m³.
- Numbers may not add due to rounding.

1.1.6 MINING

The Loma Larga deposit, located in the Western Cordillera mountains at an elevation of 3,800 meters in Azuay Province, Ecuador, will be mined using underground methods.

1.1.6.1 MINING METHOD

The depth of the deposit (approximately 120 m) from surface and its geometry (flat and elongated) make it ideal for conventional underground mechanized mining. Production rate for the mine is set at 3,000 t/d of ore for the first four years and 3,400 t/d from year five. This production rate requires a sophisticated mechanized mine with simple layouts and mining methods.



The selected underground mining methods are longhole stoping for the majority of the deposit with some drift-and-fill for lower portions and narrow areas of the deposit which were not amenable to longhole mining.

1.1.6.2 MINE PLAN

The global sequence can be generalized as two active mining blocks, a north block and a south block. Numerical stress models suggest that there are very low geomechanical risks associated with the global sequence.

Short and long-term crown pillar stability have been evaluated. The application of backfill essentially negates any risk of long-term instability. The ramp portal will be excavated in two phases. The first phase will be to excavate the surface trench. The soil will be excavated to the bed rock with an excavator. The bedrock will be benched down using a long hole surface drill. The rock will then be trucked to the waste stock pile close to the process plant. The goal is to create a rock face with a 5 metres pillar above the portal.

The main and internal ramps are sized at 5.0 m wide by 5.0 m high to allow for a 40-tonne underground truck during development and up to a 40-tonne truck during production. The main ramp from the surface will have remuck bays every 200 m, sumps and passing bays every 400 m, and safety bays every 30 m.

	Document Number	J01834-PM-REP-002	Rev	0	
	Date	11 January 2019	Page	25 of 417	

1.1.6.3 VENTILATION

Six vent raises will be excavated from the 3,600 level to the surface to satisfy the ventilation needs of the underground operation for the entire life of mine. During the first two years, the first two raises will be driven near the bottom of the ramp. One will be the air intake and will be equipped with manways for a second egress. The other raise will be the exhaust. The ventilation study recommends 3.8 m diameter vent raises with smooth walls. These raises will therefore be driven using a raisebore machine. Ventilation equipment will be installed underground. As part of the ventilation program, small 1.5 m diameter raises will be excavated between levels at the far ends of the ore body. These raises will be equipped with escapeways, to allow 2nd emergency egresses from the levels.

1.1.6.4 RAMP-UP PERIOD

For the first 10 months of the mine development, the development will focus on level accesses, excavating main infrastructure rooms, and excavating two vent raises, etc. The pre-production (or ramp-up) phase will start with three development crews in the ore development. The ore development will produce 43,000 tonnes of ore which will be stockpiled at the surface. At the end of the ramp-up period, the mine will start stope production to rapidly ramp up to full production in the next months. The process mill and backfill plant will commence two months later and continue with the design production of 3,000 t/d.



1.1.6.5 EQUIPMENT

The underground mining equipment fleet was chosen based on the evaluation of productivity needed to achieve the daily production rate of 3,000 t/d. The level access and the stope draw point development will be drilled using two boom hydraulic jumbos. The development face will be loaded using a mobile ANFO Loader. The ground support will be done using a two-boom bolter. Stopes will be cable-bolted using a fully automated and mobile cable-bolter. The production drilling will be accomplished using down the hole hammer drills.

Mucking of the development round will be done using 17-tonne LHDs. In the early development phases, the waste from the development round will be mucked with the LHD to the closest waste transfer bay (remuck bay) and from there, will be loaded into 40-tonne haulage trucks and dumped in the waste stockpile at the surface. When the secondary stopes are opened, the waste from the development will be dumped directly into them, and the surface waste stockpile will be hauled back underground to be dumped into the secondary stopes. The ore development round will be mucked with 17-tonne LHDs directly into the underground ore sorting transfer bay. From there, it will be loaded, using a 14-tonne front end loader, into a 40-tonne truck and hauled to the surface stockpile close to the plant. The 40-tonne truck gives the flexibility and mobility needed for this operation and reduces the size of the main access drift and ramp. At full production, the mine will need five LHDs, five haulage trucks and one loader working full time.

1.1.6.6 INFRASTRUCTURE

Main infrastructure for the mine includes a maintenance bay, fuel bay, explosives magazine, mine dewatering system, ore and waste stockpiles, an office, and a dry. As part of the mine development, other miscellaneous infrastructures will be excavated in the mine. The main approach is to excavate crosscuts from the main haulage ramp to the size required. Other

	Document Number	J01834-PM-REP-002	Rev	0	
	Date	11 January 2019	Page	26 of 417	

infrastructures include: an underground shop, a parking area, a warehouse, a pump station, ventilation raise cut-outs, two main substations, and the main refuge station.

1.1.7 RECOVERY METHODS

The Loma Larga process plant flowsheet and design are robust and allows for the treatment of the various ore types that will be encountered over the project life of mine. It is also considered to be conventional and fit for purpose. The design removes the requirement for acid addition in flotation pH control, reducing both operating and capital costs. The design considers two stages of copper cleaner flotation and one stage of pyrite cleaner flotation. However, provision has been made in the plant design and layout for one additional copper and one additional pyrite cleaning stage. Provision has also been made in the plant design and layout for additional innovative flowsheet options that improve overall LOM gold recovery

The Loma Larga processing plant is designed to process 3,000 t/d of run-of-mine (ROM) ore from a single underground mine. However, the plant will increase throughput to 3,400 t/d in year five when plant feed gold grades reduce.

The plant will produce separate copper and pyrite concentrates for sale using conventional sulphide flotation techniques.

Flotation (plant) tailings will be filtered and disposed of in a single tailings storage facility (TSF) or directed to the paste backfill circuit to be used for mine backfill.

1.1.8 PROJECT INFRASTRUCTURE

The site is located close to existing infrastructure (approximately 30 km from a major centre).

Tailings production and deposition methods were evaluated, and filtered tailings was the technology chosen. Approximately half of the tailings produced will be stored on surface in the filtered tailings storage facility (FTSF). Geochemical characterization of filtered tailings suggests that the material is potentially acid generating (PAG) and has the potential to leach constituents of potential concern (COPC), including metals. The FTSF will be lined to avoid contact of tailings material with the environment, and any water drained from the facility, along with contact water, will be collected and treated to appropriate standards during operations and closure.

1.1.9 MARKET STUDIES AND CONTRACTS

An extensive list of potential off-takers was approached in order to determine the relevant markets and to identify appropriate commercial terms for purpose of the feasibility study. Various indications were secured for both concentrates. For purpose of the gold pyrite concentrates, Chinese copper smelters provided the most competitive terms. This market has the added benefit of representing the lowest freight destination, providing important financial advantages. Conversely, commercial feedback received for the gold copper concentrates suggests both China and the West could emerge as appropriate long-term outlets.

The terms summarized below are shown as a percentage of the payable metals on a Carriage and Insurance Paid To (CIP) destination port basis, and include all applicable refining, treatment and penalty charges. From a logistics perspective, the mine would need to absorb

all costs from the mine to the relevant destination port, with the buyer bearing all remaining transportation costs from the discharge port to the receiving smelter.

Table 1-3: Smelter Terms

Item	Unit	Gold Pyrite Concentrate	Gold Copper Concentrate
Gold	%	80	88
Silver	%	60	80
Copper	%	-	82

– Payability includes the treatment and refining charges

1.1.10 ENVIRONMENTAL STUDIES, PERMITTING AND SOCIAL OR COMMUNITY IMPACT



The Loma Larga Project is currently operating within an Advanced Exploration Phase and holds the required permits, as well as land tenure, and mining and water rights that enable INV to perform exploratory activities in the concessions of Río Falso and Cerro Casco. For the Cristal concession, INV is awaiting the Environmental Authority to re-issue the environmental license for the Advanced Exploration Phase.

To progress to the exploitation phase, the main permit for the construction and operation of a mining project is the Environmental License. An Environmental Impact Study (EIS) process will be managed by the Provincial Directorate of the Ministry of Environment and Water (MAE) in Azuay. The Environmental License will enable the Company to request and obtain other necessary permits to start the construction, operation and closure of the Project.

INV is progressing with an EIS to Ecuadorian standards, and where feasible, to International Finance Corporation (IFC) standards as well. Baseline data sets, and ongoing data collection, are being used to support the development of an EIS for the Project. A stakeholder engagement strategy should be implemented alongside the submission of the EIS.

Section 20 describes the applicable permits and authorizations for the three main components of the Project: mine, power transmission line, and access road. INV will require a water deviation authorization for the exploitation phase, as well as rights of way through third party mining rights and private land for the project site, transmission line and access roads, which are not yet in place. A land acquisition plan will be implemented for the Project linear components, in a parallel process to the EIS submission. This approach should be confirmed with regulators and statements of regulator support would mitigate potential concerns with progressing parallel processes to the exploitation phase EIS.

There are no communities within the mining concession area, and the perception of the Project in the Area of Direct Influence (ADI) is largely positive. This perception is based on INV’s engagement activities and the commonly-cited Project advantages of employment and economic resources generation. The Project’s perception in the Area of Indirect Influence (All) is more balanced between positive, negative and neutral. Negative perceptions are primarily related with environmental concerns associated to impacts to water sources and environmental pollution. These concerns have been considered in the feasibility level project planning and will be addressed in a stakeholder engagement strategy to be implemented alongside the EIS submission and review. Further stakeholder engagement will identify any areas of further concern with communities in the All about the existing design of the project and associated infrastructure.

	Document Number	J01834-PM-REP-002	Rev	0	
	Date	11 January 2019	Page	28 of 417	

Based on the available information, there are currently no environmental and social considerations that pose a material threat to the Project. There are areas of uncertainty, in particular, related to timeliness of approvals, effluent water quality, baseline groundwater conditions in the areas of the FTSF, and presence of special-status species that will need to be addressed as the project development progresses. Regulator and stakeholder engagement plans should be implemented alongside the initiation of the EIS process, to gain regulatory clarity and support, prevent misinformation, and identify any areas of further concern that should be addressed as the Project develops. Permitting timelines have inherent uncertainty and a proactive approach to regulatory and stakeholder engagement implemented alongside the development and review of the EIS is recommended.

1.1.11 CAPITAL AND OPERATING COSTS

1.1.11.1 CAPITAL COSTS

The overall capital cost estimate was compiled by DRA and summarized in the **Table 1-4** below. DRA developed the mining, process plant, plant infrastructure and off-site infrastructure capital cost estimates for the project scope described in this report. External inputs were received as follows:

- NewFields prepared the construction quantities for the FTSF and DRA and NewFields applied rates to complete the capital cost estimate.
- Paterson & Cooke prepared the cost estimate for the paste backfill system, where DRA only estimated the bulk earthworks, concrete and structural steel.
- Owners G&A costs, taxes and duties, and closure costs were provided by INV.

All costs are expressed in United States Dollars (US\$) and are based on Q3 2018 pricing. The capital cost estimate is deemed to have an accuracy of +/-15% and was prepared in accordance with the ACEI (Association for the Advancement of Cost Engineering) Class 3 estimating standard. The capital cost estimated was developed based on a typical EPCM project implementation model. Major equipment was specified, and priced quotations obtained from reputable Original Equipment Manufactures (OEM). Construction contract packages were prepared, issued and priced in-country by capable construction companies.

Table 1-4: Capital Cost Summary

Area	US\$
Direct Cost	
Mining – Underground	39,784,517
Mining Surface Infrastructure	10,064,338
Process Plant	67,879,603
Waste Management	18,475,238
Plant Infrastructure	19,802,553
Off-site Infrastructure	14,497,824
Subtotal Direct Cost	170,504,074
Indirect Cost	
Contractor Indirects	26,192,721
Inventory	7,008,541
Project Services	23,774,571
Vendor Rep & Commissioning	2,404,867
Owner's Costs	17,376,883
Freight & Logistics	5,275,777
Taxes & Duties	27,571,731
Contingency	29,360,835
Subtotal Indirect Cost	138,965,926
Total Initial Capital Cost	309,470,000
Sustaining Capital Cost	72,730,000
Closure Cost	22,000,000
Total Project Capital Cost	404,200,000

The initial Project capital cost estimate by discipline is provided in **Table 1-5**.

Table 1-5: Initial Capital Estimate Summary by Discipline

Description	Supply US\$	Install US\$	Contingency US\$	Total US\$
Underground Mining	396,973	12,395,749	4,229,241	17,021,962
Bulk Earthworks		32,621,510	4,487,870	37,109,380
Detail Earthworks	100,000	533,949	66,347	700,296
Civils – Concrete		6,939,652	753,575	7,693,226
Structural Steelwork	2,677,189	2,290,089	436,497	5,403,774
Architectural	660,810	2,422,342	114,354	3,197,506
Mechanical	59,433,709	8,701,860	3,863,240	71,998,809
Platework	1,492,001	1,482,546	290,998	3,265,545
Painting/Protection& Insulation	589,538	635,910	122,544	1,347,992
Building Services	695,000	25,000	114,354	834,354
Piping	4,393,634	3,242,852	755,223	8,391,710
Electrical	20,892,271	4,182,267	2,008,763	27,083,301
Instrumentation & Control	2,832,404	866,821	424,529	4,123,754
Indirects		59,380,700	6,670,865	66,051,565
Owners		17,376,883	1,737,688	19,114,571
Freight & Logistics		5,275,777	527,578	5,803,355
Taxes & Duties		27,571,731	2,757,173	30,328,904
Total Initial Capital Cost	94,163,527 \$	185,945,640	29,360,840	309,470,000

The Project sustaining capital is presented in the **Table 1-6**.

Table 1-6: Summary of Sustaining Capital Cost

Description	US\$ Million
Mining Capital	50,713,808
FTSF Capital	11,288,767
Taxes & Duties	3,358,452
VAT on Initial Capital	7,368,974
Total Sustaining Capital	72,730,000

1.1.11.2 OPERATING COSTS

A summary of the overall LOM project operating costs is presented in **Table 1-7** and the summary of the unit operating costs over life-of-mine are presented in **Figure 1-1**. The costs presented exclude pre-production operating cost allowances for mining, process and G&A which were covered in the capital cost estimate. Labour rates used for the study were provided by INV dated to 2018. Direct employment during operations will total approximately 460 people.

Table 1-7: Project Life-of-Mine Operating Costs by Major Area

Major Project Area	LOM Total (US\$)	LOM Unit Cost (US\$/t)
Mining Cost	323,389,258	23.22
Processing Cost	239,603,848	17.20
Backfill Cost	43,708,658	3.14
Tailings Disposal	31,469,759	2.26
G&A Cost	104,951,553	7.54
Total Cost	743,123,076	53.36

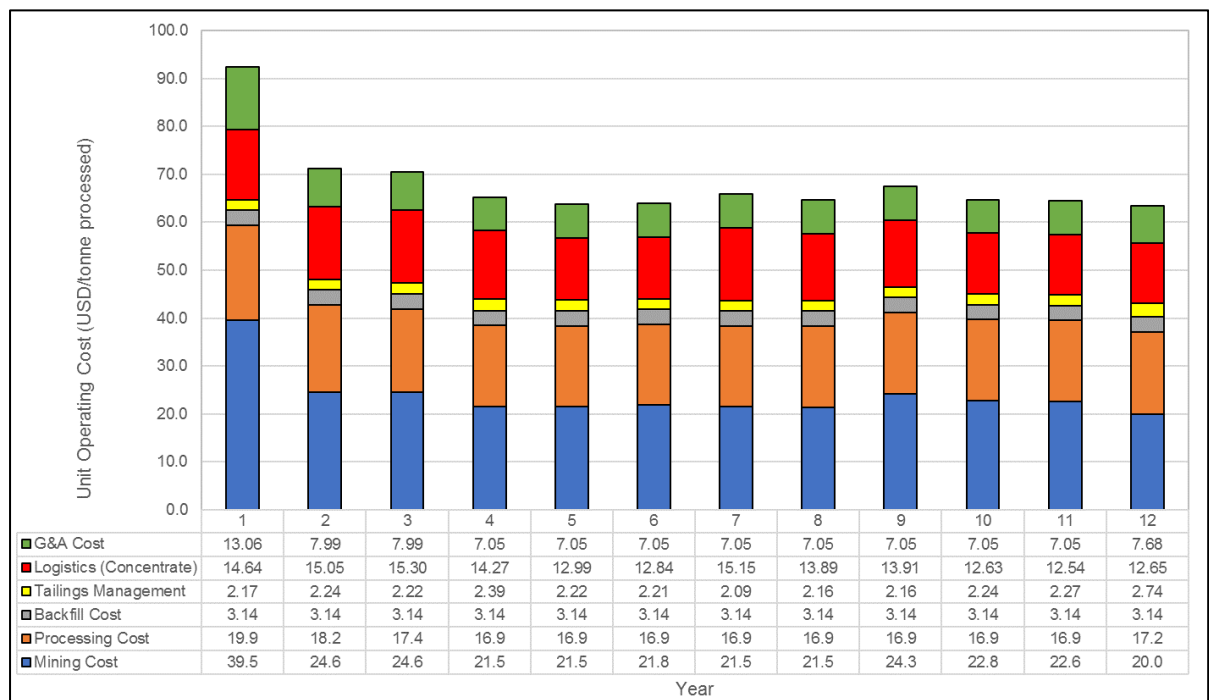



Figure 1-1: Project Life-of-Mine Unit Operating Costs

	Document Number	J01834-PM-REP-002	Rev	0	
	Date	11 January 2019	Page	32 of 417	

1.1.12 ECONOMIC ANALYSIS

Based on the assumptions presented in this Technical Report, the Project demonstrates positive economics. The pre-tax NPV at 5% discount rate is US\$621 M and pre-tax IRR is 35.1%. The pre-tax payback period is 2.2 years after the start of production.

The after-tax NPV at 5% discount rate is US\$356 M and after-tax IRR is 24.7%. The after-tax payback period is 2.6 years.

1.1.13 ADJACENT PROPERTIES

There are no adjacent properties as defined by NI 43-101.

1.1.14 OTHER RELEVANT DATA AND INFORMATION

INV head office is located in Toronto which will be the base for the engineering and procurement phases. The project team will be established as an integrated Owner-Engineering team to minimize project overhead costs (management, administration or reporting). Engineering will be established with execution centres in Canada and Ecuador, with local engineering companies contracted to reduce costs and provide design in Spanish and to local standards. INV will oversee control for the design to ensure design integrity, conformance to the process design and functional specification and to integrate the overall scope into a successfully constructed, commissioned and operating facility, including on-site and off-site plant and infrastructure; integrating vendors and external consultants.

Procurement support will be carried out in Toronto during detailed engineering to support engineering data needs; and manage vendor's conformance to specification.

Contracts administration will be set-up in Toronto and Ecuador to develop the major contracts technical and commercial templates. A contracts administration team will be established in-country to coordinate the local contracts and develop and translate contracts into Spanish.

Construction personnel will mobilize in time to support construction activities and ramp up in accordance with the construction schedule. The construction of the mine portal will be executed with a local contractor and will be followed by the ramp development which will be executed by the owner. No camp will be provided at the Loma Larga Project site as it is suited to daily commute as it is readily accessible to several nearby towns and the city of Cuenca.

The overall Project duration from detailed engineering through to start of ramp-up is estimated at 27 months (excluding the bridging phase) as shown in *Figure 1-2*. Limited activities will occur ahead of this in the bridging phase. The overall project duration could be reduced to 24 months if the gap between finance and permits for construction availability are reduced.

The critical path for the project runs through the EIS, construction permit and process facilities construction.

The milestones for commencement of the critical activities are as follows:

- Detailed engineering and commitment for equipment procurement: finance availability.
- Construction activities: construction permit availability.

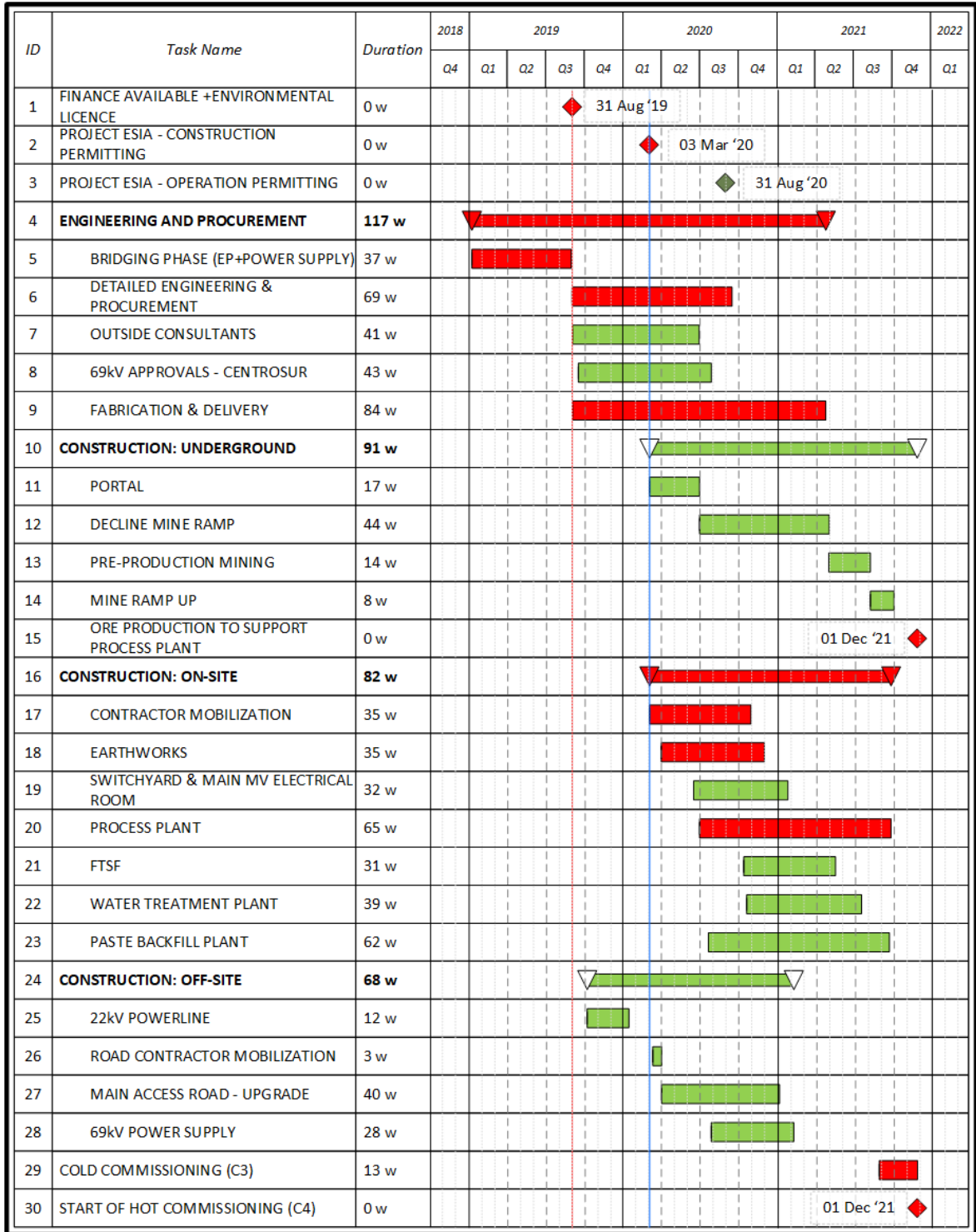

Figure 1-2: Loma Larga Level 1 Schedule – Project

The estimated quantities for major bulk / commodity works for the Project, on which the FS engineering design and capital and operating cost estimates are based, are shown in **Table 1-8**.

Table 1-8: Bulk Quantity Summary

Package	Unit	Quantity
Bulk Earthworks	m ³	2,469,450
Detail Earthworks	m ³	35,368
High Density Polyethylene (HDPE) liner	m ²	356,011
Concrete	m ³	11,747
Structural Steel	tonne	1,051
Buildings	m ²	17,000
Mechanical equipment	tonne	860
Mechanical equipment	No. of tags	240
Platwork	tonne	522
Power cable	m	101,885
Instrument cable	m	50,308

Commissioning of the Loma Larga Project will be progressive by subsystems using EPCM contractor standard procedures. The standard steps are typically:



- Construction completion (C1 certificates).
- Construction pre-commissioning (C2 certificate).
- Cold / wet commissioning: functional testing of equipment by the commissioning team of a system / sub-system – (C3 cold commissioning and taking over certificate, transfer of care, custody and control to operations).
- Hot commissioning (first feed) is carried out by operations supported by construction and commissioning personnel. Product is introduced into the circuits progressively.
- Punch list process will be maintained through out the commissioning cycle.
- Commissioning and turnover activities present significant safety risks and all necessary lock-out / tag-out procedures will be in place, notably where construction, commissioning and operations may be working in common areas.

During the feasibility study, the risk management process was initiated. Project risk and HAZOP (Hazard and Operability) review sessions were concluded. The most significant risks identified for the execution phase identified as:

- Potential FTSF dam failure (see below).
- Potential oxidation of ore on stockpile.
- Geotechnical conditions of plant and FTSF location (drilling will be completed when permit is received to confirm bedrock depth).
- Unknown political and social risks.

FTSF failures are an inherent risk of tailings facilities. The FTSF dam has been designed to minimize the potential for any failures and INV is confident this risk has been mitigated to the extent possible.

Risk management activities will continue to be addressed by INV in the execution phase with Owner and EPCM contractor procedures and will address project, business and event risks

	Document Number	J01834-PM-REP-002	Rev	0	
	Date	11 January 2019	Page	35 of 417	

1.2 RECOMMENDATIONS

Specific recommendations for the Loma Larga Project are summarized below.

1.2.1 PROPERTY DESCRIPTION AND LOCATION

- Prepare and implement a land easement acquisition strategy for the linear components of the project based on IFC guidelines.
- Further engage with the local Government of San Gerardo to gain endorsement of the process for access road easement acquisition in order to facilitate community acceptance.
- If required, consider minor design adjustments, particularly with respect to the transmission line, to facilitate mutually agreed land access agreements and minimize legal easement enforcement cases.
- Obtain detailed cadastral information of affected landowners to confirm available data from the access road and identify the properties impacted by the transmission line, in order to perform the impact analysis and implement the land access strategy.

1.2.2 ACCESS, CLIMATE, LOCAL RESOURCES, INFRASTRUCTURE AND PHYSIOGRAPHY



- INV will engage local ports during Project execution to consider opportunities in switching from bagged-containerized to bulk export for the pyrite concentrate; and investigate exporting pyrite concentrate in bulk in lined containers.

1.2.3 GEOLOGY AND MINERAL RESOURCES

- Ensure that procedures for investigating, correcting, and documenting results of QA/QC non-compliance issues such as biases or failures are followed for every drillhole program.
- Procure reference standards with grades that better reflect the range of gold grades within the Mineral Resource (i.e., 2 g/t Au to greater than 30 g/t Au). RPA further recommends that INV obtain an analytical standard for silver and another for copper that reflect the average grades expected in the deposit, in order to quantify the accuracy of analyses.
- Complete an external check on the reference materials used on the Loma Larga Project.
- Resume the regular submission of check assays (pulp replicates) to a secondary laboratory.
- Check half core duplicate analyses using core from the existing core library, to ensure that the current practice of quarter-core analysis is accurate.
- Resurvey drillhole collars that deviated more than one metre above or below the topographic surface.
- INV plans future drilling to potentially upgrade Mineral Resources from Inferred to Indicated for inclusion in the mine plan and Mineral Reserves.

1.2.4 MINERAL RESERVE ESTIMATE

- Following the recommendations listed for the Mineral Resources, DRA recommends a program of in-fill drilling be started once the ore body is reached by the ramp to better delineate the limits of the high-grade zones and refine the limits of the ore body.

	Document Number	J01834-PM-REP-002	Rev	0	
	Date	11 January 2019	Page	36 of 417	

1.2.5 MINING METHODS

- Investigate options to obtain ultra-low sulphur diesel for the underground operation; with benefits including: a more diversified choice from equipment manufacturers; improve performance of underground equipment at a high elevation; and improved quality of vehicle emissions reducing the exposure of workers to NOx or toxic gases.
- Investigate electric and battery operated mine fleet for the replacement underground fleet in eight to nine years: technology improvements and potential affordability may result in it being more competitive with the diesel option. This would result on an opportunity to lower the ventilation cost for the remaining of the mine life.
- During the early design phase, investigate moving the level development into the ore body to reduce waste development, and initial and sustaining capital expenses.

1.2.6 MINERAL PROCESSING AND METALLURGICAL TESTING



- Representative copper and pyrite concentrates, and flotation tailings samples will need to be produced in sufficient quantities for filtration to be conducted by potential filtration vendors.
- Further confirmatory testwork, through the testing of additional composite and variability samples, can improve the process design conditions. Potential upside of additional testwork would focus on lowering capital and / or operating costs.
- Continue to develop and optimize the metallurgical relationships for gold recovery in the pyrite and copper concentrates.
- Investigate the applicability of new innovative technologies to improve gold recoveries. The use of SFR cells are one such example of potential opportunities, should equipment costs become more economical.
- Ramp up to 3,400 tpd as soon as practicable (de-bottleneck process sub-systems) and validate further increased tonnage through de-bottlenecking.
- Evaluation of processing lower grade ore to extend the mine life.

1.2.7 PROJECT INFRASTRUCTURE

- Infrastructure buildings such as offices, kitchens and washroom facilities to be reviewed for suitability as modularised prefabricated units or pre-engineered structures in the final design phase.
- Completion of tailings filtration testing to verify tailings characteristics and additional geochemical, geotechnical and hydrogeological investigation to support the FTSF design.
- Completion of geotechnical investigation and testing to confirm suitability and design for the selected sites for the processing facilities.

1.2.8 ENVIRONMENTAL STUDIES, PERMITTING AND SOCIAL OR COMMUNITY IMPACT

- Regulatory agency engagement to support the EIS, Environmental Licence and permitting process.
- Additional hydrogeology characterization to optimize water-treatment plant design and to provide baseline for monitoring purposes around the FTSF.
- Additional water balance and water quality modeling to better characterize potential need for, and duration of, post-closure water treatment.

	Document Number	J01834-PM-REP-002	Rev	0	
	Date	11 January 2019	Page	37 of 417	



- Continuation of baseline surface water quality monitoring.
- Targeted surveys to establish the occurrence and distribution of special status species to determine potential critical habitat.
- Continuation of seasonal baseline data collection to support monitoring and management plans for the exploitation phase of the Project.
- Development and implementation of local employment, procurement, and training strategies to support local hiring and developing skills.
- Complete a material balance to demonstrate that sufficient soil will be available for reclamation purposes.
- Formalized Social Management Plan and Stakeholder Engagement Plan.

1.2.9 MARKET STUDIES AND CONTRACTS

- INV will engage the market and assess potential to increase payabilities of concentrates with contracts.

1.2.10 OTHER RELEVANT DATA AND INFORMATION

- The critical milestones for commencement of the critical activities is as follows:
 - Detailed engineering and commitment for equipment procurement: finance availability.
 - Construction activities: construction permit availability.
- The overall project execution duration of 27 months could reasonably be reduced to 24 months if there were no restrictions between start of engineering and construction permits – for start of construction. This can be achieved either by delaying the start of detailed engineering until it is on critical path; or by bringing forward the construction permits.
- Commence the bridging work to de-risk the execution phase and activities on the critical path, including testwork, fieldwork, select engineering (update design and layout optimization based on metallurgical data results), procurement and contracts activities in support of project critical path activities. Engage select external consultants during the feed phase (69kV supply and access road).

	Document Number	J01834-PM-REP-002	Rev	0	
	Date	11 January 2019	Page	38 of 417	

2 INTRODUCTION

This technical report was prepared for INV to summarize the results of the FS on the Loma Larga gold-copper-silver development project, located in Ecuador. This report was prepared in compliance with the disclosure requirements of the Canadian National Instrument 43-101 (NI 43-101) and in accordance with the requirements of Form 43-101 F1.

INV is a Canadian mineral resource company headquartered in Toronto, focused on the acquisition, exploration and development of its 100% interest in the Loma Larga gold-copper-silver project, and its regional exploration properties, located in Ecuador. On November 14, 2012, INV acquired 100% of the Loma Larga Project from IAMGOLD Corporation (IAMGOLD). INV is listed on the Toronto Stock Exchange under the symbol INV.



INV retained DRA Americas Inc. (DRA), an international engineering firm with extensive experience both in the construction and operation of mining projects, to perform the mine planning, mineral reserve estimation, metallurgy, processing and economic estimation and coordinate the preparation of the Feasibility Study (FS or the Study) for the Loma Larga Project (the Project), located in Ecuador. INV further retained the services of additional leading consultants with expertise in various fields, including: Rosco Postle Associates Inc. (RPA) for Mineral Resource estimation, Mine Design Engineering Inc. (MDEng) for geotechnical design of the underground mine, Itasca Denver, Inc. (Itasca) for hydrogeology and water quality, Environmental Resources Management (ERM) for social and environmental, NewFields for tailings design, Paterson & Cooke Canada Inc. (P&C) for paste backfill, and SGS Canada Inc. for metallurgical test work.

DRA, RPA, MDEng, ERM, Itasca, NewFields, P&C and INV provided input to the report and the individuals presented in Table 2-1 are considered Qualified Persons (QPs) as defined in NI 43-101 for this report and meet the requirement of independence as defined in NI 43-101.

The Loma Larga Project is located 30 kilometres southwest of the city of Cuenca and approximately 15 kilometers north of the town of Girón and comprises concessions covering an area of approximately 7,960 ha.

The Loma Larga gold-copper-silver deposit is classified as a high sulphidation epithermal system and alteration is characterized by multiphase injections of hydrothermal fluids strongly controlled by both structure and stratigraphy. The deposit is a flat lying to gently western dipping (less than ten degrees), north-south striking, cigar shaped body, which has a strike length of approximately 1,600 metres north-south by 120 metres to 400 metres east-west and up to 60 metres thick, beginning approximately 120 metres below surface.

The FS is based on underground mining over a period of 12 years. The underground mine will be accessed by a 1.2-kilometre-long ramp into the deposit. The ramp will serve as the access to the mine for personnel and materials, the haulage of waste and ore, and for ventilation. Due to the high-grade nature of the ore body and the positive geotechnical conditions, the deposit will primarily be mined by the long-hole stoping method. Certain zones will utilize the drift-and-fill method where appropriate. Initial daily ore production of 3,000 t/d is planned from primary and secondary stopes for the first four years, generating approximately 1,095,000 tonnes of ore annually. From year 5, daily average ore production of 3,400 t/d is planned to be achieved through plant optimization, generating 1,241,000 tonnes of ore annually. Ore will be trucked approximately 3.5 kilometres from the portal to the process facilities. Ore will be processed using primary and secondary crushing, a ball mill, and a two-stage sequential flotation circuit to recover gold, silver and copper into two separate saleable

	Document Number	J01834-PM-REP-002	Rev	0	
	Date	11 January 2019	Page	39 of 417	

concentrates which will be trucked to the port for export. No cyanide will be used in the extraction process and it is anticipated that acid will not need to be trucked to site.

2.1 SOURCES OF INFORMATION

Discussions were held with personnel from INV:



- Candace MacGibbon, CEO
- William Shaver, COO
- Kevin Canario, CFO (to November 14, 2018)
- Sunny Lowe, CFO (current)
- Jorge Barreno, General and Country Manager
- Fernando Carrión, Social Responsibility Manager
- Franklin Vega, Geologist
- Marco Camino, Geologist and Database Manager
- Vicente Jaramillo, Manager of Environmental, Health and Safety
- Parviz Farsangi, Director
- Terry MacGibbon, Chairman
- Darren King, VP Exploration

The Qualified Persons' responsibilities for this Technical Report are listed below: The list of qualified persons responsible for the preparation of this technical report and the sections under their responsibility are provided in *Table 2-1*.

Table 2-1: List of QPs

Name	Company	Position	Site Visit Date	Designation	Report Sections ¹
Esias P. Scholtz	DRA	SVP Projects	August 1 to 2, 2017	Pr. Eng.	5.1; 5.3; 5.4; 18; 21.1 (excluding 21.1.1; FTSF and Paste Backfill); 21.2.1; 21.2.5; 24
Daniel Gagnon	DRA	VP Mining, Geology and Operations	August 1 to 2, 2017	P.Eng.	6; 15; 16; 21.1.1; 21.2.2
David Frost	DRA	VP Process Engineering	June 27 to 28, 2017	FAusIMM	13; 17; 21.2.3
Silvia del Carpio	DRA	Process Engineer and Financial Analyst	Did not visit site	P.Eng., MBA	19; 22
Derek Chubb	ERM	Senior Partner	June 28, 2017	P. Eng.	4; 5.5; 20
Houmao Liu	Itasca	Principal Hydrogeologist, General Manager	Did not visit site	Ph.D., P.E.	10.2.2; 16.10; 16.11.5
Kathy Kalenchuk	MDEng	Principal Geomechanics Consultant	Did not visit site	"Ph.D., P.Eng., P.E.	16.3
Paul Kaplan	NewFields	Partner, Principal	June 27 to 29, 2017	P.E.	5.2; 18.6; 18.10.1; 21.1 and 21.2 (FTSF CAPEX and OPEX)
Leslie Correia	P&C	Engineering Manager	Did not visit site	Pr. Eng.	16.9; 21.1.1 (paste backfill CAPEX); 21.2.4
Katharine Masun	RPA	Senior Geologist,	February 17 to 20, 2014	P.Geo.	7 to 12; 14; 23

– Note 1: QPs are responsible for those portions of Sections 1, 2, 3, 24, 25, 26 and 27 related to the sections of the Technical Report which they authored.

	Document Number	J01834-PM-REP-002	Rev	0	
	Date	11 January 2019	Page	41 of 417	

3 RELIANCE ON OTHER EXPERTS

This Report, following National Instrument 43-101 rules and guidelines, was prepared as a Technical Report for INV by DRA, RPA, MDEng, ERM, Itasca, NewFields and P&C at the request of INV. The quality of information, conclusions and estimates contained herein is consistent with the level of effort involved in DRA's services, based on: i) information available at the time of preparation, ii) data supplied by outside sources, and iii) the assumptions, conditions, and qualifications set forth in this Report. This Report can be filed as a Technical Report with Canadian Securities Regulatory Authorities pursuant to National Instrument 43-101, Standards of Disclosure for Mineral Projects. Except for the purposes legislated under Canadian securities laws, any other use of this Report by any third party are at that party's sole risk.

For the purpose of this report, ERM has relied on ownership information provided by INV, as referenced in the documents ARCOM-C-CR-RMC-2016-0220-ME (Rio Falso), ARCOM-C-CRRMC-2016-0221-ME (Cerro Casco), ARCOM-C-CR-RMC-2016-0219-ME (Cristal) which correspond to certificates of validity and effectiveness issued by the Agencia de Regulacion y Control Minero (ARCOM) of Cuenca, Ecuador, on July 2016, and the update of the Mining Titles issued in Cuenca on May 17, 2016 in the documents MM-CZM-CS-2016-0182-RM (Rio Falso), MM-CZM-CS-2016-0183-RM (Cerro Casco), MM-CZM-CS-2016-0181-RM (Cristal), issued by the Regional Undersecretary of Mines, Zone 6. ERM has not researched property title or mineral rights for the Project and express no opinion as to the ownership status of the property.

DRA has relied on INV for guidance on applicable taxes, royalties, and other government levies or interests, applicable to revenue or income from the Loma Larga Project.

DRA has relied on INV and Ocean Partners USA, Inc. for guidance on revenue for the sale of concentrates and associated data for the Loma Larga Project.

4 PROPERTY DESCRIPTION AND LOCATION

4.1 LAND TENURE

4.1.1 MINING CONCESSIONS

INV obtained 100% title to the Loma Larga property by acquiring IAMGOLD's Ecuadorian subsidiary in November 2012. The IAMGOLD mining concessions, each with an initial 30-year term, are shown in **Table 4-1**.

Table 4-1: Initial IAMGOLD Mining Concessions (INV Metals Inc. – Loma Larga Project)

Name	Code	Area (ha)	Registered	Expiry
Cerro Casco	101580	2,572	November 23, 2001	July 1, 2030
Cristal	102195	2,250	June 5, 2003	July 12, 2032
Rio Falso	101575	3,208	November 23, 2001	July 1, 2030

To meet the requirement of Article 38 of the Mining Law and to maintain concessions in good standing, INV has been submitting annual exploration reports for each claim, itemizing expenditures, exploration activities and the investment plan for the following period. The concessions have been most recently validated on September 17, 2018.



In May 2014, INV had the right under the Mining Law to submit an application to advance the concessions from the initial exploration stage to a four-year advanced exploration stage. INV's minimum exploration commitment is \$500,000 per year for the period from 2014 to 2018, which has been met on an annual basis over this period. The property was reduced by 70 ha to a revised total of 7,960 ha as required by the application (**Table 4-2**).

Table 4-2: Property Size for Advanced Exploration Stage

Mining Concession	Code	Current Area (ha)
Cerro Casco	101580	2,552
Rio Falso	101575	3,168
Cristal	102195	2,240
Total		7,960

The government approved the conversion of the Project's mining concessions to the advanced exploration stage on October 23, 2014, complying with the concession reduction process, as noted in the registry of minutes at the Mining Registry on May 4, 2016. In October 2018, INV submitted requests to the Ministry of Energy and Non-renewable Natural Resources to change the phase from Advanced Exploration to Economic Evaluation for the three concessions of the Loma Larga Project, and a response has not yet been received.

The Mining Act of Ecuador stipulates that holders of mining concessions must pay an annual "Patent Conservation Fee" for each mining hectare by March in each year. The conservation patent fee from the date of the concession is granted up until December 31 in the year the initial exploration period expires and is equivalent to 2.5 percent of a unified basic salary (equivalent to US\$386/month for 2018) for each mining hectare. This fee doubles to 5% of the basic salary per hectare for the advanced exploration and economic evaluation periods. During the operational phase of the mining licence, the fee doubles again to 10%, per hectare per year.

	Document Number	J01834-PM-REP-002	Rev	0	
	Date	11 January 2019	Page	43 of 417	

INV mining concessions intersect legally recognized natural areas belonging to the National System of Protected Areas and Protective Forests. These natural areas are:

- The National Recreation Area Quimsacocha (created on January 25, 2012, by Ministerial Agreement No. 007 published in the Official Gazette No. 680 of April 11, 2012).
- The Protective Forest and Vegetation Sun Yanasacha.
- The Protective Forest and Vegetation El Chorro (created through Ministerial Agreement No. 12, published in the Official Gazette No. 143 of March 4, 2010, with an update on August 3, 2010).
- The Protective Forest of the Micro-basins of Yanuncay and Irquis rivers within the Paute River Basin (created by Ministerial Agreement No. 292 published in the Official Gazette Supplement No. 255 of 22 August 1985. The last change to this agreement was done on September 3, 2015).

The Loma Larga Project layout falls within the last two areas (*Figure 4-1*).

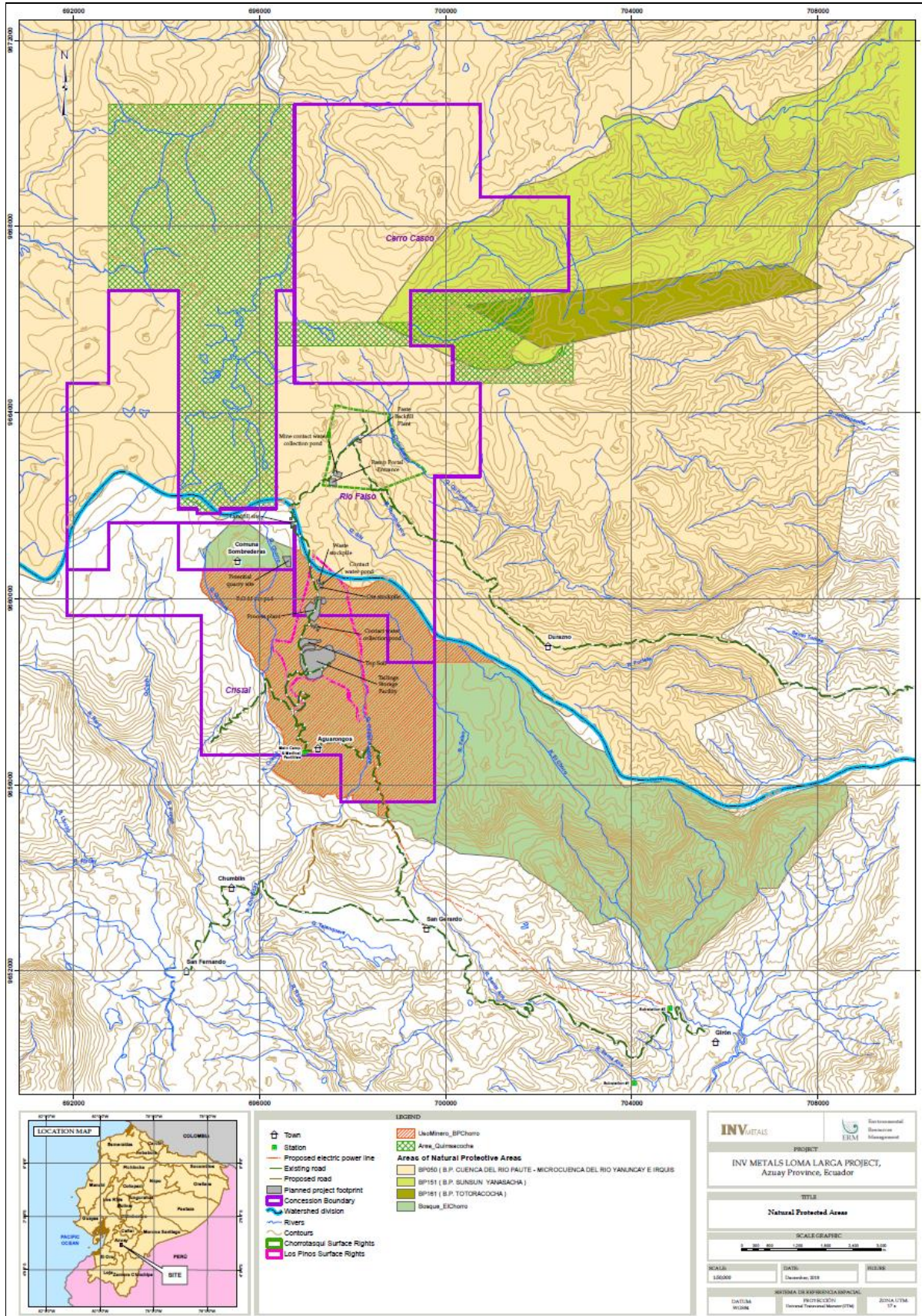

Figure 4-1: Loma Larga Project and Natural Protected Areas

Mining activities are allowed within some natural protected areas, where special mining use zones are determined. A review of the available management plans for El Chorro, Yanuncais Irquis and Quimsacocha, indicates 12 mining concessions within the Yanuncais Irquis Protective Forest and the El Chorro defines a specific special mining use zone. However, the relevant authorities have not yet included specific management requirements for these special mining zones. Current requirements are focused on protection of the biodiversity, land reclamation, use and management of water resources, and research and strengthening of the organizations involved in the management of the protected area. It is expected that through the Environmental Impact Statement (EIS) review process, the Ministry of Environment and Water will establish specific requirements for the Project, and there exists potential for constraints to be placed on the mine that have not been considered in this FS.

4.1.2 SURFACE RIGHTS

In addition to the mining concessions, IAMGOLD Ecuador S.A. had previously purchased two areas of surface rights, approximately 300 ha, at the Los Pinos Camp area and a 200- ha parcel within the Forestry Reserve referred to as Chorro Tasqui. In addition, an easement agreement was entered into with a local landowner (**Table 4-3**). The two land purchases as well as the easement agreements were transferred to INV and have been maintained in good standing.

Table 4-3: Current Surface Rights Agreements (INV Metals Inc. – Loma Larga Project)



Date	Document	Owner
March 17, 2006	Purchase-Sale Public Deed to Mr. Jorge Jarrin	INV Minerales Ecuador S.A.
December 7, 2006	Purchase-Sale Public Deed to Mr. Leonardo Castro	INV Minerales Ecuador S.A.
June 27, 2007	Easement Agreement (to carry out exploration activities in the North Concession Cerro Casco)	Mr. Juan José Mogroveio

4.1.3 LAND ACQUISITION STRATEGY

The Project’s planned mine infrastructure will be developed within the surface rights already owned by INV. As a result, there is no need to acquire additional land to develop mine infrastructure. That is not the case for the linear components associated with the Project, which are the access road from San Gerardo and the transmission line. INV does not currently possess the right-of-way for the transmission line and for sections of the access road where modifications to the public road are required. To address the need for these easement rights, INV has developed a land acquisition strategy and land access strategy that incorporates relevant international standards, national legislation and corporate policies.

The land acquisition and access strategy prioritizes achieving easement access agreements through a process that is transparent, equitable and effective. Through this process, INV will seek to mitigate impacts caused by the project’s easement access requirements. IFC’s Performance Standard No. 5 (PS5) on Land Acquisition and Involuntary Resettlement will be a guiding principle for the application of the land access strategy. The proposed land access strategy for the linear components of the Loma Larga project is structured in three phases: preparation, collective implementation, and individual implementation.

There are two considerations in terms of land access requirements for the construction of the proposed access road. The first consideration addresses the segments that cross the existing

	Document Number	J01834-PM-REP-002	Rev	0	
	Date	11 January 2019	Page	46 of 417	

road where the right of way will need to be increased, and the second concerns new road segments that deviate from the existing road.

Land access requirements to increase the right of way of the existing road in the areas required add up to 1.7 ha of land. This area affects approximately 27 properties. INV plans to approach these landowners to initiate the process to acquire the relevant easement rights. After the completion of these works, INV will transfer these easement rights back to the local government or the Ministry of Public Works.



Land access requirements for the sections where INV proposes to build a new road total approximately 3.1 ha. This area includes the acquisition of the easement rights for a six-metre-wide road for the entire length of the new road. This segment crosses approximately 20 properties. INV will approach the landowners of these properties to negotiate the easement rights. As before, INV expects to transfer the easement rights to the relevant government authorities once construction is completed.

Preliminary engagement with stakeholders in the area revealed that people perceive the construction of the access road as a positive development since it increases the value of their lands. As a result, the team leading fieldwork and social engagement have not identified major risks in the form of potential holdouts or complicated negotiations.

Approximately 21 ha of land will be required to establish the transmission line right-of-way, assuming that construction access is within the same easement. The estimation of affected properties and landowners is still in progress as the available cadastral information only covers the area affected by the access road. Based on an initial review of available information, 44 properties are affected in the seven km section where cadastral data is available.

The estimation of landowners available on the cadastral information built by INV is based on orthophotos and INV's knowledge of the area. INV expects to revise this estimation once field verification of the desktop cadastre begins.

It is worth noting that the easement rights will impose certain constraints on land use to the landowners but will not require ceding property rights. As a result, INV expects that this process will have minimal risks. Minor adjustments of the alignment and location of transmission line poles could be considered in order to facilitate mutually agreed land access agreements and minimize legal easement enforcement cases. In addition, encroachment on forestry reserves may need to be addressed.

	Document Number	J01834-PM-REP-002	Rev	0	
	Date	11 January 2019	Page	47 of 417	

5 ACCESS, CLIMATE, LOCAL RESOURCES, INFRASTRUCTURE AND PHYSIOGRAPHY

5.1 ACCESS, TRANSPORTATION AND LOGISTICS

The Loma Larga Project is located 30 kilometres southwest of the city of Cuenca and approximately 15 kilometers north of the town of Girón. The current regional and national infrastructure is adequate to access the Project site through a well-established network of existing major ports and roadways. The road between San Gerardo and the Project site will be upgraded during the early stages of the project and will be ready to support the operations phase of the project as described in Section 18 of this report.

5.1.1 PORTS

The Contecon Concession, Guayaquil Port has infrastructure and facilities to serve the Project needs for importation, construction and operations phase. Manta Port is the closest regional port which will support any oversize and roll-on/roll-off cargo.

The copper and pyrite flotation concentrates will be exported from Contecon Concession at the Guayaquil Port in bulk bags and loaded into containers as described in **Section 18.11.2**.

5.1.2 ROAD TRANSPORTATION

The Ministry of Transportation (MTO, Ministerio de Transporte y Obras Publicas) is responsible for issuing permits for the transport of: overweight, oversize, high-volume or hazardous cargo. A permit will be required for the import of the major equipment for the Loma Larga Project.

There are three main routes between Guayaquil and Project Site as shown in **Figure 5-1**.

- Option 1 – Guayaquil, La Troncal, Cuenca, Girón (approximately 310 km)
- Option 2 – Guayaquil, Machala, Girón (approximately 300 km)
- Option 3 – Guayaquil, El Cajas National Park, Cuenca, Girón (approximately 260 km)

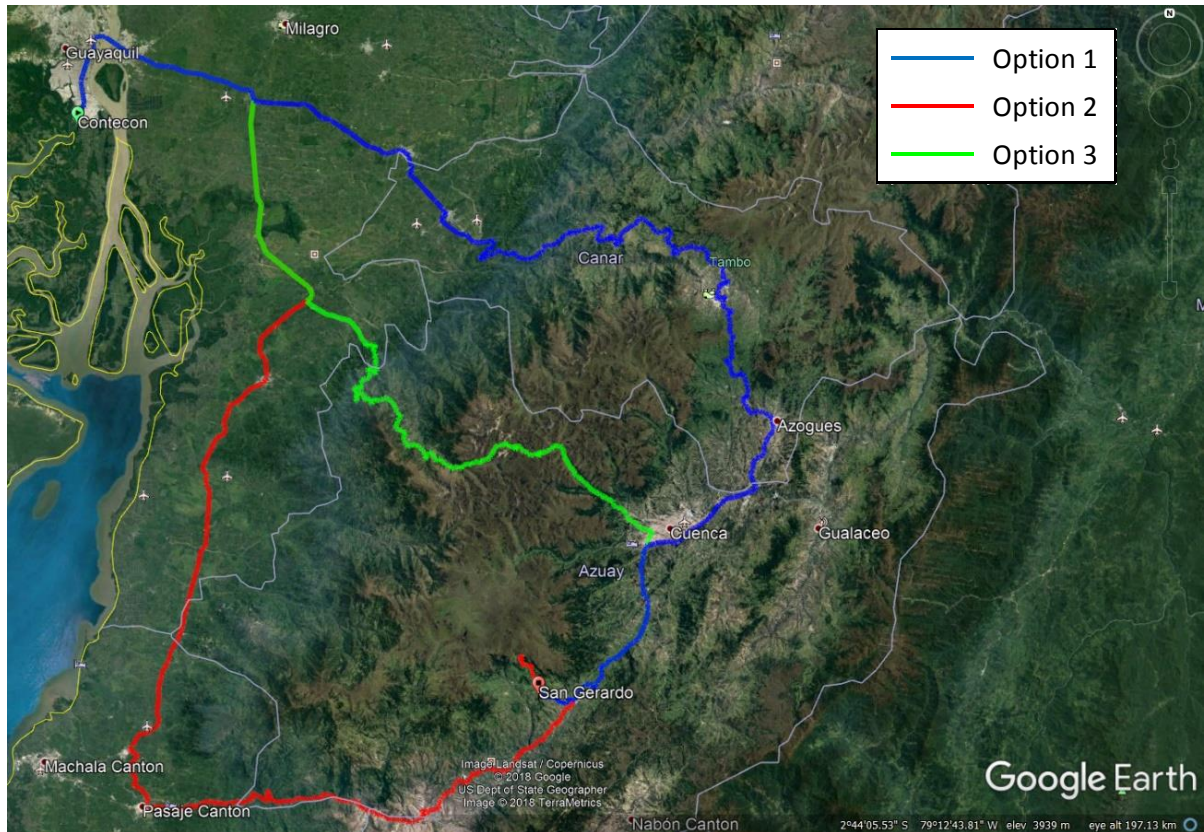

Figure 5-1: Route options between Guayaquil and Girón

INV will engage with the MTOP during the evaluation and selection of the best route for overweight or oversize cargo imported for the Project; and for the export of concentrate from site to Contecon port. The condition of the roads between Guayaquil and San Gerardo are in good condition.

The road from San Gerardo to the Loma Larga Site is currently in a condition adequate for the work that has been performed to date. An upgrade planned for the project to make it suitable for a mining operation is described in **Section 18.3** of this Technical Report.

A staging area will be required, the preferred alternative would be to use any of several existing commercial options at secure storage facilities, located in the area of Guayaquil port, which have their own lifting equipment. Where required, mining equipment can be off loaded in San Gerardo and driven to site.

5.1.3 CUSTOMS CLEARANCE AND TRANSIT TIMES

Customs clearance processes are well established for permanent imports and differentiated between: cases where documentation is in order and the importer is in good standing; and cases where a customs official requests that a shipment be physically inspected. Processes for temporary imports usually have added complexity and typically require physical inspection.

Transit from port Guayaquil to site will take approximately 12 hours for Option 1 and 12 to 14 hours from port Manta to site on a regular flatbed truck. Transit times for oversize / overweight cargo requiring low-bed or extended / hydraulic trucks, time will be significantly longer and, in certain cases, traveling may be restricted to daylight hours.

Capital projects executed in Ecuador can apply to register to declare the entire plant as a “functional unit” (proper term as defined by Customs is “Unidad Funcional”) and declare a single customs tariff number. The importer would then declare the single customs tariff number as a “functional unit”, with authorization to receive the equipment from multiple origins in multiple shipments. It typically takes 9 to 12 months to get the duty exemption or declared “functional unit” / single customs tariff number. This has the advantage that it significantly simplifies and expedites import clearance procedures, and potentially reduces customs tariffs for select equipment. The alternative would be to declare each import on its own merits. Used equipment is more difficult to import but can be imported nonetheless, including for construction equipment.

Regularly scheduled commercial flights are available between Quito, Cuenca, and Guayaquil. The flight duration ranges between 30 and 45 minutes, while the drive between Cuenca and the Project takes approximately 90 minutes. International flights are available from Quito and Guayaquil.

5.2 CLIMATE

The analysis of the meteorological conditions of the area was based on site and regional climate data collected by PROMAS - Universidad del Azuay. The climate data analysis was completed by NewFields (2018) using data collected by the meteorological stations. Data from the Quimsacocha 1 meteorological station was used to provide an indication of the regional air temperature. The average annual temperature ranged from a high of 7.5 °C in 2010 to a low of 5.7°C in 2012 (represent values for full years of data available between 2005-2013). The absolute minimum and absolute maximum daily air temperatures ranged from a low of -5.3°C on November 28, 2005 to a high of 24.2°C on October 3, 2008.

Average peak 24-hour precipitation values from three of the meteorological stations were as follows:

- Quimsacocha 1 met station: 31.3 mm
- Chanlud met station: 40.2 mm
- Labrado met station: 36.4 mm

All three sites were on the same order of magnitude with an average from the three sites of approximately 36 mm (NewFields, 2018).

Based on an evaluation of the existing monthly and annual precipitation, there is some uncertainty in the long-term average precipitation at the site (NewFields, 2018). Therefore, a conservative approach (overestimation) has been used for the purposes of the FS.

Table 5-1 shows the average estimated monthly and annual site precipitation based on long-term monthly precipitation data from Labrado with values increased by 30 percent. This 30 percent increase corresponds to the differences observed between Labrado and Zhuracay Pozas from 2011 to 2014. As presented in the resultant mean precipitation rate is 1.625 m per year. Actual mean annual precipitation could be less and closer to the uncorrected Labrado value of 1.256 m per year; ongoing data collection will allow precipitation estimates to be refined in the future.

Table 5-1: Estimated Mean Monthly and Annual Site Precipitation at Loma Larga Site (NewFields, 2018)

MONTH	MEAN PRECIPITATION (mm)
-------	-------------------------

January	123
February	148
March	173
April	190
May	152
June	133
July	123
August	94
September	107
October	129
November	129
December	124
Annual	1,625

Review of the available data from the Quimsacocha 1 station (2005 – 2013) showed that wind direction is highly variable and there is no single predominant direction (NewFields, 2018). The mean daily wind speed over the entire measurement period was 4.2 m/s, with the maximum daily wind speed of 11.9 m/s recorded on October 31, 2011. A wind rose for 2012 data showed that winds were recorded as being predominantly from the east-northeast direction (31%) and from east (19%) and northeast (16%). The highest wind speeds were from the easterly direction. During the period of record, winds were higher than 8 m/s (28.8 km/h) 11.4% of the time and calm (less than 0.5 m/s) 8.2% of the time. The wind classes 2-4, 4-6 and 6-8 m/s held 68.1% of the wind frequency.

The mean relative humidity over the entire measurement period of record at the Quimsacocha 1 meteorological station was 91.7%.

Daily data of wind speed, temperature, relative humidity and solar radiation was used between August 2005 to October 2015 to estimate evaporation (NewFields, 2018). The daily data was used to generate average monthly estimates from both the Penman-Monteith and the Hargreaves-Samani equations. Using an average of values determined by the two methods, average annual evaporation is estimated to be approximately 844 mm with monthly distributions shown in **Table 5-2**.

Table 5-2: Mean Monthly Potential Evaporation Estimates at Loma Larga Site (NewFields, 2018)

MONTH	AVERAGE (mm)
January	73.7
February	70.2
March	77.8
April	64.7
May	65.3
June	56.6
July	58.0
August	60.8
September	73.4
October	83.0
November	80.1
December	80.9
Annual	844.2

5.3 LOCAL RESOURCES

The Project could attract resources from the surrounding local communities, including San Gerardo, Chumblin and Victoria del Portete. A baseline study has been completed to understand businesses and individuals that may be interested and/or able to support the Project (Propraxis, 2018). The Company is incorporating this information and engaging with the local communities as the Project advances.

5.4 INFRASTRUCTURE



There is currently a minimal amount of infrastructure on the property mainly consisting of several man-made water ponds/reservoirs for storage and treatment of water, a nursery which is used to grow fauna and flora for present and future rehabilitation purposes and buildings used for storage of cores. The north-south access road, which has been deemed a public road by the government, extends all the way past the future portal entrance and up to the mine concession above the ore body.

In addition, there is a small camp at Los Pinos that can house 30 people including office space and there is electrical power from the grid. There is also good cellular and Wi-Fi service.

5.4.1 TRANSMISSION LINE AND EMERGENCY POWER

Electrical power is to be provided via the local utility, CENTROSUR, from the local network in Ecuador. This area is part of the national 230 / 138 / 69 / 22 kV network, with 69 kV and 22 kV feeds identified to supply the site. The main 69 kV / 25 MVA supply connect to the network running between Lentag and Victoria del Portete, with the new substation located near Girón and the transmission line up to the plant site. The incoming 69 kV will terminate into the main substation at the plant site and will be stepped down to 22 kV from where it will be distributed to site facilities.

A 2 MVA, 22 kV supply from San Fernando is proposed for construction power with the permanent power supply of 69 kV being fed from the network running between Lentag and Victoria del Portete. Lentag is fed from multiple 69 kV sources from the national grid and has necessary protection giving assurance for the supply.

	Document Number	J01834-PM-REP-002	Rev	0	
	Date	11 January 2019	Page	52 of 417	

CENTROSUR have indicated that the 22-kV supply from San Fernando is fed from different distribution networks and can therefore suitable for emergency backup power as it is fed from a different source, on different infrastructure and overhead lines that run a different route. Diesel generators were therefore deemed not to be necessary



The 22-kV emergency supply will terminate on a second incomer of the main substation. All on-site distribution to the concentrator plant, mining operations, support infrastructure and administration facilities will be from the main 22 kV substation.

The plant site electrical distribution is described in **Section 18.2** of this report.

5.5 PHYSIOGRAPHY

The property of Loma Larga is located within the Western Cordillera of the Andes, which is made up of a series of narrow lands, oriented in a north-easterly direction. The Project is located in the southern part of the Chaucha continental terrain, in the physiographic province of the Western Cordillera. The terrain is composed of volcanic rocks from the Tertiary continental arc deposited on marine sedimentary rocks to fluvial from the Upper Cretaceous, which in turn were deposited on metamorphic rocks in the Paleozoic and Mesozoic bases.

The physiography at the Project consists of desert plains and rugged valleys, mainly formed by glaciers, with an altitude ranging from 3,500 m ASL to 3,960 m ASL. Vegetation is sparse and typical of the Andean region above tree line. Much of the property is covered by Andean “paramo”, a type of moorland vegetation consisting mainly of coarse grasses (*Calamagrostis* sp.), Pads (*Plantago* sp.), and upper montane forest. There are stands of small pine on hillsides adjacent to the concessions. These were planted as part of a forestation project.

	Document Number	J01834-PM-REP-002	Rev	0	
	Date	11 January 2019	Page	53 of 417	

6 HISTORY

Exploration activity began in the area in the late 1970s when a United Nations survey identified the Tasqui and Jordanita base metal stream sediment geochemical anomalies five kilometres south of the margin of the Quimsacocha caldera.

In 1991, the property was acquired by COGEMA (now Areva), which completed 2,944 m of diamond drilling in 17 holes on vein and disseminated targets. COGEMA entered into a joint venture with Newmont Mining Corporation (Newmont) and TVX Gold Inc. in 1993. Newmont, as field operator, drilled 82 holes totalling 7,581 m. With the average hole being less than 100 m deep, the drill program failed to reach the levels of the Loma Larga deposit. The flat-lying nature of the target mineralization was not recognized. The best intersection reported was 83 g/t Au and 316 g/t Ag over two metres and the joint venture was dissolved.

COGEMA entered into an option agreement with IAMGOLD in 1999. However, no work on the property was carried out for several years. In 2004, IAMGOLD resumed exploration activities, drilling a total of 65,117 m across 280 drill holes, leading to the discovery of the Loma Larga deposit in 2004 (IAMGOLD, 2009).

In April 2008, the Constituent Assembly of Ecuador passed a mandate to revise mining laws. The Ecuadorian Ministry of Mines and Petroleum issued a 180-day suspension of all mining and exploration activity while laws were being revised.

In October 2008, a new Ecuadorian Constitution was approved which established that non-renewable resources, such as mineral and petroleum deposits, could only be produced in strict compliance with the environmental principles set forth in the Constitution. Resumption of mining activities was granted by the Ministry of Non-Renewable Natural Resources of Ecuador on February 14, 2011.



Following a competitive bidding process in 2011, INV was selected by IAMGOLD to exclusively negotiate a purchase agreement. On June 20, 2012, INV entered into a share purchase agreement with IAMGOLD and its two subsidiaries, AGEM Ltd. and Repadre Capital (BVI) Inc., to purchase a 100% interest in IAMGOLD Ecuador S.A. The transaction closed on November 14, 2012. The subsidiary was renamed INV Minerales Ecuador S.A in January 2014.

After the acquisition of the Project, INV initiated a 12-hole drill campaign which included seven holes to test step-out targets to extend the deposit, three deeper holes to test for stacked lenses at depth, and two holes drilled to obtain core samples for metallurgical testing. The program totaled 3,684.7 metres.

Exploration activities to date at Loma Larga have been focused within the Rio Falso concession with the objective being drilling, core collection, logging and testing of drill samples to understand and evaluate the potential mineral resource and establish the technical, environmental and economic conditions that must be considered in the evaluation of a potential mine.



A Technical Report on the Loma Larga Project, Azuay Province, Ecuador, dated August 29, 2016 (2016 Technical Report) was published in 2016 that envisaged operating the mine at a throughput of approximately 3,000 t/d. There has been no production from the Loma Larga Project to date.

Geotechnical, hydrological, and exploration drilling was performed by INV in 2016-2017. A total of 6,978.21 metres were drilled in 32 drill holes.

	Document Number	J01834-PM-REP-002	Rev	0	
	Date	11 January 2019	Page	54 of 417	

As a result of this drill program, an indication of the presence of multiple feeder zones along the north-south length of the deposit were identified.

In 2018, Western Mining Services (WMS) completed a project assessment and target study on Loma Larga (Western Mining Services, 2018). Following a review of the project geology, geochemistry, and geophysics, WMS identified and prioritized nine targets within INV concessions for future exploration programs. INV plans to follow up on these recommendations in the next major drilling program.

	Document Number	J01834-PM-REP-002	Rev	0	
	Date	11 January 2019	Page	55 of 417	

7 GEOLOGICAL SETTING AND MINERALIZATION

7.1 REGIONAL GEOLOGY

Ecuador can be subdivided into a number of distinct physiographic provinces, which broadly coincide with the subdivision of the crust into several terranes (*Figure 7-1*, Scott Wilson RPA, 2006). The Loma Larga property is located within the Ecuadorian cordillera, which consists of a number of narrow, north to northeast trending terranes which were formed during the separation of the Central and South American plates and accreted onto the Amazon Craton from the Late Jurassic to Eocene (Chiaradia, 2004). Most of the terranes extend for several hundreds of kilometres in a north-northeast direction and are only a few tens of kilometres wide. These terranes are separated by deep north-northeast trending faults and were created during the Tertiary and Quaternary periods by subduction related continental arc magmatism and reactivation of the terrane bounding faults.

The Project lies in the southern part of the Chaucha continental terrane, in the Western Cordilleran physiographic province, as shown in *Figure 7-1* (Scott Wilson RPA, 2006). The Chaucha terrane is defined by the northeast trending fault systems of Bulubulu on the northwest side and the Girón fault system on the southeast side (*Figure 7-2*).

These fault zones are interpreted to have been active during the entire evolution of the intervening basin. During each reactivation phase, fault movements influenced the location of some intrusive and subvolcanic bodies while some acted as channels for the mineralizing hydrothermal fluids.

The Chaucha terrane consists of Tertiary continental arc volcanic rocks deposited upon Cretaceous marine to fluvial sedimentary rocks, which in turn were deposited on basement Paleozoic and Mesozoic metamorphic rocks (MacDonald et al., 2010).

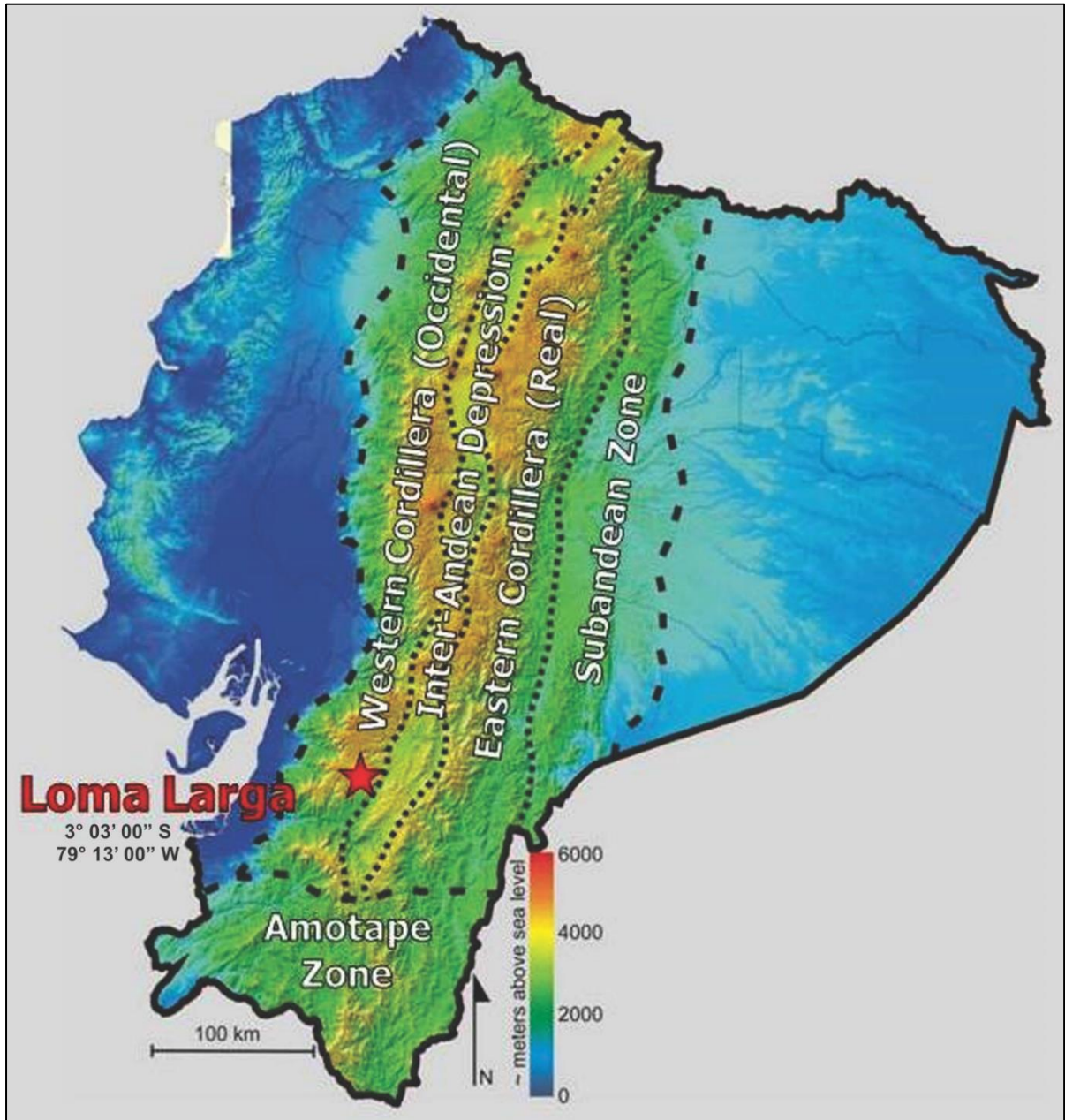

Figure 7-1: Major Terranes of Ecuador
 – Source: Modified from MacDonald et al., SEG September 25, 2013 Whistler

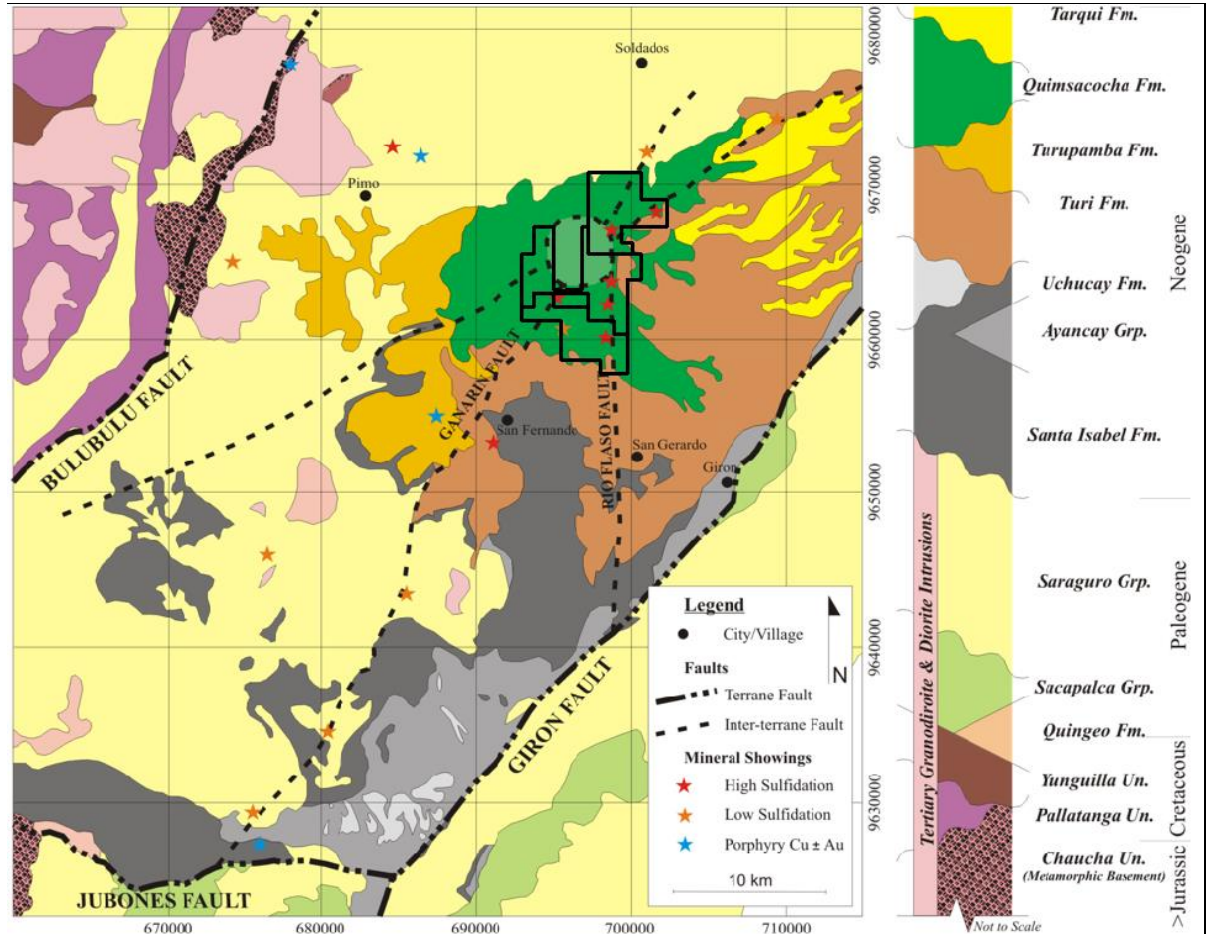

Figure 7-2: Regional Geology



– Source: Modified from MacDonald et al., SEG September 2012 Peru

7.2 LOCAL AND PROPERTY GEOLOGY

The Loma Larga property is located between the Gañarin fault to the northwest and the Girón fault to the southeast. A collapsed caldera structure, four kilometres in diameter, the remnant of an eroded stratovolcano, lies along (and probably emplaced and controlled by) the Gañarin fault and 400 m west of the main Loma Larga mineralization. The caldera is underlain by late felsic domes and is cut by a multi-phase diatreme. The north-south trending Rio Falso fault, which appears to be a conjugate fault linking the Gañarin and Girón faults, is the locus for alteration and mineralizing fluids (**Figure 7-2** and **Figure 7-3**).

The property and immediate surrounding area is mostly underlain by Upper Miocene volcanic and volcanoclastic rocks, of the Turi, Turupamba, Quimsacocha, and Tarqui formations (Scott Wilson RPA, 2006) (**Figure 7-2** and **Figure 7-3**). These formations are flat lying to gently dipping and usually do not outcrop on the property. The outcrops that are exposed form a radial pattern around the caldera and gently dip away from it to the south and east.

The property is largely underlain by the Quimsacocha Formation which hosts the Loma Larga deposit and consists of alternating andesitic banded lava flows with phenocrysts of fresh plagioclase and andesite tuffs and breccias, distributed radially only around the outside of the

	Document Number	J01834-PM-REP-002	Rev	0	
	Date	11 January 2019	Page	58 of 417	

caldera. The Quimsacocha Formation overlies the Turi Formation which consists of tuffaceous breccias, conglomerates, and sandstones with a high content of andesitic clasts and occasional clasts of tuffaceous breccia.

The Turupamba Formation is composed of rhyolitic to dacitic tuffs with a lesser amount of lapilli tuffs and appears to be the result of numerous minor ash falls with periods of fluvial and lacustrine sedimentation. In the immediate surrounding area and bordering the Quimsacocha Formation is the Saraguro Group to the north, the Tarqui Formation to the east, and the Turupamba Formation to west.

The Saraguro Group consists of andesitic to rhyolitic pyroclastics, lava flows and volcanoclastics as well as subordinate rocks.

The Turupamba Formation is composed of rhyolitic to dacitic tuffs with a lesser amount of lapilli tuffs. The Turupamba Formation appears to be the result of numerous minor ash falls with periods of fluvial and lacustrine sedimentation.

The Tarqui Formation overlies the Turi Formation. It unconformably overlies all older formations and has a maximum thickness of 400 m. Near the Loma Larga deposit, the Tarqui Formation mostly consists of strongly weathered quartz phyric rhyolite tuffs. In contrast, further north the unit is mainly composed of thinly banded tuffs, tuffaceous sandstones, and conglomerates. Plant remnants and coal are also common.

Following caldera collapse, a post-mineralization volcanic intrusive event occurred, resulting in dacitic to rhyolitic domes and quartz-feldspar porphyritic dacite cryptodomes, emplaced into and around the caldera in the Pliocene. Accompanying these lithologies are caldera collapse related breccias and diatreme breccias, which locally contain mineralized clasts.

Much of the surface of the property is composed of Pliocene and Quaternary alluvial debris, glacial moraine, and lacustrine deposits.

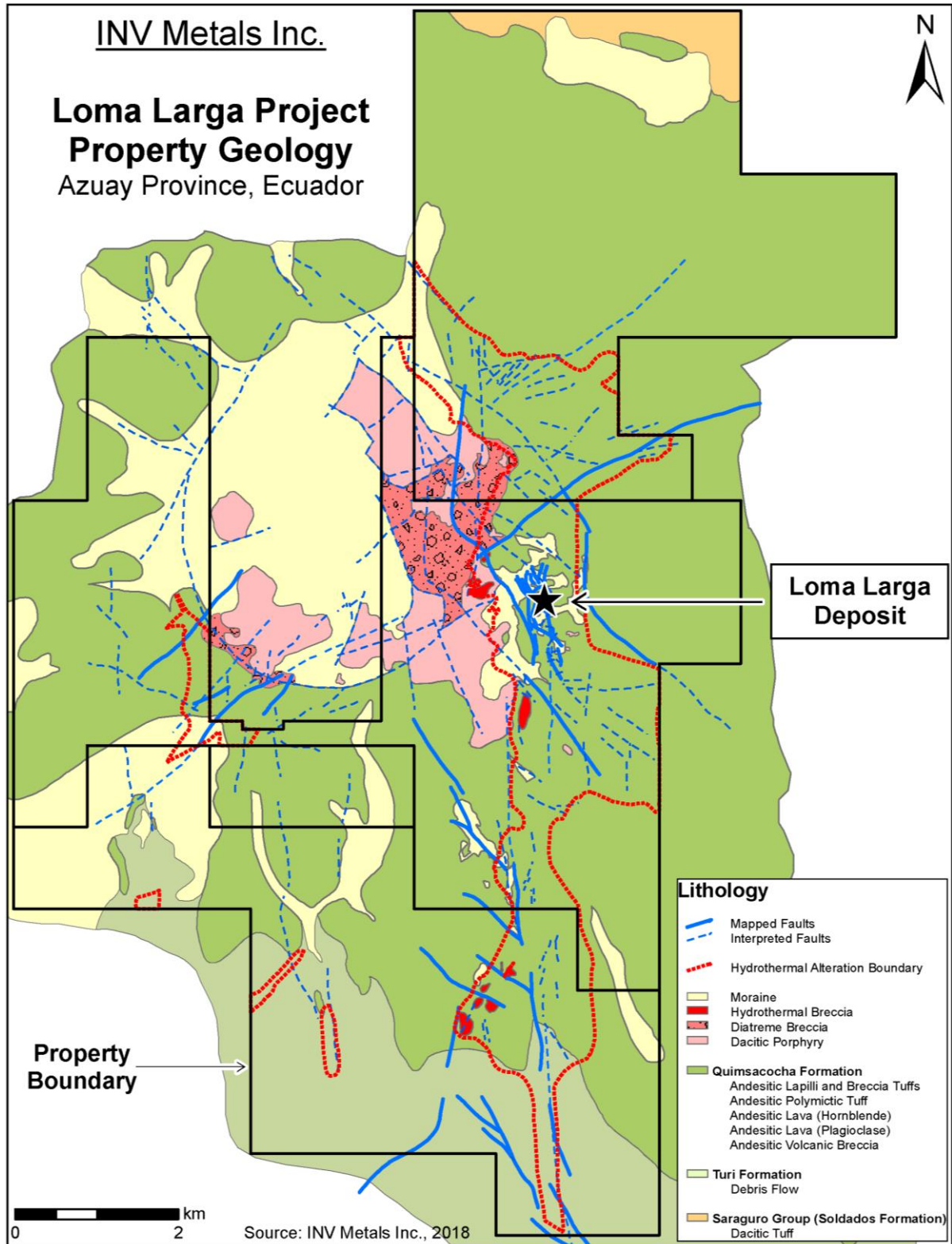



Figure 7-3: Property Geology

	Document Number	J01834-PM-REP-002	Rev	0	
	Date	11 January 2019	Page	60 of 417	

7.3 MINERALIZATION

At Loma Larga, like in most typical high sulphidation epithermal systems, alteration is characterized by multiphase injections of hydrothermal fluids strongly controlled by both structure and stratigraphy. The alteration-mineralizing event is characterized by an early alteration phase caused by a strong inflow of volatile, acidic fluids which cooled progressively and were neutralized by their reaction with country rock, leading to the formation of silicified layers surrounded by alteration halos of clay minerals while the sulphides and gangue minerals associated with the mineralization were deposited by later fluids inside the silicified bodies (IAMGOLD, 2008).

The majority of the limited amount of outcrop exposed at Loma Larga exhibits silica alteration, due to its resistance to weathering. In epithermal environments the silica alteration displays evidence of hot acidic leaching. Multiple types of silica alteration occur at Loma Larga, including vuggy, sugary, banded, fracture fill, and hydraulic-breccia (MacDonald, 2010).

Alteration can be seen to be structurally controlled as it typically occurs as silica ribs mimicking fault locations and orientations. The most significant alteration zone, host to the deposit, is coincident with the north-trending Rio Falso fault, extending for over eight kilometres north-south, along the eastern edge of the collapsed caldera. This long, linear zone contains multiple large pods of silica alteration ranging up to two kilometres in east to west width. The location of the Rio Falso fault suggests that it was coeval with or postdates the caldera collapse (MacDonald, 2010).

The silica alteration is surrounded by varying widths of a halo of argillic alteration, grading from higher to lower temperature mineral assemblages including pyrophyllite, alunite, dickite, kaolinite, illite, and smectite.

The high sulphidation epithermal gold-copper-silver mineralization in the Loma Larga deposit is also stratigraphically controlled as it occurs at lithological contacts between Quimsacocha Formation andesitic lavas and tuffs and reaches greater thickness in the more permeable tuffs. The deposit is a flat lying to gently western dipping (less than ten degrees), north-south striking, cigar shaped body, which has a strike length of approximately 1,600 m north-south by 120 m to 400 m east-west and up to 60 m thick, beginning approximately 120 m below surface (cross section in *Figure 7-4* and long section in *Figure 7-5*). It also dips slightly to the north, such that the mineralized zone is closer to surface at the south end. Resources are defined as a smaller, higher-grade subset within this mineralization.

Mineralized zones are characterized by multiple brecciation and open-space filling events and sulphides such as pyrite, enargite, covellite, chalcopyrite, and luzonite or, at lower sulphidation states, tennantite and tetrahedrite. Higher grade intervals typically coincide with increased amounts of enargite, minor barite, and intense hydraulic brecciation that contains subrounded to rounded silicified fragments. Visible gold is rare. Gold mineralization is found, for the most part, in one of the following mineralogical assemblages: (a) vuggy silica plus fine-grained pyrite and enargite; (b) massive pyrite, including a brilliant arsenical pyrite; or (c) vuggy silica with grey silica banding, sulphide space-filling and banded pyrite. Very fine-grained pyrite is dominant in semi-massive to massive zones and is interpreted to have formed earlier than coarser fracture and vug-filling pyrite (MacDonald, 2010).

The focus of mineralization occurs at approximately 3,610 m (\pm 30 m) elevation, where structural feeder zone(s) intersected a permeable tuff horizon that was acid leached. There is an upper barren silicic lithocap, locally indicative of steam heated alteration, which is typically barren of mineralization, although there is an outcrop exposure of this zone that

contains minor, fine visible gold (MacDonald, 2010). Silica textures within the upper zone range from sugary, to two-phase, massive, vuggy, and laminated, while the main body centred at 3,610 m exhibits either massive or vuggy silica with intense brecciation in the core and pervasive veinlet and vug infilling alunite alteration. A third lower silicified horizon described below is primarily vuggy in nature (MacDonald, 2010).

Drilling has led to the recognition of a third, deeper zone of residual quartz, below approximately 3,550 m elevation. This horizon is typically 20 m in thickness but is locally thicker. Because these deeper intersections can be correlated between several drillholes and sections, INV has interpreted the zone as a poly lithic tuffaceous horizon (as opposed to a vertical feeder); mineralization is typically ten to twenty metres thick with gold grades of 1.0 g/t to 3.0 g/t. IAMGOLD's drilling on many sections stopped within ten to twenty metres of passing through the main zone, leaving the third horizon and potentially deeper ones virtually untested.

There may be multiple feeder structures along the north-south length of the deposit, possibly associated with north-northeast trending en-echelon structures (Hedenquist, 2013). It is interpreted that at least two vertical to sub-vertical feeder zones occur in the central to eastern part of the deposit, in the vicinity of IAMGOLD's discovery hole IQD-122 (9.2 g/t Au over 102 m). Above this thick, high grade zone, there is an upper lens of mineralization that is included in the current resource as inferred based on the limited number of drillholes intersecting it. Significant drillhole intersections in the Loma Larga upper lens include 24.0 g/t Au over 9.0 m in drillhole IQD124 and 8.4 g/t Au over 30.7 m in drillhole IQD152501.

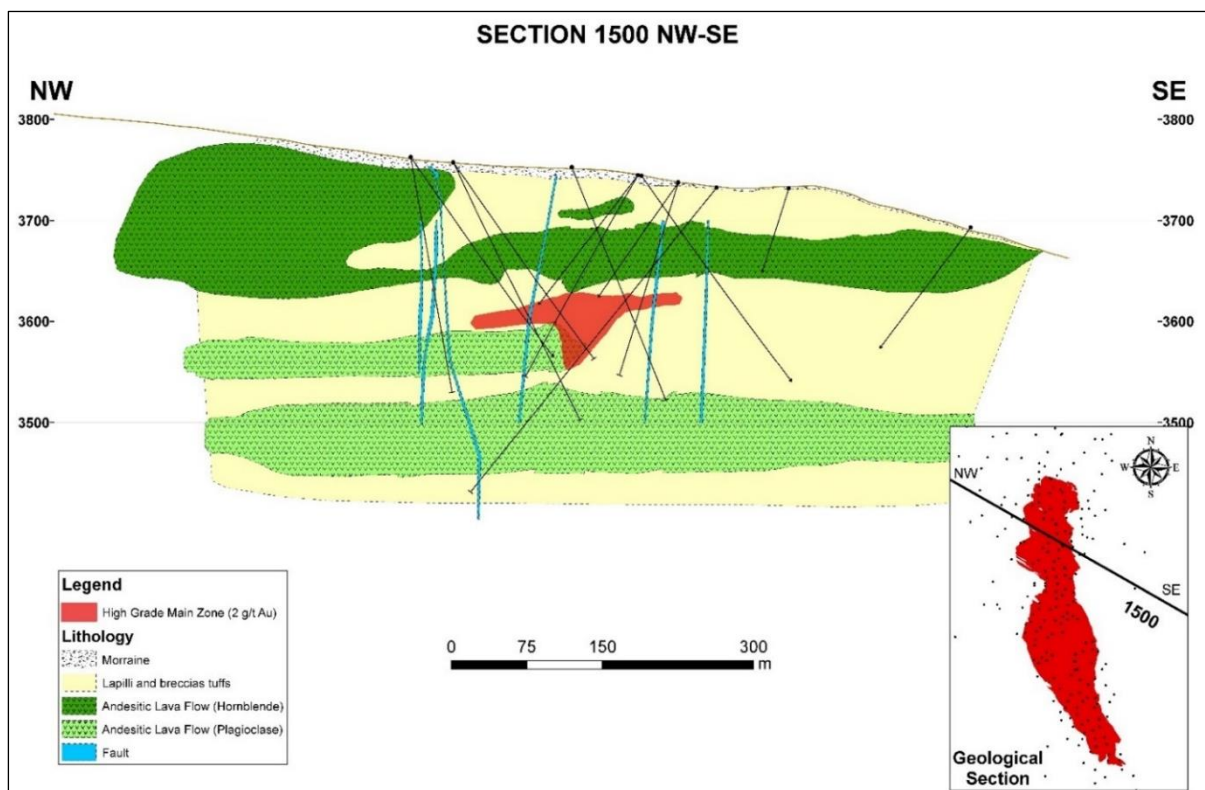

Figure 7-4: Cross Section of the Loma Larga Deposit, Looking Northeast

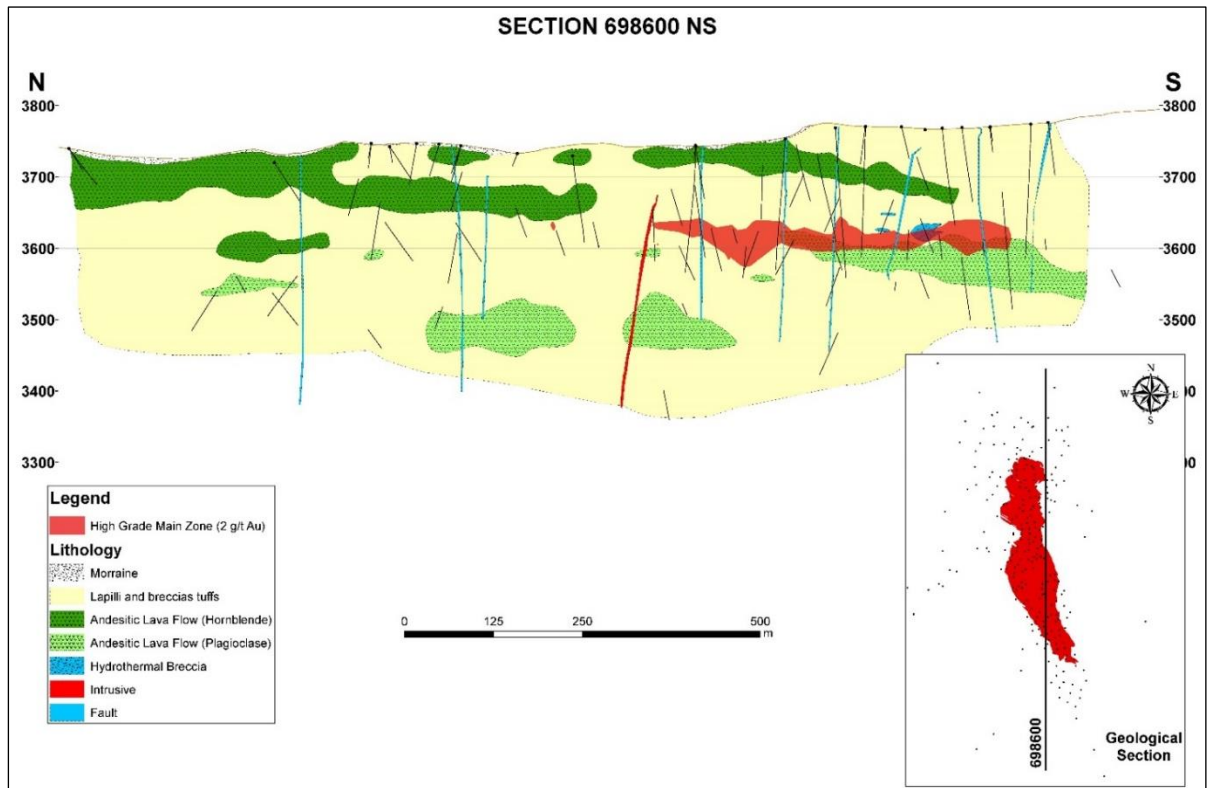



Figure 7-5: Longitudinal Section of the Loma Larga Deposit, Looking East

The presence of copper mineralized porphyry fragments within the diatreme exposed approximately one kilometre to the northwest of the current northern margin of the deposit, along with the zonation of decreasing copper in the deposit from north to south, suggests that the causative intrusion that drove the hydrothermal system is located to the north, and that fluid flow was from north to south. This is consistent with observation of chalcocite and chalcopyrite associated with stockworks of veinlets at depth in the north (Hedenquist, 2013). Evidence for a deeper porphyry copper-gold deposit is suggested by the following observations:

- quartz veinlets with centre lines and margins of chalcocite to the north (IQD-109, approximately 317 m to 343 m at 2.02 g/t Au and 0.14% Cu as chalcocite; As values of less than 100 ppm);
- high Cu/As ratios to the north, i.e., enargite and tennantite poor despite Cu values greater than 0.1 wt%, suggesting the presence of chalcocite and/or chalcopyrite;
- broad illite-pyrite alteration with disseminated magnetite plus pyrite ± magnetite veinlets associated with a fragmental intrusion; and
- the diatreme to the northwest, on the eastern margin of the caldera, which contains quartz-feldspar porphyry fragments plus potassic and phyllic-altered clasts with anomalous copper (up to 0.1% Cu) and gold (up to 0.5 g/t Au), associated with quartz ± magnetite ± pyrite veinlets with disseminated magnetite, chalcopyrite, chalcocite, covellite, and molybdenite (Hedenquist, 2013).

There are multiple exploration targets. For example, INV's 2013 drillhole LLD-367 intersected 4.9 g/t Au, 48.7 g/t Ag, and 0.51% Cu over a core length of 25.1 m, including 11.9 g/t Au, 78.7 g/t Ag, and 0.33% Cu over 6.2 m. This intersection is located approximately 165 m north of the northern limits of the current Loma Larga Mineral Resource. Additional drilling completed

	Document Number	J01834-PM-REP-002	Rev	0	
	Date	11 January 2019	Page	63 of 417	

in 2016 and 2017 investigated the extent of mineralization north and west of the currently defined resource at Loma Larga.

In 2018, Western Mining Services (WMS) completed a project assessment and target study on Loma Larga (Western Mining Services, 2018). Following a review of the project geology, geochemistry, and geophysics, WMS identified and prioritized nine targets within INV concessions. The targets include eight high sulphidation style Au-Cu targets to the north, east, west, and south of Loma Larga, and one low sulphidation style Au-Ag target to the west of the ore body. WMS also identified the opportunity to discover a porphyry style Au-Cu deposit at depth to the east of the Quimsacocha crater, proximate to the Loma Larga deposit. Further to the study, WMS provided rough estimates of the size of the potential discoveries within each target area and provided recommendations to better define targets and improve exploration effectiveness.



The isolated gold- and copper-rich drillhole intersections between 3,550 m and 3,500 m elevation constitute high grade mineralization that may be hosted within a structurally related feeder zone, as at shallower depths, rather than being associated with the lower silicic horizon. Further north, similar high-grade intervals that have been intersected at approximately 3,600 m elevation have yet to be tested at depth for possible structural control.

In addition to the deeper high-grade zones that have yet to be tested for their potential depth extent, there are also shallower high-grade zones that have not yet been tested. It is anticipated that drilling scissor holes would define their potential depth extent and determine if the high grades are hosted in structurally related feeder zones. This includes, for example, IQD-323 with 2.7 m of approximately 77 g/t Au, 89 g/t Ag, and 7.2% Cu at approximately 3,630 m elevation, at the base of the silicic zone.

In 2017, INV completed several drillholes along the western margin of the Loma Larga deposit. Further drilling, however, is recommended to define and constrain the margins of the mineralization, which remains open. In addition, deeper drilling is needed to define a horizon at approximately 3,550 m elevation.

The indications of porphyry potential at depth in the north, including veinlet stockwork with copper sulphides, is consistent with the lithocap alteration and high sulphidation-state sulfides of Loma Larga; the location of the intrusive centre of the porphyry and its depth remain to be determined by further study, and eventual drill testing.

South of the southern extent of the current Loma Larga Mineral Resource there is a silver-rich zone with drillhole IQD-265 intersecting 2.4 m of 3,180 g/t Ag, 0.2 g/t Au, and 0.1% Cu, near the base of the silicic zone, under the main mineralized horizon. The silver-to-gold ratio for the resources is approximately ten-to-one, or less, whereas the silver-rich intervals in IQD-263 and 265 are two hundred-to-one, or higher. Sections to the north of the currently-defined deposit also have high silver-to-gold ratio intersections. For example, drillhole IQD-269 intersects four metres of 896 g/t Ag and 1.3 g/t Au, and drillhole IQD-269 intersects five metres of 566 g/t Ag and 3.8 g/t Au. The two drillholes intersect 0.3% Cu and 0.6% Cu, respectively. Given the uncertain mineralogy responsible for the high silver-to-gold ratio and resulting high grades, INV commissioned Inspectorate Services Peru S.A. to carry out a mineralogical study using optical microscopy and electronic scanning. This study determined that the silver species present include silver sulphides (argentite - acanthite), sulfosalts (AgCuAs and CuAgAs) and sulphides (AgAs).

	Document Number	J01834-PM-REP-002	Rev	0	
	Date	11 January 2019	Page	64 of 417	

8 DEPOSIT TYPES

Epithermal deposits are defined as precious and base metal deposits that formed at depths of less than two kilometres and at temperatures of less than 300°C in subaerial environments within volcanic arcs at convergent plate margins and in intra-arc and back-arc as well as post-collisional extensional settings (Robert et al., 2007). A hydrothermal system consisting of fluids derived at depth will undergo abrupt physical and chemical changes at the shallow depths where epithermal deposits form. These changes occur because of the change from lithostatic to hydrodynamic pressure, which results in boiling, interaction of the fluids with near-surface water, permeability changes, and reaction between the fluids and host rocks. These changes affect the capacity of the hydrothermal fluid to transport metals in solution. This decrease in the solubility of metals in the fluids results in the metals being deposited within a restricted space as a result of focussing of the fluid flow near the surface (White and Hedenquist, 1990).

Epithermal deposits are typically classified as either high or low sulphidation based upon the sulphidation state of the ore minerals; as enargite and luzonite for high sulphidation and chalcopyrite-galena-sphalerite for low sulphidation. The term high sulphidation is frequently misused to suggest a high sulphide or high sulphur deposit, whereas in fact it refers to the chemical state of the metals (the sulphur to metal ratio).

A schematic section showing alteration zonation through a high sulphidation gold deposit environment is provided as **Figure 8-1**. High sulphidation epithermal copper-gold-silver deposits develop in settings where volatiles (dominantly gases such as SO₂, HF, and HCl) and metal bearing fluids vent from hot magma sources at considerable depth and travel rapidly to elevated crustal settings, without reaction with wall rocks, or mixing with groundwater. The volatile component, which rises more rapidly than the fluids, becomes progressively depressurized and SO₂ in particular comes out of solution and in turn oxidizes to form H₂SO₄, such that the rising and cooling fluid becomes increasingly acidic (to pH of 1.0 to 2.0) as it ascends to epithermal levels, where it reacts with wall rocks to produce advanced argillic alteration. Because of the progressive cooling and neutralization of the hot acid fluid by wall rock reaction, the advanced argillic alteration is zoned outwards from a central core of vuggy or residual silica, from which everything but silica has been leached by the strongly acidic waters, through alteration zones dominated by alunite, pyrophyllite, dickite, kaolin, and then illite (**Figure 8-1**) (Corbett, 2005). Use of a portable infrared mineral analyzer (PIMA) has been critical in a number of discoveries, including Loma Larga, as it allows one to vector towards mineralization based on the zonation of the various clay alteration minerals.

The shape and intensity of alteration vary according to crustal level and permeability of the host rocks. At Loma Larga the acidic fluids preferentially altered the more permeable andesitic tuffs, sandwiched between more resistant and less altered andesitic lavas. The liquid rich phase of the high sulphidation hydrothermal fluid generally follows the volatile rich portion. Most copper-gold mineralization deposition, usually as sulphide breccia infill of competent vuggy silica and silica-alunite altered clasts, typically is associated with pyrite-enargite (and its low temperature polymorph luzonite) and lesser covellite (at deeper levels) and local, generally peripheral, tennantite-tetrahedrite, as well as barite and alunite, and post-dates the alteration.

The hot magma source for the hydrothermal system is frequently a copper-gold porphyry (**Figure 8-2**). Approximately half of the major high sulphidation ore deposits around the world have evidence for underlying porphyry mineralization, based on observations of deeply eroded systems (e.g., Minas Conga, Peru; Halilaga, Turkey), deep drilling (e.g., Far

Southeast, Philippines), and porphyry-altered and mineralized clasts contained within diatremes (numerous systems, including Loma Larga) (Hedenquist, 2013).

The Far Southeast porphyry deposit located under and adjacent to the Lepanto high sulphidation deposit was discovered as a follow-up to the presence of copper-bearing porphyry fragments within a diatreme breccia exposed at surface. A similar situation occurs at Loma Larga, with a diatreme to the north and west of the gold deposit containing copper-mineralized, altered porphyry fragments, suggesting that at some unknown depth a copper ± gold porphyry may have driven the hydrothermal system responsible for forming Loma Larga.

High sulphidation deposits are the major gold producers in the Andes (e.g., Yanacocha, Pierina, El Indio, La Coipa, Veladero), and represent some significant undeveloped resources (e.g., Pascua-Lama and Loma Larga). Other global examples include Lepanto, Philippines; Pueblo Viejo, Dominican Republic; Mulatos, Mexico; Paradise Peak, Nevada; and Chelopech, Bulgaria.

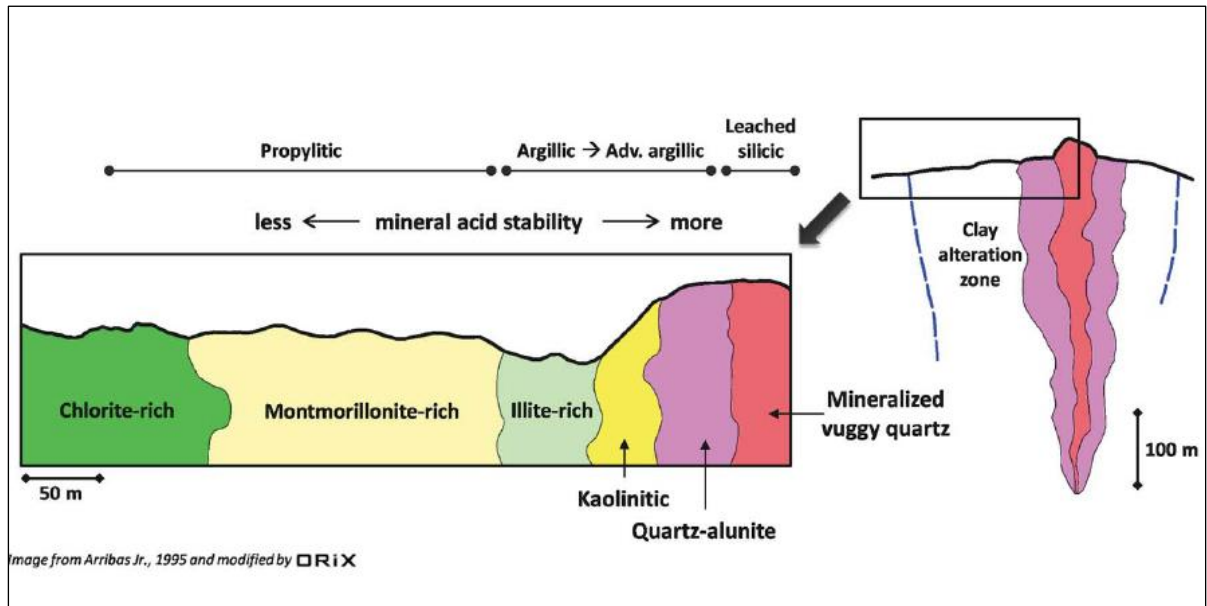

Figure 8-1: Zonation of Alteration in a High Sulphidation Deposit
 – After Arribas Jr. (1995)

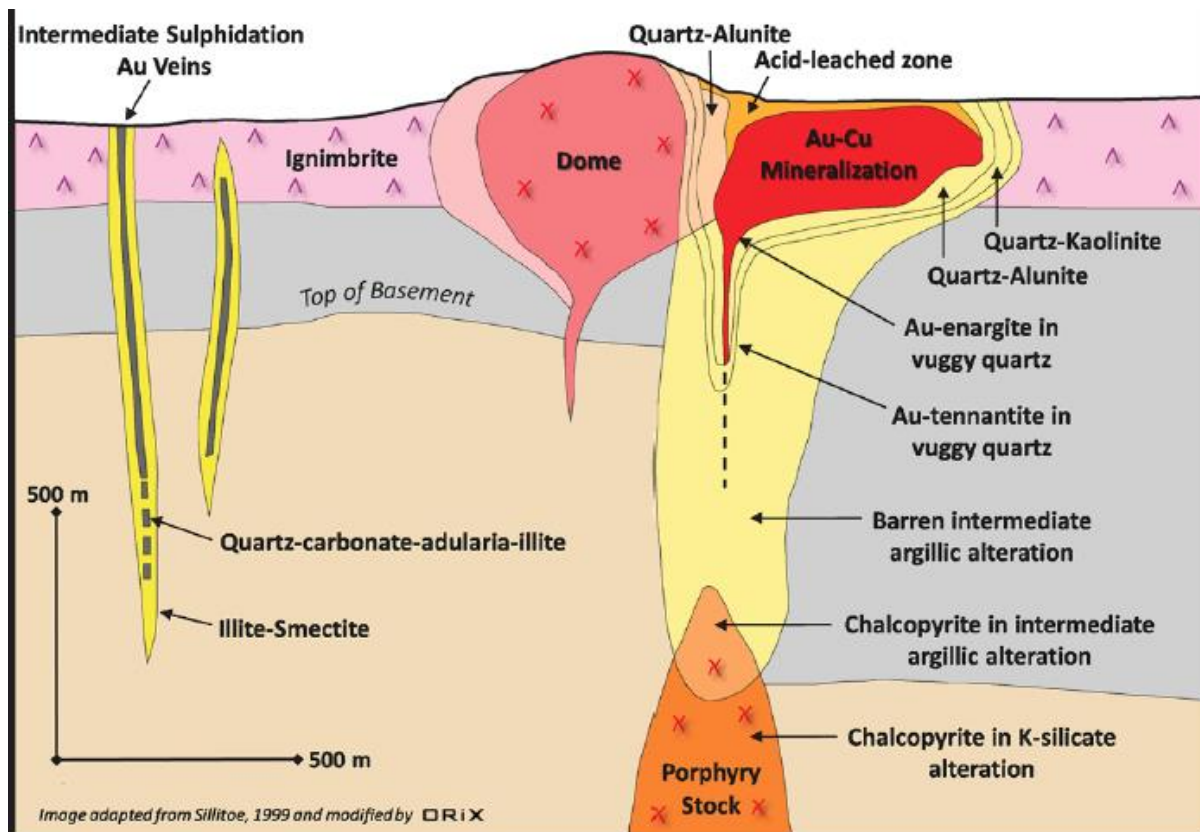



Figure 8-2: Schematic Section of a High Sulphidation Deposit
 – After Sillitoe (1999)



	Document Number	J01834-PM-REP-002	Rev	0	
	Date	11 January 2019	Page	67 of 417	

9 EXPLORATION

Exploration activities by all previous owners are discussed in **Section 6** – History.

INV carried out exploration activities on the property in 2017 and 2018. These are summarized below.

- Contracted Geoscience North Ltd. to organize and analyze geophysical data within the Rio Falso concession. Data sets from Newmont and Val D’Or Sud America were evaluated and a report was produced outlining potential exploration targets (Geosciences North, 2018).
- WMS was contracted to complete a project assessment and target study on the Project. WMS analyzed diamond drillhole data, geological maps, and geophysical data to develop a targeting matrix for the Loma Larga exploration program. A final report was provided in June 2018 (Western Mining Services, 2018).
- Together with Geominingold Cia. Ltda. of Ecuador, the regional geology map for the Loma Larga concessions was updated during June of 2018. The mapping targeted areas with no previous geological mapping along the concession boundaries and validated areas of previous mapping.

	Document Number	J01834-PM-REP-002	Rev	0	
	Date	11 January 2019	Page	68 of 417	

10 DRILLING

10.1 IAMGOLD DRILLING

In 2002, IAMGOLD initiated diamond drilling programs based on the exploration information accumulated by previous operators as well as their own follow-up exploration programs. The Loma Larga deposit was discovered as a result of the 2004 drilling campaign, during which a total of 13,930 m was drilled in 45 holes. Four of the holes were drilled in the Loma Larga Zone, and returned encouraging results, including one sample of 214 g/t Au. From October 2005 to August 2006, IAMGOLD drilled an additional 24,542 m in 125 holes, of which approximately half was infill drilling and the remainder was undertaken to test for a possible extension.

IAMGOLD contracted two companies: Kluane and Paragon, to carry out drilling. All work was done by diamond core drilling and the core diameters used were HQ (63.5 mm) and NQ (47.6 mm) for Paragon and NT (56 mm) and BT (42 mm) for Kluane. All collars were surveyed. Most of the holes were drilled at -55° to -65° but ranged from -45° to -90°. All core obtained from the drilling was placed in wooden boxes and transferred to the logging room at the field camp for logging and sampling for assay. Core diameter depended on the drill type used by each company.

From 2004 to December 2007, IAMGOLD drilled a total of 65,117 m in 280 holes (IAMGOLD, 2009).

No drilling was carried out between 2008 and 2012.

10.2 INV DRILLING

10.2.1 2013

After acquiring the Project in 2012, INV contracted Orix Geosciences Inc. (ORIX) to carry out a detailed 3D compilation and reinterpretation of the deposit, with the goals of furthering the understanding of the deposit and identifying drill targets. Geoscience North was engaged to review and compile all previously collected geophysical data, which was then integrated into the ORIX compilation. INV's drill program in 2013 included 12 diamond drillholes totalling 3,684.7 m, including two holes drilled for metallurgical testwork, three holes to further define the High Grade Main Zone, and seven holes to test step-out targets to extend the deposit.

Holes LLD-371 and LLD-372 were drilled to obtain material for metallurgical testwork. The metallurgical drilling in the high-grade zone clearly demonstrates that the Loma Larga gold deposit contains a high-grade core surrounded by a lower grade halo. For example, drillhole LLD-371 intersected 77 m grading 13.7 g/t Au, including 20 m grading 34 g/t Au, while LLD-372 intersected 36.5 m grading 11.8 g/t Au including 6.3 m grading 47.7 g/t Au. Holes LLD-373 to LLD-375 were drilled to better define the margins of the high-grade zone.

The results for these holes are provided in **Table 10-1**.

Table 10-1: Metallurgical and High-Grade Zone Drill Results

Hole		From (m)	To (m)	Width (m)	True Width* (m)	Au (g/t)	Ag (g/t)	Cu (%)
LLD-371		105.00	182.00	77.00	77.00	13.65	40.15	0.52
	including	132.00	152.00	20.00	20.00	33.95	98.84	1.23
	and	158.00	163.00	5.00	5.00	12.21	24.96	0.36
LLD-372		142.50	179.00	36.50	36.50	11.80	79.57	0.93
	including	170.00	176.30	6.30	6.30	47.72	217.32	3.32
LLD-373		48.50	54.86	6.36	6.36	1.66	8.54	0.12
		166.50	171.00	4.50	4.50	10.36	57.30	2.90
	including	167.50	168.60	1.10	1.10	38.20	214.90	11.21
LLD-374		53.40	69.00	15.60	15.60	2.73	15.69	0.77
	including	56.40	60.40	4.00	4.00	4.65	30.48	1.29
	and	65.00	69.00	4.00	4.00	4.46	5.59	1.00
		133.50	146.00	12.50	12.50	2.81	15.58	0.24
	including	133.50	137.00	3.50	3.50	5.14	34.00	0.50
	and	143.80	146.00	2.20	2.20	5.01	14.44	0.43
LLD-375		124.00	162.00	38.00	37.90	3.27	55.65	0.23
	including	155.00	162.00	7.00	7.00	6.83	131.21	0.19
	and	128.00	131.00	3.00	3.00	6.60	48.10	0.14

– *True Width is an estimation that considers both the dip of the borehole and the interpreted dip of the mineralized zone of 10° to the west.

10.2.2 2017

INV completed nine geotechnical and 14 hydrogeological drillholes on the Loma Larga deposit to obtain data for modelling (**Table 10-2**). Among the 14 hydrogeological drillholes, five of them were for dual purposes: hydrogeological and geotechnical investigation. Various samples of the core from these holes were used for the metallurgical and geotechnical testwork programs as part of this Feasibility Study. Geotechnical samples included strength testing (i.e. unconfined compressive strength, triaxial, and tensile) and unconfined swelling tests. The location of the drillholes is shown in **Figure 10-1** and **Figure 10-2**, and **Table 10-3** summarizes the drilling and assay sample results.

Table 10-2: Geotechnical and Hydrogeological Drill Holes Completed in 2016 - 2017

Drill Hole	Hole Type	Easting (m)	Northing (m)	Elevation (m)	Azimuth (deg)	Dip (deg)	Length (m)	No. of Samples	
LLDGT-001	GT	697787.40	9663471.61	3803.58	180.00	-60.00	50.29	-	
LLDGT-002	GT	698032.21	9663700.91	3780.99	75.00	-60.00	138.90	-	
LLDGT-003	GT	698011.69	9663521.94	3781.19	360.00	-70.00	216.27	14	
LLDGT-003B	HG/GT	697955.93	9663488.55	3784.29	60.00	-80.00	103.70	16	
LLDGT-003C	HG/GT	697953.13	9663486.77	3784.72	240.00	-90.00	134.20	54	
LLDGT-004	GT	698111.08	9663589.94	3776.62	90.00	-60.00	281.95	57	
LLDGT-005	HG/GT	698623.30	9663566.41	3746.71	270.00	-70.00	220.70	74	
LLDGT-006	HG/GT	698455.04	9663937.40	3750.00	45.00	-60.00	231.04	32	
LLDGT-007	HG/GT	698598.68	9663371.64	3770.00	225.00	-70.00	213.30	88	
LLDHG-008	HG	698576.00	9663764.31	3746.00	225.00	-60.00	231.30	135	
LLDHG-009	HG	699149.41	9663312.20	3627.74	0.00	-90.00	22.86	-	
LLDHG-009A	HG	699150.52	9663314.55	3626.92	0.00	-90.00	12.50	-	
LLDHG-010	HG	698853.73	9663920.87	3665.69	0.00	-90.00	15.24	-	
LLDHG-010A	HG	698618.96	9663914.59	3731.04	0.00	-90.00	2.20	-	
LLDHG-011	HG	698581.97	9663461.11	3767.08	300.00	-74.00	208.79	120	
LLDHG-012	HG	697887.88	9663356.53	3798.18	70.00	-80.00	109.73	-	
LLDHG-013	HG	697885.19	9663355.09	3798.24	250.00	-75.00	156.98	-	
LLDHG-014	HG	697760.66	9663095.50	3795.48	270.00	-90.00	60.85	-	
*GT = geotechnical; HG= hydrogeological							Total	2,410.8	590

Table 10-3: Selected Drill Results from the 2017 Geotechnical and Hydrogeological Drilling

Hole		From (m)	To (m)	Width (m)	True Width* (m)	Au (g/t)	Ag (g/t)
LLDGT-004		223.50	243.00	19.50	16.90	2.17	52.5
	including	223.50	238.00	14.50	12.60	2.63	51.5
LLDGT-007		71.45	77.50	6.05	5.70	1.24	1.5
		131.24	183.23	51.99	48.90	3.25	27.6
	including	131.24	153.00	21.76	20.40	4.20	11.8
	and	163.00	170.00	7.00	6.60	4.88	53.7
LLDGT-008		60.50	71.50	11.00	9.50	7.27	91.8
	including	64.50	67.50	3.00	2.60	12.97	155.8
		92.80	173.00	80.20	69.50	3.28	13.6
LLDGT-011		120.00	161.00	41.00	39.40	4.72	14.0
	including	141.00	149.00	8.00	7.70	8.68	21.9
		173.00	196.00	23.00	22.10	3.00	12.8
	including	189.00	196.00	7.00	6.70	4.82	18.1

– * Note: True widths determinations are estimated at 84-96% of the reported core length intervals for most of the holes, estimated sectionally based on the current alteration zone interpretation.

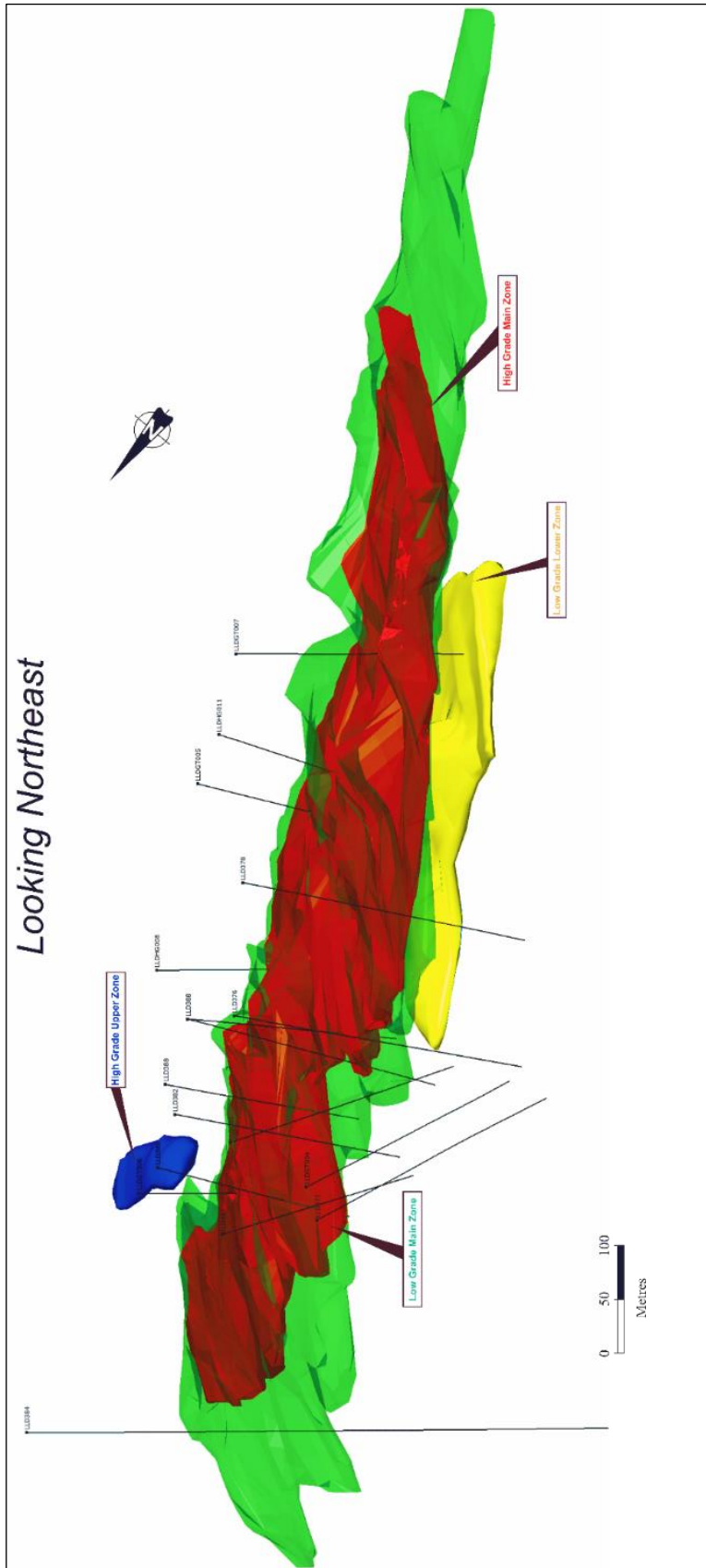

Figure 10-1: Location of INV 2016-2017 Drill Holes in 3D Isometric View

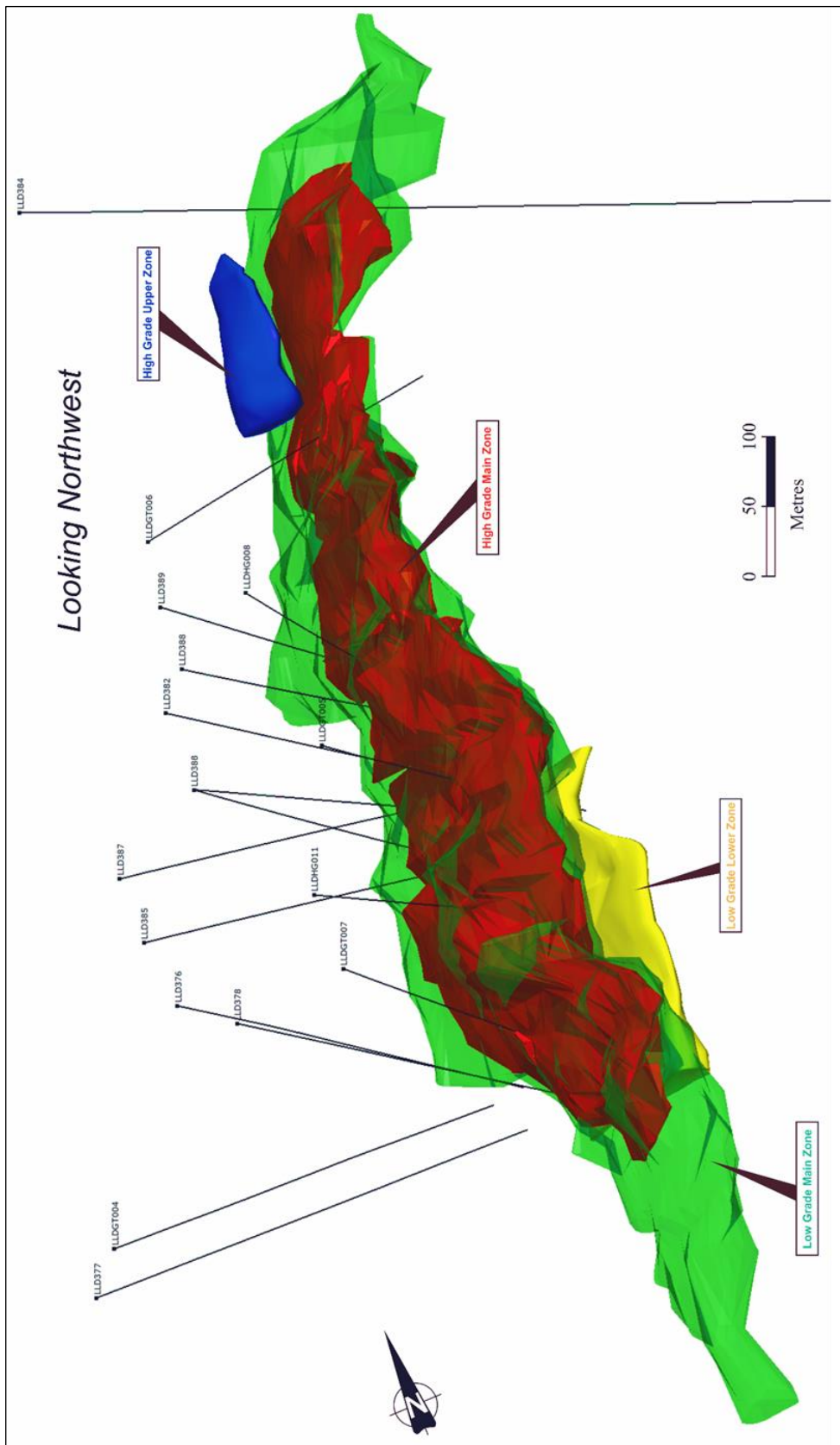

Figure 10-2: Location of 2016-2017 Loma Larga Drill Holes in 3D Isometric View

In 2017, INV initiated an exploration program at Loma Larga to evaluate the exploration potential of the property and further delineate gold mineralization within silica alteration intersected in 2017 during geotechnical and hydrogeological drilling program. The 14-hole, 4,318 m drill program commenced in April and was completed in August of 2017. Mineralization was intersected to the west of the delineated resource at Loma Larga. **Table 10-4** and **Table 10-5** summarize the drillhole program and results, and the location of the drillholes are shown in **Figure 10-1** and **Figure 10-2**.

Highlights of the 2017 drill program include a deep hole (LLD-384) drilled to a depth of 1,160 m to follow up on historical drillholes which indicated the potential for porphyry style mineralization outside of the mineral resource to the north of the known deposit. LLD-384 returned encouraging results including 0.2 g/t Au and 523 ppm Cu over 622.22 m (from a depth of 538 m), including 0.29 g/t Au and 416 ppm Cu over 214.5 m (**Table 10-4**).



Table 10-4: Summary of 2017 Loma Larga Drill Program

Drill Hole	Easting (m)	Northing (m)	Elevation (m)	Azimuth (deg)	Dip (deg)	Length (m)	No. of Samples
LLD-376	698343	9663594	3,782	275	-75	277.4	128
LLD-377	698065	9663588	3,779	90	-60	321.6	89
LLD-378	698422	9663497	3,779	270	-75	274.3	60
LLD-379	697838	9663499	3,794	90	-70	397.8	171
LLD-380	697772	9663497	3,799	90	-80	320.0	86
LLD-381	698027	9663510	3,783	90	-68	285.0	89
LLD-382	698422	9663802	3,761	270	-75	217.9	79
LLD-383	698447	9663701	3,769	270	-70	242.3	119
LLD-384	698460	9664256	3,772	0	-90	1,160.2	607
LLD-385	698291	9663709	3,769	90	-70	266.7	148
LLD-386	698447	9663701	3,769	270	-85	205.7	69
LLD-387	698262	9663801	3,758	90	-70	225.6	61
LLD-388	698464	9663803	3,758	270	-75	187.5	52
LLD-389	698439	9663889	3,749	270	-70	185.9	75
					Total	4,567.9	1,833

Table 10-5: 2017 Selected Loma Larga Drill Program Results

Hole		From (m)	To (m)	Length (m)	True Width (m)	Au (g/t)	Ag (g/t)
LLD-376		187.00	196.00	9.00	8.70	3.25	32.3
	including	192.00	196.00	4.00	3.90	5.27	64.6
LLD-377		226.50	254.50	28.00	24.20	2.35	29.6
	including	230.50	236.50	6.00	5.20	3.44	16.2
LLD-378		170.00	187.00	17.00	16.40	1.65	30.6
LLD-381		249.20	252.80	3.60	1.58	2.45	28.9
LLD-382		167.50	186.50	19.00	18.40	2.66	57.1
	including	171.50	180.50	9.00	8.70	3.25	91.0
LLD-383		170.00	221.25	51.25	48.15	3.22	48.7
	including	179.00	217.00	38.00	35.70	2.53	31.6
	and	213.00	217.00	4.00	3.80	3.36	65.8
		218.50	221.25	2.75	1.74	20.24	434.4
LLD-384		538.00	1,160.22	622.22	*	0.20	0.83
(Porphyry)	including	720.50	935.00	214.50	*	0.29	0.8
LLD-385		161.00	214.00	53.00	49.80	1.59	25.5
	including	162.00	177.00	15.00	14.10	1.83	11.9
	and	193.00	201.00	8.00	7.50	2.69	54.6
		244.00	262.00	18.00	16.90	2.28	38.8
	including	250.00	252.70	2.70	1.70	8.75	211.2
LLD-386		152.00	189.35	37.35	37.20	4.89	52.2
	including	162.00	189.35	27.35	27.20	5.89	67.4
	and	174.00	181.00	7.00	6.97	9.39	72.0
LLD-387		137.00	197.20	60.20	56.60	0.83	26.0
	including	149.00	153.00	4.00	3.80	1.44	4.5
	and	186.00	197.20	11.20	10.50	1.27	64.0
	and	192.00	197.20	5.20	4.90	1.65	94.5
LLD-388		126.00	161.00	35.00	33.80	2.32	20.3
	including	126.00	137.00	11.00	10.60	3.36	14.0
	and	133.00	137.00	4.00	3.90	5.31	24.9
LLD-389		153.00	172.00	19.00	17.9	1.81	29.7
	including	165.00	172.00	7.00	6.6	2.24	32.2

– *Note: True widths determinations are estimated at 84-100% of the reported core length intervals for most of the holes, estimated sectionally based on the current alteration zone interpretation. The true width of Hole LLD-384 cannot be determined at this time.

	Document Number	J01834-PM-REP-002	Rev	0	
	Date	11 January 2019	Page	75 of 417	

11 SAMPLE PREPARATION, ANALYSES AND SECURITY

As part of the September 2018 Mineral Resource estimate, RPA compiled and reviewed all of the Loma Larga Project Quality Control (QC) sample results for INV's 2016-2017 drilling campaigns. RPA reviewed the QC sample results from the Loma Larga 2013 drill campaign and also completed a procedural and statistical review of all historical QC data on the Project.

The current Mineral Resource incorporates drilling completed up to the end of August 2017. No further drilling has been completed since this date. RPA compiled and reviewed the QC sample results for the 2017 exploration, geotechnical, and hydrogeological drilling programs.

In RPA's opinion, the results of the QC samples, together with the QA/QC procedures implemented by INV at Loma Larga, provide adequate confidence in the data collection and processing, and the assay data is suitable for Mineral Resource estimation.

11.1 PRE-2012 PROGRAMS

No information is available on the procedures utilized for the drill campaigns conducted by Newmont (1992-1993) and COGEMA (now Areva) (1994-1996), and assay results from those programs are not included in the current Mineral Resource.

From 2002 to 2008, sample preparation, analysis, and security on the Loma Larga Project were conducted by IAMGOLD. This work is summarized in this section from IAMGOLD (2009) and RPA (2012).

No drilling or sampling occurred on the Loma Larga Project between 2008 and 2012.



11.1.1 SAMPLE COLLECTION

IAMGOLD collected samples for geochemical analyses primarily in mineralized zones. Geological criteria (feeders, hydrothermal breccias, mineralization styles, etc.) guided sample length, to a maximum of two metres. For intervals where core loss was recorded, sample length may be more than two metres.

After the drill core was logged, boxes tagged, and samples identified, all selected samples were cut in half with a diamond saw. One half was sent for geochemical analysis; the other returned to the box and later transferred to a secure warehouse at the IAMGOLD exploration office in the city of Cuenca, Ecuador. Care was taken to prevent contamination, accidental swapping, or loss during crating and transportation of the core. IAMGOLD personnel transported the core from the Project to Cuenca and a shipping contractor was used to transport the core on to Quito.

Sample collection was completed at the Project camp using the following methodology:

- Core was marked every metre from the collar down to the bottom of the hole to check and correct driller's metre marks.
- For each hole, a digital file was created, and all core boxes were photographed and identified by the "FROM" and "TO" depths.
- Geotechnical logging followed by geological logging was carried out and then saved in a dedicated database.
- The core was sampled by cutting in half using a Boart diamond saw with an eight-inch blade.
- Samples were tagged for geochemical, metallurgical, and geotechnical tests.

	Document Number	J01834-PM-REP-002	Rev	0	
	Date	11 January 2019	Page	76 of 417	

- Samples were crated and shipped to the IAMGOLD Cuenca regional office where they were numbered, and QC samples (standards and blanks) were placed into the sample stream at predetermined frequencies.
- Four to five sample bags were grouped into rice bags that were sealed with tie-wraps and shipped to the assay laboratory. A copy of the sample checklist held inside each rice bag was also forwarded to the assay laboratory. A laboratory employee cross-checked the list upon reception and faxed the list to IAMGOLD's Quito office where it was reviewed for inconsistencies.
- All pulps and rejects were kept at the laboratory's yard. Only check assay pulps and rejects were discarded.

11.1.2 DENSITY SAMPLING

To estimate rock densities at the Project, IAMGOLD took representative samples of typical lithologies, alteration, and mineralization types. Samples were approximately three centimetres in length, and density was determined by the Archimedes principle.

IAMGOLD's density sampling procedure consisted of:

- Identifying a representative zone (lithology and grade) and selecting a three-centimetre sample of core.
- Weighing the sample dry.
- Immersing the sample in melted paraffin.
- Weighing the sample and paraffin.
- Weighing the sample and paraffin in water.

IAMGOLD compiled a database of 10,793 density measurements (10,153 at Loma Larga), of which 7,767 were used for the current Mineral Resource estimation (see **Section 14**).



In the opinion of RPA, the density measurements are suitable for use in the Resource estimate.

11.1.3 SAMPLE PREPARATION AND ASSAY PROTOCOLS

All samples were sent to internationally recognized and independent laboratories for preparation and testing. Prior to September 2004, samples were prepared in Quito by ALS Chemex and analyzed by ALS Chemex laboratory in North Vancouver, Canada. IAMGOLD's system of check samples identified inconsistent results for ALS Chemex and from October 2004 onward (to the end of drilling by IAMGOLD by 2008); samples were prepared by Inspectorate del Ecuador S.A. in Quito and analyzed by BSI Laboratories in Lima, Peru (BSI). Both analytical laboratories are accredited to ISO/IEC 17025 for specific registered test and certified to ISO 9001 standards.

The sample preparation and assay procedures are summarized below.

- Samples were dried, if necessary.
- The entire sample was crushed to 95% passing 10 mesh.
- 1,000 g was riffle-split and pulverized to 90% passing 150 mesh.
- A 250 g portion of each sample was returned to IAMGOLD.
- Each sample was analyzed for Au and Ag by fire assay and for a multi-element package using an aqua regia digestion with an inductively coupled plasma (ICP) finish.

	Document Number	J01834-PM-REP-002	Rev	0	
	Date	11 January 2019	Page	77 of 417	

- Assay results were sent by the laboratory to IAMGOLD by email, followed by a hard copy assay certificate.
- Results were imported into IAMGOLD's database.

11.2 INV 2013 DRILL PROGRAM

11.2.1 SAMPLE COLLECTION



Collection of core samples was carried out in mineralized or altered zones. The sample length was determined according to geological criteria (feeder zones, hydrothermal breccias, mineralization styles and percentages, etc.) with a maximum length of two metres; samples do not cross geological or hydrothermal alteration contacts. One metre sample lengths were the default size within homogenous mineralized zones. At intervals where there was core loss, the sample length may be more than two metres. Periodic sampling of barren-looking wall rocks was done to ensure no cryptic mineralization was missed. After logging and tagging, all selected samples were cut in half with a diamond saw. For the two metallurgical drillholes (LLD371 and LLD372) in 2013, the core was split in half, with one half sent for routine analysis (see Sample Preparation and Assay Protocols). The remaining half was then quarter-split, with one quarter retained as a permanent record, and one quarter shipped to Lakefield, Ontario, for metallurgical testwork.

Core logging was carried out at INV's base camp, Campamento Cristal, and consisted of the following activities:

- Core boxes, core blocks, and sample intervals were all well marked with marker blocks nailed into place and positions marked on sides of trays.
- Aluminum tags were used to provide permanent markings on core blocks.
- Core photos were taken using a custom photo stand and tripod to provide a uniform field of view and high-resolution photos.
- Core recovery and basic geotechnical data was collected at the same time that the driller's core run marker block position was checked.
- Core was labelled at one metre intervals and then logged by a project geologist, who marked sample intervals.

The samples were double bagged in high density, clean, unused, transparent plastic bags. Each sample was assigned a unique sample number and labelled with permanent marker. A pre-printed paper sample ticket was placed inside each sample. Once the samples were bagged, they were sealed. The sample bags, up to a maximum of six, were placed inside of jute sacks, and labelled very clearly with the name of the project and the number of the samples in each sack. The sacks were then placed in secure, sturdy fabric bags, and locked with tamper proof seals for transport to the preparation laboratory.

In 2016 both the retained core and the samples to be dispatched for analysis were transported by INV personnel from the Loma Larga site to Cuenca. In Cuenca, the samples taken for analysis were trucked by Transportes Ortiz, a local trucking company, to the preparation laboratory in Quito. In 2017 the samples taken for analysis were trucked by INV personnel from the Loma Larga site to San Gerardo. In San Gerardo, the samples taken for analysis were trucked by Top Logistics Solutions to the preparation laboratory in Quito. All retained core is stored at INV's core storage facility located on the property.

	Document Number	J01834-PM-REP-002	Rev	0	
	Date	11 January 2019	Page	78 of 417	

Sample preparation was carried out by Inspectorate del Ecuador S.A. (Inspectorate), part of the Bureau Veritas Group, at their office located at Calle Garcia Moreno 886 y Calle 23 de Abril, Llano Grande-Quito, Ecuador. Following sample preparation, Inspectorate sent the prepared samples by air freight to their analytical laboratory at Av Elmer Faucett 444, Callao-Lima, Peru. Inspectorate holds an international certificate for ISO 9001:2008 and fulfills NTP-ISO 17025:2006.

11.2.2 DENSITY SAMPLING

No density sampling was carried out by INV. IAMGOLD had previously compiled an extensive database of density values.

11.2.3 SAMPLE PREPARATION AND ASSAY PROTOCOLS

Sample preparation and analytical procedures are as follows:

- Samples are dried, if necessary.
- The entire sample is crushed to 95% passing 10 mesh.
- 1,000 g is riffle-split and pulverized to 90% passing 150 mesh.
- 200 g samples are returned to INV's Quito office to recode in a simple random ID_INV to ID_LAB code.
- Reference material and blanks are inserted by INV personnel.
- Samples are assayed for gold by fire assay and a multi-element package using an aqua regia digestion with an ICP finish.
- Assay data is emailed simultaneously to INV's Quito office as both Excel and PDF files (the latter as the digital equivalent of an assay certificate).

In RPA's opinion, the sample preparation, security, and analytical procedures are adequate to support a Mineral Resource estimate.



11.3 RESULTS OF QA/QC PROGRAMS

Quality Assurance (QA) consists of evidence to demonstrate that the assay data has precision and accuracy within generally accepted limits for the sampling and analytical method(s) used in order to have confidence in future resource estimations. Quality Control (QC) consists of procedures used to ensure that an adequate level of quality is maintained in the process of sampling, preparing, and assaying the exploration drilling samples. In general, QA/QC programs are designed to prevent or detect contamination and allow assaying (analytical) precision (repeatability) and accuracy to be quantified. In addition, a QA/QC program can disclose the overall sampling-assaying variability of the sampling method itself.

11.3.1 PRE-2012 PROGRAMS

No QA/QC results are available for programs prior to 2002. As noted above, data from those drill campaigns was not used to estimate the current Mineral Resource. All results and discussion in this section relate to IAMGOLD's campaigns from 2002 to 2008. For additional detail, tables, and figures, the reader is referred to the 2016 Technical Report (RPA, 2016).

IAMGOLD developed an industry standard QA/QC program for the Project early on in the exploration work, which consisted of the regular submission of blanks, duplicates, and

	Document Number	J01834-PM-REP-002	Rev	0	
	Date	11 January 2019	Page	79 of 417	

standards. Furthermore, IAMGOLD defined control limits and implemented procedures to follow up results that were at or exceeded these limits (see below). The reader is referred to IAMGOLD (2009) for a comprehensive overview of the QA/QC program from 2002 to the completion of the latest drill campaign at the end of 2007.

IAMGOLD inserted Certified Reference Material (CRM or analytical standard) and blank samples, each at a rate of one in every 15 samples (6.7%). In addition, for every 20 samples, a pulp duplicate was prepared and submitted, and ten percent of the pulp samples were split and sent to a second laboratory (replicates). Pulp replicates were introduced in 2005. IAMGOLD randomly selected samples every three months to be re-analyzed at ALS Chemex (the secondary laboratory).

From 2002 to 2008, a total of 1,015 CRMs and 714 blank samples were inserted into the process stream. IAMGOLD also collected 1,046 pulp replicates, 456 pulp duplicates, and 263 triplicates (replicates) for comparative analysis.

Once results from the analytical laboratory were uploaded, IAMGOLD personnel plotted the control sample results to determine if the analyses for CRMs, blanks, and duplicates were within pre-defined limits. IAMGOLD reviewed all failures in the following way:



- Notified IAMGOLD Technical Management.
- Requested a new analysis on the failed sample. In the case of a failed CRM, the five samples analyzed prior to and after the CRM would also be re-analyzed.
- When the new analyses were received, a decision was made on how to handle the results. This included rejection of the initial batch results, re-submittal of the samples, or averaging the original and re-analyzed batch.
- Once final certificate was verified, results were submitted to the Project database.

In August 2005, Lynda Bloom of Analytical Solutions Ltd., Toronto, conducted a review of the QC program. In general, Ms. Bloom concluded there was no evidence of contamination in the analysis of the 2005 diamond drill samples. Gold assays were biased low by approximately five percent based on reported values for CRMs and comparisons with ALS Chemex assays. A comparison of BSI and ALS Chemex silver and copper assays demonstrated there were biases depending on grade. Ms. Bloom recommended that analytical procedures at both laboratories should be investigated to determine the differences. Ms. Bloom also recommended that the IAMGOLD QC program should be augmented by studies of the laboratory pulp duplicate assays as well as duplicate assaying of preparation and core samples.

Scott Wilson RPA (2006) compiled and reviewed all of the Project QC sample results for the 2006 drilling program and concluded that the statistics and scatterplots of the CRMs and duplicate samples revealed a high degree of assay precision and accuracy, and that the results of the blank samples suggested that contamination was not an issue at the Project. RPA notes that only the gold results were reviewed, as gold represented approximately 90% of the unit value of the mineralization.

IAMGOLD (2009) reviewed the QA/QC results for gold only, for all of the drilling completed on the Project, and RPA (2012) evaluated the results of IAMGOLD's final drilling program in 2007 (i.e., all drilling that occurred after the effective date of Scott Wilson RPA, 2006) for gold, silver, and copper.

During IAMGOLD's drilling campaigns, control samples included 714 blanks, 1,015 CRMs, 456 pulp duplicates, and 263 pulp triplicates.

	Document Number	J01834-PM-REP-002	Rev	0	
	Date	11 January 2019	Page	80 of 417	

RPA reviewed the results for the CRMs, and although there are no failures, RPA notes that there is a low bias to gold results for SG14 (15 of 18 samples returned values below the certified value) and silver results for SN16 and SI15 (all analyses are less than the certified mean minus one SD) and SG14 (16 of 18 are less than the certified mean minus one SD). This suggests that the silver assay results may be low, at least for silver grades less than 20 g/t.

Of the 42 blank samples analyzed, a single sample returned a gold value (10 ppb Au) greater than detection limit (5 ppb Au), which is still within the control limits (three times detection limit is equivalent to 15 ppb Au). These results, along with conclusions reached by Bloom and Scott Wilson RPA (2006), indicate that there is no evidence of gold or silver contamination at the Project.

RPA examined scatterplots of the pulp duplicate and triplicate (replicate) assays. The results showed excellent agreement between the primary laboratory duplicates and triplicate gold and silver assays. Both sets of data had R-squared values of 0.98 to greater than 0.99 (a near perfect correlation) and a coefficient of variation of 0.98.

In RPA's opinion, the results of the QC samples, together with the QA/QC procedures used during IAMGOLD's ownership of the property provide adequate confidence in the data collection and processing, and the assay data is suitable for Mineral Resource estimation.

11.3.2 2013 PROGRAM

In July 2013, INV completed a 12-hole drilling program at Loma Larga, collecting and assaying 1,561 samples. During the drilling campaign, INV maintained a rigorous QA/QC program that incorporated the regular submission of blanks, duplicates, and standards. Specifically, the program included:

- Preparation duplicates (a second pulp prepared from the coarse reject) were prepared and inserted every 20 samples according to the downhole sampling sequence.
- Assay duplicates (a second analysis of the same pulp) were prepared concurrently with the preparation duplicates, every 20 samples according to the same downhole sequence as the preparation duplicates.
- Field duplicates were inserted one in every 40 drill samples, with the duplicate pair consisting of a pair of quarter core samples obtained from the original half core that would have normally been sent for assay.
- Ten percent of all pulps were sent for check assay (pulp replicates) to a secondary laboratory, ALS Chemex in Vancouver, British Columbia (ALS Chemex is independent from INV).
- CRMs for gold and silver, in the form of pulps, were inserted into the sample stream at a ratio of one in every fifteen samples, independent of the duplicates. CRMs were commercially prepared sourced from Rocklabs in New Zealand. Gold standards included three different grades ranging from less than 1.0 g/t Au to greater than 8.0 g/t Au.
- Blank pulp samples were inserted into the sample after each high-grade standard (SN16), and at regular intervals throughout the sample stream. RPA notes that the analysis of a blank pulp does not provide information on possible cross contamination during the sample preparation process. INV initially used commercial sand as the blank, but subsequently prepared and certified an in-house rock blank standard. Commencing with the final drillhole of the 2013 program, INV inserted the in-house blank consisting of uncrushed rock into the sample stream in intervals thought to be mineralized. These

blank samples provide information on possible cross contamination during the sample preparation process. Only three in-house blanks have been analyzed, and there is insufficient data to permit a statistical analysis.

RPA reviewed the QA/QC results of INV’s 2013 drilling campaign at Loma Larga, which comprised 12 holes. As part of the drilling program, 74 CRMs and 68 blank samples were inserted into the process stream. Additionally, INV collected 24 field duplicates, 77 pulp duplicates, 77 reject duplicates, and 167 pulp replicates as listed in **Table 11-1**.

Table 11-1: QA/QC Review Summary – 2013 Drilling Program

Metal	Blanks Count	Field Dup. Count	Pulp Dup. Count	Reject Dup. Count	CRM Count	Check Assays Count
Au	42	24	77	77	74	167
Ag	42	24	77	77	74	167
Cu	42	24	77	77	0	167

Results from the analytical laboratory are imported into the INV’s exploration database and plotted to determine if the control sample results are within pre-defined limits. If the analysis for a CRM is outside a two standard deviation range of the CRM certified gold content, INV requests a new analysis from the laboratory, including five samples upstream and five samples downstream of the suspected failed sample. When the new analyses are received, INV personnel decide how the repeated analyses are managed. This includes rejection of the original batch, averaging of the original and repeat results, or re-submittal of the entire batch.

If duplicate mineralized sample results differ by more than 20% from the original assays, unless the values are insignificant and outside the resource, a new analysis is requested on the first, second, and third pulps. Once the problem is identified, a new analysis of the batch is requested by INV, if needed.

Dr. Matthew Gray of Resource Geosciences Inc., an independent consultant to INV, conducted a review of the drilling database of this campaign, including a statistical and procedural QA/QC review (Gray, 2013). RPA notes that Dr. Gray only reviewed the results for gold.

Dr. Gray compared analyses from the original laboratory certificates with INV digital database. Approximately 20% of the samples were verified in this manner and no discrepancies were observed. In addition, Dr. Gray conducted a statistical review of the drillhole database, analyzing the assay results for mineralized standards, blanks, preparation and assay duplicates, and independent laboratory check assays, and determined that the gold assays provided by Inspectorate are reliable.

Dr. Gray concluded that field duplicates demonstrated variability indicative of primary heterogeneity of the gold distribution (i.e., “nugget effect”), and that field duplicate data overestimates the sampling error because field duplicates are quarter core samples. Nonetheless, there is no significant bias between the sample sets. Gray noted a mislabeled field bank and a significant control sample failure, which was followed up satisfactorily by INV. Coarse reject and pulp duplicate results, once mislabeling errors were accounted for, were acceptable. Check assays performed at a secondary laboratory were materially equivalent for gold, silver, and copper, without significant bias.

Dr. Gray recommended that INV conduct field duplicate analyses using half core field duplicates in order to determine if half core samples are adequately sized to provide sampling

error within acceptable limits. Furthermore, Dr. Gray suggested that metallic sieve fire assays of representative intervals of high grade zones be conducted using the existing core library.

11.3.2.1 CERTIFIED REFERENCE MATERIAL

INV used three CRMs obtained from Rocklabs, certified for gold and silver: SG14, SI15, and SN16. The CRMs were inserted as pulps into the sample stream after the laboratory had completed its sample preparation, thus testing the analytical accuracy of the laboratory, but not contamination during sample preparation. INV inserted a total of 74 CRMs for 12 drillholes in 2013.

Table 11-2 lists the CRM name, expected mean, standard deviation, and the number of CRMs inserted during the drilling program. No copper CRM was used during the 2013 drilling campaign.

Table 11-2: CRMs Used In 2013 Drilling Program

Gold			
CRM	No	Mean (g/t)	St. Dev.
SG14	25	0.989	0.044
SI15	21	1.805	0.067
SN16	28	8.367	0.217
Silver			
CRM	No	Mean (g/t)	St. Dev.
SG14	25	11.12	1.03
SI15	21	19.68	1.02
SN16	28	17.64	0.96

Using INV's criterion, four of the 74 results failed (5.4%) for gold, which is slightly higher than the three percent that would be expected to fall outside the limits. Of these four failures, two returned assayed values greater than ten percent above the certified mean and one failure was greater than ten percent below the certified mean. The failures were deemed to be minor and no re-analyses were requested by INV. The mean gold content reported by Inspectorate for all gold control samples was within three percent of the certified mean for all three CRMs (**Table 11-3**).

Table 11-3: Summary of CRM Results

Gold						
CRM	Number	Observed Au (g/t)		Expected Au (g/t)		% Diff. Observed to Expected Mean
		Mean	Std. Dev.	Mean	Std. Dev.	
SG14	25	0.978	0.036	0.989	0.044	-1.11
SI15	21	1.748	0.063	1.805	0.067	-3.17
SN16	28	8.631	0.199	8.367	0.217	+3.15
Silver						
CRM	Number	Observed Ag (g/t)		Expected Ag (g/t)		% Diff. Observed to Expected Mean
		Mean	St. Dev.	Mean	St. Dev.	
SG14	25	11.168	0.532	11.12	1.03	+0.43
SI15	21	19.429	0.450	19.68	1.02	-1.28
SN16	28	18.182	0.805	17.64	0.96	-3.07

RPA evaluated the QA/QC results within a more conventional three standard deviation range of the CRM certified gold content. Observed results that fell outside this range were deemed to be failures. Using this criterion, one of 74 results failed (1.35%): a single control sample result fell greater than three standard deviations above the mean (+16%).

RPA further notes that although observed results from CRM SG14 do not show an obvious bias, bias is observed in both SI15 and SN16 (*Figure 11-1, Figure 11-2 and Figure 11-3*). The observed results from SI15 are clearly biased low, and the observed results from SN16 are biased high. RPA recommends that INV follow up the high bias observed in SN16.

INV noted a significant control sample gold failure in Job 13-703-00313-01 and subsequent follow-up determined a laboratory error was the cause. A sequence of 20 samples was re-assayed (46464 to 46484), and RPA reviewed the corrected data.

RPA also evaluated the QA/QC results for silver. A description of the evaluation and supporting graphs are available on the RPA Technical Report on the Loma Larga Project (2016).

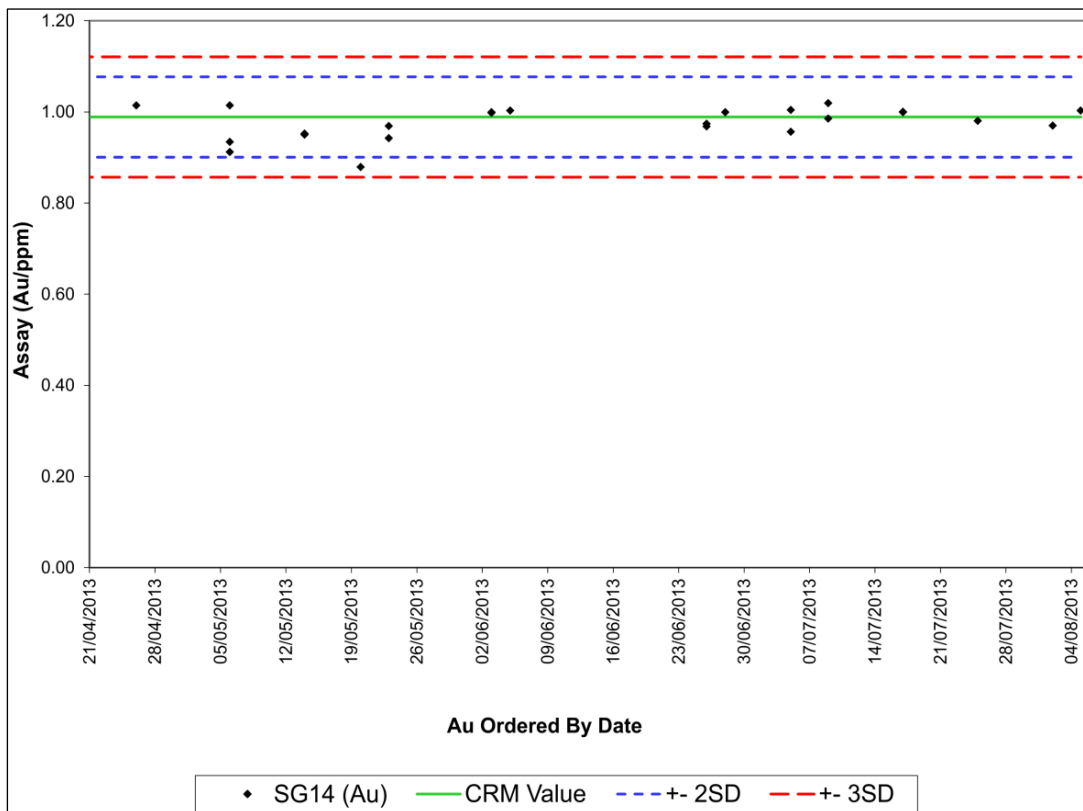

Figure 11-1: Gold Control Chart for 2013 Drilling: CRM SG14

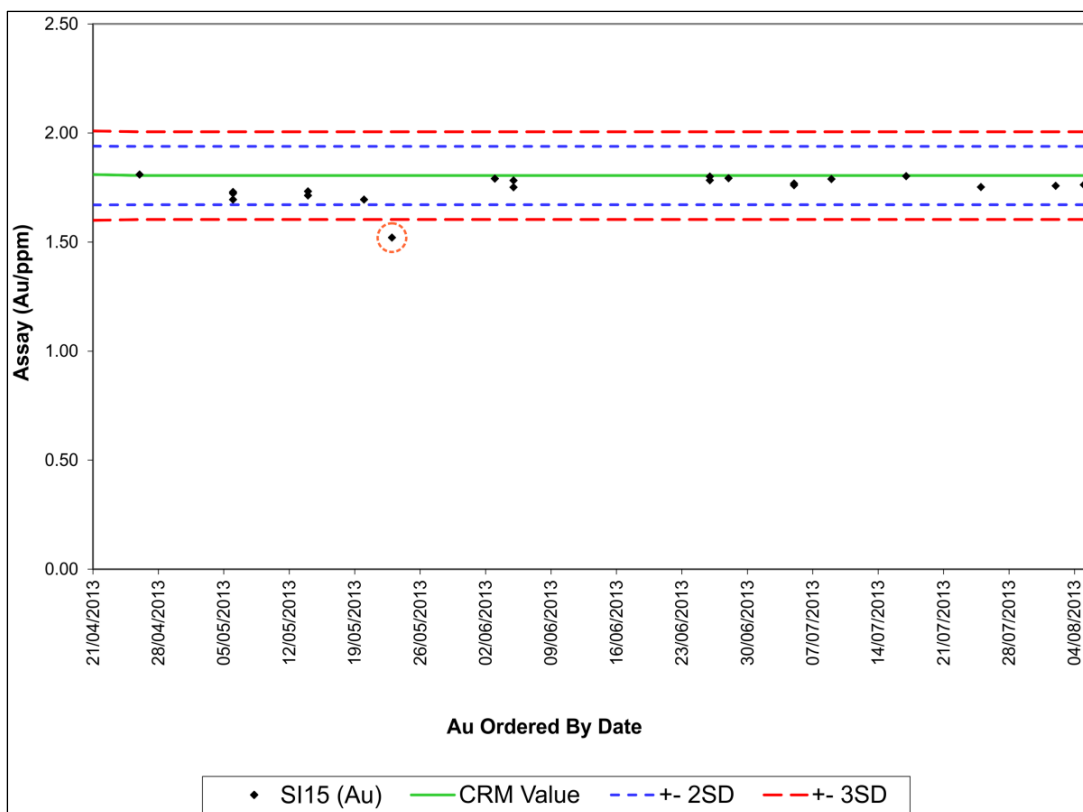

Figure 11-2: Gold Control Chart for 2013 drilling: CRM SI15

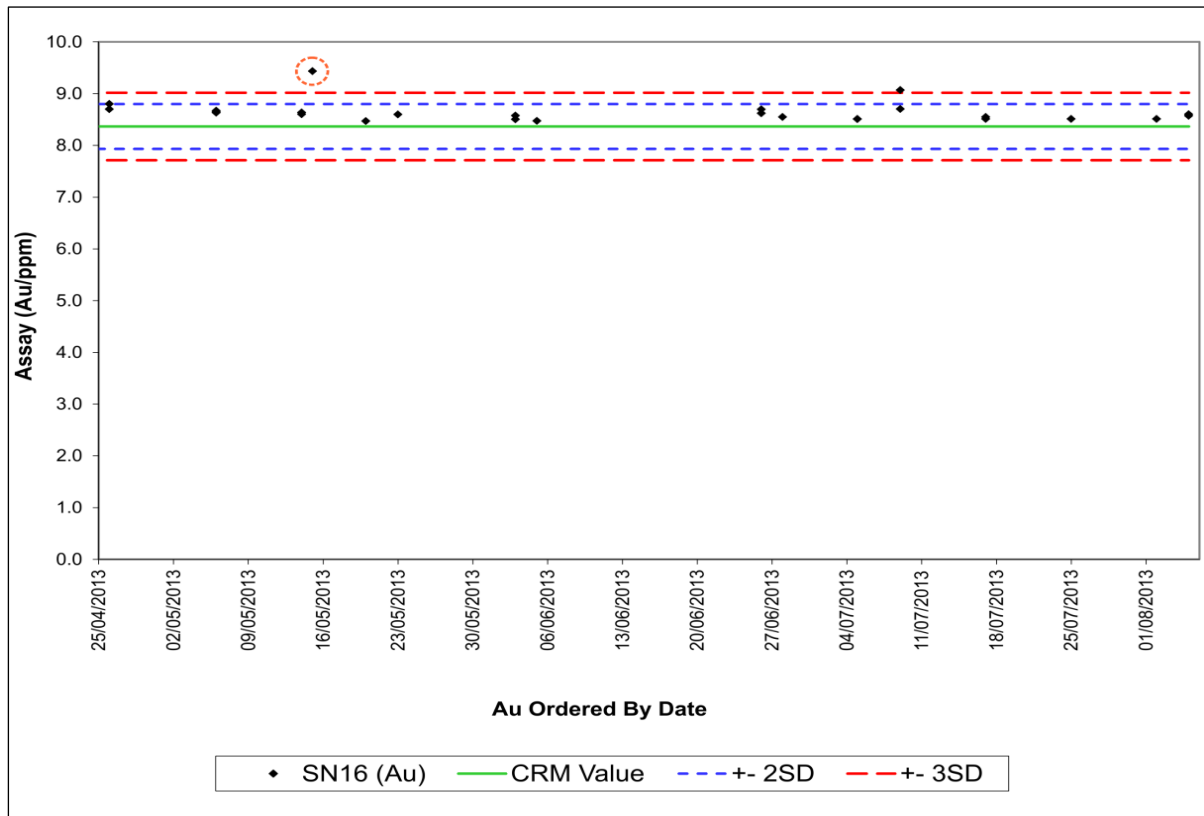

Figure 11-3: Gold Control Chart for 2013 drilling: CRM SN16

11.3.2.2 BLANKS

Contamination and sample numbering errors are assessed through blank samples. A significant level of contamination is identified when the blank samples yield values exceeding ten times the detection limit of the analytical method. For the 2013 drilling program at the Loma Larga Project, gold values should be below 0.05 g/t, silver below 2 g/t, and copper below 20 ppm. A total of 68 blank samples were inserted into the sample stream by INV during the 2013 drilling program. The results for these samples were plotted chronologically to determine if any trends had occurred over time. All blank assay results for gold and silver were at or below detection limit, and copper results varied between 7 ppm and 13 ppm, with no detectable systematic pattern.

It is RPA's opinion that these results demonstrate no evidence of contamination.

In the QA/QC report dated June 17, 2013, Dr. Gray called attention to the failure of blank sample 46321 in Job 13-703-00278-01. A review of original data indicated an inadvertent mislabelling of a core sample as a blank. The data used in this review by RPA is the corrected data set.

11.3.2.3 DUPLICATES

Field Duplicates

Field duplicates assess the variability introduced by sampling the same interval. The duplicate splits are bagged separately with separate sample numbers so as to be blind to the sample preparation laboratory. The duplicates contain all levels of sampling and analytical error and are used to calculate field, sample preparation, and analytical precision. To permit the most meaningful interpretations, field duplicates should be the same size as the regular samples sent for analysis.

A total of 24 field duplicate samples were submitted to Inspectorate during the 2013 drilling program. INV chose to use quarter core field duplicates to maintain a complete core record. That is, the interval selected for a field duplicate included two samples of quarter core (a regular sample and a duplicate), whereas regular samples comprised a half core split. The variances, however, of the smaller sample size will be greater, thus the field duplicates overestimate the sampling error associated with the standard half core assay samples.

RPA reviewed the gold, silver, and copper field duplicate data. Summary statistics for gold are presented in **Table 11-4** and scatterplots for gold in **Figure 11-4**. Summary statistics, scatterplots and description of the reviews for silver and copper are available in the RPA Technical Report on the Loma Larga Project (2016).

The percent relative difference between mean gold content of field duplicates and originals is less than three percent, and although observed variance is greatest at the lowest grade ranges, there is a paucity of data (one data point) for gold grades above the Loma Larga resource average.

Table 11-4: Summary of Field Duplicate Results

	Gold (g/t)	
	Original	Duplicate
Number of Samples	24	24
Mean	1.14	1.11
Maximum Value	13.27	10.53
Minimum Value	0.01	0.01
Median	0.16	0.20
Correlation Coefficient	0.984	
Percent Difference Between Means	2.4%	

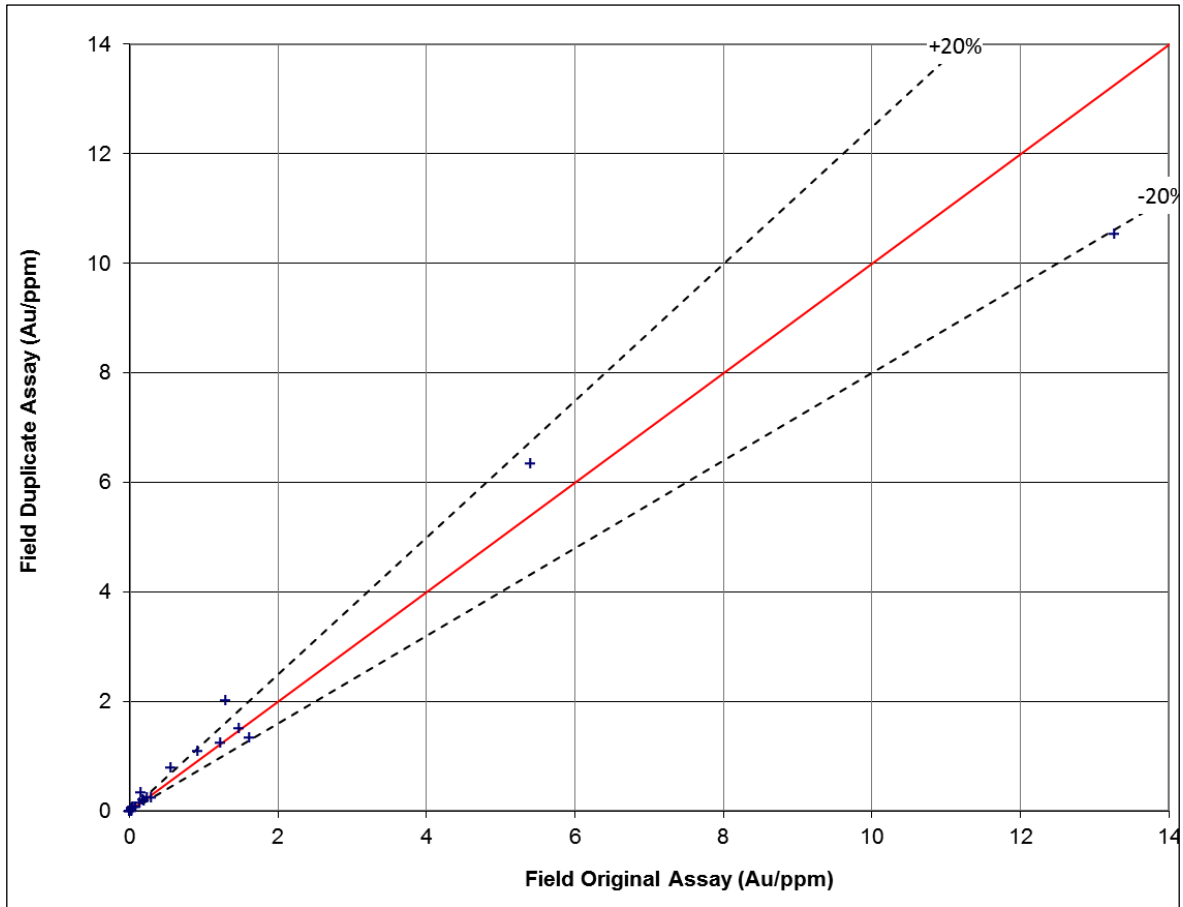

Figure 11-4: Gold Field Duplicate Scatterplot

Reject Duplicates

Reject duplicates (or coarse reject duplicates) are duplicate samples taken immediately after the first crushing and splitting step. This was done by Inspectorate at INV’s request. The reject duplicate will inform about the subsampling precision, that is, the errors due to sample size reduction after crushing and the errors associated with weighing and analysis of the pulp. Pulverization and assaying follow the same procedure, at the same laboratory, for each sample in the duplicate pair.

Table 11-5 summarizes the basic statistics of the gold reject duplicate pairs and the gold scatterplot is illustrated in **Figure 11-5**. Summary statistics, scatterplots, and description of the reviews for silver and copper are available on the RPA Technical Report on the Loma Larga Project (2016). Gold, silver, and copper all show excellent correlation between means and very low percent difference between means (all less than one percent absolute difference). No bias is observed at either very low grades, or near-average resource grades of gold, silver, and copper.

Table 11-5: Summary of Reject Duplicate Results

Gold (g/t)		
	Original	Duplicate
Number of Samples	77	77
Mean	19.7	19.7
Maximum Value	456.0	455.0
Minimum Value	0.2	0.2
Median	1.5	1.5
Correlation Coefficient	1.00	
Percent Difference Between Means	-0.6%	

The duplicate data pairs taken in 2013 from Loma Larga follow the expected progression of decreasing variance and percent difference between means from field to preparation to assay duplicates. Although the precision is somewhat high for field duplicate pairs, it is not atypical for an epithermal gold deposit, and also must be interpreted in consideration of the relatively small quarter core sample size, which would overestimate the sampling error associated with the half core assay samples.

With development at Loma Larga focused on high grade zones within the deposit, RPA recommended that duplicate samples test intersections that are representative of the expected average grade of the Mineral Resource.

RPA suggested that INV procure reference standards with grades that better reflect the range of gold grades within the Mineral Resource. RPA recommended the following gold grade ranges:

- A “low grade” standard (5 g/t to 7 g/t);
- An “average grade” standard (9 g/t to 12 g/t); and
- A “high grade” standard (greater than 30 g/t).

RPA also suggested that INV obtain a copper standard with a grade range of 6,000 ppm to 8,000 ppm (approximately the average grade of the Loma Larga Mineral Resource).

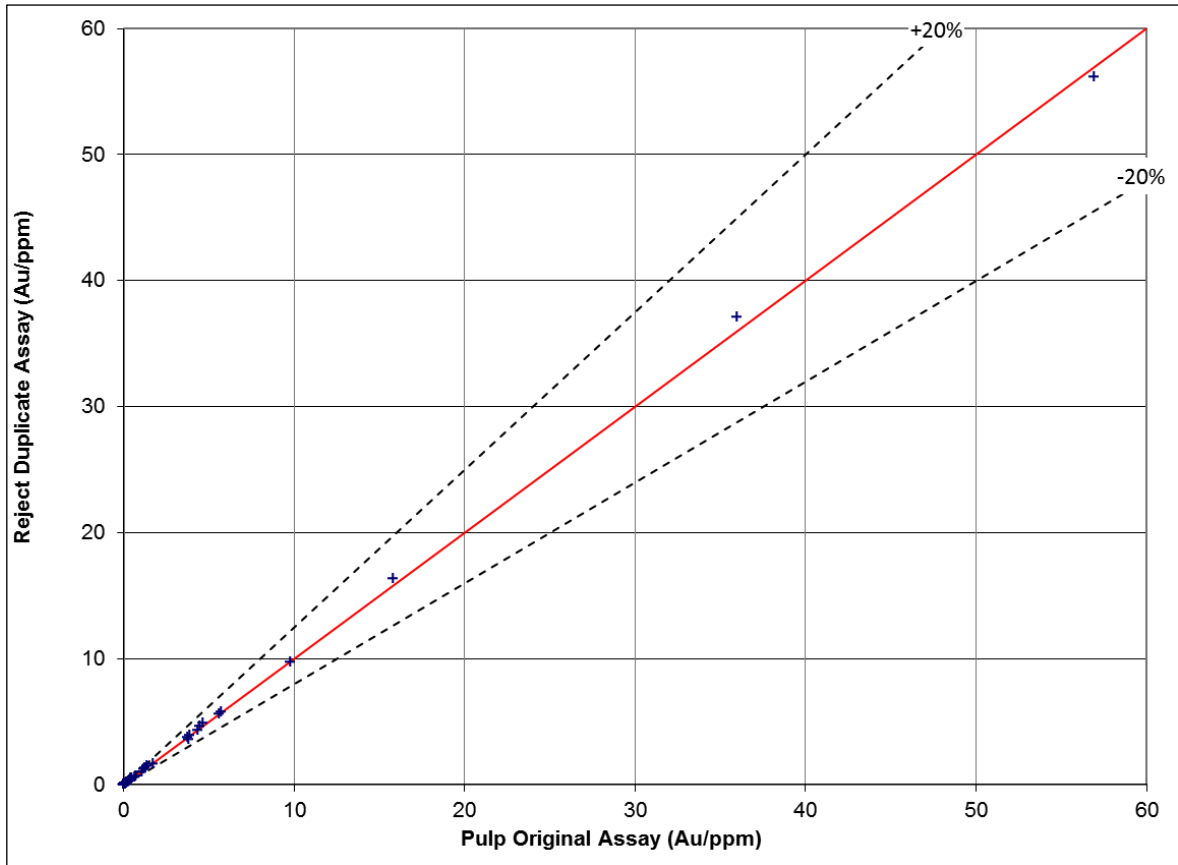

Figure 11-5: Gold Reject Duplicate Scatterplot

Pulp Duplicates

Pulp duplicates consist of second splits of final prepared pulverized samples, analyzed by the same laboratory as the original samples under different sample numbers. The pulp duplicates are indicators of the analytical precision, which may also be affected by the quality of pulverization and homogenization. INV chose to analyze pulp duplicates on the same samples that were selected for reject duplicate analysis.

Table 11-6 summarizes the basic statistics of the gold pulp duplicate pairs and the gold scatterplot is illustrated in **Figure 11-6**. Summary statistics, scatterplots, and description of the reviews for silver and copper are available on the RPA Technical Report on the Loma Larga Project (2016). Gold, silver, and copper all show excellent correlation between means and very low percent difference between means. No bias is observed either at very low grades (below 1 g/t Au, 10 g/t Ag, and 1,000 ppm Cu), or near average resource grades of gold, silver, and copper.

Table 11-6: Summary of Pulp Duplicate Results

Gold (g/t)		
	Original	Duplicate
Number of Samples	77	77
Mean	2.21	2.20
Maximum Value	56.90	56.20
Minimum Value	0.01	0.01
Median	0.14	0.13
Correlation Coefficient	1.00	
Percent Difference Between Means	0.4%	

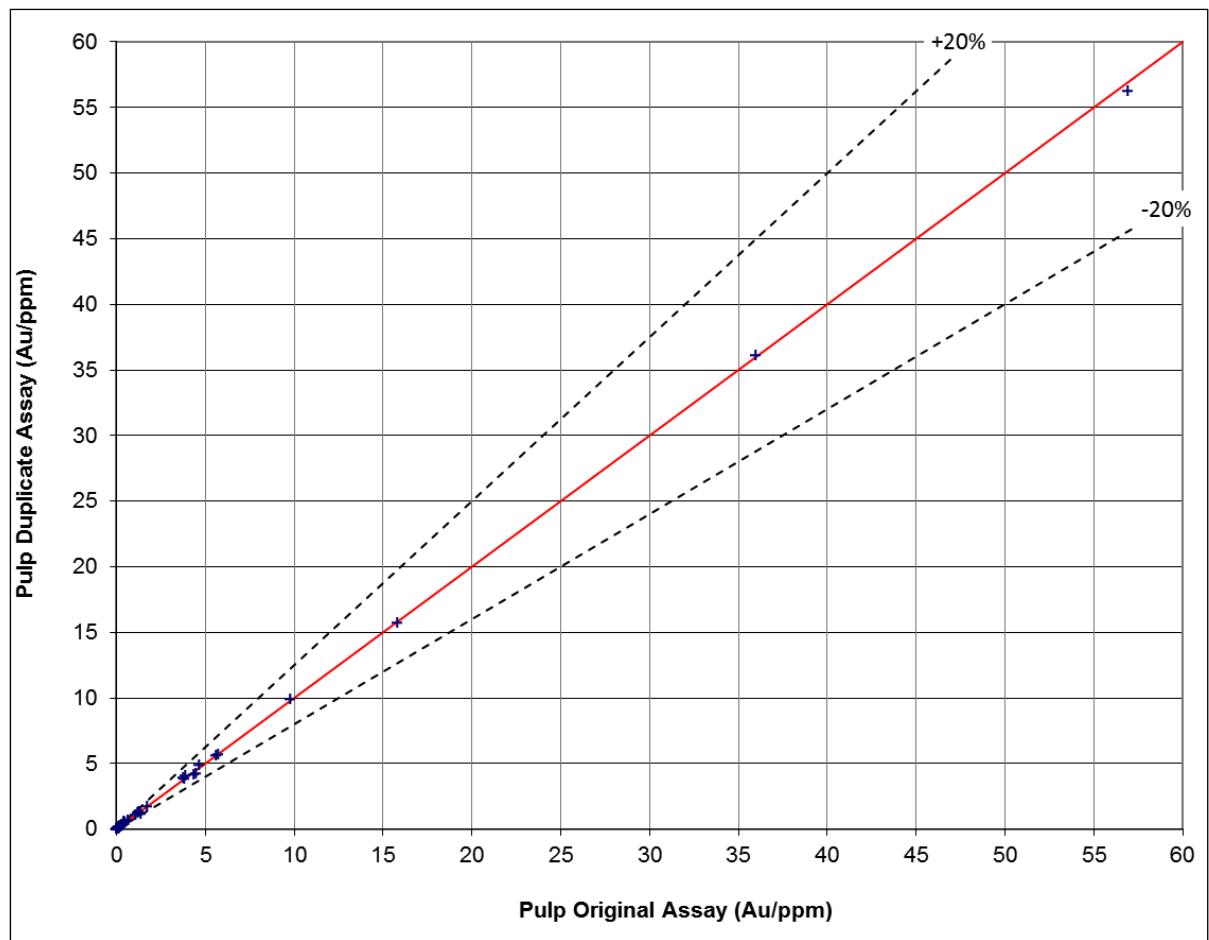

Figure 11-6: Gold Pulp Duplicate Scatterplot

Pulp Replicates (Check Assays)

A total of 167 regular samples (a rate of greater than ten percent) were selected from the 2013 drilling program and duplicate splits of the pulps were sent to ALS Ltd., which served as the secondary (check) laboratory. Sample preparation was completed at ALS's Ecuador facility, ALS Laboratory Group Quito, and pulps were forwarded to ALS Peru S.A. in Lima for laboratory for analyses.

Table 11-7 summarizes the basic gold statistics of the pulp replicate pairs and the gold scatterplot is illustrated in **Figure 11-17**. Summary statistics, scatterplots, and description of the reviews for silver and copper are available on the RPA Technical Report on the Loma Larga Project (2016). Gold, silver, and copper all show excellent correlation between means and very low percent difference between means. No bias is observed either at very low grades, or near average resource grades of gold, silver, and copper.

Table 11-7: Summary of Pulp Replicate Results

Gold (g/t)		
	Primary Lab	Secondary Lab
Number of Samples	167	167
Mean	1.41	1.40
Maximum Value	53.15	54.00
Minimum Value	0.01	0.01
Median	0.11	0.09
Correlation Coefficient	0.998	
Percent Difference Between Means	0.7%	

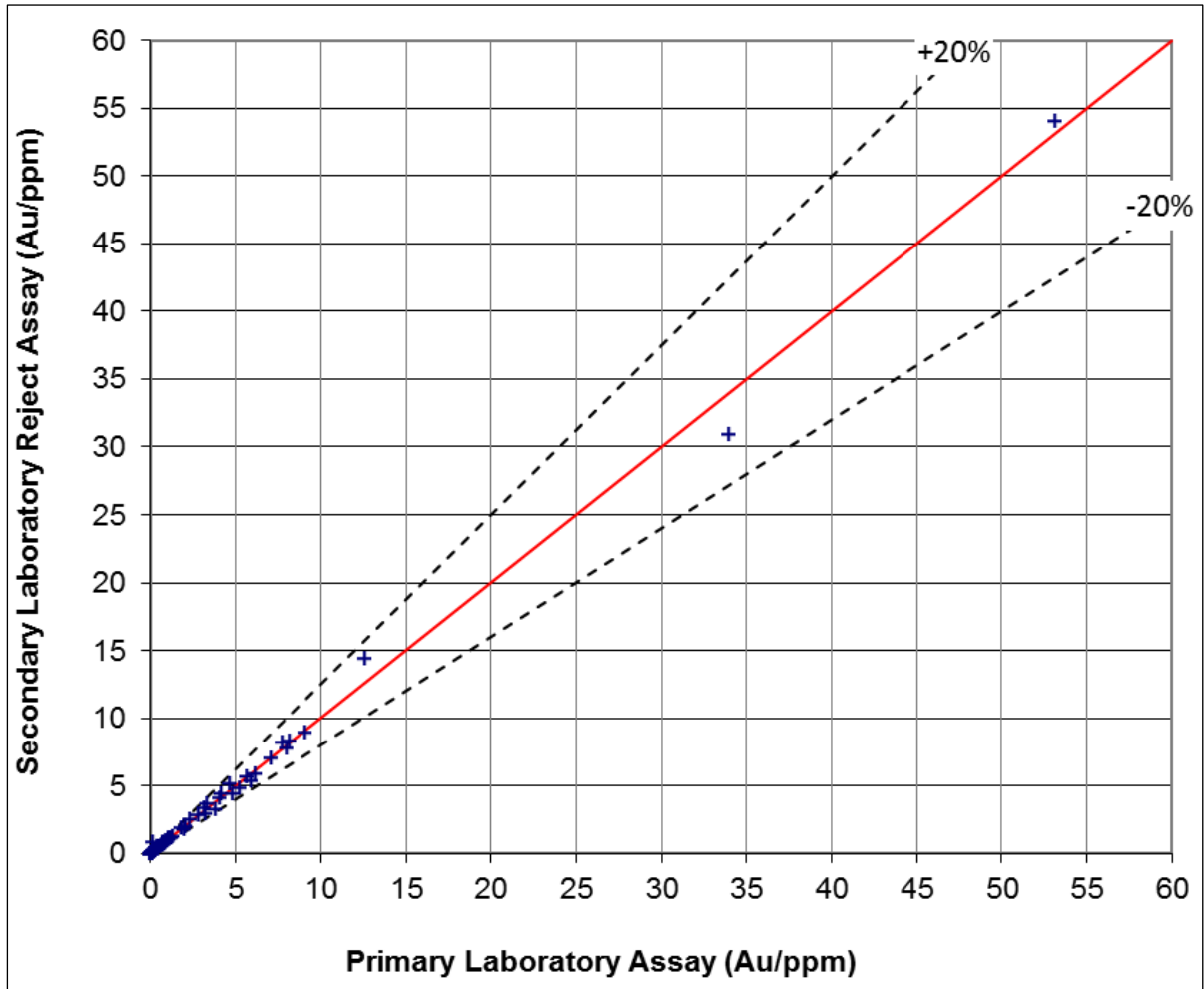

Figure 11-7: Gold Pulp Replicate Scatterplot

11.3.3 2016-2017 PROGRAM

In August 2017, INV completed a 23-hole drilling program at Loma Larga, collecting and assaying 2,423 samples. During the drilling campaign, INV maintained a rigorous QA/QC program that incorporated the regular submission of blanks, duplicates, and standards. Specifically, the program included:

- Preparation duplicates (a second pulp prepared from the coarse reject) were prepared and inserted every 20 samples according to the downhole sampling sequence.
- Assay duplicates (a second analysis of the same pulp) were prepared concurrently with the preparation duplicates, every 20 samples according to the same downhole sequence as the preparation duplicates.
- Field duplicates were inserted one in every 40 drill samples, with the duplicate pair consisting of a pair of quarter core samples obtained from the original half core that would have normally been sent for assay.
- CRMs for gold, in the form of pulps, were inserted into the sample stream at a ratio of one in every fifteen samples, independent of the duplicates. CRMs were commercially prepared sourced from Rocklabs in New Zealand. Gold standards included seven different grades ranging from less than 1.0 g/t Au to greater than 8.0 g/t Au.

- Blank pulp samples were inserted into the sample after each high-grade standard (SN16, SN60), and at regular intervals throughout the sample stream. RPA notes that the analysis of a blank pulp does not provide information on possible cross contamination during the sample preparation process. INV initially used commercial sand as the blank, but subsequently prepared and certified an in-house rock blank standard commencing with the final drillhole of the 2013 program. The blank consists of uncrushed rock and is inserted into the sample stream in intervals thought to be mineralized. These blank samples provide information on possible cross contamination during the sample preparation process.

For the current Mineral Resource estimate, RPA reviewed the QA/QC results of INV's 2016-2017 drilling campaign at Loma Larga. **Table 11-8** lists the drillholes, all of which were completed after the effective date of RPA's previous 2016 Mineral Resource estimate.

Table 11-8: Summary of the 2016-2017 Drilling Program

Hole	Hole ID	Hole	Hole ID
1	LLD-376	13	LLD-388
2	LLD-377	14	LLD-389
3	LLD-378	15	LLDGT-003
4	LLD-379	16	LLDGT-004
5	LLD-380	17	LLDGT-005
6	LLD-381	18	LLDGT-006
7	LLD-382	19	LLDGT-007
8	LLD-383	20	LLDGT-03B
9	LLD-384	21	LLDGT-03C
10	LLD-385	22	LLDHG-008
11	LLD-386	23	LLDHG-011
12	LLD-387		

During the 2016-2017 drill campaign, 84 CRMs and 94 blank samples were inserted into the process stream. INV also collected 127 pulp duplicates, and 127 reject duplicates, as listed in **Table 11-9**.

Table 11-9: QA/QC Review Summary – 2017 Drilling Program

Metal	Blanks	Pulp Dup.	Reject Dup.	CRM
	Count	Count	Count	Count
Au	94	127	127	84
Ag	94	127	127	0
Cu	94	127	127	0

Results from the analytical laboratory are imported into INV's exploration database and plotted to determine if the control sample results are within pre-defined limits. If the analysis for a CRM is outside a two standard deviation range of the CRM certified gold content, INV's procedure is to request a new analysis from the laboratory, including five samples upstream and five samples downstream, of the suspected failed sample. When the new analyses are received, INV personnel decide how the repeated analyses are managed. This includes rejection of the original batch, averaging of the original and repeat results, or re-submittal of the entire batch. RPA notes that INV did not utilize these procedures for CRM results that were outside of the control limits.

If duplicate mineralized sample results within the resource area differ by more than 20% from the original assays, INV's procedure is to request a new analysis on the first, second, and third pulps. Once the problem is identified, a new analysis of the batch is requested by INV, if needed.

11.3.3.1 CERTIFIED REFERENCE MATERIAL

INV used eight gold CRMs obtained from Rocklabs: HISILK2, HISILP1, SG14, SG66, SI15, SJ63, SN16 and SN60. The CRMs were inserted as pulps into the sample stream after the laboratory had completed its sample preparation, thus testing the analytical accuracy of the analytical process, but not contamination during sample preparation. INV inserted a total of 84 CRMs for 23 drillholes in 2017. Three of the eight CRMs consisted of single samples and as a result, cannot be used for statistical purposes, therefore reducing the practical number of CRMs to 81.

Table 11-10 lists the CRM name, expected mean, standard deviation, and the number of CRMs inserted during the drilling program. No silver or copper CRM were used during the 2017 drilling campaign.

Table 11-10: CRMs Used In 2017 Drilling Program

Gold			
CRM	No	Mean (g/t)	St. Dev.
HISILK2	1	N/A	N/A
HISILP1	1	N/A	N/A
SG14	1	N/A	N/A
SG66	5	1.070	0.049
SI15	33	1.810	0.067
SJ63	8	2.490	0.155
SN16	27	8.367	0.217
SN60	9	8.600	0.223

INV chose to evaluate the QA/QC results within a conventional three standard deviation range of the CRM certified gold content. Observed results that fell outside this range were deemed to be failures. Using this criterion, 10 of 81 results failed (8.1%) for gold. As a result of the unusually high failure rate of SG66 and SJ63 with respect to their certified mean values, INV evaluated these CRM results using the mean of their respective assay results as opposed to the expected values provided on the Certificate of Analysis. Using the recalculated mean and standard deviation parameters, 2 of the 81 results failed (2.4%) for gold, which is lower than the three percent that would be expected to fall outside the limits. The mean gold content reported by Inspectorate for all gold control samples was within three percent of the certified mean for CRMs SG66, SI15, SN16 and SN60 but above it for CRM SJ63 (**Table 11-11** and **Figure 11-8, Figure 11-9, Figure 11-10, Figure 11-11, and Figure 11-12**).

Table 11-11: Summary of CRM Results

Gold						
CRM	Number	Observed Au (g/t)		Expected Au (g/t)		% Diff. Observed to Expected Mean
		Mean	Std. Dev.	Mean	Std. Dev.	
HISILK2	1	N/A	N/A	N/A	N/A	N/A
HISILP1	1	N/A	N/A	N/A	N/A	N/A
SG14	1	N/A	N/A	N/A	N/A	N/A
SG66	5	1.086	0.032	1.070	0.049	-1.50%
SI15	33	1.805	0.067	1.810	0.067	0.28%
SJ63	8	2.632	0.055	2.490	0.155	-5.70%
SN16	27	8.370	0.217	8.367	0.217	-0.04%
SN60	9	8.595	0.223	8.600	0.223	0.06%

RPA notes that there may be a slight overestimation bias on results from CRM SN16. The observed results from CRM SG66 appear to be biased low. RPA recommends that INV investigate the high and low bias observed in CRMs SN16 and SG66, respectively. RPA recommends that INV investigate the differences between the supplied expected mean and round-robin determined mean observed in CRMs SG66 and SJ63 by conducting an external check.

No assay batches determined to have failed QA/QC were re-assayed.

Due to the low NSR value of silver and copper (less than 1%) no CRM evaluation for silver or copper was performed.

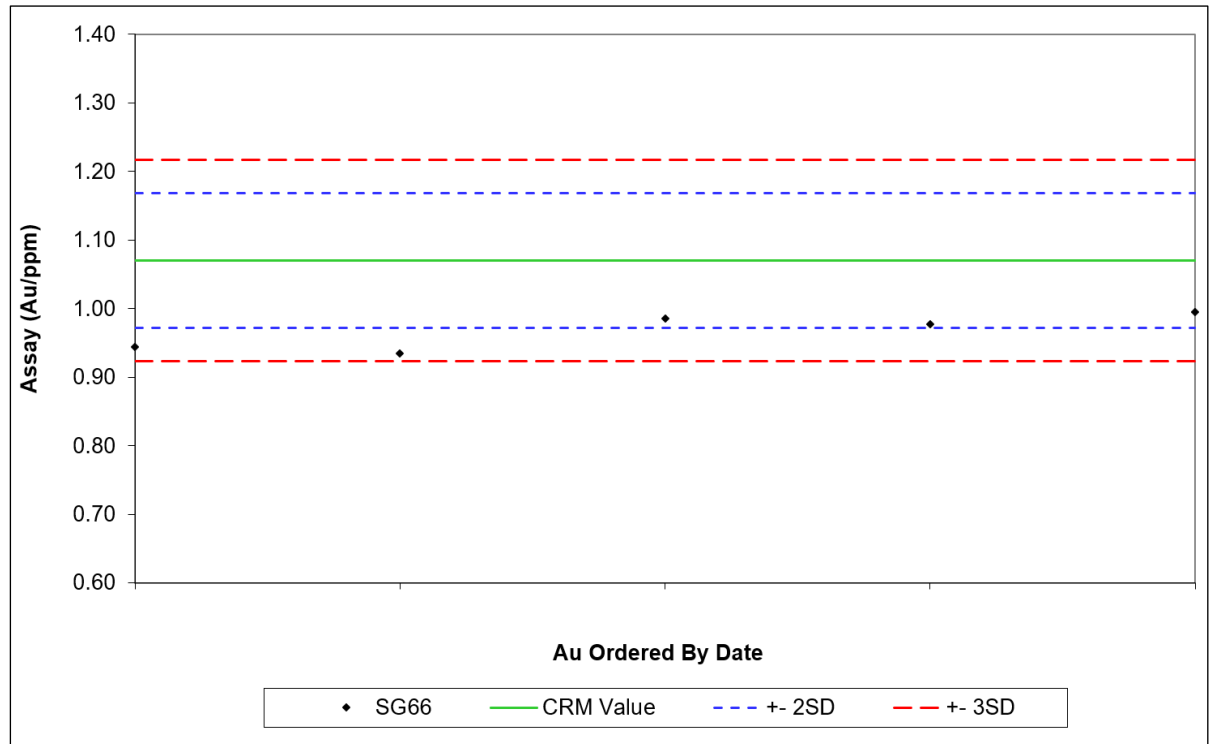

Figure 11-8: Gold Control Chart: CRM SG66

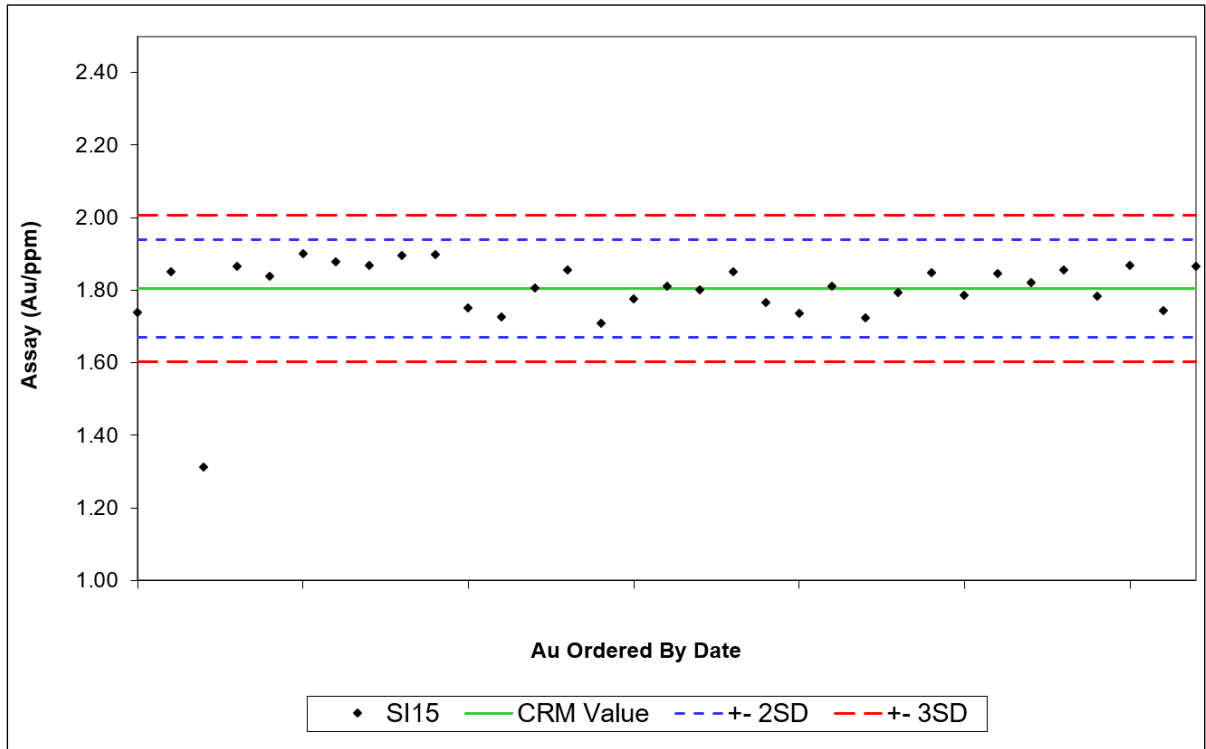

Figure 11-9: Gold Control Chart: CRM SI15

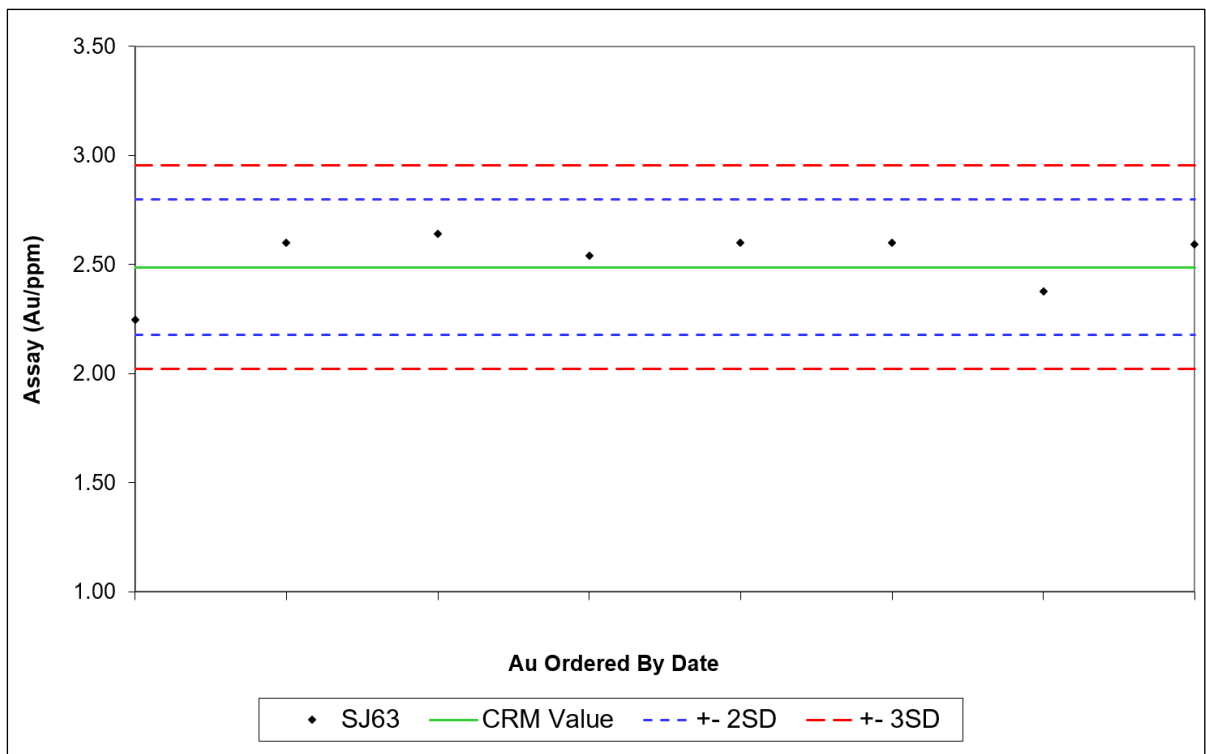

Figure 11-10: Gold Control Chart: CRM SJ63

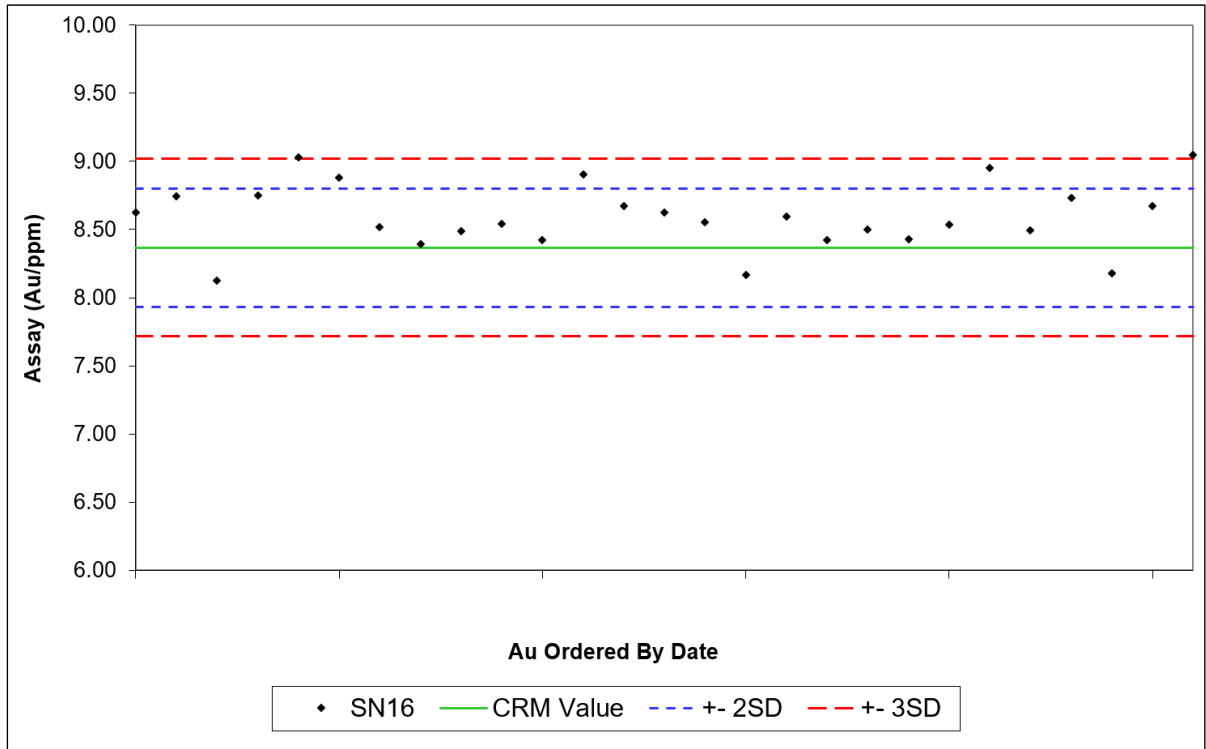

Figure 11-11: Gold Control Chart: CRM SN16

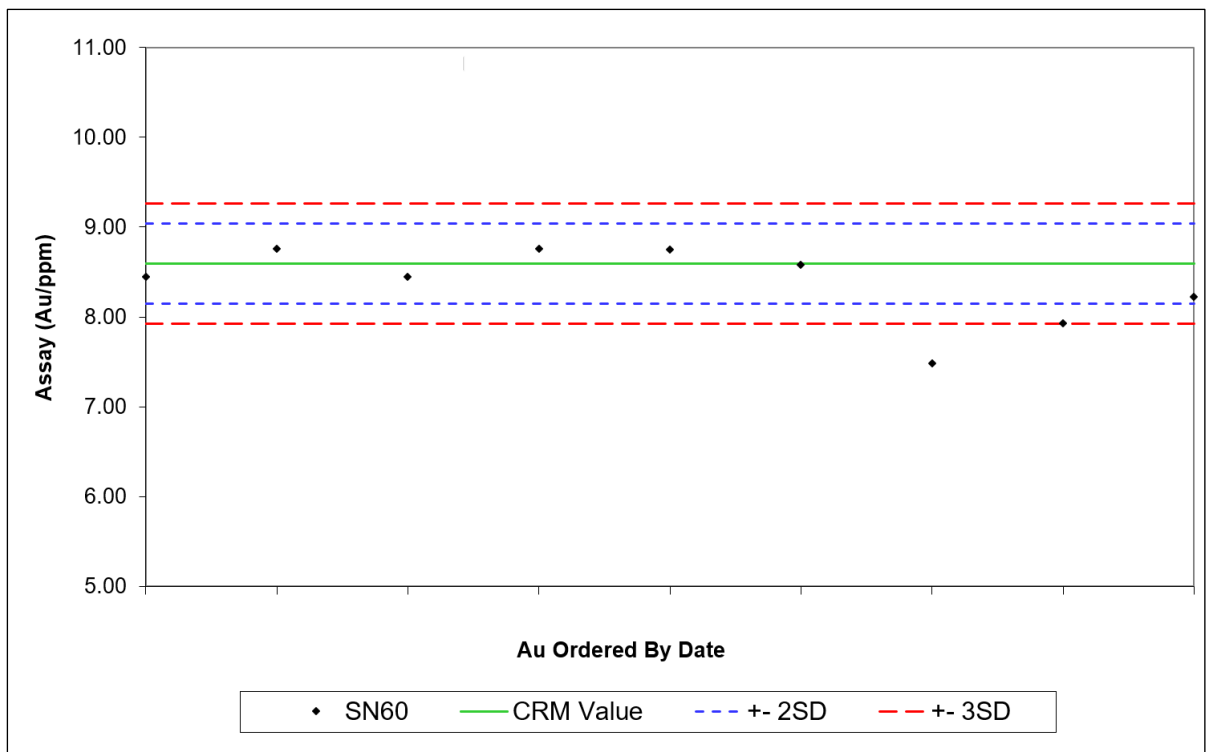



Figure 11-12: Gold Control Chart: CRM SN60

	Document Number	J01834-PM-REP-002	Rev	0	
	Date	11 January 2019	Page	98 of 417	

11.3.3.2 BLANKS

Contamination and sample numbering errors are assessed through blank samples. In general, contamination is identified when the blank samples yield values exceeding ten times the detection limit of the analytical method. For the 2016-2017 drilling program, gold values should be below 0.05 g/t Au, silver below 2 g/t Ag, and copper below 20 ppm Cu. A total of 94 blank samples were inserted into the sample stream by INV during the 2016-2017 drilling program. The results for these samples were plotted chronologically to determine if any trends had occurred over time. All blank assay results for gold and silver were at or below detection limit, and copper results varied between 2 ppm and 24 ppm, with no detectable systematic pattern.

It is RPA's opinion that these results demonstrate no evidence of contamination.

11.3.3.3 DUPLICATES

Field Duplicates

No field duplicates were collected during the 2016-2017 drilling program. RPA recommends that the practice of collecting field duplicates resumes in future drilling campaigns.

Reject Duplicates

Table 11-12 summarizes the basic statistics of the reject duplicate pairs and scatterplots of each data set are illustrated in **Figure 11-13**, **Figure 11-14**, and **Figure 11-15**. Gold, silver, and copper all show excellent correlation between means and very low percent difference between means (all less than one percent absolute difference). No bias is observed at either very low grades, or near-average resource grades of gold, silver, and copper.

As in 2013, the duplicate data pairs taken in 2016-2017 from Loma Larga follow the expected progression of decreasing variance and percent difference between means from preparation to assay duplicates.

Table 11-12: Summary of Reject Duplicate Results

Gold (g/t)		
	Original	Duplicate
Number of Samples	127	127
Mean	1.11	1.11
Maximum Value	14.10	14.90
Minimum Value	0.01	0.01
Median	0.17	0.16
Correlation Coefficient	0.988	
Percent Difference Between Means	-0.1%	
Silver (g/t)		
	Original	Duplicate
Number of Samples	127	127
Mean	8.02	8.07
Maximum Value	141.50	142.00
Minimum Value	0.20	0.20
Median	2.00	1.70
Correlation Coefficient	0.997	
Percent Difference Between Means	-0.6%	
Copper (ppm)		
	Original	Duplicate
Number of Samples	127	127
Mean	710.62	704.76
Maximum Value	17,610	16,800
Minimum Value	2.00	2.00
Median	126.00	130.00
Correlation Coefficient	0.999	
Percent Difference Between Means	0.8%	

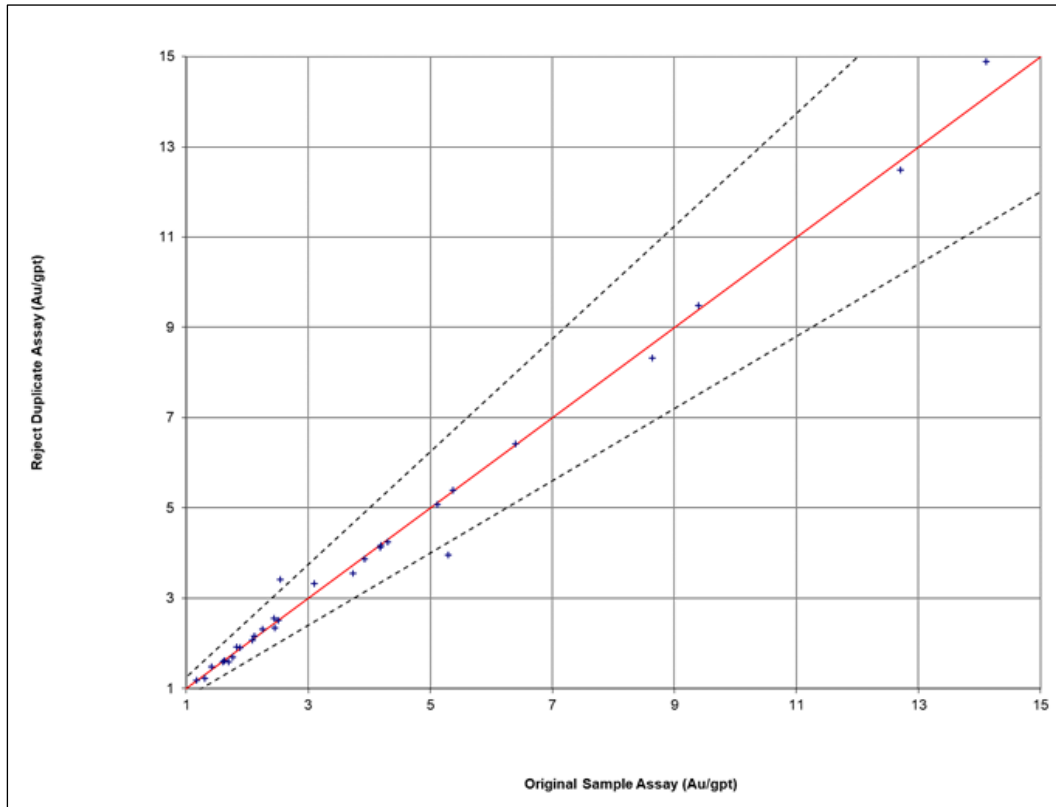

Figure 11-13: Gold Reject Duplicate Scatterplot

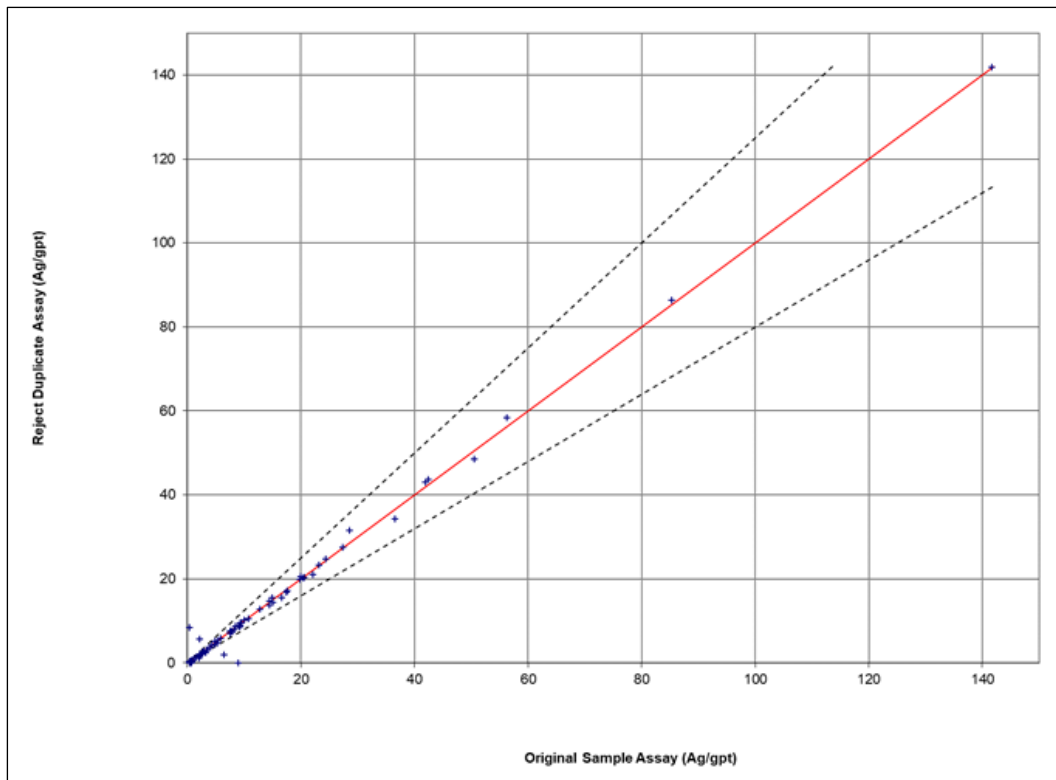

Figure 11-14: Silver Reject Duplicate Scatterplot

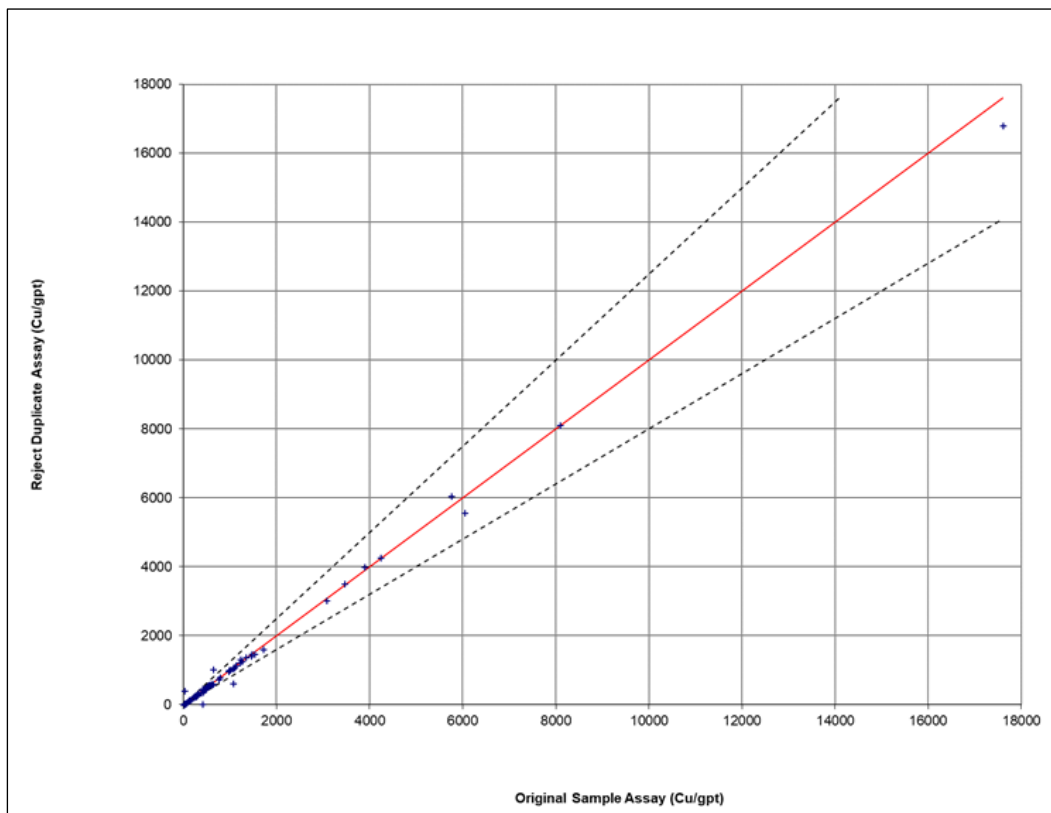

Figure 11-15: Copper Reject Duplicate Scatterplot

Pulp Duplicates

Pulp duplicates consist of second splits of final prepared pulverized samples, analyzed by the same laboratory as the original samples under different sample numbers. The pulp duplicates are indicators of the analytical precision, which may also be affected by the quality of pulverization and homogenization. INV chose to analyze pulp duplicates on the same samples that were selected for reject duplicate analysis.

Table 11-13 summarizes the basic statistics of the pulp duplicate pairs and scatterplots of each data set are illustrated in Figure 11-16, Figure 11-17, and Figure 11-18. Gold, silver, and copper all show excellent correlation between means and very low percent difference between means. No bias is observed either at very low grades (below 1 g/t Au, 10 g/t Ag, and 1,000 ppm Cu), or near average resource grades of gold, silver, and copper.

Table 11-13: Summary of Pulp Duplicate Results

Gold (g/t)		
	Original	Duplicate
Number of Samples	127	127
Mean	1.11	1.12
Maximum Value	14.10	14.20
Minimum Value	0.01	0.01
Median	0.17	0.17
Correlation Coefficient	0.989	
Percent Difference Between Means	-0.7%	
Silver (g/t)		
	Original	Duplicate
Number of Samples	127	127
Mean	8.02	8.02
Maximum Value	141.50	140.00
Minimum Value	0.20	0.20
Median	2.00	1.70
Correlation Coefficient	0.997	
Percent Difference Between Means	0.0%	
Copper (ppm)		
	Original	Duplicate
Number of Samples	127	127
Mean	710.62	703.94
Maximum Value	17,610	17,380
Minimum Value	2.00	2.00
Median	126.00	129.00
Correlation Coefficient	0.999	
Percent Difference Between Means	0.9%	

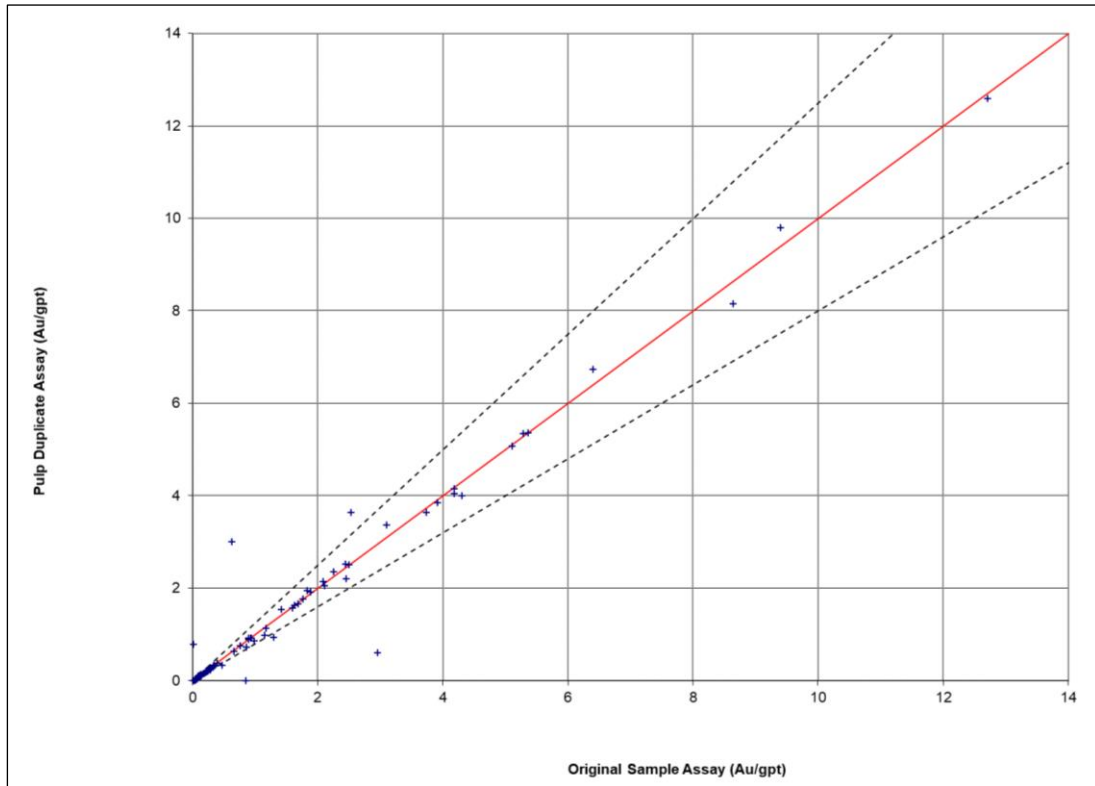

Figure 11-16: Gold Pulp Duplicate Scatterplot

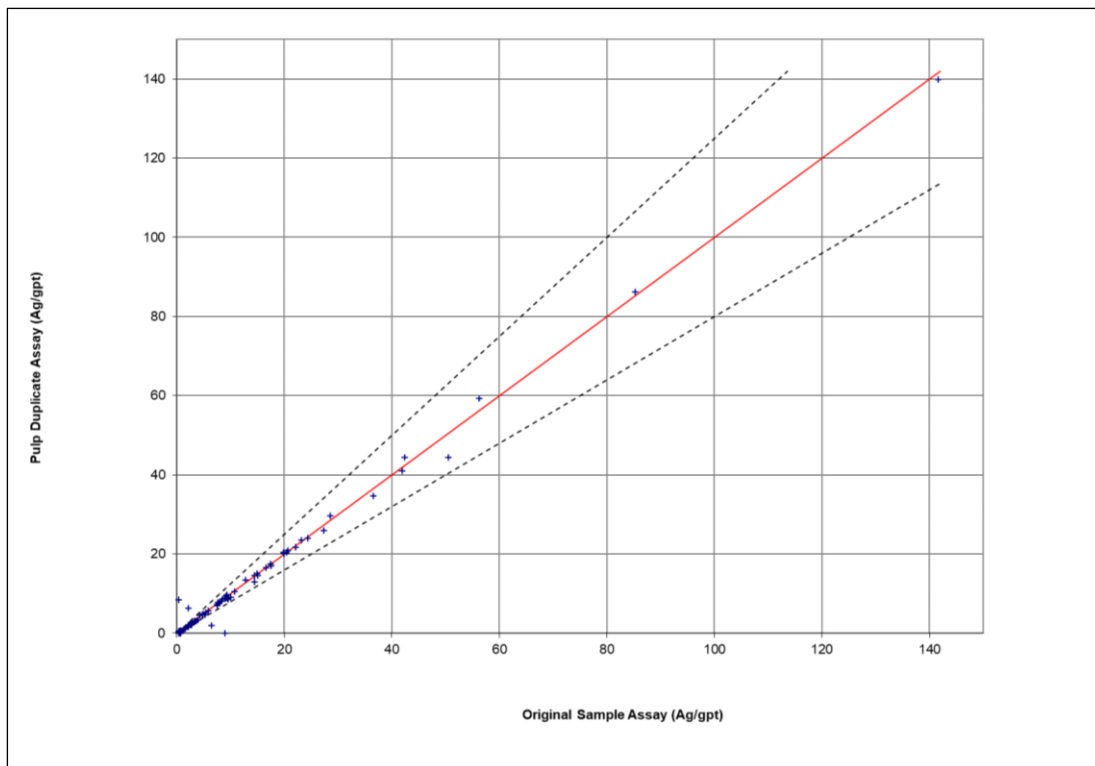

Figure 11-17: Silver Pulp Duplicate Scatterplot

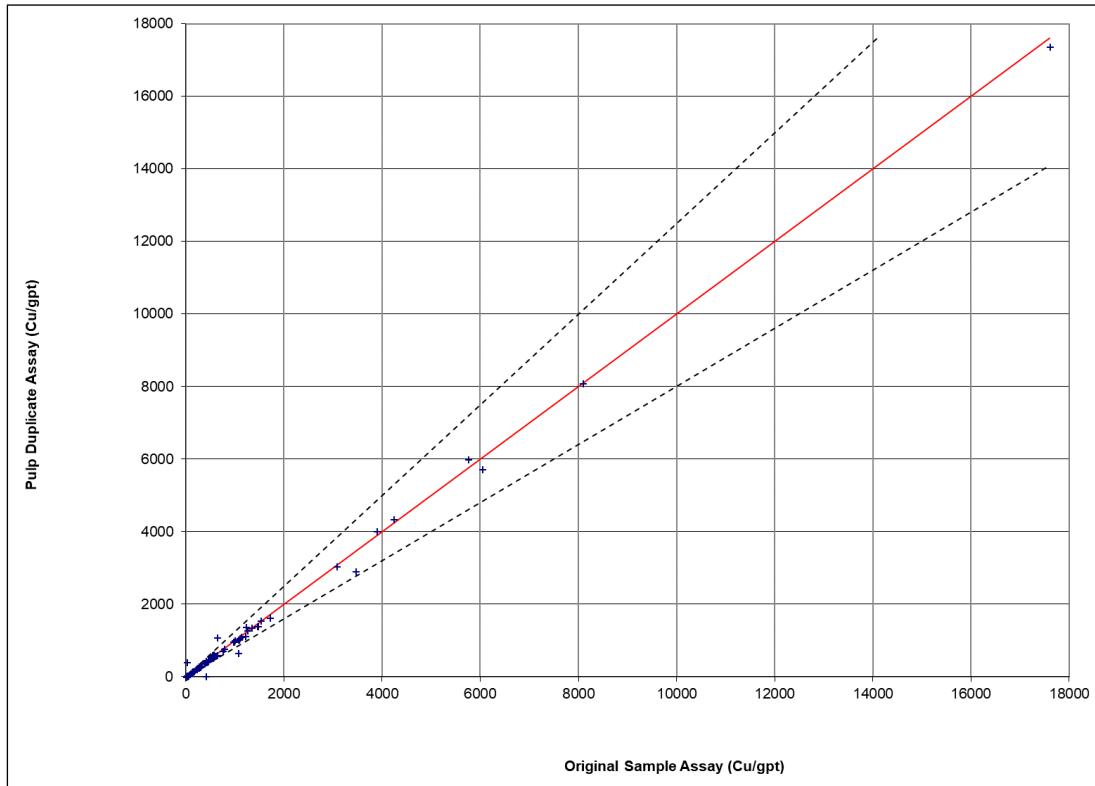

Figure 11-18: Copper Pulp Duplicate Scatterplot



11.3.4 RECOMMENDATIONS AND ENHANCEMENTS TO QA/QC PROGRAM

RPA strongly recommends INV ensures that procedures for investigating, correcting, and documenting results of QA/QC non-compliance issues such as biases or failures are followed for all drilling programs. Non-compliance results include:

- 2013
 - High bias observed in gold CRM SN16 since the expected grade of 8.37 g/t Au is very near the average gold grade of the Loma Larga Mineral Resource.
 - High bias observed in silver analyses after a brief hiatus in testing should be followed up with the laboratory.
- 2017
 - High bias observed in CRM SN16.
 - Initial high bias of CRM SI15.
 - Calibration issues with CRM SN60.
 - Low bias in CRM SG66.
 - Potential high bias in CRM SJ63.

The biases in the CRM results have been observed throughout several drilling campaigns at Loma Larga and RPA recommends that INV completes an external check on the reference materials used on the Loma Larga Project.

RPA recommends that INV carry out field duplicate analyses using half core duplicates. To ensure that the results are meaningful in the context of the Loma Larga resource, RPA



	Document Number	J01834-PM-REP-002	Rev	0	
	Date	11 January 2019	Page	105 of 417	

recommends that INV collect duplicate field samples within mineralized core intersections. Duplicate analyses can be achieved by using the existing core library.

Furthermore, RPA recommends that INV resume the regular submission of check assays (pulp replicates) to a secondary laboratory.

In 2017, INV introduced eight gold analytical standards, however, only four had sufficient data to be meaningfully analyzed. Of the four CRMs, two had grades approximately 8 g/t Au (SN16 at 8.37 g/t Au and SN60 at 8.595 g/t Au) and two CRMs were less than 3 g/t Au (SG66 at 1.156 g/t Au and SJ63 at 2.488 g/t Au). RPA recommends that INV reduce the number of CRMs used and ensure that the grades are consistent with the ranges expected to be found at Loma Larga (up to and greater than 30 g/t Au), as recommended in 2016. Similarly, RPA reiterates the 2016 recommendation that INV obtain analytical standards for silver and reintroduced a copper CRM.

RPA is of the opinion that the results of the QC samples, together with the QA/QC procedures implemented by INV at Loma Larga, provide adequate confidence in the data collection and processing, and the assay data is suitable for Mineral Resource estimation.

	Document Number	J01834-PM-REP-002	Rev	0	
	Date	11 January 2019	Page	106 of 417	

12 DATA VERIFICATION

Sampling details for the historic drilling program by IAMGOLD were verified by RPA in 2006. At that time, RPA validated the drillhole database up to hole IQD354. In 2012, RPA verified 30 drillholes completed by IAMGOLD in 2008, which included 28 resource delineation drillholes and two drillholes for metallurgical testwork. Prior to accepting the resource database used to estimate the current Mineral Resources for the Loma Larga Project, RPA reviewed and verified 12 drillholes completed by INV in 2013, which included drillholes LLD364 to LLD375. The verification work included a review of the QA/QC methods and results, checking assay certificates against the database assay table, a site visit and review of drill core, and standard database validation tests.

In 2018, RPA verified the assay results from 23 drillholes that were completed subsequent to the 2016 Technical Report. Verification included checking assay certificates against the database assay table. RPA also completed standard database validation tests of the new drilling.

RPA considers the resource database reliable and appropriate to support a Mineral Resource estimate.

In addition, RPA reviewed and verified the 248 drillholes with sulphur data, including 26 drillholes that were completed by INV during the 2017 drilling campaigns on the Project. The verification work consisted of a review of the QA/QC results, checking assay certificates against the database assay tables, and standard manual validation tests.

Katharine Masun, P.Geo., RPA Senior Geologist, visited the Loma Larga property site on February 19, 2014. During the site visit, RPA inspected the Loma Larga property, including the location of drill collars LLD148, LLD149, and LLD370.

RPA reviewed the geological core, checked lithology, mineralization, and sampling against drill logs of the following drillholes: IQD122, IQD183, IQ210, LLD367, and LLD372. During the core review, no notable discrepancies were found: metre tags were placed in the correct locations in the core boxes, samples were clearly and accurately marked, and core boxes were clearly labelled.

12.1 MANUAL DATABASE VERIFICATION

The review of the resource database included header, survey, lithology (major and minor), assay, and density tables. Database verification was performed using tools provided within the Dassault Systèmes GEOVIA GEMS Version 6.6 software package (GEMS). As well, the assay and density tables were reviewed for outliers. Any inconsistencies that were identified were promptly corrected by INV.

A visual check of the drillhole collar elevations with respect to the topographic surface and drillhole traces was completed. RPA noted 19 drillhole collars within the mineralized wireframe domains that were greater than one metre above the topographic surface, and four were greater than three metres. RPA followed up these discrepancies and found that it was not a transcription error. RPA recommends that INV resurvey the drillhole collars listed in **Table 12-1**.

Table 12-1: Drill Hole Collar Elevation Errors

Drill Hole	Collar Error (m)
IQD253	6.44
IQD145001	5.37
IQD330	4.61
IQD314	4.06
IQD142501	2.95
IQD133	2.26
IQD190	2.12
IQD181	2.09
IQD165	2.02
IQD176	1.76
IQD146	1.72
IQD179	1.37
IQD142	1.32
IQD344	1.24
LLD375	1.19
IQD138	1.14
IQD175	1.14
LLD370	1.10
IQD163	1.04

RPA verified all 1,722 assay records. This included a comparison of assay results in the resource database to 18 digital laboratory certificates of analysis (COA), which were received directly from Inspectorate. Any inconsistencies that were identified were promptly corrected by INV.



RPA verified 2,423 assay records to 30 digital COAs from 23 drillholes that were sampled during INV's 2017 drilling programs. A visual check of the drillhole GEMS collar elevations and drillhole traces was completed. No errors or inconsistencies were found.

12.2 INDEPENDENT ASSAYS OF DRILL CORE

RPA did not collect samples from drill core for independent assay during the 2014 site visit.

In 2005, Wayne Valliant, P.Geo., Principal Geologist with RPA, collected seven samples of quartered core for independent analyses at SGS Minerals Services, Toronto. Analyses were by fire assay for gold and ICP for silver and copper. Although seven samples are not sufficient for statistical comparisons, Scott Wilson RPA (2006) found the agreement to be reasonable and confirmed the presence of gold in the samples.

RPA is of the opinion that database verification procedures for the Loma Larga Project comply with industry standards and are adequate for the purposes of Mineral Resource estimation.

	Document Number	J01834-PM-REP-002	Rev	0	
	Date	11 January 2019	Page	108 of 417	

13 MINERAL PROCESSING AND METALLURGICAL TESTING

13.1 INTRODUCTION

Metallurgical testwork for the project location commenced in 2006. Initial testwork and process design efforts by IAMGOLD focused on the direct production of gold dore onsite using a combination of concentration, oxidation and cyanidation methods. In 2014, the new project owners, INV, engaged RPA to conduct a pre-feasibility study and corroborating testwork program. The 2014 program investigated the potential of producing saleable concentrate via conventional bulk or sequential flotation methods. The outcome of the 2014 program was the selection of a high level sequential flotation flowsheet for the recovery of separate gold bearing copper and pyrite concentrates. (2016 Technical Report)

DRA reviewed the data presented in the 2014 metallurgical testwork program and agreed with the approach of utilising a sequential flowsheet.

INV, in consultation with Promet 101 and DRA Americas, undertook a second testwork program (the 2017 Feasibility Study Program) to further optimize the flotation flowsheet. Optimization efforts focused on improving the operability, maintainability, capital and operating costs associated with the flowsheet. The outcomes of the 2017 Feasibility Study Program form the basis for the FS.

The majority of the results obtained from the 2006 Metallurgical programs are not relevant to the current process flowsheet selected but is included with respect to the mineral properties for the deposit and for completeness.

13.2 HISTORICAL METALLURGICAL TESTWORK

A review of the available historical metallurgical data was carried out, with a focus on obtaining pertinent results to the current process design criteria. The findings of the review are presented in the section below.



13.2.1 IAMGOLD METALLURGICAL TESTWORK PROGRAMS – 2006 TO 2010

Numerous metallurgical testwork programs were carried out by IAMGOLD between 2006 and 2010. In total, a set of twenty-six samples with gold grades ranging between 5 and 42 g/t and copper grades between 0.30 to 5.40% were received at SGS Lakefield and tested.

The focus of these programs was to identify suitable conditions to maximize gold recovery via a hydrometallurgical processing route to generate gold dore on site at Loma Larga.

The following results are relevant to the current version on the Loma Larga flowsheet:

- The ore was identified as being highly refractory in nature;
- Mineralogical testing indicated that the bulk of the gold (72%) was associated with pyrite, followed by enargite (12%) and the remainder with siliceous gangue;
- A total of nine Bond Ball Mill Work Index tests were completed. Results ranged from 15.2 kWh/t to 18.0 kWh/t, with an average value of 16.8 kWh/t;
- Gravity preconcentration achieved less than 10% recovery of the feed gold content;
- Whole ore cyanidation achieved low gold recoveries (16 to 30% of the gold in the feed) with high cyanide consumption levels; and

	Document Number	J01834-PM-REP-002	Rev	0	
	Date	11 January 2019	Page	109 of 417	

- Flotation testing achieved high gold and copper recoveries of 90 to 93% and 94 to 96%, respectively, into a single bulk concentrate containing enargite and pyrite.

13.2.2 INV METALS METALLURGICAL TESTWORK PROGRAM – 2014

The focus of the 2014 metallurgical program was to investigate possible flotation configurations to produce saleable concentrate(s) from the Loma Larga deposit. Both bulk and sequential (copper, pyrite) flotation circuits were investigated using a series of open circuit tests. The locked cycle test was subsequently completed for the sequential flotation flowsheet. The results of the 2014 metallurgical program were used in the 2016 Technical Report prepared by RPA.

The following tests were carried out:

- Physical characterization and mineralogy;
- Bulk rougher flotation;
- Bulk rougher cleaner flotation;
- Sequential cleaner flotation; and
- Locked cycle flotation.

The two composite (59 kg and 30.5 kg) samples were prepared from 230 kg of quartered HQ drill core intervals by SGS Lakefield. Drill holes LLD 371 and LLD 372 contributed the sample material for both composites. Composites head assays were found to be 12.5 g/t Au, 6.38 g/t Au and 0.59% Cu, 0.51% Cu, respectively.

The 2014 testwork program demonstrated, at a preliminary level, the following:

- The ore can be considered moderately hard, as assessed by the bond work index;
- The ore is highly abrasive;
- Bulk flotation results in significant gold losses at the cleaner flotation stage; and
- Sequential flotation resulted in the production of saleable concentrates. However, reagent consumption levels needed to be examined further.

The conclusions from the 2014 metallurgical testing program was that a sequential flotation process producing separate enargite and pyrite concentrates was identified as being the preferred process route. The sequential flotation consisted of producing a high pH pulp in a copper rougher stage to depress pyrite (and contained gold) followed by a low pH pyrite flotation stage via the addition of acid to the copper rougher tails stream.



13.3 TESTWORK FOR 2017 FEASIBILITY STUDY

13.3.1 INTRODUCTION

The 2017 metallurgical testwork program was designed to further optimize the flotation flowsheets and reagent schemes in the 2014 program. Both bulk and sequential flotation flowsheets were investigated, as each option assessed in earlier works was not considered to be optimized (high reagent consumptions).

The 2017 metallurgical test work program consisted of:

- Physical characterization of three composites and ten variability samples;
- 91 x Rougher/Rougher Cleaner tests on 14 composites;
- 12 x Variability Rougher tests on 10 variability composites;

	Document Number	J01834-PM-REP-002	Rev	0	
	Date	11 January 2019	Page	110 of 417	

- 46 x Cleaner Flotation tests;
- 4 x Locked Cycle tests;
- Pilot scale Staged Flotation Reactor (SFR) tests; and
- Tails samples for downstream characterization testing.

13.3.2 SAMPLE SELECTION

The source material for the 2017/18 metallurgical program was remaining composite material from the 2014 metallurgical program and drill core from the latest Loma Larga 2017 drill program. In total, 14 composites were prepared over the life of the program.

It should be noted that the samples used for the metallurgical testwork were at SGS Lakefield prior to the commencement of the feasibility study program. It is understood that all samples are from diamond drill cores, drilled between 2014 and 2017. The impact of sample age appears to be minimal with respect to metallurgical performance, but this has not been checked in detail.

The samples were prepared by INV on site at Loma Larga and shipped to SGS Lakefield in Ontario Canada.

The selection of drill core intervals for the testwork composites and variability samples was carried out by INV. Orix Geoscience Inc. performed a comprehensive analysis of the ore types within the deposit, see **Table 13-1**, and concluded that the samples chosen by INV were representative of the overall deposit. At the time of sample selection, the production schedule and LOM plan generated in the feasibility study was not available.

Figure 13-1 illustrates the location of each drill hole and the variability sample intervals, with respect to the ore body.

Drill holes LLDGT-005 and LLDGT-006 were used to form the majority of the composites and as the source of the variability samples for the project. Both LLDGT-005 and LLDGT-006 are within the boundary of the deposit and intersect type 1 and 2 ore types. Ore types are defined in accordance with **Table 13-1**.

Table 13-1 Ore Type Categories

Geological Data Type	TYPE 1	TYPE 2	TYPE 3	TYPE 4	TYPE 5
PLNDDH	2,3	6	1,4,5,7,8,9,10,11	12, 13	14, 15, 16
Lithology	Tuff, BxHyd, And, CBx, MBx	Tuff, MBx, BxHyd, RBx	Tuff, And, CBx, BxFr, BxHyd	Tuff, And, MBx, CBx, RBx	Tuff, RBx, BxHyd, MBx, CBx
Alteration	Sil, Kaol, Dck, Alun	Sil, Kaol, Alun, Dck	Sil, Kaol, Alun, Dck	Sil, Kaol, Alun, Pyro	Sil, Alun
Mineralization	Py, En (Ba, Sph, Lz, Cpy, Cv)	Py, En (Ba, Sph, Lz, Tn)	Py, En (Ba, S, Sph, Tn, Lz)	Py, En (Ba, Sph, S, Tn, Gal)	Py, En (Ba, Gt, S, Tn)
Assays	Au Moderate-High	Moderate-High	Moderate	Moderate	Moderate-Low
	Ag Moderate-High	Moderate-High	Moderate-Low	Moderate	Moderate-High
	Cu Moderate-High	Moderate-High	Moderate-Low	Moderate	Moderate-Low
	As Moderate-High	Moderate-High	Moderate-Low	Moderate	Moderate-Low
	Sb High	Moderate-High	Low	Moderate	Moderate
	Hg High	Moderate-High	Low	Moderate	High
	Mo Moderate-High	Moderate	Moderate-Low	Low	Moderate
	Bi Moderate-High	Moderate	Low	Low	Low
	Fe Moderate-High	Moderate-Low	Low	High	High
	Pb Moderate-Low	Low	Low	Moderate-High	Moderate-Low
	Zn Moderate-Low	Moderate-Low	Moderate-Low	Moderate	Low

– Source: Ore type categories work performed by Orix Geoscience Inc.

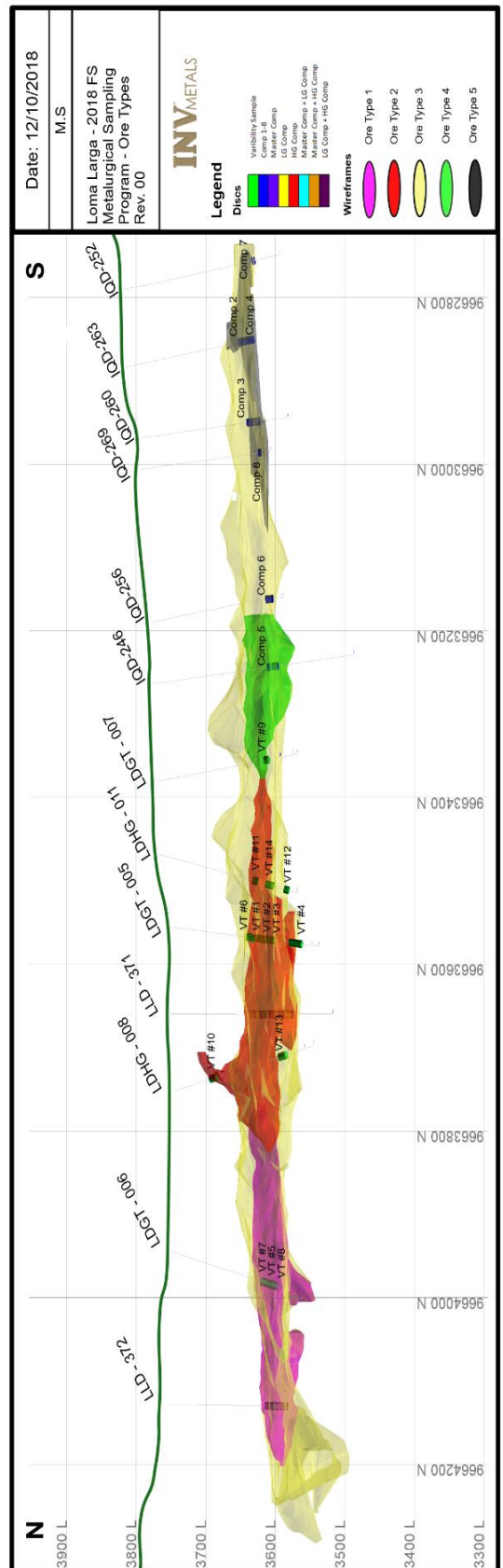
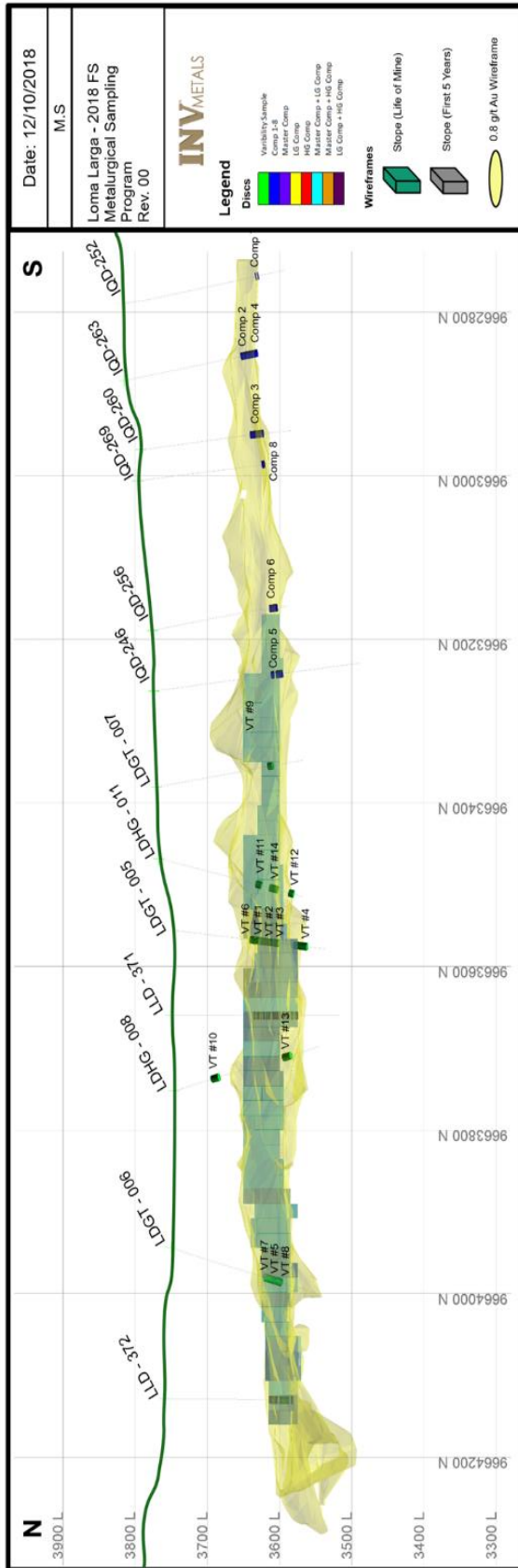

Figure 13-1: Drill Hole Locations and Ore Types

13.3.3 HEAD AND MINERALOGY CHARACTERIZATION

Head assays and mineralogical analysis was carried out on subsamples on a number of composites and variability samples (**Table 13-2**). Head assays for gold ranged from 1.06 to 15.4 g/t, averaging 5.6 g/t Au. Head assays for copper ranged from 0.033 to 4.12% Cu, averaging 0.50% Cu, while sulphur assays ranged from 3.95 to 15.3% S, averaging 8.93% S.

Mineralogy was consistent for all samples examined. On average 97% of the minerals present were either quartz or pyrite, with trace amounts of other minerals making up the difference. Enargite was the primary copper-bearing mineral.

At a P₈₀ of 75 µm, liberation (>80% of the cross-sectional particle area) averaged 85% for pyrite, with little variance in this value across the samples evaluated. The liberation characteristics for enargite were not as favourable averaging 59%, with considerably higher variance. Non-liberated enargite was more commonly associated with pyrite than quartz, while non-liberated pyrite was associated largely with quartz.

An analysis of the mineralogical data indicated that the primary grind size should be in the P₈₀ range of 50 to 75 microns. Re-grinding for pyrite should be in the P₈₀ equals 30 to 40 microns range, while copper re-grinding should finer, in the P₈₀ equals 20 to 30 microns range.

Table 13-2: Head Sample Assays and Mineralogical Data

Sample ID	Head Assays					Mineral Distribution, %					% Liberation*	
	Au g/t	Ag g/t	Cu %	As %	S %	Pyrite	Quartz	Enargite	Other Cu	Remainder	Pyrite	Enargite
Master	12.5	47.0	0.59	0.22	12.8	24.2	72.1	1.19	0.07	2.4	89.5	78.4
Low Grade	6.38	34.1	0.51	0.19	8.79							
Blend Comp	16.7	59.2	0.68	0.23	12.1							
SFR Comp	4.83	25.9	0.21	0.088	6.36							
VT-1	3.29	19.6	0.033	0.020	5.12	9.9	87.5	0.05	0.00	2.6		
VT-2	3.61	13.1	0.087	0.036	4.91	9.6	88.1	0.13	0.00	2.2		
VT-3	2.88	13.6	0.068	0.033	9.23	17.8	80.5	0.07	0.00	1.6		
VT-4	2.66	16.8	0.20	0.074	5.91	11.4	83.5	0.26	0.00	4.9		
VT-5	5.58	39.7	0.28	0.11	5.97	11.1	86.7	0.57	0.01	1.6		
VT-8	14.8	112	0.71	0.27	12.9	21.6	73.2	1.57	0.02	3.7		
VT-9	4.68	59.1	0.16	0.061	15.3	29.8	68.8	0.17	0.08	1.1	91.0	59.0
VT-10	6.86	79.1	4.12	1.20	7.15	8.3	79.4	5.92	2.26	4.1	83.5	35.4
VT-11	8.32	23.2	0.16	0.059	7.50	13.5	85.4	0.10	0.02	1.0	90.9	38.5
VT-12	3.96	18.3	0.30	0.11	10.2	17.1	81.4	0.33	0.03	1.2	78.5	0.0
VT-13	2.91	41.3	0.21	0.057	6.40							
VT-14	3.73	107	0.50	0.11	7.76							
Comp 1	5.01	23.7	0.24	0.093	6.44							
Comp 2	3.18	142	0.070	0.049	12.8	21.6	73.9	0.15	0.00	4.4	90.2	59.2
Comp 3	1.74	51.4	0.39	0.18	3.95	6.9	90.5	0.82	0.00	1.8	83.1	80.5
Comp 4	1.06	475	0.054	0.037	8.84	15.1	81.2	0.12	0.00	3.6	85.3	77.3
Comp 5	2.35	148	0.15	0.054	15.4	27.6	69.0	0.19	0.00	3.2	86.9	68.3
Comp 6	1.43	146	0.31	0.11	9.09	14.8	81.7	0.62	0.00	2.9	79.1	73.7
Comp 7	1.94	260	0.053	0.022	8.84	14.2	83.3	0.08	0.00	2.4	79.3	81.0
Comp 9	15.4	104	2.17	0.67	11.5							
Comp 10	4.43	26.2	0.21	0.081	8.08							

* P₈₀ = 75 microns. Liberation = >80% of area is the mineral of interest

– Note: Where cells are empty, data was not measured.

13.3.4 PHYSICAL CHARACTERIZATION

Physical characterization test work was conducted on three different composite samples and 10 variability samples. The results of physical characterization tests performed on each sample are shown in **Table 13-3** below.

For the coarser particle grindability tests i.e. Drop Weight Test (DWT), Sag Mill Comminution (SMC), and Sag Power Index (SPI), the indices indicate samples were medium to moderately

hard or competent on average in comparison to the SGS database. For the mid-range particle grindability tests (i.e. RWI), samples averaged moderately hard, while for the fine particle grindability tests (i.e. BWI), samples were considered moderately hard on average.

Table 13-3: 2017/18 Ore Hardness Testing

Sample Name	Relative Density	JK Parameters				CWI (kWh/t)	SPI (min)	RWI (kWh/t)	BWI (kWh/t)		AI (g)
		A x b ¹	A x b ²	t _a ³	SCSE				150M	200M	
Blend Comp	2.70	-	54.6	0.52	8.6	-	66.0	17.2	17.3	-	0.750
LLDHG-008	2.78	36.9	40.0	0.22	10.4	8.9	82.7	18.3	18.5	17.9	1.176
LLDHG-011	2.66	38.2	40.0	0.22	10.0	11.5	71.3	16.3	16.5	-	0.851
VT Sample #1	-	-	-	-	-	-	87.4	-	16.7	-	-
VT Sample #2	-	-	-	-	-	-	90.3	-	19.6	-	-
VT Sample #3	-	-	-	-	-	-	76.3	-	18.6	-	-
VT Sample #4	-	-	-	-	-	-	76.1	-	14.8	-	-
VT Sample #5	-	-	-	-	-	-	102.1	-	18.0	-	-
VT Sample #8	-	-	-	-	-	-	93.6	-	17.4	-	-
VT Sample #9	-	-	-	-	-	-	109.4	-	12.3	-	-
VT Sample #10	-	-	-	-	-	-	85.0	-	15.7	-	-
VT Sample #11	-	-	-	-	-	-	89.1	-	17.8	-	-
VT Sample #12	-	-	-	-	-	-	102.8	-	17.1	-	-

¹ A x b from DWT

² A x b from SMC

³ t_a from SMC test is an estimate



Abrasion index measurements indicated extremely abrasive material, ranging from 0.75 to 1.176. The variance within each test series was relatively low in comparison to other similar deposits. This is probably a natural feature of the Loma Larga deposit considering the consistent predominant presence of silica gangue in the samples tested. Composite samples tested tended to show less variance than the discrete samples tested from various locations across the deposit which is a common observation. All composites tested can be characterized as moderately competent, with moderately hard grindability and are highly abrasive. These properties are most likely influenced by the predominance of silica gangue in the material.

13.3.5 FLOTATION TESTWORK

Flotation testing was completed to evaluate the performance of the bulk and sequential flowsheets. The flotation performed testwork was designed to provide sufficient information for selection of the optimal processing flowsheet and design and allow for the estimation of recoveries, concentrate grades, CAPEX and OPEX to a feasibility level design.

The objectives of the flotation testing programs were as follows:

- Evaluate flotation conditions to maximize the recovery of copper to a copper concentrate containing gold and a gold bearing pyrite concentrate as final products;
- Identify conditions which maximize concentrate grades without significant reductions in total copper and gold recovery;
- Identify optimal recoveries of copper and gold into the separate concentrate streams;
- Identify the optimal primary grind required for the grinding circuit design;
- Identify rougher flotation concentrate regrind requirements;
- Evaluate reagent requirements and the subsequent impact on metal recoveries; and
- Generate sufficient data to determine the preferred flotation circuit design and flowsheet to be used in the study.

	Document Number	J01834-PM-REP-002	Rev	0	
	Date	11 January 2019	Page	115 of 417	

All flotation testing was carried out at the SGS facilities in Lakefield, Ontario.

The sections below summarize the results of the bulk and sequential flowsheet options investigated during the study. The outcomes of these investigations were as follows:

- The sequential flowsheet achieves higher grade copper and pyrite concentrates;
- The sequential flowsheet delivers higher overall metal recoveries to concentrate; and
- The sequential flowsheet achieved these recoveries utilizing lower reagent dosages.

13.3.5.1 BULK FLOTATION

The bulk flotation circuit considered that enargite and pyrite were to be recovered together in a bulk concentrate, using a bulk rougher and three stage cleaning separation process; followed by selective cleaning to produce both copper and pyrite concentrates.

Bulk rougher flotation is conducted at a pH of ~7.0, using a strong sulphide collector (PAX). Bulk rougher concentrate is reground prior to cleaning to produce a “cleaned” bulk concentrate.

This “cleaned” bulk concentrate is then separated into the two final concentrates in a selective cleaning circuit. This is achieved by increasing pulp pH significantly to depress pyrite and the use of selective copper collectors. The circuit utilizes a selective copper rougher stage followed by three sequential stages of copper cleaning.

The concentrate of the copper cleaning circuit being the final copper concentrate and the combined tails streams the pyrite concentrate. Both concentrates contain both gold and silver.

Two bulk circuit rougher tests and a further thirty-three combined bulk rougher-cleaner tests were completed. The following present results of the bulk flotation testwork program.

Bulk Flowsheet Rougher Testing



Only two rougher only tests (F23 and F32) were carried out using the bulk circuit flowsheet. The first test (F23) was carried out using the high-grade gold “Blend composite” at a primary grind of 80% passing 60 µm, 1.3 kg/t Lime, 30 g/t PAX (collector), 15 g/t 3418A (selective copper sulphide collector) and 25 g/t MIBC (frother). Recoveries of the major elements were 95.7% for copper, 95.1% for arsenic, 93.6% for gold and 88.8% for silver.

The second test (F32) rougher only bulk test was carried out to evaluate the staged use of 3418A versus PAX. The test conditions being a low pulp pH (7.0), 3418A (15.0 g/t), PAX (30.0 g/t) and MIBC (20.0 g/t). Overall recoveries were 94.7% for copper, 95.1% for arsenic, 92.9% for gold and 88.5% for silver.

Bulk Flowsheet Cleaner Testing

A total of thirty-three bulk rougher cleaner tests were completed. These tests can be collated into four different categories as follows:

- Bulk rougher flotation followed by bulk cleaning to generate a bulk concentrate, and separation cleaning stages to generate separate copper and pyrite concentrates (Tests F11, 13, 17 and 19). These tests were carried out on high grade gold and copper samples (6.0-16.7 g/t Au and 0.5-0.7% Cu).
- Bulk variability sample testing followed by bulk cleaning to generate separate bulk concentrates for each variability sample (Tests F21, F22, F24, F25, F26, F27, F28, F50, F51, F52 and F53).

	Document Number	J01834-PM-REP-002	Rev	0	
	Date	11 January 2019	Page	116 of 417	

- Bulk rougher flotation followed by bulk cleaning (kinetics tests) to generate a single bulk concentrate (F29, F30, F31 and F33).
- Bulk cleaning of LCT#2 products to generate bulk concentrate with further cleaning of this concentrate to generate separate copper and pyrite concentrates (Tests F35, F36, F37, F38, F39, F40, F41, F42, F43, F54, F55, F56, F66 & F67).

The tests were carried out on Composite 1 and Blend composites. The test conditions for this phase of testing were:

- Grind target of 80% passing 66 - 78µm;
- Regrind target of 80% passing 30 - 50µm;
- Bulk rougher pulp pH target of 7.0; and
- Reagent additions of 3418A (12.5 g/t), PAX (30 g/t) and MIBC (15 g/t).

The following observations were noted:

- Only F11 resulted in a reasonable copper concentrate recovery and grade of 76.6% and 30.3% Cu respectively;
- Gold recovery to copper concentrate was on average 20%; and
- Gold losses to the bulk rougher tails and first bulk cleaner tails were on average 10.5%.

Bulk Variability Testing including Bulk Cleaner Stage

A total of eleven bulk variability tests were completed, including a bulk rougher stage and then multiple stages of bulk concentrate cleaning.

All of the variability tests were run at the following conditions:

- Primary grind of 80% passing 60 µm. Add lime to target pulp pH 7.0;
- Bulk rougher for 20 minutes after 6 minutes conditioning time with 15 g/t 3418A, 25 g/t MIBC, 25 g/t PAX;
- Regrind bulk concentrate for 15 minutes with 7.5 g/t 3418A and 15.0 g/t PAX;
- Bulk 1st cleaner for 10 minutes after two minutes conditioning time with up to 5 g/t 3418A, 8.0 g/t MIBC & 10 g/t PAX as required. Some tests did not use extra reagents at all; and
- Bulk 2nd cleaner for 10 minutes after one minute of conditioning time with 8 g/t MIBC.

No extra lime was added to the regrind and cleaner stages and pulp pH stabilized between 7.0 - 8.0 in cleaner stages. Total PAX addition was up to 70 g/t.

Table 13-4 presents the head grades, mass and elemental recoveries of each of the eleven tests. Note that the concentrates generated here represent the combined final product as this would subsequently be separated into either a copper or pyrite concentrate.

Table 13-4: Bulk Circuit Rougher and Cleaner Variability Test

Test Details		Test #										
		F21	F22	F24	F25	F26	F27	F28	F50	F51	F52	F53
		VT#8	VT#8AR	VT#1	VT#2	VT#3	VT#4	VT#5	VT#9	VT#10	VT#11	VT#12
Head Grades	% Cu	0.73	0.68	0.047	0.11	0.086	0.201	0.27	0.14	4.00	0.17	0.29
	% As	0.27	0.25	0.021	0.035	0.033	0.073	0.11	0.052	1.14	0.062	0.11
	% S	13.0	12.9	5.13	4.73	9.15	5.85	5.64	15.4	7.28	7.51	10.0
	ppm Au	15.51	15.02	3.30	3.67	2.85	2.62	5.57	4.66	7.06	8.01	3.85
Recovery to Bulk Cleaner Concentrate	Mass %	26.8	27.1	8.1	8.8	17.8	12.2	9.94	28.2	16.8	15.2	24.6
	Cu %	95.1	92.1	73.7	70.0	87.1	93.2	92.1	91.3	95.3	89.4	91.1
	As %	93.5	90.1	69.7	84.9	80.8	92.6	89.2	81.2	95.5	86.0	89.9
	S%	90.0	90.9	78.1	80.5	87.0	83.8	84.8	90.3	88.0	86.2	86.5
	Au %	90.4	89.8	72.3	71.5	78.7	77.2	84.6	85.4	90.9	83.9	83.2

The following was noted from the results:

- Copper head grades were highly variable from 0.05 to 4.0% Cu;
- Copper recoveries ranged from 70.0 to 95.3% despite some very low copper grades;
- Arsenic responds in a similar manner to copper as expected as the predominant copper bearing mineral is enargite;
- Sulphur recoveries are also good but on average 5% lower than required to maximize gold recovery;
- The sulphur grade recovery curves were not the same as gold recovery curves, implying that the residual gold not recovered with copper is not totally associated with the pyrite; and
- Gold head grades cover a very wide range of assays from 2.62 to 15.5 ppm Au. Gold recovery performance was highly variable from 71.5 to 90.9%, at grades of 14 to 52 g/t Au.

Bulk Rougher Testing and Cleaner Kinetics Evaluation

A total of four cleaner kinetics tests were carried out. Two on the blend composite, one on assay reject samples, and one on an SFR concentrate prepared from the assay reject samples.

The conditions used at the bulk rougher stage included a primary grind target of 80% passing 60 µm, regrind bulk concentrate to 80% passing 30 µm, and bulk cleaning using 7 and 5 stages (tests F29 and F30, respectively). Results of the test showed relatively quick kinetics, with flotation completed within 10 minutes and 6 minutes, respectively. 70% mass pull to concentrate was also achieved.

Assay reject material was used for bulk rougher tests F31 and F33. For bulk rougher test F31 the following conditions were applied: regrind to 80% passing 30 µm and two stages of bulk cleaning with an additional 1st cleaner scavenger stage used. Test F33 was carried out on the SFR bulk concentrate and reground to 80% passing 30 µm and 2 stages of bulk cleaning applied, with an additional 1st cleaner scavenger stage being used.

For the two tests completed, the equivalent stage recovery to the bulk cleaner circuit are shown in **Figure 13-2**. The figure shows no substantial change in the cleaner stage recoveries as a result of the differing processing methods.

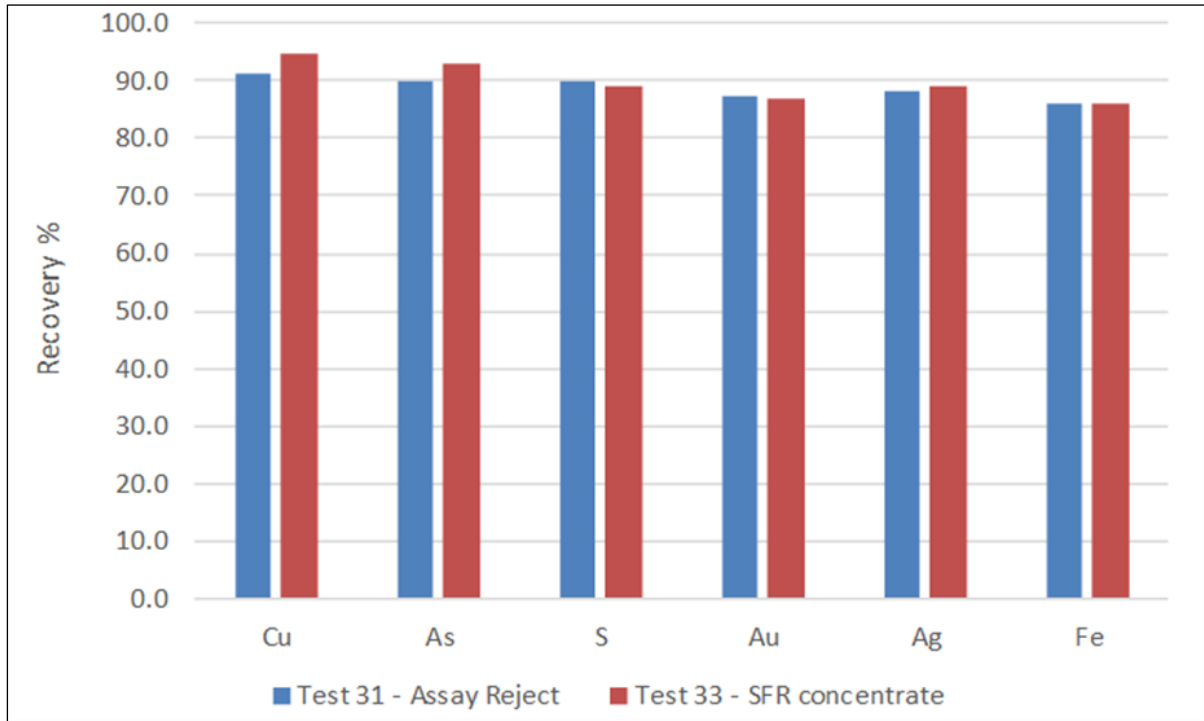

Figure 13-2: Bulk Cleaner Assay Reject Samples – SFR Bulk Concentrates

Cleaning of the LCT#2 Bulk Concentrate

Bulk rougher concentrate produced from Locked Cycle Test #2 was submitted for further cleaning. In total, fifteen tests (F35 to F43, F55 to 56, F66, and F67) were completed under the supervision of INV.

For each test, three stages of cleaning at elevated pulp pH (12) was used with different collectors and or depressants (Sodium Meta-Bisulphate, Cyanide, Quebracho) being evaluated. The detailed testwork conditions are defined in the 2017/2018 SGS Lakefield metallurgical testwork report.

The recovery results for each of the individual 15 cleaner tests were used to then calculate the final recoveries of copper to the copper concentrate versus the original feed and results as shown in **Table 13-5** below.

Table 13-5: Overall Bulk Cleaner Results to Copper Concentrate

Test #	Wt %	Assays, %, g/t						% Distribution					
		Cu	As	S	Au	Ag	Fe	Cu	As	S	Au	Ag	Fe
F35	0.87	11.8	4.57	44.8	64.3	727	31.8	49.1	45.7	6.04	12.2	23.8	5.01
F36	1.36	10.4	3.89	45.5	61.0	630	34.4	66.5	60.9	9.6	18.5	32.5	8.5
F37	1.48	8.99	3.41	47.1	57.2	565	35.6	63.0	58.1	10.8	18.9	31.6	9.7
F38	0.92	13.7	5.13	43.7	68.5	830	30.9	60.3	55.4	6.28	14.2	28.7	5.19
F39	1.11	12.0	4.64	45.7	68.1	750	30.6	63.1	57.8	7.69	16.2	31.3	6.20
F40	0.29	2.29	0.91	48.4	40.4	297	40.2	3.12	2.99	2.14	2.59	3.19	2.13
F41	0.25	29.8	10.90	38.3	104.0	1600	15.6	34.3	31.0	1.49	5.57	14.7	0.68
F42	1.07	12.3	5.07	42.9	72.4	813	27.2	64.5	60.7	7.14	16.5	45.4	5.30
F43	1.07	13.9	4.91	44.6	68.9	811	31.7	66.6	60.1	7.27	16.0	32.3	5.94
F54	1.06	12.2	4.55	45.3	63.9	755	32.4	61.3	55.7	7.29	14.9	28.6	6.09
F55	1.97	7.15	2.59	49.2	51.3	463	38.8	64.4	59.0	14.6	21.9	34.2	13.6
F56	1.18	10.2	3.76	47.3	58.9	620	35.4	56.6	51.9	8.5	15.2	27.5	7.51
F66	0.41	16.3	5.90	45.8	72.0	878	30.1	31.8	29.0	2.74	6.51	14.0	2.19
F67	0.18	10.5	3.76	49.0	53.7	594	35.8	8.7	8.0	1.33	2.13	4.05	1.14

Second stage cleaning results are presented in **Table 13-6**.

Table 13-6: LCT # 2 Recovery to Bulk Second Cleaner Concentrate

Product	Weight %	Assays, %, g/t					% Distribution				
		Cu	As	S	Au	Ag	Cu	As	S	Au	Ag
Bulk 2nd Cl Conc	11.25	1.68	0.63	48.4	36.1	203	87.0	82.9	86.9	82.2	82.6
Bulk 1st Cl Scav Tail	15.27	0.025	0.016	1.35	1.45	6.66	1.8	2.9	3.3	4.5	3.7
Bulk Ro Tail	73.48	0.033	0.017	0.84	0.90	5.16	11.2	14.2	9.8	13.3	13.7
Combined Tail	88.75	0.032	0.017	0.93	0.99	5.41	13.0	17.1	13.1	17.8	17.4
Head (calc.)	100.0	0.22	0.086	6.27	4.95	27.6	100.0	100.0	100.0	100.0	100.0

The overall recovery of copper to final copper concentrate was relatively low (40-80%) and that the concentrate grades were generally understood to be less than marketable. The cause for the relatively low grades can be linked to the high pyrite content in all of the samples, ranging from 60 to 80% by weight.

13.3.5.2 SEQUENTIAL FLOTATION

The sequential flotation circuit considered that enargite and pyrite are recovered sequentially and separately via separate copper sulphides and pyrite roughing and cleaning circuits.

In the first stage of flotation, enargite and other copper sulphides are preferentially recovered via the use of a moderately high pulp pH and a collector that is more selective to the recovery of copper sulphides versus iron sulphides.



The copper concentrate collected may also recover associated pyrite in composites and as such this concentrate stream is sent to a regrind circuit for further liberation before being cleaned in three sequential stages of copper cleaner flotation.

The tails stream from the copper rougher and cleaner circuits is then combined and fed to the pyrite rougher flotation stage, where the pulp pH is reduced and a strong collector (PAX) introduced to activate pyrite for optimum recovery.

The recovered pyrite rougher concentrate is then regrind to achieve suitable liberation and cleaned in two sequential stages of cleaning for gangue rejection.

A total of 58 rougher, rougher-cleaner and locked cycle tests were completed as part of the sequential flotation testing program. A breakdown of these tests are as follows:

- A total of 38 rougher only tests;

	Document Number	J01834-PM-REP-002	Rev	0	
	Date	11 January 2019	Page	120 of 417	

- A total of 15 rougher-cleaner tests;
- A total of 3 cleaner tests carried out on LCT tails product; and
- 2 locked cycle tests.

Rougher Flotation Tests

The rougher flotation tests provide an indication of the amount of material reporting to each of the two rougher concentrates. Ideally, the copper recovery needs to be maximized to the copper concentrate, and the gold recovery to the pyrite concentrate.

A total of 38 rougher flotation tests were completed as follows:

- 24 rougher kinetics tests on various composites;
- 12 rougher kinetics tests on variability composites; and
- 2 rougher kinetics tests to evaluate the impact of utilizing recycle water to reduce acid and lime consumption.

The objectives of each test are summarized as follows:



- Tests F1 through F12 evaluated the use of high pulp pH (~11.5 – 12.0) in the copper rougher stage followed by acid addition to achieve low pulp pH in the pyrite rougher stage;
- Tests F14 through F18 evaluated reduced copper rougher pulp pH, different collector strategies and no acid addition to pyrite rougher feed;
- Tests F20, and F34 through F48 evaluated use of alternative reagents to improve on the results obtained during previous test work;
- Tests F58 through F59 evaluated the impact of primary grind size on performance;
- Tests F60 and F61 evaluated the impact of regrind sizes;
- Tests F62 through F72 evaluated the impact of reagent dosage on flotation kinetics;
- Tests F73 through F82 represent rougher kinetic testing using the variability samples;
- Tests F87 and 88 represent repeat rougher testing at increased collector addition levels to improve sulphur and gold recoveries; and
- Tests F86A and F86B represent tests including the recycle of process water to evaluate the elimination of acid usage in the process plant.

The following observations were made regarding the copper rougher performance:

- Copper recovery ranged between 80 to 90% of copper in the feed;
- Arsenic recovery performance was similar to copper recovery;
- The average gold recovery was 32.3% (all samples) to the copper rougher concentrate. Excluding the high sulphur recovery samples, the average gold recovery was 20%;
- Sulphur recovery averaged 22.4% (all samples). Excluding “Freezer samples from 13J and 13G” (which gave very high sulphur and gold recoveries), the adjusted average is 10%. Freezer samples 13J and 13G were considered to have been oxidized resulting in activation of pyrite; and
- Mass recovery of the copper rougher concentrate was on average 6.0% of fresh feed. Excluding oxidized samples, average mass recovery was 3.0 to 3.5%.

The following observations were made regarding the pyrite rougher performance:

- Copper recovery to the rougher concentrate was on average 16.5% of copper in the feed;
- Gold recovery was on average 60.6%;
- Excluding the high recovery results to the copper concentrate average gold recovery was 68%;

	Document Number	J01834-PM-REP-002	Rev	0	
	Date	11 January 2019	Page	121 of 417	

- Sulphur recovery was on average 73%. Excluding the higher recovery results to the copper concentrate, average sulphur recovery was 85%; and
- Mass recovery was on average 24.8% of new feed.

Evaluation of Kinetics in Copper and Pyrite Rougher Circuits

An evaluation of the kinetics at different primary grind sizes for both the sequential copper and pyrite rougher circuits was completed. These tests were all completed at high copper rougher flotation pulp pH (~11.9) levels and low pyrite rougher pulp pH (~7.0) via acid addition.

Lime consumption to achieve the desired copper rougher pulp pH was in the order of 3.5 to 4.3 kg/t. The reagent and collector additions used in the copper rougher stage included Sodium Metabisulphate (Na₂SO₃ – 1 Kg/t) depressant and collectors Aerophine 407 (10 g/t) and Aerophine 3418A (15g/t) and MIBC (20 g/t) frother.

For the pyrite rougher flotation circuit, 2.4 to 2.8 kg/t of sulphuric acid was used together with MIBC (40 g/t) frother, and Potassium Amyl Xanthate (PAX) (70 g/t) collector.

The observations from copper kinetics tests are as follows:



- A primary grind size (P80) between 50 and 75 µm appears to be optimum for targeting overall recovery. Note that collector addition rates can affect kinetics and overall recovery and has not been optimised;
- Copper flotation kinetics are relatively quick and that flotation recovery for copper is essentially completed between four and six minutes;
- Gold recovery kinetics are fast achieving 30 to 50% of recovery in the first 3 to 5 minutes;
- Pyrite recovery is similar to gold, with significant recovery within 3 to 5 minutes; and
- The non-sulphide gangue recovery profile indicates a steady recovery rate in the order of 0.15 to 2.0% per minute of feed. This needs to be considered during design to prevent over collection of gangue material and ensure that high copper rougher grades are achieved.

The observations from pyrite kinetics are as follows:

- The optimum primary grind for pyrite recovery appears to be at 80% passing 54 µm;
- Pyrite recovery appears to follow a delayed response implying insufficient conditioning time. However, kinetics is relatively fast and effectively completed in 6 to 8 minutes;
- Gold recovery profile follows that of the pyrite with some slow floating particles still being recovered after eight minutes;
- Enargite recovery appears to be related to the recovery of non-sulphide gangue (NSG); and
- NSG recovery is relatively constant at 0.08 to 0.12% w/w of new feed per minute. Dilution of pyrite concentrate via excessive pulp residence times should be avoided.

Evaluation of Pulp pH on Copper and Pyrite Rougher Kinetics

Pulp pH was found to have a significant impact on the overall metal recoveries and kinetics for both copper and pyrite. Pulp pHs between 11.0 and 11.5 were shown to be optimal for copper flotation. Above a pH of 11.5, flotation kinetics start to reduce due to the viscosity effects encountered through lime addition. Pyrite depression was optimal at a pulp pH greater than 11.5.

	Document Number	J01834-PM-REP-002	Rev	0	
	Date	11 January 2019	Page	122 of 417	

Variability Rougher Results

A series of copper and pyrite rougher tests using the conditions defined from the kinetic testing phase on the low-grade composites were carried out. The following conditions were applied:

- Primary grind of 80% passing 60 µm;
- Copper rougher pulp pH 11.0;
- Pyrite rougher pulp pH 9.5;
- 3418A (15 g/t) and MIBC (45 g/t) for the copper rougher circuit; and
- PAX (50 g/t) and MIBC (50 g/t) for the pyrite rougher stage.

Figure 13-3 and **Figure 13-4** illustrate the results obtained during the variability testwork. It was observed that:

- Copper recovery to copper rougher concentrate was highly variable averaging only 75%;
- Gold recovery to copper rougher concentrate was also highly variable from 8 to 23%;
- Sulphur recovery to pyrite concentrate was relatively high at an average of 70%, with significant variability (37 to 92%);
- Gold recovery to pyrite concentrate was highly variable (19 to 82%); and
- Overall gold recovery to both rougher concentrates was on average 92.9%.

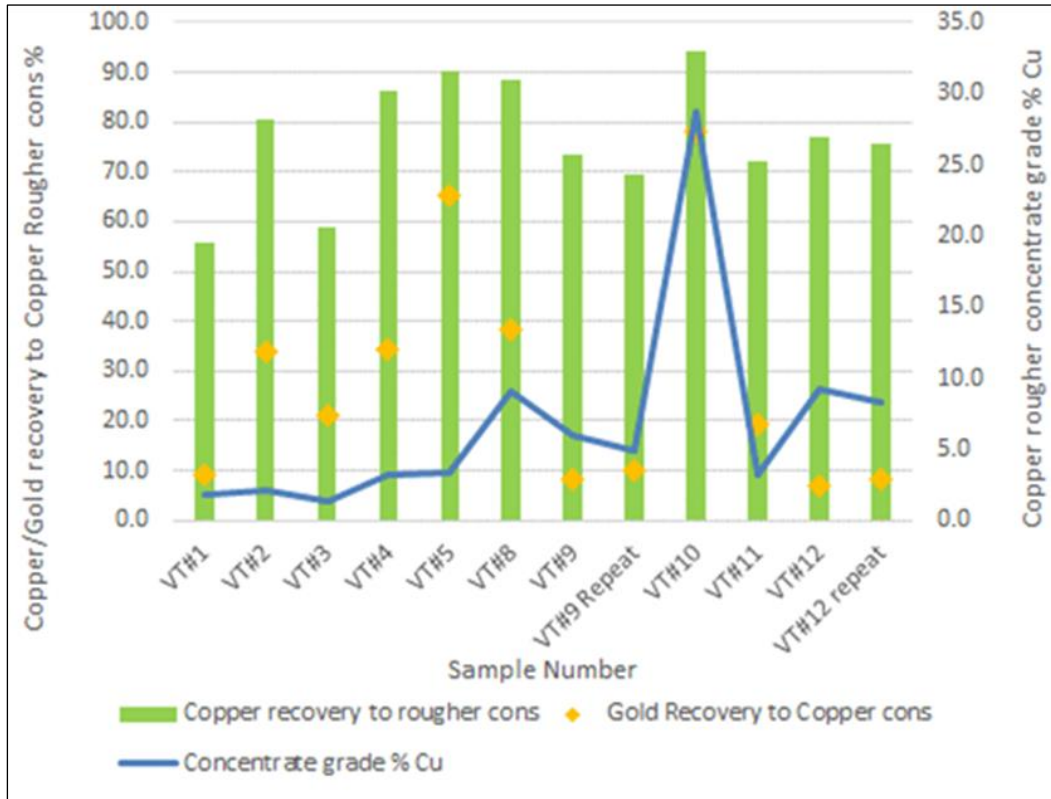

Figure 13-3: Copper Rougher Variability Results

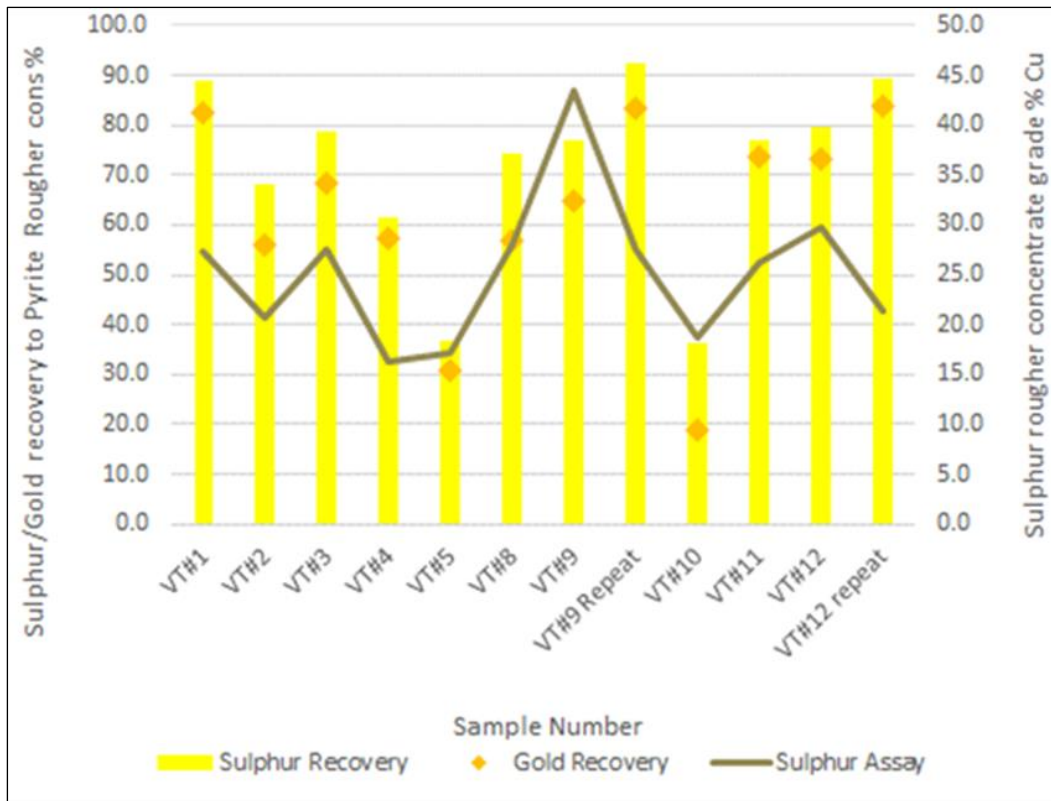



Figure 13-4: Pyrite Rougher Variability Results

	Document Number	J01834-PM-REP-002	Rev	0	
	Date	11 January 2019	Page	124 of 417	

Cleaner Flotation Testing

The sequential flowsheet cleaner testing was carried out in the following groupings:

- Tests carried on high-grade gold and copper samples. Samples ranged from 6.0 to 16.7 g/t Au and 0.5% to 0.7% Cu, respectively):
 - Initial testing at the start of the project using high pulp pH to depress pyrite, Na₂SO₃ and 407 (F3, F4, F12 and F20). These being on the high-grade gold and copper samples (6.0 to 16.7 g/t Au and 0.5 to 0.7% Cu);
 - An evaluation of primary grind on performance (F57, F58, F59, F62, F63 and F64). These being on high grade gold and copper samples (6.0 to 16.7 g/t Au and 0.5 to 0.7% Cu); and
 - Evaluation of regrind size on performance (F60 and F61). These being on high grade gold and copper samples (6.0 to 16.7 g/t Au and 0.5 to 0.7% Cu).
- Tests carried out on the final five-year composite. The composite assayed 5.0 g/t Au and 0.24% Cu:
 - Final optimization testing (F89, F90 and F91) using test conditions identified from Locked Cycle Test #3.

Copper Cleaner Flotation Circuit Concentrate Evaluation

The first set of sequential flotation tests were carried out on the initial high-grade copper and composite samples from the 2014 metallurgical testwork program. These used very high pulp pH (~12.0) followed by acid addition to achieve the desired pyrite rougher feed pulp pH.

The grind series tests utilized a low copper rougher pulp pH, with no acid in the pyrite rougher stage. This allowed the pulp pH to naturally reduce via oxidation of pyrite.

During the final optimization tests (F86A and F86B), a lower copper rougher pulp pH, with minor addition of acid in the pyrite cleaner stage was used. Minor additions are meant to emulate the use of recycle of low pH process water.

Figure 13-5 to **Figure 13-8** summarize the grade-recovery curves obtained for each test.

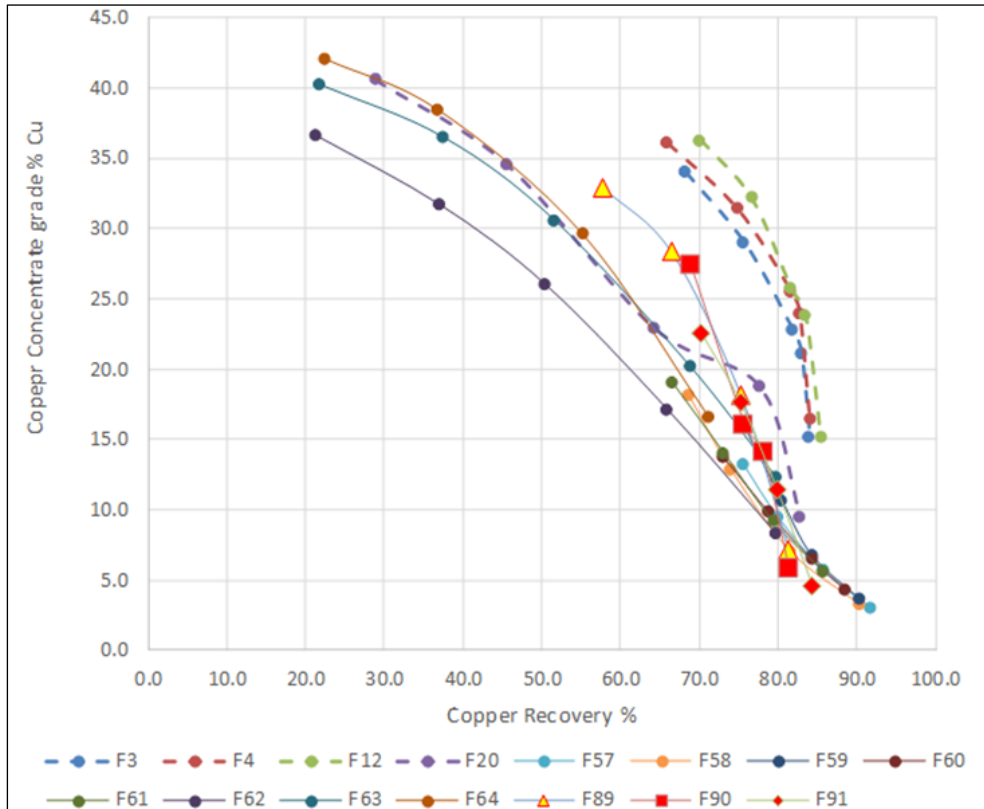

Figure 13-5: Copper Cleaner – Copper Grade vs Recovery

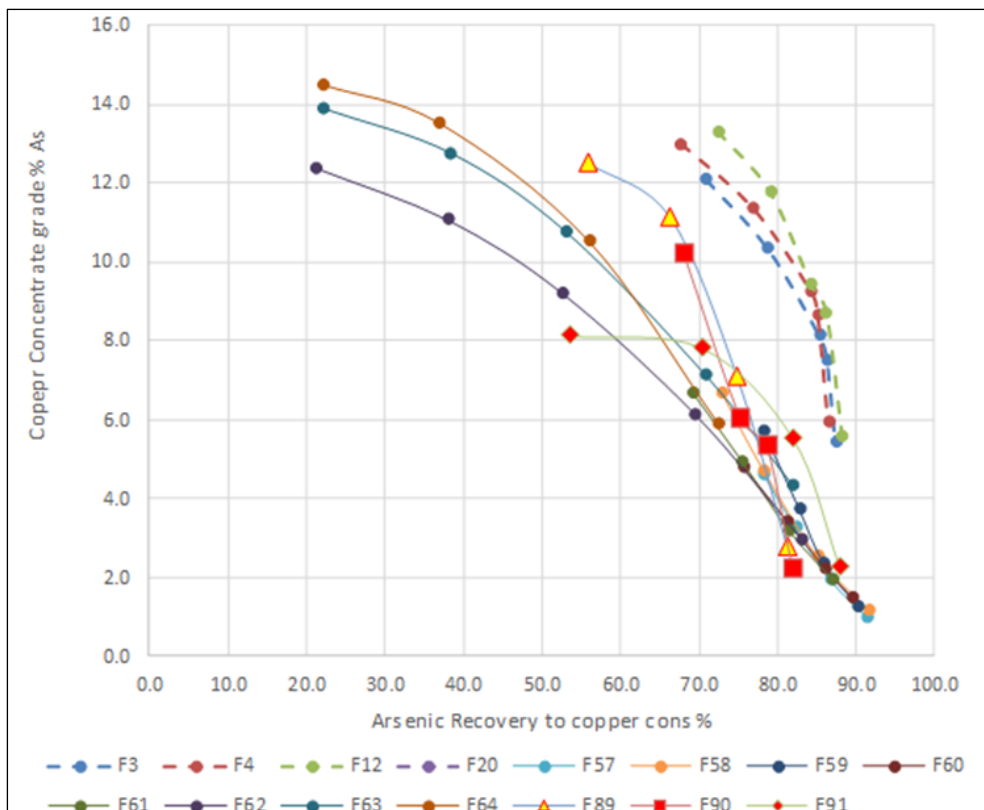

Figure 13-6: Copper Cleaner – Arsenic Grade vs Recovery

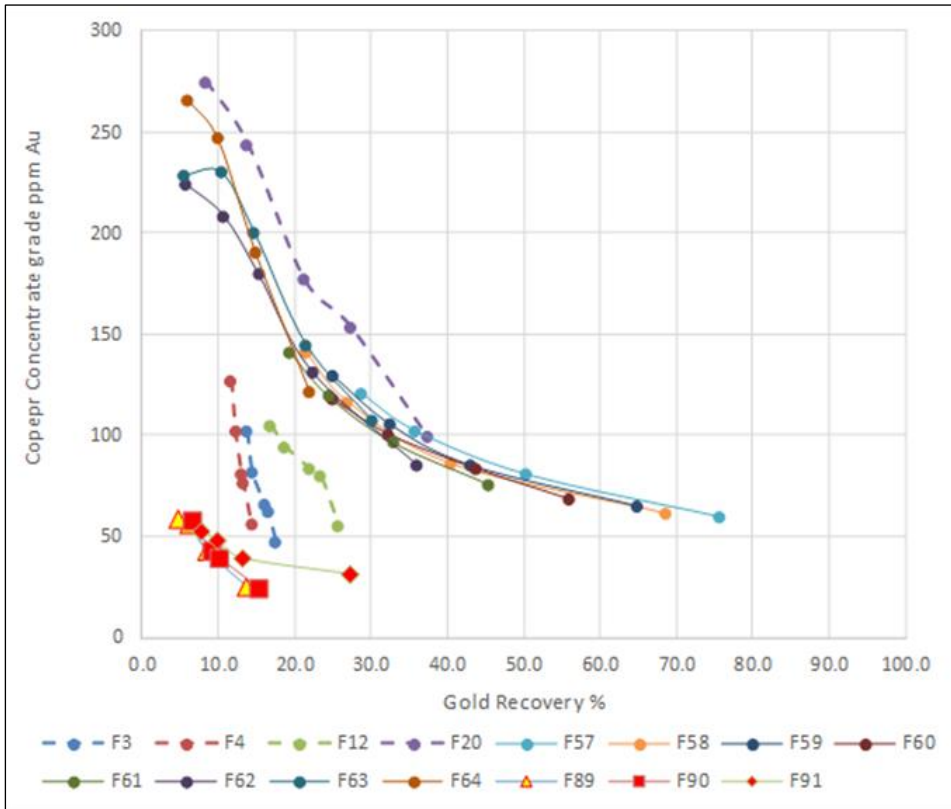

Figure 13-7: Copper Cleaner Gold Grade vs Recovery

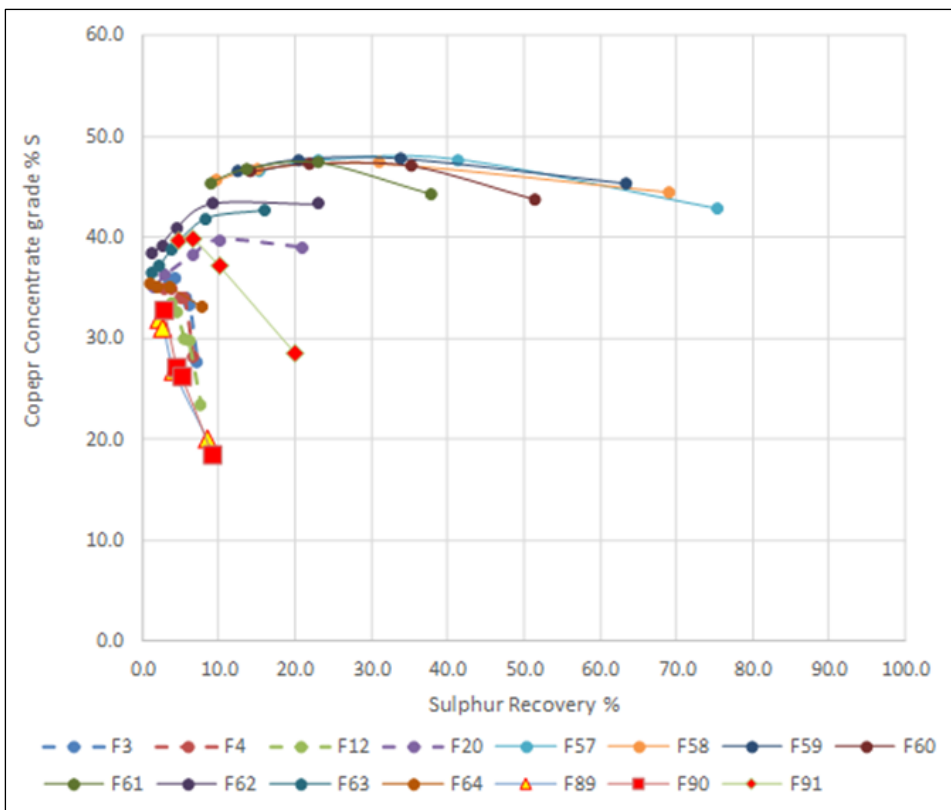



Figure 13-8: Copper Concentrate Sulphur Grade vs Recovery

	Document Number	J01834-PM-REP-002	Rev	0	
	Date	11 January 2019	Page	127 of 417	

The best grade recovery relationships were those of the early tests with the high-grade samples. The last tests were carried out at a much lower copper grade of only 0.24% Cu and achieved similar results with reasonable final concentrate grades being achieved. Arsenic performance follows that of the copper, as expected.

The best performance with respect to the rejection of gold/pyrite from the copper concentrate, was achieved in the last few tests F89, F90 and F91 with lower gold head grades. As with the gold, the best rejection of pyrite occurred with the last tests carried out on the 5-year mine composite with lower head grades.

Pyrite Cleaner Flotation Performance Evaluation

The objective of the pyrite flotation stage is to recover gold associated with pyrite into a saleable concentrate. To simulate the actual flowsheet, copper flotation rougher tails was used as feed material to the pyrite rougher stage.

The following observations are noted with respect to the pyrite grade-recovery relationships:

- Steep grade recovery curves indicate good liberation and suitable pulp chemistry;
- The final tests indicate high recoveries and concentrate grades. Concentrate grades for the 5-year composite achieved similar grades as those of the early tests with three times as high head grade;
- Copper recovery is low due to good recovery in the upstream copper circuit;
- The pyrite-gold response was as expected with a very consistent relationship being observed; and
- Optimal gold recovery ranged between 80-90% of sulphur recovery.

13.3.6 LOCKED CYCLE TESTWORK

A total of four locked cycle tests (LCT) were completed for the 2017/18 metallurgical testing program as follows:

- LCT # 1 – Bulk flotation circuit tested using Blend Composite;
- LCT # 2 – Bulk rougher cleaner of SFR concentrates;
- LCT # 3 – Sequential flotation circuit using Low Grade Comp; and
- LCT # 4 – Sequential flotation circuit using “Five-year Composite”.

The test conditions used for each of these tests including results obtained and comments on results achieved provided in the following sections.

13.3.6.1 LOCKED CYCLE TEST #1

Locked Cycled Test #1 evaluated the performance of the bulk flotation flowsheet. Feed material for the test was the “Blend Composite”. The lock cycle test flowsheet is illustrated in Figure 13-9 and test conditions outlined in **Table 13-7**.

The target grind sizes, pulp pH and reagent additions and actual test conditions achieved were as follows:

- Primary grind target 80% passing 60 µm;
- Bulk concentrate regrind target 80% passing 30 µm - actual 29 µm;
- Each of the flotation stages included one minute of conditioning time (not included in **Table 13-7**); and

- The bulk rougher stages included six stages of flotation, the two stages in the bulk 1st cleaner, two stages in the bulk 2nd cleaner, and single stages thereafter.

Table 13-7: LCT #1 Test Conditions

	Reagent Additions (g/t)					Time mins	pH	eH mV
	Lime	3418A	MIBC	Na2SO3	PAX			
Primary Grind	1,250					50	6.5	0
Bulk Rougher	50	15	45		30	20	7.0	+50
Regrind		7.5			15	15	7.0	+175
Bulk 1st Cleaner		2.5	10		5	13	7.1	+175
Bulk 1st Cl-Scav		2.5	2.5		5	5	7.3	+100
Bulk 2nd Cleaner		2.5	7.5		2.5	10	7.2	+100
Cu Conditioner	1,000			500		5	12.2	-50
Cu Rougher	500		2.5			4	12.2	-50
Cu 1st Cleaner	250		2.5	50		3	12.2	-50
Cu 2nd Cleaner	250			50		2.5	12.2	-25
Total	3,300	30	70	600	57.5			

Table 13-8 through **Table 13-10** outline the results obtained during LCT #1.

The results of the locked cycle test showed a copper concentrate grade of 17.3%, with a mass recovery of 2.97% and overall metal recovery of 76.5%. Gold recovery to the pyrite concentrate was relatively poor at only 64%. The performance of this bulk circuit test indicating insufficient rejection of pyrite with associated gold from the copper circuit to the pyrite concentrates.

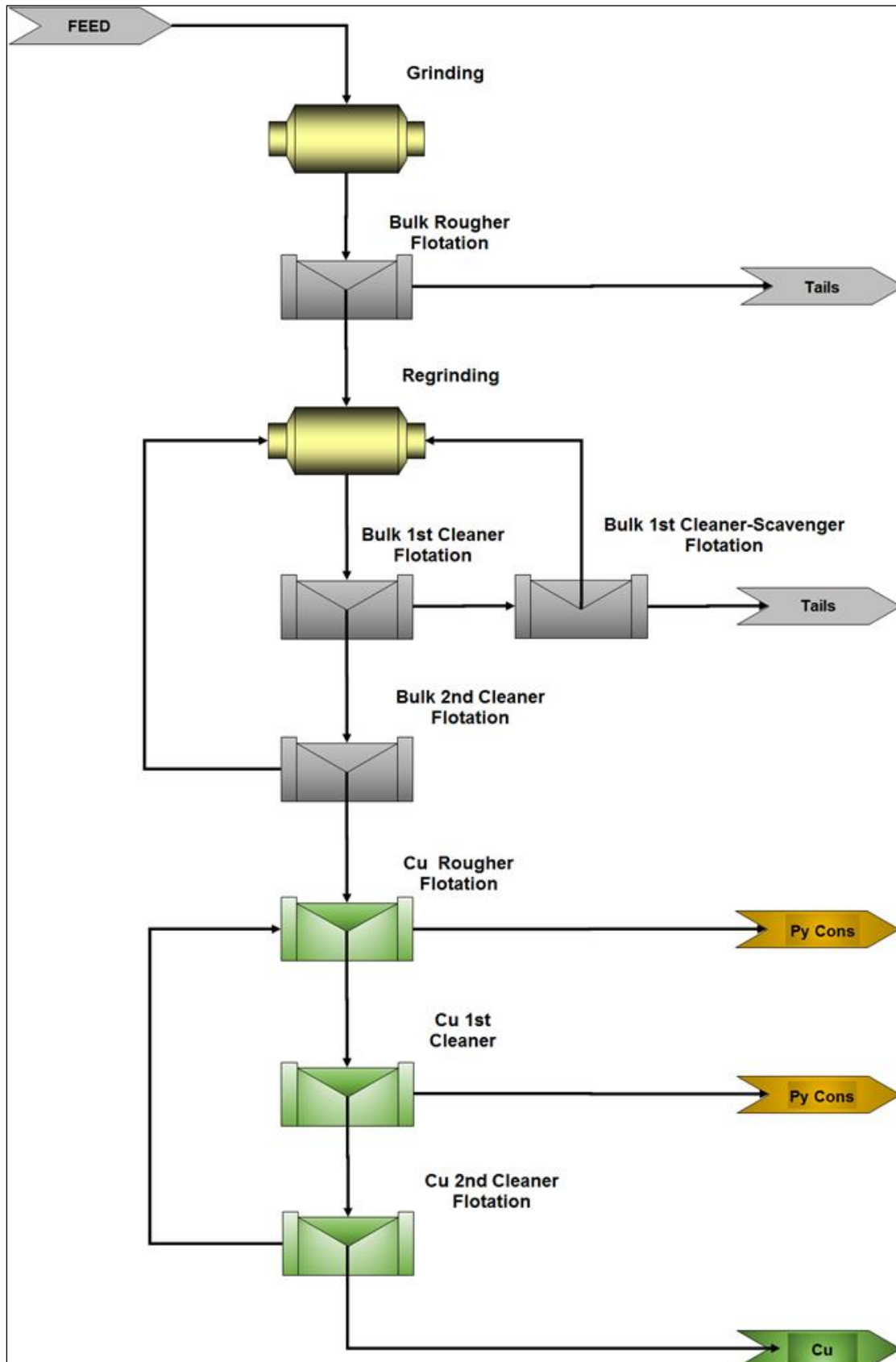

Figure 13-9: LCT #1 Flowsheet

Table 13-8: LCT #1 Stream Assays

Stage	Assays % (Cu, Fe, As, S), g/t (Au, Ag)					
	Copper	Gold	Silver	Arsenic	Sulphur	Iron
Flotation Feed	0.66	16.7	70.3	0.23	11.8	10.1
Bulk rougher tail	0.042	1.42	5.38	0.013	0.76	0.97
Bulk rougher con	1.97	48.8	207	0.68	35.0	29.3
Bulk 1st cl-scav tail	0.21	10.7	33.3	0.074	5.96	7.23
Bulk 2nd cleaner con	2.68	64.2	277	0.92	46.7	38.3
Bulk circuit combined tails	0.062	2.54	8.75	0.020	1.39	1.72
Cu rougher con	5.66	81.5	442	1.99	49.5	38.6
Cu rougher tail	0.44	52.0	146	0.11	45.5	38.8
Cu 1st cleaner tail	0.84	55.5	329	0.23	50.8	42.8
Cu 2nd cleaner con	17.3	141	857	6.23	45.9	28.0
Pyrite con	0.54	52.9	191	0.14	46.8	39.8

– Source: Promet101 (2018)

Table 13-9: LCT #1 Overall Recoveries

Stage	Recoveries % of Feed						
	Mass	Copper	Gold	Silver	Arsenic	Sulphur	Iron
Bulk Rougher	32.3	95.7	94.2	94.8	96.1	95.6	93.5
Bulk 1st Cleaner	25.2	94.5	90.4	92.0	94.9	93.7	90.2
Bulk 1st Cl-scav	0.60	0.60	1.12	0.78	0.58	1.18	1.35
Bulk 2nd Cleaner	23.0	92.8	88.3	90.4	93.1	91.0	86.9
Cu Rougher	10.5	89.4	51.2	66.1	91.9	44.1	40.1
Cu 1st Cleaner	5.49	83.1	34.6	42.6	86.8	22.5	18.9
Cu 2nd cleaner	2.94	76.5	24.9	35.9	80.8	11.5	8.14
Pyrite cons	20.03	16.3	63.4	54.6	12.4	79.5	78.7

– Source: Promet101 (2018)

Table 13-10: LCT #1 Staged Recoveries

Stage	Stage Recoveries %						
	Mass	Copper	Gold	Silver	Arsenic	Sulphur	Iron
Bulk Rougher	32.3	95.7	94.2	94.8	96.1	95.6	93.5
Bulk 1st Cleaner	71.8	96.4	92.8	94.7	96.4	94.1	91.9
Bulk 1st Cl-scav	6.06	17.0	15.8	15.0	16.1	20.1	16.9
Bulk 2nd Cleaner	91.3	98.2	97.7	98.3	98.2	97.1	96.3
Cu Rougher	41.2	90.0	52.3	68.0	92.7	43.2	41.1
Cu 1st Cleaner	52.3	92.9	67.5	64.5	94.5	51.1	47.1
Cu 2nd cleaner	53.6	92.1	71.9	84.2	93.0	50.9	43.1

– Source: Promet101 (2018)

13.3.6.2 LOCKED CYCLE TEST #2

The second locked cycle test carried out was on the bulk concentrate generated as part of pilot testing of the Staged Flotation Reactor (SFR).

Figure 13-10 outlines the flowsheet used in LCT #2. It includes the SFR rougher to generate a bulk concentrate, concentrate regrind, two stages of cleaning and a cleaner scavenger. The final concentrate generated would typically be re-cleaned at high pulp pH to depress pyrite and generate the two final concentrates. As such the second cleaner concentrate generated in this LCT represents the total recovery of copper and precious metals when using this circuit.

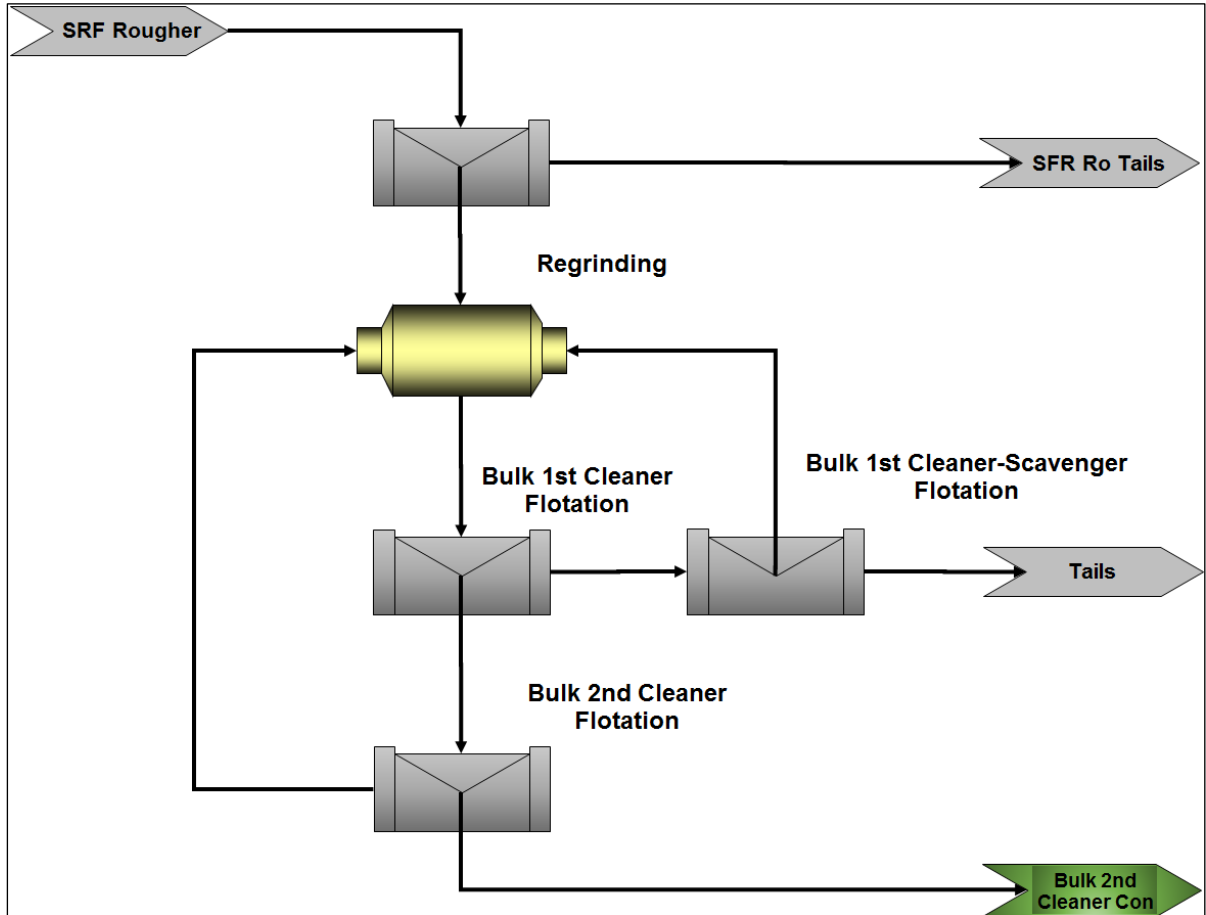

Figure 13-10: Loma Larga 2017 Metallurgical Testing Program LCT #2 Flowsheet

The feed material for this bulk cleaner locked cycle test was generated as part of the SFR pilot plant program using assay reject samples.

Table 13-11 outlines the test conditions of the locked cycle test.

Table 13-11: LCT #2 Test Conditions

Unit	Reagent Additions g/t				Time mins	pH	eH mV
	Lime	3418A	MIBC	PAX			
Bulk Con Regrind	-	7.5	-	15	45	6.4	+350
Bulk 1st Cleaner	17	2.5	15	5	26	6.6	+400
Bulk 1st Cl-Scav	-	2.5	2.5	5	10	6.9	+350
Bulk 2nd Cleaner	-	-	7.5	-	10	6.5	+200
Total	17	12.5	25	25	-	-	-

Table 13-12 to Table 13-14 represent the results of LCT #2.

Table 13-12: LCT #2 Stream Assays

Stage	Assay % (Cu, Fe, As, S), g/t (Au, Ag)					
	Copper	Gold	Silver	Sulphur	Arsenic	Iron
SFR Feed	0.21	4.95	27.6	6.27	0.09	5.65
SFR Rougher Con	0.71	16.0	89.0	21.1	0.27	18.0
Bulk 1st Cleaner Con	1.47	33.7	187	44.9	0.57	38.5
Bulk 1st Cl-Scav Con	0.23	14.0	57.3	14.6	0.12	15.3
Bulk 2nd Cleaner Con	1.66	36.2	203	48.5	0.63	41.3
SFR Rougher Tail	0.033	0.90	5.16	0.84	0.017	1.11
Bulk 1st Cl-Scav Tail	0.025	1.45	6.59	1.35	0.016	1.27
Combined Tail	0.032	0.99	5.41	0.93	0.017	1.14

– Source: Promet101 (2018)

Table 13-13: LCT #2 Overall Recoveries

Stage	Recoveries % of Feed						
	Mass	Copper	Gold	Silver	Sulphur	Arsenic	Iron
SFR Rougher Con	26.7	88.7	86.7	86.3	90.2	85.4	85.6
Bulk 1st Cleaner	12.7	87.0	86.7	86.0	91.0	84.8	86.5
Bulk 1st Cl-Scav	0.38	0.41	1.08	0.78	0.89	0.53	1.04
Bulk 2nd Cleaner	11.2	86.9	82.2	82.6	86.9	82.5	82.2

– Source: Promet101 (2018)



Table 13-14: LCT #2 Staged Recoveries

Stage	Stage Recoveries %						
	Mass	Copper	Gold	Silver	Arsenic	Sulphur	Iron
SFR Rougher	26.7	88.7	86.7	86.3	90.2	85.5	85.6
Bulk 1st Cleaner	44.5	97.5	93.9	95.0	95.6	96.1	95.1
Bulk 1st Cl-Scavenger	2.40	18.6	19.3	17.6	21.1	15.5	23.0
Bulk 2nd Cleaner	88.4	99.8	94.8	96.0	95.4	97.4	94.9

– Source: Promet101 (2018)

The SFR gold and copper recoveries to the bulk concentrate were relatively low at 86.7 and 88.7%, respectively. Mass recovery was high at 26.7% with good sulphur recovery.

Subsequent regrind and cleaning resulted in a further recovery loss of 4.5 % and 1.8% for gold and copper, respectively. The maximum gold recovery possible from the bulk cleaned concentrate is 82.2%.

	Document Number	J01834-PM-REP-002	Rev	0	
	Date	11 January 2019	Page	133 of 417	

13.3.6.3 LOCKED CYCLE TEST #3

Locked Cycle Test #3 tested the sequential flowsheet at the conditions established during the previous sequential flotation optimization phase of the program and approximate LOM head grade (

Table 13-15). The flowsheet used for this locked cycle test is presented in Figure 13-11 below.

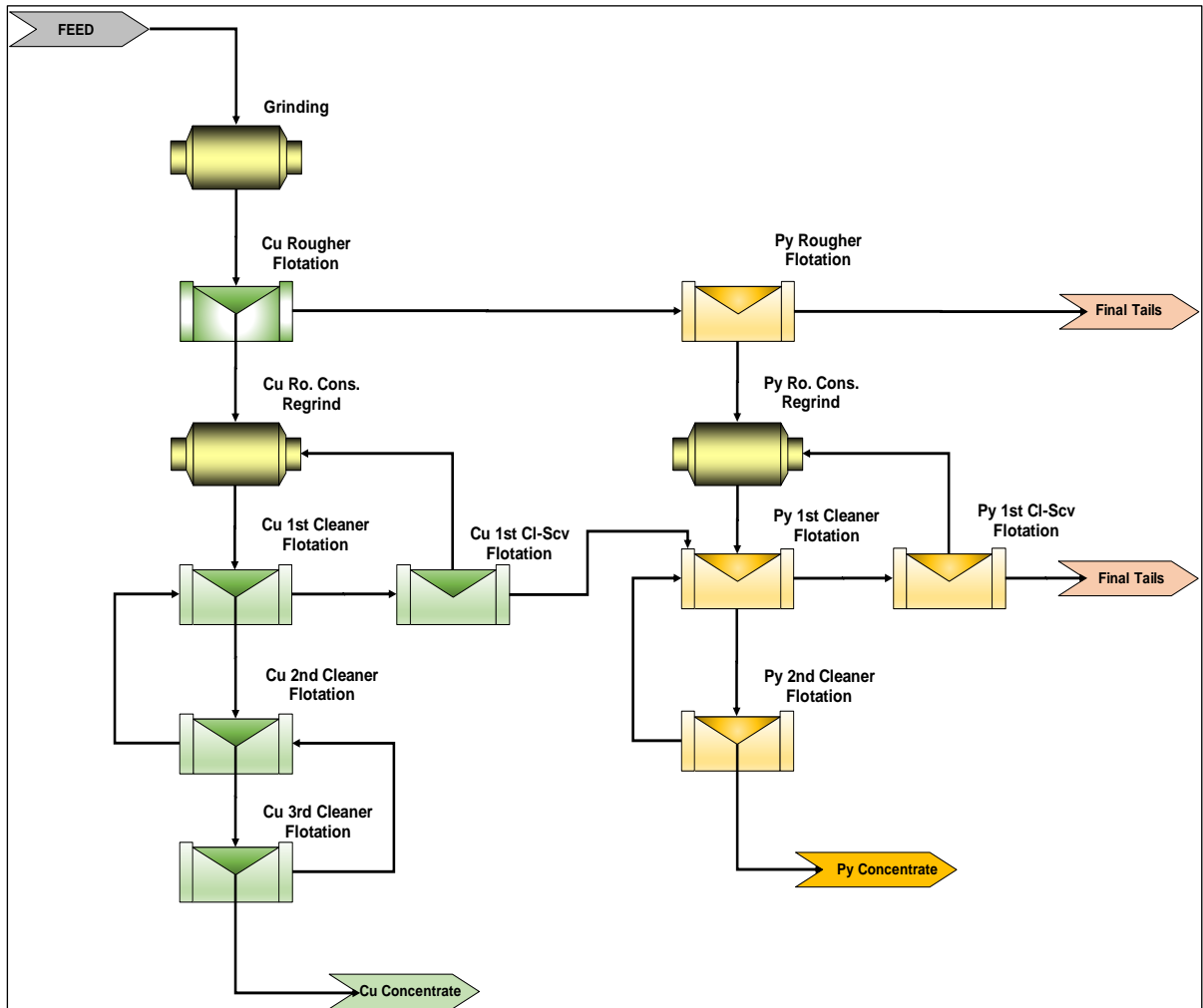

Figure 13-11: LCT #3 Flowsheet

Table 13-15: LCT #3 Sample Head Grade

	Head grades % or ppm							
	Copper	Gold	Arsenic	Iron	Sulphur	Zinc	Lead	Antimony
Composite	0.51	5.96	0.18	7.49	8.61	182	120	117

For this test, four stages of copper rougher collection, with a total of 12 minutes of residence time, followed by six stage of pyrite rougher collection, with a total of twenty minutes of residence time, was used. The target grind sizes, pulp pH and reagent additions and actual test conditions achieved were as follows:

- Primary grind target 80% passing 60 µm;
- Copper regrind target 80% passing 30 µm;
- Pyrite regrind target 80% passing ~30 µm – Actual 29 µm;
- Pyrite rougher tails Actual 80% passing 58 µm; and
- Conditioning time of one minute (not reported in **Table 13-16**)

Table 13-16: LCT #3 Test Conditions

Unit	Reagent Additions g/t					Time mins	pH	eH mV
	Lime	3418A	MIBC	H2SO4	PAX			
Primary Grind	1,250	-	-	-	-	60	8.3	-50
Conditioning	625	-	-	-	-	5	11.0	+25
Cu Rougher	340	15	45	-	-	10	11.0	+25
Regrind	250	2.5	-	-	-	5	11.5	+25
Cu 1st Cleaner	20	-	2	-	-	4.5	11.5	+25
Cu Cl-Scav	-	2.5	2	-	-	2.5	11.4	+50
Cu 2nd Cleaner	60	-	2	-	-	3.0	11.5	+25
Cu 3rd Cleaner	85	-	4	-	-	2.5	11.5	+25
Pyrite Aeration	-	-	-	-	-	5	10.5	+75
Pyrite rougher	-	-	50	500	50	14	8.0	+100
Pyrite regrind	-	-	-	-	-	8	9.0	+100
Pyrite 1st Cleaner	-	-	5	100	25	8	8.0	0
Pyrite Cl-Scav	-	-	5	-	10	3	8.0	+25
Pyrite 2nd Cleaner	-	-	5	-	-	6	8.0	+100
Total	2,630	20	120	600	85	-	-	-

The results of LCT #3 were statistically balanced to obtain stage by stage recoveries and performance. This balance was the basis for process design and flotation circuit sizing. **Table 13-17** to **Table 13-19** present the key performance data obtained for the individual stages of the flotation circuit for LCT #3.

Table 13-17: LCT #3 Stream Balanced Data

Stage	Assays % (Cu, Fe, As, S), g/t (Au, Ag)					
	Copper	Gold	Silver	Arsenic	Sulphur	Iron
Flotation Feed	0.51	5.96	33.5	0.180	8.61	7.50
Copper Rougher	11.5	46.1	493	4.23	20.2	8.29
Copper 1st Cleaner	30.2	96.3	1270	10.9	36.0	14.1
Copper 2nd Cleaner	32.2	101	1348	11.7	36.0	12.9
Copper 3rd Cleaner	33.5	104	1397	12.1	35.9	12.2
Copper CI-Scav	3.10	39.4	239	1.09	41.8	33.4
Pyrite rougher	0.18	16.4	50.1	0.039	34.2	30.4
Pyrite 1st Cleaner	0.28	22.7	61.2	0.089	42.9	36.9
Pyrite 2nd Cleaner	0.30	24.1	66.9	0.092	46.4	39.6
Pyrite CI-Scav	0.13	11.5	17.29	0.059	17.5	14.9
Final Tails	0.02	0.98	5.38	0.005	1.07	1.39

– Source: Promet101 (2018)

Table 13-18: LCT #3 Overall Recoveries Balanced Data

Stage	Recoveries % of Feed						
	Mass	Copper	Gold	Silver	Arsenic	Sulphur	Iron
Copper Rougher	4.01	90.2	31.1	59.0	94.2	9.42	4.44
Copper 1st Cleaner	1.49	88.3	24.1	56.5	90.5	6.24	2.80
Copper 2nd Cleaner	1.40	88.2	23.6	56.1	90.4	5.84	2.41
Copper 3rd Cleaner	1.33	87.4	23.1	55.5	89.7	5.55	2.16
Copper CI-Scav	0.10	0.61	0.66	0.72	0.60	0.49	0.45
Pyrite Rougher	21.5	7.48	59.0	32.1	4.60	85.2	87.1
Pyrite 1st Cleaner	17.7	9.71	67.3	32.3	8.76	88.3	87.1
Pyrite 2nd Cleaner	15.6	9.10	63.2	31.2	8.01	84.2	82.5
Pyrite CI-Scav	0.13	0.03	0.25	0.11	0.04	0.26	0.25

– Source: Promet101 (2018)

Table 13-19: LCT #3 Stage Recoveries Balanced Data

Stage	Stage Recoveries %						
	Mass	Copper	Gold	Silver	Arsenic	Sulphur	Iron
Copper Rougher	4.01	90.2	31.1	59.0	94.2	9.4	4.44
Copper 1st Cleaner	34.9	96.4	73.7	93.1	94.7	58.9	50.6
Copper 2nd Cleaner	90.3	99.0	96.2	98.3	99.1	89.4	79.0
Copper 3rd Cleaner	95.0	99.2	97.8	98.9	99.2	95.0	89.6
Copper CI-Scavenger	3.60	18.3	7.67	17.1	11.7	11.2	16.5
Pyrite Rougher	22.4	75.9	85.5	78.2	78.6	94.1	91.1
Pyrite 1st Cleaner	67.2	89.5	94.5	87.8	88.6	94.4	92.4
Pyrite 2nd Cleaner	88.3	93.7	94.0	96.5	91.4	95.4	94.7
Pyrite CI-Scavenger	1.50	2.63	6.33	2.44	3.54	5.00	3.51

– Source: Promet101 (2018)

The feed composite used for LCT #3 was relatively close in grade to that of the expected feed gold grade of the process facilities for the first five years of operation, but almost double that of the copper grade. A relatively high pulp pH was used to ensure low pyrite recovery in the copper rougher stage, with a relatively low mass recovery being achieved (~4.01%) and good copper (90.2%) and arsenic (94.2%) recoveries. Subsequent copper cleaner stages rejected 66.8% of the mass from the rougher concentrate, but only lost 2.8% of the copper. Gold and sulphur rejected from the copper rougher concentrate being 8.0 and 3.9% respectively. The

copper concentrate grade achieved in the cleaning stages was 33.5% Cu, 12.1% As, 1,397 ppm Ag and 104 g/t Au. Gold recovery to the copper concentrate was 23.1% of total gold.

The pyrite rougher stage recovered 85.5% of the feed gold and 94.1% of the feed sulphur into 21.5% of the total feed. Subsequent cleaning of the pyrite rougher concentrate resulted in a total of 63.2% of feed gold being recovered into the final pyrite concentrate. Note that for this test the copper cleaner tails were sent to the pyrite first cleaner stage, not the pyrite rougher feed.

Overall gold recovery was 86.3% at a feed grade of 5.96 g/t gold, as compared to 88.3% for LCT #1 with a feed grade of 16.7 g/t gold and 86.9% for LCT #2 at a feed grade of 4.95 g/t gold.

The different recoveries of copper and arsenic in the copper cleaner-scavenger stage implies that there is some arsenic present in the form of arsenopyrite which is depressed, or non-arsenic associated copper minerals. Arsenopyrite was noted in some of the QEMSCAN analysis.

13.3.6.4 LOCKED CYCLE TEST #4

The objective of LCT4 was to test a more representative sample of the initial five-year average LOM plan and confirm the influence of collector addition and residence time on the gold recovery within the pyrite circuit.

Feed material for LCT #4 was composited from sub-samples of the “5-year composite” and individual variability samples. The sample head grade of the final composite is presented in **Table 13-20**.

Table 13-20: LCT #4 Sample Head Grade – 5 Year Composite

	Head grades % or ppm							
	Copper	Gold	Arsenic	Iron	Sulphur	Zinc	Lead	Antimony
Composite	0.25	5.10	0.092	5.94	6.47	177	198	101

This test utilized four stages of copper rougher collection with a total of 12 minutes of residence time, followed by six stages of pyrite rougher collection, with a total of twenty minutes of residence time.

The target grind sizes, pulp pH and reagent additions and actual test conditions achieved were as follows:

- Primary grind target 80% passing 60 µm – Actual 67 µm;
- Copper regrind target 80% passing 30 µm – Actual 17 µm;
- Pyrite regrind target 80% passing 30 µm – Actual 31 µm;
- Pyrite rougher tails Actual 80% passing 55 µm;
- One minute of conditioning time (excluded from **Table 13-21**); and
- Moderate copper rougher pulp pH was targeted to limit lime consumption and acid use in pyrite rougher feed.

The flowsheet used for this locked cycle test is presented in **Figure 13-12** below.

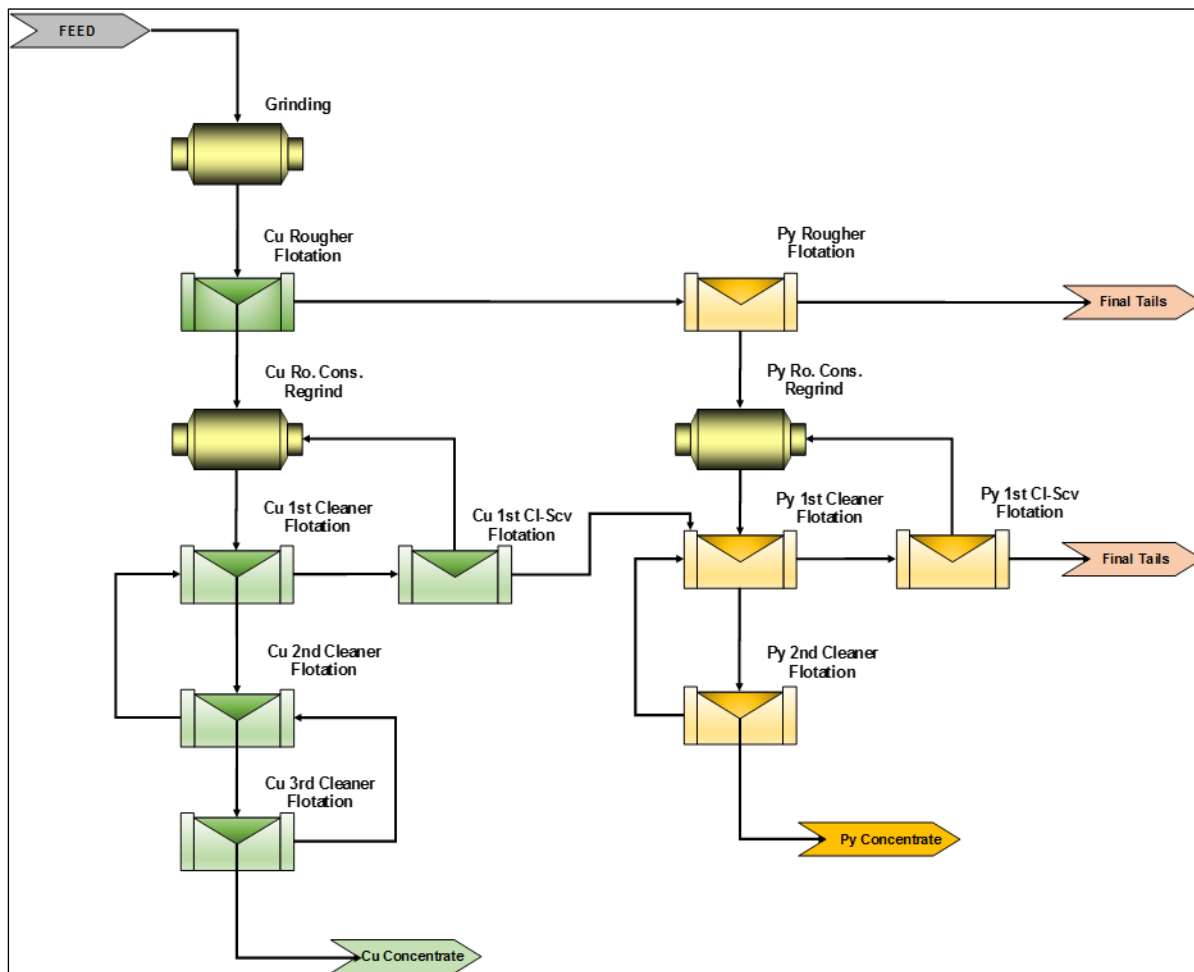

Figure 13-12: LCT #4 Flowsheet

Table 13-21: LCT #4 Test Conditions

Unit	Reagent additions g/t					Time mins	pH	eH mV
	Lime	3418A	MIBC	H2SO4	PAX			
Primary Grind	1250	-	-	-	-	60	8.4	+25
Conditioning	870	-	-	-	-	5.0	11.0	0
Cu Rougher	250	20	45	-	-	12	11.0	+25
Regrind	250	2.5	-	-	-	3.0	11.3	+50
Cu 1st Cleaner	110	-	10	-	-	4.5	11.5	+25
Cu Cl-Scavenger	-	2.5	10	-	-	2.5	11.4	+25
Cu 2nd Cleaner	85	-	10	-	-	3.0	11.5	+25
Cu 3rd Cleaner	115	-	10	-	-	2.5	11.5	+25
Pyrite Aeration	-	-	-	-	-	5	-	+50
Pyrite rougher	-	-	60	835	80	20	7.0	+100
Pyrite regrind	-	-	-	-	-	9.0	8.7	+100
Pyrite 1st Cleaner	-	-	5	185	25	8	7.0	+50
Pyrite Cl-Scavenger	-	-	5	35	15	3	7.0	0
Pyrite 2nd Cleaner	-	-	5	45	-	6	7.0	+125
Total	2,930	25	160	1,100	120	-	-	-

The results of LCT #4 were balanced to obtain stage by stage recoveries and performance. This balance (in conjunction with the results of LCT #3) was the basis for the project process design and flotation circuit sizing stage recoveries. **Table 13-22** to **Table 13-24** present the key performance data obtained for the individual stages of the flotation circuit for LCT #4.

Table 13-22: LCT #4 Stream Assays – Balanced Data

Stage	Assays % (Cu, Fe, As, S), g/t (Au, Ag)					
	Copper	Gold	Arsenic	Silver	Sulphur	Iron
Flotation Feed	0.25	5.15	0.093	24.1	6.38	5.98
Copper Rougher	5.59	23.1	2.07	304	18.6	18.9
Copper 1st Cleaner	15.1	43.7	5.55	932	27.8	16.9
Copper 2nd Cleaner	22.4	54.1	8.12	1,340	31.1	15.3
Copper 3rd Cleaner	27.4	61.7	10.1	1,615	32.6	13.6
Copper Cl-Scav	1.67	24.8	0.59	226	24.0	20.9
Pyrite Rougher	0.094	19.9	0.028	55.6	27.5	23.9
Pyrite 1st Cleaner	0.27	27.6	0.092	76.7	37.7	33.4
Pyrite 2nd Cleaner	0.29	29.6	0.098	82.4	40.5	35.8
Pyrite Cl-Scav	0.090	6.04	0.044	0.98	6.51	7.15
Final Tails	0.013	0.73	0.006	1.24	0.67	1.12

– Source: Promet101 (2018)

Table 13-23: LCT #4 Overall Recoveries – Balanced Data

Stage	Recoveries % of Feed						
	Mass	Copper	Gold	Silver	Arsenic	Sulphur	Iron
Copper Rougher	4.08	89.8	18.3	50.8	90.8	11.9	12.8
Copper 1st Cleaner	1.40	83.2	11.9	53.8	83.5	6.09	3.96
Copper 2nd Cleaner	0.93	82.0	9.77	51.6	81.2	4.53	2.38
Copper 3rd Cleaner	0.74	79.8	8.85	49.4	80.2	3.77	1.68
Copper Cl-Scav	0.45	2.96	2.16	4.3	2.86	1.69	1.57
Pyrite rougher	19.4	7.1	74.8	45.2	5.9	83.4	77.6
Pyrite 1st Cleaner	15.0	15.9	80.3	46.9	14.8	88.4	83.6
Pyrite 2nd Cleaner	13.8	15.7	79.1	46.2	14.4	87.2	82.3
Pyrite Cl-Scav	1.66	0.59	1.94	1.23	0.78	1.69	1.98

– Source: Promet101 (2018)

Table 13-24: LCT #4 Stage Recoveries – Balanced Data

Stage	Stage Recoveries %						
	Mass	Copper	Gold	Silver	Arsenic	Sulphur	Iron
Copper Rougher	4.08	89.8	18.3	50.8	90.8	11.9	12.8
Copper 1st Cleaner	27.0	86.5	50.6	90.4	86.1	38.4	23.7
Copper 2nd Cleaner	58.5	96.1	76.4	92.2	96.0	66.1	51.1
Copper 3rd Cleaner	79.6	97.3	90.6	95.8	98.7	83.2	70.6
Copper Cl-Scavenger	11.9	22.9	18.7	75.6	21.2	17.3	12.3
Pyrite rougher	20.2	70.1	91.4	91.8	64.2	94.6	89.0
Pyrite 1st Cleaner	58.6	88.7	91.9	96.7	83.8	93.7	90.8
Pyrite 2nd Cleaner	91.8	98.5	98.5	98.5	97.4	98.6	98.4
Pyrite Cl-Scavenger	15.7	29.1	27.6	76.4	27.2	28.5	23.5

– Source: Promet101 (2018)

For this LCT, the copper rougher stage recovered 89.8% of the feed copper. For the LCT, the copper rougher stage recovered 89.8% of the feed copper. Subsequent cleaning of the rougher concentrate produced a cleaner concentrate, grading 27.4% Cu and 1,615 ppm Silver. This corresponds to an overall of recovery 79.8% copper. Final mass recovery to copper concentrate was low at only 0.74% of feed. Overall mass rejection in the copper cleaner circuit was 81.8%.

The extended pyrite residence time and increased collector dosage resulted in excellent sulphur (i.e. pyrite) and hence gold recovery to the pyrite rougher concentrate. Gold recovery was 91.5%, copper recovery 88.7% and sulphur recovery 94.6% of feed to that stage. Note that the copper cleaner tails stream with its associated gold was fed directly to the pyrite cleaner circuit.

The final gold recovery to the pyrite concentrate being 79.1%. Overall gold recovery achieved to the two concentrates was 88.0%.

13.3.7 STAGED FLOTATION REACTOR

The potential application of Woodgrove Technologies' Staged Flotation Reactor (SFR) was investigated as part of the 2017 metallurgical testwork program. Seven pilot plant scale SFR rougher tests were conducted at SGS Lakefield. Composite and variability assay reject material was used for all SFR testwork. The response to bench flotation of each pilot SFR

test feed sample (after reagent addition) was determined by SGS, for comparison purposes. **Table 13-25** summarizes the results obtained from the best performing metallurgical sample (PP-01).

Table 13-25: SFR (PP-01) vs. Average Bench Flotation Performance

Element	SFR Pilot Plant		Bench Flotation (20 minutes)	
	Grade (g/t)	Recovery	Grade (g/t)	Recovery
Au	18.9	88.5	20	91
Cu	0.89	93.3	0.84	94
Ag	106	88.0	105	92

Several findings were made during the SFR pilot plant preliminary program:

- The use of MIBC in conditioning and in the initial stages of the SFR tests increased metallurgical performance. MIBC performance increased when used in conjunction with X-133 frother;
- When directly compared to one another, X-133 frother outperformed W31 frother;
- Adding collector to the grind did not appear to positively affect overall metallurgical performance;
- PAX addition was effective when added in doses 10 g/t and larger, though adding significant amounts (30 g/t) did not result in improved metallurgical performance; and
- Little additional recovery occurs in the final eight minutes of bench flotation (from minutes 12 to 20). Although the SFR performance is not optimized, it is anticipated that the equivalent SFR performance for 12 minutes of bench-scale lab flotation time would be eight stages of rougher SFRs.

13.4 SUPPLEMENTAL TESTWORK



Supplementary testwork was undertaken on tailings material produced from the Stage Flotation Reactor testwork only. No supplementary testwork was undertaken on either the pyrite or copper concentrates produced.

13.4.1 SETTLING

Flocculant BASF MF5250 was found to have the fastest free settling rate of the flocculant samples tested with an estimated underflow solids concentration of 64.7% w/w.

The optimum feed solids concentration was measured to be 10% w/w using MF5250. Dynamic thickening testwork was completed with a targeted feed concentration of 10% w/w. Testwork investigated a range of flocculant dosages between 21 and 56 g/t and a range of solids loading rates between 0.4 and 0.8 t/h/m².

Thickener underflow solids concentrations of 67.3% w/w, and a thickener overflow solids concentration of 19 ppm were achieved at a solid loading rate of 0.6 t/h/m² and a flocculant dosage of 29 g/t.

	Document Number	J01834-PM-REP-002	Rev	0	
	Date	11 January 2019	Page	142 of 417	

13.4.2 FILTRATION

13.4.2.1 VACUUM FILTRATION

The rougher tailings were tested at a vacuum level of 377 mm (15") Hg, adjusted for a vacuum pump efficiency of 85% (with one cycle time tested at 127 mm (5") Hg to simulate blinding) at 50%, 60%, and 65% mass concentration. The cake thickness ranged from 2.8 to 18.1 mm and cake moisture ranged from 19.1 to 22.4 % w/w.

13.4.2.2 PRESSURE FILTRATION

P&C undertook pressure filtration testwork. The testwork determined that cake moisture levels as low as 15.5% can be achieved using pressure filtration. Filtration rates were found to increase significantly with increasing chamber depths, reaching 324 (kg/h)/m² for a 60 mm chamber with 30 seconds of air drying.

The conclusion from the testwork was that the tailings material is amenable to pressure filtration.

13.4.3 RHEOLOGY

The uncemented tailings yield stress was determined over a mass concentration range from 75.4% w/w to 78.8% w/w. At 77.6% w/w, the calculated yield stress is 200 Pa.

The cemented tailings yield stress was determined over a mass concentration range from 74.5% w/w to 78.5% w/w. At 76.7% w/w (weight per weight) and 4% Guapan Type IP, the calculated yield stress is 200 Pa.

13.5 RECOVERY ESTIMATES

Recovery estimates were derived from the sequential flotation locked cycle test completed during the 2014 metallurgical program and LCT #3 and #4, completed during the 2017 metallurgical program.

Using the results, recovery relationships for gold and copper concentrates were developed.

13.5.1 COPPER RECOVERY

Figure 13-13 illustrates the copper recovery and concentrate grade figures obtained during the locked cycle testwork.

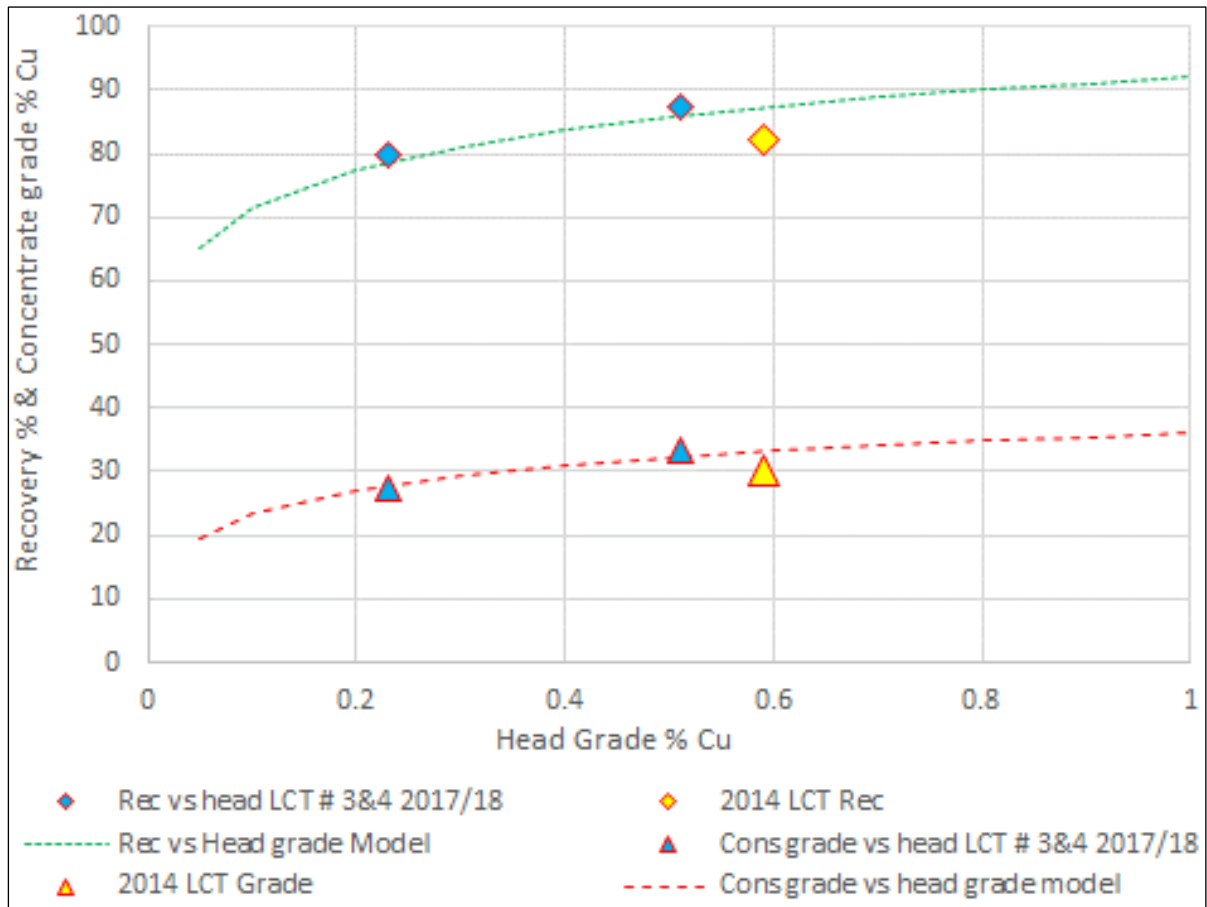

Figure 13-13: Metallurgical Data and Model for Copper Recovery and Concentrate Grade

A copper concentrate recovery and concentrate grade model can be constructed from fitting the data presented in Figure 13-13. The model is considered accurate for all copper head grades (H_{Cu}) greater than 0.1% and less than 1.0%. Below lower limit, all copper is assumed to report to the pyrite concentrate. Above a head grade of 1.0%, recovery is capped at 92% and concentrate grade at 36%.

$$Recovery_{Cu} = 9.0 \ln H_{Cu} + 92$$

$$Concentrate_{Cu} = 5.5 \ln H_{Cu} + 36$$

13.5.2 GOLD RECOVERY TO COPPER CONCENTRATE

Development of a gold recovery model to the copper concentrate is not as robust as that of the copper model due to the significant variability in the association of gold with copper or iron sulphide minerals. **Figure 13-14** presents the gold department in the 2018 rougher variability testing using the sequential flowsheet and the rougher and final cleaner stage recoveries for the 2014 and 2018 LCTs.

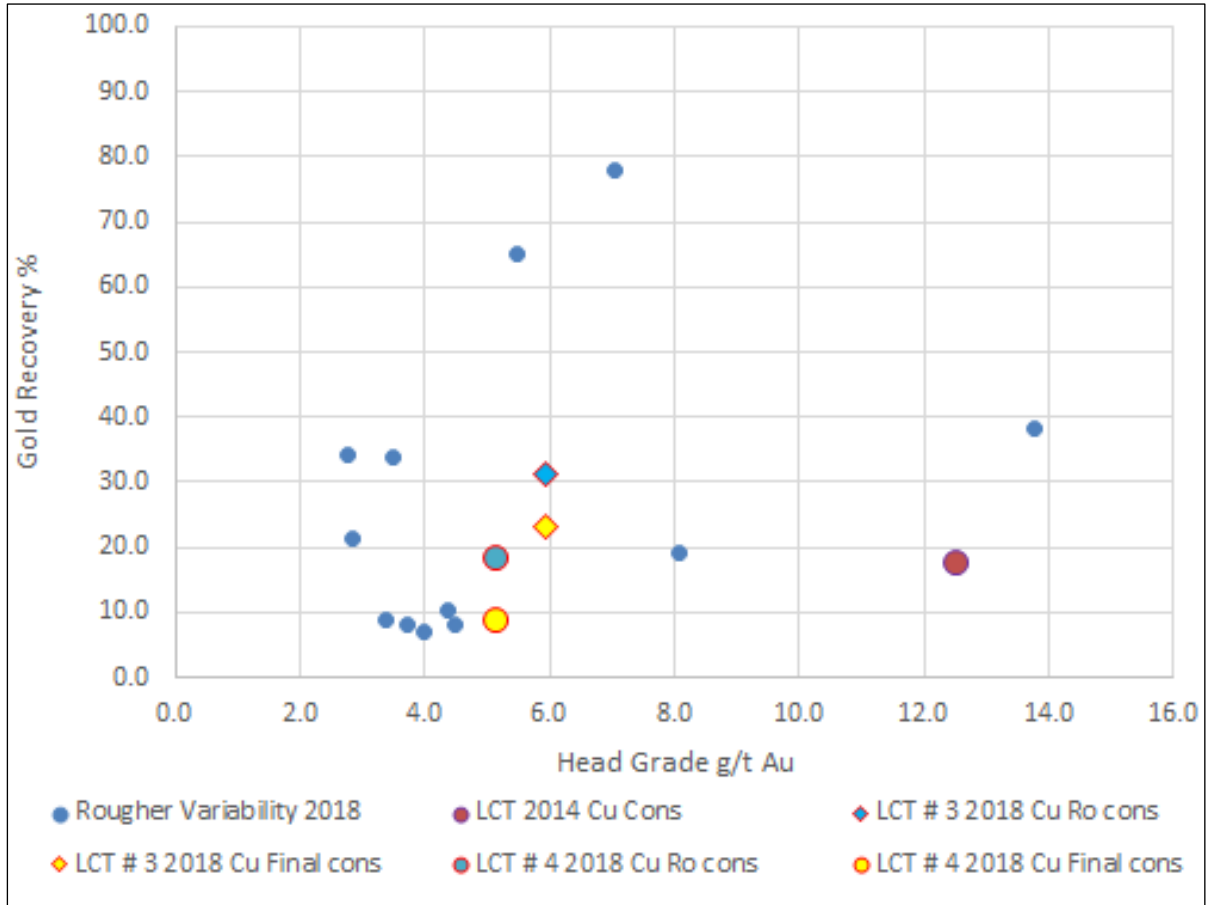

Figure 13-14: Gold Department to Copper Concentrates

Figure 13-14 clearly shows that rougher and clear recoveries are highly variable. For the 2014 LCT the recovery at a high feed grade (12.5 Au g/t) was 17.5%

As a result of the observed variability, a fixed gold recovery to the copper final concentrate of 15% was assumed. This is considered the average of the locked cycle tests 3 and 4 from 2017 program and the median of the variability samples from the 2014 testwork program.

13.6 METALLURGICAL VARIABILITY

The metallurgical testwork completed to date is based on samples which adequately represent the variability of the Loma Larga deposit and associated mine plan.

Mineralogical analysis of the various composites and variability samples has shown the Loma Larga deposit to be homogenous.

13.7 DELETERIOUS ELEMENTS

Both copper and pyrite concentrates will be subject to penalty conditions, should significant grades of zinc, lead, mercury, antimony, bismuth and arsenic be present in the concentrate.

In-situ assays of these elements within the block model are highly variable and recoveries are difficult to predict based on the limited testwork focusing on these elements.

Table 13-26 and **Table 13-27** presents the recoveries of the main deleterious elements into the copper and pyrite concentrates, respectively. The results are based on the two LCT's completed in 2017 metallurgical testwork program.

Table 13-26: Deleterious Elements Recovery to Copper Concentrate

Element	2018 LCT # 3			2028 LCT # 4			Recommended Recovery for NSR
	Assay ppm/recoveries %			Assays ppm/Recoveries %			
	Head	Cons	Rec	Head	Cons	Rec	
Zinc	151	3,100	28.4	177	8,815	38.5	35.0
Lead	103	760	9.97	198	3,380	0.29	5.0
Antimony	113	7,110	86.0	101	7,516	32.7	50.0
Mercury	3.49	85.5	33.6	-	79	-	30.0

Table 13-27: Deleterious Elements Recovery to Pyrite Concentrate

Element	2018 LCT # 3			2028 LCT # 4			Recommended recovery for NSR
	Assay ppm/recoveries %			Assays ppm/Recoveries %			
	Head	Cons	Rec	Head	Cons	Rec	
Zinc	151	582	65.1	177	509	40.6	55.0
Lead	103	484	80.4	198	727	50.5	65.0
Antimony	113	70	9.72	101	<60	34.9	25.0
Mercury	3.49	12.1	57.0	-	15.9	-	50.0

The final assay value of bismuth in both the copper and pyrite concentrates indicated levels less than 300 and 100 ppm, respectively.

14 MINERAL RESOURCE ESTIMATE

14.1 SUMMARY

RPA estimated Mineral Resources for the Loma Larga Project using all drillhole data available as of October 31, 2018. This Mineral Resource estimate was previously updated June 30, 2016 and reported in the 2016 Technical Report (RPA, 2016). The current Mineral Resource estimate is based on an underground mining scenario and is reported inclusive of Mineral Reserves. Using a US\$60/t Net Smelter Return (NSR) cut-off value, Mineral Resources as of October 31, 2018 are summarized in **Table 14-1**.

Table 14-1: Mineral Resource Estimate Summary – October 31, 2018

Resource Classification	Tonnage (Mt)	Au (g/t)	Contained Au (M oz)	Ag (g/t)	Contained Ag (M oz)	Cu (%)	Contained Cu (M lb)	Grade (g/t AuEq)	Contained Gold Equivalent (M oz AuEq)
Measured	2.9	7.31	0.67	34.9	3.2	0.44	28.2	8.45	0.78
Indicated	17.0	3.74	2.04	26.5	14.5	0.22	81.4	4.43	2.42
Measured + Indicated	19.8	4.25	2.71	27.8	17.7	0.25	109.5	5.01	3.20
Inferred	4.7	2.22	0.33	29.7	4.5	0.14	14.5	2.84	0.43

– Notes:

- CIM (2014) definitions were followed for Mineral Resources.
- Mineral Resources are reported at an NSR cut-off value of US\$60/t.
- Mineral Resources are estimated using a long-term gold price of US\$1,450 per ounce, silver price of US\$22.00 per ounce, and copper price of US\$3.50 per pound.
- The formula used to calculate gold equivalence (AuEq) is: $(Au\ g/t \times 31.31 + Ag\ g/t \times 0.44 + Cu\% \times 46.19) \div 31.31$. The formula used for calculated AuEq ounces is: $AuEq\ Oz = (Tonnage \times AuEq\ g/t) \div 31.1035$
- Mineral Resources are inclusive of Mineral Reserves.
- Mineral Resources that are not Mineral Reserves do not have demonstrated economic viability.
- Average bulk density is 2.7 t/m³.
- Numbers may not add due to rounding.

RPA was provided with a drillhole database consisting of 365 holes, totalling 81,183 m, with 249 of the holes (58,990 m) located within the mineralization domains. INV completed two drilling programs on the Project since the 2016 Technical Report and the current Mineral Resource update incorporates the new drilling results.

Three-dimensional (3D) grade shell wireframes were constructed at 2.0 g/t Au (High Grade Zone) and 0.8 g/t Au (Low Grade Zone). RPA used cross sections, long sections, and plan views to interpret and validate the wireframes.

The Loma Larga High Grade Zone comprises two mineralized zones: High Grade Main Zone and High Grade Upper Zone. The Low Grade Zone comprises two domains: Low Grade Main Zone wireframe domain that encompasses the High Grade Main Zone, and Low Grade Lower Zone, which lies below the Low Grade Main Zone.

Variography was performed on the 2.0 m Au, Ag, Cu, S, and density composites from the High Grade Main Zone and Low Grade Main Zone. Block grade interpolation was carried out using Ordinary Kriging (OK) and the gold grade shell wireframe models were used to constrain the grade interpolations. A soft boundary was used between the Low and High Grade Main Zones for density block interpolation.

The polymetallic sulphide mineralization at the Loma Larga deposit contains significant values of Au, Ag, and Cu. Therefore, original assays were converted into NSR values (\$ per tonne).

The NSR values account for parameters such as metal price, metallurgical recoveries, smelter terms and refining charges, and transportation costs. For the purposes of developing an NSR cut-off value for an underground operation, a total operating cost of US\$60/t milled was assumed, which includes mining, processing, and general and administrative (G&A) expenses.

RPA is not aware of any environmental, permitting, legal, title, taxation, socio-economic, marketing, political, or other relevant factors that could materially affect the Mineral Resource estimate.

14.2 MINERAL RESOURCE DATABASE

RPA received new drillhole data in CSV format. Data were amalgamated and parsed as required and imported into GEMS for modelling. **Table 14-2** summarizes records directly related to the resource estimate.

Table 14-2: Mineral Resource Database

Attribute	Number
Holes	249 (199 with sulphur assays)
Surveys	806
Assays (payable metals)	23,857 (10,816 within mineralization domains)
Assays (sulphur)	13,688 (6,890 within mineralization domains)
Assay Composites (>0.5 m in length)	6,236
Sulphur Composites (>0.5 m in length)	3,993
Full zone width composites	692
Density measurements	10,153 (7,767 within mineralization domains)
Density Composites (>0.5 m in length)	4,988

Section 12, Data Verification, describes the verification steps undertaken by RPA. In summary, all minor discrepancies identified were resolved and RPA is of the opinion that the GEMS drillhole database is valid and suitable to estimate Mineral Resources for the Project.

14.3 GEOLOGICAL INTERPRETATION AND 3D SOLID

The wireframe model of the mineralized domains was used to constrain block model interpretation.

Prior to creating the mineralized wireframe domains for the Loma Larga Project, RPA validated the drillhole database by completing the following:

- Checking for location and elevation discrepancies by comparing collar coordinates with historical data,
- Checking for inconsistencies in drillhole dip directions, and
- Checking gaps, overlaps, and out-of-sequence intervals for both assay and lithology tables.

For the High Grade Zone, RPA reinterpreted the mineralized wireframe domains, restricting the modelling cut-off grade to 2.0 g/t Au. The High Grade Zone 3.0 g/t Au wireframe model from the previous resource estimate was used to assist in domaining the mineralization. The modelling cut-off grade was reduced to align with the mine design and planning process.

For the Low Grade Zone, RPA updated the wireframe domains at a modelling cut-off grade of 0.8 g/t Au with new drilling. The Low Grade Lower Zone was combined into a single domain.

The Loma Larga High Grade Zone comprises two mineralized domains: Main and Upper (**Figure 14-1**, **Figure 14-2** and **Figure 14-3**). The Loma Larga Low Grade Zone also comprises two mineralized domains: Main and Lower (**Figure 14-1**, **Figure 14-2** and **Figure 14-3**). Mineralization in the High Grade Zone and Low Grade Zone has been categorized into rock codes according to **Table 14-3**.

Table 14-3: Rock Codes

Mineralization	GEMS Solid Name	Rock Code	Volume (m ³)
High Grade Main Zone	130/final/2018	130	4,854,433
High Grade Upper Zone	131/final/2018	131	64,605
Low Grade Main Zone ¹	108/final/2018	108	13,420,552
Low Grade Lower Zone	208/final/2018	208	922,193

– Note: ¹inclusive of the High Grade Main Zone

A description of each modelled zone follows.

14.3.1 HIGH GRADE ZONE



- The High Grade Main Zone is a north-northwest trending, flattened, cigar-shaped zone. It is approximately 1,150 m in length and 120 m to 290 m in width, averages 40 m to 50 m in thickness, and lies about 120 m to 125 m below the surface. The Main Zone is intersected by 199 drillholes, i.e., 16 more than in the 2016 model (RPA, 2016).
- The High Grade Upper Zone is a north-northeast trending, tabular body approximately 125 m in length by 55 m in width, averaging 10 m in thickness. It lies 55 m to 60 m below the surface and approximately 60 m above the Main Zone. The zone plunges steeply to the south (approximately 60°) and the width of mineralization increases from approximately 5 m to 20 m. The Upper Zone is intersected by six drillholes.

14.3.2 LOW GRADE ZONE

- The Low Grade Main Zone is a north-trending elongated zone that encompasses the High Grade Main Zone and is nearly 1,600 m in length and ranges from 100 m to 400 m in width. It averages approximately 50 m to 60 m thick and lies approximately 110 m to 120 m below the surface. It is intersected by 247 drillholes and dips at approximately two degrees to the south.
- The Low Grade Lower Zone is a northeast trending, generally flat-lying, tabular body approximately 200 m in length by 120 m to 340 m in width, averaging 10 m to 20 m in thickness. It lies 10 m to 20 m below the Low Grade Main Zone and is intersected by 37 drillholes.

14.3.3 HIGH GRADE ZONE INTERPRETATION

Mineralization for the High Grade Zone Main Zone was interpreted RPA using GEOVIA GEMS 6.8.2 (GEMS). Sectional interpretations were performed on screen via strings snapped to drillhole intersections on northwest-southeast vertical cross sections spaced 12.5 m apart and plans spaced at a minimum of 25 m. Above the High Grade Main Zone, where

	Document Number	J01834-PM-REP-002	Rev	0	
	Date	11 January 2019	Page	149 of 417	

spatial continuity was evident base on drillhole spacing, the high-grade assays were incorporated into the High Grade Upper Zone.

Strings were joined together using tie lines to honour the drillhole assay data between sections and triangulated to build 3D wireframe solids. At model extremities, strings were extrapolated along dip approximately 10-15 m or less, unless lithological interpretation suggested extending mineralization further. The zones of interpreted mineralization were generally contiguous; however, the wireframes were extended through drillholes with low grade or narrow intersections to preserve continuity.

The re-interpretation at a 2.0 g/t Au cut-off grade resulted in a volume increase of approximately 28% (High Grade Main Zone only), when compared to the High Grade Zone, also modelled at a 3.0 g/t Au cut-off, from the 2016 resource estimate (4.85 Mm³ versus 3.78 Mm³).

14.3.4 LOW GRADE ZONE INTERPRETATION

Mineralization for the Low Grade Zone was interpreted using northwest-southeast sections spaced at 25 m and plans spaced at a minimum of 25 m. Based on the visual continuity of assay results and using the 2016 Low Grade Zone wireframe model as a guide, sections and plans were used to make an on-screen interpretation of grade shells at a cut-off of 0.8 g/t Au. Sectional interpretations were performed on screen via strings snapped to drillhole intersections on the northwest-southeast oriented cross. Polylines were joined together in 3D using tie lines. At the model extremities and along section lines, polylines were extrapolated less than 25 m beyond the last drillhole section. Solids were further reviewed in longitudinal sections in order to confirm continuity. RPA made minor modifications to the interpretation along the margins of the Low Grade Main Zone and combined the two domains that comprised the Low Grade Lower Zone in the previous resource estimate into a single wireframe.

The incorporation of new drilling and the minor modifications to interpretation of the Low Grade Zone wireframes has resulted in the following changes when compared to the 2016 Mineral Resource estimate:

- A volume increase of less than 1.2% in the Low Grade Main Zone inclusive of the nested High Grade Main Zone (13.4 Mm³ vs. 13.3 Mm³).
- An increase of 4.8% in the Low Grade Lower Zone (0.92 Mm³ vs. 0.88 Mm³), when compared to the Low Grade Zone, also modelled at a 0.8 g/t Au cut-off grade.
- Exclusive of the High Grade Main Zone, the volume of the Low Grade Main Zone has decreased 11% (8.6 Mm³ vs. 9.5 Mm³).

Figure 14-1 illustrates the revisions to the Low Grade Zone wireframes in plan view.

All Mineral Resources estimated on the Loma Larga Project are located within the mineralized zone wireframes.

RPA notes that there are additional drillhole intercepts outside the mineralized wireframe domains that are greater than 2.0 g/t Au and represent exploration potential. In RPA's opinion, the isolated location and narrow thickness of these intercepts together with the wide drillhole spacing, or substantial intervening material that is below the cut-off grade, precludes the inclusion of the intercepts as Mineral Resources at this time.

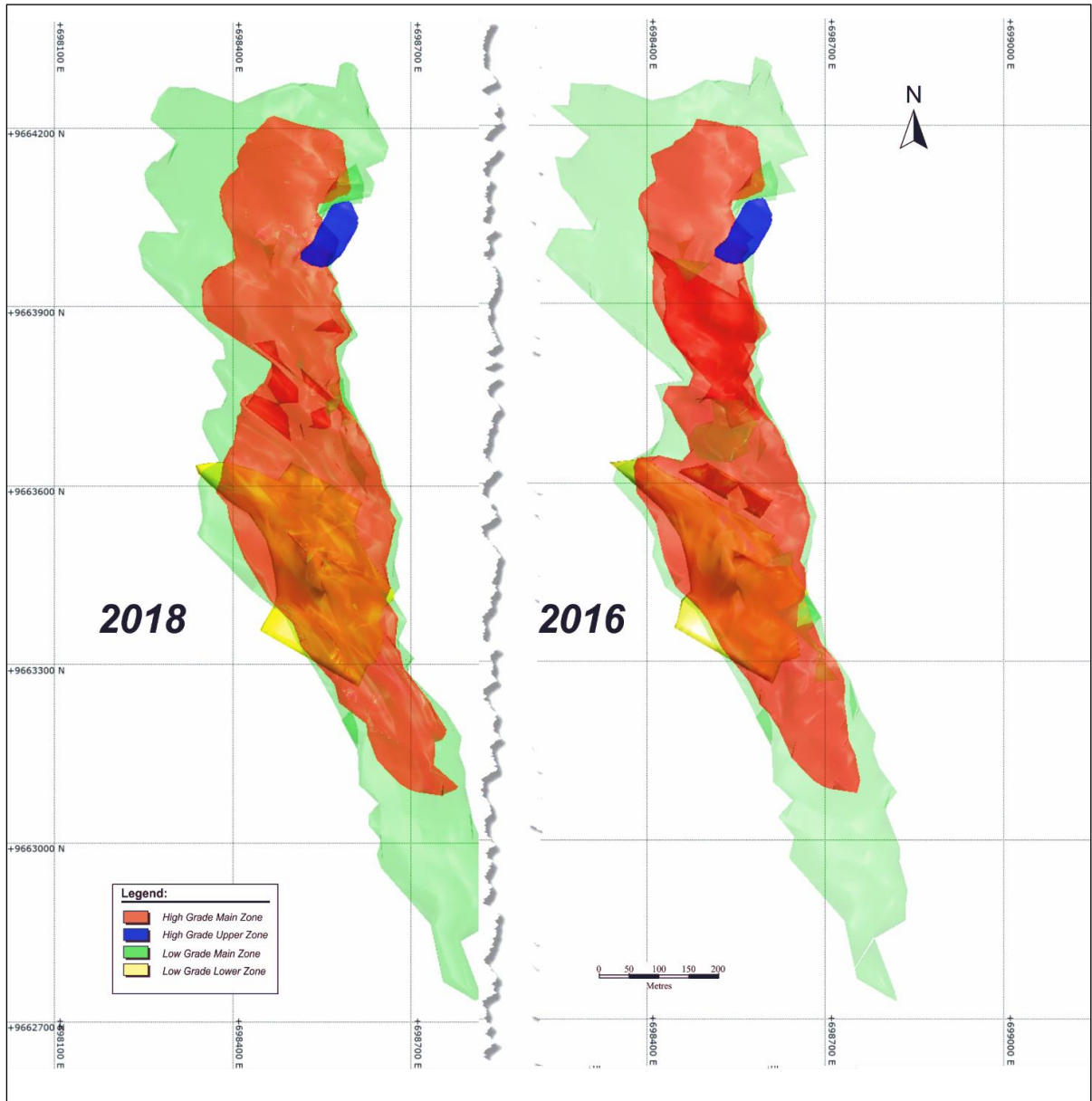

Figure 14-1: 2018 versus 2016 Wireframe Domains in Plan View (3,600 m Level)

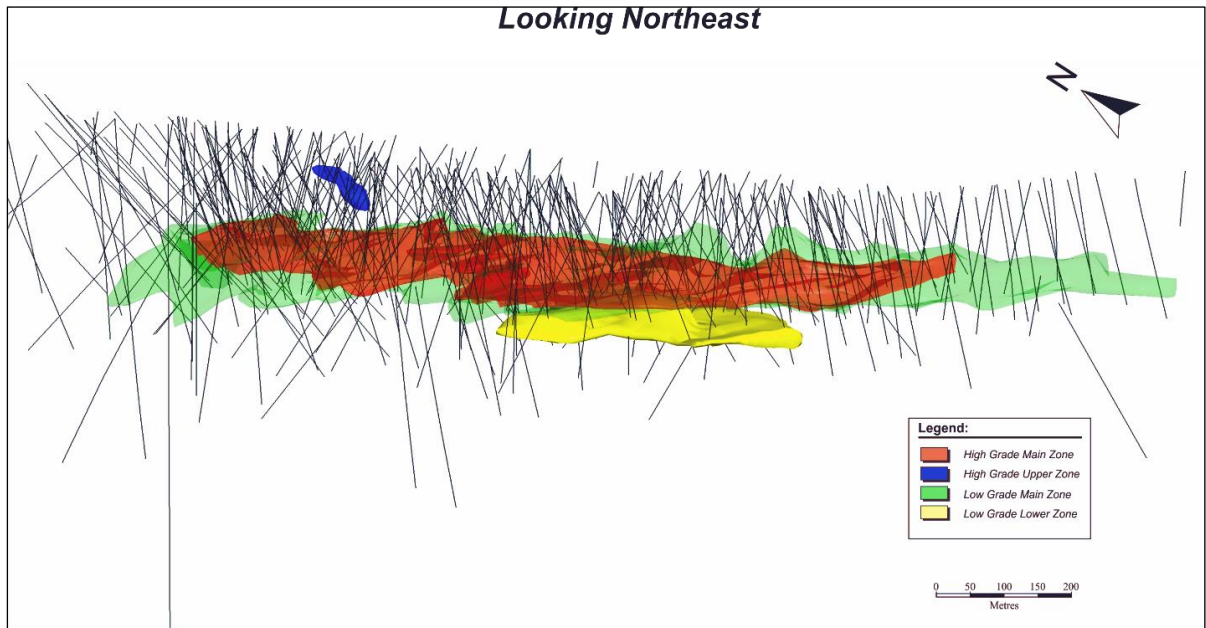

Figure 14-2: 3D View of 2018 High Grade (2.0 g/t Au) and Low Grade (0.8 g/t Au) Wireframe Domains, Looking Northeast.

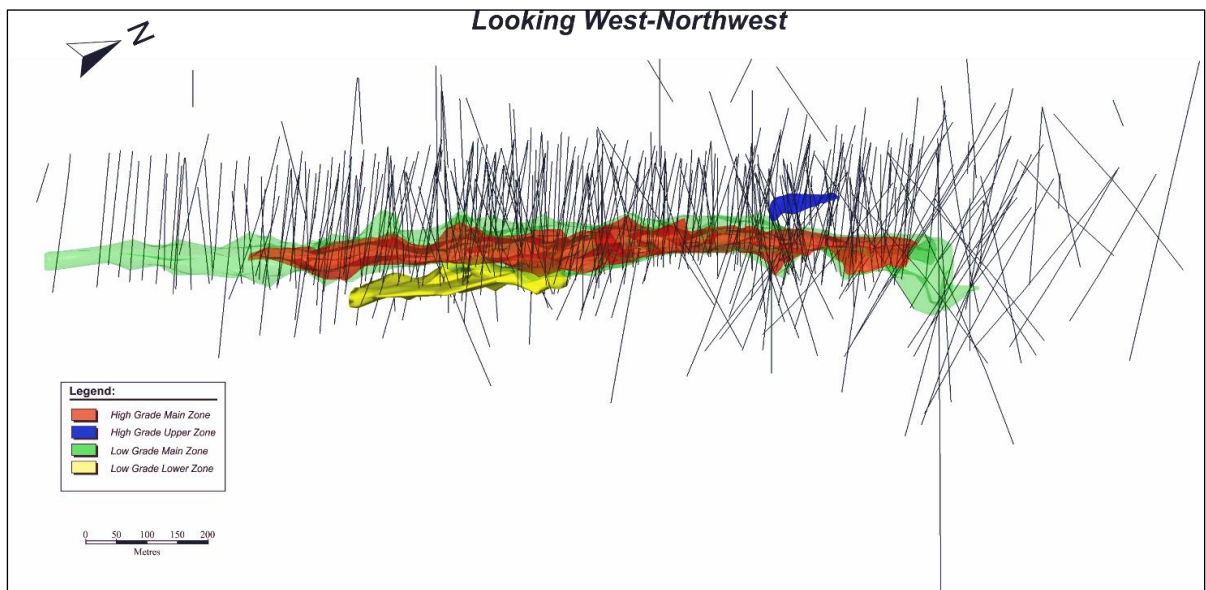

Figure 14-3: 3D View of 2018 High Grade (2.0 g/t Au) and Low Grade (0.8 g/t Au) Wireframe Domains, Looking West.

14.4 STATISTICAL ANALYSIS

Assay values located inside the wireframes, or resource assays, were tagged with mineralized zone domain identifiers (rock codes) and exported for statistical analysis. RPA compiled and reviewed the basic statistics for Au, Ag, and Cu assays, which are summarized in **Table 14-4**.

Table 14-4: Descriptive Statistics of Resource Assay Values

	Length (m)	Au (g/t)	Ag (g/t)	Cu (ppm)
High Grade Main Zone				
No. of Cases	5,255	5,255	5,255	5,255
Minimum	0.07	0.00	0.50	1
Maximum	4.43	768.67	2,295.6	204,000
Median	1.00	3.46	16.60	1,169
Length Weighted Mean	-	6.40	33.21	3,762
Standard Deviation	0.33	18.24	65.78	10,242
Coefficient of Variation	0.31	2.85	1.98	2.72
High Grade Upper Zone				
No. of Cases	67	67	67	67
Minimum	0.52	0.21	0.10	53
Maximum	2.00	105.50	250.1	67,000
Median	1.10	3.28	13.49	2,604
Length Weighted Mean	-	9.51	26.13	6,078
Standard Deviation	0.45	18.15	38.93	9,966
Coefficient of Variation	0.37	1.91	1.49	1.64
High Grade Zone Total				
No. of Cases	5,322	5,322	5,322	5,322
Minimum	0.07	0.00	0.10	1
Maximum	4.43	768.67	2,295.6	204,000
Median	1.00	3.46	16.50	1,180
Length Weighted Mean	-	6.45	33.10	3,796
Standard Deviation	0.33	18.24	65.47	10,240
Coefficient of Variation	0.31	2.83	1.98	2.70
Low Grade Main Zone¹				
No. of Cases	4,839	4,839	4,839	4,839
Minimum	0.18	0.01	0.00	1
Maximum	5.00	101.80	1,743.0	216,000
Median	1.00	1.25	6.70	338
Length Weighted Mean	-	1.67	16.16	920
Standard Deviation	0.39	2.88	49.11	3,505
Coefficient of Variation	0.33	1.72	3.04	3.81
Low Grade Lower Zone¹				
No. of Cases	655	655	655	655
Minimum	0.24	0.02	0.20	8
Maximum	3.00	59.33	721.0	126,800
Median	1.00	1.62	10.20	990
Length Weighted Mean	-	2.19	15.89	1,969
Standard Deviation	0.32	2.88	37.44	6,977
Coefficient of Variation	0.30	1.31	2.36	3.54
Low Grade Zone Total¹				
No. of Cases	5,494	5,494	5,494	5,494
Minimum	0.18	0.01	0.00	1

	Length (m)	Au (g/t)	Ag (g/t)	Cu (ppm)
Maximum	5.00	101.80	1,743.0	216,000
Median	1.00	1.28	7.20	383
Length Weighted Mean	-	1.73	16.13	1,036
Standard Deviation	0.38	2.88	47.96	4,052
Coefficient of Variation	0.33	1.67	2.97	3.91

– Note: ¹unsampled intervals not included in statistical analysis

14.5 CAPPING HIGH GRADE VALUES

In order to highlight areas of higher sulphur content, outlier values were not capped and RPA did not perform capping analysis on the sulphur assays.

Table 14-5 summarizes capping grade values used in the current Mineral Resource estimate and compares the values to the capping grade values used in the 2016 Technical Report. The resource assay histograms and cumulative probability plots within the High Grade Zone and Low Grade Zone wireframe domains for Au, Ag, and Cu are included in Appendix 6-A of the Feasibility Study Report.

Table 14-5: Capped Grade Values of Resource Assays

Grade Element	Capped Value	No. of Samples Capped	% Metal Removed	Capped Value	No. of Samples Capped	% Metal Removed
2018 High Grade Zone			2016 High Grade Zone			
Au	75 g/t	39	9%	65 g/t	48	12%
Ag	380 g/t	24	4%	350 g/t	31	5%
Cu	45,000 ppm	67	10%	40,000 ppm	81	13%
2018 Low Grade Zone			2016 Low Grade Zone			
Au	25 g/t	12	9%	35 g/t	14	12%
Ag	220 g/t	36	10%	200 g/t	44	10%
Cu	20,000 ppm	25	10%	20,000 ppm	36	20%

Capping outliers in the High Grade Zone to 75 g/t Au, 380 g/t Ag, and 45,000 ppm Cu results in the reduction of the coefficients of variation (COV) for Au, Ag, and Cu to 1.49, 1.46, and 2.00 respectively, and slightly decreases the average grades of resource assays (**Table 14-6**).

For the Low Grade Zone, Au was capped at 25 g/t, high grade Ag outliers were capped at 220 g/t Ag, and high grade Cu outliers were capped to 20,000 ppm Cu. The COVs of capped Au, Ag, and Cu are 1.12, 1.73, and 2.09, respectively (**Table 14-6**).

Table 14-6: Descriptive Statistics of Resource Capped Assay Values

	Length (m)	Au (g/t)	Ag (g/t)	Cu (ppm)
High Grade Main Zone				
No. of Cases	5,255	5,255	5,255	5,255
Minimum	0.07	0.00	0.50	1
Maximum	4.43	75.00	380.0	45,000
Median	1.00	3.46	16.60	1,169
Length Weighted Mean	-	5.79	31.92	3,368
Standard Deviation	0.33	8.53	46.46	6,767
Coefficient of Variation	0.31	1.47	1.46	2.01
High Grade Upper Zone				
No. of Cases	67	67	67	67
Minimum	0.52	0.21	0.10	53
Maximum	2.00	75.00	250.1	45,000
Median	1.10	3.28	13.49	2,604
Length Weighted Mean	-	8.99	26.13	5,871
Standard Deviation	0.45	15.70	38.93	8,849
Coefficient of Variation	0.37	1.75	1.49	1.51
High Grade Zone Total				
No. of Cases	5,322	5,322	5,322	5,322
Minimum	0.07	0.00	0.10	1
Maximum	4.43	75.00	380.0	45,000
Median	1.00	3.46	16.50	1,180
Length Weighted Mean	-	5.84	31.84	3,404
Standard Deviation	0.33	8.68	46.36	6,807
Coefficient of Variation	0.31	1.49	1.46	2.00
Low Grade Main Zone1				
No. of Cases	4,839	4,839	4,839	4,839
Minimum	0.18	0.01	0.00	1
Maximum	5.00	25.00	220.0	22,000
Median	1.00	1.25	6.70	338
Length Weighted Mean	-	1.62	14.51	848
Standard Deviation	0.39	1.83	25.56	1,832
Coefficient of Variation	0.33	1.13	1.76	2.16
Low Grade Lower Zone1				
No. of Cases	655	655	655	655
Minimum	0.24	0.02	0.20	8
Maximum	3.00	25.00	220.0	22,000
Median	1.00	1.62	10.20	990
Length Weighted Mean	-	2.15	14.66	1,629
Standard Deviation	0.32	2.23	20.87	2,654
Coefficient of Variation	0.30	1.04	1.42	1.63
Low Grade Zone Total1				
No. of Cases	5,494	5,494	5,494	5,494
Minimum	0.18	0.01	0.00	1

	Length (m)	Au (g/t)	Ag (g/t)	Cu (ppm)
Maximum	5.00	25.00	220.0	22,000
Median	1.00	1.28	7.20	383
Length Weighted Mean	-	1.68	14.52	934
Standard Deviation	0.38	1.88	25.08	1,956
Coefficient of Variation	0.33	1.12	1.73	2.09

– Note: ¹unsampled intervals not included in statistical analysis

14.6 COMPOSITING

Assay sample lengths range from 0.07 m to 5.00 m within the wireframe domains. Slightly less than half the samples (47%) were taken at 1.0 m lengths. The median assay length is 1.0 m and mean assay length is 1.11 m. Approximately 0.7% have lengths greater than 2.0 m. Given these distributions and considering the width of mineralization, RPA determined that a composite length of 2.0 m was appropriate.

A set of wireframe intersection intervals were identified for each drillhole within the mineralized wireframe domains and resource assays were composited starting at the first composite control interval from the collar and resetting at each new wireframe boundary. Within the Low Grade Zone wireframe models, unsampled intervals were treated as null. Within the High Grade Zone wireframe models, all unsampled intervals were metallurgical samples and treated as unsampled. A total of 151 Au, Ag, and Cu composites measuring less than 0.5 m were removed from the database prior to statistical analysis, variography, and resource estimation. The elimination of the small composites did not affect the overall integrity of the composited database.

Table 14-7 summarizes statistics of the capped and uncapped composite resource assay values. When Au, Ag, and Cu values are compared to uncapped resource assays, the average grades have decreased slightly, while the COV values have been greatly reduced.

Table 14-7: Descriptive Statistics of Resource Capped Composite Values

	Uncapped			Capped		
	Au (g/t)	Ag (g/t)	Cu (ppm)	Au (g/t)	Ag (g/t)	Cu (ppm)
High Grade Main Zone						
No. of Cases	2,846	2,846	2,846	2,846	2,846	2,846
Minimum	0.24	0.70	1	0.24	0.70	1
Maximum	341.68	1,483.8	143,469	75.00	373.6	45,000
Median	3.70	18.57	1,331	3.69	18.56	1,331
Arithmetic Mean	6.38	33.38	3,744	5.78	32.07	3,352
Standard Deviation	14.18	55.82	8,581	7.44	41.23	5,871
Coefficient of Variation	2.22	1.67	2.29	1.29	1.29	1.75
High Grade Upper Zone						
No. of Cases	43	43	43	43	43	43
Minimum	0.27	1.20	65	0.27	1.20	65
Maximum	60.29	130.4	33,732	43.51	130.4	25,262
Median	3.86	15.00	3,183	3.86	15.00	3,183
Arithmetic Mean	9.38	26.06	6,154	8.89	26.06	5,956
Standard Deviation	12.12	26.91	7,563	10.38	26.91	6,910
Coefficient of Variation	1.29	1.03	1.23	1.17	1.03	1.16
High Grade Zone Total						
No. of Cases	2,889	2,889	2,889	2,889	2,889	2,889
Minimum	0.24	0.70	1	0.24	0.70	1
Maximum	341.68	1,483.8	143,469	75.00	373.6	45,000
Median	3.71	18.50	1,346	3.71	18.49	1,345
Arithmetic Mean	6.42	33.27	3,780	5.83	31.98	3,391
Standard Deviation	14.16	55.50	8,570	7.50	41.06	5,895
Coefficient of Variation	2.20	1.67	2.27	1.29	1.28	1.74
Low Grade Main Zone						
No. of Cases	2,968	2,968	2,968	2,968	2,968	2,968
Minimum	0.00	0.00	0	0.00	0.00	0
Maximum	71.04	1,385.4	78,334	24.46	220.0	22,000
Median	1.31	7.11	373	1.31	7.10	372
Arithmetic Mean	1.64	16.00	896	1.59	14.38	826
Standard Deviation	2.29	44.68	2,551	1.51	23.50	1,482
Coefficient of Variation	1.39	2.79	2.85	0.95	1.63	1.79
Low Grade Lower Zone						
No. of Cases	368	368	368	368	368	368
Minimum	0.00	0.00	0	0.00	0.00	0
Maximum	24.00	434.9	75,711	15.77	207.1	20,917
Median	1.66	10.85	1,037	1.64	10.85	1,027
Arithmetic Mean	2.14	15.69	1,942	2.10	14.41	1,600
Standard Deviation	2.13	32.14	5,849	1.82	19.20	2,354
Coefficient of Variation	0.99	2.05	3.01	0.87	1.33	1.47
Low Grade Zone Total						
No. of Cases	3,336	3,336	3,336	3,336	3,336	3,336
Minimum	0.00	0.00	0	0.00	0.00	0
Maximum	71.04	1,385.4	78,334	24.46	220.0	22,000
Median	1.34	7.61	419	1.34	7.60	419
Arithmetic Mean	1.70	15.97	1,011	1.65	14.38	912
Standard Deviation	2.27	43.47	3,109	1.55	23.06	1,619
Coefficient of Variation	1.34	2.72	3.07	0.94	1.60	1.78

14.7 DENSITY

IAMGOLD began a systematic density measurement program at the Project in 2005 (IAMGOLD, 2009). To estimate densities, representative samples of typical lithology, alteration, and mineralization styles were collected. Selected core was sealed in wax before estimating the density using the water immersion method.

The Loma Larga density database included 10,793 density measurements covering a diverse range of lithology, mineralization, and alteration types. Approximately 72% (7,767) of the measurements were located within the mineralized wireframe domains. RPA reviewed the descriptive statistics for density samples taken within the mineralization wireframes (**Table 14-8**). Although the density data shows an approximately normal distribution, there is a long tail to the right of the mean (positively skewed). RPA reviewed the descriptive statistics (**Table 14-8**), histograms (**Figure 14-4**) box plots (**Figure 14-5**) for density samples taken within the mineralization wireframes the data, and determined that there were no high density outliers that should be removed from the data set. RPA further tested whether density weighting should be applied to grade interpolation and concluded that there was no strong correlation between grade and density.

Table 14-8: Descriptive Statistics of Resource Density Values

Domain	Rock Code	No. of Cases	Min (g/cm ³)	Max (g/cm ³)	Median (g/cm ³)	Arithmetic Mean	Std. Dev.	COV
High Grade Zone								
	130	3,995	1.85	4.75	2.66	2.76	0.34	0.12
	131	27	2.51	3.01	2.69	2.72	0.15	0.05
All High Grade Zone		4,022	1.85	4.75	2.66	2.76	0.34	0.12
Low Grade Zone								
	108	3,298	1.77	4.29	2.59	2.62	0.23	0.09
	208	447	2.02	4.44	2.61	2.68	0.29	0.11
All Low Grade Zone		3,745	1.77	4.44	2.60	2.62	0.24	0.09
All Composites		7,767	1.77	4.75	2.62	2.70	0.30	0.11

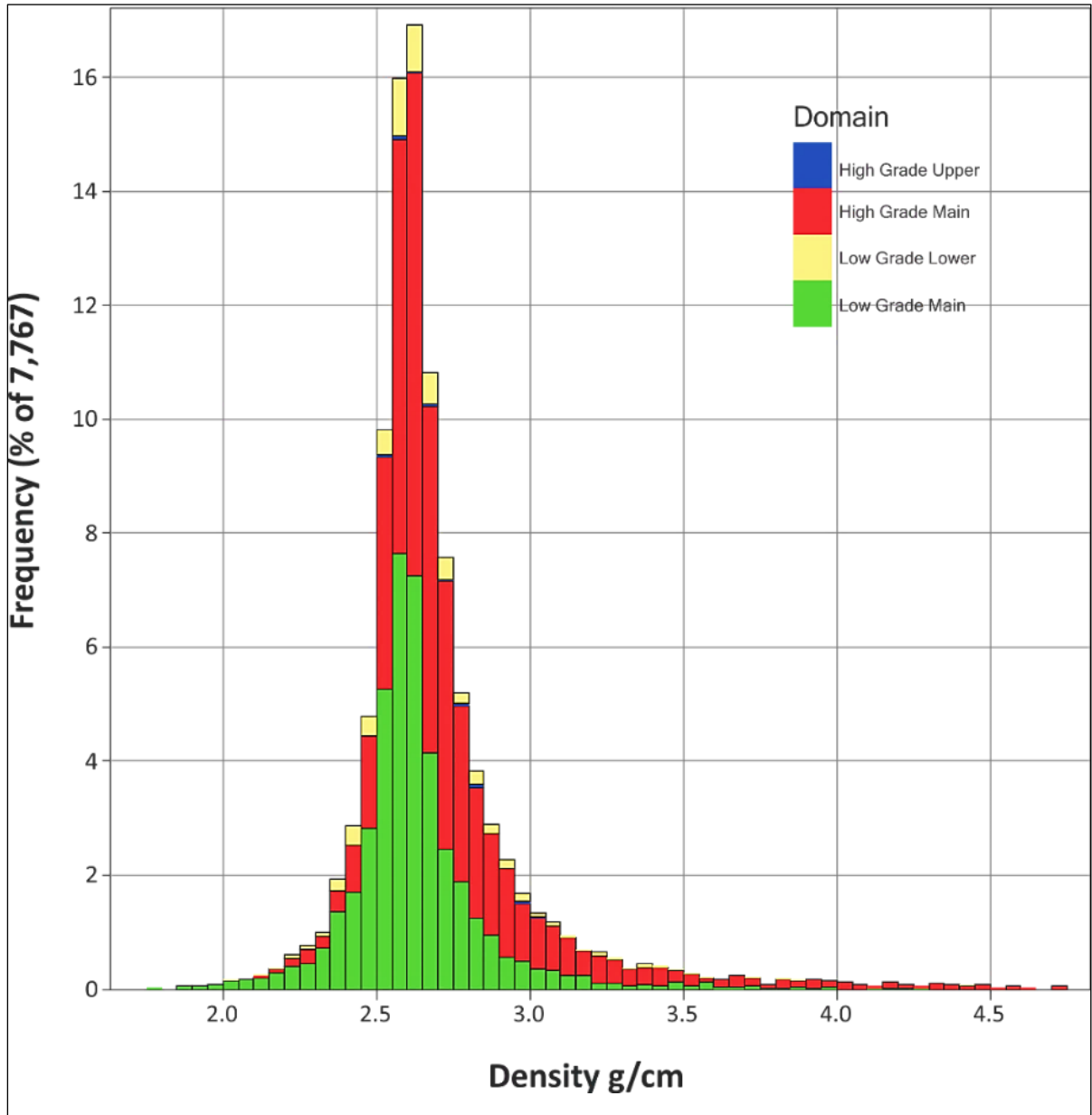

Figure 14-4: Histogram of Resource Density Samples

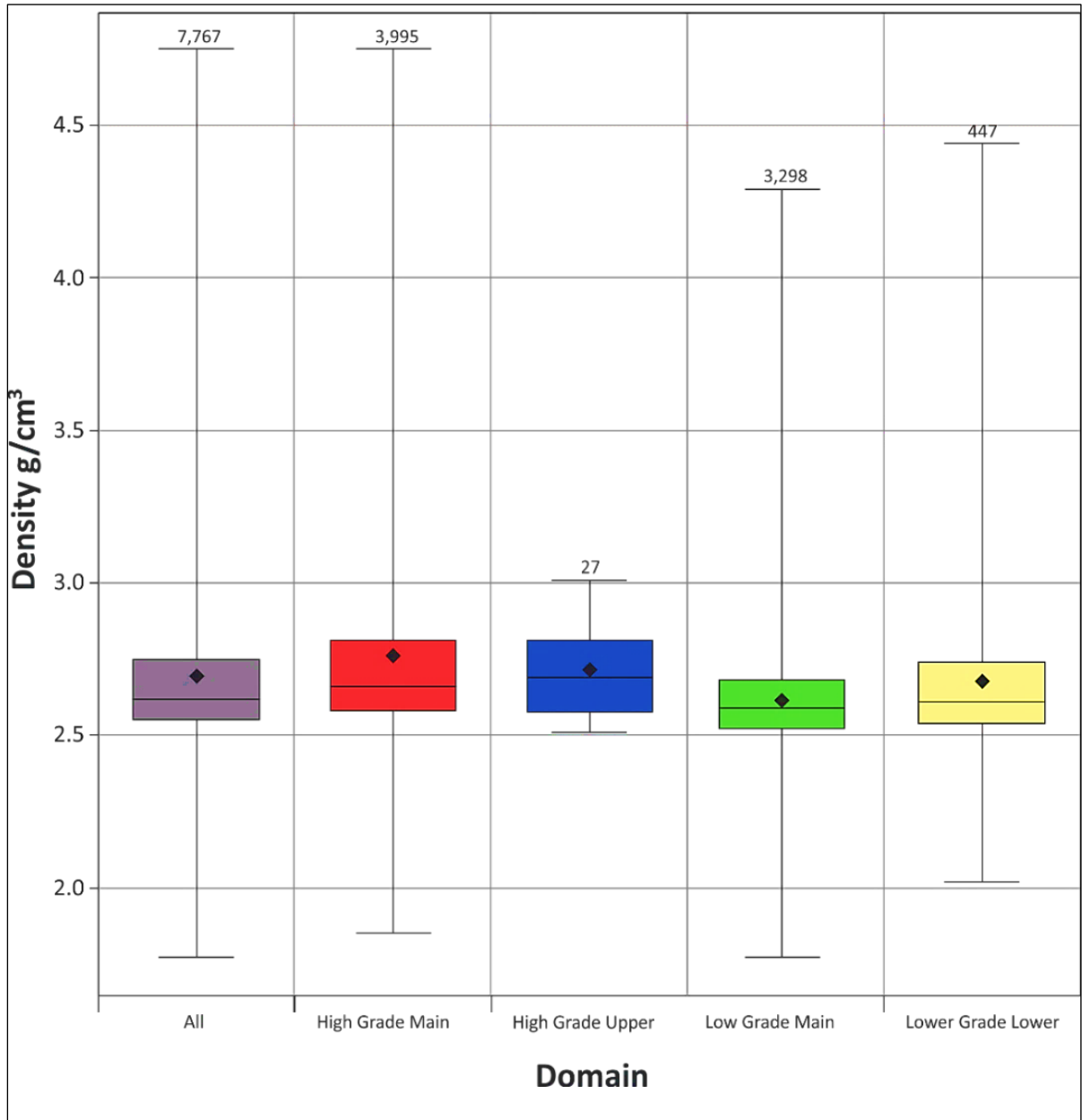

Figure 14-5: Box Plot of Resource Density Samples by Domain

The average density of the High Grade Main and Upper Zones is 2.76 g/cm³ and 2.72 g/cm³, respectively. The Low Grade Main and Lower Zones have average density values of 2.62 g/cm³ and 2.68 g/cm³, respectively, and these values are consistent with those calculated by RPA in 2012 and 2016.

As with the resource assays, density samples were composited to 2.0 m, starting at the first mineralized wireframe boundary from the collar and resetting at each new wireframe boundary. Composites less than 0.5 m were removed from the database for Mineral Resource estimation and unsampled intervals were treated as unsampled.

Table 14-9 summarizes the descriptive statistics of the composited resource density samples.

Table 14-9: Descriptive Statistics of Composited Density Samples

Domain	Rock Code	No. of Cases	Min (g/cm ³)	Max (g/cm ³)	Median (g/cm ³)	Arithmetic Mean	Std. Dev.	COV
High Grade Zone								
	130	2,201	2.09	4.46	2.68	2.74	0.25	0.09
	131	21	2.38	2.90	2.65	2.67	0.12	0.05
All High Grade Zone		2,222	2.09	4.46	2.68	2.74	0.25	0.09
Low Grade Zone								
	108	2,474	1.85	3.61	2.57	2.58	0.18	0.07
	208	292	2.20	3.90	2.59	2.65	0.23	0.09
All Low Grade Zone		2,766	1.85	3.90	2.57	2.59	0.19	0.07
All Composites		4,988	1.850	4.460	2.62	2.657	0.23	0.09



14.8 NSR CUT-OFF VALUE

The shallow depth of the mineralized zone at Loma Larga makes it amenable to either open pit or underground mining methods. The large stripping ratio that would be required for an open pit, and the resulting large tonnage of potentially acid-generating waste rock, however, has led to the selection of underground mining as the most appropriate method with the smallest environmental footprint for the Project. Thus, a potential underground production scenario serves as the basis for estimating the cut-off grade for Mineral Resources.

NSR factors were developed by RPA for the purposes of Mineral Resource reporting. NSR is the estimated value per tonne of mineralized material after allowance for metallurgical recovery and consideration of smelter terms, which may include payables, treatment charges, refining charges, price participation, penalties, smelter losses, transportation, and sales charges. These assumptions, summarized in **Table 14-10**, are based on the current processing scenario and results from metallurgical testwork.

Table 14-10: Cut-Off Value Assumptions

	Unit	2018
Metal Recovery		
Pyrite Concentrate	Au	75%
	Ag	45%
	Cu	17%
	As	14%
Copper Concentrate	Au	15%
	Ag	50%
	Cu	79%
	As	83%
Operating Costs		
Mining Underground	\$/t	31.00
Processing (1.05 M tpa)	\$/t	20.00
G&A	\$/t	7.56
Total (Rounded)	\$/t	60
NSR Royalty		5%

	Document Number	J01834-PM-REP-002	Rev	0	
	Date	11 January 2019	Page	161 of 417	

The net revenue from each metal is used to calculate an NSR factor, representing revenue (US\$) per metal grade unit (per g/t Au, for example). RPA multiplied block grades by the following factors to calculate NSR: \$31.31 per g/t Au, \$0.44 per g/t Ag, and \$46.19 per % Cu, for each block in the model.

Although various inputs to the NSR calculation have changed from those used in the 2016 Mineral Resource estimate, the net effect on the NSR factors is not significant.

The NSR value (in units of US\$ per tonne) for each block in the block model, was compared directly to unit operating costs required to mine that block. For the purposes of developing an NSR cut-off value for an underground mining operation, a total operating cost of US\$60/t milled was assumed, which includes mining, processing, and G&A expenses. The NSR cut-off value remains unchanged from the 2016 Technical Report.

All classified resource blocks located within the mineralized wireframe domains with NSR values greater than US\$60/t were included in the Mineral Resource estimate. RPA reviewed the blocks above the cut-off to found continuity to be reasonable.

In RPA's opinion, an NSR of US\$60/t (rounded) is suitable for an underground mining scenario.

14.9 VARIOGRAPHY AND INTERPOLATION VALUES



RPA re-evaluated variography for Au, Ag, Cu, and density and also prepared variograms using composites located within the main mineralized domains. The nugget effect was established with the downhole linear semi-variogram and was well developed in all cases. The longest semi-variogram ranges were consistently oriented parallel to and across strike in the horizontal plane. Variogram models for gold, silver, copper, and density are included in Appendix 6-A of the Feasibility Study Report.

For both the High Grade and Low Grade Zones, grades for Au, Ag, and Cu were interpolated using Ordinary Kriging (OK) and density values were also interpolated using OK. Variography was used to determine the search ellipsoid orientation and dimensions. Parameters derived for the High Grade Main Zone were applied to the High Grade Upper Zone and the parameters derived for the Low Grade Main Zone were applied the Low Grade Lower Zone. Interpolation and search parameters used by RPA are summarized in **Table 14-11**.

Table 14-11: Block Estimation Parameters

Parameter1		Au	Ag	Cu	Density
	Method	OK	OK	OK	OK
	Boundary Type	Hard	Hard	Hard	Soft
High Grade Zone Sample Restrictions	Min. No. Comps.	4	4	4	3
	Max. No. Comps.	12	12	12	15
	Max. Comps. Per Drill Hole	3	3	3	3
High Grade Zone Search Ellipse	Range X (m)	200	180	190	300
	Range Y (m)	140	150	140	240
	Range Z (m)	40	60	65	55
High Grade Zone Search Anisotropy ¹	Z	+0°	+165°	+165°	-160°
	Y	+0°	+15°	+10°	+15°
	Z	+75°	-90°	-90°	+90°
Variogram Model High Grade Zone	Nugget (C0)	0.06	0.09	0.05	0.11
	Relative Nugget (C0)	6%	9%	5%	11%
Structure High Grade Zone	C1	0.61	0.11	0.28	0.32
	Range X (m)	43	29	20	12
	Range Y (m)	17	18	26	20
	Range Z (m)	2	6	8	3
	C2	0.34	0.81	0.68	0.58
	Range X (m)	98	89	93	41
	Range Y (m)	71	73	70	71
	Range Z (m)	20	27	33	22
	Total Sill	1.00	1.00	1.00	1.00
Low Grade Zone Sample Restrictions	Min. No. Comps.	4	4	4	3
	Max. No. Comps.	12	12	12	15
	Max. Comps. Per Drill Hole	3	3	3	3
Low Grade Zone Search Ellipse	Range X (m)	240	390	390	300
	Range Y (m)	150	270	190	240
	Range Z (m)	60	45	60	55
Low Grade Zone Search Anisotropy ¹	Z	-165°	+0°	+45°	-160°
	Y	+10°	+0°	+10°	+15°
	Z	+75°	+75°	+45°	+90°
Variogram Model Low Grade Zone	Nugget (C0)	0.23	0.16	0.28	0.11
	Relative Nugget (C0)	23%	16%	28%	11%
Structure Low Grade Zone	C1	0.73	0.29	0.33	0.32
	Range X (m)	53	26	57	12
	Range Y (m)	43	65	56	20
	Range Z (m)	12	17	6	3
	C2	0.04	0.56	0.39	0.58
	Range X (m)	118	268	258	41
	Range Y (m)	76	180	125	71
	Range Z (m)	29	29	41	22
	Total Sill	1.00	1.00	1.00	1.00

– Note: ¹ Rotation around each axis (positive is counter-clockwise)

	Document Number	J01834-PM-REP-002	Rev	0	
	Date	11 January 2019	Page	163 of 417	

Block grade interpolation was carried out in a single pass using OK. Interpolation was restricted by the mineralized wireframe models for Au, Ag, and Cu, which were used as hard boundaries to prevent the use of composites outside of the zones. A minimum of four 2.0 m composites and a maximum of 12 composites were used to interpolate grades within each block for Au, Ag, and Cu, with a maximum of three composites per drillhole.

A soft boundary was used to interpolate density in the High and Low Grade Main Zones. A soft boundary allowed composites from one zone to be used for density interpolation of the other zone. A minimum of three 2.0 m composites and a maximum of 15 composites were used to interpolate density within each block with a maximum of three composites per drillhole. The wireframe model was used to restrict the density interpolation of the Low Grade Lower Zone, using the same composite sample restriction as the main zones. The average value of domain density composites was coded directly into the block model for the High Grade Upper Zone.

14.10 BLOCK MODEL

A model of 2,992,500 blocks was built in GEMS. Blocks are 5 m by 10 m by 5 m with 270 columns, 235 rows, and 90 levels. The model is oriented N15°W and fully encloses the modelled resource wireframes. The extents and dimensions of the block model are summarized in **Table 14-12**.

Table 14-12: Block Model Dimensions

Description	Easting (X)	Northing (Y)	Elevation (Z)
Minimum (m)	698,366.43	9,662,637.824	3,400
Maximum (m)	699,316.43	9,664,387.824	3,850
Extents (m)	950	1,750	450
	Column	Row	Level
Block size (m)	5	10	5
Number of blocks	190	175	90



RPA built a block model with separate GEMS folders for the High Grade Zone and Low Grade Zone, with attributes that included rock type, density, Au, Ag, Cu, S grades, and NSR value (**Table 14-13**). The blocks were assigned a volumetric percent to adequately account for the proportion of the blocks located within the wireframe domains.

Table 14-13: Block Model Field Descriptions

Block Model	Description
Rock Type	Air=0, Waste=99, High Grade Main Zone = 130, High Grade Upper Zone = 131, Low Grade Main Zone = 108, Low Grade Lower Zone = 208/308
Density	High Grade and Low Grade Main Zones interpolated density composite samples High Grade Upper Zone = 2.67 g/cm ³
Percent	Percent of block ascribed to the assigned rock type
AU_KR	Interpolated Au capped grades using OK
AG_KR	Interpolated Ag capped grades using OK
CU_KR	Interpolated Cu capped grades using OK
S ¹	Interpolated S grades using OK
NSR_KR	NSR factor calculated from OK metal grades: $30.90 \cdot \text{Au(g/t)} + 0.49 \cdot \text{Ag(g/t)} + 38.02 \cdot \text{Cu(\%)}$
CLASS	Classification of block (1 = Measured, 2 = Indicated, 3 = Inferred)
Min-Dist	Distance from the block centroid to the nearest sample used in block estimate
No-DHs	Number of drillholes used in block estimate
No-Samp	Number of sample points used in block estimate

– Note: ¹ See **Section 14.14- Sulphur Model**

The density factor applied to the High Grade Main Zone and Low Grade Main and Lower Zones was interpolated into each block using OK and applied to convert block volume to tonnage. A tonnage factor of 2.67 g/cm³ for the High Grade Upper Zone was coded directly into each block based on the rock type model.

	Document Number	J01834-PM-REP-002	Rev	0	
	Date	11 January 2019	Page	165 of 417	

14.11 BLOCK MODEL VALIDATION

RPA carried out a number of block model validation procedures including:

- Visual comparisons of block gold, silver, and copper grades versus composite grades.
- Statistical comparisons.
- Comparison of the volumes of the wireframe models to the block model volume results.
- Trend plots of block and composite gold, silver, and copper grades by elevation and northings/eastings.
- Comparison of block and composite grades in blocks containing composites.

Block model grades were visually examined and compared with composite grades in vertical cross sections and on elevation level plans. RPA found grade continuity to be reasonable and confirmed that the block grades were reasonably consistent with local drillhole assay and composite grades and that there was no significant bias.

Grade statistics for assays, composites, and resource blocks were examined and compared for the High Grade Main and Upper Zones and Low Grade Main and Lower Zones (**Table 14-14**). In the Low Grade Lower Zone, average block grades are slightly higher than average composite grades. This is attributed to a larger influence of higher grade drillholes in some parts of these zones due to their relative location and spacing locally, and accordingly the blocks are assigned an Inferred classification (**Figure 14-6**). Otherwise, the comparisons of average grades of capped assays, composites, and blocks are reasonable.

Table 14-14: Comparison of Grade Statistics for Assays, Composites and Resource Blocks

Zone	Capped Assays			2.0 m Capped Composites			Block Model Grades		
	Au (g/t)	Ag (g/t)	Cu (ppm)	Au (g/t)	Ag (g/t)	Cu (ppm)	Au (g/t)	Ag (g/t)	Cu (ppm)
High Grade Main Zone									
Number of Cases	5,255	5,255	5,255	2,846	2,846	2,846	27,365	27,365	27,365
Minimum	0.00	0.50	1	0.24	0.70	1	1.49	4.22	153
Maximum	75.00	380.0	45,000	75.00	373.6	45,000	58.80	243.17	36,047
Median	3.46	16.60	1,169	3.69	18.56	1,331	4.09	23.41	1,913
Arithmetic Mean ¹	5.79	31.92	3,368	5.78	32.07	3,352	5.34	31.58	3,060
Standard Deviation	8.53	46.46	6,767	7.44	41.23	5,871	3.82	24.44	3,299
Coefficient of Variation	1.47	1.46	2.01	1.29	1.29	1.75	0.72	0.77	1.08
High Grade Upper Zone									
Number of Cases	67	67	67	43	43	43	548	548	548
Minimum	0.21	0.10	53	0.27	1.20	65	2.48	6.28	1,751
Maximum	75.00	250.1	45,000	43.51	130.4	25,262	20.30	66.47	18,331
Median	3.28	13.49	2,604	3.86	15.00	3,183	6.57	19.65	5,358
Arithmetic Mean ¹	8.99	26.13	5,871	8.89	26.06	5,956	7.54	22.62	5,895
Standard Deviation	15.70	38.93	8,849	10.38	26.91	6,910	3.68	10.30	2,409
Coefficient of Variation	1.75	1.49	1.51	1.17	1.03	1.16	0.49	0.46	0.41
Low Grade Main Zone									
Number of Cases	4,839	4,839	4,839	2,968	2,968	2,968	53,957	53,957	53,957
Minimum	0.01	0.00	1	0.00	0.00	0	0.11	0.78	23
Maximum	25.00	220.0	22,000	24.46	220.0	22,000	11.38	199.66	11,098
Median	1.25	6.70	338	1.31	7.10	372	1.45	10.47	673
Arithmetic Mean ¹	1.62	14.51	848	1.59	14.38	826	1.54	15.94	837
Standard Deviation	1.83	25.56	1,832	1.51	23.50	1,482	0.62	18.23	733
Coefficient of Variation	1.13	1.76	2.16	0.95	1.63	1.79	0.40	1.14	0.88
Low Grade Lower Zone									
Number of Cases	655	655	655	368	368	368	5,781	5,781	5,781
Minimum	0.02	0.20	8	0.00	0.00	0	0.30	2.53	186
Maximum	25.00	220.0	22,000	15.77	207.1	20,917	11.24	153.12	16,444
Median	1.62	10.20	990	1.64	10.85	1,027	1.78	13.14	1,120
Arithmetic Mean ¹	2.15	14.66	1,629	2.10	14.41	1,600	1.96	16.06	1,548
Standard Deviation	2.23	20.87	2,654	1.82	19.20	2,354	0.91	13.43	1,587
Coefficient of Variation	1.04	1.42	1.63	0.87	1.33	1.47	0.47	0.84	1.03

– Note: ¹Assay mean values are length weighted

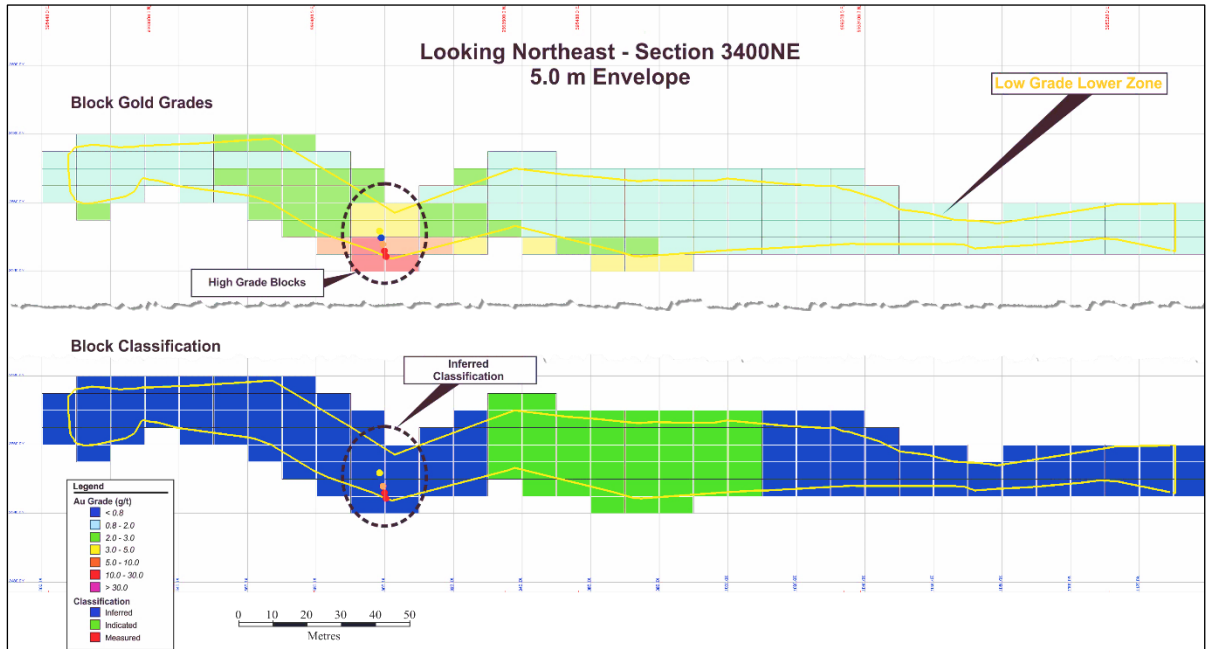

Figure 14-6: High Gold Grade and Classification of Selected Block in the Low Grade Lower Zone

Examples of the composite and block grades of Au, Ag, and Cu in plan and sections are provided in **Figure 14-7**, **Figure 14-8**, and **Figure 14-9** respectively.

To check for conditional bias, trend plots were created which compared the Au, Ag, and Cu block model grade estimates of the High Grade Zone and Low Grade Zone to capped composite sample average grades. **Figure 14-10** and **Figure 14-11** illustrate the gold trend plots for the High Grade Main Zone and Low Grade Main Zone, respectively. In RPA’s opinion, there is no significant bias between the resource block grades and the composited capped assay samples.

RPA compared the volume of the wireframe models to the block model volume results. The estimated total volume of the wireframe models is 14,407,350 m³ and the block model volume is 14,395,927 m³. The volume difference is -0.08%, which RPA considers to be an acceptable result.

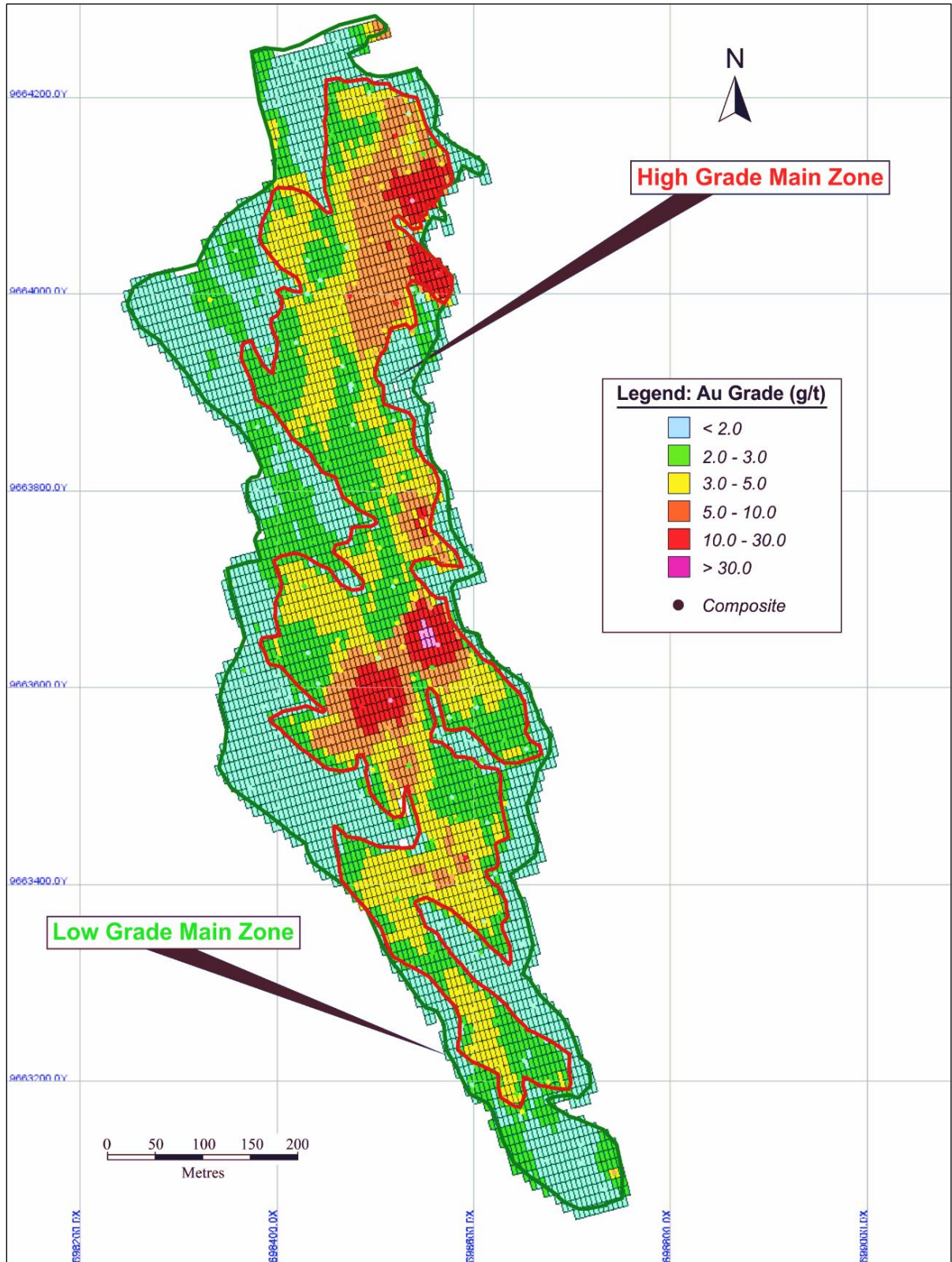

Figure 14-7: Capped Gold Composites and Blocks on 3,600 m Level

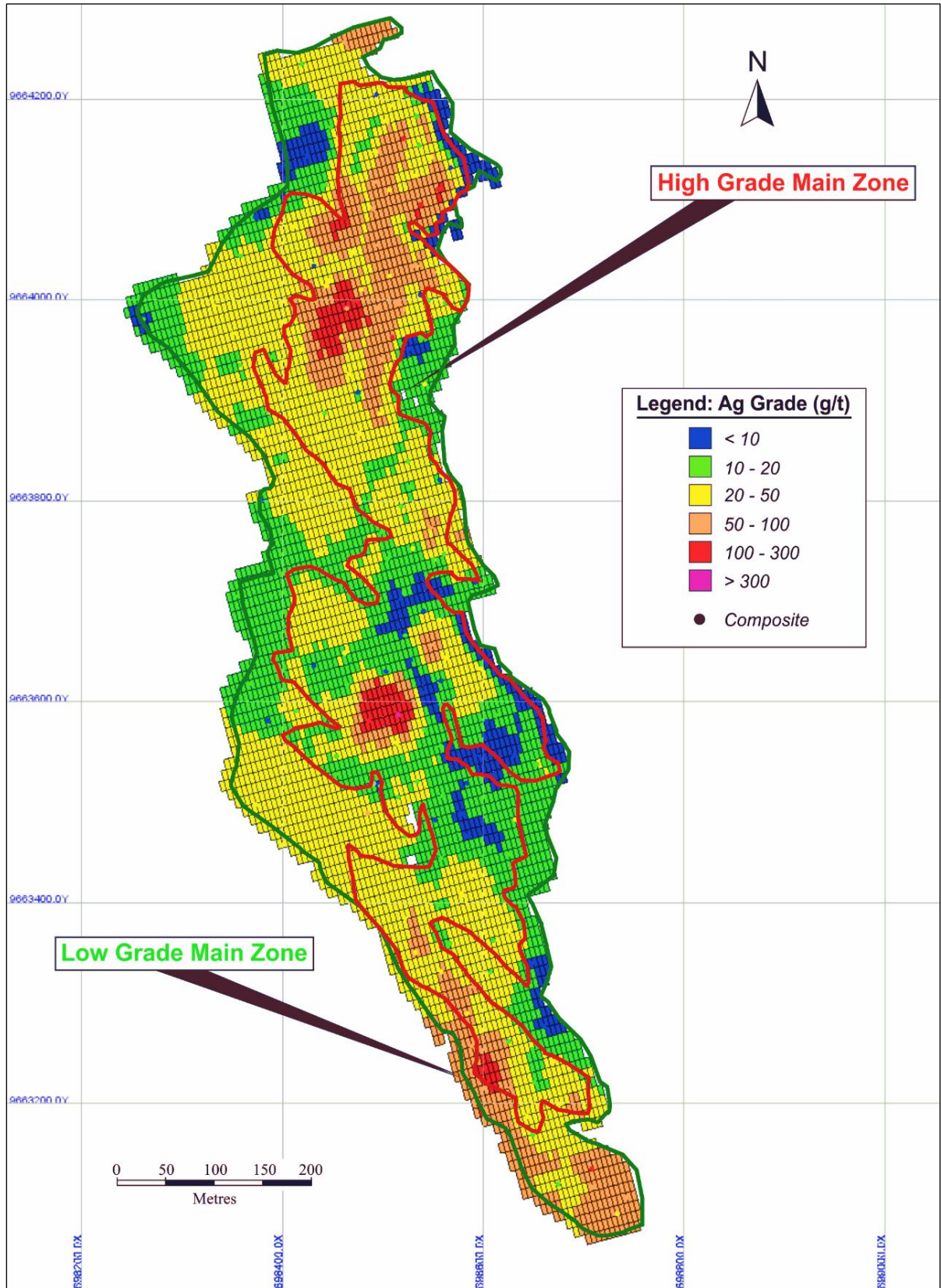

Figure 14-8: Capped Silver Composites and Blocks on 3,600 m Level

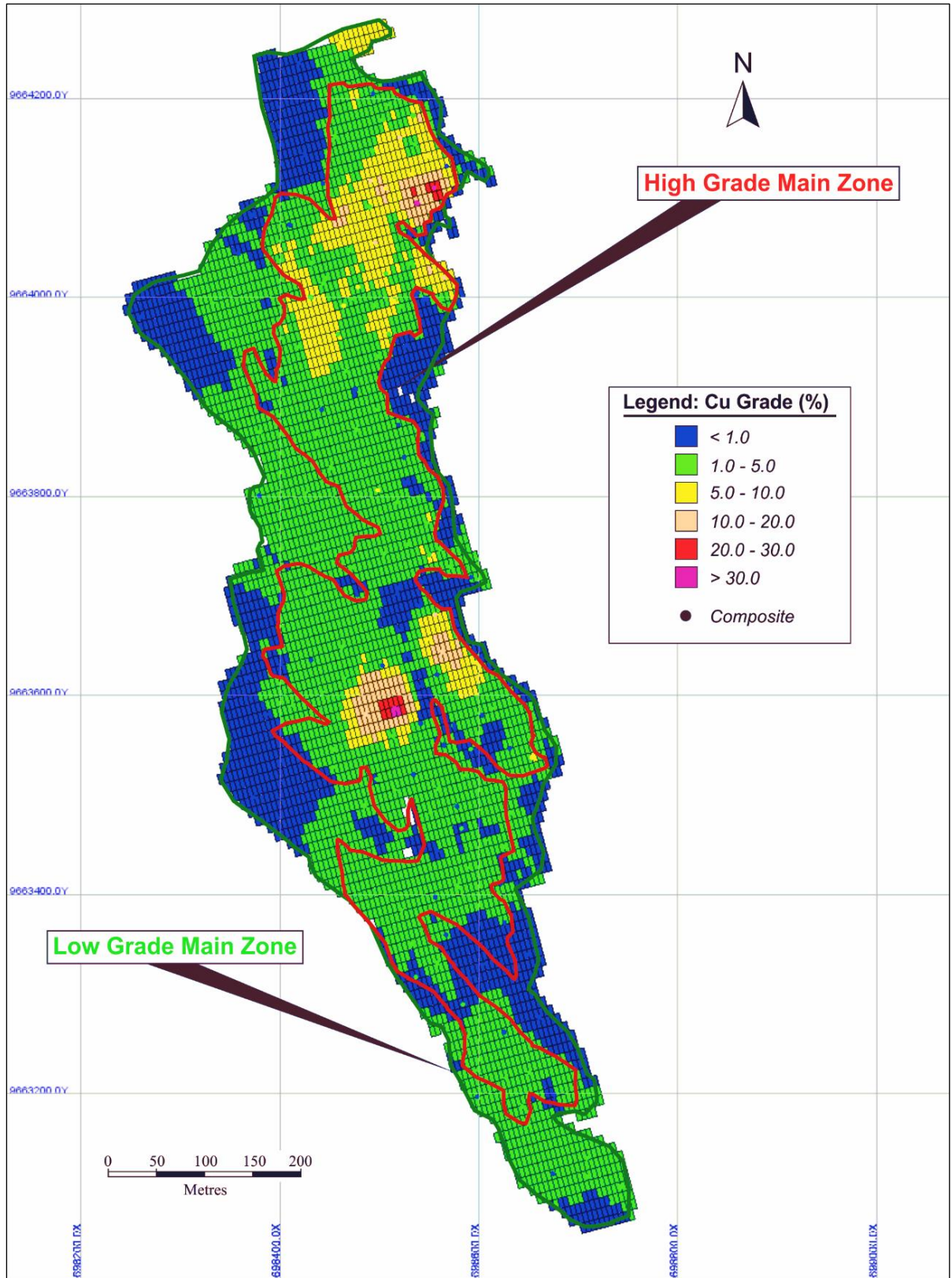

Figure 14-9: Capped Copper Composites and Blocks on 3,600 m Level

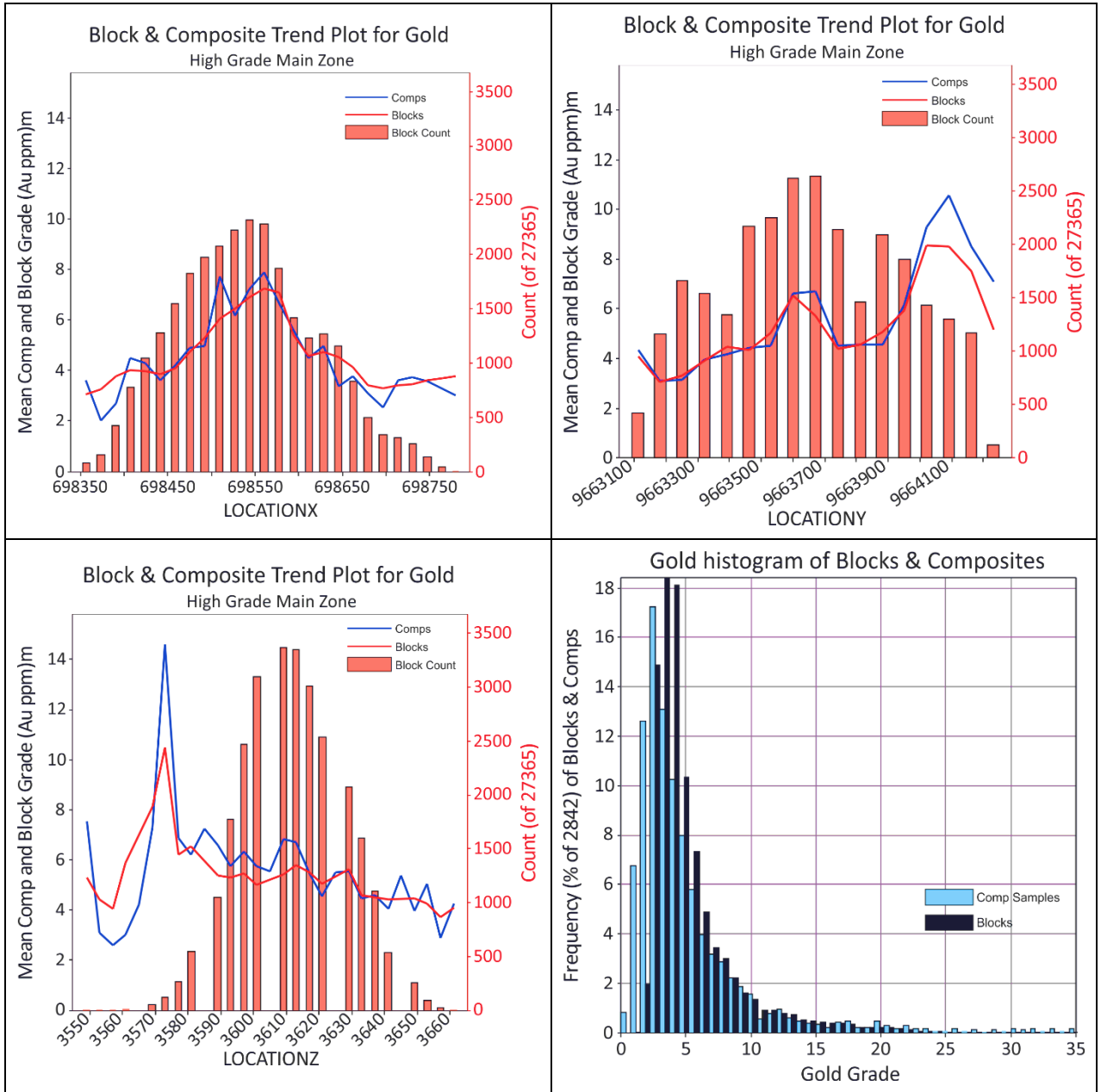

Figure 14-10: High Grade Main Zone Trend Plots and Histograms of Capped Gold Assays versus Block Grades

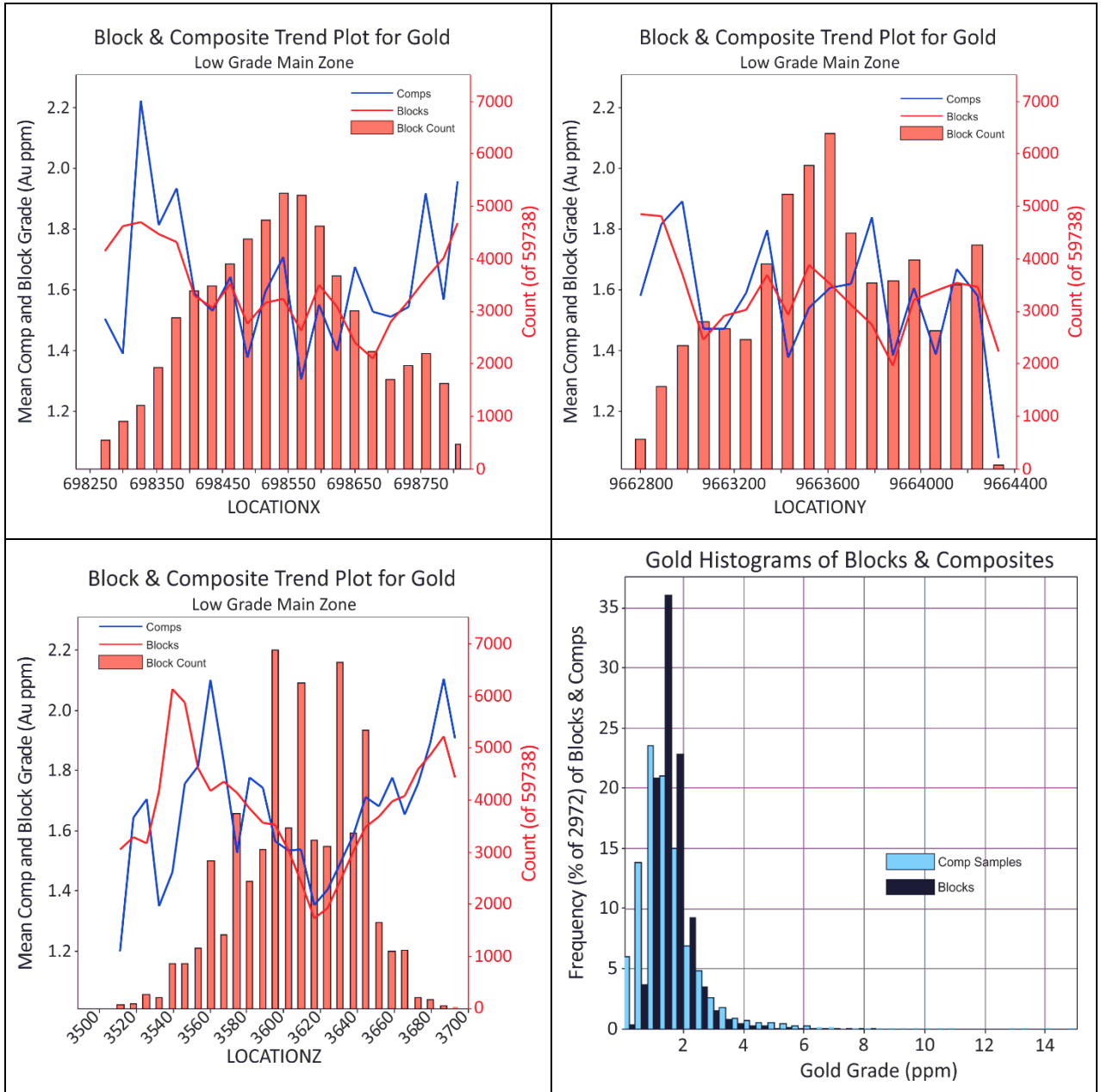



Figure 14-11: Low Grade Main Zone Trend Plots and Histograms of Capped Gold Assays versus Block Grades

14.12 CLASSIFICATION

Definitions for resource categories used in this report are consistent with those defined by Canadian Institute of Mining, Metallurgy, Petroleum (CIM) Definition Standards for Mineral Resources and Mineral Reserves (CIM (2014) definitions) as incorporated by reference in NI 43-101. In the CIM classification, a Mineral Resource is defined as “a concentration or occurrence of natural, solid, inorganic or fossilized organic material in or on the Earth’s crust in such form and quantity and of such grade or quality that it has reasonable prospects for economic extraction”. Mineral Resources are classified into Measured, Indicated, and Inferred categories, according to the confidence level in the estimated blocks.

	Document Number	J01834-PM-REP-002	Rev	0	
	Date	11 January 2019	Page	173 of 417	

RPA classified the Mineral Resources on the Loma Larga Project as Measured, Indicated, and Inferred. All blocks within the High Grade Main Zone were classified as Measured or Indicated Mineral Resources, and all blocks in the High Grade Upper Zone were classified as Inferred Mineral Resources. Blocks within the Low Grade Main Zone and Low Grade Lower Zone were classified as Indicated and Inferred. RPA manually classified the blocks within these zones based on drillhole spacing and grade continuity above the NSR cut-off of US\$60/t. The general guidelines for drillhole spacing are as follows:

- Measured: 25 m x 25 m.
- Indicated: 50 m x 50 m.
- Inferred: > 100 m x 100 m.

Figure 14-12 illustrates block classification on the 3,600 m level, and the distance to the nearest sample is shown for Measured, Indicated, and Inferred blocks as a histogram in **Figure 14-13**. Drillhole spacing for Measured blocks averages 20 m, and ranges from less than ten metres to 40 m. Nearly 75% of blocks classified as Measured have a drillhole spacing less than 25 m.

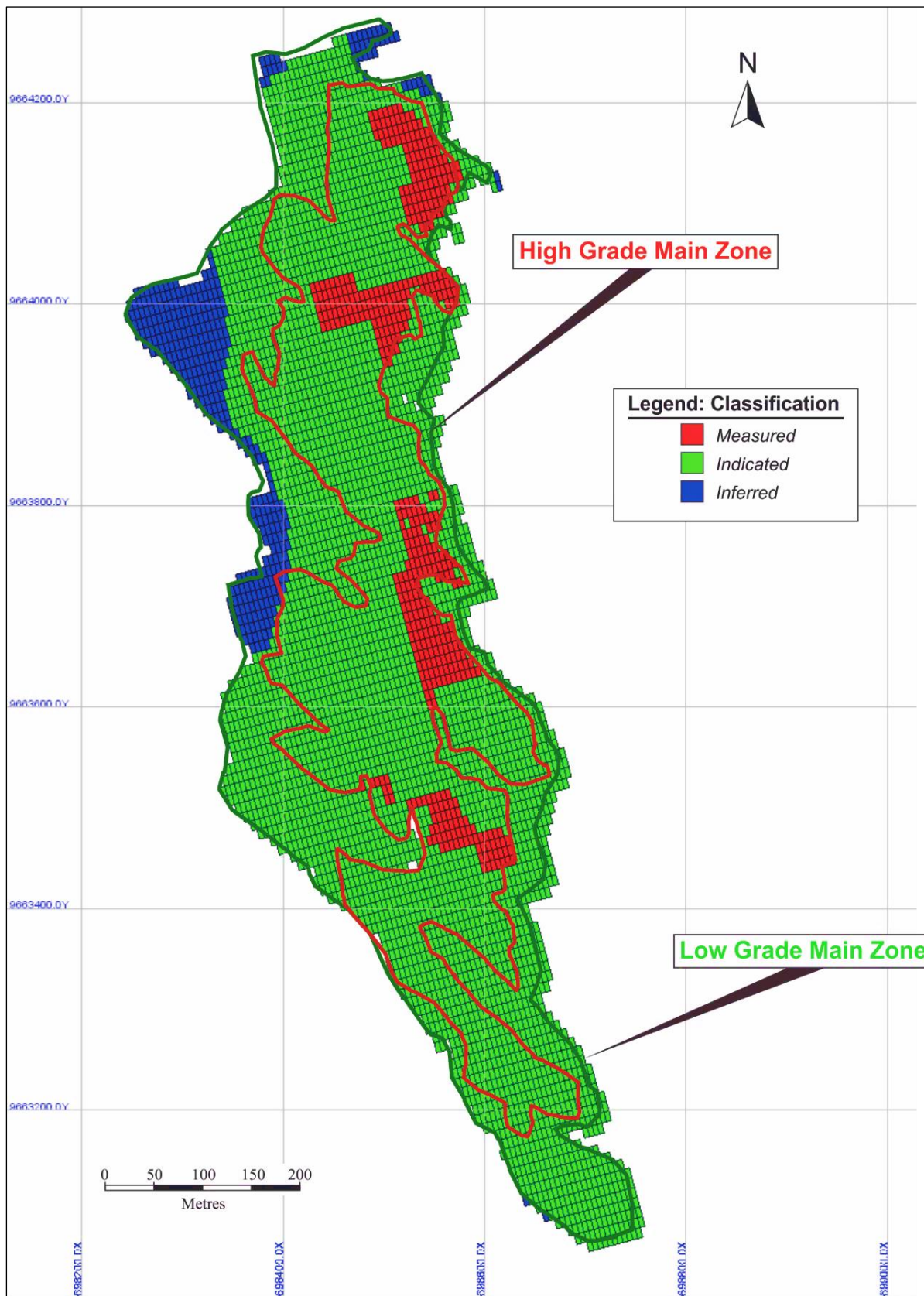

Figure 14-12: Plan View of Block Classification on the 3,600 m Level.

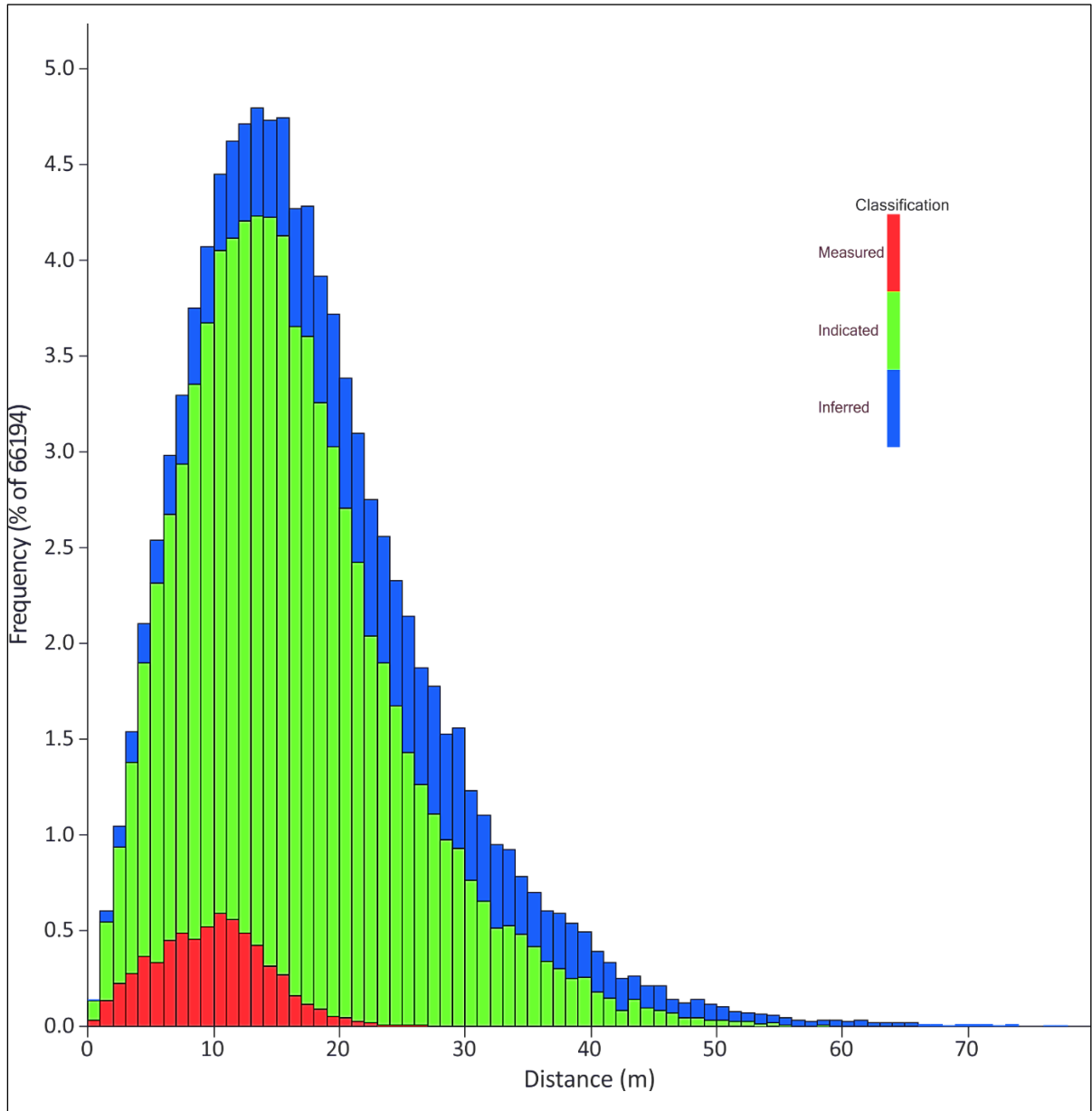



Figure 14-13: Cumulative Histogram of Distance to Nearest Sample Grouped by Class

Most of the blocks classified as Indicated Mineral Resources in the Low Grade Main Zone have good continuity, but RPA cautions that there are a few isolated drillhole intercepts with grades above the cut-off that are classified as Indicated.

	Document Number	J01834-PM-REP-002	Rev	0	
	Date	11 January 2019	Page	176 of 417	

14.13 SUMMARY OF MINERAL RESOURCE ESTIMATE

RPA estimated Mineral Resources for the Loma Larga Project using drillhole data available as of October 31, 2018.

In RPA's opinion, an NSR cut-off value of US\$60/t is appropriate for reporting current Mineral Resources for the Project. The Mineral Resources, effective October 31, 2018, are summarized in **Table 14-15**.

Table 14-15: Mineral Resource Estimate – October 31, 2018

Resource Classification	Zone	Tonnage	Grade	Contained Gold	Grade	Contained Silver	Grade	Contained Copper	Grade	Contained Gold Equivalent
		(Mt)	(g/t Au)	(M oz Au)	(g/t Ag)	(M oz Ag)	(% Cu)	(M lb Cu)	(g/t AuEq)	(M oz AuEq)
Measured	High Grade Main Zone	2.9	7.31	0.67	34.9	3.2	0.44	28.2	8.45	0.78
Indicated	High Grade Main Zone	10.3	4.85	1.60	30.7	10.1	0.28	62.3	5.68	1.88
	Low Grade Main Zone	6.0	2.01	0.39	21.1	4.0	0.12	15.7	2.49	0.48
	Low Grade Lower Zone	0.7	2.21	0.05	12.8	0.3	0.21	3.4	2.70	0.06
	Total	17.0	3.74	2.04	26.5	14.5	0.22	81.4	4.43	2.42
Measured + Indicated	High Grade Main Zone	13.1	5.4	2.28	31.6	13.4	0.31	90.5	6.29	2.66
	Low Grade Main Zone	6.0	2.0	0.39	21.1	4.0	0.12	15.7	2.49	0.48
	Low Grade Lower Zone	0.7	2.21	0.05	12.8	0.3	0.21	3.4	2.70	0.06
	Total	19.8	4.25	2.71	27.8	17.7	0.25	109.5	5.01	3.20
Inferred	High Grade Upper Zone	0.2	7.10	0.04	21.7	0.1	0.56	2.1	8.24	0.05
	Low Grade Main Zone	3.6	1.96	0.23	32.7	3.8	0.12	9.4	2.60	0.30
	Low Grade Lower Zone	0.9	2.31	0.07	18.7	0.5	0.15	2.9	2.79	0.08
	Total	4.7	2.22	0.33	29.7	4.5	0.14	14.5	2.84	0.43

– Notes:

- CIM (2014) definitions were followed for Mineral Resources.
- Mineral Resources are reported at an NSR cut-off value of US\$60/t.
- Mineral Resources are estimated using a long-term gold price of US\$1,450 per ounce, silver price of US\$22.00 per ounce, and copper price of US\$3.50 per pound.
- The formula used to calculate gold equivalence (AuEq) is: $(Au\ g/t \times 31.31 + Ag\ g/t \times 0.44 + Cu\% \times 46.19) \div 31.31$. The formula used for calculated AuEq ounces is: $AuEq\ Oz = (Tonnage \times AuEq\ g/t) \div 31.1035$
- Mineral Resources are inclusive of Mineral Reserves.
- Mineral Resources that are not Mineral Reserves do not have demonstrated economic viability.
- Average bulk density is 2.7 t/m³.
- Numbers may not add due to rounding.

14.14 SULPHUR MODEL

14.14.1 SULPHUR DATABASE

Using data available as of October 31, 2018, RPA generated a block model for sulphur grades to support metallurgical testwork (RPA, 2018). INV provided sulphur assay data for drilling completed in 2017 in addition to sulphur assay data from drillholes completed prior to 2016 by IAMGOLD. Files were received in Excel format, amalgamated and parsed as required, and imported into GEMS. Table 14-16 summarizes data used for the sulphur block grade estimates.

RPA notes that not all drillhole assay samples were analyzed for sulphur (see **Table 14-2**), and there are no samples south of 9,663,100 metres North. As a result, a small area of the southern portion of the Low Grade Main Zone (located in Inferred Mineral Resources outside the current mine plan) does not have sulphur grade estimates and RPA did not assign default values to the blocks.

Table 14-16: Sulphur Database used for Block Grade Estimation

Attribute	Count
Holes	199
Total Length Drilled	36,059 m
Assays	6,890
Composites (>0.5 m)	3,993

The sulphur block model estimate is based on assays from 199 drillholes that totalled 36,059 m in length. Drilling was completed by IAMGOLD and INV between 2005 and 2017. **Figure 14-14** illustrates the location of drillholes with sulphur data within the Loma Larga deposit.

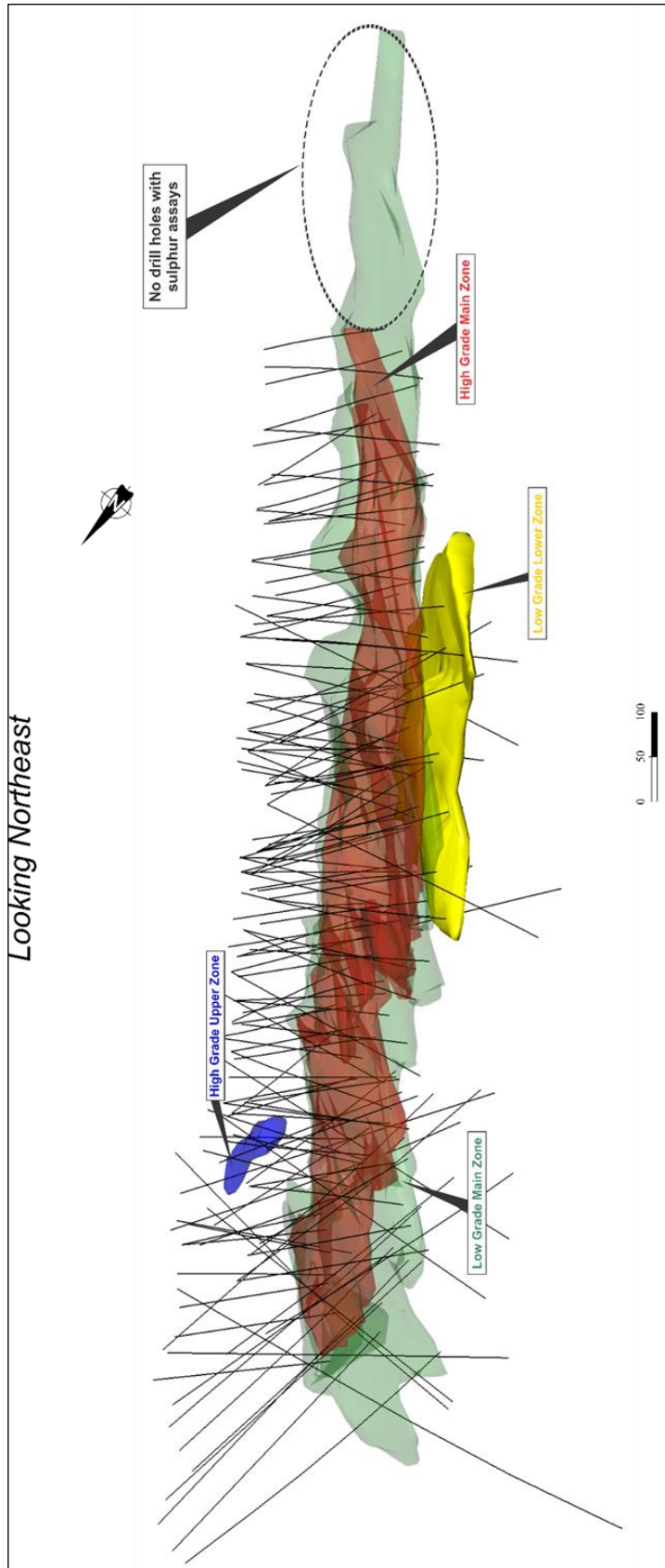

Figure 14-14: 3D Isometric View of Drill Holes with Sulphur Data

14.14.2 STATISTICAL ANALYSIS

Sulphur assays located inside the Loma Larga mineralization wireframe domains were tagged within the GEMS project drillhole database rock codes. RPA exported the sulphur assays for statistical analysis and for later comparison with composite grades and block model grades.

Sulphur assay grades less than the detection limit were replaced with zero values, and sulphur assay grades above the analytical method detection limit were replaced by the upper detection limit (**Figure 14-15**). Intervals without sulphur assays were treated as unsampled.

For statistical analysis, the sulphur assays have been subdivided into High Grade Zone (Main Zone and Upper Zone) and Low Grade Zone (Main Zone and Lower Zone). The basic statistics are summarized in **Table 14-17**, and the histograms are illustrated in **Figure 14-15**. The histogram shows distinct peaks where assays results were above the analytical upper detection limit and not reanalyzed. RPA is unaware of the risk that may be associated with the uncertainty of high sulphur assays.

Table 14-17: Descriptive Statistics of Geochemistry Resource Assay Values

High Grade Zone		S %
Count		3,458
Minimum		0.18
Maximum		16.00
Median		5.58
Arithmetic Mean		6.47
Standard Deviation		3.74
Coefficient of Variation		0.58
Low Grade Zone		S %
Count		3,432
Minimum		0.03
Maximum		21.18
Median		3.70
Arithmetic Mean		4.38
Standard Deviation		3.05
Coefficient of Variation		0.70

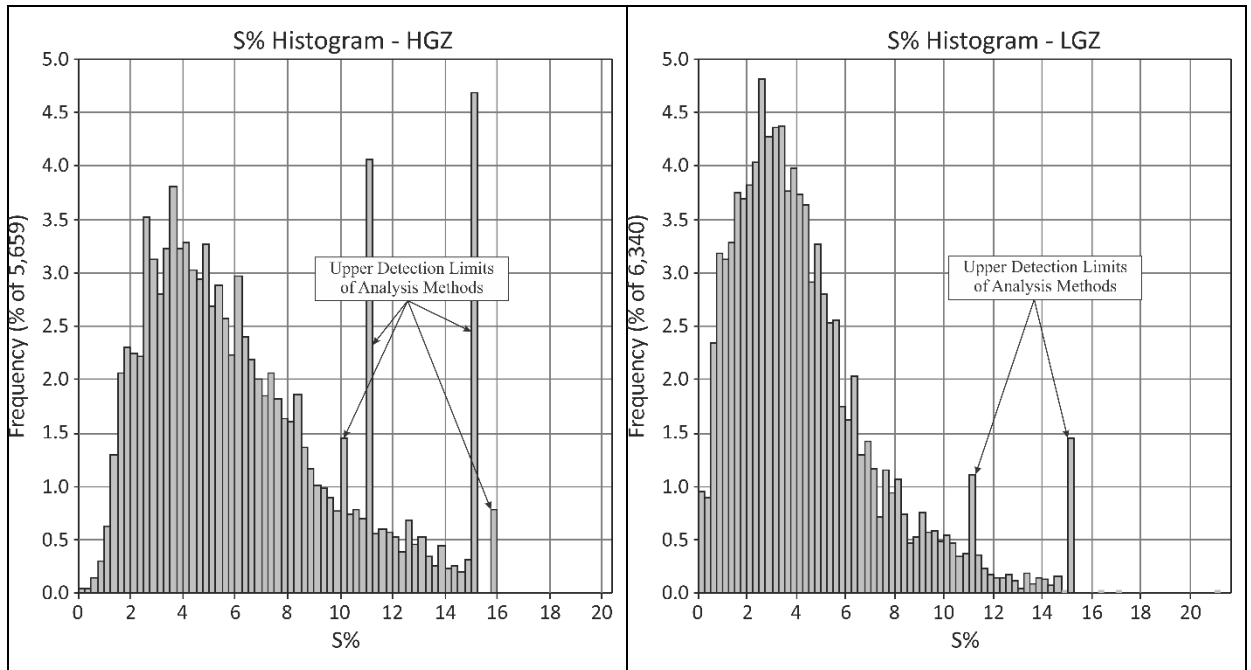

Figure 14-15: Assay Histograms for Sulphur

14.14.3 CAPPING OF HIGH VALUES

In order to highlight areas of higher sulphur content, outlier values were not capped and RPA did not perform capping analysis on the sulphur assays. However, many analyses were effectively capped by exceeding the upper detection limit of the analytical method with no subsequent reanalysis.

14.14.4 COMPOSITING

Sulphur assay sample lengths range from 0.15 m to 4.20 m within the wireframe domains. Greater than 99% of the resource assays have lengths less than 2.0 m. RPA used composite lengths of 2.0 m.

A set of drillhole-wireframe intersection intervals were identified for each drillhole within the mineralized wireframe domains and sulphur assays were composited starting at the first composite control interval from the collar and resetting at each new wireframe boundary. Unsampled intervals were treated as unsampled and not used in the composite calculation. Composites measuring less than 0.5 m were removed from the database prior to statistical analysis and block model grade interpolation. The elimination of the small composites did not affect the overall integrity of the composited database.

Table 14-18 summarizes statistics of the uncapped sulphur composite assay values.

Table 14-18: Descriptive Statistics of Sulphur Composite Values

High Grade Zone		S %
Count		1,908
Minimum		0.76
Maximum		16.00
Median		5.89
Arithmetic Mean		6.50
Standard Deviation		3.37
Coefficient of Variation		0.52
Low Grade Zone		S %
Count		2,085
Minimum		0.03
Maximum		18.06
Median		3.87
Arithmetic Mean		4.41
Standard Deviation		2.79
Coefficient of Variation		0.63

14.14.5 VARIOGRAPHY AND INTERPOLATION VALUES

RPA reviewed the variography for sulphur and also prepared variograms using composites located within the main mineralized domains. The nugget effect was established with the downhole linear semi-variogram and the longest semi-variogram range was oriented parallel to and across strike in the horizontal plane.

Interpolation and search parameters used for sulphur are summarized in **Table 14-19**.

Table 14-19: Sulphur Block Estimation Parameters

Parameter	Method	OK
	Boundary Type	Hard
High Grade Zone Sample Restrictions	Min. No. Comps.	3
	Max. No. Comps.	15
	Max. Comps. Per Drill Hole	3
High Grade Zone Search Ellipse	Range X (m)	160
	Range Y (m)	130
	Range Z (m)	130
High Grade Zone Search Anisotropy ¹	Z	0°
	Y	0°
	Z	+75°
Variogram Model High Grade Zone	Nugget (C0)	0.05
	Relative Nugget (C0)	5%
Structure High Grade Zone	C1	0.65
	Range X (m)	24
	Range Y (m)	8
	Range Z (m)	6
	C2	0.30
	Range X (m)	79
	Range Y (m)	63
	Range Z (m)	67
Total Sill	1.00	
Low Grade Zone Sample Restrictions	Min. No. Comps.	3
	Max. No. Comps.	15
	Max. Comps. Per Drill Hole	3
Low Grade Zone Search Ellipse	Range X (m)	300
	Range Y (m)	215
	Range Z (m)	165
Low Grade Zone Search Anisotropy ¹	Z	0°
	Y	0°
	Z	-40°
Variogram Model Low Grade Zone	Nugget (C0)	0.05
	Relative Nugget (C0)	5%
Structure Low Grade Zone	C1	0.52
	Range X (m)	72
	Range Y (m)	102
	Range Z (m)	13
	C2	0.43
	Range X (m)	203
	Range Y (m)	144
	Range Z (m)	111
Total Sill	1.00	

– Note:¹ Rotation around each axis (positive is counter-clockwise)

Block grade interpolation was carried out in a single pass using OK. Interpolation was restricted by the mineralized wireframe models, which were used as hard boundaries to prevent the use of composites outside of the zones. A minimum of three 2.0 m composites and a maximum of 15 composites were used to interpolate grades within each block for sulphur, with a maximum of three samples per drillhole.

14.14.6 BLOCK MODEL

A sulphur block model was added to the Loma Larga GEMS project. **Table 14-20** summarizes the statistics of the uncapped sulphur block grades.

Table 14-20: Descriptive Statistics of Sulphur Block Values

High Grade Zone	S %
Count	27,913
Minimum	1.89
Maximum	14.00
Median	6.54
Arithmetic Mean	6.71
Standard Deviation	1.72
Coefficient of Variation	0.26
% of Interpolated blocks	100%
Low Grade Zone ¹	S %
Count	58,784
Minimum	0.50
Maximum	14.43
Median	4.38
Arithmetic Mean	4.71
Standard Deviation	1.91
Coefficient of Variation	0.41
% of Interpolated blocks	98.4%

– Note:¹ Includes only blocks with interpolated grades



14.14.7 BLOCK MODEL VALIDATION

RPA carried out a number of block model validation procedures including:

- Visual comparisons of block sulphur grades versus composite grades.
- Statistical comparisons of assays, composites, and blocks on plan and vertical section.
- Trend plots of block and composite sulphur grades by elevation and northings/eastings.

Block model sulphur grades were visually examined and compared with composite grades in cross section and on elevation plans. RPA found grade continuity to be reasonable and confirmed that the block grades were reasonably consistent with local drillhole assay and composite grades and that there was no significant bias. RPA notes that the mean block grades were slightly higher than mean composite grades. This result is expected since capping was not performed, and higher sulphur assays had a larger influence on block grades, especially in areas where drillhole spacing was wide.

Figure 14-16 shows sulphur composite and block grades in plan view.

	Document Number	J01834-PM-REP-002	Rev	0	
	Date	11 January 2019	Page	185 of 417	

In RPA's opinion, the sulphur block grade estimates are suitable to support metallurgical testwork for the Feasibility Study but cautions that local block sulphur grades are not as well supported as the payable metal block grades in the Mineral Resource estimate. This includes areas of the block model without date and incomplete or lacking information on the analytical methods used for sulphur assaying.

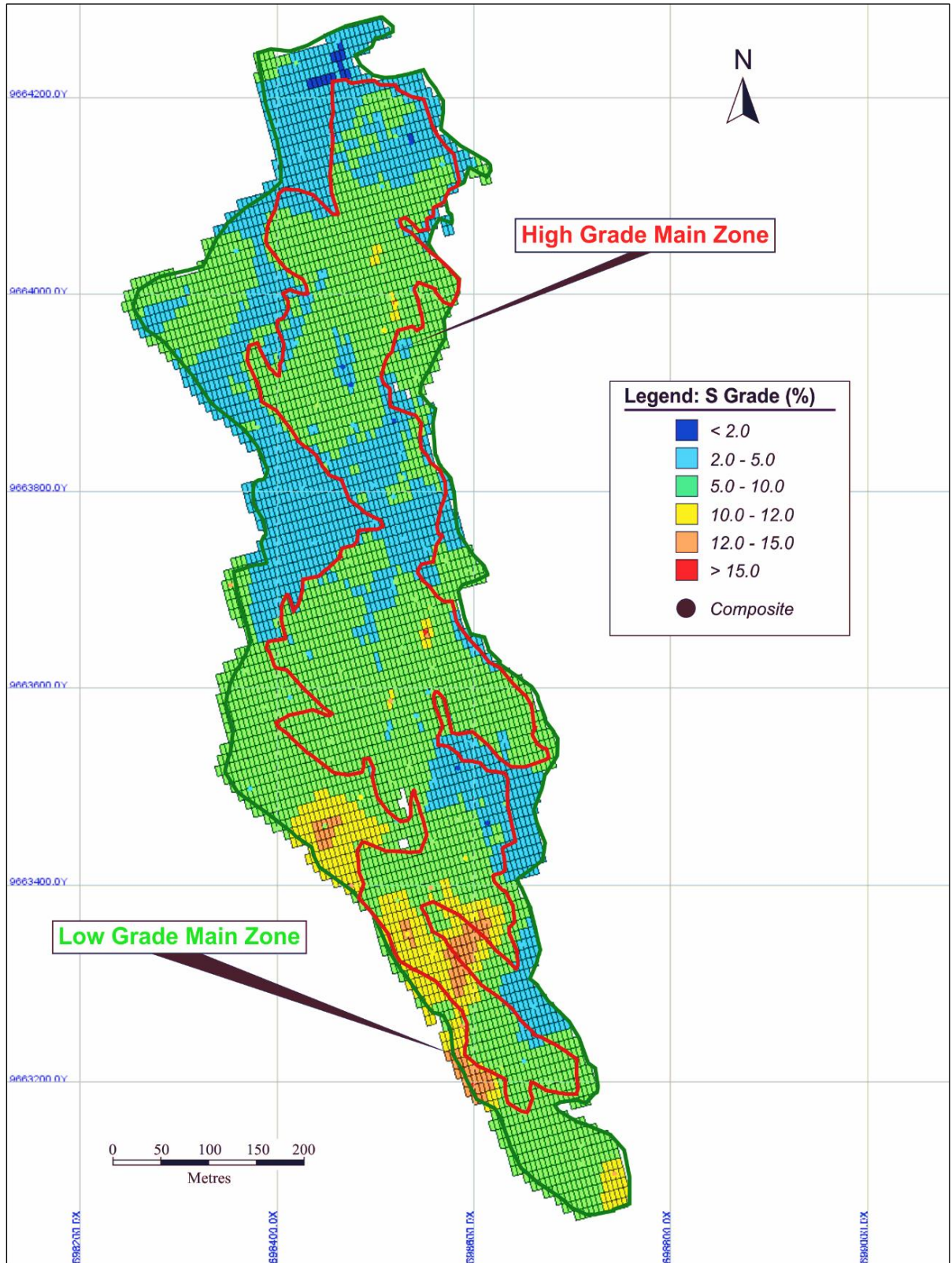

Figure 14-16: Sulphur Composites and Blocks on 3,600 m Level

15 MINERAL RESERVE ESTIMATE

15.1 SUMMARY

DRA has designed an underground mine to produce 3,000 t/d of gold-copper and silver ore from the Loma Larga deposit for 12 years. The mine will be accessed by a decline and mined using conventional mechanized transverse long-hole and drift-and-fill mining methods. Ore will be trucked to the concentrator via a 3 km surface road.

The mineral reserves for Loma Larga are estimated at 13,926,500 tonnes of recoverable and diluted ore grading 4.91 g/t Au, 29.6 g/t Ag, and 0.29% Cu using an economic cut-off of US \$60/t NSR. The mineral reserves are comprised of 21% in proven category (2,924,600 tonnes grading 7.30 g/t Au, 34.80 g/t Ag and 0.44% Cu) and 79% in probable category (11,001,900 tonnes grading 4.28 g/t Au, 28.26 g/t Ag and 0.25% Cu). Reserves are inclusive of dilution and ore loss.

The mineral reserves are based on the mining schedule presented in **Section 16**. The mineral reserves are the stope and development tonnage (including material above the cut-off and internal low-grade dilution) to which dilution and recovery factors explained below are added.

Details of the mineral reserves are given in **Table 15-1** below.

Table 15-1: Loma Larga Mineral Reserves estimate as of October 31, 2018

Ore Category	Tonne (M)	Au Grade (g/t)	Au Contained (M oz)	Ag Grade (g/t)	Ag Contained (M oz)	Cu Grade (%)	Cu Contained (M lb)	Au Equivalent (M oz)	Au Equivalent Grade (g/t)
Proven	2.9	7.30	0.69	34.8	3.27	0.44%	28.5	0.8019	8.53
Probable	11.0	4.28	1.51	28.3	10.00	0.25%	59.5	1.80	5.09
Proven and Probable	13.9	4.91	2.20	29.6	13.27	0.29%	88.0	2.60	5.81

– Notes:



- CIM (2014) definitions were followed for Mineral Reserves.
- Mineral Reserves include long hole and drift-and-fill stopes as well as development in ore
- Mineral Reserves are reported at an NSR cut-off value of US\$60/t.
- Mineral Reserves are estimated using average gold price of US\$1,250 per ounce, silver price of US\$18.00 per ounce, and copper price of US\$3.00 per pound.
- Average bulk density is 2.7 t/m³.
- Numbers may not add due to rounding.
- Headings -see above.

15.2 DILUTION

Dilution is the material (ore, waste, or backfill) that breaks off from stope and drift walls, backs and walls and which is inherent to underground mining. The dilution was calculated as per the formula and parameters below.

Dilution = (Stope volume + dilution shell) / (Stope volume)

- For primary stopes:
 - Hanging wall and footwall dilution: 0.5m.
 - Unsupported stope back dilution: 0.4m.
 - Supported stope back dilution: 0m.
 - Bottom level floor dilution: 0.25m.

	Document Number	J01834-PM-REP-002	Rev	0	
	Date	11 January 2019	Page	188 of 417	

- Ore/Waste contact limit dilution (North and South): 0.20m.
- Internal dilution from secondary stopes: 0m.
- Dilution from adjacent backfilled primary stope: 0.25m.
- For secondary stopes:
 - Hanging wall and footwall dilution: 0.5m.
 - Unsupported stope back dilution: 0.4m.
 - Supported stope back dilution: 0m.
 - Bottom level floor dilution: 0.25m.
 - Ore/Waste contact limit dilution (North and South): 0.20m.
 - Internal dilution from primary backfilled stopes: 0.25m (each side).
 - Dilution from adjacent backfilled secondary stope: 0.25m.

DRA calculated the number of primary and secondary stopes affected by these dilution factors and estimated an overall stope dilution at 6.31%, with 2.81% coming from low grade and waste, and 3.5% coming from backfill.

Low grade and waste dilution grades were estimated by querying the block model with an envelope of 0.5m thickness around the stope solids which reported average grades of 1.82 g/t Au, 12.76 g/t Ag and 0.096% Cu. These grades were applied to the external dilution. Backfill dilution was given a grade of 0.

15.3 ORE RECOVERY

DRA assessed the stope recovery factor based on the geometry of the deposit and the stopes and the mining methods. The following factors were estimated:

- For 25m long hole stopes, ore loss in the stope is estimated at leaving an equivalent thickness of ore of 0.50m or 2% resulting in ore recovery of 98%.
- For drift-and-fill stopes and ore development, ore loss is estimated at 0% (100% ore recovery).

Since long hole stopes count for approximately 80% of all ore tonnage, overall ore recovery is estimated at 98.4%: $100\% - (80\% \text{ at } 2\%) - (20\% \text{ at } 0\%)$. Overall ore loss is therefore estimated at 1.6%.

15.4 GOLD EQUIVALENT CALCULATIONS

The mineral reserves economic cut-off grade for Loma Larga was estimated at \$60/t NSR. An NSR value was estimated for each block of the block model allowing for metallurgical recovery and consideration of smelter terms, including payables, treatment charges, refining charges, price participation, penalties, smelter losses, transportation, and sales charges. The value of \$60/t selected as the cut-off is the total cost per tonne of ore including mining, processing, G&A, sustaining and closure costs. Any block that has a minimum NSR value of \$60/t is considered ore. Cut-offs were taken at stope and development levels.

Details of the NSR parameters used to calculate the value for each block is presented in **Table 15-2** below.

Table 15-2: Loma Larga NSR Cut-off Parameters



Parameter	Unit	Value
Au Price	USD /Oz	1,250
Ag Price	USD / Oz	18
Cu Price	USD / lb	3
Au recovery in copper concentrate	%	15.0
Ag recovery in copper concentrate	%	49.3
Cu recovery in copper concentrate	%	81.5
Au recovery in pyrite concentrate	%	75.2
Ag recovery in pyrite concentrate	%	45.7
Cu recovery in pyrite concentrate	%	14.5
Au payable in copper concentrate	%	88
Ag payable in copper concentrate	%	80
Cu payable in copper concentrate	%	82
Au payable in pyrite concentrate	%	80
Ag payable in pyrite concentrate	%	60
Cu payable in pyrite concentrate	%	0
Mining & backfill cost	\$/t ore	31.00
Process & tailings costs	\$/t ore	19.50
G & A costs	\$/t ore	7.50
Sustaining costs	\$/t ore	4.70
Closure costs	\$/t ore	1.60
Refinery & transport cost	\$/t conc.	98.00

15.5 EQUIVALENT GOLD

The equivalent gold (AuEq) values in ounces (oz) and g/t (gpt) in the reserves estimate were calculated as follows, based on the parameters in **Table 15-1**:

$$AuEq (oz) = Au(oz) + \left(Ag (oz) \times \frac{\$ 18/oz}{\$ 1,250/oz} \right) + \left(Cu (t) \times 32,150.7 \frac{oz}{t} \times \frac{\$3.0 lb}{14.5833 \frac{lb}{oz}} \right) \times \frac{1}{\$1,250/oz}$$

$$AuEq (gpt) = AuEq (oz) \times \frac{32.1034}{total\ ore\ tonnage}$$

	Document Number	J01834-PM-REP-002	Rev	0	
	Date	11 January 2019	Page	190 of 417	

16 MINING

16.1 INTRODUCTION

The Loma Larga ore body is approximately 1.6 km long, 150 to 400 m wide and 60 to 80 m thick. The bottom of the orebody is relatively flat and lies 175 m below surface at 3,600 m.

The mine has been designed to have the smallest environmental impact possible in terms of the area of disturbance. The mine will be operated as an underground operation which will have a very small surface impact compared to an open pit mining operation.

Access to the mine will be via a surface portal and ramp to the orebody. This portal will be approximately 1.2 km southwest of the center of the orebody. The ore from the mine will be moved via a road from the mine to the process plant facilities which will be approximately 3 km south of the mine as shown in *Figure 16-1*.

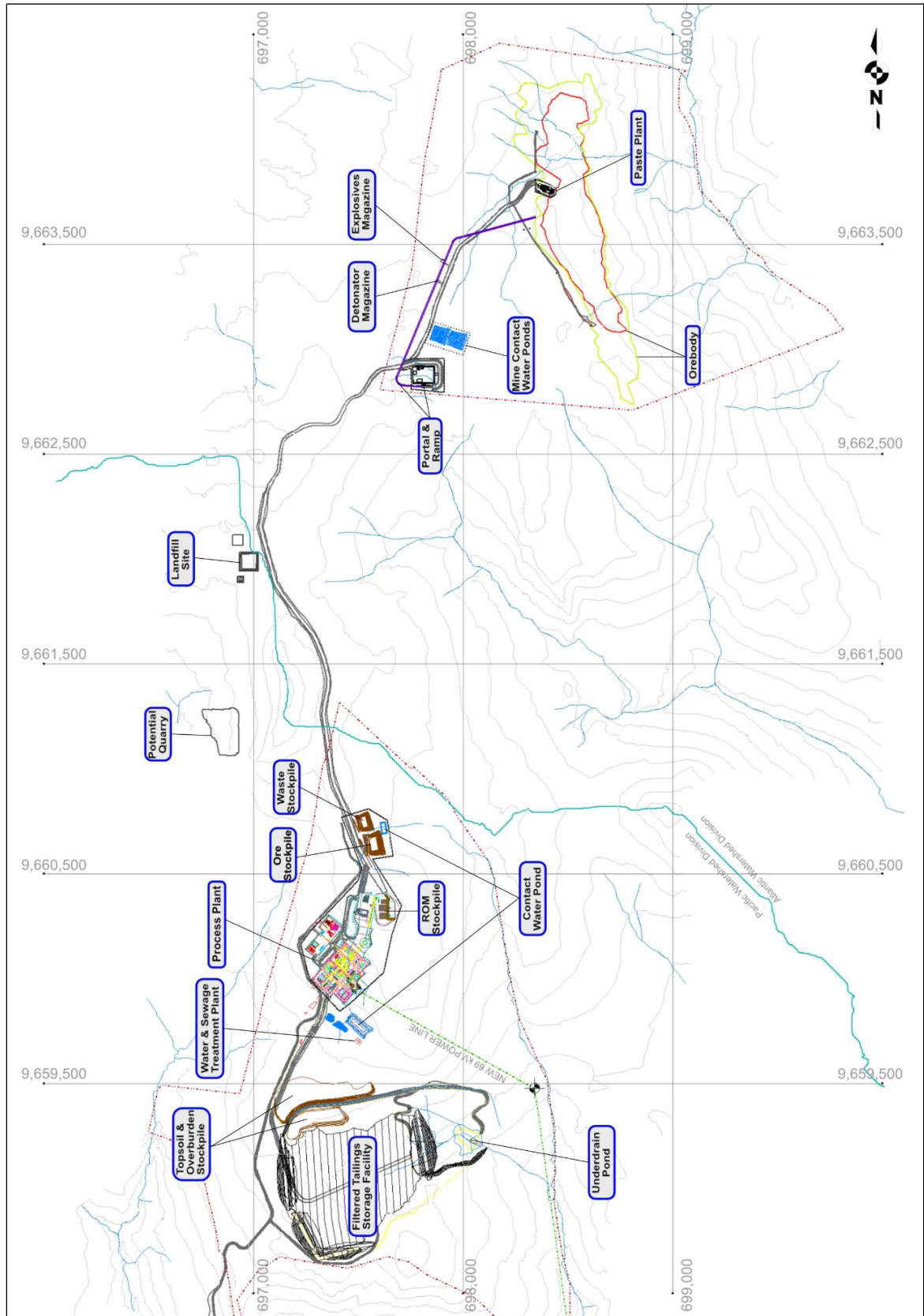

Figure 16-1: Loma Larga Deposit, Portal and Main Surface Infrastructure

16.2 MINING METHODS

The mine has been designed to produce 3,000 to 3,500 t/d from an underground operation using conventional highly mechanized mining equipment routinely used in similar operations around the world.

The orebody configuration will allow for a straightforward and simple mine layout. The mine will have a relatively small amount of lateral development due to the elongated and flat configuration of the ore. There are only three main mining levels and almost no ramp development other than the initial access ramp and the accesses to the three levels.

The principal mining method will be transverse longhole stoping followed by paste backfilling.

Drift-and-fill will also be used where the ore is narrower than a full stope or where the stopes are relatively short in height. The method is very similar to the cut-and-fill mining method.

The selected mining methods are relatively simple, permit standard operating routines and are highly flexible. This, combined with good ground conditions, in a high percentage of the orebody (as per MDEng) should lead to a safe and highly productive operation.

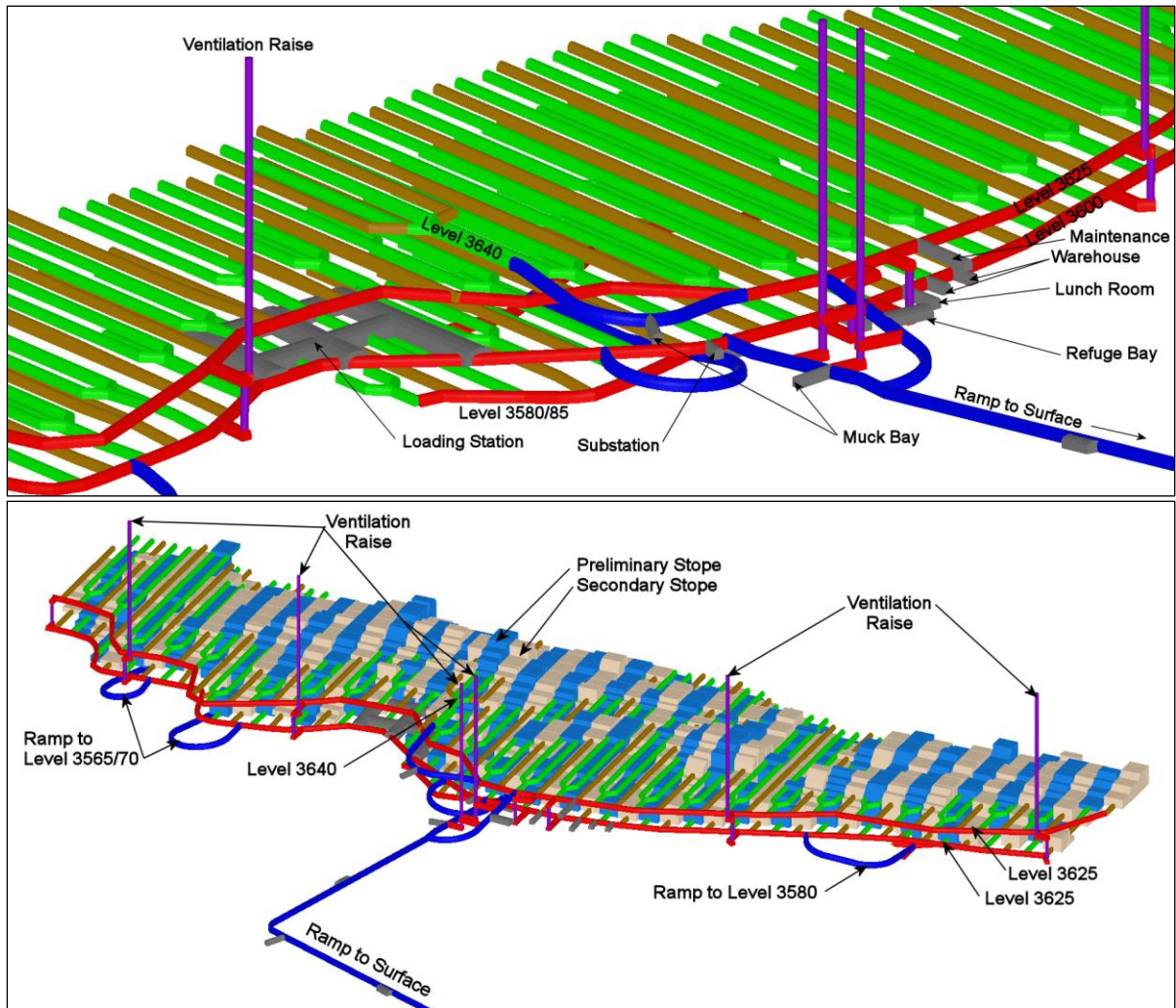

Figure 16-2: Loma Larga Mine Layout

16.2.1 STOPE DESIGN

Stopes were designed using a two-pass method. The first pass design was done using Mining Stope Optimizer (MSO) module in Datamine software to automatically design longhole stopes based on several parameters (minimum and maximum stope dimensions, minimum cut-off, dilution and recovery). The MSO parameters used for Loma Larga are presented in **Table 16-1** below. The second pass was implemented to manually adjust (in Datamine) the automatic Longhole stope shapes designed by MSO to reduce dilution and remove low grade stopes. Drift-and-fill stopes not identified by MSO were also added.

Table 16-1: MSO Parameters for Transverse Longhole Stope Design

MSO Parameter	Unit	Longhole	
		Value	Variance
Block Density	t/m ³	2.75	
Slice Interval	m	0.5	
Default Dip	degrees	90	
Default Strike	degrees	0	
Section Spacing	m	20	18 to 20
Level Spacing	m	25	15 to 40
Maximum Waste Fraction	%	5	0 to 100
Minimum Width of Shape	m	5	
Maximum Length (Span) of Shape	m	100	
Minimum Waste Pillar Width	m	~0	
Minimum Dip Angle of Shape	degrees	85	
Maximum Dip Angle of Shape	degrees	95	
Maximum Strike Angle of Shape	degrees	45	
Maximum Angle Change	degrees	20	
Maximum Side Length Ratio		1.5	

16.2.2 TRANSVERSE LONGHOLE MINING

The majority of the mine will be developed for transverse longhole stoping, with stopes aligned perpendicularly to the strike of the orebody. The stopes will be mined in a primary-secondary sequence, with primary stopes measuring 20 m wide x 25 m high x 20 m deep and secondary stopes measuring 20 m wide x 25 m high x 20 m deep. Mining will start at the footwall (east) and retreat to the hanging wall (west).

Stope access and development will be performed by two-boom jumbos to open the upper drilling drifts and lower drawpoints.

Production drilling will be done by longhole drills, capable of drilling up to 115 mm diameter holes up to 40 m long. Twin parallel drilling drifts in the primary stopes will permit vertical parallel holes along the primary stope walls to help provide smoother blasted walls for tight backfill placement and reduce backfill dilution in adjacent secondary stopes. Secondary stopes will have single centrally located drilling drifts as shown in **Figure 16-3**. Both primary and secondary stopes will use a small raise boring machine to drill the cut.

Mucking of the ore will be done using 17-tonne (10m³) Load-Haul-Dump (LHD) machines equipped with remote control for mucking in the stopes. Broken ore will be brought to three central truck loading and blending stations, including one near the main ramp by the LHDs, before haulage to the surface ore stockpile near the process plant by 40-tonne underground mining trucks.

The truck loading will be carried out by a Caterpillar 988 or equivalent loader which will minimize the truck loading time. The elimination of the truck-LHD interface will make both operations very efficient and reduce the number of machines involved in each operation.

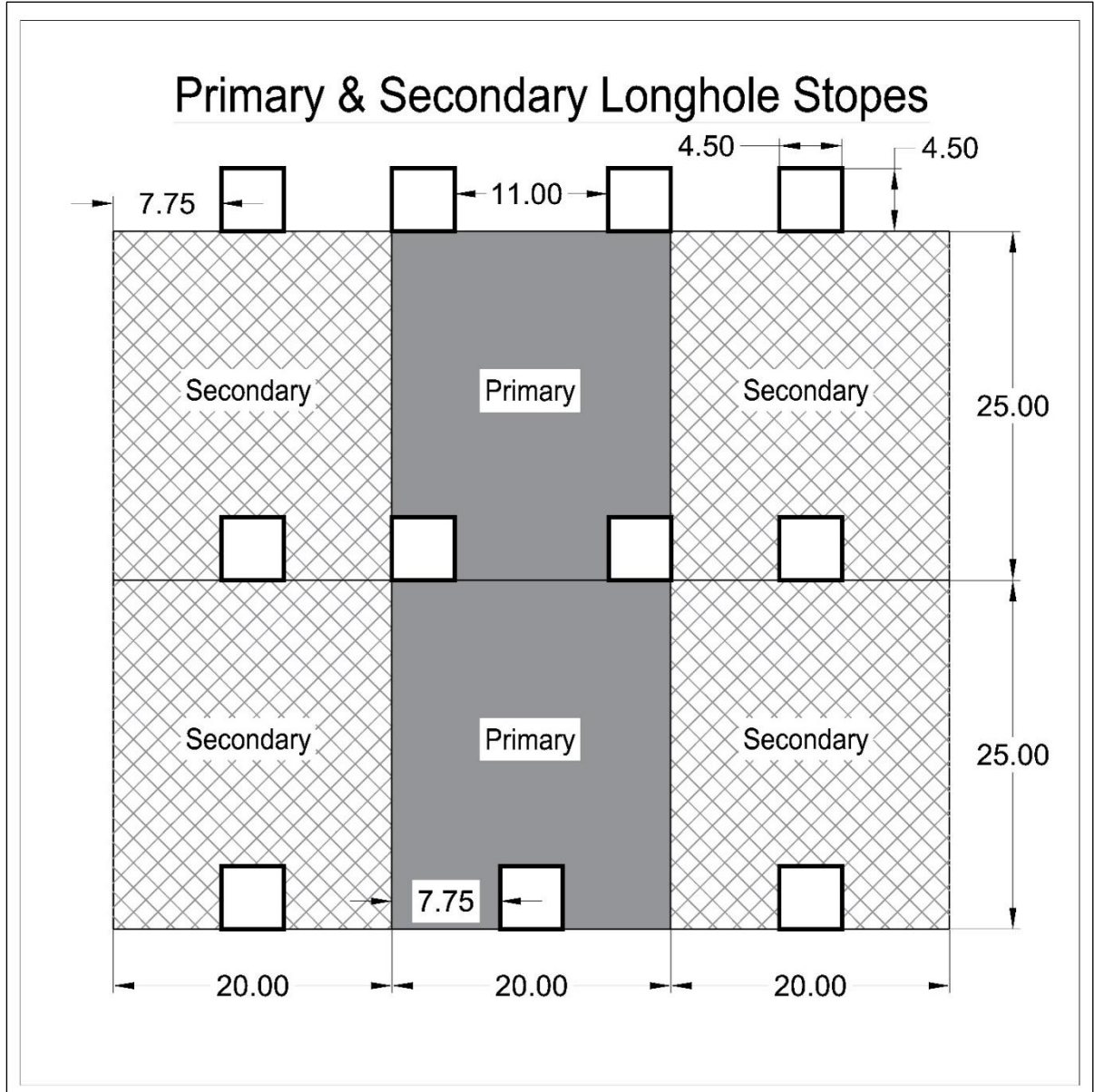

Figure 16-3: Primary and Secondary Transverse Longhole Stopes

16.2.3 DRIFT-AND-FILL MINING METHOD

In areas of the deposit where the thickness of the ore is less than 10 m, the drift-and-fill mining method will be accomplished using lateral development equipment.

For the drift-and-fill operation, the backfill will be pumped in place using a pipe installed in the drift to be backfilled. The backfill will start from the far end of the drift and the backfill pipe will be removed as the backfill is placed. When the backfill operation is completed the upper drift excavation will start. A total of 13,400 m of drift-and-fill will occur at Loma Larga. **Figure 16-4** illustrates the drift and fill mining method.

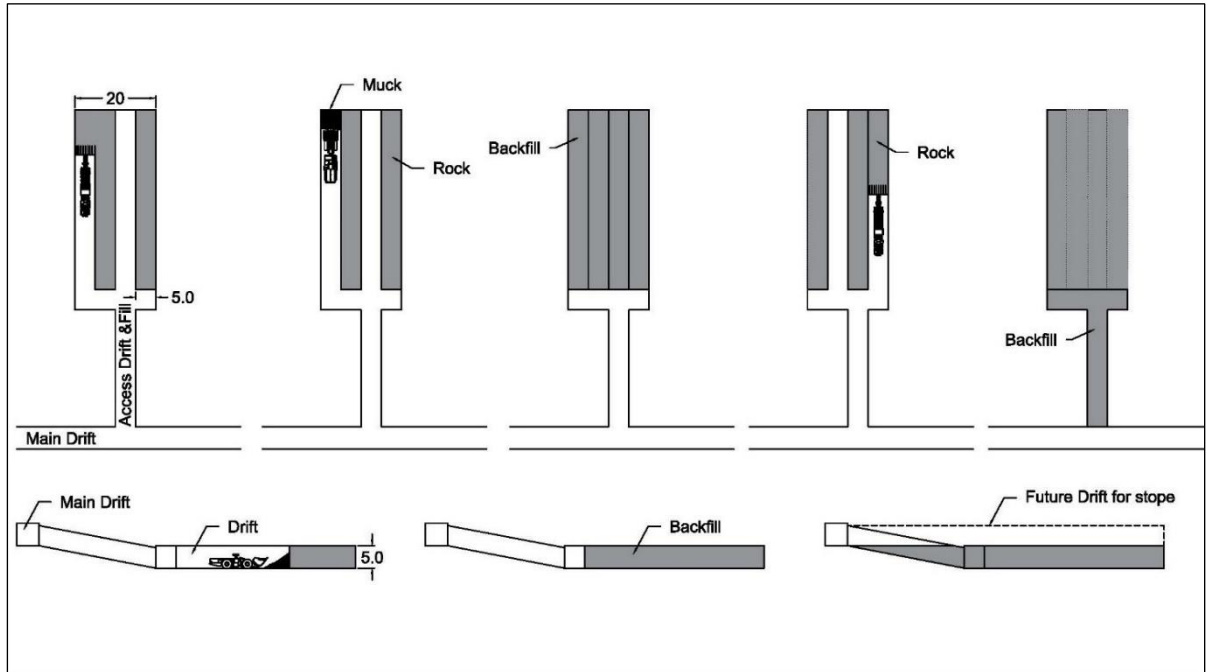

Figure 16-4: Drift and Fill Method

16.3 GEOTECHNICAL CONSIDERATIONS

Geotechnical considerations for the underground development and production were performed by MDEng. The summary of their findings is found below.

16.3.1 GROUND CONDITIONS

The Loma Larga geotechnical site characterization has incorporated geological and geotechnical drill core logs and laboratory strength testing. Detailed review and analyses of all available data has led to the following conclusions:

- Rock quality is closely associated with alteration type:
 - Silicified ground is on average very strong (UCS = 150 to 250 MPa), and of good rock mass quality.
 - Advanced Argillic ground is on average strong (UCS = 50 to 80 MPa), and of fair to good rock mass quality.
 - Propylitic ground is on average medium strong (UCS = 30 to 50 MPa), and of fair rock mass quality.



- The mean rock mass classification rankings for each alteration type is presented in **Table 16-2**.
- Spatial variances in joint set orientations have been identified, resulting in four spatial domains: Dacite, North Volcanics, South Volcanics and West Volcanics. Since all of the domains have less than three well-defined joint sets, wedge-type instability is not a major design consideration. The orientations are summarized in **Table 16-3**.
- The three volcanic domains have a common steeply dipping joint set which strikes north-south (correlating to regional strike-slip faulting). The North and South Volcanics domains have additional steeply dipping sets (NE-SW striking in the north and SSE-NNW striking in the south). These both correlate to fault trends in each of the respective domains. In addition to these sets, the volcanics all have random jointing.
- The dacite features a steeply south dipping joint set, an inclined set dipping to the southeast plus random jointing.
- There is high uncertainty in the in-situ stress field due to limited regional data. This study has evaluated two stress tensors:
 - Extensional: $\sigma_1 = \sigma_v$, $\sigma_2 = 0.7\sigma_v$ (horizontal trending E-W), $\sigma_3 = 0.5\sigma_v$ (horizontal trending N-S).
 - Compressional: $\sigma_3 = \sigma_v$, $\sigma_2 = 1.5\sigma_v$ (horizontal trending N-S), $\sigma_1 = 2\sigma_v$ (horizontal trending E-W).
- Analyses indicate that the in-situ stress field does not play a significant role in mine stability thus the risk associated with this uncertainty is small.

Table 16-2: Summary of Rock Mass Classification Statistics

Alteration	Q' 50	RMR8950
Fresh	13.2	67
Silica	20.5	71
Kaolinite	7.7	62
Illite	6.2	60
Pyrophyllite	9.7	64
Dickite	9.6	64
Smectite	8.4	63
Smectite+Chlorite	4.4	57
Smectite+Illite	3.1	54

Table 16-3: Summary of Joint Set Orientations (Dip/Dip Dir'n, in degrees)

Structural Domain	J1	J2	J3	J4
Dacite	--		74/179	53/132
Volcanics North	86/263	87/033	--	--
Volcanics South	81/077	--	78/156	--
Volcanics West	86/258	--	87/297	--

	Document Number	J01834-PM-REP-002	Rev	0	
	Date	11 January 2019	Page	197 of 417	

16.3.2 LONGHOLE MINING

The base case mining method intended for Loma Larga is primarily transverse open stope.

16.3.2.1 STOPE SIZING AND TRANSVERSE PRIMARY-SECONDARY STOPE

The majority of stopes (approx. 69% of stope backs) are located entirely within the silica domain and are generally expected to perform well. Cable bolting of stope backs in silica is expected to be rarely required and only minor overbreak is anticipated in stope sidewalls. Stopes which expose advanced argillic (approx. 23% of stope backs) or propylitic materials (approx. 8% of stope backs) will perform much more poorly than stopes in silica. It is empirically predicted that roughly a third of stope backs in advanced argillic ground and 80% of stopes in propylitic ground will require cable bolting. Overall (all domains combined), it is expected that cable bolting will be required in 19% of the proposed stope backs.

In the worst ground conditions (7% of all proposed stopes) cable bolts may not be effective at stabilizing the backs of stopes in the advanced argillic or propylitic domains. Stope sidewalls in advanced argillic and propylitic material are also expected to commonly see severe failures (>2 m of overbreak).

Very poor stope performance is expected when advanced argillic and propylitic ground is exposed in stope backs and/or side walls. The exposure of these domains will occur in some areas of the ore body periphery. Smaller stopes in these design domains will significantly reduce this risk; constraints on stope sizes are provided in MDEng report #17018-104.

Another geotechnical risk associated with the weaker alteration domains is that failure may occur in the secondary stope pillar foundations where lower strength argillic and/or propylitic material is encountered. This is particularly problematic where the advanced argillic zone is thin and propylitic material is more likely to be exposed. Strategies for mitigating pillar foundation failure are provided within the MDEng report.

Complete backfilling of all stopes will be important in all areas.

Overall, it is concluded that primary-secondary sequencing presents low geotechnical risk to Loma Larga operations as secondary stope pillars are predicted to perform well. Long transverse stoping panels (multiple stopes per cross cut) provide operational flexibility to optimize stope design by adjusting individual stope panel lengths according to local ground conditions. Adjustments for optimization can also be made for panel length in primary vs. secondary stopes depending on backfill strengths. (Note: longer panel lengths in secondary stopes may increase the amount of cable bolting required within the silica domain).

16.3.3 DEVELOPMENT HEADINGS

Three categories for primary ground support have been defined for the Loma Larga Project according to rock mass quality.

- Category 1: Typical Ground Conditions ($Q \geq 1$)
 - 19 mm or #6 Grade 60 (or better) fully grouted rebar, 2.1 m bolt length installed on a 3-2-3 pattern for each sheet of screen (maximum 1.2 x 1.2 m bolt spacing).
 - #6 AWG screen (sheet size will be 1.5 m x 2.7 m), installed with 3 squares of overlap (bolt through the center square).
 - Screens and bolts across the back and down the walls to within 1.2 m of the floor
 - MDEng does not recommend the use of push plates to pin overlapping screens

- Category 2: ($0.2 \leq Q < 1$) and all Clay Rich rock units with $Q > 1$
 - 19 mm or #6 Grade 60 (or better) fully grouted rebar, 2.1 m bolt length installed on a 3-2-3 pattern for each sheet of screen (maximum 1.2 x 1.2 m bolt spacing).
 - #6 AWG screen (sheet size will be 1.5 m x 2.7 m), installed with 3 squares of overlap (bolt through the center square).
 - 75 mm of shotcrete should be installed.
 - Shotcrete should cover the walls down to the floor. To avoid a loss of shotcrete in the lower portion of the walls, it is recommended that screen and bolts be brought down as low as reasonably possible to the floor (realistically this is likely near 0.5 m).
- Category 3: ($Q < 0.2$)
 - 19 mm or #6 Grade 60 (or better) fully grouted rebar, 2.1 m bolt length installed on a 3-2-3 pattern for each sheet of screen (maximum 1.2 x 1.2 m bolt spacing).
 - #6 AWG screen (sheet size will be 1.5 m x 2.7 m), installed with 3 squares of overlap (bolt through the center square).
 - 100 mm of shotcrete should be installed.
 - Shotcrete should cover the walls down to the floor. To avoid loss of shotcrete in the lower portion of the walls it is recommended that screens and bolts be brought down as low as reasonably possible to the floor (realistically this is likely near 0.5 m).

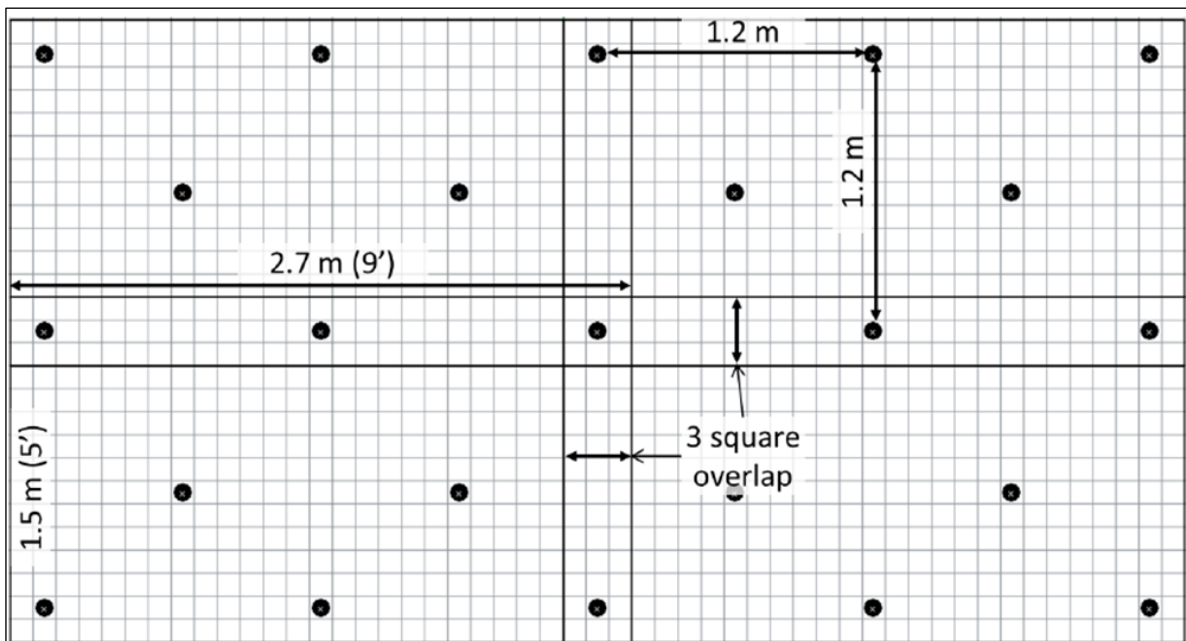

A schematic of the 1.2 m x 1.2 m, 3-2-3 bolting pattern with a 3 square overlap can be found in **Figure 16-5** below.

Figure 16-5: Ground Support for 1.2 m x 1.2 m Pattern

16.3.3.1 LARGER SPANS – SECONDARY SUPPORT

In addition to the primary support detailed above, for larger back spans such as a 3-way or 4-way intersection, secondary support will be necessary in the back. This includes a 4.0 m long, single strand bulbed cable bolts installed on a 2.0 m x 2.0 m pattern which will provide sufficient support for a 3-way intersection spanning 7.0 m, and for 4-way intersections spanning up to 10.0 m. Each individual cable bolt should have a minimum capacity of 25 tonnes. It is recommended that 4-way intersections be avoided to minimize ground control issues. It is also recommended that all very large spans be structurally mapped to verify ground support requirements on a case-by-case basis.

A design of the 3-way and 4-way intersections can be found in *Figure 16-6* below.

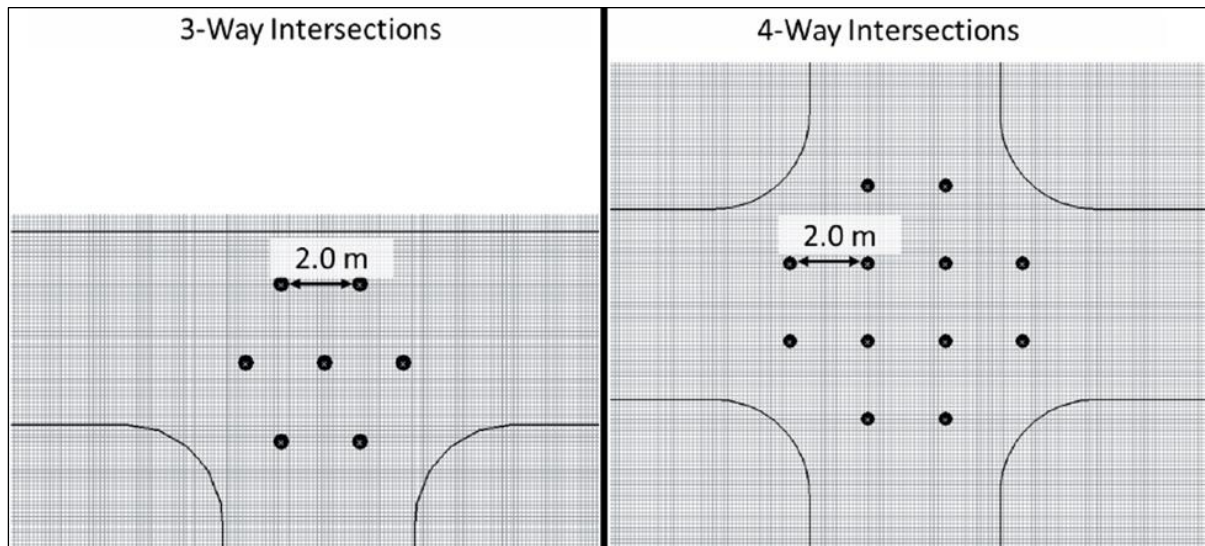

Figure 16-6: Ground Support for 3 and 4-way Intersections



16.3.3.2 DISTRIBUTION OF SUPPORT CATEGORIES THROUGH MINE WORKINGS

A preliminary estimation on the expected ground support requirements has been made for costing purposes. The three primary support categories have been defined on the basis of rock mass quality (in terms of a Q-value range) and type of alteration of rock. By determining the cumulative distribution of rock mass quality for a given rock type, a probabilistic assessment of the Category 1, 2, and 3 primary support requirements can be made. *Table 16-4* presents the estimated percentages of development requiring primary support Category 1, 2, and 3, grouped by each of the major alteration types.

Table 16-4: Percentage of Each Support Category (5 m Spans) by Alteration for Permanent Openings

Alteration Type	% of development by support category		
	Category 1	Category 2	Category 3
Unaltered (andesite) and dacite	96	4	-
Silicified	97	3	-
Non-swelling clay (Kaolinite, Dickite)	-	100	0
Swelling clay (smectite)*	-	78	22

– * The smectite altered rocks have proven to be susceptible to swelling. The design of ground support for swelling ground conditions will require special consideration further discussed below in the Section on Special Design Considerations.

	Document Number	J01834-PM-REP-002	Rev	0	
	Date	11 January 2019	Page	201 of 417	

Special Considerations for Swelling Clays

Swelling clays are located in the propylitic domain and are expected to be most severe near the boundary of advanced argillic alteration, as alteration intensity generally reduces with distance from the siliceous core. The thickness of the swelling clay zone is expected to correspond with the thickness of the adjacent advanced argillic alteration zone. Swelling clays will rarely affect stopes and will primarily influence mine access excavations (ramps and drifts) and ventilation raises.

Excavations in strongly altered smectite zones may incur very high swelling pressures which are likely to exceed the capacity of the conventional support (Categories 1, 2 and 3). It is expected that over-excavation, short rounds, and two cycles (minimum) of ground support will be required to stabilize excavations in highly altered smectite zones. In severe squeezing conditions floor support may be required. There is exceptionally high uncertainty regarding how swelling clays will behave in underground excavations; instrumentation will be heavily relied on to monitor ground behaviour in swelling clays.

The optimal bolt type and support design for poorer ground conditions will require some trial and optimization as severe ground squeezing can be very difficult to control without proper mitigation measures. The potential for squeezing ground to require ongoing support rehabilitation is significant and could lead to production delays if critical infrastructures (i.e. ramps, ventilation shafts) are affected. Development in this type of ground should be avoided whenever practical.

Infrastructure Siting



None of the Loma Larga permanent infrastructure (ramp and raise development) is expected to be influenced by mine-induced rock mass damage

Additional general guidelines for infrastructure siting are as follows:

- Cross structures (faults, contacts, shears) at angles as near to perpendicular as reasonably possible.
- Avoid “stacking” intersections from level to level.
- Minimize spans by avoiding 4-way intersections.
- Based on numerical stress modelling results, there are no stress-related limitations on cross-cut length. A reasonable minimum is three times the haulage drive width (~15 m) to minimize interaction between the haulage drive and stopes. This dimension is more likely to be constrained by operational factors.
- Delay developing secondary cross-cuts until they are needed to minimize required rehabilitation

16.3.4 DRIFT-AND-FILL MINING

Drift and fill stopes can be supported according to the same support classes defined for infrastructure development. Where the span or height of the drift and fill stopes exceeds the typical 5 m span of the development, additional support will be required. This should be analyzed once location and expected ground conditions for drift and fill mining have been identified.

	Document Number	J01834-PM-REP-002	Rev	0	
	Date	11 January 2019	Page	202 of 417	

16.3.5 RAISE SUPPORT

Development plans provided to MDEng include 6 raises to surface. Some of the currently proposed raise locations pass through long (>10m) zones of poor quality ground, though it is understood that the locations of raises have not yet been finalized. Where weak ground conditions are intercepted raise development will be difficult. Special consideration will have to be given to the presence of clay rich units which will be susceptible to deterioration over time (slaking), at which time shotcrete will be required. Some clays may also be susceptible to swelling which will make raise development exceptionally difficult and present significant risk to long-term raise stability. Swelling clays and long zones of weak ground also pose a risk to raise boring equipment and could result in loss of the raise and/or boring equipment. Pilot holes are strongly recommended to verify local ground conditions prior to raise construction.

The stability of individual raises should be analysed at the design stage, following drilling of geotechnical pilot/probe holes at the proposed locations. If ground conditions at the currently proposed locations are deemed unsatisfactory for vertical development, the following guidelines are given for finding more suitable locations:

- Wide, heavily clay-altered zones and long stretches of ground (>10 m) with low RMR should be avoided
- Where bad ground is present near surface, it could be stabilized using conventional shaft sinking techniques prior to raise-boring the remainder of the excavation.
- Areas, where the advanced argillic halo is thinnest, provide the least geotechnical risk.
- Areas between stacked silica zones pose the greatest likelihood of wide clay-altered zones and should be avoided.
- Faults identified in the structural model should be avoided, particularly those located in clay-altered zones.
- Once a new ventilation raise location has been selected a new geotechnical hole will have to be drilled to confirm the new location as suitable.



16.3.6 GENERAL COMMENTS

16.3.6.1 MINING METHOD AND GLOBAL SEQUENCE

The global sequence can be generalized as two active mining blocks, a north block and a south block. Numerical stress models suggest that there are very low geomechanical risks associated with the global sequence. However, it will be very important to follow the mine plan sequencing and to ensure that backfill is placed judiciously to ensure stopes are completely filled, especially in areas with poor ground conditions and in all stopes next to the crown pillar.

16.3.6.2 CROWN PILLAR

Short and long-term crown pillar stability has been evaluated. The application of backfill essentially negates any risk of long-term instability. A 20% probability of failure (POF) has been estimated for short term crown pillar stability. 20% POF is an acceptable standard for service life in the order of one year. If multiple panels are left open simultaneously the POF will increase. A well-managed backfill program is of critical importance for maintaining global mine stability. Backfill should be filled to stope backs as tightly as is practicable to minimize instability. Risk of short-term failure is mitigated by:

	Document Number	J01834-PM-REP-002	Rev	0	
	Date	11 January 2019	Page	203 of 417	

- Ground support installed in stope backs.
- Rapid cycle time to minimize the necessary stand up time for critical crown pillar areas.
- Continuous monitoring. In most circumstances visual monitoring of stope performance and/or cavity surveys will be sufficient. If critical stopes are identified during stoping operations (i.e. very poor local ground conditions encountered during development) conventional geotechnical instrumentation can also be implemented (i.e. slough meters or borehole extensometers installed in stope backs).

From a geotechnical perspective, the most significant crown pillar risk is deemed to be unanticipated fluid flow along the fault structures. Some rock mass yield will occur within the crown pillar over the LOM. It is not known how rock mass yield in the crown pillar may influence groundwater flow from the Paramo horizon to the deep bedrock water system. The risks associated with a high permeability fault zone is increased water inflow (requires a more extensive dewatering program) and degradation of the fault within the crown pillar. In severe conditions fluid flow along the fault zone can result in wash out of fault material which can cause piping failure (and hence accelerated inflows and crown pillar destabilization).

16.3.6.3 FAULTING

Regionally, the Loma Larga deposit is located between the Girón and Bulubulu faults. In the fall of 2016, Orix Geosciences Inc. (Orix) consolidated and validated a project-scale fault model based on previous structural interpretations developed by project geologists and a review of all available surface mapping and drillhole data including core photos. The interpreted structures are based on zones of poor quality ground encountered in exploration holes and surface mapping. Orix validated structures within, and in close proximity to the mineralization. They provided a three-dimensional structural model as shown below in **Figure 16-7**. Structures beyond this footprint have not been validated and are not included in the Orix model. It should therefore be noted that the area beyond the mineralized zone is not devoid of faults, only that they have not been delineated.

The geotechnical characteristics of these faults are highly variable. Ground conditions ranging from minor increases in fracture frequency, to highly fractured zones to clay-gouge seams may be encountered. Faulting in the silica body is more likely to be characterized as fractured with little or no clay while faulting outside of the silica body is more likely to contain clay/gouge seams.

Stope design should consider these faults as proper placement of these faults within. Stope boundaries will mitigate their impact and ensure the extension of these faults are fully supported.

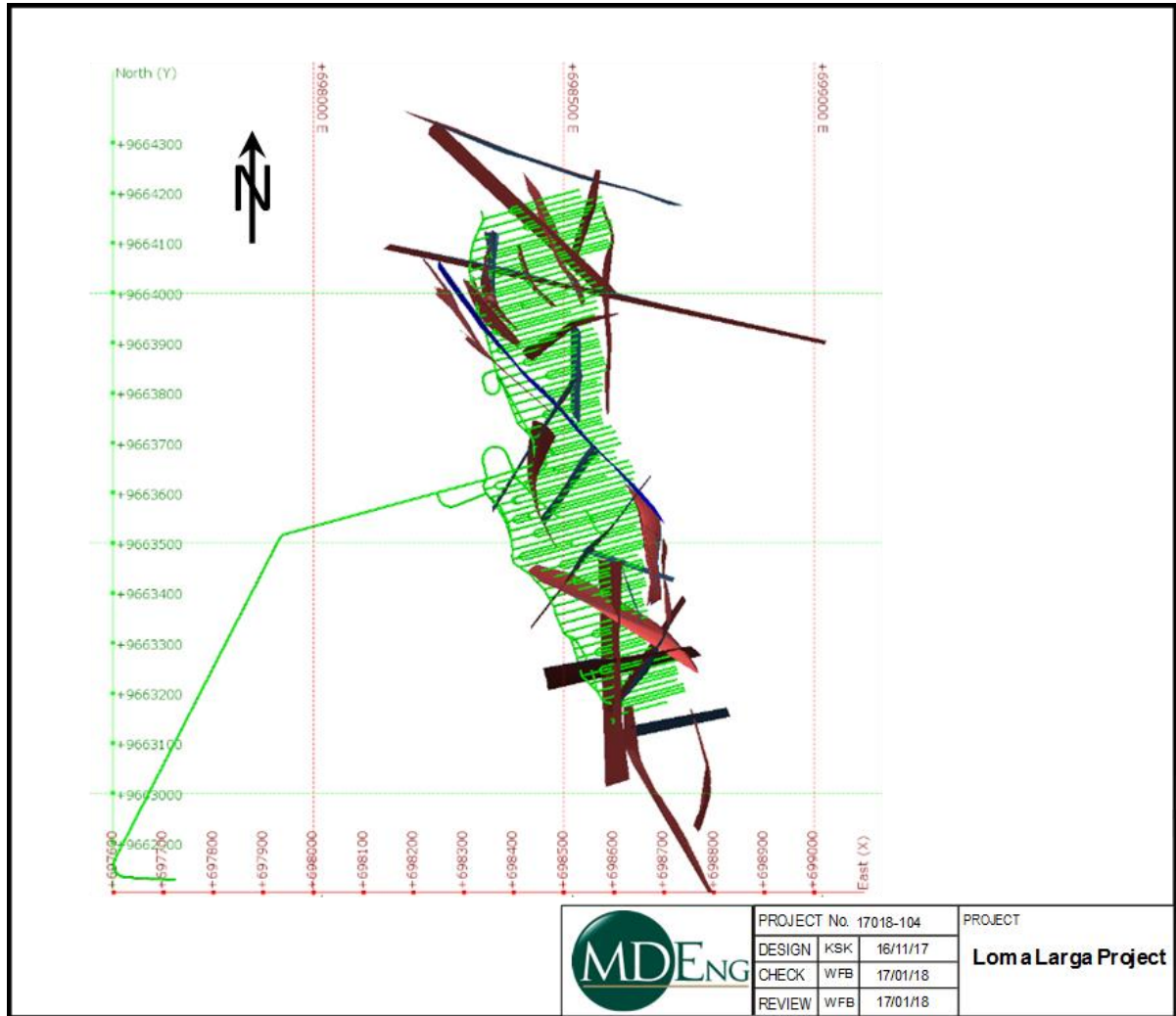

Figure 16-7: Large-Scale Structural Features

16.4 UNDERGROUND MINE DEVELOPMENT

The Loma Larga mine will be developed with underground headings to handle at least 3,000 t/d of ore plus related waste development. Main ramp and headings are sized to handle up to 40-tonne haulage trucks.

16.4.1 RAMP PORTAL

The ramp portal will be excavated in two phases. The first phase will be to excavate the surface rock cut. The soil will be excavated to the bed rock with an excavator. The bedrock will be benched down using a surface drill. The rock will then be trucked to the waste stock pile close to the process plant. The goal is to create a rock face with a 5-metre pillar above the portal. Thereafter, the first portal round will be taken with the tunnelling equipment. The same blast pattern as the ramp will be used and will be described in detail later in this report.

If ground conditions are not as good as expected, modification of the round length, blasting sequence and ground support, etc. must be considered.

The portal will be driven at + 3% slope for 10 metres to avoid any runoff water going inside the mine. The portal area is presented in **Figure 16-8**.

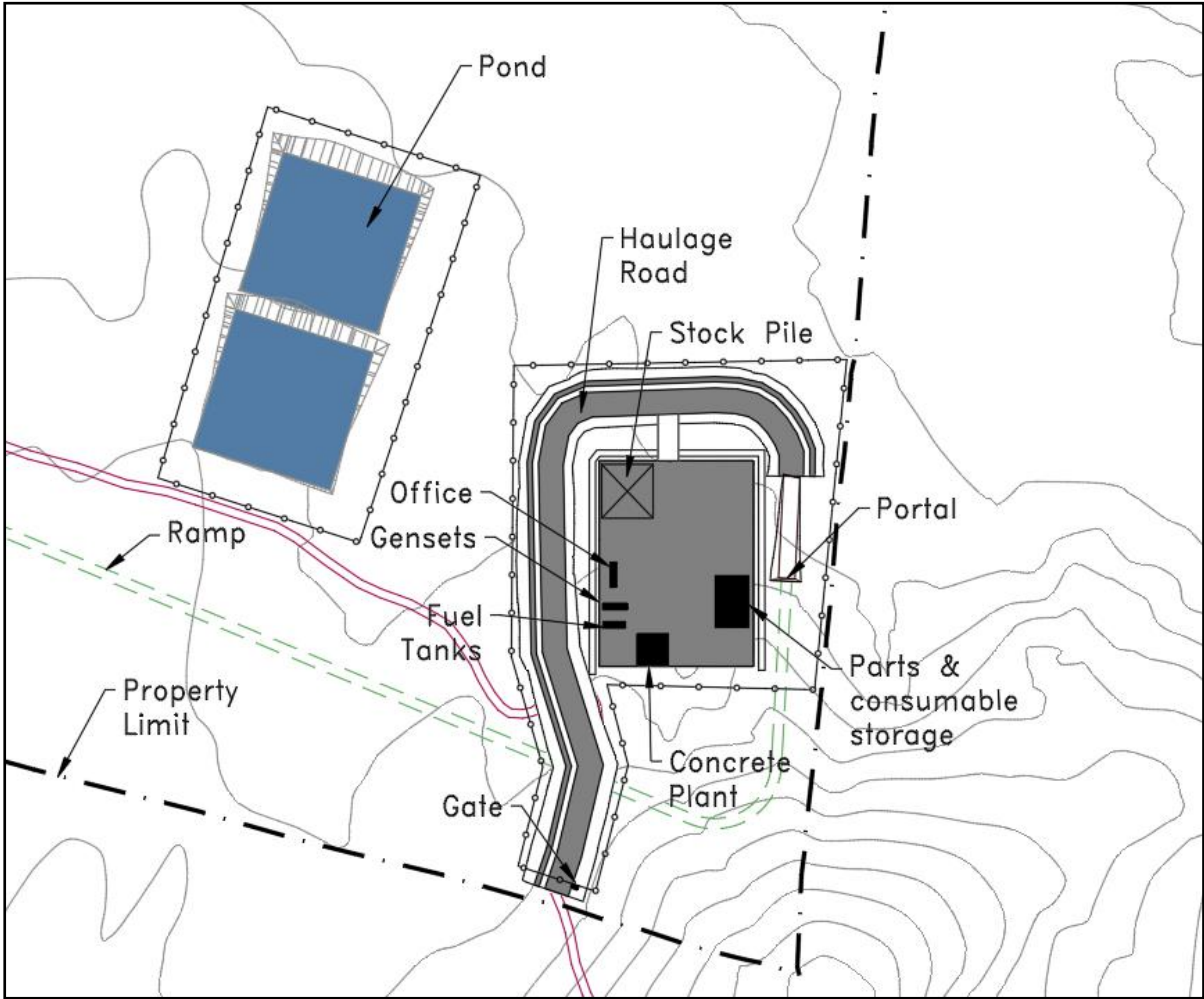

Figure 16-8: Portal Layout



Figure 16-9: Portal 3D View

16.4.2 RAMPS

The main and internal ramps are sized 5 m high by 5 m wide to allow for 40-tonne underground trucks during development and up to 60-tonne trucks during production, and 1.5 m rigid ventilation ducts as shown in Figure 16-10. Ramps have a maximum slope of 15%, which is typical for underground mines.

The main ramp from the surface will have remuck bays every 200 m, sumps every 400 m and safety bays every 30 m. Equipment passing bays are also excavated at every 400 m of the ramp. The main ramp will be approximately 1,200 m long and will include approximately 1,820 equivalent meters of development within an additional 1,150 m of ramp development to be completed to access other levels. The 2.1 m resin ground support and screening will be installed using a fully mechanized bolter. If needed, fibre shotcrete will be applied on top of the screen using a wet shotcrete mix. Mucking of the heading will be completed by 17-tonne load-haul-dump (LDH) equipment to the remuck bay to be thereafter loaded in 40-tonne trucks and hauled to the surface.

The general arrangement of the ramp is shown in *Figure 16-10*.

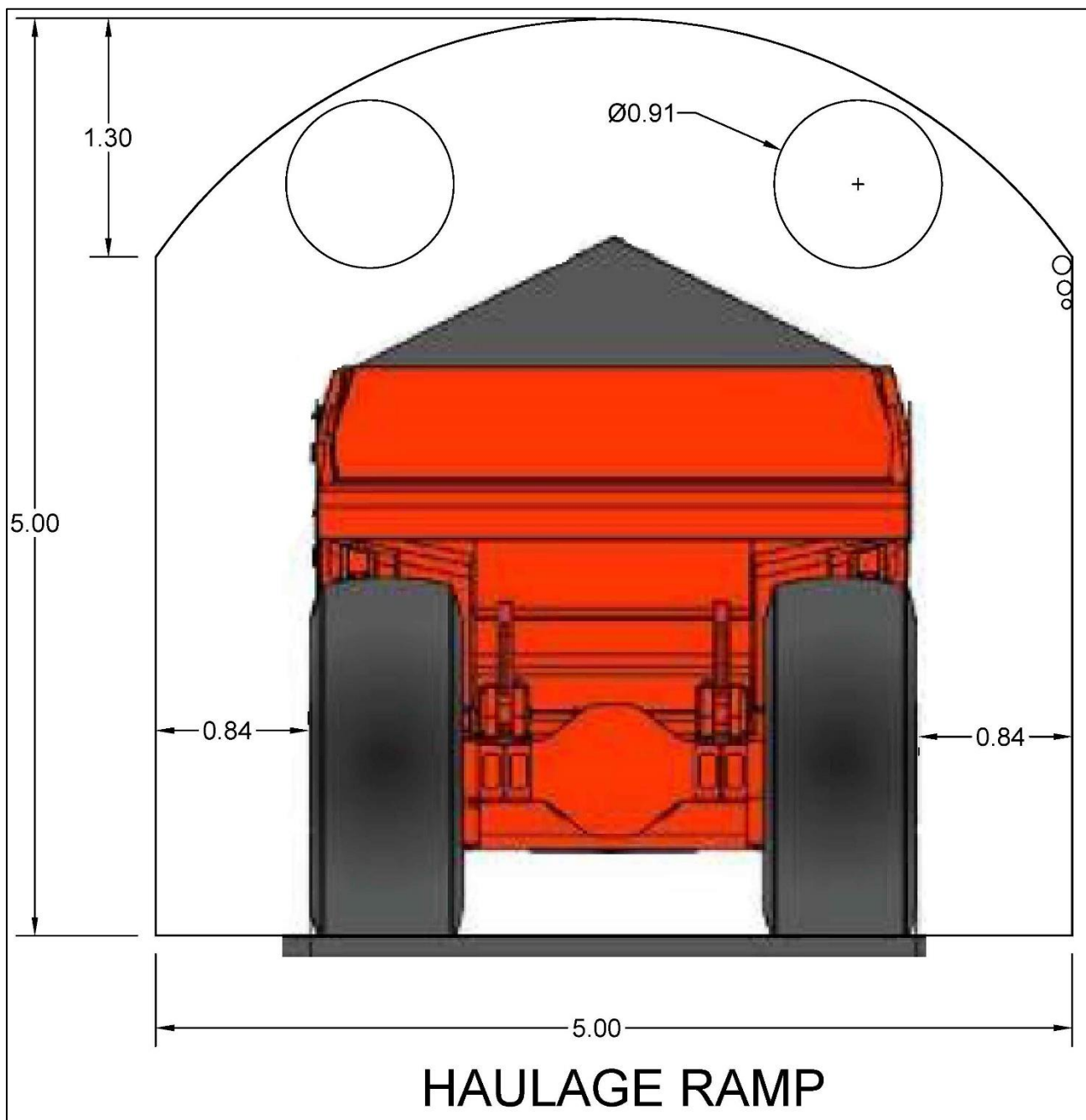

Figure 16-10: Haulage Ramp General Arrangement with 40-ton Truck

16.4.3 MAIN HAULAGE DRIFTS

The main haulage drifts have been designed at 5 m wide by 5 m high to fit a 40-tonne truck and a 17-tonne LHD using a smaller ventilation duct. They will connect the drawpoints to the ramp access located near the center of the level. During production, the main activity in the haulage drifts will be by LHDs carrying the ore from the stope to the loading station. Furthermore, this access will be equipped with services to carry compressed air, water, power, communication and blasting and ground cables, and ventilation conduit to the working areas.

All haulage drifts will be driven at a 3% slope to drain the ground water and process water towards the main ramp where the water management system will be located.

The level access has been designed and located in the best ground possible to optimize ground support requirements. No excavations are presently planned on the east side of the orebody due to ground condition consideration. The primary ground support remains the same as the ramp and is installed sharing the same bolters. The access will be mucked with 17-tonne LHDs to the remuck bay to be later loaded in 40-tonne trucks and hauled to the surface or to secondary stopes as backfill. Alternatively, the waste can go directly to the truck loading station for haulage to the waste stockpile. Parts of the access drift is in ore. This muck will be hauled to the truck loading station and be hauled to the ore stockpile area at the plant (high grade or low grade).

The general arrangement of the main haulage drifts is shown in *Figure 16-11*.

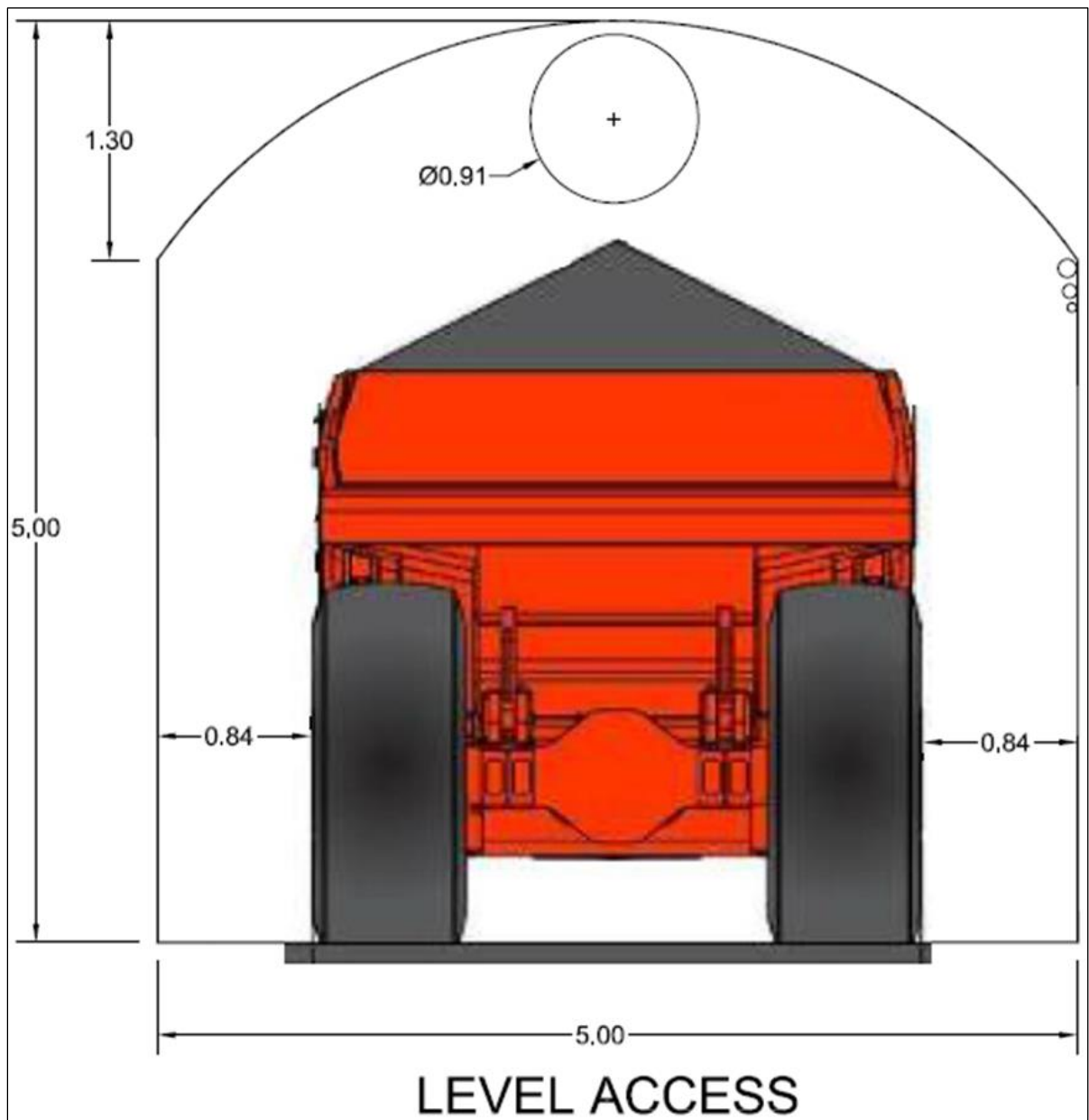

Figure 16-11: Level Access General Arrangement with 40-ton Truck

16.4.4 DRAWPOINTS AND DRILLING DRIFTS

The drawpoints and drilling drifts are designed at 4.5 m wide by 4.5 m high to fit 17-tonne LHDs used for the ore mucking. Temporary ventilation flexible ducting will be installed to ventilate the excavation and ore mucking operations. Temporary services will be installed for longer drawpoints. The drilling drifts will become drawpoints as the stope drilling moves to an upper level.

Including the drilling drift, 37.5 km of drawpoints are planned to be excavated throughout the life of the mine in ore or marginal waste and will be mucked to the truck loading station and to surface proper stockpiles. The ore will be trucked to the surface sorting stockpiles and the marginal ore will be trucked to a surface stockpile near the process plant to be processed at the end of mine life or perhaps as part of the future plant expansion.

The general arrangement of the drawpoints and drilling drifts is shown in *Figure 16-12*.

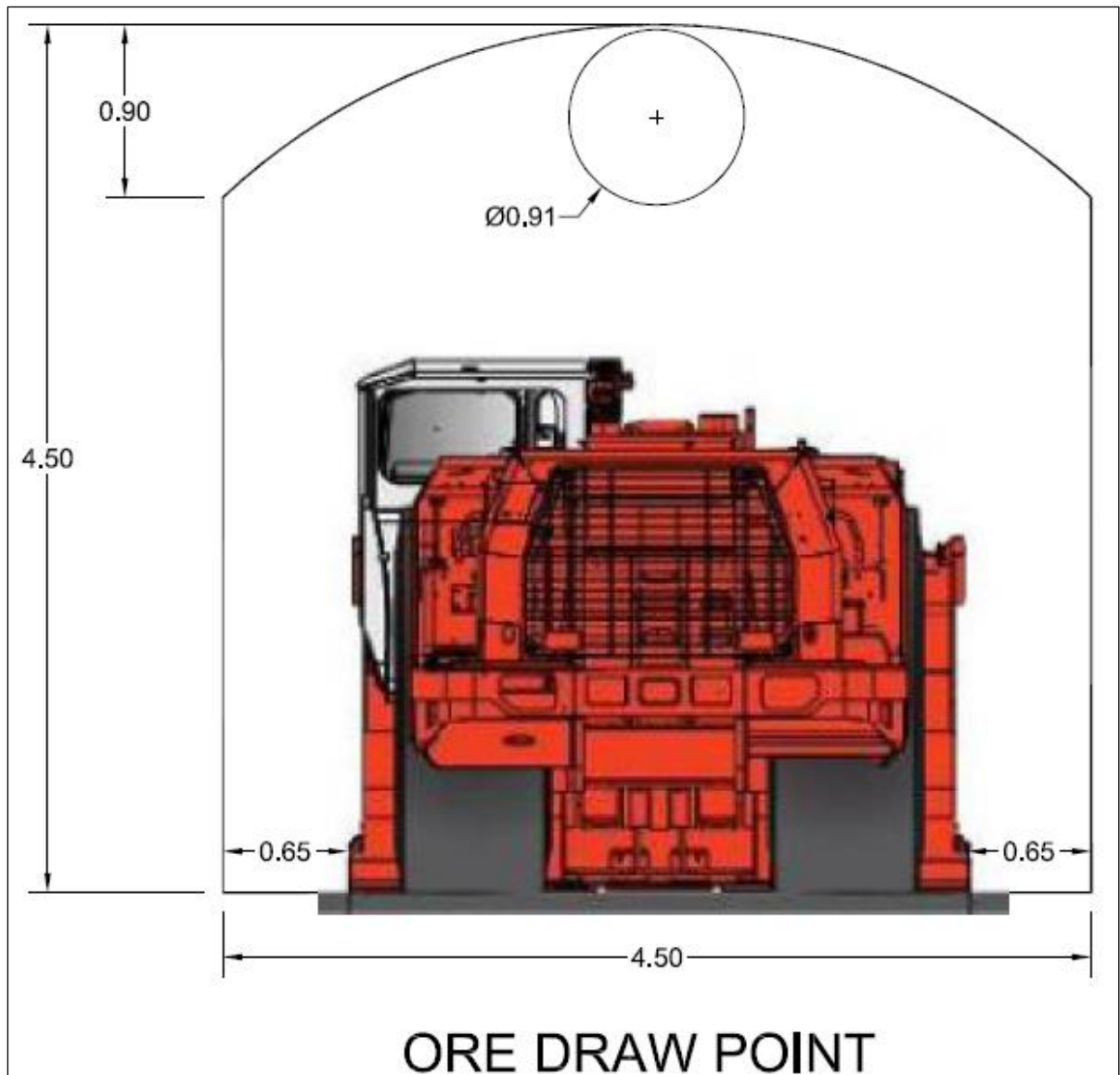

Figure 16-12: Drawpoints and Drilling Drift General Arrangement

16.4.5 TRUCK LOADING STATION

Ore and waste will be moved with LHDs to an underground truck loading station on the 3,600 level. This loading station is a group of temporary storage bays created from opening crosscuts between drawpoints to store ore and waste for easy loading and access of the underground haul trucks without disturbance from LHDs. During the operation, the ore will be stored by grade (high grade, medium grade, low grade and waste) in the different storage bays then loaded into the haul trucks by a dedicated surface loader (Cat 988 type) for transport to the surface stockpiles near the plant. Blending of the ore will be carried out as the ore is being hauled to the plant or on surface at the plant from the high, medium and low-grade stockpiles.

The excavation of the station will use the same methodology as all the other lateral development. Shotcrete will be applied to the back and walls of this excavation that will remain a high traffic area for the full life of the mine. *Figure 16-13* shows a plan view of the loading station.

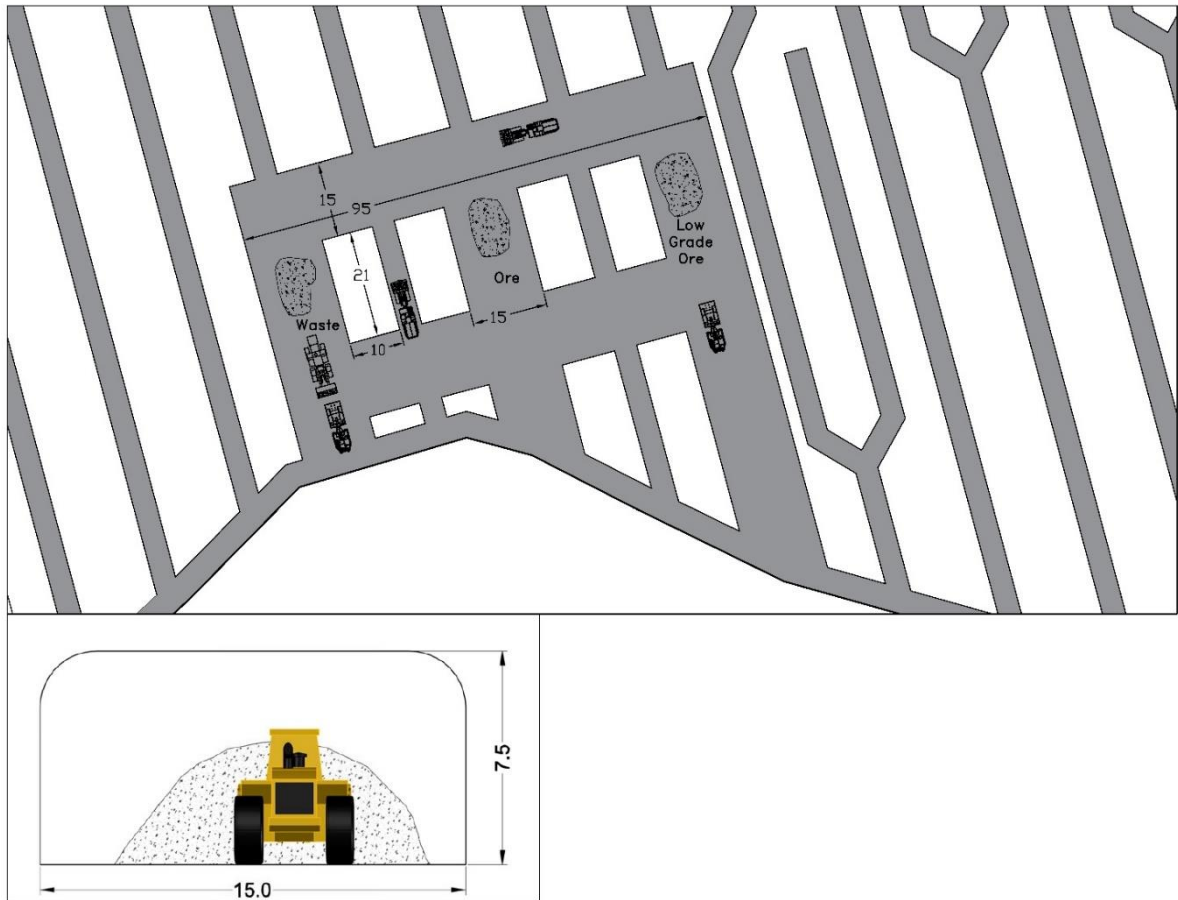



Figure 16-13: Loading Station - Plan View

	Document Number	J01834-PM-REP-002	Rev	0	
	Date	11 January 2019	Page	211 of 417	

16.4.6 ORE AND WASTE PASSES

Ore and waste passes will be limited to excavating short ore and waste passes in low grade ore close to the loading station from the levels above to eliminate ore and waste transport in the ramp. This will allow for limited interference between the LHDs and the haul trucks, while also minimizing the travel time of the LHDs. The ore and waste passes will be excavated using a longhole drop raise method with a production drill.

16.4.7 VENT RAISES AND ESCAPEWAYS

Six vent raises will be excavated from level 3,600 to the surface throughout the LOM to satisfy the ventilation needs of the underground operation. During the first two years, the first two raises will be driven near the bottom of the ramp. One 3.8 m diameter raise will be the air intake and equipped with a manway for a second safety egress (in addition to the main ramp). The other raise will be the air exhaust. The ventilation study recommends 3.8 m diameter vent raises with smooth walls for the other raises. These raises will therefore be driven using a raisebore machine and the ventilation raises have been placed to optimize ground condition and avoid swelling clay. Geotechnical diamond drill core holes will be drilled prior to drilling these holes to ensure they will be in the best ground possible. At the surface, a concrete collar and slab will be poured, and a cover installed to prevent unauthorised access to the mine. Ventilation equipment will be installed underground. For each raise breakthrough on surface, an access road will be built for construction and maintenance.

As part of the ventilation program, small raises will be bored between levels at the far end. Off the main haulage drift, these raises will be equipped with escapeways, to allow second emergency egresses from the levels. Raises will also be bored for ventilation and safety egress for the sublevels below level 3,600.



A total of approximately 1,100 metres of raises will be excavated at Loma Larga for the ventilation system with a raisebore drill.

16.4.8 MISCELLANEOUS UNDERGROUND INFRASTRUCTURE

As part of the mine development, other miscellaneous infrastructure will be excavated in the mine. The main approach is to excavate crosscuts from the main haulage ramp to the size required. Other infrastructure includes: an underground shop; a parking area; a warehouse; a pump station; ventilation raise cut-outs; two main substations; and the main refuge station.

16.5 PRODUCTION SCHEDULE

The production schedule for Loma Larga was prepared using EPS scheduling module from Datamine software based on the 3D stope design and underground development and block model provided by RPA. The software used the productivities and scheduling assumptions listed below as well as the dilution and ore loss described in Section 6 of this Feasibility Study Report.

	Document Number	J01834-PM-REP-002	Rev	0	
	Date	11 January 2019	Page	212 of 417	

16.5.1 PRODUCTIVITIES

The following is a description of the mine scheduling parameters used in the Loma Larga production schedule.

For all working areas of the mine, the productivities take into consideration the Ecuadorian regulation for underground mines, which states that underground miners are limited to six hours of active work underground per eight-hour shift.

- Development heading:
 - The main ramp development will be done as a single heading. The single heading productivity on a 5 m wide x 5 m high is estimated at an average of 140 m per month for 1.3 rounds per day at 3.6 m broken per round.
 - For the remainder of the lateral development, the advancing development will be done as multiple headings. The estimate productivity for the average size excavation is 250 m per month representing 2.3 rounds per day per crew.
- Stope production:
 - The stope productivity is 91,250 tonnes per month, driven by the process plant capacity. Approximately 11,250 tonnes of ore will come from development and 80,000 tonnes will come from stopes.
 - A slot drilling rate was included of four days per slot.
 - The stope drilling and blasting rate is 38 days per blast of 24,000 tonnes.
 - Stope mucking rate is six days per blast of 24,000 tonnes.
- Backfilling rate and curing time:
 - Three days for building of barricade and six days for filling of the stope.
 - 28 days for curing of backfill.

16.5.2 SCHEDULE ASSUMPTIONS

The mine mill complex is designed to produce and process 1,241,000 tonnes of ore per year at a rate of 3,545 t/d, seven days per week, 350 days per year. During the first four years, the high-grade zones will be prioritized, and the mine will produce and process 91,250 tonnes of ore per month at a rate of 3,000 t/d. Starting in year five, when most of the high-grade zone have been mined, the productivity will be increased to 103,417 tonnes per month at a rate of 3,400 t/d. At the beginning, in the pre-production phase, the ore from the level development will be stockpiled at the surface for processing in the initial ramp-up period. The mine is scheduled to ramp up production before the mill is completed construction.

16.5.3 RAMP DEVELOPMENT AND PRODUCTION RAMP-UP PERIOD

The ramp-up period assumes that the main ramp has already been excavated as well as 500 m of level development on level 3,600, and three stopes will be available.

The ramp development schedule is given in the *Table 16-5* below.

Table 16-5: Ramp Development Schedule

Ramp Development	Advance Rate	Cumulative Advance	Notes
Month 1	70 m	60 m	Portal and ramp up period
Month 2	120 m	190 m	1 Heading start
Month 3	145 m	335 m	
Month 4	145 m	480 m	
Month 5	145 m	625 m	
Month 6	145 m	770 m	
Month 7	145 m	915 m	
Month 8	145 m	1060 m	
Month 9	145 m	1205 m	Main ramp bottom
Month 10	145 m	1350 m	Multiple heading level development start

The first nine months of the development will focus on the ramp development. At the ramp bottom, the following month will focus on ramp access to the 3,625 level and 3,600 level, excavating at the same time the main infrastructure rooms. The development crew will then focus on ore development to open stopes in the central zone at the 3,600 level. Prior to the first stope blast, the excavation of the two first vent raises will take place. The permanent pumping system, the first main fan and the electrical installations will all be installed as well.

The pre-production (or ramp-up) phase will start then with three development crews in the ore development. The ore development will produce 52,100 tonnes of ore which will be stockpiled at the surface. **Table 16-6** and **Table 16-7** below outline the production ramp-up and stockpiling of ore on surface during the same period.

Table 16-6: Pre-Production (Ramp-up) Phase

Month	Stope Ore (t)	Development Ore (t)	Total (t)
Month 11	0	3,900	3,900
Month 12	6,000 (1 Stope)	17,300	23,300
Month 13	7,900 (2 Stopes)	21,400	29,300
Month 14 (Mill Start)	24,700 (2 Stopes)	9,400	34,100
Month 15	40,100 (3 Stopes)	12,900	53,000
Month 16	76,300 (4 Stopes)	13,900	90,200
Month 17	47,600 (4 Stopes)	11,000	58,600
Month 18	79,000 (6 Stopes)	10,000	89,000
Month 19	72,000 (6 Stopes)	21,300	93,200

Table 16-7: Ore Stockpiling During Pre-Production Phase

Month	Mine (t)	Mill (t)	Ore Stockpile (t)
Month 11-13	56,500	0	56,500
Month 14 (Mill Start)	34,100	-53,500	37,100
Month 15	53,000	-73,000	17,100
Month 16	90,200	-77,500	29,800
Month 17	58,600	-86,700	1,700
Month 18	89,000	-90,400	200
Month 19	93,200	-91,250	2,200



As described in **Table 16-6** at the end of the ramp-up period, the mine will start stope production to rapidly ramp up to full production in the next month. The process mill and backfill plan will commence one months later and continue with the design production of 3,000 t/d.

16.5.4 MINE PRODUCTION SCHEDULE (MINE PLAN)

The total proven reserve is estimated to be 13,976,476 tonnes of ore which represents 2,199,965 ounces of gold that will be produced over 12 years as per the schedule below, using the scheduling parameters discussed previously. The mine plan presented in Table 16-8 below does not show the blending taking place at the process plant stockpiles and does not represent the actual ore going through the plant. The process plant schedule is discussed in Section 17 of this Technical Report.

Table 16-8: Detailed Mine Schedule

Description	Units	Pre Production					Year 1					Year 2					Year 3					Year 4	Year 5	Year 6	Year 7	Year 8	Year 9	Year 10	Year 11	Year 12	Total
		Q-1	Q-2	Q-3	Q-4	Q-5	Y1-Q1	Y1-Q2	Y1-Q3	Y1-Q4	Y1-Q4	Y2-Q1	Y2-Q2	Y2-Q3	Y2-Q4	Y2-Q4	Y3-Q1	Y3-Q2	Y3-Q3	Y3-Q4	Y3-Q4										
Gold Production	Ounces	14,297	43,186	52,039	61,636	61,258	53,800	74,959	62,057	76,509	233,771	164,944	157,743	158,882	150,688	163,646	139,785	152,567	90,310	2,198,965											
Equivalent Gold Ounces	Ounces	16,126	49,506	58,293	68,270	68,623	59,811	86,058	72,276	90,525	278,631	195,745	186,834	180,271	180,533	195,124	162,225	179,330	105,594	2,583,628											
Ore Production	t	56,474	177,343	240,697	280,189	276,857	268,266	277,516	279,274	280,511	1,132,853	1,249,328	1,259,979	1,260,005	1,259,436	1,259,693	1,250,328	1,209,679	785,302	13,976,476											
Mine Production	t	56,474	177,343	240,697	280,189	276,857	268,266	277,516	279,274	280,511	1,132,853	1,249,328	1,259,979	1,260,005	1,259,436	1,259,693	1,250,328	1,209,679	785,302	13,976,476											
Ore (onstage (Shipping))	t	13,792	141,144	195,425	246,118	246,194	233,215	226,149	249,900	223,218	1,005,493	1,095,586	1,119,377	1,119,600	1,121,592	1,190,889	1,219,736	1,183,886	1,175,039	784,625	12,922,912										
Ore (onstage (Development))	t	42,683	35,200	42,272	34,081	28,663	13,042	51,367	29,375	55,293	106,358	127,219	97,951	80,300	44,213	68,337	39,937	61,432	33,947	10,677	1,005,964										
Ore meters (stopping)	equiv/m	-	-	-	-	-	-	1	6	8	10	10	9	10	9	41	49	30	48	32											
Gold Grade	g/t	7.87	7.57	6.72	6.84	6.88	6.17	8.40	6.94	8.48	8.13	6.42	4.10	3.89	3.87	3.72	4.04	3.92	3.53	4.31											
Copper Grade	%	0.47%	0.46%	0.34%	0.34%	0.37%	0.31%	0.46%	0.42%	0.54%	0.60%	0.42%	0.26%	0.21%	0.22%	0.22%	0.16%	0.24%	0.21%	0.28%											
Silver Grade	g/t	27.0	30.3	26.8	23.5	26.3	22.1	39.9	34.9	51.3	45.6	41.9	26.8	27.9	25.8	28.1	23.0	23.0	21.1	29.6											
Equivalent Gold Grade	g/t	8.88	8.88	7.51	7.89	7.81	6.95	9.85	8.05	10.04	9.69	7.85	4.87	4.61	4.45	4.46	4.82	4.04	4.15	5.77											
Waste development	t	4,983	32,462	32,677	39,215	17,742	3	25,873	45,203	32,582	9,217	1,268	1,031	31,720	39,813	35,303	15,166	15,449	7,387	451,053											
Latent Development meters	m	68	503	465	555	2,148	1,811	1,872	1,872	1,892	1,521	5,448	3,544	3,535	1,888	1,883	1,888	1,023	235	38,954											
Ramp	m	69	405	433	444	196	-	-	191	166	-	-	265	-	-	-	-	-	-	2,347											
Infrastructure	m	-	88	62	111	-	-	-	8	30	-	-	57	8	42	10	10	144	16	1,004											
Level Access	m	-	-	-	-	-	-	-	-	-	-	-	-	-	-	-	-	-	-	2,896											
Footwall DIRT (5m x 4.5m)	m	-	-	-	-	-	-	-	-	-	-	-	-	-	-	-	-	-	-	37,612											
Vertical Development Meters	m	-	-	-	-	-	-	-	-	-	-	-	-	-	-	-	-	-	-	1,115											

	Document Number	J01834-PM-REP-002	Rev	0	
	Date	11 January 2019	Page	216 of 417	

16.6 DRILLING AND BLASTING

Details for drilling and blasting for the different development headings and production is presented in this section of the report.

16.6.1 DEVELOPMENT HEADINGS

All development headings will be drilled with a two-boom hydraulic jumbo. All blast holes will be charged with an ammonium nitrate and fuel oil (ANFO) loader (usually ANFO and emulsion for wet areas).

16.6.1.1 RAMPS

The ramp will be excavated using drill and blast methodology. A two-boom jumbo will drill the 5 m wide by 5 m high ramps. The arch height will be 1.3 m which represents 26% of the tunnel width, and the arch radius will be 3.06 m. The round depth will be 3.6 m deep, the blast holes will be 45 mm diameters and four cut holes will be rimmed to a 101 mm diameter. A total of 25 perimeter holes will be drilled at a spacing of 60 cm and charged with light control explosives to minimize overbreak and wall damage. A total of 42 production holes, with four reamed to 100 mm, including the 13 holes cut, will be charged with ANFO and the seven lifters will be charged using stick emulsion. In normal ground conditions the jumbo will be drilling 3.8 metre rounds and breaking 3.6 meters. Shorter rounds may be drilled in difficult ground conditions.

The blast pattern for the ramp excavation is shown in *Figure 16-14*.

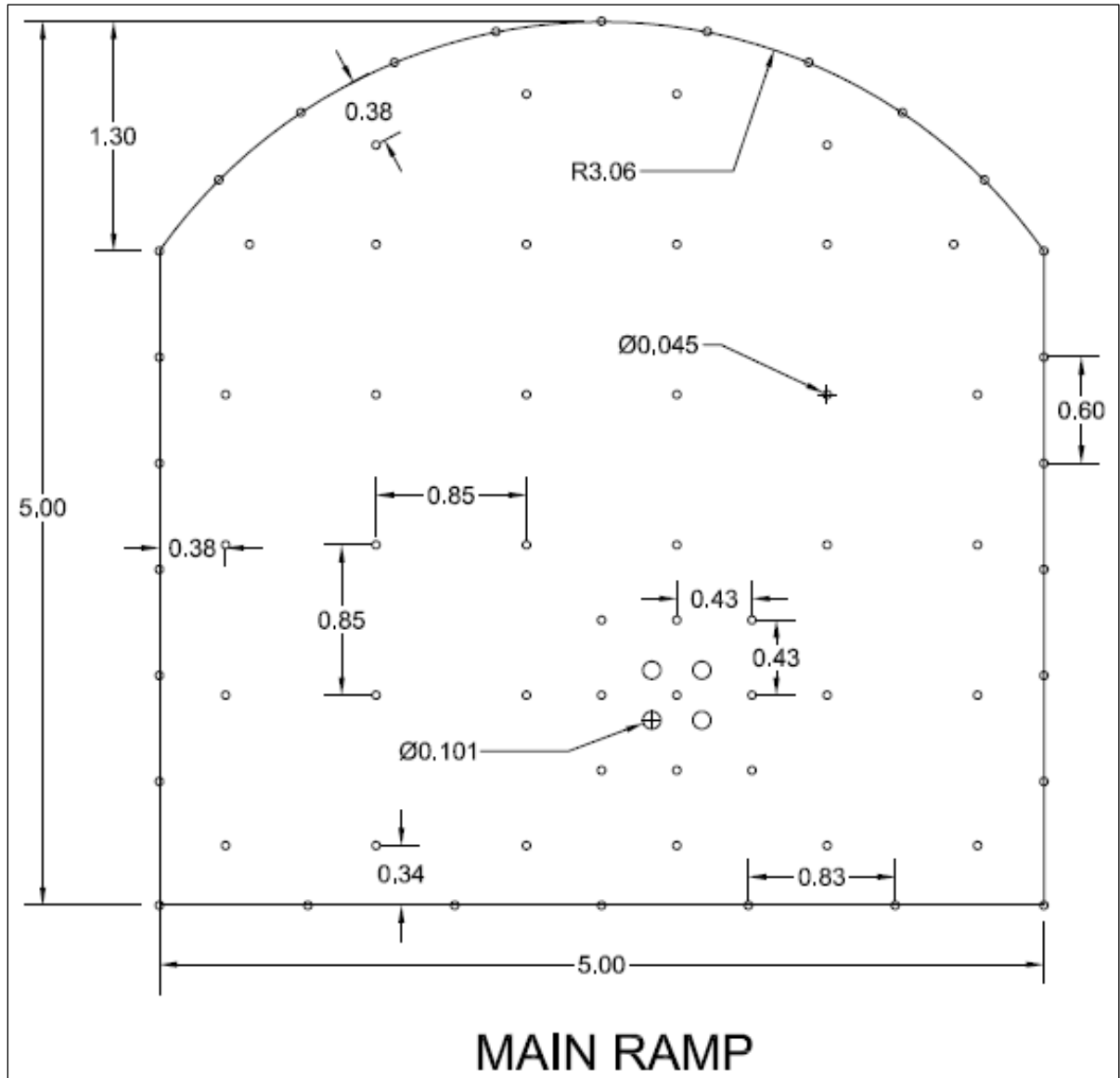

Figure 16-14: Main Haulage Ramp and Main Haulage Drift Blast Drilling Pattern

The same drill jumbo and the same blast methodology as the ramp will be used for the other lateral development heading. The blast pattern for the main haulage drift will be similar to the main ramp and the ore access drifts (drawpoints) drilling pattern in presented in **Figure 16-15** below.

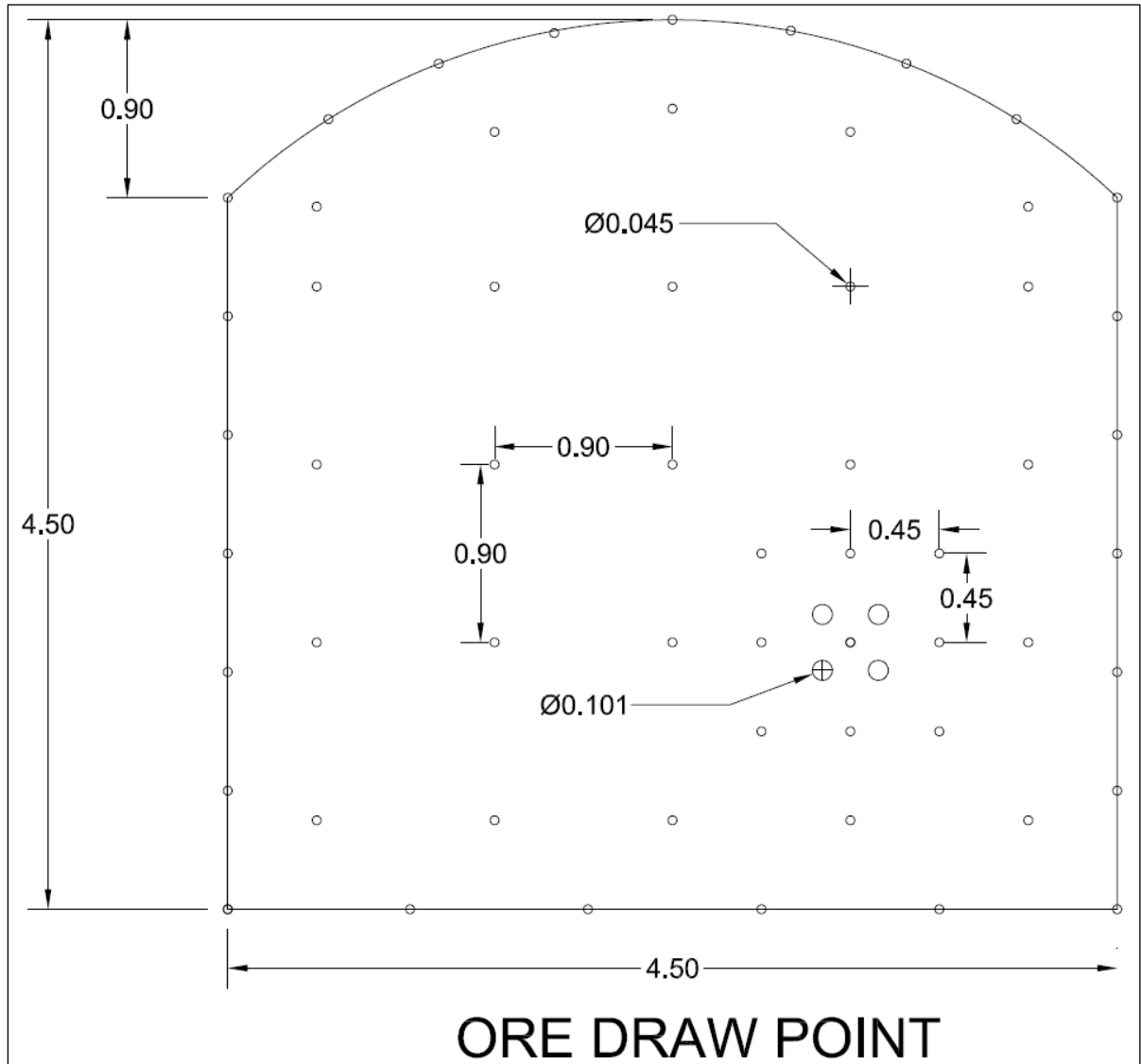



Figure 16-15: Drawpoint Drift Blast Drilling Pattern

16.6.2 TRANSVERSE LONGHOLE STOPES

Production drilling is done using a longhole hydraulic drill. For the primary stope, the perimeter holes are drilled parallel and the center is fanned. The secondary stopes are drilled on a fanned pattern. For all stopes, the blast hole diameter is 115 mm by 25 m long and is loaded with ANFO. The average spacing and burden is 1.83 m and average staming is 13 m. A 76 cm diameter open cut is drilled using a small raisebore machine. Overall powder factor is 0.56 kg/tonnes.

16.7 MINE EQUIPMENT

The underground mining equipment fleet was chosen based on the evaluation of productivity needed to achieve the daily production rate of 3,000 t/d (3,400 t/d in year five), 350 days per year. Including a variability factor of 85%.

	Document Number	J01834-PM-REP-002	Rev	0	
	Date	11 January 2019	Page	219 of 417	



The underground equipment fleet has been chosen based on productivity, safety, reliability, anticipated to be achievable in Ecuador. The study assumed that INV will purchase the underground mining equipment fleet.

The development of the ramp and pre-production phases will be accomplished by the owner. Prior to the ramp portal, a fleet of equipment will be purchased to complete the 1,200 m of the main ramp access. After the nine months of the main ramp development, it is anticipated that INV will have purchased and received a full underground equipment fleet and will increase to three lateral development crew and start the stope development and production.

16.7.1 EQUIPMENT OPERATING PARAMETERS

The equipment selection for the Loma Larga Project was based on a productivity goal of 3,000 t/d. For each major mobile equipment, the productivity was calculated in relation to the working area. The average operating parameters are as follows:

- 17-Tonne LHD
 - Hauling distance: 500 m maximum.
 - Average LHD loading and dumping time: 90 sec per bucket.
 - Haulage speed: 11 km/hr maximum.
 - Mechanical Availability: 85%.
 - Trips per hour: 12.9.
 - Load factor: 14.5 t.
 - Overall Productivity: Tonnes / LHD / shift: 180 t.
 - Overall Productivity: Tonnes / LDH / day: 540 t.
 - Overall Productivity: Operating LHD required: 7 (6 considering mechanical availability).
 - Effective hours / shift: 6 hrs.
- 40-Tonne Truck
 - Hauling distance: 5,160 m.
 - Average speed: 11 km/hr.
 - Loading and dumping time: 3 minutes 45 seconds.
 - Haulage time roundtrip: 57 mins (from truck loading station to surface stockpile near concentrator).
 - Availability: 85%.
 - Load factor: 100%.
 - Overall Productivity: Tonnes / truck / shift: 180 t.
 - Overall Productivity: Tonnes / truck / day: 540 t.
 - Overall Productivity: Operating trucks required: 7 (6 considering mechanical availability).
- 2 Boom Jumbo
 - Availability: 80% (multiple heading).
 - Overall productivity: 57 drilled m per hour (29 m per boom hour).
- Bolter
 - Availability: 80% (multiple heading).
 - Overall Productivity: 14 m of bolt per hr + 10 m² screen per hour.
- Longhole Production Drill

	Document Number	J01834-PM-REP-002	Rev	0	
	Date	11 January 2019	Page	220 of 417	

- Availability: 80%.
- Overall Productivity: 5.5 drilled m per hour.
- ANFO Loader
 - Availability: 80%.
 - Overall Productivity: 744 kg loaded per hour.

16.7.2 DEVELOPMENT MINING EQUIPMENT

The level access and the stope drawpoints development will be drilled using two boom hydraulic jumbos. The two-boom jumbo has been selected based on the size of the different headings at Loma Larga. For the ramp and lateral development, the jumbo will drill a 3.8 m round and break 3.6 m with an average of 70 blast holes of 45 mm diameter with four ream holes in the cut of 100 mm diameter.

The development face will be loaded using a mobile ANFO Loader. This loader will also be used to load the production stopes and has been selected for its productivity and mobility as it will need to travel from the explosive magazine to all underground headings and stopes. When the mine reaches the full production of 3,000 t/d, one ANFO loader with an average of 10 hours per day to load 2,500 kg of ANFO per day will be required. A second separate loader will also be required.



16.7.3 GROUND SUPPORT EQUIPMENT

The ground support will be done using a two-boom bolting Jumbo. The first boom will be equipped with a screen holder and the second boom equipped with a drill and carousel to install 2.4 metre resins grouted rebars. The bolter will also be equipped with a resin cartridge injector. To complete the ground support at the peak of the mine development phase, two bolters will be needed, both working 15 hours per day to install 120 square m of screen and 120 rebars for the 4 rounds per day.

Stopes will be cable-bolted using a fully automated and mobile cable-bolter. The cable-bolts will be drilled, installed and grouted with that same unit. Only one cable bolter will be used when required and will install a maximum of 400 m of cables installed per day. The cables will be 6 to 12 m long depending on the ground support requirement.

16.7.4 MUCKING EQUIPMENT

Mucking of the development round will be done using 17-tonne LHDs. In the early development phases, the waste from the development round will be mucked with the LHD to the closest waste transfer bay (remuck bay) and from there, will be loaded into 40-tonne haulage trucks and dumped in the waste stockpile at the surface. When the secondary stopes will be operational, the waste from the development will be dumped directly into them, also the surface waste stockpile will be hauled back underground to be dumped into the secondary stopes. The ore development round will be mucked with 17-tonne LHDs directly into the underground truck loading station then loaded, using a 14-tonne front end loader, into 40-tonne truck and haul to the surface stockpile close to the plant. The truck loading station has been inserted into the process for two reasons. First, to make the LHD equipment more productive as these pieces of equipment will not be loading the trucks. Second, the truck loading stations will make the trucks more effective as they will always have a full load and at

	Document Number	J01834-PM-REP-002	Rev	0	
	Date	11 January 2019	Page	221 of 417	

no time will they be waiting to be loaded as the loader will be fully dedicated to this work. The loader will also load the trucks faster than an LHD.

The 40-tonne trucks give the flexibility and mobility needed for this operation and reduces the size of the main access drift and ramp. At full production, the mine will need seven LHDs, seven haulage trucks and one loader working full time.

16.7.5 PRODUCTION DRILLING

The production drilling will be accomplished using hydraulic Top Hammer Drills. The production drills will be mobile and equipped with an air compressor for drill lubrication and with a carousel to handle 1.5 m drilling rods. Hydraulic Drills will be required to offset for the loss of power at high altitudes. The blast hole diameter will be 115 mm diameter and a 760 mm diameter boring head will be used to drill the cut hole. The plan is to ramp up the production to three drills working full time and drilling on average 90 metres per day, per unit.

16.7.6 SHOTCRETE INSTALLATION

The shotcrete operation will be assumed to be a wet shotcrete sprayer. The wet shotcrete gives the opportunities to pre-mix additives and fibers to the concrete batch. The shotcrete mix will be carried underground using a concrete low profile mobile mixer. One shotcrete sprayer will be on site and ready to work when needed. One mobile concrete mixer will be on site to support the shotcrete operation and some underground concrete pouring in the early construction phases. The concrete will be prepared in the concrete plant located on surface.

16.7.7 SERVICE VEHICLES

The service installations will be assumed by two scissor decks and will also be used to assist the mine development and production activities.

The major mobile underground equipment purchased in the first four years is shown in **Table 16-9**.

Table 16-9: Major Mine Mobile Equipment

DESCRIPTION	P-P	Year 1	Year 2	Year 3	Year 4	Total
Mobile ANFO Loader	1	-	-	-	-	1
Cable Bolter	1	-	-	-	-	1
Hydraulic Production Drill	4	-	-	-	1	5
Raise Drill	1	-	1	-	1	2
Jumbo Drill 2 Boom	2	-	-	-	-	2
LHD 17 Tonnes	3	-	4	-	-	7
Mine Truck 40t	2	-	5	-	-	7
Roof Bolter	2	-	-	-	-	2
Scissor Lift	1	-	-	-	-	1
Shotcrete Sprayer	-	-	1	-	-	1
Shotcrete Mixer	-	-	1	-	-	1
Loader Cat 988	-	-	1	-	-	1

16.7.8 AUXILIARY MOBILE EQUIPMENT

The following auxiliary underground mobile equipment has been planned to support the underground operation:

- Underground boom truck: For transporting consumables, small and stationary equipment, and spare parts.
- Underground grader: For maintaining the underground ramp and the main haulage roads as well as the surface road to the concentrator.
- Fuel and lube truck: To service the underground equipment fleet as needed.
- Underground forklift with man-basket: Will be used to pull electrical cables and help install underground services.
- Telehandler: Will be used to help the operations at the portal and at the lay-down areas, to unload containers and to move surface inventory.
- Underground 4x4 pickup trucks: To transport personnel underground to access the underground mine by the ramp. The summary of auxiliary underground equipment is shown in **Table 16-10**.

Table 16-10: Auxiliary Mobile Mine Equipment

Description	Number Required
Telehandler	1
Grader	1
Forklift	1
UG Boom truck	1
Fuel/Lube truck	1
4x4 UG Pick-up - Project Manager (8 passengers)	1
4x4 UG Pick-up - Personnel Carrier (8 passenger)	3
4x4 UG Pick-up - Shift Boss (Crew Cab)	1
4x4 UG Pick-up - Surveyor (Scissor)	1
4x4 UG Pick-up - Ambulance	1

16.8 MINE VENTILATION

The objective of the ventilation system is to provide the best and safest possible working conditions for the people working at Loma Larga, as well as providing very good working conditions for the equipment that will be used in the mine.

A one pass exhaust system where the major ventilation power is on the exhaust side of the system will be used.

The system will have a Near North Ventilation Raise and a Near South Ventilation Raise which will be installed in the early part of the mine life (as early as possible).

The system will also have a Far North Ventilation Raise and a Far South Ventilation Raise which will only be installed when the development gets to the end of the ore.

If more ore is found, these raises can be located closer to the end of the ore. Note also, if more ore is found to the west of the present ore, another raise could be installed for this zone. In this regard, the system is very flexible.

16.8.1 PLAN OVERVIEW

The plan below in **Figure 16-16** depicts the main ventilation infrastructure for the Loma Larga Project in January 2027.

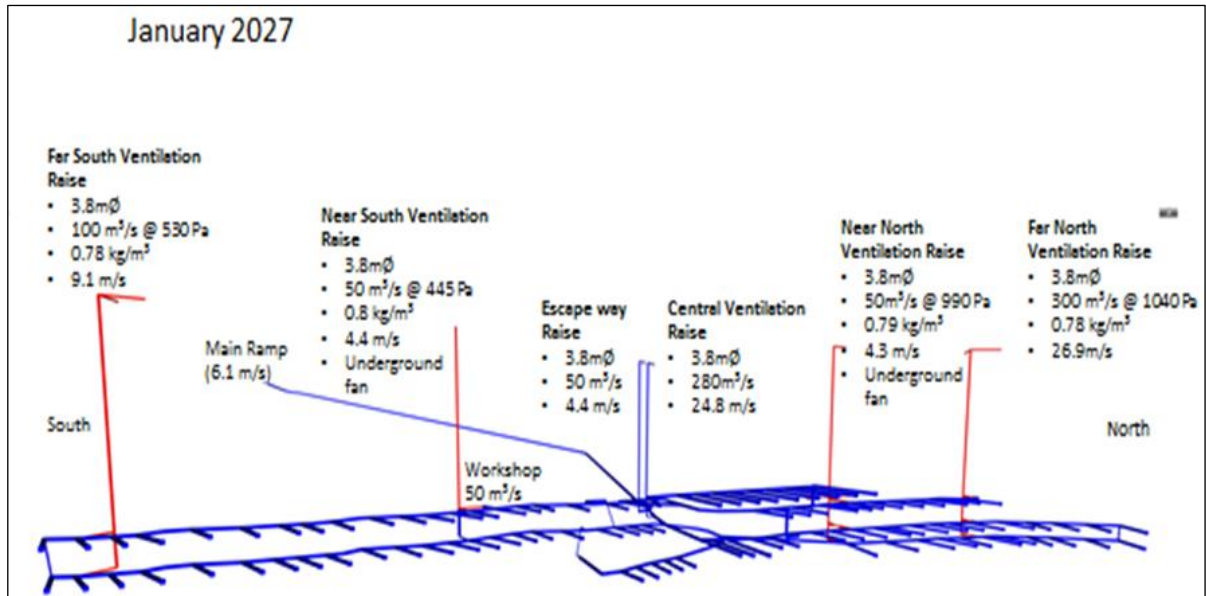

Figure 16-16: Main Ventilation Infrastructure

16.8.1.1 AIR DISTRIBUTION

The mine will be accessed from one decline adit. Steady state operations will require six, raisebore shafts, one intake, four returns and a dedicated escape way which will also be used as an intake, but at a lower velocity. The main decline adit further augments the intake air requirement. The volumetric flow in the decline will be modulated by using an air jet fan should the velocity in the decline increase to unacceptable levels. The trucking and dedicated loading bay will be in through ventilation, allowing for unimpeded 24 hours operation.

An overall allowance of 10% has been made for leakages.

16.8.1.2 MAIN FANS

Five axial flow fans will operate over a series of duties between 50 and 150 m³/s. The peak steady state operation of these fans will be a combined quantity of 500 m³/s. These fans will be equipped with Variable Frequency Drives (VFD) in order to match volume requirement with extraction strategy, and to ensure fan efficacy.

Emanating from the Vuma model, the maximum fan design duty is 150 m³/s @ 1 040 Pa with density of 0.78 kg/m³.

16.8.1.3 PRODUCTION OF DRIFT VENTILATION

The production drifts should be developed using a 55-kW dual speed axial flow, high efficiency silenced fans on 1,016 mm anti-static force ducting with the following two duties.

- Duty 1-22m³/s @ 1 800 Pa. (@ 0.063m³/s per kW the LHD would require 17 m³/s).
- Duty 2-12m³/s @ 500 Pa. (@ 0.063m³/s per kW the other utilities would require 8 to 10 m³/s)

Each developing drift will be equipped with the above mentioned dual speed fan. The fan will speed up to full duty of 22 m³/s while either mucking or blasting takes place and will revert to the reduced volume of 12 m³/s for all other activities. This has a major positive impact on the

electrical infrastructure and overall operating cost. This dual speed arrangement drastically reduces power requirements for this facet of mining.

16.8.2 DESIGN CRITERIA

This section outlines the key design parameters used in the ventilation assessment study.

16.8.2.1 GENERAL MINE LAYOUT AND CONSTRAINTS

The mine will be accessed from one adit. Steady state operations will require six, raisebore shafts, one intake, four returns and a dedicated escape way.

The project has the following features and design assumptions:

- Mining will be on an eight-hour cycle.
- Blasting of production 'hang-ups' or development will be synchronised at the end of a shift on a fixed-time system.
- All workshops are ventilated directly to return.

Dimensions for Underground Excavation

Main decline haulage (adit)	5 m x 5 m
Main haulage drifts	5 m x 5 m
Main intake raisebore airway	3.8 m
Main return raisebore airways	3.8 m
Dedicated escape raisebore	1.8 m

16.8.2.2 PRODUCTION PROFILE

The total production rate will be approximately 3,000 t/d of ore, increasing to 3,400 t/d in year five.

Although the tonnage profile remains constant, the ventilation requirement varies due to the initial ramp-up sequence, and extraction profile. *Figure 16-17* depicts the tonnage over the LOM operation.

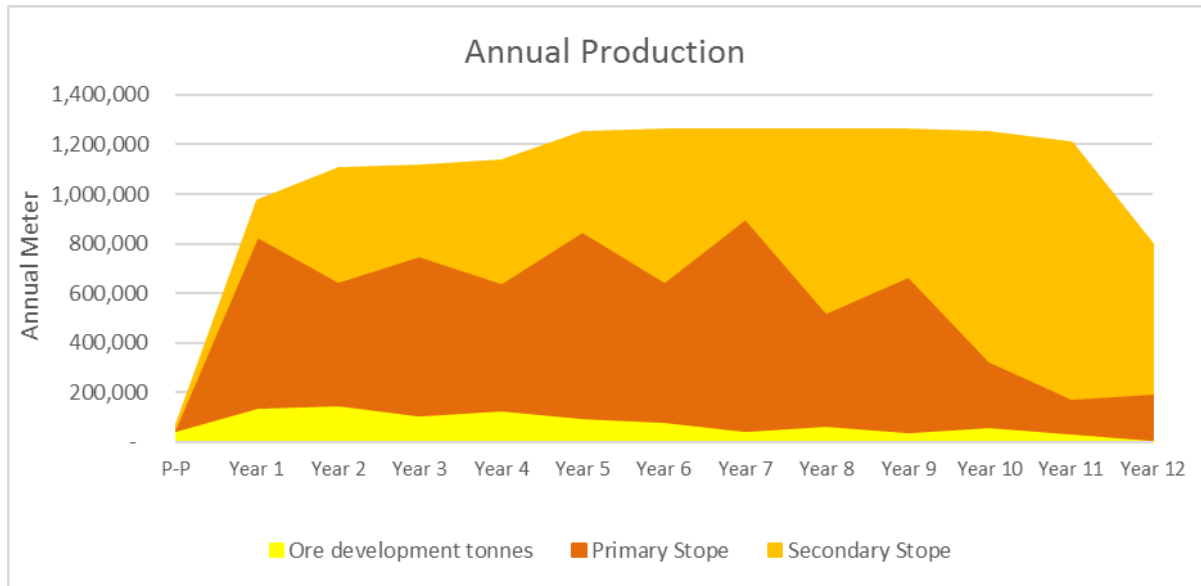

Figure 16-17: Extraction Profile

16.8.2.3 DESIGN AIR VELOCITIES AND QUANTITIES

When determining velocity, pressure loss and critical speed, economics and other practical issues were taken into account, design velocities are listed in **Table 16-11**.

Table 16-11: Design Velocities and Quantities

Description	Ideal Design Range
Max. upcast shafts (unequipped)	24m/s
Max. downcast shafts (unequipped)	24m/s
Max. intake airways (personnel)	8m/s
Max. return airways (personnel and trammig]	8m/s
Max. dedicated escape way	12m/s
Min. drift airways	0.20m ³ /s/m ²
Min. workshops	0.3m/s

16.8.2.4 FRICTION FACTORS

Design friction factors used for modelling are listed in **Table 16-12**.

Table 16-12: Friction Factors

Blasted airways (intake/return)	0.0158Ns ² /m ⁴
Corten ventilation ducting (shaft sink)	0.0025Ns ² /m ⁴
Steel ventilation ducting	0.0021Ns ² /m ⁴
Ventilation flexible duct	0.003Ns ² /m ⁴
Raise bore holes (unequipped)	0.004Ns ² /m ⁴

16.8.2.5 LEAKAGE

Table 16-13: Leakage

Primary leakage [main intake to main return airways]	5%
Secondary leakage doors, seals, etc.	5%

- Notes:
- Normal leakage factors are:
- Primary 10%
- Secondary 20%
- The ventilation layout in this study is such that leakage will be minimal, thus the reduced design leakage factors.

16.8.2.6 DEVELOPMENT VENTILATION

Requirements for capital development and production phases are listed in **Table 16-14**.

Table 16-14: Development Ventilation

Force quantity at face (minimum – diesel requirements normally dictate)	0.3m ³ /s/m ² face
Maximum force column distance from face (after the blast)	20m
Leakage, steel duct	2% per 100m
Leakage, plastic tube	5% per 100m
Re-entry	After minimum of 8 air changes

16.8.2.7 DIESEL EQUIPMENT UTILIZATION

Table 16-15: Diesel Equipment Utilization

Air requirement for dilution of diesel exhaust gas	0.063m ³ /s/kW rated at point-of-use
Heat added by LHDs	1.5kW/kW rated power
Heat added by haul trucks	0.7kW/kW rated power

- Notes:
- Engine specifications (EU-Type 4 / Tier 4 or higher), diesel sulphur content [<50 ppm], after exhaust treatment (Catalytic Converter) and diesel particulate filters should be used.

16.8.2.8 DIESEL FLEET

The diesel vehicle fleet provided by mining is listed in **Table 16-16**.

Table 16-16: Diesel Fleet

Machine Type	Quantity	Rated kW	% Utilization	Total kW	Air Required [@ 0.063 m ³ /s per kW]
Production					
Mobile Anfo loader A64 EXC3000	1	129	50% 100%	65 129	4m ³ /s 8m ³ /s
Cable Bolter DS421	1	119	50% 100%	60 119	4m ³ /s 8m ³ /s
Hydraulic Production Drill	2	93	50% 100%	93 186	6m ³ /s 12m ³ /s
Jumbo Drill DD321	2	134	50% 100%	134 268	9m ³ /s 18m ³ /s
LHD 17 tonnes	6	275	100%	1650	104m ³ /s
Roof bolter DS411	2	119	50% 100%	119 238	8m ³ /s 16m ³ /s
Scissor Lift A64 SL	2	129	100%	258	4m ³ /s
Shotcrete sprayer A64 SST	1	150	100%	150	10m ³ /s
Shotcrete mixer HD R60	1	164 (Cummins Motor)	100%	164	10m ³ /s
Tramming					
Loader Cat 988	2	280	100%	560	35m ³ /s
Mine truck 40t TH540	7	405	60% 100%	1701 2835	107m ³ /s 179m ³ /s

- Volume required based on percentage utilization (excluding leakage and commitments) 303m³/s
- Volume required based on total kW @ 0.063 m³/s per kW (excluding leakage and commitments) 413m³/s
- Total volume required including leakage 10% and commitments 50 m³/s (Workshop) 503m³/s

16.8.2.9 SURFACE AMBIENT DESIGN CONDITIONS

Table 16-17: Surface Ambient Design Conditions

Design temperature	4.0°C to 17°C
Average minimum temperature	8°C
Average temperature	11.0°C
Barometric pressure	65.0kPa
Surface density	0.800kg/m ³

16.8.2.10 GEOTHERMAL PROPERTIES

Reference Virgin Rock Temperatures (VRTs) are given in the **Table 16-18** below.

Table 16-18: Virgin Rock Temperatures

Level	VRT [°C]
3,600 m (Estimated)	4°C

16.8.2.11 THERMAL CRITERIA

Table 16-19: Thermal Criteria

Minimum temperature	2°C
---------------------	-----

16.8.2.12 FIRE PREVENTION AND DETECTION

Compliance with best practice, and any legal requirements.

16.8.2.13 WORKSHOPS / TYRE BAYS / BULK LIQUID AND OIL STORES

Workshops, bulk fuel and oil storage tanks are ventilated directly to return. An automatic foam / sprinkler system should be installed in these areas.

16.8.2.14 VEHICLES AND MACHINERY

All vehicles and machines will be equipped with an automated approved on-board fire suppression system.

16.8.2.15 FLAMMABLE GAS

A Code of Practice (COP) is required in compliance with best practice, and any legal requirements.

16.8.2.16 AIRBORNE POLLUTANTS

All exposures to airborne pollutants are to be within the following Occupational Exposure Limits (OELs) as specified. (See **Table 16-20**).

Table 16-20: Summary of Airborne Pollutants OEL

Silica dust, crystalline	0.1mg/m3 Time Weighted Average (TWA)
Fibres	2 f/mL Time Weighted Average (TWA)
PNO ₂	Inhalable 10mg/m3 and respirable 3mg/m3
Carbon Monoxide (CO)	30ppm (TWA) and 100ppm (OEL-Stel)
Carbon Dioxide (CO ₂)	5000ppm (TWA) and 30,000ppm (OEL-Stel)
Nitric oxide (NO)	25ppm (TW)] and 35ppm (OEL-Stel)
Nitrogen dioxide (NO ₂)	3ppm (TWA) and 5ppm (OEL-Stel)
Sulphur dioxide (SO ₂)	2ppm (TWA) and 5ppm (OEL-Stel)
Diesel Particulate Matter – Total carbon	160µg/m3
Diesel Particulate Matter – Elemental carbon	123µg/m3
Flammable gas	< 1.0%
Radiation	< 20mSv/annum (personal exposure)

16.8.2.17 COLD STRESS MANAGEMENT

Table 16-21: Maximum Time of Exposure

Temperature Range	Exposure Time
0°C to -18°C	No restriction
-19°C to -34°C	Fifty minutes per hour
-35°C to -57°C	Two periods of 30 minutes each, after a 4-hour interval
Below -57°C	Fifty minutes during any period of 8 hours

16.8.2.18 ERGONOMICS

Albeit that most vehicles will be operating remotely, several concerns must be highlighted in terms of ergonomic hazards with regards to work station design interface, these include:

- Body positions and movement.
- Handling loads.

It is recommended that an ergonomic survey be conducted as part of the ongoing risk assessment process. In addition, manufacturers of machinery to demonstrate their duty of care by furnishing reports on their machinery in this regard.

16.8.3 DECLINE RAMP VENTILATION

16.8.3.1 BACKGROUND

The initial ramp ventilation calculations catered for the ventilation requirements up to the downcast shaft position, with a nominal 500 m of extra haulage development.

To this end revised calculations are included to cater for the increased diesel vehicle ratings as well as leakages for this initial scenario.

However, mine schedule indicates that a considerable amount of development on multiple fronts are being planned, prior to the availability of the raisebore hole (RBH) to surface. This RBH will initially be used as an upcast to facilitate through ventilation and cater for the development program.

16.8.3.2 UPDATED RAMP VENTILATION REQUIREMENTS AS PER INITIAL BRIEF

The following illustrates the updated ventilation requirements as per initial brief, taking cognizance of the increased kW and making allowance for leakage:

- Air Requirement in Main Decline (5 x 5 m)
- Design Mining Equipment
- LHD (1 x 275 = 275 kW)
- Dump Trucks (2 x 405 x 60% utilization = 486 kW)
- Total kW = 761 kW
- Air requirement 68.5 m³/s (This includes allowance for leakages, and to ensure the minimum volume of 48 m³/s is delivered to place of work is maintained).

16.8.3.3 FAN PRESSURE REQUIREMENTS IN MAIN DECLINE

- Distance to upcast raisebore 1,267 m
- Plan for an additional underground 500 m
- Tramming distance with vent ducting 1,767 m
- Vent ducting K factor 0.0021 Ns²/m⁴
- Volume 70 m³/s divided by 2 (twin 1 500 mm ducts) = 35m³/s in each duct.
- Fan specification 35 m³/s @ 2 588 Pa at w = 0.08 kg/m³ and BP of 65 kPa
- This would allow 50 kg/s for further development which will limit the number of main ends worked to two. This is depicted in *Figure 16-18*.



Figure 16-18: Fan Pressure Requirements Main Ramp

16.8.3.4 REVISED VENTILATION REQUIREMENTS AS PER MINING SCHEDULE

In order to meet the planned development as per the mining schedule, the model indicates that before the first surface hole is complete the duct system would need to exhaust almost double the volume required from the initial estimate. A total fan volume of 120 m³/s is required. The alternative would be to stop development at the RBH position and carry on in one area with both columns.

Volume 120 m³/s divided by 2 (twin 1 500 mm ducts) = 60 m³/s in each duct.

Fan specification $60 \text{ m}^3/\text{s}$ @ $5\,400 \text{ Pa}$ at $w = 0.8 \text{ kg}/\text{m}^3$ and BP of 65 kPa .

This would allow $90 \text{ kg}/\text{s}$ for further development and will satisfy the development schedule requirements. *Figure 16-19* and *Figure 16-20* depict the main ventilation requirements for this scenario.

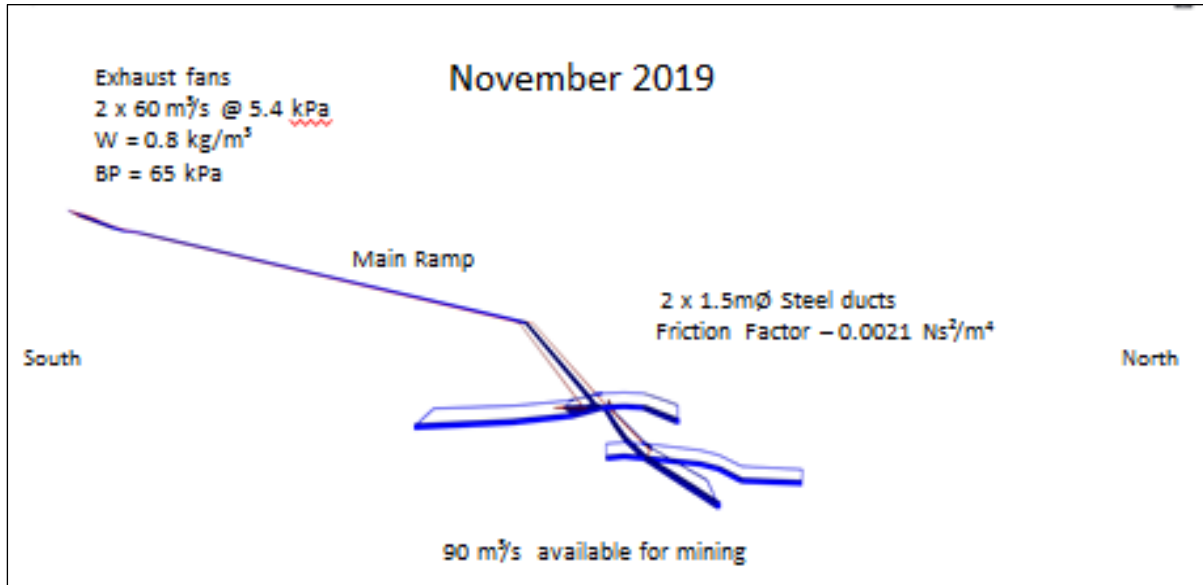

Figure 16-19: Ramp Ventilation Requirements to Meet Mine Development Schedule

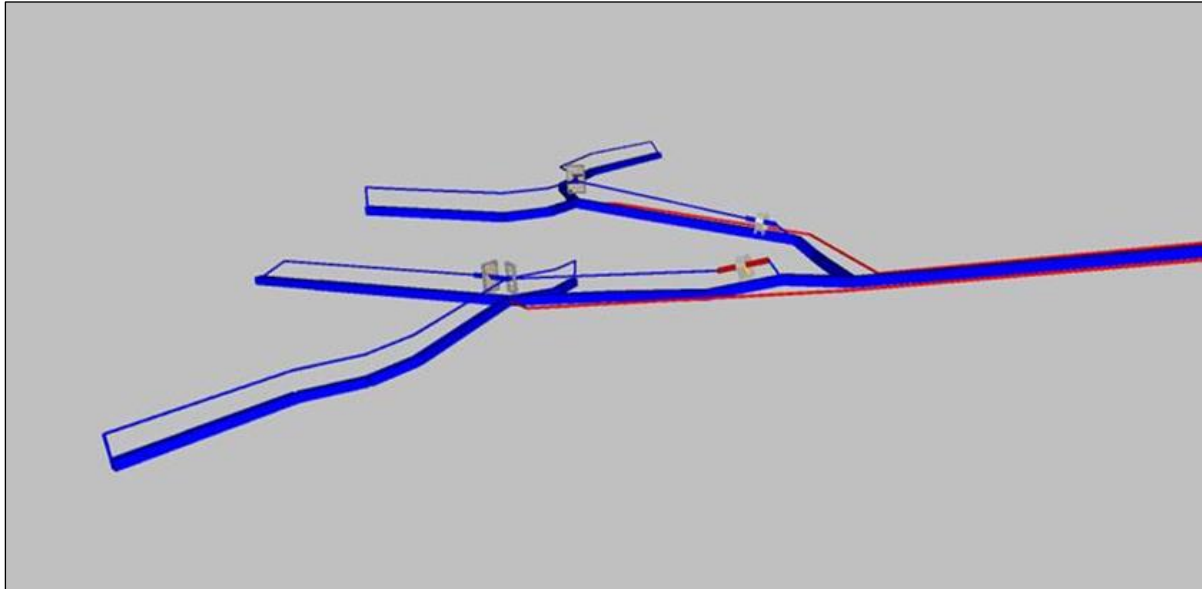

Figure 16-20: Development of Multiple Ends as per the Mining Schedule

16.8.4 PRIMARY VENTILATION

16.8.4.1 OVERVIEW

The mine will be accessed from one decline adit. Steady state operations will require six, raisebore shafts, one intake, four returns and a dedicated escape way which will also be used

as an intake, but at a lower velocity. The main decline adit further augments the intake air requirement. The volumetric flow in the decline will be modulated by using an air jet fan should the velocity in the decline increase to unacceptable levels. The trucking and dedicated loading bay will be in through ventilation, allowing for unimpeded 24-hour operation. The workshop and lubrication stores will ventilate directly to return enabling all contaminants in these areas to report directly to return.

During steady state, air will be extracted from the mine via underground main fan installations situated at the connections to the various upcast shafts. Fans will be moved as per the ventilation dictates stemming from the mine extraction strategy.

During the LOM, and depending on the mining sequence, the volumetric flow varies from 190 to 500 m³/s. The main fans have been specifically selected in order to cater for this varied requirement.

These fans will be equipped with Variable Speed Drives (VSD) in order to match volume requirement with ramp up, varied volumetric requirements to meet the extraction plan, and to ensure fan efficiency. A set of critical spares has also been recommended.

The layout is designed, that leakage which can normally consume 30% of installed volume is reduced to 10%.

16.8.4.2 VENTILATION REQUIREMENTS

Airflow requirements allow for the adequate ventilation of production and drift development, the central loading station, the underground offices and workshop.

The main air quantities, excluding leakages required during the LOM and captured at significant ventilation infrastructure stages, are depicted below.

Table 16-22: Ventilation Requirement Start of Stope Development

Main Ventilation Infrastructure	Number of Main Fans in Operation	Quantity Per Fan	Volume Circulated
Central ventilation raise (Temporary Exhaust)	2	95m ³ /s	190m ³ /s
Escape way raise (Regulated Intake)		20m ³ /s	20m ³ /s
Main ramp (Intake)			170m ³ /s
Total Required			190m³/s

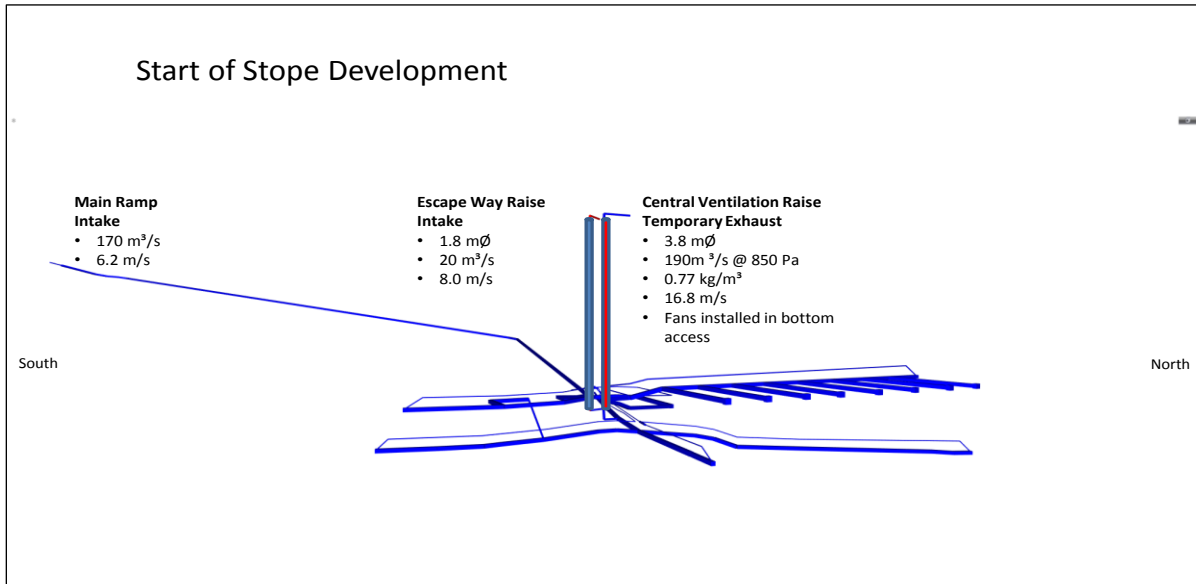

Figure 16-21: Start of Stope Development

– **Note:** The escape way raise will be regulated to a nominal 20 m³/s for the LOM. Furthermore, as an additional safety precaution a diesel standby fan installed at the top of the escape way shaft, with a simple ducting arrangement and airlock could be started in an emergency (total power failure scenario) with a recommended duty for the fan of 20 m³/s @ 500 Pa.

Table 16-23: Ventilation Requirement, Near North Ventilation Raise Operational

Main Ventilation Infrastructure	Number of Main Fans in Operation	Quantity Per Fan	Volume Circulated
Escape way raise (Regulated Intake)	2	80m ³ /s	160m ³ /s
Near north ventilation raise (Exhaust)	2	125m ³ /s	250m ³ /s
Main ramp (Intake)			160m ³ /s
Central ventilation raise (Temporary Exhaust)			250m ³ /s
Total Required			340m³/s

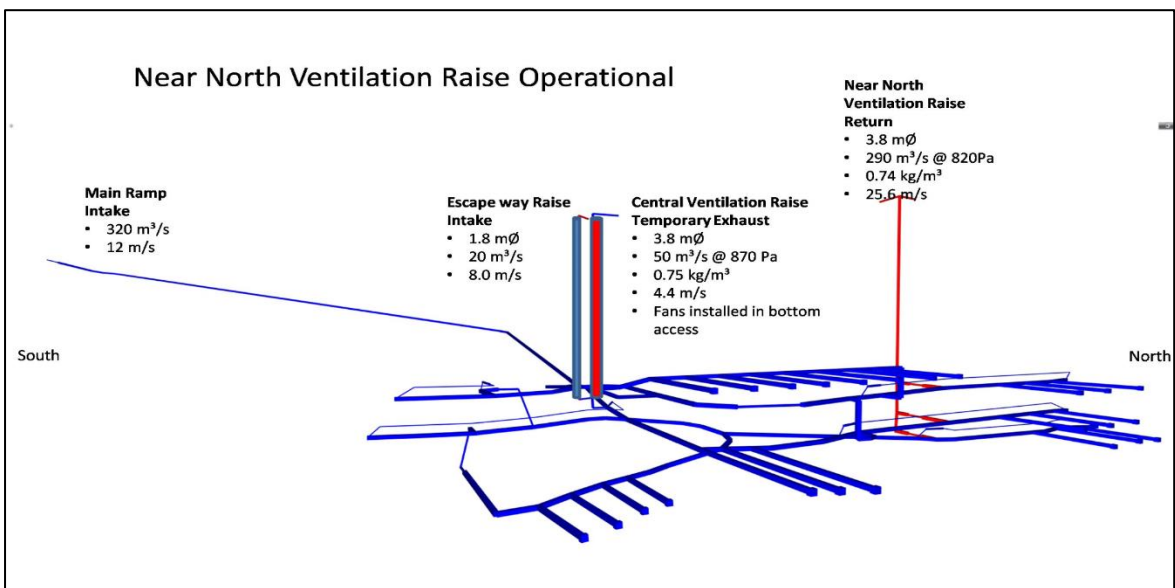

Figure 16-22: Near North Ventilation Raise Operational

– Note: The central upper mining block needs to be accessed from the South side in order to return the air from this section to the Near North Ventilation Raise. It is recommended that this is affected by a drilling a small ventilation raise down to the North Upper haulage and connected to the Near North Ventilation Raise with steel ducting. This will ensure that the contaminants from this section do not affect the rest of the mine as it will be a separate ventilation district.

Table 16-24: Ventilation Requirement, Near South Ventilation Raise Operational

Main Ventilation Infrastructure	Number of Main Fans in Operation	Quantity Per Fan	Volume Circulated
Near south ventilation raise (Exhaust)	2	100m ³ /s	200m ³ /s
Near north ventilation raise (Exhaust)	2	140m ³ /s	280m ³ /s
Main ramp (Intake)			180m ³ /s
Central ventilation raise (Intake)			280m ³ /s
Escape way raise (Regulated Intake)			20m ³ /s
Total Required			480m³/s

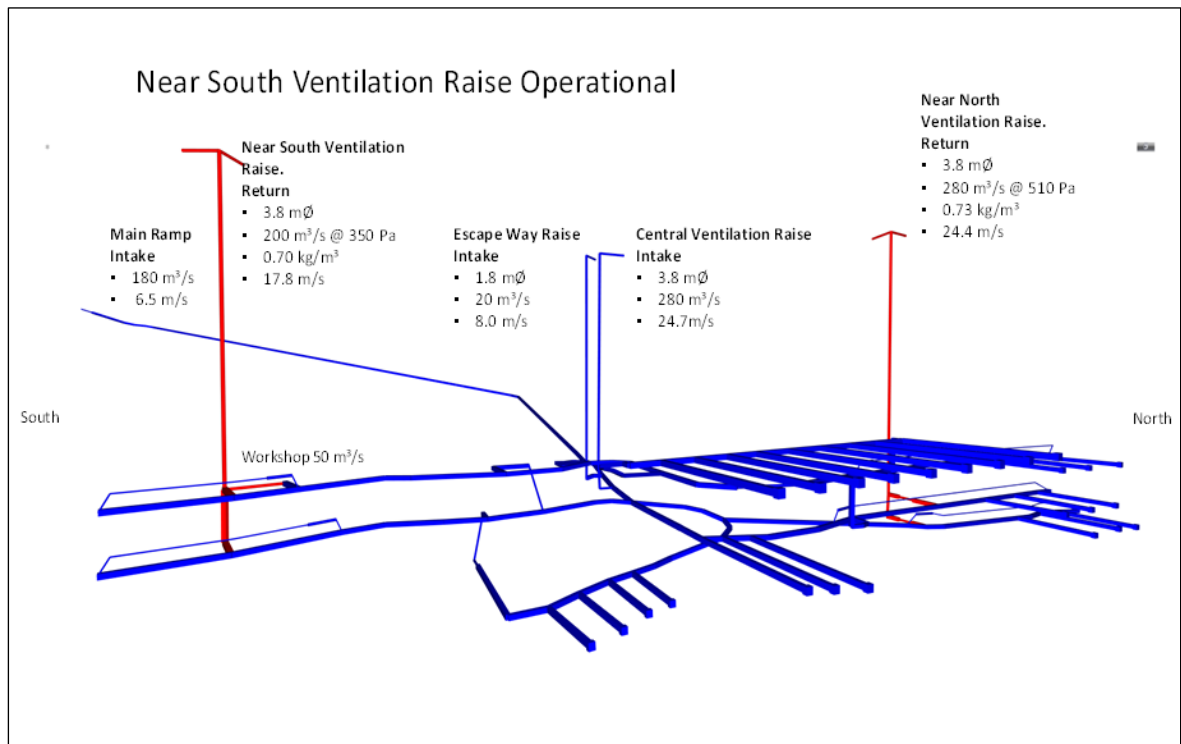

Figure 16-23: Near South Ventilation Raise Operational

Table 16-25: Ventilation Requirement, Far North Ventilation Raise Operational

Main Ventilation Infrastructure	Number of Main Fans in Operation	Quantity Per Fan	Volume Circulated
Near south ventilation raise (Exhaust)	2	100m ³ /s	200m ³ /s
Near north ventilation raise (Exhaust)	1	60m ³ /s	60m ³ /s
Far north ventilation raise (Exhaust)	2	118m ³ /s	235m ³ /s
Main ramp (Intake)			180m ³ /s
Central ventilation raise (Intake)			295m ³ /s
Escape way raise (Regulated Intake)			20m ³ /s
Total Required			495m³/s

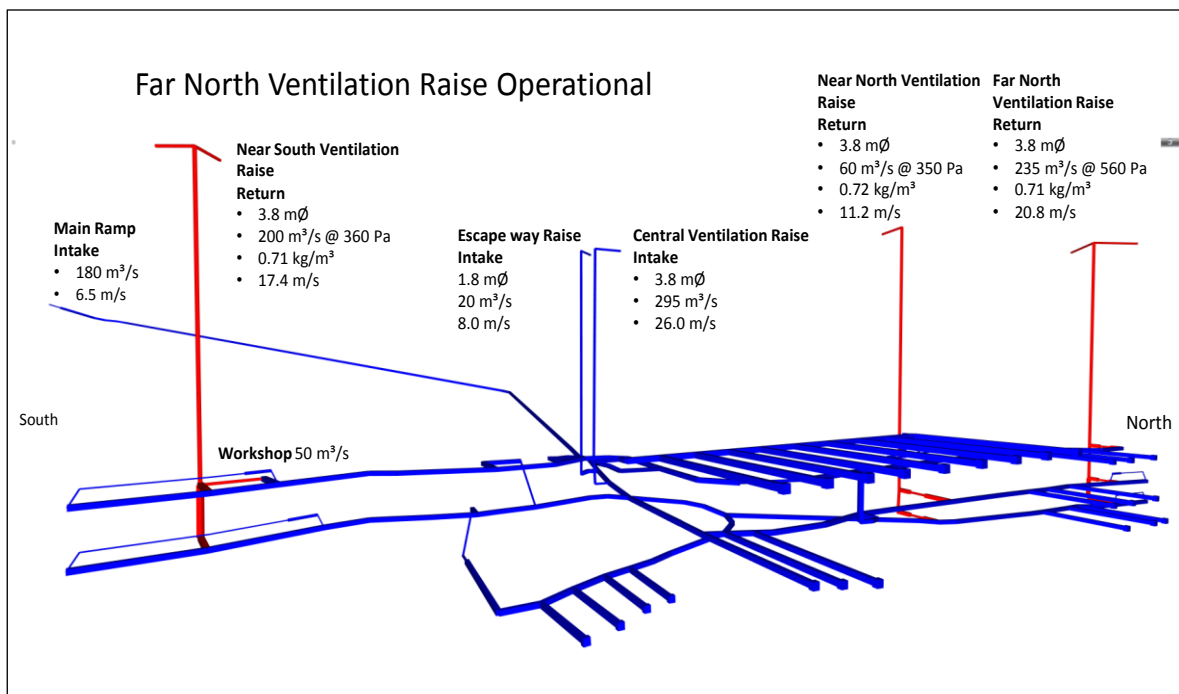

Figure 16-24: Far North Ventilation Raise Operational

Table 16-26: Ventilation Requirement, Full Ventilation System Operational

Main Ventilation Infrastructure	Number of Main Fans in Operation	Quantity Per Fan	Volume Circulated
Far south ventilation raise (Exhaust)	1	100m ³ /s	100m ³ /s
Near south ventilation raise (Exhaust)	1	50m ³ /s	50m ³ /s
Far north ventilation raise (Exhaust)	2	150m ³ /s	300m ³ /s
Near north ventilation raise (Exhaust)	1	50m ³ /s	50m ³ /s
Main ramp (Intake)			180m ³ /s
Central ventilation raise (Intake)			300m ³ /s
Escape way raise (Regulated Intake)			20m ³ /s
Total Required			500m³/s

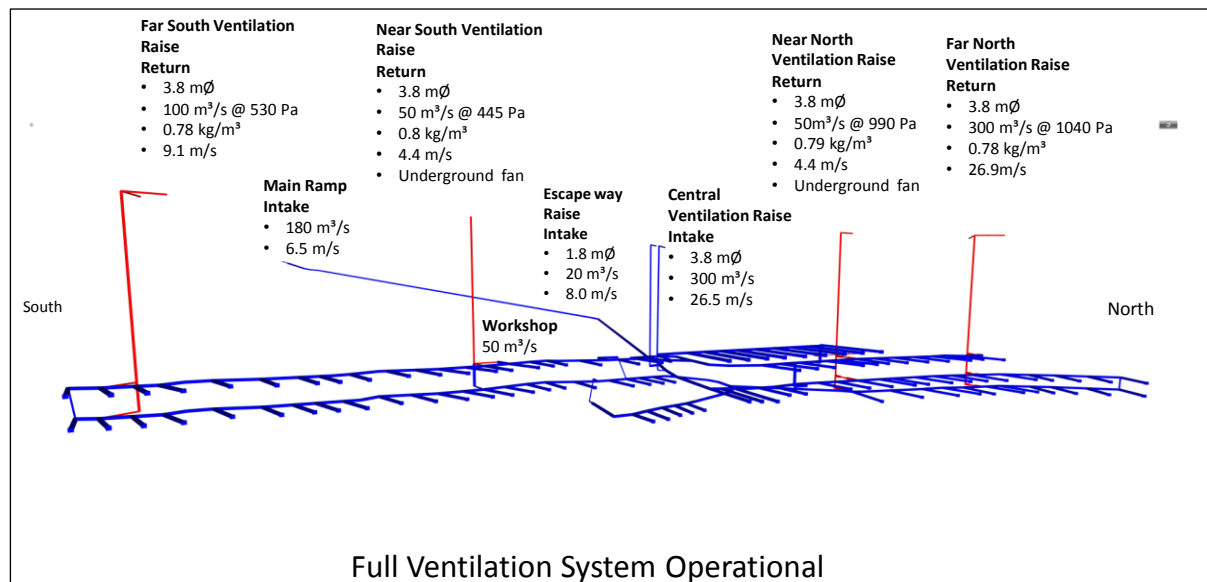

Figure 16-25: Full Ventilation System Operational



16.8.5 SECONDARY VENTILATION

16.8.5.1 PRODUCTION DRIFT DEVELOPMENT VENTILATION

The production drifts should be developed using a 55-kW dual speed axial flow, high efficiency silenced fan on 1 016 mm anti-static force ducting with the following two duties.



- Duty 1.22 m³/s @ 1 800 Pa. (@ 0.063 m³/s per kW the LHD would require 17 m³/s)
- Duty 2.12m³/s @ 500 Pa. (@ 0.063 m³/s per kW the other utilities would require 8 to 10 m³/s)

Each developing drift will be equipped with the above mentioned dual speed fan. The fan will speed up to full duty of 22 m³/s while either mucking or blasting takes place and will revert to the reduced volume of 12m³/s for all other activities. This has a major positive impact on the electrical infrastructure and overall operating cost. This dual speed arrangement drastically reduces power requirements for this facet of mining.

	Document Number	J01834-PM-REP-002	Rev	0	
	Date	11 January 2019	Page	238 of 417	

16.8.5.2 HAULAGE TUNNEL DEVELOPMENT VENTILATION

The haulage tunnels should be developed using 90 kW axial flow high efficiency silenced fans on 1 200 mm anti-static flexible force ducting, with a duty of 37 m³/s @ 2.0 kPa. This will allow for adequate volumes in terms of drift development offtake and negate recirculation.

	Document Number	J01834-PM-REP-002	Rev	0	
	Date	11 January 2019	Page	239 of 417	

16.8.6 MAIN FAN SPECIFICATION

16.8.6.1 FAN DUTY

Emanating from the Vuma model, the maximum fan design duty is 150 m³/s @ 1040 Pa with density of 0.78 kg/m³.

16.8.6.2 FAN TYPE

It is recommended that these fans be of the Axial Flow type. Centrifugal fans are generally quieter than axial fans operating at the same speed and duty, primarily due to reduced blade tip clearance. However, if silencing is required, axial fans are inherently easier to silence due to their architecture. In terms of reliability, modern axial flow fans have been shown to provide good reliability, and their component nature, hub and blades, provides simple maintenance and replacement methods, should excess wear be noticed. If an impeller on a centrifugal fan is damaged or worn, a major replacement exercise is to be expected.

Further motivation for the selection of axial flow fans are:

- Identical fans can be selected for all sites, with differences in duty handled by small adjustments to blade angles.
- Axial flow fans are generally less expensive. The relatively short lifespan of the Loma Larga project does not justify the extra cost of centrifugal fans, which are typically designed to last for 25 to 40 years.

16.8.6.3 VOLUME FLEXIBILITY

The available multiple return raise-bores and the planned Variable Frequency Drives (VFDs) gives full ventilation flexibility over the LOM extraction.

Blade angles can be adjusted to compensate for variations in the build-up, and steady state requirements

These fans will operate over a wide range of duties during its life, due to the initial build-up and ore extraction plan which is not split evenly between the North and South mining blocks. The maximum volume will be 500 m³/s

With the wide range of operation, it would be prudent to specify a higher motor kW rating, which at a negligible cost will provide a much higher volume capability if an increase in tonnage/mining is possible in the future.

16.8.6.4 FAN SPECIFICATION

The fan should be able to operate over the following continuum:

- Maxima Main Fan Design Duty (Fan Operating Point)
 - Volume 150 m³/s
 - Pressure 1 200 Pa
 - Density 0.8k g/m³
 - Atmospheric Pressure 65 kPa
- Minima Main Fan Design Duty (Fan Operating Point)
 - Volume 50 m³/s
 - Pressure 350 Pa

- Density 0.8 kg/m³
- Atmospheric Pressure 65 kPa

16.8.6.5 NUMBER OF FANS REQUIRED

Five complete Axial Flow units.

16.8.6.6 FAN CURVE

The following fan curve as depicted in *Figure 16-26* is included as an example of the fan duties required. The budget quotation is appended for benchmarking purposes.

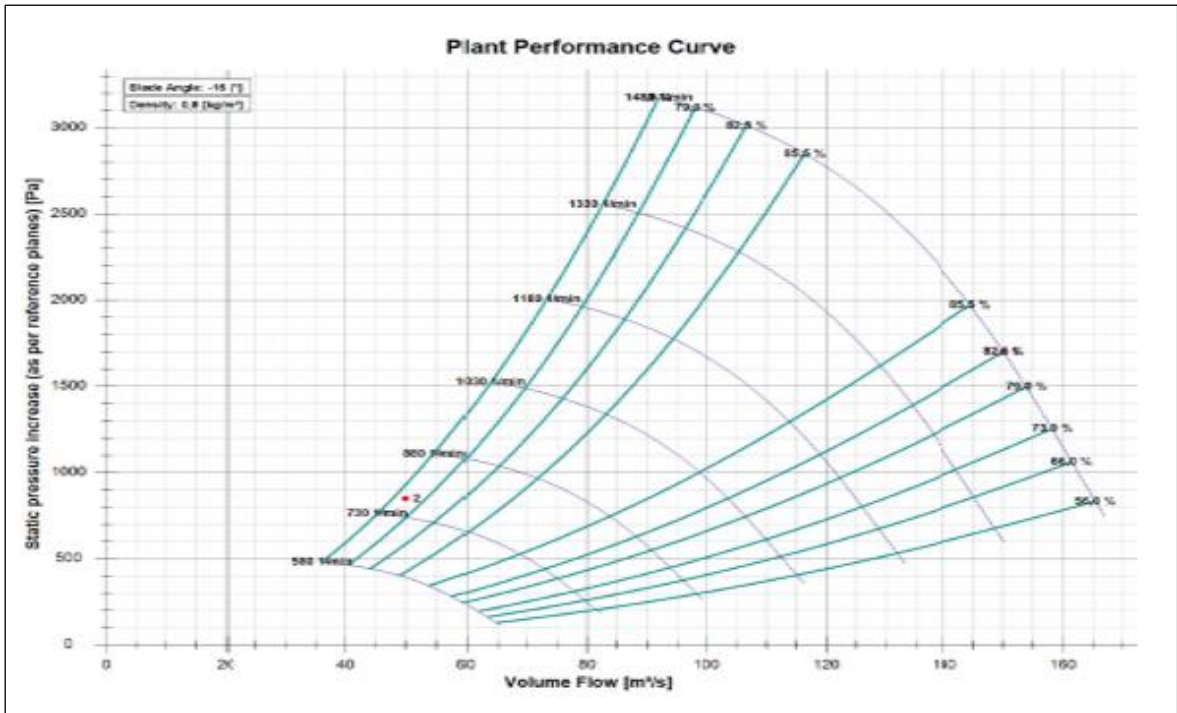



Figure 16-26: Main Fan Curve

	Document Number	J01834-PM-REP-002	Rev	0	
	Date	11 January 2019	Page	241 of 417	

16.8.6.7 FAN TYPE AND ANCILLIARY EQUIPMENT

Axial Flow

Low voltage motors and Variable Frequency Drives (VFDs) will:

- Allow start-up from generator power supply with low inrush current.
- Provide flexibility during ‘mine establishment and production ‘ramp-up.
- Provide the necessary flexibility to meet the varied production volume requirements, between the north and south mining areas, as per the Mine extraction schedule.
- In the event of a fan failure, other motors can be “speeded up” to compensate.

Manually adjustable impellers which with the VFDs, will allow the fans to operate at optimal efficiency during mine establishment and full production phases. This will specifically allow for good efficiencies at low duties.

Allowance for the following critical spares should be made:

- One complete rotating assembly.
- One spare motor.

It is further recommended that it would be beneficial to procure fans that are driven by motors that are external to the fan drift via a cardan shaft. The benefits of this arrangement are:

- Improved cooling of the motor as in a mechanised mine, the amount of diesel soot flowing through the fan drift can impair the cooling capabilities of the fan motor.
- Improved access to the electric motor for maintenance.

16.9 PASTE BACKFILL

Patterson & Cooke (P&C) has completed a feasibility level study of the backfill system for the Loma Larga Project. A mine plan has been completed by DRA which relies on backfill as a primary ground support medium. The majority of voids underground are to be filled using cemented pastefill.

P&C’s scope of work included supporting test work and the design of the paste plant and reticulation, capable of supplying cemented pastefill to the underground stopes.



This section has been prepared by P&C to document the work undertaken, provide an overview of the process design and equipment selected, and to present the engineering for both the paste plant and underground distribution system.

Reference is made to P&C’s Feasibility Study Report (32-0252-2210-GE-REP-0001) which presents the complete backfill feasibility level engineering design and is included in Appendix 8D of the Feasibility Study Report.

The base case for the feasibility study considered pumping thickened tails from the process plant to the paste plant area near the mine. An alternate option was reviewed and selected for the feasibility study utilising the tailings filtration facility in the process plant area which is sized to filter the full tailings throughput. The filter cake that is produced in the process plant area is then trucked to either the filtered tailings storage facility or the paste plant as required.

16.9.1 PASTE FILL STRENGTH REQUIREMENTS

Cemented paste backfill requires a minimum strength to ensure wall stability in vertical exposures. MDEng recommended (MDEng Feasibility Level Geotechnical Design Report

	Document Number	J01834-PM-REP-002	Rev	0	
	Date	11 January 2019	Page	242 of 417	

#17018-104) the paste strength requirements will vary from ~190 to 340 kPa depending on the panel length in secondary transverse stopes.

Current mine plans are for bottom-up advance and so strength requirements for mining under paste have not been evaluated at this time.

Tight filling of backfill is important for long term stability of stope backs and particularly for the crown pillar. Stopes should be backfilled as soon as reasonably practicable and should be tight filled to minimize potential for instability.

16.9.2 PASTE FILL DEMANDS

On average, the paste plant will be required to fill ~990 m³ per day for the 3,000 t/d milling rate. This represents approximately 90% of the stope volume which is normally excavated on a daily basis. The remaining 10% will remain empty or will be filled with waste rock. The paste plant system capacity volumetric rate is calculated at 100 to 120 m³:

The same system capacity is assumed over the LOM.

16.9.3 PASTE TEST WORK SUMMARY AND RECIPES

P&C conducted pastefill test work on both rougher and a combined tailing comprising 2:1 rougher to cleaner ratio (Loma Larga Paste Backfill Feasibility Study Report 32-0252-00-TW-REP-0001). The following summarizes the main outcomes of the test work which influenced the design process:

- Rougher tailings Particle Size Distribution (PSD): Fine with 46% passing 20 µm. Cleaner tailings PSD: Very fine with 72% passing 20 µm.
- Rougher tailings comprise mostly of quartz (~98%) with ~1% of rutile and ~1% of pyrite. Cleaner tailings consist of the silicate minerals Quartz (96%) and oxide mineral Rutile (titanium oxide, 1%). Quartz and Rutile are inert and will not participate in any cementitious reactions in the backfill and provide a good filler material for the backfill. Pyrite can be a concern for long-term strengths due to sulfate attack; however, the content is sufficiently low that it will not have a significant effect.
- The binder estimate required is presented in **Figure 16-27**. This estimate is based on achieving 300 kPa after 28 days and distributing paste at a mass concentration of 77%_m.

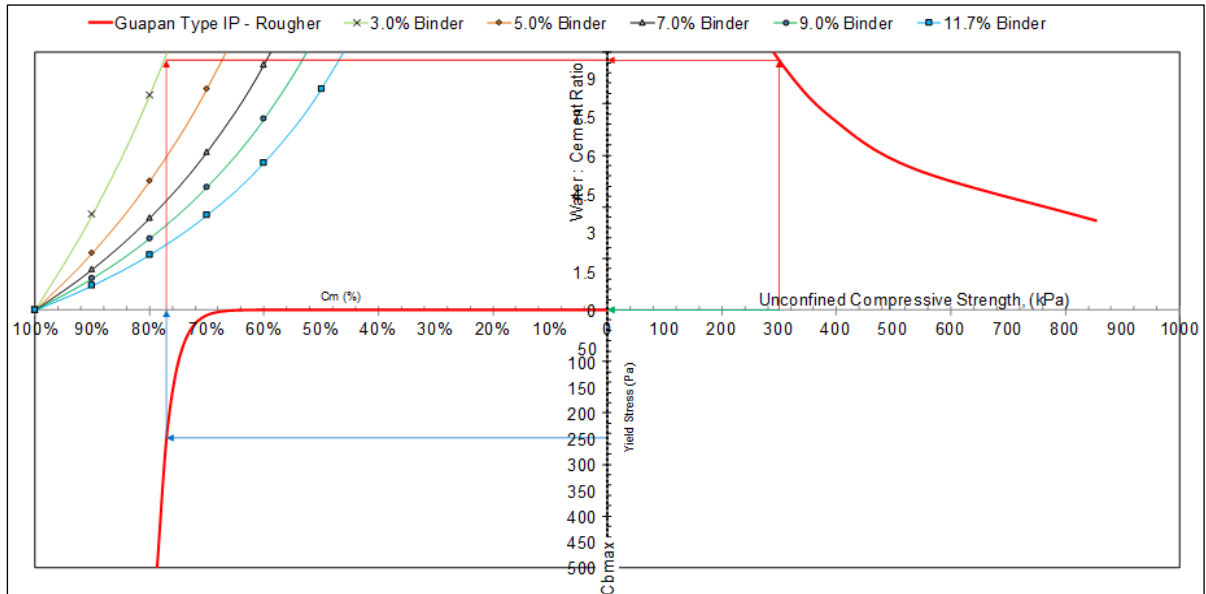

Figure 16-27: Binder Estimate (28 Day Target Strength)

16.9.4 PASTE PLANT SITE OVERVIEW

The paste plant is located above the orebody centroid and directly north of the process plant (**Figure 16-28**). A mine road approximately 4 km in length will connect the paste plant with the process plant. Filtered tailings will be trucked along this road and return water pipelines will be routed in an adjacent pipe corridor. Return water will include the excess water and slurry from the backfill plant, from the mining process, as well as water that flows into the mine from the surrounding rock mass.

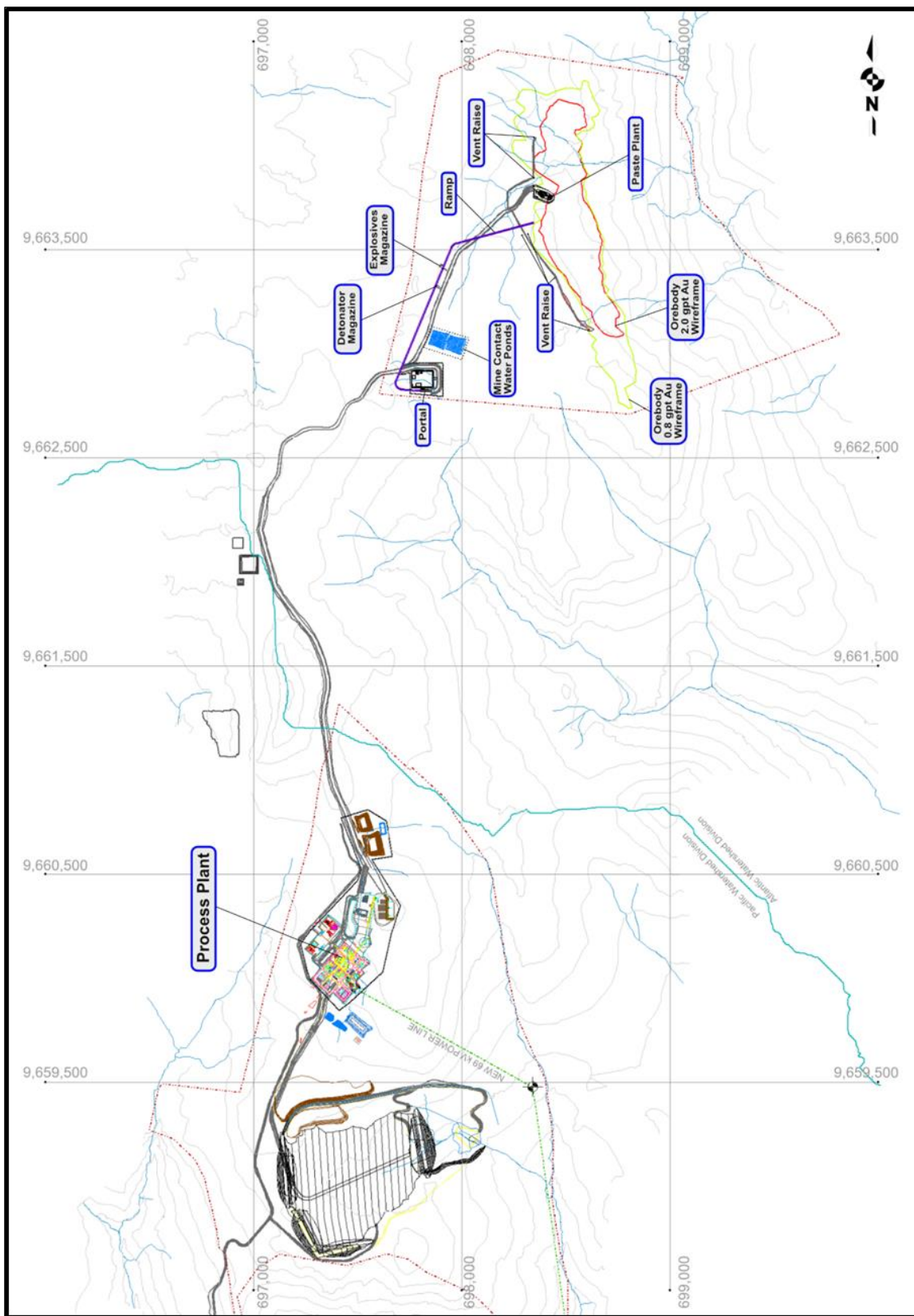



Figure 16-28: Paste Plant Site Plan (including Paste Plant and Process Plant Location)

	Document Number	J01834-PM-REP-002	Rev	0	
	Date	11 January 2019	Page	245 of 417	

16.9.5 PASTE PLANT DESIGN

The process design on surface is strongly influenced by the requirements of the underground (both mining and reticulation) and the material properties of the tailings. It is expected that the properties of the filtered tailings will remain fairly constant and the use of a continuous mixing process is therefore included in the design. Minor changes to the tailings material properties, binder content, water content etc. will be controlled by specific sampling and monitoring measures included in the design to ensure a consistent backfill is produced.

All tailings leaving the process plant are dewatered to ~85% solids. When pastefill is scheduled for underground, approximately 50 to 100% of the dewatered tailings is trucked 4 km to the paste plant. The balance of filtered tailings will be trucked to the FTSF. Excess paste and/or process water will be pumped back from the paste plant to the process plant using a second pipeline.

Tailings will be received at the paste backfill plant via dump hopper and filter cake feeder filter cake feeder. From the feeder, filter cake will be measured onto a filter cake conveyor and be fed into a continuous twin-shaft mixer fitted.

Dry binder is screw fed from two storage silos (one duty / one standby) and discharged into the mixer. A binder content of ~3% will be added depending on the underground distribution point and recipe requirements.

Final slump control water is dosed into the mixer by the Programmable Logic Controller (PLC) based on the power draw that the mixer motors are experiencing. A power draw that is too high indicates the pastefill is too stiff, so water is added to bring the power draw back in line with the recipe's expectations.

The mixer has an inner volume of 7.8 m³ and a mixing capacity of 149 m³/h (peak) with 150 second retention time. The mixing action is performed by mixing arms and paddles which are hydrodynamically designed to reduce wear and promote optimum mixing. The mixer includes a high impact washing system.

The pastefill from the mixer overflows into a paste hopper and is gravity fed into the suction side of one of the two piston positive displacement pumps. The piston pumps (one duty and one standby) pump paste on a continuous basis down the paste boreholes for deposition underground at the nominal design flow rate of 124 m³/h.

16.9.6 PASTE PLANT LAYOUT

The design of the site, building and foundations is governed by the process and equipment requirements, in conjunction with specific design criteria provided by DRA, as well as the Ecuadorian National Codes. The paste plant consists of a single multilevel building and a service area. Contained within this area will be the major and supporting pieces of equipment required to produce pastefill.

The lab building, e-rooms and control room are modularized modified high cube containers. The rooms have been strategically located around the paste plant to optimize operating and maintenance activities required.

The Loma Larga Project site is located within an environmentally sensitive zone. All design considerations have been taken to ensure the paste plant area is a zero-discharge site.

Only a single service road is required around the front of the paste plant building. Any equipment outside the paste plant building will be accessed with the 200-tonne plant mobile crane.

The cement silos will be fed from the front of the building with a truck pulling up in front of the plant and blowing the cement into the silos.

16.9.7 PASTE BACKFILL UNDERGROUND DISTRIBUTION SYSTEM

The Loma Larga underground pastefill distribution system includes two surface to underground cased boreholes to supply paste to the underground workings. The surface boreholes were designed to breakthrough on 3,625 level with a dip between 65° and 70°. The second borehole will be constructed as backup which is considered good practice.

Once underground, the pastefill travels through a network of pipelines to reach the locations where the paste is needed. An eight-inch pipe size has been specified for the underground distribution system.

Paste backfill deposition will occur from the 3,625 and 3,600 levels. No top access will be available to the stopes that sill out on the 3,625 level and will be mined using blind uphole blast techniques. As a result, paste will be deposited into the tops of these upper stopes using inclined deposition and breather boreholes.

Pressure instrumentation and cameras will be provided throughout the mine for monitoring the pour. Emergency blast-off spools and manual drain valves will be installed at critical locations. Manual valves near the discharge to the stopes will be used to divert water during a flush.

The pipeline profile is shown as a plan view and mine elevation view in *Figure 16-29* and *Figure 16-30*, respectively.

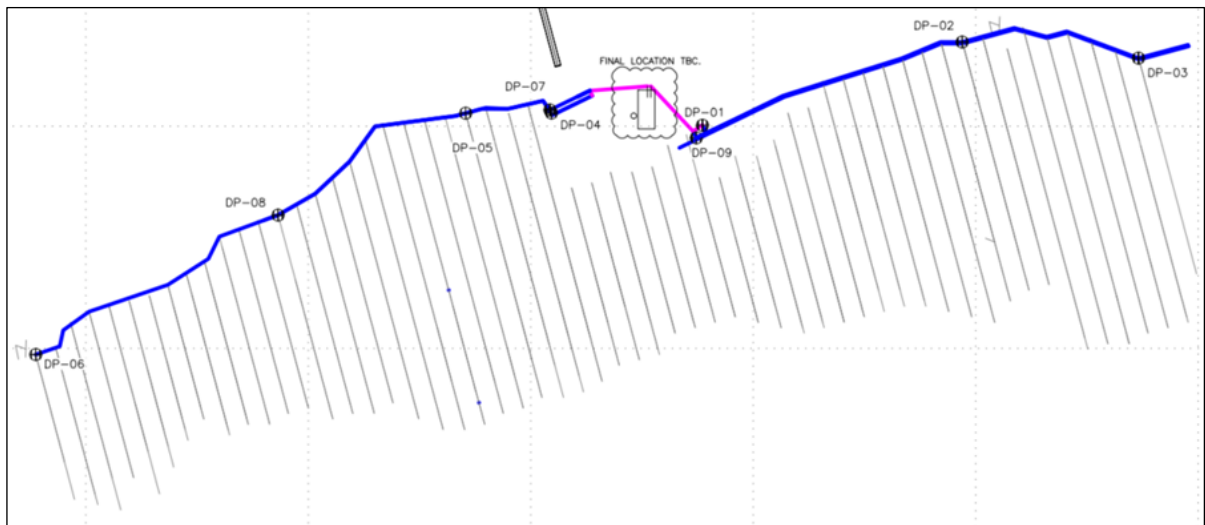

Figure 16-29: Schematic Diagram of Underground Workings – Pipeline Profile (Plan View)

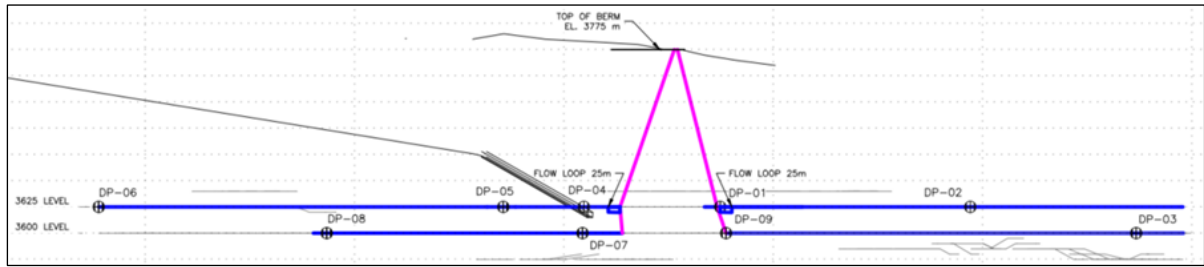

Figure 16-30: Schematic Diagram of Underground Workings – Pipeline Profile (Mine Elevation)

16.10 UNDERGROUND HYDROGEOLOGY CONSIDERATIONS

Itasca have done extensive work at the Loma Larga project to determine the quantity and quality of the water that will be expected underground during the ramp development and during operations. The summary of their findings is presented below.

During the ramp development phase, the water supply will be pumped out of the settling pond near the portal. The main water consumption (estimated by DRA) during that phase will be the jumbo drill (30 L/min) and the Bolter (15 L/min) for a maximum consumption of 45 L/min. The average daily water consumption will be 10,800 litres. Also, for the first 300 m of the ramp, the ground will not generate enough water and it is assuming that some fresh water will be required for 50% of the mine needs. As the ramp advances, sumps will be used to collect ground water and waste water. The water collected will be pumped to the settling pond near the portal to be used for development purposes. The same principle will be applied during the pre-production development as a second development crew will be added.

The summary of the underground water supply for the ramp and pre-production development (estimated by DRA) is shown in **Table 16-27**.

Table 16-27: Underground Water Supply for Ramp and Pre-Production Development

Ramp Development				
Equipment	Number	Consumption	Peak Consumption	Consumption per day
	(ea)	(l/min)	(l/hours)	(litre)
Jumbo 2 boom	1	30	1,800	7,200
Bolter	1	15	900	3,600
Total Water Equipment Consumption per day			1,800	10,800
% recirculated for the first 300 metres				50%
Water needed for the treatment plant for the first 300 m				5,400
Pre-Production development				
Equipment	Number of	Consumption	Peak Consumption	Consumption per day
	Equipment	(l/min)	(l/hours)	(litre)
Jumbo 2 boom	2	60	3,600	14,400
Bolter	2	30	1,800	7,200
Total Water Equipment Consumption per day			3,600	25,600
% recirculated				100%
Water needed from the treatment plant				-

In the mining production phase, the required water supply will come from the main dewatering system. The solids will be separated, from the water collected underground, and recirculated to the development and production drills. In addition to the jumbos and bolters from the mine development, DRA estimates that four production drills will each consume water at a rate of 5 L/min and one cable bolter will consume water at a rate of 15 L/min. The average daily water consumption will be 45,000 litres and will be all supplied from the underground dewatering system. Throughout the full mine life, the underground water supply will come entirely from the water collected underground.

The summary of the underground water supply at full production (estimated by DRA) is shown in **Table 16-28**.



Table 16-28: Underground Water Supply for Full Production

Production phase (14 years)				
Equipment	Number of	Consumption	Peak Consumption	Consumption per day
	Equipment	(l/min)	(l/hours)	(litre)
Jumbo 2 boom	2	60	3,600	14,400
Production Drill	4	20	1,200	21,600
Cable Bolter	1	15	900	1,800
Bolter	2	30	1,800	7,200
Total Water Consumption per day			7,200	45,000
% recirculated				100%
Water needed from the treatment plant				-

16.11 UNDERGROUND SERVICE FACILITIES

16.11.1 MAINTENANCE

Most of the repair services on mobile underground equipment will be done on the surface. The maintenance shop will be built near the plant and office facilities. The underground

	Document Number	J01834-PM-REP-002	Rev	0	
	Date	11 January 2019	Page	249 of 417	

mobile equipment will be on a maintenance schedule to minimize equipment breakdowns during work. Only emergency repairs will be done underground on mobile equipment. A small underground shop bay will carry minimal parts inventory to quickly respond to equipment breakdowns. Also, the fuel and lube truck will be able to fill up the hydraulic systems underground when needed.

The underground shop will carry spare pumps, pump motors, auxiliary ventilators and motors, in case of a breakdown. The pump and fans will be replaced underground and serviced in the surface shop. The pumps will also be on a maintenance schedule and brought to the surface shop on a regular basis. The same principle will apply for the ventilation fans. Spare fans will be kept in inventory for all motor fans.

16.11.2 FUEL BAY

The underground haulage truck will refuel at the surface fuel tank. An underground fuel and lube truck will bring the fuel from the surface tank to refuel the underground mobile equipment. Also, the underground fuel and lube truck will be responsible to refuel dedicated to work equipment such as jumbos and production drills at the work place.

16.11.3 EXPLOSIVE MAGAZINES

The explosive storage magazines will be located on surface one kilometre from any infrastructure. One storage magazine will be for the detonators and the other for ammonia nitrate/fuel (ANFO), the detonating cord and the sticks of packaged emulsion and perimeter explosives. The magazines will be purchased from the explosive supplier. The mobile ANFO loader will directly take the explosives from the magazines. The blasting crew will be responsible for marking the explosives used in the inventory log books located in each magazine. The site superintendent will be responsible to arrange regular powder magazine inventory as required by regulations.

16.11.4 REFUGE STATIONS AND SANITARY FACILITIES



Portable self-contained refuge stations will be purchased and installed to follow the lateral development. The portable refuge will primarily be installed near a fresh air intake and connected to the compressed air system coming from the surface. A main refuge station will be installed close at the bottom of the main fresh air raise intake. This facility will be equipped with eye and hand washing system and potable water will be available. The facility will also be used as a lunch room and meeting room.

Portable toilets will also be advancing with the lateral development.

16.11.5 MINE DEWATERING

As mentioned in the previous section, the underground water supply will not represent additional water consumption from the main water treatment plant. The dewatering system, throughout all phases of the operation, has been designed to supply clear water to the underground operations and to handle the water inflow.

A simulation of the groundwater inflow for the mine life has been conducted by Itasca. The study indicates that during the ramp excavation the water inflow will be 7.5 L/sec. As the

	Document Number	J01834-PM-REP-002	Rev	0	
	Date	11 January 2019	Page	250 of 417	

Project reaches full production, a peak water inflow of 13.8 L/sec is anticipated due to the presence of the two main ventilation raises and several open stopes, as well as a significant amount of level development.

During the ramp development phase, a sump will be excavated every 400 m to collect ground water running down the ramp. Also, a face pump will collect drilling water to convey it to the nearest sump. These sumps will settle the biggest solid particles and the waste water will get pumped from one sump to the other all the way to the surface settling pond using a series of 13 HP submersible pumps through a schedule 80, 102 mm diameter discharge line. The water in the settling pond will be treated and part of the water will be sent back to the underground operation.

At the ramp bottom, the main sump will be excavated, and the main dewatering system installed. The main dewatering system is designed to separate the solids from the water. This system will give clear water and a 30% solid slurry. The resulting clear water will be used for the underground drilling operation, the excess will be pumped directly to the surface plant using a 125 HP centrifugal pump through a schedule 10, 102 mm discharge line installed in the ramp. The slurry will be pumped to surface using a mixer and slurry pumps. This slurry will be pumped through another schedule 80, 102 mm diameter installed in the ramp.

The water balance for the mine is represented in *Figure 16-31*.

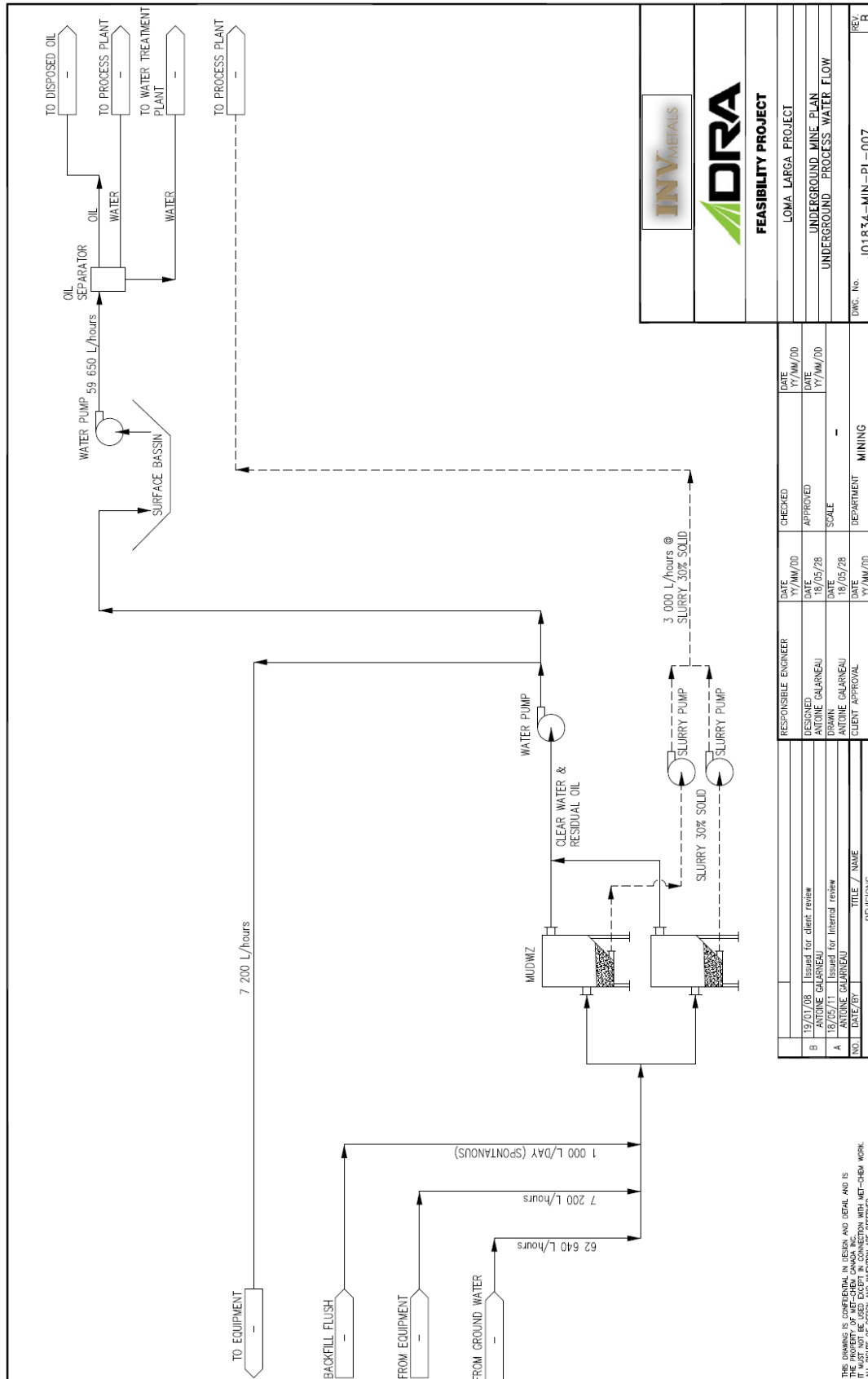

Figure 16-31: Mine Water Balance

16.11.6 UNDERGROUND MINE ELECTRICAL DISTRIBUTION

The objective of having sufficient electrical distribution is to provide the safest possible environment for the people working at Loma Larga. Having a sufficient electrical distribution will also create the best conditions for mobile equipment operators trying to perform their daily tasks. The following section outlines the electrical requirements of the underground mine. To satisfy the electrical requirements of Loma Larga, an electrical substation is required.

Table 16-29: Underground Electrical Equipment List and Consumption details the underground electrical mining equipment.

Table 16-29: Underground Electrical Equipment List and Consumption

Loma Larga - Underground Electrical Equipment List and Consumption				
Equipment	Number	Consumption	Usage	Daily Consumption
		KW/hr	hr/day	kW/day
Jumbo 2 booms	2	50	12	600
Bolter	2	50	9	450
Cable bolter	1	25	9	225
700 cfm Compressor	1	55	9	495
Production drill cw compressor	4	87	54	4,698
13 hp submersible pump	12	9.5	288	2,736
40 hp submersible pump	2	48	48	2,304
125 hp centrifugal pump	2	71	48	3,408
150 hp fans (84in, 150hp)	2	110	48	5,280
125 hp fans (84in, 125hp)	2	92	48	4,416
75 hp fans	1	55	24	1,320
40 hp fans	5	30	120	3,600
Light	1	10	24	240
Total Consumption		1,774		29,770

Furthermore, there will be five 350 HP main ventilation fans installed underground at the bottom of the ventilation raises. The mine will be developed over two main levels, 3,600 and 3,625. Access to the surface will be at level 3,600. The face width will be about one kilometer on level 3,625, 1.2 km on level 3,600. Surface power is available at 22 kV.

To provide power to the mine, a mining substation will be established near the entrance at level 3,600. This substation will consist of 2 incomers from the surface substation and 8 feeders. Please refer to **Figure 16-32** below.

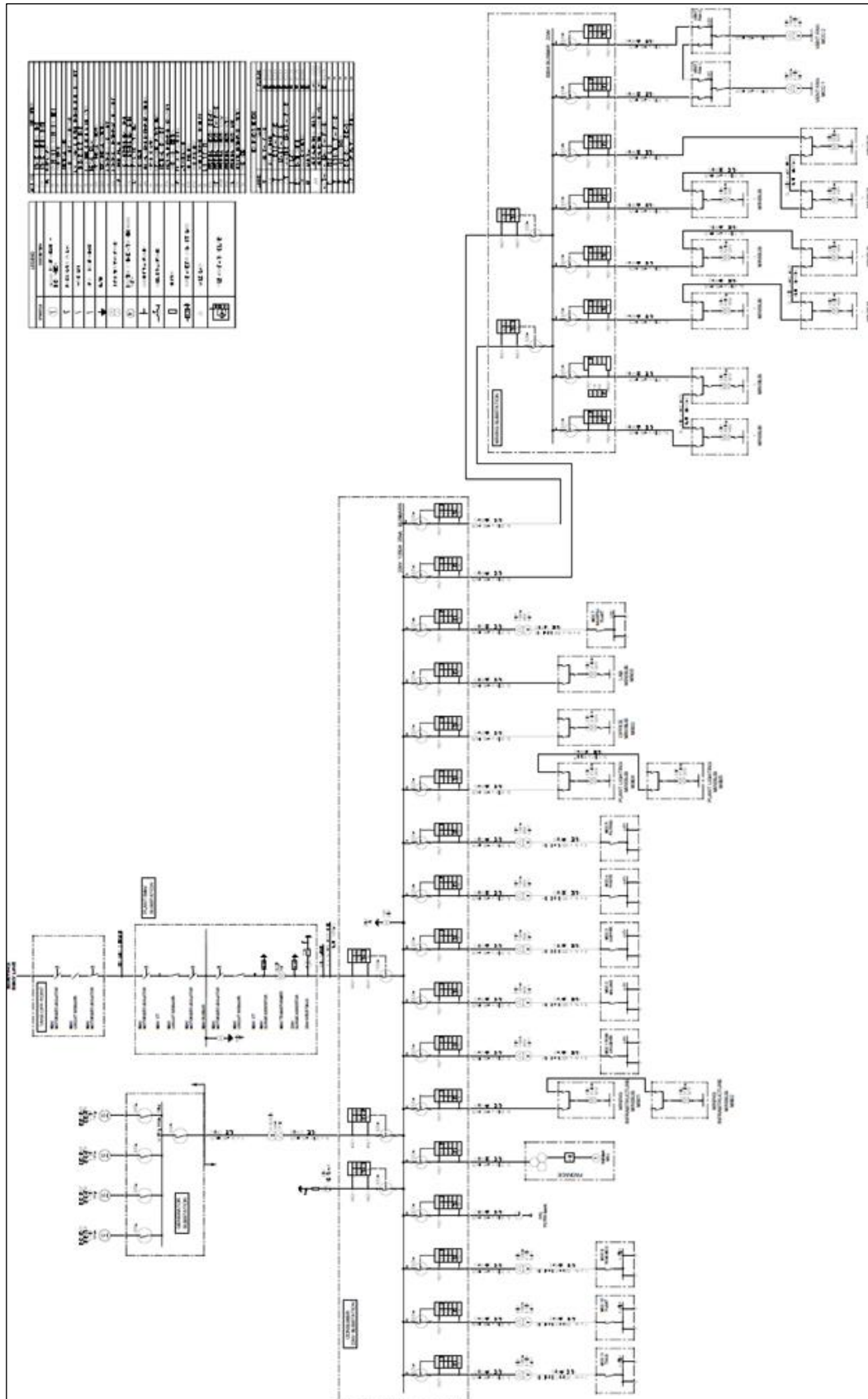



Figure 16-32 : Electrical Single Line Drawing

	Document Number	J01834-PM-REP-002	Rev	0	
	Date	11 January 2019	Page	254 of 417	

The 460-volt unitary substations will provide power to the mining equipment. The unitary substations will be equipped with feeder circuit breakers for connection of the mining motor control panels. This configuration will be repeated with two feeders and four unitary substations on level 3,600 and two feeders and three unitary substations on level 3,625. Please refer to **Figure 16-33** and **Figure 16-34** below.

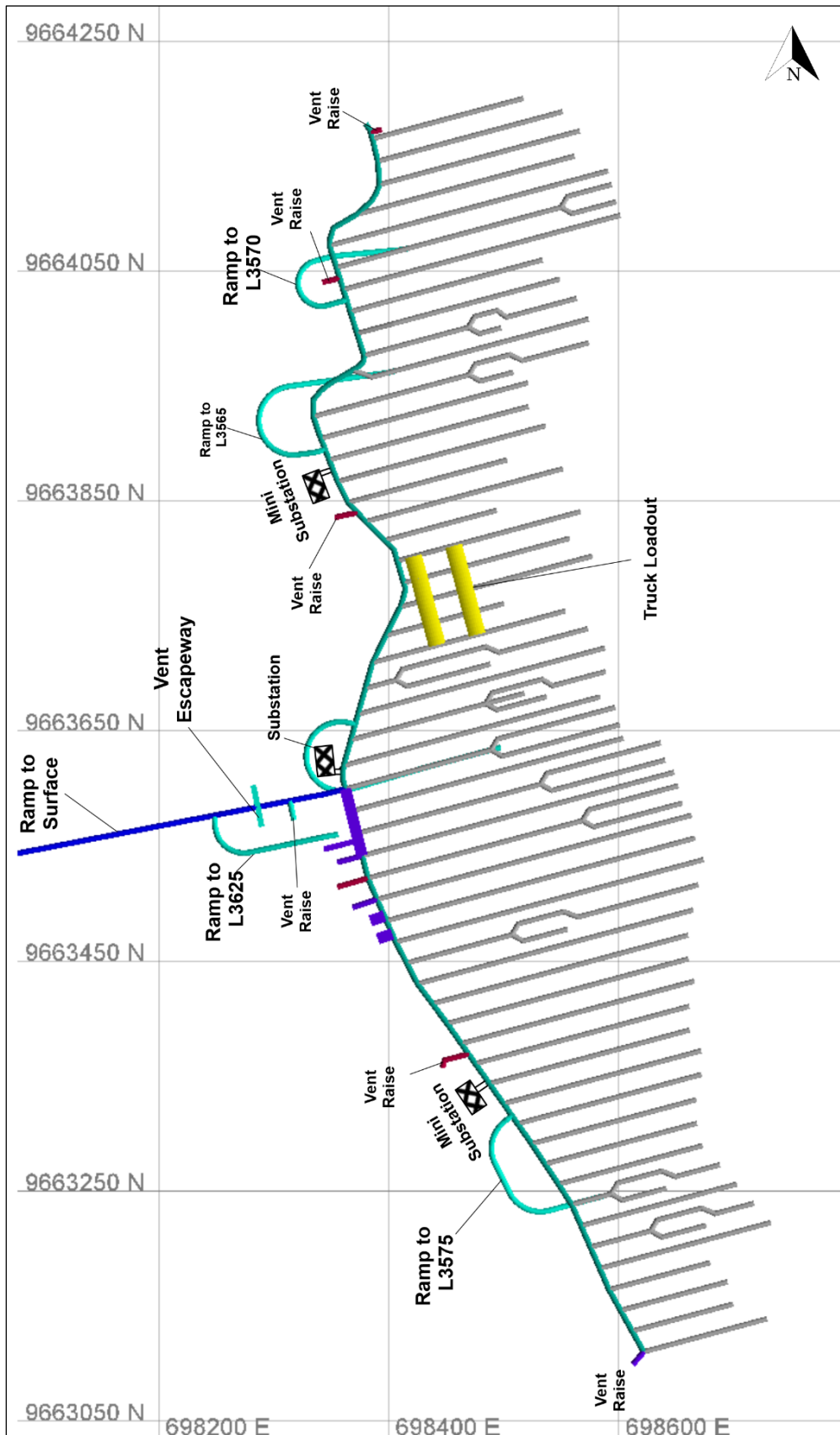

Figure 16-33: Level 3,600 Power Distribution

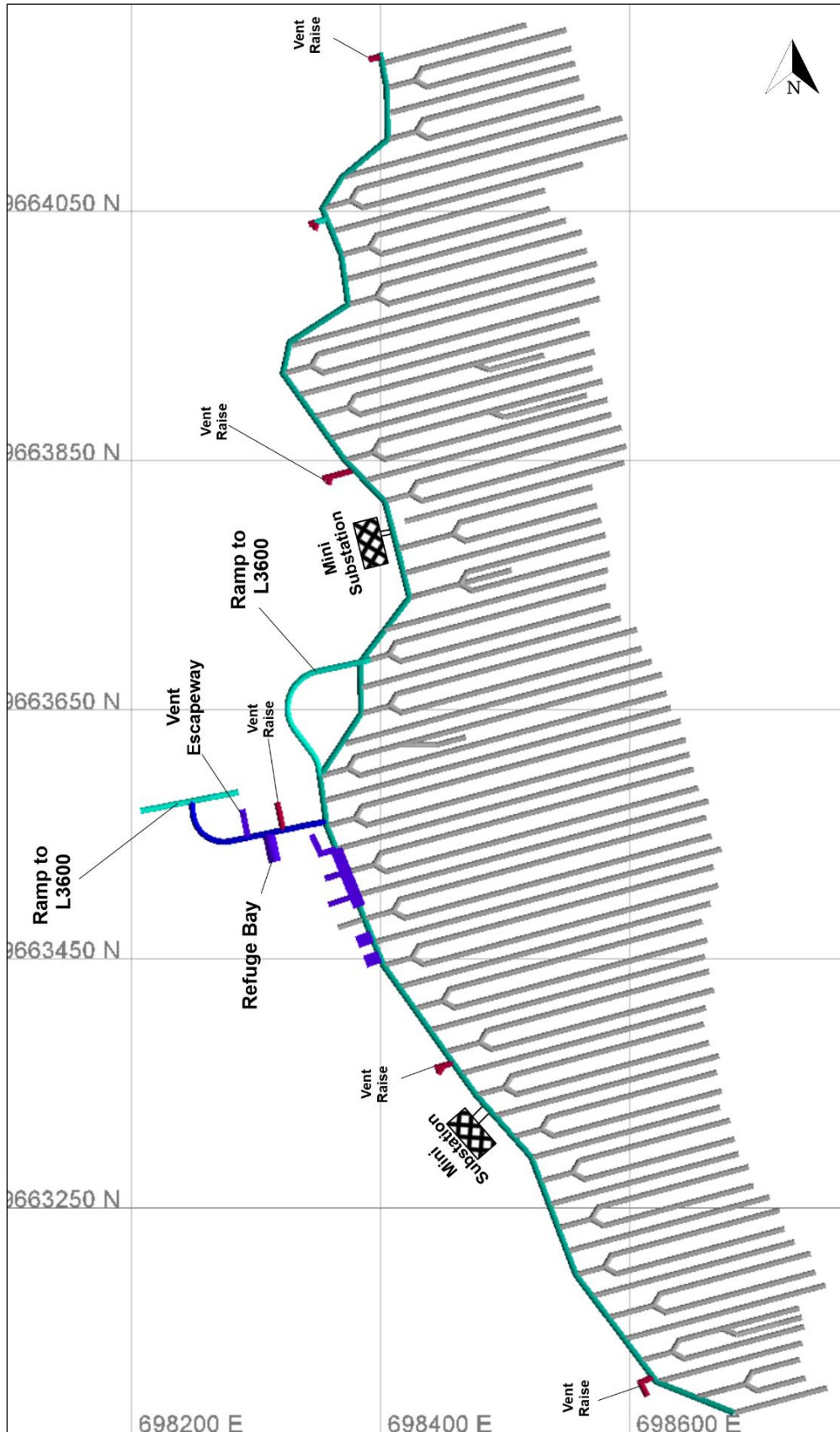



Figure 16-34: Level 3,625 Power Distribution

	Document Number	J01834-PM-REP-002	Rev	0	
	Date	11 January 2019	Page	257 of 417	

For the ventilation vans there will be a ring supply, feeding two ring main units. Fed from the ring, there will be two 22 kV main units, 4,160-volt units and 1.6 MVA transformers. The 4,160-volt units will feed the 400 HP starters for the ventilation vans.

16.11.7 UNDERGROUND COMMUNICATION

Based on the reliability, ease of use and ease of maintenance and repair, a leaky feeder system is recommended for the underground communication system.

A leaky feeder system can be used to transmit data, video and voice communication from underground to the mine surface. It can also be used to remotely operate fans, pumps and the blasting system. It can do wireless or wired PLC / SCADA interface with equipment like fans and pumps. It can connect to cameras and can be used for people and machine tracking and voice communication.

The leaky feeder equipment has been designed to allow for underground communication within range of the leaky feeder cable positioning.

The leaky feeder system will consist of a base repeater station comprising of a base station cabinet with the functionality of enabling full radio communications and coverage for providing voice channels to surface and underground. Batteries will allow for backup power under power outages as well. Further stations will be installed in levels 3,600, 3,625 and 3,575.

16.12 MINE SURFACE FACILITIES

16.12.1 PRE-PRODUCTION FACILITIES

During the ramp development and pre-production until the main haul road is constructed, a temporary installation will be constructed at the portal of the mine ramp. That area will include a temporary shop, a small waste stockpile, a small ore stockpile, temporary compressors and generators. The temporary shop and surface plant will be used by the underground contractor completing the main ramp and pre-production development. The portal waste stockpile will be loaded into highway trucks and hauled to the main waste stockpile near the FTSF. Also, near the portal the mine settling pond will collect the water coming out of the ramp. This water will be treated to remove solids and directed to a temporary water treatment facility (WTF) prior to discharge.



16.12.2 STOCKPILES

The main waste stockpile will be located at the tailings site. The design for the waste stockpile has a capacity of 60,000 cubic metres.

A 100,000-tonne ore stockpile is planned close to the process plant to allow for the stockpiling of different ore grades (high, low and marginal).

16.12.3 WAREHOUSE

Also close to the process plant, the main laydown area and warehouse will carry the inventory required for the mining operation. The main maintenance will also be close to the warehouse and laydown area.

	Document Number	J01834-PM-REP-002	Rev	0	
	Date	11 January 2019	Page	258 of 417	

16.12.4 MINE OFFICE, DRY AND MAINTENANCE FACILITIES

The mine office will be in the office complex near the maintenance facility and will include the man dry. That building will include office places for the management, administration and technical support. This is also where the main blasting switch will be and where the underground workers will tag in and out of the mine. The main office will have rooms for safety talks and conferences. The mine and process facilities are combined, and a detailed description is included in **Section 18**.

Figure 16-35 represents the general layout of the surface facilities.

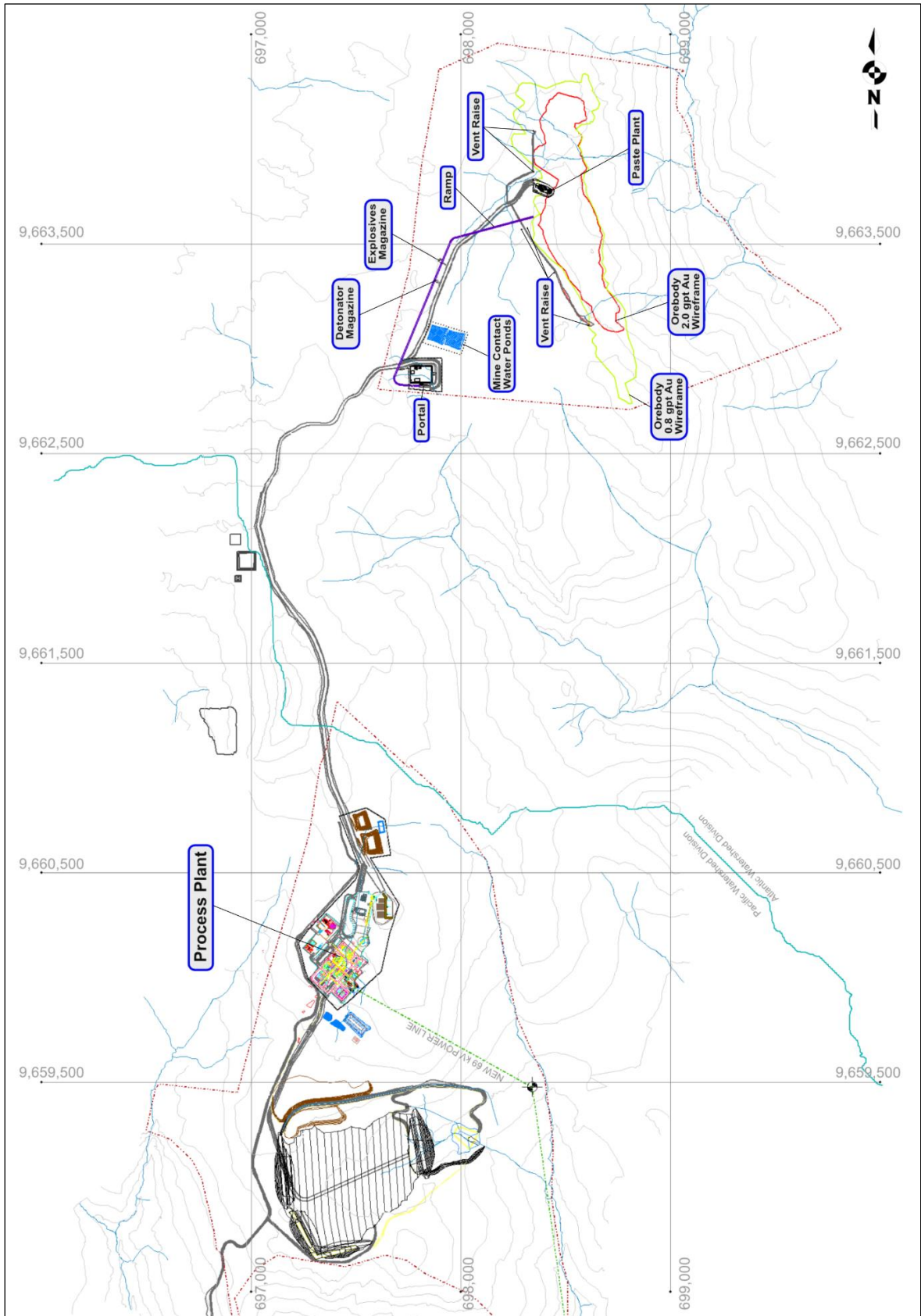



Figure 16-35: Surface Facilities

	Document Number	J01834-PM-REP-002	Rev	0	
	Date	11 January 2019	Page	260 of 417	

17 RECOVERY METHODS

17.1 INTRODUCTION

The process plant design is derived from data and design criteria provided by INV, DRA Americas, Promet101, vendor data, testwork and regulatory/ permitting requirements. These data and criteria provide the basis for the calculation and design criteria derived from the mass balance.

The crushing and grinding circuit design is based upon the design throughput requirements and ore competency and hardness. The ball mill sizing is based on achieving the primary grind size required to obtain optimal flotation performance and based on the outcomes of the metallurgical testwork. Sizing calculations have been completed using, first principle, power-based modelling methods.

The design of the flotation circuit is based upon the testwork results. The results of the locked cycle testwork provided the basis for recovery and grade calculations, and residence times.

Concentrate and tailings products are dewatered using conventional plate and frame pressure filtration. The filtration circuit design is based on pressure filtration testwork on tailings and common design practices for concentrate.

For other equipment items the peak production rates were used for sizing. For equipment which is influenced by the volumetric flow, the sizing requirement is based off the requirement for 120% of the instantaneous flow.

There are four types of water defined for the process: low pH process water, high pH process water, raw water, and gland seal water. Low and high pH process water are recovered from the grinding product and copper tailings thickener, respectively. Raw water is sourced from the local environment and gland seal is produced by filtration from the raw water tank.



Electrical power is provided by the local utility via overland power line. No diesel generators will be used for emergency power generation. Emergency power will be provided by the 22 KV line discussed earlier.

17.2 PROCESS FLOW SHEET

The process plant is designed to produce saleable separate copper and pyrite concentrates. Testwork examined both bulk and sequential sulphide flotation circuit flowsheets; with sequential flotation being shown as the optimal flowsheet. The sequential flowsheet was shown to reduce capital and operating costs whilst producing high value concentrates.

ROM ore from the underground mine is crushed on surface in a two-stage crushing (primary jaw crusher, secondary cone crusher) closed circuit to provide feed material suitable for milling in a single-stage ball mill. A 3,000-tonne live capacity stockpile provides an operating buffer between the crushing and milling circuits.

Material is withdrawn via tunnel reclaim from the stockpile and fed to the ball mill. The ball mill operates in closed circuit with a bank of hydro-cyclones. Milk of lime and low pH process water are added to the ball mill feed chute with the crushed ore to maintain a target mill pulp pH. Hydro-cyclone underflow material is returned to the grinding circuit. Hydro-cyclone overflow pulp reports to a grinding product thickener. Thickened underflow is conditioned with lime to raise the pH prior to copper rougher flotation in conventional tank cells.

	Document Number	J01834-PM-REP-002	Rev	0	
	Date	11 January 2019	Page	261 of 417	

Copper flotation feed is first conditioned with milk of lime and high pH process water in the copper rougher flotation conditioning tank. The conditioned slurry flows by gravity to the copper rougher feed box and into the first of four rougher flotation tank cells. Copper rougher tails are sent to the copper tails thickener. Copper rougher concentrate is reground in a vertically stirred media mill before copper cleaner flotation using two sequential stages of cleaning.

The first stage of copper cleaning consists of four conventional forced air flotation cells. Tails from the first cleaner cells flow to the copper first cleaner scavenger feed box and then to four conventional forced air flotation cells. Tails from the cleaner scavenger cells are directed to the copper tails thickener. Concentrate from the first cleaners is pumped to the second cleaners, whilst concentrate from the first cleaner scavengers is returned to the first cleaner feed box.

The second cleaner bank consists of three conventional forced air flotation cells. The second cleaner concentrate reports to final concentrate dewatering, and the second cleaner tails report to the first cleaner feed box.

Provision for the future addition of a bank of third cleaner cells and associated equipment has been allowed for in the process plant layout.

Final copper concentrate is thickened and filtered prior to being bagged for shipment on site.

The underflow from the copper tails thickener is pumped to the pyrite rougher flotation conditioning tank, where low pH process water is added. The conditioning tank overflows to the pyrite rougher feed box and discharges into the first of six pyrite rougher flotation tank cells.

Pyrite rougher concentrate is reground in a vertically stirred media mill before further cleaning in a single stage of flotation. The pyrite cleaning flotation circuit consists of six conventional forced air flotation cells. Tails from the pyrite rougher and first cleaner cells flow to the tailings thickener.

Concentrate from the first cleaners is final pyrite concentrate and reports to the pyrite concentrate thickener and pressure filters.

Provision in the future has been made for the installation of a bank of second cleaner cells and associated equipment.

Pyrite concentrate is dewatered and stored, in bulk, in the concentrate storage area prior to being shipped in containers.

Pyrite flotation tails are thickened in the tailings thickener. Thickener underflow is directed to the tailings filtration area for final dewatering. Filtered tails are hauled to either the FTSF for deposition or to the paste backfill plant at the mine as required.

Water recovered from the grinding circuit thickener, copper thickener and pressure filters are considered the source of high pH process water. Low pH water is recovered from the tailings thickener and pyrite pressure filters.

Figure 17-1 illustrates the process plant flowsheet for the Loma Larga project.

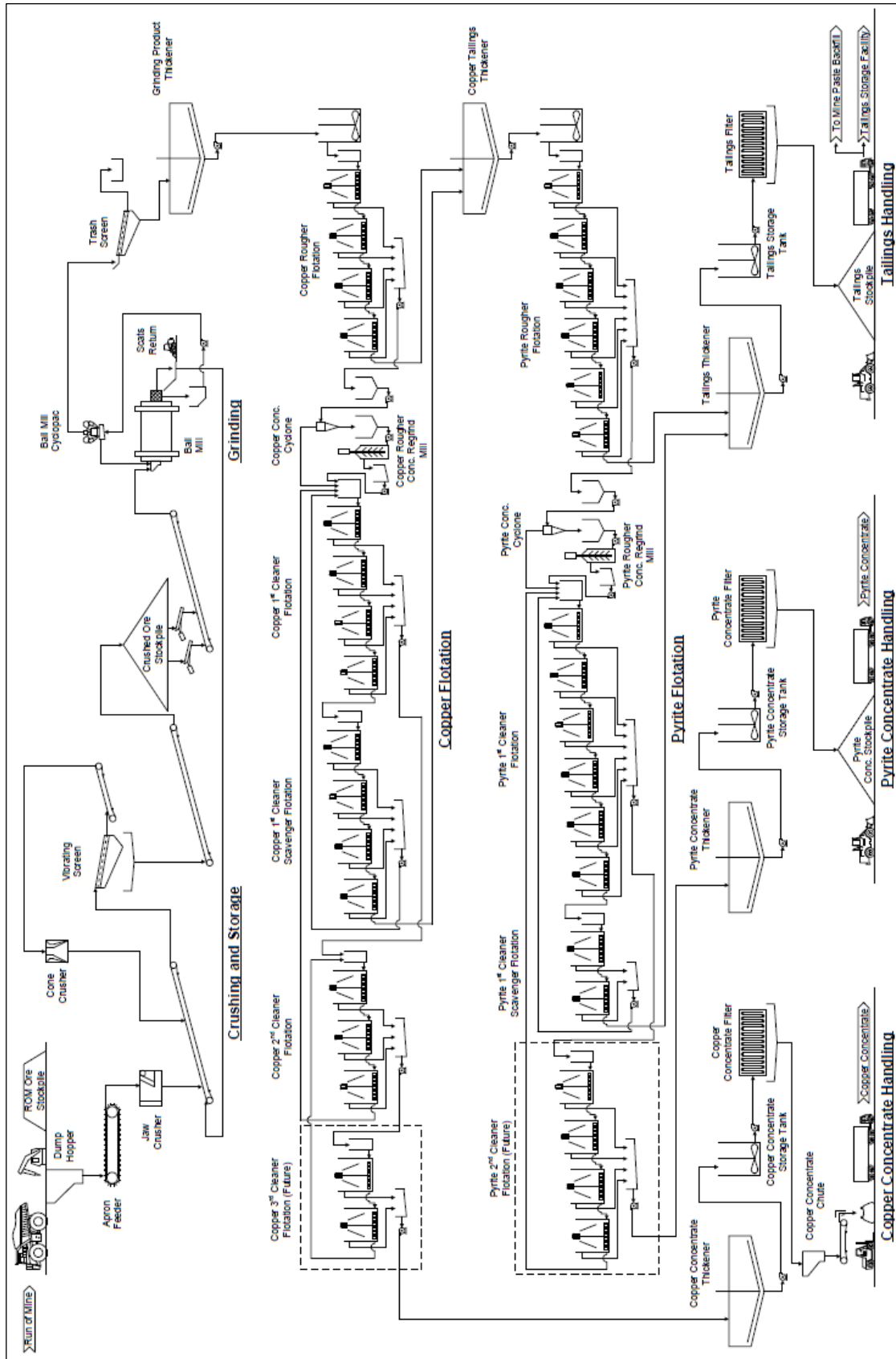

Figure 17-1: Simplified Overall Process Flow Diagram

17.3 PLANT DESIGN

The processing plant is designed to process a nominal 3,000 tonnes per day of ROM ore from an underground mine. The plant will produce separate copper and pyrite concentrates using a sequential conventional sulphide flotation flowsheet. Plant tailings will be filtered and trucked to either the FTSF or to the paste backfill plant for deposition in the underground workings.

The nominal and design feed grades were determined from the 50th and 85th percentile of the original high-grade block model values. The average LOM grades from the latest production plan are at or below these grades at 0.29% Cu, 4.9 g/t Au, 29.6 g/t Ag and 6.3% S. The highest average monthly grades in the LOM plan exceed the 85th percentile grade values of 0.63% Cu on 3 occasions (monthly average), 8.72 g/t Au on 9 occasions, 56.8 g/t Ag on 2 occasions and 9.4% S (Nil). The most important value with respect to flotation circuit design is the sulphur grade and the value of 9.4% is not exceeded throughout the LOM. As flotation equipment capacity is limited by sulphur content.

Table 17-1: Summary Process Design Criteria

Description	Unit	Nominal	Design
Nominal Throughput – Daily	tonnes/day	3,000	3600
Nominal Throughput – Annual	tonnes/annum	1,095,000	1,314,000
Feed grades (PDC)			
- Cu	%	0.23	0.63
- Au	grams/tonne	5.20	8.72
- Ag	grams/tonne	28.2	56.8
- S	%	6.6	9.4
Utilization			
- Crushing circuit	%	70	67
- Concentrator	%	92	92
- Tails Filtration	%	81	81
Ore hardness			
- Crushing Work Index (CWi)	kWh/t	11.5	11.5
- Abrasion Index (Ai)	g	0.9	1.2
- Bond Ball Mill Work Index (BWi)	kWh/t	17.3	18.5
Primary Crushing			
- Installed Power	kW	132	
- Feed Size F80	mm	460	610
- Closed Size Setting	mm	125	
Secondary Crushing			
- Installed Power	kW	220	
- Feed Size F80	mm	111	
- Crusher Product P80	mm	25	
Milling			
- Primary Stockpile (Live)	tonnes	3,000	
- Installed Power	kW	5,000	5,000
- Circulating Load	%	272	286
- Primary Grinding Product P80	µm	75	
- Grinding Thickener Settling Rate	t/h/m ²	0.67	0.81
Copper Flotation Circuit			
- Rougher Conditioner Time	min	5.7	4.8
- Rougher Cell Volume	m ³ /cell	50	50
- # Rougher Cells		4	4
- Rougher Concentrate Regrind P80	µm	20	20
- # of Cleaning Stages			
- Cleaner Cell Volume (1st/ 2nd)		2	

Description	Unit	Nominal	Design
- # of Cells per Stage (1st/ 2nd)	m3	4 / 2	
- Cleaner-Scavenger Cell Volume		4 / 3	
- # of Cells per Stage (CI-Scav)	m3	2	
- Copper Tails Thickener Settling Rate	t/h/m2	2	0.80
		0.67	
Pyrite Flotation Circuit			
- Rougher Conditioner Time	min	5.5	4.8
- Rougher Cell Volume	m3/cell	50	
- # Rougher Cells		6	
- Rougher Concentrate Regrind P80	µm	30	30
- # of Cleaning Stages			
- Cleaner Cell Volume (1st)		1	
- # of Cells per Stage (1st)	m3	10	
- Cleaner-Scavenger Cell Volume		6	
- # of Cells per Stage (CI-Scav)	m3	2	
		10	

17.4 PRODUCTION SUMMARY



An integrated mine and process plant concentrator plan was developed with the following considerations:

- The process plant nominal throughput rate is 3,000 t/d. This rate will increase to 3,400 t/d in year five, after the commencement of mining;
- A high-grade stockpile is created during the mining development and ramp up period such that once the process plant commences operations there will be no periods where plant operations cease due to insufficient ore supply from the mine;
- The process plant has a throughput ramp up period of six months and a metal recovery ramp up period of nine months;

Table 17-2 outlines the anticipated production results over the LOM. The basis for the development of the concentrate recoveries and grades were the locked cycle tests carried out during the 2017 metallurgical program, in consideration of the final flow sheet. Life of mine gold recovery is estimated at 90% with 15% of the gold recovery to the copper concentrate and 75% reporting to the pyrite concentrate.

Table 17-2: Loma Larga LOM Process Plant Production Plan

Year	Feed			Copper Concentrate				Pyrite Concentrate				Tailings			
	Tonnes	Au g/t	Ag g/t	Tonnes	Au g/t	Ag g/t	Cu Rec %	Au Rec %	Tonnes	Au g/t	Ag g/t	Au Rec %	Tonnes	Au g/t	Ag g/t
1	-	-	-	-	-	-	-	-	-	-	-	-	-	-	-
2	669,775	7.49	27.5	7,160	105.07	1284.0	84.0	15.0	92,014	40.90	89.9	75.0	570,601	0.88	1.6
3	1,095,000	7.61	35.9	12,600	99.18	1559.0	85.0	15.0	154,467	40.50	114.5	75.0	927,933	0.89	2.1
4	1,095,000	7.99	45.0	16,995	77.23	1451.0	87.0	15.0	151,616	43.30	146.4	75.0	926,389	0.94	2.7
5	1,241,000	6.76	40.2	14,302	88.03	1746.0	85.0	15.0	165,091	38.10	136.1	75.0	1,061,607	0.79	2.4
6	1,241,000	4.32	28.3	9,594	83.82	1829.0	81.0	15.0	154,683	26.00	102.1	75.0	1,076,723	0.50	1.6
7	1,241,000	3.94	27.7	8,174	89.66	2103.0	79.0	15.0	154,587	23.70	100.1	75.0	1,078,239	0.46	1.6
8	1,241,000	3.96	26.0	4,715	130.53	2816.0	68.0	15.0	188,913	20.20	92.1	75.0	1,047,372	0.46	1.5
9	1,241,000	3.73	28.3	7,180	96.72	2444.0	78.0	15.0	169,445	20.50	93.2	75.0	1,064,375	0.43	1.6
10	1,241,000	4.04	30.6	8,303	90.53	2284.0	80.0	15.0	168,230	22.30	101.5	75.0	1,064,467	0.48	1.8
11	1,241,000	3.60	21.9	6,149	109.10	2212.0	76.0	15.0	154,567	21.70	79.2	75.0	1,080,284	0.41	1.3
12	1,241,000	3.81	23.5	7,833	90.63	1862.0	79.0	15.0	151,157	23.50	86.8	75.0	1,082,010	0.43	1.4
13	1,138,701	3.45	21.7	6,491	90.78	1899.0	78.0	15.0	141,007	20.90	78.7	75.0	991,203	0.40	1.2
Yrs 1-3	1,764,775	7.56	32.7	19,760	101.31	1459.4	84.64	15.0	246,481	40.65	105.3	75.0	1,498,534	0.89	1.9
Yrs 1-5	4,100,775	7.43	38.3	51,057	89.58	1536.9	85.53	15.0	563,188	40.62	125.4	75.0	3,486,530	0.87	2.2
LOM	13,926,476	4.91	29.6	109,496	92.63	1858.6	81.53	15.0	1,845,777	27.88	102.2	75.0	11,971,203	0.57	1.7

	Document Number	J01834-PM-REP-002	Rev	0	
	Date	11 January 2019	Page	266 of 417	

17.5 ENERGY, WATER AND PROCESS MATERIAL REQUIREMENTS

17.5.1 REAGENTS AND CONSUMABLES

The following reagents are used throughout the process plant:

- Methyl Isobutyl Carbinol (MIBC) – frother;
- Aerophine 3418A – copper mineral collector;
- Potassium Amyl Xanthate (PAX) –pyrite mineral collector;
- Hydrated Lime – alkalinity control;
- BASF MF250 Flocculant – for increased settling rates in thickeners; and
- Antiscalant – prevention of pipe scale.

Reagent mixing will be completed in a designated area within the plant. The design of this area includes features such as bunding, with dedicated sump pumps. The layout and general arrangement of the reagent area account for the need to prevent contact of incompatible reagent types. Separate onsite long-term reagent supply storage is provided a safe distance away from the process plant.

Reagents are made up or diluted with fresh water (where necessary); milk of lime and solid flocculant are made up using clean fresh or raw water. PAX collector is diluted with fresh water. Copper collector 3418A and MIBC are delivered in 1,000 L bulk containers and added to the flotation circuit neat.

Grinding media is supplied in 200 L steel drums (steel balls for the primary grinding mill) or 500 kg supersacs whilst the ceramic grinding media for the regrind mills will be delivered in 500 kg supersacs. Replacement filter clothes are also provided for the concentrate and tailings pressure filtration systems. Based on the available geometallurgical information, no acid addition is anticipated to maintain steady state operating conditions. It is recommended that a minimum supply of acid is retained on site for plant start-ups and abnormal conditions that may be encountered during operations.

17.5.2 AIR

Dedicated, independent, low pressure air blowers and distribution systems will supply the process air required for each flotation circuit. In each circuit, one blower will be operational, the other will be on standby.



Compressed air for plant distribution will be provided by the centralized plant compressor plant. Air receivers will be positioned throughout the process plant to buffer and control fluctuations within the system.

Instrument air for the process plant will be provided by drying an off-take stream from the centralized compressed air plant. Air receivers will be positioned throughout the plant to buffer and control fluctuations within the system.

Compressed air for the truck shop and primary crusher area will be provided by independent systems due to their distance away from the main plant.

17.5.3 WATER

The use of external make-up water has been minimized as part of the process plant design. Process water is recovered within the circuit using thickeners and filtration unit operations. In



	Document Number	J01834-PM-REP-002	Rev	0	
	Date	11 January 2019	Page	267 of 417	

the low pH case, water will be recovered from the grinding circuit and the tailings thickener. In the high pH case, water will be recovered from the copper tailings thickener.

Independent low and high pH process water tanks and distribution systems have been incorporated into the design. The utilization of independent systems will reduce reagent consumption and reduce interaction effects.

Raw (fresh) water will be withdrawn from local collection ponds or supplied from the water treatment plant. A combined raw and fire water tank will hold sufficient quantities of water to meet the instantaneous process demands of the plant. The raw water suction nozzle will be placed mid-way up the tank wall to ensure a reserve volume is always available for fire suppression.

Gland seal water will be withdrawn from the raw water tank, filtered and stored in a tank prior to distribution.

	Document Number	J01834-PM-REP-002	Rev	0	
	Date	11 January 2019	Page	268 of 417	

18 PROJECT INFRASTRUCTURE

18.1 SUMMARY

Loma Larga consists of both on-site and off-site infrastructure.

- The on-site infrastructure includes:
 - Site roads;
 - Water supply and distribution;
 - Fuel storage and distribution;
 - Warehouse;
 - Truck shop and maintenance facility;
 - Assay and metallurgical laboratory;
 - Plant offices and control room;
 - Administrative offices;
 - Mining offices and change house facilities;
 - Telephone and internet communications systems;
 - Filtered tailings storage facility (FTSF);
 - Waste water treatment plant (WTP); and
 - Site power distribution.
- The off-site infrastructure includes:
 - Transmission line;
 - Site access road;
 - Off site parking facilities.

The overall site layout is shown in *Figure 18-1*.

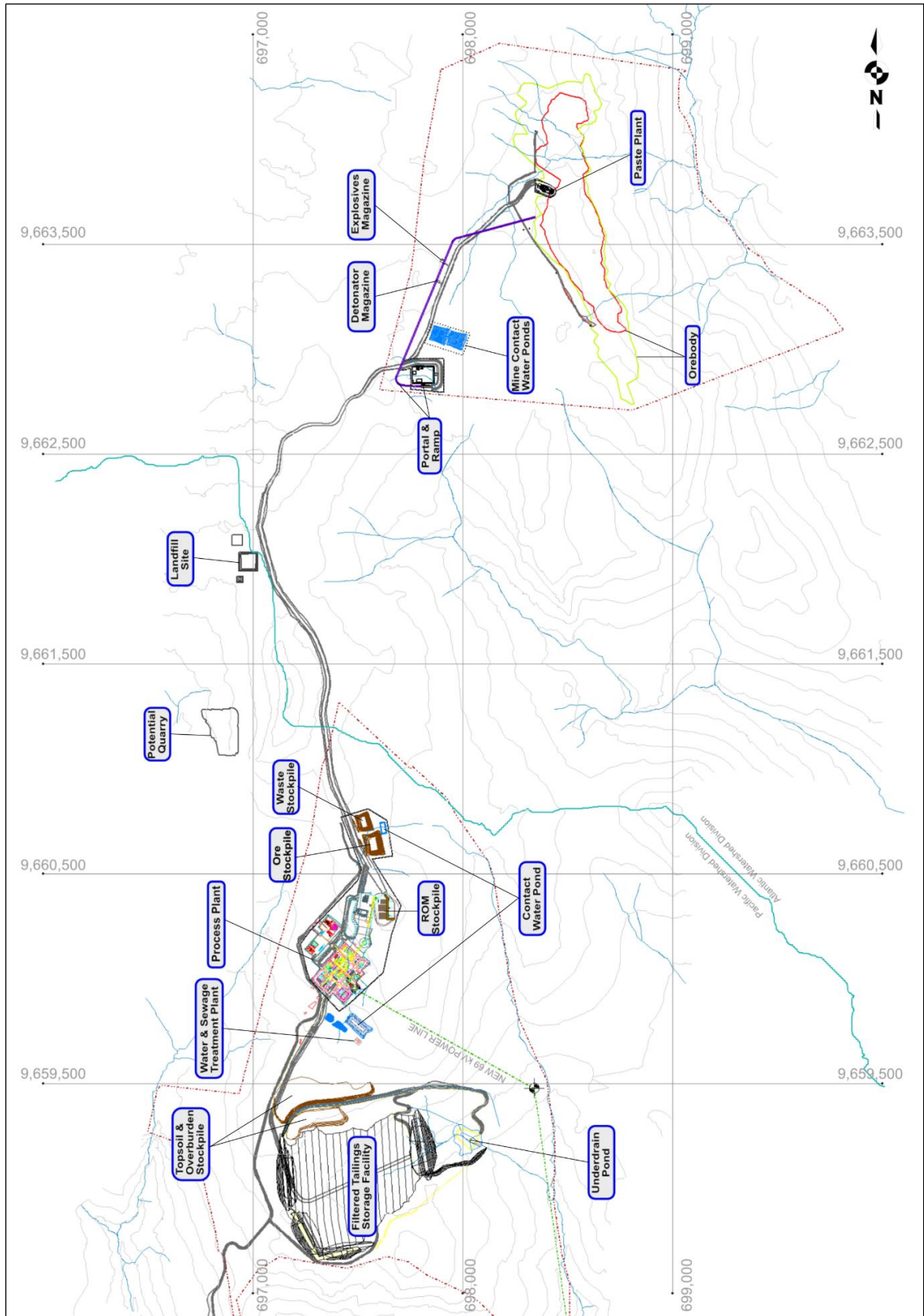



Figure 18-1: Overall Site Layout

	Document Number	J01834-PM-REP-002	Rev	0	
	Date	11 January 2019	Page	270 of 417	

18.2 TRANSMISSION LINE AND SITE POWER DISTRIBUTION

Electrical power is to be provided via the local utility, CENTROSUR, from the local network in Ecuador. This area is part of the national 230 / 138 / 69 / 22 kV network, with 69 kV and 22 kV feeds identified to supply the site. The main 69 kV / 25 MVA supply connect to the network running between Lentag and Victoria del Portete, with the new substation located near Girón and the transmission line up to the plant site. The incoming 69 kV will terminate into the main substation at the plant site and will be stepped down to 22 kV from where it will be distributed to site facilities. Lentag is fed from multiple 69 kV sources from the national grid and has necessary protection, assuring the reliability of the supply

A 2 MVA, 22 kV supply from San Fernando is proposed for construction power.

CENTROSUR have indicated that the 22-kV supply from San Fernando is fed from different distribution networks and is therefore suitable for emergency backup power as it is fed from a different source, on different infrastructure and overhead lines that run a different route. Diesel generators were therefore deemed not necessary

The 22-kV emergency supply will terminate on a second incomer of the main substation. All on-site distribution to the concentrator plant, mining operations, support infrastructure and administration facilities will be from the main 22 kV substation.

The surface 22 kV substation will be metalclad switchgear of modular construction fed from the 69 / 22 kV transformer and distribute power to the mine, backfill plant and process plant as well as the related infrastructure buildings and utilities.

22 kV / 440 V and 22 kV / 4 160 V stepdown transformers will feed the 440 V and 4,160 V MCCs. The MCCs will be located close to the equipment to reduce cable lengths and will be housed in E-House type structures throughout the plant.

22 kV / 207 V stepdown transformers will provide the lighting and small power supply and also feed the infrastructure buildings.



18.3 ROADS

The main access road from San Gerardo to the mine site will be upgraded in two phases during the execution of the Project with completion of phase two scheduled prior to the commencement of operation of the process plant.

Phase one will consist of the enhancement and ongoing maintenance, during the construction phase, of the existing road only. The existing road surface will be improved to a minimum road width of 3.6 m, a turning radius of 9.4 m and the cross-fall slopes will be maintained to ensure drainage into the existing side drains. This road currently has an average gradient of approximately 12-16% and isolated areas where the maximum gradient reaches 20%. No major realignment is planned ahead of the start of the main road construction.

Phase two will be the upgrade of the existing enhanced road. The FS level design for the site access road was completed using the functional classification C3 for an agricultural/forestry class of roadway according to the Ecuadorian standard for roads, NEVI-12, published by the ministry of transport and public works “Ministerio de Transporte y Obras Publicas” (MTO). This classification allows for a maximum of 500 vehicles per day which is above the calculated expected daily vehicle traffic volumes for the construction phase and LOM operation.

The road is 11.6 km long and has a width of 4 m with an additional 1 m wide shoulder on either side. Design speed is a maximum of 30 km/h and maximum slope of 14%. A new

	Document Number	J01834-PM-REP-002	Rev	0	
	Date	11 January 2019	Page	271 of 417	

section of road will be constructed from the existing road between San Gerardo and Chumblin up to the local existing quarry area primarily to: bypass the centre of San Gerardo, and to avoid a section of road that was identified to be prone to rock falls and slope instabilities on the existing road. From the local quarry up to the FTSF the existing road will be modified to meet the design parameters.

Various site roads will be required to access other areas of the site and these are as follows:

- A 3 km long and 12 m wide haul road will be constructed between the process plant stockpile, ROM tip and the portal to the underground mine. This road will have a gravel-wearing coarse with safety berms on both sides of the roadway, and will accommodate mine trucks that will be delivering ore from the mine to the primary crusher stockpile area and other vehicles between the two locations.
- A 1.1 km long class C3 road between the portal and the location of the paste backfill plant
- A pipe corridor with berms on either side will be constructed adjacent to the above two mentioned roads to accommodate various pipes between the process plant, mine portal and paste backfill plant.
- Internal plant roads will be designed to access the crusher, milling, flotation and concentrate filtration areas.
- A 12 m wide road and adjacent pipe corridor will be designed to join the maintenance workshop area to the new haul road.
- Additional roads will be added to access the explosives storage areas, ventilation fans, FTSF and WTP.

To minimize the number of vehicles travelling between San Gerardo and the Project site, parking facilities for personnel private vehicles will be provided in San Gerardo. Bus transportation will be provided to and from facilities and the Project site. A drop-off point has been allowed at the main entrance to the process facility, near the main gate house, and this includes a small parking area for visitor's light vehicles.

18.4 BUILDINGS

Infrastructure buildings have been designed as brickwork structures combined with steel and cladding where required.



A lube storage area, fuel storage tanks and a fuel dispensing area are provided adjacent to the truck shop to store and dispense fuel for surface vehicles and the underground mining fleet.

A warehouse structure of 500 m² will provide for plant and mining stores. A separate office area of approximately 90 m² is included and positioned against one of the sides of the warehouse.

An 800 m² steel structured building is provided for the combined surface and mining truck shop and process plant maintenance facility. A separate area of approximately 345 m² for offices, stores and facilities are positioned along the sides of the building.

An assay and metallurgical laboratory of 450 m² will include office space, the assay and metallurgical laboratories, storage for samples and other associated facilities.

Plant offices and a control room measuring 165 m² will be located close to the concentrator facility and away from the administrative offices.

	Document Number	J01834-PM-REP-002	Rev	0	
	Date	11 January 2019	Page	272 of 417	

An administrative office building measuring 470 m² will include a combination of single and open plan office spaces, boardrooms, store and filing rooms and washrooms.

Mining offices, training facility, change house, laundry, first aid area, kitchen and dining area will be combined into one building, measuring 1,970 m², and have been sized to accommodate the surface and underground crews. The mining offices will include a combination of single and open plan office spaces and washrooms.

18.5 COMMUNICATIONS

The communication network on site will be a modular ethernet network for ease of future upgrade and functionality, with connection to internet and telecommunications providers dictated by their network speeds. The architecture will be a single physical layer network, segmented into several virtual networks to enable segregation and isolation of different types of network traffic.

The network backbone is a multicore fiber backbone consisting of a combination of single mode and multimode fiber cables. The use of a fiber network will ensure that communications will not be affected by interference from any electrical or magnetic sources along the various cabling runs. Fiber networks is also the most efficient transmission mechanism with the least performance loss over long distances.

A Multicore Fiber cable network will provide redundancy in the form of a multi route configuration and the flexibility to create a mesh network design. A mesh network is a local network topology in which the infrastructure nodes (i.e. bridges, switches and other infrastructure devices) connect directly, dynamically and non-hierarchically to as many other nodes as possible and cooperate with one another to efficiently route data from/to clients.

18.6 FILTERED TAILINGS STORAGE FACILITY

The process plant production is currently planned for 3,000 t/d with a conventional ball mill and flotation circuit. Following metallurgical processing, the tailings will be thickened and 1) filtered and stored on surface at the FTSF or 2) routed to the paste plant for placement as cemented backfill in the underground mine.

The planned FTSF is located adjacent to and on the Pacific side of the continental divide. The FTSF is located on Rio Cristal, which is part of the Rio Zhurucay basin. The location is within the project surface rights and there is a significantly smaller population within the downstream catchments in comparison to other locations. The location is approximately 500 m to the south of the proposed mill and process facility in a small drainage basin, as illustrated in *Figure 18-2*.

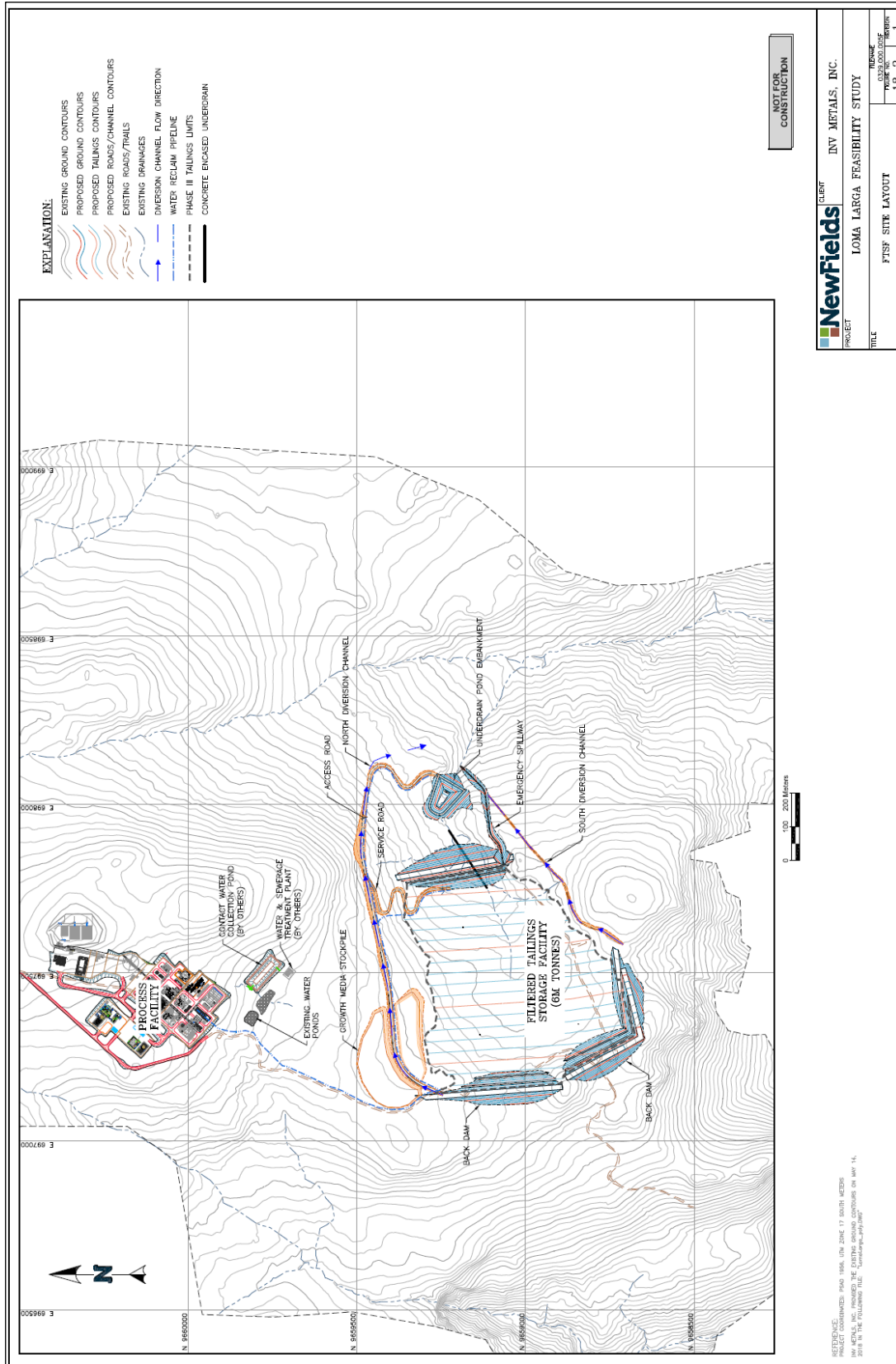

Figure 18-2: FTSF Site Layout

Approximately half of the tailings produced will be stored on surface in the FTSF and it is estimated that approximately 5.5 million dry tonnes (Mt) will be placed in the FTSF over the life-of-mine currently projected as approximately 12 years.

The FTSF design consists of four phases to limit the footprint of disturbed area as the mine develops and to facilitate effective management of Project capital resources. The phases (1A, 1B, 2 and 3) have been designed to store 1.0, 1.5, 4 and 6 Mt (dry) of filtered tailings, respectively. The storage capacity provides for an extra 0.5 Mt of tailings to provide for some upside in the resource.

The elevation – capacity characteristics of the proposed FTSF are presented in **Table 18-1**.

Table 18-1: Elevation – Tailings Storage Capacity



Phase	Capacity (M tonnes)	Main Embankment Elevation (m amsl)
1 (A + B)	1.5	3,663.5
2	4	3,668.0
3	6	3,672.0

Geochemical characterization of filtered tailings suggests that the material is potentially acid generating (PAG) and has the potential to leach constituents of potential concern (COPC), including metals. FTSF design components that address contact water during operations and closure include the following:

- Surface water diversion channels to minimize the amount of contact water;
- Embankment design to achieve acceptable factors of safety for static and pseudostatic scenarios;
- Basin and embankment liner systems to provide containment;
- Internal storage for contact stormwater;
- An internal underdrain system to collect consolidation flow and drainage from the tailings;
- A double-lined external underdrain collection pond with leachate collection recovery system to manage contact water prior to treatment;
- A FTSF cover system installed at the start of closure to limit infiltration and promote run off; and
- An emergency spillway, constructed during Phase 3 of development, to convey stormwater from the facility during closure.

The design also includes a groundwater collection system below the FTSF lining system to intercept, collect and convey non-contact groundwater downstream of the facility. The FTSF design was supported by climate analyses, water balance calculations, a seismic hazard assessment and slope stability calculations.

The FTSF closure strategy includes managing stormwater runoff, providing a 2.0 mm HDPE geomembrane cover system overlain by approximately 1 m of growth media material and revegetated to limit infiltration. Post-closure maintenance will be provided. During placement and in anticipation of the closure strategy, the tailings will be deposited to slope to the southeast corner of the facility where the Phase 3 emergency spillway will be constructed.

	Document Number	J01834-PM-REP-002	Rev	0	
	Date	11 January 2019	Page	275 of 417	

18.7 WASTE ROCK

Waste rock geochemistry assessments consisted of identifying loading rates from the major lithological and alteration categories for the rock expected to be removed as waste (e.g., non-ore-bearing) material from the underground mine and ramp developments. Additionally, these materials will be exposed as wall rock in the underground workings and have the potential to generate acidity and release metals once exposed to oxygen.

Testing programs were carried out as follows:

- Phase 1: Included static geochemical testing, such as acid-base accounting (ABA) and static leaching tests.
- Phase 2: Included kinetic geochemical testing, including humidity cell tests (HCTs), specific surface area measurements using gas adsorption and sieve analysis techniques, mineralogical determinations (X-ray diffraction [XRD]), and whole rock digestion methods.

The results of the Phase 1 and Phase 2 testing indicate that all of the altered andesite rock types present at the site are PAG and have the potential to leach a variety of constituents at concentrations that may exceed applicable water quality standards. Although some samples of the propylitic altered andesite were net acid neutralizing, half of the propylitic samples were net acid generating, and the average net neutralization potential (NNP) for the propylitic samples was net acid generating. The dacite rock type is essentially inert and is classified as non-PAG, but the dacite testing did indicate the potential to leach some metals at concentrations that exceed applicable water quality standards.

Consequently, it was assumed in the Study that all waste rock and temporary ore storage facilities will be lined with a HDPE geomembrane to prevent migration of seepage into the native materials and groundwater regime. A collection pond has been allowed and water will be pumped to the main contact water pond for treatment.

18.8 WATER AND OTHER LIQUID EFFLUENT HANDLING

Natural runoff will be diverted around the mine infrastructure to the extent possible. Contact water including water that must be withdrawn from the underground mine to maintain a safe working environment, will be collected and used for mineral processing.

The site drainage system will consist of a combination of terraces, cut-off berms, roads, drainage trenches and culverts throughout the plant site. The surface drainage system will consist of a combination of cut-off berms, drainage trenches, culverts and elevated roads throughout the mine property. Both systems will be designed to keep clean water from mixing with contact water wherever possible.

A static site-wide water balance model was developed using the GoldSim™ simulation platform, for a maximum build-out snapshot near the end of mine life. The objectives of the water balance model are to quantify annual treatment volume requirements and predict quality of site contact water. The maximum build-out snapshot was selected to provide conservative estimates of contact water volumes and quality characteristics. Contact water includes water withdrawn from the mine, water discharged from the process facility, and surface water that comes into contact with plant areas and stockpiled material, including ore, waste rock, and tailings. Based on geochemical analysis completed to date, contact water will require treatment and will be directed to the waste water treatment plant (WWTP), located between the FTSF and the process facility.

Predicted annual volumes of water reporting to Project site ponds and the WWTP are summarized in **Table 18-2** for an average precipitation year and for one-in-ten year wet and dry conditions.

Table 18-2 Annual Contact Water Volumes Requiring Treatment (Mm³/year)

Surface Water Facility	Average Conditions	1 in 10 Year Dry	1 in 10 Year Wet
Contact Water Pond	0.313	0.270	0.352
FTSF Stormwater Pond	0.291	0.169	0.399
FTSF Underdrain Collection Pond	0.072	0.068	0.076
Total to WWTP	0.676	0.507	0.827

The site-wide water balance model was also used to predict contact water quality influent to the water treatment plant to identify target constituents for treatment.

A buried sewer pipe reticulation network collects sewage and gray water from the various buildings, across the process plant facility, into a combined main system which flows to the lowest point in the plant area and discharges to a sewage treatment plant. This system will treat the incoming water to the required criteria for treated water discharge into the natural environment. Solids will be collected and transported off site to the appropriate waste management facility.

18.9 WASTE WATER TREATMENT PLANT

Excess contact water, not used in mineral processing, will be treated and discharged to meet drinking water standards in the immediate receiving environment. The point of discharge from the treatment plant has been sited outside of the watershed that supplies the City of Cuenca, which will ensure there are no impacts to water quality upstream of the city. Water management, including water treatment, will continue during the closure phase until discharge from the site meets established discharge criteria without treatment

The Loma Larga site is expected to operate in a positive water balance over the duration of the project. All water falling within the catchment area of the site and excess water released from the process will require treatment to ensure compliance with the governing discharge standards. **Table 18-3**, extracted from BQE (2018a), outlines the anticipated metal concentration and assumed discharge limits, based on complying with the most conservative of Ecuadorian aquatic life, drinking water and irrigation use standards, or existing downstream conditions in the receiving environment where existing downstream average concentrations exceed Ecuadorian standards.

Table 18-3 Expected Water Quality and Anticipated Discharge Limits

Constituent (mg/L)	Phase 1 (Itasca) Upper Case	Phase 2 (ERM) 1:10 Year, Wet	Discharge Target
Al	7.1	14.89	0.95
Cd	0.0006	0.264	0.0011
Co	0.013	1.084	0.011
Cr	0.046	2.376	0.035
Cu	0.027	6.223	0.0052
Fe	36	140	1.0
Pb	0.019	2.679	0.0069
Mn	1.2	7.864	0.11
Mo	0.09	0.012	0.011
Ni	0.006	1.088	0.027
Zn	0.3	10.22	0.03
Se	0.012	0.007	0.001
SO4	210	382	250

The potential contaminants of concern in waste water are mostly from metals leaching from mineralized surfaces of waste rock and tailings and nitrogen species (nitrate/ammonia) leaching from explosive residue left on blasted rock.



During Phase 1 (ramp development) both metals and nitrogen species are expected to be relevant contaminants of potential concern, while during Phase 2 (operations) the load of nitrogen species is expected to decrease, and metals will be the only relevant contaminants of potential concern.

All water requiring treatment will be collected in the contact water collection pond, located southeast of process plant area. The proposed water treatment plant will consist of:

- Oxidation and neutralization circuit for metals removal.
- Sulphide precipitation.
- Clarification to remove the majority of solids from treated water.
- Multi Media Filtration (MMF) to remove any residual particulates.

The applicable receiving environment regulations will be confirmed during permitting. For the purposes of this study, the water treatment plant will meet Ecuadorian drinking water standards. Should the more-stringent Ecuadorian aquatic life standards apply, a modification(s) to the water treatment plant may be required. This has been identified as a risk in the Feasibility Study Risk Register (Source: DRA Americas Inc. 2018; Loma Larga Feasibility Study Risk Register).

Natural runoff will be diverted around the mine infrastructure to the extent possible. Contact water, including water from mine dewatering will be collected and used for mineral processing. This will minimize the amount of water use from surrounding groundwater and surface water systems. Water recycling within the process plant is expected to be greater than 90%. Excess contact water, not used in mineral processing, will be treated and discharged to meet applicable standards in the receiving environment in the Quebrada Cristal-Alumbre watershed. The treated discharge will avoid the watershed that feeds the City of Cuenca. Water management, including water treatment, will continue during the closure phase until discharge from the site meets established discharge criteria without treatment.

	Document Number	J01834-PM-REP-002	Rev	0	
	Date	11 January 2019	Page	278 of 417	

The complete water treatment plant will be modular in design, consisting of pre-fabricated and standard shipping containers. Final installation of larger mechanical pieces will be completed on site.

All reagent make-up and distribution will be included within the water treatment plant. The following reagents are required for successful operation:

- Flocculant.
- Sodium hydrosulphide (NaHS).
- Organosulphide (TMT).
- Lime (calcium hydroxide).
- Calcium hypochlorite (Ca(OCl)₂).

18.10 GARBAGE, HAZARDOUS & OTHER WASTE

18.10.1 GARBAGE DISPOSAL AND LANDFILL

Domestic waste generated during mine construction and operation will be disposed of and managed at the mine landfill. The waste will be non-hazardous and comprised of construction debris, food wastes, glass, office waste, cardboard, paper and plastics. The waste will be generated from a variety of sources including the construction areas, warehouse, workshop, plant, offices and cafeteria.

The volume of waste generated during mine construction and operation is based on the assumption that a total of 520 mine personnel will be commuting to the mine on a daily basis. The daily per person mass of waste generated is estimated to be 1.5 kg/day according to a World Bank (2012) 2015 projection for Ecuador. This estimate was doubled to account for other wastes generated by construction and mine activities. The mass assumptions equate to a total of approximately 570 tonnes/year and approximately 8,500 tonnes for the 2 years of construction and 13 years of mine operation. It is assumed that the waste will be placed and compacted to a density of 0.6 tonnes/m³ (World Bank, 2012). The annual compacted volume of waste is estimated at approximately 950 m³/yr, for a total of approximately 14,000 m³ for the period of mine construction and operation.

The landfill will be located adjacent to the rock quarry and between the mine and process plant, as illustrated in **Figure 18-3**. According to the PFS (RPA, 2016), wind direction at the Quimsacocha weather station is predominately from the west. The facility will not be upwind of mine and plant facilities.

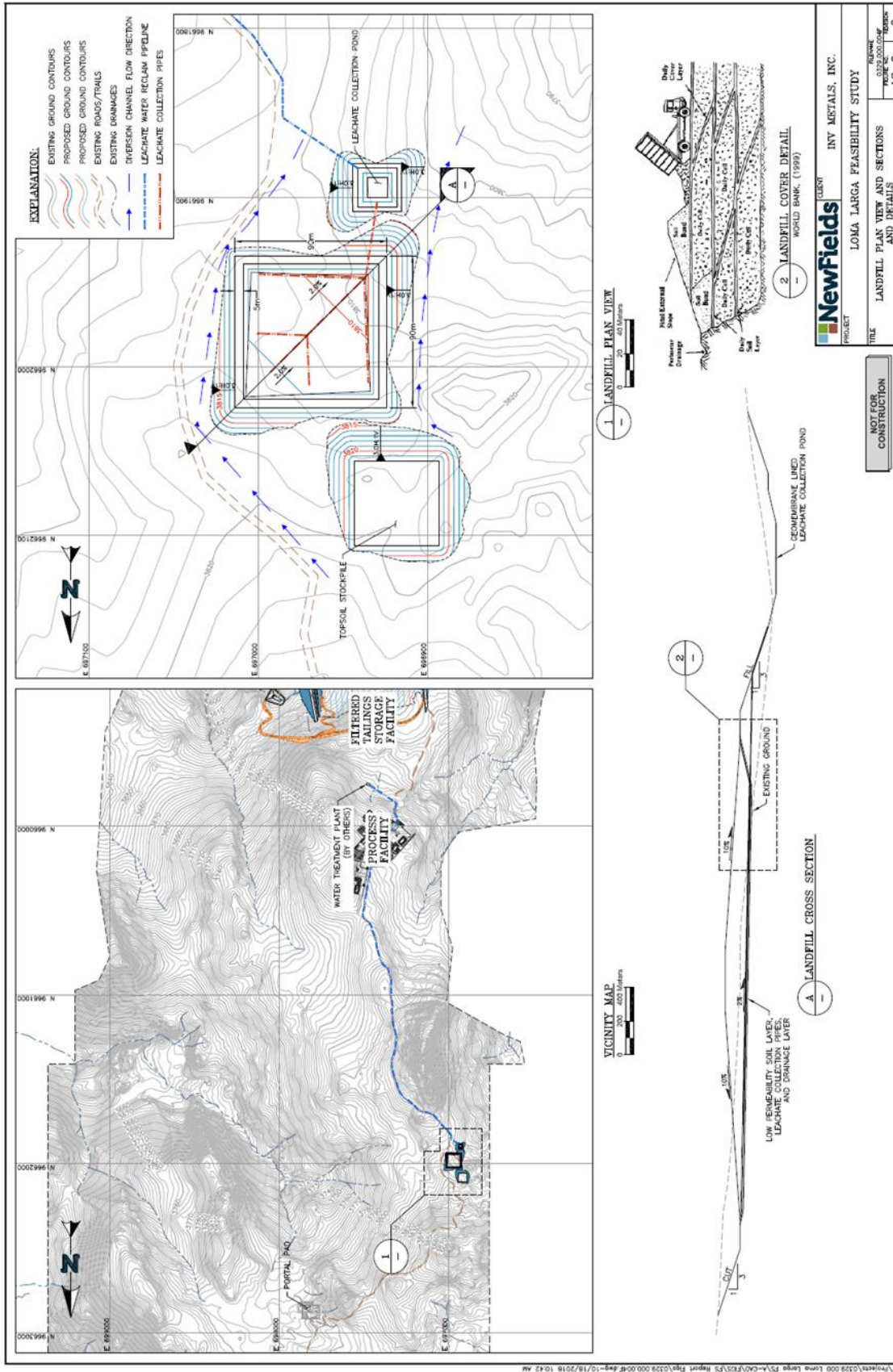



Figure 18-3: Landfill Plan View and Sections and Details

	Document Number	J01834-PM-REP-002	Rev	0	
	Date	11 January 2019	Page	280 of 417	

The landfill will include an access road, stormwater diversion channel, disposal area, leachate drainage and collection system and leachate management pond. An access road will provide light vehicle access to the perimeter of the landfill and leachate management pond to facilitate waste disposal and maintenance. Diversion channels will be constructed and maintained upstream of the landfill to minimize run-on and leachate generation.

The landfill disposal area will be constructed in phases to manage the area of disturbance and minimize the potential for erosion and sediment transport. Growth media will be removed from areas underlying each phase of landfill development and stockpiled for future reclamation. The disposal area will consist of compacted, low permeability soil layer to limit the migration of leachate into the subsurface (*Figure 18-3*). Leachate and runoff will flow via gravity to a double-lined leachate collection pond and be routed to the process facility or the WTP via a small-diameter pipeline, as necessary and based on routine sampling and laboratory analytical results. Leachate and runoff that meets relevant water quality standards will be discharged to the environment. It is estimated that discharge from the leachate collection pond, based on average monthly precipitation inputs, will range from approximately 600 m³/month in August to 1,600 m³/month in April.

The waste will be placed in layers to form a domed landfill. On a daily basis, the waste will be covered by a 150-mm layer of soil to prevent animals from scavenging, improve access and reduce wind dispersion. Gas monitoring is not specified because there are no adjacent structures and therefore no risk of gas migration (World Bank, 1999). The access road and seepage management collection ponds will be constructed in Phase I.

At closure the landfill surface will be covered with 1 m of compacted clay overlain by approximately 1 m of growth media material and will be revegetated. Once the cover system is in place and infiltration of surface water is eliminated, the post-closure leachate flows will decrease over time. Leachate flow will continue to be collected and treated until flow has ceased or water quality supports discharge. The leachate collection pond will then be reclaimed by folding the liner system in on itself and covering the area with backfill to provide positive drainage. The pond area will then be covered with growth media and reseeded.

18.10.2 HAZARDOUS MATERIAL



The hazardous materials can be broken down into two distinct areas:

- Concentrates; and
- Reagents.

The hazards for the copper concentrate are associated with the high content of contained arsenic which is in the order of 10% by weight.

Precautions will need to be taken including wearing dust masks when working within the confines of the copper concentrate filtering building. A fume extraction system will also be installed. Whenever possible, filtered product should be bagged and placed into a sea container ready for shipping. The product also poses an explosive risk due to the high level of sulphur present at 33% by weight. The building must be kept ventilated at all times to prevent the buildup of gas. The pyrite product at 42% sulphur by weight poses a similar risk and is maintained in a well-ventilated building with fume extraction.

On the chemical front, the main chemical of concern is potassium amyl xanthate (PAX) which is toxic and poses a risk to health if ingested or absorbed. The product can also leak easily from mild steel fittings due to its corrosive nature and the materials of construction for the

	Document Number	J01834-PM-REP-002	Rev	0	
	Date	11 January 2019	Page	281 of 417	

mixing, storage and dosing of the pump need to be well considered. Hydrate lime poses a burn risk once it has been mixed with water and stored prior to dosing. The lines for dosing should be well marked and be HDPE to prevent any direct contact with plant personnel. Methyl isobutyl carbinol (MIBC) and Aerophine 3418A chemicals are also toxic when ingested. They are delivered in bulk containers and dosed directly to the flotation circuit. It is important that the lines for dosing a chemical resistant are well marked to prevent contact with the skin of employees. Flocculant is a slip hazard once it is mixed with water and any spillages of mixed flocculant need to be cleaned quickly once they occur. Dosing lines to the thickeners should be well marked.

18.10.3 OTHER WASTE

Medical waste from the clinic and first aid facilities will be collected and transported off site to the appropriate waste management facility.

18.11 TRANSPORTATION AND LOGISTICS

The Loma Larga Project is located 30 kilometres southwest of the city of Cuenca and 15 kilometers north of the town of Girón. The current regional and national infrastructure is adequate to access the Project site through a well-established network of existing major ports and roadways. The road between San Gerardo and the Project site will be upgraded during the early stages of the project and will be ready to support the operations phase of the project. Regional infrastructure (ports and roads) is described in [Section 5.1](#) of this Technical Report.

18.11.1 PERSONNEL TRANSPORTATION



On-site vehicles will be provided to transport employees from the bus unloading area adjacent to the change house to their place of work. Pickups will be provided to transport supervisors and maintenance personnel around the site. No private vehicles will be allowed on site.

It is planned that employees will primarily live in the Girón, San Gerardo, Chumblin and surrounding areas. No camp is planned for the Loma Larga site. INV may contract an independent service provider for the transportation services during construction and operations phases for INV personnel. Construction contractors will be responsible to transport their personnel to site.

18.11.2 CONCENTRATE STORAGE, HANDLING AND TRANSPORT

The copper concentrate will be directly loaded into bags and into standard twenty-foot shipping containers prior to trucking to the port for export over the life of the operations, as the low volume does not support bulk export. The copper concentrate loadout building includes special controls for dust due to the presence of arsenic in the concentrate.

The pyrite concentrate filtration and storage area is located inside an enclosed building at the Project site. The pyrite concentrate will be loaded by front-end loader into dump trucks for transport to the bagging facility located near Guayaquil. Handling equipment will be provided on-site for handling the bags and containers. The pyrite concentrate will be loaded into bags and loaded into standard twenty-foot shipping containers near Guayaquil initially due to the lack of existing concentrate bulk loadout facilities at the regional ports. When facilities are operational at a regional port, INV will consider switching to bulk export for the pyrite concentrate.

	Document Number	J01834-PM-REP-002	Rev	0	
	Date	11 January 2019	Page	282 of 417	

19 MARKET STUDIES AND CONTRACTS

19.1 MARKETS

INV' Loma Larga Mine will produce two different concentrates, specifically a pyrite concentrate (also referred to as gold-pyrite), and a high-grade gold-copper concentrate. The gold-pyrite concentrate will represent the majority of the annual concentrate production (90%), and it is expected to contain 28 g/t of gold, and 102 g/t of silver, with no significant deleterious elements. The gold-copper concentrate is expected to grade 93 g/t of gold, 30% copper, and 1,860 g/t of silver. Other than containing roughly 8.5% arsenic, there are expected to be no other significant deleterious elements in the gold-copper concentrate.

INV's pyrite concentrate can be considered clean from an impurity perspective and relatively low in gold content. The market for these types of materials is generally gold smelters and refineries, copper smelters, especially where sulphur fuel may be required and, to a lesser extent, blending facilities where trading companies would mix such clean material with other complex gold and copper concentrates.

Traditionally Western smelters look for pyrite concentrates with a higher gold content (i.e. minimum 3 ounces per tonne or 93 g/t), and as a result it is the Chinese market that consumes the lion's share of the lower grade pyrite concentrates exported globally. These concentrates are mainly processed by gold smelters located in Shangdong and Henan provinces. However, Chinese copper smelters have become more interested in pyrite concentrates, as their precious metal refining capacity has increased significantly. In addition, Chinese copper smelters use clean pyrite concentrates to balance and regulate their average feed intake.

The potential market for Loma Larga gold copper concentrate is more focused, due to the expected arsenic level. This would include several Western custom copper smelters, who would be well positioned to treat such arsenic levels. Further, given the high gold content of Loma Larga's gold-copper concentrate, it could be imported to China as a gold concentrate without arsenic restrictions. Accordingly, China represents an additional potential outlet, which depending on prevailing market conditions, could be quite competitive.

Blending facilities could also represent a potential market for Loma Larga's gold-cooper concentrate. Blending operations have proliferated in recent years as a solution to both the increasing level of impurities, especially arsenic, and the introduction of regulatory restrictions of harmful elements in destination markets. Traditionally, the largest blending facilities have been located in South America, as the majority of complex concentrates are found there. More recently, blending operations have emerged closer to destination markets such as Taiwan and Korea.

An extensive list of potential off-takers was approached to determine the relevant markets as outlined above, and also to identify commercial terms for the feasibility study. Various indications were secured for both concentrates. For purpose of the gold-pyrite concentrate, Chinese copper smelters provided the most competitive terms. This market has the added benefit of representing the lowest freight destination. Commercial feedback received for the gold-copper concentrates suggests both China and the West would offer potential long-term sales agreements.

The terms summarized below are shown as a percentage of the payable metals on a Carriage and Insurance Paid To (CIP) destination port basis, and include all applicable refining, treatment and penalty charges. From a logistics perspective, the mine would need to absorb

all costs from the mine to the relevant destination port, with the buyer bearing all remaining transportation costs from the discharge port to the receiving smelter.

Table 19-1: Smelter Terms

Item	Unit	Gold Pyrite Concentrate	Gold Copper Concentrate
Gold	%	80	88
Silver	%	60	80
Copper	%	-	82

– Payability includes the treatment and refining charges

19.2 CONTRACTS

No contracts have been established to date by INV. However, based on feedback secured by INV, it is expected that the full production of both concentrates will be sold.

20 ENVIRONMENTAL STUDIES, PERMITTING, AND SOCIAL OR COMMUNITY IMPACT

20.1 INTRODUCTION

This section presents available and relevant information on environmental, permitting and social or community issues related to the Project. A summary of Project environmental baseline studies and discussion of pertinent environmental issues which are material to the development of the Project are provided. Potential social and community related plans and ongoing consultation and engagement efforts with local communities are discussed.

Data and information gathered in all areas (i.e., environmental baselines, regulatory compliance, stakeholder feedback and practicable closure options) have been used to inform and optimize Project design to date. Ongoing data collection will be used by INV to continue to refine the Project design and mitigate environmental and social impacts through its various phases of development.

20.2 PROJECT PERMITTING AND ENVIRONMENTAL ASSESSMENT



Ecuador has specific legislation for mining activities as well as for environmental impact prevention and mitigation. In Ecuador, the mine exploitation phase includes a set of mining operations and works for the preparation and development of a mineral deposit, its extraction, and transport of the minerals for processing. The environmental license for new projects is granted through an Ex ante¹ - Environmental Impact Study (EIS) review process.

The timelines for the Loma Larga project permitting are outlined in Section 24. Based on existing information and understanding of current Ecuadorian regulations, an allowance of 7 months has been included in the project schedule to obtain an Environmental License after submission of the complete document to the government regulator. After approval of the Environmental License, an additional 7 months has been built into the schedule to obtain construction permits. The permitting schedule is based on reasonable expectations with government review timelines, however there is inherent uncertainty in these timelines. The political spectrum in Ecuador is also changing with the increasing presence of opposition to development and mining in particular. INV continues monitoring these developments and working with stakeholders to reduce risks for the project.

20.2.1 PERMITTING REQUIREMENTS

The main government institutions that regulate and provide approval to a mining project are: The Ministry of Energy and Non-Renewable Natural Resources, including the Mining Control and Regulatory Agency (ARCOM), and Electricity Control and Regulatory Agency (ARCONEL); and the Ministry of Environment and Water (MAE). As of November 2018, the former National Secretariat of Water (SENAGUA) merged with the former Ministry of Environment and the new MAE applies the same administrative procedures as both institutions had previously established. Each of these institutions have representation in

¹ “Ex ante – Environmental Impact Study” is the full name of an EIS applicable for new activities obtaining environmental permits.

	Document Number	J01834-PM-REP-002	Rev	0	
	Date	11 January 2019	Page	285 of 417	

every Province for administrative and permitting processes. In the case of the Loma Larga Project, the agencies of the Province of Azuay will manage the permitting process.

The Mining Law and its regulations were issued in 2009, including the first mining guidelines for generating responsible mining activities in the country. The largest number of regulations related to mining activities were issued in 2014. Since then, the regulations have continued to change, or new regulations have been generated. Thus, some important legislation and regulations related to mining activities, especially specific mining guidelines from the Agency of Mining Regulation and Control, ARCOM, are relatively new.

The previous Ministry of Mines, currently the Ministry of Energy and Non-Renewable Natural Resources grants mining title for each project phase, administrative authorization for phase changes, and negotiates and administers mining exploitation contracts. INV has submitted a report called “Previous Report for the Change of Advanced Exploration Phase to the Stage of Economic Evaluation of the Mineral Deposit” to ARCOM to change from the Advanced Exploration phase to the Economic Evaluation phase. To change from Economic Evaluation to the Exploitation phase the Company will be required to submit a report called “Report on Activities and Investments Prior to Subscription of the Exploitation Contract”.



The Mining Exploitation Contract between the Company and the Government of Ecuador (normally, through the Ministry of Energy and Non-Renewable Natural Resources), will allow the Company to initiate the project exploitation phase. This contract will establish the terms, conditions and schedule for the construction, assembly, extraction, transport and commercialization of minerals. Additionally, the contract will define the Company obligations on environmental management, bonds, community engagement, royalties and closure activities including environmental liabilities payments for LOM. The contract will only be signed by the Government upon submission of the aforementioned mandatory reports and once the Environmental License for the Exploitation Project is granted.

The Environmental Organic Code (COA) regulates all the economic activities including mining. The Environmental Mining Rule (Reglamento Ambiental de Actividades Mineras, RAAM) regulates specifically the mining sector, which establishes the environmental requirements for each of the phases of the mining activities. The COA and the main Ministerial Agreements No. 061, No. 097A, No. 109, No. 1040, and the RAAM establish the permits, administrative processes, environmental standards and social participation that are applicable to the projects.

The main permit granted by the MAE for the construction and operation of a mining project is the Environmental License. For the exploitation phase of the Loma Larga Project the environmental impact study (EIS) process will be managed by the Provincial Directorate of the Ministry of Environment and Water in Azuay. The MAE is responsible for the review and approval of the environmental impact study and issuance of the environmental license, after payment of administrative taxes, and the issuance of the Environmental Management Plan Compliance Bond (póliza de fiel cumplimiento del Plan de Manejo Ambiental).

In order to apply for the Environmental License, the following permits or documentation are required to be submitted with the EIS Terms of Reference for approval, and then subsequently alongside the submission of the Draft Environmental Impact Study:

- Original and validated Mining Concession Title, including rights payments;
- Water intake permit and water diversion permit;

	Document Number	J01834-PM-REP-002	Rev	0	
	Date	11 January 2019	Page	286 of 417	

- Technical feasibility certificate of the project granted by the Ministry of Energy and Non-Renewable Natural Resources, with the certification of environmental feasibility assessed within the report of feasibility of the mining right;
- Creation of user in the Unique System of Environmental Information (SUIA);
- Certificate of Intersection in SUIA by uploading the name of the project and the geographic coordinates in the Reference System in SUIA (WGS84-Zone 17 South). The system will perform a verification of coordinates with respect to the mining cadastre and the coordinate system requested by SUIA;
- Rights of way for Project infrastructure (transmission line and access road).

The Environmental License will enable the Company to request and obtain other necessary permits to start the construction, operation and closure of the Project.

Through analysis and review of the main mining and environmental legislation, technical and environmental regulations and general authorizations, a list of the primary permits and authorizations required for the Exploitation Phase of the Project is summarized below in **Table 20-1**. The Ministry of Environment and Water is still developing or updating regulations, so the list of permits and authorizations currently identified for this Project may change with time, and new requirements or additional permits may need to be considered.

Table 20-1 includes a brief description of the applicable permits and authorizations required for the three main components of the Project: mine, power transmission line for the mine, and access road (note that this table does not include the needs for the land access rights necessary to develop the area – see Section 4 for further details on land tenure). The permits for the 22-kV power line proposed for construction use are not considered in this permit list.

Table 20-1: Main Permitting requirements for the Loma Larga Project

PERMIT, AUTHORIZATION OR CONCESSION	DESCRIPTION OF THE AUTHORIZATION	RELEVANT AUTHORITY	LAW	PERIOD OF VALIDITY
MINE				
Environmental License (includes mine, transmission line and access road)	The Environmental License will enable the signature of the Mining Exploitation Contract, the Authorization for enhancement of the road design and construction, the Authorization for the transmission line construction, the Registration of Hazardous waste management, construction permits, and the explosives consumer permit.	Ministry of Environment	Environmental Code Art. 172, 179, 180, 185 Environmental Management Law Art. 20 Mining Law, Art. 26, Art. 59, Art. 78 Environmental regulation of mining activities Art. 7, 10, 33, 63 Ministerial Agreement of the Ministry of Environment 083b. Art. 2	Life of Mine; validated through regular audits
Notarized Affidavit (sworn statement)	Submission of a notarized affidavit acknowledging that the mining activities do not adversely affect public roads, public infrastructure, telecommunications networks, military installations, oil infrastructure; aeronautical facilities, electrical networks or infrastructure, or archaeological vestiges or natural and cultural heritage. This notarized affidavit enables construction permits.	Ministry of Energy and Non-Renewable Natural Resources, created by Executive Decree No. 399 issued on May 15, 2018. This Ministry merged the Ministries of Mines, Hydrocarbons and Energy)	Mining Law, Art. 26	Life of Mine
Reduction or waiver of mining concessions.	The holder of mining rights will request the reduction of mining concessions in compliance of Mining Law Art 39 "No mining concessionaire may have one or more titles that together have a total of more than five thousand mining hectares from the exploitation stage." This reduction of mining concession area will enable an accurate EIS project description (design of the underground mine, processing plants, and other design considerations) while in parallel the Economic Evaluation phase can be performed for only 5,000 mining hectares at maximum.	Ministry of Energy and Non-Renewable Natural Resources and ARCOM or their equivalent	General Regulation of the Mining Law Art. 65 Environmental Regulation of Mining Activities Art. 56	Life of Mine



	PERMIT, AUTHORIZATION OR CONCESSION	DESCRIPTION OF THE AUTHORIZATION	RELEVANT AUTHORITY	LAW	PERIOD OF VALIDITY
MINE	Authorization for the installation and operation of processing plants, smelting, refining and construction of tailings management facilities and Registration	This Authorization enables the construction of processing plants, smelting, refining and construction of tailings management facilities. Registration of this authorization in the Mining Registry in charge of the Mining Regulation and Control Agency is mandatory or the authorization will be invalidated.	Ministry of Energy and Non-Renewable Natural Resources	Ministerial Agreement No.18 of the Ministry of Mines, published in the Official Gazette 554 of July 29, 2015 - Instructions for authorizations for processing plants, smelting and tailings. Articles 3, 4, 5, 6, 7, 13 and the first and third general provisions	Life of Mine
	Approval of Internal Regulation of occupational health and safety for the exploitation phase	This Internal Regulation of health and safety enables the operation of the mine.	Labor Ministry	Regulation of health and safety at work in the mining sector Art. 8, 9, 15, Title V, Title VI, Title VIII, Title IX	Two years with ability to renew
	Construction Permit	Relevant municipalities issue construction permits by the approval of electric, sanitary, communication, camps, civil works, water facilities, evacuation, and resources drawings. This permit enables the construction of all civil facilities of the Project.	Municipality of Cuenca Municipality of Girón	Municipal ordinances (provisions or requirements vary from Municipality to Municipality)	Period of active construction
	Archaeological liberation initial prospection	This permit is already in place and enables the Company to break ground or remove soil during the construction and operation of the underground mine. A Chance Find Procedure (CFP) needs to be in place that includes the presence of an archaeologist when performing these works. If archaeological sites are encountered the project activities must be suspended until the CFP is fulfilled and completed.	National Institute of Cultural Heritage (Acronym in Spanish INPC)	Mining Law (Article 3) Law of Cultural Patrimony (article 28, A17) Environmental Regulation of Mining Activities (Article 70) General regulations of the Cultural Heritage Law (Article 61-68)	Life of Mine, only for the evaluated land area

PERMIT, AUTHORIZATION OR CONCESSION	DESCRIPTION OF THE AUTHORIZATION	RELEVANT AUTHORITY	LAW	PERIOD OF VALIDITY
MINE				
Contract of Mining Exploitation with the Government of Ecuador	The Contract empowers the company to prepare and develop the deposit, and commercialization of minerals. The Contract will also enable the company to obtain construction permits, the approval of the Internal Regulation of occupational health and safety for the exploitation phase, the trader's registry and the Explosives consumer permit.	Ministry of Energy and Non-Renewable Natural Resources	Mining Law Art. 37, 39, 41 ARCOM Technical Guideline 006 Integral Mining Manual numeral 4.3.9	To be established in the contract and corresponds to the mining concession time (current concession period is 25 years with ability to renew)
Concession maintenance	The concession maintenance payments will enable a constant operation of the mine, extraction, transport, benefit and commercialization of minerals.	Ministry of Energy and Non-Renewable Natural Resources	Mining Law Art. 34	One year, renewed annually.
Permission to use radioactive substances	This permit will enable the use of radioactive substances or equipment with this type of substances such as control devices (process flow meters) or laboratory equipment.	Ministry of Energy and Non-Renewable Natural Resources	Regulation of Radiological Safety. Art. 37, 39, 41, 43, 54 - 63	Four years with ability to renew
Explosives user permit	The transport, handling and storage of explosives must proceed according to the specific regulations, and a permit is required for the use of this material type. This permit will enable the use of explosives for mining industry activities.	Ministry of National Defense - Joint command of the armed forces	Law on arms, ammunition, explosives and accessories Art. 25 Environmental regulation of mining activities Art. 78 Regulation of the law on arms, ammunition, explosives and accessories Art. 10	Specific to each product delivery.
Traders Registry	To keep and report control of the internal marketing activities and the export of products. This permit will enable commercialization of minerals	ARCOM or its equivalent	Ministerial Agreement 270 of the Ministry of Defense, Art. 14 Mining Law - Art. 52, 53	One year, renewed annually

PERMIT, AUTHORIZATION OR CONCESSION	DESCRIPTION OF THE AUTHORIZATION	RELEVANT AUTHORITY	LAW	PERIOD OF VALIDITY
MINE				
Registration of hazardous waste generator	This registration will enable the generation and delivery of hazardous waste to authorized national managers.	Ministry of Environment	Ministerial Agreement No. 26 of the Ministry of Environment - Art. 1 and Annex 1	Permanent (with Annual Reports)
Service permit for catering service or other as appropriate	This operating health permit for the catering service or other similar facility will enable the operation of catering service to the Company's mine staff.	National Agency for Health Regulation and Control – ARCSA	Ministerial Agreement No. 00004712, 2014 of the Ministry of Public Health. Art. 4,5,6,7	One year, renewed annually
Permit for first aid building and ambulance	This registration and operating permit are additional to the requirements that the Ministry of Labor Rights could determine in the Regulation for Health and Safety in Mining Work, and will enable the provision of medical care during mining activities	Agency for Quality Assurance of Health Services and Prepaid Medicine (Acronym in Spanish ACCESS, entity attached to the Ministry of Public Health) through Zonal Coordination No.6	Ministerial Agreement No. 5212, 2014, of Ministry of Public Health - Art. 1, 2, 4, 5-7, 23, 29 Ministerial Agreement No. 79, 2016 of Ministry of Public Health - Art. 1, 2, 8-16	One year, renewed annually
Permit for the use of fuel in the industrial sector	This permit enables the use of fuel in all of the facilities and equipment of the Company that required this type of energy.	Agency for Hydrocarbon Regulation and Control	Resolution of the Hydrocarbons Regulation and Control Agency No. 5 Official Registry 387 of 02-Dec. -2014 - Art. 4 – 11	Specific to each fuel delivery.
Fire protection system construction permit	This permit enables construction permits.	Local Fire Department(s)	Ecuadorian Standard for Fire Construction - Code NEC-HS-CI	Permanent until operation permit is obtained
Fire protection system operation permit	The operation permit is granted once the facilities are built (based on approved drawings) and a local inspection has been carried out. This permit enables the operation of civil work facilities.	Local Fire Department(s)	Ecuadorian Standard for Fire Construction - Code NEC-HS-CI	Permanent until facilities' change/modification or expansion.
Affection to surface and underground water bodies and compliance with the order of priority for the water use	This permit will enable the Company to obtain the approval for the use of industrial and domestic water (surface or underground) and the environmental license approval.	National Water Secretariat (in Spanish acronym SENAGUA)	Mining Law, Art. 26	Life of Mine

PERMIT, AUTHORIZATION OR CONCESSION	DESCRIPTION OF THE AUTHORIZATION	RELEVANT AUTHORITY	LAW	PERIOD OF VALIDITY
MINE				
Authorization of Industrial and Domestic Use of Water (superficial water or underground water)	Will enable the use of water in the project. This authorization will also enable the issuance of the Environmental License.	National Water Secretariat (in Spanish acronym SENAGUA)	Mining Law, Art. 26, 61, 79 Law of Water Resources and Use of Water Art. 110, 132 Regulation to the Law of Water Resources and Use of Water Art. 82, 83, 85, 90, 91, 92	Up to ten years with ability to renew
Authorization of Deviation of Water (underground or superficial water)	This authorization will enable jointly or separately the deviation of water from one watershed to another and/or, in case of underground water evidence, the use of underground water if needed by the project. This authorization will also enable the issuance of the Environmental License.	National Water Secretariat (in Spanish acronym SENAGUA)	Environmental regulation of mining activities Art. 86	Concurrent with water use permits
Authorization of the Final Operations Closure Plan	Two years prior to the planned completion of the project, the company must submit the Final Operations Closure Plan. This permit enables the Company to abandon the area without fines or legal contraventions/trials.	Ministry of Environment Ministry of Energy and Non-Renewable Natural Resources	Mining Law Art. 41 and 85 Ministerial Agreement of the Ministry of Environment 083b. Art. 2	Permanent
Landfill (if required)	A Landfill for rock material and inorganic waste coming from the construction of the Project will be considered in Spanish as an "Escombrera". The construction permit of the landfill will enable the Company to build and operate the landfill.	Ministry of Environment and Water (applicable for the Environmental License) Municipalities of each facilities' location for the construction permit.	Environmental regulation of mining activities Art. 7, 10, 33, 93 INTEGRAL MANAGEMENT OF SOLID WASTE IN THE GIRON CANTON. Municipal Ordinance 4. Official Register Special Edition 585 of 03-Jun-2016. CHAPTER XI OF THE HANDLING OF WASTE AND DEBRIS Art. 83 - 87	Period of active construction and further on validated through regular audits

PERMIT, AUTHORIZATION OR CONCESSION	DESCRIPTION OF THE AUTHORIZATION	RELEVANT AUTHORITY	LAW	PERIOD OF VALIDITY
ACCESS ROAD				
Authorization for Design and Road Construction	Permit to build or improve roads that will be part of the local road network and the national system. This permit will enable the construction of the access road.	Ministry of Transport and Public Works Prefecture Municipalities	Regulation on Land Transport, Traffic and Road Safety Law - Art. 102 Municipal and local ordinances Standards for studies and road designs General specifications for construction of roads and bridges	Permanent
Certificate of Registration of Hazardous Chemical Materials (if required)	This registration will enable the generation, transportation and storage of hazardous chemical materials. This applies for the transportation, handling and storage of Hg, NaCN, KCN	Ministry of Environment and Water	Agreement 099. Guidance Process for Registration of Hazardous Chemical Materials and Environmental Obligations	issued once and reported annually
POWER TRANSMISSION LINE				
Authorization of Electrical Transmission Line Design	This authorization will enable the Transmission line construction.	Regional electrical company (Centro Sur C.A)	Regulation for the distribution and commercialization of electrical energy - Regulation No. ARCONEL 005/17 of December 7, 2017 - numerals: 6.1.2, 6.3, 8.2.1, 8.2.2, 9, 9.2, 9.4, 11.2, 13 and 21	Life of Mine
Authorization for Transmission Line construction	This authorization will enable the notarized affidavit, the subscription of the Mining Exploitation Contract and the construction of the transmission line.	Regional electrical company (Centro Sur C.A) Ministry of Electricity and Renewable Energy (or its equivalent) ARCONEL	Regulation for the Distribution and commercialization of electrical energy - Regulation No. ARCONEL 005/17 of December 7, 2017 - numerals: 6.1.2, 6.3, 8.2.1, 8.2.2, 9, 9.2, 9.4, 11.2, 13 and 21	Life of Mine

	Document Number	J01834-PM-REP-002	Rev	0	
	Date	11 January 2019	Page	293 of 417	

20.2.2 EXISTING PERMITS

INV currently holds various permits in accordance with national legislation. INV has submitted its application for the Economic Evaluation phase and holds the required permits for the Advanced Exploration phase, as well as land tenure, and mining and water rights that enable them to perform exploratory activities in the concessions of Río Falso and Cerro Casco. For the Cristal concession INV is awaiting the Ministry of Environment and Water to re-issue the environmental license for the Advanced Exploration Phase.

The permits and authorizations held by INV, are listed below:



- 100% land title of the Loma Larga property in order to develop the mining Project;
- Mining Titles for Metallic Mining, in the concessions Cerro Casco (Code 101580), Río Falso (Code 101577), and Cristal (Code 102195), most recently validated on September 17, 2018;
- Environmental license No. 054 for the advanced exploration of the mining areas Cerro Casco and Río Falso, granted on October 11, 2002. INV has maintained its environmental permit through periodic audits and evidence of compliance with the environmental management plan of the approved environmental license No. 054;
- Authorization for the right to use and consume water, granted on July 5, 2010. This authorization is for rainwater up to 1 L/s to be collected in the Cristal-Aguarongos sector of the San Gerardo Parish, Girón Canton for forest nursery irrigation and for advanced exploration use;
- Authorization for the right to use and consume water. This authorization is for withdrawal of up to 8 L/s taken from the Quebrada Cristal-Alumbre located in the San Gerardo Parish of the Girón Canton, Province of Azuay for mining industrial activities use. The authorization was renewed on October 11th, 2016;
- Certification of the National Institute of Cultural Heritage that endorses an authorization granted by this institute on August 30, 2007 to IAMGOLD in the area of concessions Cristal - code 102195, Cerro Casco - code 101580, Río Falso - code 101575. The Certification established that the mine area has no known archaeological structures or sites but does have a potential for archeological findings and approves the development of the mining concession under specific considerations that include active presence of an archaeologist during development in case unknown sites are encountered.

20.2.3 SUPPORT FOR ENVIRONMENTAL APPROVALS

Under the Ecuadorian Mining Law and the Environmental Management Law, issuance of an Environmental License, is a key authorization required prior to approval of the full suite of permits and authorizations needed to advance the project into the exploitation phase.

Prior to the initiation of mining exploitation activities, the proponent of a mining project, must prepare and develop an environmental impact study (EIS) to prevent, mitigate, control and repair environmental and social impacts arising from their activities. An EIS describes the potential environmental impacts that may occur due to a proposed project in a particular area and associated management and/or mitigation measures that will be implemented. The EIS process is managed by the Ministry of Environment and Water (MAE). The general steps of the EIS process are summarized below:

- Prior to submission of an EIS, the proponent obtains an “Intersection certificate with the National System of Protected Areas, Protective Forests and Forest Patrimony of the State”;

	Document Number	J01834-PM-REP-002	Rev	0	
	Date	11 January 2019	Page	294 of 417	



- Proponent submits a proposed Terms of Reference (TOR) for the EIS to the MAE for review and approval;
- Proponent requests Biological Research Permit for baseline development (to be requested and granted after TORs are approved);
- Proponent completes a draft EIS and submits to the MAE a request to begin the social participation process, including public disclosure;
- Social participation process, including a public disclosure hearing and other social participation mechanisms, is undertaken following a process approved by the MAE and facilitated by an Environmental Facilitator assigned by the MAE;
- Proponent addresses the results of the social participation process and public hearing in a Final EIS submitted to the MAE;
- MAE reviews the EIS and may request additional information or clarifications from the proponent;
- MAE issues an official statement approving the EIS;
- Payment of fees and issuance of environmental compliance bond are completed;
- Issuance of an Environmental License following payment of applicable fees and issuance of environmental compliance bond. The license will be an Ex-ante Environmental License.

In accordance with common administrative practice by the MAE, it is preferable that water use and water deviation authorizations be in place prior to submission of the exploitation phase EIS. INV has existing water use permits associated with the advanced exploration activities but will require water deviation authorization for the exploitation phase. An exploitation phase EIS can be prepared within the timeframe required to obtain water deviation authorization. In order to advance the overall time frame to complete the exploitation phase EIS process, it is recommended that the relevant agency of water, formerly SENAGUA now MAE, be engaged to gain statements of support regarding water diversion.

Statements of support from MAE and ARCOM would mitigate potential concerns in relation to progressing the exploitation phase EIS in parallel with the water deviation authorization and rights-of-way processes. While this is an opportunity to advance the overall permitting and EIS timelines, there remains a risk that MAE will enforce the requirement of having the water deviation authorization and rights-of-way in place before review of the EIS and/or issuance of Environmental License for the exploitation phase.

The EIS must describe all project activities, project resources, previous exploration phases, areas of influence, and alternatives that were evaluated with respect to the proposed activities. The environmental baseline for all physical and social components, evaluation of potential impacts, and environmental management plan, are also required to be collected. While a robust set of environmental and social baseline data exists for the Project, additional baseline data collection is required to address some data gaps specific to the exploitation phase project description, including the power transmission line corridor and area of new access road construction. Baseline data collection will need to continue while the exploitation phase EIS is advanced. Some allowance for outstanding data gaps can be accommodated in the EIS with the use of regionally available information and incorporation of conservative assumptions.

In addition to the laws and regulations indicated in the *Table 20-1* that require specific permits, authorization, or concession, other applicable regulations to the exploitation phase of the project are listed below.

	Document Number	J01834-PM-REP-002	Rev	0	
	Date	11 January 2019	Page	295 of 417	

The Ministerial Agreement 097A establishes applicable environmental standards to all economic activities, including mining. The following Book VI annexes of the Unified Text of Secondary Legislation of the Ministry of the Environment apply to the Project.

- Annex 1. Environmental Quality Standard and Discharge of Water Resource Effluents.
- Annex 2. Standard of Environmental Quality of the Soil Resource and Remediation Criteria for Contaminated Soils.
- Annex 3. Standard of Air Emissions from Stationary Sources.
- Annex 4. Ambient Air Quality Standard or Emission Level
- Annex 5. Maximum Noise Emission Levels and Measurement Methodology for Fixed Sources and Mobile Sources and Maximum Vibration Emission Levels and Measurement Methodology.

According to the National Constitution and the Mining Law, mining activities are forbidden in protected areas.

Upon declaration of National Interest of Mining Activities by the Government, in 2010 it was declared that mining activities will be allowed within some natural protected areas for which a special zone was declared and instructed the authorities include these special zones in the Protective Forest Management Plans.

INV mining concessions intersect legally recognized natural areas belonging to the National System of Protected Areas and Protective Forests. These natural areas are:



- The National Recreation Area Quimsacocha - created on January 25, 2012, by Ministerial Agreement No. 007 published in the Official Gazette No. 680 of April 11, 2012);
- The Protective Forest and Vegetation Sun Yanasacha;
- The Protective Forest and Vegetation El Chorro (created through Ministerial Agreement No. 12, published in the Official Gazette No. 143 of March 4, 2010, with an update on August 3, 2010); and
- The Protective Forest of the Micro-basins of Yanuncay and Irquis rivers within the Paute River Basin (created by Ministerial Agreement No. 292 published in the Official Gazette Supplement No. 255 of 22 August 1985. The last change to this agreement was on September 3, 2015).

The Loma Larga Project layout falls within the last two areas.

A review of the available management plans for El Chorro, Yanuncas Irquis and Quimsacocha, indicates that the relevant authorities have not yet included specific management requirements for the exclusion zone. Current requirements are focused on protection of the biodiversity, land reclamation, use and management of water resources, research and strengthening of the organizations involved in the management of the protected area. It is expected that through the EIS review process MAE will establish specific requirements for the Project, and there exists potential for constraints to be placed on the mine that have not been considered in this FS. As part of the EIS, a forest inventory and economical ecosystem valuation is in progress for the project area. As a result, there may be a value identified which the Company will need to pay.

The environmental approval processes include public consultation, and should follow the guidance below:

- Ministerial Agreement No. 109 – Reform of the Book VI of TULSMA established in the Ministerial Agreement No. 061.
- Executive Decree 1040 – Regulation of Application of the Social Participation Mechanisms established in the Law of Environmental Management.

	Document Number	J01834-PM-REP-002	Rev	0	
	Date	11 January 2019	Page	296 of 417	

- Guide for the Elaboration of the Social Component of Terms of Reference and Environmental Studies of Hydrocarbons, Mining and Other Sectors.
- Ministry of the Environment, Subsecretariat Of Environmental Quality - National Direction Of Prevention Of Pollution- Environmental Standardized Guide For The Execution Of Processes Of Social Participation Of Environmental Studies Of Category II, III and IV.
- Technical Guide for the Definition of Influence Areas - March 2015.
- Manual for Category IV Environmental License.
- General Guide for the Development of Standard Terms of Reference for the Preparation of Environmental Impact Studies applicable to the Phases of Exploitation, Benefit, Smelting and Refining - Mining Projects Category IV.

20.2.4 COMPLIANCE WITH INTERNATIONAL LENDING PRACTICE

INV has committed to the establishment of environmental and social practices for the Loma Larga Project that comply with the legal requirements established by the government of Ecuador. Where possible and practicable, INV may align its efforts with the applicable International Finance Corporation (IFC) Performance Standards (IFC 2012a) and environmental, health and safety guidelines (IFC 2007a).

Based on the baseline studies and stakeholder engagement to date, the following IFC Performance Standards would be applicable to the Project:



- Performance Standard 1: Assessment and Management of Environmental and Social Risks and Impacts;
- Performance Standard 2: Labor and Working Conditions;
- Performance Standard 3: Resource Efficiency and Pollution Prevention;
- Performance Standard 4: Community Health, Safety, and Security;
- Performance Standard 5: Land Acquisition and Involuntary Resettlement;
- Performance Standard 6: Biodiversity Conservation and Sustainable Management of Living Natural Resources; and
- Performance Standard 8: Cultural Heritage.

Current information available shows that Performance Standard 7: Indigenous Peoples would not be triggered, as there are no currently-identified Indigenous People in the Project Area of Influence.

The following World Bank Group/IFC Environmental, Health and Safety (EHS) Guidelines may also be applied to the Project:

- General EHS Guidelines (IFC 2007a);
- EHS Guidelines for Mining (IFC 2007b);
- EHS Guidelines for Electric Power Transmission and Distribution (IFC 2007c).

The approach INV will use to demonstrate alignment to international lenders standards, if required, will be to prepare supplementary documentation following submission of an Environmental Impact Study pursuant to Ecuadorian requirements. This could take the form of a “Supplementary Lenders Information Package” (SLIP) or a second Environmental and Social Impact Assessment developed specifically for potential lenders to the Project. These are often referred to as a “bankable ESIA” or “BESIA”. In either case, the document would be prepared to address all relevant aspects of the applicable IFC Performance Standards and EHS Guidelines including impact predictions, mitigation measure including application of the mitigation hierarchy, and management plans.

	Document Number	J01834-PM-REP-002	Rev	0	
	Date	11 January 2019	Page	297 of 417	

As public consultations/stakeholder engagement, land acquisition, baseline data collection and impact predictions for the Ecuadorean EIS have been purposely aligned, where possible, with requirements of the applicable IFC Performance Standards, the BESIA will endeavor to maximize use of existing information, which will facilitate the process. If additional environmental or social baseline data is necessary to align with IFC, the work may need to be carried out prior to preparation of the SLIP/BESIA. Considering that baseline data gathering will continue occurring after submission of an EIS to the MAE, the SLIP/ESIA could include an expanded baseline characterisation of the Project area and also an expanded impact assessment.

The main aspects that may require additional preparation to comply with IFC expectations are the definition and implementation of an Environmental and Social Management System, including all relevant policies for the Project and Management Plans for the different Project phases.

20.3 ENVIRONMENTAL STUDIES

Environmental studies associated with the development of the Loma Larga Project have been ongoing since 2004. Key environmental studies have included:

- Baseline data collection from 2005 to 2008, to support authorization for earlier and ongoing Advanced Exploration activities;
- Environmental monitoring as part of regular environmental audits required by the Environmental License No. 054 for Advanced Exploration of the Mining Areas Cerro Casco and Río Falso (2004-2017);
- Additional data to support feasibility level planning and authorization for development of the underground mine and ancillary components in Concessions Río Falso, Cerro Casco and Cristal (2017-ongoing).

Table 20-2 Summary of Environmental Studies Conducted on the Loma Larga Concessions (Rio Falso, Cerro Casco and Cristal) from 2003 to 2018

Environmental Discipline	Source	Timeframe	Data Collection Ongoing or Planned
Climate	PROMAS – University of Cuenca University of Cuenca*	2005–2017 2010-2017	Yes
Air Quality	AFH Services Gruntec Environmental Services INV Metals, Inc.: Environmental Audits	2013 & 2016 2016-2018 2003-2016	Yes
Noise	Gruntec Environmental Services INV Metals, Inc.: Environmental Audits	2013-2018 2003-2016	Yes
Soil	INV Metals, Inc.: Environmental Audits Gruntec Environmental Services	2003-2016 2008, 2009, 2011-2018	Yes
Hydrology	PROMAS – University of Cuenca INV Metals, Inc.	2006-2017 2006-2017	Yes
Hydrogeology	Itasca Gruntec Environmental Services INV Metals, INC.: Groundwater sampling	2016-2018 2017-2018 2017 – 2018	Yes
Surface Water Quality	PROMAS – University of Cuenca Gruntec Environmental Services	2009-2011 2008-2018	Yes
Terrestrial Biology	University of Azuay	2008-2018	Yes
Aquatic Resources and Sediment	University of Azuay Gruntec Environmental Services	2008-2018	Yes

– * *Department of Water Resources and Environmental Sciences (Departamento de Recursos Hídricos y Ciencias Ambientales (IDHRICA))*



The following sections provide a summary of the baseline information collected to date, to support subsequent phases of project development, including completion of an EIS to meet Ecuadorian standards. Sampling locations associated with baseline data collection and project-related monitoring conducted to date are shown on **Figure 20-1; Figure 20-2; Figure 20-3** and **Figure 20-4**.

20.3.1 CLIMATE

Understanding local climate is important for project planning, design, and to support environmental impact studies. Climate data, such as precipitation and evaporation, has been incorporated in the site water balance and subsequent water quality predictive modelling.

The main source of local meteorological information for the Project has been collected from the Quimsacocha 1 station (IAM-001-M) and IFSII-Calluancay station (IFS-II-004-M) (**Figure 20-1**). The Quimsacocha 1 station is located in the Chorrotasqui surface rights area within the Río Irquis watershed and has been operating since 2005 with continuous data available to 2012 and discontinuous data from 2013 - 2015 in the Project area. The IFSII-Calluancay station is also located in the Río Falso concession area but is further to the west, outside the surface rights area and in the Río Bermejós watershed. The station was installed in 2012 and data is available until 2017. The stations have been administered by PROMAS - Universidad del Cuenca (PROMAS), and now are managed by INV.

The location around the Project area is mountainous with great topographic relief. Therefore, due to elevation changes and topographic features, there can be substantial spatial variability in climate conditions. Additional regional and local climate data exists and has been taken

	Document Number	J01834-PM-REP-002	Rev	0	
	Date	11 January 2019	Page	299 of 417	

into consideration in the planning and design phases of the Project as outlined in this FS (NewFields 2018).

Average annual temperatures have been observed to range from 5.2°C (in 2012) to 7.5°C (in 2010) at the two stations. The coolest months are typically July and August and the warmest typically is February at Quimsachoca 1 and November at IFSII-Calluancay.

The absolute minimum and absolute maximum daily air temperatures recorded in the Project area have ranged from a low of -5.3°C on November 28, 2005 to a high of 24.2°C on October 3, 2008 recorded by the Quimsachoca station, and of -3.0°C on November 21, 2016 to a high of 16.1°C on March 25, 2013 at the IFSII-Calluancay station.

Average annual wind speeds recorded in at the Quimsachoca 1 station have ranged between 3.7 m/s to 4.5 m/s. The predominant wind direction recorded for the Quimsachoca 1 station is from the east-northeast direction. At the IFSII-Calluancay station the mean daily wind speed over the entire measurement period was 6.9 m/s with the maximum daily wind speed being 16.8 m/s on June 27, 2015. Winds at IFSII-Calluancay are predominantly from the east-northeast with highest wind speeds from the easterly direction.

The area is typically humid with average relative humidity measured at both Quimsachoca 1 and IFSII-Calluancay to be greater than 90%.

As climate conditions can vary substantially from year to year and can display longer-term trends, site-specific climate monitoring will continue in order to support on-going project planning and design, as well as operational air quality and water management.



20.3.2 AIR QUALITY

The Project area has no current industrial activities and no urban areas. The only anthropogenic sources of air emissions are dirt roads, where the emission source includes vehicle, road and fugitive emissions.

To characterize the baseline air quality in the vicinity of the Project area a number of air quality monitoring events have been undertaken since 2016. Monitoring was conducted by AFH Services in June 2016 and Gruntec thereafter, through the use of a mobile air quality monitoring station. Results of the measurement events completed (i.e., January 2016-December 2017) indicate that in general, the ambient concentrations of the measured contaminants are very low with all measurements below the permissible limits established by the Ecuadorian government (Unified Text of Secondary Legislation of the Ministry of the Environment (TULSMA) - Ministerial Agreement 097a, Annex 3: Standard of Air Emissions from Stationary Sources and Annex 4: Ambient Air Quality Standard or Emission Level). Four 24-hour air quality monitoring events were conducted in October 2018 to supplement previous measurement campaigns. The 2018 measurements took place in Chumblin, San Gerardo, Campamento Los Pinos and the deposit site. The results were consistent with previous measurement periods with most parameters measuring below the instrumental detection limits.

20.3.3 NOISE

In 2009, Center for Environmental Studies (CEA) of the University of Cuenca performed 24-hour noise monitoring events each month over a four-month period at monitoring points in the towns of San Gerardo, Chumblin and Victoria del Portete, the Campamento Pinos (within Los

	Document Number	J01834-PM-REP-002	Rev	0	
	Date	11 January 2019	Page	300 of 417	

Pinos Surface Rights area), and in the planned underground mine area within the Río Falso concession. Additional monitoring has been conducted biannually since December 2015 at Campamento Pinos and the planned underground mine area and results are compared to Ecuadorian standards (Table 1 – Industrial Zone, Annex 5, Ministerial Agreement 097a, Ministerial Agreement 061, Book VI of TULSMA) (*Figure 20-1*).

All the baseline information collected to date indicates that background noise levels in the Project area are low, below Ecuadorian standards. Monitoring at site stations P1 and P2 will continue on a quarterly basis in order to obtain robust dataset for evaluating impacts of the Project and inform management and monitoring plans.

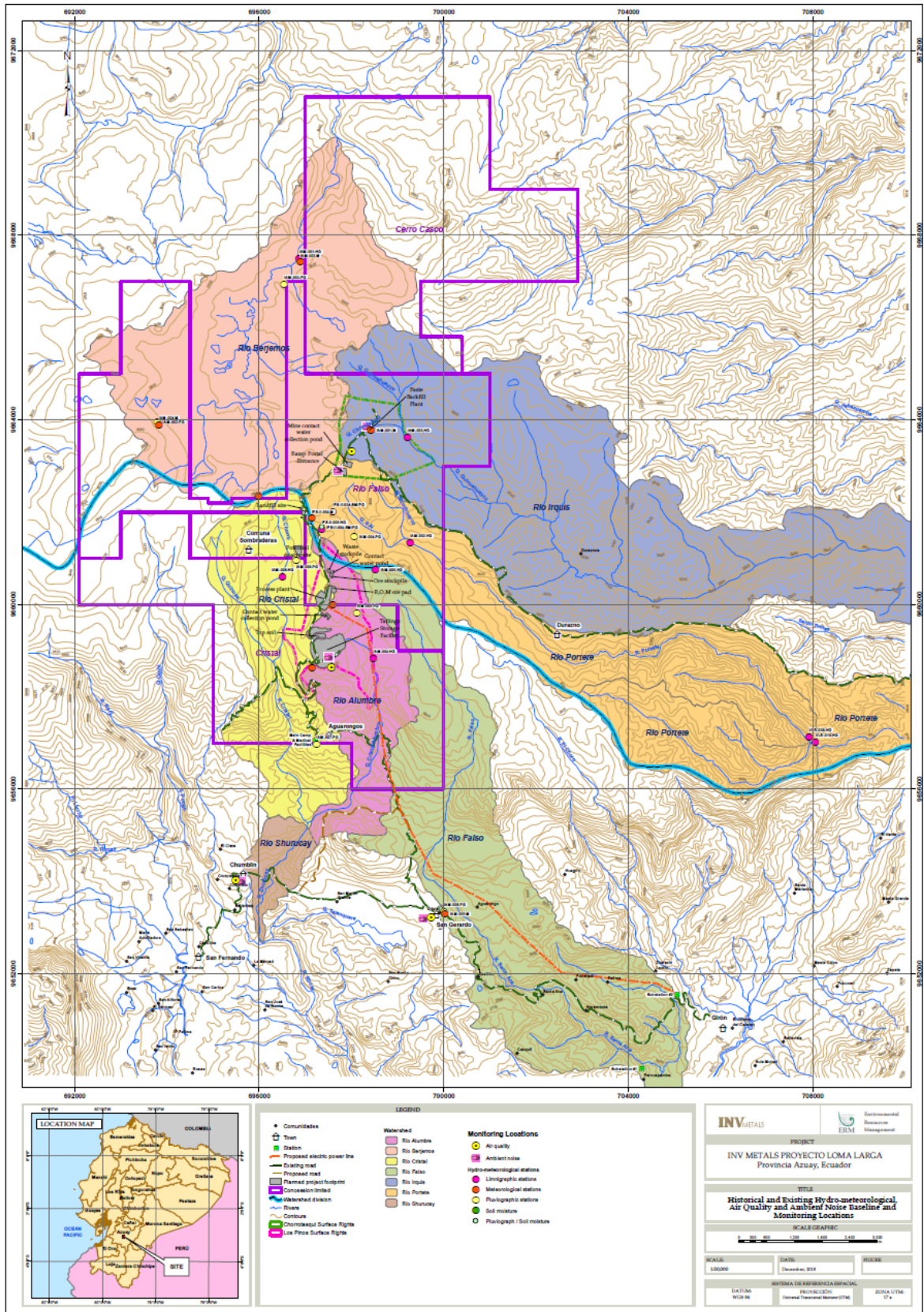



Figure 20-1 Historical and Existing Hydro-meteorological, Air Quality and Ambient Noise Baseline and Monitoring Locations

	Document Number	J01834-PM-REP-002	Rev	0	
	Date	11 January 2019	Page	302 of 417	

20.3.4 SOIL

From 2008 to 2011, PROMAS carried out annual soil studies describing the physical, hydrophysical and chemical characteristics, as well as the morphological conditions within the project area, with a primary focus on the underground mine area. Additional soil quality monitoring has been conducted by Gruntec within the project area including the Los Pinos surface rights area (*Figure 20-3*).

The predominant soils are the Andosols and Histosols formed from the accumulation of volcanic ash and organic matter, with a very low apparent density (less than 0.5 g cm⁻³) and a high capacity of water retention (PROMAS 2011). Results of the soil quality monitoring within the project area indicate that most of the parameters evaluated are well below the maximum limit established in the TULSMA (Tables 2 - Industrial Use, Annex 2, Ministerial Agreement 097a, Ministerial Agreement 061, Book VI of TULSMA). There are some parameters that exceed the regulatory limits, but these are naturally occurring. The locations sampled focused primarily on the planned underground mine area, which would suggest that concentrations are due to a natural characteristic of the Páramo soils of the areas evaluated and that additional soil monitoring in the project area may result in similar observations.

The sampling completed to date has been localized to the planned underground mine area and does not capture the areas of surface disturbance that will result from the full scale mine. Additional baseline soil sampling will be conducted within the footprint of the mine including FTSF and the plant area (i.e., Los Pinos surface rights area), transmission line corridor, and new sections of the access road. Data gained from the additional sampling program will support further understanding of soil management needs, longer-term reclamation and closure planning, and environmental impact study.



20.3.5 HYDROLOGY

The Project straddles the continental divide. The three northern watersheds, Río Berjemos, Río Irquis (Quinuahuaycu), and Río Portete, drain to the Atlantic Ocean. The three southern watersheds, Río Falso, Río Cristal, and Río Alumbre (Quebrada Cristal- Alumbre) are both sub-watersheds of the Río Zhuruca; (*Figure 20-2*) that flow to the Pacific Ocean.

In December 2006, a hydrometeorological monitoring network was installed by PROMAS. In 2009, PROMAS performed a survey specifically developing the baseline hydrology in the high-altitude wetlands (Páramos) of Quimsacocha and its area of influence. The stations were installed at the Bermejitos, Calluancay (in the Río Portete watershed), Quinuahuaycu, Zhuruca, Jordanita (in the Río Alumbre watershed), and the San Gerardo Irrigation Canal.

Streams in the area are primarily driven by rainfall runoff events, with peak flow periods typically during the wet period of May to July. Low flows occur during the months of November to January. The Jordanita station (Quebrada Cristal-Alumbre) and Quinuahuaycu station (Río Irquis) were selected for analysis as they have the longest periods of records when compared to the other monitoring stations (2007-2013, and 2006-2014 respectively). Average annual runoff is to 633 mm in the Jordanita tributary of the Quebrada Cristal-Alumbre and 743 mm in the Río Irquis.

Baseflow reduction in the Río Irquis is expected through the construction and operations phases as the underground mine is dewatered which will redirect groundwater towards the underground mine rather than naturally discharging into the stream. The water collected in the underground mine will be transferred via pipe to the process plant for use as make-up

	Document Number	J01834-PM-REP-002	Rev	0	
	Date	11 January 2019	Page	303 of 417	

water. Excess water (not used for mining purposes), will be treated and discharged to the Jordanita tributary of the Quebrada Cristal-Alumbre. Baseflow reduction in the Río Irquiz is expected to be approximately 0.38 L/s, compared to current estimated baseflows between 0 and 5 L/s and monitored stream flows in the downstream receiving environment in the range of 5 to 100 L/s in the Upper Río Irquiz.

Water collected within diversions around the ore processing plant site, ore stockpile, temporary waste rock stockpile and FTSF, along with dewatering inputs from the mine, will be directed to the planned water treatment facility before discharge to the receiving environment (the Quebrada Cristal-Alumbre). The average annual background flows in the Quebrada Cristal-Alumbre are 54 L/s (measured at the Jordanita Station). The Project site infrastructure and diversions will reduce natural flows by approximately 9 L/s on average, and approximately 21 L/s of treated water will be discharged, meaning that during mine operations, average annual flows in the Quebrada Cristal-Alumbre may increase to 66 L/s. The flow changes represent an expected average flow increase of 6.6% at the mouth of this watercourse. The expected average flow increase further downstream in Rio Zhurucay (near Chumblin) is less than 3%.



The existing data sets provide a reasonable spatial and temporal coverage of the Project area, however additional data analysis will be completed using the available field collected data to increase the confidence of the flow data for use in on-going project planning and environmental impact study.

20.3.6 HYDROGEOLOGY

Hydrogeologic field investigation around the ore zone and access ramp (i.e., Río Falso concession) was conducted in 2016 and 2017. This field investigation focused on hydraulic testing of boreholes (drilled across the ore zone) and installation of 11 piezometers (Itasca 2017a).

Subsequent to this field investigation, additional water-level data for the Project was collected (Itasca 2017b) and used to generate a conceptual water balance and water management plan (Itasca 2017c). In Q1 of 2018 analytical and numerical simulations of groundwater inflows provided an assessment of the inflows to the proposed mine during its various stages of development. Maximum model-predicted rate of groundwater inflow into the mine, 13.8 L/sec, would occur during mine year 3. The analyses also generated predictions of the chemical composition of the discharge waters from the planned ramp to the underground mine (Itasca 2018a; Itasca 2018b; Itasca 2018c).

Data from the field investigations completed to date, indicate that the Project is within a complex geologic setting, which translates into a complex hydrogeologic system (Itasca 2017a). The complexity of the system can result in highly-variable groundwater flow gradients (Itasca 2017a). The system features in the area of the mine include bedrock groundwater underlying a cap of saturated Páramo vegetation, and shallow, perched groundwater. The underground mine is in bedrock and dewatering will affect the groundwater system and, to a limited extent, the streams around. Reductions in the groundwater table are unlikely, as the mine will influence primarily the groundwater within localized bedrock formations. The shallow Paramo groundwater would be affected by the mine dewatering to a much lesser extent as it is perched over bedrock.

	Document Number	J01834-PM-REP-002	Rev	0	
	Date	11 January 2019	Page	304 of 417	

20.3.7 WATER USE

There are no known human groundwater users within the model-simulated cone of depression that could be affected by dewatering of the underground mine.

The social baseline study (Propaxis 2018) indicates that within the direct area of influence of the Project 48% of households are connected to a community irrigation system. Community irrigation systems allow these water users to manage available water resources, which are critical for agricultural and livestock production. Schedules and regulations of the irrigation systems are enforced and respected by all members. These systems report low levels of technical and administrative capacity, which has a direct impact on the continuity and quality of maintenance work, which has the potential to impact the distribution of water (Propaxis 2018). The remaining households that are not connected to community irrigation systems, mainly rely on rainfall for agricultural and livestock production.

Currently, INV holds an administrative authorization for the right to use and consume water, which was granted on July 5, 2010. This authorization provides INV the right to use rainwater to be collected in the Cristal-Aguarongos sector of the San Gerardo Parish, Canton Girón in eight reservoirs/storage ponds up to 0.03 million cubic metres per year (Mm³/yr) (flow of 1 liter/second (L/s)). The reservoirs/ponds capacity is approximately 15,000 m³ and the authorization particularly indicates that the water will be used for forest nurseries irrigation and advanced exploration activities. The existing permitted flow is 0.6 L/s for nurseries (granted for a 10-year renewable concession) and 0.4 L/s for industrial use for the duration of advanced exploration works.

INV also holds another administrative authorization for the right to use and consume water, granted with renewal possibility for 10 years. This is a Production Water Use Authorization for mining activities with an 8 L/s flow taken from the Quebrada Cristal-Alumbre located in the San Gerardo Parish of the Girón Canton, Province of Azuay. This Authorization ensures a water use up to 0.25 Mm³/yr (8 L/s) for mining industrial activities from Cristal Creek.



20.3.8 WATER QUALITY

20.3.8.1 SURFACE WATER

Surface water quality monitoring has occurred between 2003 and 2017 at a total of 30 water quality stations (PROMAS, INV and IAMGOLD) (**Figure 20-2**). While the spatial extent of monitoring is adequate, covering potential receiving environments, farfield sites, and upstream watersheds, the scope of monitoring (parameters monitored, monitoring frequency, and monitoring duration) has varied from year-to-year.

INV has been conducting quarterly monitoring in the Quinuahuaycu Alto, Quinuahuaycu, Calluancay, Kalluancay and Río Falso streams. The results are compared with Ecuadorian regulatory standards and submitted as an annual report to the Ecuadorian Ministry of Environment. In addition, two discharge points in the location of the Pino and Base camp, are monitored quarterly.

Comparison of available water quality data to Ecuador's criteria for aquatic life and IFC's guidelines for monitoring mining effluents indicates several exceedances in the levels of aluminum, copper, lead, cadmium, mercury, selenium, manganese, iron and zinc. In addition, baseline pH levels have been measured to be as low as 3.2, below the minimum pH per Ecuador's aquatic life criteria of 6.5, indicating existing naturally occurring acidic

	Document Number	J01834-PM-REP-002	Rev	0	
	Date	11 January 2019	Page	305 of 417	

drainage from local mineral deposits. Results of site wide water balance modelling (see **Sections 18.8** and **18.9**) indicate that constituents of potential concern in mine-related waters directed to treatment are generally consistent with those identified above in baseline monitoring that are naturally occurring. Parameters that are expected to be main targets for treatment, based on preliminary results from the site wide water balance modelling and proposed regulatory criteria, are aluminum, cadmium, cobalt, chromium, copper, iron, lead, manganese, molybdenum, nickel and zinc.

Within the Zhurucay Bajo watershed, exceedances were found for copper, iron, lead and zinc at all three sites within the watershed. Aluminum, cadmium, manganese, mercury and selenium were only higher for one or two of the sites. Metals concentration exceedances, like those observed in other watersheds, are attributable to natural processes.

Within the Cristal Concession, surface water quality monitoring will continue on a quarterly basis for Río Alumbre, the main receiving environment for the Project. At minimum, monitoring will capture wet season, dry season and shoulder seasons (quarterly). A far-field monitoring station will be established on Río Alumbre at the concession boundary, downstream of WQ-011 and upstream of WQ-003 and data will be collected on a quarterly basis prior to the start of effluent discharge from the FTSF. Within the Río Falso Concession, monitoring will continue at existing sites on Quinahuaycu which will capture wet season, dry season and shoulder seasons (quarterly).

Although existing conditions in the near-stream receiving environment indicate low quality aquatic habitat, regulatory uncertainty exists with respect to whether Ecuadorian aquatic and wildlife criteria will be applicable to Project effluent discharge permitting. Currently the water treatment systems will be designed to limit potential for additional exceedances of Ecuador's water use criteria for drinking water and irrigation in the receiving environment and effects on receptors and existing water uses. If the aquatic and wildlife criteria are applicable, additional costs associated with implementing specialized water treatment technologies may be incurred to meet more stringent standards for some constituents.

20.3.8.2 GROUND WATER



No previous deep groundwater chemistry data existed for the Project (Itasca 2017a), therefore a 2016-2017 field investigation program commenced with the installation of additional monitoring points for collection of water-quality samples of the deep-bedrock groundwater system.

The main Project elements that have a potential to affect groundwater system (and indirectly surface waters) are the underground mine and tailings storage facility.

Predictions of the chemical composition of the discharge waters indicate that the Ecuadorian Freshwater Aquatic Life and Wildlife Standards (Freshwater Standards) would be exceeded for some solutes including aluminum, copper, nitrate, lead, arsenic, chromium, iron, mercury, manganese, and zinc. Itasca has indicated that this geochemical characterization can be used to preliminarily characterize groundwater quality characteristics during full mine development.

As such, water from the underground will be transferred to the FTSF; excess water will be treated prior to discharge to the environment.

Additional groundwater characteristics will continue to be monitored as recommended by Itasca (2018c) to optimize the water-treatment plant design. The existing network for the

	Document Number	J01834-PM-REP-002	Rev	0	
	Date	11 January 2019	Page	306 of 417	

mine area will be augmented by installing a few shallow wells for monitoring water quality of the Páramo system, some of them located up-gradient of the Proyecto/Chorotasqui and Upper Irquis streams (receiving environment for post-closure mine-contact groundwater). Surface seeps near the bottom of the (Proyecto/Chorotasqui) stream's valleys (within the mine site) have been sampled in late 2018 and the analytical results will also provide some information on current baseline and naturally occurring groundwater quality conditions.

Additional modelling for the Project closure phase is required to support the environmental impact study as well as refinement of closure and reclamation planning. Such analysis will include estimation of the dissolved chemical concentrations in the post-mine contact groundwater (geochemical modeling) and a simple (as a minimum) fate and transport analysis (with consideration of preferential pathways, such as the ramp).

The Project includes a fully lined FTSF that provides the primary mechanism of control for impacts to groundwater and surface water from seepage, which reduces risk of impacts to the receiving environment. Characterizing the baseline groundwater around the FTSF conditions prior to development of the FTSF will allow for monitoring of potential groundwater contamination from the FTSF during the operation and post-closure phases of the project. Without additional characterization, any naturally elevated concentrations of groundwater chemicals likely could not be distinguished from the Project related impacts.

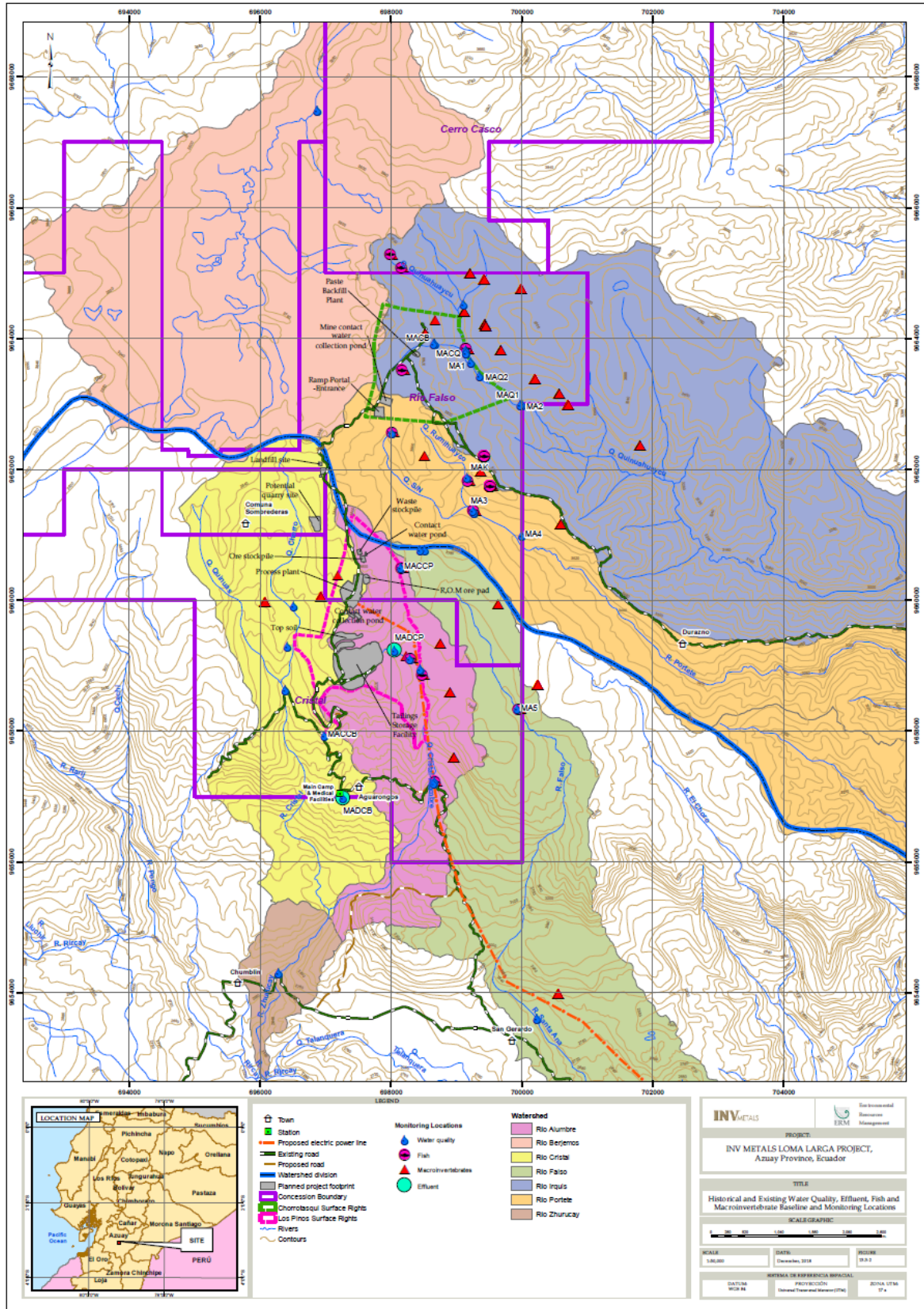



Figure 20-2: Historical and Existing Water Quality, Effluent, Fish and Macroinvertebrate Baseline and Monitoring Locations

	Document Number	J01834-PM-REP-002	Rev	0	
	Date	11 January 2019	Page	308 of 417	

20.3.9 TERRESTRIAL ENVIRONMENT

20.3.9.1 TERRESTRIAL FAUNA

The predominant ecosystem type within the Project area is Páramo grasslands which also includes wetlands (Mosquera et al. 2015). This ecosystem occurs above treeline and below the snowline in the Andes (Carrascal et al. 2011, Madrinan et al. 2013).

Terrestrial fauna groups for which baseline data has been collected include mammals, amphibians and reptiles, birds, and insects. Baseline data on these groups have been collected to determine the species occurrence within the Project area and to identify any special status species and their habitat that could interact with the Project (**Figure 20-4**). Threatened and endemic species that are considered Endangered or Critically Endangered as identified on the International Union for Conservation of Nature (IUCN) red list or have small ranges (i.e. endemic to Ecuador) require more in-depth consideration for mitigation to meet International Finance Corporation (IFC) Performance Standard 6 expectations of avoid, minimize, restore and offset.

Habitat that is of significant importance to IUCN red list Critically Endangered or Endangered, and range-restricted species is considered Critical Habitat under IFC PS6 (IFC 2012a; IFC, 2018). Mitigation for impacts to critical habitat includes following the mitigation hierarchy of avoid, minimize, restore and offset (IFC 2018). The portal location was chosen to avoid a nearby stream and its associated riparian area, thereby incorporating the principle of 'mitigation by design' in the Project.



20.3.9.2 AMPHIBIANS AND REPTILES

Surveys for amphibians and reptiles have been conducted by Azuay University biologists for 10 years between 2007 and 2018 (no sampling in 2011 and 2014), at 36 locations. Based on survey programs conducted to-date, ten species have been detected in the Project area, three reptiles and seven amphibian species, from two orders and six families. The most commonly observed species was the frog species *Pristimantis riveti*. Four of the amphibian species are considered Endangered or Critically Endangered by IUCN and one reptile species is considered Vulnerable. Critical habitat (as defined under the recently-released IFC threshold, IFC 2018; Frenkel et al., 2018), for one amphibian species may also exist on site.

For the three amphibian species that reproduce in streams and wetlands, avoiding these habitats whenever possible during the Project design assists with reducing other potential mitigation requirements.

For Project impacts on special-status species that cannot be avoided, or sufficiently minimized, a biodiversity offset may be required for the Critically Endangered, Endangered and range-restricted frog species. The need for an offset and the specifics of a biodiversity management plan will be defined once the EIS of the Project is complete. It is expected that through the EIS review process, the Ministry of Environment and Water will establish specific requirements for the Project.

Biannual data collection associated with the 13 transects associated with the Project footprint will continue to be monitored, as surveying at some of these locations has been limited to 2017 and repeat sampling will give a more robust data set. Additional baseline data collection will be carried out for habitats not previously sampled along new segments of the access road and along the transmission line during both the wet and dry seasons (biannual; January and August) to inform the evaluation of impacts for the construction and use of these Project

	Document Number	J01834-PM-REP-002	Rev	0	
	Date	11 January 2019	Page	309 of 417	

features. It is possible that during additional surveys for other project components e.g. access road and transmission line, that additional IUCN red list species may be detected. The probability of this occurring is highest in habitats that have not been extensively surveyed previously such as high montane evergreen forest through which the new road route will pass. However, it is anticipated that important habitat for these species can be avoided through minor adjustments of the road route and location of transmission line poles.

20.3.9.3 BIRDS



Avian surveys have been conducted by Azuay University biologists from 2007 to 2018 at 51 sampling locations. The information in the Azuay University database indicates that a total of 95 species have been detected corresponding with nine orders and 26 families. The families with the most number of species detected were hummingbirds, *Trochilidae*, with 16 species and *Tyrannidae* with 14 species. Four species that have been detected are of conservation concern, the hummingbird, *Metallura baroni*, is considered Endangered by the IUCN and is endemic to Ecuador, and the shrike, *Agriornis andicola*, is considered Vulnerable. Both species are federally Endangered (Granizo et al. 2002). The songbird, *Xenodacnis parina*, is considered federally Endangered (IUCN Least Concern) and the vulture, *Vultur gryphus*, is Critically Endangered federally (IUCN Near Threatened; Granizo et al. 2002). Based on information in the database it is unknown if habitat that these species use for nesting is present within the Project area. However, if there is a Project interaction with potential nesting habitat, impacts to these species can be minimized by avoiding vegetation clearing and ground disturbance activities during the nesting period. If this is not possible then pre-clearing surveys can be conducted to identify any active nests and avoid them using no disturbance buffers until the young have left the nest.

Biannual data collection associated with the 11 transects associated with the Project footprint will continue, as surveying at some of these locations has been limited to 2017 and repeat sampling would give a more robust data set. Additional baseline data collection for new habitats not previously sampled along the new segments of the access road and along the transmission line during both the wet and dry seasons will be carried out. This will provide data for the evaluation of impacts and identification of mitigation for the construction and use of these Project features.

20.3.9.4 MAMMALS

Mammal surveys have been conducted by Azuay University biologists from 2009 to 2018 at 24 locations. More recent data collection in December 2017 (Universidad del Azuay, 2017) and February 2018 (Universidad del Azuay, 2017) has occurred within the Los Pinos Surface Rights area within the Cristal concession.

Based on survey programs conducted to-date, a total of 28 species have been detected from nine orders and 15 families. The most commonly observed species was *Sylvilagus brasiliensis*, the tapeti or forest rabbit. One species detected is considered Vulnerable by the IUCN (IUCN 2018), *Mazama rufina*, the little red brocket deer, was observed during field surveys in 2009 and 2010. Vulnerable species are important to consider for mitigation and monitoring programs in the event that their status changes to Endangered. Two species endemic to Ecuador were observed: *Cryptotis montivaga* (Ecuadorian small-eared shrew) and *Phyllotis haggard* (Haggard's Leaf-eared Mouse), both of which are considered Least Concern by IUCN.

	Document Number	J01834-PM-REP-002	Rev	0	
	Date	11 January 2019	Page	310 of 417	

Biannual data collection associated with the 12 transects associated with the Project footprint will continue, as surveying at some of these locations has only occurred in 2017 and repeat sampling will give a more robust data set to inform management plans. Data collection for habitats not previously sampled along new segments of the access road and along the transmission line during both the wet and dry seasons to inform the evaluation of impacts and identification of mitigation measures for the construction and use of these Project features will be carried out over one year.

20.3.9.5 INSECTS

Entomological surveys have been conducted by Azuay University biologists in 2012, 2013, 2016 and 2018 at 35 locations. The information in the database indicates that 39 orders have been detected and 150 families. The families with the most number of morphospecies observed were family of small flies and fungus gnats, *Mycetophilidae* (10), and leafhoppers, *Cicadellidae* (9). The maximum number of morphospecies per family were determined from a single survey rather than multiple surveys when species overlap may have been possible. Biannual data collection associated with the nine locations associated with the Project footprint will be continued in order to provide a robust baseline set for impact predictions, mitigation and monitoring plans.

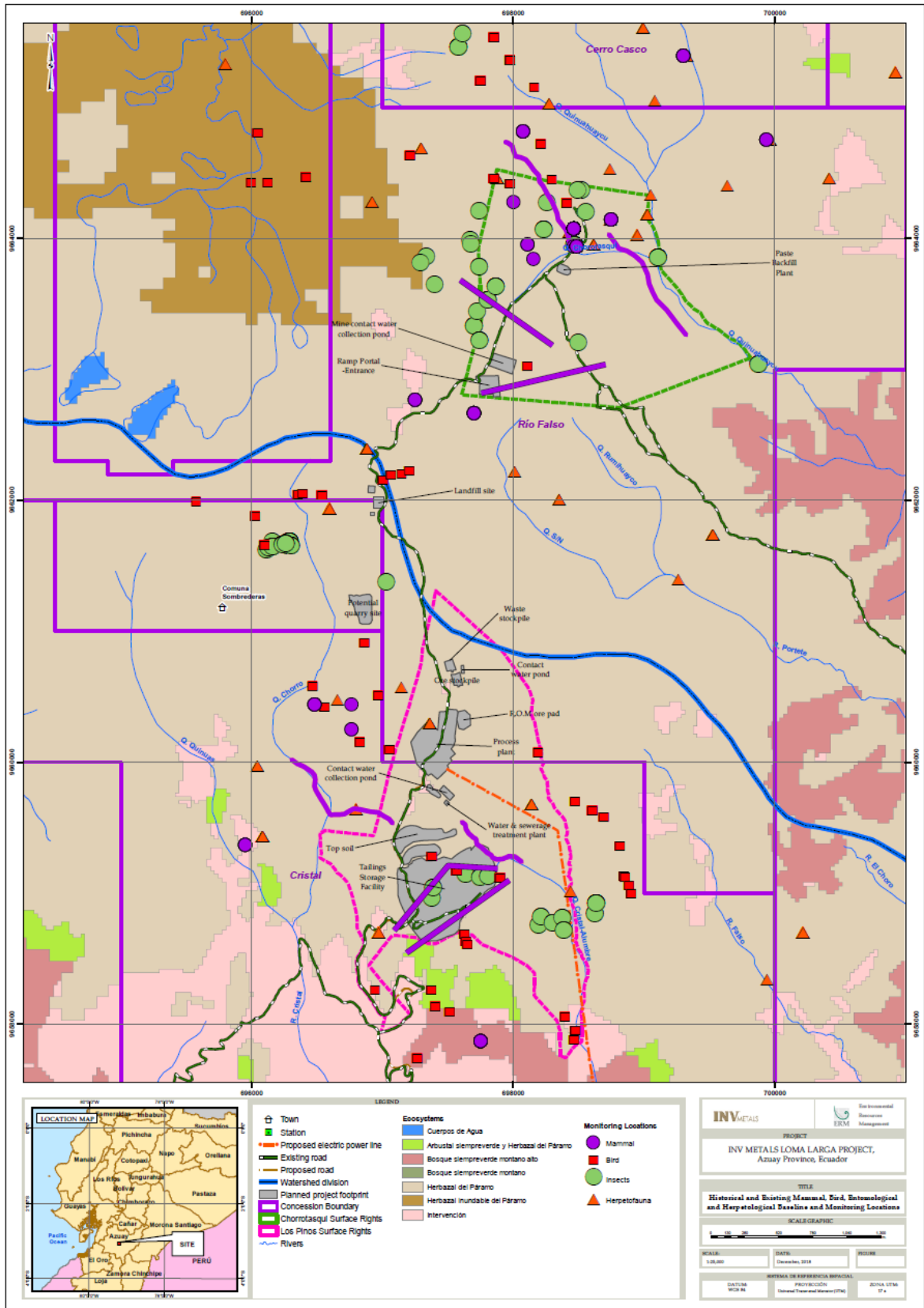



Figure 20-3: Historical and Existing Mammal, Bird, Entomological and Herpetological Baseline and Monitoring Locations

	Document Number	J01834-PM-REP-002	Rev	0	
	Date	11 January 2019	Page	312 of 417	

20.3.9.6 TERRESTRIAL FLORA

Vegetation surveys have been conducted by Azuay University biologists from 2007 to 2018 at 45 locations. Based on survey programs conducted to-date 47 orders, 91 families, and 410 species have been observed in the Project area; potentially more were observed as not all species were identified beyond the genus level. The most commonly observed family was the Aster family, Asteraceae, with at least 66 species detected. Six of the observed species are listed as Endangered by IUCN, 20 as Vulnerable, 6 as Near Threatened (IUCN 2018), one as extinct in the wild, and 10 are Endemic to Ecuador that are rare, or little is known about them. Two of the endemic plant species are *Polylepis reticulata* and *P. lanuginosa* which are also considered Vulnerable by IUCN (IUCN 2018).

Four of the Endangered plant species have been observed in the Chorro Tasqui surface rights area and three in the Los Pinos surface rights area. The Project as described in this FS will directly impact three Endangered species, *Gentianella hirculus*, *Lysipomia vitreola* and *Loricaria azuayensis*, which have been detected within the FTSF area. Critical habitat under IFC thresholds (IFC, 2018), may exist for *L. azuayensis*.

Mitigation measures for the species in the FTSF area could include creating no disturbance buffers around the plants during Project construction (for occurrences near but not within the project footprint), translocating plants or propagating them in the existing nursery. For Project impacts on special-status species that cannot be avoided or sufficiently minimized, a biodiversity offset may be required for Endangered and range-restricted plant species. The need for an offset and the specifics of a biodiversity management plan will be defined once the EIS of the Project is complete. It is expected that through the EIS review process, the Ministry of Environment and Water will establish specific requirements for the Project.

A species that is considered to be extinct in the wild by IUCN, *Brugmansia sanguinea*, was observed during August 2018 field studies. This species is sometimes cultivated by communities. It is known locally as floripondio, grown in people's gardens and used for certain rituals. The observation of the plant was in a small patch of forest surrounded by pasture and cattle. It is thought to be a cultivated plant.

Polylepis forests are important biologically as they occur at the highest treeline elevations globally (i.e, up to ~5000 m) and provide habitat for unique biodiversity such as endemic plant and animal species (Gradstein and Leon-Yanez 2017, Toivonen et al. 2011). Many Polylepis forests exist as fragmented or remnant habitat patches due to a long history of human land use in the Andes (Castillo et al. 2017, Toivonen et al. 2011). To date these species have only been observed between the Río Falso and Cristal concessions outside of the Comuna Sombrederas community.

Biannual data collection associated with the Project footprint will be continued to provide a robust baseline set for impact predictions, mitigation and monitoring plans.

Additional data collection will be carried out for habitats not previously sampled along new segments of the access road and along the transmission line during both the wet and dry seasons to inform the evaluation of impacts and identification of mitigation for the construction and use of these Project features.

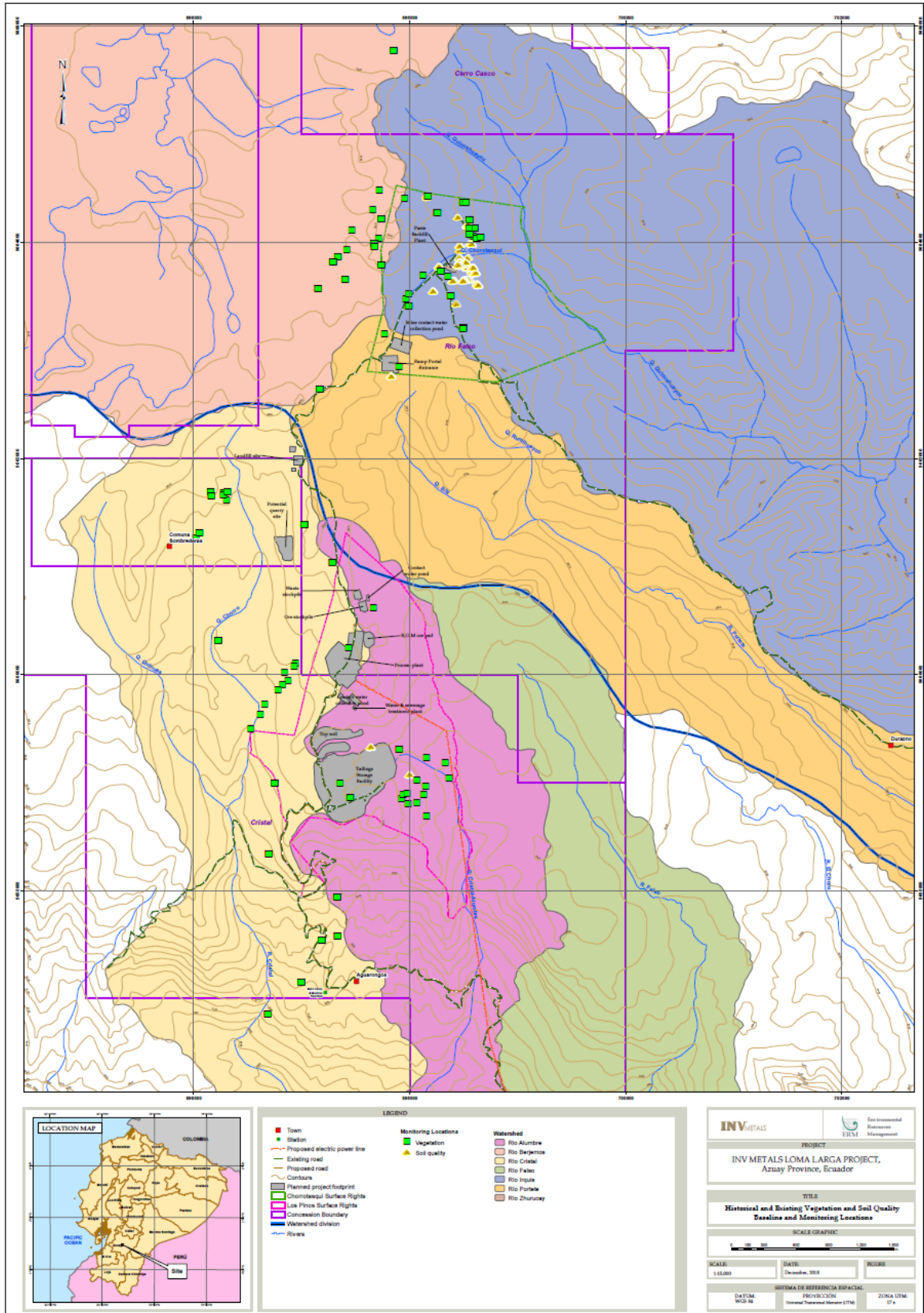



Figure 20-4: Historical and Existing Vegetation and Soil Quality Baseline and Monitoring Locations

	Document Number	J01834-PM-REP-002	Rev	0	
	Date	11 January 2019	Page	314 of 417	

20.3.10 AQUATIC BIOLOGY

Aquatic faunal groups for which baseline data has been collected include fish and macroinvertebrates.

Aquatic biology surveys have occurred in the following rivers in the Loma Larga concessions:

- Quebrada Quinahuayca in the Cerro Casco concession;
- Quebrada Quinahuayca, Quebrada Chorotasqui, Quebrada Rumihuayco, and Río Portete in the Río Falso concession;
- Río Falso, and Quebrada Cristal-Alumbre in the Cristal concession.

20.3.10.1 FISH AND FISH HABITAT

Fish surveys have been conducted by Azuay University biologists in 2013, 2015, 2016 and 2018 from 13 locations. Two species were detected from the Salmonid family, Salmonidae, rainbow trout (*Oncorhynchus mykiss*) and brown trout (*Salmo trutta*), both of which are introduced species in Ecuador. Rainbow trout have been detected in Río Falso, Quebrada Quinahuayca, and Quebrada Kalluancay (Anexos Ambiental Cuarto Trimestre 2015). Brown trout have been detected in Quebrada Kalluancay. Of the rivers and streams where fish have been detected, only the Quebrada Quinahuayca within the Río Falso concession is potentially impacted by the Project. No other fish species have been detected during the baseline surveys conducted to-date and no IUCN Redlisted Vulnerable, Endangered or Critically Endangered fish species have ranges that overlap the Project area.



Biannual data collection at 11 locations associated with the Project footprint will be conducted to obtain robust dataset for evaluating impacts of the Project and identifying appropriate mitigation and to inform management and monitoring plans. One year of biannual data collection will be carried out during the wet and dry seasons in Quebrada Cristal-Alumbre near the new segment of the access road and at stream crossings along the transmission line alignment. This will provide data for the evaluation of impacts and identification of potential mitigation for the construction and use of this Project feature.

20.3.10.2 MACROINVERTEBRATES

Macroinvertebrate data has been collected and analyzed by biologists with the Azuay University during eight years between 2008 and 2018 (no data collected in 2009, 2010 and 2012) at 37 locations.

Based on surveys conducted to-date, 21 orders, 63 families, and 77 genera have been identified in the Project area. Non-biting midges (Chironomidae) had the most number of genera detected (9) and crane flies, Tipulidae (6) genera were detected. Recent analyses of the data from February 2018 (Universidad de Azuay, 2018) indicated that there were three sampling locations along the Quebrada Cristal-Alumbre where water quality was degraded using the Andean Biotic Index (Acosta et al. 2009) which uses the presence of Ephemeroptera, Plecoptera and Tricoptera as indicators of good quality water. Two of these sites also had baseline (naturally occurring) water quality exceedances.

Biannual data collection at 11 locations associated with the Project footprint will be conducted to obtain robust dataset for evaluating impacts of the Project and identifying appropriate mitigation and to inform management and monitoring plans. One year of data collection will be carried out during the wet and dry seasons in Quebrada Cristal-Alumbre near the new segment of the access road and at stream crossings along the transmission line alignment.

	Document Number	J01834-PM-REP-002	Rev	0	
	Date	11 January 2019	Page	315 of 417	

20.4 SOCIAL OR COMMUNITY REQUIREMENTS

20.4.1 SOCIO-ECONOMIC CONTEXT

The Loma Larga Project is located in the province of Azuay, in the western mountain range of the Andes. The concession area of the Project is located in the cantons of Cuenca, Girón and San Fernando. The Project is one of five mining projects in the country declared as “National Strategic Projects” by the Ecuadorian Government (Ministry of Mines, 2016 and 2018).

The socio-economic context and social baseline data presented, corresponds to the areas of influence of the Project. The area of social influence of the Project refers to the area that is likely to be affected by the activities of the Project and its facilities. Although there are no communities within the mining concession area, the area of social influence considers the communities closest to the Project that are most likely expected to be impacted.



The delimitation of the area of social influence considers three levels: area of direct influence (ADI), area of indirect influence (All) and area of regional influence (ARI). The Ministry of Environment provides guidelines to define the first two (Guide for the elaboration of the social component of terms of reference and environmental studies of hydrocarbons, mining and other sectors, 2015).

Taking into account the role that the city of Cuenca plays in the socio-economic context of the Province of Azuay, INV included it as part of the regional layer of its area of influence. INV expects that the city will provide a variety of inputs, services and materials that can't be found in the ADI and All, and that are required for the construction and the production phases of the Project.

The population in the ADI and All is mainly rural. The results of the social baseline show that the number of people living below the poverty line in the ADI and All is above the national average. Approximately 75% of households qualify as poor in the ADI, while in the All the number is closer to 50%. The ADI and All are rural areas where most of the people work in agriculture and cattle raising (49% of population in ADI and 28% in All). These activities do not formally employ people and do not provide access to recognized social security or employment benefits. Rural family income is not likely to cover expenses and families often need to access informal credit to cover basic needs (52% of families in ADI, and 41% in All are in debt). These numbers contrast the average poverty, income and employment rates of the Province of Azuay, which are driven by the urban population of Cuenca, Ecuador's third largest city and one of the most important industrial hubs of the country.

The female population in the ADI and All is proportionally greater than male population (54% women, 46% men). This indicator responds to the high migration rates reported in the past in the studied area. The annual growth rate of the population from 2001 to 2010 was only 0.3% due to the high migration rate from people looking for employment opportunities outside the areas of influence. Most households in the area identify themselves as mestizo (person of mixed race, Spaniard and American Indian), Spanish speakers, and Catholics. This characterization is in-line with the cultural and traditional practices of the studied communities (Propraxis 2018).

Literacy levels show that 93% of adult residents in the area of influence are literate; however, there are low rates of formal education, only 22% of adults have finished high school. Lack of resources is the most common limitation reported for not studying. Economic activities are

	Document Number	J01834-PM-REP-002	Rev	0	
	Date	11 January 2019	Page	316 of 417	

concentrated in cattle growing and farming. The unemployment rate of economically active population reaches 13.4%. Employment in the area does not offer stability or social security benefits, most of the people are either self-employed or work per day. Around 82% of the population do not have social security (Propraxis 2018).

Housing indicators show that most residents have access to electricity on their homes (99%). Access to potable water reaches 71% of households, some households obtain water through a connection to the local water distribution network or use of a well. In terms of sanitation, 42% of houses in San Gerardo, Chumblin and Victoria del Portete have toilet and sewerage connected to the public network, while 43 % have a toilet connected to a septic tank system. Public service of garbage collection covers 76% of households. Household overcrowding indicator shows that 3% of households have more than 3 people per room, 2 people per room is the area's average. Internet penetration in homes remains low with 49% of households reporting not having any kind of internet access (Propraxis 2018).

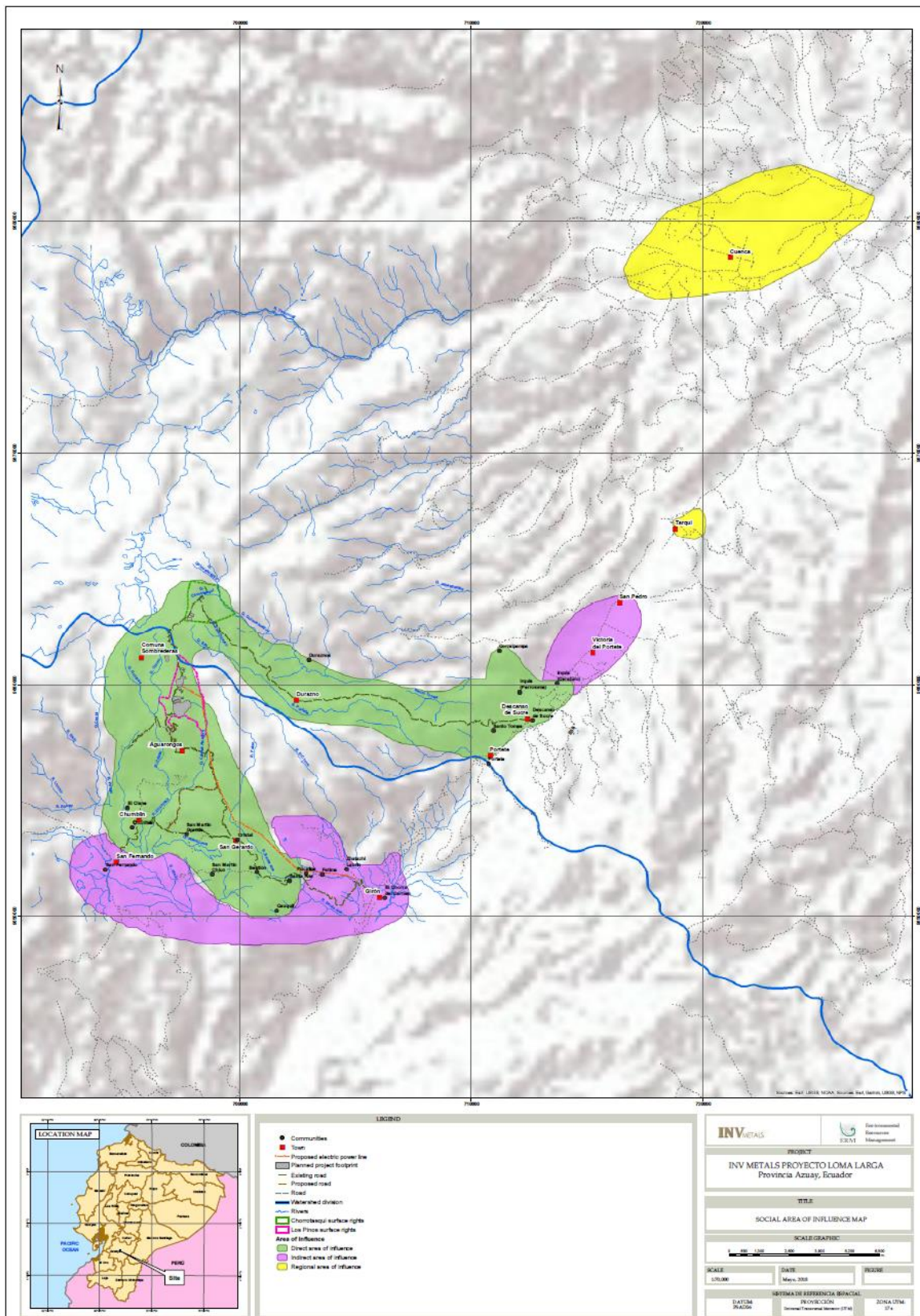



Figure 20-5: Areas of Social Influence of the Loma Larga Project

	Document Number	J01834-PM-REP-002	Rev	0	
	Date	11 January 2019	Page	318 of 417	

20.4.2 SUMMARY OF SOCIO-ECONOMIC BASELINE INFORMATION

Under the direction of ERM, Propraxis S.A. (Propraxis), an Ecuadorean consulting firm, conducted a detailed socio-economic baseline study for the direct and indirect areas of influence of the Loma Larga Project (Propraxis, 2018). The socio-economic baseline study included quantitative and qualitative information collected through a socio-economic survey, focus groups, community mappings, and interviews.

The socio-economic baseline information collected and analyzed as part of the study was organized using the methodology of the sustainable livelihoods framework, which considers that societal units have five capitals: human, economic, natural, physical, and social capital. The structure of the data collection tool included the following sections:

- **General information:** demographics, migration, head of household characteristics;
- **Human capital:** education, training, health, food security;
- **Economic capital:** productive activities, employment, income and expenses;
- **Social capital:** Participation and social cohesion, governance, gender equality, Project's perception;
- **Natural capital:** land use, ecological services; and
- **Physical capital:** house characteristics, household services, transport, public and communal infrastructure.



Migration is a phenomenon that affects a large part of ADI. Approximately 30% of households report that at least a member of their family has permanently emigrated. Annual population growth in both areas is very low (0.3%) due to the high emigration rate of people looking for employment opportunities. In this sense, the Loma Larga Project represents an opportunity that may provide local employment alternatives that could decrease emigration and promote the return of people who left the area.

Low levels of formal education and low skilled labor in the area of influence increases the difficulty to directly hire local people for mining projects. Training programs will be required in advance of mining activity to facilitate the availability of local labor for the Project and reduce the reliance on skilled labor to immigrate to the area. INV is aware of this need of training programs, which is something that will be integrated into the social management plans to be developed as part of the ESIA.

Income remuneration is low in agriculture and livestock, which are the main economic activities in the area of influence; hence there are high levels of poverty, as measured by the wealth index, 84% of HH in the ADI are considered poor. Employment in the area does not often offer stability or social security benefits, and the long working hours per week in precarious conditions report little economic return. As reported by the households, there is a lack of technology to support the production processes of the families (Propraxis 2018).

As reflected in the survey results, most of the families in the ADI know about the Project and have received information from INV through the Company's engagement activities. In addition, more than 44% of families in the ADI, have a positive perception of the project, mostly in the parishes of Chumblin and San Gerardo. In the All 31% of surveyed households do not know about the Project.

The expectation of employment opportunities and economic resources generation are the most common advantages cited that generate a positive perception of the Project. Potential risks of water and environmental pollution are the main concerns related to Project development from families of the ADI and All (Propraxis 2018). INV will need to include specific strategies in its Social Management Plans and Stakeholder Engagement and

	Document Number	J01834-PM-REP-002	Rev	0	
	Date	11 January 2019	Page	319 of 417	

Communications Plans that consider the interests of local stakeholders. These plans will need to be formalized as the Company advances the Project and seeks regulatory approval.

Population growth in the ADI if the Project was to induce immigration to the area could also become a challenge given that the rural parishes have limited capacity in terms of local infrastructure to accommodate newcomers. An influx management plan for immigration flows needs to be developed by INV in order to mitigate the potential impact of migration to the ADI.

A strategy for achieving easement access agreements for the Project's linear components, the power transmission line and access road, will be designed and implemented to comply with national regulations. This strategy may need to take into consideration the particularities of land tenure in the area to account for legitimate ownership rights, even when a property title does not exist. According to the baseline information, around 41% of households in the ADI, and 25% of households in the All do not have a property title over the land they own (Propraxis 2018).

20.4.3 CONSULTATION ACTIVITIES



This section summarizes consultation work conducted by INV and IAMGOLD to support exploration activities, early stage Project development, and social baseline data collection activities. The main focus of consultation efforts to date has been to inform local communities about the state of the Project and social projects undertaken in local communities.

INV has a communication and dissemination system that considers several mechanisms of communication to inform the public about the Loma Larga Project and associated community development projects. These mechanisms include:

- Public assemblies;
- Guided visits to the concession area;
- Information centers in ADI parishes San Gerardo and Chumblin;
- Mining tent with participation in the area of influence, Azuay province, and national forums of mining dialogue;
- Door to door information campaigns;
- Radio campaigns;
- Newspaper publications;
- Printed material to hand over to people visiting the information centers;
- Community development project planning sessions;
- Training sessions for community members.

INV's consultation efforts look to comply with national regulations requirements, by disseminating environmental management plans, environmental auditing and environmental impact studies (when available). Furthermore, INV's efforts go beyond regulatory requirements, aiming to reach families and individuals of the area of influence in an effective manner providing key, factual information specific to the Project, engaging them to interact with the Project, discuss doubts and issues, and get involved in community development programs.

INV's Community Relations staff have conducted numerous consultation activities from 2008 to 2018 (INV, 2018). During that period, the team has held a total of 328 events in the Parishes of Chumblin and San Gerardo. Over 7,380 local and regional residents, authorities, and institutional representatives have visited either the mine site or the information centers

	Document Number	J01834-PM-REP-002	Rev	0	
	Date	11 January 2019	Page	320 of 417	

and have received information regarding exploration and future activities (INV, 2018). Around 11,900 people received information at INV's Mining Tent that has been participating in several fairs, congresses and events to present INV's technical work, and environmental and social responsibility practices (INV 2018). Additionally, since 2010, INV has been implementing a program called "Mining Door to Door" in the direct and indirect area of influence looking to address residents' concerns of potential environmental impacts of the Project.

Consultation activities are documented using sign-in sheets, guest registers, photographs, videos, audios, reports and other written registers (INV, 2018).

An engagement and communication strategy for the EIS will be designed and implemented in order to comply with Ecuadorian regulations. The existing mechanisms of communication will be key elements during the consultation and dissemination activities related to the Project's EIS given that these are communication channels already established with the residents of the area of influence and other relevant stakeholders. The proposed mechanisms include:

- Establishing of public information spaces;
- Holding disclosure assemblies;
- Conducting disclosure workshops;
- Organizing group meetings with leaders and authorities;
- Performing door to door information campaigns;
- Information disclosure in public media; and
- Publishing relevant information in Project's web page.



The focus of the engagement and communication strategy will be to validate EIS findings in a participatory manner and with inputs to finalize the EIS and inform detailed engineering. The strategy will aim to identify any further areas of concern with the communities about the existing design of the project and associated infrastructure. Information regarding the perceived environmental impacts of the Project, particularly to water sources, will be an area of focus for these efforts.

20.4.4 CORPORATE SOCIAL RESPONSIBILITY AND COMMUNITY DEVELOPMENT PROJECTS

INV has conducted numerous corporate social responsibility initiatives focused within the areas of influence. The areas of work carried out with the communities are based on aspects considered of importance by the local population(s). These include:

- Enhancement of traditional production activities;
- Projects to stimulate agricultural and livestock production;
- Land management;
- Local human talent;
- Local employment;
- Productive entrepreneurship;
- Gender equality; and
- Education and environmental protection.

INV maintains cooperation agreements with the local Governments at the parish level to align the community programs and projects with the land use and development plans of each parish. The agreements establish that the programs and projects to be financed and implemented have to be framed within the local development plans. Each local Government,

	Document Number	J01834-PM-REP-002	Rev	0	
	Date	11 January 2019	Page	321 of 417	

as the main authority, permanently coordinates with community members, representatives, organized groups, and public institutions, to jointly perform project management and implementation. The actions implemented are publicly evaluated and endorsed every six months in the parish assemblies. All programs and projects, with the allocated budget are known and approved by the parish assemblies, the local organizations and local authorities. Monitoring and accountability are public through the communication and disclosure system.

The cooperation agreements between INV and the local Governments, facilitates the idea that mining can become a factor of local development that does not compete with the State or create parallel development plans, and that the objective is to strengthen and optimize public and private resources.

INV has generated strategic agreements of mutual collaboration for monitoring of its technical and scientific processes with the academic sector. INV currently works with two key universities: The University of Cuenca and the University of Azuay. These academic entities participate in specific studies related to water quality and quantity, water basins, soil structure, and monitoring systems of biological indicators, among others.

20.5 SOCIAL MANAGEMENT POLICIES AND PROCEDURES

INV has developed a set of policies and procedures to prevent and minimize social risks. The Community Complaints Procedure functions as an early warning system to allow INV's Community Relations Team to quickly deal with any community concerns before it becomes a major issue. The Code of Business Conduct and Ethics outlines the behavior that INV expects from its employees. The Disclosure, Foreign Corrupt Practices, and Whistleblower Policies outline corporate commitments to applicable laws and regulations.



20.6 MINE CLOSURE REQUIREMENTS

The Ecuadorian Mining Law (art. 27), and the Environmental Regulation of Mining Activities, consider the closure of a mine as a regulated phase of the mining activities. The closure phase consists of the termination of the mining activities and the consequent dismantling of facilities used in either exploitation, beneficiation, foundry, refining, or commercialization.

Two years prior to the planned completion of the Project, INV must submit the Mining Operations Closure Plan to the National Environmental Authority, for approval. The Mining Operations Closure Plan should include plans for the recovery of the area, and a plan to verify environmental compliance, to identify social impacts and to establish compensation measures (if needed). The preliminary Closure Plan must be included in the EIS of the Mine Project, and planning of the final closure and abandonment must be incorporated in the Environmental Management Plans as part of the Mine EIS.

The Mining Exploitation Contract will also have specific closure considerations including the payment of all environmental liabilities corresponding to a period equivalent to that of the mining concession. An insurance policy or bank guarantee, unconditional, irrevocable and of immediate collection in favor of the Ministry of the Environment will be required during closure. The insurance policy must remain in force and be updated until full closure of operations in the area and for one year after the end of the period of validity of the concessions.

Mine Closure and Reclamation for the Project also seeks to be consistent with the International Finance Corporation (IFC) EHS Mining Guidelines 1.1 and 1.4 Mine Closure and Post-Closure (IFC 2007b).

	Document Number	J01834-PM-REP-002	Rev	0	
	Date	11 January 2019	Page	322 of 417	

An adequate period of monitoring will be implemented to demonstrate compliance with proposed criteria and conditions that ensure the mine site is safe, stable and has reached the planned closure objectives. Such conditions must be demonstrated for a period of five years after the cessation of mining and closure of the mine or until the time that the Ministry of the Environment foresees according to the nature of the mine project. A progress and effectiveness report of the environmental measures implemented for the closure of the mine must be submitted to the Environmental Authority on a biannual basis for its approval.

Once the obligations of the closing and monitoring activities have been fulfilled after the operations have been completed, INV will present a closing environmental audit, which will verify compliance with closure activities and will allow the extinction of the environmental license. All environmental records will be present in an environmental closure report. The communication of the results of the Environmental Audit will be defined in the respective Terms of Reference of the Audit and will be subject to the approval of the Environmental Authority. In the event that closure of the Project cannot be fulfilled for all of the aspects of the Project, such as water quality compliance with the criteria selected, INV will present a closure plan that include long term management of that particular aspect until compliance can be achieved.

The Closure Environmental Audit approval will determine the rehabilitation of the mining area and the requirement for any financial guarantee.

If the Project ceases operations due to expiration or extinction of the mining rights, the Environmental Authority will carry out an inspection in order to determine the current situation of the area, considering the following conditions:



- For operations that have an approved Environmental Management Plan, the company must apply the closure and abandonment plan specified therein.
- In the event that the National Environmental Authority determines that an area has not been intervened at all, a Closure Plan will not be applied, and only the report issued by the Environmental Authority and the ARCOM inactivity certificate will be the enabling documents.

The Conceptual Mine Closure and Reclamation Plan is applicable for the life of the mine (LOM) extending over all Project areas within the Los Pinos and Chorrotasqi Surface rights, including the mine access road and power / waterline corridors connecting these two surface rights. The closure of the offsite mine access road from San Gerardo to the mine site from the south is not included in the closure plan or cost estimate at this time as the future of ownership of these project support components will need confirmation. If ownership of this infrastructure remains with INV at closure, the cost of closure will increase.

A final detailed Plan will be prepared and approved near the end of the Operational phase, prior to closure.

The specific objectives of the mine closure and reclamation activities are to:

- Leave a site with physical, chemical and biological stable landforms, including meeting site specific discharge surface water and groundwater quality standards of Ecuador for the protection of drinking water.
- Consult with local stakeholders on the desired end land use and function of the site post-closure that is compliant with regulations and sustains socio-economic benefits.
- Salvage, stockpile and protect soil from disturbed areas, which will be used to restore and revegetate the site. Reclamation may start as soon as any area is defined as not required by the Project or areas that require erosion management.

	Document Number	J01834-PM-REP-002	Rev	0	
	Date	11 January 2019	Page	323 of 417	

- Implement the mine closure and reclamation program as cost effectively as possible with commercially available skills, equipment and materials, taking into consideration prevailing local factors such as climate, seasonality, geography, demography, infrastructure, security, governance, capacity and operational reliability.
- Include contingencies for temporary suspension of activities and permanent early closure.

The successful reclamation program will depend on the identification and retention of soil resources for future growth medium on disturbed sites, as well as the continued implementation of successful native plant re-establishment that has been developed on the site at the existing plant nursery. To date, no full material balance study exists and it is an assumption that sufficient soil exists to meet the reclamation and closure objectives stated in this FS. A full material balance is recommended to validate whether there is enough soils to progressively cap the landfill.

For the underground mine, all stoping areas will be backfilled to best standard practices in Normal Mining Operations in North America. All areas of development where there could be long term potential for ground failures resulting in a failure to surface will be backfilled, although none are anticipated.

The backfill plant area buildings, utilities and all equipment will be removed from the backfill plant area, and will be trucked from site, sold or scrapped. The foundation will be left in place with all anchor bolts cut off at the top of the concrete. Concrete foundations may be broken and left in place, covered by overburden and 300 mm soil to provide for successful revegetation growth media. Site drainage will be re-established to natural patterns.



The paste backfill plant site pond will be decommissioned. Remaining water will be pumped to the FTSF. Accumulated sediment will be sampled and removed to the FTSF if determined to be of potential environmental concern. The drained sediment pond liners will be removed and placed into the ramp or removed from site. The final decommissioned ponds will be filled with suitable material from the berms and if necessary, covering with 300 mm soil prior to revegetation.

In the portal area, buildings and electrical equipment will be removed, including the powerline from the main substation. Surface areas will be de-compacted and ripped, covered with 300 mm soil and revegetated.

The portal area water and sediment ponds will be decommissioned and reclaimed in the same manner as the paste backfill plant pond.

The ramp will be closed to access. A steel fence will be installed 6 m inside the portal with stainless steel 100mm x 100mm welded wire fabric to limit entry. The complete portal area will be backfilled with clean material to an angle of repose of 30 degrees to return the area to the original topography as much as possible and covered with 300 mm soils and seeded with native grasses.

Ventilation raise areas and site access are to be decommissioned and reclaimed. All ventilation and escape raise equipment will be removed from the top of the raises and the fan foundations will be left in place. A platform will be hung from the surface to allow the installation of an engineered concrete bulkhead at the top of the raise complete with proper reinforcing. All protruding construction material will be removed, and the bulkhead will be covered with overburden as appropriate to create positive drainage, and 300 mm of topsoil material so that the area can be revegetated. The site access roads to the ventilation raises

	Document Number	J01834-PM-REP-002	Rev	0	
	Date	11 January 2019	Page	324 of 417	

will be decommissioned, landscaped and scarified, covered with soil and revegetated with grasses and plants. Ditches will be filled, culverts removed, and natural drainage patterns restored.

At the end of the LOM, any material left on the storage pad of the run of mine ore storage area will be processed or moved to the FTSF for sub-aerial deposition and will be part of the FTSF closure. The stockpile base seepage collection liner may be removed, and the site will be de-compacted, ripped and regraded to restrict issues with angles of repose over 30 degrees, and covered with overburden, as required, to complete landscaping as well as 300 mm of topsoil material as a growth medium for revegetation.

The electrical substation and specific powerlines will be left in place as power is required to run the water treatment plant until it is no longer required. INV will hold discussions with CENTROSUR prior to closure to determine the ownership structure of the transmissions line in the future. For the purposes of this study, INV have assumed that the powerlines will remain with INV post-closure.

The 3 km long on-site powerline connecting the plant site to the mine site will be decommissioned, conductors removed from site, sold or scrapped, and the power poles removed.

The feed and return pipelines connecting the plant site with the mine site will be drained to the FTSF, dismantled and removed from site, and along with steel supports, sold or scrapped. Cement foundations for the supports will be buried and capped with growth medium and revegetated.



The potential waste rock stockpile of non-PAG rock at the various locations on site will be re-contoured to stable configuration and topped with 0.5 m of overburden and up to 300 mm of growth medium prior to revegetation.

The FTSF area will require ongoing operating and maintenance considerations. The Operation, Maintenance and Surveillance Manual for the FTSF will specify the inspection, monitoring and reporting requirements of the facility until permanent closure is achieved. Post-closure water treatment not yet been modeled and for the purposes of this FS only, has been assumed for a period of ten years. Modeling of post-closure water treatment needs is recommended to determine the timeline of water treatment after closure. An operable emergency spillway will be maintained until permanent closure of the facility. The spillway area will be incorporated into the final closure plan. The spillway may still be in effect for major storm events, and in this case, will divert water around the dam structure in a similar way to the operating plan. Annual maintenance and post-storm maintenance may be required in addition to regular monitoring, which could be done remotely (e.g. SCADA system).

The FTSF is estimated to have approximately 6 Mt of tailings at closure. The FTSF may also have some waste material from mining operation, and if so, this material will be placed underground as fill.

The FTSF underdrain collection pond will be maintained, monitored and inspected as required to meet closure criteria until closed.

After reclamation is complete, the tailings will drain over a period of time. During the time the FTSF is draining to the FTSF underdrain collection pond, the water treatment plant will be operated on a regular basis to treat effluent to meet receiving environment water quality standards. The FTSF will be permanently closed once surface and seepage water from the facility is demonstrated to meet discharge criteria without further management/treatment.

	Document Number	J01834-PM-REP-002	Rev	0	
	Date	11 January 2019	Page	325 of 417	

The tailings facility will be covered with a geomembrane liner, and then covered by overburden and soil to form a growth medium for grasses and shrubs. Trees and deep-rooting shrubs will be discouraged from establishing to prevent liner damage by root systems at depth.

The water treatment plant will be operated throughout the post-closure mining phase until such time as stable water discharge from the FTSF, and other surface water discharges can demonstrate an approved period of time where effluent can be safely discharged to the surface receiving environment without further treatment.

Decommissioning of the water treatment plant will involve disconnecting electrical infrastructure, removal of all chemicals and equipment from buildings and on site, dismantling buildings, covering broken up cement foundations with overburden and soil, and revegetation.

The FTSF underdrain collection ponds, when no longer required, will be reclaimed by folding the liner system in on itself and covering the area with backfill to provide positive drainage. The area will then be covered with growth media and reseeded. Post closure will require maintenance of the closure cap until a vegetated surface can be established. The closure surface will be monitored, inspected and repaired, if needed, to address water and wind erosion. In addition to the closure cap, the perimeter road, stormwater diversion channels and underdrain collection pond areas will also be monitored, inspected and repaired, if needed.

During closure activities, monitoring will be undertaken to confirm that no incremental environmental impacts are incurred as a result of closure activities, with special attention to incidental spills of hydrocarbon fluids and chemicals during their containerization and shipment. Regular inspections will be undertaken to confirm sites are left clean and reclamation actions are undertaken as prescribed. INV will monitor chain of custody performance offsite to confirm proper disposal.

The existing plant nursery will be maintained and operated for additional plant and seed stock into the post-closure period as some revegetation and reforestation is anticipated. The nursery will eventually be shut-down, and the site reclaimed.

21 CAPITAL AND OPERATING COSTS

21.1 CAPITAL COST ESTIMATE

The overall capital cost estimate was compiled by DRA and summarized in the **Table 21-1** below. DRA developed the mining, process plant, plant infrastructure and off-site infrastructure capital cost estimates for the Project scope described in this report. External inputs received are given in **Section 21.1.4.9**.

All costs are expressed in United States Dollars (US\$) and are based on Q3 2018 pricing. The capital cost estimate is deemed to have an accuracy of $\pm 15\%$ and was prepared in accordance with the AACEI (Association for the Advancement of Cost Engineering) Class 3 estimating standard.

The capital cost estimated was developed based on a typical EPCM project execution model. Major equipment was specified, and priced quotations obtained from reputable Original Equipment Manufacturers (OEM). Construction contract packages were prepared, issued and priced in-country by capable construction companies.

Table 21-1: Capital Cost Summary

Area	US\$
Direct Cost	
Mining – Underground	39,784,517
Mining Surface Infrastructure	10,064,338
Process Plant	67,879,603
Waste Management	18,475,238
Plant Infrastructure	19,802,553
Off-site Infrastructure	14,497,824
Subtotal Direct Cost	170,504,074
Indirect Cost	
Contractor Indirects	26,192,721
Inventory	7,008,541
Project Services	23,774,571
Vendor Rep & Commissioning	2,404,867
Owner's Costs	17,376,883
Freight & Logistics	5,275,777
Taxes & Duties	27,571,731
Contingency	29,360,835
Subtotal Indirect Cost	138,965,926
Total Initial Capital Cost	309,470,000
Sustaining Capital Cost	72,730,000
Closure Cost	22,000,000
Total Project Capital Cost	404,200,000

The initial Project capital cost estimate by discipline is provided in **Table 21-2**.

Table 21-2: Initial Capital Estimate Summary by Discipline

Description	Supply US\$	Install US\$	Contingency US\$	Total US\$
Underground Mining	396,973	12,395,749	4,229,241	17,021,962
Bulk Earthworks		32,621,510	4,487,870	37,109,380
Detail Earthworks	100,000	533,949	66,347	700,296
Civils – Concrete		6,939,652	753,575	7,693,226
Structural Steelwork	2,677,189	2,290,089	436,497	5,403,774
Architectural	660,810	2,422,342	114,354	3,197,506
Mechanical	59,433,709	8,701,860	3,863,240	71,998,809
Platwork	1,492,001	1,482,546	290,998	3,265,545
Painting/Protection& Insulation	589,538	635,910	122,544	1,347,992
Building Services	695,000	25,000	114,354	834,354
Piping	4,393,634	3,242,852	755,223	8,391,710
Electrical	20,892,271	4,182,267	2,008,763	27,083,301
Instrumentation & Control	2,832,404	866,821	424,529	4,123,754
Indirects		59,380,700	6,670,865	66,051,565
Owners		17,376,883	1,737,688	19,114,571
Freight & Logistics		5,275,777	527,578	5,803,355
Taxes & Duties		27,571,731	2,757,173	30,328,904
Total Initial Capital Cost	94,163,527	185,945,640	29,360,840	309,470,000

The Project sustaining capital is presented in **Table 21-3**.

Table 21-3: Summary of Sustaining Capital Cost

Description	US\$
Mining Capital	50,713,808
FTSF Capital	11,288,767
Taxes & Duties	3,358,452
VAT on Initial Capital	7,368,974
Total Sustaining Capital	72,730,000

The summary of closure costs is presented in **Table 21-4** below.

Table 21-4: Summary of Closure Costs

Description	Amount US\$
Mining - Underground	1,532,827
Mining - Surface Infrastructure	900,201
Process Plant	5,878,872
Waste Management	6,840,993
Plant Infrastructure	1,206,130
Off-Site Infrastructure	935,000
Total Direct cost	17,294,024
Total Indirect cost	2,594,104
Contingency	2,111,873
Total Closure Cost	22,000,000

21.1.1 MINE CAPITAL COST

The mine capital estimate includes the facilities described in this report and can be summarised as follows:



- Mining underground: mobile equipment, mine development, mine infrastructure, underground services and stationary equipment.
- Mining surface infrastructure: ventilation, backfill plant, fuel storage and distribution, surface ore and waste storage.

The underground mine capital cost is summarized in **Table 21-5**.

Table 21-5: Summary of Mine Capital Cost

Description	Initial Capital US\$	Sustaining Capital US\$	Total US\$
Mobile Equipment	17,196,012	22,743,553	39,939,566
Mine Development	14,818,547	12,047,724	26,866,271
Mine Infrastructure	199,390	200,000	399,390
Underground Services	7,570,568	10,685,745	18,256,313
Mine Surface Infrastructure	10,064,338	74,500	10,138,838
Total Mining	49,848,856	45,751,522	95,600,378

Initial capital requirements were estimated to be US\$49.8M and include capitalized preproduction cost of US\$6.1M. The capital cost estimate is based on INV completing the ramp and pre-production underground development. INV will purchase the required equipment directly. The initial portal trench will be prepared by a contractor. The capital estimate further allows for mine infrastructure including temporary laydown, warehousing, batch plant, fuelling system, electrical substations, electrical switchgear, explosive magazine, detonator magazine, dewatering pump systems, safety gear and main refuge station, surface settling pond and piping systems as described in this report. In addition, mine support equipment was estimated to include the main and auxiliary fans, submersible and main mine dewater pump systems.

	Document Number	J01834-PM-REP-002	Rev	0	
	Date	11 January 2019	Page	329 of 417	

21.1.2 PLANT AND INFRASTRUCTURE CAPITAL COST

The process plant and infrastructure capital estimate are based on the facilities described in this report and can be summarized as follows:

- Process plant: ore receiving, crushing and pre-concentration, grinding, cleaner flotation, tailings handling, concentrate handling, concentrate plant services and utilities and reagents.
- Waste management: FTSF, waste rock, surface water management and effluent water treatment.
- Plant infrastructure: site development and roads, power generation and distribution and buildings.
- Off-site Infrastructure: port facilities, site access road and offsite parking facilities in San Gerardo.

The plant and infrastructure capital cost estimate is summarized in **Table 21-6**.

Table 21-6: Summary of Process Plant Capital Cost Estimate

Description	Initial Capital US\$	Sustaining Capital US\$	Total US\$
Ore Receiving, Crushing & Pre-Concentration	8,840,729		8,840,729
Milling	13,824,833		13,824,833
Copper Flotation	7,035,844		7,035,844
Pyrite Flotation	5,562,878		5,562,878
Tailings Handling	6,373,884		6,373,884
Concentrate Handling	6,035,775		6,035,775
Process Plant Services and Utilities	2,912,736		2,912,736
Reagents	2,356,028		2,356,028
Plant Mobile Equipment	4,792,224		4,792,224
Electrical Rooms	5,606,410		5,606,410
Grounding	1,000,525		1,000,525
Control and Communication Systems	3,280,305		3,280,305
Control Room	257,433		257,433
Total Process Plant	67,879,603		67,879,603

A summary of the waste management capital cost estimate is set out in **Table 21-7**.

Table 21-7: Summary of Waste Management Capital Cost Estimate

Description	Initial Capital US\$	Sustaining Capital US\$	Total US\$
Tailings Storage Facility	12,804,396	6,922,042	19,726,438
Surface Water Management	1,264,022		1,264,022
Effluent Water Treatment	4,406,820		4,406,820
Total Waste Management	18,475,238	6,922,042	25,397,280

A summary of the plant infrastructure capital cost estimate is shown in **Table 21-8**.

Table 21-8: Summary of Plant Infrastructure Capital Cost Estimate

Description	Initial Capital US\$	Total US\$
Site Development and Roads	7,549,661	7,549,661
Power Generation and Distribution	4,841,801	4,841,801
Admin Facilities & Stores	3,715,503	3,715,503
Maintenance Facilities	3,695,588	3,695,588
Total Plant Infrastructure	19,802,553	19,802,553

A summary of the off-site infrastructure capital cost estimate is set out in **Table 21-9**.

Table 21-9: Summary of Off-Site Infrastructure Capital Cost Estimate

Description	Initial Capital US\$	Total US\$
Roads	9,680,386	9,680,386
Power Supply	2,903,982	2,903,982
Port Facilities	1,527,328	1,527,328
Cuenca Facilities	198,064	198,064
San Gerardo Facilities	188,064	188,064
Total Off-Site Infrastructure	14,497,824	14,497,824



A summary of the Project indirect capital cost estimate is set out in **Table 21-10**.

Table 21-10: Summary of Project Indirect Capital Cost Estimate

Description	Initial Capital US\$	Sustaining Capital US\$	Total US\$
Contractor Indirect			
Construction Temporary Facilities	15,912,123	1,799,731	17,711,854
Construction Equipment / Site Support	10,280,598		10,280,598
Inventory			
Spares	917,136		917,136
Initial Fill	2,738,631		2,738,631
Inventory Setup	3,352,773		3,352,773
Project Services			
EP - Engineering & Procurement	17,642,441	346,102	17,988,544
CM - Construction Management	5,246,923	276,882	5,523,805
Quality Control	507,162		507,162
Other Consultants	378,044	415,323	793,367
Vendor Representative & Commissioning			
Vendor Representative	1,327,972		1,327,972
Start-up & Commissioning	1,076,895		1,076,895
Owner's Cost	17,376,883		17,376,883
Freight & Logistics			
Ocean Freight-Port of Origin to Port of Destination	3,438,373		3,438,373
Land Transport-Port of Destination to Mine site	1,837,404		1,837,404
Taxes & Duties			
Taxes	5,394,684	3,053,138	8,447,822
VAT	22,177,046	6,661,392	28,838,438
Contingency	29,360,835	7,503,868	36,864,703
Total Project Indirect	138,965,924	20,056,436	159,022,360

21.1.3 BASIS OF ESTIMATE

This section describes the basis and methodology used to compile the capital cost estimate, covering initial and sustaining capital requirements, including direct, indirect and contingency. The capital cost estimate provides a substantiated assessment of capital requirements for the

	Document Number	J01834-PM-REP-002	Rev	0	
	Date	11 January 2019	Page	332 of 417	

defined scope to provide a basis to allow project economic evaluation and provide a budget for project implementation.

21.1.3.1 CAPITAL ESTIMATE BASIS

The basis for the capital cost estimate is summarized in the **Table 21-11** below.

Table 21-11: Capital Cost Estimate Basis

Description	Basis
Mine	
Mining Method	Detailed
Mine Plan, Layout and Infrastructure	Detailed
Mine Production Schedule	Detailed
Fleet Sizing and Sequence	Detailed
Mine Man Plan	Detailed
Waste Rock Dumps	Detailed
Ventilation	Detailed
Backfill	Detailed
Mine Surface Infrastructure	Detailed
Process	
Process Design Criteria	Finalized
Process Flow Diagrams	Finalized
Mechanical Equipment List	Finalized
Mass and Water Balance	Finalized
Piping and Instrumentation Diagrams	Preliminary
Control Philosophy	Preliminary
Engineering	
Engineering Design Criteria	Detailed
Site Location	Finalized
Geotechnical	Assumed
Plot and Block Plan	Finalized
Plant General Arrangement Drawings	Finalized for FS
Architectural Drawings	Preliminary
Electrical Load List	Detailed
Electrical Drawings (SLDs, MCCs)	Detailed
Electrical Design	Finalized for FS
Instrumentation Design	Finalized for FS
Infrastructure	
Tailings Storage Facility	Detailed
Access Road	Detailed
Closure Cost	
Closure Cost	Preliminary

21.1.3.2 QUANTITY DEVELOPMENT

Bulk commodity quantities were derived through preliminary engineering related to the specific layouts prepared for the Project, estimated or factored from similar project designs with the necessary adjustment. These quantities are summarized in **Table 21-12** and expressed as a percentage based on value.

Table 21-12: Bulk Commodity Quantities for Process Plant

Description	Quantity	Unit	Preliminary Engineering %	Estimated %	Factored %
Bulk Earthworks	409,648	m ³	100%	0	0
Detail Earthworks	22,061	m ³	100%	0	0
Concrete	8,142	m ³	100%	0	0
Structural Steel	724	t	100%	0	0
Architectural Building	8,277	m ²	100%	0	0
Platwork	416	t	100%	0	0
Electrical	101,885	m	62%	0	38%
Instrumentation	50,308	m	62%	0	38%
Piping	0	-	0	0	100%

Bulk quantities are summarized in **Table 21-13** below.

Table 21-13: Bulk Quantity Summary

Package	Unit	Quantity
Bulk Earthworks	m ³	2,469,450
Detail Earthworks	m ³	35,368
High Density Polyethylene (HDPE) liner	m ²	356,011
Concrete	m ³	11,747
Structural Steel	tonne	1,051
Buildings	m ²	17,000
Mechanical equipment	tonne	860
Mechanical equipment	No. of tags	240
Platwork	tonne	522
Power cable	m	101,885
Instrument cable	m	50,308

21.1.3.3 PRICING BASIS

Estimate pricing was determined from a combination of budget quotations, historical data, benchmarked industry factors and allowances. **Table 21-14** summarize the source of pricing used by major commodity expressed as a percentage by value of the project direct cost.

Table 21-14: Pricing Source Breakdown

Description	Budget Quotation %	Database %	Estimated %	Factored / Allowance %
Bulk Earthworks	100	0	0	0
Detail Earthworks	100	0	0	0
Concrete	99	1	0	0
Structural Steel	100	0	0	0
Architectural Building	45	30	0	25
Platwork	99	1	0	0
Mechanical Equipment	90	8	2	0
Electrical	20	20	10	50
Instrumentation	20	20	10	50
Piping-Plant	0	0	0	100
Overland Pipeline	100	0	0	0

21.1.4 ESTIMATE CRITERIA

21.1.4.1 BASE DATE

The base date for the capital cost estimate is September 2018.

21.1.4.2 BASE CURRENCY

The estimate is presented in United States Dollars (US\$). Prices obtained in other currencies have been converted to US\$ using the applicable exchange rates. Equipment and services quoted in other currencies were converted using exchange rates specified in **Table 21-15**. These exchange rates have been used and fixed in the estimate data sheet and all costs quoted in these currencies have been linked to these exchange rates to enable them to be changed at a later stage, if required.

Table 21-15: Foreign Exchange Rates



Currency	Rate	Currency Code	Value of Initial Capital (shown in US\$)	%
United States Dollar	1	USD	300,797,800	97
Canadian Dollar	1.292	CAD	5,720,100	2
Euro	0.847	EURO	2,952,100	1
Total			309,470,000	100

21.1.4.3 ACCURACY

The capital cost estimate is deemed to have an accuracy of $\pm 15\%$ and was prepared in accordance with the AACE (Association for the Advancement of Cost Engineering) Class 3 estimating standard.

21.1.4.4 ESCALATION

Escalation after the estimate Base Date has not been allowed for in the Capital Cost Estimate.

	Document Number	J01834-PM-REP-002	Rev	0	
	Date	11 January 2019	Page	336 of 417	

21.1.4.5 ESTIMATING SYSTEM AND FORMAT

The estimate was prepared in the DRA estimating system in MS Excel format.

21.1.4.6 ESTIMATE REPORT REQUIREMENTS

The capital cost estimate is presented as a fully detailed estimate, together with various summary sheets. The summary sheets have been compiled with the following area splits so that the total costs for each area can be immediately identified:

- Mining;
- Mining Infrastructure;
- Processing Plant;
- Processing Plant Infrastructure;
- Project Indirect Costs;
- Capital by Area; and
- Capital by Discipline.

21.1.4.7 COST CATEGORIES



The cost category for the allocation of costs to the engineering disciplines, as well as the defined Project support functions are as follows:

- 08 Underground mining;
- 10 Bulk Earthworks;
- 13 Detail Earthworks;
- 20 Concrete;
- 30 Structural Steel;
- 40 Architectural;
- 50 Equipment;
- 55 Platework;
- 58 Building Services;
- 59 Plant Mobile Equipment;
- 60 Piping;
- 70 Electrical;
- 80 Instrumentation/Automation; and
- 90 Project Indirects.

These codes represent the different tabs within the estimate where the discipline costs are captured. Each separate section of the project is designated with a Work Breakdown Structure (WBS) code for that area.

21.1.4.8 ITEM LEVEL

Each line item of the estimate is in accordance with the WBS numbering system and ties up with the equipment item number as shown on the Mechanical Equipment List and the applicable PFD.

	Document Number	J01834-PM-REP-002	Rev	0	
	Date	11 January 2019	Page	337 of 417	

21.1.4.9 ESTIMATING RESPONSIBILITY

DRA prepared the estimate for the mine and concentrator plant, the associated equipment and infrastructure. NewFields were responsible for the FTSF and Paterson & Cooke for the backfill plant system. G&A costs, taxes and duties, and closure costs were provided by INV.

21.1.5 ESTIMATE METHODOLOGY

The general approach followed to estimating the project capital was to define Project areas in accordance with the WBS and quantify or measure each cost element from engineering drawings, PFDs, mechanical equipment list, motor lists, cable schedules, and instrument lists.

Budget quotations from vendors were obtained for the all major items of mechanical and electrical equipment whereas minor items of mechanical or electrical equipment, in general, were either single sourced, or taken from the DRA database.

The estimate for the mine and plant have been developed assuming a continuous engineering, procurement and construction effort with no interruption of the implementation programme after funding approval has been obtained.

The estimate is based on an EPCM Project execution strategy whereby the Project execution will be managed by an EPCM Contractor who would work in conjunction with the Owner's Team that would provide overall direction and oversight. The EPCM Contractor would place contracts for and on behalf of the Owner. Contracts for major construction work packages would be tendered to multiple regional pre-selected Construction Contractors, covering the general disciplines of Earthworks, Civil Works (Concrete), Structural Steel, Platework, Piping, Mechanical Installation, Electrical and Instrumentation Installation. Mechanical and Electrical equipment will be supplied by OEMs and free-issued to the appointed erection contractors for installation or erected by the OEM.



The total Project cost and duration has been estimated on a single shift basis and therefore no secondary shifts, or overtime work has been allowed for in the estimate.

The productivity rates for the project have been provided by local subcontractors.

DRA utilized the internationally recognized FIDIC (Fédération Internationale Des Ingénieurs-Conseils) suite of contract terms and conditions for all measurable construction work packages and DRA's standard terms and conditions for equipment supply packages.

21.1.5.1 MINING

The mining estimate considered a cycle time for each task calculated based on the equipment selected. The mine will operate on three shifts of eight hours with six hours of working time per shift. The total amount of hours required to complete the work have been estimated for each piece of equipment. Based on the total amount on hours calculated, the number of each piece of equipment required have been estimated. The labour work force required to complete the work was then estimated based on the equipment fleet. Support crew and equipment were evaluate based on the direct equipment fleet and staff required to complete the work. DRA issued enquiries for all equipment and mine fleet to prominent suppliers and received up to three quotations for major equipment whilst minor equipment was generally single sourced. Quotations for major equipment were technically and commercially adjudicated to determine selection and inclusion in the estimate.

	Document Number	J01834-PM-REP-002	Rev	0	
	Date	11 January 2019	Page	338 of 417	

21.1.5.2 EARTHWORKS

Earthworks were quantified by DRA from the block plan, general arrangement drawings, plant terrace model and access road design. A bill of quantities was produced by DRA, quantifying all earthworks items in accordance with a detailed preamble describing each item to allow for clear and consistent pricing.

Earthworks rates were obtained in the market from regional contractors during a formal tendering process. Earthworks rates were selected following adjudication of tenders and clarifications with the contractors. These rates were populated in the estimate to determine the capital cost.

The earthworks contractor's indirect costs were priced and applied as a percentage in the estimate.

21.1.5.3 CIVIL WORKS

Concrete quantities were quantified by DRA from the block plan and general arrangement drawings developed specifically for this project. A bill of quantities was produced to quantify all civil works items in accordance with a detailed preamble describing each item to allow for clear and consistent pricing.

Concrete rates were obtained in the market from regional contractors during a formal tendering process. Concrete rates were selected following adjudication of tenders and clarifications with the contractors. These rates were populated in the estimate to determine the capital cost.

The civil works contractor's indirect costs were priced and applied as a percentage in the estimate.

21.1.5.4 BUILDING WORKS

The building works were quantified from preliminary layout drawings and a schedule of square meterage was produced by DRA. Buildings will mostly be brickwork structures with pre-engineered structures for workshops and stores.



Building rates were obtained from local vendors and contractors, benchmarked against DRA internal database information and used to populate the estimate.

The building works contractor's indirect costs were estimated and applied as a percentage in the estimate.

21.1.5.5 STRUCTURAL STEELWORK SUPPLY AND ERECTION

Steelwork quantities for plant structures were estimated by DRA from general arrangement and layout drawings specifically prepared for this project referencing similar concepts from DRA's database. The quantity take-off covered all of the steelwork as well as ancillary equipment, i.e. sheeting, grating, handrailing, kickflats, stairtreads, etc. These quantities were inserted directly into the estimate.

Structural steel fabrication and erection rates were obtained in the market from regional Contractors during a formal tendering process, as part of the Structural, Mechanical and Platework (SMP) package. The steel supply and erection rates were selected following adjudication of tenders and clarifications with the contractors. These rates were populated in the estimate to determine the capital cost.

	Document Number	J01834-PM-REP-002	Rev	0	
	Date	11 January 2019	Page	339 of 417	

Unit rates were priced per tonne of steel, with separate rates being provided for shop fabrications, delivery to site and erection on site. Rates for steel fabrication, delivery and erection are categorised as either, light, medium or heavy steelwork. Rates for erection on site are for all heights and regardless of position in the structure.

The SMP contractor's indirect costs were priced and applied as a percentage in the estimate.

21.1.5.6 PLATEWORK AND LINING

All platework and liner quantities were estimated and quantified by DRA from general arrangement and layout drawings. The material take-offs were inserted directly into the estimate.

Rates for platework and lining were selected from the SMP package used for structural steel. These rates were populated in the estimate to determine the capital cost.

The platework (SMP) contractor's indirect costs were priced and applied as a percentage in the estimate.

21.1.5.7 CORROSION PROTECTION

All steelwork and platework will be painted. The rates for painting to the specified specification were quoted by the fabrication contractor and these have been included in the estimate as part of the fabrication rate. A rate for site touch-up painting has been allowed for in the estimate for both steelwork and platework to repair damage from both transportation and installation.

Indirect costs related to corrosion protection are included in the SMP contractor's allowance.

21.1.5.8 MECHANICAL EQUIPMENT

DRA issued enquiries, complete with full specifications, to prominent suppliers of mechanical equipment and received up to three quotations for major equipment whilst minor equipment was generally single sourced. Quotations for major equipment were technically and commercially adjudicated to determine selection and inclusion in the estimate.

The erection cost for the mechanical equipment was based on rates received from the OEM or erection contractor. Erection costs for minor and ancillary items were taken from previous quotations or the DRA's database.



The SMP contractor's indirect costs were priced and applied as a percentage in the estimate.

21.1.5.9 CONVEYORS

From the conveyor belt-line drawings and preliminary engineering designs, quotations were received to provide a complete conveyor package. The conveyor design, supply and construction package cost were included in the estimate.

21.1.5.10 PIPING

The cost for process plant piping was factored as a percentage of the mechanical equipment cost based on DRA's historical data and experience. In this case, the factor is 16% (12% supply and 4% erect). Overland piping was quantified with material take-offs and priced using rates from suppliers and fabricators of piping systems.

	Document Number	J01834-PM-REP-002	Rev	0	
	Date	11 January 2019	Page	340 of 417	

The piping contractor's indirect cost were estimated and applied as a percentage in the estimate.

21.1.5.11 ELECTRICAL AND INSTRUMENTATION

E&I Equipment

The electrical and instrumentation equipment was priced using a combination of quotations, suppliers pricing, DRA database and recent project information. Budget quotations were obtained for major equipment (like the MV switchgear, transformers and Motor Control Centres (MCCs)) from reputable electrical and instrumentation suppliers represented in Ecuador.

In-country quotations were obtained for the HV power distribution to site by the local power utility.

E&I Installations Contract

The installation cost was built up using estimated quantities and priced by in-country installation contractors. Where additional information and rates were required for items or equipment not covered by the quotations, this was obtained from DRA's electrical and instrumentation database prices.

The instrumentation quantities were based on a set of Process Control Diagrams (PCDs) and the Mechanical Equipment List combined with the instrumentation and control components typical to concentrator plants similar to this project. Instrument pricing was obtained from reputable international manufacturers.

A basic control network design was estimated and priced based on equipment manufactured by Siemens.

The electrical & instrumentation contractor's indirect costs were priced and applied as a percentage in the estimate.



21.1.5.12 TRANSPORT AND LOGISTICS

Transport costs for mechanical equipment for shipping and freight forwarding based on the location and transport details received from the equipment vendors was estimated by Ballore Logistics – Toronto, Canada and Intercilsa Logistics – Quito, Ecuador. Transport costs for steelwork and platework were quoted by the fabricator / erector. Other transport costs were based on a tonnage or “per load” basis.

21.1.5.13 CONTRACTOR INDIRECT COSTS

Contractor indirect costs include all contractors' overheads such as contractual requirements (safety, sureties, insurance, etc.), the site establishment and the removal thereof, as well as company and head office overheads. They also cover supervision, travel to and from the site, contractor supplied temporary facilities, offices and laydown areas, tools and contractors' equipment.

Indirect costs have been converted to a percentage of the value of the works to be executed and are shown separately against each discipline estimate value.

	Document Number	J01834-PM-REP-002	Rev	0	
	Date	11 January 2019	Page	341 of 417	

21.1.5.14 FIRST FILL AND CONSUMABLES

The extent of the first fill and consumables has been determined by DRA. Enquiries were issued to suppliers and quotations were received. From the information received, this section of the estimate was populated with the quoted rates.

21.1.5.15 SPARE PARTS

Commissioning and operating spares for the mechanical equipment were estimated by a combination of priced spares and a percentage of mechanical equipment supply prices. The percentages used are 1% for the mechanical commissioning spares and 4.5% for the mechanical operating spares.

Strategic spares were identified and individually priced by the relevant vendors and included in an itemised strategic spares schedule in the estimate.

For the electrical and instrumentation spares, a percentage has been taken of electrical and instrumentation equipment supply prices. The percentages used are 5% for all electrical and instrumentation spares. Piping and valve spares were taken as 2% of the piping and valve supply price.

21.1.5.16 PROJECT SERVICES



The following costs have been allowed for in for project services:

- EPCM-Engineering Procurement Construction Management:
 - These costs cover the project management, detailed engineering, procurement and construction management costs directly associated with the implementation of the project.
 - Project management and EPCM costs relating to mining, processing and associated infrastructure were developed from first principles considering the team organisational structure, in-country detail design and project schedule. The EPCM cost was benchmarked to similar projects and is considered appropriate for the type, nature, size and location of the project. The EPCM cost includes reimbursable travel and other sundry costs.
- Quality control.
- Geotechnical services.
- Fire protection consultant.
- FTSF site surveying services.

21.1.5.17 ASSUMPTIONS

The following assumptions have been made in the preparation of this estimate:

- Quotes from vendors for equipment and materials are valid for budget purposes only.
- Suitable backfill material will be available locally. Soil conditions will be adequate for foundation bearing pressures.
- Engineering and construction activities will be carried out in a continuous program with full funding available including contingency.
- Labour productivities are established with input from experienced local contractors and checked against DRA's in-house database of current projects.
- Bulk materials such as cement, rebar, structural steel and plate, cable, cable tray, and piping are all readily available in the scheduled timeframe.

	Document Number	J01834-PM-REP-002	Rev	0	
	Date	11 January 2019	Page	342 of 417	

21.1.5.18 EXCLUSIONS

The following are not included in the capital cost estimate:

- Escalation.
- Cost of schedule delays such as those caused by:
 - Scope changes.
 - Events that would be considered Force Majeure.
- Environmental permitting activities.
- Cost of financing.
- Acquisition costs.
- Sunk costs.
- Additional studies prior to EPCM.
- All royalties, commissions, lease payments, rentals and other payments to landowners, title holders, mineral rights holders, surface right holders, and / or any other third parties not mentioned in this documentation.
- Forward cover for any foreign content, (it is assumed that this would be accommodated by the client if necessary).
- All operating costs.
- Any work outside the defined battery limits.
- Any provision for project risks outside of those related to design and estimating confidence levels.
- Fuel storage, other than the provision of any fuel bunkers in our scope of work
- Interest on capital loans.
- Any costs to be expended following completion of the feasibility study and prior to Board approval for project implementation.
- Mineral rights and the purchase or use of land.
- The costs of any trade off studies.
- Post-closure operating costs.
- Scope outside of the battery limits as defined by the block plan, PFD's, equipment list and scope specifically defined in the Technical Report.
- Any management reserves required by the owner outside of contingency, including project risk reserve.



21.1.6 ESCALATION

Escalation costs past the base date have not been allowed for in the estimate.

21.1.7 CONTINGENCY

Estimating Accuracy and Design Development Allowance

The Project capital estimate was developed as described in this section, supported by preliminary engineering which vary in level of development in specific discipline areas. The estimate is considered comprehensive and adequate for a FS. Contingency was assessed per discipline considering the level of engineering development, level and confidence of market pricing for supply and erection costs received.

	Document Number	J01834-PM-REP-002	Rev	0	
	Date	11 January 2019	Page	343 of 417	

A schedule and project duration have been considered in the development of this estimate detailing the design development assessment and contingency value assigned to each discipline.

Contingency has then been assessed as a percentage for the individual cost components, from which and overall estimating design development allowance has been derived.

The design development allowance, reflected as contingency, is assessed as a measure of the confidence in the design and estimating processes /outputs. The confidence in each design and engineering discipline has been assessed against the following scale with the following scale with the associated contingency allowance.

- HH (High High Confidence) 5%
- H (High Confidence) 7.5%
- HM (High Medium Confidence) 10%
- M (Medium Confidence) 12.5%
- ML (Medium Low Confidence) 15%
- L (Low Confidence) 20%

It should be noted that the design development allowance / estimating contingency is applicable only to potential quantity and rate inaccuracies within the estimate.

For this estimate a total contingency of 10.6% has been provided.

21.1.8 CASH FLOW FORECASTING

A cash flow forecast was prepared as input to the financial model.

21.2 OPERATING COST ESTIMATE

This chapter describes the basis of estimate and approach taken in the FS operating cost estimation.

The operating cost estimate is presented in United States Dollars (US\$) and uses prices obtained in H1 2018. The estimate is deemed to have an accuracy of $\pm 15\%$. DRA developed these operating costs in conjunction with INV, with specific inputs provided by external consultants for backfill and tailings disposal costs which were determined by P&C and NewFields.

All labour, materials and consumables deemed to be required for the operation have been included in this estimate. The process inputs were generated by DRA, based on data obtained from metallurgical test work results from SGS and others, using quotations from reputable suppliers for plant consumables, as well as current design and DRA database information.

For economic modelling, the operating cost has been broken into the following major areas:

- Mine operations;
- Process plant;
- Backfill plant and tailings disposal;
- G&A.

Operating costs, when reported as a LOM average annual value, are stated as a weighted average cost basis in accordance with the LOM production plan.

The following are examples of cost items specifically excluded from the operating cost estimate:

- VAT (included in the financial model, Section 16 of this report), import duties and / or any other statutory taxation, levies by national and / or local institutions.
- Project financing and interest charges.

21.2.1 OPERATING COST SUMMARY

A summary of the overall LOM operating costs, by major project areas is presented in **Table 21-16**. The costs presented exclude pre-production operating. All pre-production costs are covered in the capital cost estimate presented in **Section 21.1** of this Technical Report.

Table 21-16: Project Life-of-Mine Operating Costs by Major Area

Major Project Area	LOM Total (US\$)	LOM Unit Cost (US\$/t)
Mining Cost	323,389,258	23.22
Processing Cost	239,603,848	17.20
Backfill Cost	43,708,658	3.14
Tailings Disposal	31,469,759	2.26
G&A Cost	104,951,553	7.54
Total Cost	743,123,076	53.36

A summary of the unit operating costs, by major project area, and for the total Project over LOM is presented in **Figure 21-1**.

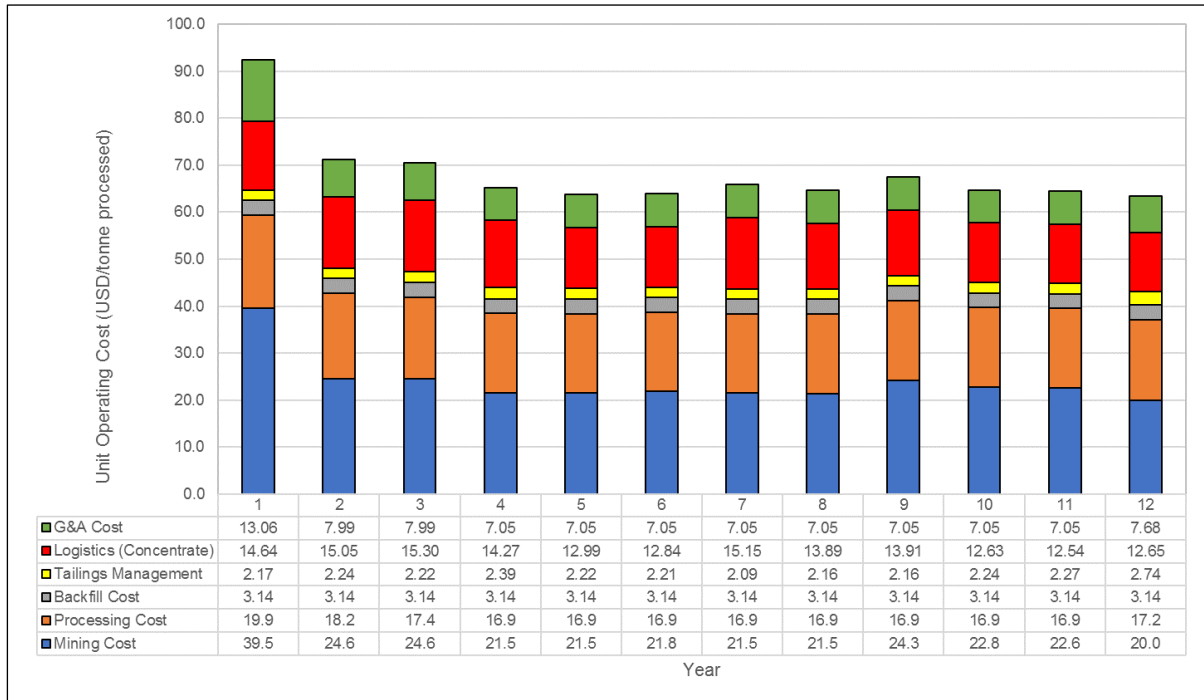

Figure 21-1: Project Life-of-Mine Unit Operating Costs

21.2.2 MINING COSTS

21.2.2.1 LABOUR COSTS

Labour costs reflect the labour complement for mine management, operations and maintenance. The labour costs for mine management are shown in **Table 21-17**. **Table 21-18** and **Table 21-19** respectively were developed jointly by DRA and INV, with the labour rates used for the study provided by INV.

The annualized overall, LOM, labour costs for mining are summarized in **Figure 21-2**.

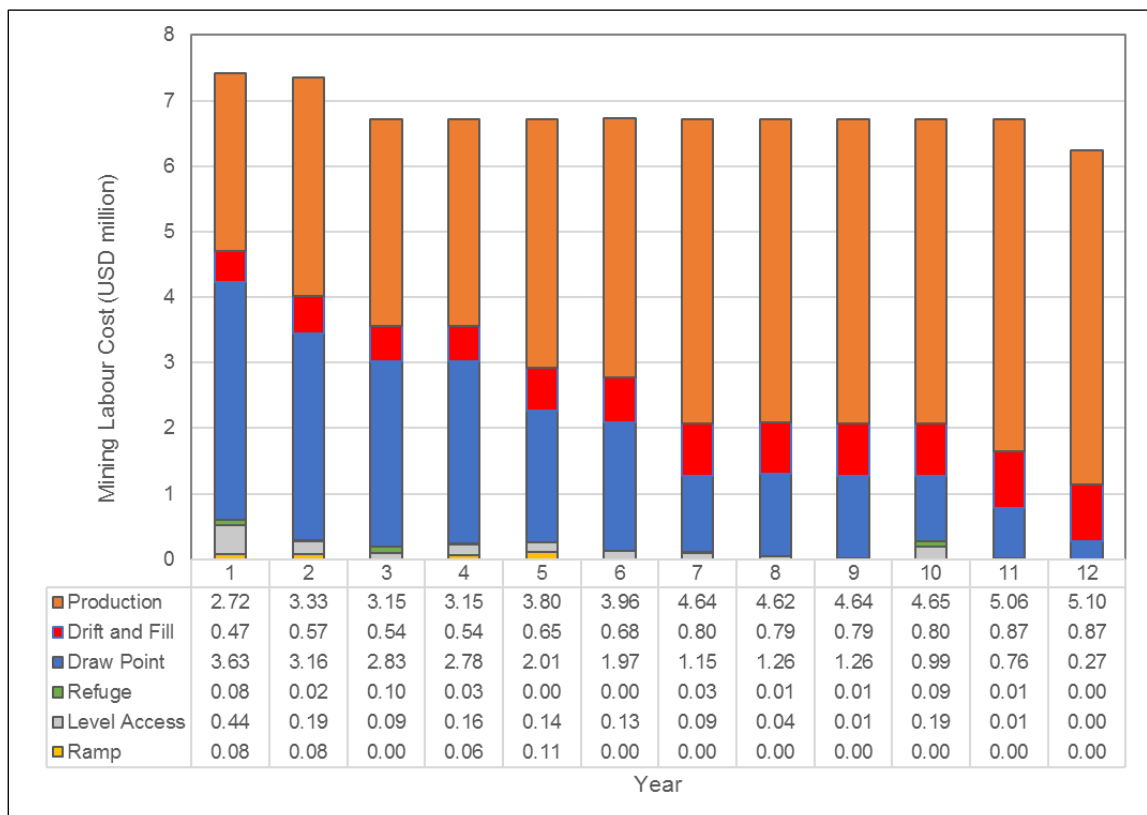
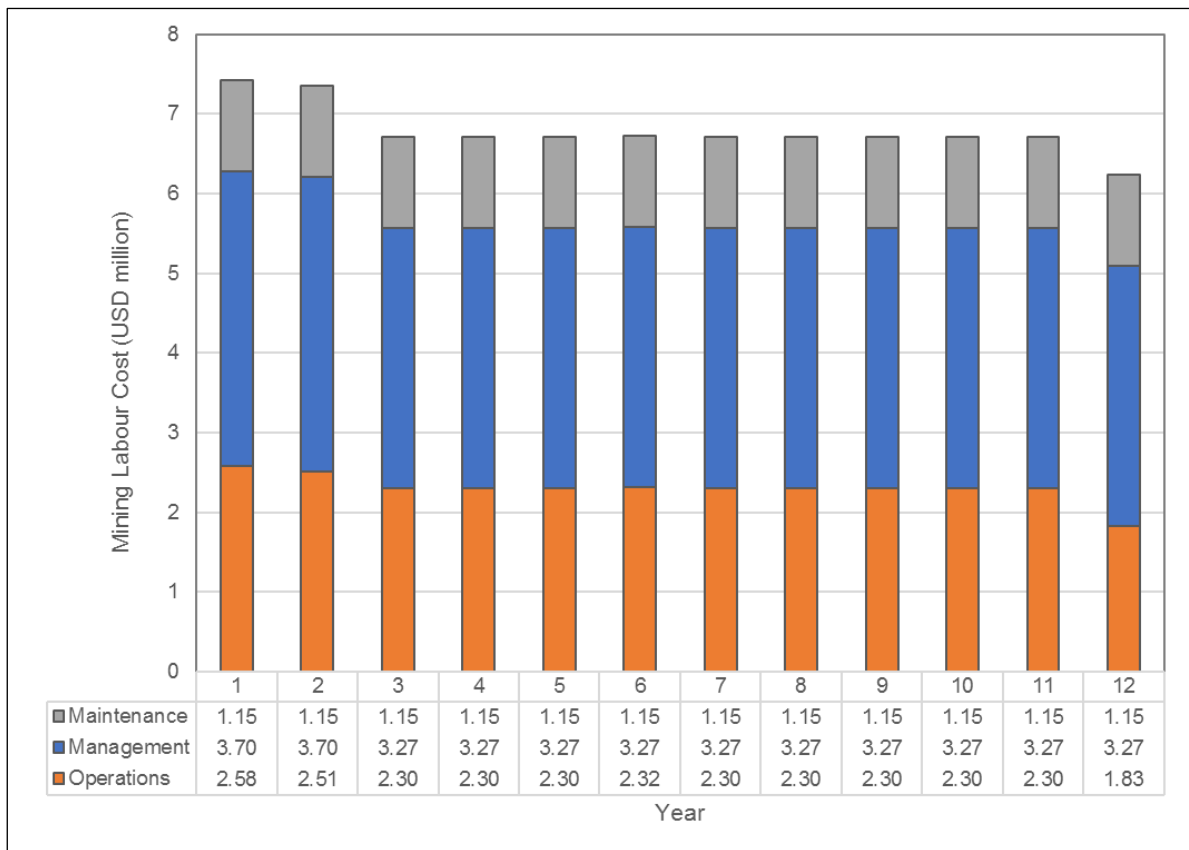

Figure 21-2: Mining Labour Costs by Category and Activity

The labour costs exclude any cost for administration, camp and security. These costs are accounted for under the G&A costs for the project. The average steady state (Year 2 -12) labour complement for management, operations and maintenance is 34, 126 and 43 respectively.

Table 21-17: Mining Labour Complement – Management

Description	Year 1	Year 2	Year 3	Year 4	Year 5	Year 6	Year 7	Year 8	Year 9	Year 10	Year 11	Year 12
1. MANAGEMENT												
Mine Manager	1	1	1	1	1	1	1	1	1	1	1	1
Underground Superintendent (expatriate)	2	2	2	2	2	2	2	2	2	2	2	2
Mine Captain (expatriate)	2	2	2	2	2	2	2	2	2	2	2	2
Mechanical General Foreman (expatriate)	2	2	2	2	2	2	2	2	2	2	2	2
Shift Boss (expatriate)	4	4	4	4	4	4	4	4	4	4	4	4
Operations Trainer (Expat)	2	2	2	2	2	2	2	2	2	2	2	2
Clerk	1	1	1	1	1	1	1	1	1	1	1	1
Maintenance Superintendent	1	1	1	1	1	1	1	1	1	1	1	1
Maintenance Foreman	3	3	3	3	3	3	3	3	3	3	3	3
Mechanical Engineer	1	1	1	1	1	1	1	1	1	1	1	1
Electrical Engineer	1	1	1	1	1	1	1	1	1	1	1	1
Chief Mining Engineer	1	1	1	1	1	1	1	1	1	1	1	1
Mining Engineer Production	2	2	2	2	2	2	2	2	2	2	2	2
Mining Engineer Development	3	3	3	3	3	3	3	3	3	3	3	3
Mining Engineer Ventilation	1	1	1	1	1	1	1	1	1	1	1	1
Mine Technician Survey	3	3	3	3	3	3	3	3	3	3	3	3
Senior Geologist	1	1	1	1	1	1	1	1	1	1	1	1
Mine Geologist	3	3	3	3	3	3	3	3	3	3	3	3
Surveyor Expat	4	4	0	0	0	0	0	0	0	0	0	0

Table 21-18: Mining Labour Complement – Operations

Description	Year 1	Year 2	Year 3	Year 4	Year 5	Year 6	Year 7	Year 8	Year 9	Year 10	Year 11	Year 12
2. OPERATIONS												
In The Hole (ITH) drilling operator (local)	15	20	20	20	24	24	24	24	24	24	24	14
In The Hole (ITH) drilling operator (expatriate)	2	0	0	0	0	0	0	0	0	0	0	0
Blasting miner (local)	2	3	3	3	3	3	3	3	3	3	3	3
Blasting miner (expatriate)	1	0	0	0	0	0	0	0	0	0	0	0
LHD Operator (local)	10	24	24	24	24	24	24	24	24	24	24	17
Truck operator (local)	7	24	24	24	24	25	24	24	24	24	24	17
Loader Operator (local)	0	3	3	3	3	3	3	3	3	3	3	3
Ground Support miner (local)	1	3	3	3	3	3	3	3	3	3	3	3
Ground Support miner (Expatriate)	2	0	0	0	0	0	0	0	0	0	0	0
Cable Bolter Operator (Local)	0	1	3	3	3	3	3	3	3	3	3	3
Cable Bolter (expatriate)	3	2	0	0	0	0	0	0	0	0	0	0
Jumbo Operator (local)	5	7	7	7	3	3	3	3	3	3	3	3
Jumbo Operator (expatriate)	2	0	0	0	0	0	0	0	0	0	0	0
Shotcrete Operator (local)	0	3	3	3	3	3	3	3	3	3	3	3
UG Labourer (local)	12	12	12	12	12	12	12	12	12	12	12	12
Services												
Pump Operators (local)	3	3	3	3	3	3	3	3	3	3	3	3
Machine doctor drill (local)	1	1	1	1	1	1	1	1	1	1	1	1
Bit Sharpening & Tool Deck mechanic (local)	1	1	1	1	1	1	1	1	1	1	1	1
Grader operator (local)	4	4	4	4	4	4	4	4	4	4	4	4
U/G Labor (local)	4	4	4	4	4	4	4	4	4	4	4	4
U/G Backfill Operator (local)	8	8	8	8	8	8	8	8	8	8	8	8
Maintenance (surface) (local)	3	3	3	3	3	3	3	3	3	3	3	3

Table 21-19: Mining Labour Complement – Maintenance

Description	Year 1	Year 2	Year 3	Year 4	Year 5	Year 6	Year 7	Year 8	Year 9	Year 10	Year 11	Year 12
3. MAINTENANCE												
Maintenance Superintendent	1	1	1	1	1	1	1	1	1	1	1	1
Maintenance Foreman	5	5	5	5	5	5	5	5	5	5	5	5
Mechanic	12	12	12	12	12	12	12	12	12	12	12	12
Mechanic's helper	4	4	4	4	4	4	4	4	4	4	4	4
Welder	4	4	4	4	4	4	4	4	4	4	4	4
Electrician	8	8	8	8	8	8	8	8	8	8	8	8
Instrumentation	1	1	1	1	1	1	1	1	1	1	1	1
Tradesmen (surface and u/g) (local)	4	4	4	4	4	4	4	4	4	4	4	4
Clerk/Warehouse	4	4	4	4	4	4	4	4	4	4	4	4

The following tables show the development and stope production labour cost distribution for the mining operation at production.

Table 21-20: Draw Point Development – Mining Labour Cost

Description	Quantity (Linear Metre)	Rate (US\$)	Total Amount (US\$)
Direct Labour	36,130	173.66	6,274,400
Indirect and Maintenance Labour	36,130	437.00	15,788,700

Table 21-21: Stope Production – Mining Labour Cost

Description	Quantity (Ore Tonne)	Rate (US\$)	Total Amount (US\$)
Direct Labour	13,870,000	1.15	15,891,400
Indirect and Maintenance Labour	13,870,000	2.98	41,280,400

– Note that there are 13,870,002 tonnes of ore mined during production and this number excludes the 56,474 tonnes mined during the pre-production phase. The combined total is 13 926 476 tonnes.

21.2.2.2 OPERATING EQUIPMENT

The mining costs make allowance for all operating equipment required for draw points and stope production. Equipment allowance includes both direct and indirect costs. A summary of the LOM equipment operating costs is provided in **Figure 21-3**.

The direct operating equipment cost for draw points includes scissor lift, jumbo drill, mobile ANFO loader, load-haul-dump (LHD) truck (10 yrd³), 40 t mine truck, shotcrete sprayer and roof bolter. Indirect costs include operating allowances for fuel, electrical, parts, filters/lube and tire replacement.

Direct costs for stope production equipment, include costs for similar equipment and are inclusive of an ITH drill. Allowance is also made for LHDs and 40 t mine dump trucks for backfill placement. Indirect costs include operating allowances for fuel, electrical, equipment parts, filters/lube and tyre replacement.

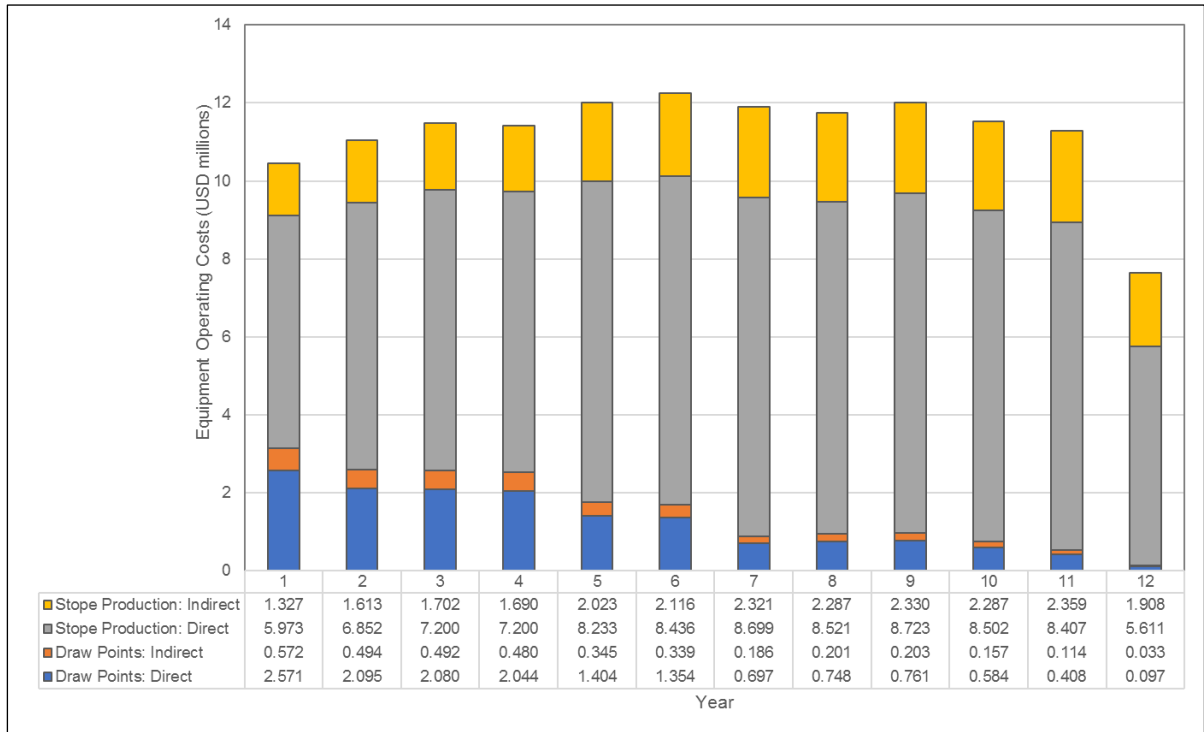

Figure 21-3: Mining Equipment Costs (Direct and Indirect Costs)

The direct and indirect equipment operating cost is provided in **Table 21-22**. The operating cost for the production equipment is built from: fuel consumption, power consumption, repair parts, filters and lubes and tire. **Table 21-23** shows the breakdown of those costs.

Table 21-22: Mining Equipment Cost Distribution

Description	Unit	Quantity	Rate (US\$)	Total Amount (US\$)
Draw Point Lateral Development				
Direct Equipment Operating	Metre	36,130	410.79	14,842,011
Indirect Equipment Operating	Metre	36,130	100.13	3,617,576
Subtotal				18,459,587
Production Stope				
Direct Equipment Operating	Tonne	13,870,000	6.66	92,355,336
Indirect Equipment Operating	Tonne	13,870,000	1.73	23,963,072
Subtotal				116,318,408
TOTAL				134,777,995

Table 21-23: Mining Equipment Cost – Component

Description	Unit	Quantity	Rate (US\$)	Total Amount (US\$)
Fuel	liter	51,047,103	0.48	24,629,998
Power Consumption	KW/h	23,390,985	0.11	2,573,008
Parts	Eq. Hours			86,217,151
Filter/lubes	Eq. Hours			5,168,641
Tire	Eq. Hours			16,189,197
TOTAL				134,777,995

21.2.2.3 MINING MATERIALS

Mining materials required for both draw points and stope production, include general items such as explosive production holes, lifters, caps, ground support meters, shotcrete and cable bolts. LOM material costs for both draw-points and stope production are shown in **Figure 21-4**.

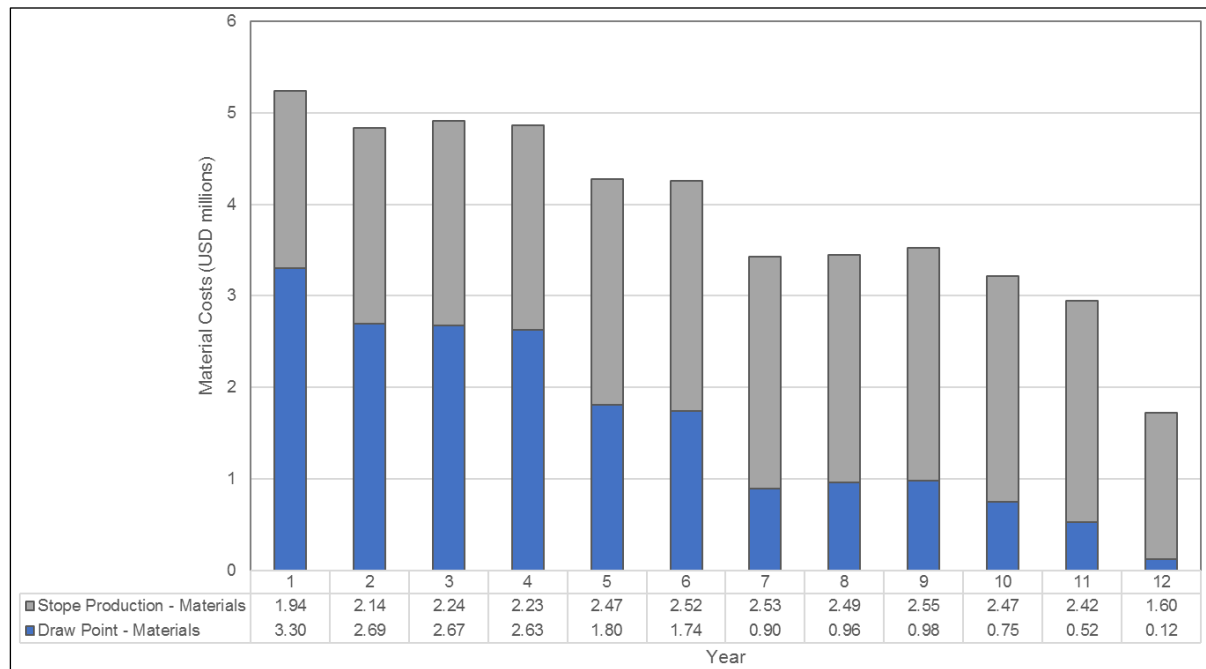

Figure 21-4: Mining Material Costs

The permanent material and the consumables have been calculated based on the volumes of rock excavated, the ground condition, the services required to support the operation and the manhours needed to complete the work. The permanent material and the consumables for the mining operation are listed in **Table 21-24** and **Table 21-25**.

Table 21-24: Draw Point Development – Mining Material Cost

Description	Unit	Quantity	Rate (US\$)	Amount (US\$)
Explosives & Accessories	kg charged	2,236,064	3.35	7,480,108
Ground Support	metre	36,130	229.56	8,293,842
Consumables	metre	36,130	91.45	3,303,942
TOTAL		36,130	528.03	19,077,892

Table 21-25: Stope Production – Mining Material Cost

Description	Unit	Quantity	Rate (US\$)	Amount (US\$)
Explosive & accessories	kg charged	8,241,103	1.41	11,647,634
Ground Support	Tonne	12,909,120	0.05	658,634
Consumables	Tonne	12,909,120	1.18	15,281,678
TOTAL		12,909,120	2.14	27,587,947

21.2.2.4 MINING SUPPORT EQUIPMENT MAINTENANCE

Allowance for mining support equipment maintenance is provided as well as support equipment power costs. The maintenance estimates vary over LOM, with an average steady state annual allowance of US\$2.58 million. Power costs average US\$1.78 million per annum during steady state, with an increase to US\$4.8 million in year nine due to an increase demand on ventilation.

The mining support equipment maintenance includes maintenance on the following equipment:

- Fans (Main and Auxiliary);
- Pumps;
- Others.

LOM material costs for both support equipment maintenance as well as support equipment power costs are shown in **Figure 21-5**.

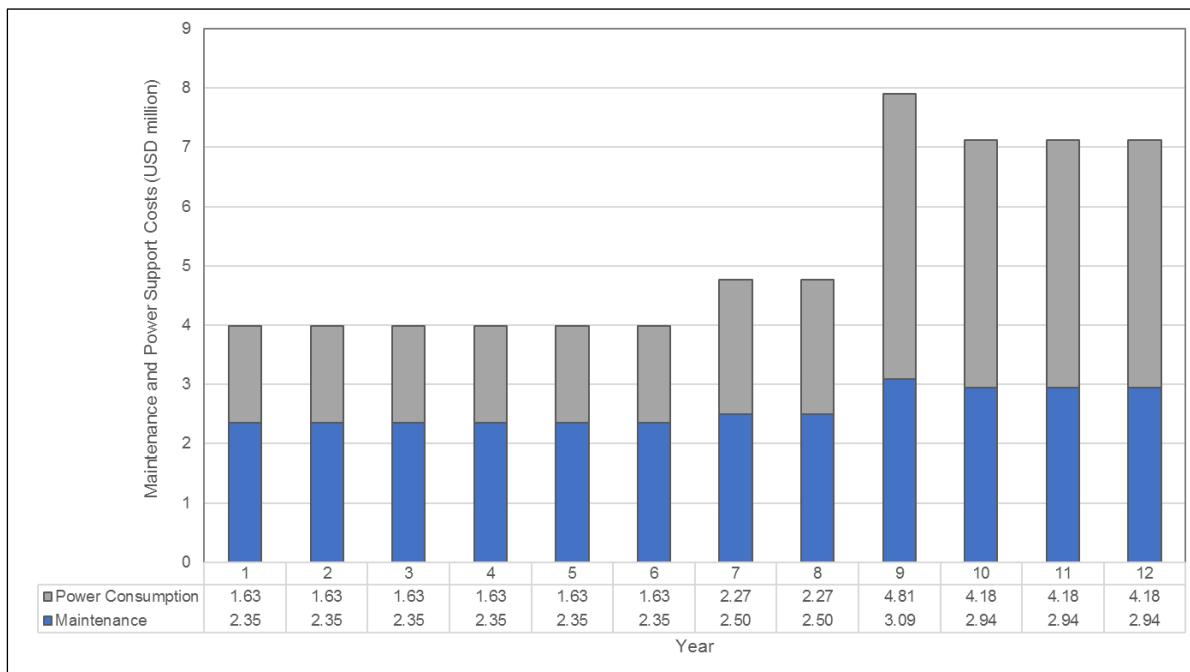

Figure 21-5: Mining Support Equipment Maintenance and Power Costs

21.2.2.5 MINING COST SUMMARY

An overall summary of the mine operating costs (excluding the pre-production period) is provided in **Table 21-26**.

Table 21-26: Mining Operating Cost Summary

Description	LOM Total	LOM Annual Average	Unit Cost
	US\$	US\$	US\$/t
DRAW POINTS	59,600,578	4,966,715	4.28
Direct Labour	6,274,380	522,865	0.45
Indirect and Maintenance Labour	15,788,719	1,315,727	1.13
Direct Equipment Operating	14,842,011	1,236,834	1.07
Indirect Equipment Operating	3,617,576	301,465	0.26
Material	19,077,892	1,589,824	1.37
STOPE PRODUCTION	201,078,180	16,756,515	14.44
Direct Labour	15,891,412	1,324,284	1.14
Indirect and Maintenance Labour	41,280,414	3,440,034	2.96
Direct Equipment Operating	92,355,336	7,696,278	6.63
Indirect Equipment Operating	23,963,072	1,996,923	1.72
Material	27,587,947	2 298 996	1.98
SUPPORT PLANT MAINTENANCE	31,014,289	2,584,524	2.23
Electrical permanent equipment	31,014,289	2,584,524	2.23
POWER CONSUMPTION	31,696,210	2,641,351	2.28
Electrical permanent equipment	31,696,210	2,641,351	2.28
TOTAL	323,389,258	26,949,105	23.22

21.2.3 PROCESS OPERATING COSTS

21.2.3.1 LABOUR COSTS

Process plant labour costs reflect the labour complement as provided in **Table 21-27**. The labour rates used for the study have been supplied directly from INV. The structure and number of team members have been collectively determined by DRA and INV.

The processing plant labour costs exclude any cost for administration and security. These costs are accounted for under the G&A costs for the project. Laboratory labour costs are included in the overall plant labour.

Operating personnel complements are based on four rotational shift teams. Allowances have been made for leave and absenteeism within the process and engineering teams. The total staff complement of 83 people has been allowed for to cover the plant management, operations and engineering maintenance functions.

Table 21-27 provides a summary of the overall labour costs for the process plant, for the initial year one to two period (additional expatriate process trainer and metallurgical support), and subsequent costs for the remainder of LOM, year three onwards.

Table 21-27: Process Plant Labour Complement and Cost

Description	Number Y1 and Y2	Number Y3 to LOM	Annual Salary (incl benefits) US\$	Total Cost Y1 and Y2 US\$ / annum	Total Cost Y3 to LOM US\$ / annum
Salaried					
Process Superintendent (Expat)	1	1	257,967	257,967	257,967
Maintenance Manager (Expat)	1	1	116,419	116,419	116,419
Process Superintendent	1	1	116,419	116,419	116,419
Process Trainer (Expat)	4	0	216,310	865,240	0
Senior Metallurgist (Expat)	1	0	280,717	280,717	0
Metallurgist/Refiner	2	3	96,140	192,280	288,420
Plant Shift Foremen	4	4	37,485	149,940	149,940
Maintenance Foreman	1	1	18,513	18,513	18,513
Supervisor - Py Facility Guayaquil	1	1	37,485	37,485	37,485
Secretary/Clerk	1	1	12,317	12,317	12,317
Total Salaried	17	13		2,047,296	997,480
Hourly					
Operators					
Crusher Operator	4	4	10,164	40,658	40,658
Grinding Operator	4	4	10,164	40,658	40,658
Control Room Operators	4	4	10,164	40,658	40,658
Flotation	4	4	10,164	40,658	40,658
Dewatering	4	4	10,164	40,658	40,658
Tailings Storage Facility Operators	4	4	10,164	40,658	40,658
Water Treatment Operator	2	2	8,580	17,160	17,160
Concentrate Loadout Operators	4	4	10,164	40,658	40,658
Concentrate Loadout Operators - Guayaquil	3	3	10,164	30,493	30,493
Helpers/Shift Relief	4	4	8,580	34,320	34,320
Day Crew (Helpers, Labour)	4	4	8,580	34,320	34,320
Subtotal Operators	41	41		400,897	400,897
Technicians					
Metallurgical Technician	2	2	77,160	154,320	154,320
Subtotal Technicians	2	2		154,320	154,320
Laboratory					
Sample Preparation Technician	2	2	77,160	154,320	154,320
Lab Technician	2	2	77,160	154,320	154,320
Assayer	2	2	77,160	154,320	154,320
Lab Supervisor	1	1	92,592	92,592	92,592
Subtotal Laboratory	7	7		555,552	555,552
Maintenance					
Mechanic	8	8	14,316	114,528	114,528
Helper	8	8	11,364	90,909	90,909
Electrician	2	2	12,440	24,880	24,880
Instrumentation Technician	2	2	14,515	29,031	29,031
Subtotal Maintenance	20	20		259,348	259,348
Total Hourly	70	70		1,370,116	1,370,116
Total Salaried and Hourly	87	83		3,417,413	2,367,596

21.2.3.2 PROCESS PLANT POWER COSTS

The electrical load requirements for the process plant were prepared in the overall process plant load list. The total absorbed electrical power estimate for the process plant, during steady state operation, is estimated at 9.2 MW. The estimated average running load has been calculated using expected power draw as determined for individual items, and after applying utilization and electrical correction factors.

Based on the operating schedules for the various areas, this equates to approximately 94 GWh/year.

The electrical tariff supply cost for the project is US\$0.11/kWh and has been determined after consultation with local authorities. The supply tariff is a time weighted average annual rate and includes all administrative and other costs.

The power costs for process and raw water supply pumps, camp or office buildings and change house have not been included in the plant power cost.

Table 21-28: Process Plant Electrical Consumption and Cost

Description	Quantity	Units
Installed Grinding Power	22.4	kWh/t
Plant Load (full Production, excluding Mill)	5,682	kW
Total Power Consumption	80,172,349	kWh/annum
Power Cost	0.11	US\$/kWh
LOM Average Annual Power Costs	8,818,958	US\$

21.2.3.3 PROCESS PLANT REAGENTS

Numerous reagents are consumed in the plant, all of which are detailed in Process Design Criteria (PDC). The consumption rates for the various reagents are based primarily on results obtained from laboratory scale test work. In the absence of metallurgical test work, reagent consumption estimates are based upon either vendor recommendations or determined from first principles, as detailed in the PDC.

The supply prices for all the reagents are based on quotations obtained from reputable suppliers. The costs include a quoted overland transportation allowance of US\$0.15/tonne/km from Guayaquil to site and include all clearance charges and taxes that may be incurred.

Table 21-29: Process Plant Reagents and Cost

Description	Supply Cost US\$/kg	Freight Allowance US\$/kg	Unit Consumption g/t	Annual Consumption kg	Annual Cost US\$	Unit Cost US\$/t milled
Hydrated Lime (Plant)	0.17	0.035	2,200	2,600,849	534,865	0.45
Hydrated Lime (WTP)	0.17	0.035		328,500	67,556	0.06
Flocculant	3.19	Incl.	35.0	41,377	131,993	0.11
Collector (3418-A)	12.50	0.250	25.0	29,555	376,828	0.32
Collector (PAX)	2.39	2.00	120	141,864	622,821	0.53
Depressant (MIBC)	2.43	Incl.	160	189,153	459,641	0.39
Total - Reagents					2,193,703	1.86

Grinding media consumption is based on results obtained from test work, namely abrasion indices, and established models. Consumption rates have been verified by vendors. Supply prices for grinding media, are based on quotations obtained from reputable suppliers.

Table 21-30: Process Plant Grinding Media and Cost

Description	Unit Cost US\$/kg	Freight Allowance US\$/kg	Unit Consumption kg/t	Annual Consumption tonnes	Annual Cost US\$	Unit Cost US\$/t milled
Primary Ball Mill	1.10	0.035	2.80	3,310.2	3,743,307	3.17
Copper Regrind Mill	3.10	Incl.	0.185	11.1	34,496	0.03
Pyrite Regrind Mill	3.10	Incl.	0.130	27.2	84,194	0.07
Total - Grinding Media				3,348.5	3,861,998	3.27

All reagents and consumables that are consumed in the laboratory, as well as all minor reagents, have not been included as the contribution and are regarded as insignificant.

Figure 21-6 provides a summary of the cost contribution for all reagents and grinding media. The chart clearly illustrates that primary ball mill grinding media is the highest cost contributor, followed by PAX and MIBC usage.

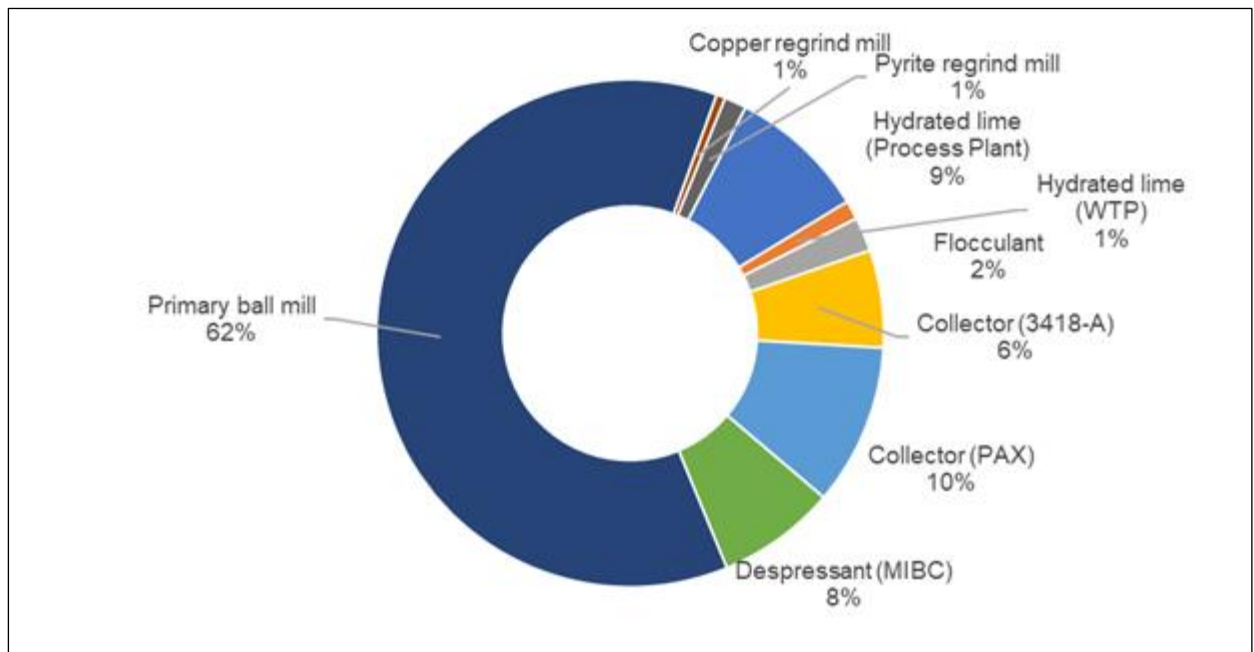

Figure 21-6: Reagent and Grinding Media Cost Contribution

21.2.3.4 ENGINEERING MAINTENANCE

The annual engineering and plant maintenance costs are described in several categories, including crusher maintenance, mill relining, conveyor and screen maintenance, mechanical maintenance, platework, piping replacements, electrical and instrumentation and general engineering costs.

The maintenance cost estimate for the front-end section of the plant is based on the abrasion indices obtained from test work. Wear rates for liner replacement frequencies were estimated based on vendor supplied data. Quoted prices for liner sets have been obtained from the respective crusher OEM.

The mill liner life for the mills was calculated using the abrasion index test results, mill dimensions and anticipated grinding media load. The monthly mill liner consumption rate is based on an annual liner change frequency.

Unit costs (for full sets) were provided by various mill suppliers in their tenders submitted for the project. **Table 21-31** outlines the anticipated annual liner costs for all mills and crushers.

Table 21-31: Crusher and Mill Liner Costs

Description	Annual Cost US\$	Unit Cost US\$/t milled
Primary jaw crusher	94,021	0.08
Secondary cone crusher	186,849	0.16
Primary ball mill	989,617	0.84
Copper regrind mill	72,268	0.06
Pyrite regrind mill	127,122	0.11
Total - Liners	1,468,876	1.24

Unit costs for (full sets of) filter clothes for each pressure filter application were also obtained from the respective bids submitted for the project. A total LOM average unit cost of \$0.03/tonne was determined.

The general maintenance cost has been calculated based on estimates derived from the mechanical, platework and piping capital estimates for the project. The cost estimate is based on a mechanical replacement estimate of 5% per annum (20-year effective life) for all mechanical, piping and platework items. A breakdown of the total maintenance estimate is shown in the **Table 21-32**.

Table 21-32: Process Plant Maintenance Costs

Description	Annual Cost US\$	Unit Cost US\$/t milled
Crushing	160,977	0.13
Milling	309,824	0.26
Copper Flotation	138,902	0.12
Pyrite Flotation	146,812	0.12
Tailings Thickener	120,580	0.10
Concentrate Handling	82,984	0.07
Utility Services	15,924	0.01
Reagents	46,079	0.04
Total - Maintenance	1,022,082	0.86

21.2.3.5 MISCELLANEOUS COSTS

Provision for a fully equipped assay and metallurgical laboratory has been made. Labour costs for laboratory operation are covered under the process plant labour costs, whilst an additional allowance of US\$150,000 per annum is provided for consumables. An allowance for external assaying is provided under miscellaneous costs.

Minor operating costs (US\$200,000 per annum) for the continued maintenance and operation of the water treatment plant and sewage treatment plant have been provided under miscellaneous costs.

21.2.3.6 PROCESS PLANT SUMMARY

An overall summary of the process plant operating costs is provided below in **Table 21-33**.

Table 21-33: Overall Process Plant Operating Cost

Description	LOM Total US\$ m	LOM Annual Average US\$ m	Unit Cost US\$/t
Labour Cost	30.51	2.50	2.19
Power	103.89	8.82	7.46
Reagents	25.91	2.20	1.86
Grinding Media	45.50	3.86	3.27
Liner and Other Consumable Costs	17.69	1.50	1.27
Maintenance	11.92	1.02	0.86
Miscellaneous Costs	4.20	0.35	0.29
Total	239.60	20.25	17.20

21.2.4 BACKFILL AND TAILINGS MANAGEMENT

The annual operating cost estimate for the backfill plant has been estimated by P&C. The estimate makes allowance for electrical power, consumables (binder and flocculant) and backfill plant maintenance cost and a general allowance for minor cost items. The total absorbed power for the backfill plant is estimated at 3.29 MW.

The cost of labour for the backfill plant is based on 13 team members, inclusive of operational and maintenance staff. **Table 21-34** provides a summary of the costs for the backfill plant.

Table 21-34: Backfill Plant Operating Costs

Description	LOM Annual Average US\$	Unit Cost US\$/t
Backfill Labour	160,878	0.15
Backfill Power	290,548	0.27
Binder	2,374,264	2.17
Maintenance Spares	511,000	0.47
Other	100,000	0.09
Total - Backfill	3,436,690	3.14

– Placement costs for backfill are included under the mining operating costs, reported under the direct stope production costs.

The annual operating cost estimate for tailings disposal has been provided by DRA, NewFields and P&C. The estimates include all equipment and personnel costs for tailings placement. The equipment includes a loader, haul truck, and support equipment. Personnel costs cover operators, labourers and maintenance.

Table 21-35: Tailings Disposal Costs

Description	LOM Annual Average US\$	Unit Cost US\$/t
Labour	144,091	0.12
Tailings to Backfill	282,622	1.89
Tailings to FTSF	2,195,767	0.24
Total - Tailings Disposal	2,622,480	2.26

Tailings dam inspection and management costs are included under the G&A costs.

21.2.5 GENERAL AND ADMINISTRATION COSTS (G&A)

Project-wide G&A costs include the following categories and allowances:

- Corporate and overhead labour;
- Corporate costs;
- Site costs; and
- Mine support costs.

The overall G&A annual costs are summarized in **Table 21-36**.

Table 21-36: Overall G&A Costs

Description	Annual Cost US\$
Labour Costs	4,516,655
Corporate Costs	562,908
Site Costs	3,196,400
Support Costs	470,000
Total - G&A	8,745,963

21.2.5.1 CORPORATE AND OVERHEAD LABOUR

Project-wide G&A labour costs cover all management, support and overhead labour for the mine. Corporate and in country personnel costs are included in the G&A allowance. No allowance is made for corporate staff members in Toronto or Quito.

The G&A labour complement and annual salary costs are summarized in **Table 21-37**.

Table 21-37: G&A Labour Complement and Cost

Description	Number	Annual Salary (incl. benefits) US\$
Cuenca		
Social Responsibility Manager	1	47,250
Secretarial, Support and Communications	3	48,507
San Gerardo, Chumblin or Girón		
Social Coordinators	4	23,757
Site Office		
Management	3	585,503
Financial and Accounts	3	156,393
Human Resources	4	84,612
Engineering and Technical Services	8	638,688
Clinic, Safety and Environment	16	350,947
Training	3	148,500
Information Technology	1	49,500
Stores	10	259,878
Security	9	226,370
Cleaning and Catering	47	787,500
Surface Infrastructure Operators	61	1,109,250
Total Salaried	173	4,516,655

21.2.5.2 CORPORATE COSTS

Corporate cost allowances include costs associated with insurances, legal services, accounting services and systems, property leases, corporate overhead costs, leases and local taxes.

A summary of the corporate allowances is provided in **Table 21-38**.

Table 21-38: G&A Costs – Corporate

Description	Annual Cost US\$
Insurances	10,000
Legal Services	120,000
Accounting Services	30,000
Property Leases	37,908
Land Lease - Parking and Bagging Loadout Facilities	120,000
Corporate Overheads (others)	45,000
Leases	150,000
Local taxes	50,000
Sub-Total - G&A: Corporate	562,908

21.2.5.3 SITE OFFICE COSTS

Site office costs provide allowance for the following items:

- Transport;
- Fire protection;
- Site security;
- Information technology, software and communications;
- Health, safety and environment;
- Training and human resources; and
- Miscellaneous office costs.

A summary of the site office costs is provided in *Table 21-39*.

Table 21-39: G&A Costs – Site Office Costs

Description	Annual Cost US\$
Employee Transport: Bus Services	200,000
Fire Protection Services	50,000
Security: Concentrate Shipping	12,000
Waste Management and Disposal	20,000
Software Fees	50,000
Computer & Office Supplies	50,000
IT and Communications	60,000
Clinic Costs, Medical and First Aid	30,000
Safety Equipment (PPE)	20,000
Employee Relations, Community Relations	400,000
Recruitment and Training Costs	50,000
Site Security Costs	14,400
Environmental Monitoring/Reporting	500,000
Access and internal road maintenance	100,000
Surface Mobile Equipment	1,300,000
Catering Costs	240,000
Miscellaneous: Supplies	100,000
Sub-Total - G&A: Site Costs	3,196,400

21.2.5.4 G&A SUPPORT COSTS

Mine support costs include all costs associated with employee travel, maintenance of light vehicles and external assaying allowances. A summary of these allowances is provided in *Table 21-40*.

Table 21-40: G&A Costs – Mine Support Costs

Description	Annual Cost US\$
International Travel	60,000
Local Travel	60,000
Travel Costs - Miscellaneous	50,000
Laboratory Costs: External Assays	200,000
Light vehicle maintenance	100,000
Sub-Total - G&A: Support Costs	470,000

22 ECONOMIC ANALYSIS

The project has been evaluated using a discounted cash flow analysis (DCF). Cash inflows were estimated based on annual revenue projections. Cash outflows consist of operating costs, capital expenditures, royalties and taxes. In addition, the economic assessment assumed the project was financed entirely through equity.

Cash flows were assumed to occur at the mid-point of each year.

The Net Present Value (NPV) of the project was calculated by discounting back cash flow projections throughout the LOM to the Project valuation date using three different discount rates, 5%, 7.5% and 10%. The base case used a discount rate of 5%. The internal rate of return (IRR) and the payback period were also calculated.

Table 22-1 summarizes the economic/financial results of the Project for the base case. All figures are in US\$ currency.

Table 22-1: Base Case Financial Results

Financial Results	Unit	Pre-tax	After-tax
NPV @ 5%	Million US\$	621	356
IRR	%	35.1	24.7
Payback Period	Year	2.2	2.6

22.1 ECONOMIC CRITERIA

The Project's cash inflows were estimated based on annual revenue projections. Cash outflows consisted of operating costs, capital expenditures, royalties and taxes.

22.1.1 REVENUE

Revenue was estimated based on the production of two concentrates, a gold pyrite and a gold copper concentrate. Annual production of each of these concentrates as well as their metal content was calculated based on the mine plan and process production plan described in Sections 16 and 13, respectively. **Table 22-2** below summarizes the LOM and annual averages production rates used.

Table 22-2: Production Rates

Item	Unit	Gold Pyrite Concentrate	Gold Copper Concentrate
Total tonnes concentrate produced	Tonnes	1,845,778	109,497
Average LOM concentrate produced ¹	Tonnes	161,276	9,585
Gold grade	g/t	27.9	92.6
Silver grade	g/t	102.2	1,858.6
Copper grade	%	0.31	29.7

¹ Annual LOM averages are calculated based on full production years from Year 2 to 11

The following metal prices provided by INV were used to estimate revenue.

Table 22-3: Metal Prices

Item	Unit	Value (Base Case)
Copper price	US\$/lb	3
Gold price	US\$/troy ounce	1,250
Silver price	US\$/troy ounce	18

22.1.1.1 CONCENTRATE TRANSPORTATION COSTS

The transport costs for concentrate included packaging, transportation by road from site to port and shipping costs from Ecuador to China.

Gold pyrite concentrate will be transported in bulk from site to a facility near the port in Guayaquil. It will then be bagged into one tonne super sacks and loaded into 20 feet containers for shipping to China.

Gold copper concentrate will be bagged on-site into one tonne super sacks and loaded into 20 feet containers to be transported by road to the port of Guayaquil. From there, it will be loaded into boats for shipping to China.

The total transport costs for each concentrate are summarized in **Table 22-4** below.

Table 22-4: Concentrate Transport

Item	Unit	Gold Pyrite Concentrate	Gold Copper Concentrate
Total transport costs	US\$	177,782,605	13,956,135
Average LOM transport costs	US\$	15,531,345	1,221,033

– ¹Annual LOM averages are calculated based on full production years from Year 2 to 11

22.1.2 PRODUCTION COSTS

The operating costs included were: mining, process, paste backfill, tailings management and general and administrative costs. The table below summarizes these costs and is compiled from information detailed in **Section 21**.

Table 22-5: LOM Operating Costs

Item	US\$/tonne milled	Total (M US\$)
Mining	23.22	323
Processing	17.20	240
Paste backfill	3.14	44
Tailings management	2.26	31
General & administration	7.54	105
Total operating costs	53.36	743

22.1.3 CAPITAL INVESTMENT

Capital expenditures for Loma Larga are detailed in **Section 21**. These include initial pre-production capital, sustaining capital and closure costs.

Table 22-6: LOM Capital Expenditure

Item	Initial Pre-production Capital (\$M)	Sustaining Capital (\$M)	Closure costs (\$M)
Total Directs + Indirects	279.1	62.3	22.0
Non-refundable taxes	5.9	3.1	-
VAT	24.5	7.3	-
Total	309.5	72.7	22.0

22.1.4 WORKING CAPITAL

Working capital cash outflows and inflows were also included in the financial model. These were calculated based on the assumptions that accounts receivables will be received within 30 days and accounts payable will be paid within 45 days.

22.1.5 MINERAL ROYALTIES

22.1.5.1 GOVERNMENT ROYALTIES

INV will be subject to a royalty of 5% on the net sales revenue of precious metals and related by-products sales and is payable to the Government of Ecuador. INV has agreed to pay US\$15 M of the royalty in advance (Advanced Royalty).

Payments of the Advanced Royalty will be subject to the following schedule and milestones:

- US\$5 M on the execution of the Exploitation Contract;
- US\$5 M on the first anniversary of the execution of the Exploitation Contract; and
- US\$5 M on the second anniversary of the execution of the Exploitation Contract.

The Advanced Royalty is deductible against future royalties payable in the amount that is lesser of:



- 50% of the royalties payable in a six-month period, or
- 20% of the total Advanced Royalty paid annually.

Based on the mine plan the second method will apply and the Advanced Royalty will be recovered over five years.

22.1.5.2 COGEMA AGREEMENT

The Loma Larga project is subject to a Net Profit Interest (NPI) payment payable to AREVA (formerly COGEMA), under an agreement signed on March 5, 1999 between IAMGOLD and AREVA. As per this agreement, INV will make a payment of two US Dollars (US\$2.00) per ounce of gold contained in proven and probable reserves plus the indicated and measured resources defined in the Feasibility Study. This payment will be made in three equal annual installments commencing on the date that a formal production decision is made.

Following commencement of production, AREVA will be entitled to a 5% NPI in any mining operation undertaken. The NPI is defined as the excess of gross cash income after all the capital investment and preproduction expenditures including working capital, interest, taxes (with the exception of income taxes), royalties and depreciation, have been recovered from the sale of minerals.

	Document Number	J01834-PM-REP-002	Rev	0	
	Date	11 January 2019	Page	365 of 417	

22.1.6 TAXATION REGIME

Corporate tax liabilities were calculated under the Ecuadorian tax regime based on public information and information provided by INV. The following taxes are applicable:

- Income tax;
- Profit sharing with state and workers;
- Sovereign adjustment;
- Value-added tax; and
- Import duties.

22.1.6.1 INCOME TAX

As per the tax update of January 1, 2018, a standard corporate tax rate of 25% was applied on income taxes. Companies domiciled in Ecuador are subject to tax on their worldwide income. The income tax is paid annually in April of the following calendar year. The income tax basis is determined by the total taxable income less allowable deductions according to the tax law. All deductions and rates are based on currently enacted legislation, and are subject to change in the future, or until the Company has an investment protection agreement subscribed with the Ecuadorian Government with tax stability benefits.

22.1.6.2 PROFIT SHARING

A profit sharing tax rate of 15% is applicable to the taxable income of the Loma Larga Project. Based on Loma Larga's scale of mining, the worker's portion will be 3% and the State's portion 12%. This tax is deductible for income tax purposes.

22.1.6.3 SOVEREIGN ADJUSTMENT



Under the "Sovereign Adjustment" tax, the Ecuadorian constitution requires that the government receives at least 50% of benefits from non-renewable resource projects. Sovereign Adjustment is only payable when the present value of cumulative company benefits exceeds the present value of cumulative government benefits.

The benefits will be calculated annually as the net present value of the cumulative free cash flows of Loma Larga since the concession was granted. The benefits to the Government of Ecuador will be calculated as the net present value of the cumulative sum of corporate income tax, royalties, state profit sharing taxes, non-recoverable VAT and previous Sovereign Adjustment payments, if any, over the same period. Based on the base case metal prices used in the financial model presented in this report, the Project will not trigger the Sovereign Adjustment payment.

22.1.6.4 VALUE ADDED TAX (VAT)

VAT is levied at the rates of either 12% or 0% on the transfer of goods, import of goods, and the rendering of services, as well as on services rendered within the country or imported. Royalties and intangible property, imported or locally paid, are also levied with a 12% VAT. VAT was applied to both capital investment and operating costs items.

In Ecuador, exportation of goods and services are levied with 0% VAT, as well as, other goods and services specifically included in the tax law. Mining concessionaires are entitled to the refund of VAT paid since January 1, 2018, once exportation of concentrate commences,

	Document Number	J01834-PM-REP-002	Rev	0	
	Date	11 January 2019	Page	366 of 417	

which will be a maximum of 12% of the value of exports in the period. Any amounts not refunded will be available for carry forward for a period of five years.

22.1.6.5 OTHER TAXES

- Environmental conservation: The concessionaire has to pay an annual fee per mining hectare each March, as follows:
 - During the initial exploration phase, an amount equivalent to 2.5% of a unified basic remuneration (UBR) (the UBR is US\$386 for 2018).
 - During the period of advanced exploration and economic evaluation an amount equivalent to 5% of the UBR.
 - During the operations phase, an amount equivalent to 10% of the UBR.
- Payments for the import of raw materials, supplies and capital goods contained on a list issued by the Tax Policy Committee generally pay duty on importation at a rate of 0% to 5%.
- Fodinfra: This is an additional contribution on the import of goods for the Development Fund for Children. The taxable basis is the cost, insurance and freight (CIF) of the importation, and the rate is 0.5%.

22.1.7 HISTORICAL COSTS

An amount of US\$75 million of historical costs is considered in the financial model. These historical costs provide a shield against taxes and profit-sharing expenses.

22.2 CASH FLOW ANALYSIS AND ECONOMIC RESULTS

Figure 22-1 shows the after-tax cash flow and cumulative cash flow profiles of the Project for base case conditions. The after-tax payback period has been estimated at 2.6 years.

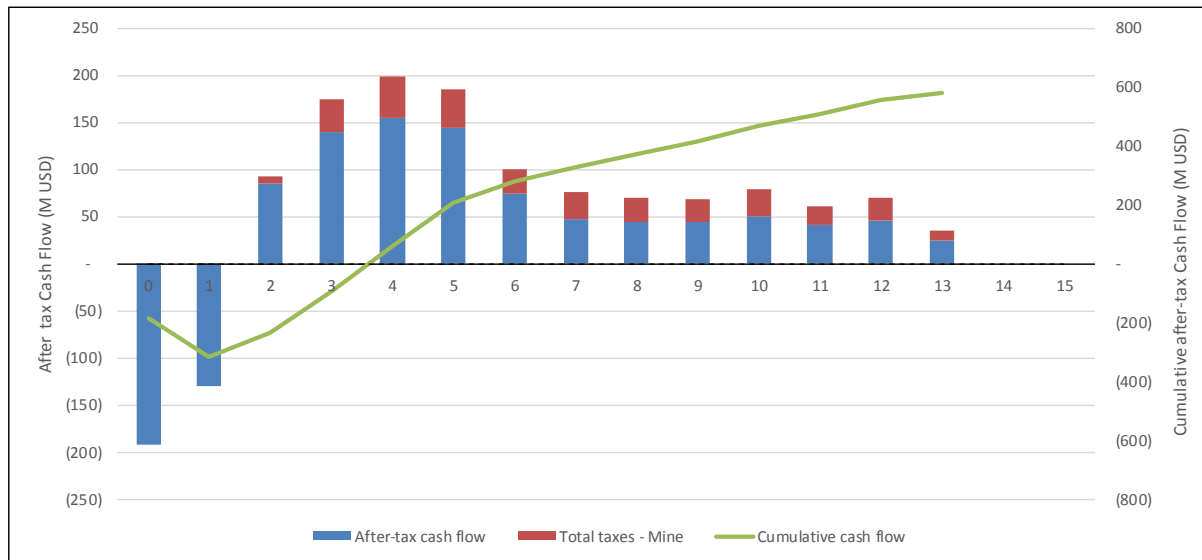

Figure 22-1: After-Tax Cash Flow and Cumulative Cash Flow Profiles

Table 22-7 summarizes the financial results. NPV is calculated at three different discount rates, 5%, 7.5% and 10%. The base case uses a discount rate of 5% and has been highlighted in the table below.

Table 22-7: Loma Larga Project Financial Results

Financial Results	Unit	Pre-tax	After-tax
NPV @ 5%	US\$ M	621	356
NPV @ 7.5%	US\$ M	503	277
NPV @ 10%	US\$ M	408	212
IRR	%	35.1	24.7
Payback period	Year	2.2	2.6

After-tax NPV is US\$356 M at a discount rate of 5%. The after-tax IRR is 24.7% and the after-tax payback on initial investment is 2.6 years.

Table 22-8 shows the annual cash flow projections for the Loma Larga project.

Table 22-8: Cash Flow Statement – Base Case

Item	Year												TOTAL		
	0	1	2	3	4	5	6	7	8	9	10	11		12	13
NPV Summary (in '000 US\$)															
Net sales revenue	-	180,806	272,977	299,083	279,219	182,244	150,237	137,570	137,541	152,410	130,388	143,147	113,309	-	-
Royalties	-	(5,900)	(11,215)	(13,033)	(12,425)	(7,183)	(6,529)	(6,248)	(7,157)	(6,106)	(6,935)	(6,477)	-	-	-
Gross income	-	155,766	261,082	286,080	266,794	180,080	143,709	131,478	131,293	146,683	124,252	136,572	110,832	-	-
Operating costs	-	(51,082)	(61,471)	(66,526)	(63,304)	(63,094)	(63,452)	(62,899)	(62,931)	(66,427)	(64,685)	(64,479)	(57,773)	-	-
BITDA	-	103,684	199,611	225,504	203,490	97,966	80,256	68,579	68,362	79,626	59,567	71,833	53,058	-	-
Other costs	-	14,829	13,106	901	574	490	721	365	288	165	274	147	-	-	-
Sub-total	-	118,513	212,717	226,405	204,065	98,457	80,977	68,944	68,650	79,791	59,842	71,981	53,058	-	-
Mine Pre-production Capital Expenditure	-	-	-	-	-	-	-	-	-	-	-	-	-	-	-
Mine development - Pre-striping	-	-	-	-	-	-	-	-	-	-	-	-	-	-	-
Mine equipment	(8,600)	(11,219)	-	-	-	-	-	-	-	-	-	-	-	-	-
Mine site infrastructure	(7,703)	(24,966)	-	-	-	-	-	-	-	-	-	-	-	-	-
Process plant	(44,634)	(31,363)	-	-	-	-	-	-	-	-	-	-	-	-	-
Tailings & water management	(7,163)	(18,975)	-	-	-	-	-	-	-	-	-	-	-	-	-
Plant infrastructure	(13,861)	(12,840)	-	-	-	-	-	-	-	-	-	-	-	-	-
Off-site infrastructure	(90,845)	(8,617)	-	-	-	-	-	-	-	-	-	-	-	-	-
Indirect costs	(17,588)	(11,773)	-	-	-	-	-	-	-	-	-	-	-	-	-
Royalty buy-out option	-	-	-	-	-	-	-	-	-	-	-	-	-	-	-
Total capital expenditure	(185,384)	(124,086)	-	-	-	-	-	-	-	-	-	-	-	-	-
Debt financing	-	-	-	-	-	-	-	-	-	-	-	-	-	-	-
Equity portion of capital expenditure	(185,384)	(124,086)	-	-	-	-	-	-	-	-	-	-	-	-	-
Residual	-	(6,890)	(8,117)	(2,349)	2,001	9,222	1,545	986	6	(869)	1,686	(1,091)	1,482	2,387	-
Change of Working Capital	-	-	-	-	-	-	-	-	-	-	-	-	-	-	-
Sustaining Capital Expenditure	-	-	-	-	-	-	-	-	-	-	-	-	-	-	-
Mine development - Open pit	-	-	-	-	(2,223)	(1,270)	-	(3,541)	(943)	(515)	-	-	-	-	-
Mine development - Underground	-	-	-	-	(3,520)	(2,010)	(2,645)	(1,121)	(619)	(204)	(1,032)	(74)	-	-	-
Underground equipment & infrastructure	-	-	-	-	-	-	-	-	-	-	-	-	-	-	-
Mine equipment	-	-	-	-	-	-	-	-	-	-	-	-	-	-	-
Tailings & surface water management	-	(983)	(701)	(1,041)	(1,054)	(1,054)	(691)	(1,038)	(1,038)	(1,038)	(1,038)	(1,038)	(1,038)	(976)	-
Non-refundable taxes	-	(835)	(374)	(374)	(238)	(298)	(298)	(151)	(119)	(68)	(114)	(161)	(248)	(3,053)	-
VAT	-	(835)	(2,271)	(816)	(520)	(444)	(653)	(330)	(261)	(149)	(248)	(133)	(248)	(6,661)	-
Contingency	-	(841)	(2,560)	(919)	(586)	(500)	(735)	(372)	(294)	(168)	(280)	(150)	(150)	(7,500)	-
Investment for sustaining capital assets	-	(9,116)	(24,809)	(8,955)	(5,677)	(4,846)	(7,159)	(3,658)	(2,845)	(1,638)	(2,712)	(1,458)	-	-	-
Mine rehabilitation trust fund payments	-	-	-	-	-	-	-	-	-	-	-	-	-	-	-
Mine closure costs	-	-	-	-	-	-	-	-	-	-	-	-	-	-	-
Debt payment	-	-	-	-	-	-	-	-	-	-	-	-	-	-	-
Pre-tax cash flow	(185,384)	(124,086)	179,790	215,152	200,388	102,833	75,397	66,322	65,811	77,294	58,815	69,432	32,540	2,387	-
Cumulative cash flow	(180,916)	(305,002)	(202,496)	(22,706)	192,446	392,834	495,667	571,064	637,386	703,197	780,491	839,306	908,739	941,279	943,666
Fractions calculations	n/m	n/m	n/m	0.11	0.96	3.82	6.57	8.61	9.69	9.10	13.27	12.09	27.93	39.427	-
Mid-year adjustment	1	1	1	1	1	1	1	1	1	1	1	1	1	1	1
Discount factor	0.976	0.929	0.885	0.843	0.803	0.765	0.728	0.694	0.661	0.629	0.599	0.571	0.543	0.518	0.489
Discounted cash flow	(180,916)	(115,329)	90,735	151,566	172,740	153,226	74,886	52,292	43,808	41,400	46,308	39,559	37,731	16,841	1,177
Advanced Royalty	(5,000)	(5,000)	-	-	-	-	-	-	-	-	-	-	-	-	-
Income tax	-	-	(4,163)	(18,862)	(24,959)	(25,459)	(14,477)	(15,955)	(13,231)	(13,139)	(11,096)	(13,379)	(5,093)	-	-
State & employment tax	-	-	(3,918)	(17,752)	(21,361)	(17,971)	(10,219)	(11,192)	(9,240)	(9,275)	(10,816)	(7,900)	(9,444)	(3,514)	-
COGEMA	(1,467)	(1,467)	-	(5,343)	(6,753)	(2,892)	(2,892)	(5,151)	(2,466)	(2,940)	(2,166)	(2,166)	(2,161)	(119)	-
After-tax cash flow	(191,850)	(130,553)	87,966	143,176	159,459	142,905	73,781	45,458	41,236	40,951	49,215	31,823	40,661	21,971	2,268
Cumulative cash flow	(187,227)	(317,780)	(229,822)	(86,645)	72,814	221,019	340,238	381,494	421,405	470,620	508,853	552,514	574,385	576,533	576,533
Fractions calculations	n/m	n/m	n/m	0.54	0.49	3.00	6.49	8.25	9.32	8.76	12.44	11.54	25.38	25.321	-
Discounted cash flow	(187,227)	(121,340)	77,858	120,701	128,026	113,324	53,730	31,528	27,237	25,736	29,887	21,587	23,944	11,867	1,118

22.3 SENSITIVITY ANALYSIS

A sensitivity analysis was carried out to assess the impact of changes in total pre-production capital expenditure (Capex), operating costs (Opex) and metal prices (Price) on the project's NPV at 5% (i.e. base case) and IRR. Each variable was examined one-at-a-time. An interval of $\pm 30\%$ with increments of 10% was applied to the Capex, Opex and Price variables.

The pre-tax sensitivity analysis is shown in **Figure 22-2**. Price has the highest impact on the Project's performance as observed by the steep change in the Project's NPV and IRR as Price changes. If the price of all metals (gold, silver and copper) was to drop by 30%, to 875 \$/oz, 12.6 \$/oz, and 2.1 \$/lb respectively, the Pre-tax NPV at 5% would drop to US\$148 M and IRR to 15%. Conversely, if metal prices were to increase by 30%, to 1,625 \$/oz Au, 23.4 \$/oz Ag and 3.9 \$/lb Cu, Pre-tax NPV at 5% would increase to US\$1,094 M and IRR to 50%.

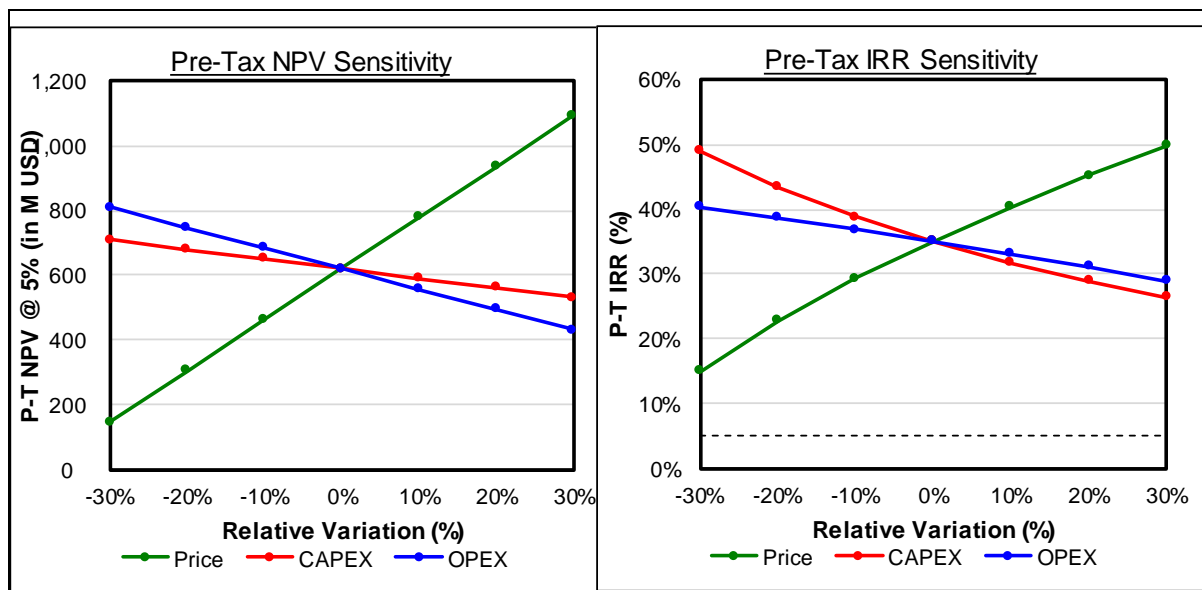

Figure 22-2: Pre-Tax NPV and IRR Sensitivity

A similar trend, although less steep, is observed on the after-tax results (see **Figure 21-3**). If all metals price decrease by 30%, after-tax NPV at 5% discount rate decreases to US\$60 M and IRR drops to 9.3%. An increase in metal prices of 30% results in an increase in after-tax NPV at 5% to US\$633 M and after-tax IRR of 35%.

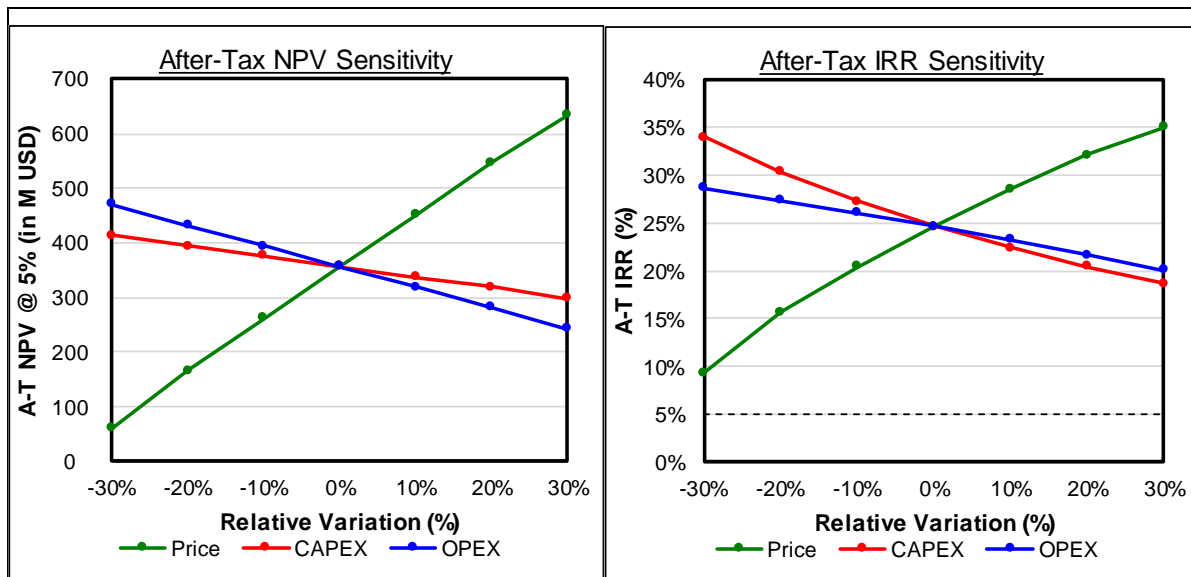



Figure 22-3: After-Tax NPV and IRR Sensitivity

Given that 86% of the Project’s revenue is generated through the sale of gold, the impact of gold price alone was also evaluated. **Table 22-9** summarizes the results obtained.



Table 22-9: Gold Price Sensitivity

Financial Results	Base Case		
	US\$1,150/oz	US\$1,250/oz	US\$1,350/oz
Pre-Tax			
NPV @ 5%	\$513 M	\$621 M	\$729 M
IRR	31.2%	35.1%	38.7%
Payback period (years)	2.3	2.2	2.0
After-Tax			
NPV @ 5%	\$291 M	\$356 M	\$422 M
IRR	21.8%	24.7%	27.4%
Payback period (years)	2.8	2.6	2.4

	Document Number	J01834-PM-REP-002	Rev	0	
	Date	11 January 2019	Page	371 of 417	

23 ADJACENT PROPERTIES

There are no adjacent properties as defined by NI 43-101.

	Document Number	J01834-PM-REP-002	Rev	0	
	Date	11 January 2019	Page	372 of 417	

24 OTHER RELEVANT DATA AND INFORMATION

24.1 EXECUTION PLAN

24.1.1 INTRODUCTION

INV head office is located in Toronto which will be the base for the engineering and procurement phases. The engineering team will be established with the main execution centres of Canada, with support centres established in Ecuador.

Procurement support will be carried out in Toronto during detailed engineering to support engineering data needs; and manage vendor's conformance to specification.

Construction personnel will commence mobilizing to support early construction activities (earthworks, access road and mine portal), and ramped up in accordance with the construction schedule. The construction of the mine portal will be executed with a local contractor and will be followed by the ramp development which will be executed by the owner.

No camp will be provided at the Loma Larga Project site as it is suited to daily commute as it is readily accessible to several nearby towns and the city of Cuenca.

24.1.2 PROJECT SCHEDULE AND KEY MILESTONES

The overall project duration from detailed engineering through to start of ramp-up is estimated at 27 months (excluding the bridging phase) as shown in *Figure 24-1*. Limited activities will occur ahead of this in the bridging phase.

The critical path for the project runs through the EIS, construction permits and process facilities construction.

The milestones for commencement of the critical activities are as follows:

- Detailed engineering and commitment for equipment procurement: finance availability.
- Construction activities: construction permit availability,

The summary of the Project milestones is presented in *Table 24-1*.

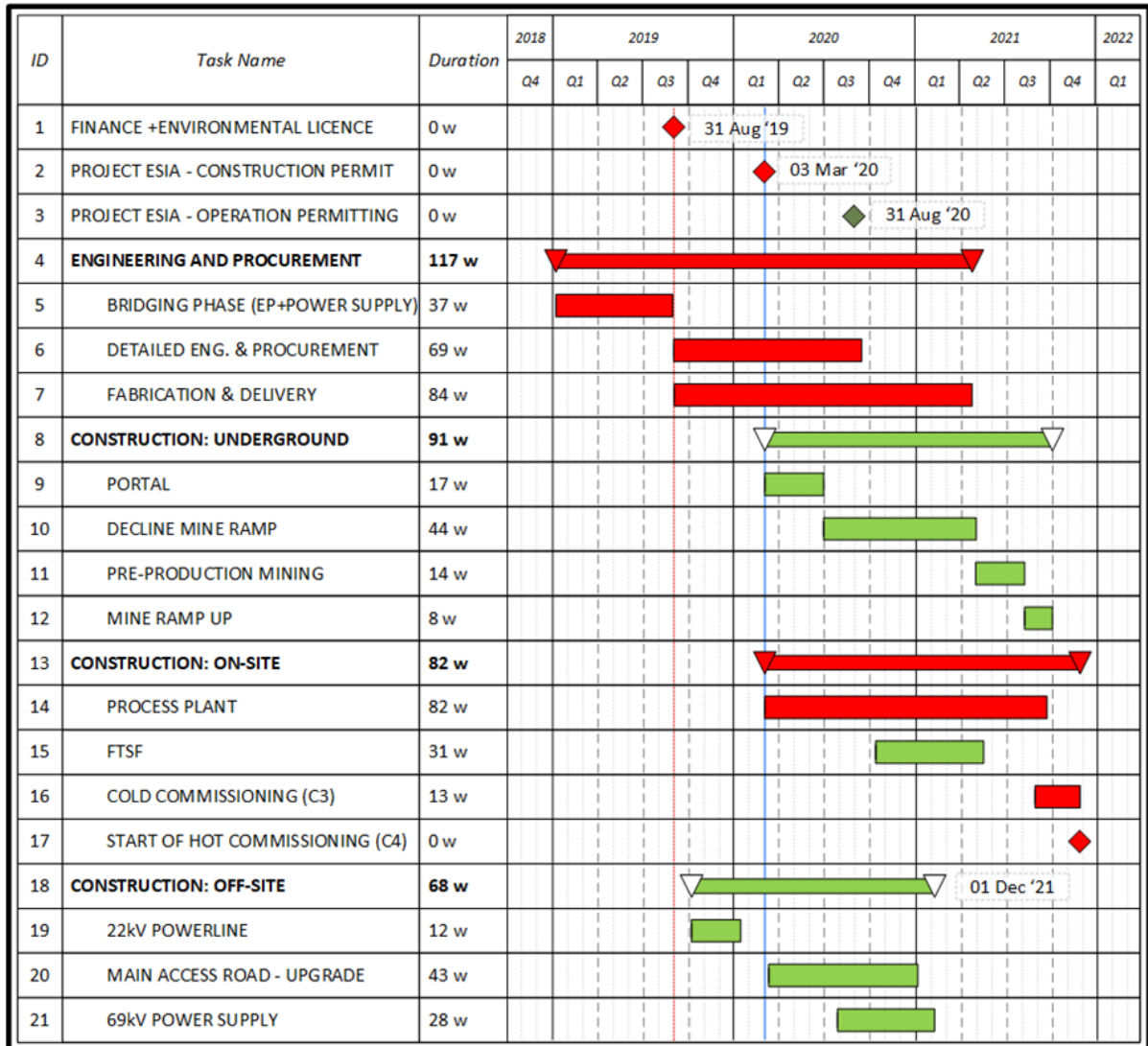

Figure 24-1: Loma Larga Level 1 Schedule – Project

Table 24-1: Loma Larga Key Milestones – Project

Activity ID	Activity	Forecast
MS0000GEN170	Commence Bridging Metallurgical Testwork and Site Fieldwork	07 Jan '19
MS0000ENV110	Project ESIA – EIS Submitted to MAE	28 Jan '19
MS0000GEN450	Commence Bridging Phase Engineering & Procurement	01 May '19
MS0000ENV120	Project ESIA – Approval – Environmental License	20 Aug '19
MS0000GEN210	Financing in Place	31 Aug '19
MS0000GEN220	Start Detailed Engineering - Process Plant	01 Sep '19
MS0000GEN370	Major Equipment Packages Awarded (Front End, Mills, Flotation, Thickeners, Filter Presses, 69kV S/G, Power TX, WTP)	01 Dec '19
MS0000GEN530	22kV 2.5MVA Off-Site Transmission Line Complete	31 Jan '20
MS0000GEN540	Start Mobilizing Contractor: Earthworks and Access Road Construction	01 Apr '20
MS0000ENV130	Project ESIA – Construction Permitting Complete	03 Mar '20
MS0000GEN460	Start Mobilizing Contractor for Mine Portal Construction	01 Mar '20
MS0000GEN480	Start Earthworks and Main Access Road Construction	01 Apr '20
MS0000GEN410	22kV 2.5MVA Power Available	31 May '20
MS0000GEN300	Substantial Engineering Completion (95%)	30 Jun '20
MS0000GEN470	Start Concrete Construction	01 Jul '20
MS0000GEN550	69kV – Approvals from CENTROSUR to commence construction	31 Jul '20
MS0000GEN400	Start FTSF Construction	01 Nov '20
MS0000GEN430	Main Access Road Complete	31 Jan '21
MS0000GEN420	Energizing 69kV Power Supply Switchyard	31 Mar '21
MS4110TSF100	FTSF Completed to 2 Year Level (Ready for Tailings Deposition)	31 May '21
MS0000GEN390	Achieve Construction Completion (C1/C2) - Process Plant	30 Sep '21
MS0000GEN260	Achieve Cold Commissioning (C3) Completion - Process Plant	30 Nov '21
MS0000GEN280	Commence Hot Commissioning (C4) - Process Plant	01 Dec '21

The lead time for long lead equipment critical or near critical is shown in **Table 24-2** with the duration from award to delivered at site. The equipment lead times were based on budgetary quotes obtained during the feasibility study and include for shipping to site.



Table 24-2: Loma Larga- Lead Time Long Lead Equipment

Activity ID	Weeks
Mining Equipment (Ramp)	28
Ball Mill	54
MV Equipment	50
Thickeners	45
Water Treatment Plant	44
Flotation Equipment	44
Regrind Mills	38
Front End Equipment	34
Filter Press	28

24.1.3 BRIDGING PHASE

The bridging work will focus on testwork, fieldwork and front-end engineering to de-risk the execution phase and activities on the critical path, and initiate procurement activities for most critical activities.

- Testwork to support process design refinement (gaps, vendor testwork and value engineering), will be concluded prior to detailed engineering to minimize rework or delays in detailed engineering.
- Fieldwork: predominantly geotechnical in the FTSF and process plant areas; geochemical and hydrogeological studies ongoing for the FTSF scope; ongoing geochemical testwork of waste and ore from the underground mine; and suitability of rock to be excavated and used for construction rock fill for the process plant and FTSF areas.
- Select engineering will be conducted ahead of the detailed engineering phase as follows:
 - Update design based on metallurgical data results: Process Design Criteria, Process Flow Diagrams, mechanical and electrical equipment lists, electrical single line diagram).
 - Prepare datasheets and technical specifications for all long lead and critical process equipment.
 - Layout optimization.
 - Further Water Balance work - recycling for pH control and clean feed / buildup.
 - Prepare site samples and conduct testwork for water treatment.
 - Review recirculation loop required for pressure filtration circuits (notable tailings).
- During the early phase external consultants will be engaged for the following:
 - Commence detailed engineering for the 69kV supply including review of quality of grid power supply for main and emergency power. The approvals and permitting process through CENTROSUR will follow during detailed engineering.
 - Prepare the design criteria and start the approvals process for the access road.
 - This phase will also include interfacing with land owners.
- Procurement and contracts activities will commence during the bridging phase for critical equipment and construction contracts:
 - Issue critical equipment bids.
 - Prepare the construction bid for mine portal construction.
 - Prepare the construction bid for the earthworks (process plant and tailings facility).
 - Engage local engineering companies for in-country detailed engineering.

	Document Number	J01834-PM-REP-002	Rev	0	
	Date	11 January 2019	Page	376 of 417	

- Engage local market for prefabricated administration facilities and mining offices.
- Initiate the process to registering or declaring the entire plant as a “functional unit” as described in Section 11.3.1 and the Technical Report.

24.1.4 PROJECT MANAGEMENT

The Project will be established as an integrated Owner-engineering team to minimize project administration and management roles required to oversee and direct the engineering, procurement, and construction. The organization chart is presented in *Figure 24-2*.

Key Project roles include:

- Owner’s Project Manager will provide guidance to the team, will support the EPCM Project Manager and report back to INV management.
- EPCM Project Manager will provide direction to the team, is responsible for all project phases and accountable for activities, including detailed engineering, procurement, logistics, construction, commissioning, and project controls.
- Project Engineer: oversee, coordinate and integrate consultant and engineering, design and drawing activities.
- Contracts administration will be established in Toronto and transition to site for the oversight of the fabrication and construction. The site-based team will establish and manage the contracts in Spanish. Expediting and quality control will report into contracts administration.
- Procurement will be based in Toronto during engineering phase and transition to site during delivery and installation.
- Project controls will develop, maintain and control: planning (forecasting, scheduling and Earned Value reporting), estimating, cost control, QA/QC and document control. Project controls will compile all project and cost reporting and change control.
- The Construction Manager will be responsible for construction safety, progress, and quality. The construction management team will coordinate and manage all site activities to ensure construction progresses on schedule and within budget.
- A core team of process, mechanical, electrical and control engineers will provide the commissioning management. They will be supported by construction and will be responsible for the handover of process and infrastructure systems to the owner. Construction contractors will be responsible to achieve mechanical completion and pre-commissioning. On successful completion of commissioning, the transfer of care, custody, and control of completed systems will be formalized to the operations team.
- The Construction Manager will retain control until formal handover of each system is completed (progressive handover).
- Owners operations team will be integrated into the construction and commissioning phases for smooth transition. Operations electrical, instrumentation and software technicians will be required to support the respective construction activities. Key resources from the integrated EPCM team will be transition over to the Owner’s team where skill set is appropriate (e.g.: HSEC, field engineering, finance, IT, administration).

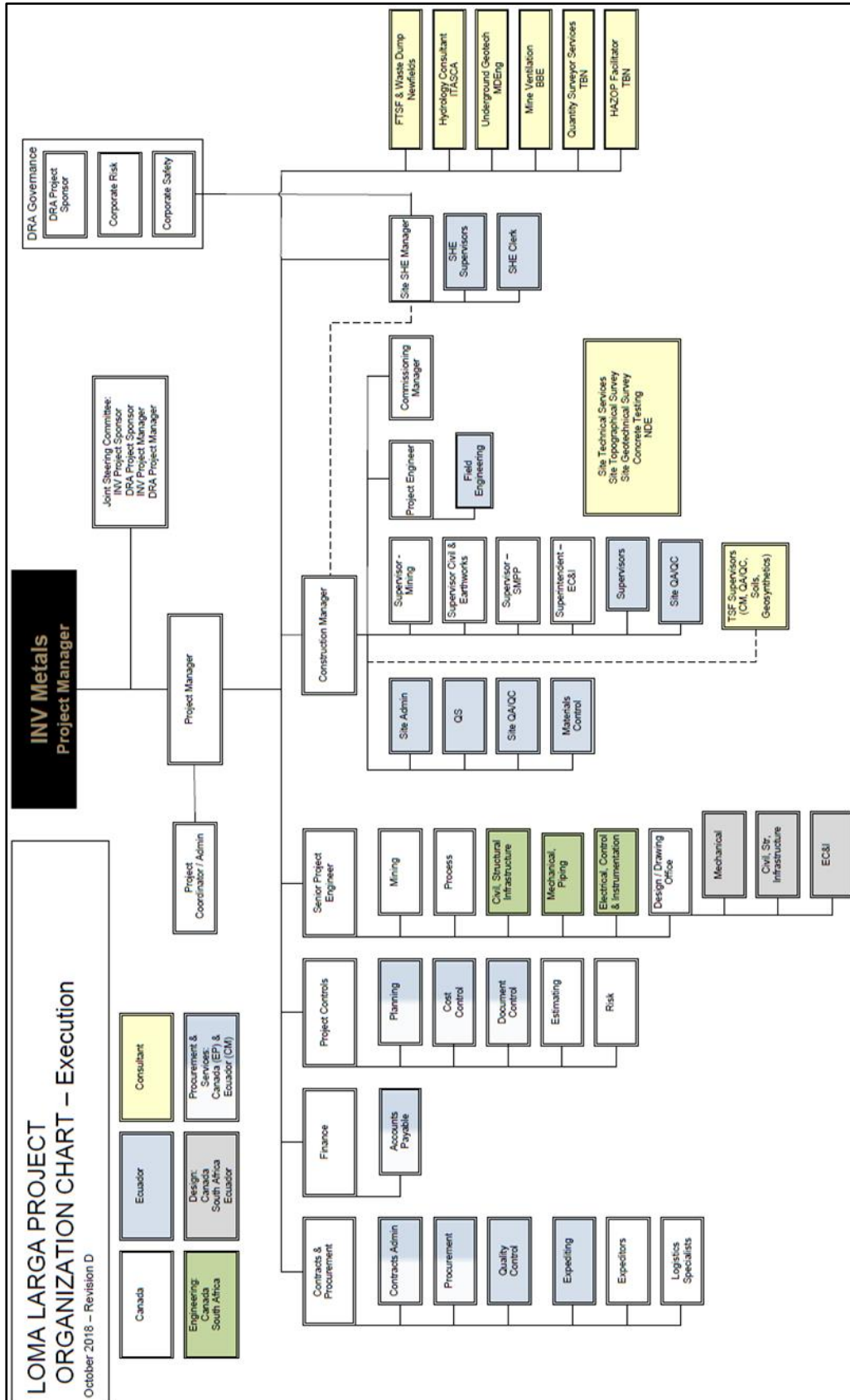



Figure 24-2: Project Management Organization Chart

	Document Number	J01834-PM-REP-002	Rev	0	
	Date	11 January 2019	Page	378 of 417	

24.1.5 ENGINEERING

The engineering team will be established with the main execution centres of Canada and Ecuador. The core engineering will be carried out in Canada which will be responsible to coordinate the detailing activities carried out in Ecuador, plant layout and scope definition for on-site and off-site plant and infrastructure; managing and integrating the scope between EPCM, vendors and external consultants, 3D model and coordination of certified vendor data in order to maintain effective quality and control of the work and minimize execution phase costs.

During execution the following detailed engineering scope will be awarded to consultants:

- FTSF associated water diversion and collection structures.
- 69kV overhead powerline from Girón to mine site including permitting and construction.
- Site access road including permitting and construction.
- Paste backfill plant including equipment supply.
- Water treatment plant including equipment supply.
- Local engineering companies will be contracted for part of the design and detailing to local standards and produce all deliverables in Spanish.
- Construction contracts will include shop drawing detailing be provided by the respective local contractors for their scope.

INV will retain overall control and responsibility for the design to ensure design integrity and conformance to the process design and functional specification and to integrate the overall scope into a successfully constructed, commissioned and operating facility.

Pre-assembly and modularization will be developed during detailed engineering.

24.1.6 PROCUREMENT

During the FS, the major equipment was tendered on budget pricing basis.

The Procurement Operating Plan (POP) will identify all equipment, construction and services contracts required for the execution of the Project.

The procurement team will be established in Toronto to manage all equipment procurement with close interface to the engineering team and will transfer to Ecuador. During project setup the preferred suppliers list and the minimum level vendor quality surveillance / inspection recommended for each package will be prepared and issued to the Owner for approval.

Procurement activities will be executed to EPCM and Owner policies and procedures, will be auditable, and will comply with ethical, anti-bribery and anti-corruption practices, and will follow competitive bidding process. Preference for vendors with local presence, local or regional support will form part of the bid evaluation and adjudication criteria.

The Project Engineer will focus on coordinating the larger engineering scope contracts (FTSF, access roads, overhead powerline, paste backfill plant and water treatment plant).

24.1.7 CONTRACTS ADMINISTRATION

Contracts administration will be set-up in Toronto to develop the major contracts. A contracts administration team will be established in-country to coordinate the local contracts and develop and translate contracts into Spanish.

During the FS the contract basis was developed as follows:

- A bespoke short form contract was developed (not used during the FS) and is intended to be used for small construction contracts and contracts for services on-site (includes minimum HSEC criteria for provision of construction activities on site).
- FIDIC Red Book (FRB) was developed based on DRA experience and customized based on INV input and INV in-country legal opinion. This contract was issued with the requests for tender during the FS to contractors as the contract basis for pricing. FIDIC contract terms are internationally recognised standard construction contracts developed by the International Federation of Consulting Engineers. The FIDIC Red book contract form is for reimbursable contracts where the engineering is provided by the Owner. It is titled “Conditions of Contract for Construction for Building and Engineering Works Designed by the Employer”.

The major construction contracts identified during the FS are shown in **Table 24-3**. Construction procedures will deal with contractor pre-qualification, criteria for local content, and local labour; health and safety culture and performance. The Owner will leverage the skills developed with the EPCM team for key administrative, management and technical (engineering) personnel.

Table 24-3: Major Construction Contracts – Bid in Feasibility Study

Package	Description
A-100	Advanced Exploration Ramp
C-100	Bulk Earthworks and Plant Roads Construction Contract
	Filtered Tailings Storage Facility
C-101	Buildings
C-102	Water Treatment Plant
C-103	Steel, Platework Supply-Install, Mechanical Install
C-104	EC&I Installation (Electrical, C&I)
C-106	Off-site Electrical
C-112	Civil Construction Contract
C-113	Pre-Production Mine Development
C-202	Logistics

24.1.8 CONSTRUCTION EXECUTION STRATEGY – PORTAL AND RAMP



The construction of the mine portal will be executed with a local contractor and will be followed by the ramp development which will be executed by the Owner.

24.1.9 INSURANCE

The project execution phase will consider an overall project specific “Owner Controlled Insurance Program” (OCIP) to cover the most significant insurable risks for purchased equipment and construction contracts and will include cover for: public and general liability, builders’ risk, marine cargo, excess liability, and professional liability. The construction contractors will cover insurance up to a limit specified in the contract.

24.1.10 CONSTRUCTION EXECUTION PLAN

The key schedule considerations for the construction phase include:

	Document Number	J01834-PM-REP-002	Rev	0	
	Date	11 January 2019	Page	380 of 417	

- The critical path for construction goes through the earthworks, and the contract award will target contractor mobilization occurring in parallel with finalizing the construction permit such that construction can commencing soon after permits are in place.
- Construction activities for major third-party packages (FTSF, paste plant and water treatment plant) will be scheduled with similar construction activities occurring at the same time as the process plant facilities.
- Off-site infrastructure is scheduled to coincide with project objectives, i.e. access road: construction to commence after construction permits are in place; 22kV off site transmission line is scheduled to commence on finance being available and ahead of permits being in place as the line will be installed on existing infrastructure; and the 69kV off-site transmission construction to commence on permits being in place and approvals from CENTROSUR, and ready for process plant commissioning of the heavy equipment (notably the mill).

The main objectives of the construction execution plan for the Loma Larga Project include:

- Goal of zero harm (personnel, facilities and the environment).
- Proactive safety management and broad participation to identify and eliminate hazards.
- Meet or exceed regulatory and permit requirements.
- Deliver a high-quality facility that meets or exceeds the defined project goals.
- Maintain morale and provide a respectful, positive and cooperative work environment for all personnel and companies involved.
- Identify and remove barriers that affect progress; project reporting to encourage barrier identification and escalation for timely attention.
- Encourage an atmosphere of positive social impact and local participation for the immediate and surrounding communities.
- Report on the successes during construction and commissioning of the Project.

The contractor's scope will include supply, fabrication and installation of all bulk items. The EPCM site materials management team will coordinate with logistics for owner purchased equipment, formal receipt on delivery and formal handover to the respective sub-contractor.

The laydown areas for equipment (EPCM team's and/or sub-contractors' control) and sub-contractors' bulk materials will be prepared on the site terrace intended for the truck maintenance and fueling facilities.

A comprehensive Health, Safety and Environment (HSE) management plan will be developed prior to mobilization. The HSE management plan will address overall policies, procedures, and standards for the Project, including standard operating practices and emergency response plans. Contractor involvement and pre-mobilization risk assessments; ongoing supervision, incident identification, investigation and reporting.

The HSE management plan specifically address safety procedures required for the attaining zero energy state for construction and commissioning phases with necessary procedures for lock-out and tag-out (LOTO) including training and work permits required prior to release of the work.

Construction quality will be managed through the implementation of a Site Quality Control Plan (SQCP), which will detail the site quality management systems to be used for all construction activities, documentation, reporting, deficiency identification and remediation, non-conformance. SQCP is the responsibility of the field engineering team, and will act to verify that quality control is being performed by the contractor, subcontractor, laboratory, and third-party inspection services.

Construction team will establish the punch list system which is used during construction and commissioning phases, to ensure quality of the works, identification of deficiencies and prioritizing safety and process critical items and as record for ongoing contractor warranty items to be addressed.

24.1.11 CONSTRUCTION QUANTITIES

The estimated quantities for the major bulk / commodity works for the Project based on the FS engineering design and capital estimate are shown in **Table 24-4**.

Table 24-4: Bulk Quantity Summary

Package	Unit	Quantity
Bulk Earthworks	m ³	2,469,450
Detail Earthworks	m ³	35,368
High Density Polyethylene (HDPE) liner	m ²	356,011
Concrete	m ³	11,747
Structural Steel	tonne	1,051
Buildings	m ²	17,000
Mechanical equipment	tonne	860
Mechanical equipment	No. of tags	240
Platwork	tonne	522
Power cable	m	101,885
Instrument cable	m	50,308

The bulk commodity quantities for the process plant are set out in **Table 24-5** below.



Table 24-5: Bulk Commodity Quantities for Process Plant

Description	Quantity	Unit	Preliminary Engineering %	Estimated %	Factored %
Bulk Earthworks	409,648	m ³	100	0	0
Detail Earthworks	22,061	m ³	100	0	0
Concrete	8,142	m ³	100	0	0
Structural Steel	724	tonne	100	0	0
Architectural Buildings	8,277	m ²	100	0	0
Platwork	416	tonne	100	0	0
Electrical	101,885	m	62	0	38
Instrumentation	50,308	m	62	0	38
Piping	0	0	0	0	100

24.1.12 COMMISSIONING PLAN

The Loma Larga Project will be commissioned progressively by subsystems using EPCM contractor standard procedures. The standard steps are typically:

- Construction activities carried out by the construction contractor include construction completion (C1 certificates) and pre-commissioning (C2 certificate) checks completed proving the equipment operates correctly, ready for cold commissioning.

	Document Number	J01834-PM-REP-002	Rev	0	
	Date	11 January 2019	Page	382 of 417	

- Cold / wet commissioning involves the functional testing of equipment by the EPCM commissioning team; equipment is considered live and all necessary controls are in place for LOTO. Safe practices from construction procedures for safe access and controlled of activities and safe work permits will be strictly enforced. On completion the cold commissioning sub-area acceptance certificate (C3 certificate) and the taking over certificate are issued which results in the transfer of care, custody and control to the operations team for the respective sub-system.
- Hot commissioning (first feed) is carried out by of operations supported by construction and commissioning personnel as needed on a sub-system.
- Punch list process will be maintained through out the commissioning cycle.
- Commissioning and turnover activities present significant safety risks and all necessary LOTO procedures will be in place, notably where construction, commissioning and operations may be working in common areas (centralized switchyard for example).



24.2 RISK

During the Feasibility study, the risk management process was initiated. Project risk and HAZOP (Hazard and Operability) review sessions were concluded.

The most significant risks identified for the execution phase are shown in **Table 24-6** (ranked high, no risks were ranked in extreme category). The findings of the risk review and HAZOP were addressed in the FS and Project Execution Plan.

Table 24-6: Loma Larga – Feasibility Study Risk Register – Major Risks

Risk	Impact	Mitigation	Level
FTSF dam failure	<ul style="list-style-type: none"> • Personal injury or death • Contamination of environment • Remediation cost • Loss of social and / or regulation license possible 	<ul style="list-style-type: none"> • Embankment design is technically very conservative (assumes no strength in tailings) • Filtered tailings has less water runout than conventional design • Conservative operating strategy • Robust closure plan • Robust dam monitoring program and emergency response plan • Ability to improve design with operational experience • More work required in detailed engineering phase 	10
Oxidation of ore on stockpiles	<ul style="list-style-type: none"> • Reduced recovery or increased OPEX or both 	<ul style="list-style-type: none"> • Production schedule / mine plan to minimize time on stockpile • Plan to develop stopes and drill production holes and blast as ore required • Issue more important in enargite • Will do testwork to understand timing and magnitude of issue • More work in bridging phase 	9
Geotech drilling not complete due to permit issues	<ul style="list-style-type: none"> • Could impact CAPEX • Critical to FTSF design • Critical to plant foundation design • May need more clean rock for site works • More PAG to deal with 	<ul style="list-style-type: none"> • Drilling required as soon as permit available • Local quarry available with 400,000 M³ capacity (NAG) • More PAG can go underground • Work will be completed during bridging or detailed engineering 	8
Political climate	<ul style="list-style-type: none"> • Schedule risk • Cost risk • Could slow or stop project 	<ul style="list-style-type: none"> • Continue very good social programs and community engagement • Continue continuous engagement at all levels of Government • Continue monitoring all mining issues in-country and keep pulse of community and political leaders 	8
Lack of hydrogeological information at FTSF Incomplete groundwater data collection due to permit issue	<ul style="list-style-type: none"> • Delay in permits / regulatory approvals could impact CAPEX and OPEX • If acidic conditions found could need larger water treatment facility 	<ul style="list-style-type: none"> • Drilling and studies to be completed as permits available • Diversion of more water may be helpful • Mitigation could include removal of PAG rock or covering with concrete or clay cover • To be completed in bridging phase 	7
Spanish translation for the local procurement packages	<ul style="list-style-type: none"> • Delay bids • Make some contractors non-responsive • Lead to high pricing due to risk understanding 	<ul style="list-style-type: none"> • All documents to be translated in bridging phase • Procurement group to be bilingual • Will use FIDIC contract which is already translated • Construction group will build report with contractors during detailed engineering phase 	7
Lack or poor engineering and execution if industry is busy	<ul style="list-style-type: none"> • Poor quality affecting schedule, CAPEX and OPEX 	<ul style="list-style-type: none"> • Plan is to build a bridging team which will carry on to detailed engineering and construction • Plan for expat / Ecuadorian integrated team with functional design in Canada and detailed engineering in Ecuador • Work packages need to be sized to attract local participation. 	7

	Document Number	J01834-PM-REP-002	Rev	0	
	Date	11 January 2019	Page	384 of 417	

Risk management activities will continue and address Project, business and event risks through progressive phases of the project (detailed engineering, construction, commissioning and operations) in accordance with Owner and EPCM contractor's procedures.

24.3 POWER LINE

The construction of a new 69 kV substation near Girón to tie-in to the existing network and new 69 kV overhead powerline up to the mine site is described in **Section 18.2** of this Technical Report.

24.4 TRANSPORTATION AND LOGISTICS



Access to the Loma Larga Project site is adequately supported through a well-established network of existing major ports and roadways up to San Gerardo. Various regional ports offer bulk, roll-on, roll-off and containerized facilities. The regional infrastructure and logistics are detailed in **Section 18.11** of this Technical Report.

24.5 ACCESS ROAD

The upgrade of the road between San Gerardo and the Project site will occur in two phases as described in Section 18.3 of this report. Phase One will consist of the enhancement and ongoing maintenance of the existing road only (during the construction phase). Phase Two will be the upgrade of the existing enhanced road to an agricultural/forestry class of roadway (C3 classification).

24.6 ENVIRONMENTAL PERMITTING

The EIS started during the FS and will continue post completion of the FS.

	Document Number	J01834-PM-REP-002	Rev	0	
	Date	11 January 2019	Page	385 of 417	

25 INTERPRETATION AND CONCLUSIONS

The Loma Larga Project supports conventional mining methods and proven processing technologies. The regional infrastructure will reasonably support all phases of the project. INV is committed to execute all phases of the Project in a socially responsible and environmentally sustainable manner. The underground mine and related processing infrastructure have been designed to minimize the footprint with an estimated disturbance area of less than 80 hectares at the Project site. The process plant design, the use of paste backfill, and a filtered tailings disposal method will recover water for re-use in processing to minimize the use of surface water and reduce treated water discharge.

INV plans to break ground in early 2020, with the goal of achieving first gold concentrate production in late 2021. Project investment will provide positive social and economic impacts locally and nationally, including new employment, training, procurement and business opportunities throughout the region, from construction through to operations.

25.1 PROPERTY DESCRIPTION AND LOCATION

INV plans to develop and implement a well-managed land access process based on international standards in order to facilitate reaching mutually consensual agreements with landowners affected by the linear components of the Loma Larga project. INV expects that doing so will mitigate the risks associated with imposing legal compulsory easements on affected parties which could complicate the relationship with stakeholders and extend the time to access the land.

Landowners around the access road perceive its improvement and modifications as a positive development since it increases the value of their properties and facilitates their transportation. INV does not estimate any major risk with the land access process for the Access Road.

INV also expects that the easement acquisition of the Transmission Line will be less sensitive since property rights remain with the landowner with certain restrictions to the use of the land.

25.2 ACCESS, CLIMATE, LOCAL RESOURCES, INFRASTRUCTURE AND PHYSIOGRAPHY



To develop the project, the existing road will be enhanced and upgraded; and a new transmission line will be required.

The Contecon Concession, Guayaquil Port has infrastructure and facilities to serve all other project needs, with Manta Port supporting oversize and roll-on/roll-off cargo. The copper and pyrite flotation concentrates will be exported from Contecon Concession at the Guayaquil Port in bulk bags and loaded into containers.

Electrical power is to be provided via the local utility, CENTROSUR, from the local network in Ecuador to the existing 69 kV grid near Girón. 22 kV supply from San Fernando will be provided for construction power and emergency backup power.

25.3 GEOLOGY AND MINERAL RESOURCES

Specific conclusions for the geology and resource database related items of the Loma Larga Project are summarized below.

	Document Number	J01834-PM-REP-002	Rev	0	
	Date	11 January 2019	Page	386 of 417	

- Loma Larga is a high sulphidation polymetallic epithermal deposit containing significant values of gold, silver, and copper.
- The Loma Larga deposit is a stratigraphically controlled, flat lying, gently westward-dipping, north-south striking, cigar-shaped body. It also dips slightly to the north, such that the mineralized zone is closer to surface at the south end.
- The results of the quality control (QC) samples, together with the quality assurance/quality control (QA/QC) procedures implemented by INV at Loma Larga, provide adequate confidence in the data collection and processing, and the assay data is suitable for Mineral Resource estimation.
- Understanding of the Project geology and mineralization, together with the deposit type, is sufficiently well established to support Mineral Resource and Mineral Reserve estimation.

25.4 MINERAL RESERVE ESTIMATE AND MINING METHODS

DRA has designed an underground mine with a 12-year LOM. In the early years, the mine will produce 3,000 t/d of gold-copper and silver ore from the Loma Larga deposit, and reach 3,400 tpd in year five. The mine will be accessed by a decline and mined using conventional mechanized transverse long-hole and drift-and-fill mining methods. Ore will be trucked to the concentrator via a 3 km surface road.

The estimated proven and probable mineral reserves are 13.9 Mt grading 4.91 g/t Au, 29.64 g/t Ag and 0.29% Cu mining both the Main High Grade and Low Grade zones.

The Mineral reserves include dilution and ore loss and are estimated at an NSR cut-off of US\$60 NSR at stope and development levels.



Definitions for reserves categories used in this report are consistent with those defined by Canadian Institute of Mining, Metallurgy and Petroleum (CIM) Definition Standards for Mineral Resources and Mineral Reserves (CIM (2014) definitions) and incorporated by reference in NI 43-101.

25.5 MINERAL PROCESSING AND METALLURGICAL TESTING

A significant amount of testwork was conducted to develop a robust and fit for purpose flowsheet for the development of the Loma Larga process plant design. The merits of sequential and bulk flotation flowsheets were examined during the program and analysed. Sufficient testwork has been conducted to support the basis of the 2018 FS.

25.6 RECOVERY METHODS

The Loma Larga process plant flowsheet and design are robust and allow for the treatment of the various ore types that will be encountered over the project LOM. It is also considered to be conventional and fit for purpose. The design removes the requirement for acid addition in flotation pH control, reducing both operating and capital costs. The design considers two stages of copper cleaner flotation and one stage of pyrite cleaner flotation. However, provision has been made in the plant design and layout for one additional copper and one additional pyrite cleaning stage. Provision has also been made in the plant design and layout for additional innovative flowsheet options that improve overall LOM gold recovery

	Document Number	J01834-PM-REP-002	Rev	0	
	Date	11 January 2019	Page	387 of 417	

25.7 PROJECT INFRASTRUCTURE

To develop the project, the existing road will be enhanced and upgraded; and a new transmission line will be required.

Tailings production and deposition methods were evaluated, and filtered tailings was the technology chosen.

25.8 ENVIRONMENTAL STUDIES, PERMITTING AND SOCIAL OR COMMUNITY IMPACT

The Loma Larga Project has submitted its application to move to the Economic Evaluation phase and is currently operating within the Advanced Exploration Phase and holds the required permits, as well as land tenure, and mining and water rights that enable INV to perform exploratory activities in the concessions of Río Falso and Cerro Casco.

To progress to the exploitation phase, the main permit for the construction and operation of a mining project is the Environmental License. An Environmental Impact Study (EIS) process will be managed by the Provincial Directorate of the Ministry of Environment and Water (MAE) in Azuay. The Environmental License will enable the Company to request and obtain other necessary permits to start the construction, operation and closure of the Project.



INV is progressing with an EIS to Ecuadorian standards, and where feasible, to International Finance Corporation (IFC) standards as well. Baseline data sets, and ongoing data collection, are being used to support the development of an EIS for the Project. A stakeholder engagement strategy should be implemented alongside the submission of the EIS.

The environmental baseline data collected to date provides a good understanding of existing conditions, and additional baseline data collection will be obtained to strengthen datasets for impact assessment as part of the exploitation phase EIS, potential international lender requirements, as well to refine specific mitigation measures and provide the basis of Project monitoring and management plans.

The applicable permits and authorizations are required for the three main components of the Project: mine, power transmission line, and access road. INV will require a water deviation authorization for the exploitation phase, as well as rights of way through third party mining rights and private land for the project site, transmission line and access roads, which are not yet in place. A land acquisition plan will be implemented for the Project linear components, in a parallel process to the EIS submission. This approach should be confirmed with regulators and statements of regulator support would mitigate potential concerns will progressing parallel processes to the exploitation phase EIS.

As some of the mining and environmental legislations are relatively new, there are some unknowns with respect to regulatory expectations for appropriate receiving water quality criteria, and the management plans associated with protective forests. A regulatory engagement plan is recommended to support the EIS and permitting for the exploitation phase of the mine.

There are no communities within the mining concession area, and the perception of the Project in the Area of Direct Influence is largely positive. This perception is based on INV's engagement activities and the commonly-cited Project advantages of employment and economic resources generation. The Project's perception in the Area of Indirect Influence is more balanced between positive, negative and neutral. Negative perceptions are primarily related with environmental concerns associated to impacts to water sources and

	Document Number	J01834-PM-REP-002	Rev	0	
	Date	11 January 2019	Page	388 of 417	

environmental pollution. These concerns have been considered in the feasibility level project planning and will be addressed in a stakeholder engagement strategy to be implemented alongside the EIS submission and review. Further stakeholder engagement will identify any areas of further concern with communities in the All about the existing design of the project and associated infrastructure.

Disclosure of information and engagement efforts are ongoing, including a public information campaign to increase understanding of mining activities as they relate to the Project. In addition to these activities, INV has designed and executed small-scale community development projects, in partnership with local communities. These community development projects have been designed in a participatory manner to ensure they meet the needs of local communities.

Based on the available information, there are currently no environmental and social considerations that pose a material threat to the Project. There are areas of uncertainty, in particular, the timeliness of approvals related to effluent water quality, baseline groundwater conditions in the areas of the FTSF and presence of special-status species that will need to be addressed as the project development progresses. Regulator and stakeholder engagement plans should be implemented alongside the initiation of the EIS process, to gain regulatory clarity and support, prevent misinformation, and identify any areas of further concern that should be addressed as the Project develops. Permitting timelines have inherent uncertainty and a proactive approach to regulatory and stakeholder engagement implemented alongside the development and review of the EIS is recommended.

25.9 CAPITAL COSTS

The overall capital cost estimate was compiled by DRA and summarized in the **Table 21-1** below. DRA developed the mining, process plant, plant Infrastructure and off-site infrastructure capital cost estimates for the project scope described in this report. External inputs were received as follows:

- NewFields prepared the construction quantities for the FTSF and DRA applied rates to complete the capital cost estimate.
- P&C prepared the cost estimate for the past backfill system, where DRA only estimated the bulk earthworks, concrete and structural steel.
- Owners G&A costs, taxes and duties, and closure costs were provided by INV.

All costs are expressed in United States Dollars (US\$) and are based on Q3 2018 pricing. The capital cost estimate is deemed to have an accuracy of +/-15% and was prepared in accordance with the AACEI (Association for the Advancement of Cost Engineering) Class 3 estimating standard.

The capital cost estimated was developed based on a typical EPCM project implementation model. Major equipment was specified, and priced quotations obtained from reputable Original Equipment Manufactures (OEM). Construction contract packages were prepared, issued and priced in-country by capable construction companies.

Table 25-1: Capital Cost Summary

Area	US\$
Direct Cost	
Mining – Underground	39,784,517
Mining Surface Infrastructure	10,064,338
Process Plant	67,879,603
Waste Management	18,475,238
Plant Infrastructure	19,802,553
Off-site Infrastructure	14,497,824
Subtotal Direct Cost	170,504,074
Indirect Cost	
Contractor Indirects	26,192,721
Inventory	7,008,541
Project Services	23,774,571
Vendor Rep & Commissioning	2,404,867
Owner's Costs	17,376,883
Freight & Logistics	5,275,777
Taxes & Duties	27,571,731
Contingency	29,360,835
Subtotal Indirect Cost	138,965,926
Total Initial Capital Cost	309,470,000
Sustaining Capital Cost	72,730,000
Closure Cost	22,000,000
Total Project Capital Cost	404,200,000

The initial Project capital cost estimate by discipline is provided in **Table 25-2**.

Table 25-2: Initial Capital Estimate Summary by Discipline

Description	Supply US\$	Install US\$	Contingency US\$	Total US\$
Underground Mining	396,973	12,395,749	4,229,241	17,021,962
Bulk Earthworks		32,621,510	4,487,870	37,109,380
Detail Earthworks	100,000	533,949	66,347	700,296
Civils – Concrete		6,939,652	753,575	7,693,226
Structural Steelwork	2,677,189	2,290,089	436,497	5,403,774
Architectural	660,810	2,422,342	114,354	3,197,506
Mechanical	59,433,709	8,701,860	3,863,240	71,998,809
Platwork	1,492,001	1,482,546	290,998	3,265,545
Painting/Protection& Insulation	589,538	635,910	122,544	1,347,992
Building Services	695,000	25,000	114,354	834,354
Piping	4,393,634	3,242,852	755,223	8,391,710
Electrical	20,892,271	4,182,267	2,008,763	27,083,301
Instrumentation & Control	2,832,404	866,821	424,529	4,123,754
Indirects		59,380,700	6,670,865	66,051,565
Owners		17,376,883	1,737,688	19,114,571
Freight & Logistics		5,275,777	527,578	5,803,355
Taxes & Duties		27,571,731	2,757,173	30,328,904
Total Initial Capital Cost	94,163,527	185,945,640	29,360,840	309,470,000

The Project sustaining capital is presented in the **Table 25-3**.

Table 25-3: Summary of Sustaining Capital Cost

Description	US\$
Mining Capital	50,713,808
FTSF Capital	11,288,767
Taxes & Duties	3,358,452
VAT on Initial CAPEX	7,368,974
Total Sustaining Capital	72,730,000

25.10 OPERATING COSTS

A summary of the overall LOM project operating costs is presented in **Table 25-4** and the summary of the unit operating costs over LOM are presented in **Figure 25-1**. The costs presented exclude pre-production operating cost allowances for mining, process and G&A which were covered in the capital cost estimate. Labour rates used for the study were provided by INV dated to 2018. Direct employment during operations will total approximately 460 people.

Table 25-4: Project Life-of-Mine Operating Costs by Major Area

Major Project Area	LOM Total (US\$)	LOM Unit Cost (US\$/t)
Mining Cost	323,389,258	23.22
Processing Cost	239,603,848	17.20
Backfill Cost	43,708,658	3.14
Tailings Disposal	31,469,759	2.26
G&A Cost	104,951,553	7.54
Total Cost	743,123,076	53.36

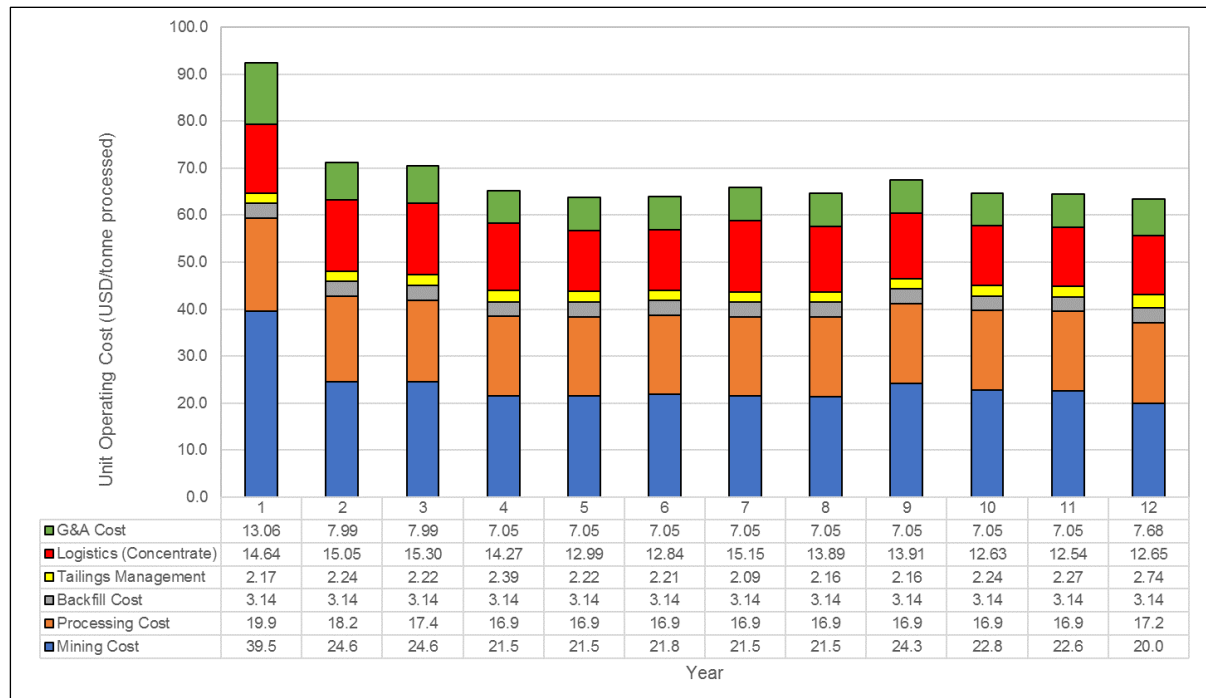





Figure 25-1: Project Life-of-Mine Unit Operating Costs

	Document Number	J01834-PM-REP-002	Rev	0	
	Date	11 January 2019	Page	392 of 417	

25.11 ECONOMIC ANALYSIS

Based on the assumptions presented in this Report, the Project demonstrates positive economics. The pre-tax NPV at 5% discount rate is US\$621 M and pre-tax IRR is 35.1%. The pre-tax payback period is 2.2 years after the start of production.

The after-tax NPV at 5% discount rate is US\$356 M and after-tax IRR is 24.7%. The after-tax payback period is 2.6 years.

	Document Number	J01834-PM-REP-002	Rev	0	
	Date	11 January 2019	Page	393 of 417	

26 RECOMMENDATIONS

Specific recommendations for the Loma Larga Project are summarized below for each area.

26.1 PROPERTY DESCRIPTION AND LOCATION

- Prepare and implement an easement acquisition strategy for the linear components of the Project based on IFC guidelines.
- Further engage with the local government of San Gerardo to gain endorsement of the process for access road land easement acquisition in order to facilitate community acceptance.
- If required, consider minor design adjustments, particularly with respect to the transmission line, to facilitate mutually agreed land access agreements and minimize legal easement enforcement cases.
- Obtain detailed cadastral information of affected landowners to confirm available data from the access road and identify the properties impacted by the power transmission line, in order to perform the impact analysis and implement the land access strategy.

26.2 ACCESS, CLIMATE, LOCAL RESOURCES, INFRASTRUCTURE AND PHYSIOGRAPHY



- INV will engage local ports during Project execution to consider opportunities in switching from bagged-containerized to bulk export for the pyrite concentrate; and investigate exporting pyrite concentrate in bulk in lined containers.

26.3 GEOLOGY AND MINERAL RESOURCES

- Ensure that procedures for investigating, correcting, and documenting results of QA/QC non-compliance issues such as biases or failures are followed for every drillhole program.
- Procure reference standards with grades that better reflect the range of gold grades within the Mineral Resource (i.e., 2 g/t Au to greater than 30 g/t Au). RPA further recommends that INV obtain an analytical standard for silver and another for copper that reflect the average grades expected in the deposit, in order to quantify the accuracy of analyses.
- Complete an external check on the reference materials used on the Loma Larga Project.
- Resume the regular submission of check assays (pulp replicates) to a secondary laboratory.
- Check half core duplicate analyses using core from the existing core library, to ensure that the current practice of quarter-core analysis is accurate.
- Resurvey drillhole collars that deviated more than one metre above or below the topographic surface.
- INV plans future drilling to potentially upgrade Mineral Resources from Inferred to Indicated for inclusion in the mine plan and Mineral Reserves;

26.4 MINERAL RESERVE ESTIMATE

- Following the recommendations listed for the Mineral Resources, DRA recommends a program of in-fill drilling be started once the ore body is reached by the ramp to better delineate the limits of the high-grade zones and refine the limits of the ore body.

	Document Number	J01834-PM-REP-002	Rev	0	
	Date	11 January 2019	Page	394 of 417	

26.5 MINING METHODS

- Investigate options to obtain ultra-low sulphur diesel for the underground operation; with benefits including: a more diversified choice from equipment manufacturers; improve performance of underground equipment at a high elevation; and improved quality of vehicle emissions reducing the exposure of workers to NOx or toxic gases.
- Investigate electric and battery operated mine fleet for the replacement underground fleet in eight to nine years: technology improvements and potential affordability may result in it being more competitive with the diesel option. This would result on an opportunity to lower the ventilation cost for the remaining of the mine life.
- During the early design phase, investigate moving the level development into the ore body to reduce waste development, initial and sustaining capitals expenses.



26.5.1 GEOTECHNICAL RECOMMENDATIONS

26.5.1.1 SITE CHARACTERIZATION

- Routine geotechnical mapping during construction, development and operation at Loma Larga should be carried out.
- Data regarding ground reactions should be collected during operation as a check on the geomechanical design assumptions. This may include:
 - Damage mapping;
 - Pull test data;
 - Overbreak/underbreak during development and mining;
 - Falls of ground; and
 - Instrumentation.
- Fault projections should be updated and maintained as new drilling or underground mapping data becomes available over the project life. Faults should be mapped when intercepted underground to better refine their geomechanical characteristics and behaviour.
- Updates to the geological model must be clearly communicated to engineering teams over the project life to achieve strategic and optimized design.

26.5.1.2 STOPE DESIGN

- During early stoping, design verification should be conducted by back analysis (using the empirical Matthews/Potvin Stability Graph Method) of observed (by CMS survey) stope performance. This will aid in identifying opportunity for:
 - Increasing stope size (where stopes have historically performed well); or
 - Reducing unplanned dilution by adjusting stope dimensions (where stopes have historically suffered from an unacceptable degree of overbreak).
- One design aspect that will require further detailed engineering will be the dimensioning of silica pillars to maintain stability where stope backs and/or floors would otherwise expose low quality ground (particularly intensely altered advanced argillic and propylitic materials).

	Document Number	J01834-PM-REP-002	Rev	0	
	Date	11 January 2019	Page	395 of 417	

26.5.1.3 GROUND SUPPORT

Additional structural data should be acquired by routine geotechnical mapping during early production. More detailed kinematic stability analyses are warranted once data is available to improve confidence in joint set orientations. Joint persistence data will be very valuable for scaling wedges for support optimization.

26.5.1.4 SWELLING CLAY

There is significant uncertainty in the ground reaction that may occur when swelling clays are encountered. It is strongly recommended that instrumentation be utilized to closely monitor deformations (rate and magnitude) where development is required in the susceptible units. Ground support can then be engineered specifically for the local conditions and behaviour.

26.5.1.5 INFRASTRUCTURE SITING:



- There are a few fault structures in proximity to the planned truck load outs (additional faults may also occur which have not been defined in the structural model). It is understood that the ultimate location of the truck loading station is flexible. From a geotechnical perspective, zones with minimal faulting (or where ground quality is not significantly reduced by the presence of faults), in siliceous rock with sufficient siliceous pillars separating the truck loading station from advanced argillic and propylitic horizons are appropriate for these larger excavations.
- Routine geotechnical mapping of the truck load-out area is strongly recommended during construction to ensure that ground support standards are adequate for in-situ conditions.

26.5.1.6 VERTICAL DEVELOPMENT:

- Pilot holes are strongly recommended prior to raise construction and individual raise stability analyses should be done at the detailed design stage prior to construction.
- Relocation of raises should be considered if zones of extensive poor ground and/or swelling clays are encountered to mitigate risk.

26.6 MINERAL PROCESSING AND METALLURGICAL TESTING

- Representative copper and pyrite concentrates, and flotation tailings samples should be produced in sufficient quantities for filtration to be conducted by potential filtration vendors.
- Further confirmatory testwork, through the testing of additional composite and variability samples, can improve the process design conditions. Potential upside of additional testwork would focus on lowering capital and / or operating costs.
- Continue to develop and optimize the metallurgical relationships for gold recovery in the pyrite and copper concentrates.
- Investigate the applicability of new innovative technologies to improve gold recoveries. The use of SFR cells are one such example of potential opportunities, should equipment costs become more economical.
- Ramp up to 3,400 tpd as soon as practicable (de-bottleneck process sub-systems) and validate further increased tonnage through de-bottlenecking.
- Evaluation of processing lower grade ore to extend the mine life.

	Document Number	J01834-PM-REP-002	Rev	0	
	Date	11 January 2019	Page	396 of 417	

26.7 PROJECT INFRASTRUCTURE

- Infrastructure buildings such as offices, kitchens and washroom facilities to be reviewed for suitability as modularised prefabricated units or pre-engineered structures in the final design phase.
- Completion of tailings filtration testing to verify tailings characteristics and additional geochemical, geotechnical and hydrogeological investigation to support the FTSF design.
- Completion of geotechnical investigation and testing to confirm suitability and design for the selected sites for the processing facilities.

26.8 ENVIRONMENTAL STUDIES, PERMITTING AND SOCIAL OR COMMUNITY IMPACT

- Regulatory agency engagement to support the EIS, Environmental Licence and permitting process.
- Additional hydrogeology characterization to optimize water-treatment plant design and to provide baseline for monitoring purposes around the FTSF.
- Additional water balance and water quality modeling to better characterize potential need for, and duration of, post-closure water treatment.
- Continuation of baseline surface water quality monitoring.
- Targeted surveys to establish the occurrence and distribution of special status species to determine potential critical habitat.
- Continuation of seasonal baseline data collection to support monitoring and management plans for the exploitation phase of the Project.
- Development and implementation of local employment, procurement, and training strategies to support local hiring and developing skills.
- Complete a material balance to demonstrate that sufficient soil will be available for reclamation purposes.
- Formalized Social Management Plan and Stakeholder Engagement Plan.

26.9 MARKET STUDIES AND CONTRACTS

- INV will engage the market and assess potential to increase payabilities of concentrates with contracts.



26.10 OTHER RELEVANT DATA AND INFORMATION

The critical milestones for commencement of the critical activities are as follows:

- Detailed engineering and commitment for equipment procurement: finance availability.
- Construction activities: construction permit availability.



The overall project execution duration of 27 months could reasonably be reduced to 24 months if there were no restrictions between start of engineering and construction permits – for start of construction. This can be achieved either by delaying the start of detailed engineering until it is on critical path; or by bringing forward the construction permits.

Commence the bridging work to de-risk the execution phase and activities on the critical path, including testwork, fieldwork, select engineering (update design and layout optimization based on metallurgical data results), procurement and contracts activities in support of Project critical path activities.



	Document Number	J01834-PM-REP-002	Rev	0	
	Date	11 January 2019	Page	397 of 417	

27 REFERENCES



- Agency of Mining Regulation and Control – ARCOM, 2010: Integral Mining Manual. Comprehensive Manual of Legal, Technical and Economic Procedures, 2010.
- Agency of Mining Regulation and Control – ARCOM, 2014: Regulation of health and safety at work 16, 2014.
- Agency of Mining Regulation and Control – ARCOM, 2015: Instructions for the Constitution of Right-of-way. Published by Resolution No. 045 DIR-ARCOM-2015 on December 29, 2015.
- Agency of Mining Regulation and Control – ARCOM, 2016: Technical Guideline 006. Technical guidelines of the ARCOM. Published in the Official Gazette, supplement 789 of July 15, 2016.
- Arribas, A. 1995: Magmas, Fluids, and Ore Deposits. Nepean, Ont.: Mineralogical Association of Canada.
- Arribas, A. Jr. 1995: Characteristics of High-Sulphidation Epithermal Deposits, and Their Relation to Magmatic Fluid. In Magmas, Fluids, and Ore Deposits, Ed.: J.F.M. Thompson, Mineralogical Association of Canada Short Course Vol. 23 (1995).
- Astudillo, P. X., Barros, S., Siddons, D. C. and E. Zarate., 2017: Influence of Habitat Modification by Livestock on Paramo Bird Abundance in Southern Andes of Ecuador. Studies on Neotropical Fauna and Environment, 2017. <https://doi.org/10.1080/01650521.2017.1382122>.
- Barbour, M., Gerristen, J., Snyder, B. & Stribling, J., 1999: Rapid Bioassessment protocols for use in streams and wadeable rivers: periphyton, benthic macroinvertebrates and fish. Second Edition. EPA 841-B-99-002. Environmental Protection Agency; Office of Water; Washington, DC <https://www3.epa.gov/region1/npdes/merrimackstation/pdfs/ar/AR-1164.pdf>
- BQE 2018a: Treatment of Mine Impacted Water at Loma Larga. Engineering Design Report, October 26, 2018.
- BQE 2018b: Selenium Removal from Mine Impacted Water at Loma Larga as Project Contingency, Addendum to Water Treatment Plant (WTP) Engineering Design, November 7, 2018.
- Canadian Dam Association 2014: Application of Dam Safety Guidelines to Mining Dams, Technical Bulletin.
- Carrascal, D. R., del Pilar Arroyave, M., Lagoueyte, M. E. G, and P. A. Z. Jaramillo, 2011: Increased Climatic Stress on High-Andean Ecosystems in the Cordillera Central of Columbia. In book: Climate change and biodiversity in the Tropical Andes. Edition: 1. MacArthur Foundation, Inter-American Institute of Global Change Research (IAI) and Scientific Committee on Problems of the Environment (SCOPE) Editors: Herzog SK, Martínez R, Jørgensen PM, Tiessen H
- Castillo, D.D, Quevedo, L. A, Gavilanes, A. V., Carrasco, J.C., Ricaurte, C. B. and S. A. Borz., 2017: Diversity, Composition, and Structure of Andean High Forest in Ecuador, South America. Bulletin of the Transilvania University of Brasov 10 (59) No. 2
- Chiaradia, M., et al. 2004: Metal Sources in Mineral Deposits and Crustal Rocks of Ecuador, A Lead Isotope Synthesis. In Economic Geology, v. 99, pp 1085-1106.

	Document Number	J01834-PM-REP-002	Rev	0	
	Date	11 January 2019	Page	398 of 417	



- Chouinard, A., Williams-Jones, A.E., Leonardson, R.W., Hodgson, C.J., Silva, P., Tellez, C., Rojas, F. 2005: Geology and Genesis of the Multistage High-Sulfidation Epithermal Pascua Au-Ag-Cu Deposit, Chile and Argentina. *Economic Geology*, 100(3), 463-490.
- CIM 2014: CIM Definition Standards for Mineral Resources and Mineral Reserves, prepared by the CIM Standing Committee on Reserve Definitions, adopted by CIM Council on May 10, 2014.
- Corbett, G. 2005: Epithermal Au-Ag Deposit Types – Implication for Exploration. In *Proceedings of Proexplo Conference Peru, 2005*.
- Directory of the Electricity Regulation and Control Agency - ARCONEL, 2017: Regulation for the Distribution and commercialization of electrical energy - Regulation No. ARCONEL 005/17 of December 7, 2017. Published on December 7, 2017.
- DRA Americas Inc. 2018; Loma Larga Feasibility Study Risk Register, J01834-PM-REG-001 Rev I, Nov 21, 2018.
- DRA Americas Inc. 2019; Feasibility Study on the Loma Larga Project, Azuay Province, Ecuador. Prepared on behalf of INV Metals Inc, January 2019.
- ERM 2018: Proyecto Minero Loma Larga: Water Modelling Report. Prepared for INV Minerales Ecuador S.A. by ERM Consultants Canada Ltd.: Vancouver, British Columbia.
- ERM, 2017: Review and Identification of Data Gaps of Baseline Studies for the Loma Larga Project. Prepared on behalf of INV Metals, Inc.
- Ex Ministry of Non-renewable Natural Resources, 2009: General regulation of the mining law. Executive Decree 119. Published in the Official Register Supplement 67 of November 16, 2009. Last modification: January 04, 2017.
- Ex Ministry of Non-renewable Natural Resources, 2009: Mining Law. Law 45 published in the Official Gazette, Supplement 517 of January 29, 2009. Last modification: April 29, 2016.
- Executive function of the Presidency of the Republic, 2010: Organic Code of Territorial Organization. Law 0 published in the Official Register Supplement 303 of October 19, 2010. Last modification: January 24, 2017.
- Farley, K. A. and E. F. Kelly., 2004: Effects of Afforestation of a Paramo Grassland on Soil Nutrient Status. *Forest Ecology and Management* 195 (3):281-290.
- Frenkel, C., Guayasamín, J. M., Yáñez-Muñoz, M. H., Varela-Jaramillo, A., Ron, S. R. 2014: *Pristimantis cryophilus* Anfibios del Ecuador: <https://bioweb.bio/faunaweb/amphibiaweb/FichaEspecie/Pristimantis%20cryophilus> (accessed October 3, 2018).
- Gareca Leon, Edgar E., Fernadez, M., and Stanton S. 2010: Dendrochronological investigation of the high Andean tree species *Polylepis besseri* and implications for management and conservation. *Biodiversity and Conservation*. 19. 1839-1851.
- Geosciences North Ltd. (2018) Internal Memo: Summary of Work on INV Loma Larga – Geophysics to date. Prepared for INV Metals Limited.
- Golder 2009: Assessment of Critical Hydrogeological Issues, Quimsacocha Project, Ecuador. Prepared for IAMGold Corporation, June.

	Document Number	J01834-PM-REP-002	Rev	0	
	Date	11 January 2019	Page	399 of 417	



- Gradstein, S. R., and S. Leon-Yanez., 2017: Liverworts (Marchantiophyta) of Polylepis pauta forests from Ecuador with description of *Leptoscyphus leoniae* sp. nov. and *Plagiochila pautaphila* sp. nov. *Nova Hedwigia* published online July 2017. DOI: 10.1127/nova_hedwigia/2017/0432.
- Granizo, T., Pacheco, C., Ribadeneira, M. B., Guerrero, M. y Suárez, L., 2002: Libro Rojo de las Aves del Ecuador. SIMBIO, Conservación Internacional, EcoCiencia, Ministerio del Ambiente, UICN. Quito, Ecuador.
- Gray, M. D. 2013: QA/QC Review, Drillhole Database Inclusive of LLD-364 through 375, Loma Larga Project, Ecuador (2013). Prepared for INV Metals Limited by Resource Geosciences Incorporated.
- Hedenquist, J.W. 2013: Update on the Loma Larga Au-Cu-Ag project, Ecuador, Report for INV, April 2013.
- Hydrocarbons Regulation and Control Agency, 2014: Instruction for Purchasing Fuels in the Industrial Segment. Resolution of the Hydrocarbons Regulation and Control Agency. Official registration 387 of December 02, 2014.
- IAMGOLD 2008: Press Release: IAMGOLD releases Quimsacocha Pre-feasibility Study, Positive Results Demonstrate a Solid Project for IAMGOLD, July 29, 2008, Toronto.
- IAMGOLD 2008: Unpublished Pre-feasibility study, July 2008.
- IAMGOLD 2009: Quimsacocha Gold Project, Azuay Province, Ecuador, a technical report prepared by IAMGOLD Technical Services, February 16, 2009.
- IAMGOLD, 2011: Auditoria Ambiental de Cumplimiento. Concesiones Mineras: Cerro Casco y Rio Falso. Año 2011. IAMGOLD Ecuador S.A.
- IFC, 2007a: International Finance Corporation Environmental, Health, and Safety General Guidelines. World Bank Group.
- IFC, 2007b: International Finance Corporation Environmental, Health, and Safety Guidelines for Mining. World Bank Group.
- IFC, 2007c: International Finance Corporation Environmental, Health, and Safety Guidelines for Electric Power Transmission and Distribution. World Bank Group.
- IFC, 2012a: International Finance Corporation Performance Standards on Environmental and Social Sustainability. World Bank Group.
- IFC, 2012b: International Finance Corporation Performance Standard 6. Biodiversity Conservation and Sustainable Management of Living Natural Resources. World Bank Group.
https://www.ifc.org/wps/wcm/connect/bff0a28049a790d6b835faa8c6a8312a/PS6_English_2012.pdf?MOD=AJPERES. Accessed June 2018.
- IFC, 2012c: International Finance Corporation Guidance Note 6. Biodiversity Conservation and Sustainable Management of Living Natural Resources. World Bank Group.
https://www.ifc.org/wps/wcm/connect/a359a380498007e9a1b7f3336b93d75f/Updated_GN6-2012.pdf?MOD=AJPERES. Accessed June 2018.
- https://www.ifc.org/wps/wcm/connect/115482804a0255db96fbffd1a5d13d27/PS_English_2012_Full-Documents.pdf?MOD=AJPERES. Accessed November 2018.

	Document Number	J01834-PM-REP-002	Rev	0	
	Date	11 January 2019	Page	400 of 417	



- <https://www.ifc.org/wps/wcm/connect/1f4dc28048855af4879cd76a6515bb18/Final%2B-%2BMining.pdf?MOD=AJPERES&id=1323153264157>. Accessed November 2018.
- <https://www.ifc.org/wps/wcm/connect/554e8d80488658e4b76af76a6515bb18/Final%2B-%2BGeneral%2BEHS%2BGuidelines.pdf?MOD=AJPERES>. Accessed November 2018.
- <https://www.ifc.org/wps/wcm/connect/66b56e00488657eeb36af36a6515bb18/Final%2B-%2BElectric%2BTransmission%2Band%2BDistribution.pdf?MOD=AJPERES&id=1323162154847>
- Iniguez, V., 2017: Multi-scale monitoring and modelling for the analysis of the hydrologic response of southern Ecuadorian Andean Páramos.
- Loma Larga 2016/2017: Ore Characterization for Metallurgical Testing – April 12, 2017.
- MacDonald, P.J., Bissig, T., Hart, C.J.R., Barreno, J., Viera, F., Mantilla, G., and Rogers, J. 2012: Hydrothermal evolution of the Rio Falso Fault, Quimsacocha High Sulfidation Au-Ag-Cu District, Azuay Province, Ecuador. Presented to SEG conference, Lima, Peru, September 2012.
- MacDonald, P.J., Bissig, T., Hart, C.J.R., Rogers, J., Barreno, J. E., and Bell, R. C. 2013: Magmatic evolution during flattened subduction and high-sulfidation epithermal ore deposition: Quimsacocha volcanic center, Azuay Province, Ecuador. Presented to SEG conference, Whistler, B.C. September 25, 2013.
- MacDonald, P.J., Hart, C., Bissig, T. 2010: Field Report on the Geology of the Quimsacocha Property, Azuay Province, Ecuador, Report for PhD at Mineral Deposit Research Unit, University of British Columbia.
- Madrinan, S., Cortes, A. J., and J. E. Richardson, 2013: Paramo is the World's Fastest Evolving and Coolest Biodiversity Hotspot. *Front Genet* 4:192 <https://www.ncbi.nlm.nih.gov/pmc/articles/PMC3793228/>. Accessed June 2018.
- Minga, D., Ansaloni R., Verdugo, A. And C.U. Ulloa. 2016: Flora del Paramo del Cajas, Ecuador. Universidad del Azuay. Imprenta Don Bosco. Cuenca.
- Ministry of Environment, Government of Ecuador, 2004: Environmental management law. Coding 19 published in the Official Gazette Supplement 418 of September 10, 2004. Last modification: May 22, 2016.
- Ministry of Environment, Government of Ecuador, 2008: Ministerial Agreement No. 26 of the issues the procedures for registering hazardous waste generators, managing hazardous waste prior to environmental licensing, and for transporting hazardous materials. Published in Official Gazette No. 334 of May 12, 2008.
- Ministry of Environment, Government of Ecuador, 2014: Environmental Regulation of Mining Activities. Ministerial Agreement 37 published in the Official Gazette Supplement 213 of March 27, 2014. Last modification: July 12, 2016.
- Ministry of Environment, Government of Ecuador, 2015: Ministerial Agreement of the Ministry of Environment 083b, Posted on June 8, 2015.
- Ministry of Environment, Government of Ecuador, 2017: Environmental Code. Official Register: Supplement 983 on April 12, 2017.

	Document Number	J01834-PM-REP-002	Rev	0	
	Date	11 January 2019	Page	401 of 417	



- Ministry of Mines, Government of Ecuador, 2015: Ministerial Agreement No.18 of the Ministry of Mines- Instructions for authorizations for processing plants, smelting and tailings, published in the Official Gazette 554 of July 29, 2015.
- Ministry of Mines, Government of Ecuador, 2018: Strategic Mining Projects. PDAC 2018 Presentation. Accessed on June 28, 2018. <https://www.mineria.gob.ec/wp-content/uploads/2018/03/Strategic-Mining-Projects-2018.pdf>.
- Ministry of National Defense, Government of Ecuador, 1997: Regulation of the Law on arms, ammunition, explosives and accessories. Executive Decree 169 published in the Official Gazette 32 of March 27, 1997. Last modification: June 15, 2015.
- Ministry of National Defense, Government of Ecuador, 2016: Ministerial Agreement 270 of the Ministry of Defense. Posted on September 6, 2016.
- Ministry of Public Health, Government of Ecuador, 2014: Ministerial Agreement No. 5212 that issues the typology to standardize health establishments by levels of care and support services of the national health system. Published by the Ministry of Public Health on December 24, 2014.
- Ministry of Public Health, Government of Ecuador, 2014: Substitute regulation for granting permits of functioning to the establishments subject to sanitary control and surveillance (Ministerial Agreement No. 00004712). Published on February 11, 2014.
- Ministry of Public Health, Government of Ecuador, 2016: Ministerial Agreement No. 79 Issues the sanitary regulations for the issuance of the operating permit of public and private health facilities of the national health system, home health care services, establishments providing indirect support services and prepaid health and medicine companies. Published in Official Gazette No. 834 of September 6, 2016.
- Ministry of Transport and Public Works, Government of Ecuador, 2013: General specifications for construction of roads and bridges. Prepared by the Ministry of Transport and Public Works. Volume No.3 in Quito, 2013.
- Ministry of Urban Development and Housing, Government of Ecuador, 2015: Ecuadorian Standard for Fire Construction- Code NEC-HS-CI. Published in October 2015.
- Mosquera, G. M., Lazo, P. X, Celleri, R., Wilcox, B. P. and P. Crespo, 2015: Runoff from Tropical Alpine Grasslands Increases with Areal Extent of Wetlands. *Catena* 125: 120-128.
- National Assembly, Government of Ecuador, 2014: Comprehensive Organic Criminal Code. Published in the Official Register Supplement 180 of February 10, 2014.
- National Congress Committee on legislation and codification, Government of Ecuador, 2005: Civil Code. Codification 10 published in the Official Register Supplement 46 of June 24, 2005. Last modification: May 22, 2016.
- National Constitution, Government of Ecuador, 2008. Published in Legislative Decree 0 through Official Register 449 of October 20, 2008. Last modified: July 13, 2011.
- National Police, Ecudaor, 2008: Organic Law of Land Transport, Traffic and Road Safety. Law published in the Official Gazette, Supplement 398 of August 07, 2008. Last modification: December 31, 2014.
- NewFields 2018: Seismic Hazard Assessment Report Loma Larga Project, Azuay Province, Ecuador, March 30,2018.

	Document Number	J01834-PM-REP-002	Rev	0	
	Date	11 January 2019	Page	402 of 417	



- NewFields 2018a: Technical Memorandum Rougher Tailings – Geotechnical Laboratory Testing Summary, Loma Larga Project, 2 February.
- NewFields 2018d: Technical Memorandum Site Visit Trip Report, Loma Larga Project, Azuay Province, Ecuador, 14 May.
- NewFields 2018e: Technical Memorandum Interim Results for the Geochemical Characterization of Floatation Tailings, Loma Larga Project, Azuay Province, Ecuador, 17 May.
- NewFields 2018f: Technical Memorandum Static Test Results for Prospective Quarry Sites, Loma Larga Project, Azuay Province, Ecuador. 15 June.
- NewFields 2018g: Technical Memorandum Additional Climate Analysis, Loma Larga Project, Azuay Province, Ecuador, 27 September.
- NewFields 2018h: Technical Memorandum Water Balance – Filtered Tailings Storage Facility, Loma Larga Feasibility Study & NI 43-101 Report, Azuay Province, Ecuador, 27 September.
- NewFields 2018i: Filtered Tailings Storage Facility, Loma Larga Project Feasibility Study. 19 November.
- NewFields. 2018: Technical Memorandum: Climate Analysis Loma Larga Project Azuay Province, Ecuador. April 30, Prepared on behalf of INV Metals, Inc.
- Orix Presentations on sample selection for PFS testwork program:
Met Sampling Program Update – December 19, 2016 Loma Larga Met test: DDH Samples INV Metals – S Ramnath – August 19, 2013.
- Paterson & Cooke Project #INL-32-0252, INV Metals Loma Larga Paste Backfill Feasibility Study.
- Paterson & Cooke Feasibility Study Report (32-0252-2210-GE-REP-0001).
- Paterson & Cooke: Loma Larga Paste Backfill Feasibility Study – Test Work Report, Document No. 32-0252-00-TW-REP-0010-C, Revision C, June 6, 2018.
- Presidency of the Republic, Ecuador, 2007: General regulations of the Cultural Heritage Law, 2007. Published in the Decree 2733 on February 27, 2007. Last modification: April 12, 2007.
- Presidency of the Republic, Ecuador, 2012: Regulation on Land Transport, Traffic and Road Safety Law. Published by Executive Decree 1196 in the Official Gazette Supplement 731 of June 25, 2012.
- Presidency of the Republic, Ecuador, 2015: Published by Executive Decree 650 in the Official Register Supplement 483 of April 20, 2015. Regulation to the Law of Water Resources and Use of Water.
- PROMAS (Universidad de Cuenca), 2009 (March): Estudio de hidrologia - informe segundo año. Universidad de Cuenca.
- PROMAS (Universidad de Cuenca), 2011a: Informe de Edafología. Línea Base en Hidrología para los páramos de Quimsacocha y su área de Influencia. Universidad de Cuenca.
- PROMAS (Universidad de Cuenca), 2011b: Línea Base En Hidrología, Cuarto Año. Universidad de Cuenca.

	Document Number	J01834-PM-REP-002	Rev	0	
	Date	11 January 2019	Page	403 of 417	

- Promet 101, 2018, Loma Larga - Feasibility Study Metallurgical Report Rev C1, November 29, 2018.
- Propaxis, 2018: Social Baseline Report for Loma Larga Project.
- Propaxis, 2018: Línea Base Social Proyecto Loma Larga. Prepared on behalf of INV Metals Inc.
- Propraxis, 2018: Línea Base Social Proyecto Loma Larga. Prepared on behalf of INV Metals Inc.
- PUCE. 2018: Libro Rojo de las Plantas Endemicas del Ecuador.
<https://bioweb.bio/floraweb/librorojo/home>. Accessed October 2018.
- Robert, F., et al. 2007: Models and Exploration Methods for Major Gold Deposit Types. In Proceedings of Exploration 07: Fifth Decennial International Conference on Mineral Exploration, Ed: B. Milkereit, 2007, pp 691-711.
- RPA 2012: Technical Report on the Quimsacocha Project, Azuay Province, Ecuador. Technical report prepared by Valliant, W., Masun, K., and Postle, J. for INV Metals Inc.
- RPA 2016: Technical Report on the Loma Larga Project, Azuay Province, Ecuador. NI 43-101 Technical Report prepared by Cox J.J., Altman K.A., Masun, K., Robertson, L., and Diaz, C.A. for INV Metals Inc. August 29, 2016.
- RPA 2018: Memorandum on the Loma Larga Geochemistry Block Model prepared by K. Masun for INV Metals Limited.
- RPA, 2016: Pre-feasibility Study on the Loma Larga Project, Azuay Province, Ecuador. Prepared on behalf of INV Metals, Inc.
- Scott Wilson RPA (2006) Technical Report on the Quimsacocha Project, Azuay Province, Ecuador. Technical report prepared by Valliant, W., Roscoe, W.E., and Ross, D. for IAMGOLD Corporation.
- SGS Lakefield Research Limited – 2018: An Investigation into the Recovery of Gold and Copper from Samples from Loma Larga, Project 14269-002 - Final Report – October 25, 2018.
- SGS Lakefield Research Limited, 2006: An Investigation into the Recovery of Gold and Copper from Quimsacocha Project Samples, Project 11035-001 – Report 1, May 10, 2006.
- Sillitoe, R.H., 1999: Styles of High-Sulphidation Gold, Silver and Copper Mineralisation in Porphyry and Epithermal Environments. In Proceedings Pacrim Congress 1999, Bali Indonesia October 10-13, 1999.
- SRK (2006). Quimsacocha Gold Project, Azuay Province, Ecuador, Preliminary Assessment Report. Prepared for IAMGold Corporation, May.
- Supreme Council of Government, Ecuador, 1980: Law on arms, ammunition, explosives and accessories Published in Supreme Decree 3757 through Official Register 311 of November 7, 1980. Last modification: March 9, 2009.
- Supreme Council of Government: Regulation of Radiological Safety. Published in the Supreme Decree 3640 of the Official Registry 891 of August 8, 1979.

	Document Number	J01834-PM-REP-002	Rev	0	
	Date	11 January 2019	Page	404 of 417	

- Tirara, D., 2017: Guia de campo de los mamiferos del Ecuador. Ediciones Murielago Blanco. Publicacion especial sobre los mamiferos del Ecuador 11. Quito. 600 pp.
- Toivonen, J. M., Kessler, M., Ruokolainen, K., and D. Hertel., 2011: Accessibility Predicts Structural Variation of Andean Polylepis forests. *Biodiversity Conservation* 20:1789-1802.
- Ulloa, C.U., Molina, S.A., Jorgensen, P.M., and D. Minga. 2018. Cajas National Park Field Guide of 100 Wild Plants of the Paramo. <http://www.missouribotanicalgarden.org/Portals/0/staff/PDFs/ulloa/GuiaPlantas.pdf>. Accessed October 2018.
- UNEP-WCMC, 2016: The State of Biodiversity in Latin America and the Caribbean: A mid-term review of progress towards the Aichi Biodiversity Targets. United Nations Environmental Programme-World Conservation Monitoring Centre, Cambridge, UK.
- Universidad de Azuay, 2017 (Diciembre): Informe Final del Monitoreo Biotico del Proyecto Minero Loma Larga. Coordinacion Dr. Pedro Astudillo Webster, Blgo. Santiago Barros Q., Blgo. Boris Landazuri P. Escuela de Biologia, Ecologia y Gestion. Cuenca, Ecuador.
- Universidad de Azuay, 2018 (Febrero): Informe Final del Monitoreo Biotico del Proyecto Minero Loma Larga. Coordinacion Dr. Pedro Astudillo Webster, Blgo. Santiago Barros Q., Blgo. Boris Landazuri P. Escuela de Biologia, Ecologia y Gestion. Cuenca, Ecuador.
- Western Mining Services (2018) Loma Larga Project Assessment and Targeting Study. Confidential report prepared by Bussey, S. and Margeson, B. for INV Metals Inc.
- White, N.C., & Hedenquist, J.W. (1995). Epithermal Gold Deposits: Styles, Characteristics and Exploration. *SEG Newsletter*, 23, 1,9-13.
- White, N.C., and Hedenquist, J.W. (1990) Epithermal Environments and Styles of Mineralization: Variations and Their Causes, and Guidelines for Exploration, II. In: J.W. Hedenquist, N.C. White and G. Siddeley (Editors), *Epithermal Gold Mineralization of the Circum-Pacific: Geology, Geochemistry, Origin and Exploration*, *J. Geochem Exploration*, 36: pp 445-474.
- World Bank (1999). *Solid Waste landfills in Middle- and Lower- Income Countries, A Technical Guide to Planning, Design, and Operation*, World Bank Technical Paper No. 426.
- World Bank (2012). *What a Waste, A Global Review of Solid Waste Management*, Urban Development Series Knowledge Papers, No. 15. March.

	Document Number	J01834-PM-REP-002	Rev	0	
	Date	11 January 2019	Page	405 of 417	

28 DATE AND SIGNATURE PAGE

This report titled “NI 43-101 Feasibility Study Technical Report” on the Loma Larga Project, Azuay Province, Ecuador and dated January 11, 2019 was prepared and signed by the following authors:

(Signed & Sealed) “Phildi Scholtz”

Dated at Toronto, ON
January 11, 2019

**Esias P. Scholtz, Pr. Eng.
SVP Projects (DRA)**

(Signed & Sealed) “Daniel Gagnon”

Dated at Montreal, QC
January 11, 2019

**Daniel Gagnon, P. Eng
SVP Mining Geology and Operations (DRA)**

(Signed & Sealed) “David Frost”

Dated at Toronto, ON
January 11, 2019

**David Frost, FAusIMM, B. Met Eng.
VP Process Engineering (DRA)**

(Signed & Sealed) “Silvia del Carpio”

Dated at Montreal, QC
January 11, 2019

**Silvia del Carpio, P. Eng., MBA
Process Engineer and Financial Analyst (DRA)**

(Signed & Sealed) “Katharine Masun”

Dated at Toronto, QC
January 11, 2019

**Katharine Masun, P. Geo
Senior Geologist (RPA)**

(Signed & Sealed) “Kathy Kalenchuk”

Dated at Toronto, QC
January 11, 2019

**Kathy Kalenchuk, P. Eng.
Principal Geomechanics Consultant (MDEng)**

(Signed & Sealed) “Houmao Liu”

Dated at Denver, CO
January 11, 2019

**Houmao Liu, Ph. D, P.E.
General Manager, Principal Hydrogeologist (ITASCA)**

(Signed & Sealed) “Paul Kaplan”

Dated at Sparks, NV
January 11, 2019

**Paul Kaplan, P.E.
Partner, Principal (NewFields)**

(Signed & Sealed) “Derek Chubb”



Dated at Toronto, ON
January 11, 2019

**Derek Chubb, P. Eng.
Senior Partner (ERM)**

(Signed & Sealed) “Leslie Correia”

Dated at Sudbury, ON
January 11, 2019

**Leslie Correia, Pr. Eng.
Engineering Manager (Paterson & Cooke)**

	Document Number	J01834-PM-REP-002	Rev	0	
	Date	11 January 2019	Page	406 of 417	

29 CERTIFICATE OF QUALIFIED PERSONS



www.draglobal.com

Certificate of Author



I, Esias P. Scholtz, Pr. Eng., as an Author of this report entitled "Technical Report on the Loma Larga Project, Azuay Province, Ecuador", prepared for INV Metals Inc. and dated January 11th, 2019, do hereby certify that:

1. I am Senior VP Projects, with DRA Americas Inc. Suite 300 / 44 Victoria Street Toronto, ON M5C 1Y2.
2. I am a graduate of the University of Pretoria, Pretoria, South Africa in 1993 with a Bachelor of Mechanical Engineering, BEng (Mech) degree.
3. I am registered as a Professional Engineer with the Engineering Council of South Africa (ECSA) (Reg. #970526). I have worked as a Mechanical Engineer, Project Manager and Project Director for a total of 25 years continuously since my graduation, with relevant experience gained in the mining industry.
4. I have read the definition of "qualified person" set out in National Instrument 43-101 (NI 43-101) and certify that by reason of my education, affiliation with a professional association (as defined in NI 43-101) and past relevant work experience, I fulfil the requirements to be a "qualified person" for the purposes of NI 43-101.
5. I visited the Loma Larga Project on August 1 to 2, 2017.
6. I participated in the preparation of the final Technical Report. I am responsible for sections 5.1, 5.3, 5.4, 18, 21.1 (excluding 21.1.1 for FSTF and Paste Backfill), 21.2.1, 21.2.5, 24 and I share responsibility with my co-authors for Sections 1, 2, 3, 21, 25, 26, and 27 of the Technical Report.
7. I am independent of the Issuer applying the test set out in Section 1.5 of NI 43-101.
8. I have no personal knowledge as of the date of this certificate of any material fact or change, which is not reflected in this Report.
9. Neither I, nor any affiliated entity of mine, is at present, under an agreement, arrangement or understanding or expects to become, an insider, associate, affiliated entity or employee of INV Metals Inc., or any associated or affiliated entities.
10. Neither I, nor any affiliated entity of mine, own, directly or indirectly, nor expect to receive, any interest in the properties or securities of INV Metals Inc., or any associated or affiliated companies
11. I have read NI 43-101, and the Technical Report has been prepared in compliance with NI 43-101 and Form 43-101F; and have prepared the Report in conformity with generally accepted Canadian mining industry practice, and as of the date of the certificate, to the best of my knowledge, information and belief, the Technical Report contains all scientific and technical information that is required to be disclosed to make the Technical Report not misleading.

Dated this 11th day of January 2019.

Esias P. Scholtz (signed and sealed)

Esias P. Scholtz, Pr. Eng.
Senior VP Projects

	Document Number	J01834-PM-REP-002	Rev	0	
	Date	11 January 2019	Page	407 of 417	



www.draglobal.com

Certificate of Author



I, Daniel M. Gagnon, P. Eng. as an Author of this report entitled “NI 43-101 Feasibility Study Technical Report”, prepared for INV Metals Inc. and dated January 11, 2019 do hereby certify that:

1. I am Vice President Mining, Geology and Met-Chem Operations, with DRA Americas Inc located at 555 René Lévesque West, 6th Floor, Montreal, Quebec Canada H2Z 1B1.
2. I am a graduate of École Polytechnique de Montréal, Montreal, Quebec, Canada in 1995 with a bachelor degree in Mining Engineering.
3. I am registered as a Professional Engineer in the Province of Quebec (Reg. #118521). I have worked as a Mining Engineer for a total of 23 years continuously since my graduation.
4. I have read the definition of “qualified person” set out in National Instrument 43-101 (NI 43-101) and certify that by reason of my education, affiliation with a professional association (as defined in NI 43-101) and past relevant work experience, I fulfil the requirements to be a “qualified person” for the purposes of NI 43-101.
5. I visited the Loma Larga Project from August 1 to 2 2017.
6. I have participated in the Technical Report and am responsible for Section 15, parts of Section 16, and I share responsibility with my co-authors for Sections 1, 2, 3, 21, 24, 25, 26, and 27 of the Technical Report.
7. I am independent of the Issuer applying the test set out in Section 1.5 of NI 43-101.
8. I have no personal knowledge as of the date of this certificate of any material fact or change, which is not reflected in this Report.
9. Neither I, nor any affiliated entity of mine, is at present, under an agreement, arrangement or understanding or expects to become, an insider, associate, affiliated entity or employee of INV Metals Inc., or any associated or affiliated entities.
10. Neither I, nor any affiliated entity of mine, own, directly or indirectly, nor expect to receive, any interest in the properties or securities of Nouveau Monde Graphite Inc., or any associated or affiliated companies
11. I have read NI 43-101, and the Technical Report has been prepared in compliance with NI 43-101 and Form 43-101F; and have prepared the Report in conformity with generally accepted Canadian mining industry practice, and as of the date of the certificate, to the best of my knowledge, information and belief, the Technical Report contains all scientific and technical information that is required to be disclosed to make the Technical Report not misleading.

Dated this 11th of January 2019.

Daniel Gagnon (signed and sealed)

Daniel M. Gagnon, P. Eng.
VP Mining, Geology & Met-Chem Operations

	Document Number	J01834-PM-REP-002	Rev	0	
	Date	11 January 2019	Page	408 of 417	





www.draglobal.com

Certificate of Author

To accompany the Report titled "NI 43-101 Feasibility Study Technical Report" which is effective as of January 11, 2019 (the "Technical Report") prepared for INV Metals Inc. (the "Company").

I, David Frost, FAusIMM, B. Met Eng, do hereby certify that:

- 1) I am employed by DRA Americas in the role of Vice President Process Engineering, with my office located at Suite 3000, 44 Victoria Street, Toronto, Canada;
- 2) I graduated from the Royal Melbourne Institute of Technology (RMIT), Melbourne, Australia with a Bachelor of Metallurgical Engineering in Metallurgy in 1993;
- 3) I am a registered Fellow Member of the Australian Institute of Mining and Metallurgy (FAusIMM) membership # 110899;
- 4) I have worked as a Metallurgist and Process Engineer in various capacities since my graduation from university in 1993;
- 5) My work experience has included more than 26 years of process plant operations and engineering design experience including the oversight of flotation circuit processing in operations and the engineering design of several sequential polymetallic flotation flowsheets including copper gold flowsheets. I have also been involved in the supervision and interpretation of numerous metallurgical testwork programs used for the derivation of process plant flowsheets involving flotation. I have previously signed Ni43101 technical reports involving conventional flotation flowsheets;
- 6) I have read the definition of "qualified person" set out in the National Instrument 43-101 and certify that by reason of my education, affiliation with a professional association and past relevant work experience, I fulfil the requirements to be an independent qualified person for the purposes of NI 43-101;
- 7) I participated in the preparation of the final Technical Report including the preparation of sections 13; 17; 21.2.3; relating to the process plant operating costs as they relate to the project and I share responsibility with my co-authors for Sections 1, 2, 3, 21, 24, 25, 26, and 27 of the Technical Report
- 8) I visited the Loma Larga site June 27 to 28, 2017 and reviewed the plant location site. I have also personally viewed a selection of cores on site;
- 9) I have no personal knowledge as of the date of this certificate of any material fact or change, which is not reflected in this Report;
- 10) Neither I, nor any affiliated entity of mine, is at present, under an agreement, arrangement or understanding or expects to become, an insider, associate, affiliated entity or employee of INV Metals Inc., or any associated or affiliated entities;
- 11) Neither I, nor any affiliated entity of mine, own, directly or indirectly, nor expect to receive, any interest in the properties or securities of INV Metals Inc., or any associated or affiliated companies;
- 12) Neither I, nor any affiliated entity of mine, have earned the majority of our income during the preceding three (3) years from INV Metals Inc., or any associated or affiliated companies;



	Document Number	J01834-PM-REP-002	Rev	0	
	Date	11 January 2019	Page	409 of 417	

- 13) I have read NI 43-101 and Form 43-101F1 and have reviewed the relevant sections involved in the Technical Report in compliance with NI 43-101 and Form 43-101F1; these Sections were prepared in conformity with generally accepted - mining industry best practice, and as of the date of the certificate, to the best of my knowledge, information and belief, the Technical Report contains the scientific and technical information that is required to be disclosed to make the Technical Report not misleading.

This 11th day of January 2019,

Dave Frost (signed and sealed)

David Frost, FAusIMM, B. Met Eng.
Vice President – Process Engineering
DRA Americas Inc.

	Document Number	J01834-PM-REP-002	Rev	0	
	Date	11 January 2019	Page	410 of 417	



www.draglobal.com

Certificate of Author

I, Silvia Del Carpio, P.Eng., MBA, as an Author of this report entitled "Technical Report on the Loma Larga Project, Azuay Province, Ecuador", prepared for INV Metals Inc. and dated January 11, 2019, do hereby certify that:

1. I am a Financial Analyst, with DRA Met-Chem.
2. I hold a Bachelor's degree in Materials Engineering from McGill University, Montreal, Quebec, Canada and a Master of Business Administration degree from London Business School in London, UK.
3. I am registered as a Professional Engineer in the Province of Ontario (Reg. #100134350). I have worked for more than 10 years in the mining industry since my graduation from university.
4. I have read the definition of "qualified person" set out in National Instrument 43-101 (NI 43-101) and certify that by reason of my education, affiliation with a professional association (as defined in NI 43-101) and past relevant work experience, I fulfil the requirements to be a "qualified person" for the purposes of NI 43-101.
5. I have not visited the site.
6. I have overall responsibility for this Technical Report. I am responsible for Sections 19 and 22, and I share responsibility with my co-authors for Sections 1, 2, 3, 24, 25, 26, and 27 of the Technical Report.
7. I am independent of the Issuer applying the test set out in Section 1.5 of NI 43-101.
8. I have no personal knowledge as of the date of this certificate of any material fact or change, which is not reflected in this Report.
9. Neither I, nor any affiliated entity of mine, is at present, under an agreement, arrangement or understanding or expects to become, an insider, associate, affiliated entity or employee of INV Metals Inc., or any associated or affiliated entities.
10. Neither I, nor any affiliated entity of mine, own, directly or indirectly, nor expect to receive, any interest in the properties or securities of INV Metals Inc., or any associated or affiliated companies.
11. I have read NI 43-101, and the Technical Report has been prepared in compliance with NI 43-101 and Form 43-101F; and have prepared the Report in conformity with generally accepted Canadian mining industry practice, and as of the date of the certificate, to the best of my knowledge, information and belief, the Technical Report contains all scientific and technical information that is required to be disclosed to make the Technical Report not misleading.

Dated this 11th day of January 2019.

Silvia Del Carpio (signed and sealed)

Silvia Del Carpio, P.Eng., MBA
Financial Analyst

	120 Adelaide Street West Suite 2010 Toronto, Ontario M5H 1T1	Telephone: +1 416 646 3608 Fax: +1 416 642 1269 www.erm.com

CERTIFICATE OF AUTHOR





I, Derek Chubb, P.Eng., as an Author of this report entitled "Technical Report on the Loma Larga Project, Azuay Province, Ecuador", prepared for INV Metals Inc. and dated January 11, 2019, do hereby certify that:

1. I am a Senior Partner, with ERM Consultants Canada Limited (ERM), Suite 2010 – 120 Adelaide Street West, Toronto, Ontario, Canada M5H 1T1.
2. I am a graduate of McMaster University, Hamilton, Ontario, Canada in Year 1990 with a Bachelor degree in Chemical Engineering.
3. I am registered as a Professional Engineer in the Province of Ontario (Reg. #90328121). I have worked as a Professional Engineer for a total of 26 years continuously since my graduation.
4. I have read the definition of "qualified person" set out in National Instrument 43-101 (NI 43-101) and certify that by reason of my education, affiliation with a professional association (as defined in NI 43-101) and past relevant work experience, I fulfil the requirements to be a "qualified person" for the purposes of NI 43-101.
5. I visited the Loma Larga Project site on June 28, 2017.
6. I am responsible for Sections 4; 5.5; 20 with the exception of closure costing in Section 20. I am responsible for those portions of Sections 1, 2, 3, 24, 25, 26, and 27 of the Technical Report for which I have authored.
7. I am independent of the Issuer applying the test set out in Section 1.5 of NI 43-101.
8. I have no personal knowledge as of the date of this certificate of any material fact or change, which is not reflected in this Report.
9. Neither I, nor any affiliated entity of mine, is at present, under an agreement, arrangement or understanding or expects to become, an insider, associate, affiliated entity or employee of INV Metals Inc., or any associated or affiliated entities.
10. Neither I, nor any affiliated entity of mine, own, directly or indirectly, nor expect to receive, any interest in the properties or securities of INV Metals Inc., or any associated or affiliated companies
11. At the effective date of the Technical Report, to the best of my knowledge, information, and belief, the portions of the Technical Report for which I am responsible contain all scientific and technical information that is required to be disclosed to make the Technical Report not misleading.

Dated this 11th day of January 2019.



 Derek Christopher Chubb, P.Eng.
 Senior Engineer

	Document Number	J01834-PM-REP-002	Rev	0	
	Date	11 January 2019	Page	412 of 417	





Itasca Denver, Inc.
143 Union Blvd., Suite 525
Lakewood, Colorado 80228 USA
tel: +1 303-969-8033 fax: +1 303-969-8357
e-mail: itasca@itascadenver.com/www.itascadenver.com

11 January 2019

SUBJECT: Certificate of Author

I, Houmao Liu, Ph.D., P.E., as an Author of this report entitled “Technical Report on the Loma Larga Project, Azuay Province, Ecuador”, prepared for INV Metals Inc. and dated January 11, 2019, do hereby certify that:

1. I am General Manager/Principal Hydrogeologist, with Itasca Denver, Inc., 143 Union Blvd., Suite 525, Lakewood, CO 80228, USA.
2. I am a graduate of the University of Colorado, Boulder, CO, USA in 1992 with a Doctor of Philosophy degree in Civil Engineering.
3. I am registered as a Professional Engineer in the state of Colorado (Reg. #30576). I have worked as a Civil Engineer and Hydrogeologist for a total of 26 years continuously since my graduation.
4. I have read the definition of “qualified person” set out in National Instrument 43-101 (NI 43-101) and certify that by reason of my education, affiliation with a professional association (as defined in NI 43-101) and past relevant work experience, I fulfill the requirements to be a “qualified person” for the purposes of NI 43-101.
5. I have not visited the Loma Larga Project. Two of Itasca’s staff have visited the site. Mr. Eric Swanson, project manager and senior hydrogeologist, visited the site from 09/30/2016 to 10/10/2016, 11/20/2016 to 01/07/2017, 01/18/2017 to 01/29/2017, and 06/27/2017 to 07/18/2017. Dr. Steven Meyerhoff, groundwater flow modeler and senior project hydrogeologist, visited the site from 06/27/2017 to 07/18/2017.
6. I am responsible for parts of Sections 10 and 16, and I share responsibility with my co-authors for Sections 1, 2, 3, 24, 25, 26, and 27 of the Technical Report.
7. I am independent of the Issuer applying the test set out in Section 1.5 of NI 43-101.
8. I have no personal knowledge as of the date of this certificate of any material fact or change which is not reflected in this Report.
9. Neither I, nor any affiliated entity of mine, is at present, under an agreement, arrangement or understanding or expects to become an insider, associate, affiliated entity or employee of INV Metals Inc., or any associated or affiliated entities.
10. Neither I, nor any affiliated entity of mine, own, directly or indirectly, nor expect to receive, any interest in the properties or securities of INV Metals Inc., or any associated or affiliated companies.

	Document Number	J01834-PM-REP-002	Rev	0	
	Date	11 January 2019	Page	413 of 417	

Certificate of Author
11 January 2019
Page 2 of 2





11. I have read NI 43-101, and the Technical Report has been prepared in compliance with NI 43-101 and Form 43-101F; and have prepared the Report in conformity with generally accepted Canadian mining industry practice, and as of the date of the certificate, to the best of my knowledge, information and belief, the Technical Report contains all scientific and technical information that is required to be disclosed to make the Technical Report not misleading.

Dated this 11th day of January 2019.



Houmao Liu, Ph.D., P.E.
General Manager/Principal Hydrogeologist

	Document Number	J01834-PM-REP-002	Rev	0	
	Date	11 January 2019	Page	414 of 417	



7-1045 John Counter Blvd.
Kingston, ON, Canada, K7K 6C7
T:613-507-7575 F:613-549-4120
www.mdeng.ca

Certificate of Author

I, Kathy Kalenchuk, Ph.D., P.Eng., as an Author of this report entitled "Technical Report on the Loma Larga Project, Azuay Province, Ecuador", prepared for INV Metals Inc. and dated January 11, 2019, do hereby certify that:



1. I am Principal Geomechanics Consultant, with Mine Design Engineering Inc., 7-1045 John Counter Blvd. Kingston, Ontario.
2. I am a graduate of the University of Alberta, Edmonton, Alberta, Canada in 2004 with a Bachelors degree in Mining Engineering. I am a graduate of the Queen's University, Kingston, Ontario, Canada in 2007 with a Master's degree in Geomechanical Engineering and 2010 with a Ph.D. in Geomechanical Engineering.
3. I am registered as a Professional Engineer in the Province of Ontario (Reg. #100164661), the Province of British Columbia (Reg. # 189685), and the State of Montana (Reg. #PEL-PE-LIC-59819). I have worked as a Geotechnical Engineer for a total of 8 years continuously since my graduation.
4. I have read the definition of "qualified person" set out in National Instrument 43-101 (NI 43-101) and certify that by reason of my education, affiliation with a professional association (as defined in NI 43-101) and past relevant work experience, I fulfil the requirements to be a "qualified person" for the purposes of NI 43-101.
5. I have not visited the Loma Larga Project.
6. I am responsible for parts of Section 16 and I share responsibility with my co-authors for Sections 16.3 of the Technical Report.
7. I am independent of the Issuer applying the test set out in Section 1.5 of NI 43-101.
8. I have no personal knowledge as of the date of this certificate of any material fact or change, which is not reflected in this Report.
9. Neither I, nor any affiliated entity of mine, is at present, under an agreement, arrangement or understanding or expects to become, an insider, associate, affiliated entity or employee of INV Metals Inc., or any associated or affiliated entities.
10. Neither I, nor any affiliated entity of mine, own, directly or indirectly, nor expect to receive, any interest in the properties or securities of INV Metals Inc., or any associated or affiliated companies
11. I have read NI 43-101, and the Technical Report has been prepared in compliance with NI 43-101 and Form 43-101F; and have prepared the Report in conformity with generally accepted Canadian mining industry practice, and as of the date of the certificate, to the best of my knowledge, information and belief, the Technical Report contains all scientific and technical information that is required to be disclosed to make the Technical Report not misleading.

Dated this 11th day of January 2019.



Kathy Kalenchuk, Ph.D., P.Eng.
Principal Geomechanics Consultant



	Document Number	J01834-PM-REP-002	Rev	0	
	Date	11 January 2019	Page	415 of 417	



Certificate of Author

I, Paul Kaplan, P.E., as an Author of this report entitled “Technical Report on the Loma Larga Project, Azuay Province, Ecuador”, prepared for INV Metals Inc. and dated January 11, 2019, do hereby certify that:

I am a Principal with NewFields Mining Design & Technical Services (NewFields) with a business address at 1301 N. McCarran Blvd., Suite 101, Sparks, Nevada 89431

I am a graduate of Arizona State University, Tempe, Arizona, USA in 1980 with a B.S. in Civil Engineering and in 1983 with an M.S. in Civil Engineering.

I am registered as a Professional Engineer the following states in the USA: Nevada (8034), Washington (50215), Montana (16917), Utah (7667), and California (C046683). I have worked as a Civil Engineer for a total of 35 years continuously since my graduation.

I have read the definition of “qualified person” set out in National Instrument 43-101 (NI 43-101) and certify that by reason of my education, affiliation with a professional association (as defined in NI 43-101) and past relevant work experience, I fulfil the requirements to be a “qualified person” for the purposes of NI 43-101.

I visited the Loma Larga Project from 27 June to 29 June 2017.

I am responsible for parts of Sections 5.2, 18.6, 18.10.1, 21.1, 21.2 (FTSF CAPEX and OPEX), and I share responsibility with my co-authors for Sections 1, 2, 3, 24, 25, 26, and 27 of the Technical Report.

I am independent of the Issuer applying the test set out in Section 1.5 of NI 43-101.

I have no personal knowledge as of the date of this certificate of any material fact or change, which is not reflected in this Report.

Neither I, nor any affiliated entity of mine, is at present, under an agreement, arrangement or understanding or expects to become, an insider, associate, affiliated entity or employee of INV Metals, Inc., or any associated or affiliated entities.



Neither I, nor any affiliated entity of mine, own, directly or indirectly, nor expect to receive, any interest in the properties or securities of INV Metals, Inc., or any associated or affiliated companies

I have read NI 43-101, and the Technical Report has been prepared in compliance with NI 43-101 and Form 43-101F; and have prepared the Report in conformity with generally accepted Canadian mining industry practice, and as of the date of the certificate, to the best of my knowledge, information and belief, the Technical Report contains all scientific and technical information that is required to be disclosed to make the Technical Report not misleading.

Dated this 11th day of January 2019.

“signed and sealed”

Paul Kaplan, P.E.
Principal, NewFields

	Document Number	J01834-PM-REP-002	Rev	0	
	Date	11 January 2019	Page	416 of 417	

	PATERSON & COOKE	<i>1351-C Kelly Lake Road, Unit #2, Sudbury, Ontario P3E 5P5, Canada</i>
		<i>Tel: +1 705 222 1720, Fax: +1 705 222 1719</i>
		<i>Email: Sudbury@PatersonCooke.com, URL: www.PatersonCooke.com</i>



Certificate of Author

I, Leslie Correia, Pr. Eng., as an Author of this report entitled “Technical Report on the Loma Larga Project, Azuay Province, Ecuador”, prepared for INV Metals Inc. and dated January 11, 2019, do hereby certify that:

1. I am Engineering Manager, with Manager with Paterson & Cooke Canada Inc., with an office at 1351-C Kelly Lake Road, Unit #2, Sudbury, Ontario, P3E 5P5.
2. I am a graduate of University of Stellenbosch, Stellenbosch, Western Province, South Africa in 2005 with a bachelor’s degree in chemical engineering.
3. I am a member in good standing of the Engineering Council of South Africa (ECSA), License #20130236. My relevant experience is 12 years as an independent consultant.
4. I have read the definition of “qualified person” set out in National Instrument 43-101 (NI 43-101) and certify that by reason of my education, affiliation with a professional association (as defined in NI 43-101) and past relevant work experience, I fulfil the requirements to be a “qualified person” for the purposes of NI 43-101.
5. I have not visited the Loma Larga Project.
6. I am responsible for specific parts related to paste backfill in Sections 16.9 and 21.2.4 of the Technical Report.
7. I am independent of the Issuer applying the test set out in Section 1.5 of NI 43-101.
8. I have no personal knowledge as of the date of this certificate of any material fact or change, which is not reflected in this Report.
9. Neither I, nor any affiliated entity of mine, is at present, under an agreement, arrangement or understanding or expects to become, an insider, associate, affiliated entity or employee of INV Metals Inc., or any associated or affiliated entities.
10. Neither I, nor any affiliated entity of mine, own, directly or indirectly, nor expect to receive, any interest in the properties or securities of INV Metal Inc., or any associated or affiliated companies
11. I have read NI 43-101, and the Technical Report has been prepared in compliance with NI 43-101 and Form 43-101F; and have prepared the Report in conformity with generally accepted Canadian mining industry practice, and as of the date of the certificate, to the best of my knowledge, information and belief, the Technical Report contains all scientific and technical information that is required to be disclosed to make the Technical Report not misleading.

Dated this 11th day of January 2019.

 Leslie Correia, Pr. Eng.
 Engineering Manager

	Document Number	J01834-PM-REP-002	Rev	0	
	Date	11 January 2019	Page	417 of 417	



Certificate of Author

I, Katharine Masun, M.Sc., P.Ge., as an Author of this report entitled “Technical Report on the Loma Larga Project, Azuay Province, Ecuador”, prepared for INV Metals Inc. and dated January 11th, 2019, do hereby certify that:

1. I am a Senior Geologist with Roscoe Postle Associates Inc. of Suite 501, 55 University Ave Toronto, ON M5J 2H7.
2. I am a graduate of Lakehead University, Thunder Bay, Ontario, Canada, in 1997 with an Honours Bachelor of Science degree in Geology and in 1999 with a Master of Science degree in Geology. I am also a graduate of Ryerson University in Toronto, Ontario, Canada, in 2010 with a Master of Spatial Analysis.
3. I am registered as a Professional Geologist in the Province of Ontario (Reg. #1583). I have worked as a geologist for a total of 18 years since my graduation.
4. I have read the definition of “qualified person” set out in National Instrument 43-101 (NI 43-101) and certify that by reason of my education, affiliation with a professional association (as defined in NI 43-101) and past relevant work experience, I fulfil the requirements to be a “qualified person” for the purposes of NI 43-101.
5. I visited the Loma Larga Project from February 17 to 20, 2014.
6. I am responsible for Sections 7 to 12, 14, and 23, and related disclosure in Sections 1, 2, 3, 24, 25, 26, and 27 of the Technical Report.
7. I am independent of the Issuer applying the test set out in Section 1.5 of NI 43-101.
8. I have no personal knowledge as of the date of this certificate of any material fact or change, which is not reflected in this Report.
9. Neither I, nor any affiliated entity of mine, is at present, under an agreement, arrangement or understanding or expects to become, an insider, associate, affiliated entity or employee of INV Metals Inc., or any associated or affiliated entities.
10. Neither I, nor any affiliated entity of mine, own, directly or indirectly, nor expect to receive, any interest in the properties or securities of INV Metals Inc., or any associated or affiliated companies
11. I have read NI 43-101, and the Technical Report has been prepared in compliance with NI 43-101 and Form 43-101F; and have prepared the Report in conformity with generally accepted Canadian mining industry practice, and as of the date of the certificate, to the best of my knowledge, information and belief, the Technical Report contains all scientific and technical information that is required to be disclosed to make the Technical Report not misleading.

Dated this 11th day of January 2019.

Katharine Masun (signed)

Katharine Masun, P.Ge.
Senior Geologist, RPA