



INTERNATIONAL FORESTRY SYMPOSIUM IFS 2016



PROCEEDINGS



DECEMBER 7-10, 2016 KASTAMONU UNIVERSITY, FACULTY OF FORESTRY, KASTAMONU, TURKEY



INTERNATIONAL FORESTRY SYMPOSIUM



7-10 December 2016

Kastamonu/TURKEY

KASTAMONU UNIVERSITY

Faculty of Forestry

PROCEEDINGS

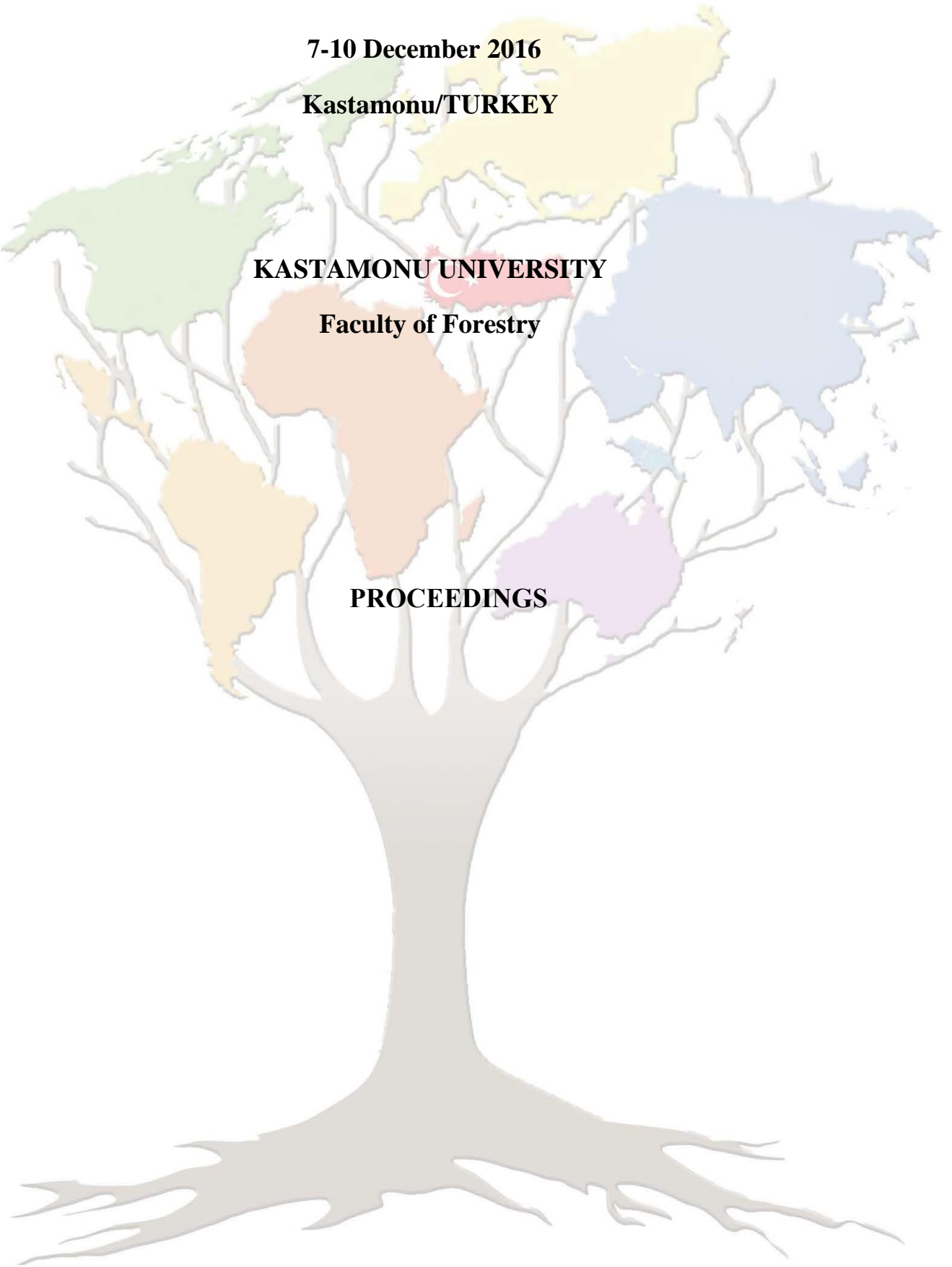



INTERNATIONAL FORESTRY SYMPOSIUM



THE COMMITTEE

Honorary Chair

Prof. Dr. Seyit AYDIN (Rector)

Symposium Chair

Prof. Dr. Ömer KÜÇÜK (Dean)

Symposium Secretariat

Dr. Oytun Emre SAKICI
Dr. Arif Oğuz ALTUNEL
Dr. Mahmut GÜR
Dr. Alperen KAYMAKCI
Dr. Hüseyin Barış TECİMEN

Organizing Committee

Dr. Erol AKKUZU
Dr. M. Hakan AKYILDIZ
Dr. Burak ARICAK
Dr. Arif Oğuz ALTUNEL
Dr. Tayyibe ALTUNEL
Dr. Burak ARICAK
Dr. Bahadır Çağrı BAYRAM
Dr. Seda ERKAN BUĞDAY
Dr. Korhan ENEZ
Dr. Mahmut GÜR
Dr. Alperen KAYMAKCI
Dr. Hacı İsmail KESİK
Dr. İnci Sevinç KRAVKAZ KUŞCU
Dr. Oytun Emre SAKICI
Dr. Temel SARIYILDIZ
Dr. Orhan SEVGİ
Dr. Ahmet SIVACIOĞLU
Dr. Gökhan ŞEN
Dr. Orhan SEVGİ

Dr. Gökhan ŞEN
Dr. Sabri ÜNAL
Dr. Nurcan DEMİRCİOĞLU YİĞİT
Dr. Gonca Ece ÖZCAN
Dr. Hüseyin Barış TECİMEN
Dr. Osman TOPAÇOĞLU
Dr. Önder TOR
Dr. Ferhat KARA
MSc. Hakan AYDOĞAN
MSc. Alper BULUT
MSc. Ekrem DURMAZ
MSc. Özkan EVCİN
MSc. Çağrı OLGUN
MSc. Mustafa ÖNCEL
MSc. Osman Emre ÖZKAN
MSc. Mehmet SEKİ
MSc. Tutku ÜÇÜNCÜ
MSc. Esra Nurten YER



INTERNATIONAL FORESTRY SYMPOSIUM



Scientific Committee

Dr. Sefa AKBULUT	Karadeniz Technical University
Dr. Süleyman AKBULUT	Düzce University
Dr. Erol AKKUZU	Kastamonu University
Dr. M. Hakan AKYILDIZ	Kastamonu University
Dr. A. Oğuz ALTUNEL	Kastamonu University
Dr. Tayyibe ALTUNEL	Kastamonu University
Dr. Burak ARİCAK	Kastamonu University
Dr. Saim ATEŞ	Kastamonu University
Dr. Sezgin AYAN	Kastamonu University
Dr. Miraç AYDIN	Kastamonu University
Dr. Emin Zeki BAŞKENT	Karadeniz Technical University
Dr. İbrahim BEKTAŞ	Kahramanmaraş Sütçü İmam University
Dr. Seda ERKAN BUĞDAY	Kastamonu University
Dr. Serdar CARUS	Süleyman Demirel University
Dr. Nihat Sami ÇETİN	İzmir Kâtip Çelebi University
Dr. Rudolf DERZENI	Transilvania University of Brasov
Dr. Elizabeth DODSON	Univesity of Montana
Dr. Korhan ENEZ	Kastamonu University
Dr. İlker ERCANLI	Çankırı Karatekin University
Dr. Sabit ERŞAHİN	Çankırı Karatekin University
Dr. Paoul M. FERNANDES	The University of Aberdeen
Dr. Yavuz GÜLOĞLU	Kastamonu University
Dr. Kerim GÜNEY	Kastamonu University
Dr. Alkan GÜNLÜ	Çankırı Karatekin University
Dr. Mahmut GÜR	Kastamonu University
Dr. Ümmü KARAGÖZ İŞLEYEN	Kastamonu University
Dr. Ferhat KARA	Kastamonu University
Dr. Selman KARAYILMAZLAR	Bartın University
Dr. Alperen KAYMAKCI	Kastamonu University
Dr. Hacı İsmail KESİK	Kastamonu University
Dr. Ramazan KURT	Bursa Technical University
Dr. İnci Sevinç KUŞCU	Kastamonu University
Dr. Ömer KÜÇÜK	Kastamonu University
Dr. Gonca Ece ÖZCAN	Kastamonu University
Dr. Ayhan ÖZÇİFTÇİ	Karabük University
Dr. Renato S. PACALDO	Mindanao State University
Dr. Oytun Emre SAKICI	Kastamonu University
Dr. Lubomír ŠÁLEK	Czech University of Life Sciences Prague
Dr. Temel SARIYILDIZ	Kastamonu University
Dr. Orhan SEVGİ	İstanbul University
Dr. Ahmet SIVACIOĞLU	Kastamonu University
Dr. Gökhan ŞEN	Kastamonu University
Dr. H. Barış TECİMEN	İstanbul University



INTERNATIONAL FORESTRY SYMPOSIUM



Scientific Committee

Dr. H. Barış TECİMEN
Dr. Fahrettin TİLKİ
Dr. Osman TOPAÇOĞLU
Dr. Önder TOR
Dr. Sabri ÜNAL
Dr. Hasan VURDU
Dr. Ahmet YEŞİL
Dr. Nurcan YİĞİT
Dr. George N. ZAIMES

İstanbul University
Artvin Çoruh University
Kastamonu University
Kastamonu University
Kastamonu University
Kastamonu University
İstanbul University
Kastamonu University
Eastern Macedonia and Thrace Institute of
Technology



INTERNATIONAL FORESTRY SYMPOSIUM



Supporting organizations

Special thanks to:



Contact

Kastamonu University,

Faculty of Forestry,
37100 Kastamonu, Turkey

Phone: +90 366 280 1702

Fax: +90 366 215 2316

ifs2016@kastamonu.edu.tr

<http://ifs2016.com>

Cover Design

Uzanlar Copy Center/Kastamonu

Printed by

Uzanlar Copy Center/Kastamonu

Copyright by Kastamonu University Faculty of Forestry. Authors are responsible for the contents of the proceedings.



PREFACE



The International Forestry Symposium is held on the Kastamonu city in Turkey which is covered approximately 65% forest lands. Thereby, it is great pleasure and honor for us to host all of you here at the Kastamonu University. We hope that the community and masses that will benefit from this symposium will be quite large. Since, there are total 253 studies as being 192 oral presentations and 61 posters from 13 countries- Belgium, Kenya, Brazil, Czech Republic, Greece, Kyrgyzstan, Bulgaria, Philippines, USA, Algeria, France, Macedonia and Turkey, have been submitted to this scientific activity. It is obvious that the symposium will create widespread benefits due to the large number of associations and contributions, thus utilization rate will also be high. We also expect that the symposium will contribute to forestry applications in terms of developing new broaden horizons and projections as in scientific areas. It is our aim that, as a result of this program, new projects and designs in the field of forestry will be developed. Due to the population growth, the rate of forest destruction increases day by day all over the world, thus every scientific study has a great importance for protection and rehabilitation of our forests.

Therefore, we would like to express our sincere thanks and appreciation to the International Forestry Symposium organized in Kastamonu city which has rich forest varieties and livable environment and we also would like to thank to valuable academicians and foresters with their great support and attendance to this symposium. We also would like to thank and congratulate the administrators and academicians of Kastamonu University, Faculty of Forestry and valuable staffs of our university for their great efforts. I would like to express my appreciation to all of our guests who showed interest in our symposium. I present my respects to meet with peace and happiness in new and successful symposiums.

Prof. Dr. Seyit AYDIN
Kastamonu University
Rector
Honorary Chair IFS 2016



PREFACE



Forests are ecosystems that interact with living and non-living things and contain ecological processes. Rapid population growth and industrialization in the world are generating serious pressures on forests that are one of the natural sources. Unfortunately, excessive and unaware utilizations in forests, misplaced practices and forest fires cause biological, ecological and financial losses. Forest areas have been gradually decreasing in many countries around the world. However, our country, Turkey is one of the countries that can increase its forest existence. Some countries have undergone changes in their understanding of forest management to protect, develop and operate forests that have been declining and shrinking globally and exposed to various biotic and abiotic factors.

We are becoming increasingly aware of the necessity of the importance of natural environment with the development in scientific and technological infrastructure. It is crucially and scientifically important to bring in new approaches and methods to increase the protection of forest and environment areas that can be effectively improved by scientists and professionals. With this perspective, the protection of ecosystems and its benefits for public are becoming the main principles of our duties.

In this conference, there has been a total of 253 proceedings by the scientists and professionals from 12 different countries such as US, France, Belgium, Greece, Brazil, Czech Republic and so on.

I deeply would like to express my sincere gratitude and appreciation to the president of Kastamonu University, Prof. Dr. Seyit Aydın. The efforts made by my colleagues in the Faculty of Forestry deserves the deepest appreciation to organize this conference. I would also like to thank to all the other supportive organizations.

I hope that this conference will provide an opportunity for an exclusive focus on the key issues relevant to forest and environment science. I, once again, would like to extend my hearties gratitude towards you all and wish you all the best.

Prof. Dr. Ömer KÜÇÜK
Kastamonu University
Dean of Forestry Faculty
Chairman of IFS 2016



CONTENTS



ORAL PRESENTATIONS

Effects of Landscape Pattern and Road Features on Wildlife Vehicle Collision: Çankırı-Kırıkkale Highway <i>Ali Uğur ÖZCAN, Mustafa Murat KUTLUTÜRK, Nuri Kaan ÖZKAZANÇ</i>	1
Determining Some Mammal Species by Camera-Trap Method: Case Study in Kastamonu Azdavay Kartdağı Wildlife Reserve Area <i>Özkan EVCİN, Erol AKKUZU, Ömer KÜÇÜK, Abdullah UGIŞ, Burhan GENÇAL, Sabri ÜNAL, Mertcan KARADENİZ</i>	9
Preliminary Results of the Observations on Oviposition and Predation Impact of <i>Rhizophagus grandis</i> Gyll. (Coleoptera: Monotomidae) on <i>Dendroctonus micans</i> (Kug.) (Coleoptera: Curculionidae) in Turkey <i>Hazan ALKAN AKINCI, Jean-Claude GRÉGOIRE</i>	16
Researches on the First Time Recorded Egg Parasitoid, <i>Telenomus euproctidis</i> (Wilcox) (Hym.: Scelionidae) of Brown-tail Moth, <i>Euproctis chrysorrhoea</i> L., (Lep.: Erebidae) on Oak (<i>Quercus infectoria</i> Oliver) in Çankırı, Turkey <i>Yalçın KONDUR, Ziya ŞİMŞEK</i>	22
Biology of <i>Phyllonorycter abrasella</i> (Duponchel) and <i>P.manni</i> (Zeller) and Pupa Parasitoids in Oak (<i>Quercus infectoria</i> Oliver) Forests in Çankırı (İndağı) <i>Yalçın KONDUR, Ziya ŞİMŞEK</i>	31
Pupal Parasitoids of Green Oak Tortrix [<i>Tortrix viridana</i> L. (Lepidoptera: Tortricidae)] in Çankırı, Turkey <i>Yalçın KONDUR, Ziya ŞİMŞEK</i>	40
Forest Fire Prevention System Based on a Hybrid Satellite-Cellular Wireless Network <i>Cenk ATLIĞ</i>	51
A Note on Turkish <i>Tomentella</i> <i>Ilgaz AKATA, Cem Tolga GÜRKANLI</i>	57
A New <i>Erysiphe</i> (Erysiphales) Record for Turkey <i>Şanlı KABAKTEPE, Ilgaz AKATA</i>	60
Investigation of Anti-Fungal Effect of Henna Plant <i>Çağlar AKÇAY, Cihat TAŞÇIOĞLU, Mesut YALÇIN</i>	64
Some Micromycetes Determined on <i>Alnus glutinosa</i> subsp. <i>glutinosa</i> in Küre Mountains National Park Forest Ecosystems <i>Makbule ERDOĞDU, Elşad HÜSEYİN</i>	68
New Records for Micromycota of <i>Juglans regia</i> L. on Level of Genera and Species. II <i>Faruk SELÇUK, Cem Can CEBECİ</i>	72
The Geographical Elements of Phyllostroph Microfungi from Black Sea Forest <i>Faruk SELÇUK</i>	76
Ecology and Economy of <i>Boletus</i> Species <i>Mertcan KARADENİZ, Sabri ÜNAL, Abdullah UGIŞ, Özkan EVCİN, Erol AKKUZU, Ömer KÜÇÜK</i>	80
Flora of Taşhyayla and Kızık (Bolu-Seben) Surrounding <i>Bilge TUNÇKOL, Ünal AKKEMİK</i>	84
Habitat and Phenological Properties of <i>Crocus ancyrensis</i> (Herbert) Maw <i>İnci Sevinç KRAVKAZ KUŞÇU, Hasan VURDU, Nurcan YİĞİT</i>	110



CONTENTS



Flora of Argözü Valley (Kıbrısçık-Bolu) <i>Neval GÜNEŞ ÖZKAN, Necmi AKSOY, Serdar ASLAN, Bilge TUNÇKOL, Nihan KOÇER</i>	115
The General Specifications of Order <i>Quercus cerridis-Carpinetalia orientalis</i> Akman, Quézel & Barbéro 1980 Fatmagül GEVEN, M. Ümit BINGÖL, Kerim GÜNEY, Tuğrul KÖRÜKLÜ, Ebru ÖZDENİZ, Osman KETENOĞLU	141
<i>Zelkova carpinifolia</i> (Pall.) C. Koch (Ulmaceae) in Turkey (Relict Tree): Floristics, Ecology, Distribution and Threats <i>Fatmagül GEVEN, Nezaket ADIGÜZEL</i>	147
The Ecological and Floristic Properties of <i>Pinus brutia</i> Ten. Community (Karaman- Ermenek) <i>Fatmagül GEVEN, Ayvaz ÜNAL, Sanem AKDENİZ ŞAFAK</i>	155
An Overview of Endemic Turkish Bryophytes <i>Gökhan ABAY</i>	164
The Responses of Water Potential, Total Carbohydrate Content and Photosynthetic Pigments of Kermes Oak (<i>Quercus coccifera</i> L.) to Summer Drought <i>Esra BAYAR, Ayşe DELİGÖZ</i>	171
Determination of Some Morphologic Properties of <i>Medicago arabica</i> L. (Huds) within Ecology of Bartın Province <i>Ayşe GENÇ LERMİ, Şahin PALTA</i>	177
Some Wild Plant Species Used in Cooking by Local People: Akçaabat Sample <i>Sefa AKBULUT, Mustafa KARAKÖSE, Zafer Cemal ÖZKAN</i>	185
Domestic Edible Landscaping Plants as Non-Wood Forest Products <i>Derya SARI</i>	189
Determining the Amounts of Aboveground Carbon Storage Using Landsat 8 Satellite Image in Crimean Pine Stands (<i>Pinus nigra</i> Arnold. subsp. <i>pallasiana</i> (Lamb.) Holmboe) <i>Alkan GÜNLÜ, İlker ERCANLI, Muammer ŞENYURT, Sedat KELEŞ</i>	197
Estimation of Carbon Sequestration for Sustainable Forest Management and Climate Change Mitigation <i>Nuray MISIR, Mehmet MISIR, Sinem ŞATIROĞLU</i>	202
Spatial Distribution of Stand Carbon in Even-Aged Mixed Forests <i>Ferhat BOLAT, Sinan BULUT</i>	208
The Place and Scope of Carbon in the Current Turkish Forest Policy Documents <i>Hasan Tezcan YILDIRIM, Seçil YURDAKUL EROL</i>	214
The Role of Urban Forests in Adaptation to Climate Change <i>Müge ÖZTÜRK</i>	222
Investigation of Forest Areas in Subalpine Zone towards Alpine Zone by Effect of Climate Change <i>Canan AÇIKGÖZ HARŞIT, Aydın TÜFEKÇİOĞLU, Mehmet KÜÇÜK, Musa DİNÇ</i>	228
Ecosystem Biomass of Oak Coppice in Turkey <i>Nuray MISIR, Sinem ŞATIROĞLU</i>	235
Recognizability of Officinal Plants in Artvin and Conscious Level on Plant Smuggling (Şavşat and Borçka Cities Sample) <i>Sevim İNANÇ, Hüseyin AYAZ, Özgür EMİNAĞAOĞLU</i>	240



CONTENTS



PES Mechanisms as Financing Source for Forest Resource Management and Their Applicability in Turkey <i>Ufuk DEMİRCİ, Atakan ÖZTÜRK, İnci Zeynep AYDIN</i>	248
Determination of Bay Leaf Production-Marketing Possibilities and Profile of Bay Leaf Collector (Case Study of Aladag District) <i>Ahmet ŞAHİN, Yeşim AYTÖP, Yunus ŞAHİN, Tuğba YILDIZ</i>	257
Economics and Industry of Non-Wood Forest Products in Turkish Forestry <i>Mustafa Fehmi TÜRKER, Emine Nur YEŞİLYURT</i>	262
Resolution of Turkish Forestry's Non-Wood Forest Products Management Issues with the Root Problem Approach <i>Mustafa Fehmi TÜRKER, Canan YILMAZ, Emine Nur YEŞİLYURT</i>	268
Determination of the Competition Level inside the Organization in the Marketing Activities: The Case Study in Kastamonu Forest Regional Directorate <i>Seda ERKAN BUĞDAY, Sezgin ÖZDEN</i>	274
Developing and Prioritizing Alternative Strategies for Establishing Honey Forests (Sample of Bartın) <i>Ersin GÜNGÖR, Elif ÖZKAN GÜNGÖR</i>	282
Contributions of Recreational Hunters in Sustainable Forestry Resources Management and in National Economy <i>Sultan BEKİROĞLU</i>	291
Evaluations on Stumpage Sales in Turkey <i>Adem GENÇ, Tevfik DEDEBAŞ, Rüknettin TEKDEMİR</i>	303
Evaluations of Relations Between the Wood-Based Panel Sector and State in Turkey <i>Tevfik DEDEBAŞ, Adem GENÇ, Rüknettin TEKDEMİR</i>	305
A Research on Previously Estimated the Cost of Fire Fighting (The Case of Taşköprü) <i>Gökhan ŞEN, Seda ERKAN BUĞDAY</i>	307
The Impacts of FSC Certification Process on Keles Forest Enterprise <i>Özgen DURSUN, İsmet DAŞDEMİR</i>	317
Thoughts and Challenges on Forest Certification in Turkey <i>Ahmet SIVACIOĞLU</i>	330
Examination of Protected Areas in Turkey in the Context of National Forestry Program <i>İnci Zeynep AYDIN, Atakan ÖZTÜRK, Mustafa Fehmi TÜRKER, Ufuk DEMİRCİ</i>	335
Monitoring within the Protected Areas; Case of Küre Mountains National Park <i>Ercan GÖKYER, Melih ÖZTÜRK</i>	346
Plant Diversity Assessment in Critically Threatened Forests to Inform Policy in Kenya-A Case Study of Nyekweri Forest <i>Vincent MAINGA, William OJWANG, Christopher CHESIRE</i>	351
Evaluation of Forest Villagers' Perceptions about Protection Activities in Kastamonu Region and Their Integration Possibilities to Forest Planning <i>Gonca Ece ÖZCAN, Oytun Emre SAKICI</i>	360
Chemical Silviculture for Wildlife Management in Forestry <i>Derya EŞEN</i>	375
Effects of Seedling Age on Survival and Growth Performance in Artificial Regeneration Practices of Oriental Beech (<i>Fagus orientalis</i> Lipsky.) <i>Halil Barış ÖZEL, Nebi BİLİR, Uğur ÇAKMAKLI</i>	384



CONTENTS



Effect of Water Stress of the Substrate on Seeds Germination of <i>Abies numidica</i> De Lannoy in Algeria <i>Malika HACHI-ILLOUL, Arezki DERRIDJ, Bruno FADY</i>	393
Determination of Potential Rehabilitation Areas Using by Dynamic Analytical Hierarchy Process (DAHP) Method and Geographic Information Systems (GIS) in the Bartın-Sökü Forest Range District in Turkey <i>Selman KARAYILMAZLAR, Halil Barış ÖZEL, Tuğrul VAROL, Hande Nur VAROL</i>	400
Effect of Crown Position on Midday Water Potential of <i>Cedrus libani</i> Trees <i>Ayşe DELİGÖZ, Esra BAYAR, Fatma Gökçe CANKARA</i>	409
Potential of Wild Service Tree (<i>Sorbus torminalis</i> L. Crantz) for Turkish Forestry <i>Derya EŞEN</i>	416
Identifying the Potential of Old Growth Forest Area in Altıparmak Forest Planning Units <i>Hacı Ahmet YOLASIĞMAZ, Burak ÇAVDAR</i>	422
Effects of Precipitation on the Soil at Pure and Mixed Stands of Black Pine and Scotch Pine (The Case of Daday) <i>Senem GÜNEŞ ŞEN, Miraç AYDIN</i>	431
Effect of Different Land Uses on Soil Erosion Losses in Semi-Arid Region: Idris Mountain-Ankara <i>Ali Uğur ÖZCAN, Semih EDİŞ</i>	441
Creating Erosion Risk Map Using Remote Sensing Techniques and ICONA Method: A Case Study of Bertiz Stream Watershed <i>Mahmut REİS, Nedim KAYA, Hurem DUTAL, Nurşen BOLAT</i>	447
Effects of River Type Hydropower Plants on Water Quality in Solaklı Watershed <i>Necla KORALAY, Ömer KARA, Uğur KEZİK</i>	454
Comparison of Water Quality Regulation Service of Different Ecosystems <i>Betül UYGUR, Yusuf SERENGİL</i>	463
A Working Framework of Non Wood Forest Products Integrated Forest Management Planning Concept <i>Emin Zeki BAŞKENT, Derya Mumcu KÜÇÜKER</i>	471
Optimum Cutting Ages Including Wood Production and Carbon Sequestration Benefits in Maritime Pine Reforestations <i>Sedat KELEŞ</i>	476
The Statistical Investigation of Stand Type Discrimination of Pure Calabrian Pine Forests in Antalya and Mersin Region of Turkey <i>Abdurrahman ŞAHİN, Aydın KAHRİMAN, Mehmet YAVUZ, Turan SÖNMEZ</i>	481
Preparation of Olur Planning Unit's Silviculture Plan <i>Hacı Ahmet YOLASIĞMAZ, Sinan GÜNER</i>	490
Bulgarian Forests and Forest Management <i>Anna PETRAKIEVA, Neno ALEXANDROV, Marius DIMITROV, Milko MILEV</i>	503
Stump Diameter and Diameter at Breast Height Relationship for Chestnut (<i>Castanea sativa</i> Mill.) Stands in Kastamonu Coastal Region <i>Fadime SAĞLAM, Oytun Emre SAKICI, Mehmet SEKİ</i>	514
Modeling Diameter Distributions of Black Pine Stands in Taşköprü Region <i>Oytun Emre SAKICI, Mehmet SEKİ, Fadime SAĞLAM, Mehmet Hakan AKYILDIZ</i>	521



CONTENTS



Using Artificial Neural Network in Describing Diameter Distribution in an Even-Aged Forest <i>Ferhat BOLAT, İlker ERCANLI</i>	536
Single and Double Entry Tree Volume Equations for Crimean Pine Trees in Çankırı-Eldivan Forest Areas <i>Muammer ŞENYURT, İlker ERCANLI, Ferhat BOLAT</i>	542
Altitude Based Leaf Area Index Analysis for a Pure Stand of <i>Quercus petraea</i> [Matt.] Liebl. Along a Mountain Transect in Bartın Forestry Administration of Turkey <i>Melih ÖZTÜRK, İlyas BOLAT, Ercan GÖKYER, Ömer KARA</i>	548
Predicting Oriental Spruce and Scots Pine Tree Diameter Increments Based on Artificial Neural Network Located in Mixed Oriental Spruce-Scots Pine Stands at Trabzon and Giresun Forest District <i>İlker ERCANLI, Aydın KAHRİMAN, Hakkı YAVUZ</i>	554
Variation in Soil and Forest Floor Characteristics and Soil Carbon and Nitrogen Stock Capacity with <i>Rhododendron</i> ssp. <i>Temel SARIYILDIZ, Gamze SAVACI</i>	559
Slope Effect on Soil Microbial Biomass in Black Pine Stands Subjected to Ground Fire <i>Musa AKBAŞ, Miraç KILIÇ, Aydın TÜFEKÇİOĞLU, Bülent SAĞLAM</i>	571
Response of Soil Moisture, Temperature and Some Soil Properties to Forest Removal in a Broadleaf Forest Ecosystem <i>Mustafa AYTEKİN, Ferhat GÖKBULAK, Hayati TEKİN</i>	580
Comparison of Water Consumption by Needle and Broad-Leaved Tree Species in the First Month of Growing Season <i>Mehmet S. ÖZÇELİK, Kamil ŞENGÖNÜL, Ferhat GÖKBULAK</i>	589
Effect of Aspect and Soil Properties on Forest Road Platform Deformation <i>Çiğdem ÖZER GENÇ, Burak ARICAK</i>	594
Productivity of the MB Trac 900 Tractor at the Mixed Conifer Stands: An Example of Artvin Forest in Turkey <i>Sadık ÇAĞLAR</i>	601
Customization and Automation of Geoprocessing with Python in ArcGIS for Natural Hazards and Forestry-related Applications <i>Remzi EKER, Abdurrahim AYDIN</i>	608
Automatic Extraction of Drainage Networks through Digital Elevation Models <i>Pakize TORUN, Arif Oğuz ALTUNEL</i>	619
Assessing Productivity and Work Safety of a Mechanized Logging Operation <i>Abdullah E. AKAY, Didem ÖZKAN, Ebru BİLİCİ</i>	624
Genome Projects and Transcriptomics Studies in Forest Trees <i>Mehmet Cengiz BALOĞLU</i>	630
Evaluating the Effects of Abiotic Stress Factors by Gene Level on Forest Trees <i>Yasemin ÇELİK ALTUNOĞLU</i>	636
Determination of Dimensional Stability of Wood Bonded with the Combination of Phenol-Formaldehyde and Bio-oil <i>Günay ÖZBAY, Nadir AYRILMIŞ</i>	641
Elastic Constants of Calabrian Pine and Cedar <i>Ergün GÜNTEKİN, Tuğba YILMAZ AYDIN, Murat AYDIN</i>	645
Some Physical and Mechanical Properties of Juvenile Chestnut Shoots <i>Nusret AS, Hüseyin AKKILIÇ, Murat KÖSE</i>	650



CONTENTS



Determination of Decay Resistance and Formaldehyde Content of OSB Produced with Different Adhesives	654
<i>Yasin KOÇ, Hacı İsmail KESİK, Sefa DURMAZ, Mahmut GÜR</i>	
Effects of Some Retention Chemicals on Physical Properties of Some Packing Papers	658
<i>Ahmet TUTUŞ, Tamer SÖZBİR, Mustafa ÇİÇEKLER</i>	
An Overview of Non-Destructive Strength Grading of Structural Timber	663
<i>Türker DÜNDAR</i>	
Determination of Minimum Bending Radius of Some Wood Species Grown in Turkey	670
<i>Nusret AS, Ümit BÜYÜKSARI</i>	
Investigation of the Corrosion Effect of CCB (Cooper, Chromium, Boron) Wood Preservative on Stainless Steels	675
<i>Çağlar AKÇAY, Hüsnü GERENGİ, Cihat TAŞCIOĞLU</i>	
Mold Resistance of Scotch Pine (<i>Pinus sylvestris</i>) Sapwood Treated with Geothermal Water	685
<i>Mesut YALÇIN, Çağlar AKÇAY, Hüseyin SİVRİKAYA, Camille FREITAG, Jeffrey J. MORRELL</i>	
Effect of Adhesive Formulation on the Physical and Mechanical Properties of Particleboard	689
<i>Mehmet Erdal KARA, Nadir AYRILMIŞ</i>	
The Selection of Samples with AHP Method in the Experimental Study: Bending Strength Test Sample	694
<i>Erol İMREN, Ahmet CAN, Rifat KURT, Hasan KURBAN</i>	
Micro-Mechanical Tension and Compression Strength of Oak Wood and Comparison with Standard Test Sample Results	699
<i>Türker DÜNDAR, Nusret AS, Ümit BÜYÜKSARI</i>	
Some Mechanical Characteristics of Thermal Modified Poplar Wood Boards	705
<i>Ekrem DURMAZ, Tutku ÜÇÜNCÜ, Alperen KAYMAKCI</i>	
The Effect of Heat Treatment and Coupling Agent on Long Term Water Absorption and Dimensional Stability of Wood Plastic Composites	712
<i>Mürşit TUFAN, Türker GÜLEÇ, Emrah PEŞMAN, Nadir AYRILMIŞ, Sezer SOLAK, Alperen KAYMAKCI</i>	
Feasibility of Incorporating <i>Ailanthus altissima</i> (Mill.) Swingle Wood in Particleboard Composite	718
<i>Selahattin BARDAK, Gökay NEMLİ</i>	
Determination of Structural Changes under SEM on Heat Treated Wood Exposed to Accelerated Weathering	726
<i>Mehmet Hakan AKYILDIZ, Mehmet KARAMANOĞLU</i>	
Investigation of Dyestuff Obtained from Elderberry (<i>Sambucus nigra</i> L.) Seeds in the Coloring Process of Paper	736
<i>Ayhan GENCER, Ahmet CAN</i>	
The Combined Effects of Copper and Oil Treatment on Wood Chemical Properties	741
<i>Ahmet CAN, Hüseyin SİVRİKAYA</i>	
Chemical Modification of Cellulose for Use in Composites	749
<i>Nihat Sami ÇETİN, Nilgül ÖZMEN</i>	
Decay Resistance Evaluation of Chemically Modified Wood Flour Filled Thermoplastic Composites	754
<i>Eylem DİZMAN TOMAK, Ayfer DÖNMEZ ÇAVDAR, Kadir KARAKUŞ</i>	



CONTENTS



Decay Resistance of Scots Pine Wood Impregnated by Organic Solvent and Tannin <i>Mahmut Ali ERMEYDAN, Eylem DİZMAN TOMAK, Oktay GÖNÜLTAS</i>	763
The Comparison of Fibre Morphologies of Growing Some Tree Woods in Turkey Naturally <i>Ekrem DURMAZ, Saim ATEŞ</i>	771
Mineral Oils in Recycled Food Packaging <i>Gülnur MERTOĞLU ELMAS</i>	778
A Research on Particle Board Factory by Utilization of Integer Linear Programming <i>Yunus ŞAHİN, Hasan SERİN</i>	785
Economic Awareness and Knowledge Level of Managers: A Sample of Forest Products Industry <i>Hasan SERİN, Muhammet DURGUN</i>	790
Factors Affecting Job Satisfaction and Performance of Forestry Workers in Turkey <i>Kadri Cemil AKYÜZ, Aytaç AYDIN, Tarık GEDİK, İbrahim YILDIRIM, İlker AKYÜZ</i>	796
Research on Noise Level of Wood Processing Machine Groups <i>Hasan SERİN, Semih DEMİR</i>	806
Conservation of Heat-treated Pine Surfaces with Nano Particles Filled Acrylic Varnishes <i>Soner AKSU, Orhan KELLEÇİ, Abdullah İSTEK, Deniz AYDEMİR</i>	814
Combined Effect of Heat Treatment and Varnishes on Thermal Conductivity of Fir and Beech Wood <i>Hamiyet ŞAHİN KOL, Erkan Sami KÖKTEN, Günay ÖZBAY</i>	819
The Determination of the Surface Adhesion Resistance and Pendulum Hardness Values on Laminated Parquets of a UV System Varnish Applied Oak Wood Derived by Using Different Water-Based Paints <i>Ümit AYATA, Levent GÜRLEYEN, Nevzat ÇAKICIER</i>	827
Effect of Heat-Treatment on Some Properties of Wood Plastic Composites <i>Emre BİRİNCİ, Alperen KAYMAKCI, Türker DÜNDAR, Nadir AYRILMIŞ</i>	832
The Determination of Visual Quality Assessment in Landscape in Urban Environment: “A Case Study of Kastamonu Castle Environment” <i>Sevgi ÖZTÜRK, Elif AYAN</i>	839
Agroforestry Landscapes for Traditional Rural Settlement Characteristics <i>Canan CENGİZ, Feride Kübra TAY</i>	846
Natural Children Playgrounds Which are Suitable for Kastamonu City’s Identity <i>Çiğdem SAKICI, Türkan Sultan YAŞAR ISMAIL, Elif AYAN</i>	854
Investigating Landscape Value of Urban Forests in Gaziantep <i>Müge ÖZTÜRK</i>	762
Evaluation of the Recreational Potential of Kastamonu Urban Forest <i>Hakan ŞEVİK, Mehmet ÇETİN</i>	868
Effects of the Recreational Aspect of Urban Forests on Ecology <i>Ertan DÜZGÜNEŞ, Elif BAYRAMOĞLU, Öner DEMİREL</i>	874
Recreational Usage of Urban Forests: The Case of Trabzon City <i>Makbulenur BEKAR, Müberra PULATKAN, Nilgün GÜNEROĞLU</i>	881
The Visitor Satisfaction of Munzur Valley National Park <i>Sevgi ÖZTÜRK, Korhan ENEZ</i>	887
Sustainable Future of Bolu-Köroğlu Uplands in terms of Ecotourism <i>Bülent CENGİZ, Başak ERTEM MUTLU</i>	892



CONTENTS



Visual Characteristics of Northern Anatolian Forest Roads in Turkey <i>Engin EROĞLU, Habip EROĞLU</i>	901
POSTER PRESENTATIONS	
Producing of Predatory Insect <i>Calosoma sycophanta</i> (L.) by Using Different Food Sources in Laboratory Conditions to Use in Biological Control of <i>Lymantria dispar</i> (L. 1758) (Lepidoptera:Lymantriidae) <i>Yaşar AKSU, Cihangir DEDEAĞAOĞLU, Berna Ç. GÖKTÜRK</i>	906
Effects of the Global Climate Change on Resin Production in Forest Trees and Harmful Insect Outbreaks <i>Yalçın KONDUR, Ceyhan GÖL</i>	911
An Investigation on Decline of Scots Pine (<i>Pinus sylvestris</i> L.) in Kastamonu Kadıdağı Recreation Site <i>Sabri ÜNAL, Mertcan KARADENİZ, Erol AKKUZU, Ömer KÜÇÜK, Özkan EVCİN, Abdullah UGIŞ</i>	916
Ecological Features and Distribution Areas in Turkey of <i>Quercus robur</i> L. <i>Fatmagül GEVEN, Ebru ÖZDENİZ, Kerim GÜNEY, Latif KURT</i>	922
Evaluation of Turkey and China INDC Documents in the Context of Climate Changes 21 st Parties Conference <i>Gül TEKİNGÜNDÜZ</i>	930
A Study on Job Satisfaction of Employees in the Düzce Forest District Directorates <i>Derya SEVİM KORKUT, Gamze ÇINAR ŞAHİN</i>	939
The Effects of The Demographic Development on Land Use Change in the Boğalı Catchment <i>Ceyhan GÖL, Meltem YILMAZ</i>	945
Discussion of Objectives and Strategies of the Turkish Forestry Industry on Basis of Development Plans <i>Mustafa Fehmi TÜRKER, Canan YILMAZ, Emine Nur YEŞİLYURT, Elif BERKER</i>	953
Chestnut Flour; White Gold <i>Selim TOKMAK</i>	959
The Economic Effects on Forest Villagers of ORKÖY's Beekeeping Investments (Case Study: Beekeeping Investments in Forest Villages in the Western Mediterranean Region) <i>Ufuk COŞGUN, K. Hale GÜLER</i>	964
Potential of Waste Paper Management Practices of Istanbul's Hotels in Sustainability of Forests <i>Gülnur MERTOĞLU ELMAS</i>	969
Economic Contribution of Waste Paper Recycling (Example of Istanbul's Hotels) <i>Sultan BEKİROĞLU, Gülnur MERTOĞLU ELMAS</i>	973
Assessment of Natural and Artificial Regeneration in Burned Turkish Red Pine (<i>Pinus brutia</i> Ten.) Stand: Case Study of Adana Region <i>Zafer YÜCESAN, Ali Ömer ÜÇLER, Ercan OKTAN, Öznur UÇAK, Sena KARAPINAR</i>	982
Effect of Topography (Aspect and Slope Position) on Soil Properties and Soil Organic Carbon and Total Nitrogen Stock Capacity in Kastamonu Forest, Turkey <i>Temel SARIYILDIZ, Gamze SAVACI</i>	987



CONTENTS



Fiber Morphology of Alder (<i>Alnus glutinosa</i> L. Gaertner) Wood Grown in Natural and Planted Stands <i>Kamile TIRAK HIZAL, Nurgün ERDİN</i>	1002
Determination of Glossiness and Color Values on Laminated UV System Varnish Applied Parquets That are Derived by Using Different Water-Based Paints on Oak Wood <i>Levent GÜRLEYEN, Ümit AYATA, Nevzat ÇAKICIER</i>	1007
The Effect of Using Siriono and Boric Acid on the Combustion Performance in Particleboard Production <i>Abdullah İSTEK, İsmail ÖZLÜSOYLU</i>	1012
The Effect of Moisture Content on the Screw Holding Capacity of Birch and Pine Plywood <i>Bekir Cihad BAL</i>	1020
The Effect of the Type of Combination on the Screw and Nail Withdrawal Strength of Eucalyptus and Poplar LVL <i>Bekir Cihad BAL</i>	1026
The Investigation of Changes in Landscape Architecture on the Coastline of Doganyurt <i>Mehmet ÇETİN</i>	1031
Assessment of the Sustainable Tourism Potential of a Natural Park for Landscape Planning: A Case Study of the Yesilyuva Nature Park <i>İlknur ZEREN, Hatice AKARSU, Hakan ŞEVİK, Mehmet ÇETİN</i>	1035
Assessment of the Area of Biocomfort for Kastamonu Forest <i>İlknur ZEREN, Hatice AKARSU, Hakan ŞEVİK, Mehmet ÇETİN</i>	1042
Anthropogenic Risks Encounter in Forestry Applications <i>Seçil AYANOĞLU, Ebru GÜL, Melda DÖLARSLAN, Sabit ERŞAHİN</i>	1047
Evaluation of Çankırı Yapraklı Hazım Dağı Natural Park in terms of Occupational Health and Safety <i>Seçil AYANOĞLU, Melda DÖLARSLAN, Ebru GÜL, Sabit ERŞAHİN</i>	1050
Determination and Assessment of Some Heavy Metal Pollution Soils of Urban Parks in Bingöl Province <i>Yasin DEMİR, Azize DOĞAN DEMİR, Alperen MERAL, Ezgi DOĞAN</i>	1055
Antibiotic Resistance of <i>Bacillus</i> Species Isolated from Diesel Fuel Polluted Soil <i>Belgin ERDEM, Alpaslan DAYANGAÇ, Merve GÜNAYDIN</i>	1060

Effects of Landscape Pattern and Road Features on Wildlife Vehicle Collision: Çankırı-Kırıkkale Highway

Ali Uğur ÖZCAN^{1,3}, Mustafa Murat KUTLUTÜRK²,
*Nuri Kaan ÖZKAZANÇ³

¹Çankırı Karatekin University, Faculty of Forestry, Çankırı / TURKEY

²Çankırı Karatekin University, Faculty of Economics and Administrative Sciences, Çankırı / TURKEY

³Bartın University, Faculty of Forestry, Bartın / TURKEY

*Corresponding Author: ozkazancnkaan@hotmail.com

Abstract

Roads and traffic have various negative ecological and environmental effects on wildlife. The effects of traffic and roads on animal populations are not limited to deaths. Division of the migration routes of wildlife into equal parts by roads, misinterpretation of the roads by the animals as a result of their mobility on the open road corridors, presence of new nutritional sources like carrions near the roads and the surroundings of the roadsides being ecological threat for some species can be considered as other effects. Along with this; isolation, traffic noise, night lights, pollution, management activities on road borders, increasing human entrances, artificial sets and erosion have a great deal of effect on the quality of wildlife habitats. We examined (i) which species are killed to Wildlife-Vehicle Collision (WVC) (ii) the effect of traffic volume (iii) the effect of road features and landscape patterns for wildlife (medium-big sized mammalia) vehicle collision on Çankırı-Kırıkkale Highway between May-October 2014. We tested to correlation between variables using logit regression analysis method for expressing two qualitative case that is fatal accident or not. Data of 58 accidents on the road with casualties of six species in total was collected. 16 accidents with casualties occurred on the part of the road with low traffic volume and 42 accidents with casualties occurred on the part with middle traffic volume. The animals mostly died were 27 hedgehogs *Erinaceus concolor*, 21 red foxes *Vulpes vulpes*. The our model indicates that probability of occurrence of WVC decreased when slope, road width, road speed limit, distance from forest area, extensive agriculture area and grassland area increased.

Keywords: Landscape pattern, Road features, WVC, Çankırı-Kırıkkale Highway

Yaban Hayatı-Araç Çarpışmaları Üzerine Peyzaj Deseni Ve Yol Özelliklerinin Etkileri: Çankırı-Kırıkkale Karayolu

Özet

Yol ve trafik yaban hayatı üzerinde ekolojik ve çevresel olarak negative etkilere sahiptir. Yaban hayatı popülasyonları üzerine yol ve trafiğin etkisi ölümlerle sınırlı değildir. Göç yolları ve yaşam alanı veya bölgesi yollar tarafından eşit parçalara bölünmesi, hayvanların açık yol koridorları boyunca hareket etmesi sonucunda trafikte birbirine karıştırması, leş ve beslenme gibi yeni besin kaynaklarının yol koridorlarında mevcudiyeti ve yol kenarının çevresi bazı türler için ekolojik tuzak etkisini göstermesi olarak söylenebilir. Bununla birlikte; izolasyon, trafik gürültüsü, gece ışıkları, kirlilik (tuz, ağır metaller, herbisit, nitrojen kirleticiler), yol sınırlarındaki yönetim aktiviteleri, insan girişlerinin artması, yapay setler ve erozyonun habitat kalitesi üzerindeki büyük etkiye sahip olması göz önünde bulundurulmalıdır. Bu çalışmada Mayıs-Ekim 2014 tarihleri arasında (i) yaban hayatı-araç çarpışmaları (YAÇ) ile ölen hayvan türleri (ii) trafik hacminin etkisi (iii) Çankırı-Kırıkkale Karayolu üzerinde yaban hayatı-araç çarpışmaları için yol ve peyzaj özelliklerinin etkileri incelenmiştir. Biz ölümlü kaza olup olmadığı ile ilgili iki nitel durumu açıklamak için logit regresyon analiz methodunu kullanarak değişkenler arasındaki ilişkiyi test ettik. Yol üzerinde 6 türe ait 58 kaza verisi toplandı. Yolun düşük yoğunluğa sahip kısmında 16 kaza ve orta yoğunluğa sahip kısmında 42 kaza meydana gelmiştir. Hayvanlar içersinde en çok 27 kirpi *Erinaceus concolor* ve 21 tilki *Vulpes vulpes* ölmüştür. Bizim modelimiz eğimin, yol genişliğinin, hız sınırının, ormana, meraya ve tarım alanlarına olan uzaklığın azaldığında YAÇ meydana gelme olasılığının arttığını göstermiştir.

Anahtar kelimeler: Peyzaj deseni, Yol özellikleri, YAÇ, Çankırı-Kırıkkale Karayolu

Introduction

Roads and traffic have various negative ecological and environmental effects on not limited to deaths. Division of the migration routes of wildlife into equal parts by roads, misinterpretation of the roads by the animals as a result of their mobility on the open road corridors, presence of new nutritional sources like carrions near the roads and the surroundings of the roadsides being ecological threat for some species can be considered as other effects (Harris and Scheck, 1991). Along with this; isolation, traffic noise, night lights, pollution (salt, heavy metals, herbicide, nitrogen polluters), management activities on road borders, increasing human entrances, artificial sets and erosion have a great deal of effect on the quality of wildlife habitats (Forman and Alexander, 1998; Huijser, 1999; Forman et al., 2003). The effect zone of these factors is not limited to roads and road sides. The effect zone can reach from a few meters to a few kilometers depending on these factors.

The locations for taking precautionary measures to reduce wildlife-vehicle collisions are of utmost importance. The high cost of physical structures such as ecological bridges may constrain such structures. Models that estimate the points of location may have an economical and practical significance. Models can be used to predict locations of the segments of roads with high probability of collision and risky, specific passage points (Malo et al., 2004). Recent studies (Finder et al., 1999; Clevenger, et al., 2003, Gunson et al., 2011; Snow et al., 2015) have shown that wildlife-vehicle collisions involving wild animals are modeled temporally (Philcox et al., 1999, Mysterud, 2004; Orłowski and Nowak, 2006; D'Amico et al., 2015) and spatially (Clarke et al., 1998, Malo et al., 2004; Ramp et al., 2005; Grilo et al. 2009). Temporal variations in road deaths are associated with the behavior and the activity of species (Grilo et al., 2009). Moreover, WVC appear to depend on population density, species biology, habitat and landscape, road and traffic characteristics and clustered as spatial (Clevenger et al., 2003 and Malo et al., 2004; Grilo et al., 2009). Various variables have been used in

wildlife (Trombulak and Frissell, 2000; Fahrig and Rytwinski, 2009). The effects of traffic and roads on wildlife populations are many studies to model wildlife-vehicle collisions and in such analyses, multiple spatial scales have been considered at road characteristics and landscape level (Finder et al., 1999; Clevenger et al., 2003; Malo et al., 2004; Ramp et al., 2005; Seiler, 2005; Borda-de-Água et al., 2011; Snow et al., 2015). Traffic volume (Cureton and Deaton, 2012), vehicle speed (Jaarsma et al., 2006), vegetation canopy of the adjacent land (Ramp et al., 2005), roadside topography (Clevenger et al., 2003), and the type of underpass-overpass in the vicinity (Clevenger et al., 2003; Malo et al., 2004) are important landscape and road characteristics that affect wildlife-vehicle collisions.

In this study on vehicle collisions with medium-sized mammals on Çankırı-Kırıkkale highway, we investigated (i) which animal species were involved in accidents more frequently, (ii) the impact of the traffic density on these accidents and (iii) the impact of road and landscape conditions on accidents.

Method

Nearly 94 km part of the Çankırı-Kırıkkale 765 (05-06-07) Highway was defined as the study area (Figure 1). The territory where the road course is located forms a rough topography and is between

650-950 m in elevation. The landscape has been exposed to anthropogenic effects in general and there are mostly agricultural areas. Some areas are dominated by pastures. Kızılırmak, Tüney and Tatlıçay streams are parallel to each other along the road course.

The speed limit for vehicles on the Çankırı-Kırıkkale Highway is 110 km h⁻¹, it is 90 km h⁻¹ for trucks, busses and rigs. The highway is made up of two parts as low and middle density. The data of the traffic density are obtained from two vehicle measurement station belonging to General Directorate of Highways in hourly averages according to vehicle type monthly. The data are given as the total of the both ways. The vehicle density was nearly 1818 vehicle day⁻¹ on the low traffic volume part on work period, and it was 4680 vehicle day⁻¹ on middle traffic volume part.

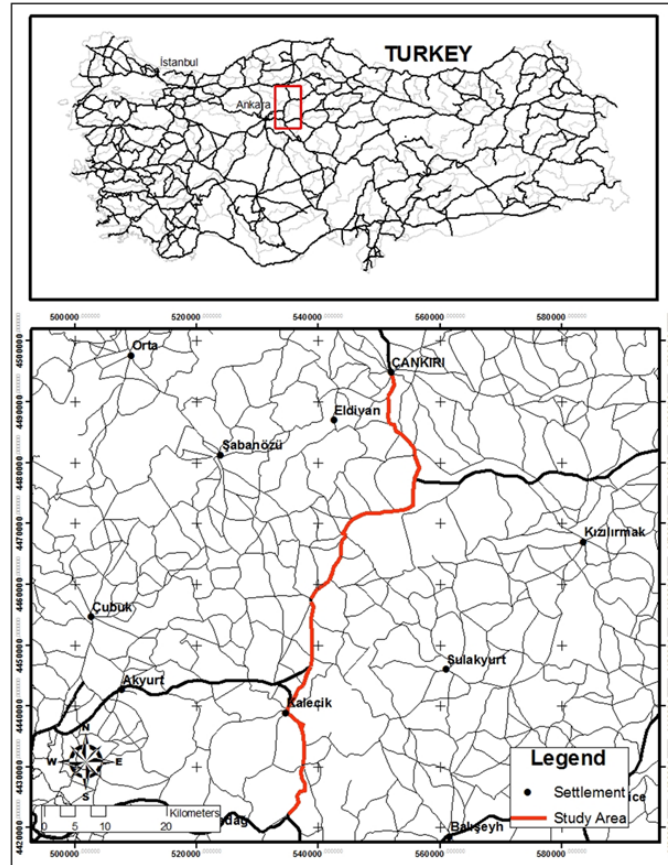

Figure 1. Study area

The number of wildlife that died as a result of accidents on Çankırı-Kırıkkale Highway was recorded between 1 May 2014 and 1 October 2014. The records were collected in the very early hours of 153 days, which was the working time, once in three days on average. The carcasses were taken to roadsides after record to prevent double count and the coordinates of the spots where the dead of the wild animals were located (UTM) were taken with Garmin GPS, which has 5 m accuracy. Eight photos were taken with 45 degree angle from the point where collision occurred and a photo was taken from nearly 50 m distance on the direction the collision occurred. The speed limit, elevation, road width, curve feature of the road were recorded. The biological features of the wild animals couldn't be taken because of crash, press and dispersion.

We aimed to identify the factors that lead to fatal accidents. For this purpose, we used logit regression analysis to test the relationship between our independent variables and the dependent variable because

our dependent variable was binary, indicating two qualitative states as presence of a fatal accident and absence of a fatal accident. The two possible values that our binomial dependent variable can take are coded as 0 and 1. The value 0 is used to indicate the absence of the respective variable (fatal accident). Since the binary dependent variable is not continuous, we can use the probability values instead of the original values of the dependent variable.

Logit model is a cumulative distribution function:

$$\left(\frac{P}{1-P} \right) = e^{z_i} \quad (1)$$

In the left of the equation p indicates probability of fatal accident and (1-p) indicates probability of the other case and right hand side indicates the odds. Using the logistic equation derived based on this information, it is possible to conduct a linear regression analysis.

$$L_i = \ln(e^{z_i}) = \ln\left(\frac{P}{1-P}\right) = X'\beta = \beta_0 + \beta_1 X_i + \dots + u_i \quad (2)$$

or

$$P = \frac{e^{X'\beta}}{1 + e^{X'\beta}} \quad (3)$$

Eq [3] is obtained to solve the probability P using logit model expressed in Eq [2]. Models of binary decision variables predict the probability of the dependent variable equaling a "success" (fatal accident) rather than a "failure" (no fatal accident) as a function of the independent variables. In line with this, the logit regression model given in Eq [3] was built to predict the probability of a fatal traffic accident involving wild animals based on the independent variables related to landscape and road characteristics given in Table 1.

Here, the binary qualitative variable has two states indicating the presence of a fatal accident (Y = 1) and the absence of a fatal accident (Y = 0). For this purpose, the roads

were divided into two segments and the segment on which a fatal accident occurred was indicated with 1 whereas the opposite case was assigned a 0. Thirteen variables that could be causes of fatal traffic accidents and are on the right hand side of our model are presented in Table 1 together with brief information about them.

ArcGIS software was used to calculate the parameters used in the model. Aerial photographs, 1/25000 scale forest maps, and 1/25000 scale topographic maps were used to determine the variables related to landscape whereas field measurements were carried out to determine the values of road-related variables.

Table 1. The variables used in the model

Variable name	Definition
Landscape related variables	
D_WOODLAND	Distance to nearest woodland (minimum 1000 m ²) (m)
D_TOWN	Distance to nearest town (m)
D_STREAM	Distance to nearest stream (m)
D_A_HOUSE	Distance to nearest a house (m)
D_INT_AGRI	Distance to nearest intensive agriculture (minimum 1000 m ²) (m)
D_GRASS	Distance to nearest grassland (minimum 1000 m ²) (m)
D_GULLY	Distance to nearest gully outlet (wide from 50 m) (m)
D_EXT_AGRI	Distance to nearest extensive agriculture (minimum 1000 m ²) (m)
ELEVATION	Mean altitude (m)
Road related variables	
R_VOL	Daily traffic volume (1: 5000 ; 2: 1200 per/day)
R_PASS	Distance to the nearest underpass (m)
R_SPEED	Vehicle speed limits (70, 90, 110 km h ⁻¹)
R_WIDTH	Road width (m)
R_SLOPE	Road slope (%)

Results

Throughout the five month summer season, 58 accidents with casualties, from six species of mammals most of which were foxes and hedgehogs, were recorded (Table 2). The most WVC took place on July (n=12). It was seen that most of the casualties were from hedgehogs (*Erinaceus*

concolor) with 27 and from foxes (*Vulpes vulpes*) with 21. The death rate for all of the mammals along the road is 0.62 km⁻¹. The death rate in the parts of the road with middle traffic density is 0.68 km⁻¹, it is 0.52 km⁻¹ in the parts with low traffic density. The death rate especially between the 20. and 50. kms

of the road rises up to 1.15 km⁻¹. For red foxes, which was the mostly killed mammal, the death rate all along the road was 0.29 km⁻¹; 0.24 km⁻¹ on the middle dense traffic part and 0.39 km⁻¹ on the low dense traffic part. The death rate all along the road for foxes,

which were the second most killed animal, was 0.224 km⁻¹, it was 0.29 km⁻¹ on the middle traffic density part and it was 0.10 km⁻¹ on the low traffic density part of the road.

Table 2. The number of the animals that were killed as a result of vehicle collisions on the Çankırı-Kırıkkale Highway (May-October 2014)

Species	Low traffic volume (between 62-93 km)		Middle traffic volume (between 0-62 km)		Total (0-93 km)	
	Carcass	%	Carcass	%	Carcass	%
<i>Erinaceus concolor</i>	12	20.69	15	25.86	27	46.55
<i>Lepus europaeus</i>			3	5.17	3	5.17
<i>Canis lupus</i>			1	1.72	1	1.72
<i>Vulpes vulpes</i>	3	5.17	18	31.03	21	36.21
<i>Martes foina</i>	1	1.72	4	6.90	5	8.62
<i>Meles meles</i>			1	1.72	1	1.72
Total	16	27.59	42	72.41	58	100.00

According to the road density data that are collected regularly by General Directorate of Highways, throughout the working period, the traffic volume between Çankırı-Kalecik was daily 4680 vehicles on average, the traffic volume between Kalecik-Kırıkkale was 1818 vehicles on average. The traffic reached the highest density on September for both roads. The density of vehicles on traffic increases and decreases during different times of the day especially on weekends and between 7 a.m. and 5 p.m. 8 (Adkins and Stott, 1998). The traffic density started to decrease after 7 a.m. on both of the roads and it increased after 5 p.m. in the morning. The risk of accident increases especially an hour after the sunset because of poor vision (Haikonen and Summala, 2001). In other words, during the time when accidents are mostly seen (between 8 p.m. and 10 p.m.), two vehicles in every minute pass on the low dense road and five vehicles pass in every minute on the middle dense road.

Model variables related to landscape and road characteristics that are hypothesized to affect wildlife-vehicle collisions are

explained in Table 3. McFadden R2 statistic suggests a strong relationship ($r > 0.7$) between the independent variables and the probability of a fatal road accident. Among the independent variables explaining the probability of a fatal accident in the study region, road density, proximity to grassland, and proximity to residential areas were not significant. Factors affecting the probability of an accident were D_PASS ($p = 0.005$), D_INT_ADRI ($p = 0.0008$), and D_EXT_AGRI ($p = 0.0016$) at the $p = 0.001$ significance level; ELEVATION ($p = 0.0201$), R_SLOPE ($p = 0.0295$), D_WOODLAND ($p = 0.0108$), R_WIDTH ($p = 0.0132$), and R_SPEED ($p = 0.0352$); at the $p = 0.05$ significance level; and finally D_GULLY ($p = 0.0733$), D_STREAM ($p = 0.0802$), and D_A_HOUSE ($p = 0.0697$) at the $p = 0.10$ significance level. According to the model results, the probability of fatal accidents decreases with increasing slope, distance to the forest area, distance to the passageways, distance to houses, distance to gully, distance to dense agricultural areas, road speed limit, and road width.

Table 3. Logit model results of factors affecting accidents

Variables	Coefficient	Standart error	Z Statistic	Probility (p)
C	3.650071	4.895663	0.745572	0.4559
Landscape related variables				
ELEVATION	0.011447	0.004923	2.325326	0.0201**
D_WOODLAND	-0.000907	0.000356	-2.548518	0.0108**
D_TOWN	-2.35E-05	0.000301	-0.077890	0.9379
D_STREAM	0.000925	0.000529	1.749596	0.0802*
D_A_HOUSE	-0.000782	0.000431	-1.814003	0.0697*
D_INT_AGRI	0.000892	0.000265	3.364538	0.0008***
D_GRASS	0.000225	0.000911	0.247267	0.8047
D_GULLY	-0.001714	0.000957	-1.790808	0.0733*
D_EXT_AGRI	-0.023866	0.007558	-3.157660	0.0016***
Road related variables				
R_PASS	-0.003560	0.001267	-2.809680	0.0050***
R_VOL	-0.918042	0.702574	-1.306682	0.1913
R_SPEED	-0.056567	0.026858	-2.106152	0.0352**
R_WIDTH	-0.168729	0.068082	-2.478322	0.0132**
R_SLOPE	-0.324243	0.148932	-2.177121	0.0295**
McFadden R ²	0.405042			
LR statistic	90.69475			

*** p < 0.01; ** p < 0.05; * p < 0.10

Discussion and Conclusion

A record of losses resulting from collisions of vehicles with medium-sized mammals was collected through a survey on the highway along the Çankırı-Kırıkkale route. The study period was limited to five months of intensive sampling from the end of spring to the beginning of autumn. According to Ramp et al. (2006), data collection over a long period of time might be necessary to measure the long-term variation in collisions originating from the changes in seasonal conditions, feeding patterns, and behavior of animals. Moreover, they showed that the highest number of accidents occurred in the high mobility period of expansion and feeding (Grilo et al., 2009).

Traffic volume and vehicle speed are important factors affecting the deaths caused by wildlife-vehicle collisions (Forman and Alexander, 1998; Hubbard et al., 2000; Trombulak and Frissell, 2000; Seiler, 2003); therefore, it is a relevant field focused by many researchers across the world. Because of avoidance behavior of wildlife on roads with the high traffic volume, WVC are intensely occurred on roads with low and medium traffic volume (Evink et al., 1996; Forman and Alexander, 1998, Clevenger et al., 2003, Ramp et al. 2006). The death rate

in the parts of the road with middle traffic density is 0.68 km⁻¹, it is 0.52 km⁻¹ in the parts with low traffic density. We were not compared on WVC, because there were no researches in Turkey. But, these rates is similar with death rate of other studies (Ramp et al., 2005, Ramp et al., 2006, Grilo et al., 2009; Gunson et al., 2011) in the world.

Generally, the six species of mammals that were killed on the accidents in the study area are active during the night. Red fox, which is one of the most killed wild animals in the accidents, is active between 5 p.m. and 5 a.m. and reaches the most active state between 9 p.m. and 1 a.m. (Adkins and Stott, 1998). The fact that traffic volume varies during the day affects the wildlife accidents in different rates. Especially, an hour after the sunset, risk of collision increases because of poor sight in the dark (Haikonen and Stott, 1998). In other words, during the time when accidents are mostly seen (between 8 p.m. and 10 p.m.), two vehicles in every minute pass on the middle dense road and five vehicles pass in every minute on the middle dense road. When we assume that a hedgehog walks 110 meters on average in an hour and 380 meters at maximum, it can walk 24 meter-road platform in 13 minutes on average and 3.5 minutes at maximum.

This makes it inevitable for hedgehogs to encounter with vehicles (Rondinini and Doncaster, 2002).

Although Orłowski and Nowak (2006) stated that daily traffic volume increased the possibility of collisions for hedgehogs, it was seen that more hedgehogs died on the low traffic density parts of the Çankırı Kırıkkale highway. This difference can be explained by the density of the hedgehog population. It was seen that in the Western Europe, the population volume of hedgehogs is 30 per km² in the places near to the residential areas (Huijser, 1999), 10-20 per km² in the parks near the detached houses in Wrocław city of Poland and 100-200 per km² in the woody and gardened areas (Orłowski and Nowak, 2006). Especially the part of the road with low density where hedgehogs are mostly killed has borders with gardens of fruit and vegetable. The wider is the road, the more collisions with stone martens occur (Grilo et al., 2009). Collisions with red foxes occur when the passing of vehicles along the road increases (Grilo et al., 2009). The density of red fox deaths are nearly three times more on the road with middle density than the road with low density. Besides, road environment is used for accessing other habitats by predator species like red fox that hunts a conduit such as fire break, power line clearing and road (Bennett, 1994, Ramp et al. 2006). Some model results (Clarke et al., 1998, Alexander et al., 2005, Orłowski and Nowak, 2006 and Grilo et al., 2009) showed that the cumulative impact of human activities may affect the daily activities and dispersal of wildlife, thus it may have an impact on the abundance of wildlife.

Detecting the volume of the wildlife deaths on roads is very important for decreasing the deaths and the secondary effects on the wildlife. Managing these effects on every part of the roads is not possible both economically and logistically. Smith (2003) carried out intense locational analysis of road deaths in Florida and defined how to diminish wildlife-vehicle collisions by stating where to make plans and design by taking animal mobility, distribution, landscape pattern and locations of road deaths into account. Also, the data collected via traffic accidents can be used not only in

decreasing accidents or preventing deaths, but also in the studies on species like population densities and habitat uses.

As a result; ecologists working on roads use statistical models according to the characteristics about the landscape, the effect and density of animal distribution, what kind of habitat distribution is present around the roads, traffic volume, road topography (Clevenger et al., 2003; Malo et al., 2004; Dussault et al., 2006; Jaarsma et al., 2007). That information can be used as a guide in building wildlife overpasses, underpasses and barriers and in taking precautions like periodical wildlife signals, decelerator wildlife reflectors, roadside wildlife management and speed bumps.

References

- Adkins, C.A., Stott, P. 1998. Home ranges, movements and habitat associations of red foxes *Vulpes vulpes* in suburban Toronto, Ontario, Canada. *J Zool*, 244: 335-346.
- Alexander, S. M., Waters, N. M., Paquet, P.C. 2005. Traffic volume and highway permeability for a mammalian community in the Canadian Rocky Mountains. *The Canadian Geographer/Le Géographe canadien*, 49(4), 321-331.
- Bennett, A.F., Henein, K., Merriam, G. 1994. Corridor use and the elements of corridor quality: chipmunks and fencerows in a farmland mosaic. *Biological Conservation*, 68(2), 155-165.
- Borda-de-Água, L., Navarro, L., Gavinhos, C., Pereira, H.M. 2011. Spatio-temporal impacts of roads on the persistence of populations: analytic and numerical approaches. *Landscape ecology*, 26(2), 253-265.
- Clarke, G.P., White, P.C.L., Harris, S. 1998. Effects of roads on badger *Meles meles* populations in south-west England. *Biol Conserv*, 86, 117-124.
- Clevenger, A.P., Chruszcz, B., Gunson, K.E. 2003. Spatial patterns and factors influencing small vertebrate fauna road-kill aggregations, *Biol Conserv*. 109, 15-26.
- Cureton, J.C., Deaton, R. 2012. Hot moments and hot spots: identifying factors explaining temporal and spatial variation in turtle road mortality. *The Journal of Wildlife Management*, 76(5), 1047-1052.
- D'Amico, M., Román, J., de los Reyes, L., Revilla, E. 2015. Vertebrate road-kill patterns in Mediterranean habitats: Who, when and where. *Biological Conservation*, 191, 234-242.
- Dussault, C.M., Roulin, M., Courtois, R., Ouellet, J.P. 2006. Temporal and spatial

distribution of moose-vehicle accidents in the Laurentides Wildlife Reserve, Quebec, Canada. *Wildlife Biol*, 12, 415-426.

Evink, G.L. 1996. Florida Department of Transportation initiatives related to wildlife mortality. Report from Environmental Management Office.

Fahrig, L., Rytwinski, T. 2009. Effects of roads on animal abundance: an empirical review and synthesis. *Ecology Soc*, 14, 21. <<http://www.ecologyandsociety.org/vol14/iss1/art21/>>

Finder, R.A., Roseberry, J.L., Woolf, A. 1999. Site and landscape conditions at white-tailed deer/vehicle collision locations in Illinois. *Landscape and Urban Planning*, 44(2), 77-85.

Forman, R.T.T., Alexander, L.E. 1998. Roads and their major ecological effects. *Annu Rev Ecol Syst*, 29, 207-231.

Forman, R.T.T., Sperling, D., Bissonette, J.A., Clevenger, A.P., Cutshal, C.C., Dale, V.H., Fahrig, L., France, R., Goldman, C.R., Heanue, K., et al. 2003 *Road ecology: science and solutions*. Island Press, Washington, DC.

Grilo, C., Bissonette, J.A., Santos-Reis, M. 2009. Spatial-temporal patterns in Mediterranean carnivore road casualties: consequences for mitigation. *Biol Conserv*, 142, 301-313.

Gunson, K.E., Mountrakis, G., Quackenbush, L.J. 2011. Spatial wildlife-vehicle collision models: A review of current work and its application to transportation mitigation projects. *Journal of environmental management*, 92(4), 1074-1082.

Haikonen, H., Summala, H. 2001. Deer-vehicle crashes: Extensive peak at 1 hour after sunset. *AM J Prev Med*, 21, 209-213.

Harris, L.D., Scheck, J. 1991. From implications to applications: the dispersal corridor principle applied to the conservation of biological diversity. In: Saunders, D.A., Hobbs, R.J. (Eds.), *Nature Conservation 2: The Role of Corridors*. Surrey Beatty, Chipping Norton, Australia, pp. 189-220.

Huijser, M.P. 1999. Human impact on population of hedgehogs *Erinaceus europaeus* through traffic and changes in the landscape: a review. *Lutra*, 42: 39-56.

Jaarsma, C.F., van Langevelde, F., Botma, H. 2006. Flattened fauna and mitigation: traffic victims related to road, traffic, vehicle, and species characteristics. *Transportation research part D: transport and environment*, 11(4), 264-276.

Jaarsma, C.F., van Langevelde, F., Baveco, J.M., van Eupen, M., Arisz, J. 2007. Model for rural transportation planning considering simulating mobility and traffic kills in the badger *Meles meles*. *Ecol Inform*, 2, 73-82.

Malo, J.E., Suarez, F., Diez, A. 2004. Can we mitigate animal-vehicle accidents using predictive models? *J Appl Ecol*, 41, 701-710.

Mysterud, A. 2004. Temporal variation in the number of car-killed red deer *Cervus elaphus* in Norway. *Wildlife Biol*, 10, 203-211.

Orlowski, G., Nowak, L. 2006. Road mortality of hedgehogs *Erinaceus* spp. in farmland in lower Silesia (South-Western Poland). *Pol J Ecol*, 52, 377-382.

Philcox, C.K., Grogan, A.L., Macdonald, D.W. 1999. Patterns of otter *Lutra lutra* road mortality in Britain. *Journal of Applied Ecology*, 36(5), 748-761.

Ramp, D., Wilson, V.K., Croft, D.B. 2006. Assessing the impacts of roads in periurban reserves: road-based fatalities and road usage by wildlife in the Royal National Park, New South Wales, Australia. *Biol Conserv*, 129, 348-359.

Ramp, D., Caldwell, J., Edwards, K.A., Warton, D., Croft, D.B. 2005. Modelling of wildlife fatality hotspots along the Snowy Mountain Highway in New South Wales, Australia. *Biol Conserv*, 126, 474-490.

Rondinini, C., Doncaster, C.P. 2002. Roads as barriers to movement for hedgehogs. *Funct Eco*, 16, 504-509.

Seiler, A. 2005. Predicting locations of moose-vehicle collisions in Sweden. *J Appl Ecol*, 42, 371-382.

Smith, D.J. 2003. Ecological effects of roads: Theory, analysis, management and planning considerations. University of Florida, Florida, USA.

Snow, N.P., Porter, W.F., Williams, D.M. 2015. Underreporting of wildlife-vehicle collisions does not hinder predictive models for large ungulates. *Biological Conservation*, 181, 44-53.

Trombulak, S.C., Frissell, C.A. 2000. Review of ecological effects of roads on terrestrial and aquatic communities. *Biol Conserv*, 14: 18-30.

Determining Some Mammal Species by Camera-Trap Method: Case Study in Kastamonu Azdavay Kartdağı Wildlife Reserve Area

*Özkan EVCİN¹, Erol AKKUZU¹, Ömer KÜÇÜK¹, Abdullah UĞIŞ¹, Burhan GENÇAL²,
Sabri ÜNAL¹, Mertcan KARADENİZ¹

¹Kastamonu University, Faculty of Forestry, Kastamonu/TURKEY

²Kastamonu University, Institute of Natural Sciences, Kastamonu/TURKEY

*Corresponding Author: oevcin@kastamonu.edu.tr

Abstract

Studies on the abundance of wildlife are important for assessing the status of wild animals' population and their environment. Identifying animal species, distribution of animals, presence - absence and their behavior are key factors to manage wildlife. Data of wildlife can be obtained from invasive and non-invasive methods. Camera trapping is an efficient non-invasive method to study wildlife. Camera traps can give valuable data such as behavior in their wild environment, food diet, presence-absence, etc. In this study, some mammal species exists in Kastamonu Azdavay Kartdağı Wildlife Reserve Area were determined by Camera-trap method. Activity patterns of animals were determined. Due to the study results, suggestions on management and conservation strategies were discussed.

Keywords: Camera trap, Mammals, Wildlife, Azdavay, Kastamonu

Kastamonu Azdavay Kartdağı Yaban Hayatı Geliştirme Sahasındaki Bazı Memeli Türlerin Fotokapan Yöntemiyle Belirlenmesi

Özet

Yaban hayatı varlığı ve yaban hayatına mahsus türlerin popülasyonu ve habitatları üzerine yapılan çalışmalar önemli bir yer tutmaktadır. Yaban hayatı türlerini teşhis, türlerin yayılışları, var-yok verileri ve davranışları yaban hayatı yönetimi için önemli faktörlerdir. Yaban hayatı verileri rahatsız verebilen ve rahatsızlık vermeyen yöntemlerle elde edilebilmektedir. Fotokapanlar yaban hayatını incelemek için uygun bir rahatsız vermeyen yöntemdir. Fotokapanlar türlerin kendi habitatlarındaki davranışları, besin tercihleri, varlık- yoklukları hakkında çok sayıda değerli bilgiler verebilmektedir. Bu çalışmada Kastamonu Azdavay Kartdağı Yaban Hayatı Geliştirme Sahası'nda bulunan bazı memeli türler fotokapan yöntemi ile belirlenmiştir. Çalışmada türlerin günlük aktiviteleri belirlenmiş ve çalışma sonuçlarına göre yönetim ve koruma stratejileri tartışılmıştır.

Anahtar Kelimeler: Fotokapan, Memeliler, Yaban hayatı, Azdavay, Kastamonu

Introduction

Turkey has a very rich flora and fauna with more than 11 000 species of plants, 162 species of mammals, 460 species of birds, 716 species of fish and 141 species of reptiles (URL 1, 2013). Turkey is located in the junction of the Asian, European and Africa continents having great biodiversity, different climate types and various ecosystems. Inventories of these areas is important in order to conserve our natural beauties and richness (Evcin et al., 2012).

Studies on the abundance of wildlife are important for assessing the status of wild animals' population and their environment. Inventory studies have a great importance for giving directions to conservation efforts,

monitoring of population development, controlling the population and making a benefit plan. Inventory studies help to determine success of conservation activities and forest management, measuring and giving importance the cultural interventions, population effecting activities (Oğurlu, 2003). Identifying animal species, distribution of animals, presence - absence and their behavior are key factors of wildlife management. Data of wildlife can be obtained from invasive and non-invasive methods. Camera trapping is an efficient non-invasive method to study wildlife (Evcin et al., 2013).

Some parameters about animals (species, density, habitat) need to be known for managing the wildlife. There should be regular and systematic monitoring of the animals to obtain these parameters. Visualizing wildlife animals in their natural environment is generally difficult. The camera trap is an alternative way for studying and identifying wild animals in their natural habitat and easy to apply in fieldwork studies (Oliveria-Santos et al. 2008).

Azdavay Forest Sub-district is located in Kastamonu. It is close to Kure Mountains,

Materials and Methods

Study area

KAKWRA is located in between Azdavay and Şenpazarı towns of Kastamonu (Figure 1). It is established in 1981 as “Conservation of Hunt and Breeding Field” for endangered species such as Red Deer (*Cervus elaphus*)

one of nine hotspots in Turkey and has a great biodiversity. The area has great importance in terms of flora and fauna (Soyumert, 2010). In this study, some mammal species exist in Kastamonu Azdavay Kartdağı Wildlife Reserve Area (KAKWRA) were determined by Camera-trap method. Activity patterns of animals were determined. Due to the study results, suggestions on management and conservation strategies were discussed.

and Roe (*Capreolus capreolus*) (Anonymous, 2010).

Geographical position

KAKWRA is being at about 50 km air distance from Kastamonu centrum. Total area of KAKWRA is 11495 hectares (Anonymous, 2010).



Figure 1. Geographical position of KAKWRA (Anonymous, 2010).

KAKWRA is an important area, located in the buffer zone with Küre Mountains National Park, with having natural forest areas, wild animals, plants and recreational zones in the Western Black Sea region (Anonymous, 2010).

Methods

Automatically triggered cameras taking photographs or videos of animals are called as camera traps. Camera traps are known as one of the most powerful and non-disturbing

tool for wildlife research. They can give valuable data such as animal behavior in their wild environment, food diet, presence-absence, etc. (Evcin, 2013). Opportunistic camera-trap method (Stein, 2008) were used in this study. The study were done between months of October and December 2015. Eight camera traps were established to four different points considering footprints and feces of animals (Figure 2, 3).



Figure 2. Camera trap locations in KAKWRA

Figure 3. Applying camera traps in the field

Results

Eight camera traps were established to KAKWRA on four different points. Results and determined species were given in Table

1. Animal photos and activity charts were given in Figure 4,5,6.

Table 1. Species determined to camera trap results

Species No	Family and Species Name	English Name	IUCN RedList
LEPORIDAE			
1	<i>Lepus europaeus</i>	Hare	LR/lc
SCIURIDAE			
2	<i>Sciurus anomalus</i>	Caucasian Squirrel	NT
CANIDAE			
3	<i>Canis lupus</i>	Wolf	LC
4	<i>Vulpes vulpes</i>	Fox	LC
MUSTELIDAE			
5	<i>Martes martes</i>	Pine Marten	LC
SUIDAE			
6	<i>Sus scrofa</i>	Wild Boar	LR/lc

Table 1. (Continue)

CERVIDAE			
7	<i>Capreolus capreolus</i>	Roe	LC
	<i>Cervus elaphus</i>	Red Deer	LC
URSIDAE			
8	<i>Ursus arctos</i>	Bear	LR/lc

LC, LR/lc= Least Concern NT= Near Threatened



Figure 4. Some photos of animals that obtained from camera trap studies

- 1- *Vulpes vulpes* (Fox)
- 2- *Martes martes* (Pine Marten)
- 3- *Sus scrofa* (Wild Boar)
- 4- *Capreolus capreolus* (Roe)
- 5- *Lepus europaeus* (Hare)
- 6- *Canis lupus* (Wolf)
- 7- *Capreolus capreolus* (Roe)
- 8- *Ursus arctos* (Bear)

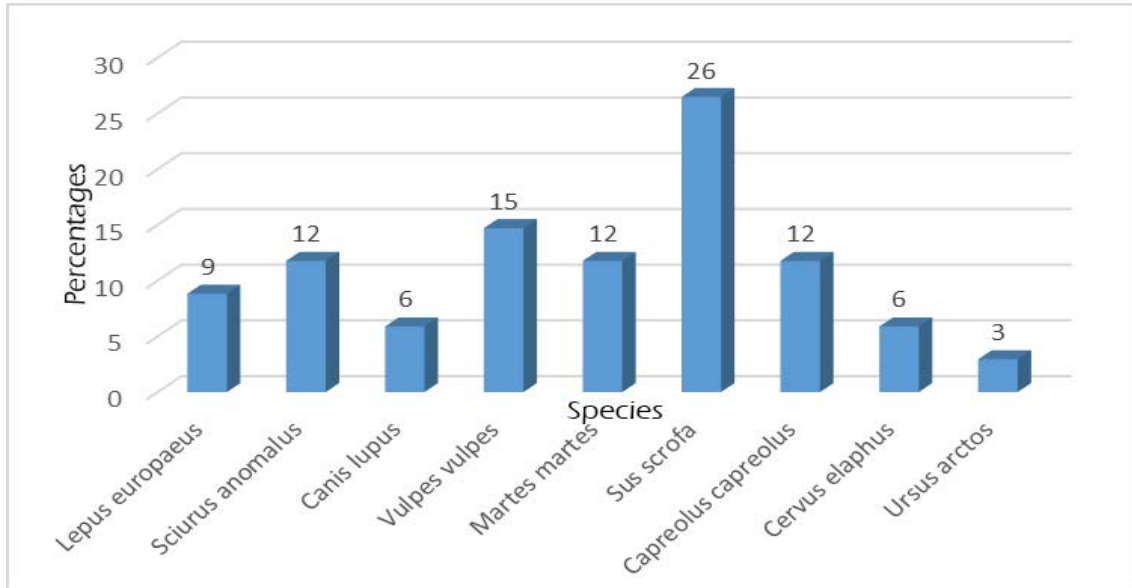
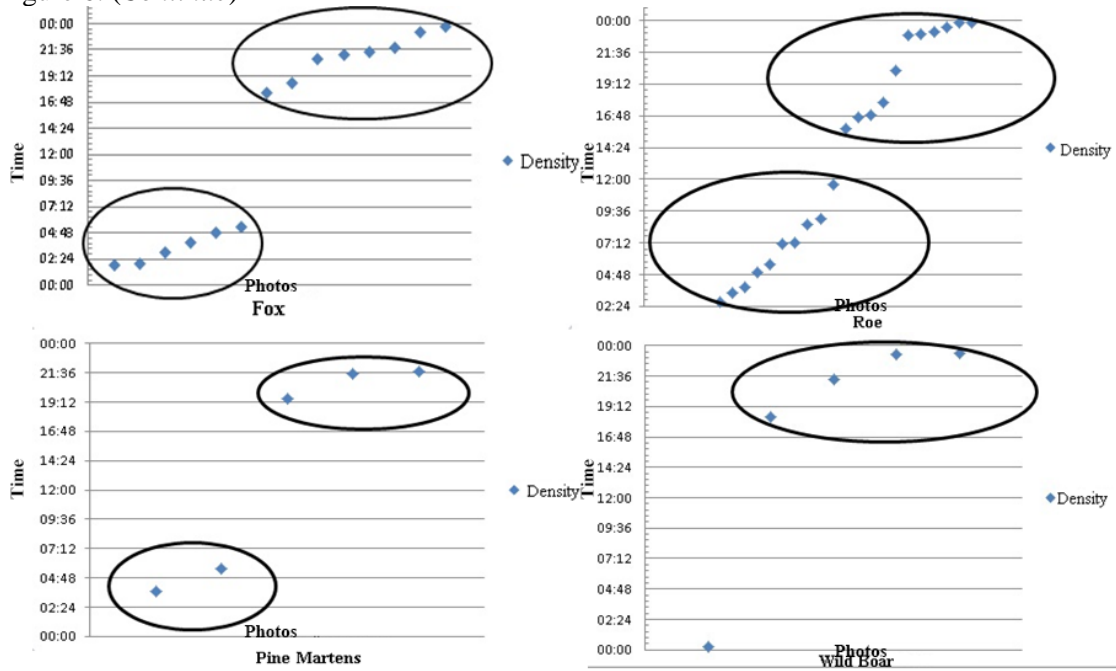

Figure 5. The percentages of data obtained from cameratrap studies

Figure 6. (Continue)



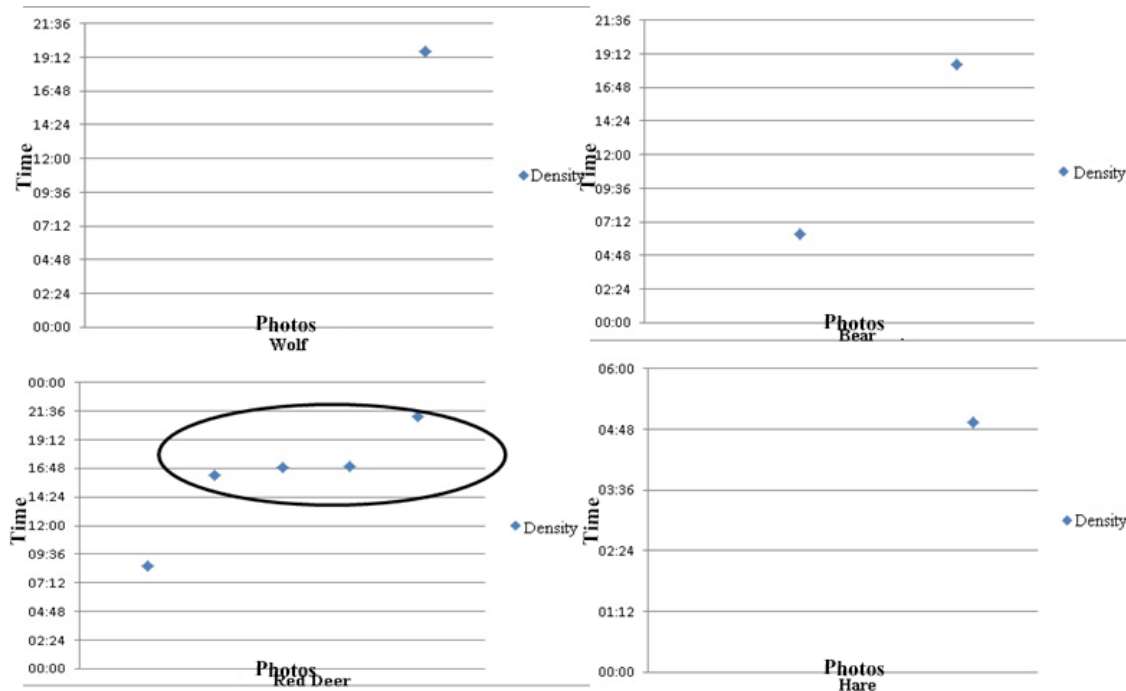

Figure 6. Activity charts developed from camera trap data

Conclusions

Eight mammal species were captured by camera traps in the study area. The number of animals captured by the camera traps was very low probably because of adverse effect of weather conditions during the study (winter of 2015) and insufficient number of camera traps.

Analysis of activity patterns showed that most of large mammals considered to be active in the wee hours and evenings as a result of camera-traps, especially predator species like: brown bear and wolf etc. showed themselves at night to cameratrap. Red deer and roe deer are thought to browse the area for food as looking their activity patterns (Bulthuis et al., 2015).

Wildlife disturbance can effect wild animal activities. For this reason, ecosystem-based planning should be preferred. Logging and mine activities should be done by non-disturbing ways to wildlife.

Detailed species map for wildlife reserve areas of Turkey should be reproduced. This study expected to be a background for future studies for this area. All the technical developments of our era should be used for producing an inventory. Wildlife studies with camera traps are insufficient in Turkey. There are however some studies in the area

via camera traps (Soyumert, 2010). These researches need to be done for each region. Daily activities and preferred areas of animals should be detected by this was.

Local people should be made aware against the poaching and detailed information should be given about the damage to the economy of the country and genre. Most wild animals prefer areas with a rich variety food and being close to wetlands (Evcin, 2013). Therefore, conservation of these areas against all kind of treats (pesticides, household and industrial waste, pollutions etc.) is very important to sustain wild animals and their habitats.

References

- Bulthuis, T., Burns, E., Greenfield, J., & Rodriguez, D., 2015. "The effects of deer browsing on species richness and density of an enclosure", The University of Michigan Biological Station https://deepblue.lib.umich.edu/bitstream/handle/2027.42/116612/Bulthuis_Burns_Greenfield_Rodriguez_2015.pdf?sequence=1&isAllowed=y.
- Evcin, Ö., Küçük, Ö., Akkuzu, E., 2012. Karaca'nın (*Capreolus capreolus*) Kastamonu İlindeki Yayılış Yaptığı Alanlar ve Habitat Tercihleri ,Kırgızistan Birinci Uluslararası Biyoloji Kongresi Bildiri Kitabı, Bişkek, Kırgızistan.

Evcin, Ö., Küçük, Ö., Akkuzu, E., Uğış, A., 2013. "Using Photographs for Observing Roe Deers", International Caucasian Forestry Symposium Proceedings Book, 24-26 October 2013, Artvin, :668- 672.

Oliveira-Santos, L.G.R., M.A. Tortato and M.E. Graipel. 2008. Activity pattern of Atlantic Forest small arboreal mammals as revealed by camera traps. *Journal of Tropical Ecology* 24: 563-567.

Oğurlu, İ., 2003. *Yaban Hayatında Envanter*, T.C Çevre ve Orman Bakanlığı Doğa Koruma ve Milli Parklar Genel Müdürlüğü Av ve Yaban Hayatı Dairesi Başkanlığı Matbaası, Ankara, 208 s.

Soyumert, A., 2010. *Kuzeybatı Anadolu Ormanlarında Fotokapan Yöntemiyle Büyük Memeli Türlerinin Tespiti Ve Ekolojik Özelliklerinin Belirlenmesi* adlı Doktora Tezi, Hacettepe Üniversitesi, Biyoloji Bölümü, Ankara.

Soyumert, A., Tavşanoğlu, Ç., Macar, O., Kaynaş, B.Y., Gurkan, B., 2010, Presence of large and medium-sized mammals in a burned pine forest in southwestern Turkey, *Hystrix Italian Journal of Mammalogy* 21(1), 97-102.

Stein, A., B., Todd K., F., Marker L., 2008. "Opportunistic use of camera traps to assess habitat-specific mammal and bird diversity in northcentral Namibia." *Biodiversity and conservation* 17.14 (2008): 3579-3587.

URL1, 2013. "Game and wildlife in Turkey", http://www.milliparklar.gov.tr/kitap/77/AV_YABAN_ING.pdf.

Preliminary Results of the Observations on Oviposition and Predation Impact of *Rhizophagus grandis* Gyll. (Coleoptera: Monotomidae) on *Dendroctonus micans* (Kug.) (Coleoptera: Curculionidae) in Turkey

*Hazan ALKAN AKINCI¹, Jean-Claude GRÉGOIRE²

¹Artvin Çoruh University, Faculty of Forestry, Artvin / TURKEY

²Université Libre de Bruxelles, Lutte biologique et écologie spatiale (LUBIES),
Brussels / BELGIUM

*Corresponding Author: hazan.akinci@artvin.edu.tr

Abstract

The oviposition of *Rhizophagus grandis* and its predation impact on *Dendroctonus micans* were investigated in the laboratory in polystyrene boxes. Two rearing series were set up with different prey-predator ratios and analyzed at different time intervals. Fifteen *D. micans* larvae and 1 pair of *R. grandis* adults, and 20 *D. micans* larvae and 1 pair of *R. grandis* adults were used in series I and series II, respectively. Wild *R. grandis* adults, and third and fourth instar *D. micans* larvae collected from naturally attacked oriental spruce forests in Artvin were used in the experiment. Two control series were arranged with only *D. micans* larvae to account for natural mortality for series I and series II. The number of *R. grandis* larvae produced after different time intervals and predation impact in these series was evaluated. A pair of *R. grandis* yielded up to 104 larvae on *Picea orientalis* in the experiment. Progeny production increased markedly during the second week. Higher numbers of *D. micans* larvae in boxes with 1 pair of *R. grandis* adults in the series II yielded higher numbers of predator progenies. But there was no statistical difference in oviposition between the two series. *R. grandis* efficiently consumed its prey. Progenies of a pair of *R. grandis* consumed more than half of the *D. micans* larvae in a week, and almost all in the second and third week.

Key words: *Dendroctonus micans*, *Rhizophagus grandis*, *Picea orientalis*, predation

Introduction

The greater European spruce bark beetle, *Dendroctonus micans* (Kugelann) (Coleoptera: Curculionidae) is one of the major pests of spruce throughout Eurasia (Grégoire 1988). It has supposedly originated from a North American ancestor that crossed the Behring Strait during the Wisconsin glaciation (Furniss 1996) and has spread westward, presently occupying most of Eurasia (Grégoire 1988; Fielding et al. 1991; Fielding and Evans 1997; Pauly and Meurisse 2007), including Georgia and northeastern Turkey, where it attacks oriental spruce, *Picea orientalis* (L.) Link. (Acatay 1968).

D. micans was first discovered in oriental spruce forests in Georgia in 1957 (Khobakhidze et al. 1970) and then in Posof (Turkey), in 1966 in a stand adjacent to the Georgian border (Acatay 1968). Presently, almost all the oriental spruce forests in Turkey are infested (Alkan-Akinci et al. 2014). During the past years, heavy losses

were recorded in Turkey during outbreaks on the edge of the beetle's expanding range (Benz 1984; Özder 1984; Eroğlu 1995; Alkan 2000; Eroğlu et al. 2005; Alkan-Akinci et al. 2009).

Although mechanical and chemical control measures have respectively been applied against *D. micans* in 1966-1971 and 1972-1985, the beetle has spread in all the spruce stands in Artvin. A biological control programme has been started in 1985. Fourteen small-scale *Rhizophagus grandis* Gyll. (Coleoptera: Monotomidae) rearing laboratories have been established within the Artvin, Ardanuç and Şavşat Directorates of Forestry Enterprises (Alkan 1989, 2000; Aksu 2011). Rearing laboratories have been established in Giresun and Trabzon after *D. micans* infestations in these vicinities (Kostak 1997; Eroğlu et al. 2005). Presently, more than 5 million *R. grandis* have been reared and released at infested stands in Turkey (Alkan 2000; Kostak 1997; Aksu 2011; Aksu et al. 2014).

In mass rearing programmes in Europe, pairs of predators yield up to 117 eggs and 70 young adults per female *R. grandis* on *Picea excelsa* (Grégoire et al., 1989). In Great Britain, two females and one male *R. grandis* are used in the rearing programmes, with a yield of up to 80 adults (Fielding and Evans 1997).

A pair of predator consumes an average of 30-40 *D. micans* eggs a week in laboratory conditions (Merlin et al., 1984). Predation significantly reduces the prey broods by two-thirds (Merlin et al., 1984; Grégoire et al., 1989). *R. grandis* larvae consume each the equivalent of one mature prey larva, which means that they generally eat more than one prey when these are smaller (Grégoire et al., 1989).

The Turkish mass rearing programme is based on the “log-breeding” method, which derives from the work of Georgian entomologists (Khobakhidze et al., 1970). In Turkey, “log-breeding” consists in introducing either *D. micans* adults or larvae into oriental spruce logs. Two pairs of *R. grandis* adults and either 8 prey adults or 750-800 prey larvae are introduced into each log. The generation time is either 90-100 days or 65-70 days at 19-22°C, and the average yield is either 134 or 102 *R. grandis* adults, respectively (Aksu, 2011). There are drawbacks, such as yield unpredictability, labour intensiveness, need for space and, *D. micans* being the only foodstuff, need for hundreds of thousands of *D. micans* larvae to be collected in the forests, as this insect cannot be reared in the laboratory, and collecting *D. micans* larvae from predator release areas mentioned by several authors (Grégoire et al 1984a, 1984b; King and Evans 1984; Aksu 2011).

This study aims to present biological data on the oviposition and predation impact of *R. grandis* under semi-natural conditions, i.e. in clear polystyrene boxes containing predator adults, prey larvae and fresh spruce phloem, the long-term objective being to overcome some of the drawbacks in the rearing technique mentioned above.

Materials and Methods

The experiment was performed on 16 August – 20 September 2013. Oriental spruce bark powder and fresh bark disks, and *D. micans* larvae and *R. grandis* adults were used in the experiment. Wild *D. micans* larvae and *R. grandis* adults were collected from natural oriental spruce forests in Artvin. One pair of *R. grandis* adults was placed in each box to have the highest possible number of progeny per female (Grégoire et al. 1984a).

Preparation of the experimental series

Two series were prepared with two different prey-predator ratios. Fifteen *D. micans* larvae and one pair of *R. grandis* adults and twenty *D. micans* larvae and one pair of *R. grandis* adults were used in series I and series II, respectively.

Before preparing the boxes, bark disks including the phloem layer 5 cm in diameter were cut from fresh logs that were harvested from natural oriental spruce stands. Round polystyrene boxes (producer: LP Italiana, Italy, model: L202038, diameter: 5.5 cm; height: 2.5 cm) were used. The boxes were filled with a layer of rehydrated bark powder at the bottom, then two bark disks with phloem layers facing each other, then again rehydrated bark powder on top of these disks. Third and fourth instar *D. micans* larvae were put between the bark disks. After preparation, the boxes were kept in the laboratory for 3 days to allow the establishment of the prey larvae in the bark disks. *R. grandis* pairs were then introduced into the boxes, which were kept for 7, 14 and 21 days in the laboratory. The *R. grandis* adults were taken out of the boxes at given days (one batch of boxes on the 8th day of the experiment, one batch on the 15th day and one batch on the 22nd day). Ten days after removing the predators (an incubation period for allowing the *R. grandis* eggs to hatch), all predator and prey larvae were counted in each box. Ten replicates were prepared for each series. Two control groups were also prepared with only *D. micans* larvae to account for natural mortality for series I and series II. Laboratory temperature was 19 °C and moisture was 59% during the experiment.

Statistical analyses

Numbers of *R. grandis* larvae at control days were compared by *t* tests between series and II. Data were analyzed using IBM SPSS statistics version 19.0.

Results

In series I (15 *D. micans* larvae; one pair of *R. grandis*) a total 347, 522 and 484 predator larvae were produced in the different batches. In series II (20 *D. micans*

larvae; one pair of *R. grandis*) 359, 559 and 572 predator larvae were produced in total (Table 1). The mean numbers of larvae per box (\pm SE) were 34.7 (\pm 3.53), 52.2 (\pm 6.00), 48.4 (\pm 11.06) and 35.9 (\pm 3.62), 55.9 (\pm 7.34), 57.2 (\pm 7.86) in series I and II, respectively. In series II, there were more predator larvae in the boxes in all the batches than in series I (Figure 1), but the differences were not statistically significant (Table 2).

Table 1. Number of *Rhizophagus grandis* larvae per box in the different batches

		Number of <i>R. grandis</i> larvae per box									
Control days / Replicates		1	2	3	4	5	6	7	8	9	10
Series I	day 7	26	29	27	32	28	37	22	51	39	56
	day 14	41	40	46	59	45	45	51	44	47	104
	day 21	8	43	97	1	2	51	72	89	54	67
Series II	day 7	34	12	39	49	48	48	37	33	25	34
	day 14	62	58	56	9	76	40	47	89	42	80
	day 21	56	102	7	52	63	42	49	51	74	76

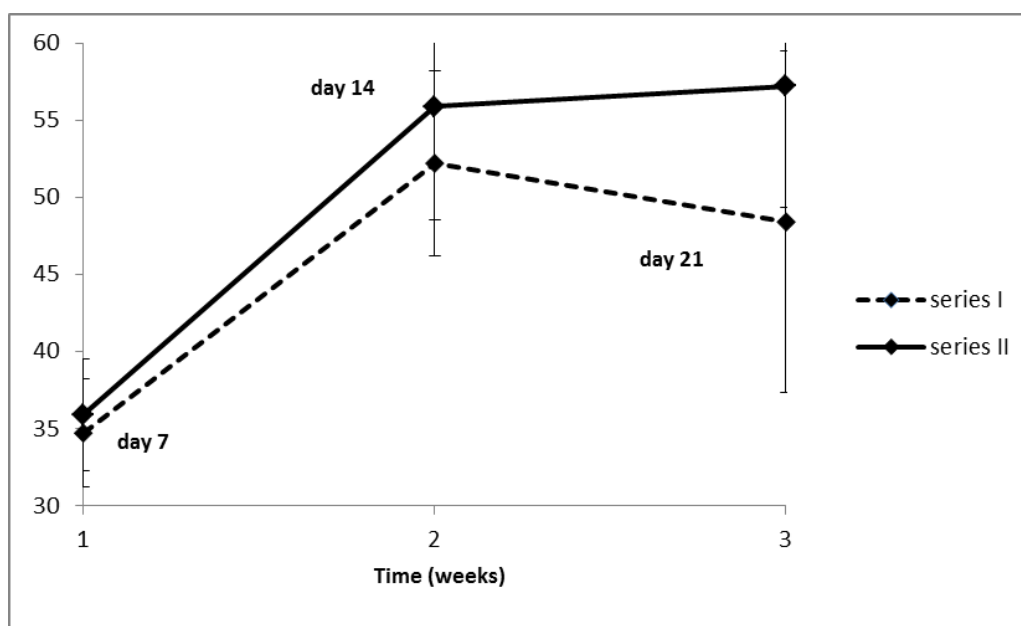

Figure 1. Variation in the number of *R. grandis* progeny with time

Table 2. Production of *R. grandis* larvae in the two series

Batch	Number of <i>R. grandis</i> larvae at control days (mean \pm SE)		df	t	p
	Series I	Series II			
Day 7	34.7 \pm 3.53	35.9 \pm 3.62	18	0.237	0.815
Day 14	52.2 \pm 6.00	55.9 \pm 7.34	18	0.390	0.701
Day 21	48.4 \pm 11.06	57.2 \pm 7.86	18	0.648	0.525

In series I, there were a total of 150 *D. micans* larvae at the beginning, and 200 *D. micans* larvae in series II. The numbers of *D. micans* larvae in the boxes at the end of the experiment in the three batches are given in Table 3. Average predation impact of the *R. grandis* was 73.3% over 150 prey larvae and 61.5% over 200 prey larvae in the first and second series in the first batch, respectively. In series I, the predation impact was 98.7% in both the second and third batch; in series

II, it reached 98.5% and 99.0% in the second and third batch, respectively. A total of 110 and 123 *D. micans* larvae were thus consumed in the first week in series I and II, respectively. 148 prey larvae were consumed in the second and third week in series I, and 197 and 198 prey larvae were consumed in the second and third week of series II, respectively. No *D. micans* mortality was observed in the controls.

Table 3. Number of *Dendroctonus micans* larvae per box in the various batches

Batches / Replicates		Number of <i>D. micans</i> larvae in boxes									
		1	2	3	4	5	6	7	8	9	10
Series I	day 7	5	4	11	2	5	4	7	0	0	2
	day 14	0	0	0	0	0	0	0	2	0	0
	day 21	0	0	0	1	1	0	0	0	0	0
Series II	day 7	9	13	11	4	8	3	7	5	2	5
	day 14	0	0	0	2	0	0	0	0	1	0
	day 21	1	0	1	0	0	0	0	0	0	0

Discussion

A pair of *R. grandis* yielded 1-104 larvae in series I and 7-102 larvae in series II. In Belgium, pairs of predators yield 30-117 eggs (Grégoire et al., 1989). In another experiment, the mean number of larvae produced by wild predators collected in the field was 109.6 (Grégoire et al., 1984a). Our results are close to the Belgian results.

British researchers report up to 80 progeny by two females and one male *R. grandis* in mass rearing programs (Fielding and Evans, 1997). Several experiments showed that a regulatory process seems to lower the egg production per female when several females are together in a brood chamber (Merlin et al., 1984). When two pairs of *R. grandis*, instead of one pair, were introduced into a brood chamber, a twofold decrease of the mean progeny per female occurred. A supplementary decrease occurred when three pairs were introduced (Grégoire et al., 1984a; Merlin et al., 1984). There are 29.3, 13.6 and 6.9 predator larvae on average when 1, 2 or 3 females introduced, respectively (Merlin et al., 1984).

Considering this, it is hard to specify the mean progeny per females in British results.

In the Turkish mass rearing programme, based on the “log-breeding” method, two pairs of *R. grandis* adults and either 8 prey adults or 750-800 prey larvae respectively produce 134 or 102 *R. grandis* adults on the average, (Aksu, 2011). In our experiment, results of series I and series II showed that about 100 larvae can be reared in boxes. About 50 and 37 rearing boxes can be prepared in series I and series II, respectively, using the total amount of *D. micans* larvae that is used in only one breeding log. Thus, the number of reared predator larvae can be increased and some drawbacks in the log breeding method, such as the need for space and the need for hundreds of thousands of *D. micans* larvae to be collected in the forests can be suppressed. The total number of predators produced in “log breeding” is only known at the end of the rearing period. The generation time is either 90-100 days or 65-70 days (Aksu, 2011). In our experiment, the number of predator larvae can be assessed during the second week. So, unsuccessful boxes can be

discarded early, and new rearing boxes can be prepared to replace them. In this manner, yield unpredictability in rearing units may be reduced. Rearing in boxes is also a less labour intensive method than “log-breeding”.

R. grandis consumes both eggs and larvae of its prey. Predation significantly reduces the prey broods by two-thirds (Merlin et al., 1984; Grégoire et al., 1989). In our experiment, predation impact on *D. micans* larvae was about 99% in the second and third week whilst it was relatively lower in the first week. This lower predation impact during the first week is very likely to have resulted from the presence of lower numbers of predator larvae and younger predator larvae in the boxes.

A period of 14 days seems appropriate for obtaining a higher number of predator larvae. There were more predator larvae at the 21st day, but this difference can be ignored when considering the advantage of spending minimum time and energy during a rearing programme.

The progeny of a pair of *R. grandis* consumed more than half of a *D. micans* brood system in a week, and almost all in the second and third week. *R. grandis* is an efficient limiting factor on its prey. *D. micans* population in Artvin and Giresun is below economic damage threshold since 2009. Predator releases has been stopped in these areas since then. Overall, *R. grandis* could be the major component in suppressing *D. micans* populations in spruce forests.

References

- Acatay, A., 1968. Türkiye’de Yeni Bir Ladin Tahripçisi, *Dendroctonus micans* Kug. İ.Ü. Orman Fakültesi Dergisi 18 (1): 18–36.
- Aksu, Y., 2011. *Rhizophagus grandis* Gyll. (Coleoptera: Rhizophagidae)’in biyolojisi, laboratuvarında üretim yöntemleri, ormanlara salınması ve mücadele sonuçları. Türkiye I. Orman Entomolojisi ve Patolojisi Sempozyumu, 23-25 Kasım 2011, Antalya, 73-79.
- Aksu, Y., Dedeğaoğlu, C., Çelik, B., 2014. *Dendroctonus micans* (Kug) (Coleoptera: Scolytidae)’in mücadelesinde kullanılan *Rhizophagus grandis* (Gyll) (Coleoptera: Rhizophagidae)’in kutu metodu ile üretilmesi. Türkiye II. Orman Entomolojisi ve Patolojisi Sempozyumu, 7-9 Nisan 2014, Antalya, 64-71.
- Alkan, Ş., 1989. *Dendroctonus micans* (Kug.)’la savaş (Dünü, bugünü, yarını). Orman Mühendisliği Dergisi 4: 30.
- Alkan, Ş., 2000. Ladin ormanlarına zarar veren *Dendroctonus micans* ve *Ips typographus* zararlılarına karşı sürdürülen mücadele uygulamaları. Eğitim Semineri, 22–26 Mayıs, İstanbul, 10–18.
- Alkan-Akıncı, H., Özcan, G.E., Eroğlu, M., 2009. Impacts of site effects on losses of oriental spruce during *Dendroctonus micans* (Kug.) outbreaks in Turkey. African Journal of Biotechnology 8, 16: 3934–3939.
- Alkan-Akıncı, H., Eroğlu, M., Özcan, G.E., 2014. Attack strategy and development of *Dendroctonus micans* (Kug.) (Coleoptera: Curculionidae) on oriental spruce in Turkey. Turkish Journal of Entomology 38 (1): 31-41.
- Benz, G., 1984. *Dendroctonus micans* in Turkey: The situation today, 43-47. Proceedings of the EEC Seminar Biological Control of Bark Beetles (*Dendroctonus micans*), (3–4 October 1984, Brussels, Belgium), 141 pp.
- Eroğlu, M., 1995. *Dendroctonus micans* (Kug.) (Coleoptera, Scolytidae)’in populasyon dinamiğine etki eden faktörler üzerine araştırmalar. I. Ulusal Karadeniz Ormancılık Kongresi Bildirileri, 3. Cilt, 23–25 Ekim 1995, Trabzon, 148-159.
- Eroğlu, M., Alkan-Akıncı, H., Özcan, G.E., 2005. Ladin ormanlarımızda Kabuk Böceği yıkımlarına karşı izlenebilecek kısa ve uzun dönemli mücadele ve iyileştirme çalışmalar. Ladin Sempozyumu Bildiriler Kitabı, I. Cilt, 20–22 Ekim 2005, Trabzon, 184-194.
- Fielding, N.J., Evans, H., 1997. Biological control of *Dendroctonus micans* (Scolytidae) in Great Britain. Biocontrol News and Information 18, 2: 51–60.
- Fielding, N.J., Evans, H.F., Williams, J.M., Evans, B., 1991. Distribution and spread of the Great European Spruce Bark Beetle, *Dendroctonus micans*, in Britain–1982 to 1989. Forestry 64 (4): 345–358.
- Furniss, M.M., 1996. Taxonomic status of *Dendroctonus punctatus* and *D. micans* (Coleoptera: Scolytidae). *Annals of the Entomological Society of America* 89 (3): 328-333.
- Grégoire, J.C., Baisier, M., Merlin, J., Naccache, Y., 1989. Interactions between *Rhizophagus grandis* (Coleoptera: Rhizophagidae) and *Dendroctonus micans* (Coleoptera: Scolytidae) in the field and the laboratory: their application for the biological control of *D. micans* in France. In: The Potential for Biological Control of *Dendroctonus* and *Ips* Bark Beetles (Ed: D. Kulhavy and M.C. Miller).

The Stephen Austin University Press,
Nagocdoches, 95-108.

Grégoire, J.C., 1988. The Greater European Spruce Beetle. In: Dynamics of Forest Insects Populations (Ed: A.A. Berryman). Plenum Press, New York, 455-478.

Grégoire, J.C., Merlin, J., Pasteels, J.M., 1984a. Mass rearing of *Rhizophagus grandis* for the biological control of *Dendroctonus micans*: An interplay between technical requirements and the species biological characteristics. Med. Fac. Landbouww. Rijksuniv. Gent, 49 / 3a, 763 – 769.

Grégoire, J.C., Merlin, J., Pasteels, J.M., Jaffuel, R., Vouland, G., Schvester, D., 1984b. Mass rearings and releases of *Rhizophagus grandis* in Lozere. Proceedings of the EEC Seminar Biological Control of Bark Beetles (*Dendroctonus micans*), 3–4 October 1984, Brussels, Belgium, 122-128.

Khobakhidze, D.N., Tvaradze, M.S., Kraveishvili, I.K., 1970. Preliminary results of introduction, study of bioecology, development of methods of artificial rearing and naturalization of the effective entomophage, *Rhizophagus grandis* Gyll., against the European spruce beetle, *Dendroctonus micans* Kugel., in spruce plantations in Georgia. Bulletin of the Academy of Sciences of the Georgian SSR60: 205–208.

King, C.J., Evans, H.F., 1984. The rearing of *Rhizophagus grandis* and its release against *Dendroctonus micans* in the United Kingdom. Proceedings of the EEC Seminar Biological Control of Bark Beetles (*Dendroctonus micans*), 3–4 October 1984, Brussels, Belgium, 87-97.

Kostak, H., 1997. Doğu Karadeniz ladin ormanlarında zarar yapan *Dendroctonus micans* (Kug.) zararlısına ait biyolojik mücadele yöntemi ve uygulamalar. Balıkesir – Akçay Orman Zararlılarıyla Mücadele Eğitim Semineri.

Merlin, J., Grégoire, J.C., Baisier, M., Pasteels, J.M., 1984. Some new data on the biology of *Rhizophagus grandis* (Col.: Rhizophagidae). Proceedings of the EEC Seminar Biological Control of Bark Beetles (*Dendroctonus micans*), 3–4 October 1984, Brussels, Belgium, 107-121.

Özder, M.Z., 1984. *Dendroctonus micans* Kug. Orman Mühendisliği Dergisi 21: 30–31.

Pauly H., Meurisse N (2007). Le Dendroctone de l'Épicéa en France: situation et mesures de lutte en cours. *Revue Forestière Française* 59 (6): 595–608.

Researches on the First Time Recorded Egg Parasitoid, *Telenomus euproctidis* (Wilcox) (Hym.: Scelionidae) of Brown-tail Moth, *Euproctis chrysorrhoea* L., (Lep.: Erebidae) on Oak (*Quercus infectoria* Oliver) in Çankırı, Turkey

*Yalçın KONDUR¹, Ziya ŞİMŞEK¹

¹Çankırı Karatekin University, Faculty of Forestry, Çankırı / TURKEY

*Corresponding Author: yalcinkondur@karatekin.edu.tr

Abstract

The Brown-tail Moth (*Euproctis chrysorrhoea* L.) has been determined to cause heavy damage on *Quercus infectoria* (Oliver), *Salix* spp., fruit trees and ornamental plants after observations carried out in oak (*Q. infectoria*) area in Çankırı (Şabanözü). Since *E. chrysorrhoea* causes certain health issues at humans beside of the economics damage, control of the pest is very important. However, since there are many natural enemies in forest ecosystems and unfavorable topographical conditions of forest lands, biological control carries great importance. Thus, this study was carried out between 2007-2008 in order to determine the natural enemies of *E. chrysorrhoea* and the relationships between the pest and its natural enemies. Flight of *E. chrysorrhoea* adults was monitored via light traps. After trapping of *E. chrysorrhoea* adults in light trap, parasitoid adults from the egg masses that have been collected from the study area, have been brought to laboratory which was set to 25°C temperature and 45%±5 relative humidity. After the emergence of the parasitoid adults, *E. chrysorrhoea* eggs were investigated under stereo-microscope and status of each egg (parasitoid emerged, larva hatched or no hatch) was recorded. The parasitization ratio for each egg mass was calculated as number of the eggs that parasitoid adult emerged was divided by the total number of the eggs at that egg mass. The results show that *E. chrysorrhoea* adults may be trapped from the end of June when the mean air temperature reaches 21°C until first week of August (approximately 42 days). A total of 639 *E. chrysorrhoea* adults were trapped at light trap. In laboratory conditions, eggs in the masses were between 105 and 278 (166.21±12.95) from 15 *E. chrysorrhoea* egg masses. 1038 out of 2509 *E. chrysorrhoea* eggs were parasitized (mean 41.37%). The egg parasitoid was identified as *Telenomus euproctidis* (Wilcox) (Hymenoptera: Scelionidae). There were not any records in literature regarding this parasitoid species existing in Turkey. It is also understood that *T. euproctidis* is an egg parasitoid of many Erebidae (Lepidoptera) species, mainly *Euproctis* spp. from literature.

Keywords: *Euproctis chrysorrhoea*, *Telenomus euproctidis*, egg parasitoid, biological control, Çankırı, *Quercus infectoria*, oak.

Çankırı Meşe (*Quercus infectoria* Oliver) Orman Alanlarında Zararlı Altın Kelebek, *Euproctis chrysorrhoea* L. (Lep.: Erebidae)'nın İlk Kez Tespit Edilen Yumurta Parazitoiti, *Telenomus euproctidis* (Wilcox) (Hym.: Scelionidae) Üzerinde Araştırmalar

Özet

Çankırı (Şabanözü) meşe (*Quercus infectoria* Oliver) orman alanlarında yürütülen gözlemler neticesinde, Altın kelebek (*Euproctis chrysorrhoea* L.)'in meşe (*Quercus* spp.), söğüt (*Salix* spp.) ve pek çok meyve ağacı ile süs bitkisinde önemli zarara neden olduğu anlaşılmıştır. *E. chrysorrhoea*'nın neden olduğu ekonomik kayıpların yanı sıra, insanlarda da sağlık sorunlarına neden olduğundan sözü edilen zararlı oldukça önemlidir. Bununla birlikte, orman alanlarının çoğunlukla uygunsuz topoğrafik koşullara sahip olması ve ayrıca orman alanlarında pek çok doğal düşman türünün bulunması nedeniyle, bu tür alanlarda biyolojik mücadele daha da önem kazanmaktadır. Bu nedenle, bu çalışma 2007-2008 yıllarında, *E. chrysorrhoea*'nın doğal düşmanları ile aralarındaki ilişkileri ortaya koymak amacıyla ele alınmıştır. *E. chrysorrhoea* uçuş periyodunun izlenmesi için ışık tuzağı kullanılmıştır. *E. chrysorrhoea* erginlerinin ışık tuzağında yakalanması tamamlandıktan sonra, araziden toplanan yumurta paketleri 25°C sıcaklık ve %45±5 oranlı nem değerlerine ayarlanmış laboratuara getirilmiştir. Ergin parazitoitlerin çıkışı tamamlandıktan sonra *E. chrysorrhoea* yumurtaları stereo mikroskop altında incelenerek her bir yumurtanın durumu (parazitoit çıkmış, larva çıkmış ya da çıkmamış) kaydedilmiştir. Her bir yumurta paketi için parazitlenme oranları; parazitoit çıkan yumurta sayısının o paketteki toplam yumurta sayısına oranlanması suretiyle hesaplanmıştır. Elde edilen sonuçlar, *E. chrysorrhoea* erginlerinin, ortalama hava sıcaklığının 21°C'ye ulaştığı Haziran ayı sonundan Ağustos ayının ilk haftasına dek (yaklaşık 42 gün) yakalanabileceğini göstermektedir. Çalışma süresince ışık tuzağında 639 *E. chrysorrhoea* ergini yakalanmıştır. Laboratuvar koşullarında yürütülen çalışmalarda, 15 yumurta paketinin her birinde 105 ila 278 (166.21±12.95) adet yumurta bulunduğu anlaşılmıştır. Sayılan 2509 *E. chrysorrhoea* yumurtasından 1038'inin parazitlenmiş olduğu (ort. %41.37) tespit edilmiştir. Çalışmada elde edilen yumurta parazitoiti *Telenomus euproctidis* (Wilcox) (Hymenoptera: Scelionidae) olarak teşhis edilmiştir. Yapılan literatür taramasında bu parazitoit türünün Türkiye'de bulunduğu dair bir kayda rastlanmamıştır. Ayrıca literatür taramalarından, söz konusu parazitoit türün, başta *Euproctis* spp. olmak üzere diğer bazı Erebidae (Lepidoptera) türlerinin de parazitoiti olabileceği de anlaşılmıştır.

Anahtar Sözcükler: *Euproctis chrysorrhoea*, *Telenomus euproctidis*, yumurta parazitoiti, Biyolojik mücadele, Çankırı, *Quercus infectoria*, meşe.

Introduction

The Brown-tail moth (*Euproctis chrysorrhoea* L. (Lepidoptera: Erebidae)) is an important pest of many deciduous plants and trees, especially oak species and also it is a polyphagous pest which is known to utilize over 80 plant species as hosts (Britton, 1914; Kansu, 1955; Gürses, 1975; İren, 1977; Eroğlu, 1990; Bulut, 1991; Dordaei et al., 2004; Erler and Cetin, 2009). Some researchers state that *E.chrysorrhoea* outbreaks may occur in agricultural trees and oaks with 8-10 year intervals in Central Anatolia and also with 3-4 year intervals in Aegean Region (Öncüer et al., 1982; Eroğlu, 1990; Bulut, 1991). Epidemic populations of *E.chrysorrhoea* defoliate trees completely (Bulut, 1991; Şimşek and Kondur, 2006a; b) and adversely affect the development of oak trees (Kulman, 1971; Şimşek and Kondur, 2006a; b). *E.chrysorrhoea* is also considered as a public pest because of causing allergic reactions due to itchy-burner hairs of larvae and adults contacting human skin (Britton, 1914; Eroğlu, 1990; Erler and Cetin, 2009).

The distribution area of *E.chrysorrhoea* both in Turkey and the world is wide (Çanakçıoğlu and Mol 1998) and it is known that this pest could be found in almost every oak site (Şimşek, 2000; Şimşek and Kondur, 2006a; b; Öner et al., 2010).

Some researchers state that egg, larva and pupa parasitoids and also entomopathogens are major factors keeping *E.chrysorrhoea* populations in balance in nature (Gürses, 1975; Öncüer et al., 1977; 1978; 1982; Bulut, 1991). Thus this study is carried out between 2007 and 2008 in order to determine the efficiency of one of *E.chrysorrhoea*'s parasitoids, *Telenomus euproctidis* (Wilcox) which is determined in Çankırı for the first time, on this pest and to call attention to future studies regarding to this parasitoid.

Material and Method

The main materials of the study were various stages of the brown-tail moth [*Euproctis chrysorrhoea* L. (Lepidoptera: Erebidae)] which was epidemic state between 2007 and 2008, light trap, adults of the parasitoid *Telenomus euproctidis* (Wilcox) (Hymenoptera: Scelionidae). Also;

ice cage, branch cutter, plastic/nylon bags, digital camera, glass tubes and stereo-microscope were used as auxiliary materials in the study.

Field studies were carried out weekly in oak (*Quercus infectoria* Oliver) forest near to Büyükyakalı village that is located within Şabanözü Forest District, Çankırı Forest Enterprise in 2007. 160 watts-powered Pennsylvania type light trap (Figure 1) was installed in oak forest (Gül, 1967; Popov, 1975; Szontagh, 1986; Lesko et al., 1995; Şimşek, 2000) and the electricity requirement for the trap was supplied from a house outside the village. In order to kill the lepidopterous insects in the collecting jar as quickly as possible, DDVP absorbed killing strips were inserted (Şimşek, 2000). The light trap was installed at coordinates of 516317, 4482208 at 1344 m. The trap was checked once a week; collection jar was changed with a new one. In the laboratory, all lepidopterous insects removed from the jar and prepared for identification. This study is carried out during lepidopterous insects captured in the trap.



Figure 1. Pennsylvania type light trap

After emergence of *E.chrysorrhoea* adults emerged, leaves of randomly selected oak trees were inspected for egg clusters. *E.chryosrrhoea* egg clusters were spotted under leaves on July 10, 2007 and 15 egg clusters were carried within ice cage to laboratory which was set to 25°C temperature and 45%±5 relative humidity. Each egg cluster was put into an 8 cm glass tube. A moisturized cotton piece was inserted at top of each tube in order to prevent eggs to dry (Figure 2). All glass tubes were inspected

daily for either larvae or parasitoids and also larvae and parasitoids removed from tubes. After egg hatchings, each cluster was inspected under stereo microscope and counted for their status (i.e., *E.chrysorrhoea* larva, parasitoid emerged, non-hatched). Since the parasitoid emerged was a solitary, parasitization was calculated based on *E.chrysorrhoea* larva and parasitoid counts and the parasitization ratio was calculated dividing the parasitoid emerged egg number by total eggs for each egg cluster (Öncüer et al., 1982).

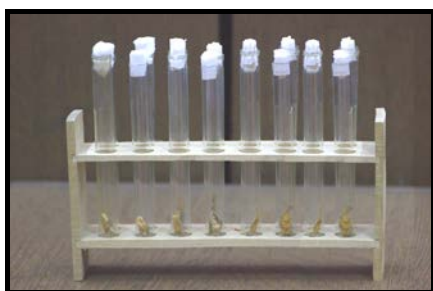

Figure 2. *Euproctis chrysorrhoea* L. egg clusters from oak leaves at Büyükyakalı (Şabanözü) village within glass tubes

The egg parasitoid of *E.chrysorrhoea* was identified by Prof. Dr. Miktat DOĞANLAR (Mustafa Kemal University, Faculty of Agriculture). The meteorological data were obtained from Şabanözü (Çankırı) station since it is the nearest meteorological station. The data were prepared as tables and figures and also relationships between were researched.

Results and Discussion

Heavy defoliation of *E.chrysorrhoea* on *Q. infectoria*, *Salix* spp., fruit trees in home gardens and other ornamental plans was observed during field observations in 2007. *E.chrysorrhoea* larvae consume tree leaves and we observed that certain oak trees were without any leaves due to heavy defoliation in 2007 (Figure 3).



Figure 3. *Euproctis chrysorrhoea* L. larvae after overwintering (top) and defoliated oaks (bottom) due to *E.chrysorrhoea* feeding

The pupae of *E.chrysorrhoea* determined on June 05, 2007 during field observations (Figure 4). After that date, the number of pupae was increased and also number of larvae was decreased. Cocoons of *E.chrysorrhoea* are in groups and cocoon lengths are between 12 and 15 mm in males and 15 and 20 mm in females (Şimşek and Kondur, 2006a; b).



Figure 4. *Euproctis chrysorrhoea* L. cocoon

First *E.chrysorrhoea* adult was captured in trap on June 26, 2007. This date shows that the pupation period of *E.chrysorrhoea* lasted 21 days. During the pupation period of *E.chrysorrhoea*, mean temperature was between 11.8 and 23.2 °C and the relative humidity was between 36.2 and 78.1%.

Şimşek and Kondur (2006a) report the pupation period of *E.chrysorrhoea* between 22 and 24 days.

The number of adults captured in light trap and the related meteorological data at Büyükyakalı (Şabanözü, Çankırı) in 2007 is given at Figure 5.

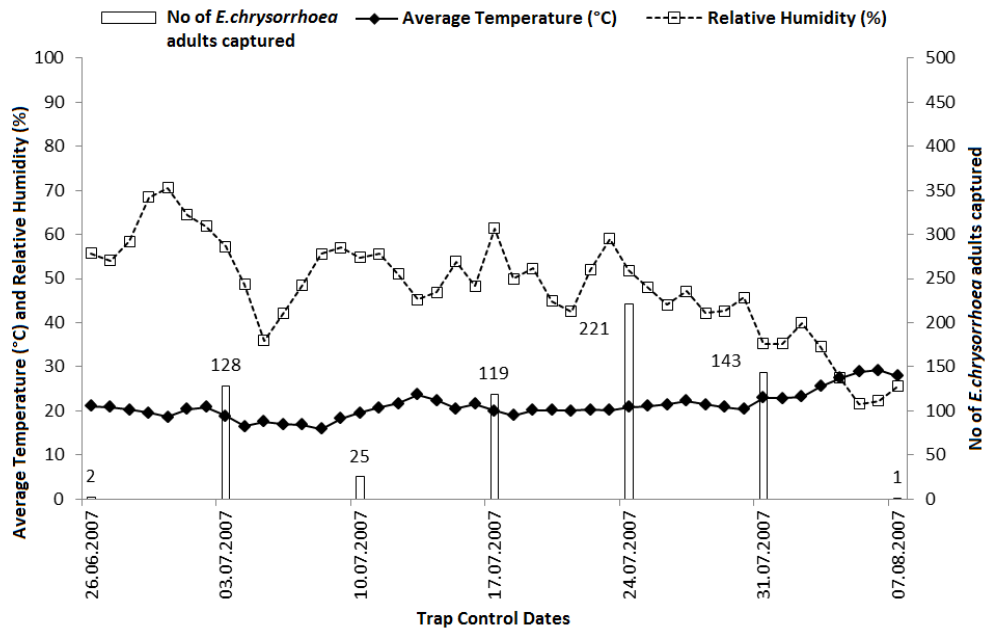

Figure 5. The number of *Euproctis chrysorrhoea* L. adults captured in light trap and the related meteorological data at Büyükyakalı (Şabanözü, Çankırı) in 2007

In figure 5, it could be seen that 2 adults of *E.chrysorrhoea* were captured at the light trap on June 26, 2007 when the average temperature was 21.1°C and the relative humidity was 55.7%. The most intense *E.chrysorrhoea* capture (221 adults) have occurred on July 24, 2007 when the average air temperature was 20.8°C and the relative humidity was 51.8%; and also the last *E.chrysorrhoea* adult was captured on August 07, 2007. Figure 5 also show that 639 adults of *E.chrysorrhoea* were captured at light trap during 42 days between June 26 and August 07, 2007. Certain researchers report adult flights of *E.chrysorrhoea* occurring in June and July (Çanakçıoğlu and Mol, 1998; Şimşek and Kondur, 2006a; b). We determined that *E.chrysorrhoea* adults' flights begin at the last week of June until the first week of August.

The adult wingspan of *E.chrysorrhoea* is between 30-35 mm. Eroğlu (1990) has reported wingspan of females and males as

28.53 and 33.39 mm respectively. Wings are white in color and there is a bunch of golden hairs at the tip of abdomen which is a characteristic attribute for females. There are generally some blackish spots under forewings of males. Antennae are single-sided comb-like in females and double-sided comb-like in males (Figure 6).





Figure 6. Adult female (left image) and male (right image) of *Euproctis chrysorrhoea* L.

During field observations on July 10, 2007 (almost one month later than the first light trap capture), *E.chrysorrhoea* egg patches were found on *Q.infectoria* leaves. *E.chrysorrhoea* females lay eggs as clusters, and then the females cover eggs with their golden colored hairs at the abdomen tip for egg protection (Figure 7). Females usually lay eggs under the oak leaves but rarely onto oak leaves. However, eggs were always covered with golden colored hairs at abdomen tip. This hair covers on the eggs were found to be very dense.



Figure 7. Oviposition of *Euproctis chrysorrhoea* L. female

In the field studies, we collected 15 egg clusters and counted eggs varying between 115 and 278 eggs (166.21 ± 12.95) in each cluster after counting under stereo microscope. Candan et al. (2008) reported that *E.chrysorrhoea* egg clusters contain varying number of eggs between 200 and 400. Craighead (1950) reported that egg clusters contained about 300 eggs. The first *E.chrysorrhoea* larva was observed on August 1, 2007 in laboratory and August 07

in the field observations (Figure 8). These findings suggest that *E.chrysorrhoea* eggs hatch after 3 weeks in field conditions. Şimşek and Kondur (2006b) state that *E.chrysorrhoea* eggs hatch about 3 weeks later than oviposition and young larvae feed on upper epidermis of leaves that support our findings.



Figure 8. Newly hatched *Euproctis chrysorrhoea* L. larvae

Newly hatched *E.chrysorrhoea* larvae (Figure 8) feed on the same oak leaf which the egg cluster is located. Latter instars also begin feeding on neighboring leaves. After the second instar, two orange-reddish spots become apparent on the dorsal side of 6th and 7th abdominal segments.

When the air temperature cools down, *E.chrysorrhoea* larvae prepare overwintering tents on the upper branches and overwinter as 4th and 5th instar larvae. Overwintered larvae leave the tents and continue feeding next year after air temperature risen up and oaks foliated. *E.chrysorrhoea* larvae are known to have 8 larval instars.

Egg clusters of *E.chrysorrhoea* was inspected under stereo-microscope in laboratory after the larvae of *E.chrysorrhoea* had left leaves and gone into overwintering tents in the field and an egg parasitoid was determined to emerge from *E.chrysorrhoea* eggs. This parasitoid species was identified as *Telenomus euproctidis* (Wilcox, 1920) (Hymenoptera: Scelionidae). While inspecting the egg clusters, the parasitoid *T.euproctidis* was determined to develop as head up in transparent eggs and also emerged from an irregularly gnawed exit hole (Figure 9).

Counting results for each *E.chrysorrhoea* egg cluster (total eggs, emerged parasitoids and parasitization ratio) are given at Table 1.

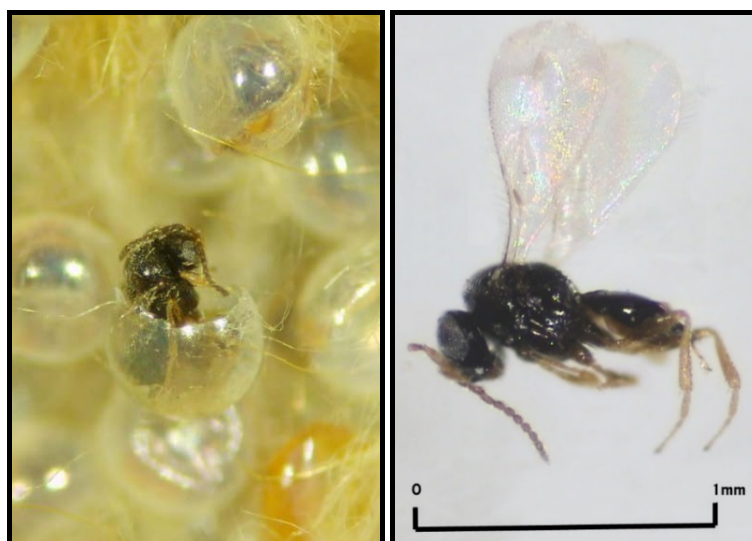

Figure 9. Emerging adult of *Telenomus euproctidis* (Wilcox) from *Euproctis chrysorrhoea* L. eggs (left) and the adult of *T.euproctidis* (right)

Table 1. Numbers of *Euproctis chrysorrhoea* L. eggs within egg clusters that have been brought laboratory from natural conditions, emerged parasitoid counts from each egg cluster and parasitization ratios

Egg Cluster No	Eggs in Clusters	Number of Parasitoid Emerged Eggs	Parasitization Ratio (%)
1	182	79	43.41
2	134	50	37.31
3	204	83	40.69
4	131	30	22.90
5	197	104	52.79
6	122	24	19.67
7	156	75	48.08
8	105	0	0.00
9	127	61	48.03
10	148	93	62.84
11	206	117	56.80
12	278	42	15.11
13	223	144	64.57
14	159	61	38.36
15	137	75	54.74
Total	2509	1038	Mean: 41.37

Table 1 shows that eggs in each egg cluster were between 105 and 278 and a certain amount of the eggs were parasitized by *T.euproctidis* up to 65.57% and also 1038 out of 2509 *E.chrysorrhoea* eggs within 15 egg clusters were parasitized (mean parasitization was 41.37%). We think that this ratio of egg parasitization is very high and may play an important role in controlling *E.chrysorrhoea*. This data also suggest *T.euproctidis* as a powerful parasitoid.

We could not any record in literature that *T.euproctidis* existed in Turkey. However,

certain researches previously carried out show that this species is an egg parasitoid of many Erebidae mainly *Euproctis* spp. (Arakaki et al., 1977; Wang, 1981; Arakaki et al., 2005; Arakaki et al., 2011). *T.euproctidis* may find its host by tracking the sexual pheromone dispersing from anal tufts of its host (Wang, 1981; Arakaki and Wakamura, 2000; Wakamura, 2006; Arakaki et al., 2011). The parasitoid attaches itself to anal tufts of ovipositing female host, and then lays its eggs into eggs of the host (Arakaki, 1990; Arakaki et al., 2006). Generally,

T.euproctidis females prefer new host eggs, however it may parasitize rather older host eggs with advanced embryonic development (Wang, 1981). Certain researchers identified *T.euproctidis* from various hosts i.e., *E.taiwana* and *E.pseudoconspersa* in Japan, *E.pseudoconspersa*, *E.smilis*, *E.varians* and *E.bipunctapex* in China (Arakaki et al., 1977; Wu and Chen, 1980; Wang, 1981; Arakaki and Tanaka, 1998; Arakaki et al., 2005; 2006; Arakaki et al., 2011).

T.euproctidis is one of the most important egg parasitoids of *E.pseudoconspersa* in the Hunan province of China. The parasitoid overwinters in the host egg as first instar larva and emerges in April next year. Life period is closely related to temperature and emerge after 21 days at 21°C, 17-18 days at 23.3°C. In the life span of this parasitoid, 2 days pass in the egg, 5 days pass in pupa and 10-11 days pass as adult. Complete life span of this parasitoid is 10-12 days at 30.1-30.9°C temperature. Females fed with honey solution live 11.6-15.2 days and lay 32.75-46.50 eggs. Oviposition performance is lower when fed with water. It lays 80-90% of its eggs in the first five days of its 10-day oviposition period. *T.euproctidis* may utilize other Erebiidae eggs as artificial hosts such as *E.smilis*, *E.varians*, *E.bipunctapex* (Wang, 1981).

In our study, with regard to trapping period of *E.chrysoorrhoea* adults at light trap (42 days), the hosts lay eggs within a broad time period in field conditions and that cause *T.euproctidis* to find host eggs in that period (Figure 5). Wang (1981) states that *T.euproctidis* as an important parasitoid of *E.pseudoconspersa* in China and the parasitoid overwintering as first instar larva in host egg, then emerge April next year. However, we could not find any record on generation of *T.euproctidis* on *Euproctis* spp. *E.chrysoorrhoea*, the host of *T.euproctidis* in Çankırı, has only one generation and overwinter as 4-5th instar larvae in the overwintering tents on oaks. Thus, the biology of *T.euproctidis* in Çankırı differs than of in China and there may be alternative hosts so the parasitoid overwinter. One of the possible alternative hosts may be *Lymantria dispar* L. which also exists in the study area and overwinter as egg on the lower parts of

oak trunks. So *T.euproctidis* also might parasitize *L.dispar* eggs and the possible relationships between *T.euproctidis* and *L.dispar* should be researched.

In our literature search on egg parasitoids of *E.chrysoorrhoea*, we came across various studies such as, *Telenomus phalaenarum* Nees (Britton, 1914), *T.turkarkandas* (Öncüer et al., 1982; Bin et al., 1988; Tiberi, 1989), *Trichogramma dendrolimi* (Bin et al., 1988; Tiberi, 1989), *Tr.turkeiensis* and *Tr.euproctidis* (Bulut, 1991). Some researchers in Turkey report the parasitizing efficiencies of egg parasitoids such as *Telenomus* sp. as 29% in Central Anatolia (Kansu, 1955), 18% in Thrace (Gürses, 1975). Öncüer et al. (1982) report *T.turkarkandas* as parasitizing up to 77.6% of *E.chrysoorrhoea* eggs in Denizli and Uşak provinces in Turkey. These parasitizing ratios from previous studies and also our parasitization results from Çankırı forests may be accepted as very high. This shows that many parasitoid species which belong to same genus may show various parasitization ratios however, *T.euproctidis* was the most efficient parasitoid.

Conclusions

The Brown-tail Moth (*Euproctis chrysoorrhoea* L.) has been determined to cause heavy damage on *Quercus infectoria* (Oliver), *Salix* spp., fruit trees and ornamental plants after observations carried out in oak (*Q.infectoria*) area in Çankırı (Şabanözü). Since *E.chrysoorrhoea* causes certain health issues at humans beside of the economic damage, control of the pest is very important. Thus, control of *E.chrysoorrhoea* has a great importance.

There are various studies on the natural enemies of *E.chrysoorrhoea* in the literature. Also, there are certain studies on the egg parasitoids of *E.chrysoorrhoea* in Turkey. However, there was not any record on *Telenomus euproctidis* (Wilcox) which was identified in this study as an egg parasitoid of *E.chrysoorrhoea* in Turkey.

Results of this study show that higher parasitization ratio up to 62.84% (mean 41.37%) of *E.chrysoorrhoea* eggs by *T.euproctidis* indicating this parasitoid as an effective egg parasitoid. However, we think that further studies on alternative hosts of

T.euproctidis instead of *E.chrysorrhoea* since this host could cause allergic reactions on human skin should be carried out and mass production and storage possibilities of the egg parasitoid should be researched in order to utilize this parasitoid in biological control applications.

Acknowledgements

We would like to thank to Prof. Dr. Mikdat DOĞANLAR (Mustafa Kemal University, Faculty of Agriculture) for identification of *Telenomus euproctidis* (Wilcox), the egg parasitoid of *Euproctis chrysorrhoea* L.

References

- Arakaki, N. 1990. Phoresy of *Telenomus* sp. (Scelionidae: Hymenoptera), an egg parasitoid of the tussock moth *Euproctis taiwana*. Journal of Ethology 8(1), 1-3.
- Arakaki, N., Tanaka, S. 1998. Diapause responses of two geographic strains of a phoretic egg parasitoid *Telenomus euproctidis* (Hymenoptera: Scelionidae) on two allopatric tussock moth species. Entomological Science, 1 (2), 145-143.
- Arakaki, N., Wakamura, S. 2000. Bridge in time and space for an egg parasitoid - kairomonal use of trace amount of sex pheromone adsorbed on egg mass scale hair of the tussock moth, *Euproctis taiwana* (Shiraki) (Lepidoptera: Lymantriidae), by egg parasitoid, *Telenomus euproctidis* Wilcox (Hymenoptera: Scelionidae), for host location. Entomological Science 3(1), 25-31.
- Arakaki, N., Wakamura, S., Yasuda, T. 2005. Phoresy by an egg parasitoid *Telenomus euproctidis* (Hymenoptera, Scelionidae), on the tea tussock moth *Euproctis pseudoconspersa* (Lepidoptera: Lymantriidae). Appl.Entomol.Zool., 30 (4), 602-603.
- Arakaki, N., Wakamura, S., Yasuda, T. 2006. Phoretic egg parasitoid, *Telenomus euproctidis* (Hymenoptera: Scelionidae) uses sex pheromones of tussock moth *Euproctis taiwana* (Lepidoptera: Lymantriidae) as a kairomone. Journal of Chemical Ecology, 22 (6), 1079-1085.
- Arakaki, N., Wakamura, S., Yasuda, T., Yamagishi, K. 1977. Two regional strains of a phoretic egg parasitoid, *Telenomus euproctidis* (Hymenoptera: Scelionidae), that use different sex pheromones of two allopatric tussock moth species as kairomones. Journal of Chemical Ecology, 23 (1), 153-161.
- Arakaki, N., Yamazawa, H., Wakamura, S. 2011. The egg parasitoid *Telenomus euproctidis* (Hymenoptera: Scelionidae) uses sex pheromone released by immobile female tussock moth *Orgyia postica* (Lepidoptera: Lymantriidae) as kairomone. Applied Entomology and Zoology, 46 (2), 195-200.
- Britton, W. E. 1914. The brown tail moth *Euproctis chrysorrhoea*. Connecticut Agricultural Experiment Station New Haven, Conn. Bulletin, 182 (20), 1-26.
- Bulut, H. 1991. Altın kelebek (*Euproctis chrysorrhoea* L.)'in yumurta parazitoidleri, buldukları yerler ve doğal etkinlikleri üzerinde araştırmalar. Türkiye Entomoloji Dergisi 15 (1), 15-24.
- Candan, S., Suludere, Z., Bayrakdar, F. 2008. Surface morphology of eggs of *Euproctis chrysorrhoea* (Linnaeus, 1758). Acta Zoologica, 89 (2), 133-136.
- Craighead, F. C. 1950. Insect enemies of eastern forests. 679, U.S. Department of Agriculture Washington.
- Çanakçıoğlu, H., Mol, T. 1998. Orman entomolojisi zararlı ve yararlı böcekler. 541, İstanbul Üniversitesi Orman Fakültesi Yayınları, İstanbul.
- Dordaei, A. A., Nikdel, M., Sadaghian, B. 2004. Daily and periodic leaf consumption of larval instars of Brawn-tail moth, *Euproctis chrysorrhoea* (L.). Iranian Journal of Forest and Range Protection Research, 2 (1), 39-47.
- Erler, F., Cetin, H. 2009. Components from the essential oils from two *Origanum* species as larvicides against *Euproctis chrysorrhoea* (Lepidoptera: Lymantriidae). Journal of Agriculture and Urban Entomology, 26 (1), 31-40.
- Eroğlu, M. 1990. *Euproctis chrysorrhoea* (L.) (Lep., Lymantriidae)'nin Biyolojisi, Doğal Düşmanları ve Kısır Böcek Salverme Metodu (SIRM) ile Kontrol Olanaklarının Araştırılması. Ph.D., Fen Bilimleri Enstitüsü, Trabzon.
- Gül, S. 1967. Böcek koleksiyonlarının hazırlanması ve muhafazaları. T.C. Tarım Bakanlığı Zirai Mücadele ve Zirai Karantina Genel Müdürlüğü, Ankara.
- Gürses, A. 1975. Trakya Bölgesinde Altın Kelebek (*Euproctis chrysorrhoea* L.)'in Biyo-Ökolojisi ve Savaşı Üzerinde Araştırmalar. Zirai Mücadele ve Karantina Genel Müdürlüğü İstanbul.
- İren, Z. 1977. Önemli meyve zararlıları, tanınmaları, Zararları, yaşayışları ve mücadele metodları. Gıda Tarım ve Hayvancılık Bakanlığı, Zirai Mücadele ve Zirai Karantina Genel Müdürlüğü, Ankara.

- Kansu, İ. A. 1955. Orta Anadolu Meyve Ağaçlarına Zarar Veren Bazı Macrolepidoptera Türlerinin Evsafi ve Kısa Biyolojileri Hakkında Araştırmalar. 203, Ziraat Vekaleti, Neşriyat ve Haberleşme Müdürlüğü, Ankara.
- Kulman, H. M. 1971. Effects of Insect Defoliation on Growth and Mortality of Trees. Annual Review of Entomology, 16 289-324.
- Lesko, K., Szentkiralyi, F., Kadar, F. 1995. Aranyfaru szovolepke (*Euproctis chrysorrhoea* L.) magyarországi populacioinak hosszutavu fluktuacios mintazatai. Erdeszeti Kutatasok, (85), 169-184.
- Öncüer, C., Yalçın, E., Erkin, E. 1977. Ege Bölgesinde meyve ağaçlarında zarar yapan *Euproctis chrysorrhoea* L. (Lepidoptera: Lymantriidae) larvalarının doğal düşmanları ve bunların etkililik durumları. Türkiye Bitki Koruma Dergisi, 1 (1), 39-47.
- Öncüer, C., Yalçın, E., Erkin, E. 1978. Ege Bölgesi'nde meyve ağaçlarında zarar yapan; *Euproctis chrysorrhoea* L. (Lepidoptera: Lymantridae) pupalarının doğal düşmanları ve bunların etkililik durumları. Türkiye Bitki Koruma Dergisi, 2 (1), 31-36.
- Öncüer, C., Yalçın, E., Erkin, E. 1982. *Euproctis chrysorrhoea* L. (Lepidoptera: Lymantriidae) yumurtalarının paraziti *Asolcus turkarkandas* Szabo (Hymenoptera: Scelionidae)'ın etkililik durumu. Türkiye Bitki Koruma Dergisi, 6 221-225.
- Öner, N., Şimşek, Z., Kondur, Y., İmal, B., Şimşek, M. 2010. Küresel iklim değişikliği dikkate alınarak kurak ve yarıkurak alanların ağaçlandırılması ve zararlı böceklerle mücadelesine yönelik öneriler (Çankırı ili örneği). III. Ulusal Karadeniz Ormancılık Kongresi (20-22.05.2010), 827-838, Artvin.
- Popov, P. 1975. Use of light trap data for forecasting and alerting. Rastitelna Zashchita, 23 (10), 13-18.
- Szontagh, P. 1986. Tolgy nagylepke karositoinak populaciodynamikaja es a masodlagos karosito rovarok okozta karlancolat. Erdeszeti Kutatasok, (76-77), 305-314.
- Şimşek, Z. 2000. Ilgaz Dağı Milli Parkı (Yenice ve Doruk)'nda bulunan Lepidoptera türleri ve populasyon dalgalanması. Batı Karadeniz Ormancılık Araştırma Enstitüsü Müdürlüğü Dergisi, 3 3-37.
- Şimşek, Z., Kondur, Y. 2006a. Çankırı ormanlarının zararlı böcekleri ve mücadele yöntemleri. Gazi Üniversitesi Orman Fakültesi Dergisi, 6 (1), 98-119.
- Şimşek, Z., Kondur, Y. 2006b. Yarıkurak mıntika orman alanları (Çankırı)'nda zarar yapan böcekler. Türkiye'de Yarıkurak Bölgelerde Yapılan Ağaçlandırma ve Erozyon Kontrolü Uygulamalarının Değerlendirilmesi Çalıştayı (7-10.11.2006), 271-286, Ürgüp, Nevşehir.
- Tiberi, R. 1989. Egg parasitism of *Euproctis chrysorrhoea* (L.) in central Italy. Redia, 72 (1), 291-301.
- Wakamura, S. 2006. Behavioral response to female sex pheromone by insects. Aroma Research, 7 (3), 20-25.
- Wang, W. X. 1981. Biology of *Telenomus euproctidis* Wilcox (Hymenoptera: Scelionidae), An Egg Parasite of Tea Lymantrid, *Euproctis pseudoconspersa* Strand (Lepidoptera: Lymantridae). Acta Entomologica Sinica, 24 (4), 384-389.
- Wu, Y. R., Chen, T. L. 1980. A study on Chinese *Telenomus (Aholcus)* (Hymenoptera: Scelionidae). Acta Zootaxonomica Sinica, 5 (1), 79-84.

Biology of *Phyllonorycter abrasella* (Duponchel) and *P.manni* (Zeller) and Pupa Parasitoids in Oak (*Quercus infectoria* Oliver) Forests in Çankırı (İndağı)

*Yalçın KONDUR¹, Ziya ŞİMŞEK¹

¹Çankırı Karatekin University, Faculty of Forestry, Çankırı / TURKEY

*Corresponding Author: yalcinkondur@karatekin.edu.tr

Abstract

This study was carried out in order to determine biology of *Phyllonorycter abrasella* (Duponchel) and *P.manni* (Zeller) (Lepidoptera: Gracillariidae), their parasitoids emerged from cocoons and efficiency of parasitoids between 2008 and 2009 in Çankırı (İndağı) Oak (*Quercus infectoria* Oliver) trees. Field studies were carried out when the mean air temperature exceeded 10°C and the larvae of *Phyllonorycter* spp. observed on oak leaves. Field studies were carried out at weekly basis. Twig and leaf samples were collected from randomly selected oak trees, and then inspected under stereoscopic microscope, and larvae of *Phyllonorycter* spp. were fed in laboratory. All sample containers at the laboratory were checked daily and emerged adults and parasitoid removed and recorded. Harmful insects at oak leaves were identified as *P.abrasella* (Duponchel) and *P.manni* (Zeller) (Lepidoptera: Gracillariidae); also the parasitoids were identified as *Achrysocharoides albiscapus* (Delucchi) and *Sympiesis gordius* (Walker) (Hymenoptera: Eulophidae). Damage ratios and emergence periods of both harmful insects and parasitoids were calculated. These pests and parasitoids are recorded for the first time in Çankırı oak forests. Results show that the mean damage of *P.abrasella* and *P.manni* on oak leaves were 31.03% (29.68%-32.08%) and 20.72 (8.41%-26.22%) in 2008 and 2009 respectively. It is understood that the species in *Phyllonorycter* genus in oak forests in Çankırı have one generation. It is determined that two parasitoid species (*A.albiscapus* and *S.gordius*) were emerged from about 2/3 of the collected *Phyllonorycter* pupae (for *A.albiscapus*; 45.95% in 2008 and 31.33% in 2009 and for *S.gordius*; 21.62% in 2008 and 43.37% in 2009). We think that protection of the parasitoid species which are determined to have an important effect on harmful population, researches on biology of both parasitoid species and mass production possibilities, and also usability in biological control are some topics of the future studies.

Keywords: Çankırı, Oak, *Quercus infectoria*, *Phyllonorycter abrasella*, *P.manni*, *Achrysocharoides albiscapus*, *Sympiesis gordius*, biological control.

Çankırı (İndağı)'da Meşe (*Quercus infectoria* Oliver) Alanlarında *Phyllonorycter abrasella* (Duponchel) ve *P.manni* (Zeller)'nin Biyolojisi ile Pupalardan Elde Edilen Parazitoidlerin Tespiti

Özet

Bu çalışma, Çankırı (İndağı)'da Meşe (*Quercus infectoria* Oliver) alanlarında *Phyllonorycter abrasella* (Duponchel) ve *P.manni* (Zeller)'nin biyolojisi ile pupalarından elde edilen parazitoidlerin ve etkinliğinin tespiti amacıyla 2008-2009 yıllarında yürütülmüştür. Çalışmalara, hava sıcaklığının 10°C'nin üzerine çıktığı ve *Phyllonorycter* spp. (Lepidoptera: Gracillariidae) larvalarının görüldüğü tarihte başlanılmış, zararlı larvaları bulunduğu sürece devam edilmiştir. Haftada bir kez araziye çıkılarak, rastgele seçilen meşe (*Q. infectoria*) ağaçlarından alınan dal ve yaprak örnekleri laboratuvara getirilerek stereo-mikroskop altında incelenmiş, *Phyllonorycter* spp.'nin larva ve pupaları tespit edilen örnekler kültüre alınmıştır. Kültür kapları her gün kontrol edilerek, çıkan zararlı erginleri ile doğal düşmanlar ortamdan alınarak sayılmıştır. Teşhis sonucunda, zararlıların *Phyllonorycter abrasella* (Duponchel) ve *P.manni* (Zeller) (Lepidoptera: Gracillariidae); doğal düşmanların ise *Achrysocharoides albiscapus* (Delucchi) ve *Sympiesis gordius* (Walker) (Hymenoptera: Eulophidae) olduğu anlaşılmıştır. Meşe dal ve yapraklarındaki bulaşma oranları ile zararlı ve doğal düşmanların çıkış seyri, ayrı ayrı hesaplanmıştır. Sözü edilen zararlılar ile doğal düşmanların Çankırı meşe alanlarında tespiti, ilk kayıt niteliğindedir. Elde edilen bulgulara göre, 2008 yılında toplam 264 adet (118 larva+146 pupa) *Phyllonorycter abrasella* (Duponchel) ve *P.manni* (Zeller) yoğunluğunun *Q.infectoria* yapraklarında ort. %31.03(29.68-32.08) bulaşmaya neden olurken 2009 yılında yine aynı sıra ile 307 adet zararlı yoğunluğunun (141 larva + 166 pupa) ort. %20.72 (8.41-26.22) bulaşmaya neden olduğu belirlenmiştir. *Phyllonorycter* türlerinin, Çankırı meşe alanında yılda 1 döl verdiği anlaşılmıştır. Saptanan iki parazitoid türü (*A. albiscapus* ve *S. gordius*)'nün, zararlı pupalarının yaklaşık 2/3'den çıktığı (*A.albiscapus* 2008 yılında %45,95 ve 2009 yılında %31,33; *S.gordius* 2008 yılında %21,62; 2009 yılında ise %43,37) belirlenmiştir. Bundan sonra yapılacak çalışmalarda, zararlı popülasyonu üzerinde etkin olduğu anlaşılan sözü edilen parazitoid türlerinin korunması, biyolojileri araştırılarak laboratuvar ortamında çoğaltılması, saklanması ve biyolojik mücadelede kullanım imkânlarının araştırılmasının yararlı olacağı kanısındayız.

Anahtar Kelimeler: Çankırı, Meşe, *Quercus infectoria*, *Phyllonorycter abrasella*, *P.manni*, *Achrysocharoides albiscapus*, *Sympiesis gordius*, biyolojik mücadele

Introduction

Oaks are Turkey's native tree species and may grow on areas where it is hard to grow climatic and soil conditions for many tree species. Oaks are important trees in sense of biological diversity. Since oaks may grow on almost everywhere, even on poor soils in Turkey, contribute to soil protection against erosion and also contribute to humans via wood, twigs and leaves considerably.

Oaks are also included into "mixed stand" plans which are suggested for establishment of new plantations and forest areas. Thus, protection of oaks against harmful insects and diseases in Çankırı where has problems in climatic conditions, soil structure and tree growth has great importance. This disease and insect issue has greater importance in certain areas where are not suitable for forest establishment in Çankırı (Şimşek and Kondur, 2006a; b).

Moths in the Gracillariidae (Lepidoptera) family are small, delicate-looking moths. Antennae are usually longer than forewings. Young larvae are generally drill plant cells in order to suck sap water in leaves, bark or fruits. Later instar larvae bore green tissues and live inside. Larvae damage leaves by skeletization or folding. The damage in leaves causes growth loss (Kulman, 1971; Şimşek and Kondur, 2006a; b). Members of this family are worldwide distributed (Çanakçıoğlu and Mol, 1998).

This study is carried out between 2008 and 2009 in oak (*Quercus infectoria* Oliver) forests in Çankırı (İndağı) in order to determine pupal parasitoids of *Phyllonorycter abrasella* and *P.mannii* and also the biology of these pests.

Material and Method

Studies were carried out as field and laboratory studies. Field studies were carried out in İndağı (Ilgaz, Çankırı) region during 2 years; 2008 and 2009 after the mean air temperature exceeded 10°C and *Phyllonorycter abrasella* (Duponchel) and *P.manii* (Zeller) larvae was detected (July 25th, 2008 and July 03th, 2009) on oak leaves until August 21st, 2008 and July 31st, 2009. Field studies were carried out with one week intervals and oak (*Quercus infectoria* Oliver) twigs and leaves were sampled from 4

directions of randomly selected oak trees. Samples were brought inside an icebox to laboratory which was set to 25°C temperature and 45%±5 relative humidity and then checked for *Phyllonorycter* spp. larvae under stereo-microscope. *Phyllonorycter* spp. larvae removed with that specific leaf into plastic cylinder-shaped (20 cm diameter, 23 cm height) cages. Plastic cages for checked daily for adult or parasitoid emergence, then removed to empty plastic cylinders. After death of both *Phyllonorycter* spp. adults and parasitoids, they were prepared for identification.

Occurrence ratio for larvae (%) at every checking date was calculated by dividing larva number at a specific date by total larvae number; occurrence ratio for pupae (%) was also calculated as in larval ratio.

Damaged leaves by *Phyllonorycter* spp. larvae were accepted as "infected" and infection rate was calculated by dividing number of infected leaves at each checking date by total number of infected leaves.

Parasitoid emergence ratio (%) was calculated as parasitoid emerged cocoon number at a specific control date dividing by total cocoon number (Öncüer et al., 1982).

Phyllonorycter species determined in this study were identified by Dr. Mustafa ÖZDEMİR (Plant Protection Central Research Institute, Ankara, Turkey) and parasitoids were identified by Prof. Dr. Miktat DOĞANLAR (Mustafa Kemal University, Faculty of Agriculture).

The meteorological data was obtained from Çankırı (Ilgaz) Meteorological Station and the data were evaluated and organized as tables and figures.

Results and Discussion

Studies in 2008

In field studies, it is observed on July 25th, 2008 that most of *Q.infectoria* leaves were partly dried and edges of the leaves were twisted. After inspection of the *Q.infectoria* leaves and twigs in laboratory, feces and feeding larvae were seen within twisted leaf edge (Figure 1). Adult moths from these larvae were identified as *Phyllonorycter abrasella* (Duponchel) and *P.mannii* (Zeller) (Lepidoptera: Gracillariidae) (Figure 2a,b).

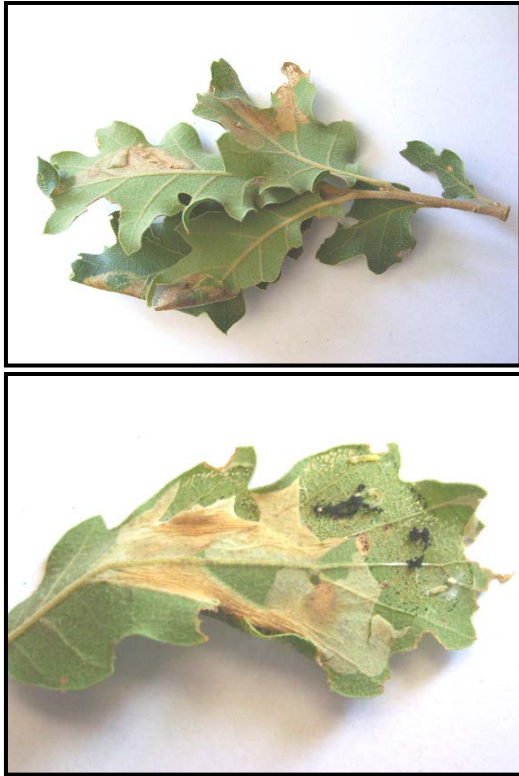

Figure 1. *Phyllonorycter abrasella* (Duponchel) ile *Phyllonorycter mannii* (Zeller) larvae feeding on *Quercus infectoria* Oliver leaves and the damage in İndağı (Ilgaz, Çankırı)



Figure 2. *Phyllonorycter abrasella* (Duponchel) adult (up) ile *Phyllonorycter mannii* (Zeller) adult (bottom)

It is observed that *Phyllonorycter* species lay eggs beneath oak leaves and hatched larvae feed inside leaves and close the cavity due to feeding with silky excretion at top side of the leaves. Larvae pupate inside the feeding cavity within the leaves and adults emerge after 12 days. *P.abrasella* and *P.mannii* have only one generation in İndağı (Ilgaz, Çankırı) conditions.

In laboratory studies (25°C temperature and 45%±5 relative humidity), when an infected leaves perforated to check whether larva feeding inside, larva –if exists any– stopped feeding and did not fix the perforated area on the leaf, then died (Figure 4a). There was not any adult or parasitoid emergence from such leaves.

Mean temperature and relative humidity data in natural conditions were given at Figure 3a, numbers of larvae and pupae found in *Q.infectoria* leaves and infection rates were given in Table 1 and Figure 3b.

Table 1 and Figure 3(a,b) show that larvae and pupae of *P.abrasella* and *P.mannii* first detected within *Q.infectoria* leaves on July 25th, 2008 when the mean air temperature was 25.2°C and the relative humidity was 48%. Data suggest that infection ratio of the leaves seems correlated with larval density and the infection rate increased until pupation then it is almost stayed at the same level. Data also show that a total of 264 *P.abrasella* and *P.mannii* (118 larvae and 146 pupae) sampled and the average *P.abrasella* and *P.mannii* density was 32.03% (29.68 – 32.08%) on *Q.infectoria* leaves (Table 1 and Figure 3b).

Emergence of *P.abrasella* and *P.manni* adults occurred on August 06th, 2008 from the pupae. It is observed that adults move through the head section of the cocoon.

Table 1. Larvae, pupae numbers and infection rates (%) of *Phyllonorycter abrasella* (Duponchel) and *P.mannii* (Zeller) found inside *Quercus infectoria* Oliver leaves in İndağı (Ilgaz, Çankırı) in 2008.

Control Date	<i>Phyllonorycter abrasella</i> + <i>P. manni</i>				Inspected Leaves	Infected Leaves	Infected Leaf Ratio (%)
	Number of Larvae	Larval Ratio (%)	Number of Pupae	Pupal Ratio (%)			
25.07.2008	93	18.67	54	10.84	498	158	31.73
01.08.2008	22	5.00	80	18.18	440	138	31.36
08.08.2008	3	0.56	49	9.09	539	160	29.68
15.08.2008	-	0.00	23	4.55	505	162	32.08
21.08.2008	-	0.00	4	0.83	483	147	30.43
Total	118		210		2465	765	
Mean							31.03

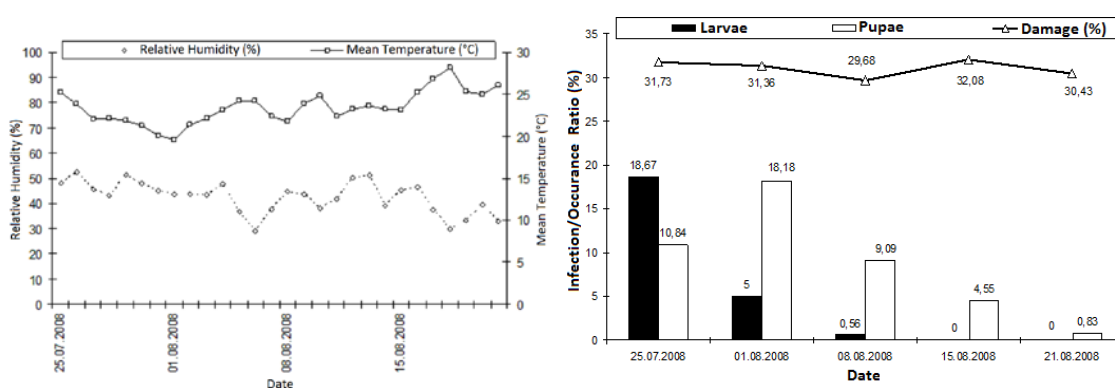

Figure 3. Meteorological data in 2008 (a) and larval and pupal occurrence ratios (%) and infection ratios (%) of *Phyllonorycter abrasella* (Duponchel) and *P.mannii* (Zeller) feeding inside *Quercus infectoria* Oliver leaves in İndağı (Ilgaz, Çankırı)



Figure 4. *Phyllonorycter abrasella* (Duponchel) and *P.mannii* (Zeller) larva and pupa (b) within *Quercus infectoria* Oliver leaf in İndağı (Ilgaz, Çankırı)

Studies in 2009

In field studies in 2009, it is observed on July 03rd, 2009 that most of *Q.infectoria* leaves were partly dried and edges of the leaves were twisted as in 2008. After inspection of the *Q.infectoria* leaves and twigs brought to laboratory, *P.abrasella* and

P.manni were found feeding inside oak leaves.

Mean temperature and relative humidity data were given at Figure 4a, numbers of larvae and pupae found in *Q.infectoria* leaves and infection rates were given in Table 2 and Figure 5b.

Table 2. Larvae, pupae numbers and infection rates (%) of *Phyllonorycter abrasella* (Duponchel) and *P.mannii* (Zeller) found inside *Quercus infectoria* Oliver leaves in İndağı (Ilgaz, Çankırı) in 2009.

Control Date	<i>Phyllonorycter abrasella</i> + <i>P. manni</i>				Inspected Leaves	Infected Leaves	Infected Leaf Ratio (%)
	Number of Larvae	Larval Ratio (%)	Number of Pupae	Pupal Ratio (%)			
03.07.2009	16	4.98	0	0.00	321	27	8.41
10.07.2009	41	7.31	15	2.67	561	83	14.80
16.07.2009	44	10.28	32	7.48	428	79	18.46
24.07.2009	29	7.40	45	11.48	392	83	21.17
31.07.2009	11	2.16	42	8.25	509	130	25.54
07.08.2009	0	0.00	24	5.57	431	113	26.22
14.08.2009	0	0.00	6	1.49	403	105	26.05
21.08.2009	0	0.00	2	0.55	362	91	25.14
Total	141		166		3407	711	
Mean							20.72

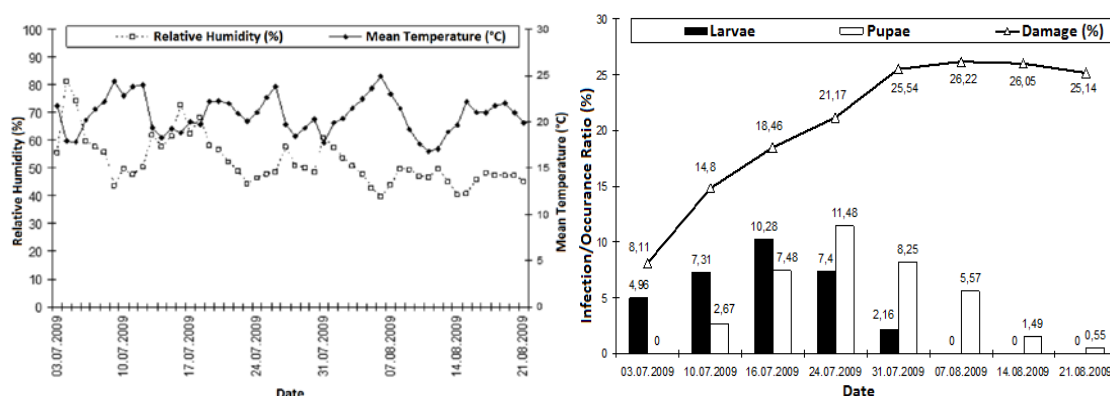

Figure 5. Meteorological data in 2009 (a) and larval and pupal occurrence ratios (%) and infection ratios (%) of *Phyllonorycter abrasella* (Duponchel) and *P.mannii* (Zeller) feeding inside *Quercus infectoria* Oliver leaves in İndağı (Ilgaz, Çankırı)

It could be understood from Table 2 and Figure 5 (a,b) that when *P.abrasella* and *P.mannii* larvae first detected on July 03rd, 2009 when the average air temperature was 21.7°C and the relative humidity was 55.4% in the *Q.infectoria* leaves. On the following control dates, pupae of these pests were found in the leaves. These data suggest that infected leaf ratio is correlated with larval density and the damage increased rapidly until the maximum number of pupae found (July 24th, 2009), then stayed almost at the same level. Data also show that a total of 307 *P.abrasella* and *P.mannii* (141 larvae and 166 pupae) sampled and the average *P.abrasella* and *P.mannii* density was 20.72% (8.41 – 26.22%) on *Q.infectoria* leaves. Also, 711 out of 3407

Q.infectoria leaves were found to be infected by these pests (Table 2 and Figure 5b).

There is limited number of literature regarding *P.abrasella* and *P.manni* in Turkey and those researches were mostly reporting species existence (İren, 1960; Soylu et al., 1983; Koçak and Kemal, 2009). This study reports these species existing in Çankırı forests for the first time. Also, we could not find any studies on this subject in Turkish forest areas. Also, we found limited number of studies on *Phyllonorycter* genus in other countries.

Gracillariidae family (Lepidoptera) which contains the *Phyllonorycter* genus, are generally leaf boring insects and one of the richest families that contain about 1901

species and 257 species out of 401 *Phyllonorycter* species exist in the temperate zone and their larvae feed on living parenchyma cells in the leaves. *Phyllonorycter* species may feed on 112 plant species in 31 families of 15 orders of 6 subclassis (DePrins et al., 2009). We think that the high number of host plants for this genus increases the importance of *P.abrasella* and *P.mannii*.

Certain researches report that both *Phyllonorycter* species have been reported in various countries in Europe such as Czech Republic, Slovakia, Hungary (Vojnits et al., 1993; Lastuvka and Liska, 2005; Kulfan et al., 2006; Turcani et al., 2009). *P.mannii* is found in Italy (Huemer, 2004).

In our study, we found that *P.abrasella* and *P.mannii* have only one generation, however Zhu and Huang (2003) reported *Phyllonorycter* species generally had two generations.

Parasitoids

In the laboratory studies, two parasitoid species emerged from *P.abrasella* and *P.mannii* pupae. Parasitoid species were identified as *Achrysocharoides albiscapus* (Delucchi) and *Sympiesis gordius* (Walker) (Hymenoptera: Eulophidae).

Phyllonorycter adult emergence, parasitoid emergence from the samples collected in 2008 and 2009 are given at Table 3.

Table 3. *Phyllonorycter abrasella* (Duponchel) and *P.mannii* (Zeller) adult and parasitoid numbers and ratios (%) from the pupae collected from İndağı (İlgaz, Çankırı) *Quercus infectoria* Oliver forest in 2008 and 2009

Years	Pests and Parasitoids	Number of Samples	Parasitization Ratio (%)	Occurrence Ratio (%)
2008	<i>Phyllonorycter abrasella</i> + <i>P. manni</i>	48		32.43
	<i>Sympiesis gordius</i> (Walker)	32	21.62	69.24
	<i>Achrysocharoides albiscapus</i> (Delucchi)	68	45.95	
	Total	148		100
2009	<i>Phyllonorycter abrasella</i> + <i>P. manni</i>	42		25.30
	<i>Sympiesis gordius</i> (Walker)	72	43.37	74.70
	<i>Achrysocharoides albiscapus</i> (Delucchi)	52	31.33	
	Total	166		100

Table 3 shows that parasitization of the pests' pupae was 69.24% in 2008 and 74.70% in 2009. Parasitization ratios of both years are similar. Parasitoid occurrence ratios of *S.gordius* and *A.albiscapus* were 21.62%, 45.95% in 2008 and 43.37%, 31.33% in 2009 respectively. These data show that occurrence ratios of both parasitoids for both years were relatively high and the parasitoids were effective of pest populations.

A.albiscapus (Figure 6a) adults are shiny metallic green colored parasitoids. Antennae of this parasitoid are clubbed and legs are transparent white. *Achrysocharoides* species are specialized parasitoids and koinobiont endoparasitoids on larvae of leaf borers, especially on *Phyllonorycter* species (Askew and Ruse, 1974; Bryan, 1980). There are 23 species in Europe, 22 species in North America and 10 species in Japan that belong

to *Achrysocharoides* genus and all species of this genus live in the temperate zone of the northern hemisphere. Also, 10 *Achrysocharoides* species exist in the tropical zones in America (Delucchi, 1957; Hansson, 2012). It could be said that *A.albiscapus* is one of the major parasitoids of *Phyllonorycter* species.

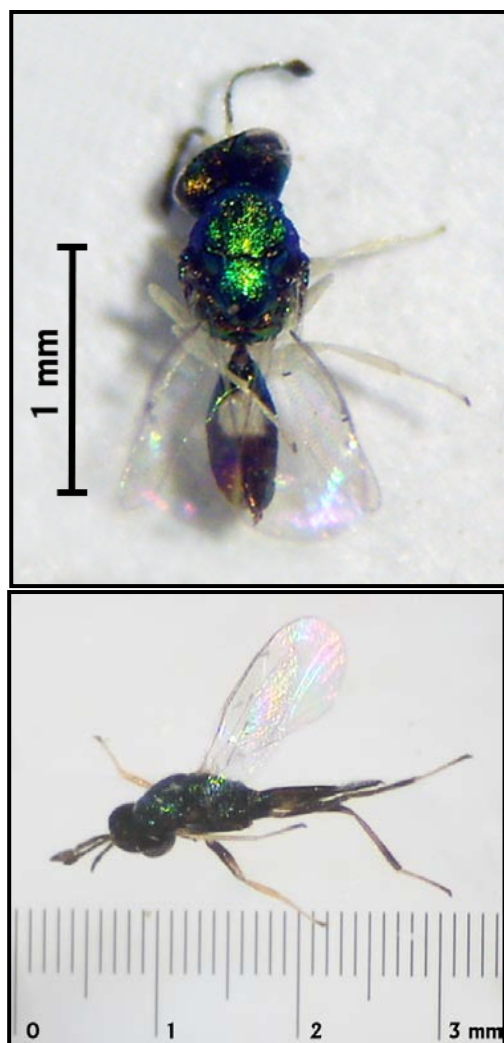

Figure 6. *Achrysocharoides albiscapus* (Delucchi) adult (a) ile *Sympiesis gordius* (Walker) adult (b)

The other parasitoid species from this study, *Sympiesis gordius* (Figure 6b), is a common parasitoid species. It is very common in Russia (Yefremova, 2003) and it is a parasitoid of *P.corylifoliella* in Iran (Amiri et al., 2009), *P.blancardella* in Poland (Kadubowski, 1984). If parasitize all *Phyllonorycter* species that harm oaks in Hungary (Csoka et al., 2009) and one of the most effective parasitoids in Spain (Tirado et al., 1996; Bellostas et al., 1998; Amiri et al., 2009). *S.gordius* is common as it is common as in Europe (Maier and Hansson, 2006). There is only one record regarding *S.gordius* existing in Turkey (Çıkman and Uygun, 2003). However we could not find any record on *S.gordius* parasitizing *Phyllonorycter* species in Turkey.

Effectiveness of *S.gordius* on *P.abrasella* and *P.manni* was 23% in 2008 and 43% in 2009. This parasitization ratios show *S.gordius* could be an important biological control agent. Maier and Hansson (2006) report that *S.gordius* is effective against many Gracillaridae species. Çanakçıoğlu and Mol (1998) report that the damage of *P.platani* which harms *Platanus* spp. is not economically important however there is not an effective control method against *P.platani*. Thus, biological control measures against pests grow inside leaves such as *Phyllonorycter* spp. has great importance.

Conclusions

The result from our study carried out during 2 years show that a total of 264 *Phyllonorycter abrasella* (Duponchel) and *P.mannii* (Zeller) (118 larvae and 146 pupae) in 2008 and 307 *P.abrasella* and *P.mannii* (141 larvae and 166 pupae) were collected from *Quercus infectoria* Oliver forest and the mean density of *P.abrasella* and *P.mannii* on oak leaves were 31.03% (29.68-32.08) and 20.72% (8.41-26.22) in 2008 and 2009 respectively. It is inevitable that infestation of leaves by these pests to cause height and diameter growth loss of oak trees (Şimşek and Kondur, 2006a). Also two parasitoid species [*Achrysocharoides albiscapus* (Delucchi) ve *Sympiesis gordius* (Walker) (Hymenoptera: Eulophidae)] were determined in this study. However, since larvae and pupae of both *Phyllonorycter* species were in the same culture cages, it was unfortunate not being able to determine the parasitization ratios for both host species separately. It would be better to address this issue in future studies.

It is determined that two parasitoid species from this study had parasitized almost 1/3 (32.38% and 31.33% by *A.albiscapus*; 15.24% and 43.37% by *S.gordius* in 2008 and 2009 respectively) of *P.abrasella*+*P.mannii* populations. Since the parasitization ratios for both parasitoid species were high and effective, parasitoid species should be protected and their biology should be researched in detail. Rearing possibilities and usability in biological control for these parasitoid species should also be researched in detail.

Acknowledgements

We would like to thank to Dr. Mustafa ÖZDEMİR (Plant Protection Central Research Institute, Ankara, Turkey) for identification of *Phyllonorycter* species and also Prof. Dr. Miktat DOĞANLAR (Mustafa Kemal University, Faculty of Agriculture) for identification of parasitoids.

References

- Amiri, A., Talebi, A. A., Navone, P., Yefremova, Z. 2009. Parasitoid wasp complex of *Phyllonorycter corylifoliella* (Lep.: Gracillariidae) in the Fars Province of Iran, and notes on their morphology and abundances. *Appl. Ent. Phytopath*, 77 (1), 1-14.
- Askew, R. R., Ruse, J. M. 1974. Biology and taxonomy of species of the genus *Enaysma* Delucchi (Hym., Eulophidae, Entedonitinae) with special reference to the British fauna. *Transactions of the Royal Entomological Society of London*, 125 257-294.
- Bellostas, J. J., Olivella, E., Verdu, M. J., Sarasua, M. J., Avilla, J. 1998. Fauna parasitoide de *Phyllonorycter* spp. en plantaciones de manzano de Lleida. *Bol. San. Veg. Plagas*, 24 313-320.
- Bryan, G. 1980. The British species of *Achrysocharoides* (Hymenoptera, Eulophidae). *Systematic Entomology*, 5 245-262.
- Csoka, G., Péntzes, Z., Hirka, A., Miko, I., Mato, D., George, M. 2009. Parasitoid assemblages of two invading black locust leaf miners, *Phyllonorycter robiniella* and *Parectopa robiniella* in Hungary. *Periodicum Biologorum UDC 57:61 111* (4), 405-411.
- Çanakçıoğlu, H., Mol, T. 1998. Orman entomolojisi zararlı ve yararlı böcekler. 541, İstanbul Üniversitesi Orman Fakültesi Yayınları, İstanbul.
- Çıkman, E., Uygun, N. 2003. Şanlıurfa ilinde tarım ve tarım dışı alanlarda saptanan galerisineği (Diptera: Agromyzidae) türleri ve parazitoidleri. *Türkiye Entomoloji Dergisi*, 27 (4), 305-318.
- Delucchi, V. 1957. Especies nouvelles du genre *Enaysma* Del. (Chalcidoidea: Eulophidae). *Zeitschrift für Angewandte Entomologie*, 41 (2/3), 260-266.
- DePrins, J., Mozüraitis, R., Lopez-Vaamonde, C., Rougerie, R. 2009. Sex Attractant, Distribution and DNA Barcodes fort he Afrotropical Leaf-Mining Moth *Phyllonorycter melanosparta* (Lepidoptera: Gracillariidae). *Zootaxa*, 2281 53-67.
- Hansson, C. 2012. *Achrysocharoides girault* (Hymenoptera, Eulophidae) new to tropical America, with eight new species. *ZooKeys*, 173 79-108.
- Huemer, P. 2004. Assesment of the species diversity of Lepidoptera in a relict forest of the Po plain - a first attempt. *Invertebrati Di Una Foresta Della Pianura Padana Bosco Della Fontana, Secondo Contributo - Conservazione Habitat Invertebrati* 3185-194.
- İren, Z. 1960. Ankara Bölgesi'nde ağ kurtları (*Yponomeuta*) türleri, arız olduğu bitkiler, bu türlerin kısa biyolojisi ve mücadelesi üzerinde araştırmalar. *Zir. Vek. - Rap. Ar. Ser.*, (4),
- Kadubowski, W. 1984. The parasite complex of the leaf-miner *Lithololletis blancardella* (F.) (Lepidoptera: Gracillariidae) in western Poland. *Polskie Pismo Entomologiczne*, 51 (4), 493-499.
- Koçak, A. Ö., Kemal, M. 2009. Revized Checklist of the Lepidoptera of Turkey.
- Kulfan, M., Holecova, M., Fajcik, J. 2006. Caterpillar (Lepidoptera) communities on European Turkey Oak (*Quercus cerris*) in Malé Carpathy Mts (SW Slovakia). *Biologia, Bratislava*, 61 (5), 573-578.
- Kulman, H. M. 1971. Effects of Insect Defoliation on Growth and Mortality of Trees. *Annual Review of Entomology*, 16 289-324.
- Lastuvka, Z., Liska, J. 2005. Checklist of Lepidoptera of the Czech Republic. 39,
- Öncüer, C., Yalçın, E., Erkin, E. 1982. *Euproctis chrysorrhoea* L. (Lepidoptera: Lymantriidae) yumurtalarının paraziti *Asolcus turkarkandas* Szabo (Hymenoptera: Scelionidae)'ın etkililik durumu. *Türkiye Bitki Koruma Dergisi*, 6 221-225.
- Soylu, O. Z., Okul, A., Ataç, Ö., Zeki, C. 1983. Orta Anadolu bölgesinde elma ağaçlarında zarar yapan yaprak galeri güvelerinden (*Phyllonorycter gerasimowi* Hering)'nin kimyasal savaşımı ve doğal düşmanlarının tespiti üzerinde araştırmalar. *Bitki Koruma Bülteni*, 23 (1), 12-41.
- Şimşek, Z., Kondur, Y. 2006a. Çankırı ormanlarının zararlı böcekleri ve mücadele yöntemleri. *Gazi Üniversitesi Orman Fakültesi Dergisi*, 6 (1), 98-119.
- Şimşek, Z., Kondur, Y. 2006b. Yarıkurak mıntika orman alanları (Çankırı)'nda zarar yapan böcekler. *Türkiye'de Yarıkurak Bölgelerde Yapılan Ağaçlandırma ve Erozyon Kontrolü Uygulamalarının Değerlendirilmesi Çalıştayı* (7-10.11.2006), 271-286, Ürgüp, Nevşehir.
- Tirado, L. G., Ruiz, P. B., Lopez, P. C. 1996. Enemigos naturales autóctonos de *Phyllocnistis citrella* Stainton. (Lepidoptera. Gracillariidae, Phyllocnistinae) en la provincia de Huelva. *Distribución geográfica, evolución estacional y*

tasas de parasitismo. . Bol. San. Veg. Plagas, 22
741-760.

Turcani, M., Patocka, J., Kulfan, M. 2009. How do lepidopteran seasonal guilds differ on some oaks (*Quercus* spp.) - A case study. Journal of Forest Science, 55 (12), 578-590.

Vojnits, A., Acs, E., Balint, Z. S., Gyulai, P., Ronkay, L., Szaboky, C. S. 1993. The fauna of the Bukk National Park), 157-220,

Yefremova, Z. A. 2003. Catalogue of the Eulophidae (Hymenoptera: Chalcidoidea) of Russia. Linzer biol. Beitr., 34 (1), 563-618.

Zhu, C. D., Huang, D. W. 2003. Preliminary cladistics and review of *Hemiptarsenus* Westwood and *Sympiesis* Förster (Hymenoptera, Eulophidae) in Hungary. Zoological Studies, 42 (2), 307-335.

Pupal Parasitoids of Green Oak Tortrix [*Tortrix viridana* L. (Lepidoptera: Tortricidae)] in Çankırı, Turkey

*Yalçın KONDUR¹, Ziya ŞİMŞEK¹

¹Çankırı Karatekin University, Faculty of Forestry, Çankırı / TURKEY

*Corresponding Author: yalcinkondur@karatekin.edu.tr

Abstract

Studies were carried out in İndağı (İlgaz Forest Enterprise, Devrez Forest District in Cankiri) between 2008 and 2009. Oak leaves from the study area were inspected carefully for cocoons of *Tortrix viridana* L. (Lepidoptera: Tortricidae), then cocoons were taken into plastic cages as culture. All emerged adults, either *T.viridana* or parasitoids, were inspected under binocular microscope and recored seperately. Results show that the parasitoid species, *Brachymeria intermedia* (Nees) (Hymenoptera: Chalcididae) (5.98%), *Itopectis maculator* (Fabr.) (2.57%), *Dirophanes invisor* (Thun.) (2.57%) (Hymenoptera: Ichneumonidae), and *Pediobius bruchicida* (Rond.) and *P.pyrgo* (Wlk.) (4.27%) (Hymenoptera: Eulophidae) emerged from the collected *T.viridana* cocoons in 2008. Total ratio of the parasitoids that emerged from *T.viridana* cocoons was 15.4% for 2008. Also the parasitoid species *B.intemedia* (10.57%), *I.maculator* (7.71%), *Monodontomerus aereus* Walker (1.14%) (Hymenoptera: Torymidae), *P.bruchicida* and *P.pyrgo* (0.86%) were determined to emerge from *T.viridana* cocoons in 2009. The sum of the parasitoid emergence ratio was Total ratio of the parasitoids emerged from *T.viridana* cocoons were 20.28% in 2009. Results from both years show that the most common parasitoid species emerged from *T.viridana* cocoons were *B.intermedia* and *I.maculator* respectively. These two parasitoid spesces were determined for the first time in Cankiri; however, parasitization ratios for both parasitoids were low and their ability to control *T.viridana* in case of an outbreak seems rather difficult. Nevertheless, we believe that existence of the parasitoid species in the area is important in biological diversity sense.

Keywords: *Tortrix viridana*, parasitoid, biological control, oak, Cankiri

Yeşil Meşe Bükücüsü [*Tortrix viridana* L. (Lepidoptera: Tortricidae)]'nün Çankırı, Türkiye'deki Pupa Parazitoidleri

Özet

Çalışmalar, İndağı (İlgaz Orman İşletme Müdürlüğü, Devrez Orman İşletme Şefliği, Çankırı) bölgelerinde, 2008-2009 yılları arasında olmak üzere 2 yıl süreyle yürütülmüştür. Çalışma alanından alınarak laboratuara getirilen meşe dallarındaki yapraklar teker teker incelenerek *Tortrix viridana* L. (Lepidoptera: Tortricidae) kokonları ayrılmış ve kültüre alınmıştır. Kültüre alınan örneklerde meydana gelen ergin ve parazitoit çıkışları binoküler mikroskop altında incelenerek ayrı ayrı kaydedilmiştir. Elde edilen bulgulara göre, 2008 Yılında doğadan alınarak laboratuarda kültüre alınan *T.viridana* pupalarından *Brachymeria intermedia* (Nees) (Hymenoptera: Chalcididae) (%5,98), *Itopectis maculator* (Fabr.) (%2,57), *Dirophanes invisor* (Thun.) (%2,57) (Hymenoptera: Ichneumonidae) ile *Pediobius bruchicida* (Rond.) ve *P.pyrgo* (Wlk.) (%4,27) (Hymenoptera: Eulophidae) çıkışı belirlenmiştir. Buna göre 2008 yılında kültüre alınan *T.viridana* pupalarının %15,40'ından parazitoit elde edilmiştir. 2009 Yılına ise *T.viridana* pupalarından *B.intemedia* (%10,57), *I.maculator* (%7,71), *Monodontomerus aereus* Walker (%1,14), *P.bruchicida* ve *P.pyrgo* (%0,86) elde edilmiştir. Buna göre, 2009 yılında kültüre alınan *T.viridana* pupalardan %20,28 oranında parazitoit çıkışı tespit edilmiştir. İki yıllık veriler birlikte değerlendirildiğinde, hakim parazitoit türünün *B.intermedia* olduğu, bunu *I.maculator*'un izlediği anlaşılmaktadır. Bu doğal düşmanlar Çankırı'da ilk kez tespit edilmiş olup parazitlenme oranları dikkate alındığında, parazitoit çıkış oranlarının düşük seviyede olduğu; çalışma alanında tespit edilen parazitoitlerin salgın koşullarında *T.viridana*'yı kontrol altına alabilmelerinin oldukça güç olduğu, bununla birlikte mevcut durumun biyolojik zenginlik bakımından önemli olduğu kanısına varılmıştır.

Anahtar Sözcükler: *Tortrix viridana*, parazitoit, biyolojik mücadele, meşe, Çankırı

Introduction

The Green Oak Tortrix [*Tortrix viridana* L. (Lepidoptera: Tortricidae)] is one of the most important insects in Turkish forestry

and it makes it damage on oaks. This species is accepted as one of the major pests in western palearctic region. It can feed on all oaks in its distribution area (Çanakçioğlu and

Mol, 1998; DuMerle et al., 1999; Ivashov et al., 2002) and also feed on various hosts such as beech, maple, poplar, willow and even on spruce and fir. The damage is caused by *T. viridana* larval feeding (Çanakçioğlu and Mol, 1998). Our previous observations show that this insect is an important pest on oak (*Quercus infectoria* Oliver) forests in Çankırı (İndağı) region (Kondur, 2004; Şimşek and Kondur, 2006; Kondur and Şimşek, 2008).

There are certain studies regarding the natural enemies of *T. viridana* in literature (Baş, 1980; Çanakçioğlu and Selmi, 1988; Tuncer and Avcı, 2016), however, we could not find any study carried out in Çankırı. Thus, this study was carried out in order to determine the cocoon parasitoids of *T. viridana* in Çankırı (İndağ, Ilgaz) between 2008 and 2009.

Material and Method

Studies were carried out in Indagi (Ilgaz Forest Enterprise, Devrez Forest District) between 2008 and 2009 and field studies were started when the mean air temperature exceeded 10°C and the Green Oak Tortrix [*Tortrix viridana* L. (Lepidoptera: Tortricidae)] larvae present on oak trees (April 19 – May 24, 2008 and April 30 – June 5, 2009) until the adult emergence completed. Cocoons of *T. viridana* were collected from randomly selected oak trees, then put into tagged plastic bags and brought to laboratory within ice-bag (Simchuk et al., 1999). Field studies were carried out with one-week intervals.

After laboratory inspection of the oak leaves, *T. viridana* cocoons were removed and inserted into plastic cages which are 20 cm in diameter, 23 cm in height. All cages were filled with sterilized turf in 5 cm height prior to leave inspections. Then, cages were covered closely with fine muslin (DuMerle, 1999; Kalapanida-Kantartzi and Glavendekic, 2002). Cages were monitored every two days for emergence and emerged adults of *T. viridana* and also parasitoids were recorded separately.

A piece of cotton that saturated with 5% sugar solution was inserted into each cage for feeding (DuMerle, 1999; DuMerle et al., 1999). Ratios of the parasitoids emerged from *T. viridana* cocoons were calculated as

parasitoid emerged cocoon count divided by the total cocoon number in cages (Öncüer et al., 1982).

T. viridana adults and parasitoids were inspected under binocular microscope and recorded separately. Parasitoids were prepared for identification and sent for identification. Identification of was done by Dr. Murat YURTCAN (Trakya University, Science-Literature Faculty, Biology Department) identified *Itopectis maculator* (Fabricious) and Dr. Klaus HORSTMANN has identified *Dirophanes invisior* (Thunberg) (Hymenoptera: Ichneumonidae); Prof. Dr. Mikdat DOĞANLAR has identified *Brachymeria intermedia* (Nees) (Hymenoptera: Chalcididae), *Achrysocharoides albiscapus* (Delucchi), *Pediobius bruchicida* (Rond.), *Pediobius pyrgo* (Wlk.), *Sympiesis gordius* (Walker) (Hymenoptera: Eulophidae) and *Monodontomerus aereus* Walker (Hymenoptera: Torymidae).

Results and Discussion

Certain pupal parasitoids of *Tortrix viridana* were determined as a result of the studies carried out and given at Table 1. The table shows that *Tortrix viridana* L. (Lepidoptera: Tortricidae) adults from 88 pupae (75.21%), *Brachymeria intermedia* (Nees) adults from 7 pupae (5.98%), *Itopectis maculator* (Fabr.) adults from 3 pupae (2.57%), *Dirophanes invisior* (Thun.) adults from 3 pupae (2.57%) and *Pediobius* spp. [*P. bruchicida* (Rond.) and *P. pyrgo* (Wlk.)] adults from 5 pupae (4.27%) were emerged out of 117 *T. viridana* pupae in 2008. These ratios show that 5 parasitoid species emerged from 15.40% of *T. viridana* pupae in laboratory in 2008. Table 1 also shows the results from the studies in 2009. The table also shows that *T. viridana* adults from 262 pupae (74.86%), *B. intermedia* adults from 37 pupae (10.57%), *I. maculator* adults from 27 pupae (7.71%), *Monodontomerus aereus* Walker adults from 4 pupae (1.14%) and *Pediobius* spp. (*P. bruchicida* and *P. pyrgo*) adults from 3 pupae (4.27%) were emerged out of 350 *T. viridana* pupae in 2009. These ratios show that 5 parasitoid species emerged from 20.28% of *T. viridana* pupae in laboratory in

2009. However, there were not any emergences from 11 (9.40%) and 17 (4.86%) of the *T.viridana* pupae in 2008 and 2009 respectively.

Literature search related to parasitoids of *T.viridana* in Turkey shows that *Itopectis maculator* Fabr., *Itopectis alternans* (Grav.), *Phaeogenes invisor* (Thunb.), *P. stimulator* (Grav.), *Apechtis rufata* (Gmel.), *A. resinator* (Thunb.), *Hemiteles areator* Panz., *Pimpla instigator* (Fabr.), *Phytodictus segmentator* Grav., *Ischnus inquisitorius*, *Hercus fontinalis* (Hymenoptera: Ichneumonidae) *Brachymeria intermedia* (Nees.), *B.tibialis* (Walker) (Hymenoptera: Chalcididae),

Pleurotropis metallicus Nees. (Hymenoptera: Eulophidae), *Apanteles laevigatus* (Ratz.), *A. rubecula* Marsh., *Bracon obscurator* Nees., *Macrocentrus collaris* (Spinola) (Hymenoptera: Braconidae), *Pteromalus semotus* (Walker) (Hymenoptera: Pteromalidae), *Actia pilipennis* Fall., *A. crassicornis* Meig., *Nemorilla maculosa* Meig., *Elodia tragica* Meig. (Diptera: Tachinidae) are among the most common parasitoids of *T.viridana* (Baş, 1980; Çanakçıoğlu and Selmi, 1988; Tuncer and Avcı, 2016). However, there was not any record on these parasitoids existing in oak forests in Çankırı.

Table 1. Parasitoids emerged from *Tortrix viridana* L. pupae in laboratory conditions (25°C mean temperature and 45±5% humidity) and emergence ratios which were collected from İndağı (İlgaz, Çankırı) oak forests.

Year	Total <i>T.viridana</i> Pupae	Species	Emergence Occured Pupae Count	Emergence Ratio (%)
2008	117	<i>Tortrix viridana</i> (Linnaeus, 1758)	88	75.21
		<i>Brachymeria intermedia</i> (Nees, 1834)	7	5.98
		<i>Dirophanes invisor</i> (Thunberg, 1822)	3	2.57
		<i>Itopectis maculator</i> (Fabricius, 1775)	3	2.57
		<i>Pediobius bruchicida</i> (Rondani, 1872)	5	4.27
		<i>Pediobius pyrgo</i> (Walker, 1839)		
		No emergence	11	9.40
	TOTAL	117	100.00	
2009	350	<i>Tortrix viridana</i> (Linnaeus, 1758)	262	74.86
		<i>Brachymeria intermedia</i> (Nees, 1834)	37	10.57
		<i>Itopectis maculator</i> (Fabricius, 1775)	27	7.71
		<i>Monodontomerus aereus</i> (Walker, 1834)	4	1.14
		<i>Pediobius bruchicida</i> (Rondani, 1872)	3	0.86
		<i>Pediobius pyrgo</i> (Walker, 1839)		
		No emergence	17	4.86
	TOTAL	350	100.00	

Biology, Hosts and Distribution of *Brachymeria intermedia* (Nees, 1834) (Hymenoptera: Chalcididae)

Pupa which *Brachymeria intermedia* emerging from is given in Figure 1 and adult parasitoid is given in Figure 2, also emergence period of *B.intermedia* is given in

Figure 3. Our observations show that *B.intermedia* adults open a hole in the mid-abdomen of the pupa and adults emerge from this hole. Then, adults walk around the pupa and stay on the oak leaf about 4-5 minutes, and after that period adult parasitoids fly away (Figure 1).

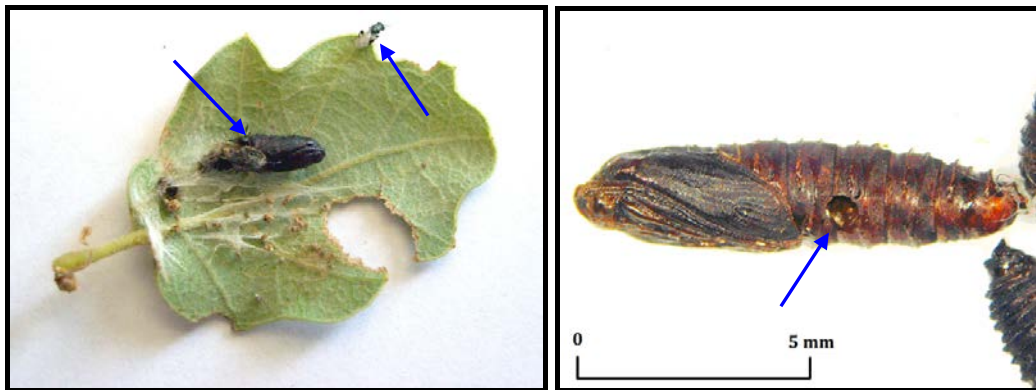

Figure 1. *Brachymeria intermedia* (Nees) adults emerging from *Tortrix viridana* L. pupa (left image) and the exit hole on *T.viridana* pupa (right image)



Figure 2. *Brachymeria intermedia* (Nees) adult

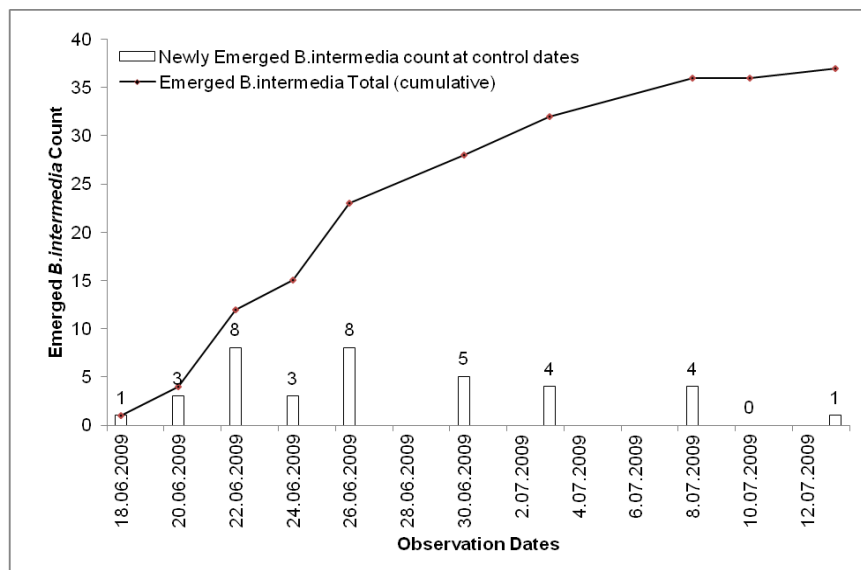

Figure 3. Emergence period of *Brachymeria intermedia* (Nees) from *Tortrix viridana* L. pupae in 2009

The first emergence of *B.intermedia* adults from *T.viridana* pupae occurred June 18, 2009, and then, *B.intermedia* emergences continued increasingly until July 13, 2009. During this period, *B.intermedia* emerged

from 37 out of 350 *T.viridana* pupae (10.57%).

B.intermedia is a solitary pupal endoparasitoid of various lepidopterous species (Dindo and Campadelli, 1992; Dindo et al., 1994) and it may quickly kill its host

within 48 hours while suspending tissue development (Thompson, 1980). *B.intermedia* females prefer lower humidity and 26-29°C temperature conditions. *B.intermedia* is active from mid-morning to late afternoon and most active period is between 13:30-15:30 hours. Females are photopositive and inactive in dark (Minot and Leonard, 1976). Kerguelen and Cardé (1998) showed that *B.intermedia* receives visual and odour signals and their behavior may change accordingly. *B.intermedia* females secrete sexual pheromones and males find females via pheromones (Mohamed and Coppel, 1987; Danci et al., 2006). Drost and Cardé (1992) reports that *B.intermedia* could learn whether its host is present or not by certain visual cues.

B.intermedia is common in many countries. Maharramova (2002) reports this parasitoid as a very effective parasitoid species emerged from *T.viridana* in Azerbaijan. Furthermore, there are other studies reporting *B.intermedia* developing on other hosts (Öncüer et al., 1978; Elkinton, 1990; Williams et al., 1993; Kerguelen and Cardé, 1996; Kerguelen and Cardé, 1998; Hoch et al., 2001; Bolu and Çınar, 2005; Hoch et al., 2006; Polat and Tozlu, 2010). Cabral et al. (1976) reported that the most common parasitoids emerged from *T.viridana* pupae were *B.intermedia* and *I.maculator* in Portugal.

It is understood that *B.intermedia* is present in certain cities such as İzmir, Manisa, Isparta and İstanbul in Turkey (Boucek, 1951; Gül Zümreoğlu, 1972; Ulu, 1983; Öncüer, 1991; Sarıkaya and Avcı, 2005; Avcı, 2009). Sarıkaya and Avcı (2005) determined *B.intermedia* from the pupae of *Choristoneura murinana* (Hbn.) which is a pest of *Abies cilicica* in Isparta, Turkey. Avcı (2009) reported that *B.intermedia* parasitized 4.5% of *L.dispar* pupae in Lakes district. However, there is not any study on this parasitoid existing in Çankırı.

Efficiency and Hosts of *Dirophanes invisor* (Thunberg, 1822) (Hymenoptera: Ichneumonidae)

Another parasitoid species, 3 *Dirophanes invisor* (Thunberg) adults (2.57% emergence ratio) were emerged from 117 *T.viridana*

pupae in 2008 (Figure 4). However, this parasitoid was not emerged from any of the *T.viridana* pupae in 2009.



Figure 4. *Dirophanes invisor* (Thunberg) adult

According to Cole (1970), *D.invisor* adults may tend to pupal sheaths of *T.viridana* about 1 week. Baş (1980) reports *D.invisor* as a parasitoid of *T.viridana* in Belgrade forests in İstanbul. Likewise, Özdemir (1996) reports that *D.invisor* emerged from *T.viridana* pupae in Central Anatolia. *D.invisor* is also known to parasitize certain agricultural pests such as *Yponomeuta padellus*, *Y.evonymella* and *Ellopija fasciaria* (Özdemir, 1996; Aliyev, 1999). In our literature search, we could not find any reference to *D.invisor* existing in Çankırı forests.

Biology, Hosts and Distribution of *Itopectis maculator* (Fabricius, 1775) (Hymenoptera: Ichneumonidae)

Adult of *Itopectis maculator* (Fabricius, 1775) is given in Figure 5 and emergence of *I.maculator* adults is given in Figure 6.

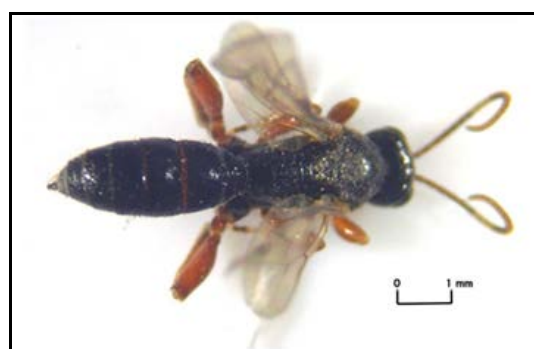

Figure 5 *Itopectis maculator* (Fabricius) adult

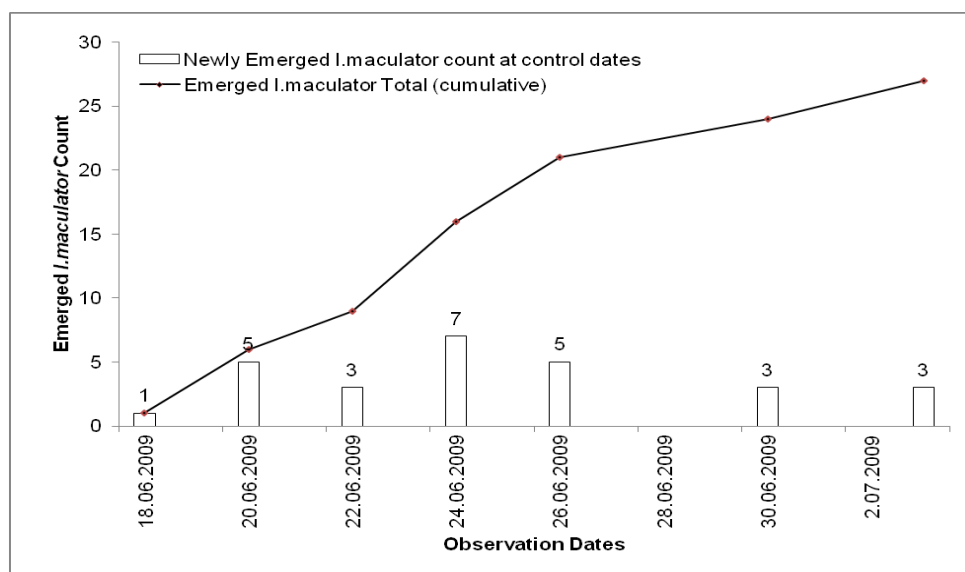

Figure 6. Emergence of *Itopectis maculator* (Fabricious) adults from *Tortrix viridana* L. pupae in 2009

In Figure 6, *I. maculator* adults started to emerge on June 20, 2009 for the first time and more *I. maculator* adults started to emerge in the latter days. The last *I. maculator* adults emerged on July 8, 2009. In this study, 3 *I. maculator* adults (2.57%) out of 117 *T. viridana* pupae and 27 *I. maculator* adults (7.71%) out of 350 *T. viridana* pupae emerged in 2008 and 2009 respectively.

I. maculator is one of the important parasitoids of *T. viridana*. It overwinters as adult (Cole, 1970). *I. maculator* prefers second and third instars of *T. viridana* larvae for parasitizing (Cole, 1967; Kidd and Jervis, 1991). *I. maculator* can detect parasitoids that are developing inside a host. Males of *I. maculator* cluster near the pupae which females are about to emerge (Martel et al., 2008). Some researchers report that *I. maculator* is one of the parasitoids of *T. viridana* in various countries such as Portugal, Ukraine and Azerbaijan (Cabral et al., 1976; Ivashov et al., 1986; Tolkanits and Seregina, 1988; Maharramova, 2002).

I. maculator is found in many provinces such as Adana, Afyonkarahisar, Ankara, Eldivan (Çankırı), Erzurum, Eskişehir, İzmir, Kars, Konya, Manisa, Nevşehir, Niğde and Yozgat in Turkey (Ulu, 1983; Doğanlar, 1987; Özdemir, 1990; Öncüer, 1991; Doğanlar, 2003; Çoruh, 2005; Polat and Tozlu,

2010; Tuncer and Avcı, 2016). In a study in Afyonkarahisar, *I. maculator* is reported to parasitize *T. viridana* as much as 11% (Tuncer and Avcı, 2016). There are many studies reporting *I. maculator* as a parasitoid of many other host species both in Turkey (İren, 1960; Özdemir and Özdemir, 2002; Bolu and Çınar, 2005; Sarıkaya and Avcı, 2005; Çoruh, 2010; Polat and Tozlu, 2010) and in other countries (Fabre and Mouna, 1983; Lim, 1986; Piekarska-Boniecka, 2004; Perju, 2005; Toth and Lukas, 2005; Piekarska-Boniecka and Wilkaniec, 2006; Piekarska-Boniecka and Wilkaniec, 2008; Piekarska-Boniecka et al., 2008; Shaw et al., 2009).

Efficiency, Hosts and Distribution of *Monodontomerus aereus* (Walker, 1834) (Hymenoptera: Torymidae)

Monodontomerus aereus (Walker, 1834), another parasitoid of *T. viridana*, is given in Figure 7.

It is determined that *M. aereus* adults emerged from 4 (1.14%) of the *T. viridana* pupae in 2009. *M. aereus* is metallic-green colored parasitoid and very common in the palearctic region (Gharali et al., 2005). This parasitoid is a gregarous endoparasitoid of various lepidopterous pupae (Popescu, 2009), however it is also may develop as hyperparasitoid (Muesebeck, 1931; Öncüer et al., 1978). In case of hyperparasitoid,

M.aereus feed on the primer ichneumonid or tachinid parasitoids (Muesebeck, 1931). Many researchers reported *M.aereus* in Afyonkarahisar, İzmir, Manisa, Edirne, Aegean Region, Erzurum, Kırklareli, Tekirdağ, İstanbul and Isparta (Boucek, 1951; Gül Zümreoğlu, 1972; Öncüer et al., 1978; Ulu, 1983; Avcı, 2009; Polat and Tozlu, 2010; Tuncer and Avcı, 2016). It is known that *Monodontomerus* spp. can utilize many insects as hosts (Claussen, 1956; Polat and Tozlu, 2010) such as *Euproctis chrysorrhoea* (Öncüer et al., 1978), *Lymantria dispar* (Avcı, 2009), *Archips rosana* (Polat and Tozlu, 2010). Also, Tuncer and Avcı (2016) reports that they determined parasitization ratio of *M.aereus* on *T.viridana* as 7.9% in Dinar, Afyonkarahisar between 2012 and 2014. However, we could not find any reference on *M.aereus* determined in Çankırı forests.



Figure 7. *Monodontomerus aereus* (Walker) adult

Efficiency and Distribution of *Pediobius bruchicida* (Rondani, 1872) and *Pediobius pyrgo* (Walker, 1839) (Hymenoptera: Eulophidae)

Also, we determined two other parasitoid species (Figure 8) which were identified as *Pediobius bruchicida* (Rondani, 1872) and *P.pyrgo* (Walker, 1839) from *T.viridana* pupae. However, their numbers could not be counted exactly, thus these parasitoids handled as *Pediobius* spp. In our study, 5 (4.27%) *Pediobius* spp. adults emerged from

117 *T.viridana* pupae in 2008, and 3 (0.86%) *Pediobius* spp. adults emerged from 350 *T.viridana* pupa in 2009.

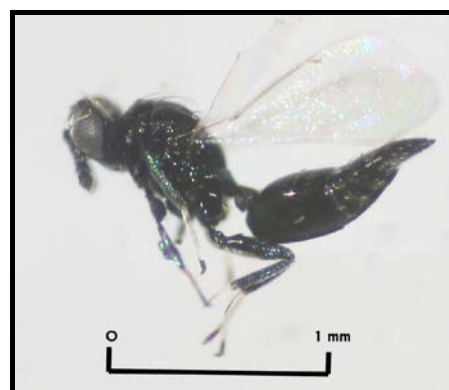

Figure 8. *Pediobius* spp. adult

Literature searching regarding to *Pediobius* genus show that all members of this genus are polyphagous species (Gates et al., 2005). There are many records about *Pediobius* species on various hosts both in the world (Junnikkala, 1960; Russo and Viggiani, 1963; Ghosh and Abdurahiman, 1985; Singh, 1993; Biljana and Ljubodrag, 2002; Gates et al., 2005; Klinkena and Burwell, 2005) and in Turkey (Öncüer et al., 1978; Doğanlar, 1982; Ulu, 1983; Kansu et al., 1986; Gençer and Doğanlar, 1996; Gençer, 2003; Bolu and Çınar, 2005; Polat and Tozlu, 2010). Also, Maharramova (2002) reports *P.pyrgo* as one of the parasitoids of *T.viridana* in Azerbaijan.

Öncüer et al. (1977) and Öncüer et al. (1978) reports *P.pyrgo* from *Euproctis chrysorrhoea* L. Polat and Tozlu (2010) also reports *P.pyrgo* as a parasitoid of *Archips rosana*. However, there is not a record related to *Pediobius* spp. existing in Çankırı.

Conclusions

Natural enemies of harmful insects are one of the most important factors in maintaining of the natural balance. As a result of this study carried out between 2008 and 2009, 6 pupal parasitoids of *Tortrix viridana* L. (Lepidoptera: Tortricidae) have been identified as *Brachymeria intermedia* (Nees) (Hymenoptera: Chalcididae), *Dirophanes invisor* (Thunberg), *Itopectis maculator* (Fabricious) (Hymenoptera: Ichneumonidae), *Monodontomerus aereus*

(Walker) (Hymenoptera: Torymidae), *Pediobius bruchicida* (Rond.) ve *P.pyrgo* (Wlk.) (Hymenoptera: Eulophidae).

Previous studies regarding the natural enemies of *T.viridana* show that there are many parasitoids of this species in various ecosystems, however, the most effective parasitoids are *B.intermedia* and *Itopectis* spp. (Baş, 1980; Maharramova, 2002). Our results also confirm that *B.intermedia* and *I.maculator* are the most common pupal parasitoids of *T.viridana*.

It is determined that various pupal parasitoids of *T.viridana* (*B.intermedia*, *D.invisor*, *I.maculator*, *P.bruchicida* and *P.pyrgo*) emerged from a total of 15.4% of *T.viridana* pupae in 2008 and (*B.intermedia*, *I.maculator*, *M.aereus*, *P.bruchicida*, *P.pyrgo*) emerged from a total of 20.3% of *T.viridana* pupae in 2009. These parasitoid species were determined for the first time in Cankiri on *T.viridana*; however, parasitization ratios for both parasitoids were low and their ability to control *T.viridana* in case of an outbreak seems rather difficult. Nevertheless, we believe that existence of the parasitoid species in the area is important in biological diversity sense. Thus, we think protection measures regarding to parasitoids and further studies in order to increase the efficiency of these parasitoids would be the most beneficial.

Acknowledgements

We would like to thank Dr. Murat YURTCAN, Dr. Klaus HORSTMANN and Prof. Dr. Mikdat DOĞANLAR for identification of parasitoid species.

References

Aliyev, A. A. O. 1999. Fauna of the subfamily Ichneumoninae (Hymenoptera, Ichneumonidae) of Azerbaijan with new records. Turkish Journal of Zoology 23 1-12.

Avcı, M. 2009. Parasitoid complex and new host plants of the Gypsy Moth, *Lymantria dispar* L. in the Lakes district, Turkey. Journal of Animal and Veterinary Advances, 8 (7), 1402-1405.

Baş, R. 1980. *Tortrix viridana* (L.) (Lep., Tortricidae)'nın Marmara bölgesi ormanlarındaki biyolojisi ve doğal düşmanları. İstanbul Üniversitesi Orman Fakültesi Dergisi A 30 (2), 49-72.

Bolu, H., Çınar, M. 2005. Elazığ, Diyarbakır ve Mardin illeri badem ağaçlarında zararlı olan Lepidoptera türleri, doğal düşmanları ve önemlileri üzerinde gözlemler. Harran Üniversitesi Ziraat Fakültesi Dergisi 9(2), 63-67.

Boucek, Z. 1951. The first revision of the European species of family Chalcididae (Hymenoptera) Act Ent. Mus. Nat.27, Suppl. I. 108, Prague.

Cabral, M. T., Neves, C. M. L. B., Nogueira, C. D. S. 1976. Utilizacao dos raias X em estudos de parasitismo na *Tortrix viridana* L., *Thaumetopoea pityocampa* Schiff. e *Lymantria dispar* L. Anais do Instituto Superior de Agronomia, 36 187-201.

Claussen, C. P. 1956. Biological control of insect pests in the continental United States. United States Department of Agriculture USA.

Cole, L. R. 1967. A study of the life-cycles and hosts of some Ichneumonidae attacking pupae of the green oak-leaf roller moth, *Tortrix viridana* (L.) (Lepidoptera: Tortricidae) in England. Transactions of the Royal Entomological Society of London 119 267-281.

Cole, L. R. 1970. Observations on the finding of mates by male *Phaeogenes invisor* and *Apanteles medicaginis* (Hymenoptera: Ichneumonidae). Animal Behaviour, 18 (1), 184-189.

Çanakçıoğlu, H., Mol, T. 1998. Orman entomolojisi zararlı ve yararlı böcekler. 541, İstanbul Üniversitesi Orman Fakültesi Yayınları, İstanbul.

Çanakçıoğlu, H., Selmi, E. 1988. Türkiye ormanlarının faydalı böcekleri. T.C. Tarım ve Köyişleri Bakanlığı Orman Genel Müdürlüğü Biyolojik Savaş Semineri Artvin 1988 Kitabı Yayın no: 670, Seri no: 27,

Çoruh, S. 2005. Erzurum ve çevre illerdeki Pimplinae (Hymenoptera: Ichneumonidae) türleri üzerinde faunistik, sistematik ve ekolojik çalışmalar. Fen Bilimleri Enstitüsü, 212, Erzurum.

Çoruh, S. 2010. Composition, habitat distribution and seasonal activity of Pimplinae (Hymenoptera: Ichneumonidae) in North-East Anatolia region of Turkey. Anadolu Tarım Bilimleri Dergisi 25 (1), 28-36.

Danci, A., Schaefer, P. W., Schopf, A., Gries, G. 2006. Species-specific close-range sexual communication systems prevent cross-attraction in three species of *Glyptapanteles* parasitic wasps (Hymenoptera: Braconidae). Biological Control 39 225-231.

- Dindo, M. L., Campadelli, G. 1992. Preliminary studies on the artificial culture of *Brachymeria intermedia* (Nees) (Hym. Chalcididae) on oligidic diets. *Bol. Ist. Ent. "G. Grandi" Univ. Bologna*, 46 221-232.
- Dindo, M. L., Sama, C., Farneti, R. 1994. Comparison of four commercial vial homogenates in artificial diets for *Brachymeria intermedia* (Nees) (Hymenoptera: Chalcididae). *Bol. Ist. Ent. "G. Grandi" Univ. Bologna* 49 15-19.
- Doğanlar, M. 1982. Doğu Anadolu Bölgesi'nde bazı lepidopterlerin hymenopter doğal düşmanları üzerine araştırmalar. *Bitki Koruma Dergisi*, 6 197-205.
- Doğanlar, M. 1987. Erzurum ve çevresindeki elma ve armut ağaçlarında bulunan yaprak büklenler ve benzer şekilde beslenen diğer Lepidopterler ile bunların parazitleri üzerinde araştırmalar. *Doğa Türk Tarım ve Ormancılık Dergisi*, 11 (1), 86-93.
- Doğanlar, O. 2003. Pozantı ve çevresinde *Archips rosanus* (L.) (Lepidoptera: Tortricidae)'un elmada biyolojisinin ve parazitoidlerinin saptanması. *Fen Bilimleri Enstitüsü*, 136, Adana.
- Drost, Y. C., Cardé, R. T. 1992. Use of learned visual cues during habitat location by *Brachymeria intermedia*. *Entomologia Experimentalis et Applicata* 64 217-224.
- DuMerle, P. 1999. Egg development and diapause: ecophysiological and genetic basis of phenological polymorphism and adaptation to varied hosts in the green oak tortrix, *Tortrix viridana* L. (Lepidoptera: Tortricidae). *Journal of Insect Physiology*, 45 599-611.
- DuMerle, P., Delarette, S., Mazet, R. 1999. Methods for mass production of eggs ve fecundity of the green oak tortrix, *Tortrix viridana* L. (Lep., Tortricidae). *Journal of Applied Entomology*, 123 385-389.
- Elkinton, J. S. 1990. Population dynamics of gypsy moth in North America. *Annu. Rev. Entomol.*, 35 581-596.
- Fabre, J. P., Mouna, M. 1983. On the presence in Morocco of a tortricid, *Acleris undulana* Walsingham (Lep. Tortricidae), a serious pest of cedars: *Cedrus atlantica* Mannetti, *Cedrus libani* Barrel. *Comptes Rendus des Séances de l'Academie d'Agriculture de France* 69 (9), 642-647.
- Gates, M. W., Liu, H., Bauer, L. S., Schauff, M. E. 2005. A new species of *Pediobius* (Hymenoptera: Eulophidae) parasitizing *Chyliza apicalis* (Diptera: Psilidae) in ash trees attacked by *Agrilus planipennis* (Coleoptera: Buprestidae). *The Great Lakes Entomologist*, 38 (1,2), 76-82.
- Gençer, L. 2003. The parasitoids of *Yponomeuta malinellus* Zeller (Lepidoptera: Yponomeutidae) in Sivas. *Turk J Zool*, 27 43-46.
- Gençer, L., Doğanlar, M. 1996. Tokat-merkezde elma bahçelerinde elma ağ kurdu (*Yponomeuta malinellus* Zell) pupalarından çıkan parazitler ve aralarındaki bazı biyolojik ilişkiler. *Cumhuriyet Üniversitesi Fen Edebiyat Fakültesi Fen Bilimleri Dergisi*, 19 11-18.
- Gharali, B., Lotfalizadeh, H. A., Ebrahimi, E., Zerova, M. 2005. Record of *Monodontomerus aereus* (Hym.: Torymidae) from Iran. *Journal of Entomological Society of Iran*, 25 (1), 60-61.
- Ghosh, S. M., Abdurahiman, U. C. 1985. Record of two new hyperparasites of *Apanteles taragamae* Vier. (Braconidae: Hymenoptera), a larval parasite of the black-headed caterpillar pest of coconut. *Current Science*, 54 (6), 295-296.
- Gül Zümreoğlu, S. 1972. İzmir bölge zirai mücadele araştırma enstitüsü böcek ve genel zararlılar kataloğu, 1928-1969. (1. Kısım). Bölge Zirai Mücadele Araştırma Enstitüsü, İzmir.
- Hoch, G., Kalbacher, G., Schopf, A. 2006. Gypsy moth revisited: studies on the natural enemy complex of *Lymantria dispar* L. (Lep., Lymantriidae) during an outbreak in a well known gypsy moth area. *Mitt. Dtsch.Ges.Allg.Endew.Ent.*, 15 201-204.
- Hoch, G., Zubrik, M., Novotny, J., Schopf, A. 2001. The natural enemy complex of the gypsy moth, *Lymantria dispar* (Lep., Lymantriidae) in different phases of its population Dynamics in eastern Austria and Slovakia - a comparative study. *Journal of Applied Entomology*, 125 217-227.
- İren, Z. 1960. Ankara Bölgesi'nde ağ kurtları (*Yponomeuta*) türleri, arız olduğu bitkiler, bu türlerin kısa biyolojisi ve mücadelesi üzerinde araştırmalar. *Zir. Vek. - Rap. Ar. Ser.*, (4),
- Ivashov, A. V., Boyko, G. E., Simchuk, A. P. 2002. The role of host plant phenology in the development of the oak leafroller moth, *Tortrix viridana* L. (Lepidoptera: Tortricidae). *Forest Ecology and Management*, 157 7-14.
- Ivashov, A. V., Podmarkov, N. Y., Sirenko, M. D. 1986. Parasites of pupae of *Tortrix viridana* in the Crimea. *Lesnoi Zhurnal*, 3 108-110.
- Junnikkala, E. 1960. Life history and insect enemies of *Hyponomeuta malinellus* Zell. (Lep., Hyponomeutidae) in Finland. *Annales Zoologici Societatis Botanicae Fennicae "Vanamo"*, 21 3-44.
- Kalapanida-Kantartzi, M., Glavendekic, M. 2002. Observation on the appearance and the development *Tortrix viridana* L. (Lepidoptera: Tortricidae). *Acta Entomologica Serbica*, 7 (1-2), 59-65.

Kansu, A., Kılınçer, N., Uğur, A., Gürkan, O. 1986. Ankara, Nevşehir, Niğde İllerinde kültür bitkilerinde zararlı Lepidopterlerin larva ve pupa asalakları. Türkiye I. Biyolojik Mücadele Kongresi (12-14 Şubat 1986), 146-161, Adana.

Kerguelen, V., Cardé, R. T. 1996. Seasonal occurrence of *Brachymeria intermedia* (Hymenoptera: Chalcididae), a parasitoid of the gypsy moth, *Lymantria dispar* (Lepidoptera: Lymantriidae), in western Massachusetts. Journal of the New York Entomological Society, 104 (1-2), 89-94.

Kerguelen, V., Cardé, R. T. 1998. Flight toward a learned odor and factors inducing landing of female *Brachymeria intermedia* (Hymenoptera: Chalcididae), a parasitoid of the gypsy moth, *Lymantria dispar* (Lepidoptera: Lymantriidae). Journal of Insect Behavior, 11 (2), 221-234.

Kidd, N. A. C., Jervis, M. A. 1991. Host-feeding and oviposition strategies of parasitoids in relation to host stage. Res. Popul. Ecol., 33 13-28.

Klinkena, R. D., Burwell, C. J. 2005. Evidence from a gelechiid leaf-tier on mesquite (Mimosaceae: Prosopis) that semi-concealed Lepidopteran biological control agents may not be at risk from parasitism in Australian rangelands. Biological Control 32 121-129.

Kondur, Y. 2004. Çankırı (İndağı) Meşe (*Quercus* sp.) ormanlarında zarar yapan yeşil meşe bükücüsü (*Tortrix viridana* L.) [Lepidoptera: Tortricidae]'nın biyolojisi ile meşcere kuruluşları üzerine etkileri. Fen Bilimleri Enstitüsü, 83, Çankırı.

Kondur, Y., Şimşek, Z. 2008. Çankırı (İndağı)'da meşelerde zararlı Yeşil meşe bükücüsü [*Tortrix viridana* L. (Lep.: Tortricidae)]'nın farklı yüksekliklerde uçuş periyodunun belirlenmesi. Bitki Koruma Bülteni 48 (1), 19-36.

Lim, G. S. 1986. (T. D. Talekar N.S. and Griggs, .), Diamondback moth management. Proceedings of the first International Workshop 11-15 March, 1985), Asian Vegetable Research and Development Center, 159-171, Shanhua, Taiwan.

Maharramova, S. 2002. Role of parasitoid complex in control of *Tortrix viridana* (L.) (Lepidoptera, Tortricidae). Türkiye 5. Biyolojik Mücadele Kongresi (4-7 Eylül 2002), 189-198, Erzurum.

Martel, V., Wajnberg, E., Boivin, G. 2008. Patch time allocation in male parasitoids. Ecological Entomology, 33 608-613.

Minot, M. C., Leonard, D. E. 1976. Effect of temperature, humidity, light, and gravity on the parasitoid *Brachymeria intermedia*. Environmental Entomology, 5 (3), 427-430.

Mohamed, M. A., Coppel, H. G. 1987. Pheromonal basis for aggregation behavior of parasitoids of the gypsy moth: *Brachymeria intermedia* (Nees) and *Brachymeria lasus* (Walker) (Hymenoptera: Chalcididae). Journal of Chemical Ecology, 13 (6), 1385-1393.

Muesebeck, C. F. W. 1931. *Monodontomerus aereus* Walker, both a primary and a secondary parasite of the brown-tail moth and the gypsy moth. Journal of Agricultural Research 43 (5), 445-459.

Öncüer, C. 1991. Türkiye Bitki Zararlısı Böceklerinin Parazit ve Predatör Kataloğu (I. Basım). 354, Ege Üniversitesi Ziraat Fakültesi Ofset Atölyesi, Bornova, İzmir.

Öncüer, C., Yalçın, E., Erkin, E. 1977. Ege Bölgesinde meyve ağaçlarında zarar yapan *Euproctis chrysorrhoea* L. (Lepidoptera: Lymantriidae) larvalarının doğal düşmanları ve bunların etkililik durumları. Türkiye Bitki Koruma Dergisi, 1 (1), 39-47.

Öncüer, C., Yalçın, E., Erkin, E. 1978. Ege Bölgesi'nde meyve ağaçlarında zarar yapan; *Euproctis chrysorrhoea* L. (Lepidoptera: Lymantridae) pupalarının doğal düşmanları ve bunların etkililik durumları. Türkiye Bitki Koruma Dergisi, 2 (1), 31-36.

Öncüer, C., Yalçın, E., Erkin, E. 1982. *Euproctis chrysorrhoea* L. (Lepidoptera: Lymantriidae) yumurtalarının paraziti *Asolcus turkarkandas* Szabo (Hymenoptera: Scelionidae)'nın etkililik durumu. Türkiye Bitki Koruma Dergisi, 6 221-225.

Özdemir, Y. 1990. İç Anadolu Bölgesinde Pimplinae ve Ophioninae (Hymenoptera: Ichneumonidae) altfamilyaları üzerinde taksonomik araştırmalar. Fen Bilimleri Enstitüsü, 275.

Özdemir, Y. 1996. İç Anadolu bölgesinde tespit edilen Banchinae ve Ichneumoninae (Hym.: Ichneumonidae) türleri. Bitki Koruma Bülteni 36 (3-4), 91-104.

Özdemir, Y., Özdemir, M. 2002. Orta Anadolu bölgesinde *Archips* türlerinde (Lep.: Tortricidae) saptanan Ichneumonidae (Hymenoptera) türleri. Bitki Koruma Bülteni 42 (1-4), 1-7.

Perju, T. 2005. Parasitoids reared from insect pests of different agroecosystems. Lucrarile simpozionului "Entomofagii și rolul lor în pastrea echilibrului natural" Universitatea "Al.I. Cuza" Iași, 47-54.

- Piekarska-Boniecka, H. 2004. Natural control of rose tortrix moth *Archips rosanus* (L.) occurring in an apple orchard in Rosnowo. Roczn. AR Pozn. CCCLX, Ogród, 38 119-122.
- Piekarska-Boniecka, H., Wilkaniec, B. 2006. Pimplinae, Diacritinae, Poemeniinae and Rhyssinae parasitoid subfamilies (Hymenoptera, Ichneumonidae) of refugium habitats in agricultural landscape of Central Wielkopolska. Roczn. AR Pozn. CCCLXXIX, Ogród, 40 33-41.
- Piekarska-Boniecka, H., Wilkaniec, B. 2008. Selected insect groups of shrubbery complexes of "Biedrusko" Protected Landscape. Part II: Parasitic wasps of Pimplinae and Poemeniinae subfamily (Hymenoptera, Ichneumonidae). Polish Journal of Entomology 77 109-124.
- Piekarska-Boniecka, H., Wilkaniec, B., Dolanska-Niedbala, E. 2008. Parazytoidy z rodziny Ichneumonidae (Hymenoptera, Apocrita) ograniczające liczebność zwójki różoweczki [*Archips rosana* (L.)] w wybranych sadach wielkopolski. Progress in Plant Protection/Postępy w Ochronie Roslin 48 (4), 2008.
- Polat, A., Tozlu, G. 2010. Erzurum'da *Archips rosana* (Linnaeus, 1758) (Lepidoptera: Tortricidae)'nın kısa biyolojisi, konukçuları ve parazitotitleri üzerinde araştırmalar. Türkiye Entomoloji Derneği Dergisi 4529-542.
- Popescu, I. E. 2009. Travaux du Muséum National d'Histoire Naturelle Vol. LII), 457-477,
- Russo, G., Viggiani, G. 1963. Il *Pediobius pyrgo* Walk. (Hym. Eulophidae) efficace parassita della *Leucoptera scitella* Zell. nell'Italia meridionale. Boll. Lab. Ent. agr. "Filippo Silvestri" 21 217-235.
- Sarıkaya, O., Avcı, M. 2005. Studied on the parasitoid complex of *Choristoneura murinana* (Hbn.) (Lep.: Tortricidae) in Turkey. J. Pest. Sci., 78 63-66.
- Shaw, M. R., Stefanescu, C., vanNouhuys, S. 2009. (T. G. S. J. Settele, M. Konvicka & H. Van Dyck, Cambridge University Press, 130-156, UK.
- Simchuk, A. P., Ivashov, A. V., Companytsev, V. A. 1999. Genetic patterns as possible factors causing population cycles in oak leafroller moth, *Tortrix viridana* L. Forest Ecology and Management, 113 35-49.
- Singh, S. P. 1993. Biological control of insect pests. Malhotra Publishing House, New Delhi, India.
- Şimşek, Z., Kondur, Y. 2006. Çankırı ormanlarının zararlı böcekleri ve mücadele yöntemleri. Gazi Üniversitesi Orman Fakültesi Dergisi, 6 (1), 98-119.
- Thompson, S. N. 1980. Artificial culture techniques for rearing larvae of the chalcidoid parasite, *Brachymeria intermedia*. Entomologia Experimentalis et Applicata, 27 133-143.
- Tolkanits, V. I., Seregina, L. Y. 1988. Ichneumon flies (Hymenoptera, Ichneumonidae) - natural enemies of the oak leaf roller in the south of the Ukraine. Vestnik Zoologii 122-29.
- Toth, P., Lukas, J. 2005. Pasozyticzne względem *Cameraria ohridella* (Lepidoptera: Gracillariidae) Ichneumonoidea na Słowacji. J. Pest. Sci., 78 (3), 151-154.
- Tuncer, İ., Avcı, M. 2016. Dinar yöresi meşe ormanlarında Yeşil Meşe Bükücüsü [*Tortrix viridana* L. 1758 (Lep., Tortricidae)]'nın zararı, biyolojisi ve doğal düşmanları. Turkish Journal of Forestry, 16 (1), 11-19.
- Ulu, O. 1983. İzmir ve Manisa illeri çevresi taş çekirdekli meyve ağaçlarında zarar yapan *Archips* (= *Cacoecia* spp.) (Lepidoptera: Tortricidae) türleri, tanımları, konukçuları, yayılışları ve kısa biyolojileri üzerinde araştırmalar. Zirai Mücadele Zirai Karantina Genel Müdürlüğü, Bornova Bölge Zirai Mücadele Araştırma Enstitüsü Müdürlüğü, İzmir.
- Williams, D. W., Fuester, R. W., Metterhouse, W. W., Balaam, R. J., Bullock, R. H., Chianese, R. J., Reardon, R. C. 1993. Incidence and ecological relationships of pupal parasitism by *Brachymeria intermedia* in New Jersey populations of the gypsy moth. Entomophaga, 38 (2), 257-266.

Forest Fire Prevention System Based on a Hybrid Satellite-Cellular Wireless Network

Cenk ATLIĞ

Trakya University, Computer Programming, Edirne / TURKEY

cenkatlig@trakya.edu.tr

Abstract

Fire is an essential problem for forest sustainability. Primarily, prevention of fire is crucial. But, if somehow fire becomes a reality then it is worthwhile to identify and put out the fire as soon as possible. In this paper, we present a fire prevention system based on a hybrid satellite-cellular wireless network. In our framework, actual fire risk data provided by TERRA and AQUA satellites by the use of MODIS system, is considered. Then we utilize decision tree and random forest algorithms in machine learning technology. Based on these evaluations, potential high risk areas for wildfire have identified. Currently existing cellular wireless network is used to signal wildfire within the observed forest region.

Keywords: Fire prevention, satellite, cellular network, Geographical Information System (GIS).

Hibrid Uydu-Hücreli Kablosuz Ağ Tabanlı Orman Yangını Önleme Sistemi

Özet

Yangın ormanların sürdürülebilirliği için temel bir problemdir. Öncelikle, yangının önlenmesi çok önemlidir. Ancak bir şekilde yangın başladıysa, en kısa sürede yangının algılanması ve söndürülmesi kritiktir. Bu bildiriye, hibrid uydu-hücreli kablosuz ağ tabanlı yangın önleme sistemi sunulmaktadır. Sistemimizin yapısında, yangın riski MODIS sistemi üzerinden TERRA ve AQUA uyduları tarafından sağlanmaktadır. Daha sonra makine öğrenmesinin karar ağacı (decision tree) ve rastgele orman (random forest) algoritmaları kullanılmaktadır. Yapılan gözlemler sonucunda, potansiyel yüksek riskli söndürülmesi zor olan yangınların tespiti mümkündür. Söndürülmesi zor yangınlar gözlemlendiğinde, uyarı verilmesi için mevcut hücreli kablosuz ağlar kullanılmaktadır.

Anahtar Kelimeler: Yangın önleme, uydu, hücreli ağ, Coğrafi Bilgi Sistemi (GIS).

1. Introduction

Forests are inseparable part of world ecosystem. This is not only because it host a fauna system but it also balances soil quality, weather style and human behaviour. Considering these important benefits, forest are not only fundamental treasure for a certain region but also for all nations and even all earth. For instance, Amazon forest is known as lungs of the earth.

Since forests are considered as a fundamental part of nature, it is essential to protect and even it is necessary to increase the amount of forest land. On the other hand, a single fire may quickly result to burn hundreds of thousands trees, which consequences large amount of deforested land. Hence, it is very appropriate to use effective yet efficient fire defending systems for forests.

Countries have different management strategies for forestland. As in the case in

Europe for example. Parliament is responsible in some of the countries such as in Norway and Sweden. As for Poland and Portugal, group of ministers endorse. Government with unspecified manner are in charge for Finland and Belgium. As in the case for Austria, France, and Germany, minister responsible with forest. When we look at Turkey, forests are handled by general directory of forestry like Switzerland, United Kingdom and Greece [10]. Considering different organizational structure of forest, it is necessary to establish appropriate cooperation between different countries, for cross-border as well as national forestry issues.

As in the case of forest fire, there are various conventional fire defending systems. These approaches include using fire warden, fire observation tower. More recent approaches include helicopters, two-way radio systems and even drones.

Climate change generates significant destructive effect towards ecosystem and forest are not an exception in this respect. Based on this circumstance, it is more important to observe, analyse, and detect fire-prone regions. Computerized systems automatize prevention system without any (or significant) human intervention.

In this paper, we propose a new approach to be used as a fire avoidance scheme built on a hybrid satellite-cellular wireless system. In our structure, real fire threat figures delivered by TERRA and AQUA satellites by the use of MODIS organization, is considered. Then we apply machine learning technics. Considering these estimations, potentially high risk regions for fire have identified. Present cellular wireless network in the region is used to signal wildfire for perceived woodland area.

The rest of the paper is organized as follows. Section 2 describes the geographic and information systems. Section 3 demonstrates the proposed system. We conclude in Section 4 with a summary of the paper and some future directions.

2. Geographic and Information Systems

Forests fires dates back to hundred million years [1]. This catastrophic problem tried to be prevented by various strategies. Some of the preliminary approaches include human interventions such as fire warden and fire observation towers.

There are some prior approaches to eliminate or minimize the risk of fire. For instance, Canada burns dry regions to decrease the risk of future fire.

As technology advances, utilization of technological fire prevention systems are being used. Observations with helicopters, planes and even drones is utilized.

Advance prevention technics include ecological arrangements and air control systems. Computerized systems have started to be implemented for fire prevention. Some of these include sensor networks, mobile and/or smart phone systems.

Crucial part of forest fire prevention is detection of a started fire. This can be categorized in four categories, human oriented, satellite oriented, optical camera based and wireless sensor networks [2].

One of the advance computerized fire prevention system is satellite oriented and we will discuss these systems in the next subsection.

2.1 Satellite Based Fire Prevention

Besides the various valuable features of forests, their fire prevention requires additional efforts. First of all, majority of the forests are located to nonurban and distant regions. Similarly, they are frequently located to isolated and unmanaged regions. Hence, forest observations and intervention process is much more complicated.

In order to overcome this problem, satellite systems might be used and some satellite based systems have already been implemented. One of the satellite oriented fire prevention system is *Rapid Response* [9]. This system is using imagery from MODIS system. In addition to this, *MODIS Active Fire and Burned Area* [14], *Global Fire Information Management System (GFIMS)* [15], *Visible Infrared Imager Radiometer Suite (VIIRS)* [16], *Advanced Fire Monitoring System (AFIS)* [17] are also available.

2.2 TERRA and AQUA Satellites

TERRA and AQUA satellite systems are both producing information flow to MODIS system. According to different requirements, appropriate data can be used from the corresponding satellites. Some of the key differences of two satellites can be listed as follows.

Their algorithms are different so that detection of different operations may vary. Another difference is their orbitals. Terra is rotating from north to south (descending) and AQUA is rotating from south to north (ascending). Thus, their equator crossings are also different too. They have different coverages. Therefore some arrangements are necessary to compare similar regions.

Figure 1 demonstrates operational functions of TERRA and AQUA satellites. Despite their differences, data from these two satellites is collected in MODIS system and it is used for analyses and assessments.

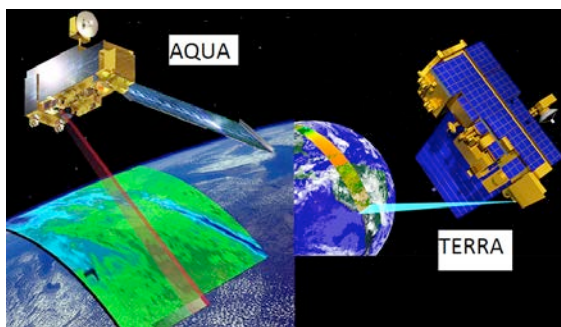

Figure 1 Operational view of TERRA and AQUA satellites

2.3 Geology Applications

There are various geology applications, which can be used to improve the assessment of geographic regions. One of them is iGeology [18] and iGeology 3D [19]. Different geological maps are available for United Kingdom. 3D is the advanced version of the other one. Flyover Country [20] has online and offline features to analyse geological data for the extended area. myVolcano [21] volcano information flow is available. Direct interaction with scientist worldwide is also supported. *mySoil* [22] provides information about European soil properties.

3. Proposed System

In order to prevent unintended operations, it is crucial to observe and then analyse and finally take appropriate operations. As in the case for forest fires, concentration of the forest regions will increase the reaction time. In other words, different type of geographical structures (especially seas, lakes and rivers etc.) will be eliminated at the time of observation stage. Based on this approach, it is better to consider local structure first. As in the case for Republic of Turkey forest, Figure 2 shows forest distribution across the country. Since this is not last minute information, this information is used for the preliminary assessments and data will be updated as MODIS system information support more recent information.

Appropriate feature selection and suitable algorithm for a given problem are critical problems in classification [11]. This is also valid for our system in this study. We have

compiled image data from MODIS system. Since we intend to classify wildfire activity, we need to focus smoke, temperature, soil type and similar identifiers in the data.

Therefore, we have analysed occurrence of certain patterns in the target forest. Proper method rockets the estimation performance but enhancements are not always noteworthy [11].

Gustafsson and Andersson proposed an extended dynamic planning for fire and rescue systems using a decision support tool [12].

Cheng and Wang developed spatio-temporal data mining for forest fire prediction and they have provided a case study for Canada [13].

According to [13] support vector machines are applicable to spatial and temporal forecasting nonlinearly, and obtain better forecasting accuracy than previous methods.

Architecture of the proposed system is shown in Figure 3.

In the proposed system, information collected from TERRA and Aqua satellites provided to MODIS system. In this gigantic system, vast amount of data are ready to be serve for different type of observations. We are using this gigantic system for detection and observing of forest regions as well as smoke, temperature, evaporation data.

Collected data from MODIS system is listed in Table 1. As stated in this table, one of the data is land information. This is intended to understand forest regions as well as unintended regions such as seas, lakes, etc.

Smoke information is also collected that is to understand there is a fire related smoke or not. Smoke detection approach is also used in [26].



Figure 2 Forests distribution map of Republic of Turkey [8]

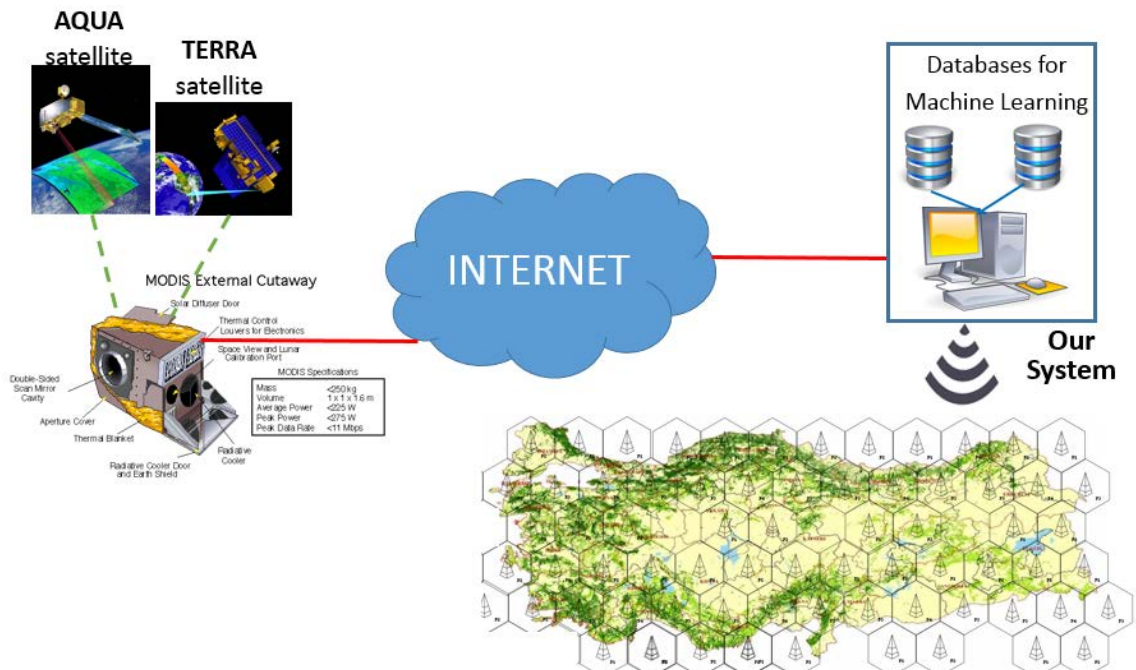

Figure 3 Architecture of the proposed system

Temperature data is also collected from MODIS that is to understand whether certain region is prone to fire risk.

Evaporation is also observed. This is important since fire balancing factor is important.

Through internet connection these information collected from MODIS system. At this stage we have perform manual data collection by using log in to the MODIS system by personal information. But this can be simply automatized by using simple middleware program.

As we collect these data, we can apply different type of machine learning techniques [23] on this source. At this time, we design our system for decision tree [24] and random forest [25] algorithms.

Table 1 Data collected from MODIS system

Data Collected	Reason
Land info	Forest detection and (includes unintended regions such as seas, lakes, etc.)
Smoke	Whether Due to a Fire or Industrialization/Urbanization
Temperature	Limiting for fire
Evaporation	Possible fire balance

We have used Weka tool [27] in our experiments. Our preliminary experiments shows our MODIS assisted system can be used for fire detection.

4. Conclusion

Fire detection is important and forest fires are especially important. Thus, more research efforts need to be performed toward this direction.

We concentrated on MODIS supported machine learning system to detect forest fire. Data are considered in general scale.

Our further research interests to develop more generalized version of this framework system. We also plan to integrate fifth generation mobile communication technology (5G), as it will be soon available

and suitable for large scale project such as Internet of Things (IoT) applications.

References

- [1] Glasspool I.J., et al. (2004). "Charcoal in the Silurian as evidence for the earliest wildfire". *Geology* 32 (5): 381–383.
- [2] Alkhatib, A.A.A., "A Review on Forest Fire Detection Techniques," *International Journal of Distributed Sensor Networks*, March 2014, Vol.10, No.3, pp.1-12. doi:10.1155/2014/597368
- [3] Peng, D.; Hu, Y.; Li, Z. (2016). Spectral Reflectance and Vegetation Index Changes in Deciduous Forest Foliage Following Tree Removal: Potential for Deforestation Monitoring. *JOURNAL OF APPLIED SPECTROSCOPY*, 83(2), 330-337.
- [4] Wu, Mingquan; Wu, Chaoyang; Huang, Wenjiang; Niu, Zheng; Wang, Changyao; Li, Wang; Hao, Pengyu (2016). An improved high spatial and temporal data fusion approach for combining Landsat and MODIS data to generate daily synthetic Landsat imagery. *INFORMATION FUSION*, 31, 14-25.
- [5] Jimenez-Munoz, Juan C.; Mattar, Cristian; Sobrino, Jose A.; Malhi, Yadvinder (2016). Digital thermal monitoring of the Amazon forest: an intercomparison of satellite and reanalysis products, *INTERNATIONAL JOURNAL OF DIGITAL EARTH*, 9(5), 477-498.
- [6] Byun, Y. G., et al., "Evaluation of graph-based analysis for forest fire detection," *Journal of Computer, Electrical, Automation, Control and Information Engineering*, Vol.1, No.10, 2007, pp.3166-3171.
- [7] Pavlidou, E., et al., "Finding a needle by removing the haystack: A spatio-temporal normalization method for geophysical data," *Computers & Geosciences*, 90 (2016), pp.78-86.
- [8] Republic of Turkey General Directory of Forestry, Distribution map of forests in Republic of Turkey <http://www.ogm.gov.tr/Sayfalar/Ormanlarimiz/T%C3%BCrkiye-Orman-Varl%C4%B1%C4%9F%C4%B1-Haritas%C4%B1.aspx> (last visited on 01.August.2016.)
- [9] Sohlberg R, Descloitres J, Bobbe T (2001). *MODIS Land Rapid Response: operational use of Terra data for USFS wildfire management*, Earth Obs 13:8–10.

- [10] *State of Europe's Forests country statistics, Status & Trends in Sustainable Forest Management in Europe*, FOREST EUROPE Liaison Unit Oslo, UNECE and FAO, 2011.
- [11] Guyon I, Elisseeff, A. An introduction to variable and feature selection. *J Mach Learn Res* 2003; 3: 1157–1182.
- [12] Gustafsson, A., Andersson, T., Dynamic plans of fire and rescue services, 9th Int.Conference ISCRAM, Vancouver, Canada, 2012, 4 pages.
- [13] Cheng T., Wang, J., Integrated Spatio-Temporal Data Mining for Forest Fire Prediction, *Transactions GIS*, 12, (2008), pp.591-611.
- [14] Giglio, L., Descloitres, J., Justice, C.O., Kaufman, Y. 2003. An enhanced contextual fire detection algorithm for MODIS. *Remote Sensing of Environment*, 87:273-282.
- [15] Global Fire Information Management System (GFIMS)
<http://www.fao.org/nr/gfims/gf-home/en/>
- [16] Visible Infrared Imager Radiometer Suite (VIIRS) <http://viirsfire.geog.umd.edu>
- [17] Advanced Fire Monitoring System (AFIS) <http://www.afis.co.za/mobile/>
- [18] *iGeology*, British Geological Survey.
- [19] *iGeology 3D*, British Geological Survey.
- [20] *Flyover Country*, The University of Minnesota and The National Science Foundation, USA.
- [21] *myVolcano*, British Geological Survey and the Smithsonian Institute, USA.
- [22] *mySoil*, British Geological Survey.
- [23] Schapire, R., *Machine Learning Algorithms for Classification*, Princeton University.
- [24] Quinlan, J.R., "Induction of Decision Trees," *Machine Learning*, Vol.1, Issue 1, March 1986, pp.81-106.
- [25] Breiman, L., "Random Forest," *Machine Learning*, Vol.45, Issue 1, October 2001, pp.5-32.
- [26] Acharya C, Mohanty S, Sukla L B, and Misra V N 2006 Prediction of sulphur removal with acidithiobacillus using artificial neural networks. *Ecological Modelling* 190: 223–230.
- [27] Mark Hall, Eibe Frank, Geoffrey Holmes, Bernhard Pfahringer, Peter Reutemann, Ian H. Witten (2009); *The WEKA Data Mining Software: An Update*; SIGKDD Explorations, Volume 11, Issue 1.

A Note on Turkish *Tomentella*

*İlgaz AKATA¹, Cem Tolga GÜRKANLI²

¹Ankara University, Faculty of Science, Department of Biology, 06100, Tandoğan,
Ankara/TURKEY

²Department of Fisheries Technology Engineering, Fatsa Faculty of Marine Sciences, Ordu
University, Fatsa/Ordu/TURKEY

*Corresponding Author: fungus@hotmail.com.tr

Abstract

In this study, *Tomentella bryophila* (Pers.) M.J. Larsen was recorded for the first time from Turkey and it is the 12th member of Turkish *Tomentella*. A short description and figures of the new recorded species based on the collected materials are provided.

Keywords: Macrofungi, *Tomentella*, New record, Turkey

Türkiye *Tomentella*' ları Üzerine Bir Not

Özet

Bu çalışmada, *Cordyceps militaris* (L.) Link Türkiye'den ilk defa kayıt edilmiştir ve bu tür Türkiye'de tespit edilmiş 12. *Tomentella* üyesidir. Yeni kayıt türe ait mantar örneklerinin kısa tanımı ve şekilleri verilmiştir.

Anahtar Kelimeler: Macrofunguslar, *Tomentella*, Yeni kayıt, Türkiye

Introduction

Tomentella is a genus of resupinate basidiomycete fungi in the family *Thelephoraceae*. The genus includes more than 80 widespread species that generally occur on the dead underside of dead plant materials such as stumps, trunks, branches, barks or leaves, more rarely on part of living plants (Kirk et al., 2008; Peintner and Dämmrich, 2011).

The members of the genus are characterized by resupinate, usually 1-10 cm in diameter, up to 2 mm thick, separable form or adherent to the substratum, continuous basidiocarps, mostly pale to dark brown or yellowish, more rarely grey, reddish, greenish or olive, smooth, granulose, colliculose or hydroid hymenophore, monomitic to dimitic hyphal system, clavate to utriform, 4 spored basidia clamped or simple septate at base, with or without cystidia, globose, ellipsoid, triangular or lobed, echinulate to verrucose spores brownish in most, hyaline or yellowish in few species (Köljalg, 1995; Hansen and Knudsen, 1997).

According to checklists on Turkish macrofungi (Sesli et al., 2008, Solak et al., 2015), *Tomentella bryophila* (Pers.) M.J.

Larsen has not previously been recorded from Turkey.

The aim of this study is to make a contribution to mycobiota of Turkey.

Materials and Methods

Samples were collected from Belgrad Forest (İstanbul) in 2015. During field studies, macroscopic and ecological characteristics of the samples were noted and they were photographed in their natural habitats. In the herbarium, macroscopic and microscopic investigations and micro-chemical reactions were carried out. Reagents such as melzer's reagent, 5 % KOH, H₂O and H₂SO₄ etc. were used. Identification of the specimens was performed according to literature (Breitenbach and Kränzlin, 1986; Köljalg, 1995).

Results

Thelephorales Corner ex Oberw.

Thelephoraceae Chevall.

Tomentella bryophila (Pers.) M.J. Larsen (1974).

Syn: *Botrytis bryophila* (Pers.) Sacc. (1885), *Hypochnus obscuratus* P. Karst. (1896), *Hypochnus pallidofulvus* (Peck) Burt (1926), *Hypochnus subferrugineus* Burt (1916), *Sporotrichum bryophilum* Pers. (1822), *Sporotrichum viticola* Schwein. (1832), *Tomentella pallidofulva* (Peck) Litsch. (1939), *Tomentella pseudoferruginea* Skovst. (1950), *Tomentella pseudofusca* Skovst. (1950), *Tomentella subferruginea* (Burt) Donk (1933), *Zygodesmus fulvus* Sacc. (1880), *Zygodesmus pallidofulvus* Peck, (1906).

Macroscopic and microscopic features

Basidiocarps fully resupinate, adherent to the substratum, continuous, arachnoid to mucedinoid. Hymenophore smooth and rust brown concolorous with subiculum. Margin often indeterminate (Figure 1). Hyphal system monomitic, Subicular hyphae 4-6 μm across, pale brown and thick walled with clamps. Subhymenial hyphae 6-9 μm across, hyaline, thin walled with clamps (Figure 2). Hyphal strands absent. Basidia 45-55 \times 8-10 μm , cylindrical to clavate, 4-spored and basal clamped. Spores 8-9 μm , globose, smooth, echinulate and pale brown (Figure 3).



Figure 1. Basidiocarp of *Tomentella bryophila*



Figure 2. Hyphae of *Tomentella bryophila*

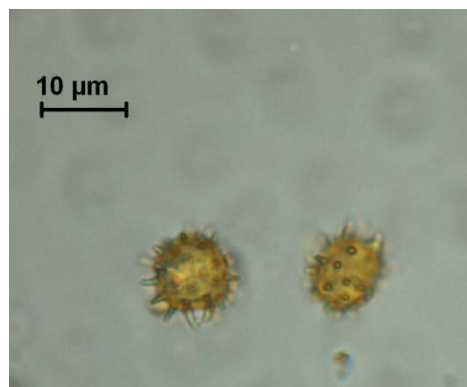

Figure 3. Spores of *Tomentella bryophila*

Ecology: Widespread, summer to autumn, on rotten wood of deciduous and conifer trees (Breitenbach and Kränzlin, 1986; Kõljalg, 1995).

Material examined: İstanbul: Belgrad Forest, on beech branch, N 41° 12' - E 28° 56', 100 m, 09.11.2014, Akata, 6221.

Discussion

Tomentella bryophila macroscopically resembles *T. ferruginella* (Bourdot & Galzin) Svrček in terms of morphology and ecology, but latter species has hyphal strands, narrower hyphae and smaller spores. (Breitenbach and Kränzlin, 1986; Kõljalg, 1995).

Tracing to literature on Turkish macrofungi (Akata et al., 2009; 2010; Doğan et al., 2005; 2011; Pilat, 1933; Sesli et al., 2008, Solak et al., 2015), 11 *Tomentella* species (*T. asperula* (P. Karst.) Höhn. & Litsch., *T. badia* (Link) Stalpers, *T. cinerascens* (P. Karst.) Höhn. & Litsch., *T. coerulea* (Bres.) Höhn. & Litsch., *T. crinalis* (Fr.) M.J. Larsen, *T. ferruginea* (Pers.) Pat., *T. lapida* (Pers.) Stalpers, *T. pilatii* Litsch., *T. stiposa* (Link) Stalpers, *T. subclavigera* Litsch. and *T. subfusca* (P. Karst.) Höhn. & Litsch) have so far been reported from Turkey. With the current study, *Tomentella bryophila* (Pers.) M.J. Larsen is reported for the first time from Turkey and it will be 12th member of Turkish *Tomentella*.

Acknowledgements

We would like to thank Ankara University Research Fund (Project No: 15H0430001) for its financial support.

References

- Akata, I., Çetin, B., Işıloğlu, M. 2009. Türkiye mikotasi için yeni bir tomentelloyit fungus kaydı, Ot Sistemik Botanik Dergisi 16 (1): 149-154.
- Akata, I., Çetin, B., Işıloğlu, M. 2010. Macrofungal diversity of Ilgaz Mountain National Park and its environs (Turkey). Mycotaxon 113:287-290.
- Breitenbach, J., Kränzlin, F. 1986. Fungi of Switzerland Vol: 2, Nongilled Fungi, Lucern, Verlag Mykologia.
- Doğan, H.H., Öztürk, C., Kaşık, G., Aktaş, S. 2005. A Checklist of *Aphylophorales* of Turkey. Pakistan Journal of Botany, 37(2): 459-485.
- Doğan, H.H., Karadalev, M., Işıloğlu, M. 2011. Macrofungal diversity associated with the scale-leaf juniper trees, *Juniperus excelsa* and *J. foetidissima*, distributed in Turkey. Turkish Journal of Botany, 35: 219-237.
- Kirk, P.F, Cannon, P.F, Minter, D.W., Stalpers, J.A. 2008. Dictionary of the fungi, 10th ed. Wallingford: CAB International.
- Köljalg, U. 1995. Tomentella and related genera in Temperate Eurasia. Synopsis Fungorum 9. Oslo, Fungiflora.
- Peintner, U., Dämmrich, F. 2012. Tomentella alpina and other tomentelloid taxa fruiting in a glacier valley. Mycological Progress, 11(1): 109-119.
- Pilát, A.A. 1933. Additamenta ad floram Asiae Minoris hymenomycetum pars tertia: *Meruliaceae*, *Hydnaceae*, *Stereaceae*, *Cyphellaceae*, *Cluvariaceae*, *Asterostromellineae*. Bulletin Trimestriel Society Mycologie France 49: 34-77.
- Sesli, E., Denchev, C.M. 2008. Checklists of the myxomycetes, larger ascomycetes, and larger basidiomycetes in Turkey. – Mycotaxon 106: 65–67. + [complete version, 1–145, new version uploaded in January 2014].
- Solak, M.H., Işıloğlu, M., Kalmış, E., Allı, H. 2015. Macrofungi of Turkey Vol. II. Üniversiteliler Ofset, İzmir.

A New *Erysiphe (Erysiphales)* Record for Turkey

*Şanlı KABAKTEPE¹, İlğaz AKATA²

¹Inonu University, Battalgazi Vocat Sch, TR-44210 Battalgazi, Malatya/TURKEY

²Ankara University, Faculty of Science, Department of Biology, 06100, Tandoğan,
Ankara/TURKEY

*Corresponding Author: fungus@hotmail.com.tr

Abstract

In this study, *Erysiphe guarinonii* (Briosi & Cavara) U. Braun & S. Takam. on *Laburnum anagyroides* Medik. (*Fabaceae*) is reported for the first time from Turkey. A short description, host, distribution and photographs related to macro and micromorphologies of the species are provided and discussed briefly.

Keywords: New record, Powdery mildew, Turkey

Özet

Bu çalışmada, *Laburnum anagyroides* Medik. (*Fabaceae*) üzerinde bulunan *Erysiphe guarinonii* (Briosi & Cavara) U. Braun & S. Takam. Türkiye için ilk kez kaydedilmiştir. Türün kısa deskripsiyonu, konakçısı, yayılışı ve makro ve mikromorfolojilerine ait fotoğrafları verilmiş ve kısaca tartışılmıştır.

Anahtar Kelimeler: Yeni kayıt, külleme, Türkiye

Introduction

The *Erysiphales* is a fungal group causing important plant diseases (powdery mildew) on about ten thousand angiosperm plants including many economically important cultivated plants (Amano 1986, Braun & Cook, 2012). *Erysiphales* (powdery mildews) is an order that is represented by 1 family (*Erysiphaceae*), 16 genera and 873 species. Members of the order are widely distributed all over the world and they are noted for their virulence, causing great losses to crops on a worldwide basis, as well as for their host specificity. A total of 143 species belonging to 14 teleomorphic and anamorphic genera of *Erysiphales* were identified and reported from Turkey (Kabaktepe et. al., 2015).

An outbreak of powdery mildew was noticed also on various *Laburnum* species. The powdery mildew species parasitising on *Laburnum* were described as *Erysiphe guarinonii* (Briosi & Cavara) U. Braun & S. Takam. (Braun and Cook 2012), *Erysiphe pisi* DC. (Amano, 1986), *Leveillula papilionacearum* (Kom.) U. Braun (Amano, 1986, Kabaktepe et. al., 2015) and *Oidium* sp. (Amano, 1986, Foister, 1961).

Erysiphe guarinonii (U. Braun) U. Braun et S. Takam. is a native powdery mildew originally described as *Microsphaera*

guarinonii Briosi & Cavara, by Braun (1982) based on infected leaves of *Laburnum anagyroides* Medik. The first record of the teleomorph state of *Erysiphe guarinonii* was published from Europe (especially in the mediterian region, Austria, Denmark, Germany, poland, Switzerland) (Braun & Cook, 2012).

According to the checklist of powdery mildew in Turkey (Kabaktepe et. al., 2015), 46 species in the genus *Erysiphe* have so far been recorded from Turkey but there is not any record of *Erysiphe guarinonii*.

The present study aims to make contribution to the mycobita of Turkey.

Materials and methods

Fungi samples were collected from were collected from Halkapınar (Konya) in 15.10.2015. For identification of the fungus both visual symptoms of infected plants and anatomical-morphological characteristics were used. For observations a Euromex light microscope was employed. ImageFocus 4.0 software used to measure. For chasmothecia, asci and ascospores 100 chasmothecia, asci and ascospores were measured. Identification was performed with the aid of literature (Braun and Cook, 2012). The current names of fungi are given according to

www.indexfungorum.org. Names of host plants and families are given according to <http://www.theplantlist.org>. The collected

material was deposited in the İnönü University Herbarium (INU).



Figure 1. *Erysiphe guarinonii*. **A.** herbarium specimen of host, **B.** SM view of chasmothecia

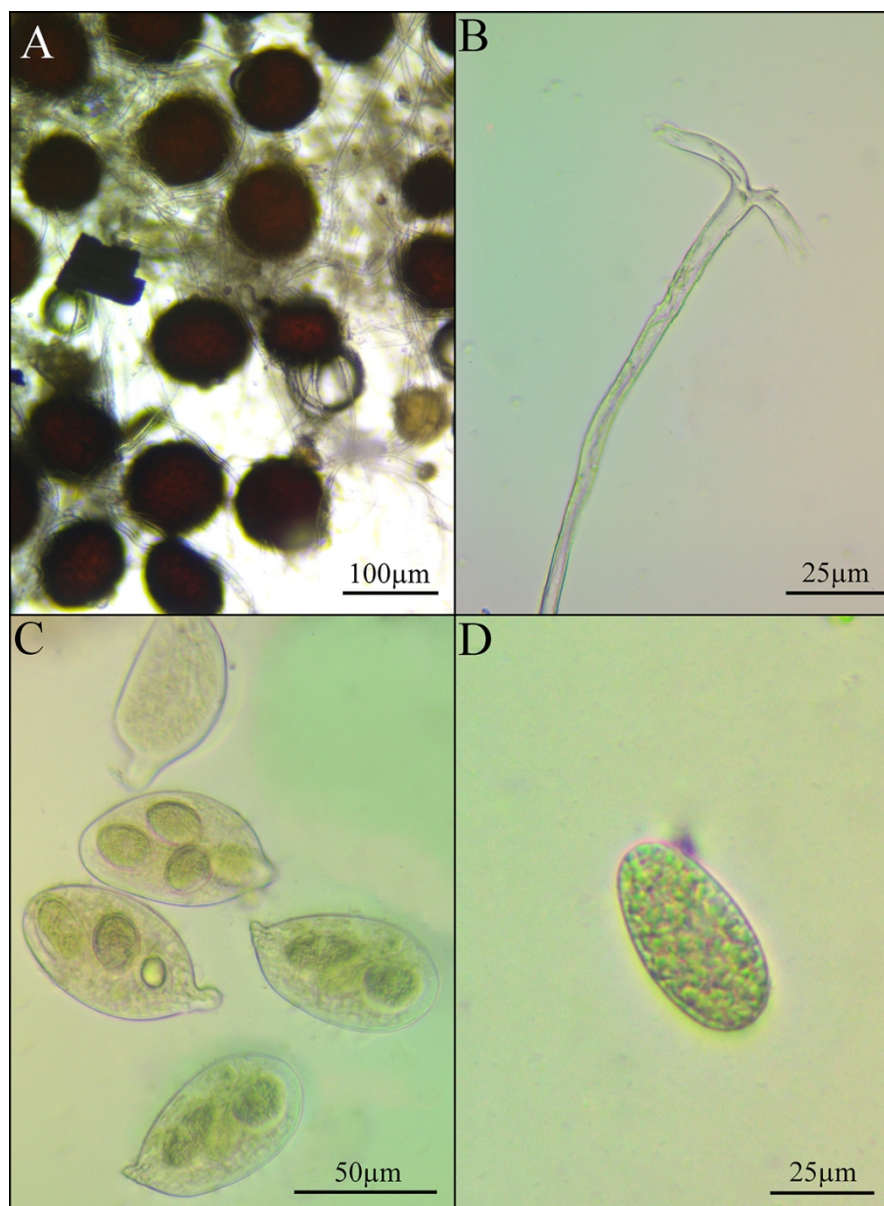

Figure 2. *Erysiphe guarinonii* (LM view) **A.** chasmothecia, **B.** appendage **C.** ascus, **D.** ascospore

Results

Erysiphe guarinonii (Briosi & Cavara)
U. Braun & S. Takam., *Schlechtendalia* 4: 9
(2000) (Figure 1-2).

Mycelium amphigenous, white, effuse, persistent. Chasmothecia gregarious, 90-150 µm, peridium cells irregularly polygonal, 10-25 µm, appendages about 4-20, usually more than 10, arising equatorially or somewhat from the upper half, flexuous, 6-12 times the chasmothecial diam., 6-8 µm wide, aseptate, wall thin, apices 3-5 times loosely dichotomously branched, asci 5-10, broadly ellipsoid-obovoid, saccate, 50- 70 × 30-50

µm, usually short stalked, 4-6 (-8) spored, ascospores ellipsoid, about 20- 25 × 10-14 µm, colourless.

Material examined: TURKEY—Konya, Halkapınar, 3-5 km south of İvriz village, 1200-1300 m, 15.10.2015, Ş. Kabaktepe & I. Akata 8324.

Discussion

There are two species of *Erysiphe* (*Erysiphe guarinonii* and *Erysiphe pisi* var. *pisi*) on *Laburnum* members.

Erysiphe guarinonii on *Laburnum anagyroides* and *Laburnum alpinum* (Mill.)

Bercht. & J.Presl has been recorded from Europe (Denmark, Germany, France, Italy, Austria, Switzerland, Estonia, Poland, U.K) (Braun and Cook, 2012).

Erysiphe pisi DC. var. *psii* on *Laburnum anagyroides* has been recorded from Denmark, Germany, Iran and Russia (Amano, 1986). The species differs from *Erysiphe guarinonii* by the chasmothecial appendages mycelioid, about 0,5-3 times as long as the chasmothecial diam., arising equatorially and the from the lower half, unbranched or irregularly branched.

As a results of this study, *Erysiphe guarinonii* (Briosi & Cavara) U. Braun & S. Takam. determined on *Laburnum anagyroides* Medik. (*Fabaceae*) is reported for the first time from Turkey. So the number of Turkish powdery mildew fungi and *Erysiphe* species will increase to 144 and 47.

Acknowledgements

This study was supported by TUBITAK (Project no: 113Z093).

References

- Amano K. 1986. Host range and geographical distribution of the powdery mildew fungi. Japan Sci. Soc. Press, Tokyo.
- Braun U. 1982. Descriptions of new species and combinations in *Microsphaera* and *Erysiphe*. Mycotaxon, 14(1): 369–374.
- Braun U., Cook R.T.A. 2012. Taxonomic manual of the *Erysiphales* (powdery mildews). CBS Biodiversity Series II, CBS-KHAW Fungal Biodiversity Centre, Utrecht, The Netherlands.
- Foister C.E. 1961. The economic plant diseases of Scotland. Techn. Bull. Dept. Agric. Fish. Scotland, 1: 1-210.
- Kabaktepe Ş., Heluta V.P., Akata I. 2015. Checklist of Powdery mildews (*Erysiphales*) in Turkey. Biological Diversity and Conservation, 8 (3): 128-146

Investigation of Anti-Fungal Effect of Henna Plant

*Çağlar AKÇAY¹, Cihat TAŞÇIOĞLU¹, Mesut YALÇIN¹

¹Department of Forest Products Engineering, Faculty of Forestry, Duzce University, 81620
Duzce, Turkey

*Corresponding Author: caglarakcay@duzce.edu.tr

Abstract

Wood is one the most common used material in construction. But, when wood material used outdoor or indoor applications without protection, can be degraded by biological organisms such as termite, insects and fungi. There have been various chemical to protect the wood against these organisms. However, many traditional wood preservatives have been banned because of their harmful environmental effect. Researches have produced new generation wood preservatives to extend of the wood material in the recent years. In this study, we evaluated the antifungal properties of henna plant (*Lawsonia inermis*). Henna plant powders were purchased from an herbalist in Duzce, Turkey. Henna plant powders were solved in pure water by mixing with magnetic mixer in an Erlenmeyer. Scotch pine (*pinus sylvestris*) and poplar (*populus nigra*) wood samples were impregnated with henna plant solution under a vacuum as well as impregnated with Tanalith E wood preservative to compare mass losses. Impregnated samples were exposure to white rot (*pleurotus ostreatus*) and brown rot (*coniophora puteana*) fungi which decay wood material for 12 weeks. After fungi test, mass losses were calculated. According to the results, poplar wood control samples exposed to brown rot fungi gave (28.84%) mean mass loss while poplar wood samples impregnated with henna solution gave only 5.55% mean mass loss. Likewise, Scotch pine control samples exposed brown rot and white rot gave 27.77% and 18.12% mean mass loss while henna impregnated Scotch pine samples gave 7.02 and 8.48% mean mass losses, respectively. However, all mass losses in henna impregnated samples were found higher than the mass losses in Tanalith E impregnated samples. The present study showed that henna plant might be evaluated as natural wood production material in wood protection industry.

Keywords: Henna, Decay, Scotch pine, Poplar, Tanalith E

Introduction

Although wood material has many advantages such as easy workability, high strength and stiffness, renewability and aesthetic properties, it has some disadvantages when compared with other materials such as changing dimensions, flammability and degradation by biological organism. Protecting wood material is one of the most important issues in wood industry today. Scientists have developed several methods and chemical to protect wood material in outdoor or indoor applications. Especially in indoor applications, the importance of natural wood protection materials has increased, recently.

It has been started to use natural plant as wood protection material against biological organisms that destroy wood. Tascioglu et al (2013) used mimosa bark and quebracho heartwood, Nzokou and Kamdem (2002) *Pterocarpus soyauxii*, Lin et al., (2007) *Cinnamomum osmophloem* and Kazami et al (2006) used *Zelkova carpinifolia*, *Quercus*

castanifolia and *Moris alba* wood extracts against fungi and they found effective at certain concentration levels.

Several studies have been done on the antibacterial, anti-mycotic anti-parasitic and anti virucidal activity effect of henna plant and these previous studies showed that henna plant can be successfully used against bacteria, parasite and virus. (Emori and Gaynes 1993; Papageorgiou et al., 1999; Riffel et al., 2002) reported that henna is active to bacteria, Tripathi et al., 1978; Singh and Pandey, 1989) found that *Lawsonia inermis* exhibited absolutely toxic against some fungal species such as *gypseum* and *Trichophyton mentagrophytes*. Khan et al.1991 showed that *Lawsonia inermis* displayed highly potential activity against sembiki forest virus in Swiss mice in 10-15 days. Although there has been many studies related with *Lawsonia inermis* antibacterial effect unfortunately there was not reported any study related with antifungal activity on wood material in literature.

Lawsonia inermis is commonly named as henna or Mehendi and abundantly available in tropical and subtropical areas. In many countries, it is widely cultivated as ornamental and dye plant. *Lawsonia inermis* has been used as a cosmetic hair dye for 6.000 years in history. Today, it is available in Europe, United States of America, Middle East, Australia as well as it is popular in India. In Turkey, it is used for many purposes as well. Leaves are small and opposite in arrangement along the branches which are green color. Flowers are small and 1cm, fragrant, white or rose colored with four with four crumbled petals. The bark, flowers, seeds, root and leaves of *Lawsonia inermis* are used for many purposes in medicine, cosmetic and chemistry area (Chaudhary et al., 2010).

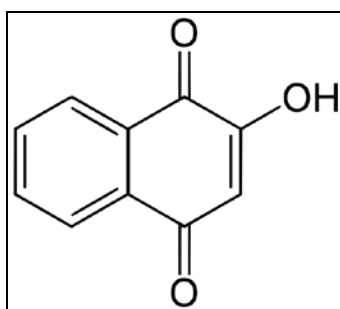

Figure 1. Compound of *Lawsonia inermis*



Figure 2. Powders of *Lawsonia inermis*

In this study, anti-fungal activity of *Lawsonia inermis* which is abundantly available in Turkey was investigated.

Materials and Methods

Wood materials

The test specimens were prepared from randomly selected first grade Scotch pine (*Pinus sylvestris* L.), and poplar wood (*Populus tremula* L.) 2x1x1 (longitudinal x

radial x tangential directions). All specimens were conditioned at 20 °C and 65 % RH for 3 weeks before the henna impregnation process.

Henna plant (*Lawsonia inermis*) and preparing impregnation solution

Henna plant powders were purchased from an herbalist in Duzce, Turkey. The powders kept at 2°C in a refrigerator. Henna plant powders were solved in pure water by mixing with magnetic mixer in an erlenmeyer. The concentration level of the solution was 4.8%.

Impregnation process

Previously conditioned and weighed Scotch pine wood blocks were placed into a glass desiccator. After then henna plant solution was added to the desiccator. 760 mmHg vacuum treatment level was applied using glass desiccators for 15 min. After vacuum treatment process, treated wood samples were weighed to calculate retention level using following formula (TS 5723, 1988).

$$R = \frac{(M1 - M0) \times C}{V}$$

In this formula, M0: weight before treatment (g), M1: weight after treatment (g), C: Concentration of solutions, V: volume of wood blocks (m³). The treated wood blocks were stored in a conditioning room at 20 °C C and 65 % relative humidity until they reach stable weight before the decay resistance tests.

Decay resistance test

Decay resistance tests were carried out in Forest Biology and Wood Preservation Laboratory of Duzce University. Unimpregnated and impregnated samples with henna plant solution were exposed *Pleurotus ostreatus* and *Coniophora puteana* two different fungi for 12 weeks. After fungal test, fungi mycelium was cleaned and mass losses were calculated.

Results and Discussions

Retentions

According to results, the maximum retention level (22.71) was recorded in Scotch pine impregnated with Tanalith E wood preservative and not significant with Scotch pine impregnated with henna

solution. These results showed that wood blocks could absorb the henna as Tanalith E. While there were significant differences between wood species in terms of wood protection materials, there were significant differences in wood species. It was found that retention values of poplar wood impregnated henna and Tanalith E were same statically (Table 1).

Table 1. Retention levels of wood samples impregnated with henna and Tanalith E

Wood Species	Impregnation	Mean Retention (kg/m ³)	H.G
Scotch pine	Henna	20.12	ab
	Tanalith E	22.71	b
Poplar	Henna	18.55	a
	Tanalith E	17.03	a

H.G: Homogeneity Goup

Table 2. Mean retention values of wood species according to impregnation and decay type

Treatment type	Mean Retentions (kg/m ³)			
	Scotch Pine	H. G	Poplar	H. G
Tanalith E white rot	25.93 (9.08)	b	17.68 (0.43)	ab
Tanalith E brown rot	19.51 (0.62)	a	16.39 (1.03)	a
Henna white rot	19.02 (0.63)	a	17.84 (0.93)	ab
Henna brown rot	21.24 (2.51)	ab	19.28 (1.92)	b

(Numbers in parenthesis are standard deviations)

H.G: Homogeneity Goup

According to table 2, while the maximum retention level was recording in Scotch pine impregnated with Tanalith E and exposure white rot fungi, the minimum retention level was recorded in poplar wood impregnated with Tanalith E and exposure brown rot fungi.

Table 3. Mass losses of wood species impregnated with Tanalith E and henna

Decay type	Mass losses (%)				
	Scotch		Poplar		
	Pine	H.G	H.G	H.G	
Control	White rot	18.12 (1.66)	a	23.80 (3.87)	a
	Brown rot	27.77 (6.08)	b	28.84 (11.60)	a
Tanalith E	White rot	0.95 (0.06)	c	0.01 (0.86)	b
	Brown rot	1.97 (0.93)	c	0.34 (0.24)	b
Henna	White rot	7.02 (3.48)	d	9.55 (2.80)	b
	Brown rot	8.46 (1.28)	d	5.55 (0.04)	b

(Numbers in parenthesis are standard deviations)

H.G: Homogeneity Goup

Table 3 showed that 18% and 27% mass losses occurred in Scotch pine control groups due to white rot and brown rot, respectively. On the other hand, % 0.96 and 1.97% mass losses occurred in Scotch pine impregnated with Thanalith E wood preservative due to white rot and brown rot. As it expected, Thanalith E protected the wood material against fungal attack and mass losses were very low levels. When Scotch pine samples impregnated with henna were investigated, 7.02% and 8.46% mass losses occurred because of the white rot and brown rot fungi, respectively. Henna material protected the Scotch pine against white rot and brown rot by 61.25% and 69.53% when compared with control samples. Similar tendency can be seen in poplar wood samples. For instance, poplar wood control sample exposure brown rot gave 28.84% mass loss while henna impregnated poplar wood gave only 5.55%. Likewise, Henna material decreased the mass loss by 80.75 against brown rot in poplar wood.

Conclusions

In this study, the anti-fungal effect of henna (*Lawsonia inermis*) on Scotch pine and poplar wood. The present study showed that when Scotch pine and poplar impregnated with henna, the decreases occurred in mass losses against fungal white rot (*Pleurotus ostreatus*) and brown rot

(*Coniophora puteana*) according to control samples. As it expected, Tanalith E greatly protected the wood materials against fungi. Tanalith E protected poplar wood by 98.8% while Henna protected poplar wood against brown rot 80.75%. This study showed henna might be used for wood protection in wood protection industry.

References

Chaudhary G., Goyal S., Poonia P., 2010. *Lawsonia inermis* Linnaeus: A phyto pharmacological review. International Journal of Pharmaceutical Sciences and Drug Research, 2(2), 91-98

Emori T.G., Gaynes R.P., 1993. An overview of nosocomial infections including the role of microbiology laboratory. Clin Microbiol Rev, 6, 428-42.

Kazemi, S.M., Hosseinzadeh, A., Rezaei, M.B., 2006. The effect of woody and non woody plants extractives on microbial resistance of non-durable species,. Journal of Agricultural Sciences and Natural Resources 13 (2), 183-193.

Khan M.M., Ali A., Jain D.C, Bhakuni R.S, Zaim M., Thakur RS. 1991. Occurrence of some antiviral sterols in *Artemisia annua*. Plant Sci.. 75 (2), 161-165.

Lin C.Y., Wu C.L., Chang S.T. 2007. Evaluating the Potency of Cinnamaldehyde as a Natural Wood Preservative. International Research Group Wood Preservation, Sweden. IRG/WP 07-30444.

Nzokou P., Kamdem D.P. 2002. Evaluation of extractives from african padauk (*pterocarpus soyauxii taub.*) for protection of non-decay resistant species. International Research Group Wood Preservation, U.K. IRG/WP 02-10419

Papageorgiou V.P., Assimopoulou A.N., Couladouros E.A., Hepworth D., Nicolaou K.C. 1999. The chemistry and biology of alkannin, shikonin and related naphthazarin natural products, Angewandte Chemie Int., 38, 270-300.

Riffel A., Medina L.F., Stefani V., Santos R.C., Bizani D., Brandelli A. 2002. In vitro antimicrobial activity of a new series of 1, 4-naphthoquinones. Braz. J. Med Biol Res., 35, 811-18.

Singh V.K., Pandey D.K. 1989. Fungitoxic studies on bark extract of *Lawsonia inermis* against ringworm fungi. Hindustani Antibiot Bull, 31(1), 32-5.

Tascioglu C., Yalcin M., Sen S., Akcay C. 2013. Antifungal properties of some plant extracts used as wood preservatives. Int Biodeter Biodegr 85, 23-28.

Tripathi R.D., Srivastava H.S., Dixit S.N. 1978. A fungitoxic principle from the leaves of *Lawsonia inermis* Linn. Experientia, 15(34), 51-2.

TS 5723. 1988. Ahşap koruma-emprenye maddesi nüfuz derinliğinin tayini. Türk Standartları Enstitüsü, Ankara.

Some Micromycetes Determined on *Alnus glutinosa* subsp. *glutinosa* in Küre Mountains National Park Forest Ecosystems

*Makbule ERDOĞDU¹, Elşad HÜSEYİN¹

¹Ahi Evran University, Arts and Sciences Faculty, Kırşehir/ TURKEY

*Corresponding Author: merdogdu@ahievran.edu.tr

Abstract

The material of this study comprises microfungi specimens collected on *Alnus glutinosa* subsp. *glutinosa* in Kastamonu Küre Mountains National Park in the years 2005 and 2006. As a result of field and laboratory studies, a total 11 species of micromycetes identified on *Alnus glutinosa* subsp. *glutinosa* (*Annulohypoxylon multiforme*, *Asteroma cylindrosperrum*, *Cytospora occulta*, *Diatrypella favacea*, *Ditopella fusispora*, *Eutypa flavovirens*, *Hysterographium fraxini*, *Melanconis alni*, *Melanconium apiocarpum*, *Passalora bacilligera* and *Trinacrium mycogonis*). *Asteroma cylindrosperrum*, *Diatrypella favacea* and *Trinacrium mycogonis* are reported for the first time from Turkey. Trophic structure and consort relationships with their host plants of identified fungi were given.

Keywords: Microfungi, New records, Trophic structure, Consort relationships

Küre Dağları Milli Parkı Orman Ekosistemlerinde *Alnus glutinosa* subsp. *glutinosa* Üzerinde Tespit Edilmiş Bazı Mikrofunguslar

Özet

Bu çalışmanın materyallerini 2005-2006 yıllarında, Kastamonu Küre Dağları Milli Parkı'nda *Alnus glutinosa* subsp. *glutinosa* üzerinden toplanan mikrofunguslar oluşturmaktadır. Arazi ve laboratuvar çalışmaları sonucu *Alnus glutinosa* subsp. *glutinosa* üzerinde toplam 11 tür mikrofungus türü tespit edilmiştir (*Annulohypoxylon multiforme*, *Asteroma cylindrosperrum*, *Cytospora occulta*, *Diatrypella favacea*, *Ditopella fusispora*, *Eutypa flavovirens*, *Hysterographium fraxini*, *Melanconis alni*, *Melanconium apiocarpum*, *Passalora bacilligera* ve *Trinacrium mycogonis*). *Asteroma cylindrosperrum*, *Diatrypella favacea* ve *Trinacrium mycogonis* türleri Türkiye'den ilk kez kaydedilmiştir. Teşhis edilen mantarların konukçu bitkileri ile olan konsortif ilişkileri ve trofik yapıları verilmiştir.

Anahtar Kelimeler: Mikrofungus, Yeni kayıt, Trofik yapı, Konsortif ilişkiler

Introduction

It is of great importance to study the activities of fungi in forest ecosystems for both protecting them and optimizing their functions. Parasitic fungi can attack a very wide range of plants, and by doing so can cause very serious qualitative and quantitative losses (Mayer, 2006). Floristic studies of the microfungal biota are the first and the most important step to controlling the fungal diseases in a country. The present taxonomic research is based on the microfungi collected on *Alnus glutinosa* subsp. *glutinosa* in Kastamonu Küre Mountains National Park.

The genus *Alnus* Miller, which belongs to Betulaceae family, is represented by approximately 35 species all around the world and grows especially in the hot regions of the Northern hemisphere (Ludwiczuk et al., 2011). According to the records, two species (*Alnus glutinosa* (L.) Gaertner and *Alnus*

orientalis Decne) and six taxons (*A. glutinosa* subsp. *glutinosa*, *A. glutinosa* subsp. *barbata* (C.A. Meyer) Yalt., *A. glutinosa* subsp. *antitaurica* Yalt., *A. glutinosa* subsp. *betuloides* Anşın, *A. orientalis* var. *orientalis*, *A. orientalis* var. *pubescens* Dippel) of this genus grow and known as Kızılağaç in Turkey (Altınyay et al., 2016; Davis, 1965-1988; Güner et al., 2000).

Küre Mountains National Park is located within the Kastamonu and Bartın Provinces. Kastamonu Province is situated in the Euro – Siberian phytogeographic region. This region lies to the northern Turkey and constitutes an important National Park. According to the grid square system adopted by Davis (1965–1985), Kastamonu is located in the squares A4. The climate of the province is oceanic. It is rainy during all 4 seasons. The Kastamonu province was chosen as a research area, because its climatic conditions (especially

high humidity) and plant distributions are very suitable for the growth of microfungi.

Material and Method

Plant specimens infected with microfungi were collected in the Küre Mountain National Park in Kastamonu Province (Black Sea Region). The fungal specimens were examined microscopically by thin sections. Microscopic examination and microphotographs were done using a Leica DM E light microscope. The microfungi were identified using the relevant literature (Ellis and Ellis, 1987; Saccardo, 1881-1931; Dennis, 1981; Smitskaya et al., 1986; Ignatavičiūtė and Treigienė, 1998; Mel'nik and Popushoj, 1992; Grove, 1935; Vassilevskiy and Karakulin, 1937; Popushoy, 1971). All specimens examined were deposited in the mycological collection of the Department of Biology, Arts and Sciences Faculty, Ahi Evran University, in Kırşehir Province of Turkey.

List of Taxa: The list of microfungi with their host plant, collection sites, coordinates, altitudes, dates and the numbers of the collector (ME = Makbule Erdogdu) is arranged below. The systematics of taxa follow Index Fungorum (URL1, accessed 2016) with slight modifications. Species cited for the first time for Turkey remarked by an asterisk (*).

Ascomycota

Dothideomycetes

Capnodiales

Mycosphaerellaceae

Passalora bacilligera (Mont. & Fr.) Fresen.

A4 Kastamonu: Kastamonu-Pınarbaşı, Sarınc, 479 m, 25.08.05, 41°40'363''N, 33°07'562''E, on living leaves of *Alnus glutinosa* (L.) Gaertner subsp. *glutinosa*, ME 1653; A4 Kastamonu: Kastamonu-Cide, Emirler, 203 m, 22.08.06, in forest, 41°49'67''N, 32°48'47''E, on living leaves of *Alnus glutinosa* (L.) Gaertner subsp. *glutinosa*, ME 1904.

Incertae sedis

Incertae sedis

Hysteroglyphium fraxini (Pers.) De Not.

A4 Kastamonu: Kastamonu-Azdavay, Çatak Canyon entrance, 777 m, 19.08.06, 41°37'66''N, 33°15'06''E, stream side, on branches of *Alnus glutinosa* (L.) Gaertner subsp. *glutinosa*, ME 1842.

Orbiliomycetes

Orbiliiales

Orbiliaceae

**Trinacrium mycogonis* Tassi

A4 Kastamonu: Kastamonu-Şenpazar, 1 km to Sade village, 878 m, 19.08.06, 41°43'84''N, 33°29'59''E, on branches of *Alnus glutinosa* (L.) Gaertner subsp. *glutinosa*, ME 1843.

Sordariomycetes

Diaporthales

Gnomoniaceae

**Asteroma cylindrospermum* (Bonord.) Sacc.

A4 Kastamonu: Kastamonu-Azdavay, Gültepe, 567 m, 30.08.05, 41°40'056''N, 33°09'272''E, on living leaves of *Alnus glutinosa* (L.) Gaertner subsp. *glutinosa*, ME 1738.

Ditopella fusispora De Not.

A4 Kastamonu: Kastamonu-Pınarbaşı, Kahya Quarter, 753 m, 30.08.05, 41°42'433''N, 33°08'009''E, on branches of *Alnus glutinosa* (L.) Gaertner subsp. *glutinosa*, ME 1726.

Melanconidaceae

Melanconis alni Tul. & C. Tul.

A4 Kastamonu: Kastamonu-Şenpazar, 1 km to Sade village, 878 m, 19.08.06, 41°43'84''N, 33°29'59''E, on branches of *Alnus glutinosa* (L.) Gaertner subsp. *glutinosa*, ME 1843.

Melanconium apiocarpum Link

A4 Kastamonu: Kastamonu-Şenpazar, 1 km to Sade village, 878 m, 19.08.06, 41°43'84''N, 33°29'59''E, on branches of *Alnus glutinosa* (L.) Gaertner subsp. *glutinosa*, ME 1843; A4 Kastamonu: Kastamonu-Şenpazar, Kalaycı, 469 m, 23.08.06, in glade inter forest, 41°49'60''N,

33°19'36''E, on branches of *Alnus glutinosa* (L.) Gaertner subsp. *glutinosa*, ME 1932.

Xylariales

Diatrypaceae

**Diatrypella favacea* (Fr.) Ces. & De Not.

A4 Kastamonu: Kastamonu-Şenpazar, 1 km to Sade village, 878 m, 19.08.06, 41°43'84''N, 33°29'59''E, on branches of *Alnus glutinosa* (L.) Gaertner subsp. *glutinosa*, ME 1843.

Eutypa flavovirens (Pers.) Tul. & C. Tul.

A4 Kastamonu: Kastamonu-Şenpazar, 1 km to Sade village, 878 m, 19.08.06, 41°43'84''N, 33°29'59''E, on branches of *Alnus glutinosa* (L.) Gaertner subsp. *glutinosa*, ME 1843.

Annulohyphoxylon multiforme (Fr.) Y.M. Ju, J.D. Rogers & H.M. Hsieh

A4 Kastamonu: Kastamonu-Pınarbaşı, Kahya Quarter, 753 m, 30.08.05, 41°42'433''N, 33°08'009''E, on branches of *Alnus glutinosa* (L.) Gaertner subsp. *glutinosa*, ME 1731.

Valsaceae

Cytospora occulta Sacc.

A4 Kastamonu: Kastamonu-Pınarbaşı, Sarnıç area, 479 m, 25.08.05, 41°40'363''N, 33°07'562''E, on branches of *Alnus glutinosa* (L.) Gaertner subsp. *glutinosa*, ME 1563.

Result and Discussion

Identified microfungi are represented by Ascomycota. The largest classis is Sordariomycetes, of which we found 8 species in the study area. Another classis Dothideomycetes is represented with 2 species. Orbiliomycetes represented by 1 species. Orders in these classis are: Capnodiales (1), Diaporthales (4), Incertae sedis (1), Orbiliales (1), Xylariales (4).

The identified 11 species belong to two trophic groups. Xylotrophs (9) are richest in the number of species and dominant among the trophic groups. Xylotrophic group is represented by *Hysterographium fraxini* (Pers.) De Not., *Trinacrium mycogonis* Tassi,

Ditopella fusispora De Not., *Melanconis alni* Tul. & C. Tul., *Melanconium apiocarpum* Link, *Diatrypella favacea* (Fr.) Ces. & De Not., *Eutypa flavovirens* (Pers.) Tul. & C. Tul., *Annulohyphoxylon multiforme* (Fr.) Y.M. Ju, J.D. Rogers & H.M. Hsieh and *Cytospora occulta* Sacc. Phyllostrophic group is represented by *Passalora bacilligera* (Mont. & Fr.) Fresen. and *Asteroma cylindrospermum* (Bonord.) Sacc.

Some microfungi were registered on several host plants. For example, *Hysterographium fraxini* (Pers.) De Not. was collected on branches of *Alnus glutinosa* (L.) Gaertner subsp. *glutinosa*, *Olea europaea* L. and *Salix alba* L.; *Annulohyphoxylon multiforme* var. *multiforme* was found on branches of *Alnus glutinosa* (L.) Gaertner subsp. *glutinosa*, *Fagus orientalis* Lipsky and *Crateagus monogyna* Jacq. subsp. *monogyna*.

The recorded microfungi revealed different consort relationships with their host plants. This consort relationships were positive, negative, indifferent and antagonistic. Although fungi develop on edificators in indifferent consortive relations, hosts can continue their normal development and seed. Microfungus consort in negative consortive relations are generally represented with obligate parasites and sometimes with facultative parasites or pathogens. *Passalora bacilligera* (Mont. & Fr.) Fresen., *Asteroma cylindrospermum* (Bonord.) Sacc. and *Cytospora occulta* Sacc. with *Alnus glutinosa* (L.) Gaertner subsp. *glutinosa* and is example of microfungi and host that have negative relations. In positive consortive relations, microfungi enable fragmentation of organic components (lignin, pektit, cellulose) until simple mineral components and ensure continuity of energy flow in biocoenosis. Saprotroph microfungi that play an active role in substance cycle by creating a humus-like substance by crumbling wood are in a positive relation with their hosts. There are positive consortive relations between *Hysterographium fraxini* (Pers.) De Not., *Trinacrium mycogonis* Tassi, *Ditopella fusispora* De Not., *Melanconis alni* Tul. & C. Tul., *Melanconium apiocarpum* Link, *Diatrypella favacea* (Fr.) Ces. & De Not., *Eutypa flavovirens* (Pers.) Tul. & C. Tul. and *Annulohyphoxylon multiforme* (Fr.) Y.M. Ju,

J.D. Rogers & H.M. Hsieh and *Alnus glutinosa* (L.) Gaertner subsp. *glutinosa*. Antagonistic relations were not registered in study area.

Asteroma cylindrosporum, *Diatrypella favacea* and *Trinacrium mycogonis* are reported for the first time from Turkey.

References

- Altinyay Ç., Ergene Öz B., Altun M.L. 2016. Quantification of Shikimic Acid in the Methanolic Extracts of Three *Alnus* Taxons Growing in Turkey. Turk J Pharm Sci, 13(1), 115-120.
- Davis P.H. 1965-1988. Flora of Turkey and the East Aegean Islands. Vol. 1-9. Edinburgh Univ. Press., Edinburgh.
- Dennis R.W.G. 1981. British Ascomycetes. 585 s, Cramer, Stutgard.
- Ellis B.M., Ellis J.P. 1987. Microfungi on Land Plants. 818 s, Croom Helm, London & Sydney.
- Grove W.B. 1935. British stem-and leaf fungi. Coelomycetes. Vol. 1. 488 s, At the Universty Pres, Cambridge.
- Güner A, Özhatay N, Ekim T., Bafler K.H.C. 2000. Flora of Turkey and the East Aegean Islands, Vol. 11. Edinburgh: University Press.
- Ignatavičiūtė M., Treigienė A. 1998. Mycota Lithuaniae Vol: IX, Melanconiales. 248 s, UAB Vaslstiečiu Laikraštis, Vilnius.
- Ludwiczuk A, Saha A, Kuzuhara T, Asakawa Y. 2011. Bioactivity guided isolation of anticancer constituents from leaves of *Alnus sieboldiana* (Betulaceae). Phytomedicine, 18 (6), 491-498.
- Mayer A.M. 2006. Pathogenesis by fungi and parasitic plants: Similarities and differences. Phytoparasitica, 34, 3-16.
- Mel'nik V.A., Popushoy I.S. 1992. Nesoverşenniye gribi na drevesnikh kustarnikovikh porodakl. Ştiintsa, Kişinev.
- Popushoy I.S. 1971. Mikoflora Plodovikh derevyev SSSR. Nauka, Moskova.
- Saccardo P.A. 1881-1931. Sylloge Fungorum omnium hucusque cognitorum. Vol. 1-25. Pavia, Johnson reprint corporation, New York, London.
- Smitskaya M.F., Smyk L.W. Merezko T.A. 1986. Opredelitel' pirenomitsetov. Naukova Dumka, Kiev.
- Vassilevskiy N.I., Karakulin B.P. 1937. The parasites Fungi imperfecti. Pt. I. Hyphomycetes URSS Acad. Sciences Press., Moscow-Leningrad.
- URL1. 2016. www.speciesfungorum.org.

New Records for Micromycota of *Juglans regia* L. on Level of Genera and Species. II^a

*Faruk SELÇUK¹, Cem Can CEBECİ¹

¹Ahi Evran University, Sciences and Arts Faculty, Department of Biology, Kırşehir/TURKEY

*Corresponding Author: selcuk_faruk@yahoo.com

Abstract

This study was carried out on *Juglans regia* L. which was located in the middle Kızılırmak river basin between years 2012 – 2013. The result of investigation about collected materials during mycological excursion from *J. regia* trees showed that four microfungi species (*Phaeoacremonium minimum* (Tul. & C. Tul.) D. Gramaje, L. Mostert & Crous, *Stegonsporium juglandis* Schwarzman, *Valsa juglandis* (Berk. & M.A. Curtis) Sacc., and *Valsa nivea* (Hoffm.) Fr.) have been identified as new records for mycobiota of our country. One species (*P. minimum*) has also been determined as a new record on level of genera among these species.

Keywords: Microfungi, *Juglans regia*, new record, Turkey

Juglans regia L.'nin Mikromikotası için Cins ve Tür Düzeyinde Yeni Kayıtlar

Özet

Bu çalışma 2012 – 2013 yılları arasında orta Kızılırmak havzasındaki *Juglans regia* L. üzerinde gerçekleştirilmiştir. *J. regia* ağaçları üzerinden mikolojik saha çalışmaları esnasında toplanan örneklerin çalışılması sonucunda dört mikromantar türü (*Phaeoacremonium minimum* (Tul. & C. Tul.) D. Gramaje, L. Mostert & Crous, *Stegonsporium juglandis* Schwarzman, *Valsa juglandis* (Berk. & M.A. Curtis) Sacc., ve *Valsa nivea* (Hoffm.) Fr.) Ülkemiz mikobiyotası için yeni kayıt olarak belirlenmiştir. Bunların arasından *P. minimum* cins düzeyinde yeni kayıttır.

Anahtar Kelimeler: Mikromantarlar, *Juglans regia*, Yeni kayıt, Türkiye

^a II. National Mycology Days, İstanbul, Abstract Book 46 (2015)

Introduction

Juglans regia L. (Juglandaceae), which has grown as naturally in Eastern Anatolia and Thrace, has been cultivated in every part of Turkey because of its very valuable timber and fruit. Besides, it is being among gene center and homeland of *J. regia*, one of the important country in terms of the presence of walnut, Turkey is ranked third after China and the US in terms of production.

Even though, the mycobiota of walnut has not been examined as directly in Turkey, there are few articles consist of fungi given below for different times (Erdoğan et al. 2010). These are: *Ascochyta juglandis* Boltsh., *Coniothyrium incrustans* Sacc., *Cytospora juglandina* Sacc., *Diaporthe juglandina* (Fuckel) Nitschke, *Diplodia juglandis* Fr., *Eutypa ludibunda* Sacc., *Fusicoccum juglandinum* Died., *Gnomonia leptostyla* (Fr.) Ces. & De Not., *Hendersonia juglandis* Schwarzman, *Melanconium juglandinum* Kunze, *Microstroma juglandis* (Berenger) Sacc., *Nectria cinnabarina* (Tode) Fr.,

Nectria coccinea (Pers.) Fr., *Pestalotiopsis guepinii* (Desm.) Steyaert, *Phoma cavalliniana* Sacc., *Phyllosticta juglandis* (DC.) Sacc., and *Sporidesmium coronatum* Fuckel. And following, *Alternaria nucis* Moesz, *Amphisphaeria bufonia* (Berk. & Broome) Ces. & De Not., *Cucurbitaria juglandis* Fuckel, *Dendrodochium gelatinosum* P. Karst. *Diplodia juglandina* G.H. Otth, *D. nucis* Brunaud, *Leptosphaeria platycarpa* Sacc., *Melanomma effugiens* (P. Karst.) Berl. & Voglino, *Monosporium affine* Sacc. & Schulzer, *Torula antiqua* Corda, *Trematosphaeria melina* (Berk. & Broome) Sacc. and *Trimmatostroma salicis* Corda are also new records given by Selçuk et al (2015a; 2015b).

Our study area is located within central Anatolian region (Figure 1), middle Kızılırmak river basin that situated in the Irano – Turanian phytogeographic region. Vegetation formations of study area: Some area are mostly *Quercus* spp. forests, others antropogenic steppe, still others steppe.



Figure 1. Study areas

Material and Method

Materials collected on Walnut trees infected by microfungi from different natural and cultivated ecosystems of middle Kızılırmak river basin in 2012 – 2013. Thereafter, the specimens were taken to the laboratory and examined morphologically using an Olympus SZX 16 – (Japan) a compound binocular stereomicroscope. The collections were examined in distilled water and for microphotographs and investigations Leica DM 3000 research microscope was used. For the identification of fungi species numerous literature sources were employed (Mostert et al. 2006; Shvartsman et al. 1971; Saccardo, 1884; Teterevnikova-Babayan et al. 1983).

The systematic status, and synonyms of identified species and the author abbreviations of microfungi are arranged following Index Fungorum (URL1, accessed 2016 July).

Samples are deposited as fungarium material in the Mycology Laboratory of Ahi Evran University, Arts and Sciences Faculty, Department of Biology and have collection numbers of Cem Can Cebeci (CCC).

Results and Discussion

The list of identified species with their systematics, current name, identified source, parts of plant containing, collected localities,

coordinates, altitudes, dates, collector & deposited number and synonyms is given below.

Ascomycota

Pezizomycotina

Sordariomycetes

Sordariomycetidae

Diaporthales

Togniniaceae

Phaeocremonium W. Gams, Crous & M.J. Wingf.

Phaeocremonium minimum (Tul. & C. Tul.) D. Gramaje, L. Mostert & Crous (Figure 2).

Mostert et al., (2006): 58.

On bark of branches. Kırşehir province, Mucur district, Köme picnic area, 39° 04' 398''N, 34° 22' 817''E, 1078 m a.s.l., 28.07.2013, CCC 048.

Synonyms of *P. minimum*:

Calosphaeria alnicola Ellis & Everh.

C. minima Tul. & C. Tul.

Erostella minima (Tul. & C. Tul.) Traverso

Longoa paniculata Curzi

Phaeocremonium aleophilum W. Gams, Crous, M.J. Wingf. & Mugnai

Pleurostoma minimum (Tul. & C. Tul.)

M.E. Barr, J.D. Rogers & Y.M. Ju

Togninia alnicola (Ellis & Everh.) Berl.

T. minima (Tul. & C. Tul.) Berl.



Fig. 2.: Conidia of *Phaeoacremonium minimum*



Fig. 3.: Conidia of *Valsa juglandis*

Incertae sedis

Stegosporium Corda

Stegosporium juglandis Schwarzman
Schvartsman et al., (1971): 161.

On bark of dead branches. Niğde province,
Altunhisar district, 37° 59' 447''N, 34° 22'
216''E, 1191 m a.s.l., 31.07.2012, CCC 009;
Nevşehir province, Avanos district, road from
Avanos to Zelve, near bridge, 38° 40' 540''N,
34° 51' 655''E, 1033 m a.s.l., 31.07.2012,
CCC 002.

Valsaceae

Valsa Fr.

Valsa juglandis (Berk. & M.A. Curtis)
Sacc. (Figure 3).

Saccardo, (1884): 584.

On naked dead branches, Çankırı province,
road from Kalecik to Çankırı, crossroad of
Pelitözü village, 40° 28' 600''N, 33° 39'
456''E, 655 m a.s.l., 01.12.2012, CCC 028.

Synonyms of *V. juglandis*:

Filaspora juglandis (Berk. & M.A. Curtis)
Kuntze

Rhabdospora juglandis (Berk. & M.A.
Curtis) Sacc.

Septoria juglandis Berk. & M.A. Curtis

Sphaeria juglandis Schwein.

V. nivea (Hoffm.) Fr. (Figure 4).

Teterevnikova-Babayan, (1983): 228.

On dead branches (memorial tree, nearly
350 years old), Kırşehir province, Kaman
district, Yelek small town, garden of Üçler
Demirhan, 39° 16' 932''N, 33° 42' 521''E,
1134 m a.s.l., 03.05.2013. CCC 038.

Synonyms of *V. nivea*:

Cytospora nivea (Hoffm.) Sacc.

C. nivea Fuckel

Engizostoma niveum (Hoffm.) Kuntze

Leucocytospora nivea (Hoffm.) Tak.
Kobay.

Leucostoma niveum (Hoffm.) Höhn.

Sphaeria nivea Hoffm.

S. tetraspora Hoffm.

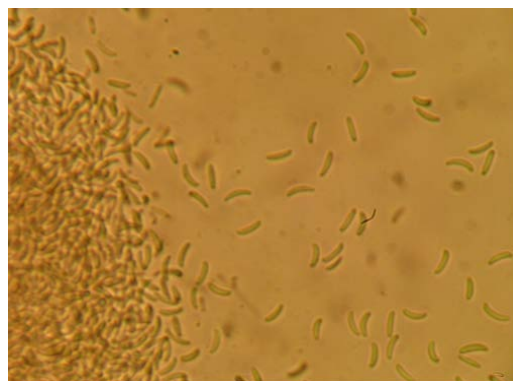

Fig. 4.: Conidia of *Valsa nivea*

Conclusions

Phaeoacremonium minimum (Tul. & C.
Tul.) D. Gramaje, L. Mostert & Crous is the
most common *Phaeoacremonium* species, but
it is the first record at genus level in Turkey.
It causes indefensible economic losses to the
grapevine industry (Mostert et al. 2006).
Stegosporium juglandis Schwarzman, *Valsa
juglandis* (Berk. & M.A. Curtis) Sacc. and *V.*

nivea (Hoffm.) Fr. are reported for the first time in our country.

Acknowledgement

The Authors wish to express their thanks for the financial support to Ahi Evran University Scientific Project Fund (Project no: PYO-FEN.4003.12.008).

References

- Erdođdu M., Selçuk F., Hüseyin E., Ay E. 2010. Türkiye’de ceviz (*Juglans regia* L.) üzerinde tespit edilmiş mikrofunguslar. Ekoloji 2010 Sempozyumu, Özet Kitapçığı, (5-7 Mayıs 2010), 187, Aksaray, Türkiye.
- Mostert L., Groenewald J.Z., Summerbell R.C., Gams W., Crous P.W. 2006. Taxonomy and Pathology of *Togninia* (Diaporthales) and its *Phaeoacremonium* Anamorphs. *Studies in Mycology*, 54, 1–113.
- Saccardo P.A. 1884. *Sylloge Fungorum Omnium Hucusque Cognitorum*. Tom. III. Pavia., 860 p, Jonson reprint corporation, New York, London.
- Selçuk F., Hüseyin E., Cebeci C.C. 2015a. *Juglans regia* L. Mikromikotası İçin Cins ve Tür Düzeyinde Yeni Kayıtlar. Ulusal Mikoloji Günleri, Özet Kitabı, (9-11 Eylül 2015), 46, İstanbul, Türkiye.
- Selçuk F., Hüseyin E., Cebeci C.C. 2015b. *Juglans regia* L. Mikromikotası İçin Yeni Kayıtlar. 12. Ulusal Ekoloji ve Çevre Kongresi, Bildiri Özetleri Kitabı, (14-17 Eylül 2015), 140, Muğla, Türkiye.
- Schvartsman S.R., Vasyagina M.P., Pisareva N.F., Byzova Z.M. 1971. Flora of the spore plants of Kazakhstan. Vol. 7. Fungi imperfecti (Deuteromycetes, Melanconiales). Nauka, Alma – Ata. (In Russia)
- Teterevnikova-Babayyan D.N. Taslakhchyan M.G., Martirosyan I.A. 1983. Mycoflora of Armenian SSR. Tom 6.I. Sphaeropsidales with unicellular and hyaline conidia. 304 p, Yerevan Univ. Press. Yerevan. (In Russian).
- URL1. 2016.
<http://www.indexfungorum.org/names/Names.asp>

The Geographical Elements of Phyllostroph Microfungi from Black Sea Forest

Faruk SELÇUK

Ahi Evran University, Sciences and Arts Faculty, Department of Biology, Kırşehir/TURKEY
selcuk_faruk@yahoo.com

Abstract

There have been limited information about geographical elements interested in Turkish micromycobiota. One hundred six phyllostroph microfungi species have been investigated to reveal the geographical elements. As a result: Boreal type 86 species (For example: *Cerotelium fici*, *Cylindrium clandestinum*, *Gnomonia fimbriata*, *Gymnosporangium cornutum*, *Gyothrix podosperma*, *Lasiobotrys lonicera*, *Mamianiella coryli*, *Melampsora epitea*, *Melampsoridium betulinum*, *Microstroma album*, *Mycosphaerella fagi*, *Puccinia coronata*, *Ramularia alnicola* etc.), Adventitious type 13 species (For instance: *Cercospora rubrocincta*, *Cristulariella depraedans*, *Dennisiella babingtonii*, *Morenoina clarkii*, *Mycosphaerella rhododendri* etc.), Cosmopolitan type 2 species (*Cladosporium herbarum* and *Ramularia endophylla*), Xerophyte type 4 species (*Cylindrosporium corni*, *Gloeosporium hedericola*, *Seimatosporium arbuti*, and *Volutella vinosa*), and Steppe type only one species that *Cylindrosporium quercus* have been determined. They are evaluated in sub-categories classified in themselves.

Keywords: Microfungi, Geographical element, phyllostroph, Turkey

Karadeniz Ormanları Fillostrof mikrofunguslarının Coğrafik Analizi

Özet

Türkiye mikobiyotasının coğrafi elementleri hakkında veriler yok derecesindedir. Coğrafi elementlerinin ortaya çıkarılması için 106 fillostrof mikrofungus türü incelenmiştir. Sonuç olarak Boreal tip 86 tür (Ör.: *Cerotelium fici*, *Cylindrium clandestinum*, *Gnomonia fimbriata*, *Gymnosporangium cornutum*, *Gyothrix podosperma*, *Lasiobotrys lonicera*, *Mamianiella coryli*, *Melampsora epitea*, *Melampsoridium betulinum*, *Microstroma album*, *Mycosphaerella fagi*, *Puccinia coronate*, *Ramularia alnicola* vb.) Adventif tip 13 (ör.: *Cercospora rubrocincta*, *Cristulariella depraedans*, *Dennisiella babingtonii*, *Morenoina clarkia*, *Mycosphaerella rhododendri* vb.) Kosmopolit tip 2 (ör.: *Cladosporium herbarum* ve *Ramularia endophylla*) Kserofit tip 4 (ör.: *Cylindrosporium corni*, *Gloeosporium hedericola*, *Seimatosporium arbuti*, ve *Volutella vinosa*) ve Step tipi 1 (*Cylindrosporium quercus*) tür tespit edilmiştir. Bunlar kendi içinde alt kategorilerde sınıflandırılarak değerlendirilmiştir.

Anahtar Kelimeler: Mikromantarlar, Coğrafi element, fillostrof, Türkiye

Introduction

Although fungi show wide distribution in the earth, unfortunately, their geography is one of the least explored areas of mycology until today. Previous studies are focused on the investigation of separately small areas (regions) these or other groups of fungi. One of the important work on this subject is Reichert's (1958) study on the geographical distribution of fungi species in Egypt. Other related studies on fungi are: Smut (Ustilaginales), Rust (Uredinales), and Peranosporales (false mildew or downy mildew) of Azerbaijan in Uliyanizhev at 1967, Osipyan's (1967) research of Armenia's false mildew updates, Kalymbetov's (1969) research on Zaily Alatau mountain fungi,

Akhundov's (1979) research on fungi of Nakhichevan autonomous republic, and Simonian's (1981) Armenia botanical gardens and dendroparks.

Most researchers who want to attempt making geographic analysis of individual fungi or fungi groups connect the fungi areals to host areals (Azbukina 1974, Nikolayevna and Greysina 1971). But despite being tightly bound by fungi with their host plants for their own development, fungi have their own areals, and areal is sufficiently different from often areal of hosts (Ulyanishv 1967, Tomilin 1974, Kalamees 1974). These differences depend on the different ecological requirements of host plant and fungus. This often limits the spread of the fungi. But some

fungi species are expanding their distribution area because of being one or several genera and even several families (Simonian 1981). In this regard, intraspecific complex structure of many pathology and saprotrophs fungi enables them to wide spread (Gorlenko 1975b). The regional characteristics of many fungi species are difficult to detect because there is no enough information on the ecology of them worldwide. Rust, smut, downy mildew, and powdery mildew fungi, are well researched exceptional groups. Depending on this type of information about downy mildews and rust, Uliyanizhev (1967) has made the areal analysis of these fungi in the Caucasus region. Grozgame's (1936) study on the "Classification of Caucasian flora areal" stays on the origin of this analysis. However, Uliyanizhev's (1967) work is always on fungi areal rather than plant areal. In a similar study, concerned the classification of Kazakhstan smut fungi areal studied by Schvartsman (1962).

Previous efforts which were based on this principle revealing geographical analysis of separate regions and fungi groups in details can be accepted as substantially enough (Schvartsman, 1962, 1975) Simonian (1968, 1981), and Vasyagina (1974).

Material and Method

Materials collected on forest trees infected by microfungi from different natural forest ecosystems of Rize province of Black Sea Coast. Thereafter, the specimens were taken to the laboratory and examined

morphologically and identified using standart mycological methods, monographs and some fungi flora. There are almost no study exist about geographical elements of Turkish mycobiota. In order to analyse the geographical elements, 106 phyllotroph microfungi species was examined. For this purpose, the study based on Grozegeym (1936) areal classification of the Caucasian flora which was modified by Uliyanizhev (1967) has been considered as reference. In this manner, geographical elements of forest ecosystems phyllotroph microfungi of Rize region were revealed as following (Table and List).

Results and Discussion

The formation of the Rize province forest ecosystems microfungi is a long process which is related to history of the formation of the fungi content of plant communities. This time period is in close relationship with the history of geology, the development of trees and shrubs vegetation and genesis. Increasing anthropogenic factors day by day play an important role. New artificial forests created by the result of human active activity are creates a new favourable environment qualitatively for increasing recreation burden of intraspecific structure of fungi, the formation of new virulent strain of the parasite species, expansion of saprotrophs of the host plant diversity, and sometimes for the formation of new species.

Table 1. Areal analysis of phyllotroph fungi of Rize province's forests

TYPE	ELEMENT	AREAL		SPECIES NUMBER	%
		GROUP			
Boreal	European			51	48
	Holarctic			26	25
	Palaearctic			9	8
Adventitious	Adventitious			13	12
Xerophyte	Mediterranean	Mediterranean		4	4
Cosmopolitan	Cosmopolitan			2	2
Steppe	Pontic			1	1
Total				106	100

The List of Areal analysis of Fungi:

Boreal Type, European Element

Anthostomella clypeata (De Not.) Sacc., *Ascochyta caricae* Rabenh., *A. quercus* Sacc. & Speg., *Asteromella bacteriiformis* (Pass.) Petr., *A. caricae* (C. Massal.) Aa, *Asterostomella saccardoii* (Thuem.) Petr., *Blumeriella jaapii* (Rehm) Arx, *Boeremia hedericola* (Durieu & Mont.) Aveskamp, Gruyter & Verkley, *Colletotrichum ficus* Koord., *C. gloeosporioides* (Penz.) Penz. & Sacc., *C. trichellum* (Fr.) Duke, *Cylindrosporium associatum* Bub., *C. castanicola* (Desmaz.) Berl., *C. ulmi* (Fr.) Vassiljevskiy, *Dicarpella dryina* Belisario & M.E. Barr, *Diplodina acerina* (Pass.) B. Sutton, *Discosia artocreas* (Tode) Fr., *Drepanopeziza populorum* (Desm.) Höhn., *Gloeosporium perexiguum* Sacc., *G. sueticum* Bubák & Vleugel, *Leptothyrium ilicinum* Sacc., *Marssonina sorbi* Magnus, *Monochaetia saccardoii* (Speg.) Sacc. & D. Sacc., *Monostichella robergei* (Desm.) Höhn., *Mycosphaerella millegrana* (Cooke) J. Schröt., *M. rosicola* (Pass.) B.H. Davis, *Passalora bacilligera* (Mont. & Fr.) Fresen., *P. bolleana* (Thüm.) Poonam Srivast., *Pestalotiopsis gracilis* (Kleb.) Steyaert, *P. guepinii* (Desm.) Steyaert, *P. neglecta* (Thüm.) Steyaert, *P. versicolor* (Speg.) Steyaert, *Phomopsis quercus* (Sacc. & Speg.) Curzi & Barbaini, *Phyllosticta alni-glutinosae* P. Syd., *P. aquifolii* Allesch., *P. auerswaldii* Allesch., *P. carpineae* Sacc., *P. cinerea* Pass., *P. cunninghamiae* Allesch., *P. fagi* Oudem., *P. fici-caricae* Rothers, *P. haynaldii* Sacc. & Roum., *P. italica* Montemart., *P. padi* Brunaud, *P. sycophila* Thüm., *Pseudonectria buxi* (DC.) Seifert, Gräfenhan & Schroers, *Ramularia alnicola* Cooke, *R. endophylla* Verkley & U. Braun, *Septoria mahoniae* Pass., *Sphaceloma sorbi* (Rostr.) Jenkins, and *Titaosporina tremulae* (Lib.) Luijk.

Boreal Type, Holarctic Element

Apiognomonina errabunda (Roberge ex Desm.) Höhn., *Ascochyta tenerrima* Sacc. & Roum., *Cerotelium fici* (Castagne) Arthur, *Erysiphe adunca* (Wallr.) Fr., *E. alphitoides* (Griffon & Maubl.) U. Braun & S. Takam., *E. penicillata* (Wallr.) Link, *E. platani* (Howe) U. Braun & S. Takam., *Gnomonia fimbriata*

(Pers.) Fuckel, *Gymnosporangium cornutum* Arthur, *Hendersonia mali* Thüm., *Kabatia mirabilis* Bubák, *Mamianiella coryli* (Batsch) Höhn., *Melampsora epitea* Thüm., *Melampsoridium betulinum* (Pers.) Kleb., *M. carpini* (Nees) Dietel, *Monochaetia flagellata* (Earle) Sacc. & D. Sacc., *Mycosphaerella millegrana* (Cooke) J. Schröt., *M. populi* (Auersw.) J. Schröt., *M. ribis* (Sacc.) Lindau, *Ophiognomonina leptostyla* (Fr.) Sogonov, *Phyllactinia guttata* (Wallr.) Lév., *Phyllosticta juglandis* (DC.) Sacc., *P. coronata* Corda, *Puccinia festucae* Plowr., *Sawadaea bicornis* (Wallr.) Homma, and *Sphaerulina cornicola* (DC.) Verkley, Quaedvl. & Crous.

Adventitious Type, Adventitious Element

Ascochyta tehonii Melnik, *Cercospora handelii* Bubák, *C. rubrocincta* Pat., *Cristulariella depraedans* (Cooke) Höhn., *Cylindrosporium populinum* 8Peck) Vassiljevsky, *Dennisella babingtonii* (Berk.) Bat. & Cif., *Gloeosporium minus* Shear, *Morenoina clarkii* J.P. Ellis, *Mycosphaerella rhododendri* Feltgen, *Pestalotiopsis montellica* (Sacc. & Voglino) Tak. Kobay., *Phyllosticta fagicola* Ellis & Morgan, *Pseudocercospora salicina* (Ellis & Everh.) Deighton, and *Septoria querceti* Thüm.

Boreal Type, Palearctic Element

Asteroma alneum (Pers.) B. Sutton, *A. inconspicuum* (Cavara) B. Sutton, *Cylindrosporium pseudoplatani* (Rob. & Desmaz.) Died., *Cylindrium clandestinum* (Corda) Sacc., *Gyothrix podosperma* (Corda) Rabenh., *Lasiobotrys lonicerae* (Fr.) Kunze, *Microstroma album* (Desm.) Sacc., *Mycosphaerella cerasella* Aderh., and *M. fagi* (Auersw.) Lindau.

Xerophyte Type, Mediterranean Element, Mediterranean Group

Cylindrosporium corni Solheim, *Gloeosporium hedericola* Delacr., *Seimatosporium arbuti* (Bonar) Shoemaker, and *Volutella vinosa* (P. Crouan & H. Crouan) Sacc.

Cosmopolitan Type, Cosmopolitan Element

Cladosporium herbarum (Pers.) Link and
Ramularia endophylla Verkley & U. Braun.

Steppe Type, Pontic Element

Cylindrosporium quercus Sorok.

Forests of the neighboring countries have also great importance for the development of forest microfungi. The basis for this lies in the ability to migrate fungi in various sizes. Phytopathogenic fungi migration was examined in detail by Gorlenko (1975). Migration of fungi into the forest is transported from other regions with crop material. For example: *Asterostomella saccardoi* were moved by brought forest seedlings and timber etc. from neighboring Georgia to Rize's forest. Some fungi species are moved from other regions by aero. For example: Rust fungus (*Melampsorium carpini*) resists to survive because of the durability of uredo and telia, and not to lose germination ability in transportation to long distances. For instance: *Cylindrosporium quercus* etc. species have come to Rize forests from other regions by air. Forest pests play an important role in the migration and spread of fungi which either directly or indirectly they cause the transport of the fungus. For example: *Ceratocystis castanea* is spread by insects.

One factor in the infrastructure formation of Fungi is that our forests have all the conditions for intensive type formation process. The majority of all reported types of the species is peculiar to native forest.

To sum up: The main lines of formation of forest species microfungi are: migration of fungi on various sizes, forest activities, ownership to the new host by fungi, and species and form formation.

References

- Akhundov T.M. 1979. Mycoflora Nakhchivan Autonomous Republic. 165 p.
Azbukina Z.M. 1974. Rust fungi of Far East. 527 p, Nauka, Moscow.
Gorlenko M.B. 1975. Some problems of Biology and Geography of Fungi. Moscow. Bulletin, Moscow Society of Naturalists, Department of Biology. 80 (2), 30-35.
Grossgeim A.A. 1936. Analyses Caucasian flora. Proceedings of the Institute of Botany of the

Academy of Sciences of Azerbaijan, Vol. I, 157 p, Baku, Azerbaijan.

Kalamees K.A. 1974. Some precepts of Mycogeographical analyses. Recent Advances Mycology and Lichenology in the Soviet Baltic, 82-85, Tartu, Estonia.

Kalymbetov B.K. 1969. Mycoflora of Zaily Alatau. 469 p, Almaty.

Nikolayeva M.I, Greysina L.B. 1971. Geographic analyses of Genus *Ascochyta* of Central Chernozem Region. Material of 6th. Symposium of Mycologists and Lichenologists of Baltic State. Issue II, 31-33, Riga, Latvia.

Osiptyan L.L. 1967. Mycoflora of Armenia SSR. Vol.1., 255 p, Mitk Publ, Yerevan.

Reichert J. 1958. Fungi and plant diseases in relation to biogeography. Transactions of the New York Academy of Sciences, 20 (4), 333-339.

Schvartsman S.R. 1962. Material to Mycoflora Kazakhstan. 184 p, Almaty.

Schvartsman S.R. 1975. The geographical elements of Mycoflora of Kazakhstan. Proceedings 12th. M.B.K., Vol.I, 82, Leningrad, Russia.

Simonian S.A. 1968. Overview of mycoflora of Megrin district of Armenian SSR. Materials of III. Transcaucasian conference on Cryptogamic Plants, 186-190, Tbilisi, Georgia.

Simonian S.A. 1981. Mycoflora of Botanic Garden and Dendropark of Armenia. 232 p, Yerevan.

Tomilin B.A. 1974. Geograph of the genus *Mycosphaerella* fungi. Proceedings of the 3th. Conference on Cryptogamic plants Middle Asia and Kazakhstan Ashgabat. Issue II, 361-363, Ashgabat, Kazakhstan.

Uliyanizhev V.I. 1967. Mycoflora of Azerbaijan. Peronosporales. Vol. 4., 352 p, Elm, Baku.

Vasyagina M.P. 1974. The Geographical elements of Species of Genus *Ramularia* Sacc. of Kazakhstan. Proceedings 5th. conference on Cryptogamic Plants Middle Asia and Kazakhstan, 62-63p, Ashgabat, Kazakhstan.

Ecology and Economy of *Boletus* Species

*Mertcan KARADENİZ¹, Sabri ÜNAL¹, Abdullah UĞIŞ¹, Özkan EVCİN¹,
Erol AKKUZU¹, Ömer KÜÇÜK¹

¹Kastamonu University, Faculty of Forestry, Kastamonu / TURKEY

*Corresponding Author: mkaradeniz@kastamonu.edu.tr

Abstract

Mushrooms which are ecologically important play an important role in nature and forest ecosystems. Some of the mushrooms has been used in religious ceremonies, as food and for medicinal purposes for centuries. Although there is a rich mushroom flora in our country, the studies on this issue seems to be quite less when compared with higher plants. *Boletus*, one of the mushrooms growing naturally in our country, belongs to the fungi family Boletacea. The name “*Boletus*” is derived from the Latin term “*bōlētus*” that means mushroom. This family contains about 200 species of mushrooms and under hats, there is spongy structure formed by the thin tubes instead of lamella. In some countries, *Boletus edulis*, *B. aureus*, *B. aestivalis* and *B. pinophilus* are *Boletus* species that consumed gladly and export. For this reason there is economic importance of *Boletus* species. In this review paper, information about characteristics, ecology and economic value of some *Boletus* species that grows in our country is given.

Keywords: Turkey, Boletaceae, *Boletus spp.*, Ecology, Economy

Boletus Türü Mantarların Ekolojisi ve Ekonomisi

Özet

Ekolojik açıdan önemli olan mantarlar tabiat ve orman ekosisteminde önemli rol oynamaktadırlar. Doğada kolayca görülebilen büyüklükte üreme yapıları oluşturan mantarların bazıları yüzyıllardan beri insanlar tarafından dini törenlerde, tıbbi amaçlı ve gıda maddesi olarak kullanılmıştır. Ülkemizin zengin bir mantar florasına sahip olmasına karşılık, bu konuda yapılan çalışmalar, yüksek bitkilerle mukayese edildiğinde oldukça az olduğu görülmektedir. Ülkemizde doğal olarak yetişen mantar türlerinden biri olan *Boletus* mantarları Boletaceae familyasına aittir. Bolet, Latince “üstün mantar” anlamına gelmektedir. Yaklaşık 200 tür içeren bu familya, mantarlarının şapka altında lamel yerine çok sayıda ince borucuğun yan yana gelmesiyle oluşmuş süngerimsi bir yapı bulunmaktadır. Spor üretimi bu borucukların içinde gerçekleşmektedir. *Boletus edulis*, *B. aureus*, *B. aestivalis* ve *B. pinophilus* İtalya’da beğenilerek tüketilen ve ihracatı yapılan mantar türleridir. Bu sebepten ötürü *Boletus* türü mantarların ekonomik önemi de bulunmaktadır. Yapılan bu çalışmamızda ülkemizde yetişen bazı *Boletus* türü fungusların özellikleri, ekolojisi ve ekonomik değeri hakkında bilgiler derlenmiştir.

Anahtar Kelimeler: Türkiye, Boletaceae, *Boletus spp.*, Ekoloji, Ekonomi

Introduction

Nowadays mushrooms are represented approximately 125.000 species. Some of wild mushrooms are consumed as food by humans for centuries. Besides some mushroom species that collected and consumed, there are mushrooms which are cultivated. Today in many country mushroom cultivation has become an industry. Many species of wild mushrooms have more flavor than the cultivated mushrooms. Despite the fact that having a rich mushrooms flora in Turkey but studies on this subject, deemed to be less when compared with higher plants. The richness of mushrooms which emerging usually in the spring and autumn, is due to the suitability of

the ecological conditions (Demirel, 1993). Both cultivated and foraged mushrooms are one of the most important source of food and income.

Boletacea family contains many edible and poisonous mushroom species in it. Edible *Boletus* species are valuable wild mushrooms that spread around the world. And the trade of these mushrooms is dominated by Italians. Huge volumes are imported from China, Eastern Europe and Southern Africa. Known in Italian as porcini, they are dried and sold preserved, sometimes in mixtures with other *Boletus* species and other cultivated mushrooms.

These mushrooms are seen from June to November under deciduous trees (oak, birch, beech) in particular; coniferous trees (pine, especially under young spruce) stands with acidic soils (Karadeniz et al., 2015).

In this review paper, information about characteristics, ecology and economic value of some *Boletus* species that grows in our country is given.

Some *Boletus* Species in Turkey

***Boletus edulis* Bull. (1782)**

Boletus edulis grows in deciduous and coniferous forests and forming ectomycorrhizal associations with them. The fruit body has a large brown cap which on occasion can reach 15 cm in diameter. *B. edulis* fruit body is reddish-brown fading to white in areas near the margin, and continues to darken as it matures. The under surface of the cap is made of thin tubes, the site of spore production (Karadeniz et al., 2015).

Boletus edulis has economic importance due to exportation of various countries in Europe and the US. This mushroom can be stored dried or cooked without significant loss of its flavour. For its strong flavour it is demand by chefs throughout the world, but also used in the pharmaceutical industry as an ingredient in medicines (Hall et al., 1998; Dentinger et al., 2014).

***Boletus aereus* Bull. (1789)**

Boletus aereus is a highly prized and much sought-after edible mushroom in the family Boletaceae. This mushroom found mainly in Central and Southern Europe as well as North Africa. is widely consumed in Spain, France, Italy, Greece, and generally throughout the Mediterranean (Watling and Hills, 2005).

The fungus grows in habitats with broad-leaved trees and shrubs, forming symbiotic ectomycorrhizal associations (Loizides et al., 2011).

The cap is hemispherical to convex, reaching 16 cm in diameter and its color is dark brown, greyish-brown. The stipe is usually shorter than the cap diameter and is pale Brown colored (Karadeniz et al., 2015).

Boletus aereus have been collected and exported commercially for centuries. These mushrooms is widely consumed in Spain, France, Italy, Greece, and generally

throughout the Mediterranean (Sitta N, Floriani M., 2008).

***Boletus pinophilus* Pilát & Dermek (1973)**

Boletus pinophilus grows in coniferous forests. The fungus produces fruit bodies in summer and autumn. The large, edible fruiting bodies has a matte brown coloured cap and its stipe is often large and swollen, and the colour is orange.

Boletus pinophilus may be used fresh, preserved, dried and cooked. he taste and smell is pleasant. (Læssøe and Del Conte, 1996).

***Boletus aestivalis* (Paulet) Fr. (1838)**

Boletus aestivalis is much more common in southern Europe. This *Boletus* species occurs in deciduous forests but occasionally it occurs under spruces. This mushroom found mainly South Europe. This mushroom appears during start of summer until the end of autumn (Feng et al., 2012).

Fruiting body of this mushroom has a bulbous stem, and large convex cap. It differs *Boletus edulis* from its velvety cap. Like most ceps, *Boletus aestivalis*, is edible and useful in cooking (Heleno et al., 2011)

***Boletus porosporus* Imler ex Bon & G. Moreno (1977)**

Boletus porosporus is commonly known as the sepia bolete and it is a small wild mushroom in the Boletaceae family. This mushroom grows singly or in small groups in mixed deciduous woods and appears occasionally in the autumn (Hills, 2009).

The caps are up to 8 centimetres in diameter, and varying in colour from putty beige to dull brown. The stipe is usually with very little red, and is olivaceous, more yellow at the apex, and bruises brown (Courtecuisse and Duhem, 1995).

Commercial Trade of *Boletus* Species

The international trade in wild edible fungi has taken place for many years. Prized as an ingredient in various foods, *B. edulis* is an edible mushroom held in high regard in many cuisines, and is commonly prepared and eaten in soups, pasta, or risotto. Although it is sold commercially, it is very difficult to cultivate. Therefore it is commercially important mushroom species.

The most expensive fresh wild fungi in Spain are *Boletus* spp. which are sold for up to 30 €/kg, but price which steadily increases year after year, does not seem to affect the demand (De Roman and Boa, 2004).

An estimate suggests the total annual worldwide consumption of *Boletus* species to be between 20.000 and 100.000 tons. Approximate world market value of *Boletus* species is 250 million dolar (Hall et al., 2003).

In Spain 8.500 tons of *Boletus edulis* produces annually (Agueda et al., 2008) In autumn, the price of porcini in the Northern Hemisphere typically ranges between \$20 and \$80 dollars per kilogram (Hall et al., 2003).

In Italy, *Boletus edulis*, *B. aereus*, *B. aestivalis* and *B. pinophilus* have been recognised for their taste. Also these mushrooms have been exported commercially. Boletes and other mushrooms are imported into Italy from various locations, especially China and Eastern European countries and these are then often re-exported under the "Italian porcini" label (Sitta N, Floriani M., 2008).

In our country, 50% of companies that export *Boletus* species to Europe, and America, Japan and the Middle Eastern countries are determined as other recipient (Ak et al., 2016).

Turkey exported 730 tons of *Boletus edulis* in 1990 while India, Pakistan, Nepal, Afghanistan and possibly Iran collect around 2.000 tons fresh weight of morels in a year. The benefits to rural livelihoods are significant and widespread and large numbers of people earn significant amounts of Money (Boa, 2004).

Boletus species in our country estimated to grow in 66 689 hectares and the potential presence of them is about 195,000 kg (Yaman ve Akyıldız, 2008). It shows that Turkey has a significant potential for the export of *Boletus* species.

Conclusions

These mushroom which has 200 species in the world and grows in humid and temperate climate of Europe and Asia. Besides the presence of approximately 13 species of boletes. Boletes which have 13

species in our country, distributed from the north of Thrace to Artvin, in mixed stands of oak, beech and pine with humidity.

According to results of former researches, it was determined that most of the exportation of *Boletus aereus* ve *Boletus edulis* in Turkey made to European countries, and it varies year to year. Some countries have been found be regular buyers while other few countries have been found be limited buyers.

Results revealed that boletes could have a high export potential in our country. With the increase of export potential, job opportunities could increase. For this reason more detailed researches and accordingly arrangements about this subject should be made.

References

Agueda B, Parlade J, Fernandez-Toiran LM, Cisneros O, de Miguel AM, Modrego MP, Martinez-Pena F, Pera J., 2008. Mycorrhizal synthesis between *Boletus edulis* species complex and rockroses (*Cistus* sp.). *Mycorrhiza*. 18 (8): 443–49.

Ak, E.e., Tüzel, Y., Eren, E., Atilla, F., 2016. Türkiye'nin Mantar İhracatının Değerlendirilmesi. *Türk Tarım – Gıda Bilim ve Teknoloji Dergisi*, 4(3): 239-243, 2016

Boa, E., 2004. Wild Edible Fungi: A Global Overview of Their Use and Importance to People (Non-Wood Forest Products). Food & Agriculture Org., 2004 - 147 sayfa

Courtecuisse R, Duhem B., 1995. Mushrooms and Toadstools of Britain and Europe (British version)

Demirel, K., Isıloğlu, M., 1993 Ardanuç (Artvin) Yöresi Makrofungusları, Yüzüncü Yıl Üniversitesi Fen Edebiyat Fakültesi Fen Bilimleri Dergisi, 4 49-57

Dentinger BTM, Suz LM., 2014. What's for dinner? Undescribed species of porcini in a commercial packet. *PeerJ* 2:e570

Feng B, Xu J, Wu G, Zeng N-K, Li Y-C, Bau T, Kost GW, Yang ZL (2012). "DNA sequence analyses reveal abundant diversity, endemism and evidence for Asian origin of the porcini mushrooms". *PLoS ONE* 7 (5). doi:10.1371/journal.pone.0037567. e37567.

Hall IR, Stephenson SR, Buchanan PK, Yun W, Cole A., 2003. Edible and Poisonous Mushrooms of the World. Portland, Oregon: Timber Press. pp. 224–25.

Hall, I.R., Lyon, A.J.E., Wang, Y. and Sinclair, L., 1998. Ectomycorrhizal Fungi with Edible Fruiting Bodies 2. *Boletus edulis*.

Economic Botany, Vol. 52, No. 1 (Jan. - Mar., 1998), pp. 44-56

Heleno SA, Barros L, Sousa MJ, Martins A, Santos-Buelga C, Ferreira CFR, 2011. Targeted metabolites analysis in wild *Boletus* species. *LWT – Food Science and Technology*. 44 (6): 1343–48.

Hills, Alan E., 2009. The Genus *Xerocomus*: A personal view, with a key to the British species. *Field mycology* Vol. 9(3) p. 77-96

Laessoe T, Del Conte A (1996). *The Mushroom Book*. Dorling Kindersley. ISBN 0-7894-1073-7.

Loizides M, Kyriakou T, Tziakouris A., 2011. Edible & Toxic Fungi of Cyprus (in Greek and English). Published by the authors. pp. 122–23.D

De Roman, M. and Boa, E., 2004. Collection, Marketing And Cultivation Of Edible Fungi In Spain. *Micologia Aplicada International*, 16(2), 2004, pp. 25-33

Sitta N, Floriani M., 2008. Nationalization and globalization trends in the wild mushroom commerce of Italy with emphasis on porcini (*Boletus edulis* and allied species). *Economic Botany*. 62 (3): 307–22.

Karadeniz, M., Ünal, S., Aslan, B. 2015. Türkiye'deki *Boletus* Türü Fungusların Özellikleri ve Ekolojisi. X. Yemeklik Mantar Kongresi, 20-23 Ekim 2015, Adana, Türkiye.

Watling R, Hills AE (2005). "Boletes and their allies (revised and enlarged edition)". In Henderson DM, Orton PD, Watling R. *British Fungus Flora. Agarics and boleti*. 1. Edinburgh, Scotland: Royal Botanic Garden.

Yaman, K. and Akyıldız, M.H., 2008. Kastamonu'da Yetişen Bazı Odun Dışı Orman Ürünlerinin Toplama, İşleme ve Pazarlama Maliyetleri. *Kastamonu Üni., Orman Fakültesi Dergisi*, 2008, 8 (1): 26-36

Flora of Taşlıyayla and Kızık (Bolu–Seben) Surrounding

*Bilge TUNÇKOL¹, Ünal AKKEMİK²

¹Bartın University, Bartın Vocational School, Department of Forestry Forestry and Forest Products Program, 74100 Bartın

²Istanbul University, Faculty of Forestry, Department of Forest Botany, 34473 Bahçeköy / İstanbul

*Corresponding Author: btunckol@bartin.edu.tr

Abstract

Studies on the flora of Turkey are still important. In the present research, we aimed to determine the flora of Taşlıyayla and Kızık surroundings. Research field is located between Bolu and Seben in Bolu province. It covers the Alms Solaklar, Nimetli, Dedeler, Ayman, Korucuk, Hacıođlan, Bozyer, Alpogut, Kozyaka, Keskinli and Demirciler together with the villages of Kızık, Dereceören, Kuzgölcük and Kabak. According to the P.H.Davis's grid system, it is in the A3 square.

As a result of 35 times excursions to research area, 1750 plant samples were collected in different vegetation periods from February 2010 to October 2011. As a consequence of identification of the plant specimens collected, 575 taxa belonging to 298 genera and 80 families have been determined. 80 of these taxa are endemic for Turkey.

The largest families recorded are as follows: Fabaceae-61 taxa (% 10.64), Asteraceae-56 taxa (% 9.77), Labiatae-42 taxa (% 7.32), Poaceae-32 taxa (% 5.58), Brassicaceae-31 taxa (% 5.41).

The phytogeographical distribution of determined taxa are as follows; Euro-Siberian 129 (% 22.5), Irano-Turanian 57 (% 9.94), Mediterranean: 52 (9.07). In the study, 58 taxa have been determined as new records for the A3 square.

Keywords: Turkey, Bolu, A3, Flora, Botany

Introduction

The flora studies revealed that Turkey had a rich flora having more than 12.000 taxa. New floristic studies still show new distribution areas of the present species and new records for the flora of Turkey. Recently Akkemik and Yılmaz (2016) added a new record (*Barbarea bracteosa*) to the flora.

In the northwestern Anatolia several flora studies were performed. Aksoy (2001) determined the flora of Karakiriş Mountain. Güner (2000) studied the flora of Dođan Dede Hill and its environment, Dođan (2000) worked on the flora of Nallıhan Kuş Cenneti, Türker (1990) determined the flora of Abant and İkinci (2000) studied the flora of Bolu-Gölcük. These studies where were located at the surroundings of the studied area revealed valuable results. However, there is a still a gap in the region. No study was done on the flora of Taşlıyayla and Kızık Plateu between Seben and Bolu.

The purpose of the present paper is to submit the flora of this region and thus to fill the gap.

Study area

Research field is located in the A3 square according to the grid system of Davis (1965) and it is phytogeographically located in an area in which it is seen the effects of Euro-Siberian, Mediterranean and Irano-Turanian Floristic Regions. The research area covers about 10.532ha (Anonim, 2004). The highest part of the research area is Kayakapı Hill with 1727m elevation which is in the southeast of the Kızık Village. It is in between the area of 40 32' 00"–40 34' 03" north latitudes and 31 27' 33"–31 41' 53" east longitudes (Figure 1).

The soil type of the research area are alluvial soil (in the Aladađ Stream Valley), colluvial soil (in the plateaus that are in the northern sides of the research area), brown forest soil (in the southern and western parts of the area), brown soil (in the eastern part of the Aladađ Stream Valley), and limeless brown forest soil (in the northern and eastern parts of the area) (Şahin, 1984).

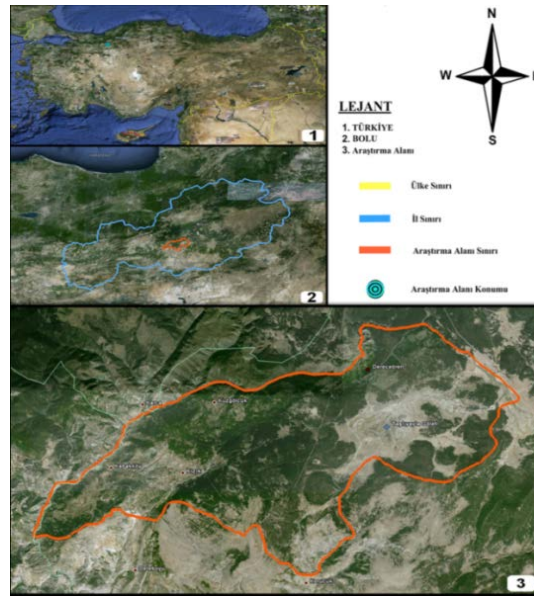

Figure 1. Geographic location of research area

In determining the climate of the research area, the data of Bolu meteorology station has been used together with the Thornthwaite methods of

estimating and a water balance table has been prepared (Çepel, 1995; Özyuvacı, 1999) (Table 1).

Table 1: Water balance showing mean temperature and precipitation

Balance sheet elements	Months												Annual
	1	2	3	4	5	6	7	8	9	10	11	12	
Temperature (°C)	1.0	1.9	5.0	9.8	14.0	17.5	19.8	19.7	16.0	11.8	6.5	2.8	10.5
Temperature index	0.09	0.23	1.00	2.77	4.75	6.66	8.03	7.97	5.82	3.67	1.42	0.42	42.81
Uncorrected PE mm	3.0	6.5	20.0	40.0	57.2	100.0	114.3	113.6	81.8	54.5	26.3	10.0	
Corrected PE mm	2.52	5.4	20.6	44.4	70.9	125.9	145.2	134.1	85.1	52.3	21.8	8.1	715.42
Precipitation mm	58.2	42.1	47.2	48.4	57.8	46.1	32.0	25.4	25.3	42.1	47.8	8.2	530.6
Monthly storechange mm	23.9	0	0	0	-13.1	-78.9	-8.0	0	0	0	26.0	50.1	
Storage mm	100	100	100	100	86.9	8.0	0	0	0	0	26.0	76.1	
Actual evapotranspiration mm	2.52	5.4	20.6	44.4	70.9	125.9	40.0	25.4	25.3	42.1	21.8	8.1	431.52
Water deficiency mm	0	0	0	0	0	0	105.2	108.7	59.8	10.2	0	0	283.9
Water surplus mm	31.78	36.7	26.6	4.0	0	0	0	0	0	0	0	0	99.08
Surface flow	15.89	26.30	26.45	15.22	7.61	3.81	1.90	0.95	0.48	0.24	0.12	0.06	99.02
Humidity rate	22.10	6.80	1.29	0.09	-0.18	-0.63	-0.78	-0.81	-0.70	-0.20	1.19	6.19	

In this evaluation, according to Thornthwaite methods of estimating, it is determined that the climate type of Bolu is

slightly humid, mesothermal, having water surplus in winter by showing similar characteristics with oceanic climate.

Material and Methods

It has been benefited from the method used by P.H. Davis in the Flora of Turkey while forming the systematic order and from Angiosperm Phylogeny Flowering Plant Systematics for the subdivision systematic of the angiospermae (APG IV) (Cole et. all, 2016; Davis 1965-1985). In this study, as a result of 35 times fieldworks to research area from February 2010 to October 2011, 1750 plant samples were collected.

Findings

Identification results showed that total 575 taxa belonging to 298 genera and 80 families were determined.

The list of the species determined was given below. The abbreviations used in the flora list are as follows: Th: Therophytes, Ch: Chamaephytes, Hy: Hydrophytes, G: Geophytes, K: Cryptophytes, H: Hemicryptophytes, Ir-Tur.: Irano-Turanian, Eu.Sib.: Euro-Siberian, Med.: Mediterranean, el.: Elementi, Ph: Phanerophytes, 1: A3 Bolu Seben.

PTERIDOPHYTA

EQUISETACEAE

Equisetum arvense L., 1, 1360 m., 23.10.2010, K 40° 33' 62" D 031° 39' 29", TUNÇKOL 2219, ISTO 35120, G.

E. telmateia Ehrh., 1, Dereceören, 1290 m., 04.06.2011, K 40° 33' 10" D 031° 39' 42" T 2329, ISTO 35121, G.

DENNSTAEDTIACEAE

Pteridium aquilinum (L.) Kuhn, 1, Ayman Alm, 1450 m., 10.10.2010, K 40° 32' 17" D 031° 40' 58", T 2244, ISTO 35122, H.

DRYOPTERIDACEAE

Dryopteris filix-mas (L.) Schott, 1, on the road of Kızık, 1591 m., 23.10.2010, K 40° 31' 17" D 031° 33' 25", T 2243, ISTO 35123, G.

POYPODIACEAE

Polypodium vulgare L. subsp. *vulgare*, 1, Demirciler Alm, 1589 m., 18.06.2011, K 40° 31' 15" D 031° 36' 17", T 2551, ISTO 35409, G.

SPERMATOPHYTA

GYMNOSPERMAE

PINACEAE

Abies nordmanniana (Stev.) Spach subsp. *bornmuelleriana* (Mattf.) Coode & Cullen, 1,

on the road of Kızık, 1530 m., 10.10.2010, K 40° 31' 24" D 031° 35' 41", T 2242, ISTO 35410, Eu-Sib.el., Ph.

Pinus nigra Arn. subsp. *pallasiana* (Lamb.) Holmboe var. *pallasiana*, 1, Kabak Village, 1013 m., 01.09.2011, K 40° 30' 25" D 031° 29' 47", T 2738, Ph.

P. sylvestris L. var. *hamata*, 1, Solaklar Alm, 1454 m., 10.10.2010, K 40° 31' 46" D 031° 40' 57", T 2239, ISTO 35411, Eu-Sib.el., Ph.

CUPRESSACEAE

Juniperus communis L. var. *saxatilis*, 1, Kızık Village, 1473 m., 10.10.2010, K 40° 31' 48" D 031° 35' 49", T 2235, ISTO 35412, Ph.

J. oxycedrus L. subsp. *oxycedrus*, 1, Nimetli Alm, 1456 m. 25.09.2010, K 40° 35' 46" D 031° 39' 29", T 2076, ISTO 35413, Ph.

J. foetidissima Willd., 1, Kabak Village, 926 m., 07.03.2010, K 40° 30' 31" D 031° 29' 26", T 2258, ISTO 35414, Ph.

J. excelsa Bieb. subsp. *excelsa*, 1, Kabak Village, 1052 m., 26.02.2011, K 40° 30' 12" D 031° 29' 33", T 2260, ISTO 35415, Ph.

EPHEDRACEAE

Ephedra major Host. subsp. *major*, 1, Kabak Village, 1050 m., 31.03.2011, K 40° 30' 15" D 031° 29' 46", T 2297, Ph.

ANGIOSPERMAE

ARISTOLACHIACEAE

Aristolochia maurorum L., 1, Kabak-Kozyaka, 1608 m., 03.05.2011, K 40° 29' 16" D 031° 33' 36", T 2349, ISTO 35771, H.

ARACEAE

Arum euxinum R. Mill, 1, Kabak Village, 938 m., 03.05.2011, K 40° 30' 24" D 031° 39' 12", T 2316, ISTO 35774, Eu-Sib.el., G.

COLCHICACEAE

Colchicum szovitsii Fisch. & Mey., 1, Taşhyayla location, 454 m., 26.02.2011, K 40° 32' 06" D 031° 37' 29", T 2268, ISTO 35869, Ir-Tur. el., G.

C. umbrosum Steven, 1, Kuzgölcük, 966 m., 10.10.2010, K 40° 31' 49" D 031° 30' 50", T 2196, ISTO 35868, Eu-Sib.el., G.

C. bivonae Guss., 1, Kuzgölcük, 1366 m., 10.10.2010, K 40° 31' 48" D 031° 32' 31", T 2209, ISTO 35867, Med. el., G.

C. speciosum Steven, 1, Kabak Village, 955 m., 10.10.2010, K 40° 30' 03" D 031° 28' 19", T 2195, Eu-Sib. el., G.

LILIACEAE

Allium olympicum Boiss., 1, Kızık Village, 1566 m., 25.09.2010, K 40° 30' 36" D 031° 33' 26", T 1991, ISTO 35863, Eu-Sib.el., G.

A. paniculatum L. subsp. *paniculatum*, 1, Dereceören Village, 1310 m., 10.10.2010, K 40° 33' 45" D 031° 37' 15", T 2151, ISTO 35866, Med. el., G.

A. paniculatum L. subsp. *fuscum* (Waldst. & Kit.) Arc., 1, Dereceören, 1308 m., 25.09.2010, K 40° 33' 48" D 031° 37' 15", T 1990, ISTO 35862, Med. el., G.

A. huber-morathii Kollmann, N. Özhatay & Koyuncu, 1, Kabak Village, 907 m., 25.09.2010, K 40° 29' 22" D 031° 37' 57", T 1993, ISTO 35865, Ir-Tur. el., G.

A. scorodoprasum L. subsp. *rotundum* (L.) Stearn, 1, Dedeler Alm, 1442 m., 02.07.2010, K 40° 30' 58" D 031° 38' 18", T 1504, ISTO 35858, Med. el., G.

A. scorodoprasum L. subsp. *waldsteinii* (G. Don) Stearn, 1, Nimetli Alm, 1442 m., 12.09.2010, K 40° 31' 18" D 031° 39' 06", T 1941, ISTO 35861, Eu-Sib.el., G.

A. guttatum Steven subsp. *guttatum*, 1, Kızık Village, 1550 m., 25.09.2010, K 40° 30' 53" D 031° 33' 11", T 1992, ISTO 35864, Med. el., G.

A. guttatum Steven subsp. *dalmaticum* (A. Kerner ex Janchen) Stearn, 1, Taşlıyayla location, 1437 m., 07.08.2010, K 40° 31' 47" D 031° 37' 34", T 1722, ISTO 35847, Doğu Med. el., G.

Allium efeae Özhatay & İ.Genç, 1, Nimetli Alm, 1442 m., 12.09.2010, K 40° 31' 18" D 031° 39' 06", T 1439.

Fritillaria pinardii Boiss., 1, Ayman Alm, 1436 m., 21.03.2010, K 40° 32' 51" D 031° 40' 24", T 1039, ISTO 35846, Ir-Tur. el., G.

Tulipa sylvestris L., 1, Nimetli Alm, 1446 m., 04.04.2010, K 40° 32' 04" D 031° 39' 21", T 1096, ISTO 35845, G.

Gagea bithynica Pascher, 1, Demirciler Alm, 1471 m., 21.03.2010, K 40° 30' 53" D 031° 37' 14", T 1037, ISTO 35853, Med. el., G.

G. fistulosa Ker-Gawler, 1, Taşlıyayla location, 1438 m., 21.03.2010, K 40° 31' 54" D 031° 37' 54", T 1036, ISTO 35849, Eu-Sib.el., G.

G. granatellii (Parl.) Parl., 1, Korucuk Alm, 1262 m., 21.03.2010, K 40° 28' 36" D

031° 36' 09", T 1033, ISTO 35850, Med. el., G.

AMARYLLIDACEAE

Galanyhus elwesii Hooker fil. subsp. *elwesii*, 1, Dereceören, 1285 m., 31.03.2011, K 40° 33' 43" D 031° 37' 25", T 2283, ISTO 35773, Med. el., G.

Sternbergia colchiciflora Waldst. & Kit., Kuzgölcük, Köçekkaya, 1235 m., 20.03.2010, K 40° 31' 42" D 031° 31' 23", T 2530, G.

ASPARAGACEAE

Polygonatum orientale Desf., 1, Dereceören, 1329 m., 20.06.2010, K 40° 33' 20" D 031° 37' 40", T 1414, ISTO 35856, Eu-Sib.el., G.

Scilla bifolia L., 1, Çavuşlar Alm, 1479 m., 21.03.2010, K 40° 30' 49" D 031° 37' 05", T 1043, ISTO 35848, Med. el., G.

Ornithogalum narbonense L., 1, Kuzgölcük, Büvecik Hill location, 1405 m., 29.08.2010, K 40° 31' 25" D 031° 33' 12", T 1865, ISTO 35860, Med. el., G.

O. oligophyllum E. D. Clarke, 1, Nimetli Alm, 1442 m., 17.04.2010, K 40° 31' 14" D 031° 39' 10", T 1172, ISTO 35851, G.

O. platyphyllum Boiss., 1, Demirciler Alm, 1438 m., 16.05.2010, K 40° 31' 26" D 031° 37' 14", T 1336, ISTO 35855, Ir-Tur. el., G.

O. fimbriatum Willd., 1, Kabak Village, 899 m., 21.03.2010, K 40° 30' 00" D 031° 28' 10", T 1050, ISTO 35852, Med. el., G.

Muscari comosum (L.) Miller, 1, Kızık, 899 m., 15.07.2010, K 40° 28' 31" D 031° 27' 46", T 1639, ISTO 35859, Med. el., G.

M. aucheri (Boiss.) Baker, 1, Taşlıyayla location, 1437 m., 04.04.2010, K 40° 31' 47" D 031° 37' 51", T 1072, ISTO 35857, G.

M. armeniacum Leichtlin ex Baker, 1, Dereceören, 1303 m., 07.03.2010, K 40° 33' 46" D 031° 37' 15", T 1028, ISTO 35854, G.

IRIDACEAE

Iris kerneriana Ascherson & Sint. ex Baker, 1, Korucuk Alm, 1425 m., 19.06.2011, K 40° 29' 20" D 031° 30' 39" T 2627, ISTO 35844, Eu-Sib.el., G.

Crocus biflorus Miller subsp. *pulchricolor* (Herbert) Mathew, 1, Dedeler Alm, 1462 m., 10.10.2010, K 40° 30' 53" D 031° 38' 00", T 2193, ISTO 35842, Eu-Sib.el., G.

C. ancyrensis (Herbert) Maw, 1, Demirciler Alm, 1438 m., 26.02.2011, K 40° 31' 33" D 031° 37' 06", T 2276, ISTO 35840, Ir-Tur. el, G.

C. olivieri Gay subsp. *olivieri*, 1, Kızık Village, 1538 m., 31.03.2011, K 40° 30' 39" D 031° 33' 22", T 2295, ISTO 35839, G.

C. speciosus Bieb subsp. *speciosus*, 1, Kuzgölcük, Fındıcak Fountain, 1268 m., 10.10.2010, K 40° 31' 58" D 031° 33' 50", T 2193, ISTO 35843, G.

Gladiolus atroviolaceus Boiss., 1, Taşlıyayla location, 1442 m., 16.05.2010, K 40° 32' 07" D 031° 38' 12", T 1339, ISTO 35841, Ir-Tur. el., G.

ORCHIDACEAE

Cephalanthera rubra (L.) L.C.M. Richard, 1, Dereceören, 1298 m., 16.07.2011, K 40° 32' 55" D 031° 37' 16", T 2726, ISTO 35898, G.

Limodorum abortivum (L.) Swartz, 1, Dedeler Alm, 1505 m., 10.10.2010, K 40° 30' 50" D 031° 38' 45", T 2201, G.

Ophrys oestriifera Bieb. subsp. *oestriifera*, 1, Kuzgölcük, 1235 m., 20.06.2010, K 40° 31' 42" D 031° 31' 23", T 2633, ISTO 35904, G.

Himantoglossum caprinum (Bieb.) Sprengel, 1, Kabak Village, 1113 m., 19.06.2011, K 40° 30' 10" D 031° 29' 47", T 2729, ISTO 35906, Eu-Sib.el., G.

Orchis coriophora L., 1, Seben-Kıbrısık turnout, 1379 m., 04.04.2010, K 40° 33' 55" D 031° 39' 02", T 1063, ISTO 35901, G.

O. tridentata Scop., 1, Kabak Village, 1010 m., 04.04.2010, K 40° 29' 17" D 031° 28' 01" T 1062 G.

O. mascula (L.) L. subsp. *pinetorum* (Boiss. & Kotschy) G. Camus, 1, Kızık Village, 1702 m., 17.04.2010, K 40° 30' 01" D 031° 33' 08", T 1189, ISTO 35900, Med. el., G.

O. pallens L., 1, Kuzgölcük, 1173 m., 17.04.2010, K 40° 31' 51" D 031° 31' 55", T 1189, ISTO 35899, Med. el., G.

O. palustris Jacq., 1, Dereceören, 1352 m., 04.04.2010, K 40° 33' 26" D 031° 37' 41", T 1066, ISTO 35902, G.

Dactylorhiza romana (Seb.) Soó subsp. *romana*, 1, Kızık road, 1558 m., 10.10.2010, K 40° 31' 14" D 031° 34' 56", T 2205, ISTO 35903, Med. el., G.

CYPERACEAE

Carex muricata L., 1, Demirciler Alm, 1470 m., 25.09.2010, K 40° 31' 33" D 031° 36' 32", T 1988, ISTO 35916, Eu-Sib.el., H.

JUNACEAE

Juncus conglomeratus L., 1, Taşlıyayla location, 1460 m., 10.10.2010, K 40° 32' 03" D 031° 37' 15", T 2230, Eu-Sib.el., Hy.

J. articulatus L., 1, Nimetli Alm, 1436 m., 25.09.2010, K 40° 32' 05" D 031° 39' 56", T 1994, ISTO 35768, Eu-Sib.el., Hy.

Luzula campestris (L.) DC., 1, Solaklar Alm, 1437 m., 14.07.2010, K 40° 31' 51" D 031° 40' 19", T 1546, ISTO 35769, Eu-Sib.el., G.

POACEAE

Elymus repens (L.) Gould subsp. *repens*, 1, Nimetli Alm, 1434 m., 07.08.2010, K 40° 32' 16" D 031° 39' 06", T 1772, H.

Aegilops triuncialis L. subsp. *triuncialis*, 1, Dedeler Alm, 1476 m., 14.08.2010, K 40° 30' 54" D 031° 37' 39", T 1818, ISTO 35886, Th.

Hordeum bulbosum L., 1, Taşlıyayla location, 1438 m., 29.08.2010, K 40° 31' 36" D 031° 37' 03", T 1840, ISTO 35881, G.

Taeniatherum caput-medusae (L.) Nevski subsp. *crinitum* (Schreber) Melderis, 1, Ayman Alm, 1438 m., 29.08.2010, K 40° 32' 24" D 031° 40' 00", T 1828, ISTO 35878, Ir-Tur. el., Th.

Bromus japonicus Thunb. subsp. *japonicus*, 1, Demirciler Alm, 1435 m., 29.08.2010, K 40° 31' 29" D 031° 37' 19", T 1851, ISTO 35875, Th.

B. tectorum L., 1, Nimetli Alm, 1430 m., 29.08.2010, K 40° 32' 14" D 031° 39' 11", T 1857, ISTO 35876, Th.

B. sterilis L., 1, Seben-Kıbrısık turnout, 1474 m., 29.08.2010, K 40° 33' 58" D 031° 39' 05", T 1853, ISTO 35877, Th.

B. ramosus Hudson, 1, Solaklar Alm, 1484 m., 29.08.2010, K 40° 31' 37" D 031° 40' 46", T 1850, Th.

Avena barbata Pott ex Link subsp. *barbata*, 1, Dereceören, 1289 m., 14.08.2010, K 40° 33' 44" D 031° 37' 24", T 1800, ISTO 35890, Med. el., Th.

Koeleria cristata (L.) Pers., 1, Taşlıyayla location, 1440 m., 07.08.2010, K 40° 31' 49" D 031° 37' 16", T 1779, ISTO 35871, H.

Deschampsia caespitosa (L.) P. Beauv., 1, Taşlıyayla location, 1464 m., 07.08.2010, K

40° 32' 03" D 031° 37' 12", T 1773, ISTO 35873, H.

Holcus lanatus L., 1, Dedeler Alm, 1444 m., 29.08.2010, K 40° 30' 57" D 031° 38' 22", T 1833, ISTO 35888, Eu-Sib.el., H.

Calamagrostis epigejos (L.) Roth, 1, Alpagut Alm, 1450 m., 06.06.2010, K 40° 31' 11" D 031° 39' 52", T 1359, Eu-Sib.el., H.

C. pseudophragmites (Haller fil.) Koeler, 1, Çavuşlar Alm, 1567 m., 02.07.2010, K 40° 30' 48" D 031° 36' 42", T 1461, ISTO 35874, Eu-Sib.el., H.

Agrostis canina L., 1, Solaklar Alm, 1435 m., 12.09.2010, K 40° 32' 09" D 031° 39' 44", T 1995, ISTO 35880, Eu-Sib.el., H.

Anthoxanthum odoratum L. subsp. *alpinum* (A. & D. Löve) B. Jones & Melderis, 1, Dereceören, 1310 m., 07.08.2010, K 40° 32' 50" D 031° 37' 15", T 1776, ISTO 35872, Eu-Sib.el., H.

Alopecurus arundinaceus Poiret, 1, Nimetli Alm, 1437 m., 02.07.2010, K 40° 32' 10" D 031° 39' 41", T 1466, ISTO 35882, Eu-Sib.el., Cr.

Phleum alpinum L., 1, Demirciler Alm 1565 m., 14.08.2010, K 40° 31' 13" D 031° 36' 05", T 1817, ISTO 35894, Eu-Sib.el., H.

P. pratense L., 1, Taşlıyayla location, 1437 m., 14.08.2010, K 40° 31' 56" D 031° 38' 00", T 1816, ISTO 35895, Eu-Sib.el., H.

P. montanum C. Koch subsp. *montanum*, 1, Demirciler Alm, 1444 m., 16.05.2010, K 40° 31' 27" D 031° 36' 57", T 1343, ISTO 35892, H.

Festuca cyllenica Boiss. & Heldr., 1, Nimetli Alm, 1434 m., 29.08.2010, K 40° 32' 14" D 031° 39' 09", T 1839, ISTO 35896, Eu-Sib.el., H.

F. rubra L. subsp. *pseudorivularis* Markgr.-Dannenb, 1, Dedeler Alm, 1442 m., 29.08.2010, K 40° 30' 57" D 031° 38' 11", T 1838, ISTO 35884, Eu-Sib.el., H.

F. callieri (Hackel ex St.-Yves) F. Markgraf apud Hayek subsp. *callieri*, 1, Taşlıyayla location, 1440 m., 14.07.2010, K 40° 31' 57" D 031° 37' 50", T 1510, H.

F. arundinacea Schreber subsp. *arundinacea*, 1, Bozyer Alm, 1476 m., 29.08.2010, K 40° 30' 47" D 031° 39' 23", T 1836, H.

Poa trivialis L., 1, Alpagut Alm, 1480 m., 12.09.2010, K 40° 30' 57" D 031° 40' 24", T 1996, ISTO 35893, H.

P. nemoralis L., 1, Ayman Alm, 1430 m., 12.09.2010, K 40° 33' 03" D 031° 40' 32", T 1997, ISTO 35883, H.

P. bulbosa L., 1, Dedeler Alm, 1443 m., 06.06.2010, K 40° 31' 01" D 031° 38' 21", T 1361, ISTO 35879, G.

Dactylis glomerata L. subsp. *hispanica* (Roth.) Nyman, 1, Demirciler Alm, 1500 m., 29.08.2010, K 40° 31' 10" D 031° 36' 51", T 1844, ISTO 35885, H.

Briza media L., 1, Dedeler Alm, 1489 m., 10.10.2010, K 40° 30' 48" D 031° 37' 46", T 2161, ISTO 35891, H.

Melica ciliata L. subsp. *ciliata*, 1, Solaklar Alm, 1435 m., 14.08.2010, K 40° 32' 04" D 031° 40' 06", T 1813, ISTO 35889, H.

Stipa holosericea Trin., 1, Kabak Village, 911 m., 14.07.2010, K 40° 29' 22" D 031° 27' 51", T 1511, ISTO 35887, Ir-Tur. el., H.

Cynodon dactylon (L.) Pers. *villosus* Regel, 1, Korucuk Alm, 1211 m., 29.08.2010, K 40° 28' 24" D 031° 35' 38", T 1854, G.

TYPHACEAE

Typha angustifolia L., 1, Taşlıyayla location, 1462 m., 10.10.2010, K 40° 32' 01" D 031° 37' 13", T 2238, ISTO 35909, Hy.

BERBERIDACEAE

Berberis crataegina DC., 1, Taşlıyayla Pond, 1517 m., 10.10.2010, K 40° 30' 51" D 031° 40' 28", T 2121, ISTO 35438, Ph.

PAPAVERACEAE

Chelidonium majus L., 1, Kuzgölcük, 1478 m., 04.06.2011, K 40° 31' 19" D 031° 32' 36" T 2468, ISTO 35439, Eu-Sib.el., H.

Glaucium corniculatum (L.) Rud. subsp. *refractum* (Nab.) Cullen, 1, Kızık, 1568 m., 12.09.2010, K 40° 30' 19" D 031° 32' 36" T 1971, ISTO 35440, Ir-Tur. el., H.

G. flavum Crantz, 1, Kabak Village, 18.06.2011, K 40° 30' 23" D 031° 29' 43", T 2506, ISTO 35441, H.

Papaver pilosum Sibth. & Sm., 1, Dereceören, 1426 m., 20.06.2010, K 40° 30' 24" D 031° 37' 57", T 2048, Th.

P. rhoeas L., 1, Kıbrısçık-Seben turnout, 1435 m., 14.07.2010, K 40° 33' 44" D 031° 39' 12", T 2545, ISTO 35442, Th.

P. lacerum Popov, 1, Kıbrısçık-Seben turnout, 1430 m., 14.07.2010, K 40° 33' 47" D 031° 39' 16", T 1538, ISTO 35443, Th.

Corydalis solida (L.) Swartz. subsp. *solida*, 1, Solaklar Alm, Akçakilise brook location, 1434 m., 07.03.2010, K 40° 32' 27" D 031° 41' 34", T 1001, G.

Fumaria officinalis L., 1, Taşlıyayla Pond, 1445 m., 16.05.2010, K 40° 31' 68" D 031° 37' 22", T 1322, ISTO 35445, Th.

RANUNCULACEAE

Nigella arvensis L. var. *glauca* Boiss., A3 Bolu: Kabak ridge, 1166 m., 05.07.2010, K 40° 29' 35" D 031° 28' 87", T 1621, ISTO 35417, Th.

Delphinium venulosum Boiss., 1, Kozyaka Alm, 1617 m., 25.09.2010, K 40° 29' 33" D 031° 32' 26", T 2060, Ir-Tur. el., Th.

D. fissum Waldst. & Kit. subsp. *anatolicum* Chowdhuri & P.H. Davis, 1, Kabak Village, 910 m., 14.08.2010, K 40° 28' 49" D 031° 27' 34", T 1812, ISTO 35419, E. H.

Consolida orientalis (Gay) Schröd., 1, Demirciler Alm, 1540 m., 12.09.2010, K 40° 31' 48" D 031° 35' 41", T 1945, ISTO 35420, Th.

Anemone blanda Schott & Kotschy, 1, Taşlıyayla Pond, 1464 m., 04.04.2010, K 40° 32' 51" D 031° 37' 12", T 1067, ISTO 35421, G.

Clematis vitalba L., 1, Kıbrısçık-Seben turnout, 1375 m., 05.07.2010, K 40° 33' 58" D 031° 37' 12", T 1624, ISTO 35422, Ph.

C. viticella L., 1, Kuzgölcük, 1269 m., 05.07.2010, K 40° 32' 14" D 031° 32' 33", T 1622, ISTO 35423, Ph.

Adonis aestivalis L. subsp. *aestivalis*, 1, Kızık Pond, 1505 m., 19.06.2011, K 40° 30' 38" D 031° 32' 56", T 2688, ISTO 35424, Th.

A. flammea Jacq., 1, Kızık Village, 1530 m., 14.07.2010, K 40° 31' 10" D 031° 31' 41", T 1619, ISTO 35425, Th.

Ranunculus brutius Ten., 1, Kızık Village, 1600 m., 19.06.2011, K 40° 30' 56" D 031° 33' 19", T 2694, ISTO 35426, Eu-Sib.el., H.

R. saniculifolius Viv., 1, Solaklar Alm, 1434 m., 17.04.2010, K 40° 32' 29" D 031° 41' 23", T 1143, ISTO 35427, Hy.

R. repens L., 1, Nimetli Alm, 1442 m., 14.07.2010, K 40° 31' 15" D 031° 39' 11", T 1523, ISTO 35428, H.

R. constantinopolitanus (DC.) d'Urv., 1, Dedeler Alm, 1472 m., 04.04.2010, K 40° 30' 45" D 031° 28' 20" T 1060, ISTO 35429, H.

R. argyreus Boiss., 1, Dedeler Alm, 1472 m., 17.04.2010, K 40° 30' 34" D 031° 28' 15", T 1144, ISTO 35430, H.

R. neapolitanus Ten., 1, Keskinli Alm, 1460 m., 17.04.2010, K 40° 30' 35" D 031° 36' 58", T 1148, ISTO 35431, H.

R. illyricus L. subsp. *illyricus*, 1, Dedeler Alm, 1472 m., 02.05.2010, K 40° 30' 34" D 031° 28' 15", T 1262, ISTO 35432, H.

R. gracilis Clarke, 1, Dedeler Alm, 1461 m., 07.03.2010, K 40° 30' 34" D 031° 28' 17", T 1019, ISTO 35433 Th.

R. arvensis L., 1, Çavuşlar Alm location, 1514 m., 03.05.2011, K 40° 30' 47" D 031° 36' 55", T 2364, ISTO 35434, Th.

R. ficaria L. subsp. *ficariiformis* Rouy & Fouc., 1, Kızık Village, 1451 m., 03.05.2011, K 40° 30' 53" D 031° 31' 32", T 2368, ISTO 35435, G.

Thalictrum minus L. var. *minus*, 1, Kızık Pond, 1508 m., 14.07.2010, K 40° 30' 37" D 031° 32' 53", T 1551, ISTO 35436, G.

CRASSULACEAE

Umbilicus luteus (Huds.) Webb & Berthel., 1, Kızık Village, 1583 m., 14.07.2010, K 40° 31' 13" D 031° 34' 35", T 1574, ISTO 35648, H.

Sedum obtusifolium C. A. Meyer, 1, Kuzgölcük, 1155 m., 25.09.2010, K 40° 32' 00" D 031° 32' 15", T 2091, ISTO 35647, Ch.

S. acre L., 1, Kızık Village, 1701 m., 12.09.2010, K 40° 30' 01" D 031° 33' 08", T 1902, ISTO 35644, Ch.

S. album L., 1, Kayakapı Hill, 1640 m., 14.07.2010, K 40° 30' 14" D 031° 33' 47", T 1597, ISTO 35645, Ch.

S. pallidum Bieb. var. *bithynicum* (Boiss.) Chamberlain, 1, Dereceören, 1345 m., 20.06.2010, K 40° 33' 39" D 031° 36' 57", T 1400, ISTO 35646, Eu-Sib.el., Ch.

Sempervivum armenum Boiss. & Huet. var. *armenum*, 1, Kızık, 1692 m., 01.09.2011, K 40° 30' 10" D 031° 33' 13", T 2714, ISTO 35649, Eu-Sib.el., Ch.

PAEONIACEAE

Paeonia peregrina Miller, 1, Kızık-Kozyaka Alm, 1417 m., 03.05.2011, K 40° 29' 26" D 031° 30' 38", T 2476, ISTO 35437, G.

SAXIFRAGACEAE

Saxifraga rotundifolia L., 1, Dereceören, Kuyupınar Hill, 1305 m., 14.07.2010, K 40° 33' 20" D 031° 39' 15", T 1540, ISTO 35650, Eu-Sib.el., H.

S. cymbalaria L. var. *cymbalaria*, 1, Kıbrısık-Seben turnout, 1367 m., 10.10.2010, K 40° 33' 52" D 031° 39' 03", T 2221, ISTO 35651, Th.

CELASTRACEAE

Euonymus latifolius (L.) Miller. subsp. *latifolius*, 1, Kabak Village, 1100 m., 10.10.2010, K 40° 28' 02" D 031° 37' 59", T 2120, ISTO 35550, Eu-Sib.el., Ph.

EUPHORBIACEAE

Euphorbia cardiophylla Boiss. & Heldr., 1, Seben road, 1499 m., 03.05.2011, K 40° 32' 57" D 031° 38' 19", T 2327, ISTO 35920, G.

E. stricta L., 1, Dereceören Village, 1396 m., 10.10.2010, K 40° 33' 26" D 031° 37' 45", T 2116, ISTO 35918, Eu-Sib.el., Th.

E. peplus L. var. *minima* DC., 1, Kabak Village, 903 m., 10.10.2010, K 40° 29' 22" D 031° 27' 48", T 2245, ISTO 35917, Eu-Sib.el., Th.

E. myrsinites L., 1, Dedeler Alm, 1442 m., 07.03.2010, K 40° 30' 57" D 031° 38' 19", T 1010, ISTO 35922, H.

E. seguieriana Necker subsp. *niciciana* (Barbas ex Novak) Rech., 1, Dereceören turnout, 1291 m., 10.10.2010, K 40° 32' 46" D 031° 37' 07", T 2246, ISTO 35921, H.

E. amygdaloides L. var. *amygdaloides*, 1, Seben road, 1510 m., 10.10.2010, K 40° 33' 18" D 031° 39' 15", T 2114, ISTO 35919, Eu-Sib.el., H.

E. lathyris L., 1, Dereceören, 1290 m., 23.10.2010, K 40° 32' 49" D 031° 37' 11", T 2247, ISTO 35923, H.

HYPERICACEAE

Hypericum heterophyllum Vent., 1, Dereceören, 1234 m., 10.10.2010, K 40° 33' 10" D 031° 37' 18", T 2127, ISTO 35520, Ch.

H. hyssopifolium Chaix subsp. *elongatum* (Ledeb.) Woron var. *elongatum*, 1, Kızık Village, 1589 m., 01.09.2011, K 40° 30' 19" D 031° 33' 46", T 2732, ISTO 35521, Ir-Tur. el, H.

H. linarioides Bosse., 1, Dedeler Alm, 1543 m., 16.05.2010, K 40° 30' 38" D 031° 38' 43", T 1318, ISTO 35522, H.

H. montbretii Spach, 1, Kızık, Kayakapı Hill, 1599 m., 16.07.2011, K 40° 30' 14" D 031° 34' 03", T 2727, ISTO 35523, H.

H. adenotrichum Spach, 1, Kayakapı Hill, 1721 m., 05.07.2010, K 40° 30' 05" D 031° 32' 04", T 1655, ISTO 35524, H.

H. orientale L., 1, Dedeler Alm on the road, 1536 m., 02.07.2010, K 40° 30' 15" D 031° 37' 46", T 1501, ISTO 35525, H.

H. origanifolium Willd., 1, Kızık, 1450 m., 19.06.2011, K 40° 29' 36" D 031° 31' 18", T 2673, ISTO 35526, H.

H. perforatum L., 1, Taşlıyayla, 1460 m., 14.07.2010, K 40° 32' 01" D 031° 37' 27", T 1533, ISTO 35527, H.

LINACEAE

Linum flavum L. subsp. *scabrinerve* (Davis) P. H. Davis, 1, Kızık Village, 1505 m., 01.09.2011, K 40° 30' 05" D 031° 31' 52", T 2737, ISTO 35532, Ir-Tur. el., Th.

L. nodiflorum L., 1, Kozyaka Alm, 1368 m., 19.06.2011, K 40° 29' 10" D 031° 30' 38", T 2655, ISTO 35533, Med. el., Th.

L. hirsutum L. subsp. *anatolicum* (Boiss.) Hayek var. *anatolicum*, 1, Dereceören, 1255 m., 12.09.2010, K 40° 33' 07" D 031° 37' 19", T 1967, ISTO 35534, Ir-Tur. el., H.

SALICACEAE

Salix alba L., 1, Taşlıyayla location, 1467 m., 18.06.2011, K 40° 32' 02" D 031° 37' 10", T 2609, ISTO 35914, Eu-Sib.el., Ph.

S. caprea L., 1, Taşlıyayla location, 1468 m., 10.10.2010, K 40° 32' 05" D 031° 37' 15", T 2229, ISTO 35913, Eu-Sib.el., Ph.

S. amplexicaulis Bory & Chaub., 1, Taşlıyayla location, 1463 m., 10.10.2010, K 40° 32' 00" D 031° 37' 13", T 2225, ISTO 35915, Med. el., Ph.

Populus tremula L., 1, Dereceören, 1268 m., 14.07.2010, K 40° 32' 59" D 031° 37' 13", T 1557, ISTO 35912, Eu-Sib.el., Ph.

P. nigra L. subsp. *nigra*, 1, Kabak Village, 901 m., 18.06.2011, K 40° 29' 38" D 031° 28' 01", T 2519, Eu-Sib.el., Ph.

VIOLACEAE

Viola odorata L., 1, Taşlıyayla forest storehouse, 1438 m., 07.03.2010, K 40° 32' 03" D 031° 38' 23", T 1022, ISTO 35480, H.

V. suavis Bieb., 1, Demirciler Alm, 1474 m., 17.04.2010, K 40° 31' 24" D 031° 36' 42", T 1176, ISTO 35481, H.

V. reichenbachiana Jord. ex Bor., 1, Nimetli Alm, 1439 m., 17.04.2010, K 40° 31' 21" D 031° 39' 22", T 1116, ISTO 35482, H.

V. sieheana Becker, 1, Alpagut Alm, 1472 m., 03.05.2011, K 40° 30' 58" D 031° 41' 51", T 2374, ISTO 35483, H.

V. occulta Lehm, 1, Taşlıyayla location, 1444 m., 31.03.2011, K 40° 31' 40" D 031° 36' 52", T 2292, ISTO 35484, Th.

V. parvula Tieno, 1, Taşlıyayla, forest storehouse, 1439 m., 20.06.2010, K 40° 31' 56" D 031° 38' 07", T 1435, ISTO 35485, Th.

V. kitaibeliana Roem. & Schult., 1, Taşlıyayla, location, 1437 m., 03.05.2011, K 40° 32' 03" D 031° 38' 02", T 2366, ISTO 35486, Th.

FABACEAE

Cytisus hirsutus L., 1, Solaklar Alm, 1460 m., 04.06.2011, K 40° 31' 40" D 031° 41' 22", T 2427, ISTO 35570, Ch.

Genista albida Willd., 1, Gökçepinar location, 1473 m., 16.05.2010, K 40° 32' 48" D 031° 37' 57", T 1346, ISTO 35567, Ch.

G. aucheri Boiss., 1, Kozyaka Alm, 1423 m., 19.06.2011, K 40° 33' 52" D 031° 39' 03", T 2708, ISTO 35568, Ir-Tur. el., Ch.

Argyrobium biebersteinii P.W.Ball, 1, Demirciler Alm, 1476 m., 10.10.2010, K 40° 30' 56" D 031° 36' 03", T 2175, ISTO 35596, H.

Colutea cilicica Boiss & Bal., 1, Dedeler Alm, 1512 m., 12.09.2010, K 40° 30' 40" D 031° 38' 32", T 1953, ISTO 35593, Ph.

Astragalus nanus DC., 1, Korucuk Alm, 1200 m., 04.06.2011, K 40° 29' 03" D 031° 36' 22", T 2454, ISTO 35572, Ch.

A. glycyphyllos L. subsp. *glycyphylloides* (DC.) Matthews, 1, Dedeler Alm, 1512 m., 14.07.2010, K 40° 30' 46" D 031° 38' 39", T 1568, ISTO 35553, Eu-Sib.el., H.

A. trichostigma Bunge, 1, Dedeler Alm, 1512 m., 07.08.2010, K 40° 30' 46" D 031° 38' 39", T 1713, ISTO 35562, H.

A. plumosus Willd. var. *plumosus*, 1, Nimetli Alm, 1439 m., 10.10.2010, K 40° 31' 50" D 031° 39' 51", T 2176, ISTO 35571, Ch.

A. prusianus Boiss., 1, Dedeler Alm, 1512 m., 18.06.2011, K 40° 30' 46" D 031° 38' 39", T 2559, ISTO 35582, Med. el., Ch.

A. brachypterus Fischer, 1, Demirciler Alm, 1501 m., 06.06.2010, K 40° 31' 07" D 031° 36' 57", T 1391, ISTO 35576, Ir-Tur. el., Ch.

A. wiedemannianus Fischer, 1, Dedeler Alm, 1512 m., 14.07.2010, K 40° 30' 46" D 031° 38' 39", T 1568, ISTO 35573, Ir-Tur. el., Ch.

A. ponticus Pall., 1, Kızık Village, 1512 m., 01.09.2011, K 40° 29' 12" D 031° 30' 39", T 2740, ISTO 35579, Ch.

A. macrocephalus Willd. subsp. *macrocephalus*, 1, Kızık Village, 1414 m., 19.06.2011, K 40° 29' 01" D 031° 30' 53", T 2723, ISTO 35577, Ch.

A. lydius Boiss., 1, Kabak Village, Toprak Hill location, 970 m., 17.04.2010, K 40° 30' 06" D 031° 28' 43", T 1185, ISTO 35575, Ir-Tur. el., H.

A. karamasicus Boiss. & Bal., 1, Kızık, 1461 m., 04.06.2011, K 40° 30' 05" D 031° 31' 46", T 2457, ISTO 35578, Ir-Tur. el., H.

A. xylobasis Freyn & Bornm. var. *angustus* (Freyn & Sint.) Freyn & Bornm., 1, Dedeler Alm, 1508 m., 07.08.2010, K 40° 30' 59" D 031° 39' 00", T 1715, ISTO 35574, Ir-Tur. el., H.

A. squalidus Boiss. & Noe, 1, Dedeler Alm, 1508 m., 16.05.2010, K 40° 30' 59" D 031° 39' 00", T 1358, ISTO 35580, H.

A. spruneri Boiss., 1, Kabak Village, 908 m., 04.06.2011, K 40° 29' 19" D 031° 27' 47", T 2419, ISTO 35581, H.

Vicia cracca L. subsp. *cracca*, 1, Dereceören, 1245 m., 16.05.2010, K 40° 32' 50" D 031° 37' 05", T 1347, ISTO 35556, Eu-Sib.el., H.

V. pannonica Crantz. var. *pannonica*, 1, Ayman Alm, 1448 m., 06.06.2010, K 40° 32' 52" D 031° 40' 28", T 1384, ISTO 35555, Th.

V. sativa L. subsp. *sativa*, 1, Kızık Village road, 535 m., 04.06.2011, K 40° 31' 19" D 031° 35' 03", T 2474, ISTO 35563, Th.

V. sativa L. subsp. *incisa* (Bieb.) Arc. var. *cordata* (Wulfen ex Hoppe) Arc., 1, Kuzgölcük, 1092 m., 04.06.2011, K 40° 32' 11" D 031° 32' 17", T 2453, ISTO 35564, Th.

V. narbonensis L. var. *narbonensis*, 1, Kızık Village, 1640 m., 04.06.2011, K 40° 30' 11" D 031° 33' 35", T 2472, ISTO 35565, Th.

Lathyrus aureus (Stev.) Brandza, 1, Bozyer Alm, 1496 m., 02.07.2010, K 40° 30' 43" D 031° 40' 06", T 1473, ISTO 35606, Eu-Sib.el., H.

L. brachypterus Cel. var. *brachypterus*, 1, Demirciler Alm, 1549 m., 02.05.2010, K 40°

31' 07" D 031° 35' 43", T 1273, ISTO 35560, Ir-Tur. el, H.

L. digitatus (Bieb.) Fiori, 1, Taşlıyayla location, 1435 m., 17.04.2010, K 40° 31' 52" D 031° 37' 46", T 1192, ISTO 35557, Med. el., H.

L. tukhtensis Czecz., 1, Kabak Village, 1300 m., 17.04.2010, K 40° 29' 59" D 031° 30' 33", T 1193, ISTO 35559, H.

L. laxiflorus (Desf.) O. Kuntze subsp. *laxiflorus*, 1, Demirciler Alm, 1474 m., 02.05.2010, K 40° 31' 12" D 031° 37' 03", T 1236, ISTO 35558, H.

L. cicera L., 1, Dereceören, Soğucak Pınarı location, 1266 m., 04.06.2011, K 40° 32' 49" D 031° 36' 27", T 2410, ISTO 35588, Th.

L. nissolia L., 1, Solaklar Alm, 1440 m., 16.05.2010, K 40° 31' 52" D 031° 40' 23", T 1356, ISTO 35561, Th.

Pisum sativum L. var. *brevipedunculatum* P. H. Davis & Meikle, 1, Kabak Village, 1258 m., 04.06.2011, K 40° 30' 11" D 031° 30' 18", T 2442, ISTO 35566, Th.

Ononis spinosa L. subsp. *leiosperma* (Boiss.) Sirj., 1 Kabak Village, 1329 m., 29.08.2010, K 40° 29' 55" D 031° 30' 23", T 1862, ISTO 35597, H.

Trifolium hybridum L. var. *hybridum*, 1, Demirciler Alm, 1440 m., 02.07.2010, K 40° 31' 43" D 031° 37' 10", T 1453, ISTO 35604, H.

T. speciosum Willd., 1, Ayman Alm, 1445 m., 05.07.2010, K 40° 32' 13" D 031° 41' 47", T 1671, ISTO 35590, Th.

T. spadiceum L., 1, Kızık Village road, 1519 m., 02.07.2010, K 40° 31' 17" D 031° 35' 04", T 1488, ISTO 35603, Eu-Sib.el., Th.

T. aureum Poll., 1, Demirciler Alm, 1440 m., 07.08.2010, K 40° 31' 11" D 031° 38' 48", T 1710, ISTO 35608, Eu-Sib.el., Th.

T. patens Schreb., 1, Dereceören, 1265 m., 20.06.2010, K 40° 33' 29" D 031° 37' 24", T 1446, ISTO 35600, Th.

T. pratense L. var. *pratense*, 1, Taşlıyayla location, 1466 m., 02.07.2010, K 40° 32' 03" D 031° 37' 15", T 1489, ISTO 35611, H.

T. medium L. var. *medium*, 1, Taşlıyayla location, 1436 m., 02.07.2010, K 40° 31' 59" D 031° 38' 13", T 1453, ISTO 35599, H.

T. medium L. var. *ericalycinum* Hausskn., 1, Demirciler Alm, 1550 m.,

02.07.2010, K 40° 31' 12" D 031° 36' 26", T 1452, ISTO 35607, H.

T. pannonicum Jacq. subsp. *elongatum* (Willd.) Zoh., 1, Dedeler Alm, 1448 m., 20.06.2010, K 40° 30' 57" D 031° 30' 58", T 1422, ISTO 35569, H.

T. lappaceum L., 1, Ayman Alm, 1428 m., 05.07.2010, K 40° 32' 24" D 031° 39' 09", T 1670, ISTO 35589, Med. el., Th.

T. arvense L. var. *arvense*, 1, Kızık Village road, 1580 m., 12.09.2010, K 40° 31' 20" D 031° 33' 35", T 1947, ISTO 35594, Th.

T. echinatum Bieb., 1, Kızık Village road, 1590 m., 20.06.2010, K 40° 30' 52" D 031° 34' 33", T 1445, ISTO 35598, Med. el., Th.

Melilotus officinalis (L.) Desr., 1, Kozyaka Alm, Ömürce Boğazı location, 1617 m., 12.09.2010, K 40° 29' 37" D 031° 33' 13", T 1952, ISTO 35592, Th.

M. bicolor Boiss. & Bal., 1, Kabak Village, 899 m., 12.09.2010, K 40° 28' 33" D 031° 27' 45", T 2558, ISTO 35585, Ir-Tur. el, Th.

Trigonella astroites Fisch. & Mey., 1, Kıbrısçık turnout, 1379 m., 12.09.2010, K 40° 33' 59" D 031° 39' 05", T 1950, ISTO 35595, Ir-Tur. el, Th.

T. spicata Sibth. & Sm., 1, Kuzgölcük, 1470 m., 05.07.2010, K 40° 31' 12" D 031° 32' 23", T 1675, ISTO 35609, Doğu Med. el., Th.

Medicago lupulina L., 1, Taşlıyayla forest storehouse, 1439 m., 02.07.2010, K 40° 32' 17" D 031° 38' 53", T 1476, ISTO 35605, H.

M. sativa L. subsp. *sativa*, 1, Kabak Village, 910 m., 29.08.2010, K 40° 28' 45" D 031° 27' 30", T 1881, ISTO 35591, H.

Dorycnium graecum (L.) Ser., 1, Dedeler Alm, 1560 m., 16.05.2010, K 40° 30' 33" D 031° 38' 30", T 1350, ISTO 35552, Eu-Sib.el., Ch.

Lotus ornithopodioides L., 1, Nimetli Alm, 1455 m., 10.10.2010, K 40° 31' 25" D 031° 38' 55", T 2173, ISTO 35601, Med. el., Th.

L. corniculatus L. var. *tenuifolius*, 1, Çavuşlu Alm, 1555 m., 02.05.2010, K 40° 30' 42" D 031° 36' 30", T 1237, ISTO 35583, H.

L. aegaeus (Gris.) Boiss., 1, Kozyaka Alm, Çoplum brook location, 1560 m., 19.06.2011, K 40° 29' 14" D 031° 33' 53", T 2617, ISTO 35586, H.

Anthyllis vulneraria L. subsp. *boisseri* (Sag.) Bornm., 1, Kızık Village turnout, 1501 m., 02.07.2010, K 40° 31' 28" D 031° 36' 03", T 1497, ISTO 35554, H.

Coronilla scorpioides (L.) Koch, 1, Kabak Village, 899 m., 03.05.2011, K 40° 28' 34" D 031° 27' 42", T 2389, ISTO 35587, Th.

C. varia L. subsp. *varia*, 1, Taşlıyayla, 1450 m., 06.06.2010, K 40° 32' 02" D 031° 37' 01", T 1377, ISTO 35551, H.

Hedysarum varium Willd., 1, Kuzgölcük, 1510 m., 05.07.2010, K 40° 30' 44" D 031° 39' 19", T 1634, ISTO 35602, Ir-Tur. el., H.

Onobrychis armena Boiss. & Huet., 1, Dereceören, 1260 m., 04.06.2011, K 40° 32' 42" D 031° 37' 03", T 2420, ISTO 35584, E.

O. tournefortii (Willd.) Desv., 1, Kozyaka Alm, 1610 m., 07.08.2010, K 40° 29' 35" D 031° 33' 29", T 1704, ISTO 35610, H.

POLYGALACEAE

Polygala supina Schreb., 1, Dereceören, Gökçepinar Kayası, 1363 m., 14.07.2010, K 40° 32' 53" D 031° 37' 23", T 1536, ISTO 35487, H.

P. anatolica Boiss. & Heldr., 1, Kıbrıscık-Seben turnout, 1380 m., 04.06.2011, K 40° 33' 52" D 031° 39' 03", T 2433, ISTO 35488, H.

ELAEAGNACEAE

Elaeagnus angustifolia L. var. *orientalis*, 1, Kozyaka Alm, 1566 m., 18.06.2011, K 40° 29' 14" D 031° 33' 55", T 2546, ISTO 35870, Ph.

RHAMNACEAE

Paliurus spina-christi Miller, 1, Kabak Village, 1150 m., 10.10.2010, K 40° 29' 57" D 031° 30' 04", T 2110, ISTO 35545, Ph.

Frangula alnus Miller subsp. *alnus*, 1, Kızık road, 1373 m., 10.10.2010, K 40° 33' 52" D 031° 39' 03", T 2208, ISTO 35546, Eu-Sib.el., Ph.

Rhamnus thymifolius Bornm., 1, Korucuk Alm, 1223 m., 01.09.2011, K 40° 28' 27" D 031° 36' 01", T 2749, ISTO 35547, Ph

ROSACEAE

Prunus x domestica L., 1, Kızık Village, 920 m., 04.06.2011, K 40° 29' 05" D 031° 27' 46", T 2393, Ph.

Cerasus mahaleb (L.) Miller var. *mahaleb*, 1, Kabak Village, 1489 m., 18.06.2011, K 40° 28' 52" D 031° 28' 34", T 2477, ISTO 35632, Ph.

Filipendula vulgaris Moench., 1, Kuzgölcük, m., 16.05.2010, K 40° 31' 54" D 031° 37' 03", T 1319, ISTO 35612, Eu-Sib.el., G.

Rubus sanctus Schreber, 1, Taşlıyayla location, 1476 m., 10.10.2010, K 40° 31' 57" D 031° 36' 50", T 2186, ISTO 35626, Ch.

R. canescens DC. var. *canescens*, 1, Kızık Village, 1565 m., 16.07.2011, K 40° 30' 20" D 031° 33' 12", T 2728, ISTO 35615, Eu-Sib.el., Ch.

Potentilla rupestris L., 1, Kuzgölcük, 1430 m., 18.06.2011, K 40° 31' 22" D 031° 33' 05", T 2614, ISTO 35628, Eu-Sib.el, H.

P. calabra Ten., 1, Ayman Alm, 1435 m., 05.07.2010, K 40° 32' 44" D 031° 40' 39", T 1626, ISTO 35622, Med. el., H.

P. recta L., 1, Kuzgölcük, 1540 m., 29.08.2010, K 40° 31' 15" D 031° 30' 43", T 1890, ISTO 35619, H.

P. reptans L., 1, Alpagut Alm, 1470 m., 10.10.2010, K 40° 30' 32" D 031° 41' 28", T 2211, ISTO 35620, H.

Fragaria vesca L., 1, Kıbrıscık-Seben turnout, 1428 m., 20.06.2010, K 40° 33' 30" D 031° 38' 30", T 1555, ISTO 35613, H.

Geum urbanum L., 1, Kızık Village, Harman Taşı location, 1571 m., 14.07.2010, K 40° 30' 22" D 031° 32' 33", T 1618, ISTO 35623, Eu-Sib.el., H.

Agrimonia eupatoria L., 1, Kızık Village, 1507 m., 29.08.2010, K 40° 30' 33" D 031° 32' 55", T 1889, ISTO 35618, H.

Rosa pulverulenta Bieb., 1, Kızık Village, Killik Hill location, 1493 m., 02.07.2010, K 40° 31' 17" D 031° 32' 17", T 2184, ISTO 35625, Ch.

R. canina L., 1, Taşlıyayla location, 1479 m., 02.07.2010, K 40° 31' 50" D 031° 37' 07", T 1468, ISTO 35614, Ph.

Cotoneaster nummularia Fisch. & Mey., 1, Taşlıyayla location, 1440 m., 18.06.2011, K 40° 31' 12" D 031° 37' 13", T 2485, ISTO 35616, Ph.

Crataegus tanacetifolia (Lam.) Pers., 1, Kabak Village, 1160 m., 10.10.2010, K 40° 30' 14" D 031° 30' 12", T 2180, ISTO 35630, Ph.

C. monogyna Jacq. subsp. *monogyna*, 1, Kabak Village, 1050 m., 10.10.2010, K 40° 30' 21" D 031° 29' 40", T 2182, ISTO 35631, Ph.

C. monogyna Jacq. subsp. *azarella* (Gris.) Franco., 1, Kızık Village road, 1569 m., 10.10.2010, K 40° 31' 01" D 031° 32' 56", T 2210, ISTO 35627, Ph.

Pyracantha coccinea Roemer, 1, Kabak Village, 940 m., 26.02.2011, K 40° 30' 58" D 031° 29' 58", T 2265, ISTO 35621, Ph.

Sorbus aucuparia L., 1, Dereceören, 1297 m., 25.09.2010, K 40° 33' 16" D 031° 37' 11", T 2074, ISTO 35624, Eu-Sib.el., Ph.

S. umbellata (Desf.) Fritsch var. *umbellata*, 1, Kızık Village, 1461 m., 19.06.2011, K 40° 29' 47", D 031° 31' 26", T 2692, ISTO 35629, Ph.

S. torminalis (L.) Crantz var. *torminalis*, 1, Kızık Village, 1530 m., 18.06.2011, K 40° 30' 32" D 031° 32' 58", T 2489, ISTO 35617, Eu-Sib.el., Ph.

Malus sylvestris Miller subsp. *orientalis* var. *orientalis*, 1, Kuzgölcük, Küçükkaya Ridge, 1310 m., 01.09.2011, K 40° 31' 43" D 031° 32' 52", T 2744, ISTO 35633, Ph.

Pyrus communis L. subsp. *communis*, 1, Kızık Village road, Emin Hoca Fountain location, 1534 m., 01.09.2011, K 40° 30' 41" D 031° 33' 20", T 2742, ISTO 35634, Ph.

P. amygdaliformis Vill. var. *lanceolata*, 1, Kabak Village, 1132 m., 01.09.2011, K 40° 30' 08" D 031° 29' 48", T 2743, ISTO 35635, Med. el., Ph.

P. elaeagnifolia Pallas subsp. *elaeagnifolia*, 1, Kızık Village road, 1532 m., 01.09.2011, K 40° 30' 54" D 031° 33' 04", T 2731, Ph.

ULMACEAE

Celtis tournefortii Lam., 1, Kabak Village, Aşılıkbaşı Ridge 938 m., 18.06.2011, K 40° 30' 26" D 031° 29' 08", T 2481, ISTO 35907, Ph.

C. glabrata Steven ex Planchon, 1, Korucuk Alm, 1185 m., 18.06.2011, K 40° 28' 12" D 031° 35' 47", T 2547, ISTO 35908, Eu-Sib.el., Ph.

CUCURBIATACEAE

Bryonia alba L., 1, Kabak Village, 1091 m., 19.06.2011, K 40° 30' 06" D 031° 29' 37", T 2646, ISTO 35642, Eu-Sib.el., H.

DATISCEAE

Datisca cannabina L., 1, Kabak Village, 935 m., 12.09.2010, K 40° 30' 40" D 031° 29' 37", T 1964, ISTO 35643, Ch.

BETULACEAE

Carpinus betulus L., 1, Kuzgölcük, 1004 m., 10.10.2010, K 40° 31' 57" D 031° 31' 26", T 2214, ISTO 35945, Eu-Sib.el., Ph.

Corylus colurna L., 1, Korucuk Alm, 1256 m., 18.06.2011, K 40° 28' 32" D 031° 35' 58", T 2482, ISTO 35944, Eu-Sib.el., Ph.

C. avellana L. var. *avellana*, 1, Kızık Village, 1536 m., 18.06.2011, K 40° 30' 44" D 031° 33' 18", T 2480, Eu-Sib.el., Ph.

Alnus glutinosa (L.) Gaertner subsp. *glutinosa*, 1, Kuzgölcük, 1036 m., 16.07.2011, K 40° 32' 25" D 031° 32' 43", T 2724, ISTO 35797, Eu-Sib.el., Ph.

FAGACEAE

Quercus robur L. subsp. *robur*, 1, Kabak Village, 958 m., 18.06.2011, K 40° 31' 45" D 031° 30' 45", T 2515, ISTO 35927, Eu-Sib.el., Ph.

Q. macranthera Fisch. & Mey. ex Hohen. subsp. *sypirensis* (C. Koch) Menitsky, 1, Kızık Village, 1566 m., 19.06.2011, K 40° 30' 51" D 031° 32' 46", T 2690, ISTO 35928, Ph.

Q. petraea (Mattuschka) Liebl. subsp. *petraea*, 1, Kızık Pond, 1549 m., 19.06.2011, K 40° 30' 31" D 031° 33' 36", T 2677, Eu-Sib.el., Ph.

Q. petraea (Mattuschka) Liebl. subsp. *iberica* (Steven ex Bieb.) Krassiln., 1, Kızık Village, 1495 m., 10.10.2010, K 40° 30' 09" D 031° 31' 55", T 2224, ISTO 35926, Ph.

Q. infectoria Oliver subsp. *boissieri* (Reuter) O. Schwarz, 1, Kabak Village, 925 m., 10.10.2010, K 40° 30' 20" D 031° 29' 34", T 2198, ISTO 35930, Ph.

Q. pubescens Willd., 1, Kızık Village, 1587 m., 18.06.2011, K 40° 30' 27" D 031° 33' 08", T 2611, ISTO 35925, Ph.

Q. cerris L. var. *cerris*, 1, Kızık Village, 1533 m., 19.06.2011, K 40° 30' 42" D 031° 33' 19", T 2684, ISTO 35929, Ph.

JUGLANDACEAE

Juglans regia L., 1, Kızık Village, 1380 m., 18.06.2011, K 40° 30' 05" D 031° 31' 47", T 2484, Ph.

GERANIACEAE

Geranium robertianum L., 1, Kızık Village, Harman Taşı location, 1541 m., 20.06.2010, K 40° 30' 18" D 031° 32' 21", T 2411, ISTO 35535, Th.

G. columbinum L., 1, Kabak Village, 888 m., 04.06.2011, K 40° 29' 00" D 031° 27' 43", T 2411, ISTO 35536, Th.

G. macrostylum Boiss., 1, Dereceören, 1350 m., 17.04.2010, K 40° 33' 17" D 031° 37' 13", T 1156, ISTO 35537, Med. el., Th.

G. asphodeloides Burnm subsp. *sintenisii* (Freyn) P. H. Davis, 1, Kıbrısık turnout, 1404 m., 10.10.2010, K 40° 33' 44" D 031° 38' 48", T 2216, ISTO 35538, Eu-Sib.el., Th.

G. pyrenaicum Burm., 1, Dereceören, 1216 m., 25.09.2010, K 40° 33' 05" D 031° 37' 16", T 2054, ISTO 35539, H.

Erodium cicutarium (L.) L'Hérit. subsp. *cutarium*, 1, Taşlıyayla, 1444 m., 26.02.2011, K 40° 31' 54" D 031° 37' 49", T 2255, ISTO 35540, Th.

LYTHRACEAE

Lythrum salicaria L., 1, Kabak Village, 914 m., 25.09.2010, K 40° 28' 49" D 031° 27' 34", T 2078, ISTO 35636, Eu-Sib.el., H.

ONAGRACEAE

Epilobium angustifolium L., 1, Kabak Village, 899 m., 14.07.2010, K 40° 29' 40" D 031° 28' 00", T 1524, Eu-Sib.el., H.

E. hirsutum L., 1, Kabak Village, 910 m., 05.07.2010, K 40° 28' 48" D 031° 27' 24", T 1668, ISTO 35640, H.

E. montanum L., 1, Kabak Village, 1190 m., 25.09.2010, K 40° 29' 07" D 031° 38' 06", T 1944, ISTO 35637, Eu-Sib.el., H.

E. lanceolatum Seb. & Mauri, 1, Kabak Village, 888 m., 14.07.2010, K 40° 28' 44" D 031° 27' 43", T 1617, ISTO 35638, Eu-Sib.el., H.

E. tetragonum L. subsp. *tetraganum*, 1, Kabak Village, 909 m., 02.07.2010, K 40° 29' 16" D 031° 27' 46", T 1471, ISTO 35639, H.

ANACARDIACEAE

Rhus coriaria L., 1, Kabak Village, 1047 m., 04.06.2011, K 40° 30' 04" D 031° 28' 15", T 2397, ISTO 35549, Ph.

SAPINDACEAE

Acer tataricum L., 1, Kabak Village, 1306 m., 01.09.2011, K 40° 29' 44" D 031° 30' 05", T 2735, ISTO 35541, Ph.

A. platanoides L., 1, Kabak Village, 1283 m., 18.06.2011, K 40° 28' 12" D 031° 35' 43", T 2510, ISTO 35542, Eu-Sib.el., Ph.

A. campestre L. subsp. *campestre*, 1, Kızık Village, 1526 m., 19.06.2011, K 40° 30' 27" D 031° 37' 42", T 2620, ISTO 35543, Eu-Sib.el., Ph.

A. hyrcanum Fisch. & Mey. subsp. *hyrcanum*, 1, Kabak Village, 1155 m.,

01.09.2011, K 40° 30' 09" D 031° 29' 57", T 2734, ISTO 35544, Eu-Sib.el., Ph.

CISTACEAE

Cistus creticus L., 1, Kabak Village, 1100 m., 19.06.2011, K 40° 30' 10" D 031° 29' 46", T 2634, ISTO 35477, Med. el., Ch.

C. laurifolius L., 1, Kabak Village, 970 m., 01.09.2011, K 40° 30' 32" D 031° 29' 34", T 2739, ISTO 35478, Med. el., Ch.

Helianthemum nummularium (L.) Miller subsp. *nummularium*, 1, Taşlıyayla location, 1435 m., 16.05.2010, K 40° 31' 50" D 031° 37' 49", T 1315, ISTO 35479, Ch.

MALVACEAE

Malva neglecta Wallr., 1, Taşlıyayla forest storehouse, 1442 m., 25.09.2010, K 40° 31' 56" D 031° 37' 46", T 2046, ISTO 35528, Th.

Alcea apterocarpa (Fenzl) Boiss., 1, Kızık Village, 1593 m., 05.07.2010, K 40° 30' 56" D 031° 33' 35", T 1644, ISTO 35529, Ir-Tur. el., H.

A. pallida Waldst. & Kit., 1, Kızık Village, 1525 m., 05.07.2010, K 40° 30' 34" D 031° 32' 56", T 1643, ISTO 35530, H.

Tilia rubra DC. subsp. *caucasica* (Rupr.) V. Engler, 1, Kabak Village, 940 m., 19.06.2011, K 40° 30' 35" D 031° 29' 45", T 2669, ISTO 35531, Eu-Sib.el., Ph.

THYMELIACEAE

Daphne pontica L., 1, Kızık Village road, 1623 m., 10.10.2010, K 40° 31' 03" D 031° 33' 26", T 2130, Eu-Sib.el., Ch.

BRASSICACEAE

Conringia orientalis (L.) Anrdz., 1, Kızık Alm, 1568 m., 03.05.2011, K 40° 30' 19" D 031° 32' 36", T 2348, ISTO 35446, Th.

C. perfoliata (C. A. Mey.) Busch, 1, Kızık-Kozyaka Alm, 1417 m., 03.05.2011, K 40° 29' 26" D 031° 30' 38", T 2390, ISTO 35447, Th.

Cardaria draba (L.) Desv subsp. *draba*, 1, Demirciler Alm, Aşılı Çayın location, 1527 m., 04.06.2011, K 40° 30' 58" D 031° 36' 79", T 2435, ISTO 35448, H.

Isatis floribunda Boiss. ex Bornm., 1, Kabak Village, 1208 m., 19.06.2011, K 40° 29' 11" D 031° 28' 57", T 2713, ISTO 35449, Ir-Tur. el., H.

Iberis taurica DC., 1, Kuzgölcük Village, 1519 m., 04.06.2011, K 40° 31' 14" D 031° 32' 22", T 2438, ISTO 35450, H.

Thlaspi perfoliatum L., 1, Taşlıyayla location, 1449 m., 02.05.2010, K 40° 32' 03" D 031° 37' 55", T 1211, ISTO 35451, Th.

T. ochroleucum Boiss. & Heldr., 1, Nimetli Alm, 1450 m., 02.05.2010, K 40° 32' 40" D 031° 37' 14", T 1212, ISTO 35452, Th.

T. lilacinum Boiss. & Huet, 1, Demirciler Alm, 1479 m., 03.05.2011, K 40° 31' 19" D 031° 37' 13", T 2372, ISTO 35453, Th.

Capsella bursa-pastoris (L.) Medik., 1, Solaklar Alm, 1460 m., 03.05.2011, K 40° 31' 30" D 031° 43' 59", T 2339, ISTO 35454, Th.

Fibigia clypeata (L.) Medik., 1, Kuzgölcük, 1250 m., 10.10.2010, K 40° 33' 13" D 031° 37' 22", T 2190, ISTO 35455, H.

Alyssum linifolium Steph. ex Willd. var. *linifolium*, 1, Kızık, 1360 m., 04.04.2010, K 40° 30' 27" D 031° 31' 50", T 1089, ISTO 35456, Th.

A. minutum Schelecht. ex DC., 1, Kızık Village road, 1570 m., 18.06.2011, K 40° 31' 08" D 031° 34' 44", T 2485, Th.

A. strigosum Banks. & Sol. subsp. *strigosum*, 1, Taşlıyayla location, 1440 m., 05.07.2010, K 40° 31' 52" D 031° 37' 52", T 1672, ISTO 35457, Th.

A. armenum Boiss., 1, Çavuşlar Alm location, 1542 m., 20.06.2010, K 40° 30' 40" D 031° 37' 46", T 1429, ISTO 35458, Th.

A. murale Waldst. & Kit. var. *murale*, 1, Korucuk Alm, 1387 m., 02.07.2010, K 40° 29' 13" D 031° 35' 23", T 1472, ISTO 35459, H.

Draba muralis L., 1, Dedeler Alm location, 1441 m., 03.05.2011, K 40° 30' 49" D 031° 38' 19", T 2371, ISTO 35460, H.

Arabis sagittata (Bertol.) DC., 1, Keskinli Alm, 1540 m., 02.05.2010, K 40° 30' 26" D 031° 36' 48", T 1213, ISTO 35461, H.

A. nova Vill., 1, Solaklar Alm, 1439 m., 04.06.2011, K 40° 32' 24" D 031° 41' 17", T 2450, ISTO 35462, Th.

A. verna (L.) DC., 1, Dedeler Alm, 1495 m., 03.05.2011, K 40° 30' 43" D 031° 38' 28", T 2365, ISTO 35463, Med. el., Th.

Turritis laxa (Sibth. & Sm.) Hayek, 1, Dedeler Alm, 1459 m., 10.10.2010, K 40° 30' 51" D 031° 38' 17", T 2156, ISTO 35464, H.

Rorippa sylvestre (L.) Bess., 1, Kızık Village road, 1527 m., 25.09.2010, K 40° 31' 26" D 031° 35' 39", T 2012, ISTO 35465, H.

Barbarea vulgaris R. Br., 1, Seben-Kızık turnout, 1473 m., 04.04.2010, K 40° 30' 43" D 031° 36' 56", T 1092, ISTO 35466, H.

B. trichopoda Hausskn. ex Bornm., 1, Kuzgölcük, 1147 m., 04.04.2010, K 40° 32' 18" D 031° 32' 56", T 1091, ISTO 35467, H.

B. plantaginea DC., 1, Kuzgölcük, 998 m., 02.05.2010, K 40° 32' 08" D 031° 31' 34", T 1201, ISTO 35468, H.

Aubrieta canescens (Boiss.) Bornm. subsp. *canescens*, 1, Korucuk Alm, 1396 m., 03.05.2011, K 40° 28' 43" D 031° 35' 04", T 2332, ISTO 35469, H.

Matthiola longipetala (Vent.) DC. subsp. *bicornis* (Sibth. & Smith) P. W. Ball, 1, Kabak Village, 1394 m., 04.06.2011, K 40° 29' 17" D 031° 30' 36", T 2445, ISTO 35470, Th.

Erysimum cuspidatum (Bieb.) DC., 1, Nimetli Alm, 1439 m., 02.05.2010, K 40° 31' 23" D 031° 39' 42", T 1207, ISTO 35471, H.

Alliaria petiolata (Bieb.) Cavara & Grande, 1, Dereceören, 1326 m., 03.05.2011, K 40° 33' 26" D 031° 37' 36", T 2335, ISTO 35472, H.

Sisymbrium loeselii L., 1, Kuzgölcük, 1301 m., 10.10.2010, K 40° 33' 44" D 031° 37' 39", T 2206, ISTO 35473, Th.

Descurainia sophia (L.) Webb ex Prantl, 1, Kabak Village, 888 m., 31.03.2011, K 40° 28' 44" D 031° 27' 43", T 2303, ISTO 35474, Th.

Camelina rumelica Vel., 1, Kızık Village, 1528 m., 04.06.2011, K 40° 30' 20" D 031° 32' 32", T 2412, ISTO 35475, Th.

RESEDACEAE

Reseda lutea L. var. *lutea*, 1, Kuzgölcük, 1360 m., 04.06.2011, K 40° 32' 14" D 031° 34' 29", T 2436, ISTO 35476, H.

SANTALACEAE

Viscum album L. subsp. *album*, 1, Kuzgölcük, 989 m., 26.02.2011, K 40° 32' 07" D 031° 31' 53", T 2248, Ph.

Chenopodium botrys L., 1, Taşlıyayla forest storehouse, 1432 m., 05.07.2010, K 40° 31' 27" D 031° 37' 43", T 1663, ISTO 35517, Th.

C. foliosum (Moench) Aschers., 1, Nimetli Alm, 1437 m., 10.10.2010, K 40° 31' 32" D 031° 39' 13", T 2222, ISTO 35518, H.

CARYOPHYLLACEAE

Minuartia anatolica (Boiss.) Woron var. *anatolica*, 1, Dedeler Alm, 1489 m.,

05.07.2010, K 40° 30' 47" D 031° 37' 57", T 1656, ISTO 35489, E. H.

Stellaria media (L.) Vill. subsp. *media*, 1, Kızık Village, 1505 m., 03.05.2011, K 40° 31' 29" D 031° 35' 59", T 2379, ISTO 35490, Th.

S. holostea L., 1, Kızık Village road, 1549 m., 07.03.2010, K 40° 31' 22" D 031° 35' 52", T 1021, ISTO 35491, Eu-Sib.el, H.

Cerastium fragillimum Boiss., 1, Dereceören, 1234 m., 17.04.2010, K 40° 33' 10" D 031° 37' 18", T 1117, ISTO 35492, Th.

Moenchia mantica (L.) Bartl subsp. *mantica*, 1, Demirciler Alm, 1421 m., 03.05.2011, K 40° 31' 22" D 031° 37' 21", T 2378, ISTO 35493, Th.

Dianthus micranthus Boiss.& Heldr., 1, Nimetli Alm, 1451 m., 10.10.2010, K 40° 31'39" D 031° 39'09", T 2101, ISTO 35494, H.

D. ancycensis Hausskn. & Bornm., 1, Demirciler Alm, 1440 m., 14.07.2010, K 40°31'11"D 031°37'15", T 1590, ISTO 35495, Ir-Tur. el., H.

D. crinitus Sm. var. *crinitus*, 1, Kozyaka-Kabak Village, 1377 m., 10.10.2010, K 40° 29' 25" D 031° 30' 58", T 2133, ISTO 35496, H.

D. corymbosus Sibth. & Sm., 1, Kuzgölcük, 1331 m., 10.10.2010, K 40° 31' 32" D 031° 33' 50", T 2145, ISTO 35497, H.

D. calocephalus Boiss., 1, Dereceören, 1320 m., 25.09.2010, K 40° 34' 23" D 031° 35' 56", T 2070, ISTO 35498, H.

Petrorhagia alpina (Halb.) Ball & Heywood subsp. *alpina*, 1, Dedeler Alm, 1420 m., 14.07.2010, K 40° 30' 59" D 031° 38' 20", T 1571, ISTO 35499, Th.

Saponaria glutinosa Bieb., 1, Kabak Village, 934 m., 10.07.2011, K 40° 30' 25" D 031° 29' 08", T 2725, ISTO 35500, H.

S. prostrata Willd. subsp. *prostrata*, 1, Dereceören, 1445 m., 12.09.2010, K 40° 33' 57" D 031° 39' 32", T 1903, ISTO 35501, Ir-Tur. el., Th.

Gypsophila brachypetala Trautv.,1, Dereceören, 1222 m., 10.10.2010, K 40° 33' 12" D 031° 37' 22", T 2149, ISTO 35502, Th.

Silene italica (L.) Pers., 1, Taşlıyayla Pond, 1480 m., 25.09.2010, K 40° 30' 47" D 031° 37' 38", T 2065, ISTO 35503, H.

S. laxa Boiss. & Kotschy., 1, Kozyaka Alm, 1222 m., 14.08.2010, K 40° 28' 32" D

031° 35' 46", T 1575, ISTO 35504, Ir-Tur. el., H.

S. chlorifolia Sm., 1, Kabak Village, 1070 m., 01.09.2011, K 40° 29' 16" D 031° 28' 11", T 2741, ISTO 35505, Ir-Tur. el., H.

S. vulgaris (Moench) Garcke var. *vulgaris*, 1, Keskinli Alm, 1440 m., 12.09.2010, K 40° 30' 26" D 031° 33' 26", T 1975, ISTO 35506, H.

S. compacta Fischer, 1, Kayakapı Hill, 1660 m., 18.06.2011, K 40° 30' 32" D 031° 34' 13", T 2602, ISTO 35507, H.

S. dichotoma Ehrh. subsp. *dichotoma*, 1, Kayakapı Hill, 1548 m., 12.09.2010, K 40° 29' 12" D 031° 32' 29", T 1940, ISTO 35508, Th.

S. dichotoma Ehrh. subsp. *sibthorpiana* (Reichb.) Rech., 1, Kızık, 1439 m., 04.06.2011, K 40° 30' 22" D 031° 31' 41", T 2430, ISTO 35509, Th.

S. conica L., 1, Korucuk Alm, 1255 m., 18.06.2011, K 40° 28' 24" D 031° 35' 51", T 2604, ISTO 35510, Th.

S. subconica Friv., 1, Kozyaka Alm, 1595 m., 18.06.2011, K 40° 29' 18" D 031° 33' 47", T 2599, ISTO 35511, Th.

Agrostemma githago L., 1, Kozyaka-Kabak turnout, 1379 m., 19.06.2011, K 40° 29' 08" D 031° 30' 38", T 2697, ISTO 35512, Th.

Paronychia beauverdi Czecz., 1, Kızık Village, 1450 m., 19.06.2011, K 40° 29' 38" D 031° 31' 27", T 2641, ISTO 35513, Ir-Tur. el, H.

Scleranthus annus L. subsp. *annus*, 1, Kuzgölcük, 1525 m., 18.06.2011, K 40° 31' 22" D 031° 32' 03", T 2522, ISTO 35514, H.

PLUMBAGINACEAE

Acantholimon acerosum (Willd.) Boiss var. *acerosum*, 1, Dedeler Alm, 1460 m., 12.09.2010, K 40° 30' 57" D 031° 37' 50", T 1965, ISTO 35897, Ir-Tur. el., Ch.

POLYGONACEAE

Rumex acetosella L., 1, Kabak Village, 1119 m., 16.05.2010, K 40° 29' 32" D 031° 27' 49", T 1328, ISTO 35515, H.

R. crispus L., 1, Kızık road, 1457 m., 16.05.2010, K 40° 31' 22" D 031° 33' 43", T 1326, ISTO 35516, H.

TAMARICACEAE

Tamarix parviflora DC., 1, Korucuk Alm, 1190 m., 18.06.2011, K 40° 28' 15" D 031° 35' 47", T 2520, ISTO 35519, Ph.

CORNACEAE

Cornus sanguinea L. subsp. *australis* (C.A. Meyer) Jav., 1, Kabak Village, 933 m., 18.06.2011, K 40° 30' 48" D 031° 29' 51", T 2511, Ph.

C. mas L., 1, Kızık Village, 1532 m., 18.06.2011, K 40° 30' 33" D 031° 33' 01", T 2705, Eu-Sib.el., Ph.

ERICACEAE

Orthilia secunda (L.) House, 1, Kuzgölcük, 1338 m., 25.09.2010, K 40° 31' 37" D 031° 33' 20", T 2075, ISTO 35947, Th.

Monotropa hypopithys L., 1, Kızık Village, 1563 m., 06.06.2010, K 40° 30' 52" D 031° 32' 50", T 1399, ISTO 35946, Th.

PRIMULACEAE

Primula vulgaris Huds. subsp. *vulgaris*, 1, Dedeler Alm, 1555 m., 07.03.2010, K 40° 30' 56" D 031° 39' 01", T 1007, ISTO 35955, Eu-Sib.el., H.

Androsace maxima L., 1, Kabak Village, 925 m., 03.05.2011, K 40° 28' 51" D 031° 27' 36", T 2392, ISTO 35957, Th.

Anagallis arvensis L. var. *arvensis*, 1, Taşlıyayla forest storehouse, 1436 m., 20.10.2010, K 40° 31' 51" D 031° 37' 43", T 2117, ISTO 35953, Th.

Lysimachia vulgaris L., 1, Dereceören, 1297 m., 25.09.2010, K 40° 33' 36" D 031° 37' 25", T 2024, ISTO 35955, H.

L. verticillaris Sprengel, 1, Kuzgölcük, ISTO 35954, Eu-Sib.el., H.

L. atropurpurea L., 1, Seben road, 1301 m., 17.07.2010, K 40° 28' 47" D 031° 35' 27", T 1650, ISTO 35952, Med. el., H.

CONVOLVULACEAE

Convolvulus arvensis L., 1, Kızık Village road, 1515 m., 15.07.2010, K 40° 31' 26" D 031° 35' 07", T 1652, ISTO 35949, H.

C. galaticus Rostan ex Choisy, 1, Korucuk Alm, 1314 m., 19.06.2011, K 40° 28' 48" D 031° 35' 34", T 2653, ISTO 35948, E, Ir-Tur. el., H.

SOLANACEAE

Solanum dulcamara L., 1, Kabak Village, 939 m., 10.10.2010, K 40° 30' 16" D 031° 28' 59", T 2223, ISTO 35910, Eu-Sib.el., Ph.

APOCYNACEAE

Vinca herbaceae Waldst. & Kit., 1, Kabak Village, 1167 m., 03.05.2011, K 40° 29' 59" D 031° 39' 42", T 2369, ISTO 35772, Ch.

Vincetoxicum canescens (Willd.) Decne subsp. *canescens*, 1, Demirciler Alm, 1442

m., 15.07.2010, K 40° 31' 31" D 031° 36' 58", T 1662, ISTO 35777, H.

V. fuscatum (Hornem.) Reichb. subsp. *boissieri* (Kusn.) Browicz, 1, Kuzgölcük, 1161 m., 15.07.2010, K 40° 32' 19" D 031° 33' 16", T 1543, ISTO 35778, Ir-Tur. el., H.

GENTIANACEAE

Centaurium erythraea Rafn. subsp. *erythraea*, 1, Kabak Village, Eldoğan brook, 929 m., 10.10.2010, K 40° 30' 20" D 031° 29' 00", T 2141, ISTO 35924, Eu-Sib.el., H.

RUBIACEAE

Asperula involucrata Wahlenb., 1, Çavuşlar Alm, 1499 m., 02.05.2010, K 40° 30' 48" D 031° 36' 56", T 1250, ISTO 35672, Eu-Sib.el., H.

A. arvensis L., 1, Kabak Village, 899 m., 03.05.2011, K 40° 28' 41" D 031° 27' 30", T 2391, ISTO 35668, Med. el., Th.

Galium rotundifolium L., 1, Kızık Pond, 1543 m., 10.10.2010, K 40° 30' 39" D 031° 33' 22", T 2125, ISTO 35670, Eu-Sib.el. H.

G. odoratum (L.) Scop., 1, Kızık Village road, 1582 m., 19.06.2011, K 40° 30' 58" D 031° 33' 52", T 2665, ISTO 35667, Eu-Sib.el., H.

G. verum L. subsp. *verum*, 1, Dedeler Alm, 1474 m., 14.07.2010, K 40° 30' 53" D 031° 39' 28", T 1611, ISTO 35669, Eu-Sib.el., H.

G. aparine L., 1, Kayakayı Hill, 1616 m., 12.09.2010, K 40° 30' 09" D 031° 33' 45", T 1962, ISTO 35671, Th.

Cruciata taurica (Pallas ex Willd.) Ehrend., 1, Kızık Village, 1616 m., 07.03.2010, K 40° 30' 08" D 031° 32' 14", T 1016, ISTO 35673, Ir-Tur. el., H.

ACANTHACEAE

Acanthus dioscoridis L. var. *dioscoridis*, 1, Kızık Village, 1542 m., 01.09.2011, K 40° 30' 48" D 031° 32' 56", T 2736, ISTO 35776.

A. hirsutus Boiss., 1, Kızık Village, 1448 m., 19.06.2011, K 40° 30' 05" D 031° 31' 50", T 2630, ISTO 35775, H.

LAMIACEAE

Ajuga orientalis L., 1, Kızık Village, 1572 m., 04.04.2010, K 40° 31' 06" D 031° 35' 36", T 1054, ISTO 35833, H.

A. reptans L., 1, Dedeler Alm, 1497 m., 04.04.2010, K 40° 30' 42" D 031° 38' 26", T 1103, Eu-Sib.el., H.

A. chamaepitys (L.) Schreber subsp. *chia* (Schreber) Arcangeli var. *chia*, 1, Kabak

Village, 1320 m., 03.05.2011, K 40° 33' 52" D 031° 39' 03", T 2356, ISTO 35837, H.

Teucrium chamaedrys L. subsp. *chamaedrys*, 1, Dereceören, 1304 m., 25.09.2010, K 40° 32' 49" D 031° 37' 14", T 1998, ISTO 35799, Eu-Sib.el., H, Ch.

T. polium L., 1, Kozyaka Alm, 1566 m., 07.08.2010, K 40° 29' 14" D 031° 33' 55", T 1723, ISTO 35807, Ch.

Scutellaria orientalis L. subsp. *pinnatifida* Edmondson, 1, Kızık Village, 1589 m., 04.06.2011, K 40° 31' 21" D 031° 34' 34", T 2446, ISTO 35814, Ch.

Phlomis pungens Willd. var. *pungens*, 1, Kabak Village, 956 m., 07.08.2010, K 40° 30' 03" D 031° 28' 21", T 1739, ISTO 35819, H.

P. armeniaca Willd., 1, Bozyer Alm, 1531 m., 16.05.2010, K 40° 30' 12" D 031° 39' 55", T 1345, ISTO 35825, H.

Lamium purpureum L. var. *purpureum*, 1, Taşlyayla location, 1436 m., 17.04.2010, K 40° 31' 51" D 031° 37' 43", T 1199, ISTO 35835, Eu-Sib.el., Th.

L. crinitum Montbret & Aucher ex Benth, 1, Bozyer Alm, 1477 m., 17.04.2010, K 40° 30' 43" D 031° 39' 23", T 1194, ISTO 35834, Eu-Sib.el., H.

Ballota larendana Boiss. & Heldr., 1, Korucuk Alm, 1231 m., 02.05.2010, K 40° 28' 35" D 031° 36' 01", T 1701, ISTO 35823, Ir-Tur. el., H.

Marrubium astracanicum Jacq. subsp. *astracanicum*, 1, Kızık Village road, 1609 m., 02.07.2010, K 40° 30' 57" D 031° 33' 45", T 1456, ISTO 35828, H.

Sideritis montana L. subsp. *montana*, 1, Kabak Village, 1266 m., 12.09.2010, K 40° 30' 10" D 031° 20' 21", T 1928, ISTO 35809, Med. el., Th.

S. montana L. subsp. *remota* (d'Urv.) P.W. Ball ex Heywood, 1, Kızık Village, 1666 m., 12.09.2010, K 40° 29' 36" D 031° 31' 41", T 1942, ISTO 35806, Med. el., Th.

Stachys germanica L. subsp. *bithynica* (Boiss.) Bhattacharjee, 1, Kızık Village road, 1596 m., 19.06.2011, K 40° 30' 56" D 031° 33' 54", T 2651, ISTO 35838, H.

S. thirkei C. Koch, 1, Dereceören, Asardere location, 1396 m., 10.10.2010, K 40° 33' 18" D 031° 37' 47", T 2162, ISTO 35810, H.

S. iberica Bieb. subsp. *iberica* var. *densipilosa* Bhattacharjee, 1, Korucuk Alm,

1445 m., 20.06.2010, K 40° 29' 59" D 031° 37' 46", T 1432, ISTO 35811, Ir-Tur. el., H.

Nepeta italica L., 1, Kuzgölcük, Fındıcak Fountain, 1094 m., 19.06.2011, K 40° 32' 24" D 031° 33' 57", T 2701, ISTO 35817, H.

N. nuda L. subsp. *nuda*, 1, Kızık Village, 1563 m., 20.06.2010, K 40° 30' 52" D 031° 32' 48", T 1418, ISTO 35826, H.

Prunella vulgaris L., 1, Kuzgölcük, 1020 m., 25.09.2010, K 40° 32' 18" D 031° 32' 18", T 2036, ISTO 35798, Eu-Sib.el., H.

P. laciniata (L.) L., 1, Kızık Village, 1530 m., 07.08.2010, K 40° 33' 52" D 031° 39' 03", T 1725, ISTO 35824, Eu-Sib.el., H.

Origanum vulgare L. subsp. *hirtum* (Link) Ietswaart, 1, Kabak Village, 908 m., 25.09.2010, K 40° 29' 18" D 031° 27' 47", T 2035, ISTO 35804, Med. el., H.

O. vulgare L. subsp. *vulgare*, 1, Dereceören, Su çatı location, 1304 m., 12.09.2010, K 40° 33' 46" D 031° 37' 15", T 1911, ISTO 35803, Eu-Sib.el., H.

Calamintha grandiflora (L.) Moench, 1, Kızık Village road, 1611 m., 12.09.2010, K 40° 31' 04" D 031° 33' 24", T 1924, ISTO 35813, Eu-Sib.el., H.

Clinopodium vulgare L. subsp. *vulgare*, 1, Çavuşlar Alm, 1476 m., 07.08.2010, K 40° 30' 46" D 031° 37' 23", T 1735, ISTO 35818, H.

Acinos rotundifolius Pers., 1, Nimetli Alm arkası, 1437 m., 12.09.2010, K 40° 32' 06" D 031° 39' 34", T 1920, ISTO 35802, Th.

Thymus sipyleus Boiss. subsp. *sipyleus* var. *sipyleus*, 1, Kızık Village, 1581 m., 07.08.2010, K 40° 30' 21" D 031° 33' 41", T 1732, ISTO 35822, Ch.

T. praecox Opiz. subsp. *skorpilii* (Velen.) Jalas var. *skorpilii*, 1, Bozyer Alm, 1545 m., 02.05.2010, K 40° 30' 45" D 031° 39' 36", T 1240, ISTO 35827, Ch.

T. longicaulis C. Presl subsp. *longicaulis* var. *longicaulis*, 1, Dedeler Alm, 1466 m., 20.06.2010, K 40° 30' 51" D 031° 38' 36", T 1440, ISTO 35830, Ch.

T. longicaulis C. Presl subsp. *longicaulis* var. *subisophyllus* (Borbas) Jalas, 1, Taşlyayla location, 1451 m., 02.07.2010, K 40° 32' 05" D 031° 37' 53", T 1502, ISTO 35829, Ch.

Mentha pulegium L., 1, Dereceören, 1280 m., 12.09.2010, K 40° 33' 39" D 031° 37' 26", T 1921, ISTO 35801, H.

M. spicata L. subsp. *spicata*, 1, Kabak Village, 945 m., 07.08.2010, K 40° 30' 36" D 031° 29' 33", T 1743, ISTO 35820, H.

Lycopus europaeus L., 1, Kuzgölcük, 1140 m., 25.09.2010, K 40° 31' 53" D 031° 31' 36", T 2001, ISTO 35800, Eu-Sib.el., H.

Ziziphora capitata L., 1, Kozyaka Alm, 1671 m., 19.06.2011, K 40° 29' 25" D 031° 33' 07", T 2654, ISTO 35821, Ir-Tur. el., Th.

Salvia tomentosa Miller, 1, Kabak Village, 927 m., 12.09.2010, K 40° 30' 24" D 031° 39' 10", T 1932, ISTO 35805, Med. el., H.

S. cadmica Boiss., 1, Kabak Village, 1014 m., 04.06.2011, K 40° 29' 19" D 031° 27' 49", T 2447, ISTO 35815, H.

S. cryptantha Montbret & Aucher ex Benth., 1, Kabak Village, 1478 m., 19.06.2011, K 40° 29' 01" D 031° 28' 41", T 2700, ISTO 35816, Ir-Tur. el., H.

S. viridis L., 1, Kabak Village, 896 m., 19.06.2011, K 40° 28' 32" D 031° 27' 46", T 2676, ISTO 35836, Med. el., Th.

S. sclarea L., 1, Kozyaka Alm, 1568 m., 07.08.2010, K 40° 29' 26" D 031° 34' 02", T 1748, ISTO 35831, H.

S. candidissima Vahl. subsp. *occidentalis* Hedge, 1, Kızık Village, 1493 m., 07.08.2010, K 40° 30' 00" D 031° 31' 48", T 1751, ISTO 35832, Ir-Tur. el., H.

S. virgata Jacq., 1, Kızık Village, 1335 m., 12.09.2010, K 40° 29' 52" D 031° 30' 11", T 1939, ISTO 35808, Ir-Tur. el., H.

S. verticillata L. subsp. *verticillata*, 1, Kabak Village, 1129 m., 12.09.2010, K 40° 30' 07" D 031° 29' 47", T 1929, ISTO 35812, Eu-Sib.el., H.

OLEACEAE

Jasminum fruticans L., 1, Kabak Village, 889 m., 04.06.2011, K 40° 28' 31" D 031° 27' 46", T 2401, ISTO 35951, Med. el., Ph.

Fraxinus angustifolia Vahl subsp. *angustifolia*, 1, Kabak Village, 945 m., 31.03.2011, K 40° 29' 39" D 031° 29' 07", T 2309, ISTO 35950, Ph.

OROBANCHACEAE

Orobanche arenaria Borkh., 1, Kozyaka Alm, Avdanboğazı location, 1584 m., 19.06.2011, K 40° 29' 32" D 031° 33' 48", T 2666, ISTO 35960, G.

O. crenata Forsskal, 1, Kabak Village, 948 m., 12.09.2010, K 40° 30' 40" D 031° 29' 37", T 1961, ISTO 35959, G.

O. alba Stephan, 1, Kızık Pond, Kayakapı Hill on the road, 1588 m., 25.09.2010, K 40° 30' 28" D 031° 33' 22", T 1981, ISTO 35961, G.

Melampyrum arvense L. var. *arvense*, 1, Kızık Village, 1512 m., 14.07.2010, K 40° 30' 37" D 031° 32' 57", T 1578, ISTO 35753, Eu-Sib.el., Th.

Euphrasia pectinata Ten., 1, Kabak Village, 951 m., 25.09.2010, K 40° 30' 20" D 031° 29' 11", T 2082, ISTO 35751, Eu-Sib.el., Th.

Pedicularis comosa L. var. *sibthorpii* (Boiss.) Boiss., 1, Kızık Village road, 1578 m., 18.06.2011, K 40° 30' 57" D 031° 33' 56", T 2505, ISTO 35767, H.

Rhinanthus angustifolius C. C. Gmelin subsp. *grandiflorus* (Wall.) D. A. Webb, 1, Taşlıyayla location, 1437 m., 16.05.2010, K 40° 31' 48" D 031° 37' 36", T 1300, ISTO 35754, H.

PLANTAGINACEAE

Plantago major L. subsp. *major*, 1, Dereceören, Su çatı location, 1319 m., 25.09.2010, K 40° 33' 43" D 031° 37' 16", T 2077, ISTO 35958, H.

Globularia trichosantha Fisch. & Mey., 1, Kızık Village, 1526 m., 04.06.2011, K 40° 30' 47" D 031° 33' 10", T 2421, ISTO 35770, H.

Linaria genistifolia (L.) Miller subsp. *genistifolia*, 1, Dereceören, 1270 m., 12.09.2010, K 40° 33' 03" D 031° 37' 13", T 1904, ISTO 35748, Eu-Sib.el., H.

L. corifolia Desf., 1, Kızık Village, 1388 m., 04.06.2011, K 40° 30' 27" D 031° 31' 42", T 2405, ISTO 35762, Ir-Tur. el., H.

Gratiola officinalis L., 1, Dereceören, 1331 m., 14.07.2010, K 40° 33' 57" D 031° 37' 07", T 1514, ISTO 35750, Eu-Sib.el., H.

Digitalis ferruginea L. subsp. *ferruginea*, 1, Kuzgölcük, 1270 m., 29.08.2010, K 40° 31' 59" D 031° 33' 57", T 1873, ISTO 35765, Eu-Sib.el., H.

D. lamarckii Ivan., 1, Kabak Village, 1072 m., 25.09.2010, K 40° 29' 46" D 031° 28' 19", T 2098, ISTO 35764, Ir-Tur. el., H.

Veronica gentionoides Vahl, 1, Kızık Village, 1532 m., 17.04.2010, K 40° 30' 56" D 031° 33' 05", T 1124, ISTO 35758, Eu-Sib.el., H.

V. hederifolia L., 1, Solaklar Alm, 1543 m., 03.05.2011, K 40° 31' 28" D 031° 40' 44", T 2385, ISTO 35755, Th.

V. lysimachioides Boiss., 1, Dereceören, 905 m., 29.08.2010, K 40° 33' 43" D 031° 37' 31", T 1870, ISTO 35759, H.

V. chamaedrys L., 1, Demirciler Alm, 1497 m., 17.04.2010, K 40° 31' 08" D 031° 36' 57", T 1119, ISTO 35761, Eu-Sib.el., H.

V. pectinata L. var. *pectinata*, 1, Kuzgölcük, rocky field, 1159 m., 17.04.2010, K 40° 32' 13" D 031° 33' 16", T 1142, ISTO 35757, H.

V. multifida L., 1, Demirciler Alm, Akçakilise location, 1440 m., 17.04.2010, K 40° 31' 32" D 031° 37' 20", T 1137, ISTO 35756, Ir-Tur. el., H.

V. officinalis L., 1, Kızık Village road, 1505 m., 10.10.2010, K 40° 32' 17" D 031° 36' 05", T 2213, ISTO 35760, Eu-Sib.el., H.

SCROPHULARIACEAE

Verbascum flavidum (Boiss.) Freyn & Bornm., 1, Seben road, 1475 m., 14.07.2010, K 40° 33' 05" D 031° 38' 44", T 1576, ISTO 35749, Eu-Sib.el., H.

V. blattaria L., 1, Kızık road, 1529 m., 19.06.2011, K 40° 30' 50" D 031° 33' 04", T 2663, ISTO 35763, H.

Scrophularia scopolii (Hoppe ex) Pers. var. *scopolii*, 1, Dereceören, 1303 m., 17.04.2010, K 40° 33' 49" D 031° 37' 17", T 1130, ISTO 35752, H.

S. xanthoglossa Boiss. var. *decipiens* (Boiss. & Kotschy) Boiss., 1, Kabak Village, 976 m., 04.06.2011, K 40° 30' 30" D 031° 29' 37", T 2455, ISTO 35766, Ir-Tur. el, H.

BORAGINACEAE

Myosotis ramossima Rochel ex Schultes subsp. *ramossima*, 1, Kabak Village, 1382 m., 16.05.2010, K 40° 33' 52" D 031° 39' 03", T 1330, ISTO 35783, H.

M. stricta Link ex Roemer & Schultes, 1, Demirciler Alm, 1500 m., 02.05.2010, K 40° 31' 05" D 031° 37' 04", T 1272, ISTO 35782, Eu-Sib.el, Th.

M. sylvatica Ehrh. ex Hoffm subsp. *cyanea* Vestergren, 1, Taşlıyayla location, 1443 m., 02.05.2010, K 40° 31' 40" D 031° 36' 53", T 1245, ISTO 35784, H.

M. sylvatica Ehrh. ex Hoffm. subsp. *rivularis* Vestergren, 1, Dereceören, Su Çatı location, 1299 m., 14.07.2010, K 40° 33' 39"

D 031° 37' 22", T 1545, ISTO 35796, Eu-Sib.el, H.

M. lithospermifolia (Willd.) Hornem, 1, Kızık Village, 1580 m., 04.04.2010, K 40° 30' 26" D 031° 33' 43", T 1083, ISTO 35780, Eu-Sib.el., H.

Lithospermum purpureocaeruleum L., 1, Kabak Village, 943 m., 04.06.2011, K 40° 30' 50" D 031° 29' 51", T 2452, ISTO 35792, Eu-Sib.el., H.

Buglossoides arvensis (L.) Johnston, 1, Solaklar Alm, 1532 m., 04.04.2010, K 40° 31' 30" D 031° 40' 40", T 1081, ISTO 35779, Th.

Echium orientale L., 1, Kızık Village, 1612 m., 19.06.2011, K 40° 30' 56" D 031° 33' 43", T 2695, ISTO 35786, Eu-Sib.el., H.

E. italicum L., 1, Kuzgölcük, 1296 m., 15.07.2010, K 40° 31' 56" D 031° 33' 56", T 1665, ISTO 35785, Med. el., H.

E. vulgare L., 1, Kabak Village-Kozyaka Alm, 1417 m., 06.06.2010, K 40° 29' 25" D 031° 30' 50", T 1396, ISTO 35781, Eu-Sib.el., H.

Moltkia coerulea (Willd.) Lehm., 1, Kızık road, 1539 m., 03.05.2011, K 40° 31' 20" D 031° 34' 51", T 2386, ISTO 35790, Ir-Tur. el., H.

Onosma tauricum Pallas ex Willd. subsp. *tauricum*, 1, Kızık Village, 1430 m., 04.06.2011, K 40° 29' 57" D 031° 31' 30", T 2465, ISTO 35793, H.

Cerintho minor L. subsp. *auriculata* (Ten.) Domac, 1, Kızık Village, 1508 m., 12.09.2010, K 40° 30' 40" D 031° 31' 03", T 1978, ISTO 35787, H.

Anchusa leptophylla Roemer & Schultes subsp. *incana* (Ledeb.) Chamb., 1, Korucuk Alm, 1476 m., 04.06.2011, K 40° 29' 19" D 031° 36' 27", T 2400, ISTO 35788, Ir-Tur. el., H.

A. azurea Miller var. *azurea*, 1, Demirciler Alm, 1440 m., 03.05.2011, K 40° 31' 20" D 031° 37' 13", T 2322, ISTO 35791, H.

Nonea pulla (L.) DC. subsp. *monticola* Rech. Fil., 1, Nimetli Alm, 1440 m., 17.04.2010, K 40° 31' 22" D 031° 38' 56", T 1167, ISTO 35795, H.

Alkanna orientalis (L.) Boiss. var. *orientalis*, 1, Kozyaka Alm, 1636 m., 31.03.2011, K 40° 29' 26" D 031° 31' 53", T 2307, ISTO 35789, Ir-Tur. el., H.

AQUIFOLIACEAE

Ilex colchica Poj., 1 Kabak Village, 890 m., 10.10.2010, K 40° 31' 07" D 031° 30' 12", T 2120, ISTO 35548, Eu-Sib.el., Ph.

ASTERACEAE

Inula oculus-christi L., 1, Kızık Village, 1413 m., 14.07.2010, K 40° 29' 08" D 031° 30' 52", T 1560, ISTO 35742, Eu-Sib.el., H.

Helichrysum graveolens (Bieb.) Sweet, 1, Kızık Village, Kayakapı Hill, 1601 m., 14.08.2010, K 40° 29' 49" D 031° 33' 47", T 1801, ISTO 35688, H.

H. plicatum DC. subsp. *plicatum*, 1, Korucuk Alm, 1306 m., 10.10.2010, K 40° 28' 29" D 031° 35' 43", T 2167, ISTO 35685, H.

H. arenarium (L.) Moench subsp. *aucheri* (Boiss.) P. H. Davis & Kupicha, 1, Demirciler Alm, 1602 m., 07.08.2010, K 40° 31' 01" D 031° 35' 20", T 1721, ISTO 35732, Eu-Sib.el., H.

Filago vulgaris Lam., 1, Dereceören, Kuyupınar Hill location, 1280 m., 10.10.2010, K 40° 33' 43" D 031° 37' 19", T 2166, ISTO 35686, Th.

Conyza canadensis (L.) Cronquist, 1, Kuzgölcük, 1037 m., 21.03.2010, K 40° 32' 11" D 031° 32' 10", T 2041, ISTO 35718, Th.

Bellis perennis L., 1, Demirciler Alm, 1447 m., 26.02.2011, K 40° 31' 28" D 031° 36' 57", T 2251, ISTO 35719, Eu-Sib.el., H.

Doronicum orientale Hoffm., 1, Demirciler Alm, 1446 m., 17.04.2010, K 40° 31' 41" D 031° 36' 52", T 1113, STO 35729, H.

Senecio integrifolius (L.) Clairv. subsp. *aucheri* (DC.) Matthews, 1, Kızık Village road, 1603 m., 19.06.2011, K 40° 30' 23" D 031° 33' 31", T 2629, ISTO 35747, Eu-Sib.el., H.

S. vernalis Waldst. & Kit., 1, Korucuk Alm, 1414 m., 17.04.2010, K 40° 29' 23" D 031° 36' 36", T 1178, ISTO 35713, Th.

Tussilago farfara L., 1, Kıbrısık Seben turnout, 1512 m., 31.03.2011, K 40° 33' 09" D 031° 39' 13", T 2287, ISTO 35706, Eu-Sib.el., H.

Cota tinctoria L. var. *tinctoria*, 1, Dedeler Alm, 1443 m., 05.07.2010, K 40° 30' 58" D 031° 38' 29", T 1677, ISTO 35738, H.

Cota tinctoria var. *discoidea* (All.) Özbek & Vural, 1, Kızık turnout, Taşlyayla

location, 1443 m., 05.07.2010, K 40° 31' 40" D 031° 36' 33", T 1678, H.

Achillea nobilis L. subsp. *neilreichii* (Kerner) Formanek., 1, Bozyer Alm, 1515 m., 07.08.2010, K 40° 30' 24" D 031° 39' 43", T 1767, ISTO 35698, Eu-Sib.el., H.

Tanacetum poteriifolium (Ledeb.) Grierson, 1, Dereceören, 1396 m., 07.08.2010, K 40° 33' 17" D 031° 37' 51", T 1757, ISTO 35691, Eu-Sib.el., H.

T. parthenium (L.) Schultz Bip., 1, Dereceören, 1310 m., 07.08.2010, K 40° 34' 03" D 031° 36' 59", T 1755, ISTO 35690, H.

T. armenum (DC.) Schultz Bip., 1, Demirciler Alm, 1506 m., 04.04.2010, K 40° 31' 12" D 031° 36' 55", T 1070, ISTO 35730, H.

Tripleurospermum tenuifolium (Kit.) Freyn, 1, Kızık Village, 1565 m., 02.07.2010, K 40° 30' 53" D 031° 32' 49", T 1478, ISTO 35743, Eu-Sib.el., H.

Cirsium hypoleucum DC., 1, Kızık Village turnout, 1593 m., 07.08.2010, K 40° 31' 07" D 031° 34' 27", T 1703, ISTO 35744, Eu-Sib.el., H.

C. arvense (L.) Scop. subsp. *vestitum* (Wimmer & Grab.) Petrak, 1, Kabak Village, 1538 m., 10.10.2010, K 40° 28' 56" D 031° 38' 58", T 2197, ISTO 35716, H.

Carduus nutans L. subsp. *nutans*, 1, Taşlyayla location, 1436 m., 14.07.2010, K 40° 31' 58" D 031° 38' 20", T 1566, ISTO 35741, H.

Jurinea consanguinea DC., 1, Kızık Village, 1620 m., 14.08.2010, K 40° 30' 06" D 031° 31' 52", T 1877, ISTO 35702, H.

Acroptilon repens (L.) DC., 1, Kabak Village, 985 m., 25.09.2010, K 40° 30' 27" D 031° 29' 22", T 2039, ISTO 35700, Ir-Tur. el., H.

Centaurea amasiensis Bornm., 1, Kızık Village, 1435 m., 12.09.2010, K 40° 30' 35" D 031° 32' 43", T 1901, ISTO 35697, H.

C. olympica C. Koch, 1, Dereceören, Su Çatı location, 1303 m., 29.08.2010, K 40° 33' 48" D 031° 37' 16", T 1880, H.

C. consanguinea DC., 1, Kızık Village, 1466 m., 07.08.2010, K 40° 29' 50" D 031° 31' 36", T 1717, ISTO 35735, Ir-Tur. el., H.

C. inexpectata Wagenitz, 1, Kuzgölcük, 1316 m., 29.08.2010, K 40° 31' 39" D 031° 33' 04", T 1879, ISTO 35699, Eu-Sib.el., H.

- C. thracica* (Janka) Hayek, 1, Kızık Village, 1539 m., 29.08.2010, K 40° 30' 39" D 031° 32' 45", T 1878, ISTO 35687, H.
- C. solstitialis* L. subsp. *solstitialis*, 1, Kabak Village, 954 m., 07.08.2010, K 40° 29' 49" D 031° 28' 08", T 1721, ISTO 35734, Th.
- C. urvillei* DC. subsp. *stepposa* Wagenitz, 1, Kabak Village, 904 m., 07.08.2010, K 40° 28' 46" D 031° 27' 36", T 1754, ISTO 35745, Ir-Tur. el., H.
- C. pichleri* Boiss. subsp. *pichleri*, 1, Dedeler Alm, 1441 m., 17.04.2010, K 40° 30' 59" D 031° 38' 19", T 1186, ISTO 35714, Th.
- C. triumfettii* All., 1, Demirciler Alm, 1447 m., 07.08.2010, K 40° 31' 42" D 031° 36' 52", T 1752, ISTO 35689, H.
- Crupina crupinastrum* (Moris) Vis., 1, Kabak Village, 1060 m., 19.06.2010, K 40° 30' 08" D 031° 29' 20", T 2637, ISTO 35696, Th.
- Cnicus benedictus* L. var. *benedictus*, 1, Kabak Village, 904 m., 18.06.2011, K 40° 29' 09" D 031° 27' 43", T 2478, ISTO 35720, Th.
- Carlina corymbosa* L., 1, Dereceören, 1315 m., 10.10.2010, K 40° 33' 58" D 031° 37' 18", T 2105, ISTO 35704, Med. el., H.
- C. vulgaris* L., 1, Dereceören, Gökçepınar Kayası, 1256 m., 10.10.2010, K 40° 33' 05" D 031° 37' 14", T 2106, ISTO 35705, H.
- Xeranthemum annuum* L., 1, Kabak Village, 998 m., 07.08.2010, K 40° 28' 30" D 031° 27' 58", T 1765, ISTO 35692, Th.
- Echinops microcephalus* Sm., 1, Kabak Village, 894 m., 10.10.2010, K 40° 28' 45" D 031° 27' 40", T 2107, ISTO 35703, Med. el., H.
- E.sphaerocephalus* L. subsp. *sphaerocephalus*, 1, Korucuk Alm, 1302 m., 10.10.2010, K 40° 28' 40" D 031° 35' 20", T 2113, ISTO 35717, Eu-Sib.el., H.
- Scolymus hispanicus* L., 1, Dereceören, Su Çatı location, 1300 m., 25.09.2010, K 40° 33' 47" D 031° 37' 21", T 2021, Med. el., H.
- Cichorium inthybus* L., 1, Kuzgölcük, 215 m., 25.09.2010, K 40° 32' 08" D 031° 39' 03", T 2019, H.
- Scorzonera mollis* Bieb. subsp. *szowitzii* (DC.) Chamberlain, 1, Kabak Village, 1251 m., 04.06.2011, K 40° 29' 38" D 031° 29' 23", T 2425, ISTO 35715, Ir-Tur. el, H.
- Tragopogon longirostris* Bisch. ex Schultz Bip. var. *longirostris*, 1, Kıbrısçık-Seben turnout, 1496 m., 04.06.2011, K 40° 33' 15" D 031° 39' 03", T 2423, ISTO 35733, H.
- T. coloratus* C.A. Meyer, 1, Kabak Village, 995 m., 20.06.2010, K 40° 30' 27" D 031° 29' 35", T 2612, Ir-Tur. el., H.
- T. aureus* Boiss., 1, Kızık Village, 1513 m., 14.07.2010, K 40° 30' 34" D 031° 32' 56", T 2023, ISTO 35746, H.
- Leontodon asperrimus* (Willd.) J. Ball, 1, Kozyaka Alm, 1612 m., 05.07.2010, K 40° 29' 29" D 031° 33' 30", T 1692, ISTO 35737, Ir-Tur. el., H.
- L. crispus* Vill. subsp. *asper* (Waldst. & Kit.) Rohl. var. *asper*, 1, Kuzgölcük, 1345 m., 05.07.2010, K 40° 31' 36" D 031° 33' 01", T 1696, ISTO 35736, H.
- Hieracium medianiforme* (Litw. & Zahn) Juxip, 1, Taşlıyayla location, 1441 m., 06.06.2010, K 40° 31' 51" D 031° 37' 16", T 1370, ISTO 35739, H.
- H. pannosum* Boiss., 1, Kabak Village, 1094 m., 29.08.2010, K 40° 30' 14" D 031° 29' 50", T 1869, ISTO 35701, Med. el., H.
- Pilosella hoppeana* (Schultes) C. H. & F. W. Schultz subsp. *testimonialis* (Naegli ex Peter) Sell & West, 1, Nimetli Alm, 1448 m., 25.09.2010, K 40° 31' 21" D 031° 39' 03", T 2016, ISTO 35694, Eu-Sib.el., H.
- P. piloselloides* (Vill.) Sojak subsp. *piloselloides*, 1, Dereceören turnout, 1417 m., 07.08.2010, K 40° 33' 33" D 031° 38' 10", T 1766, ISTO 35693, H.
- Lactuca saligna* L., 1, Demirciler Alm, 1438 m., 25.09.2010, K 40° 31' 33" D 031° 37' 08", T 2020, ISTO 35695, H.
- Lapsana communis* subsp. *alpina* (Boiss. & Bal.) Sell, 1, Kızık Village turnout, 1480 m., 06.06.2010, K 40° 31' 50" D 031° 35' 54", T 1376, ISTO 35731, Eu-Sib.el., H.
- L. communis* subsp. *intermedia* (Bieb.) Hayek, 1, Dereceören, 1361 m., 06.06.2010, K 40° 33' 35" D 031° 37' 27", T 1372, ISTO 35740, H.
- Taraxacum macrolepium* Schischkin, 1, Kuzgölcük, 1316 m., 07.03.2010, K 40° 31' 48" D 031° 32' 43", T 1026, ISTO 35728, H.
- Chondrilla juncea* L. var. *juncea*, 1, Taşlıyayla location, 1439 m., 10.10.2010, K 40° 31' 50" D 031° 37' 49", T 2171, ISTO 35684, H.

CAMPANULACEAE

Campanula lyrata Lam. subsp. *lyrata*, 1, Dereceören, 1299 m., 10.10.2010, K 40° 33' 12" D 031° 37' 32", T 2129, ISTO 35943, H.

C. rapunculoides L. subsp. *rapunculoides*, 1, Kızık Village, 1084 m., 14.08.2010, K 40° 30' 12" D 031° 29' 38", T 1802, ISTO 35938, Eu-Sib.el., H.

C. rapunculoides L. subsp. *cardifolia* (C. Koch) Damboldt, 1, Dereceören, Asardere location, 1266 m., 25.09.2010, K 40° 33' 23" D 031° 37' 26", T 2086, ISTO 35941, H.

C. glomerata L. subsp. *hispida* (Witasek) Hayek, 1, Kızık Village turnout, 1590 m., 10.10.2010, K 40° 30' 58" D 031° 33' 51", T 2136, ISTO 35942, Eu-Sib.el., H.

C. cymbalaria Sm., 1, Taşlıyayla location, 1447 m., 14.07.2010, K 40° 32' 03" D 031° 37' 54", T 1513, ISTO 35940, Med. el., H.

C. persicifolia L., 1, Kuzgölcük, Erenler Hill location, 1350 m., 14.07.2010, K 40° 31' 34" D 031° 33' 19", T 1581, ISTO 35939, Eu-Sib. el., H.

Asyneuma amplexicaule (Willd.) Hand.-Mazz. subsp. *amplexicaule* var. *amplexicaule*, 1, Kızık Village, 1545 m., 14.07.2010, K 40° 31' 20" D 031° 34' 50", T 1604, ISTO 35931, H.

A. limonifolium (L.) Janchen subsp. *limonifolium*, 1, Kızık Village, 1487 m., 14.07.2010, K 40° 29' 50" D 031° 31' 39", T 1586, ISTO 35933, H.

A. limonifolium (L.) Janchen subsp. *pestalozzae* (Boiss.), 1, Kızık Pond, 1554 m., 14.07.2010, K 40° 30' 45" D 031° 32' 52", T 1553, ISTO 35937, H.

A. rigidum (Willd.) Grossh. subsp. *rigidum*, 1, Korucuk Alm, 1454 m., 02.07.2010, K 40° 29' 38" D 031° 35' 56", T 2089, ISTO 35934, Ir-Tur. el., H.

A. rigidum (Willd.) Grossh. subsp. *sibthorpiatum*, 1, Kızık Village, 1619 m., 14.07.2010, K 40° 30' 07" D 031° 33' 57", T 1602, ISTO 35932, Med. el., H.

Legousia speculum-veneris (L.) Chaix, 1, Kozyaka Alm, 1572 m., 15.07.2010, K 40° 29' 37" D 031° 34' 02", T 1683, ISTO 35935, Med. el., Th.

L. pentagonia (L.) Thellung, 1, Korucuk Alm, 1483 m., 20.06.2010, K 40° 29' 11" D 031° 35' 39", T 1405, ISTO 35936, Med. el., Th.

APIACEAE

Astrantia maxima Pallas subsp. *haradjianii* (Grintz) Rech., 1, Dereceören, 1259 m., 12.09.2010, K 40° 33' 19" D 031° 37' 26", T 1968, ISTO 35657, H.

Eryngium giganteum Bieb., 1, Kızık Village, 1459 m., 01.09.2011, K 40° 30' 45" D 031° 32' 34", T 2745, Eu-Sib.el., H.

E. bithynicum Boiss., 1, Kabak Village, Toprak Hill location, 949 m., 01.09.2011, K 40° 30' 20" D 031° 29' 09", T 2746, H.

Scandix iberica Bieb., 1, Kızık Village, 1359 m., 18.06.2011, K 40° 29' 17" D 031° 30' 37", T 2555, ISTO 35659, H.

Bunium microcarpum (Boiss) Freyn. subsp. *bourgaei* (Boiss.) Hedge & Lamond, 1, Kabak Village, 1445 m., 02.05.2010, K 40° 29' 12" D 031° 30' 53", T 1261, ISTO 35656, Ir-Tur. el., G.

Bupleurum rotundifolium L., 1, Kızık Village, 995 m., 01.09.2011, K 40° 30' 27" D 031° 29' 35", T 2730, ISTO 35658, Th.

B. falcatum L. subsp. *cernuum* (Ten.) Arc., 1, Kızık Village, 1280 m., 14.07.2010, K 40° 30' 11" D 031° 30' 10", T 1573, ISTO 35652, Th.

Malabaila secacul Banks & Sol., 1, Kızık Village, 1595 m., 01.09.2011, K 40° 30' 21" D 031° 33' 45", T 2747, H.

Heracleum platytaenium Boiss., 1, Kabak Village, 955 m., 20.06.2010, K 40° 29' 37" D 031° 27' 08", T 2542, ISTO 35660, Eu-Sib.el., H.

Caucalis platycarpus L., 1, Yukarı Kabak District, 1200 m., 19.06.2011, K 40° 29' 46" D 031° 29' 24", T 2715, ISTO 35654, Th.

Turgenia latifolia (L.) Hoffm., 1, Kabak Village, Sivrice Kaya Hill location, 954 m., 19.06.2011, K 40° 29' 42" D 031° 29' 23", T 2671, ISTO 35653, Th.

Artemisia squamata L., 1, Dereceören, Gökçepinar Kayası location, 1447 m., 05.07.2010, K 40° 32' 40" D 031° 37' 20", T 1648, ISTO 35655, Th.

ARALIACEAE

Hedera helix L., 1, Kabak Village, 910 m., 10.10.2010, K 40° 28' 47" D 031° 27' 30", T 2217, ISTO 35661, Ph.

CAPRIFOLIACEAE

Sambucus ebulus L., 1, Taşlıyayla location, 1443 m., 25.09.2010, K 40° 31' 36" D 031° 36' 39", T 2051, ISTO 35666, Eu-Sib.el., H.

S. nigra L., 1, Kızık Village on the road, 1603 m., 16.05.2010, K 40° 31' 01" D 031° 33' 42", T 1309, ISTO 35662, Eu-Sib.el., Ph.

Viburnum lantana L., 1, Kızık Village, 1567 m., 18.06.2011, K 40° 30' 31" D 031° 33' 23", T 2494, ISTO 35663, Eu-Sib.el., Ph.

Lonicera caucasica Pallas subsp. *orientalis* (Lam.) Chamb. & Long., 1, Kuzgölcük Village, 1111 m., 10.10.2010, K 40° 30' 10" D 031° 29' 51", T 2126, ISTO 35664, Ph.

L. etrusca Santi var. *etrusca*, 1, Kabak Village, 951 m., 04.06.2011, K 40° 30' 46" D 031° 29' 50", T 2396, ISTO 35665, Med. el., Ph.

DIPSACACEAE

Cephalaria gigantea (Ledeb.) Bobrov, 1, Kızık Village, 1554 m., 14.08.2010, K 40° 30' 30" D 031° 33' 14", T 1810, ISTO 35679, Eu-Sib.el., H.

Knautia degenii Barbas ex Formanek, 1, Kabak Village, 913 m., 14.07.2010, K 40° 30' 10" D 031° 28' 24", T 1591, ISTO 35682, Med. el., Th.

K. involucrata Som. & Lev., 1, Kızık Village, 1554 m., 14.07.2010, K 40° 30' 30" D 031° 33' 14", T 1592, ISTO 35680, Eu-Sib.el., H.

Scabiosa columbaria L. subsp. *ochroleuca* (L.) Celak. var. *ochroleuca* (L.) Coluter, 1, Kızık Village, 1510 m., 01.09.2011, K 40° 30' 35" D 031° 32' 57", T 2748, ISTO 35683, H.

S. argentea L., 1, Korucuk Alm location, 1360 m., 14.07.2010, K 40° 29' 00" D 031° 35' 29", T 1599, ISTO 35681, H.

S. micrantha Desf., 1, Kızık, Gölcük District location, 1353 m., 12.09.2010, K 40° 30' 18" D 031° 31' 26", T 1900, ISTO 35678, Th.

MORINACEAE

Morina persica L. var. *persica*, 1, Kozyaka Alm, 1393 m., 19.06.2011, K 40° 29' 15" D 031° 30' 37", T 2709, ISTO 35677, Ir-Tur. el., H.

VALERIANACEAE

Valeriana alliarifolia Adams, 1, Keskinli Alm, 1555 m., 05.07.2010, K 40° 30' 02" D 031° 36' 59", T 1679, ISTO 35676, H.

V. dioscoridis Sm., 1, Kabak Village, 938 m., 03.05.2011, K 40° 29' 40" D 031° 27' 38", T 2350, ISTO 35674, Med. el., H.

Centranthus longiflorus Stev. subsp. *longiflorus*, 1, Kozyaka Alm, 1486 m., 18.06.2011, K 40° 28' 43" D 031° 33' 14", T 2608, ISTO 35675, Ir-Tur. el., H.

Discussion and conclusion

With this study, 1750 plant specimens were identified as 575 taxa belonging to 298 genera and 80 families have been determined. 5 of these taxa are Pteridophyta and 570 of it are Spermatophyta. 8 of these 570 Spermatophyta are Gymnospermae, and 562 of it are Angiospermae.

The distribution of identified taxa within the phytogeographical regions is showed in the Table 2. It is determined that there is Euro-Siberian elements mostly (Table 2).

Table 2: The distribution of taxa in the research area within the phytogeographical regions

Phytogeographical region	Taxa Number	Proportional distribution (%)
Euro-Siberian	129	22,5
Irano-Turanian	57	9,94
Mediterranean	52	9,07
Widely distributed plants and unknowns	337	58,46
Total	575	100

The first 5 families which include the most plant genera and the proportions of the number of taxa in these families to the total number of flora are given in the Table 3. In the research area, the family of Compositae includes the highest number of genera with 34 specimens. Its ratio is 11.5 (Table 3 and Table 4).

In the research area, the families which include the most taxa are: Leguminosae 61 taxa (%10,64) and Compositae 56 taxa (%9,77). In the flora of Turkey, Compositae family is in the first place and Leguminosae family is in the second (Table 4).

Table 3. The 5 families which include the most plant genera and the proportions of them

Family	The number of genera	The proportion of these genera in the total number of genera%
Asteraceae	34	11,5
Labiatae	21	7,11
Poaceae	21	7,11
Brassicaceae	20	6,77
Fabaceae	19	6,44
Others	183	61,43

Table 4: The 5 families which include the most taxa in the research area

Familya	Takson Sayısı	Toplam Tür Sayısına Oran %
Fabaceae	61	10,64
Asteraceae	56	9,77
Labiatae	42	7,32
Poaceae	32	5,58
Brassicaceae	31	5,41
Diğerleri	353	61,39

Table 5: The distribution of life forms of the plants according to Raunkier plant life-form

Life form	Taxa number	Proportional distribution %
Phanerophyte	70	12,21
Chamaephyte	34	5,93
Hemicryptophyte	288	50,26
Cryptophyte	69	11,69
Geophyte	65	10,99
Hydrophyte	(65 + 4)	+ 0,69)
Therophyte	114	19,89
Total	575	100

Life forms of plants revealed that hemicryptophyte plants are in the first place with 288 taxa while therophyte plants are the second with 114 taxa. The density of the phanerophyte plants with 70 taxa and geophyte plants with 65 taxa also shows that the research area has a rich floristic structure with phanerophyte and geophyte plants (Table 5).

The comparison of the research area with the phytogeographical regions of other flora studies is given in the Table 6. The proportion of Euro-Siberian taxa in the

identified total taxa is %22,5. In this sense, the most similar studies to this study are the Flora of Abant (% 29,3) and the Flora of Gölcük (Bolu) (% 31,8). Both of these studies take place in the Sub-Euxine belts of Euro-Siberian floristic area. Therefore, when it is compared to this study Euro-Siberian taxa is higher in these two studies.

The research area can be evaluated as a bridge between the Euro-Siberian and Irano-Turanian floristic regions. So, the rates of Euro-Siberian taxa are relatively lower when compared to these two studies. When the other three studies Flora of Karakiriş Mountain are (% 13,4) Flora of Doğan Dede Hill and Its Environment (%2,98) and Flora of Nallıhan Kuş Cenneti (% 4,53) are examined it is seen that the rates of Euro-Siberian taxa are lower than this study because these three studies take place in the Irano-Turanian floristic region. The proportion of Irano-Turanian taxa in the identified total taxa is % 9, 94. This rate is quite high when compared to Flora of Abant (% 4,7) and the Flora of Gölcük (Bolu) (% 1,6) which is in the north of the research area and carried out in the Sub-Euxine belts of Euro-Siberian floristic area. The reason of it is that the research area has slopes looking Central Anatolian Region (Irano-Turanian floristic region).

One of the remarkable results is the density of the Mediterranean floristic region plants with the rate of % 9,07. This rate is the second highest rate when compared to other five flora studies. The reason of this high rate of the Mediterranean floristic region plants is the Aladağ Stream Valley that constitutes the north and the west borders of the research area. This valley includes Mediterranean floristic region plants because of the warm air coming from Sakarya Valley which penetrates into this valley (Table 6).

In the research area among the identified 80 families, the 5 families which have the most taxa are compared with other five flora studies (Table 7). All studies in the region show that the family of Leguminosae and Compositae families had the highest rates of taxa.

Table 6. Comparison of the flora studies of near environment with the elements of phytogeographical regions (%)

	Research Areas					
	1	2	3	4	5	6
Euro-Siberian	22,5	13,4	2,98	4,53	29,3	31,8
Irano-Turanian	9,94	26,1	30,79	25,21	4,7	1,6
Mediterranean	9,07	7,78	8,27	9,63	5,6	5,5
Widely distributed plants and unknowns	58,49	52,7	57,95	60,63	60,6	61,1

- 1- TUNÇKOL, Flora Of Taşlıyayla And Kızık (Bolu – Seben) Surrounding
2- AKSOY, Flora of Karakiriş Mountain
3- GÜNER, Flora of Doğan Dede Hill and Its Environment
4- DOĞAN, Flora of Nallıhan Kuş Cenneti
5- TÜRKER, Flora of Abant
6- İKİNCİ, Flora of Gölcük (Bolu)

Table 7. The comparison of the families which include the most taxa in the neighbourhood of the research area (%)

Families	Research Areas					
	1	2	3	4	5	6
Fabaceae	10.6	11.8	13.2	10.8	6.9	8.6
Asteraceae	9.8	14.1	8.4	13.9	10.3	9.8
Labiatae	7.3	7.5	11.6	7.4	7.0	5.0
Poaceae	5.6	6.8	5.3	6.8	8.3	9.8
Brassicaceae	5.4	3.9	6.0	6.2	4.7	4.1

- 1- TUNÇKOL, Flora of Taşlıyayla And Kızık (Bolu – Seben) Surrounding
2- AKSOY, Flora of Karakiriş Mountain
3- GÜNER, Flora of Doğan Dede Hill and Its Environment
4- DOĞAN, Flora of Nallıhan Kuş Cenneti
5- TÜRKER, Flora of Abant
6- İKİNCİ, Flora of Gölcük (Bolu)

With this study, the flora of an area in which there is not a floristic study before, has been identified. It has also been determined that the research area is rich in woody plants and geophytes and it is an important transition center in the sense of endemic plants with identified 80 endemic taxa (Tunçkol and Akkemik, 2013). Also, 58 of the identified taxa, are new records for the A3 square (Tunçkol and Akkemik, 2013). So, it shows that floristic studies has not been completed in our country yet.

During the fieldworks to reserach area from the February 2010 to the October 2011, it is determined that there is a rapid increase in the touristic and uncontrolled constructions and second-house construction in the alms and pastures around Taşlıyayla Lake. These new buildings cause the decrease in the pasture areas and they threats

the floristic structure of Taşlıyayla part of the research area.

In fact, it must be determined the threats and oppression on the wetlands, coastlines, alms and pastures in such areas in which it is ignored the Environmental laws and in which there is rapid increase in uncontrolled constructions. In addition to that it must carefully be enforced the Environmental laws and it must be taken into consideration that the necessity to prepare the environmental impact assessment (EPA) reports in such areas which is under heavy human impact.

Acknowledgement

This study is the main part of the master thesis done by the first writer. It was supported by The Research Found of Istanbul University (project number 12802).

Resources

Akkemik, Ü., Yılmaz, H., 2016. A new species record for the flora of Turkey: *Barbarea bracteosa* Guss. Journal of the Faculty of Forestry Istanbul University 66(2): 636-640. DOI: 10.17099/jffiu.28935

Aksoy, N., 2001. Karakiriş Dağı (Seben-Nallıhan) Florası, Yüksek Lisans Tezi, İ.Ü. Fen Bilimleri Enstitüsü, İstanbul.

Anonim, 2004. Seben Orman İşletme Müdürlüğü, Taşlıyayla Orman İşletme Şefliği Amenajman Planı, Orman Genel Müdürlüğü, Bolu Orman Bölge Müdürlüğü, Çevre Ve Orman Bakanlığı.

Avcı, M., 1993. Türkiye'nin Flora Bölgeleri ve Anadolu Diyagonalı ne Coğrafi Bir Yaklaşım, Türk Coğrafya Dergisi, 28, 225-248

Boisser, E., (1867- 1888). Flora Orientalis Volume: 1-5, Supplement by Buser, R. Geneve, Switzerland.

Cole TCH, Hilger HH, Doğru-Koca A., 2016. Kapalı Tohumluların Filogenisi-Çiçekli Bitkiler Sistematiği, DOI:10.13140/RG.2.1.4533.7203

Çepel, N., 1995. Orman Ekolojisi, (3. Baskı), İ.Ü. Basımevi, Yayın No:3886, Sosyal B.M.Y.O Yayın No:433, İstanbul, 975-404-398-1.

Davis, P. H., 1971. Plant Life of South-west Asia, The Botanical Society of Edinburgh, Edinburgh.

Davis, P. H., 1965-1985. Flora of Turkey and East Aegean Islands vol. 1-9, Edinburg University Press, Edinburg.

Davis, P. H., Mill, R.R. and Tan, K., 1988. Flora of Turkey and East Aegean Islands vol. 10 (suppl. 1), Edinburg University Press, Edinburg.

Doğan, E., 2000. Nallıhan Kuş Cenneti Florası (Ankara), Yüksek Lisans Tezi, G.Ü. Fen Bilimleri Enstitüsü-Ankara

Ekim, T.; İlarıslan, R., 1982. Yedigöller Milli Parkı'nın (Bolu) Florası. Orm. Araşt. Enst. Derg. 28 (56), 53-67.

Güner, A., Özhatay, N., Ekim, T., Başer, K.H.C., 2000. Flora of Turkey and East Aegean Islands vol. 11 (suppl. 2), Edinburg University Press, Edinburg.

Güner, M.B., 2000, Doğandede Tepe ve Çevresi (Beypazarı-Ankara) Florası, Yüksek Lisans Tezi, G.Ü. Fen Bilimleri Enstitüsü, Ankara.

İkinci, N., 2000, The Flora of Gölcük Area (Bolu), MSc Thesis, A.İ.B.U. Department of Biology, Bolu.

Kaptanoğlu, D., 1995. Yaylacık Araştırma Ormanı (Bolu-Mengen) Florası, Yüksek Lisans Tezi, G.Ü. Fen Bilimleri Enstitüsü, Ankara.

Özhatay, N., Kültür, Ş., Aksoy, Ş., 1994. Chek-List of Additional Taxa to the Supplement

Flora of Turkey, Turkish Journal of Botany, Vol. 18,6:497-514, Ankara

Özhatay, N., Kültür, Ş., Aksoy, Ş., 1999. Chek-List of Additional Taxa to the Supplement Flora of Turkey, Turkish Journal of Botany, Vol. 23,3:151-169, Ankara.

Özhatay, N., Byfield, A., Atay, S., 2003. Türkiye'nin Önemli Bitki Alanları, WWF Türkiye (Doğal Hayatı Koruma Vakfı), İstanbul, 975-92433-0-X.

Özyuvacı, N., 1999. Meteoroloji ve Klimatoloji, İ.Ü. Orman Fakültesi Yayınları, Rektörlük No:4196, Fakülte No:460, İstanbul, 975-404-544-5

Şahin, C., 1984. Aladağ Çayı Havzasında Abiyotik Çevre Koşulları ve Bunlarla İlgili Bizulmuş Doğal Dengenin Yeniden Kurulmasına İlişkin Sorunlar ve Çözüm Yolları, TUBITAK Çevre Araştırmaları Grubu, ÇAĞ-55 No'lu Proje.

Tutin, T.G., Heywood, V.H., Burges, N.A., Valentine, D.H., Walters, S.M. ve Webb, D.A., 1964-1993. Flora Europaea vol. 1-5, Chambridge University Press, Chambridge.

Türker, H., 1990. Ayaş, Güdül, Beypazarı ve Polatlı Arasında Kalan Bölgenin Florası, Yüksek Lisans Tezi, G.Ü. Fen Bilimleri Enstitüsü, Ankara.

Uluğ, M., 1999. Gökçeler Dağının (Gerede, Eskipazar) Florası, Yüksek Lisans Tezi, A.Ü. Fen Bilimleri Enstitüsü, Ankara.

Uçar, A., 1996. Flora of Abant, A.İ.B.U. Department of Biology, Bolu.

Vural, M., 2009. Biyoçeşitlilik Sözleşmesi ve Türkiye'nin Floristik Yapısı. Bağbahçe Dergisi, 24. Sayı, sayfa 8-9.

Habitat and Phenological Properties of *Crocus ancyrensis* (Herbert) Maw

*İnci Sevinç KRAVKAZ KUŞÇU¹, Hasan VURDU¹, Nurcan YİĞİT¹

¹Kastamonu University, Faculty of Forestry, Kastamonu/TURKEY

*Corresponding Author: ikravkaz@kastamonu.edu.tr

Abstract

The climate, geology and geomorphological characteristics of Turkey caused to has the rich biological diversity. This is a great chance for the country. Because, Turkey has a more than 10000 different plant species. As a comparison, the European continent has about 12000 plant species eventhough continent land area is 15 times more than Turkey. Thus, Turkey has a rich biological diversity as compare to European continent. Under biological diversity, the bulbous plants are getting very importance and many researches have been contining on them. *Crocus ancyrensis* (Herbert) Maw is a corm forming plant and endemic species of Turkey. The purpose of this paper is to explain the research finding on *Crocus ancyrensis* growth habitat, flower type, phenological characteristics and soil requirement. In addition, it becomes economic value for the people and country.

Keywords: *Crocus ancyrensis* (Herbert) Maw., Phenology, Soil

Crocus ancyrensis (Herbert) Maw'ın Yetiştirme Ortamı ve Fenolojik Özellikleri

Özet

Türkiye; iklimi, jeolojisi ve jeomorfolojik özelliklerinden dolayı zengin bir biyoçeşitliliğe sahiptir. Bu ülke için büyük bir şanstır. Çünkü Türkiye 10000 den fazla bitki türüne sahiptir. Avrupa kıtasının, Türkiye'nin 15 katı büyüklüğünde olduğu düşünüldüğünde yurdumuzun floristik bakımdan ne kadar zengin olduğu daha iyi anlaşılacaktır. Biyolojik çeşitlilik içinde soğanlı bitkiler oldukça önem kazanmış ve soğanlı bitkilerle ilgili bir çok araştırma devam etmektedir. *Crocus ancyrensis* (Herbert) Maw korumlu bir bitki ve Türkiye için ednemik bir türdür. Bu çalışmanın amacı *Crocus ancyrensis* (Herbert) Maw' ın yetiştirme ortamı, çiçeklenme biçimi, fenolojik özellikleri ve toprak isteklerini açıklamaktır. Buna ek olarak, insanlar ve ülke için ekonomik değerini ortaya koymaktır.

Anahtar Kelimeler: *Crocus ancyrensis* (Herbert) Maw, Fenoloji, Toprak

Introduction

Turkey has a rich biological diversity of *Crocus* species (Davis, 1985; Ekim et al., 2000). It is know that *Crocus* genus belongs to the Iridaceae family and is represented by 85 species (Caiola,2004; Kravkaz,2008).

The exception of the cultivated species *Crocus Sativus* L. of these 72 taxa found in Turkey are wild and flower in spring or in Autumn on open, grazed, mountain side forest, among grasses and under various shrubs or tress (Kravkaz and Vurdu,2010).

Crocus species often grow in woods or meadows and scrubs by themselves (Vurdu et al., 2003, Acartürk, 2004). They mostly prefer half-shadow/full light places and mild climates in terms of cultivation requirements.

They generally favor humid soils that are with good drainage, fertility, sand, and rotted

leaves and rich in organic matter.They do not need much water, and they are resistant to cold (Yücel, 2002).

In Kastamonu province, *Crocus ancyrensis* (Herbert) Maw is one of the *Crocus* species that are widely grown. This study deals with phenological observations on the crocuses growing in Kastamonu province to indicate the phenology and certain basic soil characteristics of the species.

Material and Method

Material

The study material includes *Crocus ancyrensis* (Herbert) Maw), which is an endemic species of Turkey naturally growing in Kastamonu province. The *Crocus* species belong to *Iridaceae* family and they are perennial. They are herbaceous and have

corms. There are two corms on top of each other on the plant. One is large and the other is small (Ersoy, 1998). Corms have diverse shapes and sizes; however, they are generally in the forms of ellipsoid, oblate sphere, or eggs (Selvi, 2005). There are rings with or without ribs at the base of corms of certain crocus species. In addition, in some species, there is a cover called tunica protecting the corm from external influences whose formation is like webs, threads, membranes, or skins. The leaves are surrounded by a sheath. This sheath is fine, membranous, greenish, whitish, or light brown. Their number ranges from 3 to 5. The leaves spurting from the base of corm generally appear either with flowers or after the disappearance of flowers. Generally, the leaves of crocus species flowering in spring appear with flowers, whereas those of crocus species flowering in fall appear after the flowering. Upper faces of the leaves are white in the middle with stripes, plain, or sometimes with canaliculus, whereas median vein has two deep canals on both sides underside. Flowering takes place in fall months (i.e. September and December) or in the early spring (i.e. February and April) (Selvi, 2005). Flowers exist either as single or in numbers at the top of a short underground stem either in fall or spring (Özdemir, 2000). A flower spurts from each stem, and the stem never branches out. In addition, bractea and bracteole are tied right under the stem. Bractea and bracteole are membranous, whitish, or creamy white, and they are very similar to each other; however, bractea is larger than bracteole (Selvi, 2005). The study was conducted around Kadı Mountain in Kastamonu province. Kadı Mountain is within the provincial borders of Kastamonu. Kastamonu province is moderately mountainous in terms of topography. Ilgaz Mountains extend from east to west in the southern part of the central district with Küçükhacet Hill as the highest peak with 2,546-meter altitude. In the north, there are Küre Mountains paralleling the sea with Yaralıgöz as the highest peak with 2,019-meter altitude (Eyüpgiller, 1999). Kastamonu province has an altitude of 791 meters. It has been developing along the Karaçomak river, which is one of the

branches of Gökırmak. In terms of plant geography, it falls within Europe-Siberia (Auxin) zone (Akman, 1995). Though there are transitions from maritime climate to continental climate, the central district is characterized by continental climate.

Method

Within the scope of the study, phenological observations started with the formation of aboveground parts of the plants and ended with the termination of vegetation. In order to determine these periods, one-year observation was conducted in the study area. In the course of this period, *Crocus ancyrensis* flowered and faded, which allowed the researcher to observe the changes in its growth and development. The observations in relation to flowering and exfoliation were made with two-day intervals following the start of flowering and exfoliation. Phenological characteristics of sample plants such as the times of budding, exfoliating, flowering, fructification, and defoliating were recorded on a monthly basis. The definitions of these characteristics, which were employed as distinctive characteristics in this study, are as follows:

Budding time: It refers to the time when corms sprout buds.

Exfoliating time: It refers to the time when plant leaf appears on the soil.

Defoliating time: It refers to the time when majority of leaves dry and disappear.

Flowering time: It refers to the time when majority of the plants in the study area flower.

Fructification time: It refers to the time when the capsule (i.e. seed ball) opens, and the seeds fall onto the soil.

Dormant period of corms: It refers to the period when the growth and the development of baby corm come to an end; vegetation season ends; and the corms stay dormant under the soil (Anonymous, 1979).

Phenological observations continued for three years in the selected observation areas. In addition to phenological observations, soil samples were taken from the study areas to indicate sand rate, clay rate, dust rate, volume weight, electrical conductivity (EC), organic matter (OM), and calcium carbonate (CaCO₃) values.

Findings and Discussion

At the end of the field surveys, it was seen that flowering period of *Crocus ancyrensis* (Herbert) Maw continues from late February to mid-March. The appearance of the leaves takes place either three to four days prior to flowering or at the time of flowering. Those that fall into the latter category generally grow in lower regions and under mild climate conditions.

The appearance of seed capsules with three loci and each having two lines of seeds in light yellow color was observed through the end of the first half of April, whereas ripening of the capsules was completed in the second half of May (Kravkaz, 2008).

Crocus ancyrensis (Herbert) Maw grows under pinus nigra stands and in the open areas in meadows as a habitat (Kravkaz, 2008). It was seen that the leaves of the species appeared on the soil in the early March, and flowering took place on the following fourth day. Flowering ended on the 20th of March. As of 10th of April, seed capsules started to appear on the soil, and the capsules ripened from 15th to 20th of April. Completely ripened capsules started to spill the seeds on the soil during those days. Finally, it was understood that *Crocus ancyrensis* (Herbert) Maw preserves its flowers for approximately 15 days, and there is a 45-day period between the flowering and ripening of the seed.

At the end of the study, it was detected based on the routine soil analyses of the samples taken from the fields where *Crocus ancyrensis* (Herbert) Maw species spread that the habitat had a sand rate of 43.1%, clay rate of 33.88%, dust rate of 23.05%, volume weight of 1.26 (g/cm³), pH rate of 6.36, which refers to slight acidity, electrical conductivity (EC) value of 158.08 ($\mu\text{S}\cdot\text{cm}^{-1}$), organic matter (OM) value of 4.14, and calcium carbonate (CaCO₃) rate of 12.87% (Kravkaz Kuşcu, 2014).

Most of the studies dwelling on crocus species are about *C. sativus*, which has economic and medical importance and is cultured. The most expensive spice in the world is produced from the stigma of saffron (*Crocus sativus* L.) plant, which is one of the crocus species grown in Turkey. In addition to the extension of the culture of *C. sativus*

species, extracting cultures from other crocus species as well as protection of some of their natural habitats are important for protecting and maintaining our biological richness (Vurdu and Çiçek, 1992; Gümüşsuyu, 2003).

It is used for both modern medicine and pharmacy to cure many diseases thanks to its being an appetizer, stimulant, enhancer of cardiac muscles, sedative, preventive against and curative for dysentery, good for gout, bronchitis, and cough, preventive against and curative for gynecological diseases, and having anti-tumor effects. It is also used for making medicines against fever, measles, and hypersplenism (Baytop, 1995; Demirhan, 2002; Koç, 2002; Şekercioğlu, 1999).

Mayer conducted taxonomic and morphological studies of 12 crocus species growing naturally in Central Anatolia and specified morphological characteristics of these species by providing their general appearances, tepal shapes, and stylus types in the form of drawings (Selvi, 2005). There are also many studies dwelling on the phenology, morphology, and economy of the species belonging to crocus class (Akan and Eker, 2004; Selvi, 2005; Özdemir et al., 2006; Akan and Eker., 2004; Satıl, 2007; Rudall and Mathew, 1990; Vurdu et al., 2003). Also there are many studies on the phenology, morphology and economy of the studies on other plant species (Şevik et al., 2015; Çetin and Şevik, 2016, Güney et al., 2016, Şevik et al., 2016a; 2016b; Yiğit, 2012; Yiğit et al., 2010; Yiğit et al., 2016a; Yiğit et al., 2016b).

Conclusion

Crocuses naturally and spontaneously grow on meadows between scrubs in open and half-open areas. It is obvious that they prefer permeable soil rich in organic matter, humidity, and clay loam. It was observed that they grew in very tough and hard-soil areas; some of the observation fields were densely covered with grass; and crocuses maintained their generation over these meadows with a high competitive power.

In all the species flowering in the spring time such as *Crocus ancyrensis* (Herbert) Maw, the leaves either developed prior to the flowers or with the flowers. It was seen that seed capsules reached soil level or leaf level.

The habitats of crocuses are generally open areas and are scrubs from place to place. *Crocus ancyrensis* (Herbert) Maw grows under *Pinus nigra* stands and in open areas between meadows as a habitat.

References

- Acartürk, R., “Şifalı Bitkiler Flora ve Sağlığımız”, İzmir/Karşıyaka, 34, (2004).
- Akan, H., Eker, İ., “Some Morphological and Anatomical Investigations on Autumn Species of *Crocus* L. Occuring in Şanlıurfa”, Harran University, *Turk J. Botany* 28, Urfa, 185-19, (2004).
- Akman, Y., 1995. Türkiye Orman Vegetasyonu, A. Ü. Fen Fakültesi Botanik Anabilim Dalı, Ankara.
- Anonim, 1979. Yerli orman ağaç, ağaççık ve çalı tohumları deney metotları. TSE. TS 3404, Ankara.
- Baytop, T., “Safran Türkiye’de Bitkilerle Tedavi” İstanbul Üniversitesi Yayınları, 520, (1995).
- Caiola, M., G. 2004. Saffron reproductive biology. Proc. 1st IS on Saffron. Eds: J.-A. Fernandez & F. Abdullaev, Acta Hort 650, ISHS 2004. p. 25-37.
- Çetin M., Şevik H. 2016. Measuring the Impact of Selected Plants on Indoor CO2 Concentrations. Polish Journal of Environmental Studies, 25(3), 973-979.
- Davis, P.H., “Flora of Turkey and The East Egean Islands”, *Edinburg University Press*, Edinburg, (1-9), 1-600, (1985).
- Demirhan E., A., “Şifalı Bitkiler, Doğal İlaçlarla Geleneksel Tedaviler, Safran”, Alfa Yayınları: 928, Dizi No: 17, İstanbul, 353-355, (2002).
- Ekim, T., Koyuncu, M., Vural, M., Duman, H., Aytaç, Z., Adıgüzel, N., Türkiye Bitkileri Kırmızı Kitabı (Red Data Book of Turkish Plants), Barışcan Ofset, Ankara, 5-15, (2000).
- Ersoy, H., “Trakya’da (Edirne, Kırklareli ve Tekirdağ) Yetişen *Crocus* L. (Iridaceae) Türleri Üzerine Morfolojik, Sistematik, Korolojik Araştırmalar”, Yüksek Lisans Tezi, Trakya Üniversitesi, *Fen Bilimleri Enstitüsü*, Edirne, 2-29, (1998).
- Eyüpgiller, K.K., 1999. Bir Kent, Tarihi Kastamonu, Eren Yayıncılık, ISBN 975-7622-64-8, İstanbul.
- Gümüşsuyu, İ., “Dünyanın En Pahalı Baharatı Safran (*Crocus sativus* L.)” *Safranbolu Kaymakamlığı Yayınları*, Karabük, 32, (2003).
- Güney K., Çetin M., Şevik H., Güney KB. 2016. Influence of Germination Percentage and Morphological Properties of Some Hormones Practice on *Lilium martagon* L. Seeds. Oxidation Communications, 39 (1-II), 466-474
- Koç, H., “Bitkilerle Sağlıklı Yaşama: Safran”, *T.C. Kültür Bakanlığı. Kültür Eserleri Dizisi/373*. Ankara, 309-310, (2002).
- Kravkaz İ.S., “Kastamonu Yöresindeki *Crocus* spp.’nin Fenolojik Özellikleri”, Gazi Üniversitesi Fen Bilimleri Enstitüsü, Orman Mühendisliği Anabilim Dalı, Yüksek Lisans Tezi, Ankara, (2008).
- Kravkaz, İ.S., H. VURDU, Botany of *Crocus ancyrensis* through domestication. 3rd IS on Saffron, Eds.; M.Z. Tsimidou et al., Acta Hort. 850, ISHS 2010; P: 61-65.
- Kravkaz Kuşçu İ.S., Kastamonu Yöresindeki Tarım-Mera-Orman Topraklarındaki Enzim (Katalaz- Üreaz) Aktivitelerinin Karşılaştırılması” , İstanbul Üniversitesi Fen Bilimleri Enstitüsü, Orman Mühendisliği Anabilim Dalı, Toprak İlimi ve Ekoloji Programı Doktora Tezi, (2014).
- Özdemir, C., “Karadeniz Bölgesinde Yayılış Gösteren Bazı Geofit Bitkiler Üzerinde Morfolojik, Anatomik ve Ekolojik Bir Araştırma”, Doktora Tezi, On Dokuz Mayıs Üniversitesi, *Fen Bilimleri Enstitüsü*, Samsun, 4, (2000).
- Özdemir, C., Baran, P., Akyol, Y., “The Morphology and Anatomy of *Crocus flavus* Weston subsp. *flavus* (Irideceae)” *Turk J Bot* 30, Tübitak, 175 -180, (2006).
- Rudall, P., Mathew, B., “Leaf anatomy in *Crocus* (Iridaceae)” *Kew – Bulletin*, 45(3): 535-544, (1990).
- Şatıl, F., Selvi, S., “An Anatomical and Ecological Study Of Some *Crocus* L. Taxa (Irideceae) From The West Part of Turkey” Department of Biology, *Science and Arts Faculty, Balıkesir University*, Balıkesir, 25-26, (2007).
- Şekercioğlu, N., *Şifalı Bitkiler Ansiklopedisi*. Bilim Teknik Yayın Evi, İstanbul, 489, (1999).
- Selvi, S., “Balıkesir İlindeki *Crocus* sp. Türlerinin Taksonomisi, Morfolojisi ve Anatomisi”, Yüksek Lisans Tezi Balıkesir Üniversitesi, *Fen Bilimleri Enstitüsü*, Biyoloji Anabilim Dalı, , Balıkesir, 4-12, (2005).
- Şevik H, Çetin M, Belkayalı N. 2016b. The Determination of Characteristics Factors of Grafted Natural Varieties in Landscaping: A Case Study of Black Pine Clone. Oxidation Communications, 39 (3-II), 2820-2831.
- Şevik H., Çetin M., Kapucu Ö. 2016a. Effect of Light on Young Structures of Turkish Fir (*Abies nordmanniana* subsp. *bornmulleriana*). Oxidation Communications, 39 (1-II), 485-492.
- Şevik, H., Yiğit, N., Topaçoğlu, O. 2015. “Taşkoprü-Tekçam Sarıçam (*Pinus sylvestris* L.)

Konal Tohum Bahçesinde İbre ve Dal Karakterlerine Bağlı Genetik Varyasyon” Kastamonu University Journal of Engineering and Sciences 1(1):23-32.

Vurdu, H. and Çiçek F. F., “Biyolojik zenginliklerimiz: Çiğdem (*Crocus* spp.)” Fidan Dergisi. 57: 2–5, (1992).

Vurdu, H. Güney K. and Çiçek F. F., “Biology of *Crocus oliveri* subsp. *oliveri*” *Proceedings of the First International Symposium on Saffron and Biotechnology*, Acta Horticultura, 650: 71–83, (2003).

Yiğit, N., 2012., “Morfometrik Analiz Sistemi Kullanılarak Kastamonu Yöresi Meşelerinin Filogenetik Analizi”, Gazi Üniversitesi, Fen Bilimleri Ens. Doktora Tezi, Ankara.

Yiğit, N., Ayan, S., Sevik, H. (2010). Genetic variation in Taşköprü- Tekçam Scots pine (*Pinus sylvestris* L.) clonal seed orchard according to some needles characters. In International Symposium on Biology of Rare and Endemic Plant Species, Biorare, Muğla, Turkey.

Yiğit, N.; Sevik, H.; Cetin, M., Kaya, N. (2016a). Determination of the Effect Of Drought Stress On The Seed Germination In Some Plant Species. Water stress, Intech Open, Editör:İsmail Md. Mofizur Rahman, Ph.D., Zinnat Ara Begum, Ph.D., Hiroshi Hasegawa, D.Sc., ISBN:978-953-51-4804-3.

Yiğit, N.; Sevik, H.; Cetin, M. & Levent, G., (2016b). “Clonal Variation in Chemical Wood Characteristics in Hanönü (Kastamonu) Günlüburun Black Pine (*Pinus nigra* Arnold. Subsp. *pallasiana* (Lamb.) Holmboe) Seed Orchard” *Journal of Sustainable Forestry*, Vol. 35, No:7, 515-526.

Yücel, E. 2002. Çiçekler ve Yerörtücüler. ISBN 975-93746, 1-7-Syf:116. Eskişehir.

Flora of Argözü Valley (Kıbrısçık-Bolu)

*Neval GÜNEŞ ÖZKAN¹, Necmi AKSOY¹, Serdar ASLAN¹, Bilge TUNÇKOL²,
Nihan KOÇER¹

¹Duzce University, Faculty of Forestry, Department of Forestry Botany, 81620,
Duzce/TURKEY

²Bartın University, Bartın Vocational School, Department of Forestry, 74100, Bartın/TURKEY

*Corresponding Author: nevalgunes@duzce.edu.tr

Abstract

This study was carried out to determine flora of Argözü Valley (Kıbrısçık- Bolu) and contribute to plant diversity in Western Black Sea Region. Kıbrısçık is situated on the southern slope of Köroğlu Mountains which is located 35 km south east of Bolu. The study area is also located to the north east of Kıbrısçık and in the A3 grid square according to the categorization of P.H.Davis. 1074 plant samples were collected in 47 field trips to research area between 2012 and 2015. 63 families, 273 genus and 554 taxa were determined. 65 of the collected taxa are endemic and endemism ratio is 11,73 %. Endemic and rare plants were classified according to IUCN categories. The largest families are as follows: Poaceae 55 taxa (%9,93), Asteraceae 51 taxa (%9,21), Fabaceae 47 taxa (%8,48), Rosaceae 33 taxa (%5,96), Brassicaceae 29 taxa (%5,23), Lamiaceae 27 taxa (%4,87), Caryophyllaceae 27 taxa (%4,87), Liliaceae 20 taxa (%3,61), Boraginaceae 19 taxa (%3,43), Rubiaceae 16 taxa (%2,89), Plantaginaceae 16 taxa (%2,89), Apiaceae 13 taxa (%2,35), Campanulaceae 11 taxa (%1,99), Orchidaceae 10 taxa (%1,81). Phytogeographical regions of 334 taxa (%60,28) was identified in the research area. The distribution of taxa according to phytogeographic regions are as follows: 109 taxa (%19,68) Euro-Siberian, 78 taxa (%14,08) Mediterranean, 63 taxa (%11,37) Irano-Turanian, 80 taxa (%14,44) WS and 224 taxa (%40,43) are unknown. According to Raunkiaer's life form of the plants are 38 (%6,86) Phanerophytes, 59 (%10,63) Chamaephytes, 114 (%20,58) Cryptophytes, 209 (%37,73) Hemicryptophytes and 135 (%24,37) Therophytes.

Keywords: Flora, Raunkiaer, Argözü Valley, Kıbrısçık, Bolu

Argözü Vadisi'nin (Kıbrısçık-Bolu) Florası

Özet

Bu çalışma Argözü Vadisi'nin (Kıbrısçık- Bolu) florasının belirlenerek Batı Karadeniz Bölgesi'nin bitki çeşitliliğinin ortaya çıkarılması amacıyla gerçekleştirilmiştir. Kıbrısçık, Bolu ilinin 35 km güney doğusunda yer alan Köroğlu Dağlarının güney yamacında bulunmaktadır. Araştırma alanını oluşturan Argözü vadisi ise Kıbrısçık ilçesinin kuzey doğusunda bulunmaktadır. P.H.Davis'in kareleme sistemine göre A3 karesi içerisinde yer almaktadır. 2012-2015 yılları arasında yapılan 47 arazi çalışması sonucunda 1074 bitki örneği toplanmış, vejetasyon tiplerini ve yapısını ortaya koymak amacıyla 303 örnek alanda inceleme yapılmıştır. Bitkilerin teşhis edilmesi sonucu 63 familya ve 273 cinse ait 554 takson belirlenmiştir. Belirlenen taksonların 65'i endemik olup, alanın endemizm oranı %11,73'dür. Endemik ve nadir bitkiler, uluslararası IUCN tehlike kategorilerine göre sınıflandırılmıştır. Araştırma alanında en fazla takson içeren familyalar: Poaceae 55 takson (%9,93), Asteraceae 51 takson (%9,21), Fabaceae 47 takson (%8,48), Rosaceae 33 takson (%5,96), Brassicaceae 29 takson (%5,23), Lamiaceae 27 takson (%4,87), Caryophyllaceae 27 takson (%4,87), Scrophulariaceae 22 takson (%3,97), Liliaceae 20 takson (%3,61), Boraginaceae 19 takson (%3,43), Rubiaceae 16 takson (%2,89), Apiaceae 13 takson (%2,35), Campanulaceae 11 takson (%1,99), Orchidaceae 10 takson (%1,81) şeklinde sıralanmaktadır. Araştırma alanında belirlenen 334 taksonun (%60,28) fitocoğrafik bölgeleri belirlenmiştir. Taksonların fitocoğrafik bölgelere göre dağılımları şöyledir: 109 takson (%19,68) Avrupa-Sibirya, 78 takson (%14,08) Akdeniz, 63 takson (%11,37) İran-Turan kökenli, 80 takson (%14,44) geniş yayılışlı ve 224 takson (%40,43) ise çok bölgelidir. Araştırma alanından toplanan taksonların Raunkiaer'in yaşam biçimlerine göre 38'i (%6,86) Fanerofit, 59'u (%10,63) Kamefit, 114'ü (%20,58) Kriptofit, 209'u (%37,73) Hemikriptofit ve 135'i (%24,37) Terofittir.

Anahtar kelimeler: Flora, Raunkiaer, Argözü Vadisi, Kıbrısçık, Bolu

The threat categories of endemic and rare taxa were determined according to IUCN threat categories (Ekim et al., 2000).

New records for A3 square were arranged from other studies were carried out in the region (Akman and Ketenoglu, 1978; Akman and Yurdakulol, 1981; Aksoy, 2001; Aksoy, 2006; Dogan, 2000; Dikmen, 2012; Guner, 2000; Gunes Ozkan, 2009; İkinci, 2000; Kanoğlu, 2012; Tunçkol, 2012; Uçar, 1996).

Life forms of the plant species were classified according to Raunkiaer's method (Yaltırık and Efe, 1996, Kılınç et al., 2006).

Abbreviations

The abbreviations used in the text and in the floristic list are as follows; *: New taxa for A3 square, B.T.: Bilge Tunçkol, CH.: Chamaephyt, CR: Critically Endangered, DUOF: Duzce University Forestry Faculty Herbarium, EN: Endangered, E.: Endemic, Euro-Sib.: Euro-Siberian element, Eux.:

Euxine element, G.: Geophyt, H.: Hemicryptophyt, Hb: habitat, Hyd.: Hydrophyte, Hyr.-Eux.: Hyrcano-Euxine element, Ir.-Tur.: Irano-Turanian element, km: kilometer, LC: Least Concern, m: meter, M.A.: Mehmet Altıntaş, Med.: Mediterranean element, MeP.: Mesophanerophyt, MiP.: Microphanerophyt, N.A.: Necmi Aksoy, NaP.: Nanophanerophyt, N.G.: Neval Güneş, NT: near threatened, S.A.: Serdar Aslan, st: station, Syn.: synonymous, TH.: Therophyte, VU: Vulnerable, WS: widespread, Z.D.D.: Zeliha Deniz Dikmen.

Results

Result of the identification of samples, 554 taxa belongs to 63 families and 273 genera were determined. Stations and habitats were abbreviated as St and Hb in the floristic list and were numbered in Table 1.

Table 1. Stations and habitats abbreviated as St and Hb in the floristic list

Stations		
1. Argözü river	11. Kökez Plateau	21. Bölücekkaya Plateau
2. Aşağı Çimencik location	12. Top of Koroğlu mountain	22. Dikili alti location
3. Path of Çimencik	13. Argözü Valley	23. Boundary of Serke- Kıbrısık
4. Göknarlık location	14. Çimencik location	24. Path of Karadoğan Plateau
5. Path of Bölücekkaya village-Kıbrısık	15. 2.5 km south of Karadoğan Plateau	25. 2 km north of Kıbrısık
6. 2.5 km north of Kıbrısık	16. Karadoğan Plateau	26. Between Alabarda-Kıbrısık
7. Path of Bölücekkaya Plateau	17. Kocaörük location	27. Road junction of Aşağıyayla location
8. Devrentarla location	18. Entrence of Argözü Valley	28. Path of Göknarlık location
9. Hasan Topçuoğlu Fountain	19. Atçayırı location	29. 5 km south of Karadoğan Plateau
10. Koroğlutepe, Dikili location	20. Mallaryazlığı location	30. 4 km north of Kıbrısık
Habitats		
1. riparian vegetation	11. <i>P. sylvestris</i> stand	21. Wet meadow
2. meadow	12. Open areas	22. Openings of stand
3. meadow-water edge	13. <i>P. spina-christii</i> - <i>J. excelsa</i> shrub	23. Subalpine
4. rocky areas	14. alpine steppe	24. Rock
5. steppe	15. rocky and stony areas	25. Wetland
6. <i>A. bornmuelleriana</i> - <i>P. sylvestris</i> stand	16. rocky meadow	26. wet places
7. <i>P. nigra</i> - <i>J. oxycedrus</i> stand	17. edge of <i>P. nigra</i> stand	27. openings of <i>P. sylvestris</i> stand
8. <i>Quercus pubescens</i> - <i>Juniperus oxycedrus</i> shrub	18. <i>Juniperus</i> shrub	28. <i>Quercus pubescens</i> - <i>P. nigra</i> stand
9. Puddle	19. Roadside, slope	29. <i>Quercus pubescens</i> - <i>Juniperus oxycedrus</i> - <i>P. nigra</i> stand
10. <i>P. nigra</i> stand	20. Water edge	30. <i>J. excelsa</i> , <i>F. angustifolia</i> , <i>Rosa canina</i> shrub

1. EQUISETACEAE

1. *Equisetum palustre* L.

St 1, Hb 1, 1350 m, 10.06.2013, N.G. 3209 (DUOF 6352), G.

2. *Equisetum sylvaticum* L.

St 2, Hb 2, 1483 m, 20.10.2012, N.G. 2950 (DUOF 6293), G.

3. *Equisetum arvense* L.

St 3, Hb 3, 1486 m, 05.05.2012, N.G. 2361, N.A., B.T. (DUOF 6160), G.

2. PTERIDACEAE

4. *Paraceterach marantae* (L.)

R.M.Tyron

St 4, Hb 4, 1779 m, 18.06.2013, N.G. 3278 (DUOF 6436), G.

3. ASPLENIACEAE

- 5. *Asplenium septentrionale* (L.) Hoffm**
St 5, Hb 4, 1465 m, 05.05.2012, N.G. 2331, N.A., B.T. (DUOF 6291), G.
- 6. *Asplenium ceterach* L.**
St 6, Hb 5, 1270m, 29.05.2011, Z.D.D. 1076 et al. (DUOF 2877), WS, G.
- 4. ATHYRIACEAE**
- 7. *Athyrium filix-femina* (L.) Roth**
St 2, Hb 2, 1483 m, 20.10.2012, N.G. 2951 (DUOF 6159), G.
- 8. *Cystopteris fragilis* (L.) Bernh.**
St 3, Hb 4, 1450 m, 02.06.2012, N.G. 2418, S.A. (DUOF 6438), WS, G.
- 5. PINACEAE**
- 9. *Abies nordmanniana* (Stev) Spach. subsp. *bornmuelleriana* (Mattf.) Coode & Cullen**
St 4, Hb 6, 1777 m, 05.08.2012, N.G. 2878, S.A., B.T. (DUOF 6230), E., Eux., MeP.
- 10. *Pinus sylvestris* L. var. *hamata***
St 7, Hb 11, Hb 19, slope, 1622 m, 02.06.2012, N.G. 2498, S.A. (DUOF 6231), Euro-Sib., MeP.
- 11. *Pinus nigra* L. subsp. *pallasiana* (Lamb.) Holmboe**
St 3, Hb 7, 1403 m, 21.04.2012, observation, MeP.
- c6. CUPRESSACEAE**
- 12. *Juniperus communis* L. var. *saxatilis* Pall.**
St 4, Hb 6, 1777 m, 05.08.2012, N.G. 2879, S.A., B.T. (DUOF 6229), WS, NaP.
- 13. *Juniperus oxycedrus* L. subsp. *oxycedrus* var. *oxycedrus***
St 8, Hb 8, 1234 m, 05.05.2012, N.G. 2355, N.A., B.T. (DUOF 6228), WS, MiP.
- 14. *Juniperus excelsa* M.Bieb. subsp. *excelsa***
St 8, Hb 8, 1234 m, 05.05.2012, N.G. 2354, N.A., B.T. (DUOF 6227), WS, MeP.
- 7. ARACEAE**
- 15. *Arum rupicola* Boiss. var. *rupicola***
St 8, Hb 4, 1236 m, 08.06.2012, N.G. 2593 et al. (DUOF 6258), Ir.-Tur., G.
- 16. *Lemna minor* L.**
St 7, Hb 9, 1531 m, 02.06.2012, N.G. 2492, S.A. (DUOF 6428), Hyd.
- 8. COLCHICACEAE**
- 17. *Colchicum szovitsii* Fisch. & C.A.Mey. subsp. *szovitsii***
St 9, Hb 7, Hb 12, 1450 m, 30.03.2013, N.G. 2958 (DUOF 6197), Ir.-Tur., G.
- 18. *Colchicum speciosum* Steven**
St 3, Hb 4, 1450 m, 02.06.2012, N.G. 2410, S.A. (DUOF 6209), Euro-Sib., G.
- 9. LILIACEAE**
- 19. *Fritillaria pinardii* Boiss.**
St 3, Hb 11, Hb 12, 1616 m, 05.05.2012, N.G. 2344, N.A., B.T. (DUOF 6094), Ir.-Tur., G.
- 20. *Tulipa sylvestris* L. var. *sylvestris***
St 5, Hb 4, 1465 m, 05.05.2012, N.G. 2329, N.A., B.T. (DUOF 6095), G.
- 21. *Gagea bithynica* Pasch.**
St 8, Hb 13, 1248 m, 30.04.2013, N.G. 2975 (DUOF 6877), E., E.Med., G.
- 22. *Gagea fragifera* Steven**
St 10, Hb 14, 2073 m, 02.06.2012, N.G. 2507, S.A. (DUOF 6096), G.
- 23. *Gagea foliosa* (C.Presl) Schult. & Schult.f.**
St 11, Hb 16, 1979 m, 19.05.2013, N.G. 3088 (DUOF 6878), G.
- 24. *Gagea peduncularis* (C. Presl) Pascher***
St 8, Hb 15, 1307 m, 30.03.2013, N.G. 2963 (DUOF 6876), Med., G.
- 25. *Gagea granatellii* (Parl.) Parl.**
St 12, Hb 14, 2075 m, 29.05.2011, Z.D.D. 1111 et al. (DUOF 2946), Med., G.
- 26. *Gagea villosa* (M.Bieb.) Sweet var. *villosa****
St 5, Hb 4, 1465 m, 05.05.2012, N.G. 2322, N.A., B.T. (DUOF 6301), Med., G.
- 10. ORCHIDACEAE**
- 27. *Cephalanthera rubra* (L.) Rich.**
St 13, Hb 11, Hb 4, 1614 m, 26.06.2012, N.G. 2716, S.A., B.T. (DUOF 6183), Euro-Sib., G.
- 28. *Epipactis helleborine* (L.) Crantz subsp. *helleborine***
St 7, Hb 17, 1290 m, 22.07.2014, N.G. 3374, N.A., S.A., C. Bulut (DUOF 6075), G.
- 29. *Limodorum abortivum* (L.) Sw. var. *abortivum***
St 1, Hb 10, 1462 m, 28.06.2012, N.G. 2654, S.A., B.T. (DUOF 6074), G.
- 30. *Himantoglossum affine* (Boiss.) Schltr.***
St 8, Hb 13, 1231m, 27.06.2012, N.G. 2598-a, S.A., B.T. (DUOF 6184), E.Med., G.
- 31. *Orchis coriophora* L. subsp. *coriophora***
St 7, Hb 13, 1200 m, 09.06.2013, N.G. 3254 (DUOF 6070), Med., G.

32. *Orchis purpurea* Huds. subsp. *purpurea*

St 13, *Quercus pubescens-Juniperus oxycedrus-Hb 10*, Hb 12, 1381 m, 02.06.2012, N.G. 2529, S.A. (DUOF 6076), Euro-Sib., G.

33. *Orchis mascula* (L.) L. subsp. *pinetorum* (Boiss. & Kotschy) G. Camu

St 14, Hb 11, 1625 m, 02.06.2012, N.G. 2438, S.A. (DUOF 6073), E. Med., G.

34. *Orchis mascula* (L.) L. subsp. *longicalcarata* Akhalk., H. Baumann, R. Lorenz, Mosul. & Ruedi Peter

St 15, Hb 11, 1600 m, 29.05.2011, Z.D.D. 1120 et al. (DUOF 2918), WS, G.

35. *Orchis pallens* L.

St 7, Hb 11, 1455 m, 19.05.2013, N.G. 3074 (DUOF 6077), Euro-Sib., G.

36. *Dactylorhiza iberica* (M. Bieb. ex Willd.) Soó

St 2, Hb 17, 1483 m, 22.07.2014, N.G. 3370, N.A., S.A., C. Bulut (DUOF 6080; 6081), E. Med., G.

11. IRIDACEAE

37. *Crocus ancyrensis* (Herb.) Maw.

St 10, Hb 14, 2073 m, 02.06.2012, N.G. 2503, S.A. (DUOF 6343), E., Ir.-Tur., G.

38. *Crocus biflorus* Mill. subsp. *pulchricolor* (Herb.) Mathew

St 10, Hb 14, 2073 m, 02.06.2012, N.G. 2509, S.A. (DUOF 6300), E., Euro-Sib., G.

39. *Gladiolus atroviolaceus* Boiss.

St 13, Hb 4, 1471 m, 08.06.2012, N.G. 2559 et al. (DUOF 6342), Ir.-Tur., G.

12. XANTHORRHOEACEAE Dumort.

40. *Eremurus spectabilis* M. Bieb.

St 3, Hb 4, 1450 m, 02.06.2012, N.G. 2414, S.A. (DUOF 6097), Ir.-Tur., G.

41. *Asphodeline lutea* (L.) Reichb.

St 3, Hb 2, 1450 m, 02.06.2012, N.G. 2433, S.A. (DUOF 6393), Med., G.

13. AMARYLLIDACEAE

42. *Allium paniculatum* L. subsp. *paniculatum*

St 16, Hb 14, Hb 4, 1942 m, 22.07.2012, N.G. 2859 (DUOF 6740), Med., G.

43. *Allium hirtovaginatatum* Kunth

St 17, Hb 4, 1370 m, 05.08.2012, N.G. 2902, S.A., B.T. (DUOF 6743), G.

44. *Allium olympicum* Boiss.

St 8, Hb 13, 1217 m, 30.06.2014, N.G. 3356 (DUOF 6506), E., Eux., G.

45. *Allium huber-morathii* Kollmann, Özhatay & Koyuncu

St 4, Hb 6, Hb 4, 1777 m, 05.08.2012, N.G. 2887, S.A., B.T. (DUOF 6742), E., Ir.-Tur., G.

46. *Allium scorodoprasum* L. subsp. *rotundum* (L.) Stearn

St 8, Hb 15, 1460 m, 11.06.2013, N.G. 3256, Med., G.

47. *Allium guttatum* Stev. subsp. *guttatum*

St 13, Hb 5- Hb 11, 1661 m, 22.07.2012, N.G. 2818, G.

48. *Allium guttatum* Stev. subsp. *sardoum* (Moris) Stearn

St 10, Hb 14, 2045 m, 22.07.2012, N.G. 2865 (DUOF 6739), Med., G.

49. *Allium cyrilli* Ten. subsp. *asumaniae* N. Özhatay & İ. Genç

St 19, Hb 2, 1204 m, 18.05.2013, N.G. 3042 (DUOF 6748), E., G.

50. *Allium efeae* N. Özhatay & İ. Genç

St 14, Hb 19, humid areas, 1625 m, 02.06.2012, N.G. 2436 (DUOF 6750), E., G.

51. *Galanthus elwesii* Hook. f. var. *elwesii*

St 18, Hb 16, 1307 m, 30.03.2013, N.G. 2961 (DUOF 6744), E. Med., G.

14. ASPARAGACEAE

52. *Scilla bifolia* L.

St 2, Hb 19, 1497 m, 21.04.2012, N.G. 2308 (DUOF 6349), Med., G.

53. *Prospero autumnale* (L.) Speta

St 17, Hb 4, 1370 m, 05.08.2012, N.G. 2901, S.A., B.T. (DUOF 6179), G.

54. *Ornithogalum pyrenaicum* L.

St 8, Hb 4, 1236 m, 08.06.2012, N.G. 2591, N.A., S.A., B.T., G.

55. *Ornithogalum oligophyllum* E. D. Clarke

St 10, Hb 14, 2073 m, 02.06.2012, N.G. 2511, S.A. (DUOF 6880), G.

56. *Ornithogalum neurostegium* Boiss. & C. I. Blanche ex Boiss.*

St 17, Hb 4, 1389 m, 02.06.2012, N.G. 2398, S.A. (DUOF 6879), G.

57. *Ornithogalum sigmoideum* Freyn & Sint.

St 12, Hb 14, 1970 m, 29.05.2011, Z.D.D. 1110 et al. (DUOF 2942), Euro-Sib., G.

58. *Ornithogalum armeniacum* Baker*

St 8, Hb 13, 1248 m, 30.04.2013, N.G. 2970 (DUOF 6882), E. Med., G.

59. *Muscari aucheri* (Boiss.) Baker

St 2, Hb 1, 1481 m, 21.04.2012, N.G.
2310 (DUOF 6093, 6178), E., G.

60. *Muscari armeniacum* Leichtlin ex
Baker

St 5, Hb 4, 1465 m, 05.05.2012, N.G.
2319, N.A., B.T., WS, G.

15. JUNCACEAE

61. *Juncus inflexus* L. subsp. *inflexus*

St 13, Hb 20, 1384 m, 20.10.2012, N.G.
2941 (DUOF 6535), H.

62. *Juncus conglomeratus* L.

St 10, Hb 21, 1980 m, 18.07.2013, N.G.
3306, Euro-Sib., H.

63. *Juncus anatolicus* Snogerup

St 16, Hb 11, 1823 m, 22.07.2012, N.G.
2836 (DUOF 6536); E., E.Med., G.

64. *Luzula forsteri*(Sm) DC. subsp.
caspiica Novikov

St 16, Hb 11, 1852 m, 08.06.2013, N.G.
3172 (DUOF 6532), Euro-Sib., H.

65. *Luzula spicata* (L.) DC.

St 16, Hb 11, 1923 m, 08.06.2013, N.G.
3177, H.

16. CYPERACEAE

66. *Eleocharis palustris* (L.) Roem. &
Schult.*

St 19, Hb 9, 1204 m, 18.05.2013, N.G.
3043 (DUOF 6875), G.

34. *Blysmus* Panz. ex Schult.

67. *Blysmus compressus* (L.) Panz. ex
Link subsp. *compressus*

St 10, Hb 21, 1980 m, 18.07.2013, N.G.
3319 (DUOF 6533), G.

68. *Carex cuprina* (Sándor ex Heuff.)
Nendtv. ex A.Kern.

St 20, Hb 13, 1282 m, 02.06.2013, N.G.
3125, Euro-Sib., H.

69. *Carex muricata* L. subsp. *muricata*

St 10, Hb 21, 1980 m, 18.07.2013, N.G.
3311-b (DUOF 6874), G.

70. *Carex* cf. *colchica* J.Gay*

St 21, Hb 2, 1500 m, 02.06.2012, N.G.
2522, S.A. (DUOF 6873), Euro-Sib., G.

71. *Carex stenophylla* Wahlenb. subsp.
stenophylloides (V.I.Krecz.) Egorova*

St 8, Hb 8, 1234 m, 05.05.2012, N.G.
2351, N.A., B.T. (DUOF 6871), Ir.-Tur., G.

72. *Carex leporina* L.

St 22, Hb 14, 1902 m, 26.06.2012, N.G.
2747, S.A., B.T. (DUOF 6869), Euro-Sib., G.

73. *Carex pallescens* L.

St 16, Hb 4, opening of Hb 11 1942 m,
22.07.2012, N.G. 2854 (DUOF 6872), Eux.,
H.

74. *Carex nigra* (L.) Reichard subsp.
nigra

St 10, Hb 21, 1980 m, 18.07.2013, N.G.
3318 (DUOF 6868); Euro-Sib., G.

17. POACEAE

75. *Brachypodium sylvaticum* (Huds.)
P.Beauv.

St 22, Hb 14, 2056 m, 05.08.2012, N.G.
2907, S.A., B.T. (DUOF 6250), Euro-Sib., H.

76. *Elymus pycnanthus* (Godr.) Melderi

St 23, Hb 11, 1742 m, 05.08.2012, N.G.
2921, S.A., B.T., Med., G.

77. *Elymus elongatiformis* (Drobow)
Assadi*

St 8, Hb 13, 1254 m, 02.06.2013, N.G.
3107 (DUOF 6824), Ir.-Tur., G.

78. *Elymus hispidus* (Opiz)
Melderissubsp. *hispidus*

St 8, Hb 13, 1215 m, 27.06.2012, N.G.
2620, S.A., B.T. (DUOF 6212), G.

79. *Elymus hispidus* (Opiz) Melderis
subsp. *barbulatus* (Schur) Melderis*

St 8, Hb 13, 1217 m, 27.06.2012, N.G.
2618, S.A., B.T. (DUOF 6823), G.

80. *Aegilops triuncialis* L. subsp.
triuncialis

St 8, Hb 13, 1217 m, 27.06.2012, N.G.
2619, S.A., B.T. (DUOF 6835), WS, TH.

81. *Aegilops columnaris* Zhukovsky

St 8, Hb 13, 1256 m, 02.06.2013, N.G.
3098 (DUOF 6157), Ir.-Tur., TH.

82. *Secale cereale* L. var. *ancestrale*
(Zhuk.) Kit Tan

St 10, Hb 14, 2045 m, 22.07.2012, N.G.
2875 (DUOF 6828), E., H.

83. *Hordeum geniculatum* All.*

St 17, Hb 8, 1317 m, 02.06.2012, 3N.G.
2455, S.A. (DUOF 6125), Euro-Sib., TH.

84. *Hordeum murinum* L. subsp.
leporinum (Link) Arcang.*

St 17, Hb 8, 1317 m, 02.06.2012, N.G.
2377, S.A. (DUOF 6213), TH.

85. *Hordeum bulbosum* L.

St 8, Hb 13, 1220 m, 02.06.2013, N.G.
3113 (DUOF 6145), G.

86. *Taeniatherum caput-medusae* (L.)
Nevski subsp. *asper* (Simonk.) Melderis*

St 7, Hb 13, 1232 m, 11.06.2013, N.G.
3226 (DUOF 6829), TH.

- 87. *Taeniatherum caput-medusae* (L.) Nevski subsp. *crinitum* (Schreb.) Melderis***
St 21, Hb 2, 1500 m, 02.06.2012, N.G. 2519, S.A. (DUOF 6117), Ir.-Tur., TH.
- 88. *Bromus racemosus* L.**
St 8, Hb 13, 1231 m, 08.06.2012, N.G. 2549-a et al. (DUOF 6845), Euro-Sib., TH.
- 89. *Bromus japonicus* Thunb. subsp. *japonicus***
St 7, Hb 13, 1232 m, 11.06.2013, N.G. 3224, TH.
- 90. *Bromus squarrosus* L.***
St 8, Hb 13, 1227 m, 27.06.2012, N.G. 2603, S.A., B.T. (DUOF 6844), TH.
- 91. *Bromus scoparius* L.**
St 17, Hb 8, 1317 m, 02.06.2012, N.G. 2365, S.A. (DUOF 6843), TH.
- 92. *Bromus tectorum* L.**
St 21, Hb 2, 1500 m, 02.06.2012, N.G. 2526, S.A. (DUOF 6842), TH.
- 93. *Bromus sterilis* L.**
St 8, Hb 13, 1231 m, 08.06.2012, N.G. 2541-a et al. (DUOF 6841), TH.
- 94. *Bromus tomentellus* Boiss.***
St 13, Hb 4, 1471 m, 08.06.2012, N.G. 2565 et al. (DUOF 6839), Ir.-Tur., H.
- 95. *Helictotrichon pubescens* (Huds.) Schult. & Schult.f. subsp. *pubescens***
St 10, Hb 14, 2072 m, 26.06.2012, N.G. 2792, S.A., B.T. (DUOF 6310), Euro-Sib., H.
- 96. *Arrhenatherum elatius* (L.) P.Beauv. ex J.Presl & C.Presl subsp. *elatius***
St 4, Hb 6, 1777 m, 05.08.2012, N.G. 2890, S.A., B.T. (DUOF 6833), Euro-Sib., H.
- 97. *Arrhenatherum palaestinum* Boiss.***
St 8, Hb 13, 1220 m, 02.06.2013, N.G. 3112 (DUOF 6173), E.Med., H.
- 98. *Ventenata dubia* (Leers) Coss. & Durieu**
St 17, Hb 8, 1317 m, 02.06.2012, N.G. 2367, S.A. (DUOF 6326), Med., TH.
- 99. *Koeleria nitidula* Velen.**
St 20, Hb 13, 1270 m, 03.06.2013, N.G. 3130, H.
- 100. *Koeleria pyramidata* (Lam) P. Beauv.**
St 8, Hb 13, 1231 m, 08.06.2012, N.G. 2542-b (DUOF 6161), N.A., S.A., B.T., WS, H.
- 101. *Deschampsia caespitosa* (L.) P.Beauv.**
St 16, Hb 14, Hb 4, Hb 27 1942 m, 22.07.2012, N.G. 2856 (DUOF 6827), H.
- 102. *Apera intermedia* Hack.***
St 13, Hb 15, Hb 22, 1330 m, 26.06.2012, N.G. 2725 (DUOF 6126), S.A., B.T., Ir.-Tur., TH.
- 103. *Agrostis stolonifera* L.**
St 10, Hb 21, 1980 m, 18.07.2013, N.G. 3307 (DUOF 6210), Euro-Sib., H.
- 104. *Milium vernale* M.Bieb. subsp. *vernale***
St 19, Hb 2, 1204 m, 18.05.2013, N.G. 3044 (DUOF 6219), Med., TH.
- 105. *Anthoxanthum odoratum* L. subsp. *alpinum* (A.Löve & D.Löve) B.MG.Jones & Melderis**
St 8, Hb 13, 1231 m, 08.06.2012, N.G. 2544 et al. (DUOF 6834), Euro-Sib., H.
- 106. *Alopecurus arundinaceus* Poir.**
St 19, Hb 2, 1204 m, 18.05.2013, N.G. 3064 (DUOF 6831), Euro-Sib., G.
- 107. *Alopecurus gerardii* (All.) Vill. var. *gerardii****
St 16, Hb 11, 1823 m, 22.07.2012, N.G. 2837 (DUOF 6124), Med., H.
- 108. *Phleum bertolonii* DC.**
St 4, Hb 23, 1885 m, 20.06.2013, N.G. 3285-a (DUOF 6890), H.
- 109. *Phleum montanum* K.Koch subsp. *montanum***
St 8, Hb 13, 1250 m, 02.06.2013, N.G. 3096 (DUOF 6889), H.
- 110. *Phleum exaratum* Griseb. subsp. *exaratum***
St 8, Hb 13, 1253 m, 27.06.2012, N.G. 2636, S.A., B.T. (DUOF 6888), TH.
- 111. *Festuca cyllenica* Boiss. & Heldr. subsp. *uluana* Markgr.-Dann.**
St 10, Hb 14, 2072 m, 26.06.2012, N.G. 2777, S.A., B.T. (DUOF 6215), E., Eux., H.
- 112. *Festuca valesiaca* Schleich. ex Gaudin**
St 8, Hb 13, 1229 m, 02.06.2013, N.G. 3101 (DUOF 6891), H.
- 113. *Festuca airoides* Lam**
St 10, Hb 14, 2060 m, 18.07.2013, N.G. 3297-a (DUOF 6127), Euro-Sib., H.
- 114. *Phleum exaratum* (L.) Gray***
St 20, Hb 13, 1282 m, 02.06.2013, N.G. 3122 (DUOF 6838), Euro-Sib., TH.
- 115. *Vulpia muralis* (Kunth) Nees***
St 4, Hb 6, 1731 m, 17.06.2013, N.G. 3277 (DUOF 6837), Med., TH.
- 116. *Vulpia myuros* (L.) C.C.Gmel.**

- St 21, Hb 2, 1500 m, 02.06.2012, N.G. 2515, S.A. (DUOF 6836), Med., TH.
- 117. *Micropyrum tenellum* (L.) Link***
St 7, Hb 24, 1374 m, 13.06.2013, N.G. 3259 (DUOF 6211), Med., TH.
- 118. *Poa nemoralis* L.**
St 16, Hb 11, 1740 m, 09.06.2013, N.G. 3188 (DUOF 6825), H.
- 119. *Poa alpina* L. subsp. *fallax* F. Herm**
St 8, Hb 15, 1435 m, 11.06.2014, N.G. 3229, H.
- 120. *Poa bulbosa* L.**
St 17, Hb 8, 1317 m, 02.06.2012, N.G. 2369, S.A. (DUOF 6826), H.
- 121. *Eremopoa altaica* (Trin.) Roshev.***
St 16, Hb 2, 1812 m, 09.06.2013, N.G. 3203 (DUOF 6175), Ir.-Tur., TH.
- 122. *Dactylis glomerata* L. subsp. *hispanica* (Roth) Nyman**
St 8, Hb 13, 1220 m, 02.06.2013, N.G. 3114 (DUOF 6123), H.
- 123. *Cynosurus cristatus* L.**
St 10, Hb 21, 1975 m, 18.07.2013, N.G. 3323 (DUOF 6311), H.
- 124. *Briza media* L.**
St 1, Hb 13, 1426 m, 28.06.2012, N.G. 2675, S.A., B.T. (DUOF 6121), G.
- 125. *Briza humilis* M.Bieb.**
St 20, Hb 13, 1280 m, 03.06.2013, N.G. 3126-a, TH.
- 126. *Melica ciliata* L. subsp. *ciliata***
St 24, Hb 24, 1665 m, 14.06.2013, N.G. 3268 (DUOF 6153), WS, H.
- 127. *Stipa holosericea* Trin.***
St 8, Hb 13, 1254 m, 02.06.2013, N.G. 3106 (DUOF 6317), Ir.-Tur., H.
- 128. *Bothriochloa ischaemum* (L.) Keng**
St 8, Hb 13, 1227 m, 27.06.2012, N.G. 2601, S.A., B.T. (DUOF 6122), H.
- 129. *Oryzopsis coerulescens* (Desf.) Hack.***
St 2, Hb 17, 1483 m, 22.07.2014, N.G. 3369, N.A., S.A., C. Bulut (DUOF 6830), H.
- 18. PAPAVERACEAE**
- 130. *Papaver pilosum* Sibth. & Sm. subsp. *pilosum***
St 16, Hb 4, Hb 27, 1942 m, 22.07.2012, N.G. 2853 (DUOF 6735), E., H.
- 131. *Papaver fugax* Poir. var. *platydiscus* Cullen***
St 8, Hb 13, 1217 m, 30.06.2014, N.G. 3353 (DUOF 6732), E., Ir.-Tur., H.
- 132. *Papaver argemone* L. subsp. *argemone****
St 8, Hb 19, Hb 4, 1246 m, 09.05.2014, N.G. 3345 (DUOF 6736), TH.
- 133. *Corydalis wendelboi* Lidén subsp. *congesta* Liden & Zetterl.**
St 3, Hb 20, 1486 m, 05.05.2012, N.G. 2336, N.A., B.T. (DUOF 6082), E., G.
- 134. *Fumaria officinalis* L. subsp. *officinalis***
St 8, Hb 13, 1248 m, 30.04.2013, N.G. 2974 (DUOF 6731), TH.
- 135. *Fumaria vaillantii* Loisel.***
St 3, Hb 4, 1450 m, 02.06.2012, N.G. 2417, S.A. (DUOF 6180), TH.
- 19. BERBERIDACEAE**
- 136. *Berberis crataegina* DC.**
St 17, Hb 4, 1370 m, 05.08.2012, N.G. 2905, S.A., B.T. (DUOF 6246), Ir.-Tur., NaP.
- 20. RANUNCULACEAE**
- 137. *Nigella arvensis* L. var. *glauca* Boiss.**
St 8, Hb 13, 1217 m, 26.06.2012, N.G. 2687, S.A., B.T. (DUOF 6092), WS, TH.
- 138. *Caltha palustris* L.***
St 16, Hb 25, 1861 m, 18.05.2013, N.G. 3019 (DUOF 6886), H.
- 139. *Anemone blanda* Schott & Kotschy**
St 22, Hb 14, 1982 m, 02.06.2012, N.G. 2500, S.A. (DUOF 6169), CH.
- 140. *Ranunculus brutius* Ten.**
St 24, Hb 11, 1572 m, 07.06.2013, N.G. 3166 (DUOF 6315), Euro-Sib., G.
- 141. *Ranunculus dissectus* M.Bieb. subsp. *sibthorpii* P.H.Davis**
St 10, Hb 14, 2073 m, 02.06.2012, N.G. 2510, S.A. (DUOF 6115), G.
- 142. *Ranunculus repens* L.**
St 1, Hb 1, 1302 m, 11.06.2013, N.G. 3218 (DUOF 6389), WS, H.
- 143. *Ranunculus constantinopolitanus* (DC.) d'Urv.**
St 16, Hb 2, 1827 m, 09.06.2013, N.G. 3194 (DUOF 6388), WS, H.
- 144. *Ranunculus reuterianus* Boiss.***
St 17, Hb 4, 1389 m, 02.06.2012, N.G. 2400, S.A. (DUOF 6235), E., G.
- 145. *Ranunculus rumelicus* Griseb.**
St 25, Hb 5, 1231 m, 29.05.2011, Z.D.D. 1054 et al. (DUOF 2906), E.Med., G.
- 146. *Ranunculus illyricus* L. subsp. *illyricus***

- St 17, Hb 8, 1317 m, 02.06.2012, N.G. 2371, S.A. (DUOF 6170), WS, G.
- 147. *Ranunculus lateriflorus* DC.**
St 20, Hb 9, 1206 m, 18.05.2013, N.G. 3032 (DUOF 6885), Hyd.
- 148. *Ranunculus peltatus* Schrank subsp. *fucooides* (Freyn) Muñoz Garm**
St 20, Hb 9, 1206 m, 18.05.2013, N.G. 3033 (DUOF 6884), Med., Hyd.
- 149. *Ceratocephala falcata* (L.) Pers.***
St 8, Hb 15, 1307 m, 30.03.2013, N.G. 2966 (DUOF 6883), WS, TH.
- 21. SAXIFRAGACEAE**
- 150. *Saxifraga exarata* Vill. var. *exarata***
St 7, Hb 11, Hb 4, 1455 m, 19.05.2013, N.G. 3072 (DUOF 6503), Euro-Sib.
- 151. *Saxifraga tridactylites* L.**
St 6, Hb 5, 1270 m, 29.05.2011, Z.D.D. 1074 et al. (DUOF 2888), Med., TH.
- 152. *Saxifraga rotundifolia* L. subsp. *rotundifolia***
St 3, Hb 4, 1450 m, 02.06.2012, N.G. 2408, S.A. (DUOF 6502), Euro-Sib., H.
- 153. *Saxifraga cymbalaria* L.**
St 3, Hb 26, 1450 m, 02.06.2012, N.G. 2406, S.A. (DUOF 6295), TH.
- 22. CRASSULACEAE**
- 154. *Phedimus obtusifolius* (C.A.Mey.)'t Hart**
St 8, Hb 13, 1217 m, 26.06.2012, N.G. 2701, S.A., B.T. (DUOF 6866), H.
- 155. *Umbilicus luteus* (Huds.) Webb & Berthel.***
St 16, Hb 14, Hb 4, Hb 27, 1942 m, 22.07.2012, N.G. 2876, S.A. (DUOF 6299), G.
- 156. *Sedum amplexicaule* DC. subsp. *tenuifolium* (Sm.) Greuter & Burdet***
St 8, Hb 15, 1474 m, 11.06.2013, N.G. 3231 (DUOF 6332), Med., H.
- 157. *Sedum album* L.**
St 8, Hb 15, 1289 m, 13.06.2013, N.G. 3247 (DUOF 6865), H.
- 158. *Sedum confertiflorum* Boiss.***
St 16, Hb 2, 1790 m, 09.06.2013, N.G. 3250 (DUOF 6864), E.Med., TH.
- 159. *Sedum litoreum* Guss. var. *litoreum****
St 24, Hb 4, 1668 m, 14.06.2013, N.G. 3332 (DUOF 6867), Med., TH.
- 160. *Sedum caespitosum* (Cav.) DC.**
St 13, Hb 4, 1370 m, 29.05.2011, observation, TH.
- 161. *Sedum pallidum* M.Bieb.***
St 7, Hb 24, 1381 m, 13.06.2013, N.G. 3258-a (DUOF 6372), Eux., TH.
- 162. *Sempervivum armenum* Boiss. & A.Huet var. *armenum***
St 23, Hb 11, 1742 m, 05.08.2012, N.G. 2916, S.A., B.T. (DUOF 6248), E., Eux., H.
- 23. VITACEAE**
- 163. *Vitis vinifera* L.**
St 7, Hb 13, 1219 m, 11.06.2013, N.G. 3227-a (DUOF 6430), NaP.
- 24. FABACEAE (LEGUMINOSAE)**
- 164. *Genista tinctoria* L.**
St 10, Hb 14, 2072 m, 26.06.2012, N.G. 2783, S.A., B.T. (DUOF 6316), Euro-Sib., CH.
- 165. *Colutea cilicica* Boiss. & Balansa**
St 20, Hb 13, 1270 m, 03.06.2013, N.G. 3131 (DUOF 6756), WS, MiP.
- 166. *Astragalus coodei* D.F.Chamb. & V.A.Matthews**
St 17, Hb 4, 1389 m, 02.06.2012, N.G. 2387, S.A. (DUOF 6152), Ir.-Tur., CH.
- 167. *Astragalus glycyphylloides* DC.**
St 18, Hb 28, 1491 m, 06.06.2013, N.G. 3153, Euro-Sib., CH.
- 168. *Astragalus microcephalus* Willd.**
St 8, Hb 13, 1253 m, 27.06.2012, N.G. 2642, S.A., B.T. (DUOF 6334), CH.
- 169. *Astragalus plumosus* Willd.**
St 23, Hb 11, 1742 m, 05.08.2012, N.G. 2915, S.A., B.T. (DUOF 6327), Ir.-Tur., CH.
- 170. *Astragalus brachypterus* Fisch.**
St 10, Hb 14, 2072 m, 26.06.2012, N.G. 2776, S.A., B.T., CH.
- 171. *Astragalus oleifolius* DC.**
St 16, Hb 14, Hb 4, 1942 m, 22.07.2012, N.G. 2843 (DUOF 5518), Ir.-Tur., CH.
- 172. *Astragalus amoenus* Fenzl**
St 10, Hb 14, 2058 m, 18.07.2013, N.G. 3302, E., Ir.-Tur., CH.
- 173. *Cicer anatolicum* Alef.***
St 13, Hb 28, 1491 m, 06.06.2013, N.G. 3151, Ir.-Tur., CH.
- 174. *Vicia cracca* L. subsp. *cracca***
St 13, Hb 17, 1422 m, 26.06.2012, N.G. 2741, S.A., B.T. (DUOF 6281), Euro-Sib., CH.
- 175. *Vicia pubescens* Link**
St 25, Hb 5, 1231 m, 29.05.2011, Z.D.D. 1002 et al. (DUOF 2914), Med., TH.
- 176. *Vicia ervilia* (L.) Willd.**

- St 17, Hb 4, 1389 m, 02.06.2012, N.G. 2394, S.A. (DUOF 6217), TH.
- 177. *Vicia hirsuta* (L.) Gray**
St 20, Hb 13, 1272 m, 02.06.2013, N.G. 3118, TH.
- 178. *Vicia sativa* L. subsp. *nigra* (L.) Ehrh. var. *nigra***
St 20, Hb 13, 1272 m, 02.06.2013, N.G. 3139, TH.
- 179. *Lens nigricans* (M.Bieb.) Godr.***
St 8, Hb 4, 1236 m, 08.06.2012, N.G. 2596 et al. (DUOF 6290), Med., TH.
- 180. *Lathyrus brachypterus* Čelak.**
St 26, Hb 15, Hb 22, 1338 m, 08.06.2012, N.G. 2576 et al. (DUOF 6285), E., Ir.-Tur., H.
- 181. *Lathyrus digitatus* (M.Bieb.) Fiori**
St 8, Hb 8, 1234 m, 05.05.2012, N.G. 2358, N.A., B.T. (DUOF 6279), E.Med., H.
- 182. *Lathyrus pratensis* L.**
St 3, Hb 4, 1450 m, 02.06.2012, N.G. 2425, S.A. (DUOF 6286), Euro-Sib., H.
- 183. *Lathyrus czeczottianus* Bässler**
St 1, Hb 10, 1448 m, 28.06.2012, N.G. 2657, S.A., B.T. (DUOF 6325), E., Euro-Sib., H.
- 184. *Lathyrus saxatilis* (Vent.) Vis.***
St 13, Hb 29, Hb 4, 1382 m, 30.04.2013, N.G. 3003 (DUOF 6308), Med., TH.
- 185. *Lathyrus sphaericus* Retz.**
St 17, Hb 8, 1317 m, 02.06.2012, N.G. 2477, S.A. (DUOF 6282), Med., TH.
- 186. *Lathyrus cicera* L.**
St 8, Hb 13, 1220 m, 02.06.2013, N.G. 3110, Med., TH.
- 187. *Lathyrus nissolia* L.**
St 13, Hb 4, 1471 m, 08.06.2012, N.G. 2558 et al. (DUOF 6283), N.G. 3165-b, WS, TH.
- 188. *Ononis spinosa* L. subsp. *leiosperma* (Boiss.) Sirj.**
St 13, Hb 20, 1384 m, 20.10.2012, N.G. 2944 (DUOF 6278), WS, CH.
- 189. *Trifolium repens* L. var. *repens***
St 1, Hb 1, 1260 m, 11.06.2013, N.G. 3223 (DUOF 6354), H.
- 190. *Trifolium hybridum* L. var. *anatolicum* (Boiss.) Boiss.**
St 10, Hb 14, 2045 m, 22.07.2012, N.G. 2864 (DUOF 6356), H.
- 191. *Trifolium nigrescens* Viv. subsp. *nigrescens****
St 19, Hb 2, 1204 m, 18.05.2013, N.G. 3052 (DUOF 6304), TH.
- 192. *Trifolium campestre* Schreb. subsp. *campestre* var. *campestre***
St 20, Hb 30, 1282 m, 18.05.2013, N.G. 3037, Med., TH.
- 193. *Trifolium medium* L. var. *medium***
St 1, Hb 10, 1462 m, 08.06.2012, N.G. 2556, N.A., S.A., B.T., H.
- 194. *Trifolium caudatum* Boiss.**
St 22, Hb 14, 1902 m, 20.06.2013, N.G. 3288, E., H.
- 195. *Trifolium elongatum* Willd.**
St 13, Hb 28, 1574 m, 06.06.2013, N.G. 3156, E., H.
- 196. *Trifolium striatum* L.**
St 8, Hb 13, 1250 m, 02.06.2013, N.G. 3092-b (DUOF 6309), TH.
- 197. *Trifolium arvense* L. var. *arvense***
St 8, Hb 13, 1241 m, 27.06.2012, N.G. 2631, S.A., B.T., WS, TH.
- 198. *Melilotus bicolor* Boiss. & Balansa**
St 8, Hb 15, 1460 m, 11.06.2013, N.G. 3235, E., Ir.-Tur., TH.
- 199. *Medicago lupulina* L.**
St 7, Hb 17, 1290 m, 22.07.2014, N.G. 3379 ve diğ., H.
- 200. *Medicago sativa* L. subsp. *sativa***
St 7, Hb 17, 1290 m, 21.07.2014, N.G. 3386 (DUOF 6755), H.
- 201. *Medicago* x *varia* Martyn (*M. sativa* x *M. falcata*)**
St 13, Hb 2, stony areas, Hb 18, 1313 m, 26.06.2012, N.G. 2755, S.A., B.T. (DUOF 6320), H.
- 202. *Medicago minima* (L.) Bartal. var. *minima***
St 20, Hb 13, 1272 m, 02.06.2013, N.G. 3117, Med., TH.
- 203. *Medicago rigidula* (L.) All. var. *rigidula****
St 8, Hb 13, 1241 m, 27.06.2012, N.G. 2649, S.A., B.T. (DUOF 6288), WS, TH.
- 204. *Dorycnium graecum* (L.) Ser.**
St 1, Hb 1, 1350 m, 10.06.2013, N.G. 3208-c (DUOF 6329), Eux., CH.
- 205. *Lotus corniculatus* L. var. *corniculatus***
St 8, Hb 13, 1217 m, 26.06.2012, N.G. 2703, S.A., B.T. (DUOF 6357), H.
- 206. *Lotus corniculatus* L. var. *alpinus* Ser.**

- St 14, Hb 19, slope, 1410 m, 02.06.2012, N.G. 2441, S.A. (DUOF 6318), H.
- 207. *Lotus aegaeus*** (Griseb.) Boiss.
St 8, Hb 13, 1241 m, 27.06.2012, N.G. 2633, S.A., B.T. (DUOF 6323), Ir.-Tur., CH.
- 208. *Anthyllis vulneraria*** L. subsp. *praepropera* (Kerner) Bornm.*
St 1, Hb 10, 1385 m, 28.06.2012, N.G. 2664, S.A., B.T. (DUOF 6321), Med., H.
- 209. *Securigera varia*** (L.) Lassen
St 4, Hb 6, Hb 4, 1777 m, 05.08.2012, N.G. 2894, S.A., B.T. (DUOF 6376), WS, CH.
- 210. *Onobrychis oxyodonta*** Boiss. var. *oxyodonta*
St 8, Hb 13, 1241 m, 27.06.2012, N.G. 2645, S.A., B.T. (DUOF 6757), WS, CH.
- 25. POLYGALACEAE**
- 211. *Polygala anatolica*** Boiss. & Heldr.
St 24, Hb 6, 1614 m, 07.06.2013, N.G. 3164 (DUOF 6397), WS, CH.
- 26. ROSACEAE**
- 212. *Prunus spinosa*** L.
St 8, Hb 2, Hb 4, 1471 m, 20.10.2012, N.G. 2955 (DUOF 6857), Euro-Sib., NaP.
- 213. *Prunus divaricata*** Ledeb. subsp. *divaricata*
St 17, Hb 8, 1317 m, 02.06.2012, N.G. 2385, S.A. (DUOF 6392), MeP.
- 214. *Prunus cocomilia*** Ten.
St 17, Hb 8, 1317 m, 02.06.2012, N.G. 2384, S.A. (DUOF 6856), MiP.
- 215. *Cerasus mahaleb*** (L.) Mill. var. *mahaleb*
St 8, Hb 13, 1241 m, 27.06.2012, N.G. 2643, S.A., B.T. (DUOF 6759), MiP.
- 216. *Filipendula vulgaris*** Moench
St 13, Hb 10, Hb 19 slope, 1397 m, 18.07.2013, N.G. 3326 (DUOF 6158), Euro-Sib., H.
- 217. *Rubus idaeus*** L. subsp. *idaeus*
St 4, Hb 6, 1777 m, 05.08.2012, N.G. 2881, S.A., B.T., S.A., B.T., Euro-Sib., NaP.
- 218. *Rubus canescens*** DC. var. *canescens*
St 18, Hb 2, Hb 15, Hb 18, 1313 m, 26.06.2012, N.G. 2761, S.A., B.T.; Euro-Sib., NaP.
- 219. *Potentilla argentea*** L.
St 7, Hb 24, 1477 m, 12.06.2013, N.G. 3257 (DUOF 6381), H.
- 220. *Potentilla calabra*** Ten.
St 24, Hb 4, 1665 m, 14.06.2013, N.G. 2917, Med., H.
- 221. *Potentilla recta*** L.
St 24, Hb 24, 1665 m, 14.06.2013, N.G. 3267 (DUOF 6328), H.
- 222. *Potentilla micrantha*** Ramond ex DC.
St 16, Hb 25, 1861 m, 18.05.2013, N.G. 3022, G.
- 223. *Fragaria vesca*** L.
St 7, Hb 4, slope, 1531 m, 02.06.2012, N.G. 2491, S.A. (DUOF 6760); H.
- 224. *Sibbaldia parviflora*** Willd. var. *parviflora*
St 10, Hb 14, 2072 m, 26.06.2012, N.G. 2779, S.A., B.T. (DUOF 6363), CH.
- 225. *Geum coccineum*** Sibth. & Sm.*
St 7, Hb 10, 1396 m, 09.05.2014, N.G. 3352, Euro-Sib., H.
- 226. *Geum urbanum*** L.
St 16, Hb 11, 1776 m, 08.06.2013, N.G. 3181 (DUOF 6358), Euro-Sib., H.
- 227. *Agrimonia eupatoria*** L. subsp. *eupatoria*
St 20, Hb 13, 1257 m, 03.06.2013, N.G., observation, H.
- 228. *Sanguisorba officinalis*** L.*
St 17, Hb 8, 1317 m, 02.06.2012, N.G. 2376, S.A. (DUOF 6859), H.
- 229. *Sanguisorba minor*** Scop. subsp. *balearica* (Bourg. ex Nyman) Muñoz Garm & C.Navarro
St 20, Hb 30, 1282 m, 18.05.2013, N.G. 3041 (DUOF 6858), WS, H.
- 230. *Alchemilla valdehirsuta*** Buser
St 16, Hb 14, Hb 4, Hb 27, 1942 m, 22.07.2012, N.G. 2850, G.
- 231. *Alchemilla compactilis*** Juz.
St 10, Hb 14, 2072 m, 26.06.2012, N.G. 2787, S.A., B.T. (DUOF 6361), G.
- 232. *Alchemilla pseudocartalinica*** Juz.
St 16, Hb 2, 1823 m, 09.06.2013, N.G. 3195 (DUOF 6373), G.
- 233. *Alchemilla mollis*** (Buser) Rothm
St 10, Hb 21, 1980 m, 18.07.2013, N.G. 3309 (DUOF 6374), G.
- 234. *Rosa marginata*** Wallr.
St 13, Hb 10, Hb 19, 1475 m, 23.09.2012, N.G. 2923, M.A. (DUOF 6861), Euro-Sib., NaP.
- 235. *Rosa pulverulenta*** M.Bieb.
St 4, Hb 4, 1715 m, 18.06.2013, N.G. 3338 (DUOF 6347), NaP.

- 236. *Rosa iberica*** Stev.
St 4, Hb 4, 1781 m, 17.06.2013, N.G. 3274 (DUOF 6378), NaP.
- 237. *Rosa canina*** L.
St 4, Hb 4, 1715 m, 18.06.2013, N.G. 3280 (DUOF 6375), MiP.
- 238. *Cotaneaster nummularius*** Fisch. & C.A.Mey.
St 8, Hb 4, 1236 m, 08.06.2012, N.G. 2580, N.A., S.A., B.T., WS, MiP.
- 239. *Crataegus tanacetifolia*** (Poir.) Pers.
St 3, Hb 4, 1450 m, 02.06.2012, N.G. 2420, S.A., E., MeP.
- 240. *Crataegus orientalis*** Pallas ex M.Bieb. var. *orientalis*
St 13, Hb 10, Hb 19, 1475 m, 23.09.2012, N.G. 2924, M.A., WS, MiP.
- 241. *Crataegus monogyna*** Jacq. subsp. *monogyna*
St 19, Hb 2, 1204 m, 18.05.2013, N.G. 3051, MeP.
- 242. *Sorbus umbellata*** Fritsch
St 4, Hb 6, 1777 m, 05.08.2012, N.G. 2880, S.A., B.T. (DUOF 6855), MeP.
- 243. *Malus sylvestris*** (L.) Mill. subsp. *orientalis* (Uglitzk.) Browicz var. *orientalis*
St 14, Hb 19, 1431 m, 05.05.2012, N.G. 2313, N.A., B.T. (DUOF 6758), WS, MeP.
- 244. *Pyrus elaeagnifolia*** Pall. subsp. *elaegnifolia*
St 3, Hb 2, 1450 m, 02.06.2012, N.G. 2429, S.A. (DUOF 6762), MiP.
- 245. *Pyrus elaeagnifolia*** Pall. subsp. *kotschyana* (Boiss.) Browicz
St 8, Hb 2, Hb 4, 1471 m, 20.10.2012, N.G. 2954 (DUOF 6761), MiP.
- 27. RHAMNACEAE**
- 246. *Paliurus spina-christi*** P. Mill.
St 8, Hb 13, 1217 m, 26.06.2012, N.G. 2683, S.A., B.T. (DUOF 6084), MiP.
- 247. *Rhamnus thymifolia*** Bornm.
St 8, Hb 13, 1241 m, 27.06.2012, N.G. 2634, S.A., B.T. (DUOF 6239), E., NaP.
- 28. URTICACEAE**
- 248. *Urtica dioica*** L. subsp. *dioica*
St 17, Hb 8, 1317 m, 02.06.2012, N.G. 2450, S.A. (DUOF 6245), Euro-Sib., H.
- 249. *Parietaria lusitanica*** L.*
St 8, Hb 13, 1215 m, 27.06.2012, N.G. 2626, S.A., B.T. (DUOF 6189), Med., TH.
- 29. FAGACEAE**
- 250. *Quercus pubescens*** Willd. subsp. *pubescens*
St 1, Hb 10, 1385 m, 28.06.2012, N.G. 2673, S.A., B.T. (DUOF 6746), MeP.
- 30. EUPHORBIACEAE**
- 251. *Euphorbia condylocarpa*** M.Bieb.
St 5, Hb 4, 1465 m, 05.05.2012, N.G. 2317, N.A., B.T. (DUOF 6495), G.
- 252. *Euphorbia stricta*** L.
St 4, Hb 6, Hb 4, 1777 m, 05.08.2012, N.G. 2426, S.A., B.T. (DUOF 6437), Euro-Sib., TH.
- 253. *Euphorbia taurinensis*** All.
St 8, Hb 13, 1217 m, 26.06.2012, N.G. 2705, S.A., B.T. (DUOF 6445), TH.
- 254. *Euphorbia falcata*** L. subsp. *falcata* var. *galilaea*
St 8, Hb 13, 1215 m, 27.06.2012, N.G. 2627, S.A., B.T. (DUOF 6496), WS, TH.
- 255. *Euphorbia anacampseros*** Boiss. var. *anacampseros*
St 8, Hb 4, Hb 2, 1248 m, 30.04.2013, N.G. 2983 (DUOF 6369), E., H.
- 256. *Euphorbia myrsinites*** L. subsp. *myrsinites*
St 10, Hb 14, 2072 m, 26.06.2012, N.G. 2802, S.A., B.T. (DUOF 6386), H.
- 31. SALICACEAE**
- 257. *Salix alba*** L. subsp. *alba*
St 7, Hb 11, Hb 19, slope, 1622 m, 02.06.2012, N.G. 2497, S.A. (DUOF 6296), WS, MeP.
- 258. *Salix caprea*** L.
St 7, Hb 11, Hb 19, slope, 1622 m, 02.06.2012, N.G. 2496, S.A. (DUOF 6298); Euro-Sib., MeP.
- 259. *Salix amplexicaulis*** Bory & Chaub.
St 7, Hb 17, 1290 m, 22.07.2014, N.G. 3380 et al. (DUOF 6457), Med., MiP.
- 260. *Populus tremula*** L. subsp. *tremula*
St 13, Hb 4, 1471 m, 08.06.2012, N.G. 2561 et al. (DUOF 6297), Euro-Sib., MeP.
- 261. *Populus nigra*** L. subsp. *nigra*
St 5, Hb 19, 1115 m, 05.05.2012, N.G. 2316 (DUOF 6236), N.A., B.T., Euro-Sib., MeP.
- 32. VIOLACEAE**
- 262. *Viola odorata*** L.
St 3, Hb 3, 1486 m, 05.05.2012, N.G. 2339, N.A., B.T. (DUOF 6270), H.
- 263. *Viola sieheana*** W. Becker
St 16, Hb 11, 1852 m, 08.06.2013, N.G. 3175 (DUOF 6360), H.
- 264. *Viola kitaibeliana*** Roem & Schult.

St 8, Hb 13, 1231 m, 08.06.2012, N.G.
2546-b et al. (DUOF 6271), TH.

265. *Viola gracilis* Sibth. & Sm

St 10, Hb 14, 2073 m, 02.06.2012, N.G.
2512, S.A. (DUOF 6269), H.

**33. HYPERICACEAE
(GUTTIFERAE)**

266. *Hypericum scabrum* L.*

St 17, Hb 8, 1317 m, 02.06.2012, N.G.
2458, S.A. (DUOF 6225), Ir.-Tur., CH.

267. *Hypericum venustum* Fenzl

St 10, Hb 21, 1980 m, 18.07.2013, N.G.
3315, CH.

**268. *Hypericum linarioides* Bosse subsp.
*linarioides***

St 10, Hb 14, 2072 m, 26.06.2012, N.G.
2793, S.A., B.T. (DUOF 6448), CH.

269. *Hypericum montbretii* Spach.

St 3, Hb 4, 1450 m, 02.06.2012, N.G.
2412, S.A. (DUOF 6232), CH.

270. *Hypericum orientale* L.

St 17, Hb 4, 1389 m, 02.06.2012, N.G.
2397, S.A. (DUOF 6233), CH.

271. *Hypericum perforatum* L.

St 20, Hb 8, 1309 m, 04.06.2013, N.G.
3134-a, CH.

34. GERANIACEAE

272. *Geranium lucidum* L.

St 20, Hb 13, 1282 m, 02.06.2013, N.G.
3124; TH.

273. *Geranium purpureum* Vill.

St 27, Hb 1, 1500 m, 02.06.2012, N.G.
2487, S.A. (DUOF 6266), TH.

274. *Geranium dissectum* L.

St 6, Hb 5, 1270 m, 29.05.2011, Z.D.D.
1070 et al. (DUOF 2927), WS, TH.

275. *Geranium macrostylum* Boiss.

St 27, Hb 1, 1500 m, 02.06.2012, N.G.
2469, S.A. (DUOF 6265), E.Med., G.

**276. *Geranium asphodeloides* Burmf.
subsp. *asphodeloides***

St 10, Hb 21, 1980 m, 18.07.2013, N.G.
3310 (DUOF 6370), Euro-Sib., G.

277. *Geranium pyrenaicum* Burmf.

St 17, Hb 8, 1317 m, 02.06.2012, N.G.,
2462, S.A. (DUOF 6294), H.

**278. *Erodium cicutarium* (L.) L Hér.
subsp. *cutarium***

St 19, Hb 2, 1204 m, 18.05.2013, N.G.
3059, TH.

**279. *Erodium acaule* (L.) Becherer &
Thell.***

St 8, Hb 15, 1477 m, 12.06.2013, N.G.
3233, Med., H.

280. *Pelargonium endlicherianum* Fenzl

St 8, Hb 13, 1217 m, 26.06.2012, N.G.
2692, S.A., B.T. (DUOF 6554), Ir.-Tur., G.

35. ONAGRACEAE

281. *Epilobium angustifolium* L.

St 24, Hb 6, 1614 m, 07.06.2013, N.G.
3162, WS, H.

282. *Epilobium hirsutum* L.

St 8, Hb 13, 1217 m, 26.06.2012, N.G.
2686, S.A., B.T. (DUOF 6456), WS, H.

**283. *Epilobium tetragonum* L. subsp.
*tetragonum***

St 4, Hb 4, Hb 6, 1777 m, 05.08.2012,
N.G. 2893, S.A., B.T. (DUOF 6196), TH.

**284. *Epilobium tetragonum* L. subsp.
lamyü (F.W.Schultz) Nyman***

St 16, Hb 11, 1823 m, 22.07.2012, N.G.
2841-a (DUOF 6454), Euro-Sib., H.

285. *Epilobium minutiflorum* Hausskn.*

St 16, Hb 11, 1823 m, 22.07.2012, N.G.
2841-b, Ir.-Tur., TH.

286. *Epilobium ponticum* Hausskn.*

St 22, Hb 14, 1902 m, 26.06.2012, N.G.
2746, S.A., B.T. (DUOF 6345), G.

36. MALVACEAE

287. *Malva alcea* L.*

St 28, Hb 4, 1730 m, 09.06.2013, N.G.
3251 (DUOF 6505), H.

288. *Malva neglecta* Wallr.

St 16, Hb 2, 1812 m, 09.06.2013, N.G.
3198-a (DUOF 6154), S.A., B.T., TH.

289. *Alcea apterocarpa* (Fenzl) Boiss.

St 8, Hb 13, 1217 m, 30.06.2014, N.G.
3355, Ir.-Tur., H.

37. THYMELAEACEAE

**290. *Daphne oleoides* Schreb. subsp.
*oleoides***

St 10, Hb 14, 2072 m, 26.06.2012, N.G.
2799, S.A., B.T. (DUOF 6244), CH.

**291. *Thymelaea passerina* (L.) Casson &
Germ**

St 8, Hb 13, 1253 m, 27.06.2012, N.G.,
S.A., B.T., observation, TH.

38. CISTACEAE

292. *Cistus laurifolius* L.

St 5, Hb 4, 1465 m, 05.05.2012, N.G.
2328, N.A., B.T. (DUOF 6083), Med., CH.

**293. *Helianthemum nummularium* (L.)
Mill. subsp. *nummularium***

St 13, Hb 28, 1409 m, 05.06.2013, N.G.
3144 (DUOF 6450), CH.

- 294. *Helianthemum ledifolium* (L.) Mill.***
St 17, Hb 8, 1317 m, 02.06.2012, N.G. 2468, S.A. (DUOF 6151), Med., TH.
- 39. RESEDACEAE**
- 295. *Reseda lutea* L. var. *lutea***
St 25, Hb 5, 1231 m, 29.05.2011, Z.D.D. 1021 et al. (DUOF 2890), WS, H.
- 40. BRASSICACEAE (CRUCIFERAE)**
- 296. *Lepidium perfoliatum* L.**
St 19, Hb 2, 1204 m, 18.05.2013, N.G. 3048 (DUOF 6553), WS, H.
- 297. *Lepidium draba* L.***
St 19, Hb 2, 1204 m, 18.05.2013, N.G. 3054 (DUOF 6540), WS, H.
- 298. *Isatis cappadocica* Desv. subsp. *alyssifolia* (Boiss.) P.H.Davis**
St 11, Hb 16, 1979 m, 19.05.2013, N.G. 3090 (DUOF 6543), E., Ir.-Tur., H.
- 299. *Thlaspi perfoliatum* L.**
St 8, Hb 8, 1234 m, 05.05.2012, N.G. 2345 (DUOF 6089), N.A., B.T., WS, TH.
- 300. *Noccaea phrygia* (Borm) F.K.Mey.***
St 10, Hb 14, 2073 m, 02.06.2012, N.G. 2501, S.A. (DUOF 6140), E., H.
- 301. *Capsella bursa-pastoris* (L.) Medik.**
St 8, Hb 13, 1293 m, 09.05.2014, N.G. 3347 (DUOF 6552), WS, H.
- 302. *Capsella rubella* Reut.***
St 17, Hb 8, 1317 m, 02.06.2012, N.G. 2364-a, S.A. (DUOF 6263), Med., H.
- 303. *Bornmuellera cappadocica* (Willd.) Cullen & T.R.Dudley***
St 24, Hb 6, 1614 m, 07.06.2013, N.G. 3160 (DUOF 6558); E., Ir.-Tur., CH.
- 304. *Alyssum desertorum* Stapf.**
St 17, Hb 8, 1317 m, 02.06.2012, N.G. 2479 (DUOF 6243), WS, TH.
- 305. *Alyssum minutum* Schlecht. ex DC.***
St 17, Hb 4, 1389 m, 02.06.2012, N.G. 2393, S.A. (DUOF 6163), TH.
- 306. *Alyssum umbellatum* Desv.**
St 19, Hb 2, 1204 m, 18.05.2013, N.G. 3050 (DUOF 6545), N.G. 3058, TH.
- 307. *Alyssum sibiricum* Willd.**
St 14, Hb 19, 1410 m, 02.06.2012, N.G. 2447, S.A. (DUOF 6241), WS, CH.
- 308. *Alyssum condensatum* Boiss. & Hausskn. subsp. *condensatum***
St 10, Hb 14, 2072 m, 26.06.2012, N.G. 2790, S.A., B.T. (DUOF 6546), CH.
- 309. *Alyssum murale* Waldst. & Kit. subsp. *murale* var. *murale***
St 8, Hb 13, 1253 m, 27.06.2012, N.G. 2637, S.A., B.T. (DUOF 6090), WS, CH.
- 310. *Draba muralis* L.**
St 16, Hb 2, 1819 m, 09.06.2013, N.G. 3204 (DUOF 6550), TH.
- 311. *Draba verna* L.***
St 8, Hb 13, 1248 m, 30.04.2013, N.G. 2978 (DUOF 6541), WS, TH.
- 312. *Arabis alpina* L. subsp. *alpina***
St 5, Hb 19, 1115 m, 05.05.2012, N.G. 2314, N.A., B.T. (DUOF 6091), WS, H.
- 313. *Turritis laxa* (Sibth. & Sm.) Hayek***
St 3, Hb 4, 1450 m, 02.06.2012, N.G. 2405, S.A. (DUOF 6165), TH.
- 314. *Nasturtium officinale* R. Br., Aiton**
St 5, Hb 25, 1465 m, 05.05.2012, N.G. 2323, N.A., B.T. (DUOF 6166), WS, G.
- 315. *Barbarea trichopoda* Hausskn. ex Bormm.**
St 5, Hb 4, 1465 m, 05.05.2012, N.G. 2333, N.A., B.T. (DUOF 6264), E., Med., H.
- 316. *Barbarea plantaginea* DC.***
St 4, Hb 6, Hb 4, 1777 m, 05.08.2012, N.G. 2899, S.A., B.T. (DUOF 6341), WS, H.
- 317. *Barbarea brachycarpa* Boiss. subsp. *brachycarpa* var. *brachycarpa***
St 11, Hb 16, 1979 m, 19.05.2013, N.G. 3079 (DUOF 6551), Ir.-Tur., H.
- 318. *Cardamine tenera* S.G.Gmel. ex C.A.Mey.***
St 10, Hb 14, 2072 m, 26.06.2012, N.G. 2789-b, S.A., B.T. (DUOF 6538), Hirkanoeux., H.
- 319. *Cardamine hirsuta* L.**
St 6, Hb 26, 1270 m, 29.05.2011, Z.D.D. 1068 et al. (DUOF 2895), WS, TH.
- 320. *Hesperis bicuspidata* (Willd.) Poir.**
St 7, Hb 11, 1865 m, 02.06.2012, N.G. 2499, S.A. (DUOF 6088), E., Ir.-Tur., H.
- 321. *Erysimum leucanthemum* (Stephan ex Willd.) B.Fedtsch.***
St 14, Hb 19, slope, 1410 m, 02.06.2012, N.G. 2442, S.A. (DUOF 6262), H.
- 322. *Erysimum* cf. *kartalHb 24ense* Yild.**
St 16, Hb 14, Hb 4, Hb 27, 1942 m, 22.07.2012, N.G. 2855 (DUOF 6429), E., Eux., H.
- 323. *Sisymbrium officinale* (L.) Scop.**
St 19, Hb 2, 1204 m, 18.05.2013, N.G. 3057 (DUOF 6547), WS, TH.
- 324. *Sisymbrium altissimum* L.***

- St 19, Hb 2, 1204 m, 18.05.2013, N.G. 3055 (DUOF 6549), WS, TH.
- 325. *Descurainia sophia*** (L.) Webb ex Prantl subsp. *sophia*
St 19, Hb 2, 1204 m, 18.05.2013, N.G. 3056 (DUOF 6539), WS, TH.
- 41. SANTALACEAE**
- 326. *Thesium billardieri*** Boiss.
St 13, Hb 4, 1471 m, 08.06.2012, N.G. 2569 et al. (DUOF 6202), Ir.-Tur., H.
- 42. LORANTHACEAE**
- 327. *Viscum album*** L. subsp. *album*
St 21, Hb 10, *P. nigra* üzeri, 1276 m, 30.03.2013, N.G. 2957 (DUOF 6453), MeP.
- 43. PLUMBAGINACEAE**
- 328. *Plumbago europaea*** L.*
St 13, Hb 8, 1424 m, 23.09.2012, N.G. 2927, M.A. (DUOF 6444), Euro-Sib., H.
- 44. POLYGONACEAE**
- 329. *Polygonum setosum*** Jacq. subsp. *setosum**
St 13, Hb 4, 1566 m, 19.06.2013, N.G. 3333 (DUOF 6331), Ir.-Tur., CH.
- 330. *Polygonum cognatum*** Meissn.*
St 17, Hb 8, 1317 m, 02.06.2012, N.G. 2449, S.A. (DUOF 6273), CH.
- 331. *Polygonum aviculare*** L.
St 22, Hb 14, 2056 m, 05.08.2012, N.G. 2911, S.A., B.T. (DUOF 6272), WS, TH.
- 332. *Polygonum convolvulus*** L.
St 7, Hb 17, 1290 m, 21.07.2014, N.G. 3387 (DUOF 6458), H.
- 333. *Rumex acetosella*** L.
St 19, Hb 2, 1204 m, 18.05.2013, N.G. 3061 (DUOF 6138), WS, H.
- 334. *Rumex tuberosus*** L. subsp. *tuberosus*
St 4, Hb 6, 1777 m, 05.08.2012, N.G. 2891, S.A., B.T., G.
- 335. *Rumex alpinus*** L.
St 7, Hb 20, 1622 m, 02.06.2012, N.G. 2494-a, b, S.A. (DUOF 6221, 6222), G.
- 45. CARYOPHYLLACEAE**
- 336. *Eremogone ledebouriana*** (Fenzl) Ikonn.
St 8, Hb 13, 1241 m, 27.06.2012, N.G. 2653, S.A., B.T. (DUOF 6499), E., CH.
- 337. *Minuartia hirsuta*** (M Bieb.) Hand.-Mazz. subsp. *falcata* (Gris.) Mattf.
St 10, Hb 14, 2072 m, 26.06.2012, N.G. 2781, S.A., B.T., H.
- 338. *Minuartia juniperina*** (L.) Maire & Petitm.*
- St 8, Hb 15, 1322 m, 13.06.2013, N.G. 3262 (DUOF 6482), CH.
- 339. *Cerastium dubium*** (Bastard) O.Schwarz*
St 8, Hb 13, 1248 m, 30.04.2013, N.G. 2980 (DUOF 6466), TH.
- 340. *Cerastium purpurascens*** Adams
St 10, Hb 14, 2073 m, 02.06.2012, N.G. 2506, S.A. (DUOF 6470), H.
- 341. *Cerastium dichotomum*** L. subsp. *dichotomum**
St 3, Hb 4, 1450 m, 02.06.2012, N.G. 2404, S.A. (DUOF 6483), TH.
- 342. *Cerastium glomeratum*** Thuill.
St 8, Hb 19, 1248 m, 30.04.2013, N.G. 2988 (DUOF 6478), WS, TH.
- 343. *Moenchia mantica*** (L.) Bartl. subsp. *mantica*
St 17, Hb 8, 1317 m, 02.06.2012, N.G. 2480, S.A. (DUOF 6479), TH.
- 344. *Spergularia rubra*** (L.) J. & C. Presl
St 22, Hb 14, 2056 m, 05.08.2012, N.G. 2912, S.A., B.T. (DUOF 6486), WS, H.
- 345. *Herniaria incana*** Lam
St 13, Hb 15, Hb 22, 1330 m, 26.06.2012, N.G. 2718, S.A., B.T. (DUOF 6529), CH.
- 346. *Telephium imperati*** L. subsp. *orientale* (Boiss.) Nyman
St 20, Hb 8, 1303 m, 04.06.2013, N.G. 3141 (DUOF 6462), H.
- 347. *Dianthus leucophaeus*** Sm.
St 22, Hb 14, 1902 m, 26.06.2012, N.G. 2743, S.A., B.T. (DUOF 6485); E., H.
- 348. *Dianthus crinitus*** Sm. var. *crinitus*
St 24, Hb 4, 1642 m, 14.06.2013, N.G. 3331 (DUOF 6463), H.
- 349. *Dianthus carmelitarum*** Reut. ex Boiss.*
St 8, Hb 13, 1217 m, 30.06.2014, N.G. 3360 (DUOF 6461), E., Euro-Sib., H.
- 350. *Dianthus lydus*** Boiss.
St 8, Hb 13, 1241 m, 27.06.2012, N.G. 2629, S.A., B.T. (DUOF 6475), E., H.
- 351. *Dianthus capitatus*** J.St.-Hil.*
St 20, Hb 13, 1282 m, 02.06.2013, N.G. 3121 (DUOF 6468), Euro-Sib., H.
- 352. *Petrorhagia alpina*** (Hablitz) P.W.Ball & Heywood subsp. *alpina*
St 4, Hb 23, 1885 m, 20.06.2013, N.G. 3287 (DUOF 6465), TH.
- 353. *Petrorhagia alpina*** (Hablitz) P.W.Ball & Heywood subsp. *olympica* (Boiss.) P.W.Ball & Heywood*

- St 10, Hb 21, 1983 m, 18.07.2013, N.G. 3322, TH.
- 354. *Velezia pseudorigida*** Hub.-Mor.*
St 8, Hb 15, 1368 m, 12.06.2013, N.G. 3240-a (DUOF 6136), E., E.Med., TH.
- 355. *Saponaria chlorifolia*** Kunze*
St 1, Hb 1, 1350 m, 10.06.2013, N.G. 3208-a (DUOF 6186), E., E.Med., TH.
- 356. *Silene italica*** (L.) Pers. subsp. *italica*
St 13, Hb 1, 1340 m, 10.06.2013, N.G. 3339 (DUOF 6487), Med., H.
- 357. *Silene olympica*** Boiss. var. *olympica*
St 4, Hb 23, 1885 m, 20.06.2013, N.G. 3285-b (DUOF 6346), E., Ir.-Tur., CH.
- 358. *Silene supina*** M.Bieb. subsp. *pruinosa* (Boiss.) Chowdhuri*
St 7, Hb 17, 1290 m, 22.07.2014, N.G. 3377 et al. (DUOF 6473), CH.
- 359. *Silene vulgaris*** (Moench) Garcke var. *vulgaris*
St 13, Hb 11, 1728 m, 26.06.2012, N.G. 2775, S.A., B.T. (DUOF 6477), CH.
- 360. *Silene rhynchocarpa*** Boiss.*
St 3, Hb 4, 1450 m, 02.06.2012, N.G. 2409, S.A. (DUOF 6480), E.Med., CH.
- 360. *Silene compacta*** Fisch. ex Hornem
St 1, Hb 19, 1420 m, 28.06.2012, N.G. 2658, S.A., B.T. (DUOF 6476), WS, H.
- 361. *Scleranthus annuus*** L. subsp. *annuus*
St 10, Hb 14, 2073 m, 02.06.2012, N.G. 2508, S.A. (DUOF 6257), WS, TH.
- 46. AMARANTHACEAE**
(CHENOPODIACEAE)
- 362. *Chenopodium botrys*** L.
St 17, Hb 4, 1370 m, 05.08.2012, N.G. 2900, S.A., B.T. (DUOF 6256), Med., TH.
- 363. *Chenopodium foliosum*** Asch.
St 16, Hb 2, 1812 m, 09.06.2013, N.G. 3198-b (DUOF 6722), H.
- 364. *Chenopodium album*** L. subsp. *album* var. *album*
St 7, Hb 17, 1290 m, 21.07.2014, N.G. 3389 (DUOF 6721), TH.
- 47. PORTULACACEAE**
- 365. *Montia arvensis*** Wallr.
St 6, Hb 5, 1270 m, 29.05.2011, Z.D.D. 1086 et al. (DUOF 2932), TH.
- 48. PRIMULACEAE**
- 366. *Primula acaulis*** (L.) L. subsp. *acaulis*
St 3, Hb 3, 1486 m, 05.05.2012, N.G. 2341, N.A., B.T. (DUOF 6446), Euro-Sib., H.
- 367. *Androsace maxima*** L.
St 8, Hb 13, 1248 m, 30.04.2013, N.G. 2977 (DUOF 6439), TH.
- 368. *Lysimachia vulgaris*** L.
St 2, Hb 2, 1483 m, 20.10.2012, N.G. 2947 (DUOF 6148), WS, H.
- 369. *Lysimachia atropurpurea*** L.
St 7, Hb 13, 1232 m, 10.06.2013, N.G. 3207 (DUOF 6440), TH.
- 370. *Anagallis arvensis*** L. var. *arvensis*
St 8, Hb 13, 1215 m, 27.06.2012, N.G. 2624, S.A., B.T., TH.
- 371. *Anagallis femina*** Mill.
St 8, Hb 13, 1217 m, 30.06.2014, N.G. 3358 (DUOF 6443), Med., TH.
- 49. ERICACEAE**
- 372. *Pyrola minor*** L.
St 4, Hb 6, 1760 m, 18.06.2013, N.G. 3244 (DUOF 6427), B.T., Euro-Sib., G.
- 373. *Orthilia secunda*** (L.) House
St 4, Hb 6, 1731 m, 17.06.2013, N.G. 3243 (DUOF 6460), G.
- 49. RUBIACEAE**
- 374. *Sherardia arvensis*** L.
St 6, Hb 5, 1270 m, 29.05.2011, Z.D.D. 1072 et al. (DUOF 2920) Med., TH.
- 50. RUBIACEAE**
- 375. *Crucianella bithynica*** Boiss.
St 8, Hb 13, 1217 m, 26.06.2012, N.G. 2704, S.A., B.T. (DUOF 6130), E.Med., TH.
- 376. *Crucianella angustifolia*** L.*
St 13, Hb 28, 1390 m, 14.06.2013, N.G. 3129 (DUOF 6501), Med., TH.
- 377. *Asperula involucrata*** Wahlenb.
St 14, Hb 19, slope, 1410 m, 02.06.2012, N.G. 2440, S.A. (DUOF 6128), Eux., CH.
- 378. *Galium rotundifolium*** L.
St 4, Hb 6, 1731 m, 17.06.2013, N.G. 3275 (DUOF 6523), Euro-Sib., G.
- 379. *Galium rivale*** (Sibth. & Sm) Griseb.
St 4, Hb 6, Hb 4, 1777 m, 05.08.2012, N.G. 2889, S.A., B.T. (DUOF 6524); Euro-Sib., H.
- 380. *Galium palustre*** L.
St 10, Hb 21, 1980 m, 18.07.2013, N.G. 3314 (DUOF 6529), Euro-Sib., G.
- 381. *Galium verum*** L. subsp. *verum*
St 8, Hb 13, 1231m, 27.06.2012, N.G. 2615, S.A., B.T. (DUOF 6527), Euro-Sib., H.

- 382. *Galium verum* L. subsp. *glabrescens*** Ehrend.
St 13, Hb 15, Hb 22, 1330 m, 26.06.2012, N.G. 2731, S.A., B.T. (DUOF 6528), Ir.-Tur., H.
- 383. *Galium incanum* Sm**
St 24, Hb 19, Hb 4, 1572 m, 07.06.2013, N.G. 3167-a, H.
- 384. *Galium spurium* L. subsp. *spurium***
St 8, Hb 13, 1231m, 27.06.2012, N.G. 2598-b, S.A., B.T. (DUOF 6525), TH.
- 385. *Galium aparine* L.**
St 2, Hb 21, 1486 m, 08.06.2012, N.G. 2550-b et al. (DUOF 6522), TH.
- 386. *Galium floribundum* Sm. subsp. *floribundum****
St 8, Hb 13, 1217 m, 26.06.2012, N.G. 2688, S.A., B.T. (DUOF 6526), & N.G., TH.
- 387. *Cruciata laevipes* Opiz**
St 13, Hb 4, 1471 m, 08.06.2012, N.G. 2573 et al. (DUOF 6131), Euro-Sib., G.
- 388. *Cruciata taurica* (Pall. ex Willd.) Ehrend.**
St 17, Hb 8, 1317 m, 02.06.2012, N.G. 2373, S.A., Ir.-Tur., H.
- 389. *Cruciata pedemontana* (Bellardi) Ehrend.***
St 17, Hb 4, 1389 m, 02.06.2012, N.G. 2389, S.A. (DUOF 6132), TH.
- 51. GENTIANACEAE**
- 390. *Centaurium erythraea* Rafn. subsp. *erythraea****
St 7, Hb 13, 1200 m, 09.06.2013, N.G. 3253-a (DUOF 6150), Euro-Sib., H.
- 52. APOCYNACEAE**
- 391. *Vinca herbacea* Waldst. & Kit.**
St 8, Hb 8, 1234 m, 05.05.2012, N.G. 2357, N.A., B.T. (DUOF 6240), G.
- 392. *Vincetoxicum canescens* (Willd.) Decne. subsp. *canescens***
St 8, Hb 4, 1236 m, 08.06.2012, N.G. 2592 et al. (DUOF 6220), Ir.-Tur., CH.
- 393. *Vincetoxicum tmoleum* Boiss.***
St 20, Hb 13, 1282 m, 02.06.2013, N.G. 3119-b (DUOF 6289), Ir.-Tur., CH.
- 53. BORAGINACEAE**
- 394. *Asperugo procumbens* L.**
St 16, Hb 2, 1812 m, 09.06.2013, N.G. 3199 (DUOF 6337), Euro-Sib., TH.
- 395. *Myosotis stricta* Roem & Schult.**
St 25, Hb 5, 1231 m, 29.05.2011, Z.D.D. 1009 et al. (DUOF 2936), Euro-Sib., TH.
- 396. *Myosotis minutiflora* Boiss & Reut.***
St 17, Hb 8, 1317 m, 02.06.2012, N.G. 2478 (DUOF 6718), S.A., Med., TH.
- 397. *Myosotis arvensis* (L.) Hill. subsp. *arvensis***
St 10, Hb 21, 1980 m, 18.07.2013, N.G. 3312 (DUOF 6135), Euro-Sib., H.
- 398. *Myosotis sylvatica* Ehrh. ex Hoffm subsp. *cyanea* (Hayek) Vestegr.**
St 19, Hb 2, 1204 m, 18.05.2013, N.G. 3062 (DUOF 6719), H.
- 399. *Myosotis sylvatica* Ehrh. ex Hoffm subsp. *rivularis* Vestegr.**
St 22, Hb 14, 1920 m, 20.06.2013, N.G. 3289 (DUOF 3289), H.
- 400. *Myosotis lithospermifolia* (Willd.) Hornem**
St 14, Hb 19, slope, 1410 m, 02.06.2012, N.G. 2443, S.A.; H.
- 401. *Paracaryum calycinum* Boiss & Balansa**
St 7, Hb 11, 1455 m, 19.05.2013, N.G. 3075 (DUOF 6714), E., Ir.-Tur., H.
- 402. *Paracaryum ancyritanum* Boiss.**
St 8, Hb 13, 1217 m, 26.06.2012, N.G. 2689, S.A., B.T. (DUOF 6715), E., Ir.-Tur., H.
- 403. *Cynoglossum officinale* L.**
St 3, Hb 2, 1450 m, 02.06.2012, N.G. 2434, S.A., Euro-Sib., H.
- 404. *Cynoglossum creticum* Mill.**
St 29, Hb 10, Hb 19, 1459 m, 29.05.2011, Z.D.D. 1136 et al., WS.
- 405. *Cynoglossum montanum* L.**
St 7, Hb 4, 1531 m, 02.06.2012, N.G. 2490, S.A. (DUOF 6133), Euro-Sib., H.
- 406. *Buglossoides arvensis* (L.) I. M Johnst.**
St 16, Hb 2, 1812 m, 09.06.2013, N.G. 3200 (DUOF 6340), WS, TH.
- 407. *Echium orientale* L.**
St 2, Hb 21, 1486 m, 08.06.2012, N.G. 2550-a et al. (DUOF 6079), E., Eux., H.
- 408. *Echium italicum* L.**
St 13, Hb 8, 1424 m, 23.09.2012, N.G. 2926, M.A., Med., H.
- 409. *Onosma isaurica* Boiss & Heldr.**
St 20, Hb 30, 1282 m, 18.05.2013, N.G. 3035 (DUOF 6713), E., Ir.-Tur., H.
- 410. *Onosma taurica* Willd. var. *taurica***
St 13, Hb 28, 1491 m, 06.06.2013, N.G. 3148 (DUOF 6339), H.

- 411. *Onosma bornmuelleri*** Hausskn. & Bornm.
St 3, Hb 2, 1450 m, 02.06.2012, N.G. 2430, S.A. (DUOF 6717), E., Ir.-Tur., H.
- 412. *Alkanna tinctoria*** (L.) Tausch. subsp. *glandulosa* Hub.-Mor.*
St 20, Hb 13, 1280 m, 03.06.2013, N.G. 3127 (DUOF 6338), E., E.Med., H.
- 54. CONVULVACEAE**
- 413. *Convolvulus arvensis*** L.
St 7, Hb 10, 1289 m, 18.06.2013, N.G. 3246, WS, G.
- 55. OLEACEAE**
- 414. *Jasminum fruticans*** L.
St 19, Hb 2, 1204 m, 18.05.2013, N.G. 3046 (DUOF 6371), Med., NaP.
- 415. *Fraxinus angustifolia*** Vahl. subsp. *angustifolia*
St 8, Hb 13, 1217 m, 26.06.2012, N.G. 2684, S.A., B.T., S.A., B.T., MeP.
- 56. PLANTAGINACEAE**
- 416. *Plantago lanceolata*** L.
St 17, Hb 8, 1317 m, 02.06.2012, N.G. 2463, S.A. (DUOF 6168), H.
- 417. *Globularia trichosanta*** Fisch. & C.A.Mey. subsp. *trichosanta*
St 5, Hb 4, 1465 m, 05.05.2012, N.G. 2327, N.A., B.T. (DUOF 6382), Ir.-Tur., CH.
- 418. *Chaenorhinum minus*** (L.) Lange subsp. *minus*
St 8, Hb 13, 1217 m, 30.06.2014, N.G. 3357 (DUOF 6188), TH.
- 419. *Linaria genistifolia*** (L.) Mill. subsp. *linifolia* (Boiss.) P.H.Davis*
St 20, Hb 8, 1303 m, 04.06.2013, N.G. 3138 (DUOF 6852), H.
- 420. *Linaria corifolia*** Desf.
St 8, Hb 13, 1217 m, 30.06.2014, N.G. 3359 (DUOF 6730), E., Ir.-Tur., H.
- 421. *Digitalis lamareckii*** Ivan
St 8, Hb 13, 1217 m, 26.06.2012, N.G. 2702, S.A., B.T., E., Ir.-Tur., H.
- 422. *Veronica gentianoides*** Vahl. subsp. *gentianoides*
St 10, Hb 14, 2072 m, 26.06.2012, N.G. 2795, S.A., B.T. (DUOF 6738) Hyr.-Eux., H.
- 423. *Veronica serpyllifolia*** L.
St 16, Hb 2, 1827 m, 09.06.2013, N.G. 3192 (DUOF 6368), H.
- 424. *Veronica bozakmanii*** MA.Fischer
St 16, Hb 2, 1812 m, 09.06.2013, N.G. 3197 (DUOF 6366), Ir.-Tur., TH.
- 425. *Veronica verna*** L.
St 17, Hb 8, 1317 m, 02.06.2012, N.G. 2471, S.A. (DUOF 6727), Euro-Sib., TH.
- 426. *Veronica triphyllos*** L.*
St 8, Hb 15, 1307 m, 30.03.2013, N.G. 2965 (DUOF 6723), WS, TH.
- 427. *Veronica beccabunga*** L.
St 16, Hb 2, 1812 m, 09.06.2013, N.G. 3202-b (DUOF 6330), WS, G.
- 428. *Veronica chamaedrys*** L.
St 17, Hb 8, 1317 m, 02.06.2012, N.G. 2486, S.A. (DUOF 6728), Euro-Sib., G.
- 429. *Veronica pectinata*** L. var. *pectinata*
St 20, Hb 13, 1282 m, 02.06.2013, N.G. 3120 (DUOF 6398), H.
- 430. *Veronica multifida*** L.
St 17, Hb 4, 1389 m, 02.06.2012, N.G. 2395, S.A. (DUOF 6726); E., Ir.-Tur., H.
- 431. *Veronica officinalis*** L.
St 7, Hb 11, 1595 m, 22.07.2014, N.G. 3372 et al. (DUOF 6724), Euro-Sib., H.
- 57. SCROPHULARIACEAE**
- 432. *Verbascum flavidum*** (Boiss.) Freyn & Bornm.
St 7, Hb 18, 1292 m, 09.05.2014, N.G. 3350 (DUOF 6847), Euro-Sib., H.
- 433. *Verbascum armenum*** Boiss. & Kotschy ex Boiss. var. *occidentale* Hub.-Mor.
St 10, Hb 14, 2045 m, 22.07.2012, N.G. 2872 (DUOF 6846), E., Ir.-Tur., H.
- 434. *Verbascum abieticola*** Bornm.
St 14, Hb 19, slope, 1410 m, 02.06.2012, N.G. 2448, S.A. (DUOF 6849, 6850, 6851), E., Eux., H.
- 435. *Scrophularia scopoli*** [Hoppe ex] Pers. var. *scopoli*
St 19, Hb 2, 1204 m, 18.05.2013, N.G. 3068 (DUOF 6155), WS, H.
- 436. *Scrophularia pinardii*** Boiss.*
St 3, Hb 4, 1450 m, 02.06.2012, N.G. 2421, S.A. (DUOF 6251), E.Med., H.
- 437. *Scrophularia canina*** L. subsp. *bicolor* (Sm.) Greuter
St 13, Hb 28, 1409 m, 05.06.2013, N.G. 3143 (DUOF 6400, 6853), E.Med., CH.
- 58. LAMIACEAE (LABIATAE)**
- 438. *Teucrium chamaedrys*** L. subsp. *chamaedrys*
St 13, Hb 16, Hb 18, 1313 m, 26.06.2012, N.G. 2751, S.A., B.T. (DUOF 6609), Euro-Sib., CH.
- 439. *Teucrium polium*** L. subsp. *polium* L.

- St 8, Hb 13, 1231 m, 08.06.2012, N.G. ve diğ., observation, CH.
- 440. *Scutellaria orientalis*** L. subsp. *pinnatifida* J.R.Edm.
St 17, Hb 8, 1317 m, 02.06.2012, N.G. 2473, S.A. (DUOF 6237), WS, CH.
- 441. *Scutellaria albida*** L. subsp. *albida*
St 20, Hb 8, 1309 m, 04.06.2013, N.G. 3133 (DUOF 6395), E.Med., H.
- 442. *Phlomis armeniaca*** Willd.
St 8, Hb 13, 1217 m, 26.06.2012, N.G. 2693, S.A., B.T. (DUOF 6608), E., Ir.-Tur., CH.
- 443. *Lamium garganicum*** L. subsp. *garganicum*
St 3, Hb 4, 1450 m, 02.06.2012, N.G. 2413, S.A. (DUOF 6618), Eux., H.
- 444. *Lamium amplexicaule*** L. var. *amplexicaule*
St 8, Hb 13, 1248 m, 30.04.2013, N.G. 2973 (DUOF 6620), Euro-Sib., TH.
- 445. *Lamium purpureum*** L. var. *aznavourii* Gand. ex Aznav.*
St 10, Hb 14, 2072 m, 26.06.2012, N.G. 2801, S.A., B.T., E., Eux., TH.
- 446. *Lamium maculatum*** L.
St 11, Hb 16, 1979 m, 19.05.2013, N.G. 3085 (DUOF 6617), Eux., H.
- 447. *Lamium album*** L. subsp. *crinitum* (Montbret & Aucher ex Benth.) Mennema
St 11, Hb 16, 1979 m, 19.05.2013, N.G. 3081 (DUOF 6619), Euro-Sib., H.
- 448. *Marrubium vulgare*** L.*
St 13, Hb 20, 1384 m, 20.10.2012, N.G. 2942 (DUOF 6274), Med., CH.
- 449. *Marrubium astracanicum*** Jacq. subsp. *astracanicum*
St 1, Hb 10, 1420 m, 28.06.2012, N.G. 2660, S.A., B.T. (DUOF 6621), CH.
- 450. *Sideritis galatica*** Bornm.*
St 7, Hb 17, 1290 m, 21.07.2014, N.G. 3366 (DUOF 6610), E., Ir.-Tur., H.
- 451. *Stachys byzantina*** K.Koch
St 8, Hb 13, 1241 m, 27.06.2012, N.G. 2647, S.A., B.T. (DUOF 6623), Euro-Sib., H.
- 452. *Stachys iberica*** Bieb. subsp. *stenostachya* (Boiss.) Rech.f.*
St 20, Hb 13, 1280 m, 03.06.2013, N.G. 3128 (DUOF 6399), Ir.-Tur., CH.
- 453. *Stachys annua*** (L.) L. subsp. *annua* var. *lycaonica* Bhattacharjee
St 14, Hb 19, slope, 1410 m, 02.06.2012, N.G. 2445, S.A. (DUOF 6622), Ir.-Tur., H.
- 454. *Nepeta nuda*** L. subsp. *nuda*
St 17, Hb 8, 1317 m, 02.06.2012, N.G. 2380, S.A. (DUOF 6613), Euro-Sib., H.
- 455. *Prunella laciniata*** (L.) L.
St 8, Hb 4, 1236 m, 08.06.2012, N.G. 2588 et al. (DUOF 6614), Euro-Sib., H.
- 456. *Prunella vulgaris*** L.
St 8, Hb 13, 1253 m, 27.06.2012, observation, Euro-Sib., H.
- 457. *Clinopodium grandiflorum*** (L.) Kuntze
St 7, Hb 11, 1595 m, 22.07.2014, N.G. 3373, N.A., S.A., C. Bulut (DUOF 6612), Euro-Sib., CH.
- 458. *Clinopodium vulgare*** L. subsp. *arundanum* (Boiss.) Nyman
St 13, Hb 4, Hb 18, 1313 m, 26.06.2012, N.G. 2764, S.A. (DUOF 6611), H.
- 459. *Clinopodium graveolens*** (M.Bieb.) Kuntze subsp. *rotundifolium* (Pers.) Govaerts.
St 17, Hb 8, 1317 m, 02.06.2012, N.G. 2472, S.A. (DUOF 6607), WS, TH.
- 460. *Thymus praecox*** Opiz subsp. *jankae* (Celak.) Jalas var. *jankae*
St 10, Hb 14, 2072 m, 26.06.2012, N.G. 2797, CH.
- 461. *Thymus longicaulis*** C.Presl subsp. *longicaulis*
St 19, Hb 2, 1204 m, 18.05.2013, N.G. 3049 (DUOF 6616), Euro-Sib., CH.
- 462. *Mentha longifolia*** (L.) L. subsp. *longifolia*
St 10, Hb 21, 1980 m, 18.07.2013, N.G. 3316, Eux., H.
- 463. *Ziziphora tenuior*** L.*
St 8, Hb 13, 1217 m, 26.06.2012, N.G. 2690, S.A., B.T. (DUOF 6606), Ir.-Tur., TH.
- 464. *Salvia tomentosa*** Mill.
St 13, Hb 18, Hb 4, Hb 2, 1313 m, 26.06.2012, N.G. 2760, S.A., B.T. (DUOF 6624), Med., CH.
- 465. *Salvia sclarea*** L.
St 7, Hb 10, 1289 m, 18.06.2013, N.G. 3245 (DUOF 6625), H.
- 59. OROBANCHACEAE**
- 466. *Orobanche mutelii*** F.W.Schultz
St 7, Hb 13, 1219 m, 11.06.2013, N.G. 3227-b, G.
- 467. *Pedicularis comosa*** L. var. *sibthorpii* (Boiss.) Boiss.
St 2, Hb 21, 1486 m, 08.06.2012, N.G. 2551, N.A., S.A., B.T., H.

468. *Euphrasia pectinata* Ten.
St 8, Hb 13, 1241 m, 27.06.2012, N.G.
2648, S.A., B.T., Euro-Sib., TH.

469. *Parentucellia latifolia* (L.) Caruel.
subsp. *latifolia*

St 19, Hb 2, 1204 m, 18.05.2013, N.G.
3045, Med., TH.

60. CAMPANULACEAE

470. *Campanula lyrata* Lam. subsp.
lyrata

St 1, Hb 13, 1426 m, 28.06.2012, N.G.
2676, S.A., B.T. (DUOF 6087), WS, H.

471. *Campanula glomerata* L. subsp.
hispida (Witasek) Hayek

St 13, Hb 5, Hb 11, 1661 m, 22.07.2012,
N.G. 2832 (DUOF 6490), Euro-Sib., H.

472. *Campanula ajugifolia* Schult.

St 16, Hb 14, Hb 4, Hb 27, 1942 m,
22.07.2012, N.G. 2851 (DUOF 6489), E., Ir-
Tur., H.

473. *Campanula cymbalaria* Sibth. & Sm
St 16, Hb 11, 1735 m, 07.06.2013, N.G.
3169 (DUOF 6359), E.Med., H.

474. *Campanula olympica* Boiss.

St 8, Hb 13, 1256 m, 02.06.2013, N.G.
3099 (DUOF 6402), Eux., H.

475. *Campanula rapunculus* L. var.
rapunculus

St 7, Hb 13, 1219 m, 11.06.2013, N.G.
3228 (DUOF 6353), S.A. & T. Birtürk, Euro-
Sib., H.

476. *Asyneuma limonifolium* (L.) Janch.
subsp. *pestalozzae* (Boiss.) Damboldt*

St 4, Hb 4, 1562 m, 18.06.2013, N.G.
3282, E., H.

477. *Asyneuma rigidum* (Willd.) Grossh.
subsp. *sibthorpiatum* (Roemer & Schultes)
Damboldt*

St 10, Hb 14, 2128 m, 18.07.2013, N.G.
3304 (DUOF 6387), E., E.Med., H.

478. *Legousia speculum-veneris* (L.)
Durande ex Vill.

St 7, Hb 13, 1200 m, 09.06.2013, N.G.
3253-b (DUOF 6149), Med., TH.

479. *Legousia pentagonia* (L.) Thell.*

St 7, Hb 13, 1180 m, 11.06.2013, N.G.
3335 (DUOF 6492), E.Med., TH.

480. *Jasione supina* Sieber ex Spreng.
subsp. *akmanii* Damboldt¹

St 22, Hb 14, 1902 m, 26.06.2012, N.G.
2745, S.A., B.T. (DUOF 6172), Eux., E., H.

61. ASTERACEAE (COMPOSITAE)

481. *Inula oculus-christii* L.

St 4, Hb 6, Hb 4, 1777 m, 05.08.2012,
N.G. 2886, S.A., B.T., Euro-Sib., G.

482. *Inula montbretiana* DC.*

St 13, Hb 15, Hb 22, 1330 m, 26.06.2012,
N.G. 2728, S.A., B.T. (DUOF 6403), Ir-
Tur., G.

483. *Helichrysum plicatum* DC. subsp.
plicatum

St 4, Hb 6, Hb 4, 1777 m, 05.08.2012,
N.G. 2877, S.A., B.T. (DUOF 6385), WS,
CH.

484. *Filago arvensis* L.*

St 8, Hb 13, 1217 m, 26.06.2012, N.G.
2706, S.A., B.T. (DUOF 6383), TH.

485. *Erigeron acris* L. subsp. *acris*

St 16, Hb 14, Hb 4, *P. sylvestris*
açıklıkları, 1942 m, 22.07.2012, N.G. 2844
(DUOF 6603), Euro-Sib., H.

486. *Doronicum orientale* Hoffm.

St 19, Hb 2, 1204 m, 18.05.2013, N.G.
3066 (DUOF 6593), G.

487. *Doronicum bithynicum* J.R.Edm.
subsp. *bithynicum*

St 10, Hb 14, 2072 m, 26.06.2012, N.G.
2807, S.A., B.T. (DUOF 6379), E., Eux., G.

488. *Senecio olympicus* Boiss.*

St 10, Hb 14, 2072 m, 26.06.2012, N.G.
2808, S.A., B.T. (DUOF 6595), E., Eux., H.

489. *Senecio vernalis* Waldst. & Kit.

¹ According to flora of Turkey Vol. 6, the two subspecies belong to *Jasione supina* are divided in the following way:

involucral bracts dentate.... subsp. *pontica*

involucral bracts entire.....subsp. *akmanii*

On the same sample collected from the study area, both dentate and entire bracts were available. This feature is not enough to separate these two subspecies. Therefore, these two subspecies should be combined by extended definition. Due to *Jasione supina* subsp. *akmanii* recorded from Koroğlu mountain in flora of Turkey, this taxon was given as **subsp. akmanii** in this study.

- St 10, Hb 14, Hb 4, stony slopes, Hb 19, 1995 m, 23.09.2012, N.G. 2933, M.A. (DUOF 6594), WS, TH.
- 490. *Tussilago farfara* L.**
St 7, Hb 17, 1290 m, 21.07.2014, N.G. observation, Euro-Sib., G.
- 491. *Petasites hybridus* (L.) P.Gaertn.**
St 1, Hb 1,1348 m, 10.06.2013, N.G. observation, Euro-Sib., H.
- 492. *Achillea teretifolia* Willd.***
St 8, Hb 15, 1325 m, 13.06.2013, N.G. 3263, E., Ir.-Tur., H.
- 493. *Achillea setacea* Waldst. & Kit.**
St 13, Hb 2, Hb 4, Hb 18, 1313 m, 26.06.2012, N.G. 2758, S.A., B.T. (DUOF 6585), Euro-Sib., H.
- 494. *Tanacetum parthenium* (L.) Sch.Bip.**
St 7, Hb 17, 1290 m, 21.07.2014, N.G. 3385 (DUOF 6588), H.
- 495. *Tanacetum armenum* (DC.) Sch. Bip.**
St 11, Hb 16, 1979 m, 19.05.2013, N.G. 3082 (DUOF 6587), CH.
- 496. *Tripleurospermum rosellum* (Boiss. & Orph.) Hayek var. *album* E.Hossain**
St 17, Hb 8, 1317 m, 02.06.2012, N.G. 2452, S.A. (DUOF 6314), E., H.
- 497. *Tripleurospermum oreades* (Boiss.) Rech.f. var. *oreades***
St 6, Hb 5, 1270 m, 29.05.2011, Z.D.D. 1077 et al. (DUOF 2962), WS, H.
- 498. *Cirsium sintenisii* Freyn**
St 10, Hb 14, 2045 m, 22.07.2012, N.G. 2873 (DUOF 6580), E., H.
- 499. *Cirsium vulgare* (Savi) Ten.**
St 13, Hb 20, 1384 m, 20.10.2012, N.G. 2943 (DUOF 6579), H.
- 500. *Cirsium hypoleucum* DC.**
St 24, Hb 11, 1590 m, 07.06.2013, N.G. 3165-a, Eux., H.
- 501. *Cirsium arvense* (L.) Scop.**
St 7, Hb 17, 1290 m, 21.07.2014, N.G. 3384 et al. (DUOF 6493), H.
- 502. *Picnomon acarna* (L.) Cass.**
St 8, Hb 13, 1231 m, 08.06.2012, N.G. et al., observation, Med., H.
- 503. *Carduus nutans* L. subsp. *nutans***
St 17, Hb 4, 1370 m, 05.08.2012, N.G. 2903, S.A., B.T., H.
- 504. *Carduus pycnocephalus* L. subsp. *albidus* (M.Bieb.) Kazmi**
St 19, Hb 2, 1204 m, 18.05.2013, N.G. 3060 (DUOF 6581), WS, TH.
- 505. *Centaurea* cf. *olympica* (DC.) K.Koch.**
St 24, Hb 4, 1642 m, 14.06.2013, N.G. 3330, E., H.
- 506. *Centaurea solstitialis* L. subsp. *solstitialis***
St 17, Hb 4, 1370 m, 05.08.2012, N.G. 2904, S.A., B.T. (DUOF 6578), WS, TH.
- 507. *Centaurea urvillei* DC. subsp. *Hb Sposa* Wagenitz**
St 8, Hb 13, 1217 m, 26.06.2012, N.G. 2708, S.A., B.T. (DUOF 6576), Ir.-Tur., H.
- 508. *Cyanus pichleri* (Boiss.) Holub subsp. *pichleri****
St 13, Hb 28, 1574 m, 06.06.2013, N.G. 3157 (DUOF 6143), H.
- 509. *Cyanus triumfetti* All.**
St 17, Hb 8, 1317 m, 02.06.2012, N.G. 2366, S.A. (DUOF 6577), WS, H.
- 510. *Crupina vulgaris* Cass.**
St 13, Hb 28, 1491 m, 06.06.2013, N.G. 3150 (DUOF 6147), TH.
- 511. *Crupina crupinastrum* (Moris) Vis.**
St 8, Hb 4, 1236 m, 08.06.2012, N.G. 2597 et al. (DUOF 6598), WS, TH.
- 512. *Carlina biebersteinii* Bernh. ex Hornem subsp. *brevibracteata* (Andrae) K.Werner**
St 7, Hb 17, 1290 m, 22.07.2014, N.G. 3378 (DUOF 6599), H.
- 513. *Xeranthemum annuum* L.**
St 8, Hb 13, 1217 m, 26.06.2012, N.G. 3363 (DUOF 6584), S.A., B.T., TH.
- 514. *Cichorium intybus* L.**
St 8, Hb 13, 1217 m, 26.06.2012, N.G. 2682, S.A., B.T. (DUOF 6604), WS, H.
- 515. *Scorzonera mollis* M.Bieb. subsp. *mollis****
St 11, Hb 16, 1979 m, 19.05.2013, N.G. 3078 (DUOF 6377), Med., G.
- 516. *Scorzonera mollis* M.Bieb. subsp. *szowitzii* (DC.) D.F.Chamb.**
St 30, Hb 5, 1341 m, 29.05.2011, Z.D.D. 1094 et al. (DUOF 2969), Ir.-Tur., H.
- 517. *Tragopogon pterodes* Petrović**
St 4, Hb 6, Hb 4, 1777 m, 05.08.2012, N.G. 2896, S.A., B.T., H.
- 518. *Tragopogon dubius* Scop.**
St 8, Hb 13, 1231 m, 08.06.2012, N.G. 2543 et al. (DUOF 6583), H.

- 519. *Leontodon asperrimus*** (Willd.) Endl.*
St 20, Hb 8, 1309 m, 04.06.2013, N.G. 3134-b, Ir.-Tur., H.
- 520. *Picris pauciflora*** Willd.*
St 8, Hb 13, 1253 m, 27.06.2012, N.G. 2638, S.A., B.T. (DUOF 6600), Med., TH.
- 521. *Hieracium oblongum*** Jord.
St 24, Hb 6, 1614 m, 07.06.2013, N.G. 3163; Euro-Sib., H.
- 522. *Hieracium pannosum*** Boiss.
St 7, Hb 11, 1648 m, 22.07.2014, N.G. 3367 et al. (DUOF 6589), Med., H.
- 523. *Hieracium bornmuelleri*** Freyn*
St 16, Hb 14, Hb 4, Hb 27, 1942 m, 22.07.2012, N.G. 2852 (DUOF 6591), E., H.
- 524. *Pilosella hoppeana*** (Schult.) F.W.Schultz & Sch.Bip. subsp. *testimonialis* (Naegli ex Peter) P.D.Sell & C.West
St 10, Hb 14, 2060 m, 18.07.2013, N.G. 3299 (DUOF 6384), Euro-Sib., G.
- 525. *Pilosella piloselloides*** (Vill.) Soják subsp. *piloselloides*
St 8, Hb 4, 1236 m, 08.06.2012, N.G. 2594 et al., H.
- 526. *Lactuca viminea*** (L.) J.Presl & C.Presl
St 17, Hb 19, 1353 m, 22.07.2012, N.G. 2812 (DUOF 6592), Med., H.
- 527. *Lapsana communis*** L. subsp. *intermedia* (M.Bieb.) Hayek var. *intermedia*
St 4, Hb 4, 1779 m, 18.06.2013, N.G. 3279 (DUOF 6597), H.
- 528. *Taraxacum macrolepium*** Schischk.*
St 1, Hb 1, 1302 m, 11.06.2013, N.G. 3219, H.
- 529. *Crepis pulchra*** L. subsp. *pulchra*
St 8, Hb 13, 1231 m, 08.06.2012, N.G. 2549-b, TH.
- 530. *Crepis commutata*** (Spreng.) Greuter
St 8, Hb 13, 1253 m, 27.06.2012, N.G. 3232 (DUOF 6223), WS, TH.
- 531. *Crepis sancta*** (L.) Bornm.
St 14, Hb 19, slope, 1410 m, 02.06.2012, N.G. 2439, S.A., WS, TH.
- 62. CAPRIFOLIACEAE**
- 532. *Lonicera etrusca*** Santi var. *etrusca*
St 8, Hb 13, 1217 m, 26.06.2012, N.G. 2696, S.A., B.T. (DUOF 6422), Med., MiP.
- 533. *Valeriana alliarifolia*** Adams
St 24, Hb 19, Hb 4, 1572 m, 07.06.2013, N.G. 3167-b (DUOF 6142), WS, G.
- 534. *Valeriana phu*** L.*
St 17, Hb 4, 1389 m, 02.06.2012, N.G. 2401, S.A. (DUOF 6260); G.
- 535. *Valeriana leucophaea*** DC.*
St 13, Hb 7 1394 m, 05.05.2012, N.G. 2334, N.A., B.T. (DUOF 6261), Hyr.-Eux., G.
- 536. *Valeriana tuberosa*** L.
St 15, Hb 27, Hb 4, 1600 m, 29.05.2011, Z.D.D. 1133 et al. (DUOF 2915), WS, G.
- 537. *Valerianella costata*** (Stev.) Betcke
St 25, Hb 5, 1231 m, 29.05.2011, Z.D.D. 1026 et al. (DUOF 2889), & Z.D.D., Med., TH.
- 538. *Valerianella carinata*** Loisel.
St 3, Hb 4, 1450 m, 02.06.2012, N.G. 2424, S.A. (DUOF 6434), TH.
- 539. *Valerianella turgida*** (Steven) Betcke
St 8, Hb 4, 1236 m, 08.06.2012, N.G. 2584 et al. (DUOF 6174), TH.
- 540. *Pterocephalus plumosus*** (L.) Coulter
St 8, Hb 13, 1217 m, 26.06.2012, N.G. 2700, S.A., B.T. (DUOF 6425), TH.
- 541. *Cephalaria gigantea*** (Ledeb.) Bobrov
St 2, Hb 17, 1483 m, 22.07.2014, N.G. 3368 et al. (DUOF 6426), Eux., H.
- 63. APIACEAE (UMBELLIFERAE)**
- 542. *Eryngium campestre*** L. var. *virens* Link
St 8, Hb 13, 1248 m, 28.06.2012, N.G. 2662, S.A., B.T. (DUOF 6515), WS, CH.
- 543. *Anthriscus nemorosa*** (M.Bieb.) Spreng.
St 19, Hb 2, 1204 m, 18.05.2013, N.G. 3067 (DUOF 6517), WS, H.
- 544. *Bunium microcarpum*** (Boiss.) Freyn & Bornm. ex Freyn subsp. *bourgaei* (Boiss.) Hedge & Lamond
St 13, Hb 4, 1471 m, 08.06.2012, N.G. 2568 et al. (DUOF 6510), Ir.-Tur., G.
- 545. *Prangos ferulacea*** (L.) Lindl.*
St 7, Hb 10, 1400 m, 22.07.2014, N.G. 3382 (DUOF 6513, 6514), H.
- 546. *Torilis leptophylla*** (L.) Rchb.f.
St 8, Hb 13, 1217 m, 26.06.2012, N.G. 2698, S.A., B.T. (DUOF 6519), WS, TH.
- 547. *Malabaila secacul*** (Mill.) Boiss.
St 8, Hb 4, 1236 m, 08.06.2012, N.G. 2589 et al. (DUOF 6509), G.
- 548. *Daucus guttatus*** Sibth. & Sm

St 8, Hb 13, 1231m, 27.06.2012, N.G. 2611, S.A., B.T. (DUOF 6508), TH.

549. *Bupleurum gerardii* All.

St 8, Hb 13, 1253 m, 27.06.2012, N.G. 2640, S.A., B.T. (DUOF 6507); WS, TH.

550. *Heracleum platytaenium* Boiss.

St 13, Hb 11, 1728 m, 26.06.2012, N.G. 2771, S.A., B.T. (DUOF 6520), Eux., H.

551. *Pimpinella cappadocica* Boiss. & Balansa var. *cappadocica**

St 23, Hb 11, 1742 m, 05.08.2012, N.G. 2920-a, S.A., B.T., E., Ir.-Tur., H.

552. *Pimpinella* cf. *tragiium* Vill. subsp. *polyclada* (Boiss. & Heldr.) Tutin*

St 23, Hb 11, 1742 m, 05.08.2012, N.G. 2920-b, S.A., B.T. (DUOF 6348), H.

553. *Caucalis platycarpus* L.

St 8, Hb 13, 1253 m, 27.06.2012, N.G. 2635, S.A., B.T. (DUOF 6511), Med., TH.

554. *Physocaulis nodosus* (L.) Tausch

St 17, Hb 8, 03.06.2013, N.G. 3336 (DUOF 6512), TH.

Discussion and Conclusion

In this study 63 families, 273 genus and 554 taxa were determined. 65 of the collected taxa are endemic and endemism ratio is 11,73 %. Endemic and rare plants were classified according to IUCN categories. 96 taxa are new record for A3 square. The

largest families are as follows: Poaceae 55 taxa (%9,93), Asteraceae 51 taxa (%9,21), Fabaceae 47 taxa (%8,48), Rosaceae 33 taxa (%5,96), Brassicaceae 29 taxa (%5,23), Lamiaceae 27 taxa (%4,87), Caryophyllaceae 27 taxa (%4,87), Liliaceae 20 taxa (%3,61), Boraginaceae 19 taxa (%3,43), Rubiaceae 16 taxa (%2,89), Plantaginaceae 16 taxa (%2,89), Apiaceae 13 taxa (%2,35), Campanulaceae 11 taxa (%1,99), Orchidaceae 10 taxa (%1,81) (Table 2).

Phytogeographical regions of 334 taxa (%60,28) were identified in the research area. The distribution of taxa according to phytogeographic regions are as follows: 109 taxa (%19,68) Euro-Siberian, 78 taxa (%14,08) Mediterranean, 63 taxa (%11,37) Irano-Turanian, 80 taxa (%14,44) WS and 224 taxa (%40,43) are unknown or multiregional (Table 3).

According to Raunkiaer's life form of the plants are 38 (%6,86) Phanerophytes, 59 (%10,63) Chamaephytes, 114 (%20,58) Cryptophytes, 209 (%37,73) Hemicryptophytes and 135 (%24,37) Therophytes (Table 4).

Table 2. The largest families in the study area

Family	Number of taxa	Ratio total taxa number (%)
Poaceae	55	9.93
Asteraceae	51	9.21
Fabaceae	47	8.48
Rosaceae	33	5.96
Brassicaceae	29	5.23
Lamiaceae	27	4.87
Caryophyllaceae	27	4.87
Liliaceae	20	3.61
Boraginaceae	19	3.43
Rubiaceae	16	2.89
Plantaginaceae	16	2.89
Apiaceae	13	2.35
Campanulaceae	11	1.99
Orchidaceae	10	1.81
Others	180	32.49

Table 3. Distribution of species in research area according to phytogeographic regions.

Phytogeographic Region	Number of taxa	Ratio total taxa number (%)
Euro-Siberian	109	19.68
Mediterranean	78	14.08
Irano-Turanian	63	11.37
WS	80	14.44
Multi-regional	224	40.43

Table 4. Distribution of species according to Raunkiaer's life forms

Life Forms	Number of taxa	Ratio to total taxa according to Life Forms (%)
Phanerophytes	38	6.86
Chamaephytes	58	10.65
Hemicryptophytes	207	37.36
Cryptophytes (Geophytes+Hydrophytes)	114 (111+3)	20.58
Therophytes	134	24.19

A comparison of the largest families in this study and to previous studies carried out in nearby regions is given in Table 5. The distribution rates of these taxa according to family, are similar to other studies. Asteraceae (Compositae) and Fabaceae (Leguminosae) families include most taxa in all studies. The study area is different from flora of Elmacık, Semen (Bolu) Mountain, Taşlıyayla and Kızık (Bolu-Seben), Karakiriş

Mountain, Nallıhan Bird Sanctuary, Sündiken Mountain and Doğandede Hill (Bey pazarı), with more taxa belongs to Poaceae family. And different from some nearby regions studies like Abant, Taşlıyayla and Kızık (Bolu-Seben), Karakiriş Mountain, Nallıhan Bird Sanctuary, Sündiken Mountain, Köroğlu Mountain and Doğandede Hill (Bey pazarı), with less taxa belongs to Lamiaceae family.

Table 5. Comparison of the families containing the most species in studies conducted in nearby regions

Family	1	2	3	4	5	6	7	8	9	10	11	12
Poaceae	6.66	6.00	8.20	9.50	5.58	6.80	6.79	5.20	9.93	8.90	5.29	10.86
Asteraceae	13.33	7.40	10.40	9.80	9.77	14.01	13.88	10.10	9.21	6.20	8.40	12.77
Fabaceae	6.98	9.50	7.10	8.90	10.64	11.80	10.76	12.60	8.48	6.30	13.24	13.42
Rosaceae	4.28	7.40	5.30	5.80	4.53	5.20	1.69	4.90	5.96	5.70	0.83	0.31
Brassicaceae	3.02	5.60	4.60	4.00	5.41	3.90	6.23	5.70	5.23	3.10	5.96	6.70
Lamiaceae	6.35	6.70	6.70	5.40	7.32	7.50	7.36	7.00	4.87	10.10	11.58	9.58
Caryophyllaceae	3.34	4.90	3.40	3.80	4.18	1.75	3.39	3.50	4.87	5.70	5.29	5.43
Liliaceae	5.07	2.30	3.10	2.00	4.53	3.00	4.24	-	3.61	4.40	5.62	2.89
Boraginaceae	1.91	3.20	2.70	3.10	2.97	3.10	3.11	1.70	3.43	4.40	4.96	5.11
Rubiaceae	1.43	3.20	1.90	-	1.22	1.95	2.26	-	2.89	2.50	0.83	3.83
Plantaginaceae	-	-	-	-	-	-	-	-	2.88	-	-	-
Apiaceae	3.17	2.80	3.00	3.80	2.09	3.00	2.83	4.70	2.35	1.90	2.64	4.79
Campanulaceae	1.75	1.40	1.00	1.30	2.27	1.95	0.28	-	1.99	2.50	0.50	0.64
Orchidaceae	1.90	-	3.00	3.10	1.74	1.56	-	-	1.81	-	0.33	-
Scrophulariaceae	2.55	5.60	4.70	3.10	3.49	2.50	3.11	4.00	1.08	4.40	1.83	2.24
Others	36.76	34.00	34.90	36.40	34.26	30.74	34.28	39.70	31.41	33.90	32.70	21.43

1 Elmacık Dağı (Aksoy 2006)

2 Semen (Bolu) Dağı (Akman & Yurdakul 1981)

3 Abant (Uçar 1996)

4 Gölcük (İkinci 2000)

5 Taşlıyayla (Tunçkol 2012)

6 Karakiriş Dağı (Aksoy 2001)

7 Nallıhan Kuş Cenneti (Doğan 2000)

8 Sündiken Dağı (Ekim 1977)

9 Argözü Vadisi (Kıbrıscık)

10 Köroğlu (Akman & Ketenoğlu 1978)

11 Doğandede tepe (Güner 2000)

12 Ayaş Güdül Beypazan Polatı (Türker 1990)

A comparison of the endemism rate in this study and other studies carried out in nearby regions is given in Table 6. It is

observed that endemism rate of the study area is higher than some nearby areas.

Table 6. Comparison of the endemism rate with the studies nearby regions

	1	2	3	4	5	6	7	8	9	10	11	12
Total taxa number	631	286	672	438	573	511	354	547	554	157	302	311
Endemic taxa number	59	12	55	15	79	69	65	44	65	13	64	70
Endemism rate (%)	9.35	4.10	8.10	3.40	13.79	13.40	18.55	8.00	11.73	8.20	21.19	22.5
1 Elmacık Dağı (Aksoy 2006)					5 Taşlıyayla (Tunçkol 2012)				9 Argözü Vadisi (Kıbrıscık)			
2 Semen (Bolu) Dağı (Akman & Yurdakulol 1981)					6 Karakiriş Dağı (Aksoy 2001)				10 Köroğlu (Akman & Ketenoğlu 1978)			
3 Abant (Uçar 1996)					7 Nallıhan Kuş Cenneti (Doğan 2000)				11 Doğandede tepe (Güner 2000)			
4 Gölcük (İkinci 2000)					8 Sündiken Dağı (Ekim 1977)				12 Ayaş Gündül Beypazarı Polatı (Türker 1990)			

Considering the rate of endemism, it can be said that Argözü Valley and Köroğlu Mountains are an important plant area. However Köroğlu mountains have been declared culture, tourism, conservation and development area in 2015. Thus, the local people's socio-economic development will be supported by providing for the development of nature tourism. Forestry and ecotourism activities will have a negative impact on forest, subalpine and alpine vegetation units, and endemic and rare plants.

Most of the plant communities in the region are important in terms of endemic species they contain. So investments should be done after the local vegetation, habitat and biotope studies completed.

On the other hand, transhumance and grazing activities are potential threats for these habitats and species. Especially the Scots pine, shrub, rock and high mountain habitats with high endemism rate must be protected.

References

- Akman Y., Yurdakulol E., 1981. Semen (Bolu) Dağı Florasının İncelenmesi. Communications, De la Faculté Des Sciences de L'université d'Ankara. Série C, Tome 24, 3 1-43.
- Akman, Y., Ketenoğlu, O., 1978. Contribution á l'étude de la flore du mont de Köroğlu. Communications, De la Faculté des sciences de L'université d'Ankara. Série C, Tome: 23, 1-24.
- Aksoy, N., 2001. Karakiriş Dağı (Seben-Nallıhan) Florası. Yüksek Lisans Tezi, İstanbul Üniversitesi Fen Bilimleri Enstitüsü, İstanbul.
- Aksoy, N., 2006. Elmacık Dağı (Düzce) vejetasyonu. Doktora Tezi. İstanbul Üniversitesi Fen Bilimleri Enstitüsü, İstanbul.

Anonymous, 2002. 1/500.000 ölçekli Türkiye Jeoloji Haritaları, Zonguldak Haritası, MTA Genel Müdürlüğü, Ankara.

Davis, P. H. (ed.), 1965-1985. Flora of Turkey and the East Aegean Islands. Vols.: 1-9, Edinburg University Press.

Doğan, E., 2000. Nallıhan Kuş Cenneti florası. Yüksek Lisans Tezi, Gazi Üniversitesi Fen Bilimleri Enstitüsü, Ankara.

Ekim, T., 1977. Sündiken Dağları (Eskişehir) Vejetasyonun Sosyolojik ve Ekolojik Yönden Araştırılması. Doçentlik Tezi.

Ekim, T., 2000. Koyuncu, M, Vural, M, Duman, H., Ayaç, Z. & Adıgüzel, N., Türkiye Bitkileri Kırmızı Kitabı. TTKD & YYÜ No: 18, Ankara.

Güner, M. B., 2000. Doğandede Tepe ve Çevresi Florası (Beypazarı-Ankara). Yüksek Lisans Tezi, G.Ü. Fen Bilimleri Enstitüsü, Ankara.

Güneş Özkan, N., 2009. Hasanlar Baraj Gölü (Düzce) ve Çevresinin Florası, Yüksek Lisans Tezi, Düzce Üniversitesi.

Irkeç, T., Ünlü, T., 1993. Volkanik kuşaklarda hidrotermal sepiyolit oluşumuna bir örnek: Kıbrıscık (Bolu) sepiyoliti. MTA dergisi, 115, 99-118.

İkinci, N., 2000. The flora of Gölcük area (Bolu), MSc Thesis, A.İ.B.U. Department of Biology, March 2000, Bolu.

Kanoğlu, S. S., 2011. Sülüklügöl (Bolu-Mudurnu, Göynük / Adapazarı-Akyazı) Çevresinin Florası, Yüksek Lisans Tezi, Düzce Üniversitesi.

Kılınç, M, Kutbay, H. G., Yalçın, E., Bilgin, A., 2006. Bitki Ekolojisi ve Bitki Sosyolojisi Uygulamaları, Palme Yayıncılık, Ankara.

Tunçkol, B., 2012. Taşlıyayla ve Kızılk (Bolu-Seben) Çevresinin Florası, Yüksek Lisans Tezi, İstanbul Üniversitesi Fen Bilimleri Enstitüsü, İstanbul.

Türker, H., 1990. Ayaş, Güdül, Beypazarı ve Polatlı Arasında Kalan Bölgenin Florası, Yüksek Lisans Tezi, G.Ü. Fen Bilimleri Enstitüsü, Ankara.

Uçar, A., 1996. Flora of Abant, The Abant İzzet Baysal Univesity, Master of Sience in The Department of Biology, Bolu.

URL 1, 2015. www.mta.gov.tr/v2.0/turkiye_maden/maden_potansiyel_2010/Bolu_Madenler.pdf

URL 2, 2012. www.kibriscik.gov.tr/genel-bilgiler

Yaltrık, F., Efe, A., 1996. Otsu Bitkiler Sistematığı, İstanbul Üniversitesi Yayın No: 3940 Orman Fakültesi Yayın No: 10, İstanbul.

The General Specifications of Order *Quercus cerridis-Carpinetalia orientalis* Akman, Quézel & Barbéro 1980

*Fatmagül GEVEN¹, M. Ümit BİNGÖL¹, Kerim GÜNEY², Tuğrul KÖRÜKLÜ¹,
Ebru ÖZDENİZ¹, Osman KETENOĞLU¹

¹Ankara University, Faculty of Science, Ankara / TURKEY

²Kastamonu University, Faculty of Forestry, Kastamonu / TURKEY

*Corresponding Author: geven@science.ankara.edu.tr

Abstract

Quercus cerridis-Carpinetalia orientalis Akman, Quézel & Barbéro 1980 is a order of Class *Quercetea pubescentis* (Oberd. 1948, Doing-Kraft 1955) Scamoni and Passerge 1959. The origin of *Quercetea pubescentis* is Eur-Sib., and it spreads to the all Black Sea region / and it is common in all Black Sea region. This class, the Mediterranean region of the upper level of the Mediterranean vegetation deciduous forests in the whole formation, which is particularly prevalent in Anatolia *Quercus pubescens* Willd., *Q. cerris* L. var. *cerris*, *Q. macranthera* Fisch. & Mey. ex Hohen. subsp. *sypirensis* (C. Koch) Menitsky, *Carpinus orientalis* Mill., *C. betulus* L., *Ostrya carpinifolia* Scop. community and *Abies cilicica* (Ant. et Kotschy) Carr., *Cedrus libani* A. Rich., *Pinus nigra* Arn. subsp. *pallasiana* (Lamb.) Holmboe such as the Mediterranean conifer forests are also included.

The forest communities located within the *Quercus cerridis-Carpinetalia orientalis* order were analyzed floristic and ecological. Belonging to the Class [*Quercetea pubescentis* (Oberd. 1948, Doing-Kraft 1955) Scamoni and Passerge 1959], Order [*Quercus cerridis-Carpinetalia orientalis* Akman, Quézel & Barbéro 1980] and Allians [I. *Quercion frainetto* Horvat 1954., II. *Carpino betuli-Acerion hyrcani* Quézel, Barbéro & Akman 1978., III. *Cisto laurifolii-Pinion pallasianae* Akman, Barbéro and Quézel 1978., IV. *Quercion anatolicae* Akman, Barbéro and Quézel 1979., V. *Staphylleo pinnatae-Buxion sempervirentis* Quézel, Barbéro and Akman 1980.] diagnostic species were listed. Distribution areas of this community were shown on the map. In addition, the general view of the plant species that make up these communities were given photos.

Keywords: *Quercus-Carpinetalia*, *Quercetea pubescentis*, Phytosociologia, Diagnostic species, Turkey

Introduction

Phytosociology; it investigated the vegetation of plants they produce as a result of their relationship with each other and their environment, and classify (Akman et al., 2001). Vegetation is investigated According the to the Principles of the Zurich-Montpellier School in Turkey (Braun-Blanquet, 1964). Vegetation research in Turkey, began by Tournefort for the first time in 1700-1702. Later Handel-Mazetti, Krause, Schwarz, is given by the first information regarding the vegetation of Turkey. Birand work on the plant sociology in Turkey is Turkish botanist who first (Tatlı et al., 2005). In Turkey, some of vegetation studies were carried out by Birand (1954), Çetik (1963), Akman et al. (1978, 1979, 1983), Kilinc (1985), Ayasligil (1987), Bekat (1987), Hamzaoglu and Geven (1999). This study was investigated in Turkey's vegetation and climate characteristics. Three climate

types are available in Turkey: Mediterranean, Continental and Oceanic. The greatest part of the country, including much of the montane area, comes under the influence of various types of Mediterranean climate; the Continental climate occurs in two distinct areas in N and NE Anatolia; the Oceanic climate prevails in the region bordering the Black Sea. The forest vegetation of Turkey may also be divided into 3 main classes: QUERCETEA ILICIS; QUERCETEA PUBESCENTIS; QUERCO-FAGETEA. The first is confined to a coastal zone of the Mediterranean, the second is throughout the inner Mediterranean area, the last is in the Euxine zone of N Anatolia. Steppe vegetation belongs to the class ASTRAGALO BROMETEA widespread in C Anatolia and the Taurus (Akman and Ketenoğlu 1986). This paper reviews distribution of *Quercus cerridis-Carpinetalia orientalis* Akman, Quézel & Barbéro 1980 is

a order of Class *Quercetea pubescentis* (Oberd. 1948, Doing-Kraft 1955) Scamoni and Passarge 1959 in Turkey. Our aim in this study was to determine the orders of the distribution area.

Material and Methods

This study revised vegetation studies done until now and fieldwork notes were used.

Research area: Turkey is located between 36°-42° N and 26°-45° E, forming a land bridge between Europe and Asia, divided by the Sea of Marmara. Total land area is 783 577 km², of which 759 752 km² are in Asia and 23 825 in Europe. The Asian part is called "Anatolia" and the European part "Thrace". The country is roughly rectangular and measures about 1 600 km from east to west, and about 600 km from north to south. It is surrounded by Georgia, Armenia, Azerbaijan and Iran in the east, Iraq, Syria and the Mediterranean Sea in the south, the Aegean Sea in the West, Greece and Bulgaria in the north west and the Black Sea in the north (URL1, 2016).

Results and Discussion

Quercus cerridis-Carpinetalia orientalis Akman, Quézel & Barbéro 1980 order depends *Quercetea pubescentis* (Oberd. 1948, Doing-Kraft 1955) Scamoni and Passarge 1959 class; Usually a class that dominated the Mediterranean region. However, the Black Sea region, which extends to the Euro-Siberian origin, biogeography in the North. This class leaves on the top floor of the Mediterranean vegetation gets into the whole of the Mediterranean region deciduous forest formations. Anatolia, which is common *Quercus pubescens* (hairy oak), *Q. cerris* var. *cerris* (hairy oak), *Q. macranther* subsp. *sypirensis* (Spanish oak), *Carpinus orientalis* (Eastern hornbeam), *C. betulus* (hornbeam), *Ostrya carpinifolia* (kayacik) includes communities. Also *Abies cilicica* (fir), *Cedrus libani* (cedar) and *Pinus nigra* subsp. *pallasiana* (pine) is included as the Mediterranean conifer woods. Diagnostic species of *Quercetea pubescentis* (Oberd. 1948, Doing-Kraft 1955) Scamoni and Passarge 1959: *Acer campestre*, *Alliaria*

officinalis, *Brachypodium pinnatum*, *Buxus sempervirens*, *Cephalanthera rubra*, *C. alba*, *Clematis vitalba*, *Coronilla varia*, *Sorbus torminalis*, *Lithospermum purpureocaeruleum*, *Cornus mas*, *Cotinus coggyria*, *Dictamnus albus*, *Euonymus latifolius*, *Ligustrum vulgare*, *Mercurialis perennis*, *Trifolium medium*, *Trifolium physodes*, *Populus tremula*.

According to the geographical situation of this class is divided into two orders to:

I. *Quercus-Cedretalia libani* Barbéro, Loisel ve Quézel 1974.

Quercus-Cedretalia libani Barbéro, Loisel ve Quézel 1977 order, except order *Quercus-Carpinetalia orientalis*, which spread in the Mediterranean Mountain top floor with Mediterranean forest takes into groups. *Pinus nigra* forest in Western Anatolia with all forest formations of the Taurus and some *Pinus brutia* forest communities can be incorporated into the orders. This order not included in the Black Sea region that is located a little further east Anatolia. Bioclimatic terms of this order little rainy and wet, is connected to the cold Mediterranean climate (Akman, 1995).

II. *Quercus cerridis-Carpinetalia orientalis* Akman, Quézel & Barbéro 1980.

This order is characterized by *Carpinus orientalis* and several *Quercus* species. In Europe, which was previously defined by *Quercus robur* and *Carpinus betulus*, from *Quercus-Carpinetalia orientalis* orders, it is completely different. It also characterizes much of north-western Europe and western Mediterranean *Quercetea pubescentis* orders used for Turkey. *Quercus-Carpinetalia orientalis* orders of Turkey's top-floor Mediterranean deciduous forest community also takes part in the pine forest. In addition, western and central Black Sea, Aegean and Central Anatolian interior gets into the forest (Quézel et al., 1980; Ketenoğlu et al., 2014; Yarıcı 2000). Diagnostic species of *Quercus cerridis-Carpinetalia orientalis*: *Carpinus orientalis*, *Quercus cerris* var. *cerris*, *Q. frainetto*, *Acer monspessulanum*, *Aremonia*

agrimonoides, *Aristolochia pallida*, *Astragalus drusorum* subsp. *maroniticus*, *A. glycyphyllos* subsp. *glycyphylloides*, *Colutea cilicica*, *Celtis australis*, *Coronilla emeroides*, *Physospermum aquilegifolium*, *Digitalis ferruginea*, *Fraxinus ornus*, *Geranium asphodeloides*, *Laser trilobum*, *Lathyrus hirsutus*, *Mespilus germanica*, *Ostrya carpinifolia*, *Polygala supina*, *Oenanthe pimpinelloides*, *Sesleria alba*, *Staphyllea pinnata*, *Tanacetum parthenium*, *Pyracantha coccinea*, *Prunus institiata*.

Quercus cerridis-Carpinetalia orientalis Akman, Quézel & Barbéro 1980 includes five alliance in Anatolia; **I.** *Quercion frainetto* Horvat 1954., **II.** *Carpino betuli-Acerion hyrcani* Quézel, Barbéro & Akman 1978., **III.** *Cisto laurifolii-Pinion pallasianae* Akman, Barbéro and Quézel 1978., **IV.** *Quercion anatolicae* Akman, Barbéro and Quézel 1979., **V.** *Staphylleo pinnatae-Buxion sempervirentis* Quézel, Barbéro and Akman 1980.

I. Alliance *Quercion frainetto* Horvat 1954.

In northwest Anatolia in the upper floor of the Mediterranean, not limestone, it gets into the bedrock for developing forest communities. The narrower the spread in Turkey (Afyon B3, Balıkesir B1), (Quézel et al., 1978; Akman, 1978; Vural et al., 1985; Ketenoğlu et al., 2014). Diagnostic species of *Quercion frainetto*: *Quercus frainetto*, *Q. cerris*, *Castanea sativa*, *Tilia tomentosa*, *Pyrus communis*, *Mespilus germaica*, *Chamaecytisus pygmaeu*, *Lychnis coronaria*, *Geranium asphodeloides*, *Aristolochia pallida*, *Oenanthe pimpinelloides*, *Huetia cynapioides* subsp. *macrocarpa*, *Inula salicina*, *Achillea grandiflora* (Figure 1).

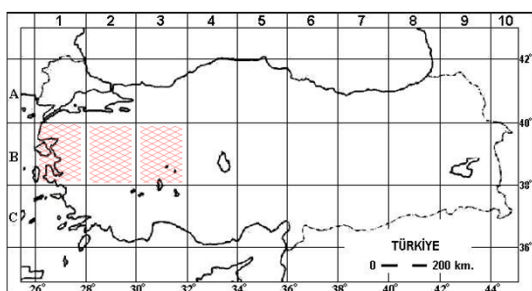

Figure 1. Distribution map of *Quercion frainetto* Horvat 1954

II. Alliance *Carpino betuli-Acerion hyrcani* Quézel, Barbéro and Akman 1978.

This alliance is vicariance of Italy and the Balkans detected *Ostryo-Carpinion orientalis* Horvat 1959. In the north-western Anatolia in the upper floor of the Mediterranean, in the rainy Mediterranean climate, they grow on limestone bedrock. (Balıkesir B1, B2, Kastamonu A4, Bilecik A3, Tokat A6, Sivas B6, Samsun A6, Çorum A5, Bolu A3, Ankara A4, B4, Amasya A5, A6, Karabük A4, Bursa A2, Kütahya B2, Eskişehir B3, Artvin A8 A9, Isparta B3, C3, Çankırı A4, Afyon B3, Sinop A5). It takes into forests of middle and western Black Sea and Inner Aegean (Quézel et al., 1978; Cansaran and Aydogdu 2001; Türe et al., 2005; Sağlam, 2007; Ketenoğlu et al., 2014). Diagnostic species of *Carpino betuli-Acerion hyrcani*: *Carpinus betulus*, *Acer hyrcanum* subsp. *hyrcanum*, *Cornus australis*, *Bromus ramosus*, *Helleborus orientalis*, *Trifolium caudatum*, *Lathyrus aureus*, *Quercus petraea* subsp. *iberica*, *Lonicera orientalis*, *Vicia truncatula*, *Asperula involucrata*, *Galium longifolium*, *Asyneuma rigidum*, *Circium hypoleucum* (Figure 2).

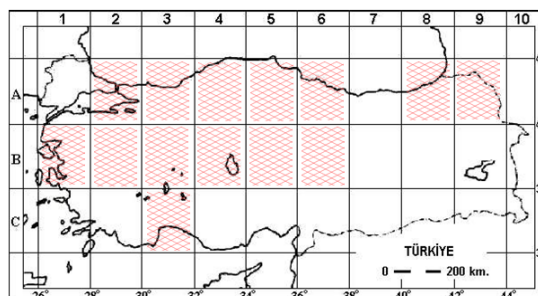

Figure 2. Distribution map of *Carpino betuli-Acerion hyrcani* Quézel, Barbéro and Akman 1978

III. Alliance *Cisto laurifolii-Pinion pallasianae* Akman, Barbéro and Quézel 1978 (*Pino-Cistion laurifolii* Akman, Barbéro & Quézel 1978).

Pinus nigra, Mediterranean and east of Marmara and Aegean regions except show a wide distribution around Central Anatolia (Isparta B3, C3, İzmir B1, Bursa A2, Eskişehir B3, Bilecik A3, Kırıkkale B4, Kastamonu A4). These forests are usually semi-arid and dry-wet cold and very cold

Mediterranean climate, metamorphic, ophiolitic parent material, particularly marl develop the best. *Pinus nigra* communities are seen in areas where deciduous oak were destroyed. These forests are similarities with the *Quercus-Cedretalia libani* Barbéro, Loisel ve Quézel 1977 (Ketenoglu et al., 2014). Diagnostic species of *Cisto laurifolii-Pinion pallasianae*: *Pinus nigra* subsp. *pallasiana*, *Cistus laurifolius*, *Chamaecytisus pygmaeus*, *Genista lydia*, *Hypericum montbretii*, *Iris schachtii* (Figure 3).

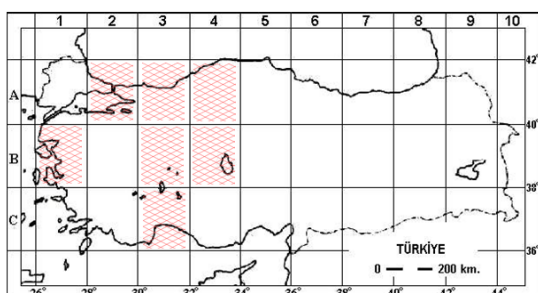

Figure 3. Distribution map of *Cisto laurifolii-Pinion pallasianae* Akman, Barbéro and Quézel 1978.

IV. Alliance *Quercion anatolicae* Akman, Barbéro and Quézel 1979.

Quercus pubescens shows a lot of distributions of around the Central Anatolia region, in the upper Mediterranean solid, semi-arid and dry-wet, cold and very cold Mediterranean climate (Kırşehir B5, Karaman B5, Kırıkkale B4, Afyon B3, Bilecik A3, B3, Bursa A2, Kütahya B2, Istanbul A2, Çankırı A4, Erzurum A8, B8, Ankara A4, B4, Uşak B2, Yozgat B5, Çorum A5, Konya B4, C4), (Hamzaoglu, 2000; Türe et al., 2005). These communities are included in the *Quercion anatolicae*. Diagnostic species of *Quercion anatolicae* (Ketenoglu et al., 2014): *Quercus pubescens*, *Coronilla varia*, *Pyrus eleagnifolia*, *Trifolium pannonicum* subsp. *elongatum* (Figure 4).

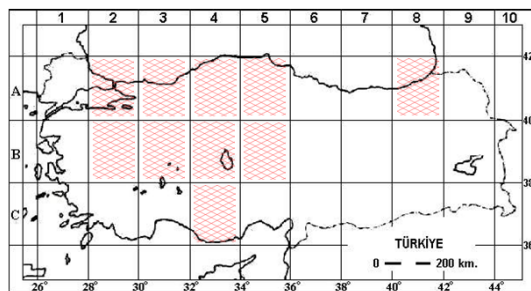

Figure 4. Distribution map of *Quercion anatolicae* Akman, Barbéro and Quézel 1979

V. Alliance *Staphylleo pinnatae-Buxion sempervirentis* Quézel, Barbéro and Akman 1980.

In less mountainous area of the Black Sea; this alliance includes forests formed by *Abies bornmuelleriana*, *Carpinus betulus*, *Fagus orientalis* and *Ostrya carpinifolia* (Gumushane A7, Giresun A7, Kastamonu A4, Sinop A5, Samsun A6, Tekirdağ A1, Trabzon A7, Ordo A6, Tokat A6, Kırklareli A1) (Ketenoglu et al., 2014). Diagnostic species of *Staphylleo pinnatae-Buxion sempervirentis*: *Acer platanoides*, *Buxus sempervirens*, *Coelus colurna*, *Euonymus latifolius*, *Fraxinus ornus*, *Laurocerasus officinalis*, *Staphyllea pinnata*, *Tanacetum parthenium*, *Tilia platyphyllos* (Figure 5).

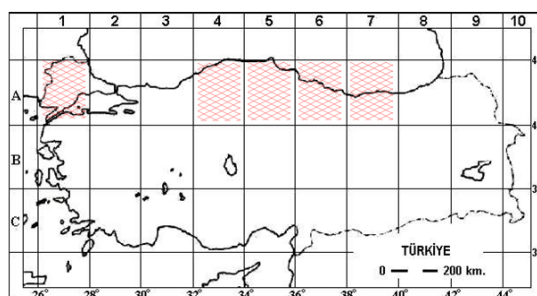

Figure 5. Distribution map of *Staphylleo pinnatae-Buxion sempervirentis* Quézel, Barbéro and Akman 1980

Turkey is generally accepted that the present dominant steppe vegetation in a great part of the country is the result of long term anthropogenic activity. Most of the area was once covered with forests. Turkey has been a pathway for many civilizations and hosted many of them. Change has become faster in the last century and is now of dangerous dimensions, especially due to the rapid population growth in recent decades.

Particularly after the 1950s, mechanization of agriculture, industrialization and tourism have increased the pressure on biological diversity. The most important consequences of these effects are reduction and fragmentation of natural habitats (URL2, 2016).

Conclusion

The order *Quercus cerridis-Carpinetalia orientalis* Akman, Quézel & Barbéro 1980 in Turkey is extended throughout the whole territory of Mediterranean region deciduous forest formations.. This order includes 5 alliance: **I.** *Quercion frainetto* Horvat 1954., **II.** *Carpino betuli-Acerion hyrcani* Quézel, Barbéro & Akman 1978., **III.** *Cisto laurifolii-Pinion pallasianae* Akman, Barbéro and Quézel 1978., **IV.** *Quercion anatolicae* Akman, Barbéro and Quézel 1979., **V.** *Staphylleo pinnatae-Buxion sempervirentis* Quézel, Barbéro and Akman 1980. Anthropological activities have been changed these special habitats; therefore, these areas must be preserved, The phytosociology of these area is still poorly known and needs urgently studied as phytosociologically (Figure 6, Figure 7).



Figure 6. Mediterranean forest

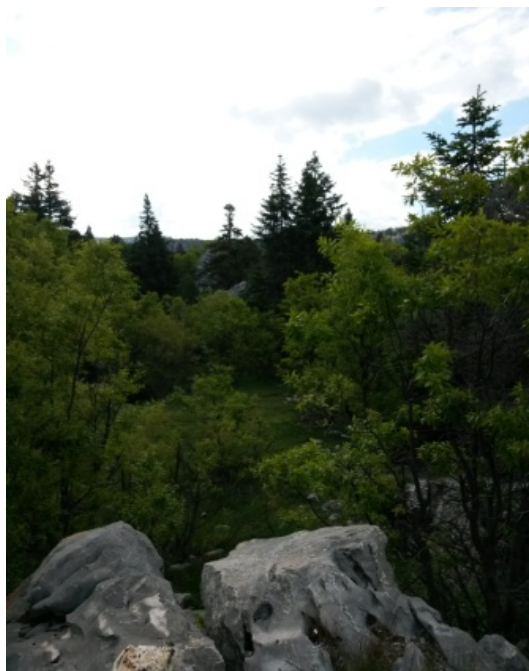

Figure 7. Mediterranean forest

References

- Akman Y., M. Barbéro and P. Quézel. 1978. Contribution à l'étude de la végétation forestière d'Anatolie méditerranéenne. *Phytocoenol.*, 5,1-79.
- Akman, Y., M. Barbéro and P. Quézel. 1979. Contribution à l'étude de la végétation forestière d'Anatolie méditerranéenne. *Phytocoenol.*, 5, 189-276.
- Akman, Y., E. Yurdakulol and M. Aydogdu. 1983. A Phytosociological research on the vegetation of the Bolu Mountains. *Commun. Fac. Sci. Univ. Ankara, Serie C.*, 1, 87-104 ()
- Akman, Y., Ketenoglu, O., Quézel, P., Demirörs, M. 1984. A syntaxonomic study of steppe vegetation in Central Anatolia. *Phytoecologia* 12(4), 563–584. Stuttgart.
- Akman, Y., Vural, M., Quézel, P., Kurt, L., Ketenoglu, O., Serin, M., Barbéro, M. 1996. Etude de la Vegetation Steppique de la Region de Karaman et Ermenek au sud d' Anatolie Centrale. *Ecologia Mediterranea XXII* (3/4), 1–20. France.
- Akman, Y. and Ketenoglu, O. 1986. The climate and vegetation of Turkey. *Proceedings of the Royal Society of Edinburgh. Section B. Biological Sciences.* Volume 89, pp 123-134.
- Akman, Y., Ketenoglu, O. and Geven, F. 2001. *Vejetasyon Ekolojisi ve Arastırma Metodları*, Kaynak Kitap, 341 s. Ankara.
- Ayasligil, Y. 1987. Der Koprulu National Park. Seine vegetation und ihre Beeniflussung durch den Menschen.

- Barbéro, M., Chalabi, N., Hahal, I. and Quézel, P. 1976. Les formations a coniferes Mediterraneens en Syrie littorale. *Ecol. Medit.*, 2, 87-99.
- Bekat, L. 1987. Barla Dagi (Egirdir)'nin vejetasyonu. *Turk J. Bot.*, 11, 270-305.
- Birand, H. 1954. La vegetation de l' Anatolie Centrale et son equilibre hdyrologique: Exraits des Actes du colloque d' Ank., Sur l' hydrologie de la Zone Aride, 247-254.
- Braun-Blanquet, J. 1964. *Pflanzensoziologie. Grundzüge der Vegetationskunde.* 3rd ed. Springer Verlag, Wien New York, 865 pp.
- Cansaran, A. and Aydogdu, M. 2001. Phytosociological research on Egerli Mountain (Amasya-Turkey). *Isr. J. Plant Sci.*, 49, 309-326.
- Cetik, R. 1963. The vegetation of Cubuk Dam. *Y.U. Fen Fak. Mec. Seri B (3-4)*, 109-138.
- Davis, P.H. 1965-1978. *Flora of Turkey and East Aegean Islands.* Vol. Univ. Press. Edinburgh, UK.
- Davis, PH., Mill, R.R., Tan, K. (eds.). 1988. *Flora of Turkey and the East Aegean Islands.* (Suppl I). Vol. 10, Edinburgh University Press, Edinburgh.
- Hamzaoglu, E. and Geven, F. 1999. Quercion Anatolicae Akman, Barbéro ve Quézel 1977 icin Yeni Bir Sintakson (Kirsehir). *G.U. Gazi Egitim Fak. Derg.*, 19, 15-24.
- Hamzaoglu, E. 2000. Buzluk Dagi Vejetasyonu (Kirsehir). The vegetation of Buzluk Mountain. *G.U. Egitim Fak. Derg.*, 20, 79-98.
- Ketenoglu, O., Vural, M., Kurt, L. 2014. Resimli Türkiye Florası Cilt 1: "Vejetasyon". Türkiye İş Bankası Kültür Yayınları, sf 178-180.
- Kilinc, M., 1985. İç Anadolu-Batı Karadeniz geçiş bölgesinde Devrez Çayı ile Kızılırmak nehri arasında kalan bölgenin vejetasyonu. *Doga TU Bot. Derg.*, A2, 9, 315-357.
- Quézel, P., M., Barbéro and Y. Akman. 1978. L'Interpretation phytoso- ciologique des groupements forestiers dans le basin Mediterranéen Oriental. *Documents Phytosociologiques* 2: 329-352.
- Quézel, P., Barbéro, M. and Akman, Y. 1978. Contribution à l'étude de la végétation forestière d'Anatolie méditerranéenne. *Phytocoenologia*, 5 (1), 1-79.
- Quézel, P., Barbéro, M. and Akman, Y. 1980. Contribution à l'étude de la végétation forestière d'Anatolie septentrionale. *Phytocoenol*, 8: 365-519.
- Sağlam, C. 2007. Davras Dagi (Isparta) ve Çevresinin Orman ve Çalı Vejetasyonu. Süleyman Demirel Üniversitesi Fen Bilimleri Enstitüsü Dergisi. 11-2. 140-157
- Tatlı, A., Başıyigit, M., Varol, Ö. and Tel, A. Z. 2005. Gümüş Dağı (Kütahya-Türkiye) Orman Vejetasyonu Üzerine Fitososyolojik Bir Araştırma. *Ekoloji*. No: 55, 6-17.
- Türe, C., Tokur, S. and Ketenoglu, O. 2005. Contributions to the syntaxonomy and ecology of the forest and scrub vegetation in Bithynia, Nortwestern Anatolia, Turkey. *Phyton*, 45, 81-115.
- URL1, 2016. http://www.countriesquest.com/middle_east/turkey/land_and_resources/
- URL2, 2016. <http://www.fao.org/ag/agp/agpc/doc/counprof/Turkey/Turkey.htm>
- Vural, M., T. Ekim, Ilarslan, R. and Malyer, H. 1985. Afyon Baskomutan Milli Parki vejetasyonu, *Doga Bilim Derg.*, 9, 363-387.
- Yarçın, C. 2000. Demirköy (Istranca Dağları/Trakya Bölgesi) ve civarının orman vejetasyonu. *Ekoloji*, 9, 13-18.

***Zelkova carpinifolia* (Pall.) C. Koch (Ulmaceae) in Turkey (Relict Tree): Floristics, Ecology, Distribution and Threats**

*Fatmagül GEVEN¹, Nezaket ADIGÜZEL²

¹Ankara University, Faculty of Science, Ankara / TURKEY

²Gazi University, Faculty of Science, Ankara / TURKEY

*Corresponding Author: geven@science.ankara.edu.tr

Abstract

Zelkova spach. (an ancient tree) is a member of the Ulmaceae family. *Zelkova* of about six species (*Zelkova sicula* Di Pasq., Garfi & Quézel, *Zelkova abelicea* (Lam.) Boiss., *Zelkova carpinifolia* (Pall.) C. Koch, *Zelkova serrata* (Thunb) Makino, *Zelkova schneideriana* Hand.-Mazz. and *Zelkova sinica* C.K. Schneid.) of deciduous, semi-evergreen trees occurring in written in woodland, thickets and in Italy, Greece, Turkey, Iran and Asia. *Zelkova* have alternate, ovate to elliptic toothed leaves. Most species display good fall colour of yellows and orange-browns. *Zelkova carpinifolia*, known as Caucasian elm, Caucasian zelkova or just zelkova is a species of *Zelkova*, native to the Caucasus, Kaçkar, and Alborz mountains in the extreme southeast of Europe and southwest Asia (Turkey, Azerbaijan, Iran, Georgia, Armenia). *Zelkova carpinifolia* is highly valued as an ornamental owing to its unusual outline, having a relatively short, wide trunk that divides into many ascending branches. It is rare in many regions and listed as Near Threatened according to IUCN Red List criteria. In Turkey, for example, only a few highly isolated populations are known (Kars, Hakkâri, Siirt, Muş). It seems very probable that other yet undiscovered sites with *Z. carpinifolia* still exist on Turkey, therefore additional field surveys should be undertaken. Currently there is no legal protection for this species.

In this study, the genus of *Zelkova*, floristic and ecological characteristics were studied. Distribution areas in the world and Turkey is shown on the map and threat categories based on the IUCN Red List criteria. In addition, pictures and images of the *Zelkova carpinifolia* species is given. Photos are taken in Turkey's Hakkari province.

Keywords: *Zelkova carpinifolia*, Caucasian elm, Ulmaceae, Turkey

Türkiye'de *Zelkova carpinifolia* (Pall.) C. Koch (Ulmaceae) (Relikt Ağacı): floristik, ekoloji, dağılım ve tehditler

Özet

Zelkova spach. (relikt bir ağaç), Ulmaceae familyasının bir üyesidir. Ormanlık ve çalılıklarda yaprak dökken ve dökmeyen *Zelkova*'nın İtalya, Yunanistan, Türkiye, İran ve Asya'da tanımlanmış yaklaşık altı türü vardır (*Zelkova sicula* Di Pasq., Garfi & Quézel, *Zelkova abelicea* (Lam.) Boiss., *Zelkova carpinifolia* (Pall.) C. Koch, *Zelkova serrata* (Thunb) Makino, *Zelkova schneideriana* Hand.-Mazz. and *Zelkova sinica* C.K. Schneid.). *Zelkova* alternat, ovat-eliptik ve dişli yapraklıdır. Çoğu türü sarı ve turuncu-kahverengi, sonbahar renklerindedirler. Kafkas karaağacı, Kafkas zelkovası ya da sadece zelkova olarak bilinen *Zelkova carpinifolia*, Kafkasya, Kaçkar, Avrupa ve güneybatı Asya (Türkiye, Azerbaycan, İran, Gürcistan, Ermenistan) güneydoğunun en uçlarında Elburz dağlarının doğal bir *Zelkova* türüdür. *Zelkova carpinifolia* çok sayıda yükselen dallara ayrılan nispeten kısa, geniş gövdeli; sıra dışı görüntüsü sayesinde çok iyi bir süs bitkisi olarak değerlendirilir. Pek çok bölgede nadir bulunur ve IUCN Kırmızı Liste kriterlerine göre NT olarak listelenir. Türkiye'de izole halde birkaç popülasyonu bilinmektedir (Kars, Hakkâri, Siirt, Muş). Türkiye'de *Z. carpinifolia*'nın mevcut olduğu henüz keşfedilmemiş yerler hala çok muhtemel görünmektedir, bu nedenle arazi araştırmaları yapılmalıdır. Şu anda bu tür için yasal koruma bulunmaktadır.

Bu çalışmada *Zelkova* cinsinin floristik ve ekolojik karakterleri araştırılmıştır. Türkiye ve Dünya'da yayılışı, harita üzerinde ve tehlike kategorileri IUCN Kırmızı Liste kriterlerine göre gösterilmiştir. Buna ek olarak *Zelkova carpinifolia* türüne ait şekiller ve çizimler verilmiştir. Fotoğraflar Türkiye'nin Hakkari ilinde çekilmiştir.

Anahtar Kelimeler: *Zelkova carpinifolia*, Kafkas karaağacı, Ulmaceae, Türkiye

Introduction

Zelkova (Ulmaceae s.s.) is a small genus that comprises six monoecious tree species in the northern hemisphere. At present, it shows a disjunct distribution in east Asia (three species), western Asia (one species) and the Mediterranean (two species), whereas it is absent from North America (Denk and Grimm 2005). During past geological epochs, *Zelkova* trees were widespread in Europe, Eurasia and North Africa. They were present in many parts of Europe from the Oligocene until the terminal Pliocene, in Italy until approximately 32000 14C yr BP, and have modern populations in southeastern Sicily (*Zelkova sicula*), Crete (*Zelkova abelicea*), Iran and Caucasus (*Zelkova carpinifolia*), and Eastern Asia (*Zelkova schneideriana*, *Zelkova serrata*, and *Zelkova sinica* (Kvavadze and Connor 2005). *Zelkova carpinifolia* a Tertiary relict tree endemic of Turkey. The genus has a particularly disjunct distribution (Güner et al. 2000). *Zelkova carpinifolia* is one of the most iconic relict trees in the Transcaucasus, between the Black and Caspian Sea. The generally warm and humid environmental conditions in this region since the late Tertiary provided a shelter for relict species during the ice ages. As a result, the Transcaucasian forests, especially those in the Colchis and Hyrcanian regions, are among the oldest, most diverse and richest habitats housing endemic, woody species in west Eurasia (URL₁ 2016).

The purpose of this paper is to review and evaluate the ecological features and distribution area of the *Zelkova carpinifolia*.

Material and Methods

We collected distribution, threat and population structure data by reviewing literature and through field surveys at two study plots throughout the range of the species. It has also benefited from

various herbarium (ANK., GAZI., VAN.). The geographical distributions of *Zelkova carpinifolia* was analyzed using Grid system (Davis 1965- 1988), (Figure 1). In addition, photos were taken (Figure 2, Figure 4).

Research in the area of Şemdinli and Yüksekova (Altısu village, 1500m.). There is a 15. km long old road.

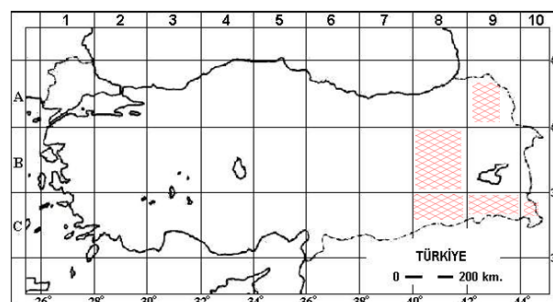

Figure 1. Distribution map of *Zelkova carpinifolia* (Pall.) K. Koch

Results and Discussion

Taxonomy

Kingdom: Plantae

Phylum: Tracheophyta

Class: Magnoliopsida

Order: Urticales

Family: Ulmaceae; Ulmaceae, the elm family of the nettle order (Urticales), with 15 genera of trees and shrubs, distributed primarily throughout temperate regions. Members of the family have watery sap, and its leaves alternate along the stem. The leaves usually have toothed edges and often are lopsided at the base. The flowers lack petals. Male and female flowers are borne together or apart on the same plant. The fruit, a samara, may be winged, fleshy, or nutlike (Zieliński 1979, UR L₂ 2016).

Genus: *Zelkova* Spach; *Zelkova* is a genus of six species of deciduous trees in the elm family Ulmaceae, native to southern Europe, and southwest and eastern Asia. They vary in size from shrubs (*Z. sicula*) to large trees up to 35 m tall (*Z. carpinifolia*). The leaves are

alternate, with serrated margins, and (unlike the related elms) a symmetrical base to the leaf blade. The fruit is a dry, nut-like drupe, produced singly in the leaf axils (UR L₃ 2016).

Species: *Zelkova carpinifolia* (Pall.) K. Koch; Western Asia (Figure 2, Figure 3).



Figure 2. *Zelkova carpinifolia* (Pall.) K. Koch

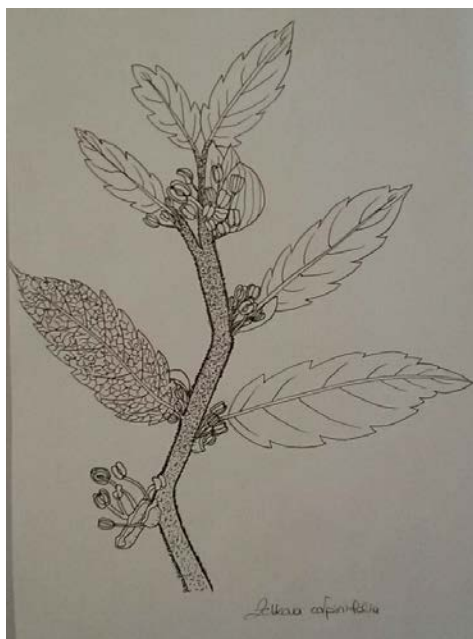

Figure 3. *Zelkova carpinifolia* (Pall.) K. Koch

Synonym for *Zelkova carpinifolia* (Pall.) K. Koch;

1. *Abelicea crenata* (Desf.) Baill. species,
 2. *Abelicea sibirica* Rafin. species,
 3. *Abelicea ulmoides* Kuntze species,
 4. *Planera carpinifolia* P. Watson species,
 5. *Planera crenata* Desf. species,
 6. *Planera repens* Hort. ex Lavalley species,
 7. *Rhamnus carpinifolius* Pall. species,
 8. *Ulmus nemoralis* Ait. species,
 9. *Ulmus polygama* Juss ex Poir. species,
 10. *Zelkova carpinifolia* subsp. *yomraensis* Ansin & Gerçek infraspecific name,
 11. *Zelkova crenata* (Desf.) Sp. species,
 12. *Zelkova crenata* var. *repens* Lavalley infraspecific name (URL₃ 2016) and *Zelkova ulmoides* Schneid. (Denk and Grimm 2005). Synonym of other species and distribution areas (names in parentheses are synonyms);
- Zelkova schneideriana* Hand.-Mazz., China
-*Zelkova sinica* C. K. Schneider, China
-*Zelkova serrata* (Thunb.) Makino, Japan, (*Zelkova formosana* Hayata),

(*Zelkova keaki* Maxim.), (*Zelkova acuminata* Planch.)

-*Zelkova abelicea* (Lam.) Boiss., Crete, (*Zelkova cretica* Spach.)

-*Zelkova sicula* Di Pasquale, Garfi & Quezel Sicily, (Denk and Grimm 2005).

Distribution: Turkey (E-Anatolia, SE-Anatolia), Iran (EC-Iran, E-Iran, NE-Iran: Mts., N-Iran: Mts., NW-Iran: Iranian Aserbaijan), Caucasus, Azerbaijan, Armenia, Gruzija, Crimea (introduced) (Güner and Zielinski 1998, URL₃ 2016). The geographical distributions of *Zelkova carpinifolia* was analyzed using Grid system (Kars A9, Hakkari B8, Siirt C9, Muş C10), (Figure 1), (Davis 1965-1988, Davis and Tan 1988, Güner et al. 2000).

Habit: *Z. carpinifolia* is a large tree, attaining an average height of 20-35 m, and measuring up to 2 m in diameter. The vase-shaped crown and short, broad trunk dividing into numerous nearly erect, strong branches, give the species its characteristic and distinctive form. The leaves, especially on young shoots, are generally much larger than those of the Mediterranean *Zelkova* species: they can measure more than 10 cm in length and 6 cm in width, with a dentate leaf base, and 7-12 secondary veins (Kozłowski and Gratzfeld 2013). *Z. carpinifolia* is observed in the region of 2-3 meters tall and shrubs form (Figure 4). Whatever the causes of this fragmentation (a complex colonization history, climate change, browsing by large Pleistocene herbivores or more recent agricultural practices), gene flow between remote populations is improbable because of the limited dispersal capacity of seeds, as is the case for all *Zelkova* species (Kozłowski et al. 2013).



Figure 4. Habit of *Zelkova carpinifolia* (Pall.) K. Koch

Ecology: Generally favouring moist, humus-rich soils but not tolerating waterlogged or swampy conditions, *Zelkova carpinifolia* is a light-demanding canopy tree. Observation area; generally mountainous area (1300-1800 m), 45% of forestland, unfit for agriculture 41%,

10% meadows and pastures can be used four or five months and 4% are arable lands. Genus of the tree in the forest is usually oak. *Quercus brantii* Lindl. and *Quercus cerris* L. are the dominant plant species of oak forest (Figure 5).



Figure 5. Habitat of *Zelkova carpinifolia* (Pall.) K. Koch

Climate: Hakkâri is seen in cold and temperate climates. much more rainfall in the summer months during the winter. According to the Köppen-Geiger climate classification it can be called Ds. The average annual temperature is 10.3 province of Hakkari. The average annual rainfall: 789 mm (Figure 6, Figure 7, Table 1), (UR L4 2016).

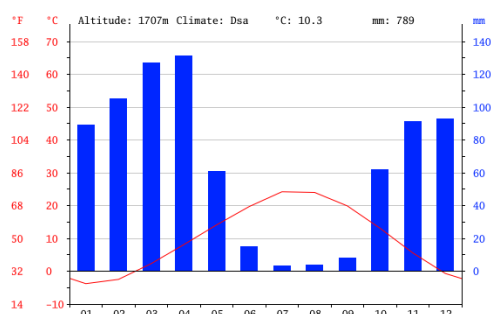

Figure 6. Graphic of precipitation (mm) and temperature (°C, °F)

24.2 temperature is the hottest month of the year in July. The average temperature in January is the lowest average of the year is -3.8.

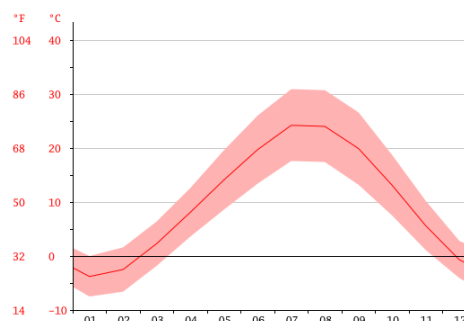

Figure 7. Graphic of temperature (°C, °F)

Table 1. Table of precipitation (mm) and temperature (°C, °F)

month	1	2	3	4	5	6	7	8	9	10	11	12
mm	37	36	44	59	53	21	5	4	12	50	51	37
°C	-3.7	-3.0	1.5	7.5	12.4	17.1	21.2	20.9	16.9	10.9	4.9	-0.3
°C (min)	-8.2	-7.7	-3.0	2.6	6.8	10.5	14.4	13.9	10.0	4.9	0.0	-4.4
°C (max)	0.8	1.8	6.0	12.4	18.0	23.7	28.1	28.0	23.9	16.9	9.8	3.9

Driest and wettest month of the year rainfall between 128 mm average temperature throughout the year varies around 28.0. (URL4, 2016).

Red List Category & Criteria:

Lower Risk/near threatened (Figure 8). Occurring in lowland as well as mountain forests across the Caucasus, including two main population centres in the east (Hyrcania) and the west (Colchis), *Z. carpinifolia* has the widest distributional range (some 100 populations) of the three Eurasian species. Molecular studies revealed a significant genetic differentiation between the two main groups which is indicative of the many million years gone by since these

populations fragmented into their current distribution. By and large, in all regions where the species occurs, overgrazing, expanding mass tourism and related infrastructure development in areas of scenic beauty, are major drivers of change. Although numerous natural reserves and parks have been created in Georgia, Azerbaijan and Iran, containing important forest stands with *Z. carpinifolia*, the pressure on these habitats is steadily rising (Güner and Zielinski 1998, Kozłowski and Gratzfeld 2013, URL3 2016).



Figure 8. Conservation status of *Zelkova carpinifolia* (Pall.) K. Koch.

Diseas: *Zelkova carpinifolia* (Pall.) K. Koch is native to the Caucasus and Alborz mountains in northern parts of Iran. The decline began with browning of the leaves, viscous liquid exudation on the branches and trunks resulting in a brown-black discoloration of bark and woody tissues. In the winter of the next year fungal growth induces a typical charcoal-black surface on diseased branches and trunks (Mirabolfathy 2013). *Zelkova carpinifolia* (Pall.) K. Koch is described as a new observations for the Hakkari region (B8) of Turkey. A detailed morphological description, photographs, distribution map and illustration of this new observations are given. Several population was observed in case of local communities in the region. Overgrazing, fire, erosion, agriculture, road construction, as a result of activities have been identified as fragmented habitats (Figure 9).



Figure 9. Fragmented habitats of the *Zelkova carpinifolia*

Conclusion

Fires, overgrazing, tourism, industrialization, agricultural struggle,

expansion of agriculture, urbanization and plantation crops such factors are threatening rare plants. In addition, by the local people medicine, fuel, unconsciously gathering for various purposes such as food and ornamental plants are also threatening a factor. These threats are not the generation of habitat fragmentation and species. It should therefore take the necessary protection measures. We can also learn a lot from relict plant; Tertiary relict trees are, therefore, ancient organisms which were able to cope with changing environmental conditions for millions of years. They provide, thus, a unique opportunity to understand past and recent biogeographical and evolutionary processes (Taberlet et al. 1998).

References

- Davis, P.H., 1965-1985. Flora of Turkey and the East Aegean Islands, Vol I-IX, Edinburgh University Press, Edinburgh.
- Davis, P.H., Mill, R.R., Tan, K., 1988. Flora of Turkey and the East Aegean Islands (Supplement), Vol 10, Edinburgh University Press, Edinburgh.
- Denk T, Grimm GW. 2005. Phylogeny and biogeography of *Zelkova* (Ulmaceae sensu stricto) as inferred from leaf morphology, ITS sequence data and the fossil record. *Botanical Journal of the Linnean Society* 147: 129-157.
- Güner, A., Özhatay, N., Ekim, T., Başer, K.H.C., 2000. Flora of Turkey and the East Aegean Islands (Supplement 2), Vol 11, University Press, Edinburgh.
- Güner, A. & Zielinski, J. 1998. *Zelkova carpinifolia*. The IUCN Red List of Threatened Species 1998: e. T31303A9622352.

Kozłowski G., Gibbs D., Huan F., Frey D., Gratzfeld J. 2012. Conservation of threatened relict trees through living ex situ collections: lessons from the global survey of the genus *Zelkova* (Ulmaceae). *Biodiversity and Conservation* 21: 671–685.

Kozłowski G., Gratzfeld J. 2013. *Zelkova*-an ancient tree. Global status and conservation action. Natural History Museum Fribourg, Fribourg.

Kozłowski G, Frey D, Fazan L, Egli B, Bétrisey S, Gratzfeld S, Garfi G, Pirintsos S. 2013. Tertiary relict tree *Zelkova abelicea* (Ulmaceae): distribution, population structure and conservation status. *Fauna & Flora International, Oryx*, 48(1), 80–87.

Kvavadze E.V., Connor S. E. 2005. *Zelkova carpinifolia* (Pallas) K. Koch in Holocene sediments of Georgia – an indicator of climatic optima. *Review of Palaeobotany and Palynology* 133: 69–89.

Mirabolfofathy M. 2013. Outbreak Of Charcoal Disease On *Quercus* spp. and *Zelkova carpinifolia* Trees In Forests of Zagros And Alborz Mountains In Iran, Iran. *J. Plant Path.*, Vol. 49, No. 2,; 77-79.

URL₁, 2016.

https://www.fr.ch/mhn/files/pdf56/Zelkova_-_an_ancient_tree_V2.pdf

URL₂, 2016.

<https://global.britannica.com/plant/Ulmaceae>

URL₃, 2016.

<http://www.gbif.org/species/2984531>

URL₄, 2016. <http://tr.climate-data.org/location/240/>

URL₅, 2016. <https://www.bgci.org/plant-conservation/zelkova>

Taberlet P, Fumagalli L, Wust-Saucy AG, Cosson J. F. 1998. Comparative phylogeography and postglacial colonization routes in Europe. *Molecular Ecology*, 7:453-464.

Zieliński J. 1979. Ulmaceae. In: *Flora Iranica* 142. Rechinger K.H. (ed.). Akademische Druck und Verlagsanstalt, Graz.

The Ecological and Floristic Properties of *Pinus brutia* Ten. Community (Karaman-Ermenek)

*Fatmagül GEVEN¹, Ayvaz ÜNAL², Sanem AKDENİZ ŞAFAK³

¹Ankara University, Faculty of Science, Department of Biology, 06100, Ankara/TURKEY

²Selçuk University, Education Faculty of Ahmet Keleşoğlu, Department of Biology, 42030, Konya/TURKEY

³Aksaray University, Faculty of Science and Arts, Department of Biology, 68100, Aksaray/TURKEY

*Corresponding Author: geven@science.ankara.edu.tr

Abstract

This study based on the vegetation field survey between 2010 and 2013 has been carried out for the purpose of determining the vegetation of Ermenek (Karaman). The vegetation that is under the influences of semi-arid soft type of Mediterranean climate was analyzed according to the Braun-Blanquet approach. *Pinus brutia* and *Lotononis genistoides* (Fenzl) Benth. were the most commonly observed species in community in Ermenek. *Pinus brutia* and *Lotononis genistoides* community's in terms of sociology, it is very difficult to interpret. The study area is located in the southeast of Central Anatolia covered with red-brown and brown soils. This area belongs to the Mediterranean region in terms of phytogeography. Relations between the ecological properties (such as pH, C (%), N (%), CaCO₃ (%)) of soil properties and climate) and plant cover was examined.

Based on the results of floral biodiversity and ecological properties were discussed of *Pinus brutia* community. Results showed that, on the distribution of vegetation are important factors, respectively; climatic, edaphic, anthropogenic. In terms of biodiversity conservation of these areas it is very important furthermore the protection of these areas showed that very necessary.

Key Words: *Pinus brutia* community, Ermenek, Karaman, Turkey

Pinus brutia Ten. Topluluklarının Ekolojik ve Floristik Özellikleri (Karaman-Ermenek)

Özet

Bu çalışma 2010 ve 2013 yılları arasında arazi çalışmalarına dayanarak, Ermenek (Karaman)'in vejetasyonun belirlenmesi amacı ile yapılmıştır. Yarı kurak yumuşak Akdeniz ikliminin etkisi altındaki vejetasyon, Braun-Blanquet yöntemine göre analiz edildi. *Pinus brutia* ve *Lotononis genistoides* Ermenek'teki toplulukta en sık görülen türlerdir. *Pinus brutia* ve *Lotononis genistoides* topluluklarını yorumlamak sosyolojik açıdan oldukça zordur. Araştırma alanı İç Anadolu'nun güneydoğusunda kırmızı-kahverengi ve kahverengi topraklarda yer alır. Fitocoğrafik açıdan Akdeniz Bölgesi kapsamındadır. Bitki örtüsü ve ekolojik özellikleri arasındaki ilişkiler (örneğin pH, C (%), N (%), CaCO₃ toprak özellikleri ve iklim (%)) incelenmiştir.

Pinus brutia topluluğu ekolojik özellikler ve bitki çeşitliliğinin sonuçlarına dayanarak tartışıldı. Sonuçlar, vejetasyonun dağılımına ilişkin önemli faktörlerin, sırasıyla; iklimsel, edafik, antropojenik olduğunu gösterdi. Bu alanlar biyoçeşitliliğinin korunması açısından çok önemlidir ilaveten bu alanların korunmasının çok gerekli olduğu görülmüştür.

Anahtar Kelimeler: *Pinus brutia* topluluğu, Ermenek, Karaman, Türkiye

Introduction

Mediterranean forests are composed of trees adapted to the hot and dry summers without precipitation and winters with precipitation, and bulbous plants and bush species tolerant to drought. This region starts from Gelibolu peninsula, follows the Aegean and Mediterranean coasts and ends up in the

Amanos Mountains. While the taxa of Calabrian pine (*Pinus brutia*), stone pine, Crimean pine, Lebanon cedar (*Cedrus libani*) and Cilician fir (*Abies cilicica*) constitute the coniferous forests in the Mediterranean Region, juniper (*Juniperus excelsa*, *J. foetidissima*) and oak (*Quercus cerris*, *Q. vulcanica*, *Q. infectoria*, *Q. ithaburensis*)

subsp. macrolepis) species also accompany them (Anonymous 2012 Akman 1995). One of such Turkish red pine (*Pinus brutia* Ten.) is the most widely distributed main tree species of Turkey and it covers approximately 5.8 million ha, accounting for 27 % of the Turkey's forests. *Pinus brutia* (Turkish or Calabrian pine), is one of the most widespread pine species in Turkey. Its main distribution area is around the Mediterranean, Aegean and Marmara regions (0-1000m.). In the Black Sea Regions it is found in the Mediterranean enclave and is widespread 10-400 m around the coastline (Samsun) (Karaer et al., 1999).

This study was carried out for the ecologic investigation of the *Pinus brutia* community of the area in Mediterranean. This species has been partly fire and forestry to the area is restricted. In addition, the habitat is threatened by pollution (agricultural, industrial and domestic pollution). Mediterranean included in Mediterranean phytogeographical region is very important in terms of its climatic, soil and geographical characteristics (Zohary 1973). The region is characterized by a Mediterranean type of climate with cold winters and hot summers. In Mediterranean, some of vegetation studies were carried out by Akman and Ekim (1988), Akman (1995), Akman et al. (1996), Tatlı (2005), Sağlam (2007), Ünalı and Toroğlu (2007).

Material and Method

In this study, the materials were collected from the area between 2010-2013. The Flora of Turkey (Davis 1965-1985; Davis et al. 1988; Güner et al. 2000) and other floras (Tutin et al. 1964-1981; Townsend, 1966-1980) were utilized in the identification of the specimens. The plant specimens collected from the relevés were stored in the herbarium of Ankara University (ANK). In order to determine the interaction between environmental factors and plant communities, 10 relevés were taken from different area. The vegetation analysis were

performed according to traditional Braun-Blanquet's "floristic unit system" (1932) and the unified abundance-cover values and sociability were determined. The widths of the relevés were determined by according to "minimal area" method which was 100 m² in *Pinus brutia* community (Akman et al. 2001). Sites were selected that exhibited minimal levels of agricultural disturbance, particularly vegetation and soil degradation caused by domestic stock grazing (sheep). Also the addresses of ten relevés were given for the definition of the community.

Description of the study area

Ermenek is located Karaman province in the Mediterranean region and C4 square according to Davis' square system (1965). Ermenek is a transitional zone between Central Anatolia and the Mediterranean regions geographically. Moreover it is a transitional zone between the Mediterranean and Irano-Turanian phytogeographic regions (Zohary 1973). The region is bounded by Konya province in the north and Karaman province in the south (Figure 1, Figure 2).

The elevations in the area range 1000 m. The soil data related to Ermenek were taken from "Konya İli Arazi Varlığı" prepared by Turkish Soil Works (Anonymous 1992). According to this report the region is dominated by "red brown" and "brown" soil. The other types of soils in the region are "alluvial" and "kolluvial". Soil samples were taken at depths of 0-30 cm at eight study spots. Chemical properties of soil samples were analysed by "T.C. Tarım ve Köy İşleri Bakanlığı".

The climatic data of the study area were obtained from Ermenek meteorological stations Anonymous (1974, 1984). The Summer rainfall (PE) of Ermenek is 10.3 mm. These values indicate that the working site is dominated by "semi-arid soft Mediterranean" climate (Table 2). The rainfall type of Ermenek meteorological station is W.Sp.S.A. (Akman 1982).

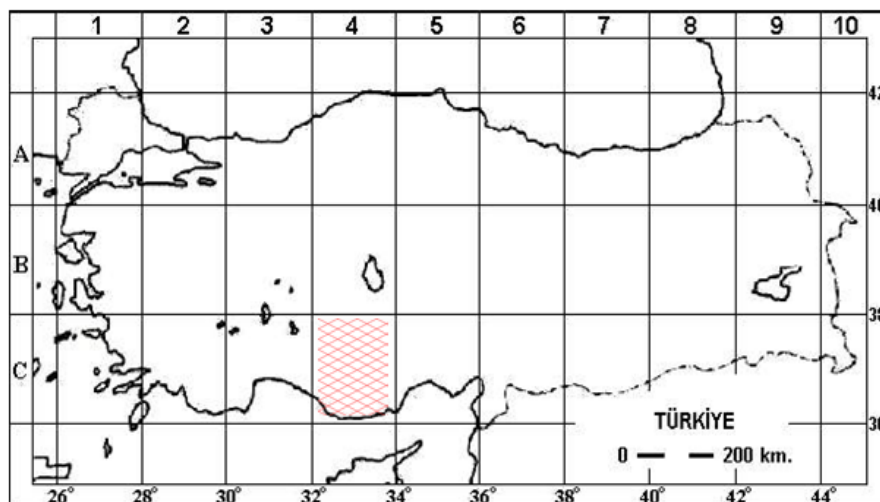

Figure 1. Map of the study area

Table 1. The physical and chemical analysis of the representative sample soil collected from the study area.

Dept (cm)	CaCO ₃ %	pH	C (%)	Organic matter	N (%)	Saturation (%)	Sand	Clay	Plate	Texture	Available water	Conductivity	C/N
30	35.4	8.2	2.41	3.41	0.21	75.80	44.00	18.21	33.16	L	12.41	0.81	21.18

Table 2. Climatic synthesis of Ermenek meteorological station.

Station	Altitude (m)	P (mm)	M (°C)	m (°C)	Q	PE	S	Bioclimatic Type	Precipitation Regime
Ermenek	1044	306,5	30,1	-3,9	31,5	10.3	1,1	semi-arid	W.Sp.S.A.

P: (mm): Mean annual precipitation,
M: (°C): Mean maximum for the hottest month,
m: (°C): Mean minimum for the coldest month,
Q: Emberger's pluviometric quotient ($2000 \cdot P / M2 - m2$),
PE: Summer rainfall,
S: Emberger's index of xericity ($S=PE / M$),
W: Winter, **Sp:** Spring, **S:** Summer, **A:** Autumn.

Results and Discussion

The community occurs on limestone area in several localities (Figure 3). A total of ten relevés were taken from the forest vegetation of Ermenek and were analysed. All plant species are belonging to *Pinus brutia* community (Table 3). The physiognomy of the community is dominated by *Pinus brutia*, *Lotononis genistoides*, *Juniperus oxycedrus* L. subsp. *oxycedrus*,

Quercus coccifera L., *Pistacia terebinthus* L. subsp. *palaestina* (Boiss.) Engler, *Paliurus spina-christi* Miller. community extends along area of north, east, northeast and southeast Ermenek (Figure 1, Figure 2). This community exhibits tree, shrub and herb layers. The tree layer in only characterised by *Pinus brutia* which has a 85 and 90% total coverage and 6 and 12 m in height. Total coverages of the shrub and herb layers are 20

and 50% and 20 and 40% respectively. The shrub layer is 2 and 3 m in height, the herb layer 10 and 60 cm in height. The most common species in the shrub layer are *Juniperus oxycedrus* subsp. *oxycedrus*, *Quercus coccifera*, *Pistacia terebinthus* subsp. *palaestina*, *Paliurus spina-christi*, *Crataegus aronia* (L.) Bosc. ex DC. var.

minuta Brozwich, *Styrax officinalis* L.. The herb layer includes *Teucrium polium* L., *Alyssum strigosum* Banks et Sol. subsp. *cedrorum* (Schott et Kotschy) Dudley, *Salvia tomentosa* Mill., *Onobrychis armena* Boiss. et Huet., *Coronilla varia* L. subsp. *varia*.



Figure 2. Distribution map of *Pinus brutia* Ten. (URL₂, 2008)

Figure 3. *Pinus brutia* Ten.



This community is spread on calcareous parent rock and brown forest occur on northeast, southeast slopes with inclination 5°-40°. The general coverage varies between 80 to 90%. The life forms of the taxa were determined according to Raunkiaer (1934) and Ellenberg and Mueller-Dombois (1967). According to Raunkiaer's life form system, the most represented classes in the floristic spectrum were geophytes (1.9%; 2), chamaephytes (25.7%; 27), hemicryptophytes (54.2 %; 57), therophytes (3.8 %; 4) and phanerophytes (14.2 %; 15), (Figure 4). The chorotype of the taxa were determined according to Zohary (1973), Davis et al. (1965-1988), Donner (1990), Güner et al. (2000). The distribution of phytogeographic elements is as follows: Mediterranean 34 (32.4%), Irano-Turanian 24 (22.8%), Euro-Siberian 4 (3.8%) and others 43 (40.9%), (Figure 5). The study area is phytogeographically located totally with in

the transitional zone between the Mediterranean and Irano-Turanian phytogeographic regions. This situation is also reflected in the community table (Table 3). Phytogeographical analysis showed that the majority of the representatives belonged to the Mediterranean phytogeographical area.

P. brutia community is found on the inclined land with brown forest soils. The chemical characteristics of soil samples are shown in (Table 1). According to values obtained from Ermenek meteorological station, climate type is “semi arid, soft Mediterranean” (Akman 1982). The seasonal precipitation regime during the year is as winter, spring, summer and autumn. The climate has a marked effect on the development of the community.

The floristic structure of the determined forest communities is highly heterogeneous. It is spread in different places in respect to climatic and edaphic factors. The forest formation of the area was formed with regressive succession as in the large part of the Mediterranean region. *P. brutia* communities were reported in some phytogeographical studies in Turkey (Quezel 1973, Akman and Ekim 1988, Kutbay and Kılınç 1995, Özen and Kılınç 1995).

At the same time, this forest vegetation has been pressure from uncontrolled and excessive grazing. Heavy grazing causes not only destruction of range vegetation but also degradation of the soils by erosion. These areas are very important especially endemic plants and they have special importance as habitat (Ekim et al. 2000). Anthropological activities have been changed these special habitats; therefore, these areas must be preserved. The phytosociology of these area is still poorly known and needs urgently studied as phytosociologically. The results of this study can be useful in determining sites suitable for afforestation and rehabilitation

practices in *Pinus brutia* forests of Mediterranean region in Turkey.

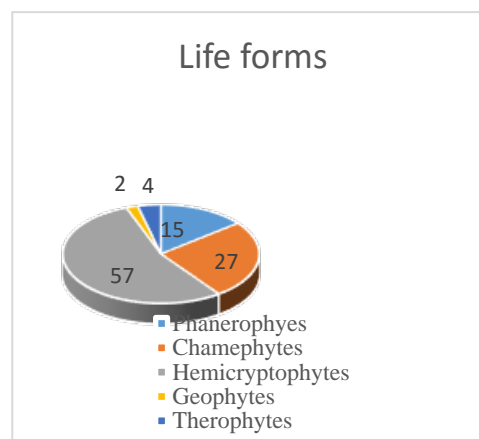

Figure 4. Spectrum of life forms

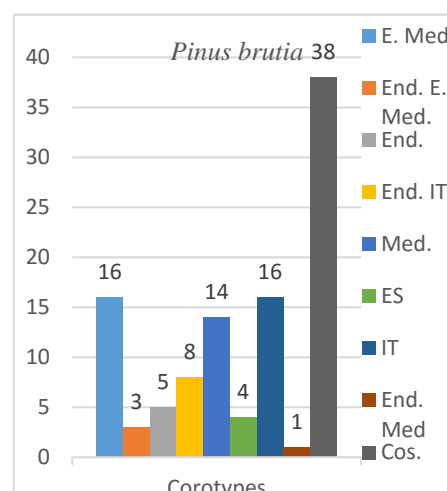

Figure 5. Spectrum of corotypes

Table 3. Analysis of the forest vegetation of Ermenek characteristic species of the *Pinus brutia* Ten. community

Number of quadrat	1	55	56	2	3	4	52	44	13	10			
Altitude (m)x10	75	80	75	75	80	95	105	80	85	50			
Square size (m ²)x10	100	100	100	100	100	100	100	100	100	100			
Exposition	E	N	N	NE	SE	SE	E	N	N	N			
Inclination (°)	5	5	5	10	10	20	5	40	30	5			
Cover (%)	80	90	90	85	90	80	90	85	85	85			
Mother rock	L	L	L	L	L	L	L	L	L	L			
											Constancy	Corotypes*	Life forms**
<i>Pinus brutia</i>	44	44	44	44	44	43	54	54	44	44	V	E.Med.	Ph
<i>Onosma stenoloba</i>	.	.	.	+1	+1	V	End.IT	H
<i>Euphorbia falcata</i> subsp. <i>macrostegia</i>	+1	.	.	+1	.	.	.	+1	.	.	IV	E.Med.	Ch
<i>Linum hirsutum</i> subsp. <i>anatolicum</i> var. <i>ana.</i>	+1	+1	.	.	IV	End.IT	H
<i>Polygonum cognatum</i>	+1	+1	IV	Cos.	H
<i>Prunella orientalis</i>	+1	+1	.	.	IV	Med.	H
<i>Micromeria nervosa</i>	+1	+1	.	.	.	IV	Cos.	Th
<i>Crucianella latifolia</i>	+1	+1	.	IV	Med.	H
<i>Trigonella plicata</i>	.	+1	+1	.	.	.	IV	End.	H
<i>Astragalus mesogitanus</i>	+1	.	.	+1	.	+1	.	.	+1	+1	III	End.IT	Ch
<i>Scorzonera kotschyi</i>	+1	+1	+1	.	.	+1	.	.	.	+1	III	IT	Ch
<i>Rhannus hirtella</i>	.	.	.	+1	+1	+1	+1	1	.	.	III	End.IT	Ph
<i>Phleum exaratum</i> subsp. <i>exaratum</i>	+1	.	.	+1	+1	.	.	1	.	+1	III	Cos.	H
<i>Astragalus zederbaueri</i>	.	.	+1	.	+1	+1	+1	.	.	.	III	End.IT	Ch
<i>Lens ervoides</i>	.	.	+1	.	.	.	+1	+1	+1	.	III	Med.	Th
<i>Ononis pusilla</i>	.	.	+1	+1	+1	.	+1	.	.	.	III	Med.	H
<i>Trifolium campestre</i> subsp. <i>campestre</i> var. <i>c.</i>	+1	.	+1	+1	+1	.	III	Cos.	H
<i>Poa bulbosa</i>	+1	.	+1	+1	.	.	+1	.	.	.	III	Cos.	H
<i>Sideritis bilgerana</i>	+1	11	11	+1	.	.	III	End.E. Med.	H
<i>Ajuga chamaepitys</i> subsp. <i>chia</i>	+1	.	+1	.	.	.	+1	.	+1	.	III	Cos.	H
<i>Hypericum confertum</i> subsp. <i>confertum</i>	+1	.	+1	+1	+1	III	End.	H
<i>Carex distachya</i> var. <i>distachya</i>	+1	.	+1	+1	+1	III	Med.	H
<i>Aegilops umbellulata</i>	+1	.	+1	.	.	+1	+1	.	.	.	III	IT	H
<i>Medicago radiata</i>	+1	+1	+1	.	III	IT	H
<i>Medicago coronata</i>	+1	.	+1	.	.	.	+1	.	.	.	III	Med.	H
<i>Veronica macrostachya</i> subsp. <i>sorgerae</i>	.	+1	+1	.	+1	III	Med.	H
<i>Clypeola jonthlaspi</i>	.	+1	+1	.	+1	III	Cos.	H
<i>Centaurea pinetorum</i>	+1	.	+1	+1	.	.	III	End. Med.	H
<i>Micromeria myrtifolia</i>	.	+1	+1	+1	.	III	Cos.	H
<i>Briza humilis</i>	.	+1	+1	.	.	.	+1	.	.	.	III	Cos.	H
<i>Pilosella procera</i>	+1	.	+1	+1	III	Cos.	H
<i>Cerastium fragillimum</i>	+1	+1	+1	+1	+1	.	II	Cos.	H
<i>Vicia cracca</i> subsp. <i>stenophylla</i>	.	12	.	.	+1	.	.	+1	+1	.	II	Cos.	H
<i>Cotoneaster nummularius</i>	+1	+1	+1	+1	.	II	Cos.	Ph
<i>Asparagus officinalis</i>	+1	.	.	+1	+1	.	.	.	+1	.	II	Cos.	H
<i>Hypericum confertum</i> subsp. <i>confertum</i>	+1	.	+1	+1	+1	II	End.	H
<i>Galium peplidifolium</i>	.	+1	.	.	+1	+1	.	+1	.	.	II	E.Med.	Ch
<i>Trifolium grandiflorum</i>	.	+1	+1	+1	II	E.Med.	H
<i>Melica ciliata</i> subsp. <i>ciliata</i>	.	+1	.	.	+1	.	.	+1	.	.	II	Cos.	H
<i>Briza humilis</i>	+1	.	.	22	.	.	11	.	.	.	II	Cos.	H
<i>Salvia tomentosa</i>	+1	.	+1	+1	+1	+1	+1	+1	+1	.	II	Med.	Ch
<i>Styrax officinalis</i>	12	+1	+1	22	.	12	+1	.	22	.	II	Cos.	Ph
<i>Cephalanthera rubra</i>	+1	11	+1	+1	.	.	.	+1	+1	+1	II	Cos.	H
<i>Silene italica</i>	.	11	+1	.	+1	.	.	+1	+1	.	II	Med.	Ch
<i>Epipactis condensata</i>	+1	11	+1	+1	+1	II	E.Med.	H
<i>Securigera varia</i>	.	+1	+1	+1	+1	.	II	E.Med.	H
<i>Lathyrus digitatus</i>	.	+1	.	.	+1	.	.	+1	+1	.	II	E.Med.	H
<i>Lotus aegaeus</i>	.	+1	+1	+1	.	II	Cos.	H
<i>Festuca heterophylla</i>	+1	+1	+1	.	II	ES	H

<i>Geum urbanum</i>	+1	II	ES	Ch
<i>Onobrychis armena</i>	.	12	.	12	+1	.	+1	+1	II	End.	Ch
<i>Helianthemum nummularium subsp. lycaon.</i>	.	+1	+1	.	+1	.	+1	+1	II	E.Med.	H
<i>Anthemis tinctoria var. tinctoria</i>	+1	+1	.	.	+1	+1	+1	II	ES	H
<i>Allium scorodoprassum subsp. rotundum</i>	+1	+1	.	+1	+1	+1	II	Cos.	G
<i>Linaria corifolia</i>	.	+1	.	.	+1	+1	II	End.IT	H
<i>Astragalus microcephalus</i>	+1	.	.	+1	II	IT	Ch
<i>Callipeltis cucullaris</i>	.	+1	+1	.	.	+1	II	IT	H
<i>Astragalus plumosus var. plumosus</i>	.	+1	+1	+1	II	IT	Ch
<i>Polygala pruniosa subsp. pruniosa</i>	+1	+1	.	.	.	+1	II	Cos.	Ch
<i>Scabiosa rotata</i>	.	+1	+1	II	IT	Th
<i>Convulvulus holosericeus subsp. holoserice.</i>	.	12	+1	II	ES	Ch
<i>Centaurea virgata</i>	.	+1	+1	II	Cos.	H
<i>Hedysarum varium</i>	.	+1	II	IT	H
<i>Teucrium polium</i>	+1	+1	+1	+1	+1	+1	II	E.Med.	Ch
<i>Stipa bromoides</i>	+1	.	+1	+1	+1	+1	+1	II	Med.	H
<i>Astragalus lydius</i>	.	+1	+1	+1	+1	+1	II	End.IT	Ch
<i>Dianthus zonatus var. zonatus</i>	+1	.	+1	.	+1	.	+1	.	+1	.	+1	II	Cos.	H
<i>Leontodon asperimus</i>	+1	.	.	+1	+1	+1	II	IT	H
<i>Silene spergulfolia</i>	+1	.	+1	+1	+1	II	IT	Ch
<i>Ziziphora taurica var. taurica</i>	+1	+1	+1	.	+1	II	IT	Th
<i>Minuartia juniperina</i>	.	11	+1	.	+1	+1	II	Cos.	H
<i>Asphodeline taurica</i>	.	+1	.	.	+1	+1	II	E.Med.	Ch
<i>Euphorbia kotschyana</i>	.	+1	+1	.	+1	II	E.Med.	H
<i>Telephium imperati subsp. orientale</i>	.	.	.	+1	+1	+1	II	Cos.	Ch
<i>Paronychia kurdica subsp. kurdica</i>	.	.	.	+1	+1	+1	II	IT	Ch
<i>Scutellaria orientalis subsp. alpina var. alpi.</i>	.	.	.	+1	+1	+1	.	.	.	+1	+1	+1	II	IT	Ch
<i>Festuca valesiaca</i>	.	12	.	12	+1	II	IT	H
<i>Astragalus angustifolius subsp. angustifolius</i>	+1	+1	II	IT	Ch
<i>Polygala anatolica</i>	+1	.	.	.	+1	II	Cos.	Ch
<i>Koeleria cristata</i>	.	+1	+1	II	E.Med.	H
<i>Globularia trichosanta subsp. longisepala</i>	+1	II	End. E.Med.	Ch
<i>Cephalanthera epipactoides</i>	+1	+1	+1	+1	+1	+1	II	E.Med.	H
<i>Thymbra capitata</i>	12	.	+1	.	.	.	+1	11	.	+1	+1	II	Med.	Ch
<i>Dactylis glomerata subsp. hispanica</i>	+1	.	+1	+1	+1	+1	.	.	.	+1	II	Cos.	G
<i>Lotononis genistoides</i>	+1	.	+1	.	.	.	+1	+1	.	.	+1	+1	I	IT	H
<i>Verbascum pseudoholotrichum</i>	+1	+1	+1	+1	.	.	+1	I	End. E Med.	H
<i>Astragalus micropterus</i>	+1	+1	+1	+1	I	End.IT	Ch
<i>Quercus coccifera</i>	+1	+1	+1	+1	+1	+1	22	.	+1	+1	I	Med.	Ph
<i>Pistacia terebinthus subsp. palaestina</i>	11	11	11	.	+1	.	11	.	.	+1	+1	I	E.Med.	Ph
<i>Crataegus aronia var. minuta</i>	+1	+1	+1	.	+1	.	+1	.	.	+1	.	.	+1	+1	I	Cos.	Ph
<i>Eryngium falcatum</i>	+1	.	.	+1	+1	I	E.Med.	H
<i>Juniperus oxycedrus subsp. oxycedrus</i>	33	12	21	22	+1	22	.	+1	+1	12	I	Cos.	Ph
<i>Dorycnium pentaphyllum subsp. haussknech</i>	11	.	+1	11	+1	+1	11	+1	+1	I	End.	H
<i>Daphne sericea</i>	+1	+1	+1	I	E.Med.	Ph
<i>Lonicera etrusca var. etrusca</i>	.	+1	11	+1	+1	I	Med.	Ph
<i>Jasminum fruticans</i>	.	.	+1	.	+1	+1	+1	I	Med.	Ph
<i>Fumana arabica var. arabica</i>	.	+1	+1	+1	I	Cos.	H
<i>Paliurus spina christi</i>	+1	+1	+1	I	Cos.	Ph
<i>Colutea cilicica</i>	.	+1	+1	I	Cos.	Ph
<i>Piptatherum coerulescens</i>	.	+1	I	Cos.	H
<i>Berberis crataegina</i>	+1	+1	+1	+1	+1	+1	+1	I	Cos.	Ph
<i>Alyssum strigosum subsp. cedrorum</i>	+1	+1	+1	+1	+1	.	.	+1	I	Cos.	Ch
<i>Minuartia multinervis</i>	+1	+1	+1	+1	+1	+1	I	Cos.	Ch
<i>Juniperus excelsa</i>	+1	+1	+1	.	+1	+1	+1	I	Cos.	Ph
<i>Sanguisorba minor subsp. minor</i>	+1	I	Cos.	H

Explanation:

The cover-Abundance: Cover < %1: +, cover %1- %5: **1**, cover %5-10: **2**, cover %11-33: **3**, cover %34-75: **4**, cover %76-100: **5** (Braun-Blanquet 1932).

L: Limestone (Calcareous)

* Chorotypes: **ES:** Euro-Siberian region, **EU:** Euroasia, **IT:** Irano-Turanian region, **Med:** Mediterranean region, **Cos:** Cosmopolitan [Davis et al. (1965-1985, 1988); Güner et al. (2000); Zohary (1973); Donner (1990)].

** Life forms: **Ph:** Phanerophyte, **Ch:** Chamaephyte, **G:** Geophyte, **H:** Hemicryptophyte, **Th:** Therophyte [Raunkiaer (1934); Ellenberg & Mueller-Dombois (1967)].

Locality of quadrat: Ermenek

Acknowledgments

In this study, Selcuk University Scientific Research Projects Fund by the Directorate EF-2002/007 is supported by the project numbered. Thank you for the support from Selcuk University Department of Scientific Research Projects Fund.

References

- Akman Y., 1982. Climats et bioclimats méditerranéens en Turquie, *Ecologia Mediterranea*, VIII (1,2), 73-87.
- Akman Y., Ketenoğlu O., Quezel P., Demirörs M. 1984. A syntaxonomic study of steppe vegetation in Central Anatolia. *Phytoecologia* 12(4), 563-584. Stuttgart.
- Akman Y, Ekim T. 1988. Gelibolu Tarihi Milli Parkı Vegetasyonu, Doğa TU Botanik D., 12, 2, 105-118.
- Akman Y. 1995. Türkiye Orman Vegetasyonu. Ankara Üniversitesi Fen Fakültesi Yayınları. Ankara
- Akman Y., Vural M., Quezel P., Kurt L., Ketenoğlu O., Serin M., Barbero M. 1996. Etude de la Vegetation Steppique de la Region de Karaman et Ermenek au sud d' Anatolie Centrale. *Ecologia Mediterranea* XXII (3/4), 1-20. France.
- Akman Y., Ketenoğlu O., Geven F. 2001. Vegetasyon Ekolojisi ve Araştırma Metodları, Kaynak Kitap, 341 s. Ankara.
- Anonymous. 1974. D.M.İ. Genel Md. Ortalama Extrem Kıymetler Meteoroloji Bülteni: Başbakanlık Basımevi.
- Anonymous. 1984. D.M.İ. Genel Md. Ortalama Extrem sıcaklık ve yağış defteri bülteni: (Günlük-Aylık) Türk Tarih Kurumu Matbaası. Ankara.
- Anonymous. 1992. Konya İli Arazi Varlığı, Köy Hizmetleri. Genel Müdürlüğü yayınları İl Rapor No:42, Ankara.
- Braun-Blanquet J. 1932. *Plant Sociology* (translated by Fuller and Cornard) New York, London.
- Çetik R. 1985. Türkiye Vegetasyonu I: İç Anadolu'nun Vegetasyonu ve Ekolojisi. Selçuk Üniversitesi Yayınları, No:7, Konya.
- Çetik R., Ocakverdi H. 1981. Sultandağları Doğanhisar bölgesinin fitososyolojik ve fitoekolojik yönden incelenmesi. *S. Ü. Fen Fak. Derg. 2. B*, 73-89. Konya.
- Davis P. H. 1965-1984. *Flora of Turkey and the East Aegean Islands: Vol I-IX*, Edinburg Univ. Press.
- Davis P.H. 1988. *Flora of Turkey and the East Aegean Islands: Vol X (Supplement)*, Edinburg Univ. Pres.
- Donner J. 1990. Distributions maps to P. H. Davis, *Flora of Turkey*, 1-10. *Linzer Biol. Beitr.* 22, 381-515.
- Ekim T., Koyuncu M., Vural M., Duman H., Aytaç Z., Adıgüzel N. 2000. *Türkiye Bitkileri Kırmızı Kitabı, Türkiye Tabiatı Koruma Derneği*, Ankara.
- Ellenberg H., Mueller-Dombois D. 1967. A key to Raunkiaer plant life forms with revised subdivisions. *Ber. Geobot. Inst. ETH. Stiftung. Rüb. Zürich* 37, 56-73.
- Güner A., Özhatay N., Ekim T., Başer K. H. C. (eds.). 2000. *Flora of Turkey and the East Aegean Islands. Vol. 11*, Edinburgh University Press, Edinburgh.
- Quezel P. 1973. Contribution a l'étude phytosociologique du massif Taurus. *Phytocoenologia*, 1(2), 131-222.
- Karaer F., Kılınç M., Kutbay H. G. 1999. The Woody Vegetation of the Kelkit Valley Tr. *J. of Botany* 23: 319-344.
- Kutbay H. G., Kılınç M. 1995. Bafra Nebyan Dağı (Samsun) ve çevresinin vegetasyonu üzerinde fitososyolojik ve ekolojik bir araştırma, *Tr. J. of Botany*, 19, 41-63.
- Krause K. 1940. Batı ve Orta Anadolu Nebat Formasyonları (Çeviren: H. Birand): *Ziraat Vekaleti Yay.*, 60, 1-29.

Özen F., Kılınç M. 1995. Alaçam-Gerze ve Boyabat-Duragan arasında kalan Bölgenin vejetasyonu I;II Tr.J. of Botany, 19, 41-105.

Raunkiaer C. 1934. The life forms of plants and statistical plant geography. Oxford University Press, London.

Sağlam C. 2007. Davras Dağı (Isparta) ve Çevresinin Orman ve Çalı Vejetasyonu. Süleyman Demirel Üniversitesi Fen Bilimleri Enstitüsü Dergisi. 11-2. 140-157

Tatlı A., Başyigit M., Varol Ö. and Tel A. Z. 2005. Gümüş Dağı (Kütahya-Türkiye) Orman Vejetasyonu Üzerine Fitososyolojik Bir Araştırma. Ekoloji. No: 55, 6-17.

Tutin G. T., Heywood V. H. 1964–1981. Flora Europaea, Vol. I-V, Cambridge Univ. Press.

Towsend C C, Guest E (1966–1980) Flora of Iraq, Vol 1–9, Baghdad.

URL₁, 2012. Orman Genel Md.

<http://www.ogm.gov.tr>.

URL₂, 2008. The distribution map of Brutia pine. <http://www.euforgen.org>.

Ünaldı Ü. E. Toroğlu E. 2007. Aladağlar'da Bitki Formasyonları ve Dağılımları. G. Ü. Gazi Eğitim Fakültesi Dergisi, Cilt 27, Sayı 2. 227-240.

Zohary M (1973) Geobotanical foundations of the Middle East. Vol. I-II. Gustav Fischer Verlag. Stuttgart.

An Overview of Endemic Turkish Bryophytes

Gökhan ABAY

Recep Tayyip Erdoğan University, Faculty of Fine Arts, Design and Architecture, Division of
Landscape Architecture, Department of Plant Material and Propagation Techniques, 53100,

RİZE

gokhanabay@gmail.com

Abstract

The aim of the review is to compile endemic bryophytes in Turkey, and to inform their distribution data and current nomenclatural changes. A total of two liverworts and three mosses are endemic for Turkey, which equals 0.52% of the total bryoflora of the country. The values for percent endemism are about 0.38% for mosses and 1.11% for liverworts. There is no endemic hornwort in Turkey, likewise. Two genera, *Solenostoma* of liverworts with two taxa, and *Cinclidotus* of mosses with three taxa, have endemic species. Two taxa of mosses, *Cinclidotus nyholmiae* and *Orthotrichum leblebici*, previously reported as endemics for Turkey were synonymized with other taxa and excluded from the endemic list.

Keywords: Endemic species, Liverworts, Mosses, Turkey

Endemik Türk Bryofitlerine Genel Bir Bakış

Özet

Bu bildirinin amacı Türkiye'nin endemik bryofitlerini derlemek ve bu bryofitlerin dağılım verileri ile güncel bilimsel isimleri hakkında bilgi vermektir. İki ciğerotu ve üç karayosunu Türkiye için endemik olup, bunların ülke bryoflorasındaki oranı % 0.52 dir. Endemik karayosunları için yüzde oranı 0.38 iken bu değer ciğerotları için % 1.11 dir. Ayrıca, Türkiye'de endemik boynuzsu ciğerotu bulunmamaktadır. *Solenostoma* cinsine ait iki ciğerotu, *Cinclidotus* cinsine ait üç endemik karayosunu söz konusudur. Daha önceden Türkiye için endemik olarak rapor edilen iki takson, *Cinclidotus nyholmiae* ve *Orthotrichum leblebici*, ilgili diğer taksonlarla sinonimize edilmiş ve endemik listenin dışında tutulmuştur.

Anahtar Kelimeler: Endemik türler, Ciğerotları, Karayosunları, Türkiye

Introduction

If a specimen is both native and restricted to a particular geographical region or country, it is described as endemic (Masseti, 2008). Considering the world distribution of endemic bryophytes, Madagascar Islands show the highest endemism; about 70% of the moss species are endemic. Hawaiian Islands take the second place; about 67% of the liverwort species and about 51% of the mosses are endemic. New Zealand, British Isles, Japan, West Indian Islands and North America (north of Mexico) are known as the other countries or islands in terms of the endemic bryophyte species (Schofield, 2001).

A survey of the situation in the world shows that the countries North America (Schofield, 2004) and Japan (Higuchi, 2011) published a research on endemic bryophyte species and genera. Some of the studies dealing with the rare and threatened bryophytes were performed by Maslovsky

(2005) in Eastern Europe and Skudnik et al., (2013) in Slovenia. Many red lists on bryophytes were carried out in different countries. These are; Slovenia (Martinčič, 1992), Portugal and Spain (Sérgio et al., 1994; 2006), Italy (Aleffi and Schumacker, 1995), Germany (Ludwig et al., 1996), Lithuania (Jukonien, 1996), Finland (Kotiranta et al., 1998; Rassi et al., 2001; Syrjänen et al., 2010), Slovakia (Kubinská, et al., 2001), United Kingdom (Church et al., 2001; Hodgetts, 2011), Czech Republic (Kučera and Váňa, 2003), Serbia and Montenegro (Sabovljevic et al., 2004), Switzerland (Schnyder et al., 2004), Bulgaria (Natcheva et al., 2006), Poland (Klama, 2006), Estonia (URL1, 2008), Madeira (Sim-Sim, 2008), Luxembourg (Werner, 2009), Norway (Hassel et al., 2010), Romania (Ștefănuț and Goia, 2012), Ireland (Lockhart et al., 2012a, 2012b), Albania (Marka et al., 2012), Netherlands (Siebel et al., 2013), Latvia (URL2, 2014), Hungary (Erzberger et

al., 2015). Moreover, there are great numbers of bryophyte red lists for different regions of Russia (Radzhi, 1998; Shkhagapsoev, 2000; Popova, 2001; Baisheva, 2002; Zykov, 2002; Konstantinova et al., 2003; Volosnova, et al., 2003; Andreeva et al., 2004; Popova and Abramova, 2005; Maksimov et al., 2007; Konstantinova et al., 2008; Ignatov, 2008).

Most information of Turkish bryophytes is nearly based on floristic lists and common species. Although there are limited number of studies (Keçeli and Abay, 2007a; 2007b) on the species within the threatened categories, there is no detailed knowledge about the bryophyte endemism in Turkey. This compilation aims to provide an overview of the endemic mosses and liverworts in Turkey and to inform their distribution localities and current nomenclatural changes.

Materials and Methods

The list of endemic mosses and liverworts in Turkey was mainly predicated on the checklists of Turkey (Gökler, 1996; Kürschner and Erdağ, 2005; Ros et al., 2013) and published papers (Çetin, 1988; Kürschner and Lübenau-Nestle, 2000; Erdağ et al. 2004; Kürschner, 2008; Erdağ and Kürschner, 2009; Erdağ and Kürschner, 2011; Ursavaş and Çetin, 2014).

Nomenclatural changes about the moss taxa are based on the recent surveys (Erdağ and Kürschner, 2011; Ros et al., 2013) and also liverwort taxa follow Váňa et al., (2010) and Söderström et al., (2016).

Results and Discussions

Estimates of the number of Turkish bryophytes

The numbers of bryophyte species in Turkey were reviewed. Accordingly, There are 4 taxa of hornworts, 181 taxa of liverworts, and 791 taxa of mosses notified from Turkey (Ros et al., 2013; Abay, 2014; Gündüz Kesim and Ursavaş, 2014; Kırmacı and Aslan, 2014; Kırmacı and Erdağ, 2014; Kürschner and Kırmacı, 2014; Tonguç Yayıntaş, 2014; Ören et al., 2015; Kara et al., 2016; Özenoğlu Kiremit et al., 2016; Ezer, 2016; Özdemir and Batan, 2016a, 2016b; Batan et al., 2016a, 2016b, 2016c; Batan and Özdemir, 2016).

Endemic bryophytes of Turkey and their latest nomenclatural changes

Past and recent surveys have recorded five bryophytes as endemics in Turkey. *Jungermannia lignicola* (Schiffn.) Grolle and *J. subtilissima* (Schiffn.) Grolle (Schiffner 1909) are endemic liverworts; *Cinclidotus bistratosus* Kürschner and Lübenau-Nestle (Kürschner and Lübenau-Nestle, 2000), *C. vardaranus* Erdağ & Kürschner (Erdağ and Kürschner, 2009), and *C. asumaniae* Ursavaş & Çetin (Ursavaş and Çetin, 2014) are also endemic mosses for Turkey. Besides, Kürschner (2008) reported the liverwort *Jungermannia handelii* (Schiffner) Amak. from Turkey as an endemic, but the taxon had been cited from different countries; in Crete (Váňa, 1974), Spain (Váňa, 1974; Sérgio et al., 1994), and Japan (Furuki and Mizutani, 1994). Therefore, this endemic report from Turkey is excluded. When evaluated based on the latest moss checklist (Ros et al., 2013) including Turkey, the scientific names of such species *Cinclidotus nyholmiae* B. Çetin (Çetin, 1988), and *Orthotrichum leblebici* Erdağ, Kürschner and Parolly (Erdağ et al., 2004) fall into the synonyms. Their current names are named as *Cinclidotus pachyloma* E.S.Salmon and *Orthotrichum vittii* Lara, Garilleti and Mazimpaka, respectively. *C. pachyloma* is endemic to Southwest Asia (Erdağ and Kürschner, 2011), cited from Israel and Lebanon (Ros et al., 2013). *O. vittii* is also distributed in Spain, France and Morocco (Ros et al., 2013). As a consequence, these moss species (*C. pachyloma* and *O. vittii*) were not mentioned as endemics for Turkey because of their distributions in different countries.

Nomenclatural changes of endemic *Jungermannia* species occur in Turkey since the 2010 publication by Váňa et al., (2010) and the world checklist of hornworts and liverworts (Söderström et al., 2016) are given as new combinations below. In the mentioned surveys, many of the taxa belonging to the genus *Jungermannia* are transferred to *Solenostoma*.

Solenostoma caucasicum (Váňa) Konstant., Arctoa 1: 123, 1992 (Konstantinova et al., 1992). Bas.: *Jungermannia caucasica* Váňa, Preslia 42: 96, 1970 (Váňa, 1970), (URL3, 2016).

Solenostoma subtilissimum (Schiffn.) R.M.Schust., Hepat. Anthocerotae N. Amer. 2: 1027, 1969 (Schuster, 1969). Bas.: *Nardia subtilissima* Schiffn., Ann. K. K. Naturhist. Hofmus. 23: 136, 1909 (Schiffner, 1909). *Jungermannia subtilissima* (Schiffn.) Grolle, J. Japan. Bot. 39: 237. 1964 (Váňa, 1975), (URL4, 2016).

Solenostoma lignicola (Schiffn.) Váňa, Hentschel et Heinrichs, Cryptog. Bryol. 31

(2): 137, 2010 (Váňa et al., 2010). Bas.: *Nardia lignicola* Schiffn., Ann. K. K. Naturhist. Hofmus. 23: 137, 1909 (Schiffner, 1909). Other combination for *Nardia lignicola* Schiffn.: *Jungermannia lignicola* (Schiffn.) Grolle. (URL5, 2016).

In the light of the above information, the latest versions of endemic liverwort and moss taxa are shown in Table 1 and Table 2, respectively. The percentage of Turkish endemic bryophytes is approximately 0.52% within the Turkish bryoflora. There is no endemic hornwort species in Turkey. The endemism rate is about 1.11% in liverworts and about 0.38% in mosses.

Table 1. Endemic liverworts in the bryoflora of Turkey

Family	Genera	Species	Taxa
Solenostomataceae	Solenostoma	S. lignicola S. subtilissimum	2

Table 2. Endemic mosses in the bryoflora of Turkey

Family	Genera	Species	Taxa
Pottiaceae	Cinclidotus	C. bistratosus C. vardaranus C. asumaniae	3

Current knowledge of *Jungermannia*, *Solenostoma* and *Cinclidotus* genera and distributions of their endemic species in Turkey

Marchantiophyta

Jungermannia L. and *Solenostoma* Mitt.

The genus *Jungermannia* was represented by 10 species in Turkish bryoflora (Özenoğlu Kiremit and Keçeli, 2009). Based on the new combinations (Váňa et al., 2010; Söderström et al., 2016) 8 of 10 taxa are transferred to the genus *Solenostoma*. Two *Jungermannia* species, *J. atrovirens* and *J. leiantha* are not transferred to the genus *Solenostoma*. The endemic *Solenostoma* taxa were shortly listed below with distribution data.

Solenostomataceae Stotler et Crand.-Stotl.

Solenostoma lignicola

There is one record for Turkey, from Ordu province (Handel-Mazzetti, 1909).

Solenostoma subtilissimum

The species was reported from two localities in Turkey; one is in Trabzon, and

the other is in Ordu, Bakacak district (Handel-Mazzetti, 1909; Váňa, 1975).

Bryophyta

Pottiaceae Schimp.

Cinclidotus P.Beauv.

The genus *Cinclidotus* is represented by 9 species in Turkish bryoflora (Ros et al., 2013; Ursavaş and Çetin, 2014). Three of 9 taxa below mentioned are endemics for Turkey. The endemic *Cinclidotus* species were briefly listed with distribution data.

Cinclidotus bistratosus

There are three records for Turkey, from the province of Antalya, Köprülü Kanyon National Park; first one is from north of Beşkonak, between Oluk bridge and Çaltepe (Kürschner and Lübenau-Nestle, 2000), the second record is from Beşkonak-Başlar neighborhood (Kırmacı and Özçelik, 2010), and the last one is from Bolhasan bridge (Erdağ and Kürschner, 2011).

Cinclidotus vardaranus

The species was only recorded from Eastern Turkey, Erzincan province,

Kemaliye county, İkisü stream (Erdağ and Kürschner, 2009; Erdağ and Kürschner, 2011).

Cinclidotus asumaniae

This species was uniquely reported from Mediterranean region of Turkey, Isparta province, Kızıldağ National Park (Ursavaş and Çetin, 2014).

Conclusions

Local, regional, and national Red Lists are important in effectuation of threatened categories of bryophytes with limited distribution. However, there is no current data about threatened categories of endemic bryophytes and organized bryophyte conservation programs in Turkey. Progress in the conservation of Turkish bryodiversity will need more experts in the field, especially specialized people on problematic families or genera. Future studies should more focus on important plant areas and hot spots of the country.

For now, preparation of the red data lists of bryophytes appears to be an urgent task for Turkish bryologists. At first step, experts on bryophytes from different regions of Turkey should meet. At the workshops held; distribution data of rare and endangered taxa, threats awaiting them, their populations, frequencies, habitat conditions and changes must firstly be determined. Besides, international cooperation can be considered in terms of speed of studies. Finally, it is expected that the lack of bryophyte information will decrease with the help of a regular monitoring programme where the threat level is high, and will be able to be put into a sensible conservation policy actions.

References

Abay, G. 2014. Bryodiversity of Turkey. International Workshop, Scientific and Technological Cooperation in the Field of Plant Biodiversity and Biotechnology between Turkey and Germany (25-27 September 2014). 15, Artvin, Turkey.

Aleffi M., Schumacker R. 1995. Check-list and red-list of the liverworts (Marchantiophyta) and hornworts (Anthocerotophyta) of Italy. Fl. Medit., 5, 73-161.

Andreeva E.N., Afonina O.M., Kuzmina E.O., Kurbaova L.E. 2004. Bryophyta. In: Red Data Book of St.-Petersburg. St.-Petersburg: 325-342.

Baisheva E.Z. 2002. Bryophyta. In: Red Data Book of the Bashkortostan Republic. Vol. 2. Bryophytes, algae, lichens and fungi. Ufa, Tabigat: 17-44.

Batan N., Jia Y., Özdemir T., Alataş M. 2016a. *Brotherella* and *Encalypta* species new to Turkey, Mediterranean and Southwest Asia. Plant Biosystems, 150(3), 436-441.

Batan N., Özdemir T. 2016. *Herzogiella turfacea* (Lindb.) Z. Iwats. (Plagiotheciaceae, Bryophyta) new to Turkey. Arctoa, 25, 141-143.

Batan N., Özdemir T., Abay G. 2016b. *Dicranella crispa* (Hedw.) Schimp. new to Turkey. Symposium on EuroAsian Biodiversity (23-27 May 2016). 271, Antalya, Turkey.

Batan N., Özdemir T., Alataş M., Erata H. 2016c. 32. *Sematophyllum micans* (Mitt.) Braithw. New national and regional bryophyte records, 47. Journal of Bryology, 10-11.

Çetin B. 1988. *Cinclidotus nyholmiae*, a new species from Köprülü Canyon National Park (Antalya) in Turkey. Journal of Bryology, 15, 269-273.

Church J.M., Hodgetts N.G., Preston C.D., Stewart N.F. 2001. British Red Data Books. Mosses and liverworts. Peterborough, JNCC, 168 pp.

Erdağ A., Kürschner H. 2009. *Cinclidotus vardaranus* Erdağ & Kürschner (Bryopsida, Pottiaceae) sp. nov. from Eastern Turkey, with some remarks on the speciation centre of the genus. Nova Hedwigia, 88, 183-188.

Erdağ A., Kürschner H. 2011. The *Cinclidotus* P.Beauv./*Dialytrichia* (Schimp.) Limpr. Complex (Bryopsida, Pottiaceae) in Turkey. Botanica Serbica, 35, 13-29.

Erdağ A., Kürschner H., Parolly G. 2004. *Orthotrichum lelebici* sp. nov. (Orthotrichaceae, Bryopsida), and two further new epiphytic *Orthotrichum* records from southern Turkey. Nova Hedwigia, 78, 517-526.

Erzberger P., Németh C., Papp B., Mesterházy A., Csiky J., Baráth K. 2015. Revision of the red list status of Hungarian bryophytes 1. New occurrences of species previously thought to be regionally extinct or without recent data. Studia Bot. Hung., 46(2), 15-53.

Ezer T. 2016. *Fissidens gymnanthus* (Bryophyta, Fissidentaceae), a new moss record from Turkey and Southwest Asia. Phytologia Balcanica 22(1), 3-5.

Furuki T., Mizutani M. 1994. Checklist of Japanese Hepaticae and Anthocerotae, 1993. Proc Bryol Soc Japan, 6, 75-83.

- Gökler İ. 1996. Studies on the liverwort flora of North Anatolia and Caucasus regions. In: Öztürk, M. A., Ö. Seçmen & G. Görk (eds.): Plant Life in Southwest and Central Asia, pp. 479-486. Ege University Press, İzmir.
- Gündüz Kesim N., Ursavaş S. 2014. Çankiri Alparsari Göleti Ve Civarındaki Yarı Kurak Bir Havzadan Tespit Edilen Bazı Önemli Karayosunu Türleri. I. Ulusal Havza Yönetimi Sempozyumu. 10-12 Eylül 2014, Çankırı. 224-237.
- Handel-Mazzetti H. 1909. Ergebnisse einer botanischen Reise in das Pontische Randgebirge im Sandschak Trapezunt, unternommen im Jahre 1907 im Auftrage des Naturwissenschaftlichen Orientvereines in Wien. Annalen des Naturhistorischen Museums Wien. 23, 6-212.
- Hassel K., Blom H.H., Flatberg K.I., Halvorsen R., Johnsen J.I. 2010. Moser. Anthocerophyta, Marchantiophyta, Bryophyta. In: Kålås, J.A., Viken, Å., Henriksen, S. and Skjelseth, S. (eds.) 2010. The 2010 Norwegian Red List for Species. Norwegian Biodiversity Information Centre.
- Higuchi M. 2011. Endemic species of bryophytes in Japan. Bull. Natl. Mus. Nat. Sci., 37(3), 117-126.
- Hodgetts N.G. 2011. A revised Red List of bryophytes in Britain. Field Bryology, 103, 40-49.
- Ignatov M.S. 2008. Bryophytes. In: Varlygina, T.I., Zubakin, V.A., Sobolev, N.A. (eds.). Red Data Book of Moscow Province. 2d edition. Moscow.
- Jukonien I. 1996. Rare and threatened bryophyte species in Lithuania. Botanica Lithuanica, 2, 327- 342.
- Kara R., Ezer T., Gözcü M.C. 2016. Three new moss records from Turkey, South-West Asia and Mediterranean. Plant Biosystems, DOI: 10.1080/11263504.2015.1103799.
- Keçeli T., Abay G. 2007a. Pallavicinia lyellii (Hook.) Carruth in Turkey, new to Southwestern Asia. Cryptogamie Bryologie, 28, 249-252.
- Keçeli T., Abay G. 2007b. Telaranea europaea (Lepidoziaceae, Hepaticae), new for Turkey. Cryptogamie Bryologie, 28, 79-81.
- Kırmacı M., Erdağ A. 2014. *Acaulon fontiquerianum* (Pottiaceae), A new species to the bryophyte flora of Turkey and SW Asia. Polish Botanical Journal, 59(2), 229-233.
- Kırmacı M., Aslan G. 2014. *Tortula acaulon* var. *marginata* (Herrnst. & Heyn) R.H.Zander. Bryological notes new national and regional bryophyte records, 52. Journal of Bryology, 36(3), 238.
- Kırmacı M., Özçelik H. 2010. Köprülü Kanyon Milli Parkı (Antalya) karayosunu florasına katkılar. Süleyman Demirel Üniversitesi Orman Fakültesi Dergisi, 2, 59-73.
- Klama H. 2006. Red list of the liverworts and hornworts in Poland, Czerwona lista watrobowców i glewików w Polsce. In: Mirek, Z., Zarzycki, K. Wojewoda, & W. Szelag, Z. Red list of plants and fungi in Poland, Czerwona lista roslin i grzybów Polski. Kraków, Polish Academy of Sciences, W. Szafer Institute of Botany.
- Konstantinova N.A., Akatova T.V., Ignatova E.A., Ignatov M.S. 2008. Bryophyta. In: Red Data Book of the Krasnodar Province. (Plants and fungi). 2d ed. Krasnodar, Dizain byuro No. 1, 450-477.
- Konstantinova N.A., Belkina O.A., Likhachev A.Y. 2003. Bryophytes - In: Konstantinova, N.A., Koryakin, A.S. & Makarova, O.A. (eds.). Red Data book of the Murmansk Province. Murmansk, Murmanskoe Knizhnoe Izdatelstvo.
- Konstantinova N.A., Potemkin A.D., Schljakov R.N. 1992. Check-list of the Hepaticae and Anthocerotae of the former USSR. Arctoa, 1, 87-127.
- Kotiranta H., Uotila P., Sulkava S., Peltonen S.-L. (eds.) 1998. Red Data Book of East Fennoscandia. Helsinki, Ministr. Envir., 351 pp.
- Kubinská A., Janovicová K., Soltes R. 2001: Red list of bryophytes of Slovakia (December 2001). In: Baláz, D., et al. (eds.), Cervený zoznam rastlín a živočíchov Slovenska. Ochr. Prír. 20 (Suppl.), 48-81.
- Kučera J., Váňa J. 2003. Check- and Red List of bryophytes of the Czech Republic. Preslia, 75, 193-222.
- Kürschner H. 2008. Biogeography of South-West Asian Bryophytes-with special emphasis on the tropical element. Turk J Bot., 32, 433-446.
- Kürschner H., Erdağ A. 2005. Bryophytes of Turkey: An annotated reference list of the species with synonyms from the recent literature and an annotated list of Turkish bryological literature. Turk J Bot., 29, 95-154.
- Kürschner H., Kırmacı M. 2014. New national and regional bryophyte records 43. 30. *Pohlia sphagnicola* (Bruch & Schimp.) Lindb. & Arnell. Journal of Bryology, 37(2), 138.
- Kürschner H., Lübenau-Nestle R. 2000. *Cinclidotus bistratosus* (Cinclidotaceae, Musci), a new species to the hygrophytic moss flora of Turkey. Nova Hedwigia 70, 471-478.
- Lockhart N., Hodgetts N., Holyoak D. 2012b. Ireland Red List No. 8: Bryophytes. National Parks and Wildlife Service, Department of Arts, Heritage and the Gaeltacht, Dublin, Ireland.

- Lockhart N., Hodgetts N.G., Holyoak D.T. 2012a. Rare and threatened bryophytes of Ireland. Belfast, Ulster Museum. (includes Red List)
- Ludwig G., Düll R., Philippi G., Ahrens M., Caspari S., Koperski M., Lütt S., Schulz F., Schwab G. 1996. Rote Liste der Moose (Anthocerophyta et Bryophyta) Deutschlands. Schriftenreihe für Vegetationskunde 28, 189-306.
- Maksimov A.I., Potemkin A.D., Maksimova T.A. 2007. Bryophytes. In: Ivanter, E.V. & Kuznetsov, O.L. (eds.). Red Data Book of the Republic of Karelia. Ministerstvo sel'skogo, rybnogo khozyajstva i ekologii Respublicii Karelia, Karel'skii nauchnyj tsentr Rossijskoj akademii nauk, Petrozavodskij gosudarstvennyj universitet. Petrozavodsk, "Karelia", 79-98.
- Marka J., Papp B., Erzberger P., Colacino C., Sabovljevic M. 2012. Towards a red list of the Albanian bryophytes. *Studia Bot. Hung.*, 43, 13-25.
- Martinčič A. 1992. Rdeci seznam ogroženih listnatih mahov (Musci) v Sloveniji. *Varstvo Narave*, 18, 1-190.
- Maslovsky O. 2005. Rare and threatened bryophytes and a proposal for an Eastern European Red Book. *Bol. Soc. Esp. Briol.*, 26-27, 47-54.
- Masetti M. 2008. Protected areas and endemic species. In: Francesca Gherardi, Manuela Gualtieri, Claudia Corti (Eds.). *Biodiversity conservation and habitat management*. 1, 118-127.
- Natcheva R., Ganeva A., Spiridonov G. 2006. Red list of the bryophytes in Bulgaria. *Phytologia Balcanica*, 12(1), 55-62.
- Ören M., Sari B., Ursavaş S. 2015. *Syntrichia minor* (Pottiaceae) and *Cephaloziella integerrima* (Cephaloziellaceae) New to bryophyte flora of Turkey. *Arch. Biol. Sci., Belgrade*, 67(2), 367-372.
- Özdemir T., Batan N. 2016a. 18. *Frullania teneriffae* (F.Weber) Nees. New national and regional bryophyte records, 47. *Journal of Bryology*, 7.
- Özdemir T., Batan N. 2016b. 24. *Leucodon pendulus* Lindb. New national and regional bryophyte records, 47. *Journal of Bryology*, 9.
- Özenoğlu Kiremit H., Keçeli T. 2009. An Annotated Check-list of the Hepaticae and Anthocerotae of Turkey. *Cryptogamie Bryologie*, 30, 343-356.
- Özenoğlu Kiremit H., Kırmacı M., Kiremit F. 2016. New findings of *Riccia* species (Marchantiophyta) in Turkey and Southwest Asia. *Cryptogamie Bryologie*, 37 (1), 19-25.
- Popova N.N. 2001. Bryophyta . In: Red Data Book of Kursk Province. Vol. 2. Rare and endangered plants and fungi. Tula, Centralno-Czernozemnyj Gos. Prir. Biospher. Zapovednik & al., 21-45.
- Popova N.N., Abramova L.I. 2005. Bryophytes. In: Novikov, V.S. (ed.). Red Data Book of Lipetsk Province. Vol. 1. Plants, Fungi, Lichens. Moscow, KMK: 15-70.
- Radzhi A.D. 1998. Bryophytes. In: Red book of Dagestan. Rare and endangered species of animal and plants. Makhachkala, Dagestanskoe Knizhnoe Izd., 191-194.
- Rassi P., Alanen A., Kanerva T., Mannerkoski I. (eds.) 2001. The Red List of Finnish Species. Helsinki, Ministry of the Environment & Finnish Environment Institute, 432 pp.
- Ros RM., Mazimpaka V., Abou-Salama U., Aleffi U., Blockeel TL., Bruges M., Cros RM., Dia MG., Dirkse G., Draper I., El-Saadawi W., Erdag A., Ganeva A., Gabriel RMA., Gonzales-Mancebo JM., Granger, C., Herrstadt I., Hugonnot V., Khalil K., Kürschner H., Losada-Lima A., Luis L., Mifsud SD., Privitera M., Puglisi M., Sabovljevic M., Sergio C., Shabbara HM., Sim-Sim M., Sotiaux A., Tacchi R., Vanderpoorten A., Werner O. 2013. Mosses of the Mediterranean, an annotated checklist. *Cryptogamie Bryologie*, 34, 99-283.
- Sabovljevic M., Cvetic T., Stevanovic V. 2004. Bryophyte red list of Serbia and Montenegro. *Biodiversity and Conservation*, 13, 1781-1790.
- Schiffner V. 1909. Hepaticae.-In: Handel-Mazzetti, H.V.: Ergebnisse einer botanischen Reise in das Pontische Randgebirge im Sandschak Trapezunt. *Annalen des Naturhistorischen Museums in Wien* 23, 133-141 (mit 2 Tafeln).
- Schnyder N., Bergamini A., Hofman H., Müller N., Schubiger-Bossard C., Urmi E. 2004. Rote Liste der gefährdeten Moose der Schweiz. Bern, Hrsg. BUWAL, FUB & NISM. BUWAL-reihe: Vollzug umwelt, 99 pp.
- Schofield W.B. 2001. Introduction to Bryology. The Blackburn Press, New Jersey.
- Schofield W.B. 2004. Endemic genera of bryophytes of North America (north of Mexico). *Preslia*, 76, 255-277.
- Schuster R.M. 1969. The Hepaticae and Anthocerotae of North America. Vol. 2. New York & London, Columbia University Press, 1062 pp.
- Sérgio C., Brugués M., Cros R.M. Casas C., Garcia C. 2006. The 2006 Red List and an updated checklist of bryophytes of the Iberian Peninsula (Portugal, Spain and Andorra). *Lindbergia*, 31, 109-125.

- Sérgio C., Casas C., Brugués M., Cros R.M. 1994. Lista Vermelha dos Briófitos da Península Ibérica [Red List of Bryophytes of the Iberian Peninsula] Lisboa: ICN, 45 pp.
- Shkhgapsoev S.H. 2000. Bryophytes. In: Red book of Kabardino-Balkar Republic. Nalchik, Ael'-Fa], 298.
- Siebel H.N., Bijlsma R.J., Sparrius L.B. 2013. Basisrapport voor de Rode Lijst Mossen 2012. Buxbaumia, 96, 1-75.
- Sim-Sim M., Luis L., Garcia C., Fontinha S., Lobo C., Martins S., Stech M. 2008. New data on the status of threatened bryophytes of Madeira Island. Journal of Bryology, 30, 226-228.
- Skudnik M., Sabovljevic A., Batic F., Sabovljevic M. 2013. Notes on some rare and interesting bryophytes of Slovenia. Botanica Serbica, 37(2), 141-146.
- Söderström L., Hagborg A., von Konrat M, Bartholomew-Began S., Bell D., Briscoe L., Brown E., Cargill DC., Costa DP., Crandall-Stotler BJ. et al. 2016. World checklist of hornworts and liverworts. Phytokeys, 59,1-828.
- Ștefănuț S., Goia I. 2012. Checklist and Red List of Bryophytes of Romania. Biodiversity & Conservation. Nova Hedwigia, 95 (1-2), 59-104.
- Syrjänen K., Anttila S., Ulvinen T., Laaka-Lindberg S., Huttunen S., Laitinen T., Ahonen I., Fagerstén R., He X., Juslén A., Korvenpää T., Parnela A., Sallantausta T., Vainio O., Virtanen R., Piippo S., Rikkinen J. 2010. Bryophytes, 208-230. In: Rassi, P., Hyvärinen, E., Juslén, A. & Mannerkoski I. (eds.) 2010. The 2010 Red List of Finnish Species, 685 p. Ministry of the Environment and Finnish Environment Institute.
- Tonguc Yayintas O. 2014. Contributions to the moss flora of western Turkey: Biga peninsula (Canakkale) and Thrace region of Turkey. Global Journal of Science Frontier Research: C Biological Science, 14 (3), 1-23.
- URL1, 2008.
www.zbi.ee/punane/liigid/samblad_e.html.
- URL2, 2014.
<http://biodiv.lvgma.gov.lv/cooperation/fo1288846/fo1707680>.
- URL3, 2016.
<http://www.tropicos.org/Name/35208682>.
- URL4, 2016.
<http://www.tropicos.org/Name/100400917>.
- URL5, 2016.
<http://www.tropicos.org/Name/100357146>.
- Ursavaş S., Çetin B. 2014. *Cinclidotus asumaniae* Ursavaş & Çetin (Bryopsida, Pottiaceae), sp. nov., a new species to the hygrophytic moss flora of Southern Turkey. Nova Hedwigia, 98, 467-472.
- Váňa J. 1970 *Jungermannia caucasica* sp. n. (Hepaticae). Preslia, 42, 96-97.
- Váňa J. 1975. Studien über die Jungermannioideae (Hepaticae) 7. Jungermannia Subg. Plectocolea: Europäische und nordamerikanische Arten. Folia Geobotanica & Phytotaxonomica, 10(1), 67-99.
- Váňa J., Hentschel J., Heinrichs J. 2010. New combinations in Jungermanniales: transfer of 32 taxa to Solenostoma Mitt. Cryptogamie Bryologie, 31(2), 135-139.
- Váňa J. 1974. Studien über die Jungermannioideae (Hepaticae). 6. Jungermannia subg. Solenostoma: Europäische und nordamerikanische arten. Folia Geobot. Phytotax., 9, 369-423.
- Volosnova L.P. et al. 2003. Bryophyta. In: Red book of Ryazan Province. Ryazan, Uzoroch'e, 27-36.
- Werner J. 2009. Check-list et liste rouge des bryophytes du Luxembourg. [Checklist and Red List of the bryophytes of Luxembourg]. Webpage:
<http://sci.mnhn.lu/colsci/weje/pdf/HP%20JW%20CHECK%20LIS%20ROU%202009.pdf>.
- Zykov I.V., Notov A.A., Spirina U.N. 2002. Bryophyta. – Divisio Bryophytes. In: Red Data Book of the Tver' Province. Tver', Veche Tveri & ANTEK, 10-35.

The Responses of Water Potential, Total Carbohydrate Content and Photosynthetic Pigments of Kermes Oak (*Quercus coccifera* L.) to Summer Drought

*Esra BAYAR¹, Ayşe DELİGÖZ¹

¹Suleyman Demirel University, Faculty of Forestry, Isparta/ TURKEY

*Corresponding Author: esrabayar@sdu.edu.tr

Abstract

Considering the effects of global warming on forests, drought is an important factor in growing forests. This study was conducted to determine the variations of the midday water potential, total carbohydrate content and photosynthetic pigments of Kermes oak (*Quercus coccifera* L.) individuals in natural conditions during the summer drought. Kermes oak samples were collected monthly between June and September from Söbü Mountain in Isparta. Significant differences in midday water potentials were determined in respect to months which measurements done. It varied from -2.08 to -3.64 MPa between June to September. The lowest midday water potential values were detected in August. It was similar in June and September. According to the results, measurement periods had influences on chlorophyll a, total chlorophyll and carotenoid content but had not an influence on chlorophyll b and total carbohydrate on.

Keywords: Kermes oak, Summer drought, Water potential, Photosynthetic pigments, Total carbohydrate

Kermes Meşesi'nde (*Quercus coccifera* L.) Su Potansiyeli, Toplam Karbonhidrat ve Pigment İçeriğinin Yaz Kuraklığına Cevabı

Özet

Küresel ısınmanın ormanlar üzerinde etkisi göz önüne alındığında, kuraklık orman yetiştirilmede önemli bir faktördür. Bu çalışma doğal koşullar altındaki kermes meşesi (*Quercus coccifera* L.) bireylerinde yaz döneminde oluşabilecek kuraklığa karşı gün ortası su potansiyeli, toplam karbonhidrat içeriği ve pigment içeriğindeki değişimlerin belirlenmesi amacıyla yapılmıştır. Çalışma, Isparta ili sınırları içindeki Söbü dağı makilik sahada haziran- eylül ayları arasında aylık periyotlarda gerçekleştirilmiştir. Gün ortası su potansiyelinde ölçüm dönemleri arasında istatistiksel anlamda önemli bir farklılık belirlenmiştir. Haziran ayından eylül ayına kadar gün ortası su potansiyeli değerleri -2.08 ile -3.64 MPa arasında değişmiş olup, en düşük gün ortası su potansiyeli ağustos ayında tespit edilmiştir. Haziran ve eylül aylarında belirlenen gün ortası su potansiyeli benzerdir. Ölçüm dönemleri klorofil a, toplam klorofil ve karotenoid miktarı üzerinde önemli olmasına karşın, klorofil b ve toplam karbonhidrat içeriğinde etkili değildir.

Anahtar Kelimeler: Kermes meşesi, Yaz kuraklığı, Su potansiyeli, Fotosentetik pigment, Toplam karbonhidrat

Introduction

The oaks (*Quercus* sp.) are widely distributed in the Turkey. There are 18 species native to the Turkey (Ozturk, 2013). *Quercus coccifera* L. is one of the most important oak species and typical evergreen scrub plants in the Mediterranean region. The wood is heavy and hard (Ansin and Ozkan, 2006). It plays a very important role for erosion control (Ozturk, 2013). The Mediterranean vegetation is severely affected by the recurrent of a summer dry period (Sala, 1999). Summer dry period means summer drought. And, this is the main

environmental limitation that vegetation has to withstand (Damesin and Rambal, 1995; Mendes et al, 2001). Plants are exposed to various environmental stresses in the field. Plants are affected from drought which is an environmental stress (Yordanov et al., 2000).

Drought stress is represented by decrease of cell enlargement, growth and water content, increased closure of stomata (Jaleel et al., 2009; Kulaç, et al., 2012). Drought stress caused changes in photosynthetic pigments (chlorophyll and carotenoids) and carbohydrate status (Chaves and Oliveira, 2004; Jaleel et al., 2009). Drought

significantly decreased chlorophyll pigment contents in *Populus przewalskii* (Lei et al, 2006). Chaves and Oliveira, (2004) reported that in general, drought can lead either to increased (under moderate stress) or to constant (under intense stress) concentration of soluble sugars in leaves.

The aim of this study was to determine response of midday water potential, total carbohydrate content and photosynthetic pigments (chlorophyll a, chlorophyll b, total chlorophyll and carotenoid) of Kermes oak to summer drought.

Material and Methods

Study area

The study area, maquis shrub lands of Söbü mountain of Isparta, is covered with Kermes oak. 1288m elevated study area is located at coordinates of 37°50'23" N and 30°31'05" E. Its slope is to the south. Individuals of Kermes oak chosen for experiments were approximately 1.65 m in height. Bedrock was neritic limestone and soil texture was clay loam (Karatepe and Lim, 2014). Mean values of daily air temperature (°C) and relative humidity (%) data of Isparta were obtained from Turkish State Meteorological Service (Figure 1). During the study period (2014), minimum temperature is observed 6.8°C in September and maximum temperature is observed 36.9 °C in August. From June to September, mean temperature values were 20°C, 25°C, 25°C and 18°C, respectively. The mean annual precipitation was about 670 mm.

Water potential

The shoots from sun-exposed terminal branches of different individuals were selected monthly to measure midday water potential (Ψ_{md}) from June to September. The shoot samples from six individuals were cut with pruning shears at midday (from 12:00 to 13:00) and wrapped in plastic bag. Ψ_{md} was measured immediately with a Scholander pressure chamber (PMS Instruments, Corvallis, OR) using the pressure chamber

technique described by Scholander et al (1965)

Total soluble sugars and pigments analysis

The fully developed mature leave samples were collected monthly from the terminal branches of individuals at 12:00 to 13:00 h from June to September, wrapped in plastic bags, and transported to the laboratory immediately. Total carbohydrate content (mg g^{-1}) was determined according to phenol sulfuric acid method (Dubois et al. 1956). Leaves were dried in 65°C for 48 hours and then grounded. Three sets of dry samples prepared. 0.1 g dry weight of leaves were incubated with 10 ml ethanol (80%) for 24 hours in unlighted conditions and then were centrifuged 6000 rpm for 10 minutes. The extract was treated with 5 % phenol and sulfuric acid, and remained at room temperature for an hour. The absorbance values were read with a spectrophotometer at 490 nm and by using glucose.

Chlorophyll content was estimated by Arnon (1949) method. Measurements were carried out on three test sets. The 0.1 g of fresh leaves was homogenized using a mortar in 10 ml of 80 % acetone. The extract was centrifuged at 3000 rpm for 10 min. Then absorbance was measured at 450, 645 and 663 nm. The amount of chlorophyll and carotenoid were expressed as mg g^{-1} fresh weight using the following equations:

$$\text{Chlorophyll a} = 12.7(A_{663}) - 2.69(A_{645})$$

$$\text{Chlorophyll b} = 22.9(A_{645}) - 4.68(A_{663})$$

$$\text{Total Chlorophyll} = 20.2(A_{645}) + 8.02(A_{663})$$

$$\text{Carotenoid} = 4.07(A_{450}) - [(0.0435 \times \text{Chlorophyll a}) + (0.367 \times \text{Chlorophyll b})]$$

Data analysis

The effect of summer drought on Ψ_{md} , total carbohydrate content and photosynthetic pigments was analyzed using one-way analysis of variance (ANOVA) using SPSS 20.0 software. Comparison of means was carried out using Duncan's test.

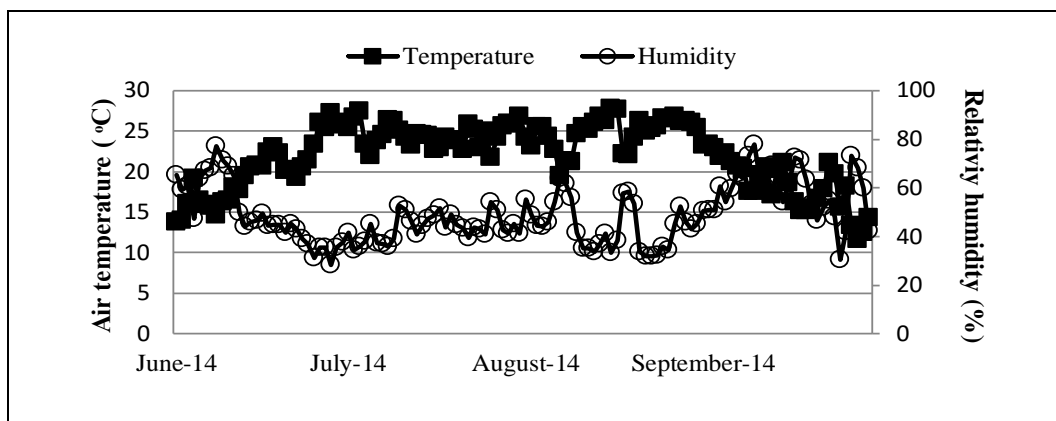

Figure 1. Daily mean air temperature and relative humidity of study area

Results

Results of midday water potential which were measured from June to September are showed in Figure 2. According to results, the summer droughts have significant effects on

Ψ_{md} ($p < 0.05$). Ψ_{md} ranged from -2.1 to -3.6 MPa. Ψ_{md} was significantly decreased in August. The higher midday water potential, -2.1 and -2.2 MPa, was determined in June and September.

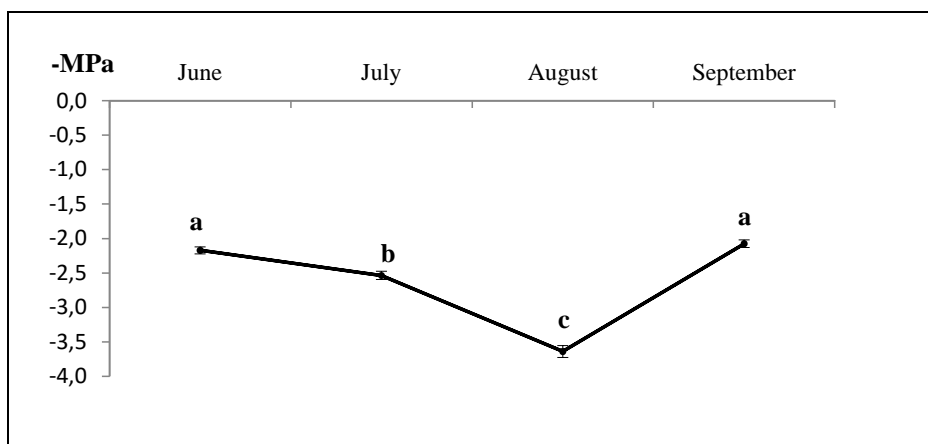

Figure 2. Midday water potential (-MPa) of Kermes oak from June to September in the study.

Total carbohydrate content has the highest values in September, but there was no statistical difference among months. In June, total soluble sugar contents were determined 83 mg/g dry weight, in July it was 105 mg/g, in August and September it was 99 and 118 mg/g dry weight, respectively (Figure 3).

In this study, there were significant changes from June to September in the chlorophyll a, total chlorophyll and carotenoid content. Chlorophyll a has the highest value in July and September, and the lowest value in June and August. The similar results were determined in total chlorophyll. While the highest carotenoid content was

observed in August and September, the lowest value was obtained in June. There were not any significant changes in chlorophyll b. However, Chl b values were generally lower than Chl a with respect to months (Table 1).

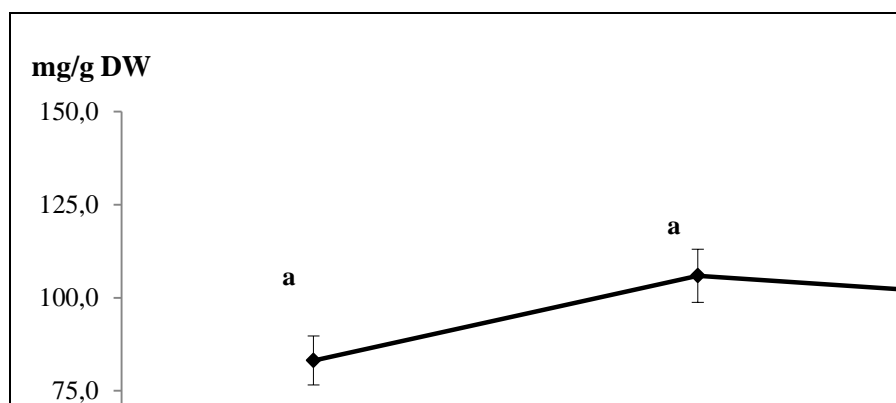

Figure 3. Total carbohydrate content of Kermes oak in the study area

Table 1. Chlorophyll a, Chlorophyll b, Chlorophyll total and Caretonoid contents (mg/g FW, mean value + SE) of study area

Parameters	June	July	August	September
Chlorophyll a (mg/g)	0.34±0.01b	0.40±0.01a	0.34±0.02b	0.41±0.01a
Chlorophyll b (mg/g)	0.14±0.01a	0.15±0.00a	0.14±0.02a	0.14±0.00a
Chlorophyll a+b (mg/g)	0.48±0.01b	0.55±0.00a	0.48±0.02b	0.55±0.00a
Caretonoid (mg/g)	0.18±0.01c	0.21±0.01b	0.22±0.03a	0.22±0.00a

Discussion and Conclusion

Plants can develop various mechanisms according to adverse environmental conditions (Kadioglu and Terzi, 2007). In this study, in the Kermes oak, midday water potential was high in June (spring) and decreased during the summer drought under natural conditions. Field observations showed that Ψ_{md} was below -3.0 MPa in August and it is an indicator of water stress. Similar results have been reported for *Quercus petraea* ssp. *medwediewii*) and *Fagus sylvatica* L. Both species had a high midday water potential in June, which then dropped to extremely negative values (-4.0 MPa) until the end of August (Raftoyannis and Radoglou, 2002). And also Ψ_{md} of *Quercus branthii* L. were determined - 3.26 MPa in August under natural conditions (Kezik and Kocacinar, 2014). *Quercus ilex* and *Q. suber* trees showed a similar seasonal pattern. Ψ_{pd} was high in spring (-0.15 MPa) and declined during the summer drought in both species (Vaz et al., 2010). In addition, drought stress caused Ψ_{pd} to reach values as low as -2.0 MPa in *Quercus petraea* trees under natural conditions (Breda et al., 1993). In this study, after the autumn rains (in September), midday water potential was recovered to pre-

summer drought values. Similarly, it reported that after rehydrating, leaf water status was immediately restored (Gallé et al., 2007).

In natural conditions, total carbohydrate content of Kermes oak was not significantly affected at summer drought. In other study, researchers studied *Q. ilex* and *Q. suber* and compared to summer and autumn, starch and total soluble sugars leaf concentrations were lower in summer than autumn (Vaz et al., 2010). If a tree completes summer period in the low metabolic state, it means that leaf starch and soluble carbohydrate reduces (Drossopoulos and Niavis, 1988). Because the carbohydrates in the leaves occur as a result of photosynthesis and it is related to water stress (Valliyodan and Nguyen, 2006). However, Olive trees had higher values for leaf starch and soluble carbohydrates both spring and autumn (Drossopoulos and Niavis, 1988).

Chlorophyll a, total chlorophyll and carotenoid contents of Kermes oak were significantly affected by measurement periods. Chlorophyll a and total chlorophyll have the highest value in July and September, and the lowest value in June and August. When midday water potential were lower values in August, Ch a and total chlorophyll were lower values, too. High

temperature and light cause to decrease in chlorophyll content (Brett and Singer, 1973). According to observations, Ch a, Ch b and carotenes contents decline under drought stress (Pukacki and Kaminska-Rozek, 2005; Yordanov et al., 2000). In other study, *Q. coccifera* and *Q. ilex* ssp. *ballota*, the photosynthetic pigment composition didn't change in drought period (Peguero-Pina et al., 2009).

In conclusion, in this study, except chlorophyll b and total carbohydrate content, midday water potential, chlorophyll a, total chlorophyll and carotenoid of Kermes oak were affected by summer drought. In the field, reducing midday water potential in August (dry period) is related to water deficit and also, it decreased chlorophyll a, total chlorophyll and total carbohydrate content.

References

- Ansin, R., Ozkan, Z.C., 2006. Tohumlu Bitkiler (Spermatophyta) Odunsu Taksonlar. Karadeniz Teknik Üniversitesi Orman Fakültesi, Fakülte Yayın No:19, Trabzon.
- Arnon, D.I., 1949. Copper Enzymes in Isolated Chloroplasts Polyphenoloxidase in *Beta vulgaris*. *Plant Physiology*, 24,1-15.
- Bréda, N., Cochard, H., Dreyer, E., Granier, A., 1993. Water transfer in a mature oak stand (*Quercus petraea*): seasonal evolution and effects of a severe drought. *Can.J.For.Res.* 23,1136-1143.
- Brett W. J., Singer, A. C. 1973. Chlorophyll Concentration in Leaves of *Juniperus virginiana* L., Measured Over a 2-year Period. *The American Midland Naturalist*, 90(1), 194-200.
- Chaves, M.M., Oliveira, M.M., 2004. Mechanisms underlying plant resilience to water deficits: prospects for water-saving agriculture. *Journal of Experimental Botany*. 55(407), 2365-2384.
- Damesin, C., Rambal, S., 1995. Field study of leaf photosynthetic performance by a Mediterranean deciduous oak tree (*Quercus pubescens*) during a severe summer drought. *New Phytol.* 131, 159-167.
- Drossopoulos, J.B., Niavis, C.A., 1988. Seasonal changes of the metabolites in the leaves, bark and xylem tissues of Olive tree (*Olea europaea* L.) II. Carbohydrates. *Annals of Botany*, 62 (3), 321-327.
- Dubois, M., Gilles, K.A., Hamilton, J.K., Rebers, P.A., Smith, F., 1956. Calorimetric Method for Determination of Sugars and Related Substances. *Analytical Chemistry*, 28,350-356.
- Gallé A., Haldimann, P., Feller, U., 2007. Photosynthetic performance and water relations in young pubescens oak (*Quercus pubescens*) trees during drought stress and recovery. *New Phytologist*. 174, 799-810.
- Jaleel, C.A., Manivannan, P., Wahid, A., Farooq, M., Somasundaram, R., Panneerselvam, R., 2009. Drought stress in plants: a review on morphological characteristics and pigments composition. *Int. J. Agric. Biol.*, 11, 100-105.
- Kadioglu, A., Terzi, R., 2007. A dehydration avoidance mechanism: Leaf rolling. *Bot. Rev.* 73(4), 290-302.
- Karatepe, Y., Lim, A.B., 2014. Biomass equations and aboveground biomass carbon stocks of Kermes oak (*Quercus coccifera* L.) in southwestern Turkey. *Research Journal of Biotechnology*. 9(10), 53-61.
- Kezik, U., Kocaçınar, F., 2014. Kurak ve Yarı-Kurak Bölgelerde Yayılış Gösteren *Quercus branthii* L. Baltalıklarında Seyreltmenin Su Potansiyeli ve Sürgün Drumu Üzerine Etkisi. II. Ulusal Akdeniz Orman ve Çevre Sempozyumu. 22-24 Ekim, 699-713, Isparta.
- Kulaç, Ş., Nzokou, P., Güney, D., Cregg, B.M., Turna, İ., 2012. Growth and Physiological Response of Fraser Fir [*Abies fraseri* (Pursh) Poir.] Seedlings to Water Stress: Seasonal and Diurnal Variations in Photosynthetic Pigments and Carbohydrate Concentration. *Hortscience*, 47 (10), 1512-1519.
- Lei, Y., Yin C., Li C., 2006. Differences in some morphological, physiological, and biochemical responses to drought stress in two contrasting populations of *Populus przewalskii*. *Physiologia Plantarum*, 127 (2), 182-191.
- Mendes, M.M., Gazarini, L.C., Rodrigues, M.L., 2001. Acclimation of *Myrtus communis* to contrasting Mediterranean light environments-effects on structure and chemical composition of foliage and plant water relations. *Environmental and Experimental Botany*. 45, 165-178.
- Öztürk, S., 2013. Türkiye Meşeleri Teşhis ve Tanı Kılavuzu. Orman ve Su İşleri Bakanlığı, Orman Genel Müdürlüğü, Ankara.
- Peguero-Pina, J.J., Sancho-Knapik, D., Morales, F., Flexas, J., Gil-Pelegrín, E., 2009. Differential photosynthetic performance and photoprotection mechanisms of three Mediterranean evergreen oaks under severe drought stress. *Functional Plant Biology*, 36, 453-462.
- Pukacki, P.M., Kaminska-Rozek, E., 2005. Effect of drought stress on chlorophyll a fluorescence and electrical admittance of shoots in Norway spruce seedlings. *Trees*. 19, 539-544.
- Raftoyannis, Y., Radaoğlu, K., 2002. Physiological Responses of Beech and Sessile

Oak in a Natural Mixed Stand During a Dry Summer. *Ann.Bot.* 89(6), 723-730.

Sala, A., 1999. Modelling Canopy Gas Exchange During Summer Drought, (Ed: Ferran Rodà et. al., Ecological Studies) Springer-Verlag, Vol:137, Berlin.

Scholander, P.F., Hammel, H.T., Bradstreet, E.D. ve Hemmingsen, E.A., 1965. Sap Pressure in Vascular Plants. *Science*, 148, 339-346.

Valliyodan, B., Nguyen, H.T., 2006. Understanding regulatory networks and engineering for enhanced drought tolerance in plants. *Current opinion in Plant Biology*. 9, 189-195.

Vaz, M., Pereira, J.S., Gazarini, L.C., David, T.S., Rodrigues, A., Maroco, J., Chaves, M.M., 2010. Drought-induced photosynthetic inhibition and autumn recovery in two Mediterranean oak species (*Quercus ilex* and *Quercus suber*). *Tree Physiology*, 30, 946-956.

Yordanov, I., Velikova, V., Tsonev, T., 2000. Plant responses to drought, acclimation, and stress tolerance. *Photosynthetica*. 38(1), 171-186.

Determination of Some Morphologic Properties of *Medicago arabica* L. (Huds) within Ecology of Bartın Province

Ayşe GENÇ LERMİ¹, *Şahin PALTA²

¹Bartın University, Vocational School, Bartın/TURKEY

²Bartın University, Faculty of Forestry, Bartın/TURKEY

*Corresponding Author: sahinpalta@hotmail.com

Abstract

This study was carried out along 2012 in Kozcağız district within Bartın province. The *Medicago arabica* plant samples were collected from a secondary pasture in Bartın. Plant samples were cut from their root collar during fifty percent of plants in flowering period in April 2012. Some plant properties such as plant height, main stem number, lateral stem number, main stem diameter, lateral stem diameter, flower number in main stem, leaf number in main stems, leaf length, leaflet length, leaflet width, dry matter yield, stem ratio, flower ratio, leaf ratio were investigated. Each plant was separated into their parts such as leaf, stem and flower and was dried at 70 °C along 48 hours. Then, dried plants were weighed by precision scale and their dry matter yield values were calculated. Also relationships each other of these plant characteristics were determined. Belong to Spotted Medic average plant height 54.95 cm, main stem number 2, lateral stem number 4, dry matter yield 0.62 g/plant were obtained in this study. Belong to *Medicago arabica* average plant stems ratio 52.79%, leaf ratio 34.99%, flowers ratio 12.23% were determined in Bartın ecology. According to Pearson correlation analysis, positive and negative relationships were determined among some plant properties of *Medicago arabica* (P<0.01). Consequently, *Medicago arabica* plants present abundancy within ecology of Bartın province. These plants can be used in improvement of degraded rangeland because of their plant characteristics.

Keywords: *Medicago arabica*, Plant properties, Bartın, Dry matter yield, Spotted medic

Bartın Ekolojisinde Arap Yoncasının (*Medicago arabica* L. (huds)'nın Bazı Morfolojik Özelliklerinin Belirlenmesi

Özet

Bu çalışma 2012 yılında Bartın ilinin Kozcağız ilçesinde yürütülmüştür. *Medicago arabica*'ya ait bitki örnekleri sekonder meradan toplanmıştır. Bitki örnekleri 2012 yılının nisan ayında yüzde elli çiçeklenme döneminde iken kök boğazından kesilerek alınmıştır. Araştırmada arap yoncasının bitki boyu, ana dal sayısı, yan dal sayısı, ana dal çapı, yan dal çapı, ana dalda çiçek sayısı, ana dalda yaprak sayısı, yaprak uzunluğu, yaprakçık uzunluğu, yaprakçık eni, kuru madde verimi, sap oranı, çiçek oranı, yaprak oranı gibi bazı bitkisel özellikleri incelenmiştir. Her bir bitki yaprak, sap ve çiçek olarak ayrılarak 70 °C'de 48 saat kurutulmuştur. Daha sonra kurutulan bu bitkilerin kuru madde verimleri hesaplanmıştır. Böylece arap yoncasının morfolojik karakteristikleri arasındaki ilişkiler belirlenmiştir. Bu çalışmada, arap yoncasına ait ortalama bitki boyu 54.95 cm, ana dal sayısı 2 adet, yan dal sayısı 4 adet ve kuru madde verimi 0.62 g/bitki olarak belirlenmiştir. Bartın ekolojisinde *Medicago arabica*'nın ortalama sap oranı % 52.79, yaprak oranı % 34.99 ve çiçek oranı % 12.23 olarak tespit edilmiştir. Korelasyon analizi sonuçlarına göre, *Medicago arabica* bitkisinin bazı morfolojik özellikleri arasında pozitif ve negatif ilişkiler bulunmuştur (P<0.01). *Medicago arabica* bitkisi Bartın ekolojisinde bol miktarda bulunmaktadır. Arap yoncasının morfolojik özellikleri dikkate alındığında, bozulmuş meraların ıslahında kullanılabileceği sonucuna varılmıştır.

Anahtar Kelimeler: *Medicago arabica*, Bitki özellikleri, Bartın, Kuru madde verimi, Arap yoncası

Introduction

Medicago arabica (L.) Huds. belong to Fabaceae (Leguminosae) family. Spotted medic has a wide distribution area such as Africa, Asia, Australia, Europe, Middle East, South America and North America. The *Medicago arabica* (The Spotted medic) is

annual, herb and not climbing plant. *Medicago arabica* is used environmental object and forage plant (Bisby et al., 1994). The name of *arabica* derived from Greek or Arabian. But, spotted medic does not present in Arabia. The Spotted medic prevails from 0 to 1300 m asl., generally in grassy moist

areas. Spotted medic is found in edges of woods, shrubs, meadows, and cleared or disturbed areas. The spotted medic flowers in the spring and finishes its life cycle by generating fruit in early or mid-summer. The Spotted medic generally grow on sandy soils or least soils with some sand. Spotted medic is present subtropical to temperate climates. The Spotted medic is cultivated as forage plant however probably contributes to forage used by livestock grazing on uncultivated areas, where it generally presents as a weed (Small 2011). Saponins from the aerial parts of spotted medic demonstrated pretty high fungicidal activity against some plant pathogenic fungi and it could become a source of natural fungicides (Saniewska et al. 2005).

Crawford (1970) reported that annual medics were used to improve both soil properties and pasture productivity, also, the medics have high adaptability than other annual legumes. Clarke and Russel (1977) informed that annual medics can fix nitrogen about 12 kg da⁻¹ per year.

Fedorenko et al. (1995) emphasized that annual medics could germinate late autumn so it can be used forage in winter, also, it could be used forage in summer by growing in spring. Altınok (1993) reported annual medics can be utilized to improve soil properties and to assist feed requirements and they are used to narrow the fallow land as alternative legumes.

Genç Lermi and Palta (2014) stated that the medics are very important for range improvement because their vegetation period is short, and their stem types are lying flat and sub-lying flat, their seeds are hard shell and they can easily adapt. The researchers reported the studies about annual medics is inadequate in our country.

Crawford (1985) stated that *Medicago lupulina* L., *Medicago arabica* L., *Medicago orbicularis* L. and *Medicago polymorpha* L. have the most economic value among medics. Aydın et al. (2010) studied on annual medics in Middle Black Sea region and determined some plant properties of *Medicago arabica* such as plant height 25-81.67 cm, leaf width 1.38-2.82 cm, leaf length 1.34-3.28 cm, crude protein ratio % 15.47-29.0, acid detergent fiber (ADF) ratio

%22.60-32.93, neutral detergent fiber (NDF) ratio % 30.54-46.39. Eraç and Özkaynak (1999) determined some plant characteristics of spotted medic such as plant height 20-60 cm, leaflet length 10-25 mm, leaflet width 10-25 mm, the number of flowers in bunches 1-6. The same researchers reported that *Medicago arabica* is widespread at woody and moist areas and also is used for grazing and green manure.

Genç Lermi and Palta (2014), investigated some plant characteristics and relationship with these characters of *Medicago polymorpha* that average plant height 57.01 cm, main stem number 4, lateral stem number 4, dry matter yield 0.90 g / plant were obtained. Within Bartın ecology *Medicago polymorpha* plant stems the ratio 50.44%, the leaf ratio 31.85%, flowers ratio 17.74% were determined. Besides, they determined that there was positive relationships among some plant characteristics such as the main stem diameter and leaflet length, between flower on main stem and leaf on main stem, leaflet length between leaflet width and dry matter yield between main stem number ($P < 0.01$).

Aydın et al. (2010) stated that rangeland areas have enormous potential in terms of annual medics and other plant species in Middle Black Sea region. The researchers reported plant properties of these plants should be investigated in terms of range rehabilitation and as forage plants. Akgün et al. (1998) reported that sustainable crop production was possible by protecting indigenous plant species in natural flora.

The objective of this research is to determine some plant characteristics of *Medicago arabica* (L.) Huds. which is abundantly present in woody and rangeland areas in Bartın province. Moreover, the relationships among some plant properties of spotted medic was investigated by using Pearson correlation analysis. In this study, using the potential of medics were presented by determining the plant properties of native medics in region ecology.

Material and Method

This study was carried out along 2012 in Kozcağız district within Bartın province. *Medicago arabica* plant samples were

collected from secondary pasture in Bartın. According to Thornthwaite method, climate of the research field was humid, mesothermal (Erinç, 1984; Çepel, 1995; Özyuvacı, 1999). The acquired Climatological data (1995-2005) demonstrated that the annual average temperature is 12.6 °C. The average temperatures of the hottest months were July (21.9 °C) and August (21.5 °C). The annual average rainfall in the district was 1029.9 mm (Bolat, 2007).

50 plant samples were cut from their root collar during fifty percent of plants in flowering period in April 2012. Some plant properties such as plant height, main stem number, lateral stem number, main stem diameter, lateral stem diameter, flower number in main stem, leave number in main stems, leaf length, leaflet length, leaflet width, dry matter yield, stem ratio, flower ratio and leaf ratio were investigated. Each plant was separated into their parts such as leaf, stem and flower and was dried at 70 °C for 48 hours. Then, dried plants were weighed by precision scale and their dry matter yield values were calculated. Also relationships among these plant characteristics were determined. Pearson correlation analysis was used to determine the relationships among plant properties by

using the Statistical Package for the Social Sciences, version 16.0 (SPSS 16.0, 2007).

Results and Discussion

In this study Some plant properties of *Medicago arabica* such as plant height, main stem number, lateral stem number, main stem diameter, lateral stem diameter, flower number in main stem, leave number in main stems, leaf length, leaflet length, leaflet width, dry matter yield, stem ratio, flower ratio and leaf ratio were investigated. Also relationships among these plant characteristics were determined.

Based on Spotted Medic average dry matter yield 0.62 g/plant, plant height 54.95 cm, main stem number 2, lateral stem number for 4, main stem diameter 1.30 mm, flower number in main stem 15.37 and leaf length 15,14 mm were obtained in this study. Based on *Medicago arabica* average plant stem ratio 52.79%, leaf ratio 34.99%, flowers ratio 12.23% were determined within Bartın ecology (Table 1). Aydın et al. (2010) reported that plant height between 25-81.67 cm of *Medicago arabica*. The values obtained from present study were similar with the values as reported by those researchers.

Table1. Some plant characteristics of *Medicago arabica*

	Dry Matter Yield (g/plant)	Stem Ratio (%)	Flower Ratio (%)	Leaf Ratio (%)	Plant Height (cm)	Main Stem	Lateral Stem Number	Main Stem Diameter (mm)	Lateral Stem Diameter (mm)	Flower number in Main Stem	Leave number in main stem	Leaf Length (mm)	Leaflet Length (mm)	Leaflet Width (mm)
Min.	0,14	30,88	1,45	14,29	28,03	1	0	0,7	0,0	2,00	3,67	26,74	8,92	8,16
Max.	1,18	78,57	28,81	51,61	89,05	7	11	2,0	0,9	28,33	32,75	70,69	19,67	15,92
Avr.	0,62	52,79	12,23	34,99	54,95	2	4	1,3	0,4	15,37	12,81	46,11	15,14	13,30

According to Pearson correlation analysis, positive relationships were determined between the plant height and main stem

number ($r=0.519$) and lateral stem number ($r=0.468$) (Figure 1).

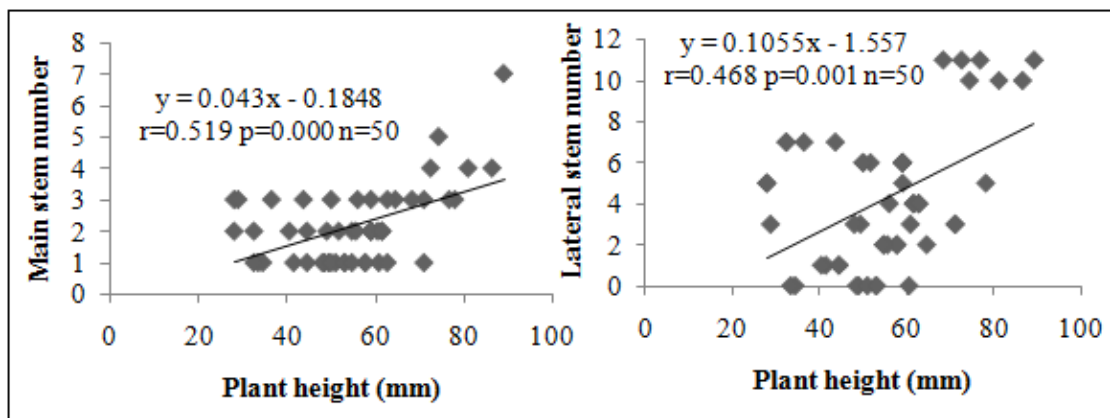

Figure 1. The relationship between plant height and main stem number and lateral stem number.

Positive relationships were determined between the lateral stem number and lateral stem diameter ($r=0.520$) and leaf number in main stem ($r=0.722$) (Figure 2). It was observed that the plant height increased main

stem number and lateral stem number increased also. When the vegetative growing is optimum, plant height and stem number increase.

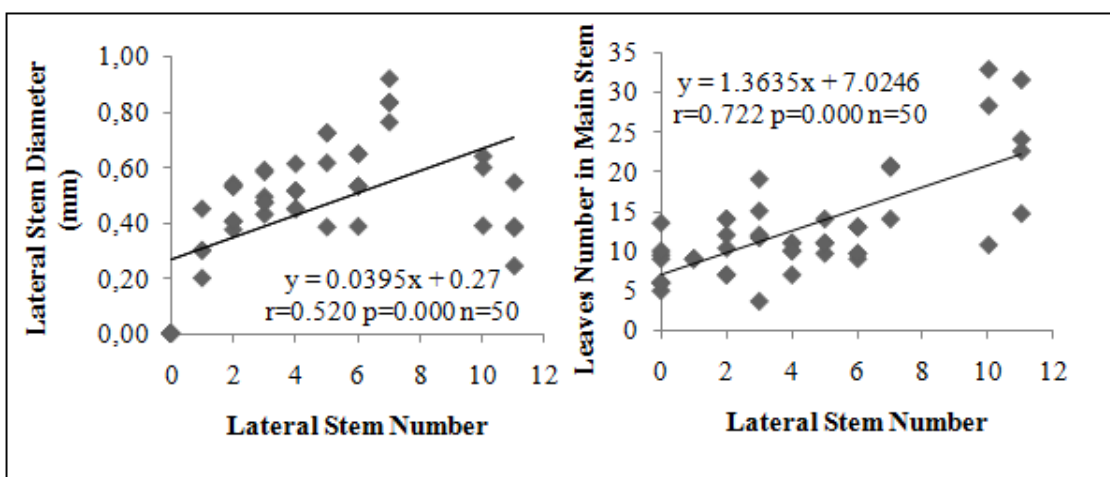

Figure 2. The relationship between lateral stem number and lateral stem diameter and leaves number in main stem.

Positive relationships were determined between the main stem diameter and leaflet length ($r=0.547$) and flower number in main stem ($r=0.524$) (Figure 3). Main stem diameter increased leaflet length and flower number in main stem increased also. This indicated that the plant vegetative organs

grew well. Vegetative growing influenced directly generative growing. These results obtained from present study were similar with the values reported by Genç Lermi and Palta (2014).

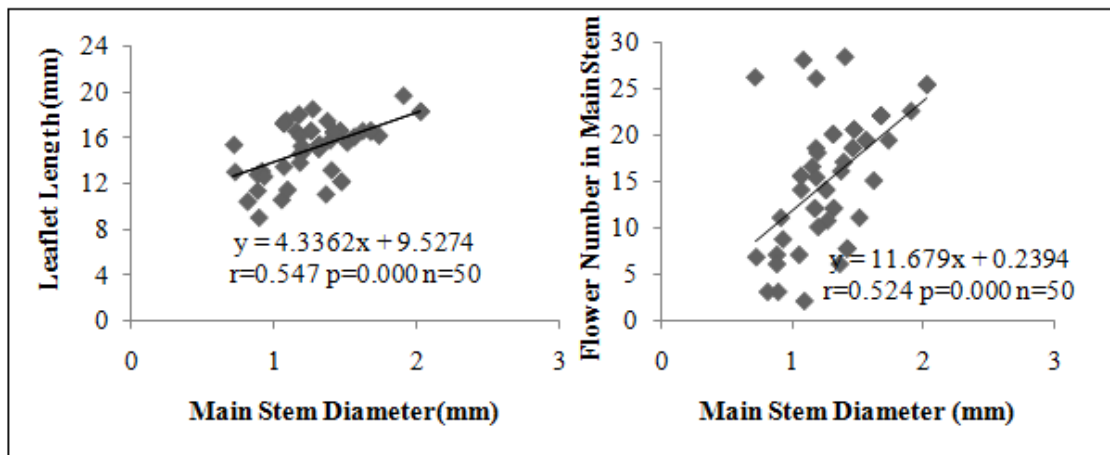

Figure 3. The relationships between main stem diameter and leaflet length and flower number in main stem.

Positive relationships were determined between the flower number in main stem and leave number in main stem ($r=0.579$) and leaflet length ($r=0.510$) (Figure 4). Flower number in main stem increased main stem leaves number and leaflet length too. This

indicates that leaf number and surface increase as obtains much more assimilate. Much photosynthesis product increase the number of flowers and fruit of the plant.

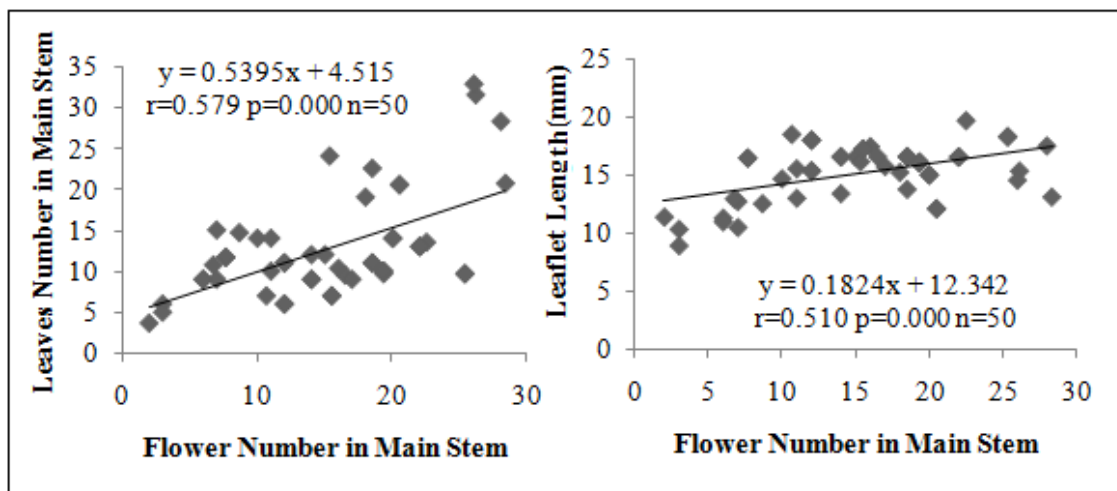

Figure 4. The relationships between flower number in main stem and leave number in main stem and leaflet length.

Positive relationships were determined between dry matter yield and main stem number ($r=0.640$) and lateral stem

($r=0.796$) (Figure 5). When dry matter yield increased main stem and lateral stem numbers increased also.

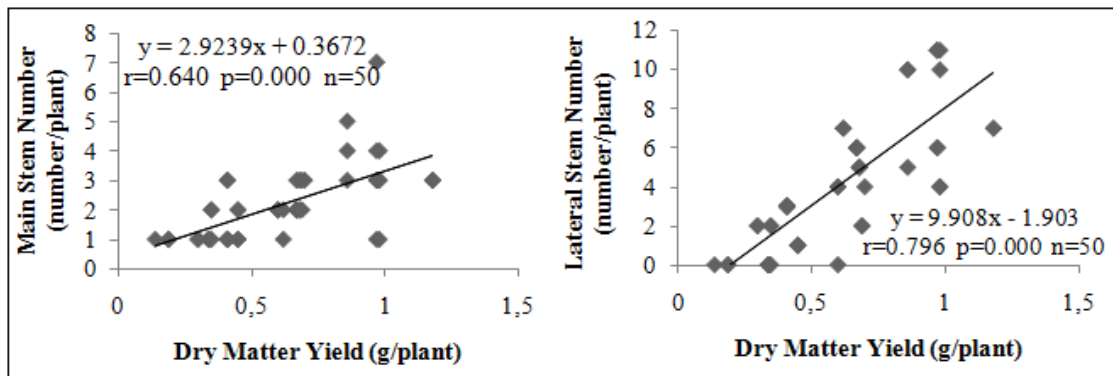

Figure 5. The relationships between dry matter yield and main stem number and lateral stem number.

Negative relationships were determined between stem ratio and leaf ratio ($r=-0.673$) and flower ratio ($r=-0.633$) (Figure 6). When the stem ratio increase, leaf and flower ratio decreased. When the photosynthesis product use for stem, leaf ratio increased. Assimilate

quantity decreased depending on leaf ratio decrease. For this reason, number of flower could have decreased.

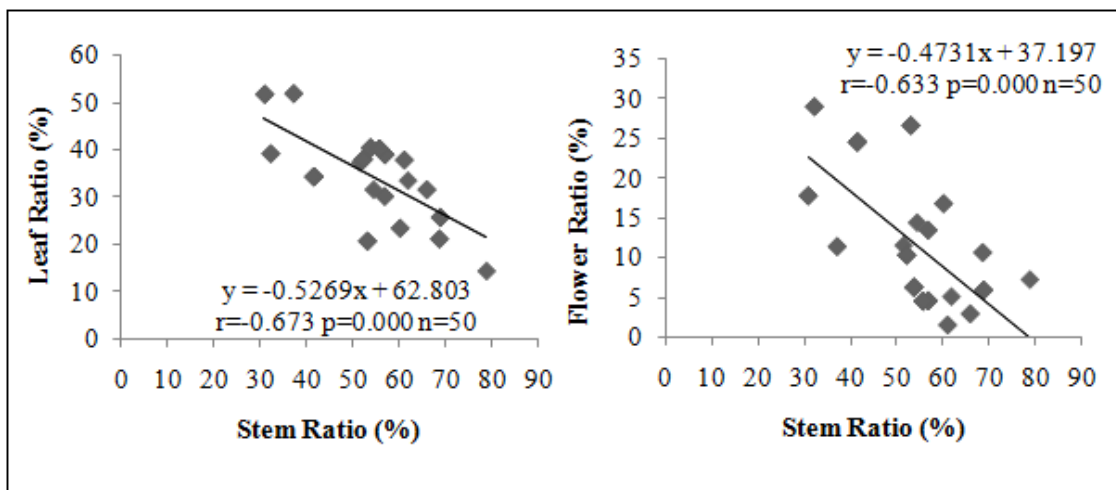

Figure 6. The relationships between stem ratio and leaf ratio and flower ratio.

When the leaf ratio increase, lateral stem diameter and dry matter yield increase also. Positive relationships were determined between leaf ratio and lateral stem diameter ($r=0.516$) and dry matter yield ($r=0.472$) (Figure 7). Leaf ratio is directly correlated

with dry matter yield. Much leaf in plant means much more assimilant produced. Depending on this situation, the dry matter yield increased.

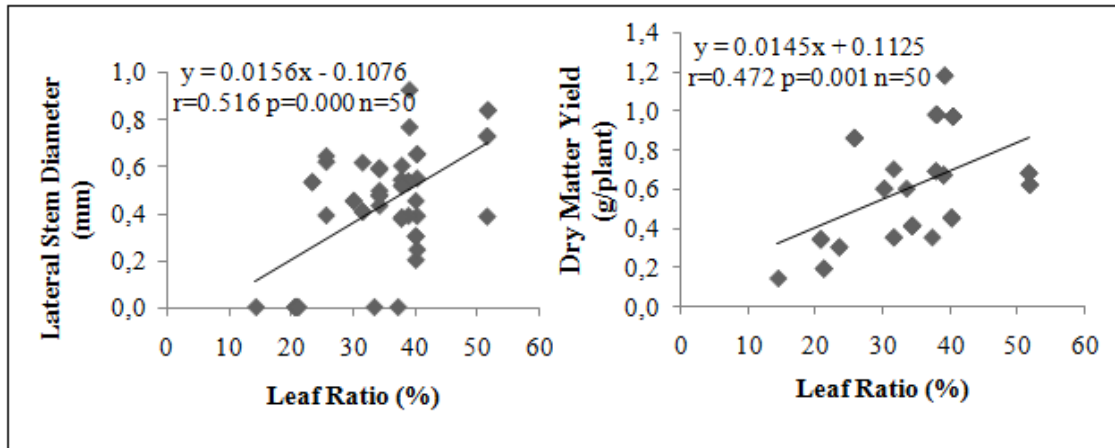

Figure 7. The relationships between leaf ratio and lateral stem diameter and dry matter yield.

Positive relationships were determined between leaf length and leaflet length ($r=0.677$) and leaflet width ($r=0.827$) (Figure 8). Leaf length increased, leaflet length

increased also. *Medicago arabica* has composite sheet so leaflet length and width increased depending on leaf length increase.

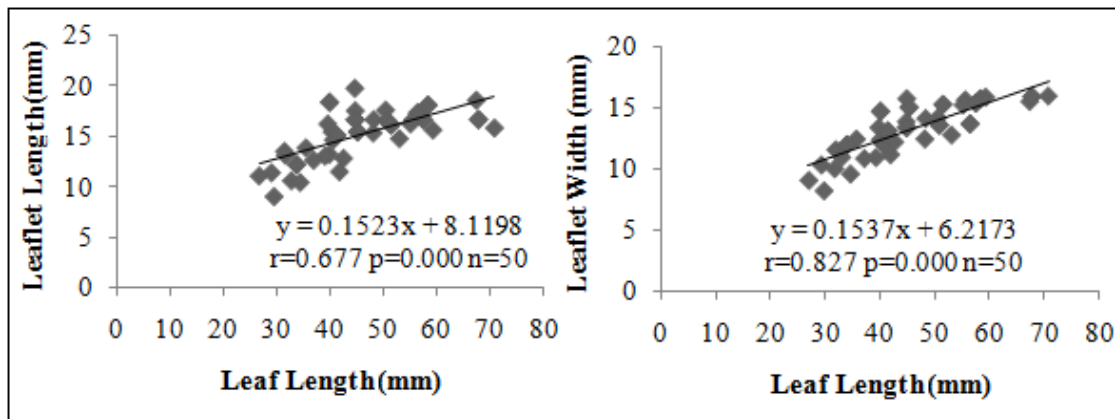

Figure 8. The relationships between leaf length and leaflet length and leaflet width.

Conclusion

In this research, it was determined that some morphological characteristics and these characteristics have correlation among Spotted Medics which constitute much populations within Bartın ecology. This study showed that there was important relationships among some plant characteristics of the *Medicago arabica*. The highest positive relationship was determined between leaflet length and leaflet width ($r = 0.837$). The highest negative relationship was determined between stem ratio and leaf ratio ($r = -0.673$). It was concluded that the plants well adapted to the region's ecology and could contribute to improve the rangelands. Also take attention to this research as a

legume plant *Medicago arabica* contribute ecosystem and can be evaluated as forage plant.

References

- Altınok S. 1993. Bazı tek yıllık yoncalarda fenolojik devrelerde biçmelerin kök gelişmesine ve yem verimine etkileri üzerinde araştırmalar. Ankara Üniversitesi Fen Bilimleri Enstitüsü Tarla Bitkileri Anabilim Dalı Doktora Tezi. Ankara.
- Aydın İ., Kutbay H. G., Seyis F., Uzun F., Sürmen M. 2010. Determination of phenological, morphological and agronomic characteristics of some annual medic species TOVAG Project No: 107 O 087.
- Akgün İ., Tosun M., Sağsöz S. 1998. Bitkisel gen kaynaklarının önemi ve Erzurum'un bitkisel gen kaynakları yönünden değerlendirilmesi. Doğu

Anadolu Tarım Kong. 14-18 Eylül. 363-372, Erzurum.

Bisby F. A., Buckingham J., Harborn J. B. (Editors) 1994. Phytochemical Dictionary of the Leguminosae. Volume 1. Plants and Their Constituents. Page: 449, Compiler: I. W. Southon. Chapman and Hall, London.

Bolat, İ., 2007. Farklı Arazi Kullanım Biçimlerinin Toprağın Mikrobiyal Biyokütle Karbon (Cmic) ve Azot (Nmic) İçeriğine Etkisi. Yüksek Lisans Tezi, ZKÜ FBE, Orman Mühendisliği ABD, Bartın, 104 s.

Çepel N. 1995. *Orman Ekolojisi*. İÜ Toprak İlimi ve Ekoloji Anabilim Dalı, Üniversite Yayın No. 3886, Sosyal B.M.Y.O. Yayın No. 433, İstanbul, 536 s.

Eraç A., Özkaynak İ. 1999. Yonca (*Medicago* L.) Türlerini Tanıma Kılavuzu. Ankara Üniversitesi Ziraat Fakültesi Yardımcı Ders Kitabı:460, Yayın No:1506. Ankara.

Eriş S. 1984. Klimatoloji ve Metodları. İÜ Yayın No. 3278, *Deniz Bilimleri ve Coğrafya Enstitüsü*, Yayın No. 2, İstanbul.

Clarke A. L., Russel J. S. 1977. Crop sequential pratices. In soil factors in crop production in a semiarid environment. Univ. of Queensland press. 279-300.

Crawford E. J. 1970. Variability in a large Mediterranean collection of introduced lines of *Medicago truncatula* Gaertn. Proc. 11 the int. Grassld. Surfers Paradise 188-92.

Crawford E. J. 1985. Flowering response and centres of origin of annual *Medicago* species. p. 7-11. In Z. Hochman (ed.) The ecology and agronomy of annual medics. Tech.Bull. 32. New South Wales. Dep. Of Agric.. Sdney.

Fedorenko D. E., Fernandez O. A., Busso L. A. 1995. The effect of water stress on top and roth in *Medicago minima*. J. Arid Environ. 29:47-54.

Genç Lermi A. and Palta Ş. 2014. Investigation of Some Plant Characteristics of *Medicago polymorpha* L. in Ecology of Bartın Province. COMU J. Agric. Fac. Vol 2 (2):141-149.

Özyuvacı N. 1999. *Meteoroloji ve Klimatoloji*, İÜ Yayın No. 4196, Orman Fakültesi Yayın No. 460, İstanbul, 369s

Saniewska A., Jarecka A., Bialy Z., Jurzysta M., 2005. Antifungal activity of saponins from *Medicago arabica* L. shoots against some pathogens. Allelopathy Journal, 16: 105-112.

Small E. 2011. Alfalfa and relatives evolution and classification. ISBN: 978-0-660-19979-5. National Research Council of Canada.

SPSS Inc., 2007. SPSS for Windows, Version 16.0. Chicago, SPSS Inc.

Some Wild Plant Species Used in Cooking by Local People: Akçaabat Sample

*Sefa AKBULUT¹, Mustafa KARAKÖSE², Zafer Cemal ÖZKAN¹

¹Karadeniz Technical University, Faculty of Forestry, Trabzon/TURKEY

²Giresun University, Espiye Vocational School, Giresun/TURKEY

*Corresponding Author: sakbulut@ktu.edu.tr

Abstract

This study was conducted to determine the plant species which are naturally grown in Akçaabat/Trabzon district, can't be made agriculture and used in cooking by local people. Semi-experimental research design was used in this study. The sample consisted of housewives residing in the district and some villages of Akçaabat. During the study, the plants that housewives used to are collected from the land, identified and interviews are carried out about their usage areas. At the end of the study the plant species that housewives identified and used in cooking are determined as; *Urtica dioica* L., *Trachystemon orientalis* (L.) G.Don, *Rumex acetosella* L., *Malva sylvestris* L., *Taraxacum* F.H.Wigg., *Plantago major* L., *Primula acaulis* (L.) L., *Arum italicum* Mill., *Chenopodium album* L., *Amaranthus chlorostachys* Willd., *Laurocerasus officinalis* M.Roem., *Oenanthe pimpinellioides* L. and ethnobotanical features of some plants were also conveyed.

Keywords: Edible plants, Cooking, Ethnobotanic, Akçaabat

Akçaabat Yöresinde Yemek Yapımında Kullanılan Bazı Doğal Bitkiler

Özet

Bu çalışmada Trabzon ilinin Akçaabat ilçesinde doğal olarak yetişen, kültüre edilmeyen ve yöre halkı tarafından yemek yapımında kullanılan 12 bitki türüne ait bilgiler derlenmiştir. Bu amaçla Akçaabat ilçe merkezinde ve köylerinde bulunan ev hanımlarıyla yüz yüze yöntemle anket düzenlenmiştir. Yöre halkı tarafından gösterilen bitkiler araziden toplanmış ve teşhis edilmiştir. Bitkilerin kullanım alanları kayıt altına alınmıştır. Ayrıca bazı bitkilerin etnobotanik özellikleri de aktarılmıştır. Teşhis edilen ve yemek yapımında kullanılan türler şunlardır: *Urtica dioica* L., *Trachystemon orientalis* (L.) G.Don, *Rumex acetosella* L., *Malva sylvestris* L., *Taraxacum* F.H.Wigg., *Plantago major* L., *Primula acaulis* (L.) L., *Arum italicum* Mill., *Chenopodium album* L., *Amaranthus chlorostachys* Willd., *Laurocerasus officinalis* M.Roem., *Oenanthe pimpinellioides* L..

Anahtar Kelimeler: Doğal bitkiler, Yemek, Etnobotanik, Akçaabat

Introduction

Geographical Conditions and Topography of the Study Area

Akçaabat district located 13 km west of the Trabzon city, is a center with an area of 385 km². Çarşıbaşı and Vakfikebir are located in the western border, Maçka and Düzköy are located in south of the district. North of the district is adjacent to the Black Sea. In past years area was the centre of some agricultural crops such as tobacco, corn, potatoes and beans. Today, the name is announced more by butter, Akçaabat meatballs and Horon. The oldest known name of the town is "Platane" from the Greek and means "Sycamore Tree". The total population of the district is 116,744 (URL-1, 2016).

Akçaabat is located on the northern side of lower zone of the Zigana Mountains overlooking the Black Sea (Figure 1). Although the research area is affected by the humid climate of the region, the annual precipitation (724 mm) is lower than the region's. The average temperature is 14 C° in summer. In terms of climate features, it characterizes oceanic climate type which is dry in summer. The floristic composition is rich and dense which changes from the sea level to alpine zone due to the effect of micro-climate. Deciduous forests like *Castanea sativa*, *Fagus orientalis*, *Alnus glutinosa* and coniferous forests like *Picea orientalis*, *Pinus pinea* spread as mix or pure in the area. The area is covered by grey-

brown podzolic soils. Söğütlü and Sera are sources of income of the rural population are agriculture and livestock breeding. Service

the main rivers in the area. The primary industry has been significantly developed in urban area (Kadioğlu, 2003).



Figure 1. Provincial and district map of Akçaabat region

The Importance of Edible Wild Plants

Wild plants has been evaluated for different purposes depending on their life style by humans since ancient times. Anatolian people living in Anatolia, also have benefitted from plants that they found around continuously since the Stone Age. Beneficial and harmful properties of these plants have been learned by experiences of the people using them. The importance of wild plants in diet reduced with the transition into plant and animal farming in Neolithic period, but in famine period public again start to benefit from wild plants (Baytop, 1984).

Today, it is reported that plants consumed as food in the world are approximately derived from 20 species. The wild plant species used as food has been reported to be of 10,000 (Baytop, 1984). These plants consumed for food are still gathered from forests and meadows in stead of culture in agricultural land. The same as the plants in agriculture, wild plants collected from nature

are used as cooked or raw, dried or pickled. Sometimes the whole plant is used, and sometimes tubers of plants, bulbs, leaves, shoots, fruits such as organs can be assessed separately (Akbulut and Özkan, 2014).

Especially in spring where as the vegetables are less, emerging wild plants, have been used particularly in Aegean and Eastern Anatolia Region throughout all over the country (Arslan, 1992). With the acceleration of ecotourism activities, the service and promotion of some of the wild plants in content with natural and local flavors have become important in restaurants and hotels in Black Sea region (Akbulut and Özkan, 2014).

This study aimed to determine some of natural herbs consumed as food and the consumption manner and of these natural herbs, in the district of Akcaabat-Trabzon.

Materials and Methods

This study was conducted to determine the plant species which are naturally grown

in Akçaabat-Trabzon district during from June to September in 2014, can't be made agriculture and used in cooking by local people. Semi-experimental research design was used in this study. The sample consisted of housewives residing in the district and some villages of Akçaabat. During the study, the plants that housewives used to are collected from the land, identified and interviews are carried out about their usage areas. Besides vernacular names of the plants were recorded.

Results and Discussions

This study was conducted to determine 12 plant species which are naturally grown in Trabzon Akçaabat district, can't be made agriculture and used in cooking by housewives. The plant species that housewives identified and used in cooking are determined as; *Urtica dioica*, *Trachystemon orientalis*, *Rumex acetosella*, *Malva sylvestris*, *Taraxacum* sp., *Plantago major*, *Primula acaulis*, *Arum italicum*, *Chenopodium album*, *Amaranthus chlorostachys*, *Laurocerasus officinalis*, *Oenanthe pimpinelloides* and ethnobotanical features of some plants were also conveyed.

Urtica dioica

(URTICACEAE)

Vernacular name: Sirgan, Isirgan

Part used: Leaves, shoots

Preparation and usage: It made meals and soups from the leaves and shoots. Sometimes it consumed food like spinach into joining. Use as infusion is available. While the leaves and stems of fresh boiled in hot water. Consumed by adding garlic or milk. The locals mind it protective against cancer and often use for eating.

Trachystemon orientalis

(BORAGINACEAE)

Vernacular name: Tomara, Hodan, Galdirik

Part used: Leaves, shoots

Preparation and usage: The stems are boiled; adding corn flour and eggs on pan frying is done. Also flowering branches boiled in water, eaten yogurt with garlic. Pickled in vinegar is made from the shoots.

Rumex acetosella

(POLYGONACEAE)

Vernacular name: Lapaza, Küçük Kuzukulağı

Part used: Leaves

Preparation and usage: The leaves are boiled, into the rice is added. Then roasted with onions cooked. Roasted leaves are eaten yogurt with garlic. To be added to bulgur salad leaves to give sour taste.

Malva sylvestris

(MALVACEAE)

Vernacular name: Büyük Ebegümeçi

Part used: Leaves, roots

Preparation and usage: Leaves are boiled and wrapped like stuffed vegetables with olive oil. The meal is made with rice. Brought into mush leaves are used in skin diseases and boils. Also drink tea made from the roots and leaves.

Taraxacum sp.

(ASTERACEAE)

Vernacular name: Karahindiba, Sütlükotu

Part used: Leaves

Preparation and usage: After boiled the leaves are roasted in butter. And then lemon squeezed over eats. It has properties facilitating the flow of bile and constipation-relieving. It is good for diabetes. Latex has melter feature bile stones and bladder salts.

Plantago major

(PLANTAGINACEAE)

Vernacular name: Damarotu, Sinirotu

Part used: Leaves

Preparation and usage: It is cooked with onions roasted leaves. Herb tea obtained by infusion of leaves is used to treat expectorant and diuretic.

Primula acaulis

(PRIMULACEAE)

Vernacular name: Çuha Çiçeği, Zimbonotu

Part used: Leaves, flowers

Preparation and usage: Boiled leaves are used in making stuffed. Herb tea prepared by infusion of 1-2 dessertspoonful dried flower with a glass of hot water is used to treat antitussive, somniferous, tranquillizer, expectorant, diuretic, diaphoretic and rheumatic pain. 2-3 cups are drunk a day of this infusion.

Arum italicum

(ARACEAE)

Vernacular name: Domuz Lahanası, Yılan Ekmeği

Part used: Tubers

Preparation and usage: Boiled tubers are eaten as potato. It is said to be good to eczema. Tubers are crushed and the juice is obtained. 1-2 drops of this juice is used to sniff in the treatment of jaundice.

Chenopodium album
(CHENOPODIACEAE)

Vernacular name: Tel Pancarı, Zaktariza

Part used: Leaves, the aerial parts

Preparation and usage: Pan frying is made with corn flour from the leaves and the aerial parts. The meal is made from leaves a similar spinach. Leaves are dried and made soup in winter.

Amaranthus retroflexus
(AMARANTHACEAE)

Vernacular name: Hoşkıran, Horozibiği, Hoştrak

Part used: Leaves, shoots

Preparation and usage: From the leaves is made a similar meal to black cabbage soup combine with the sugar beans and corn flour.

Laurocerasus officinalis
(ROSACEAE)

Vernacular name: Karayemiş, Taflan

Part used: Fruits

Preparation and usage: Pickles prepared from the fruit. Then pickled fruits are cooked combined with roasted onions. Fresh fruits are consumed by diabetics.

Oenanthe pimpinelloides
(APIACEAE)

Vernacular name: Kazayağı

Part used: Leaves, shoots

Preparation and usage: The leaves and shoots are boiled. Then they are eaten combined with olive oil and lemon as an appetizer. Also pan frying is made boiled leaves and shoots. It is useful in pass intestinal worms.

Conclusions

When recorded species, compared to a similar study conducted in Beşikdüzü region, located in the immediate vicinity, consumption shape of most of the species seem to be similar, but it is understood that species like *Oenanthe pimpinelloides*, *Amaranthus retroflexus*, *Arum italicum*, *Primula acaulis* are not used in this region (Uzun-Yılmaz, 2011). It is understood in many ethnobotanical studies done in Turkey

that similar species are not only used for food also used for medical and aromatic properties (Saraç et al., 2013; Fakir et al., 2009; Akbulut, 2015; Polat et al., 2015).

All uses and purposes differ from place to place, none of them were registered and recorded. The protection of cultural values, enrichment and dissemination such studies should be made with priority standardization products of national and international fields.

References

- Akbulut S., 2015. Differences in the Traditional Use of Wild Plants between Rural and Urban Areas: The Sample of Adana. *Ethno Med*, 9(2): 141-150.
- Akbulut S., Özkan Z.C. 2014. Trabzon Ve Çevresinde Gıda Kaynağı Bazı Doğal Bitkiler. 3rd International Non-wood Forest Products Symposium 8-10 May 2014, Kahramanmaraş-Turkey, pp. 154-163.
- Arslan N., 1992. Doğal ekonomik bitkilerin korunması. *Tarım Köy Dergisi*. 74. 17-19.
- Baytop T., 1984. Türkiye’de bitkiler ile tedavi (geçmişte ve bugün). İstanbul Üniversitesi Eczacılık Fakültesi Yayınları No: 40, İstanbul.
- Kadıoğlu Y., 2003. Akçaabat İlçesinin (Trabzon) Beşeri Ve İktisadi Coğrafya Özellikleri. Atatürk Üniversitesi Sosyal Bilimler Enstitüsü Ortaöğretim Sosyal Alanlar Eğitimi Anabilim Dalı Coğrafya Öğretmenliği Bilim Dalı, Doktora Tezi, 285 s., Erzurum.
- Polat R., Cakilcioglu U., Kaltalioglu K., Ulsan M.D., Türkmen Z. 2015. An ethnobotanical study on medicinal plants in Espiye and its surrounding (Giresun-Turkey). *Journal of Ethnopharmacology*, 163: 1-11.
- Saraç D.U., Özkan Z.C., Akbulut S. 2013. Ethnobotanic features of Rize/Turkey province. *Biodicon*, 6(3), 57-66.
- URL-1, 2016. https://tr.wikipedia.org/wiki/Ak%C3%A7aat#cite_note-3 (Erişim 03.07.2016).
- Uzun-Yılmaz Y., 2011. Beşikdüzü Yöresi’nde Gıda Amaçlı Kullanılan Bitkiler. KTÜ FBE Yüksek Lisans Tezi, 67 s., Trabzon.
- Fakir H., Korkmaz M., Guller B. 2009. Medicinal plant diversity of Western Mediterranean Region in Turkey. *Journal of Applied Biological Sciences*, 3(2), 33-43.

Domestic Edible Landscaping Plants as Non-Wood Forest Products

Derya SARI

Artvin Çoruh University, Faculty of Forestry, Department of Landscape Architecture, Artvin /
TURKEY

deryasari@artvin.edu.tr

Abstract

In recent years, various approaches arise to provide rapprochement of people moving away from nature and sustainable for human-nature relationship. One of them is using plants which make feel us a part of the nature, not only for aesthetic and functional purposes but also using them as edible landscape plants in our living space. Forest habitats provide various natural resources for people. To contribute to the sustainability of these resources; some edible plant species which have both economic and aesthetic value should generalize the use in the urban spaces.

One of the advantages of the geographical location, Turkey has a very rich floristic diversity. To benefit from this diversity in an adequate and sustainable manner, it is necessary to utilize non-wood forestry products as well as other forest products using different methods. Artvin province is an important center in Eastern Black Sea region in terms of floristic diversity, and has an important potential for non-wood forest products. Thus, within the context of the present study, 20 ornamental tree and shrub species with edible fruit characteristics and grow naturally in Artvin province are examined with respect to edible landscaping approach and areas of usage for these species are recommended.

Keywords: Edible landscaping, Edible ornamentals, Edible shrubs, Non-wood forest products, Artvin

Odun Dışı Orman Ürünleri Olarak Yerli Yenilebilir Peyzaj Bitkileri

Özet

Son yıllarda doğadan giderek uzaklaşan insanların tekrar doğa ile yakınlaşması ve sürdürülebilir insan-doğa ilişkisinin sağlanabilmesi için çeşitli arayışlar ortaya çıkmaktadır. Bunlardan biri de doğanın bir parçası olduğumuzu hissetmemizi sağlayan bitkilerin yaşam alanlarımızda sadece estetik ve fonksiyonel amaçlı değil aynı zamanda yenilebilir peyzaj bitkileri olarak da kullanılmaya başlanmasıdır. Orman habitatları insanlar için birçok doğal kaynaklar sunmaktadır. Bu kaynakların sürdürülebilirliğine katkı sağlamak için hem ekonomik hem de estetik değere sahip bazı yenilebilir bitki türlerinin kentlerde de kullanımının yaygınlaştırılması gerekmektedir.

Bulunduğu coğrafi konumunun avantajlarından biri olarak, Türkiye Zengin bir floristik çeşitliliğe sahiptir. Bu çeşitlilikten doğru ve sürdürülebilir şekilde faydalanmak için orman ürünlerinin yanı sıra odun dışı orman ürünlerinden de farklı şekillerde yararlanabilmek gerekmektedir. Doğu Karadeniz bölgesinde floristik çeşitlilik bakımından önemli bir merkez olan Artvin ili, odun dışı orman ürünleri bakımından önemli bir potansiyele sahiptir. Dolayısıyla bu çalışma kapsamında, Artvin de doğal olarak yetişen daha çok yenilebilir meyve özelliğine sahip 20 adet ornamental ağaç ve çalı türü yenilebilir peyzaj yaklaşımı kapsamında incelenmiş ve kullanım alanlarına ilişkin öneriler sunulmuştur.

Anahtar Kelimeler: Yenilebilir peyzaj, Yenilebilir süs bitkileri, Yenilebilir çalılar, Odun dışı orman ürünleri, Artvin

Introduction

Forest habitats provide various natural resources for humankind. These resources provide economic, ecological, functional and even aesthetic benefits for individuals. Although individuals today utilize the nature ex parte, sustainability of forests that has been indispensable for human-nature relationship throughout history by

maintaining a balance of protection and utilization is an important topic.

Forests are predominantly utilized for wood stock material economically. However, with the popularization of multi-dimensional use of forest resources, forest resources other than wood stock were utilized as well. All botanic and zoological products obtained in

the forest and forest spaces including all non-wood products obtained from forest sources are defined as non-wood forestry products (Türker et al., 2002; Yüzbaşıoğlu and Özhatay, 2013). According to a comprehensive study conducted on non-wood forestry products, edible plants, effluxes (resin, mastic), medical aromatic plants, those used in perfumery and cosmetics, tannin and dyeing substances, honey and beeswax, plants that produce fiber and threads and animal feed, bamboo for tool, handicraft and material production, resin fluid production via bugs were considered as non-wood forestry products (Vantomme et al., 2002).

Among these diverse non-wood forestry products, edible plants that were also utilized in different areas such as “edible landscaping” occupied the limelight during recent decades. Today, the term edible landscaping comprises vegetable gardens, but goes beyond this concept to include any constructed landscape (public or private) where edible plants are intentionally used. These landscapes may be composed of all edible plants or just a few; they may combine edible plants with ornamentals (Sima et al., 2010).

In the last three hundred years, gardens around the world have diversified and developed according to climate, location, necessity and availability of plants both ornamental and of produce value (URL 1). Edible landscaping is the use of food-producing plants in the constructed landscape. Edible landscapes combine fruit and nut trees, berry bushes, vegetables, herbs, edible flowers and ornamental plants into aesthetically pleasing designs. These designs can incorporate any garden style and can include any amount of edible species (URL 1).

Use of these plants that make us feel as a part of the nature in urban landscape areas with the edible landscaping approach would contribute to the sustainability of nature – human relationship and familiarization of nature and humankind that was alienated to the nature in addition to providing nutrients.

One of the advantages of Turkey’s geographical location is the floristic diversity. To benefit from this diversity in an

adequate and sustainable manner, it is necessary to utilize non-wood forestry products as well as other forest products using different methods. Artvin province, which is a significant center with floristic diversity in the Eastern Black Sea Region, has abundant non-wood forestry product potential. Thus, within the context of the present study, 20 ornamental tree and shrub species with edible fruit characteristics and grow naturally in Artvin province are examined with respect to edible landscaping approach and areas of usage for these species are recommended.

Material and Methods

Certain woody plant species with edible landscaping plant features and grow naturally in Artvin province in Eastern Black Sea Region in Turkey were the material of the present study.

Artvin province, located in northeastern Turkey and has three different climates (Mediterranean, continental and oceanic), is the host of several biologically diverse habitats with its rich water resources and geomorphological differences (Figure 1).

Artvin, where 8 different vegetation types including pseudo-macquis, forests, aqueous and marshlands, mountain steppes, subalpine, alpine, damp streams and rocky lands are observed, has a rich floristic diversity. According to a study conducted in 2015, 2727 plant taxa were identified in Artvin province (Eminağaoğlu, 2015). Thus, 20 plant taxa from 14 families with the properties of ornamental and edible plants were assessed in the present study.

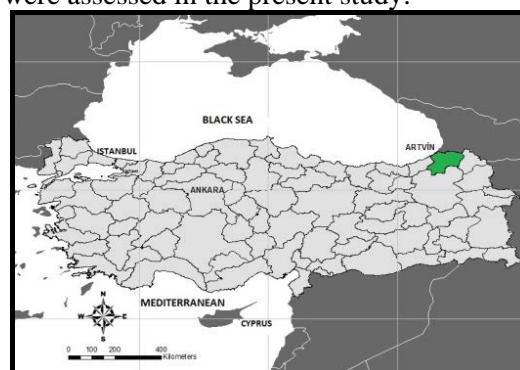

Figure 1. Location of Artvin province in Turkey

Results

There are several edible plant species that grow in Artvin region. Local people utilize these plants as edible leaves and fruits. The focus of the present study is the fact that some of these edible plant species could be used as aesthetical ornamental plants as well. Thus, as a result of the conducted assessment, 20 woody and edible plant species were identified and presented in Table 1 with their properties.

Accordingly 7 taxa were selected from *Rosaceae* genus, while 1 taxon each was selected from *Anacardiaceae*, *Caprifoliaceae*, *Cornaceae*, *Corylaceae*, *Cupressaceae*, *Ebenaceae*, *Elaeagnaceae*, *Ericaceae*, *Grossulariaceae*, *Moraceae*, *Punicaceae*, *Tiliaceae* and *Ulmaceae* families.

Common denominator of these plant taxa is that all are edible fruits with the only exception of *Tilia rubra*. At the same time, these plants have aesthetic flowers, foliage and fruits. All are deciduous species with the exception of *Juniperus communis*, *Laurocerasus officinalis* and *Pyracantha coccinea* species. Especially, the fruits of *Cornus mas*, *Diospyros kaki*, *Vaccinium myrtillus*, *Ribes orientale*, *Punica granatum*, *Mespilus germanica*, *Crataegus orientalis*, *Morus nigra* and *Laurocerasus officinalis* species are quite good for the health and could be consumed raw.

It is possible to utilize certain parts (i.e. flower, seed, fruit, leaf) of edible landscaping plants listed in Table 1 for medical and aromatic purposes (Eminağaoğlu, 2012). Flowers of *Tilia rubra* subsp. *caucasica* could be consumed as tea. It is known that it is possible to use the flowers of *Crataegus orientalis* var. *orientalis* and *Hippophae rhamnoides* subsp. *caucasica* as tea.

Among the species selected, *Rhus coriaria*, *Viburnum opulus*, *Cornus mas*, *Diospyros kaki*, *Punica granatum*, *Sorbus aucuparia*, *Celtis australis*, *Vaccinium myrtillus*, *Sorbus aucuparia*, *Mespilus germanica*, and *Tilia rubra* subsp. *caucasica* display attractive colors in fall.

Species that attract attention with fruit aesthetics were *Rhus coriaria*, *Diospyros kaki*, *Hippophae rhamnoides* subsp. *caucasica*.

Cornus mas, *Punica granatum*, *Viburnum opulus*, *Laurocerasus officinalis*, *Sorbus aucuparia*, *Pyracantha coccinea*, *Crataegus orientalis* var. *orientalis*, *Ribes orientale* attract attention with both their flower and fruit aesthetics.

It is known that the fruits of *Cornus mas*, *Corylus avellana* var. *pontica*, *Diospyros kaki*, *Morus nigra*, *Prunus divaricata*, *Laurocerasus officinalis*, *Mespilus germanica*, *Tilia rubra* subsp. *caucasica* and *Rosa canina* species are commonly used by local people. Fruits of the remaining species listed in the table are not commonly used.

Discussion and Conclusion

Natural plants were utilized since the beginning of human history. In addition to nutrition, which is one of the basic needs of humankind, one of the examples of utilizing plants that provide several benefits for people is the medical-aromatic use of plants.

In recent years, a significant increase in the use of medical and aromatic plants was observed in Turkey. Furthermore, parallel to the consumption of medical and aromatic plants in different fields and industries, their global market share increases every day. Since Turkey is located in a geographic region where three important floristic areas meet, it hosts rich plant diversity (Gül, 2014). Eastern Black Sea Region and Artvin province are rich in that respect as well.

Table 1. List of 20 domestic edible landscaping plant species alphabetically













Species	Properties	Images
<i>Celtis australis</i> L.	Family: <i>Ulmaceae</i> Edible parts: Fruit Aesthetic characteristics: Form, fall foliage	
<i>Cornus mas</i> L.	Family: <i>Cornaceae</i> Edible parts: Fruit Aesthetic characteristics: Blossom, fruit, fall foliage	
<i>Corylus avellana</i> L. var. <i>pontica</i> (C. Koch) Winkler	Family: <i>Corylaceae</i> Edible parts: Fruit Aesthetic characteristics: Form	
<i>Crataegus orientalis</i> Pallas Ex Bieb. var. <i>orientalis</i> Pallas Ex Bieb.	Family: <i>Rosaceae</i> Edible parts: Fruit, flower, foliage Aesthetic characteristics: Blossom, fruit	
<i>Diospyros kaki</i> L.	Family: <i>Ebenaceae</i> Edible parts: Fruit Aesthetic characteristics: Fruit, fall foliage	
<i>Hippophae rhamnoides</i> L. subsp. <i>caucasica</i> Rousi	Family: <i>Elaeagnaceae</i> Edible parts: Fruit, flower (tea) Aesthetic characteristics: Fruit, functional use	

Table 1. (Continued)

<i>Juniperus communis</i> L.	<p>Family: <i>Cupressaceae</i> Edible parts: Fruit Aesthetic characteristics: Form, texture</p>	
<i>Laurocerasus officinalis</i> L.	<p>Family: <i>Rosaceae</i> Edible parts: Fruit Aesthetic characteristics: Blossom, fruit, form, texture</p>	
<i>Mespilus germanica</i> L.	<p>Family: <i>Rosaceae</i> Edible parts: Fruit, foliage, seed Aesthetic characteristics: Form, fruit, fall foliage</p>	
<i>Morus nigra</i> L.	<p>Family: <i>Moraceae</i> Edible parts: Fruit, foliage Aesthetic characteristics: Form ('Pendula' cultivar)</p>	
<i>Prunus divaricata</i> Ledeb.	<p>Family: <i>Rosaceae</i> Edible parts: Fruit Aesthetic characteristics: Blossom</p>	
<i>Punica granatum</i> L.	<p>Family: <i>Punicaceae</i> Edible parts: Fruit Aesthetic characteristics: Blossom, fruit, fall foliage</p>	
<i>Pyracantha coccinea</i> Roemer	<p>Family: <i>Rosaceae</i> Edible parts: Fruit Aesthetic characteristics: Blossom, fruit</p>	

Table 1. (continued)

<i>Rhus coriaria</i> L.	<p>Family: <i>Anacardiaceae</i> Edible parts: Fruit Aesthetic characteristics: Form, fruit, fall foliage</p>	
<i>Ribes orientale</i> Desf.	<p>Family: <i>Grossulariaceae</i> Edible parts: Fruit Aesthetic characteristics: Blossom, fruit</p>	
<i>Rosa canina</i> L.	<p>Family: <i>Rosaceae</i> Edible parts: Fruit Aesthetic characteristics: Blossom, (and may be fruit)</p>	
<i>Sorbus aucuparia</i> L.	<p>Family: <i>Rosaceae</i> Edible parts: Fruit, foliage (tea) Aesthetic characteristics: Blossom, fruit, form, fall foliage</p>	
<i>Tilia rubra</i> DC. subsp. <i>caucasica</i> (Rupr.) V. Engl.	<p>Family: <i>Tiliaceae</i> Edible parts: Flower (tea) Aesthetic characteristics: Form, Blossom, fall foliage</p>	
<i>Vaccinium myrtillus</i> L.	<p>Family: <i>Ericaceae</i> Edible parts: Fruit, foliage Aesthetic characteristics: Form, fall foliage</p>	
<i>Viburnum opulus</i> L.	<p>Family: <i>Caprifoliaceae</i> Edible parts: Fruit, foliage Aesthetic characteristics: Blossom, fruit, fall foliage</p>	

In Artvin province, which is rich in edible ornamental landscaping plants, some of which also have economic value as well, only certain woody taxa were assessed in the context of the present study. Thus, future studies could investigate other perennial edible ornamental plants in this context to improve the ecologic, functional and aesthetic benefits of these plants for individuals.

Especially in urban centers with dense buildings where open green areas are limited, as a result of using certain ornamental plant species with edible flowers and fruits, nutritional resources could be created not only for humans, but also for several butterflies, bugs, birds and especially bees.

It is possible to use these edible plant species easily in the gardens (green areas) of residence and mass housing within the context of urban open green areas. In fact, in previous studies, it was determined that edible plant species were more widely used in residence and mass housing gardens when compared to public areas (Sarı, 2006; Acar et al., 2007). Thus, it is necessary to promote edible and ornamental and edible plant species in public areas as well. As a result, use of “right plants in right locations” would be accomplished, awareness of the people on regional plant species would be improved and, our cities that became similar in design due to intense use of exotic plants would attain a landscape with a more unique identity. For instance, *Laurocerasus officinalis* is regionally known in coastal areas of Eastern Black Sea and Artvin and used in residential gardens for its fruits. Although unfortunately its use is not common in Turkey as an ornamental plant, this plant species and its cultivars are widely used as an ornamental plant in European countries. Thus, by supporting the regional use of this plant, which has the potential of becoming a plant of identity for Eastern Black Sea Region and possesses flower, foliage, fruit and form aesthetics, it is necessary to provide sustainability of natural species and create awareness.

Sorbus aucuparia, *Celtis australis*, *Tilia rubra* species scrutinized in the present study have the potential of use in urban landscape designs (e.g. urban planting) as a allée plant,

not only in private green areas. Furthermore, the use of *Rhus coriaria*, *Viburnum opulus*, *Cornus mas*, *Diospyros kaki*, *Punica granatum*, *Sorbus aucuparia*, *Celtis australis*, *Vaccinium myrtillus*, *Sorbus aucuparia*, *Mespilus germanica*, *Tilia rubra* subsp. *caucasica* species that have attractive fall colors in plant designs would be beneficial aesthetically. Solitary or in group use of the species listed in Table 1 and creating compositions with other plant species would make it possible to create attractive planting designs for all seasons.

Edible plants provide the opportunity for physical activity which has health benefits and allow people to interact with the landscape by engaging them in growing, harvesting and eating edible plants (Sima et al., 2010). Furthermore, it would also be educationally beneficial to plant edible ornamental plants in public open green spaces that individuals use for various recreational activities and especially in playgrounds for children and use identification tags. For instance, *Morus nigra* “Pendula” is commonly used in urban green areas for its form aesthetics, but its fruits are not commonly consumed. However, the use of this plant which has an appropriate size even for children to gather its fruits, not only for adults, could be expanded in recreational areas and children playgrounds.

As a result, by utilizing edible domestic ornamental plants within the context of edible landscapes, it will be possible

- To protect and utilize natural plant species in their local habitats,
- To sustain these plants and support the ecosystem,
- To maintain the traditions of the society and transfer these into the future,
- To increase the awareness of the society, and
- To benefit from both nutritional and ornamental properties of these plants in thematic green areas, residential gardens and public areas.

References

Acar C., Acar H., Eroğlu E. 2007. Evaluation of ornamental plant resources to urban biodiversity and cultural changing: A case study of residential landscapes in Trabzon city

(Turkey). *Building and Environment*, 42(1), 218-229.

Eminağaoğlu Ö. 2012. Artvin’de doğa mirası, camili’nin doğal bitkileri, ISBN: 978-605-359-936-4, 376 s, Promat, İstanbul.

Eminağaoğlu Ö. 2015. Artvin’in doğal bitkileri, ISBN: 978-605-030-854-9, 456 s, Promat, İstanbul.

Gül V. 2014. Rize yöresine ait tıbbi ve aromatik bitkilere genel bir bakış. *Iğdır Üni. Fen Bilimleri Enst. Der. / Iğdır Univ. J. Inst. Sci. & Tech.* 4(4), 97-107.

Sarı D. 2006. Trabzon kenti konut ve site alanlarının floristik çeşitliliği, Yüksek Lisans Tezi, KTÜ Fen Bilimleri Enstitüsü, 109 s. Trabzon.

Sima R., Micu I., Maniutiu D., Sima N., Lazar V. 2010. Edible Landscaping – Integration of vegetable garden in the landscape of a private property. *Bulletin UASVM Horticulture*, 67(1), 278-283.

Türker, M. F., Öztürk A., Tiryaki E. 2002. Ülkemiz ormancılık sektöründe odun dışı orman ürünleri kapsamında değerlendirilen odun dışı bitkisel ürünlerin işletmeciliği. II. Ulusal Karadeniz Ormancılık Kongresi (15-18 Mayıs, 2002), Cilt 1, 270-279, Artvin.

URL 1. 2016.

<http://www.baag.com.au/ornamental-edible-gardens/>

Vantomme, P., Markkula A., Leslie R.N. 2002. Non-Wood forest products in 15 countries of tropical Asia an overview. EC-FAO Partnership Programme, Tropical Forestry Budget Line (B7-6201/1B/98/0531, Project GCP/RAS/173/EC), Thailand.

Yüzbaşıoğlu İ.S., Özhatay F.N. 2013. Örumcek ormanlarında (Kürtün, Gümüşhane) odun dışı bitkisel ürünler. *Journal of the Faculty of Forestry, Istanbul University*, 63 (2), 11-20.

Determining the Amounts of Aboveground Carbon Storage Using Landsat 8 Satellite Image in Crimean Pine Stands (*Pinus nigra* Arnold. subsp. *pallasiana* (Lamb.) Holmboe)

*Alkan GÜNLÜ¹, İlker ERCANLI¹, Muammer ŞENYURT¹, Sedat KELEŞ¹

¹Çankırı Karatekin University, Faculty of Forestry, Çankırı / TURKEY

*Corresponding Author: alkangunlu@karatekin.edu.tr

Abstract

The aim of this study was to examine the relationships between the amounts of carbon storage capacity and individual band reflectance values and some vegetation indices obtained from Landsat 8 satellite image in Crimean Pine stands [*Pinus nigra* Arnold. subsp. *pallasiana* (Lamb.) Holmboe] in Yenice management district in Ilgaz State Forest Enterprise. The relationships between amounts of carbon storage capacity using multiple regression analysis were investigated. The regression analysis showed that a linear combination of sample ratio (SR) and Difference Vegetation Index (DVI) were better predictors for estimating amount of carbon storage (adjusted $R^2=0.417$; $S_{yx}=12.8310$) than a linear combination of band 2 and band 9 (adjusted $R^2=0.335$; $S_{yx}=18.3562$).

Keywords: Carbon storage capacity, Crimean pine stands, Landsat 8 satellite image

Karaçam Meşcerelerinde Landsat 8 Uydu Görüntüsü Kullanılarak Topraküstü Karbon Miktarının Belirlenmesi

Özet

Bu çalışmanın amacı, Ilgaz Orman İşletme Müdürlüğü, Yenice Orman İşletme Şefliğinde karaçam meşcerelerinde, Landsat 8 uydu görüntüsünden elde edilen bant parlaklık ve bazı vejetasyon indis değerleri ile karbon depolama kapasitesi arasındaki ilişkiler incelenmiştir. Çoklu regresyon analizi kullanılarak ilişkiler araştırılmıştır. Örnek oranı (SR) ve farklı vejetasyon indeksi (DVI)'in yer aldığı model(düzeltilmiş $R^2=0.417$; $S_{yx}= 12.8310$) bant 2 ve bant 9'un yer aldığı modele (düzeltilmiş $R^2=0.335$; $S_{yx}=18.3562$) göre karbon depolama kapasitesi daha iyi tahmin etmiştir.

Anahtar Kelimeler: Karbon depolama kapasitesi, Karaçam meşcereleri, Landsat 8 uydu görüntüsü

Introduction

Forest ecosystems provide lots of goods and services to society when they have been planned and managed in a sustainable manner. Forests have vital ecological and environmental functions such as climate regulation, water conservation, soil protection and biodiversity conservation as well as many economic functions. Recently, high fossil-fuel combustion, deforestation and land-use and land-cover changes have caused drastic changes on the atmosphere resulting with climate change and global warming in the entire world. Forest ecosystems store large amounts of atmospheric CO₂ for a longer period of time in their biomass and soil in the context of mitigation of global climate change (Evrendilek, 2004).

In this context, quantification of forest tree biomass and its carbon storage amounts is one of the most important scientific

research areas to mitigate global warming and climate change. Forest ecosystems are an important component of the global C budget in terrestrial ecosystems, and a better understanding of the quantification of C budget of these ecosystems is needed (Sharma and Rai, 2007). Biomass estimation is very important for quantification of C budgets. There are various approaches for calculating above and below-ground forest tree biomass. These approaches are forest inventory data based on ground measurements and remote sensing methods using different satellite images.

Ground measurements are the most accurate and safest approach to predict forest tree biomass as well as biomass expansion factors, and the tree-level allometric equations developed as a function of tree species and such stand parameters as tree height and diameter at breast height (Labrecque et al., 2006; Sanquetta et al.,

2011). Most of forest inventories are often difficult and time consuming to measure (Brown, 2002). Thus, the increasing demands for cost-efficiency in forest management have increased the demands for more efficient inventory methods (Makela and Pekkarinen, 2004). On the other hand, remote sensing techniques allow researchers to investigate the function and structure of forest ecosystems and have been accepted as a low-cost and large-area coverage information source in sustainable management of forest resources (Poso et al., 1984; Wulder, 1998; Franklin et al., 2003; Venter and Koh, 2012). The use of satellite images, such as Landsat TM, SPOT, IKONOS, ASTER and Quickbird, for estimating forest tree biomass and its carbon contents, has been widely studied in recent years (Zheng et al., 2004; Makela and Pekkarinen, 2004; Neeff et al., 2005; Muukkonen and Heiskanen, 2007; Naeset, 2011; Nyström et al., 2011; Kadioğulları and Karahalili, 2013; Günlü et al., 2014). All these and other studies have showed the successful biomass and carbon storage estimations.

This study evaluates the use of a new satellite data, Landsat 8 satellite image, on determining carbon storage amounts of Crimean pine stands. In this context, it focuses firstly on examining the relationships between the amounts of carbon storage and individual band reflectance and some vegetation indices values obtained from the satellite image.

Material and methods

Study area

The research area was the Yenice forest planning unit in Ilgaz State Forest Enterprise located in the central Anatolia, Turkey. This area is between 33° 40' 13'' and 33° 51' 32'' E and 40° 55' 32'' and 41° 04' 57'' N (Figure 1). The total area of the Yenice forest planning unit is 11584.5 ha. This area is 7143,5 ha forest areas and 4441.0 ha is other areas (agriculture, grassland and settlement) (Anon. 2008). This study was carried out in pure Crimean Pine stands (*Pinus nigra* Arnold. subsp. *pallasiana* (Lamb.) Holmboe). The total area of pure Crimean Pine stands is 1690.8 ha (Figure 2).

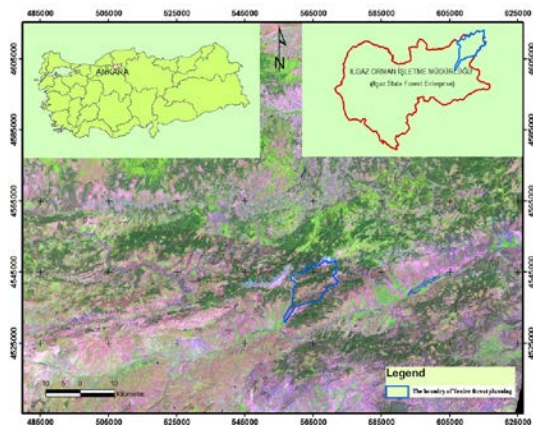

Figure 1. Geographical location of the study area

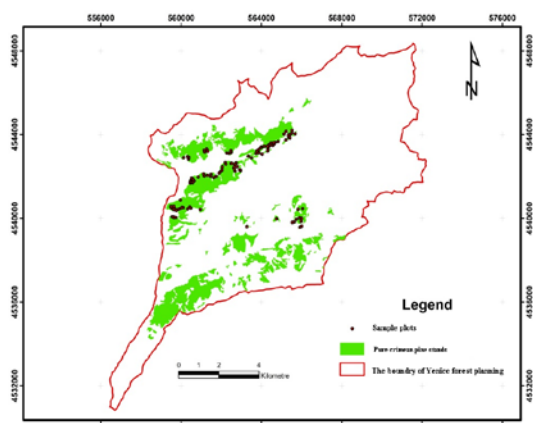

Figure 2. The area of pure Crimean pine stands and sample plots

Ground measurements

In this study, to determine the amount of carbon storage capacity in Crimean Pine stands [*Pinus nigra* Arnold. subsp. *pallasiana* (Lamb.) Holmboe] in Yenice management district in Ilgaz State Forest Enterprise was taken 108 sample plots on August 2014. At each sample plot, diameter at breast height (DBH) was measured in all trees with a diameter greater than 8 cm at breast height.

Determining the amount of carbon storage

In this study, carbon storage capacities of Crimean Pine stands were estimated. Firstly, biomass for Crimean pine stands was calculated using biomass conversion factors from the literature. To estimate above ground biomass, timber volume of Crimean pine stands were multiplied by wood density and biomass expansion factors (Tolunay, 2012).

Total dry weight biomass of a tree was converted to total stored carbon by multiplying by 0.51 for Crimean pine stands.

Remote sensing data

Landsat 8 satellite image was acquired on 14 August 2014. The eight bands (Band2, Band3, Band4, Band5, Band6, Band7, and Band 9) of Landsat 8 with 30 m spatial resolution and Band8 with 15 m spatial resolution were used. The Landsat 8 satellite image was georeferenced to UTM WGS 84 Zone 36. Using 17 control points taken from Google earth map, a root square mean error of 0.5 pixels was obtained. The UTM coordinates of the sample plots determined using GPS tool. However, the GPS points have positional errors, which normally average to ± 4 m. Therefore, it is difficult to correctly locate each sample plot on the center of the 15 and 30 m grid of Landsat 8 pixels. Therefore, several researchers used a moving window, such as a 3 x 3 pixel (Makela and Pekkarinen, 2004). We used a moving window to average the reflectance values in the neighboring pixels and the band reflectance values and vegetation indices value were calculated for each sample area on the Landsat 8 satellite image. Data processing, interpreting and analysis were performed using Erdas Imagine 9.1TM version (Erdas, 2002).

Statistical analysis

In this research, to survey the relations between the spectral reflectance values and vegetation indices generated from Landsat 8 image and the carbon storage values, multiple linear regression analysis were used in studied stands. This multiple linear regression models were developed through Ordinary Least Squares technique using the band reflectance values as independent variable, which dependent variables in models were carbon storage values. The multiple stepwise regression analysis was carried out by SPSS (SPSS Institute Inc, 2007). The stepwise regression technique was used to select the best site variables that are significant ($p < 0.05$) with the highest value of coefficient of determination adjusted by number of parameters (R^2_{adj}), also called adjusted the coefficient of determination. The model structure used in this study to below:

Carbon Storage=

$$\beta_0 + \beta_1 \cdot X_1 + \beta_2 \cdot X_2 + \dots + \beta_n \cdot X_n + \varepsilon$$

Where, $X_1 \dots X_n$ are variable vectors corresponding to Landsat 8 satellite image data, the spectral reflectance values, Band 2 and 9, and vegetation indices variables, $\beta_1 \dots \beta_n$ represent model coefficients and ε is the additive error term (Corona et al., 1998; Fontes et al., 2003).

Results and Discussion

The selected best regression models including some accuracy statistics such as the coefficients of determination (R^2) and the standard error of model ($S_{y.x}$) are presented in Table 1 for the spectral reflectance values. In these selected regression models for the carbon storage values, the F statistics and coefficients were significant at a probability level of 95 percent ($p < 0.05$). The carbon storage model based on the spectral reflectance values were developed by Band 2 and Band 9 as independent variables, and this model performance were calculated an adjusted $R^2 = 0.335$; $S_{y.x} = 18.3562$. The carbon storage model based on the vegetation indices values were developed by SR and DVI as independent variables, and this model performance were calculated an adjusted $R^2 = 0.417$; $S_{y.x} = 12.8310$ (Table 1 and 2). Remote sensing methods have been used to estimate carbon. When some of these studies made on this subject in literature, there are many researches to predicting carbon storage capacity using remote sensing data (Roy and Ravan, 1996; Trotter et al., 1997; Steininger, 2000; Dong et al., 2003; Rahman, 2005; et al., 2004; Patenaude et al., 2005; Turner et al., 2005; Balzter et al., 2007). In these studies, it has tried to predict relationships between carbon storage capacity values and band reflectance values and some vegetation indices generated from remote sensing data using regression analysis. The variability in the carbon value for developed regression equations explained 50%. In addition to, some studies have been made for determining the carbon storage capacity using Landsat satellite image in Turkey (Mısır et al., 2012; İnce, 2011; Gülsunar,

2011). In these studies, firstly, the carbon storage capacity and carbon classes were determined by ground measurements. Then, according to carbon classes was classified by supervised classification with a 0.7417,

0.7201 and 0.7889 kappa statistic values and 82.5%, 79.17% and 84.17% overall accuracy assessments, respectively.

Table 1. Parameters of the ‘best fit’ regression models of carbon storage based the band spectral reflectance values, Band2–Band9

Independent Variables	Coefficients of Independent Variables	S. E. of Variables	t-statistics	p-value
Constant	-2764.1753	977.8018	-2.8269	0.006
Band 2	-0.0304	0.0050	-6.0754	0.000
Band 9	0.6129	0.1954	3.1367	0.002
R ²	0.335			
S _e	18.3562			

Table 2. Parameters of the ‘best fit’ regression models of the amounts of carbon storage based the vegetation indices values

Independent Variables	Coefficients of Independent Variables	S. E. of Variables	t-statistics	p-value
Constant	-66,4241	21,7933	-3,0479	0.004
SR	122,4861	19,9341	6,1445	0.000
DVI	-0,0143	0,0028	-1,4438	0.002
R ²	0.417			
S _e	12.8310			

SR: Simple ratio, DVI: Difference vegetation index

Conclusions

The relationships between band reflectance values and vegetation indices generated from Landsat 8 satellite image and the carbon storage capacity was determined by multiple linear regression analysis. Our results shows that vegetation indices can better estimate the amount of carbon storage as compared to individual band spectral reflectance values. As a result of this study, the prediction of the carbon storage capacity using Landsat 8 satellite image low correlation was found in this study.

Acknowledgement

This work was supported by TÜBİTAK, Project No: 213 O 026. We would like to thank to for support to the TÜBİTAK

References

Balzter H., Talmon E., Wagner W., Gaveau D., Plummer S., Yu J.J. Quegan S., Davidson M.,

Le Toan T., Gluck M., Shvidenko A., Nilsson S., Tansey K., Luckman A., Schmullius C. 2002. Accuracy assessment of a large-scale forest map of Central Siberia from Synthetic Aperture Radar. *Canadian Journal of Remote Sensing*, 28, 719-737.

Brown S. 2002. Measuring carbon in forests: current status and future challenges. *Environmental Pollution*, 116 (3), 363–372.

Corona P., Scotti R., Tarchiani N. 1998. Relationship between environmental factors and site index in Douglas-fir plantations in central Italy. *Forest Ecology and Management*, 101, 195-207.

Dong J., Kaufmann R.K., Myneni R.B., Tucker C.J., Kauppi P.E., Liski J., Buermann W., Alexeyev V., Hughes M.K. 2003. Remote sensing estimates of boreal and temperate forest woody biomass: Carbon pools, sources and sinks, *Remote Sens. Environ.*, 84, 393– 410.

Evrendilek F. 2004. An inventory-based carbon budget for forest and woodland ecosystems of Turkey. *Journal of Environmental Monitoring*, 6, 26-30.

- Fontes L., Tome M., Thompson F., Yeomans A., Luis J.S., Savill P. 2003. Modelling the Douglas-fir (*Pseudotsuga menziesii* (Mirb.) Franco) site index from site factors in Portugal. *Forestry*, 76, 491-507.
- Franklin S.E., Hall R.J., Smith L., Gerylo G.R. 2003. Discrimination of conifer height, age and crown closure classes using Landsat-5 TM imagery in the Canadian Northwest territories. *International Journal of Remote Sensing*, 24(9), 1823-1834.
- Gülsunar M., 2011. Ormanların karbon depolama kapasitesinin uzaktan algılama yöntemi ile belirlenmesi (Düzdağ Orman İşletme Şefliği). Yüksek Lisans Tezi, KTÜ Fen Bilimleri Enstitüsü, 89 s. Trabzon.
- Günlü A., Ercanlı İ., Başkent E.Z., Çakır G. 2014. Estimating aboveground biomass using Landsat TM imagery: A case study of Anatolian Crimean pine forests in Turkey. *Annals of Forest Research*, 57 (2), 289-298.
- İnce K., 2011. Uzaktan algılama yöntemiyle karbon depolama miktarının belirlenmesi (Artvin örneği). Yüksek Lisans Tezi, KTÜ Fen Bilimleri Enstitüsü, 116 s. Trabzon.
- Kadioğulları A.İ., Karahalil U. 2013. Spatiotemporal Change of Carbon Storage in Forest Biomass: A case Study in Köprülü Canyon National Park. Kastamonu Univ., *Journal of Forestry Faculty*, 13(1), 1-14.
- Labrecque S., Fournier S.A., Luther J.E., Piercey D. 2006. A comparison of four methods to map biomass from Landsat-TM and inventory data in western Newfoundland. *Forest Ecology and Management*, 226, (1-3), 129-144.
- Makela H., Pekkarinen A. 2004. Estimation of forest stand volumes by Landsat TM imagery and stand-level field-inventory data. *Forest Ecology and Management*, 196, 245-255.
- Mısır M., Mısır N., Bulut A. 2012. Karbon depolama kapasitesinin Landsat 7 ETM+ uydu görüntüsüyle belirlenmesine ilişkin kavramsal çatı, *KSÜ Mühendislik Bil. Der., Özel Sayı*, 232-234.
- Muukkonen P., Heiskanen J. 2007. Biomass estimation over large area based on standwise forest inventory data and ASTER and MODIS satellite data: a possibility to verify carbon inventories. *Remote Sensing of Environment*, 107 (4), 617-624.
- Neeff T., Mauricio P., Dutra L.V., Freitas C.C. 2005. Carbon budget estimation in Central Amazonia: Successional forest modelling from remote sensing data. *Remote Sensing of Environment*, 94, 508-522.
- Patenaude G., Milne R., Dawson T.P. 2005. Synthesis of remote sensing approaches for forest carbon estimation: Reporting to the Kyoto Protocol. *Environmental Science and Policy*, 8 (2), 161-178.
- Poso S., Hame T., Paananen R. 1984. A method of estimating the stand characteristics of a forest compartment using satellite imagery. *Silva Fennica*, 18 (3), 261-292.
- Rahman M.M., Csaplovics E., Koch B. 2005. An efficient regression strategy for extracting forest biomass information from satellite sensor data. *International Journal of Remote Sensing*, 26(7), 1511-1519.
- Roy P.S., Ravan S.A. 1996. Biomass estimation using satellite remote sensing data—an investigation on possible approaches for natural forest. *Journal of Bioscience*, 21, 535-561.
- Sanquetta C.R., Corte A., Da Silva F. 2011. Biomass expansion factor and root-to-shoot ratio for Pinus in Brazil. *Carbon Balance and Management*, 6 (6), 1-8.
- Sharma P., Rai S.C. 2007. Carbon sequestration with land-use cover change in a Himalayan watershed. *Geoderma*, 139, 371-378.
- SPSS., 2007. Institute Inc. SPSS Base 15.0 User's Guide.
- Steininger M.K. 2000. Satellite estimation of tropical secondary forest aboveground biomass data from Brazil and Bolivia. *International Journal of Remote Sensing*, 21, 1139-1157.
- Tolunay D. 2012. Coefficients that can be used to calculate biomass and carbon amounts from increment and growing stock in Turkey. *Proceedings of the international symposium for the 50th anniversary of the forestry sector planning in Turkey (26-28 November 2013)*, 240-251, Antalya, Turkey.
- Turner D.P., Ollinger S.V., Kimball J.S. 2004. Integrating remote sensing and ecosystem process models for landscape- to regional-scale analysis of the carbon cycle. *BioScience*, 54, 573-584.
- Venter O., Koh L.P. 2012. Reducing emissions from deforestation and forest degradation (REDD+): game changer or just another quick fix. *Annals of The New York Academy of Sciences*, 1249(1), 137-150.
- Wulder M.A. 1998. Optical remote sensing techniques for the assessment of forest inventory and biophysical parameters. *Progress in Physical Geography*, 22(4), 449-476.
- Zheng D., Rademacher J., Chen J., Crow T., Bresee M., Le Mome J., Ryu S. 2004. Estimating aboveground biomass using Landsat 7 ETM+ data across a Biomass estimation 1327 managed landscape in northern Wisconsin, USA. *Remote Sensing of Environment*, 93, 402-411.

Estimation of Carbon Sequestration for Sustainable Forest Management and Climate Change Mitigation

*Nuray MISIR¹, Mehmet MISIR¹, Sinem ŞATIROĞLU¹

¹Karadeniz Technical University, Faculty of Forestry, Trabzon/ TURKEY

*Corresponding Author: nuray@ktu.edu.tr

Abstract

Sustainable forestry is considered to be a balanced management of forests that takes into account their role as a life supporting system as well as their role in meeting the needs of present and future generations for forest and their products without threatening their renewal capacity (Nijnik, 2004). Sustainable forest management and climate change mitigation policies have been evaluated in terms of the viability of their implementation in the world. Developing sustainable forest management practices and linking them to climate change mitigation offer multiple benefits for the developing countries, which possess relatively high potentials of carbon sequestration in term of physical and economic characteristics. In this regard, forests play an important role in regional and global carbon cycles because they store large quantities of C in vegetation and soil and exchange large quantities of C with the atmosphere through photosynthesis and respiration (Hu and Wang, 2008). Forests can be managed to sequester or conserve significant quantities of C in the terrestrial forest ecosystems. Information on amount of carbon sequestration resulting from direct field measurements is crucial in sustainable forest management, to know how forest ecosystems will affect the carbon cycle and also to validate measurements.

This study proposes estimates of bio mass and carbon pools from a planning unit as well as an appropriate methodology to estimate based on ecosystem carbon sequestration.

Keywords: Sustainable forest management, Carbon sequestration, Biomass, Modelling

Sürdürülebilir Orman Yönetimi ve Küresel İklim Değişiminin Önlenmesi için Karbon Döngüsünün Tahmini

Özet

Sürdürülebilir orman yönetimi ormanlar ve ormanlardan elde edilen ürünlerin kendini yenileyebilme kabiliyetini ve yaşam enerjisini tehlikeye sokmadan şimdi ve gelecekteki nesillerin ihtiyaçlarının karşılama noktasında yaşamı destekleyen bir sistem olarak ormanların dengeli planlanmasını amaçlamaktadır. Sürdürülebilir orman yönetimi ile küresel iklim değişimini önleme politikaları, dünyanın önem verdiği en hayati konulardan biri olarak yerini bulmaktadır. Sürdürülebilir orman yönetimi özellikle ormanlarda gerçekleşen karbon döngüsü ile küresel iklim değişimini önleme konusundaki son derece önemli yararına dikkat çekmektedir. Ormanların fotosentez ve solunum yoluyla önemli miktardaki karbonu depo etmesi nedeniyle hem bölgesel hem de küresel bazda iklim değişimini önlemedeki rolü gün geçtikçe önem kazanmaktadır. Bu çalışmada da orman ekosistemlerinin depoladığı karbon miktarını tahmininde kullanılan yöntemler hakkında bilgi verilip özellikle doğrudan yöntemi oluşturan alan ölçümü konusuna odaklanacaktır.

Anahtar Kelimeler: Sürdürülebilir orman yönetimi, karbon döngüsü, biyokütle, modelleme

Introduction

Global warming is one of the few scientific problems with a wide enough spatial and temporal scale to truly require long-term global solution projections. Recent trends in greenhouse gas concentrations have created concern associated with climate change. Warming of climate system is unequivocal, as is now evident from observations of increased global air and ocean temperatures, widespread melting of snow and ice, and rising global average sea level (IPCC, 2007). Land use changes from

forestry to other uses, as well as greenhouse gas emissions associated with exploitation of fossil fuels have disturbed the planet's fragile carbon balance (Wigley and Schimel, 2000).

The Intergovernmental Panel on Climate Change concluded that "a sustainable forest management strategy aimed at maintaining or increasing forest carbon stocks, while producing an annual sustained yield of timber fibre or energy from the forest, will generate the largest sustained mitigation benefit". Sustainable management practices

keep forests growing at a higher rate over a potentially longer period of time, thus providing net sequestration benefits in addition to those of unmanaged forests.

The Kyoto Protocol is the first attempt to use the flexibility of the global market place to stabilize and reduce GHG emissions, mitigate climate change, and promote sustainable development. This protocol is particularly necessary for soil conservation, where the sequestration of carbon above and below ground increases soil organic matter, enhances soil fertility, and improves production, while concomitantly reducing atmospheric CO₂. The Kyoto Protocol accepts terrestrial sinks for greenhouse gases (GHGs) as offsets for fossil fuel emissions.

A carbon sink is anything that absorbs more carbon than it releases, whilst a carbon source is anything that releases more carbon than it absorbs. Forests are carbon stores, and they are carbon dioxide sinks when they are increasing in density or area. Forests, soils, oceans and the atmosphere all store carbon and this carbon moves between them in a continuous cycle. This constant movement of carbon means that forests act as sources or sinks at different times.

Biomass is defined as the quality, expressed in mass units, of the vegetal material content per unit area in a forest. In general, the estimated biomass components are vertical aboveground biomass or standing alive aboveground biomass composed of trees and shrubs (not considering the roots), dead aboveground biomass, composed of litter and fallen trunks, and the belowground biomass, composed of roots. The sum of all considered components provides the total biomass.

Forest biomass and soil are considered to have a large potential for temporary and long-term carbon storage. Forested ecosystems may help contribute toward carbon sequestration by capturing and storing atmospheric CO₂ where it is not immediately reemitted to the atmosphere. Enhancing C sequestration by increasing forested land area has been suggested as an effective measure to mitigate elevated atmospheric carbon dioxide concentrations and hence contribute towards the prevention of global warming.

Tree biomass plays a key role in

sustainable management and in estimating forest carbon stocks. As the demand for using renewable forest biomass for energy production to mitigate climate change is growing, biomass is becoming a valuable product. Estimates of biomass are required for assessing the amount of primary energy obtainable from the forests as an alternative to fossil fuels. For scientific purposes, standing biomass is a fundamental state variable in several ecological and ecophysiological models. Rapid, easily implemented methods are needed for the assessment of standing biomass in order to estimate the carbon sequestration by forest ecosystems. The growing interest for forest energy sets new demands for forest inventory, planning and management systems to generate more detailed information on different biomass fractions. They are needed for more accurate estimates of harvested branch and needle biomasses, their nutrient contents for the estimation of ecological effects of intensified biomass removal, for the prediction of the CO₂ balances of forested areas.

This study proposes a methodology to produce spatially explicit estimates of the ecosystem-based carbon sequestration.

Material and Methods

Data Collection

Data were collected from sample trees from sample plots. Sample plots were collected from areas of rectangular plots generally varied from 400 m² and 1200 m². Sample trees were selected every diameter classes with an effort to equal allocation. For each diameter classes, effort was made to include every height classes.

Methods

There are five pools in forest ecosystems: Living trees, dead woods, understory vegetation, litter floor, and soil. The methods used in estimation of the carbon sequestered in all biomass components are different. However, carbon flux in living trees is responsible for the largest carbon storage among five forest carbon pools.

Biomass and C stocks of above-ground live and dead tree biomass, understory and forest ground vegetation, forest floor C and woody debris has been determined from plot-

level inventories and destructive tree sampling. Small root biomass and mineral soil C stocks have been estimated from soil cores. Aboveground biomass including stem, branch, leaf, bark was estimated from sample plots and sample trees.

Above ground biomass

Living trees biomass

The aboveground biomass can be estimated by direct and indirect methods. Both methods present advantages and disadvantages (Araujo et al., 1999). The direct methods are destructive, consisting of the cutting and weighing of the aboveground material in an established area. However, the choice of the area to be cut down and weighed is, in many instances, biased and simple extrapolation leads to inaccurate results. In general, the chosen area is thought to be homogeneous, but it frequently contains very large trees, resulting in over-estimated data.

The general procedure for estimating biomass is to cut down a tree, weight it, take samples of different tree components, and dry these components. The biomass (dry weight) of the tree is then calculated by applying the moisture loss of the samples to the entire tree. Depending on the researcher, however, the number of samples taken from a tree will vary.

The aboveground portion of each sample tree was divided into components and the fresh weight of each component measured. All sample trees were felled and weighed. Once cut down, the trees were divided into trunk and crown, the latter being considered as starting from the first line branch. Then, each tree component has to be measured for raw weight. To determine dry weight, samples of the different tree components are weighed before and after desiccation in a laboratory. The relationship between raw and dry weight of these samples is applied to determine the dry weight of live whole tree or individual tree components.

Without exception, the crowns of all trees are weighed. First, the leaves and thin branches are cut in pieces that could be put on the scales and also weighed one by one. Representative samples of each component are taken at the time of bulk weighing and weighed in the field on a portable digital

balance. These samples are oven-dried to constant weight at 102 °C to determine the proportion of dry matter (biomass) in each component.

For sample trunks with $dbh > 3$ cm, a method, based on the formula for a cylinder, is utilized to estimate the total volume then, disks are removed from each end and weighed. The diameter and thickness of the disks are measured. From these data, the total volume and of trunks is calculated. The fresh weight biomass is then obtained from the volume and average wood density.

The indirect methods utilize mathematical models. It relates the tree variable parameters obtained from forest inventories, such as diameter at breast height (dbh , trunk height diameter 1.3 m from the ground level), trunk height, crown diameter, total tree height, tree species, etc. Also, the application of this method can be inaccurate. For example, trees can have a hollow inside, and, in case of large trees, the error in the calculation of biomass can be significant. In the general, the forest inventory is carried out with the exclusive objective of planning land exploitation and use, for which the variable of the greatest interest is wood volume. Forest inventory is also the first step to start much of the basis of research concerning natural resources and decisions related to land use.

The total above ground biomass was estimated using allometric biomass regression equation. The total biomass of a sample plot was obtained by multiplying the weighted biomass by the number trees.

Allometric equations have been developed from this data for each tree component as well as for total tree biomass for each stand (Peichl and Arain, 2006). Based on these equations, individual aboveground, belowground, and total tree biomass was up-scaled on area basis, using the mean diameter at breast height as input variable and multiplying by stem density.

Ordinary least-squares regression is used to develop equations for each species relating tree component and total aboveground dry weight (g) to dbh (cm). Dependent variables included total aboveground, stem wood, branch (wood + bark), stem bark and needle biomass. The independent variable in all

equations is *dbh* (cm). Equations are log-transformed and are presented in the following form: $y = \beta_0 + \beta_1 x$, where y = biomass, $x = dbh$ and β_0 is the equation intercept and β_1 is the slope of the regression line.

Based on the data collected, several equations are developed. Before establishing the allometric equation, scatter plots are used to see whether the relationship between independent and dependent variables is linear. Furthermore, several allometric relationships between independent and dependent variables are tested. The independent variables included *dbh*, tree height, whereas the dependent variable is the dry weight of the aboveground biomass (Sokal and Rohlf, 1995; Sprugel, 1983; Chave et al., 2005; Sah et al., 2004).

The aboveground portion of each sample tree is divided into components and the fresh weight of each component measured. All sample trees are felled and weighed. Once cut down, the trees are divided into trunk and crown, the latter being considered as starting from the first line branch. Then, each tree component has to be measured for raw weight. To determine dry weight, samples of the different tree components are weighed before and after desiccation in a laboratory.

In the sample plots all trees are measured. The parameters recorded are species name, *dbh*, total height and geographical coordinates x and y . For sample plots, a representative sample is collected, dried weighed and the root system extracted from the soil and its dry weight measured when it was possible. To determine volume of the sample trees is used to Huber or Smalian formula and the biomass stem wood samples are taken from different heights. The wood samples are oven-dried during 96 hours at 102 °C and weighed using an electronic balance.

Understory vegetation

In each sample plots, ground vegetation (all seedling trees (height < 1.3 m), shrubs, herbs, and woody debris) is estimated destructive harvesting placing 1 m x 1 m quadrats at the peak productive time. Identification of species and an estimate of their cover-area are conducted for each species found within the plot. Biomass of

each ground vegetation component is air dried and sub-sample aware oven-dried at 65 °C for 72 hours, in order to calculate dry biomass on an area basis.

Litter was sampled with 25 cm x 25 cm wooden quadrats in different four field in each sample plot.

Soil Biomass

In each of the sample plots, soil samples are collected once at depth layers of 0-10 cm, 10-30 cm, 30-50, 50-80 cm and 80< cm. To evaluate bulk density and soil carbon 3 soil samples are collected at each layer with a cylinder of 10 cm of diameter and 30 cm of length. The carbon content is analyzed at the laboratory. Soil samples are oven-dried and analyzed for C-concentration using a CHNS elemental analyzer. The soil carbon pool in each layer was estimated using equation $SC = \%C \times p \times v$ in which %C is the weight percentage of carbon in this layer, p the bulk density of the soil in Kg/m³ and V the volume of soil per hectare.

Belowground biomass

To estimate belowground biomass of trees are used the roots directly measured in the field. The roots are separated three groups (fine, small and coarse). The biomass of fine (0-2 mm.), small (2-5 mm.) and coarse (5< mm.) roots are assessed by collecting four 30 cm depth, 6.4 cm diameter cores per plot. The roots are separated from the soil by soaking in water and then gently washing them over a series of sieves with mesh sizes of 2 and 5 mm. The roots are sorted in to diameter classes 0-2 mm (fine root), 2-5 mm (small root) and 5< mm (coarse root) root classes. The roots from each sizes category are oven-dried at 65 °C for 24 hours and weighed.

Carbon content

To estimate carbon content in tree biomass, it is collected with stem borer 4-5 core samples from each sample tree. Each core sample is oven-dried at 102 °C during 96 hours and samples are analyzed for C-concentration using CHNS elemental analyzer.

The carbon content of all tree components are calculated as multiplication component biomass with related to carbon percentages.

Then each component carbon contents are determined for each sample plots.

Each sample tree components biomass are determined to raw and oven dry. The representative samples are analyzed using an Elemental Analysis Machine. Then, carbon stocks of each tree components are calculated as weight and percentage.

Carbon sequestration

The rate of carbon sequestration in live tree biomass is computed by finding the difference between the carbon stocks of population of trees at two different ages. Estimates of carbon stock are generally produced by first measuring the total biomass of the population using one of two approaches. The first is to estimate wood volume for each tree using a volume equation, convert wood volume to mass using an estimate of timber density, and then convert wood mass to total tree biomass using a biomass expansion factor. The other approach is to apply a regression equation that directly converts external measurements, such as stem diameter and sometimes height to total tree biomass. Individual tree biomass values produced using either approach are summed to produce the biomass of entire population, which is then multiplied by a standard value of carbon concentration to produce an estimate of the carbon stock.

Results

Biomass and carbon equations for component of living trees are given according to tree species. Allometric relationship between the biomass and carbon of the tree components and diameter at breast height for tree species are presented.

The carbon contents of a tree bole for tree species are given ranging intervals. For example, the carbon content of an oriental spruce tree ranged from 28.3% to 56.17% (Mısır et al.2009). For the other the biomass components' carbon content of oriental spruce tree including branch, needle and bark ranged from 33.5 % to 43.1%, 21.57% to 22.13% and 8.57 % to 17.97%, respectively. The bole carbon storage of it was 99.8 ton/ha as average. The branch, needle and bark carbon storage of fir stand were 5.2 ton/ha, 5.3 ton/ha and 7.6 ton/ha, respectively. Total living tree biomass carbon storage of oriental

spruce (*Picea orientalis*) stands in Blacksea region was 108.8 ton/ha as an average (Mısır et al. 2009).

The soil carbon percent are given according to the bottom soil layer.

The total tree biomass of a tree for *Abies nordmanniana* S. subsp. *bornmülleriana* (Mattf.) was 445 kg from 24.8 kg to 1476 kg. The total tree carbon storage of natural fir stand was 145.6 ton/ha from 71.4 ton/ha to 299.2 ton/ha. The bole carbon storage of it was 117.1 ton/ha. The branch, needle and bark carbon storage of fir stand were 12.8 ton/ha, 9.8 ton/ha and 6.0 ton/ha, respectively. The carbon content of a tree bole for fir ranged from 43.9% to 46.0%. For the other biomass components' carbon content (branch, needle and bark) were 46.6%, 56.1% and 38%, respectively (Mısır et al., 2012).

Total living tree biomass carbon storage of scotch pine (*Pinus sylvestris*) stands have ages ranged from 11 to 80 years in Turkey was 68.28 ton/ha as an average (Yavuz et al. 2010).

Carbon content of litter for natural fir stands ranged from 26.2% to 50.6%. Litter carbon storage was 5.93 ton/ha. Shrub herb biomass carbon storage ranged from 69 kg/ha to 1016 kg/ha. Fine root biomass for natural fir stands ranged from 1684.5 kg/ha to 9214.1 kg/ha. Small and coarse roots biomass were 4097 kg/ha and 11762 kg/ha as an average. Fine, small and coarse roots carbon storages ranged from 485 kg/ha to 3566 kg/ha, 392 kg/ha to 2673 kg/ha and 1049 kg/ha to 6428 kg/ha, respectively. Total root biomass and carbon storage were 39628 kg/ha and 9365 kg/ha (Mısır et al., 2012).

The bole carbon storage of a scotch pine tree was 63 ton/ha as average. The branch, needle and bark carbon storage of scotch pine natural stand were 1.2 ton/ha, 4.2 ton/ha and 0.3 ton/ha, respectively. These values are less than oriental spruce natural stands (Yavuz et al. 2010).

While significant allometric biomass and carbon equations are obtained, the total tree biomass of a tree for tree species is determined in these studies. The total tree carbon storage of the tree species for the stands is estimated as ton/ha. The carbon storages of all living trees biomass

components including branch, needle and bark carbon storage.

The carbon content of a tree bole was calculated for tree species. The other biomass components' carbon content (branch, needle and bark) are also determined. Carbon content of litter for tree species ranged from a certain interval. Litter, shrub and herb biomass carbon storage are determined as kg/ha.

The ranging interval of fine, small and coarse root biomass are obtained as kg/ha. Fine, small and coarse roots carbon storages should be also determined as kg/ha. Thus, total root biomass and carbon storage are obtained by adding root classes.

Total ecosystem biomass carbon storage of the tree species is determined as an average ton/ha.

Conclusions

There are five pools in forest ecosystems: Living trees, dead woods, understory vegetation, litter floor, and soil. In this research, we estimated the carbon sequestration in all pools. However, carbon flux in living trees and soil are responsible for the largest carbon storage among five forest carbon pools, which could account for 87% of total carbon storage in forest ecosystems.

Total ecosystem biomass carbon storage of tree species stands according to the study area is estimated ton/ha as an average, range interval or minimum and maximum values.

The forests will play an important role in mitigating the increase of CO₂ concentration in the atmosphere if new stands were constructed and mature forests can be better protected.

All studies in this topic in Turkey and in the world results highlight the importance of forest ecosystem C pools, when estimating C sink potentials over their complete life cycle.

References

Araujo, T.M., Higuchi, N., Carvalho, J.A.J., 1999. Comparison of formulae for biomass content determination in tropical rain forest site in the state of Para, Brazil. *Forest Ecology and Management*, volume 117, issues 1-3, p. 43-52.

Chave, J., Andalo, C., Brown, S., Cairns, M.A., Chambers, J.Q., Eamus, D., Foster,

H., Fromard, F., Higuchi, N., Kira, T., Lescure, J.-P., Nelson, B.W., Ogawa, H., Puig, H., Riéra, B., Yamakura, T., 2005. Tree allometry and improved estimation of carbon stocks and balance in tropical forests. *Oecologia* 145, 87-99.

Hu, H. and Wang, G.G., 2008. Changes in forest biomass carbon storage in the South Carolina Piedmont between 1936 and 2005. *Forest Ecology and Management*, 255, 5-6, 1400-1408.

IPCC, 2007. *Climate Change 2007: The physical science basis. Contribution of Working Group I to the Fourth Assessment Report of the Intergovernmental Panel on Climate Change.* WMO/UNEP, Paris, France, 18 pp.

Peichl, M., Arain, M.A., 2006. Above- and belowground ecosystem biomass and carbon pools in an age-sequence of temperate pine plantation forests. *Agric. Forest Meteorol.* 140, 51-63.

Nihnik, M., 2004. To an economist's perception on sustainability in forestry-in-transition, *Forest Policy and Economics*, 6, issues 3-4, p. 403-413.

Mısır, M., Mısır, N., Erku, S. 2012. Estimations of total ecosystem biomass and carbon storage for fir (*Abies nordmanniana* S. subsp. *bornmülleriana* (Mattf.)) forests (Western Balkan region), *Kastamonu Univ Journal of Forestry Faculty*, special issue, 60-64.

Sah, J.P., Ross, M.S., Kaptur, S., Snyder, J.R., 2004. Estimating aboveground biomass of broadleaved woody plants in the understory of Florida Keys Pine forests. *Forest Ecology and Management* 203, 319-329.

Sokal, R.R., Rohlf, F.J., 1995. *Biometry. The Principles and Practice of Statistics in Biological Research*, 3rd ed. W.H. Freeman and Co., New York, 859 pp.

Sprugel, D.G., 1983. Correcting for bias in log-transformed allometric equations. *Ecology* 64, 209-210.

UNFCCC (United Nations Framework Convention on Climate Change), 2008. Report of the Conference of the Parties on its thirteenth session, held in Bali from 3 to 15 December 2007. Addendum, Part 2. Document FCCC/CP/2007/6/Add.1. UNFCCC, Bonn, Germany.

Wigley, T.M.L., Schimel, D.S., 2000. *The Carbon Cycle.* Cambridge University Press, Cambridge, UK, 7-36.

Spatial Distribution of Stand Carbon in Even-Aged Mixed Forests

*Ferhat BOLAT¹, Sinan BULUT¹

¹Çankırı Karatekin University, Faculty of Forestry, Çankırı/TURKEY

*Corresponding Author: fbolat@karatekin.edu.tr

Abstract

Forests are important carbon (C) sequesters. Stand C is highly variable temporally and spatially. Forest management strategies, considering spatial variability of stand C are needed for mitigating climate impact. Geostatistic is used widely as a tool for evaluating spatial distribution of soil and forest attributes. This study was conducted in Karşıkent Planning Unit of Amasya Forest Directory. In this study, 648 sample point data were used for predicting spatial variation of stand C stock. Experimental semivariogram of stand C stock was constructed and then modelled by a spherical model ($R^2:0.84$, $RSS:1.17$). Subsequently, Block kriging (BK) and inverse distance weighting (IDW) interpolation methods were used for predicting values at unsampled sites. Surface maps were built for interpreting spatial pattern of stand C stock in the study area. Correlation coefficient (r), mean absolute error (MAE) and root mean squared error (RMSE) were used for comparing performance of BK and IDW to predict stand C stock. Nugget, sill and range values for stand C stock were 1431, 2863 and 6250, respectively. Nugget effect indicated that stand C stock was moderately spatially dependent in the study area. Values of r , MAE and RMSE were 0.60, 32.06 and 41.11 for BK and 0.61, 31.47 and 40.83 for IDW. The IDW with exponent of 2 predicted stand C stock slightly better than BK. Both methods predicted stand C stock moderately well. High variability of stand C stock resulted in its inadequate prediction and this should be considered in future studies of stand C stock.

Keywords: Carbon storage, Geostatistical analyse, Kriging, Inverse distance weighting

Introduction

The temperature that is one of climate patterns is major factor that associated with forests growth. The temperature is linked strongly with concertation of atmospheric carbon dioxide (CO₂). Recently, ratio of CO₂ emission is raised rapidly along with industrial development. One of significant factors to mitigate CO₂ emission is forests. The amount of carbon stored in global forests is 359 billion tons (NOAA, 2016). In Turkey, the amount of carbon sequestered in forests is approximately 1.9 billion tons (Anon, 2015). In accordance with international agreements (e.g. Kyoto Protocol), Turkey has responsibilities such as reduction of CO₂ emission and support of carbon sink. Thus, in this regard forest management strategies are becoming important in reducing impact of deforestation and degradation on carbon sequestered in forest vegetation (IPCC, 2007). Formerly, in our country where basic objective is wood production, recently sustainable forest management regime that maintains wood production as well as i.e. carbon storage, water production, and non-wood forest productions are implemented. Therefore forest managers needed

supplemental outputs for planning of forest products and services. In Turkey, the amount of carbon stored in forests is assessed through growing stock. The growing stock is determined using data from forest management inventory. In this way, the amount of carbon stored in forests can be obtained temporally for whole forest sites or classified stand types and development stages but not spatially. The assessing temporally and spatially changes of carbon stocks contributes to conduct more effectively plans regarding carbon management. Geostatistics are ability to obtain spatial variation of a variable that are continuous spatially. Many studies in forest science were carried out to predict spatially variation of stand parameters (Hock 1993, Czaplewski et al. 1994, Hernández and Emery 2009). Gunnarsson et al. (1998) indicated that total volume, annual volume increment, mean diameter and age show positive autocorrelation. But clear cutting and sharp edges between young and over-mature stands that cause discontinuity impact spatial autocorrelation. Nanos and Montero (2002) expressed that tree diameter presents spatial autocorrelation. But, they showed that spatial dependency is based on

length of forest compartments, and if sampling intervals are smaller than forest compartments, data will be autocorrelated spatially. Nanos et al. (2004) stated that diameter and height relationships that show a high spatial dependency can be modelled using geostatistic without any additional information. The aim of this study is to (i) predict spatially the amount of stand C stock, (ii) compare different interpolation techniques, and (iii) predict the data at unsampled areas.

Material and Methods

Study Area

The study area is located in Amasya Forest Regional Directorate, Niksar Forest Enterprise, Karşikent Planning Unit. It is bounded by 338874-380000 east longitudes and 4460242-4478653 north latitudes (UTM European 50 datum 37 zone) in the Central Black Sea Region of Turkey. Total area is 21748.80 ha and 75% of this area is covered by Scots pine, Calabrian pine, Oak, Beech and Hornbeam. Elevation ranges from 442 to 1791 m and slope ranges from 1% to 85%. Average slope of the study area is 28% (Şenyurt et al. 2013).

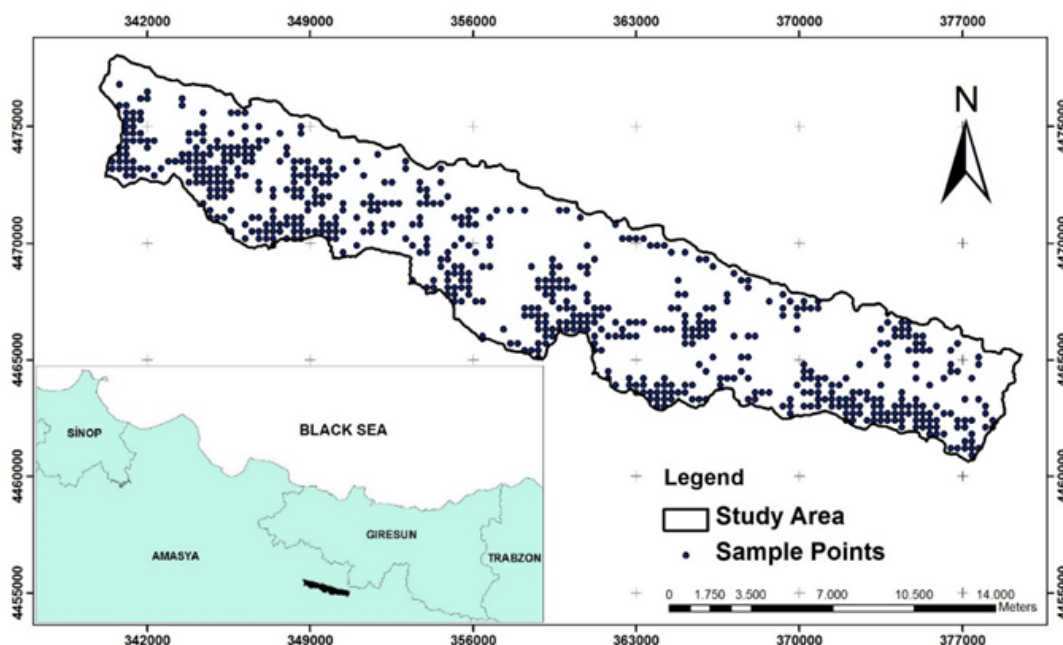

Figure 1. Map of the study area

Performance Criteria

Performans of block kriging (BK) and inverse distance weighting (IDW) methods were compared with mean absolute error (MAE) and root mean square error (RMSE). The accuracy of methods was measured by MAE and RMSE defined as follow:

$$MAE = \frac{1}{n} \sum_{i=1}^n |e_i| \quad RMSE = \sqrt{\frac{1}{n} \sum_{i=1}^n (e_i)^2}$$

where n, the number of data and e_i , the residuals.

Spatial Correlation Index

Spatial correlation index (SCI) is nugget (C_0) to sill (C_0+C) ratio and indicates level of spatial dependence. Spatial dependency is

degree of relation between observations in a given distance. If SCI is smaller 25%, variables have a strong spatial dependency. If it is between 25 and 75%, degree of spatial dependence is moderate. If it is bigger than 75%, degree of spatial dependence is weak. The relation continues over long distances while spatial dependency is strong. Low nugget values give more accurate results and present strong spatial dependency.

$$SCI = \left(\frac{C_0}{C_0 + C} \right) \times 100$$

Block Kriging and Inverse Distance Weighting

Before geostatistical analyze, Kolmogorov-Smirnov analysis way applied for control to normality of data set with SPSS® 20.0 software. Semivariogram parameters including nugget, sill and range were calculated for BK. Cross validation was used for more accurate semivariogram fitting. BK and IDW spatial interpolation methods were performed with Geostat® software for estimate stand carbon (C) stock and surface maps were prepared with ArcGIS® software.

BK estimates based on predicted systematic points for a local area. BK estimates through semivariogram parameters

for sample points. IDW uses distance between sample points. Distance among the points are weighted inversely. In this process we use the different exponents and apply exponent that gives the best result according to cross validation.

Results

Data were analyzed using descriptive statistics (Table 1), and distributions were described with classic statistics (mean, the coefficient of variation, skewness, etc.). The data presented normal distribution (Skewness= 0.518), and have moderate variability (Cv= 10-40%).

Table 1. Descriptive statistics of stand C stock

Variable	N	Min	Max	Mean	SD	Cv%	Skewness	Kurtosis
Stand C Stock	648	47.85	314.45	141.67	51.52	36.00	0.52	0.10

The best model was chosen spherical model that has lowest sum of square of residuals and accounts for most variance (% 60). Spatially variation of stand C was described using range, sill and nugget parameter (Table 2). Nugget to sill ratio was calculated as 50%. This ratio indicated that

spatial dependency of stand C was at moderate level in this study. This means that the developed model was reliable for predicting and mapping spatial distribution of stand C stock across the study area. Values of stand C were illustrated in Fig. 4 and Fig. 5 based on BK and IDW with power of 2.

Table 2. Semivariogram parameters of stand C stock

Variable	Model	(C ₀)	(C ₀ +C)	Range	SCI %	SDL
Stand C Stock	Spherical	1431	2863	6250	50	Moderate

SCI: Spatial Correlation Index, SDL: Spatial Dependence Level

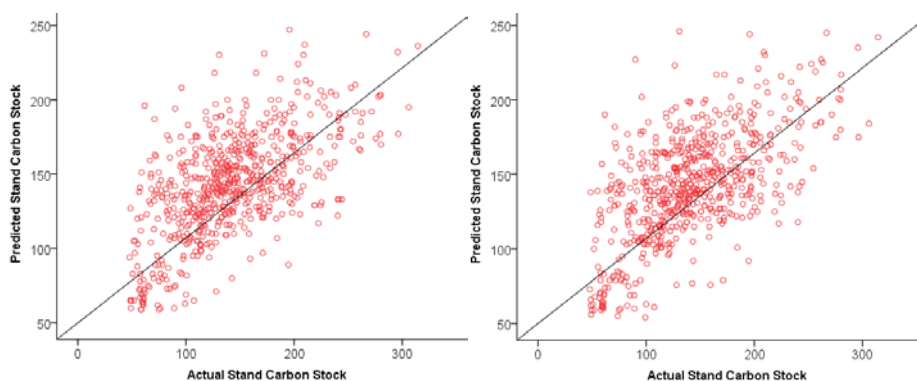

Figure 2. Relationship between actual carbon data and predicted carbon data based on BK (left) and IDW with power of 2 (right)

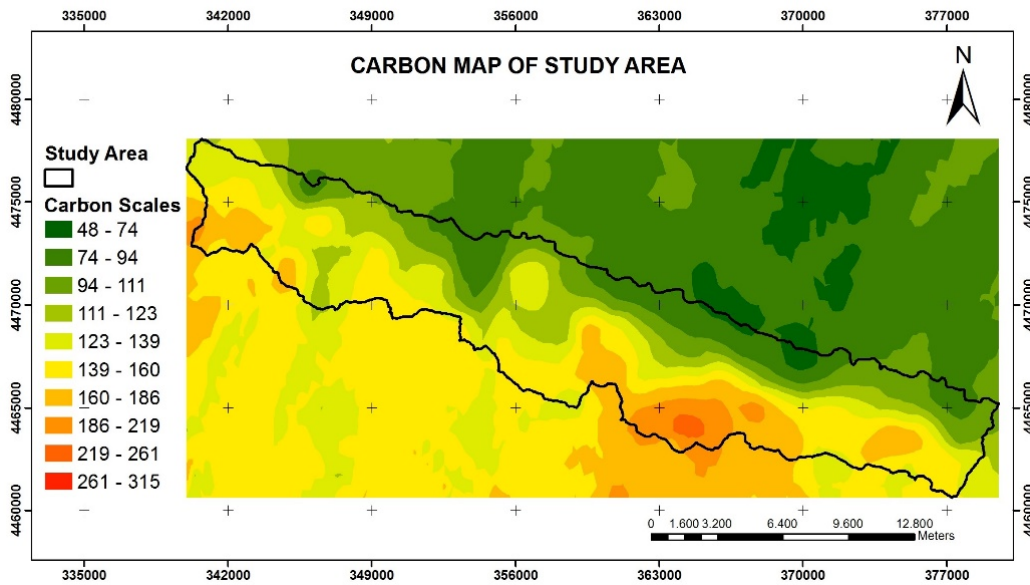

Figure 3. Interpolation map based on BK

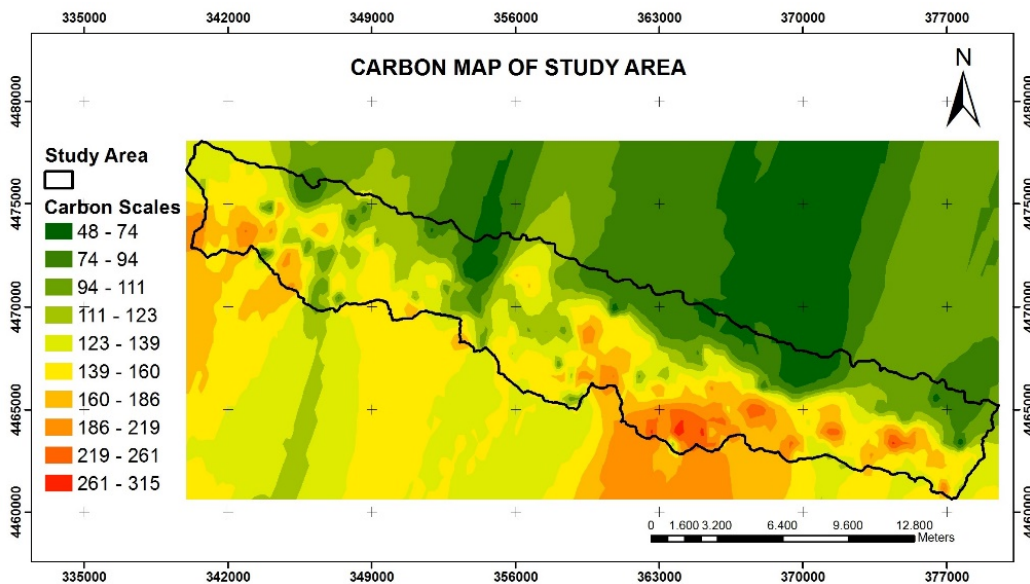

Figure 4. Interpolation map based on IDW with power of 2

Table 3. Comparison of spatial interpolation methods based on r, AME, RMSE

	BK	IDW
r	0.60	0.61
MAE	32.06	31.47
RMSE	41.11	40.83

r: the coefficient of correlation, MAE: mean absolute error, RMSE: root mean square error

According to the performance criteria, BK and IDW gave similar results. However, IDW with power of 2 was slightly better than BK.

Discussion and Conclusion

The stand C showed moderately spatial autocorrelation in this study

(Nugget/Sill=0.49). This means stand C was continuous spatially and so the estimates were satisfactory. In this study, the spatial predictions were available in 6250 m for mapping stand C across the study area. After this distance, prediction will be incorrectly because of weakly spatial autocorrelation.

Spatial dependency could be obtained moderately because the study area was covered by different tree species. The distance of spatial dependency (range) would be higher if the study area included pure stands. In this study, different sampling spacing was not evaluated because forest management inventory data were used. The finer sampling intervals can be increased the accuracy of spatial predictions. Shoulder et al. (2001) expressed both sample size and sampling interval were important for the researches done in coarse-scale area. Nanos and Montero (2002) indicated that when the number of sampling points were inadequate, the predictions would be inadequate. Inverse distance weighted method with power of 2 was appropriate for predicting spatial distribution of stand C in this study. In this study, data was distributed normally (skewness=0.52) and its coefficient of variation was 36 %. Kravchenko and Bullock (1999) expressed that the best results were obtained with power of 1 in the data set with low skewness (<1); with power of 4 in the data with high skewness (>2.5). Also, they expressed that the relationships between power values and the coefficient of variation were not found. Gotway et al. (1996) indicated that higher power should be chosen for the data with low the coefficient of variation. Those results were available for soil properties. For the data from forest inventory there is not any studies that investigate relationships between data properties and accuracy of model. In the future studies for forest science this case should be considered. Block kriging method gave similar results to inverse distance weighting methods. But in forestry planning, managers prefer local estimates to point estimates. Therefore, although inverse distance weighting method were better slightly than block kriging in this study, block kriging seems to be useful for forest research because it provides the estimates for a local area included many points. The results of this study indicated that spatial variability of stand C could be predicted well by geostatistical analysis using the data from forest management inventory. In this study, only influence of data properties on the accuracy of spatial interpolation methods could be examined because forest

management inventory data were used. But, sample size, sampling interval, forest compartments, topography, and silvicultural intensity can affect the spatial distribution of variables. Therefore, those factors should be taken into account for increasing the accuracy and precision of estimates in the future studies.

References

- Anonymous, 2015. Türkiye orman varlığı - 2015. T.C. Orman ve Su İşleri Bakanlığı, Orman Genel Müdürlüğü, 33 s., Ankara.
- Czaplewski R.L., Reich R.M. and Bechtold W.A. 1994. Spatial autocorrelation in growth of undisturbed natural pine stands across Georgia. *Forest Science*. 40; 314-328.
- Gotway A.C., Ferguson R.B., Hergert G.W. and Peterson T.A. 1996. Comprasion of kriging and inverse distance methods for mapping soil parameters. *Soil Science Society of American Journal*. 60; 1237-1247.
- Gunnarsson F., Holm S., Holmgren P. and Thuresson T. 1998. On the potential of kriging for forest management planing. *Scandinav Journal of Forest Research*. 13; 237-245.
- Hernandez J. and Emery X. 2009. A geostatistical approach to optimize sampling designs for local forest inventories. 39; (8), 1465-1474.
- Hock, B.K., Payn T.W., and Shirly J.W. 1993. Using a geographic information system and geostatistics to estimate site index of *Pinus radiata* for Kaingaroa Forest, New Zeland. *New Zeland Journal of Forest Science*. 23; 264-277.
- IPCC 2007. Contribution of working groups I, II and III to the fourth assessment report of the intergovernmental panel on climate change. Geneva, Switzerland. pp 104.
- Kravchenko A. and Bullock D.G. 1999. A comparative study of interpolation methods for mapping soil properties. *Agronomy Journal*. 91; 393-400.
- Nanos N. and Montero G. 2002. Spatial prediction of diameter distribution models. *Forest Ecology and Management*, 161 (2002); 147-158.
- NOAA 2016. National oceanic and atmospheric administration, A Global Network for Measurements of Greenhouse Gases in the Atmosphere. U.S. Department of Commerce.
- Nanos N., Calama R., Mentero G. and Gil L. 2004. Geostatistical prediction of height/diameter models. *Forest Ecology and Management*, 195 (A2004); 221-235.
- Schloeder C.A., Zimmerman N.E. and Jacobs M.J. 2001. Comparison of methods for interpolating soil properties using limited data.

Soil Science Society of American Journal. 65; 470-479.

Şenyurt, M., Günlü, A., Ercanlı, İ., Yılmaz, C. 2013. Landsat 8 uydu görüntüsü kullanarak Karşıkent Orman İşletme Şefliği meşcere özelliklerinin tahmin edilmesi. The International Symposium for the 50th Anniversary of the Forestry Sector Planning 2013. 26-28 November. Antalya, Turkey.

The Place and Scope of Carbon in the Current Turkish Forest Policy Documents

*Hasan Tezcan YILDIRIM¹, Seçil YURDAKUL EROL¹

¹Istanbul University, Faculty of Forestry

*Corresponding Author: htezcan@istanbul.edu.tr

Abstract

Deforestation and forest degradation are prominent factors that have caused negative effects in terms of social, economic and environmental aspects. The effects of deforestation and forest degradation was initially linked together with degradation of natural environment and habitats, erosion, decrement of safe clean water production, extinction of biodiversity and negative effects on rural livelihood. Except these issues the role of the forests related combating climate change and the function regarding carbon storage have gained importance recently. In this context, some global processes have continued and a lot of countries have focused on carbon and carbon related issues in the context of their current national policies and strategies. Parallel with this situation, the main aim of this paper is to analyze the national aims, targets and strategies on reducing of carbon emission in the content of current national forest policy documents. Within this context the documents which are investigated in this paper are National Forest Program, Forestry Commission Reports of 9th and 10th Development Plans, strategic plans of Ministry of Forest and Water Affairs and also National Action Plan on Climate Change. Forestry related priorities in terms of carbon emission and carbon storage aspects will have been analyzed and investigated in this study. In the light of the findings of the study some suggestions will be made regarding utilization and management of forests as important carbon sinks, and some approaches will be presented related further policies and strategies.

Keywords: Carbon emission, Carbon storage, Forestry, Policy, Strategy

Karbonun Güncel Türk Ormanlık Politikası Belgelerindeki Yeri ve Kapsamı

Özet

Ormansızlaşma ve ormanların bozulması sosyal, ekonomik ve çevresel bakımdan birçok olumsuzluğun ortaya çıkmasında önemli bir etken olmuştur. Önceleri ormanların yok olması ve tahribiyle ilgili olarak gündeme gelen konular, doğal çevrenin ve yaşam ortamlarının bozulması, toprak kaybı, temiz su üretiminin azalması, biyolojik çeşitliliğin yok olması, kırsal yaşamın olumsuz etkilenmesi gibi yaklaşımlarla ilişkilendirilmiştir. Günümüzde ise bu yaklaşımlara ek olarak, ormanların küresel iklim değişimiyle mücadelede etkisi ve ormanların karbon tutma işlevi ile ilgili konular önem kazanmaya başlamıştır. Bu kapsamda; birçok ülke yeni politika ve stratejiler belirlemiş ve güncel ormancılık dokümanlarında karbon ve karbon ile ilgili konulara ağırlık vermeye başlamıştır. Bu çalışmada; güncel ormancılık politikası dokümanlarında; karbon emisyonunun azaltılmasına ilişkin amaç, hedef ve stratejilerinin irdelenmesi amaçlanmıştır. Belirtilen kapsamda ülkemizde ormancılık politikası amaçlarının yer bulduğu güncel dokümanlardan olan ulusal ormancılık programı, 9. ve 10. Kalkınma planı ormancılık özel ihtisas komisyonu raporları ile Orman ve Su İşleri Bakanlığı ile Orman Genel Müdürlüğü stratejik planları ile ulusal iklim değişimi eylem planı çerçevesinde değerlendirme yapılacaktır. Belirtilen dokümanlar çerçevesinde ülkemizin karbon salınımı ve karbon emisyonuna ilişkin ormancılıkla ilintili öncelikleri belirlenecek ve değerlendirilecektir. Önemli karbon yutaklarından olan ormanların bu anlamda yönetimine ve orman kaynaklarının kullanımına yönelik olarak son aşamada öneriler geliştirilecektir.

Anahtar Kelimeler: Karbon emisyonu, Karbon depolanması, Ormancılık, Politika, Strateji

Introduction

The gradual and annual increase in the world population has expedited both the industrialization and urbanization. This has effected the increase in society's demand and variety crucially. This process has brought along many problems as the destruction of

natural sources, the decrease and pollution in water sources, climate change, disforestation and a decrease in biological variety (Ekizoglu and et al., 2010; Öztürk, and et al., 2012) Especially, the high number of disforestation and destruction in forests in less developed and developing countries has

a major role of forests in the climate change and the storing of carbone (Vass and Elofsson, 2016; Delacote et al., 2016). In that way, the decrease in existence of forest areas in natural sources gradually day by day has caused a global climate change with the serum effect (Naughton-Treves, 2004; COB, 2008). This main issue was in the focus of Rio World Summit held in 1992. As a result of the fact that the clima change had become so too clear, they prepared the United Nations Climate Change Frame Agreement in Rio World Summit (Gren and Zeleke, 2016). Therefore, many countries have indicated policies that prevent mainly the disforestation and have practised them. (Aguilar- Amuchastegui et al., 2014) Of course it can be said that the common aim of these studies is diminishing the emission amount on the Earth's surface.

The most significant move in diminishing the carbone release has been offered by the Kyoto Protocol. In addition to this, the protocol, accepted in 1997, became valid in 2005. As the main reason of this, as the protocol's 25th article says "The total emission on Earth's surface of the countries which have confirmed has reached the 55% in 1990", is the necessity of it. The mentioned rate was reached by the attendance of Russia after signed by the protocol and it came into the operation of protocol. (Çiçek and Çiçek, 2012) About the carbone issue, today, as it is mentioned briefly above, financial policies are designed in order to decide and practise the goals. Also, social policies are discussed.

The attention paid on the topic has been increasing in both national and international levels in the historical period. At this point, the reduction in serum gas emissions and creating Carbone markets have been the main topics as a result of that (Öztürk et al., 2012).

From this perspective, it is inevitable that the topic of the reduction in carbone release to be the first issue on the boil in all the plans, programmes and strategies about nature and forestry prepared in our country and all over the world. Even though Turkey, against the Kyoto protocol in 2009, does not benefit from the flexibility mechanisms which are the issues of protocol's emission trade, these projects, that are independent

from these mechanisms in terms of process, founded as environmental and socially responsible and aimed at Voluntary Carbon Market, have been developed and practised for a long time. In the current situation, there are 308 projects which are in operation of the Voluntary Carbone Market in our country. From these projects, serum gas emission reduction above the 20 million tCOsquare equivalent annually are expected. The range of the projects in question according to the sectors are shown in Table 1 (by 18/4/2014) (CSB, 2016).

Table 1. Reduction of annual emission in the means of the types of project since 2004

The type of project's	Number	Annual Emission Reduction (tCO square/year)
Hydroelectric power station	159	8.747.634
Wind power station	106	7.951.391
The Energy Production of Waste/ Biogas	27	3.069.273
Energy productivity	10	432.081
Geothermic	6	405.309
Total	308	20.605.688

Source: CSB, 2016

Voluntary Carbone Market , which is prepared by the recording of the projects including Voluntary Carbone Market developed in our country and the follow of the carbone certificates obtained by these projects, became active by the publication in the offical paper dated 28790 and has the project record notice of October 9,2013 (CSB, 2016).

As it is mentioned above, the importance of carbone emission is quite different, in terms of the field of forestry. Thus, in addition to the technical magnitude, also caring about the legal and administrative size has an important role. In this way, how the carbone issue is death with the plans, programmes and strategic plans about forestry, is an important research question.

Lately in the study, searching the topics about carbone, in forestry programme, specialization commission reports and strategic plans, has been put out as the main aim.

Materials and Methods

Policy is defined as “the set of basic principles and associated guidelines, formulated and enforced by the governing body of an organization, to direct and limit its actions in pursuit of long-term goals” (Business Dictionary, 2016a). On the other hand plans are “written account of intended future course of action (scheme) aimed at achieving specific goal(s) or objective(s) within a specific timeframe. It explains in detail what needs to be done, when, how, and by whom, and often includes best case, expected case, and worst case scenarios”(Business Dictionary, 2016b). In the light of these descriptions plan can be identified as one of the tools that formulize and detail the application way of policy. Because plans clarify the aims and the essential tools to realize the policy aims (Tosun, 1990). Parallel to this approach planning and plans are defined as one of the instruments of forest policy implementation (Krott, 2005). Thus related development plans, strategic plans, action plans are important documents that reflect the main aims and implementation ways of forest policy aims (Erdönmez et. al., 2010).

Parallel to this approach current forest related national plans are chosen as the main materials of the research. These documents can be listed as 9th Development Plan Forestry Expert Commission Report (SPO, 2007), 10th Development Plan Sustainable Forest Management Expert Commission Report (MoD, 2014), Turkish National Forestry Program (MoEF, 2004), Strategic Plan of General Forest Directorate (GDF, 2012), Strategic Plan of Ministry of Forestry and Water Affair (MoFWA, 2012), Climate Change Action Plan (MoEU, 2011).

Content analysis was the main method of research to reach the finding in the context of the listed material. Aforementioned analysis was defined as “a class of techniques for mapping symbolic data into a data matrix suitable for statistical analysis” (Roberts,

2015). Content analysis is also utilized to analyze transcription data and the data that has textual structure (Breweton and Millward, 2001). Besides content analysis is evaluated as a powerful data reduction technique and also its major benefit comes from the fact that it is a systematic, replicable technique for compressing many words of text into fewer content categories based on explicit rules of coding (Stemler, 2001). By this method it is possible to better understand the form and substance of the strategies, choices, messages of the documents and also this method contributes to compare them (Schorott and Lanoue, 1994). The stages of the research can be listed as:

Research question and hypothesis:

“There is no difference between the content of forestry related plans in terms of carbon aspect”

Sampling units

The main current forestry related national wide plans: 9th Five Year Development Plan Forestry Expert Commission - 10th Five Year Development Plan Sustainable Forest Management Expert Commission Report - Turkish National Forestry Program - Strategic Plan of General Forest Directorate: 2013-2017 - Strategic Plan of Ministry of Forestry and Water Affair: 2013-2017 - Climate Change Action Plan :2011-2013

Content categories

The category was formulated by considering carbon regarding international scientific researches and articles. These categories are related technical, economical and administrative-political aspects of carbon issues in forestry. These categories can be listed as:

C. Emission, C. Sink, C. Emission, C. Leakage, C. Release, C. Forest, C. Storage, C. Attitude, C. Stock , C. Amount, C. Accumulation, Carbone dioxide , C. Tax, C. Economy, Carbone Acct., C. emission trade, C. Stock market, C. Finance, C. Loan, C. Market, C. Management, Competition, Kyoto protocol, C. Administration, C. Policy, C. management plan, C. Footprint.

Recording units and counting method of analysis

The recording unit of the analysis was determined as “words and terms.” The context units were the sentences. Besides the

counting of the units was performed by frequencies.

Analysis-Findings

The related results of the analysis are explained in "Findings."

On the other hand, except the contents of the plans the meanings and relations were analyzed in a comprehensive way. Thus the content analysis was applied in both qualitative and quantitative ways.

Findings

The facts about carbone have been found 20 times in the General Directorate of Forestry current strategic plan (Table 2). "Carbone accumulation" was the most common one among these facts. (f=6) It can be seen that the 6 statements are in the "situation analysis" when there is an evaluation of the meanings and the places of the statements about specific strategic plan of carbone. In this part, the topic is about the protective and environmental functions of the forests and there are numerical data. Statement 1 is in the part where there are the considerations of world's status and the developments and there are general information. The other statements about carbone are in the strategy, aim and goals. These statements of strategy, aim and goals can be listed as:

- There is a focus on the topic of carbone between the causes of prior aims and the sivilcultural care precautions in terms of "increasement in sivilcultural care precautions of the increasement in the healing of prolific forests and the productivity".
- issues as the certification in international markets, utilizing from carbone markets and turning into economical value, in terms of carbone emission in Kyoto protocol as "Studies in benefiting from the environmental and protective services in addition to increasing ecological functions of forests regarding the fight with the climate change", are considered. Also, there is a mention of the increase in forest biological mass in basic strategies.
- Carbone trade is mentioned in terms of the charging the ecosystem services about

strengthening the financial structure of the General Management.

It is seen that there is no mention of carbone and its related terms in the Ministry of Forestry and Water Affairs strategic plan (Table 2). While the climate change, environmental problems, the relation between forests and biovariety and the reasons of climate change are mentioned, it is a strange result that there is no mention of carbone and its related outcomes.

Table 2. The Content About Carbon of the Plans of Forestry

	9th Dev. Plan Forestry Expert Com. Rep.	10th Dev. Plan Sustainable Forest Man. Expert Com. Report	Turkish National Forestry Programme	Strategic Plan of General Fores Directorate	Strategic Plan of Ministry of Forestry and Water Affair	Climate Change Action Plan	TOTAL
C. Emission	-	-	-	-	-	-	0
C. Sink	-	-	-	1	-	4	5
C. Emission	-	-	-	1	-	1	2
C. Leakage	-	-	-	-	-	-	0
C. Release	-	1	-	-	-	-	1
C. Forest	-	-	-	-	-	-	0
C. storage	-	-	-	1	-	3	4
C. Attitude	3	7	-	-	-	8	18
C. Stock	-	1	-	2	-	4	7
C. Amount	-	-	2	2	-	14	18
C. Accumulation	-	1	10	6	-	1	18
Carbone dioxide	-	-	-	1	-	3	4
C. Tax	-	-	-	-	-	-	0
C. Economy	-	-	-	1	-	4	5
Carbone Acct.	-	-	-	-	-	-	0
C/ emission trade	-	-	-	1	-	-	1
C. Stock market	-	-	-	-	-	-	0
C. Finance	-	-	-	-	-	-	0
C. Loan	-	-	-	-	-	-	0
C. Market	-	3	-	-	-	18	21
C. Management	-	-	-	2	-	-	2
Competition	-	-	-	-	-	-	0
Kyoto protocol	-	-	-	2	-	4	6
C. Adminis.	-	-	-	-	-	-	0
C. Policy	-	-	-	-	-	-	0
C. mang. plan.	-	1	-	-	-	-	1
C. Footprint	-	-	-	-	-	6	6
TOTAL	3	14	12	20	0	70	119

There are 12 statements in National Forestry Programme about carbone and it is understood that 10 of them are about carbone accumulation and the 2 of them are about carbone amount (Table 2). One of them is placed while the expectations of related groups with the functions of forests in the

context of current situation analysis are considered. 6 of the statements about carbone are in the part of Turkey's forests' current situation yet it is studied more like with the general information and numerical data. In the part where the advantages of forestry products are explained, there are statements

about carbone for 2 times. Here, it is mentioned that it is necessary to raise awareness of society and have a collaboration among the groups about carbone accumulation study. Under the title of “Actions about the protection of forests, developing and benefiting from them”, only in two actions there is a statement of carbone accumulation. The first consciousness-raising of these actions is about tryings of political conscious and support developments. In the second, there is a statement of carbon accumulation between the protective and environmental functions while mentioning the increase in various forest areas.

The statement about the carbone topic in the 9th Progress Plan Forestry Specialization Commission Report is used for 3 times. 3 of these statements are used about the carbone retainment. One of the carbone retainment statements is in the introduction part during the revelation of forests’ functions. Secondly, the expected developments are seen under the title of the related politics and the main title of benefiting from forest sources during the determination of basic politics in the period of 2007 and 2013. Thirdly, under the main title of practise strategies and precautions, it is in the context of the order of forests’ features in the financial sources part.

There are 14 related statements about carbone in the 10th Progress Plan Sustainability Forest Management Specialization Commission report. Among these statements, carbone retainment is placed for 7 times. Carbone retainment statement is in the introduction part for one time and it is used during the revelation of the services and the product produced by the forestry. Secondly, under the main title of current situation analysis, it is used during the revelation of the unmeasurable contribution by money and the forestry sector’s macroeconomics part. Thirdly, under the title of the development tendencies in Turkey and all over the world, when the possible reflections of the tendencies all over the world and the dynamics in Turkey are revealed, during the forestry studies it is pointed out that there is a necessity of carbone attitude and a decrease. In the last part, Aim, Politics suggestions and transformation matrix are placed for 3 times

and it is pointed out in the developing of methods and carbone attitude in the suggestion. Later on, carbone market sector statement is used for 3 times. In the current situation analysis, when the evaluation of forest products exists, there is also the statement that the carbone sector is a market. In SWOT analysis, gaining the carbone markets to the sector among the opportunities of forestry sector is seen as an important opportunity. Lastly again, there are aim, politics suggestion and transformation fields in matrix table as a result of carbone markets and related legislation is not sufficient. Therefore, there is also a suggestion of the development of legislation. Again in the same report, carbone release, carbone storage, carbone wealth and carbone plan are placed. These statements are revealed as the general information and the numerical data.

The carbone issue is approached in the National Environment Action Plan in the most extensive way. Within this scope, carbone market statement is there for 18 times. 4 of them are in the current situation analysis and the rest 14 of them are in the Climate Change Action Plan’s Aim and Goals. Carbone amount statement is again in the aim and goals during the action plan for 14 times. Here, the carbone amount statement is used when stating the statements of the studies according to numerical amount. Thirdly, the most located statement is the carbone attitude. Carbone attitude statement is in the 8 places and in the agricultural sector in order to keep carbone and afforestation’s physical investments and practices for the first time. Later it is again in the aim and the goals. Carbone foot print statement is at the end of the plan under the titles of goals and aims for 6 times. Here it is mainly as the following of carbone footprint and the preparation of the related reports. Other than these, Kyoto Protocol, carbone economy, carbone storage and the carbone sink statements are in the related report for 4 times. Statements in question are in the aim and the goals within the titles of physical investment and practices in the sectoral considerations. Carbone storage and Carbone dioxide emission statements are there for 3 times. Carbone storage statement is seen in the statement of terrain usage, forestry,

physical investments and practices under the title of where are the carbone storage and how the capacity can be increased. Carbone dioxide emission statement is in the indication of emission amount, revealing the role of waste sector and lastly are in the aim and goals. Carbone emission statement is in the energy sector for 1 time and it is used about the diminish of tools' carbone emission. Similarly, the statement of carbone accumulation is there only for 1 time and the statistical data about the exact carbone accumulation of Turkey is seen in the content.

Results

The facts from this study show that the Carbone Market (f=21) is the most placed statement among the statements about carbone in current political documents. The document, in which this statement is used, is Climate Change National Action Plan (f=18). Carbone Attitude, Carbone Amount and Carbone Accumulation follow this statement (f=18). The other 23 statements, indicated as with the study of carbone, shows multidimensionally that they are mentioned in the chosen politics documents very limited.

When there is a general classification of the statements about the carbones determined in the study, they can be categorized as technical, economical and managerial. In this content, it can be seen that in documents in question there are the most technical context topics (f=77). Secondly, it can be understood that there are statements which are economical content (f=27). Thirdly and lastly, there come the issues about management (f=15). In the light of above, it can stated that there is a focus on the technical context topics in political documents. On the other hand, topics about economics and administration are handled restrictly. No doubt that even though the topics are significant, it will be good to pay attention on the economic and managerial dimension in order to make the process of carbone sustainable.

The most extensive content about carbone is in the Climate Change National Action Plan (f=70). It will be vital to say that this document is prepared by the Ministry of

Environment and Urban Planning. Forestry General Management Strategic Plan is the most extensive document in which the statements about carbone among the documents prepared directly about forestry in our country (f=20). National Forestry Programme (f=12) and the 10th Progress Plan Sustainability Forestry Management Specialization Commission Report (f=14) follows this document. While the related statements are in the 9th Progress Plan Forestry Specialization Commission Report only for 3 times, it is nowhere in the Ministry of Forestry and Water Affairs Strategic Plan. The fact that the topic is placed in a large scale in the documents of forestry has a sectoral role and importance in this frame. Taking this approach into consideration in the documents about forestry will focus the inevitable role and importance of forestry about the issue of carbone in future.

References

- Aguilar-Amuchastegui, N., Riveros, J.C., Forrest, J.L., 2014. Identifying areas of deforestation risk for REDD+ using a species modeling tool. *Carbon Balance and Management* 9:10
- Brewerton, P.M., Millward, L., 2001. *Organizational Research Methods: A Guide for Students and Researchers*. Sage Publications, London.
- Business Dictionary, 2016a. Policy definitions. <http://www.businessdictionary.com/definition/policy.html> [08.08.2016]
- Business Dictionary, 2016b. Plan definition. <http://www.businessdictionary.com/definition/plan.html> [08.08.2016]
- Çiçek, H.G., Çiçek, S., 2012. Karbon Vergisi ile Karbon Ticareti İzinlerinin Karşılaştırılması. *İ.Ü. Siyasal Bilgiler Fakültesi Dergisi*. 47 (Ekim 2012): 95-119.
- ÇOB, 2008. İklim Değişikliği ve Yapılan Çalışmalar.
- ÇŞB, 2016. Çevre ve Şehircilik Bakanlığı. Gönüllü karbon piyasaları. <http://www.csb.gov.tr/projeler/iklim/index.php?Sayfa=sayfa&Tur=webmenu&Id=12461> (Referans tarihi: 15.08.2016).
- Delacote, P., Robinson, E.J., Roussel, S., 2016. Deforestation, leakage and avoided deforestation policies: A spatial analysis. *Resources and Energy Economics*. 45: 192-201.

Erdönmez, C., Atmış, E., Özden, S., 2010. Türkiye’de Ormancılık Politikası (Turkish Forest Policy) (in Turkish). Ormancılık Politikası (Forest Policy) (in Turkish) (Ed. Akesen, A., Ekizoğlu, A.). Türkiye Ormancılar Derneği Eğitim Dizisi Yayın No: 6, Özdoğan Matbaa Yayın Ltd. Şti., Ankara.

Ekizoğlu, A., Kuvan, Y., 2010. Türkiye Ormanları ve Ormancılığı. Ormancılık Politikası (Forest Policy) (in Turkish) (Ed. Akesen, A., Ekizoğlu, A.). Türkiye Ormancılar Derneği Eğitim Dizisi Yayın No: 6, Özdoğan Matbaa Yayın Ltd. Şti., Ankara.

GDF (General Directorate of Forestry), 2012. Strategic Plan of General Forest Directorate 2013-2017. General Directorate of Forestry, Ankara, Turkey.

Gren, I-M., Zeleke, A.A., 2016. Policy design for forest carbon sequestration: A review of the literature. 70: 128-136.

Krott, M., 2005. Forest Policy Analysis. ISBN 1-4020-3485-7, Springer, Netherlands, 323 p.

MoD (Ministry of Development), 2014. 10th Five Year Development Plan Sustainable Forest Management Expert Commission Report Ministry of Development, Ankara, Turkey.

MoEF (Ministry of Environment and Forestry), 2004. Turkish National Forestry Program. Ministry of Environment and Forestry, Ankara, Turkey.

MoFWA (Ministry of Forestry and Water Affairs), 2012. Strategic Plan of Ministry of Forestry and Water Affairs 2013-2017. Ministry of Forestry and Water Affairs, Ankara, Turkey.

MoEU (Ministry of Environment and Urbanisation), 2011. Climate Change Action Plan: 2011-2023. Ministry of Environment and Urbanisation, Ankara, Turkey.

Naughton-Treves, L., 2004. Deforestation and Carbon Emissions at Tropical Frontiers: A Case Study from the Peruvian Amazon. World Development, 32 (1): 173-190.

Öztürk, A., Demirci, U., Türker, M.F., 2012. İklim Değişikliği ile Mücadele Piyasaları ve Türkiye için Bir Değerlendirme. I. Ulusal Akdeniz Orman ve Çevre Sempozyumu, 26-28 Ekim 2011, Kahramanmaraş. KSÜ Doğa Bilimleri Dergisi Özel Sayı.

Robets, C. W., 2015. Content Analysis. International Encyclopedia of Social & Behavioral Sciences. Volume 4: 769-773.

Schorott, P.R., Lanoue, D. J., 1994. Trends and perspectives in content analysis. Trends and Perspectives in Empirical Social Research eds: Ingwer Borg and Peter PH. Mohler, ISBN 3-11-014311-9, Walter de Gruyter & Co., Germany, pp:327-342.

SPO (State Planning Organization), 2007. 9th Five Year Development Plan Forestry Expert Commission Report. State Planning Organization, Ankara.

Stemler, S., 2001. An overview of content analysis. Practical Assessment, Research & Evaluation, 7 (17). <http://PAREonline.net/getvn.asp?v=7&n=17>, 2001.

Tosun, K., 1990. Yönetim ve İşletme Politikası. İÜ İşletme Fakültesi Yayın No: 232, İşletme İktisadi Enstitüsü Yayın No: 125, Yön Ajans, İstanbul, 855 p.

Vass, M.M., Elofsson, K., 2016. Is forest carbon sequestration at the expense of bioenergy and forest products cost-efficient in EU climate policy to 2050? Journal of Forest Economics, 24: 82-105.

The Role of Urban Forests in Adaptation to Climate Change

Müge ÖZTÜRK

Kahramanmaraş Sutcu Imam University, Department of Landscape Architecture, Turkey
mugeozturk36@gmail.com

Abstract

The city of Gaziantep is located in southeastern part of Turkey, on a semi-arid region where desertification and soil erosion plays an important role. It has dry climate conditions and it becomes very hot in summers, owing to the desert effect found in the southeastern region. According to a study realized on the climate change and its urban-induced bias in selected Turkish cities in Turkey, in the period of 1950–2004, significant average temperature increase has been detected in Gaziantep. And, spatial analysis resulted in significant warming in southern and southeastern parts of the country. Within this study, it is aimed to detecting relationships between urban forests and their effects to climate change in the city of Gaziantep, Turkey. The aim of the study is to classify the urban forest landscapes, providing principles to guide urban forest landscapes and climate change.

Keywords: Climate change, Gaziantep, Urban forests

İklim Değişikliğine Adaptasyonda Kent Ormanlarının Rolü

Özet

Türkiye'nin Güneydoğu Anadolu Bölgesinde bulunan Gaziantep şehri, çölleşme ve toprak erozyonunun önemli rol oynadığı yarı kurak bölgede yer almaktadır. Kuru iklim koşullarına sahiptir ve güneydoğu bölgesinde bulunan çöl etkisi nedeniyle, yazlar çok sıcak olur. Türkiye'de yapılan çalışmalara göre Gaziantep şehri iklim değişikliği ve kentsel ısı adası kaynaklı olarak 1950-2004 döneminde önemli ortalama sıcaklık artışı tespit edilmiştir. Mekânsal analiz sonuçlarına göre ülkenin güney ve güneydoğu bölgelerinde önemli ısınma görülmüştür. Bu çalışma kapsamında, kentsel ormanlar ve iklim değişikliği arasındaki ilişkileri tespit etmek amaçlanmıştır. Bu çalışmanın amacı, kent ormanlarının peyzajını sınıflandırmak ve iklim değişikliği ve kent ormanları ile ilgili esasları belirleyerek yol göstermektir.

Anahtar kelimeler: İklim değişikliği, Gaziantep, Kent ormanları

Introduction

Migration from rural to urban areas in Turkey has caused increase of the population in the city center, so rapid and irregular urbanization made urban people move away from their natural environment. There have been suggestions that a proportion of the 0.5°C warming seen over the last century may be related to urbanization influences (Kukla et al., 1986; Wood, 1988). The recent studies of Jones et al. (1990), and Wigley and Jones (1988) showed that urbanization influences in the most widely used hemispheric datasets are, at most, an order of magnitude less than the warming seen over the last century. The average temperature at the Earth's surface in 1990 compared to that in 2100 as the best estimate of the expected increase to occur is between 1-3,5 °C. This rate of increase in the air temperature is greater than all the growth occurring in the

last 10,000 years; however, it will be different from region to region specific temperature ranges.

Clearly to be seen all over the world climate change and temperature rise substantially arises from various human activity, mixed greenhouse gases to the atmosphere, these gases are being sought to reduce their emissions. In recent years to reduce the urban heat island effects and greenhouse gases include carbon dioxide (CO₂), into the atmosphere from various sources emissions and to reduce in order to normalize carbon dioxide levels in the atmosphere are utilized forests.

There are very few natural forests in Gaziantep. Therefore artificial forests were formed including pine trees surrounding the city. Protecting landscape values of the urban forest and planning, which interact with urbanization, have become very important. In

this study will be explained urban forest, urban heat island, urban forest impact on climate, climate change plan and urban forests of the city of Gaziantep, also will be given some suggestions.

Urban forest contribute to climate change

Urban forestry has emerged as a part of urban planning in early 1960's, so the development of the cities were attempted to be regular, planned and compatible with the natural environment (Grey/Deneke, 1986, Atay, 1988). Urban forest was defined as, coppice forest dating from natural forests in the city and nearby city, artificial forests (including green belts), urban parks, trees on streets, roads, and residence (Atay, 1988).

Urban forests provide an array of local and global benefits (i.e. ecosystem services), including benefits to the environment, to public health and to communities. On the other hand, urban forests have declined in many cities in the last few decades and urban canopy cover in many cities is below recommendations or targets (Nowak and Greenfield, 2012; Watkins, 2015).

Urban forests can reduce atmospheric CO₂ in two ways. As long as the trees are in active growth, they give more CO₂ from the atmosphere by photosynthesis and respirations are connected, the result is a reduction of CO₂ in the atmosphere (Nowak, 1993). Forests play an important role in the global carbon cycle. Soil and vegetation C are stored, through respiration and photosynthesis are made C exchange in atmosphere, human or natural means an intervention (eg natural forest fires, felling and burning, the use of inefficient production methods, etc.) to be an atmosphere source, they abandoned after intervention or will they again rejuvenated C reserves (Brown, 1997).

An urban forest management can increase carbon capture by increasing the urban canopy cover. Bigger and younger trees capture more carbon, and the urban forest could be optimized to follow such a growth and age structure. Moreover, carbon capture can be increased by species selection. The development of a carbon-species-selection

matrix is crucial for this approach (Nowak et al., 2002).

Urban forests contribute to climate change by controlling GHG emissions. In the US, for example, urban forests capture about 23million tonnes of carbon every year (Nowak and Crane 2002). Furthermore, urban trees help regulate the urban microclimate, augmenting or minimizing climatic change. This occurs either by reducing albedo and providing shade and cover (Heisler 1986, Jonsson 2004, Scott *et al.* 1999) or by regulating the hydrological regime of cities (Sanders 1986) that affects the urban microclimate (Souch and Grimmond 2006). Urban forests also contribute to GHG emissions with the loss of canopy cover and trees and the release of volatile organic compounds (VOCs). The maintenance of the urban forests may also contribute depending on its carbon-intensity and related emissions (Nowak, 2000).

Moreover, urban forests are raises the lower relative humidity of urban air and create cool effects. As a result of research conducted in Frankfurt, Germany, surrounding the city only 50-100 m wide in the forest belt of evapotranspiration, depending on the air temperature compared to the city center 3.5 °C decreases, the air humidity is set to increase by 5% (Dirik and Ata, 2004).

Plants produce nutrient using water, sunlight and with the soil elements and atmosphere as CO₂. The effects of plants on air quality can be classified many groups. These can be shown as coolness and temperature, CO₂ and O₂ balance, relative air humidity. Plants balanced the temperature in the urban environment through the air to control of the sun's rays. They provide temperature falls during the summer the, the rise in winter temperatures below is 5-8 °C higher than average at open space in urban environment at night compared to tree (Atay, 1988). The vegetation cover reduced 17 °C of hard-surface temperature (McPherson, 1994).

CO₂ and O₂ balance is very important for living things makes the O₂ gas absorbing atmospheric CO₂ and other gases. It is vital for the world ecosystem under control keeping the balance of carbon dioxide and

oxygen arising from fossil fuels (Nowak, 1993). Plants filter harmful contaminants for humans and other living organisms (dust, ash, pollen, smoke, etc.) to increase the air quality (Meyer, 1977). In a survey study done in Beijing city, China showed that trees in the city centre absorbed 1261.4 tons of airborne pollutants, and 0.2 million tons of CO₂ (Yang et al., 2005).

Vegetation decrease water loss keeping the sun rays, wind speed to cut through the soil and reducing evaporation, and give water their transpiration and environment. For example, a tree 21 m tall leafy shade type reveals about 400 lt of water a day (Federer, 1988).

Urban heat island

A number of environmental phenomena associated with urbanisation, such as the urban heat island effect, changes to hydrology, and chemical cycling, also influence the urban forest (Grimm et al. 2008).

The urban heat island effect in summary results from heat absorption by building roofs and walls, as well as by pavement and from a substantial lack of vegetation. Buildings and pavement absorb the solar radiation instead of reflecting it, causing the temperature of the surfaces and their environment to rise. Due to the surface temperature of urban structures become 10 to 20 °C (50 to 70 °F) higher than the ambient air temperatures (Taha et al., 1992).

The effect of the urban heat island is that the annual mean temperature of cities is several degrees warmer than their surrounding area in some small open spaces up to 10°C. During the day, wide streets, squares and non-planted areas are the hottest parts of a town. At night, the narrow streets have higher temperatures than the rest of the city (Heidt, 2006).

Urban forest of Gaziantep

The study area is located in the Southeastern Anatolia Region of Turkey, in the province of Gaziantep which is one of Turkey's most important cities with its historical, industrial, trade and touristic potential. The population is in the city of

Gaziantep is 1,899,466, and in terms of population density it is the largest city in Southeastern Anatolia Region, and the 8th largest city of Turkey (Anon., 2016).

Gaziantep, with an area of 6887 km² constitutes approximately 1% of Turkey's land. Mountains cover 51.9%, lowlands cover 26.9%, plateau cover 19.0% and uplands cover 2.2% of the area (Anon., 2015).

Altitudes change between 744 and 1204 meters. Elevation has gradually increased from city center to the north, and it was observed that elevation is more intensive in the outer region.

Forests which are belong to miocene period partly covered with eocene limestone. Gaziantep city and its surrounding, the large area of basalt and limestone mixed together where there are intensive reddish brown soils. In the region there are colluvial soils, especially along river valleys (Anon., 2015). The study area is characterized by reddish brown soil, red Mediterranean soil, basaltic and colluvial soils as well as soil class is determined I., II., III., IV., VI. and VII.

Only 14% of the soil is covered with forests in Gaziantep. These forests are dominated by oak and pine species. All the oak forests are defective so they are under protection. Western and northern regions of Gaziantep are surrounded by forests, steppe and grassland. 60 per cent of land is suitable for agriculture and covered by olive, pistachio, fruit and vegetable (Özbadem et al., 2014).

The total forest area is 112922.6 ha in Gaziantep. These forests are situated on the Great Sof Hill. The high altitudes of the area are the ridge which constitutes the western boundary. Elevation of forests generally range from 800 to 1450 m. Plant and forest consist of pine, black pine, cedar, cypress, beech, poplar, oak, juniper, wild olive, sandalwood, shrub, rosaries, spruce, euphorbia, blackthorn, nettle is blackberry and meadow grasses. Artificial forests such as Dülük Baba (306 ha), Burç (192 ha), Yelligedik, Erikçe (214 ha), and Taşlıca have constituted of this area (Figure 1).



Figure 1. Location of the study area

According to LULC analyses, agricultural areas class which surrounds the city has showed the largest coverage with 16190 ha.

Urban area which consists of continuous and discontinuous urban fabric has the second largest area with 11753 ha of land (Figure 2). From the viewpoint of forests, coniferous forest areas had 2775 ha, while mixed forests have covered 320 ha. Forest areas surround the city of Gaziantep especially in the north and west sides.

Green urban areas consisted of urban parks, refuges, playgrounds, sport areas, and other public green areas cover 558 ha. The amount of open spaces with little or no vegetation had 653 ha of land. The areal coverage of bare rocks is 507 ha, while water bodies have occupied 33 ha.

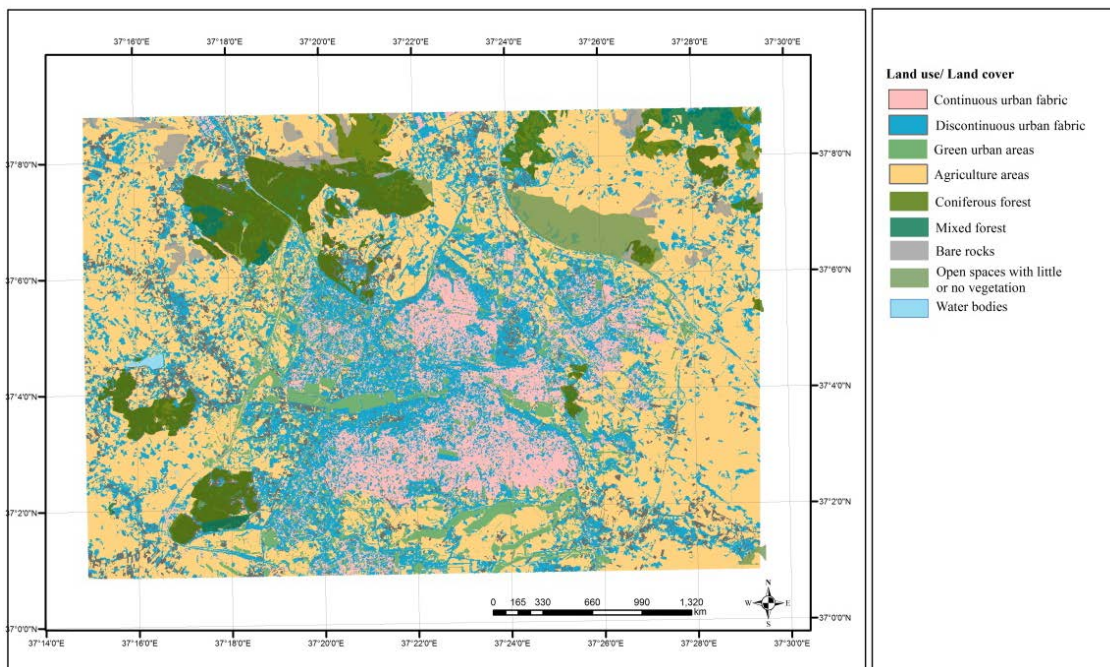

Figure 2. LULC maps

Climate change studies in city of Gaziantep

In 2015, through the 2st Gaziantep Climate Change Action Plan (“GCCAP”), the Municipality of Gaziantep established the following targets aimed at reducing the Greenhouse Gas emissions in the Municipality (Figure 3.):

1. Reduction of 15% of CO₂ per capita in 2023, compared to 2011.
2. Reduction of 15% of energy consumption per capita in 2023, compared to 2011.

Furthermore this plans, include the following actions

1. Urban renewal management
2. Urban planning expansion
3. Indirect intervention

Among others, the following actions should be considered:

1. Residential and service sectors, progress towards energy efficiency for cooling and heating systems (district heating approach),
2. Establishment of eco-regions,
3. Local residents "Energy Info Point"

and institutions "Local Energy Agency" creation,

4. Development of sustainability for Organized Industrial Zone,

5. Significant energy recovery for OSB and municipal facilities,

6. The development of public transport using the existing transport infrastructure and the transition to the advanced green technology,

7. Encourage the use of energy-efficient tools and support,

8. Creating awareness, resources, and reduce water consumption and water losses by improving the network management,

9. Sewage water treatment plant and sludge treatment projects for increasing energy efficiency.

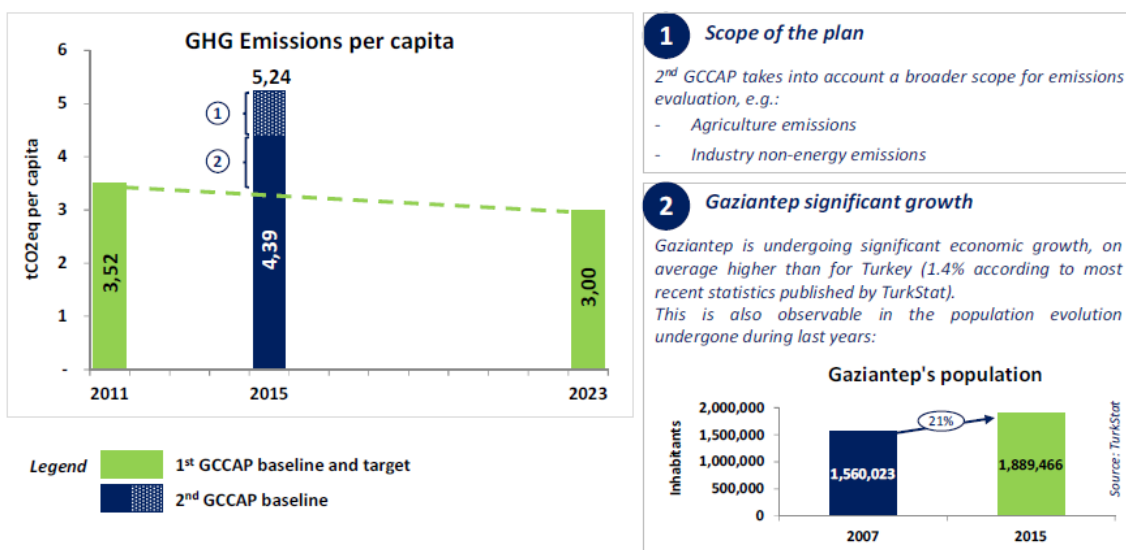

Figure 3. Greenhouse gas emissions baselines established in 1st and 2nd GCCAP. (GCCAP,2016)

Conclusion

This study has shown how an urban forest climate response can be fitted to a broad sustainable urban forest management framework and comprise both mitigation and adaptation responses.

The first in order to bring the standard as 6785 of urban green space in our country on "Reconstruction Act" of the date 07.20.1972 as amended by Law numbered 25 for 1605 was projected at a minimum of 7 m² green area per capita of Article. green fields covered by this standard, "Regulation on Principles of the Plan and Making Changes" and "active green space" as defined and scope of the park is designated as a children's playground and play areas. 09.02.1999 dated "3030 Law coverage of the Regulation on the Amendment of the remaining municipalities Type Zoning Regulations" active green space amount per capita, except for the metropolitan municipalities, within

municipalities and contiguous areas limit from 10 m², it has been increased to 14 m² levels outside these boundary (Doymun and İltir, 2007). According to land use/land cover maps was measured green area per capita as 15 m². With this study, it was observed that there is no sufficient urban forest for the rapidly growing Gaziantep province; also it is thought that, in terms of habitat function, natural tree types must be determined for enriching.

It has also seen that focus on increasing the presence of green space in the city of Gaziantep under the climate change action plan. The next action plan must be considered to be made of urban forests.

References

Anonymus, 2015. Gaziantep ili 2014 yılı çevre durum raporu, Çed ve Çevre İzinleri Şube Müdürlüğü Gaziantep - 2015

Anonymus, 2016. TÜİK, Türkiye İstatistik Kurumu, il ve ilçe nüfus göstergeleri http://www.tuik.gov.tr/yillik/Ist_gostergeler.pdf

Atay I., 1988. "Kent Ormanları ve Çevre ile Etkileşimleri", İ.Ü.Orman Fakültesi Dergisi, Seri B Cilt:40, s:1-5, İstanbul.

Brown,S., 1997. Ormanlar ve İklim Değişikliği: Karbon Rezervi Olarak Ormanlık Alanların Rolü, XI. Dünya Ormancılık Kongresi Bildirileri, Antalya.

Dirik, H., Ata, C., 2004. Kent Ormancılığının Kapsamı, Yararları, Planlanması ve Teknik Esasları, I. Ulusal Kent Ormancılığı Kongresi Bildiriler Kitabı, 63-77, Ankara.

Doygun, H. & İLTER, A. A., 2007. Kahramanmaraş Kentinde Mevcut ve Öngörülen Aktif Yeşil Alan Yeterliliğinin İncelenmesi. *Ekoloji* 17, 65: 21-27.

Federer C., 1989. "Trees Modify the Urban Microclimate", *Journal of Arboriculture*, 2(7):121-127.

Grey,G. W., Deneke F.J., 1986. *Urban Forestry*. New York: John Wiley and Sons

Heisler,G.M., 1986. Effects of individual trees on the solar radiation climate of small buildings. *Urban Ecology* 9: 337-359.

Heidt V., Neef M., 2006. "Benefits of Urban Green Space and Urban Climate", Available: <http://www.regiocomun.geowiss.uni-mainz.de>

Jones, P. D., Groisman, P. Y., Coughlan, M., Plummer, N., Wang, W-C., and Karl, T. R.: 1990, 'Assessment of Urbanization Effects in Time Series of Surface Air Temperature over Land', *Nature* 347, 169-172.

Jonsson,P., 2004. Vegetation as an urban climate control in the subtropical city of Gaborone, Botswana. *International Journal of Climatology* 24 (10): 1307-1322.

Kukla, G., Gavin, J., and Karl, T. R.: 1986, 'Urban Warming', *J. Clim. Appl. Meteorol.* 25, 1265-1270.

McPherson, E. G. 1994. "Cooling Urban Heat Island with Sustainable Landscapes The Ecological City: Preserving and Restoring", *Urban Biodiversity*, p:151-172, University of Massachusetts Press, Amherst.

Meyer, F. M., 1977. "Şehir Çevresi Ağaçlıkları", İ.Ü.Orman Fakültesi Dergisi, 26(2):256-279.

Nowak D. J., 1993, Atmospheric Carbon Reduction by Urban Trees. *Journal of Environmental management*, 37(3):207-217.

Nowak,D., 2000. The Interactions Between Urban Forests And Global Climate Change. In:Abdollahi,K.K., Ning,Z.H. Appeaning,A. (ed.) *Global climate change & the urban forest*. Franklin Press Inc. and GCRCC, Baton Rouge. p. 31-44.

Nowak,D.J., Crane,D.E., 2002. Carbon storage and sequestration by urban trees in the USA. *Environmental Pollution* 116 (3): 381-389.

Nowak, D. J., Greenfield, E. J. 2012. Tree and impervious cover change in U.S. cities. *Urban Forestry & Urban Greening*, 11(1), 21-30.

Ozbadem S.A., Okkiran P., Gökçek B., Doygun H., 2014. Gaziantep ili doğal ve kültürel peyzaj potansiyeli için yönetim planı önerisi, Akdeniz ormanlarının geleceği: sürdürülebilir toplum ve çevre, 11. Ulusal Akdeniz orman ve çevre sempozyumu, (22-24 ekim 2014) , 232-240, Isparta, Turkey.

Taha H., Akbari H., Sailor D., 1992. "On the Simulation of Urban Climates: Sensitivity to Surface Parameters and Anthropogenic Heating", Technical Note, Lawrence Berkeley Laboratory.

Sanders,R.A., 1986. Urban vegetation impacts on the hydrology of Dayton, Ohio. *Urban Ecology* 9 (3): 361-376.

Scott,K.I., Simpson,J.R. Mcpherson,E.G., 1999. Effects of tree cover on parking lot microclimate and vehicle emissions. *Journal of Arboriculture* 25 (3): 129-142.

Souch,C., Grimmond,S., 2006. Applied climatology: Urban climate. *Progress in Physical Geography* 30 (2): 270-279.

Wigley, T. M. L. and Jones, P. D.: 1988, 'Do Large-Area Average Temperature Series have an Urban Warming Bias?', *Clim. Change* 12, 313-319.

Wood, F. B.: 1988, 'Comment: On the Need for Validation of the Jones et al. Temperature Trends with Respect to Urban Warming', *Clim. Change* 12, 292-312.

Watkins, S. L., 2015. The Public Good Nature of the Urban Forest and Implications for Management, 28p.

Yang, J., McBride J., Zhou, J. Sun, Z., 2005 "The Urban Forest in Beijing and its Role in Air Pollution Reduction", *Urban Forestry & Urban Greening* 3:65-78.

Investigation of Forest Areas in Subalpine Zone towards Alpine Zone by Effect of Climate Change

*Canan AÇIKGÖZ HARŞIT¹, Aydın TÜFEKÇİOĞLU¹, Mehmet KÜÇÜK¹, Musa DİNÇ¹

¹Artvin Coruh University, Faculty of Forestry, Artvin/TURKEY

*Corresponding Author: cananackz@yahoo.com

Abstract

We investigated that climate change affected to alpine zone whether or not change in the down or upward direction in the 3 regions (2000 m and above) within the boundaries of Artvin and Rize. The study area consist of forest border, treeline and squat (crippled) tree line and located 9 different regions with a total of 40 experiment areas. The size of the each experimented area was 5 m x 20 m (100 m²). At the same time, we determined that aspects, altitude (m), slope (%) and tree diameter, age and height for taller than 3 m trees in the each study area. According to the study results; there were not significant differences between region (Artvin Central, Artvin-Yusufeli and Rize-Camlıhemşin) of top forest zones, compared to diameter, length and tree ages. But, there were a significant differences between Artvin-Central and Rize-Camlıhemşin compared to diameter, length and ages with elevation changes. The result indicated that, the upper zone of the forest moved to higher altitudes, because of the effects of global climate change in the Artvin-Central and Rize-Camlıhemşin regions.

Keywords: Forest Borders, Treeline, Global Climate Change, Artvin, Rize.

İklim Değişiminin Etkisiyle Subalpin Zondaki Orman Alanlarının Alpin Zona Doğru İlerlemesinin Araştırılması

Özet

İklim değişiminin Artvin ve Rize illeri sınırları içerisinde bulunan toplam 3 yörede 2000 m ve üzerinde bulunan alpin zon sınırında aşağı ya da yukarı yönde bir değişimin olup olmadığı araştırılmıştır. Orman sınırı, ağaç sınırı ve bodur (kötürüm) ağaç sınırını içine alan 5m x 20m boyutlarında (100 m²) 9 farklı mevki de 40 adet deneme alanı oluşturularak bu alanların bakışı, yükseltisi (m), eğimi (%), 3 m den boylu ağaçların boyları, çapları ve yaşları belirlendi. Çalışma sonucuna göre; yöreler arasında (Artvin- Merkez, Artvin- Yusufeli ve Rize- Çamlıhemşin) çap, boy ve yaş bakımından orman üstü zonlarda belirgin farklılık görülmezken, Artvin- Merkez ile Rize- Çamlıhemşin yörelerinde kendi içlerinde yükseklik değişimleri ile birlikte çap, boy ve yaş değerleri bakımından önemli farklılıklar ortaya çıkmıştır. Bu çalışma sonucunda özellikle Artvin- Merkez ve Rize- Çamlıhemşin yörelerinde orman üst zonu küresel iklim değişimi etkisi ile daha üst rakımlara taşındığı düşünülmektedir.

Anahtar Kelimeler: Orman Sınırı, Ağaç Sınırı, Küresel İklim Değişimi, Artvin, Yusufeli, Rize

Introduction

Natural climate change was replaced by climate change due to global warming. It emerged with the Industrial Revolution and the rate was increases quickly with human activity in the 20th century. As a result of human activities, CO₂, CH₄, N₂O, CFCs, greenhouse gas emissions, such as aerosols is increasing in the atmosphere. As a result of this, "global warming" is called artificially increasing process of the Earth' s temperature with the layer of the atmosphere near the earth. Due to global warming, precipitation,

humidity, air movement, droughts, etc. changes in other climatic factors is defined as "Global climate change" (Doğan, 2005). It is given in the graph Figure 1 showing the change in temperature occurring in the earth in the industrial era.

Both the rising geographical latitudes and descending temperature as well as high in the mountains, causes the formation of Forest Zones in horizontal and vertical direction in the world (Saatçioğlu, 1976).

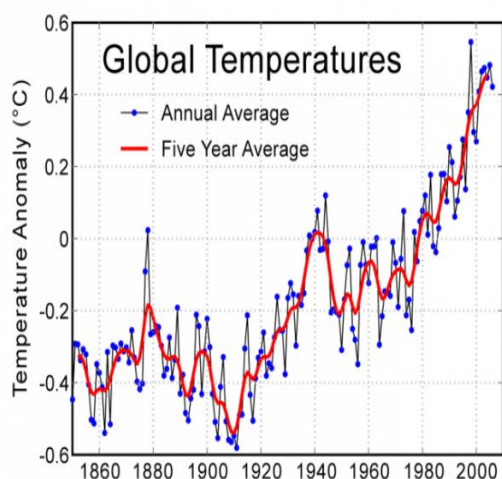

Figure 1. Changes in the Earth Temperature on Industrial Age (Anonymous, 2010)

Climatic conditions in the mountains (sea or terrestrial climate) is effective on the height of forest limits. Forest boundary is below than the place that has a continental climate, where under the influence of maritime climate. For example; Eastern Black Sea mountains, which under the influence of maritime climate has 2000 m elevation and Sarıkamış forest limit rises to an elevation of 2600 m with a continental climate. The reason for this is the lack of the summer temperatures in the sea climate. In continental climate area has more summer temperature it has to be more positive effect on tree growth. Therefore, forest boundary occurs at even higher elevations in the continental climate mountains (Yücesan, 2006).

Today, the main factor is human activity for the actual tree line in the Alps (Firewood requirement and requests the wide area as possible for cattle farming). Therefore, usually do not show a body structure cylindrical, because of the lower part of the trees wider and the top is narrow (Walter ve Breckle, 1983). Natural forest border, 1800-2000 meters from the edges of the Alps and in the middle Alps is around 2000 meters. However, overgrazing in forests, rooting and wood production has attracted a few hundred meters down the forest boundary from the potential forest borders (Çolak ve Pitterle, 1999). This situation is observed in high mountains forest in our country.

Tüfekçioğlu et al. (2008) "Climate Change and the Eastern Black Sea region of Turkey spruce (*Picea orientalis*) Ecosystem" examine the impact of climate change on the spruce forest in the light of field observations and existing literature. They stated that climate change can significantly affect the spruce ecosystem diversity, structure and stability, and also they stated that region temperature could rise by 2-4 0C according to model of the RegCM3. Also, rainfall in the Western part of the Eastern Black Sea Region not expected to increases, but in the Eastern part (Rize and Artvin) were estimated 200-300 mm of rainfall increases may occur. The temperature rise in the west region, will lead to more stress for spruce ecosystem and They predict that may increase the bark beetle epidemic. In addition, They expressed that forest fire would be a major problem in the west of spruce ecosystem. They envisaged that the spruce some probably would move up to 400-800 m and this shift will occur in the both East and West of the Eastern Black Sea Region.

It is possible to accomplish using aerial photographs for monitoring the changes occurring in the forest zone with the effects of climate change. Rondeau et al. (2014) found that the differences in the tree line by using of ArcGIS with USGS 1951- 2011 aerial photographs in the San Juan Mountains. They found significant differences in the areas of value to reflect light between the years of 1951-2011. However, they stated that it was impossible to changes reveal a numerical terms. They found that the upward climb rate was increased of between 2% to 27% for every region.

Global warming will cause the results are quite complex. According to an overview, many ecosystem are expected to change with live population of the host. Due to temperature, both plant and animal habitats of the population will change in horizontal and vertical. It will cause a change in the living area of 500 meters when the temperature rise of 3 ° c. Consequently, areas will be narrowed to live animal and plant populations. Ecosystem changes due to global warming, some species will be cause of extinction and lives zones shift the northward. Because, the tops of the mountains is narrower and this geographical situation will cause a further

reduction of animal and plant population. Consequently, they will become more sensitive for both genetic and environmental pressures (Rubenstein, 1992).

The temperature predictions for made in 2100, when temperature increase to about 3 °C the distribution of species move to 300-400 km north in the temperate zones or shift to 500 m higher elevations. Many species migrate by such a rapid change or it will have difficulties in responding through adaptation. Also, these species distribution is limited area and even generation is expected to run out completely. Under these conditions, % 15 to %37 of all species globally extinct by 2050 projected. The maximum effects is expected to occur in Arctic regions, Eastern Europe and low humidity in the ecosystem of the Mediterranean. These reduction in rainfall are expected that increased the soil erosion and emergence of more frequent forest fire. The absence of species that can replace endangered species, the wealth of available plant species in the Mediterranean region will be reduced in the twenty-first century. It can run down the generation of endemic species in the Northern Europe and is predicted to be filled by more competitive species in the long term (Hughes, 2000; Clarke, 2007; Bakkenes ve ark., 2002; Bakkenes ve ark., 2006).

Study Area

Study area is located in Forest Management Directorate of Artvin-Central, Yusufeli and Rize belongs to Regional Forest Directorate in Artvin and Rize. A total of 40 experiment area is determined. The distribution of the experiment points are as follow; Alabalık Village – Ortasirt Hill (2239 m) -2 units, Ortaköy (Berta) - Saman Hill (2547 m) -3 units, Hatila Valley - Tuzlu Hill (2531m) -5 units, Pertkaya Hill (2296 m) -4 units, Öğdem - Horsasol Hill (2907m) -6 units, Olgunlar - Kaçkarlar - Ovid Ridge (3016 m) -6 Units, Aşağıkavrun Plateau - Cargovit Hill (2859 m) -5 Units, Palakçur Plateau - Kuşaklıkul Hill (3281 m) -5 Units, Elevit, Yaylaköy - Kırmızıcağıl Hill (2900 m) -4 Units in located Ortaköy, Taşlıca, Öğdem, Altıparmak ve Çamlıhemşin Forest Management Units.

Study area latitudes was between; 4524836- 4577422 N and 670494- 759654 W (Figure 2). Areas have pure and mixed species

of Spruce, Scotch pine, Fir and Poplar. The average age of the trees between 11 to 65 years, the mean diameter between 1.7 to 35 cm and average height varies between 1.0 and 12.5 m. The average height of the study areas ranged from 1930-2465 m. The slope of the study area varies between 40% and 150%. The dominant aspect group were sunny (in general West and Northwest aspect).

Location of Research Area is given (Figure2)below.

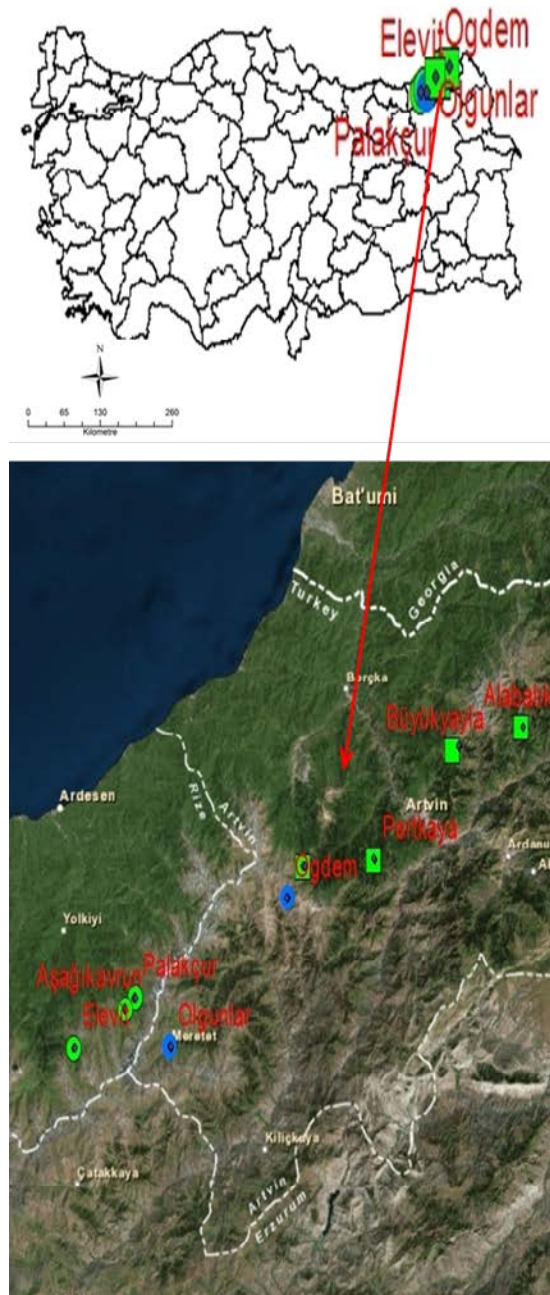

Figure 2. Location of Research Area

Material and Method

Research area consist of; located in the province of Artvin central (Alabalık Village, Ortaköy, Hatila Valley and Pertkaya), located within the boundaries of the province of Artvin Yusufeli (Öğdem and Olgunlar) and located in the province of Rize(Aşağıkavrun Plateau, Palakçur Plateau, Elevit). When the experiment area was selected, 2000 m and alpine zone boundaries and squat (crippled) tree line at the bottom of this zone has been noted. The dimension of the each experiment area was 5 mx 20 m (100m²). The study area divided into 3 regions (Artvin- Central, Artvin- Yusufeli and Rize- Çamlıhemşin) and total of 9 different sub-region. A total of 40 experiment sites were selected. All trees and shrubs species (longer than 3 meters) are identified and breast height diameter is measured at a height of 1.3 metres. For the other trees and shrubs (lower than 3 meters) diameter is measured at a height of 0.30 cm (the bottom diameter), tree age with the help of increment borer (year), tree height with using of electronic distance meter (m) and slope (%) measurement were made in the all study areas. Coordinate point values of the study area has been identified with the help of the GPS Global Positioning System). SPSS program is calculated by forming the regression equation.

To determine whether statistically significant differences between regions and sub-regions were made variance analysis and independent T test.

Results

Diameter, length and age data were evaluated for 4 sub-region in Artvin central and it has been identified in the range of average height was between 2021 to 2274, average diameter was between 2.5 to 16.6 cm, average length was between 1.66 to 7.64 m and average age was changed between 12 to

33 years. Accordingly, when elevation increases, diameter, height and age was decreased (Table 1), (Figure 3).

Diameter, length and age data were evaluated in 2 sub-region (Olgunlar and Öğdem) in Yusufeli region. it has been identified in the range of average height was 2454m, average diameter was 9.24 cm, average length was 3.4 m and average age was 24 years in Olgunlar sub-region. These values for Öğdem were; average height was 2425m, average diameter was 6.52 cm, average length was 2.6 m and average age was 20 years. There is not significant differences between these 2 sub-region in terms of elevation but diameter, height and age values were increasing depend on increasing of elevation (Table 2), (Figure 4).

Diameter, length and age data were evaluated in 3 sub-region in Rize – Çamlıhemşin region. These values are as follows; average height was between 2071 to 2222 m, average diameter was between 3.8 to 8.8 cm, average length was between 2.1 to 3.9 m and average age was between 23 to 33 years. 24 years. Accordingly, when elevation increases, diameter, height and age was increased (Table 3), (Figure 5).

There were no significant statistical differences between average diameter, height and age values ($p > 0,05$). In these reason, we can said that local temperature, precipitation and starting elevation of forest zone were different in the study areas. Also, different location types were effective for this situation. It may affect the comparison between the regions, because Rize region has high rainfall, Yusufeli has an arid climate and Artvin region has a semi-humid climate. Also, when the tree line in Yusufeli 2400m, other regions start in 2000. Therefore, diameter, height and age values in the regions making difficult to compare each other (Table 4), (Figure 6).

Table 1. Elevation and Age Table in the sub-region of Artvin (Central)

Sub-regions	Average Elevation (m)	Average Age (year)
Alabalık	2122	16 (a)
Büyükayla	2021	33 (b)
Tuzlutepe	2274	12.8 (a)
Pertkaya	2117	16 (a)

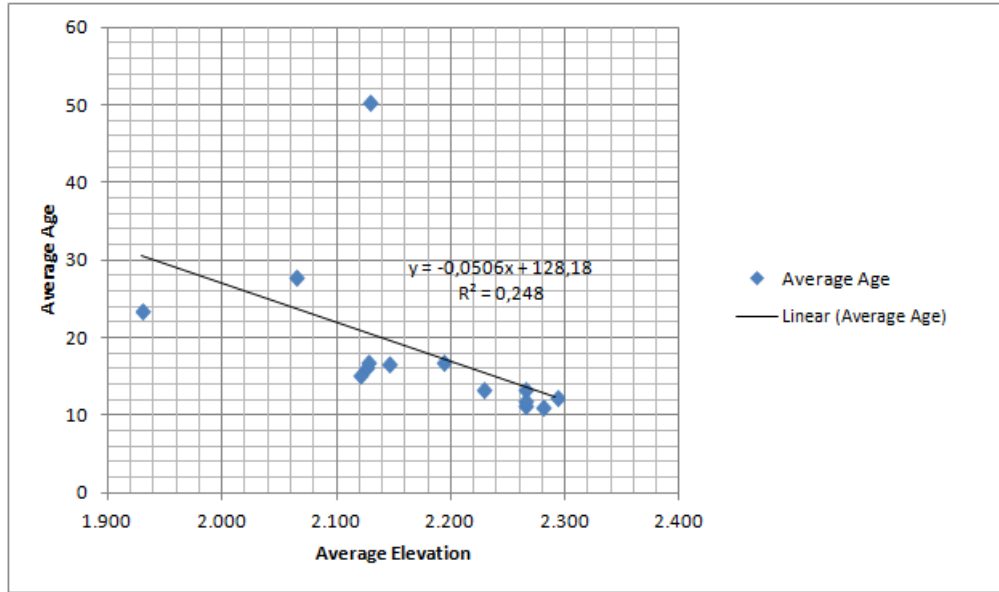

Figure 3. Graphic of Elevation and Age in the sub-region of Artvin (Central)

Table 2. Elevation –and Age Table in the sub-region of Artvin (Yusufeli)

Sub-regions	Average Elevation (m)	AverageAge (year)
Olgunlar	2454	24 (a)
Öğdem	2425	20 (a)

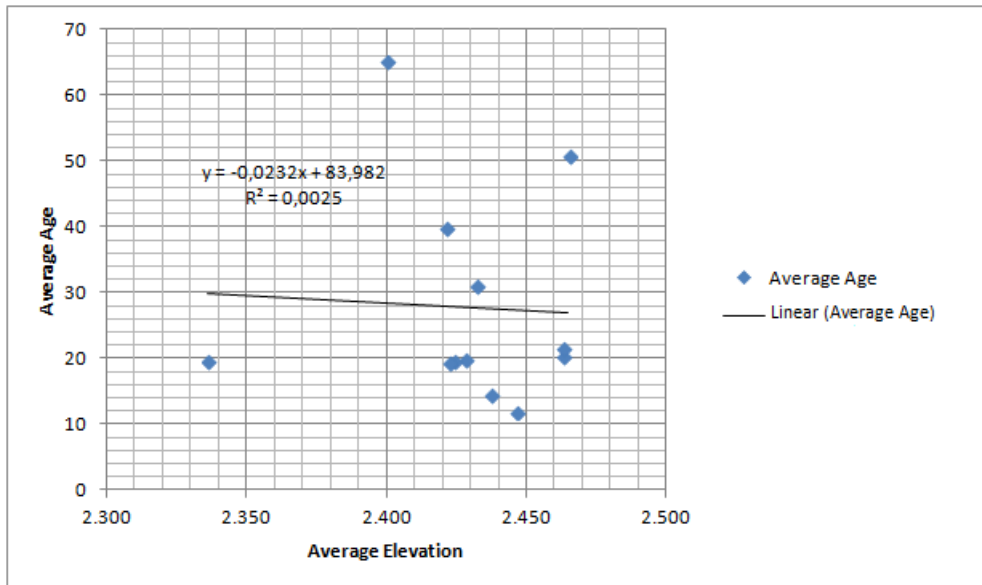

Figure 4. Graphic of Elevation and Age in the sub-region of Artvin (Yusufeli)

Table 3. Elevation and Age Table in the sub-region of Rize (Çamlıhemsin)

Sub-regions	Average Elevation (m)	AverageAge (year)
Aşağıkavrun	2071	24 (a)
Elevit	2222	33 (b)
Palakçur	2209	23 (a)

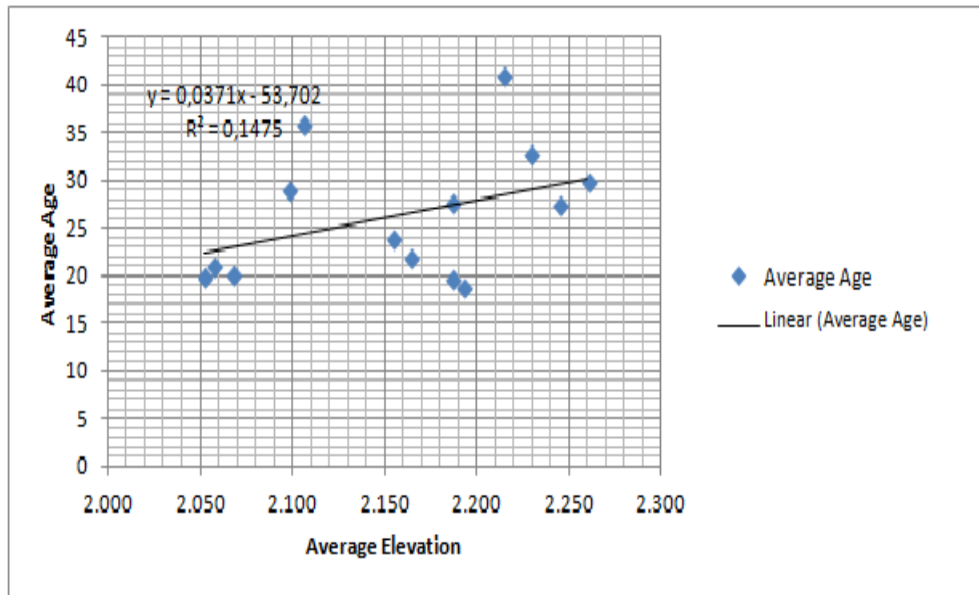

Figure 5. Graphic of Elevation and Age in the sub-region of Rize (Çamlıhemşin)

Table 4. Elevation and Age Table for all regions

Regions	Average Elevation (m)	AverageAge (year)
Artvin-Merkez	2173	19 (a)
Artvin- Yusufeli	2428	22 (a)
Rize- Çamlıhemşin	2158	27 (a)

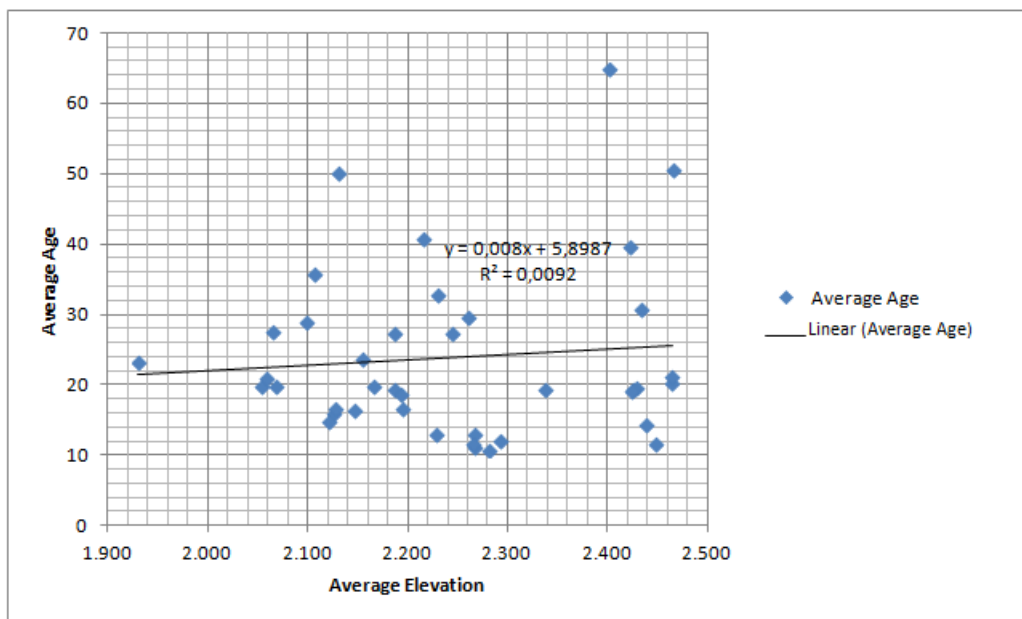

Figure 6. Graphic of Elevation and Age for all regions

Conclusion and Suggestions

Generally, considered the whole area, (Artvin- Merkez, Artvin- Yusufeli, Rize- Çamlıhemşin), average height, average diameter, average length and average age

were change between 2134 m and 2440 m, 5.7 cm and 7.9 cm, 2.8 m and 3.7 m, 19 and 27 respectively. According to these data, when elevation was increased, diameter, height and age values to have increased.

In this study, retrospective meteorological data (increase in temperature and precipitation) has been shown that the upper zone of the forest borders move to upwards. Consequently, the assumption being told in advance in Eastern Black Sea Region would be increase the forest zone a result of global climate change. However, each region would be more appropriate to evaluate separately because different locations has different diameter, height and age variation. Also, each region has different climate type, geographical and social structure. Therefore, this kind of studies must be performed locally.

Also, performed to compare the current and past situation, effect of climate change on forest zones using of aerial photographs of the region will be more effective and specific.

In case of the vegetation to go to forest above zone, damage can be minimized if take control of their grazing activities for the protection of vegetation in the upper forest zone.

References

- Anonim,2010. Word Press, n/d. Nature's Crusaders. Retrieved on April 27, 2010 from naturescrusaders.wordpress.com.
- Bakkenes, M., Alkemade, J.R.M, Ihle, F.,Leemans, R.and J.B.Latour, 2002. Assessing Effects of Forecasted Climate Change on the Diversity and Distribution of European Higher Plants for 2050, *Global Change Biology*, 8, 390–407.
- Bakkenes M., Eickhout, B. and Alkemade, R., 2006. Impacts of Different Climate Stabilisation Scenarios on Plant Species in Europe, *Global Environmental Change Volume 16, Issue 1, Pages 19-28*
- Clarke, H., 2007. Conserving Biodiversity in the Face of Climate Change, *Agenda*, Volume 14,Number 2, 2007, pages 157-170
- Çolak, A. H. ve Pitterle, A., 1999. Yüksek Dağ Silvikültürü. Cilt I-Orta Avrupa. Genel Prensipier. I. Baskı, İstanbul.
- Doğan, S., 2005. Türkiye'nin Küresel İklim Değişikliğinde Rolü ve Önleyici Küresel Çabaya Katılım Girişimleri. *CÜ İktisadi ve İdari Bilimler Dergisi*, 6(2), 57-73.
- Hughes, L., 2000. Biological Consequences of Global Warming: is the Signal Already Apparent?, *Trends in Ecology and Evolution* 15(2), ss. 56–61.

Saatçioğlu, F., 1976. Silvikültürün Biyolojik Esasları ve Prensipleri, (Silvikültür I), İÜ Orman Fakültesi, Yayın No: 2187/222, İstanbul.

Rondeau, R., Fink, M., Rodda, G. and Kummel, M., 2014, *Treeline Monitoring in the San Juan Basin Tundra: A pilot Project*, p 1-16.

Rubenstein, D. I., 1992. The Greenhouse Effect and Changes in Animal Behavior: Effects on Social Structure and Life-History Strategies. In *Global warming and Biological Diversity* (Chapter 14, pp. 180-192). Connecticut : Yale University Press.

Tüfekçioğlu, A., Güner, S. ve Tilki, F., 2008. Climate Change And Oriental Spruce (*Picea Orientalis*) Ecosystems In Eastern Blacksea Region Of Turkey. *Artvin Çoruh Üniversitesi Orman Fakültesi Dergisi*, 9(1), 101-106.

Walter, H. and Breckle, S.W., 1983. *Ökologie der Erde. Ökologische Grundlagen in Globaler Sicht. Band 1*, UTB, Stuttgart.

Yücesan, Z., 2006. Yüksek Dağ Ormanlarının Kavramsal Çerçevesi ve Silvikültürel Özellikleri. *Kırsal Çevre Yıllığı* ,s. 9.

Ecosystem Biomass of Oak Coppice in Turkey

*Nuray MISIR¹, Sinem ŞATIROĞLU¹

¹Karadeniz Technical University, Faculty of Forestry, Trabzon/ TURKEY

*Corresponding Author: nuray@ktu.edu.tr

Abstract

Forest biomass is considered to have a large potential for temporary and long-term carbon storage. Enhancing C sequestration by increasing forested land area has been suggested as an effective measure to mitigate elevated atmospheric carbon dioxide concentrations and hence contribute towards the prevention of global warming. To determine of the cause of global warming and take action, Turkey which party to various international conventions have to report and reduce greenhouse gases emissions. This situation makes our forests could be important to identify how much have biomass and carbon. Although there are several researches in our country, none of them mention coppices. We assessed aboveground ecosystem biomass for oak coppice in Turkey. Living tree biomass and litter were determined from plot-level inventories and destructive tree sampling. Living tree biomass including stem, branch, leaf, bark was estimated from sample plots and sample trees.

Keywords: Oak, Coppice, Living tree biomass, Litter, Regression analysis

Meşe Baltalıklarının Ekosistem Bazında Biyokütlesi

Özet

Ormanların sahip olduğu biyokütle geçici ve uzun süreli karbon depolaması açısından büyük bir potansiyele sahiptir. Atmosferdeki karbondioksit konsantrasyonunu azaltmak için ormanlık alanların artırılması ve mevcut olanların geliştirilmesi etkili bir önlem olarak öne sürülmüştür. Küresel ısınmanın sebeplerinin tespiti ve alınması gereken önlem ve adımların belirlenmesi için çeşitli uluslararası sözleşmelere taraf olan Türkiye, sera gazı emisyonunu rapor etmek ve azaltmak zorundadır. Bu durum ormanlarımızın ne kadar karbon depolayabileceğinin tespitini gerekliliktedir. Ülkemizde bu amaçla yapılmış birkaç çalışma olmasına rağmen baltalıklar için herhangi bir çalışma bulunmamaktadır. Bu amaçla meşe baltalıklarının topraküstü biyokütlesinin belirlenmesi amaçlanmıştır. Ağaç ve ölü örtü biyokütlesinden oluşan topraküstü biyokütlesi alan envanteri ve ağaç örnekleme yapılarak belirlenmiştir.

Anahtar Kelimeler: Meşe, Baltalık, Ağaç biyokütlesi, Ölü örtü biyokütlesi, Regresyon analizi

Introduction

Recent trends in greenhouse gas concentrations have created concern associated with climate change. Warming of the climate system is unequivocal, as is now evident from observations of increased global air and ocean temperatures, widespread melting of snow and ice, and rising global average sea level (IPCC, 2007). Forested ecosystems may help contribute toward carbon sequestration by capturing and storing atmospheric CO₂ where it is not immediately re-emitted to the atmosphere. For this reason, estimation of biomass or carbon sequestered by terrestrial plants has drawn global interest and accurate estimation of living tree and forest biomass is crucial for both practical forestry issues and scientific

forest management (Parresol 1999; Wang 2006; Chapagain et al 2014).

Forest biomass contains approximately 80% of all aboveground terrestrial carbon (C) and 40% of belowground C (Dixon et al., 1994; Goodale et al., 2002). Aboveground biomass and C storage in forest ecosystems is usually found within the living tree biomass components (stem, branches, bark and foliage). Understory and ground vegetation, litter as well as of dead standing tree and woody debris also part of the aboveground biomass. Belowground biomass is defined as the entire biomass of all live roots and soil.

Biomass models are developed with regression methods using one or more explanatory variables. Most commonly used explanatory variables are tree diameter,

height and wood density, and they are used singly or in combination in the models (e.g. Brown et al. 1989; Chave et al. 2005; Basuki et al. 2009; Chaturvedi et al. 2012a; Subedi and Sharma 2012, Chapagain et al. 2014). Some researcher in our country improved biomass models for several species (Saraçoğlu 1992; Durkaya 1998; İkinci 2000; Ünsal 2007; Atmaca 2008; Çakıl 2008; Ülküdür 2010; Ülker 2010; Aydın 2010 vb., Yavuz et al. 2010; Makineci 2011; Mısır and Mısır 2012). However, any equations exist for trees originating from coppice.

Oak is the second species which has highest distribution area in Turkey and almost %60 of these areas are coppices. Coppicing is a traditional silvicultural management system applied all over the world. It is mostly used for the production of firewood and various non-timber forest products. In many European countries, this practice was abandoned in the first half of the last century due to socio-economic changes. In recent years, Turkey has begun to abandon the concept of coppices also. However, the area of abandoned, coppice forests is assumed to amount to several million hectares. These oak coppice forests represent a potential biomass source of unknown magnitude. The aim of this study was estimate biomass and easily develops applicable equations for the calculation of aboveground biomass of one of the most common coppice forest species in Turkey.

Material and Methods

Material

The data used in this study were collected from oak coppices in Arapgir Forest District of Malatya Forest Enterprise. Total area of the study is 263 419.1 ha and forested area is 41 908.3 ha.

From the various age and site classes, 30 temporary sample plots were measured in 2013. These 30 plots, 19 are groups and 11 are individual tree plots which size range 100 m² to 800 m². Diameter at breast heights of all trees were measured in each sample plots. Subsequently, the diameter range of all trees at each study site was divided into 10 diameter size classes and 5 height size classes. To be evenly distributed to these

classes, 30 sample trees were cut these 30 plots (Table 1).

The litter was sampled by collecting the entire litter within a 0.06 m² quadrant placed at the four point of each stand.

Methods

To record the living tree biomass, all sample trees were felled as close to the ground as possible. After felling, diameter of each 50 cm section, *dbh*, tree height and green crown were measured. Before removing the branch, the basal diameter and height of each branch was measured. All branches were then clipped from the tree. Then, the branches are separated into leaves and branch wood. The stem was divided into pieces. Fresh weight of all tree compartments was measured. All of samples were labeled and transported in plastic bags to the laboratory.

All woody components (stem and branch wood) were dried at 105±3°C to a constant mass and weight (±0.01 g) to determine the dry biomass (about 96 hours). Barks of stems were peeled for each 30 trees. Leaves and litters were dried at 105±3°C to a constant mass and weight (±0.01 g) to determine the dry biomass (about 24 hours).

For regression analysis of living trees biomass we only considered the total aboveground part per tree that is the biomass values for stem, bark, branch woods and leaves. Input variable for the biomass models were *dbh*. All computation was performed using the statistical software package SPSS 20.0. After several regression models were tested, model for all component of trees were chosen to statistical criteria such as adjusted *R*², statistical significance (*P* < 0.05) and standard error.

Table 1. Some statistics of the sample tree

	Minimum	Maximum	Mean	Std. Deviation
Dbh (cm)	1.8	10.0	5.690	2.2429
Height(m)	2.2	5.4	4.107	0.7935

Result and Discussion

As a result of regression analysis Quadratic model was found to be most suitable for the prediction of tree

compartment dry mass as a function of dbh for stem biomass, Compound model was found to be most suitable for branch wood and leaves biomass, Power model was found to be most suitable for bark and living tree biomass (Table 2).

Table 2. Allometric regression models

Biomass Components	Model	Parameters			R ²	S _{yx}	F	Significance levels
		b ₀	b ₁	b ₂				
Stem	$Y = b_0 + b_1 d + b_2 d^2$	0.728	-0.064	0.122	0.992	0.341	968	P<0.05
Branch wood	$Y = b_0 \times b_1 d$	0.133	1.404		0.756	0.948	53	P<0.05
Leaves	$Y = b_0 \times b_1 d$	0.105	1.210		0.439	0.185	13	P<0.05
Bark	$Y = b_0 \times d^{b_1}$	0.064	1.608		0.954	0.255	350	P<0.05
Living tree	$Y = b_0 \times d^{b_1}$	0.471	1.574		0.944	1.457	288	P<0.05

Stem biomass at the stand level ranged from 8,3 t ha-1 to 44,0 t ha-1, branch wood biomass at the stand level ranged from 3,8 t ha-1 to 30,4 t ha-1, leaves biomass at the stand level ranged from 0,6 t ha-1 to 30,4 t ha-1, bark biomass at the stand level ranged from 1,8 t ha-1 to 9,1 t ha-1 and living tree biomass at the stand level ranged from 16,9 t ha-1 to 86,4 t ha-1. As mentioned earlier, there isn't found any biomass equations for originating oaks coppice in Turkey. In this context, compare with other works, oak coppices mostly have lower results (Table 3). Biomass of tree components and living tree was found to be lower than oak forest in Thrace region (Makineci et al., 2011). This may be attributable to the absence of thinning and hence different stem forms in the forests of coppice origin, whereas this is common practice in high forests, or to lower site qualities of coppice forests, which were often established and maintained on steep slopes with shallow soils. Lim (2012) found

more branch and leaves biomass while less than stem and living tree biomass. The reason is that Lim worked oak shrubland. When compare to other works which are made for other species, for example; Scotch pine forests in Black Sea Region (Yavuz et. al., 2010) have more stem, needles and tree biomass while have less than branch and bark biomass, Ülker (2010) was estimate stem, needles, bark and tree biomass more than us, branch biomass was estimated to lower than us (see also Table 3), shown to similar and expected results.

Litter biomass was ranged from 2.6 t ha-1 to 11.8 t ha-1. This amount was ranged from 19.8 t ha-1 to 33.8 t ha-1 in Oriental spruce (Bülbül, 2012), was ranged from 1.3 t ha-1 to 23.0 t ha-1 shrubland in South Africa (Abandan et. al., 2011), was ranged from 1.2 t ha-1 to 9.3 t ha-1 oak forest in Thrace region (Makineci et al., 2011). When we compare to Makineci et al.(2011) oak coppices have more litter biomass over high oak forest.

Total aboveground biomass for oak coppices was 41.3 t ha-1 (from 23.2 t ha-1 to 91.2 t ha-1). This amount was 80.0 t ha-1 (from 2.7 t ha-1 to 182.5 t ha-1) for high oak forest Thrace region (Makineci et al., 2011) and was 137.8 t ha-1 for oak forest in South Korea (Son et. al. 2004). Aboveground biomass for oak coppices was found to be lower than these of high oak forest (Makineci et al., 2011 and Son et. al. 2004).

Table 3. Some statistics of tree and tree components biomass

	Species	Tree Components	Amount of Biomass (t ha ⁻¹)		
			Minimum	Maximum	Mean
Yavuz et al. (2010)	Scotch Pine (High Forest)	Stem	14.8	64.2	32.4
		Branch wood	0.8	4.3	1.7
		Needles	2.1	10.6	5.7
		Bark	0.1	0.7	0.2
		Living tree	21.8	113.9	40.2
Ülker (2010)	Scotch Pine (High Forest)	Stem	12.1	60.1	24.9
		Branch wood	1.9	7.6	4.5
		Needles	1.9	10.7	5.6
		Bark	1.9	31.8	7.6
		Living tree	21.9	110.0	42.6
Lım (2012)	Oak (Shrubland)	Stem	2.8	29.2	12.4
		Branch wood	3.8	40.2	15.7
		Leaves	1.3	13.2	5.7
		Bark	-	-	-
		Living tree	8.8	82.6	33.8
Makineci et al. (2011)	Oak (High Forest)	Stem	12.9	77.0	28.2
		Branch wood	3.6	21.1	8.1
		Leaves	1.8	9.2	4.4
		Bark	3.5	19.6	8.1
		Living tree	21.9	126.9	48.8
Şatıroğlu (2015)	Oak (Coppices)	Stem	8.3	44.0	20.0
		Branch wood	3.8	30.4	8.8
		Leaves	0.6	3.0	1.4
		Bark	1.8	9.1	4.4
		Living tree	16.9	86.4	34.6

References

Abandan, P.A., Compton, J.S. and Hannigan, R. S., 2011. Soil Nutrient Content, above-ground biomass and litter in semi-arid shrubland, South Africa, *Geoderma* 164-137.

Atmaca, S., 2008. Erzurum Orman Bölge Müdürlüğü Sarıçam Biyokütle Tablolarının Düzenlenmesi, Yüksek Lisans Tezi, Z.K.Ü., Fen Bilimleri Enstitüsü, Zonguldak.

Aydın, Ç., 2010. Artvin Orman Bölge Müdürlüğü Borçka Orman İşletme Müdürlüğü Sarıçam Biyokütle Tabloları, Yüksek Lisans Tezi, Karadeniz Teknik Üniversitesi, Fen Bilimleri Enstitüsü, Trabzon.

Basuki TM, van Laake PE, Skidmore AK, Hussin YA. 2009. Allometric equations for estimating the above-ground biomass in tropical lowland Dipterocarp forests. *For Ecol Manage.* 257 (8):1684–1694.

Brown S, Gillespie AJR, Lugo AE. 1989. Biomass estimation for tropical forests with applications to forest inventory data. *For Sci.* 35(4):881–902.

Bülbül, E., 2012. K.T.Ü Orman Fakültesi Eğitim ve Araştırma Ormanı Saf Ladin Meşcerelerinin Karbon Depolama Miktarının Belirlenmesi, Yüksek Lisans Tezi Karadeniz Teknik Üniversitesi, Fen Bilimleri Enstitüsü, Trabzon.

Chapagain, T.R., Sharma, R. P. And Bhandari, S. K., 2014. Modeling above-ground biomass for three tropical tree species at their juvenile stage, *Forest Sci and Tech*, 10:2, 51-60.

Chave J., Andalo C., Brown S, Cairns M.A., Chambers J.Q., Eamus D, Folster H., Fromard F., Higuchi N., Kira T., Lescure J.P., et al. 2005. Tree allometry and improved estimation of carbon stocks and balance in tropical forests. *Oecologia*. 145 (1):187–99.

Çakıl, E., 2008. Zonguldak Orman Bölge Müdürlüğü Karaçam Meşcereleri Biyokütle Tablolarının Düzenlenmesi, Yüksek Lisans Tezi, Z.K.Ü., Fen Bilimleri Enstitüsü, Zonguldak.

Chaturvedi RK, Raghubanshi AS, Singh JS. 2012a. Biomass estimation of dry tropical woody species at juvenile stage. *The scientific world journal* 2012:1–5 (doi:10.1100/2012/790219)

Dixon, R.K., Trexler, M.C., Wisniewski, J., Brown, S., Houghton, R.A., Solomon, A.M., 1994. Carbon pools and flux of global forest ecosystems. *Science* 263, 185–190

Durkaya, B., 1998. Zonguldak Orman Bölge Müdürlüğü Meşe Meşcerelerinin Biyokütle Tablolarının Düzenlenmesi, Yüksek Lisans Tezi, Z.K.Ü., Fen Bilimleri Enstitüsü, Zonguldak.

Goodale, C.L., Heath, L.S., Houghton, R.A., Jenkins, J.C., Kohlmaier, G.H., Kurz, W., Liu, S., Nabuurs, G.J., Nilsson, S., Shvidenko, A.Z., Apps, M.J., Birdsey, R.A., Field, C.B., 2002. Forest carbon sinks in the Northern Hemisphere. *Ecol. Appl.* 12, 891–899.

IPCC (Intergovernmental Panel on Climate Change), 2007. Climate change 2007: Synthesis report. IPCC, Geneva, Switzerland.

İkinci, O., 2002. Zonguldak Orman Bölge Müdürlüğü Kestane Meşcereleri Biyokütle Tablolarının Düzenlenmesi, Yüksek Lisans Tezi, Z.K.Ü., Fen Bilimleri Enstitüsü, Zonguldak.

Makineci, E., Yılmaz, E., Kumbaşlı, M., Yılmaz, H., Çalışkan, S., Sevgi, O., Ketten, A., Zengin, H., Beşkardeş, V. ve Özdemir, E., 2011. Kuzey Trakya Koruya Tahvil Meşe Ekosistemlerinde Sağlık Durumu, Biyokütle, Karbon Depolama ve Faunistik Özelliklerin Belirlenmesi, TUBİTAK-TOVAG Projesi (Proje No:107O750), İstanbul.

Mısır, M., Mısır, N. and Erkut, S., 2012. Estimations of Total Ecosystem Biomass and Carbon Storage for Fir (*Abies nordmanniana* S. *subsp. bornmülleriana* (Mattf.)) Forests (Western

Black Sea Region)14th IUFRO Fir Symposium, September, Kastamonu, Bildiriler Kitabı.

Parresol BR. 1999. Assessing tree and stand biomass: A review with examples and critical comparisons. For Sci. 45(4): 573–593.

Peichl, M. and Arain, M. A., 2007. Allometry and partitioning of above- and belowground tree biomass in an age-sequence of white pine forests, Forest Ecology and Management, 253, 68–80.

Son, Y., Park, I. H., Yi, M.Y., Jin, H. O., Kim, D.Y., Kim, R. H. and Hwang, J. O., 2004. Biomass, Production and Nutrient Distribution of a Natural Oak Forest in Central Korea, Ecological Research, 19, 21–28.

Subedi MR, Sharma RP. 2012. Allometric biomass models for bark of *Cinnamomum tamala* in mid-hill of Nepal. Biomass Bioenerg. 47:44–49.

Ülker, C., 2010. Amasya Orman Bölge Müdürlüğü Sarıçam (*Pinus sylvestris* L.) Meşcerelerinin Biyokütle Tablolarının Düzenlenmesi (Kunduz Örneği), Yüksek Lisans Tezi, K.T.Ü., Fen Bilimleri Enstitüsü, Trabzon.

Ülküdür, M., 2010. Antalya Orman Bölge Müdürlüğü Sedir Meşcerelerinin Biyokütle Tablolarının Düzenlenmesi, Yüksek Lisans Tezi, Bartın Üniversitesi, Fen Bilimleri Enstitüsü, Bartın.

Ünsal, A., 2007. Adana Orman Bölge Müdürlüğü Karaisalı Orman İşletme Müdürlüğü Kızılcık Biyokütle Tablolarının Düzenlenmesi, Yüksek Lisans Tezi, Z.K.Ü., Fen Bilimleri Enstitüsü, Zonguldak.

Yavuz, H., Mısır, N., Mısır, M., Tüfekçioğlu, A., Karahalil, U. ve Küçük, M., 2010. Karadeniz Bölgesi Saf ve Karışık Sarıçam (*Pinus sylvestris* L.) Meşcereleri İçin Mekanistik Büyüme Modellerinin Geliştirilmesi, Biyokütle ve Karbon Depolama Miktarlarının Belirlenmesi, TÜBİTAK Projesi, Trabzon.

Wang CK. 2006. Biomass allometric equations for 10 cooccurring tree species in Chinese temperate forests. For Ecol Manage. 222(1–3):9–16.

Recognizability of Officinal Plants in Artvin and Conscious Level on Plant Smuggling (Şavşat and Borçka Cities Sample)

*Sevim İNANÇ¹, Hüseyin AYAZ², Özgür EMİNAĞAOĞLU¹

¹Artvin Çoruh University, Faculty of Forestry, Artvin / TURKEY

²Karadeniz Technical University, Faculty of Forestry, Trabzon / TURKEY

*Corresponding Author: inanc_sevim@hotmail.com

Abstract

Turkey is one of the richest countries in point of biological diversity in the world. 4 of the important plant areas from 122 important plant areas are within the boundaries of Artvin city. Active participation of local community is of vital importance for saving this biological diversity, utilising within the sustainability principles and struggle against plant smuggling.

Şavşat and Borçka cities where are the richest places in point of biological diversity in Artvin were chosen as research field. The study is limited with 50 pieces officinal plants grow over on habitat, chosen by us. The intended population is people live in countrysides of these cities. It was tested about the recognizability of officinal plants and benefiting status by people with the help of surveys that are prepared and applied with face to face meeting method. Moreover it was tried to reach the results for determining the sensitiveness of people against plant smuggling.

With regard to the results obtained, it is determined that the rural community live in research field could recognize only 34% of 50 pieces officinal plants that grow over on habitat and use them in accordance with scientific properties with the aim of healing or feeding as well. One other result is only 28% of attenders have knowledge about plant smuggling. The addition result about sensitiveness of attenders regarding plan smuggling is 59% of them will not to react, 28% of them will denounce to police forces. Education by public will be helpful in terms of either saving the natural vegetation or providing the people's utilising consciously.

Keywords: Flora of Artvin, Officinal Plants (Herbs), Plant Smuggling, Sustainable Utilization from Natural Sources

Özet

Türkiye, biyoçeşitlilik bakımından dünyanın en zengin ülkelerden birisidir. Türkiye'de tanımlanan 122 Önemli Bitki Alanı'ndan 4'ü Artvin ili sınırları içinde kalmaktadır. Bu doğal zenginliğin korunması, sürdürülebilirlik ilkeleri kapsamında yararlanılması ve bitki kaçakçılığına karşı mücadelede, bölge halkının aktif katılımı hayati öneme sahiptir.

Araştırma alanı olarak, Artvin ilinde bitki çeşitliliği bakımından en zengin olan Şavşat ve Borçka ilçeleri seçilmiştir. Çalışma, tarafımızdan seçilmiş, doğal ortamda yetişen 50 adet şifalı bitkiyle sınırlı olarak yapılmıştır. Hedef kitle, bu ilçelerin kırsal kesiminde yaşayan halktır. Hazırlanmış ve yüz yüze görüşme yöntemi ile uygulanmış anket formları yardımı ile şifalı bitkilerin tanınırlığı ve halk tarafından faydalanma durumu test edilmiştir. Ankette ayrıca, bitki kaçakçılığına karşı halkın duyarlılığını tespiti yönelik sonuçlara da ulaşılmaya da çalışılmıştır.

Elde edilen sonuçlara göre; araştırma alanı kırsal kesiminde yaşayan halkın çevrelerinde doğal olarak yetişen 50 adet şifalı bitkiden ancak %34'ünü tanıyabildiği, bu bitkileri besin olarak veya şifa bulmak amacıyla bilimsel özelliklerine uygun kullandıkları belirlenmiştir. Ayrıca, katılımcılardan sadece % 28'inin bitki kaçakçılığı kavramı konusunda bilgi sahibi olduğu sonucuna varılmıştır. Bitki kaçakçılığına karşı duyarlılık bakımından ise, deneklerin % 59'unun hiçbir tepki göstermeyeceği, % 28'inin ise bu tür olayları kolluk kuvvetlerine ihbar edeceği sonucu ortaya çıkmaktadır. Gerek doğal vejetasyonun korunması ve gerekse de toplumun bu kaynaktan bilinçli yararlanmasını temin bakımından kamu tarafından eğitimi gerekli ve faydalı olacaktır.

Anahtar Kelimeler: Artvin Florası, Şifalı Bitkiler, Bitki Kaçakçılığı, Doğal Kaynaklardan Sürdürülebilir Yararlanma

Introduction

People are in need to natural sources for feeding and housing. Moreover, various plants were made benefit of revealed diseases

throughout history and presently. It must be accepted the base of utilising for both feeding and healing started with trial and error method. And then, it could be said that

reached to a more consistent point due to collective memory background.

Several industry lines for utilising from plants arised in time. Plants are the raw materials of notably pharmaceutical industry, perfume, cosmetics, soap, sugar and many more. In this day and time, it is understood that the officinal plants that are passed through the filter of science are useful than known and so important in curing the diseases. The most important constraint in utilising from this source is plant richness of region (Karunamoorthi and Tsehay, 2012; Shill et al, 2014, Vitalini, S et al, 2015)..

Biological diversity (bio-diversity) means the species diversity in a region. Being the animal and plant species more in a region means being the biological diversity reach also. Turkey has a very important status in the subject of biological diversity. Our country is 1st in Europe and 22th in the world in point of natural plant richness with 9996 plant species (11707 taxons). Our country is substantially rich in point of endemic plants either. It was determined that Turkey has 3649 endemic species while the continental Europe has 3500 (Eminağaoğlu, 2015).

Caucasian that contains Artvin research city is defined as one of the richest and endangered 25 terrestrial "ecological zones" of the world by International Environmental Protection Organization (CI), World Bank (WB), Global Environment Fund (GEF) in point of biological diversity. Caucasian where is in "Kolsik" part of Europe-Siberian Floristic Region is the most important shelter and relict area of tertiary forests. Here is the region that temperate deciduous forests live since tertiary till today without interruption. The oldest growth forest ecosystems in the large geography that includes Europe and Cenral asia are located in here. World Nature Protection Waqf (WWF) who accepted the importance of Caucasian in point of protection declared the Caucasian's temperate zone forests as one of the 200 eceological areas that prior in protection. Furthermore, 4 of the important areas (Karçal Mountains-Çoruh-Kaçkar Mountains-Yalnız Çam Mountains) of 122 important plant areas defined in Turkey are located in Artvin as well.

In this research, there were studied to determine the rural community's utilising

habits and knowledges for both feeding and healing from plants, limited to Borçka and Şavşat cities of Artvin. It was scrutinized that if the local community's have an awareness about plant smuggling or not.

Research Method

Introducing Research Field

Research fields are Borçka and Şavşat cities of Artvin. Şavşat has continental climate properties, Borçka has Osiyenik-Black sea climate and Mediterranean climate properties in Çoruh Basin. That's why these cities could represent Artvin climatologically. Borçka and Şavşat cities were chosen as research fields with reference to this representation.

Borçka is a pretty settlement is at the eastern end of Black Sea Region, on the way to Artvin-Hopa, along with Çoruh River. It's distance is 32 km to city center and 36 km to sea, meters above sea level is 125km. It's borders are Hopa in west, Artvin and Murgul in south, Georgia Republic in north as well. There are Turkey's first and only Camili Biosphere Reserve Area, 2 pieces Nature Reserve Areas (Camili-Efeler and Camili-Gorgit) and Borçka natural park in city (Eminağaoğlu,Ö., 2012)..

Population as a whole of city is 22.293, based on 2015 population datas. City center population is 10.864, village population is 11.429. Villages natural structures make the living conditions hard, that's why there are seen migrations from rural to city centers and generally to outside of city. There are 1 municipality, 4 neighborhoods and 37 villages are under control of the city. The greater part of agrarian population earns livelihood by tea, hezalnut, beekeplig and forest products.

Şavşat is surrounded by Ardahan-Hanak in east, Posof in northeast, Artvin-Borçka in west, Georgia Republic in north. It's distance to Artvin is 66km, meters above sea level is 1100km. There are Karagöl-Sahara National Parks. Population as a whole of city is 17.524, based on 2015 population datas. City center population is 6.890, village population is 10.634. There are 2 municipalities and 61 villages are under the control of Artvin. Livelihood is predominantly animal husbandry. In addition to this, there are grown

hazelnut, tea, corn, potato, walnut and cranberry.

Preparing Survey Questions

Intended population who will conducted the survey is the rural community lives in Borçka and Şavşat. There are placed importance for using the datas as well, believable and being suitable for the purpose of study in preparing the surveys that composed of primary data sources. Survey questions aimed at show the locals thoughts about plant smuggling and learning officinal plants grow in region. Before conducting the survey, 50 pieces species of officinal plant, alias medicinal were chosen which grow naturally in Artvin (Eminağaoğlu, 2005). A3 sized colored pictures of these species were prepared.

Prestudies were done for fulfilling the needs and debug after preparing the questions and pictures. Therefore, a test application was made in Seyitler village dependent on Artvin

centre. Survey form was finalized after fulfilling the needs and faults.

Survey Conducting and Evaluating

The application was performed by a single researcher and the differences could be occurred were prevented by the reason of people changing. Prepared questions and pictures were represented to locals during application and it was asked them if they know these selected plants, regional names if available or not and for what purpose they use. The datas obtained survey conducting were evaluated statistical. This evaluation was made with parcentages and chi square analysis.

Findings

According to the survey datas recorded in research field, sociodemographic characteristics belong to local community are shown on Table 1.

Table 1: Socio-demographic features of participant

Gender	Şavşat	%	Borçka	%	Total	%
Woman	9	60	12	70,6	21	65,6
Man	6	40	5	29,6	11	34,4
Total	15	100	17	100	32	100
Age	Şavşat	%	Borçka	%	Total	%
17-20	-	-	-	-	-	-
21-30	-	-	-	-	-	-
31-40	-	-	1	5,9	1	3,1
41-50	3	20	3	17,6	6	18,8
50 +	12	80	13	76,5	25	78,1
Total	15	100	17	100	32	100
Marital Status	Şavşat	%	Borçka	%	Total	%
Single	-	-	1	5,9	1	3,1
Married	15	100	16	94,1	31	96,9
Total	15	100	17	100	32	100
Educational Status	Şavşat	%	Borçka	%	Total	%
Literate	-	-	1	5,9	1	3,1
Primary Education	7	46,7	2	11,8	9	28,1
Secondary Education	4	26,7	8	47,1	12	37,5
Faculty	4	26,7	6	35,3	10	31,3
Master- PhD	-	-	-	-	-	-
Total	15	100	17	100	32	100
Job	Şavşat	%	Borçka	%	Total	%
Retired	5	33,3	5	29,4	10	31,3
House wife	7	46,7	10	58,8	17	53,1
Laborer	2	13,3	-	-	2	6,3
Unemployed	-	-	-	-	-	-
Officer	-	-	2	11,8	2	6,3
Student	-	-	-	-	-	-
Freelancer	1	6,7	-	-	1	3,1
Total	15	100	17	100	32	100

Table 1. (continued)

Level of income	Şavşat	%	Borçka	%	Total	%
to 1000 TL	-	-	-	-	-	-
between 1001 and 2000 TL	1	6,7	1	5,9	2	6,3
between 2001 and 3000 TL	4	26,7	7	41,2	11	34,4
over 3000 TL	10	66,7	9	52,9	19	59,4
Total	15	100	17	100	32	100

15 persons from Şavşat and 17 persons from Borçka were chosen for survey conducting to reveal how do the locals know officinal plants, how correspond their knowledges about plant's healing functions with medical realities and if there are any awareness about smuggling after collected unauthorized or not. The target was the rural community because of the places where the plants naturally grow are villages and plateaus and their close relations with these plants. There were talked face to face with 32 persons for statistically revealing the thoughts and awareness of locals.

Following numbers are determined about survey attenders: 65,6% of 32 persons are

women, 34,4% are men and 78,1% are in the age of 50 and more. 53,1% of attenders are housewives, the others are retireds, workmans and self-employeds. 59,4% of attenders house income level is 3000TL and more. And it is determined that the attenders educational levels are 50% is graduated from faculty or college, 30% is secondary education, 10% is primary education and 10% is only literate.

Local's recognition and using statuses of plans for both health and nutritional source are shown on Table 2. There are written on table about which determined plants the attenders know, plant's regional names and using for which deseases to cure.

Table 2: Healing Plants People Familiar and Used By Medicinal Properties

No	Latin Name	Known* Local** name	Medicinal Features	Local Use	Number of people know plant	Number of people using this plant
2	<i>Alchemilla caucasica</i>	*Dwarf lady's mantle **Stomach tea	Diabetes, liver, bowel and stomach treatment	Stomach treatment	12-7	5
3	<i>Allium schoenoprasum</i>	*Chives **Wild garlic	Blood pressure lowering	Blood pressure lowering	10-10	5
12	<i>Crataegus caucasica</i>	*Hawthorn **Kirkat	Depressant, antipyretic	Cough treatment	7	7
16	<i>Sorbus torminalis</i>	*Chequer tree **Kirkat	Diarrhea cutter	İntestinal regulator	5	5
19	<i>Heracleum sphondylium</i> subsp. <i>artvinense</i>	*Hogweed **Kekre	Strengthening, diarrhea and dysentery treatment	Strengthening	10-3	10
20	<i>Lauroceracus officinalis</i>	*Cherry laurel	Painkiller, treatment of Cough, diabetes treatment	Diabetes treatment	7-13	20
24	<i>Origanum rotundifolium</i>	*Round-leaved oregano **Spring tea	Treatment of cough increasing urine relaxing stomach	Cold, hepatitis, gastric treatment	9-8	10
27	<i>Physalis alkekengi</i>	*Cape gooseberry **Golden strawberry	It contains vitamin C, antipyretic, pass a kidney stone	İmmune-enhancing	8-7	15
29	<i>Plantago major</i>	*Broadleaf plantain **Veined grass	Diuretic, regulatör of blood, wound treatment	Wound treatment, gastric treatment	3-5	8
30	<i>Persicaria bistorta</i>	*Common bistort **Beet	Dysentery, cholera, intestine	Meal, throat ache treatment	14-13	15
33	<i>Rhamnus imeretina</i>	*Buckthorns **Mutzvi	Heart disease, vascular disorder treatment	İmmune-enhancing	2-4	2
35	<i>Rubus canescens</i> var. <i>glabratus</i>	*Woolly blackberry **Joll	Blood cleaning, diarrhea and wound treatment	İmmune-enhancing, cancer treatment	15-17	32

Table 2. continued

42	<i>Tanacetum parthenium</i>	*Feverfew **White daisies	Depressant, menstrual period regulatory, migraine	Cold treatment , Cough,intestine	15-17	5
45	<i>Tilia rubra</i> subsp. <i>caucasica</i>	*Red stem lime	Diuretic, depressant, Cold	Cold treatment	15-17	32
47	<i>Urtica dioica</i>	*Nettles **Cincar	Diuretic, blood cleaning	Cancer, diuretic	15-17	25
49	<i>Vaccinium arctostaphylos</i>	*Caucasian whortleberry **Mutzvi	Diarrhea, anticancer	Immune-enhancing	10-3	13
50	<i>Vaccinium myrtillus</i>	*Bilberry **Mutzvi	Reduction of heart attack, anticancer, strengthening memory	Immune-enhancing	10-5	15

As is seen on the Table, the rural community knows and uses only 17 pieces, meanly 34% of 50 plant species that are shown themselves.

There are 17 plants that are known and used for curing the diseases as correspond with medically by locals in 50 officinal plants. The most popular ones are following like: Prunus Laurocerasus (Lauroceracus officinalis) thought as heal for especially diabetics, Winter cherry (Physalis alkekengi) colloquially named physalis, Urtica Urens (Urtica dioica) strengthens the immune system against cancer and increases the body resistance, Blackberry (Rubus canescens var. Glabratus), Huckleberry (Vaccinium arctostaphylos, Vaccinium myrtillus) and Hime tree (Tilia rubra subsp. Caucasica) heals cold, cough, softing the chest. Plantago and round coral plant are known in 2 cities and used for medically. Telehas plant is commonly grown in Şavşat and used for both feeding and healing as well.

There are known about fruits of some plants (Çat cehrisi, Pitlicen vb) can increase

the resistance, strengthen the immune system, helper for controlling the diabet, heal the lazy bowels and used by locals also. Again there are determined that some plant's leafs and seeds (urtica urens, winter cherry, plantago and lime tree) on Table are used for curing cancer, cleaning the urinary tracts, healing stomach diseases and cold. And some of attenders mentioned that they used foalfoot, round coral and plantago species to dermatotherapy for wound, acne and boils disease.

When asking to attenders in Şavşat and Borçka if there are any plants they use for curing any disease or nutritional source or not, many of attenders in Şavşat told they used Centaury for especially curing the stomach diseases. The attenders in Borçka answered this as they use Cydonia Vulgaris for especially cold in recent years.

There are many plants in region which are not enough known about curative sides or about itself. Table 3 shows these plants list, their medical utilities, awareness and evaluations of a small number of attenders.

Table 3: Plants That People Dont Know Medicinal Feature

No	Latin Name	Known* Local** name	Medicinal Features	Local Use	Number of people know this plant
1	<i>Aconitum orientale</i>	Wolf's bane	Analgesic , cold treatment diuretic	People don't know	10
4	<i>Anacamptis pyramidalis</i>	Pyramidal orchid	Sahlep	People don't know	8-7
7	<i>Asplenium septentrionale</i>	Maiden hair spleenwort	Chest relaxing, menstrual period regulatory	People don't know	5
8	<i>Atropa belladonna</i>	Deadly nightshade	Analgesic	People don't know	5
9	<i>Cephalanthera damasonium</i>	White Helleborine	Increases milk production in lactating women	People don't know	2-5
10	<i>Colchicum speciosum</i>	Autumn crocus	Antipyretic, analgesic	People don't know	5
13	<i>Crocus vallicola</i>	Saffron	Digestive, reduce stomach acid	People don't know	3-5
14	<i>Cyclamen coum</i>	Eastern cyclamen	The tubers are eaten	People don't know	2

Table 3. continued

15	<i>Dactylorhiza euxina</i> var. <i>euxina</i>	Salep	Strengthens, stop diarrhea in children	People don't know	-
17	<i>Empetrum nigrum</i> subsp. <i>hermaphroditum</i>	Crowberry	Appetite, strengthens	People don't know	5
18	<i>Galanthus krashnovii</i>	Snowdrop	Polio vaccine construction and physical therapy	People don't know	-
21	<i>Malva neglecta</i>	Common mallow	Digestive and respiratory disorder treatment	People don't know	3
22	<i>Morchella esculenta</i>	Common morel	Minimize anaemia	People don't know	9-7
23	<i>Nasturtium officinale</i>	Watercress	Minimize mineral deficiency, depreciation blood glucose	People don't know	5
25	<i>Origanum vulgare</i>	Oregano	Cough, expectorant	People don't know	3
26	<i>Ornithogalum olgophyllum</i>	Star-of-nature	Cancer treatment, increase of resistance	People don't know	-
27	<i>Petasites hybridus</i>	Butterbur	Diuretic, expectorant, liver and bile treatment	People don't know	2
28	<i>Phytolacca americana</i>	Amerikan pokeweed	Vomitory, lapactic	People don't know	7
31	<i>Primula veris</i>	Cowslip	Cough treatment, promote breathing tranquilizer	People don't know	3-5
32	<i>Primula vulgaris</i>	Primrose	Cough treatment, promote breathing tranquilizer	People don't know	3
34	<i>Rhus coriaria</i>	Sicilian sumac	Laxative and antihemorrhagic	People don't know	14
36	<i>Salvia sclarea</i>	Clary	Depressant, reduce sweating	People don't know	3
37	<i>Salvia verticillata</i> subsp. <i>verticillata</i>	Lilac sage	Depressant	People don't know	2
38	<i>Sambucus nigra</i>	Elderberry	Diuretic, cathartic	People don't know	2
39	<i>Satureja hortensis</i>	Summer savory	Contains vitamin-mineral	Spice	12-10
41	<i>Seseli andronakii</i>	Çoruh hogweed	Contains vitamin-mineral	Meal	13-3
43	<i>Teucrium chamaedrys</i>	Wall germander	Appetizing, strengthening, settle stomach	People don't know	-
44	<i>Thymus preacox</i>	Mother of thyme	Strengthening, minimize an anorexia, give teeth to neuron	People don't know	-
46	<i>Trifolium repens</i>	White clover	Strengthening, relieving arthritis pain	People don't know	10-7

There are plants which seem familiar and seen by locals but not to know names and medical properties. It could be seen plants among these, are valuable as both economical and medical. The result of this table is 33 pieces, meanly 66% of 50 are not known by locals and any usage areas are not existed because of unawareness about medical utilities. Some of these species are; Salep (body strengthening, increases resistance), Forest Bird (increase the milk rendement for women), Crowberry (appetising, increases the resistance, immune system strengthening), Short Mahmut, Plateau thymus, Three ear grass, Laz Salep (roborant and runs

suppressant, Horsemint (expectorant), Kabalak, Zinc, Cowslip, Henbit. According to the surveys, the locals do not know the 66% of 50 regional plants, do not use as well.

The thoughts and awareness of locals about plant smuggling were tested and the results shown on the tables below (Table 4 and 8). 9 persons said 'yes', 23 persons said 'no' for 'have you ever heard the term of plant smuggling' question. At the end of the test, it was determined that there is a relation between gender and plant smuggling recognition. One other result is there are a significant difference about plant smuggling awareness in men rather than women.

Tablo 4: Awareness of Plant Trafficking

Did you hear plant trafficking?	Yes		No		Total	
	Yes	%	No	%	Total	%
Gender						
Woman	2	6	19	59	21	66
Man	7	22	4	13	11	34
Total	9	28	23	72	32	100

Fisher 0,03 a relationship

As is seen on Table 5, awareness status is increasing in parallel with increased education level. 19 (59,3%) of attendees answered "yes" for the question "is there anybody

collects the plants out of village". 68,4% of these people are women, 31,6% of these are men.

Table 5: Awareness of Plant Trafficking and Education of The Participant

Did you hear plant trafficking?	Yes	%	No	%	Total	%
Educational Status						
Literate	1	10	-	-	1	3,1
Primary Education	1	10	8	36,4	9	28,1
Secondary Education	3	30	9	40,9	12	37,5
Faculty	5	50	5	22,7	10	31,3
Total	10	100	22		32	100

Table 6: Thoughts of Participants About Plant Trafficking

Is there anyone outside the village collect plants?	Yes	%	No	%	Total
Gender					
Woman	13	68,4	8	61,5	21
Man	6	31,6	5	38,5	11
Total	19	100	13	100	32

19 persons said "i don't nothing", 9 persons said "i call the police" and 4 persons said "i help" for the question "what do you do when seeing somebody collects the plant?". It could be possible to say the men

are more sensitive and conscious about this matter. And there is seen in the results of chi square tests about a relationship existence between gender and reaction for somebody who collects the plants out of village.

Table 7. Reaction when they see someone gathering plants

What do you do if you saw a man gathering plants?	I'd not meddle	%	I'd grass on	%	I'd help	%	Total
Gender							
Woman	17	89,5	1	11,1	3	75	21
Man	2	10,5	8	88,9	1	25	11
Total	19	100	9	100	4	100	32

Pearson 0,000 a relationship

The distribution of local's reaction for any collector is shown on Table based upon their income level and occupations. As is seen on Table 8, there is not a significant relation

between income level and attitude. Likewise there is not a significant relation between work area and attitude as well.

Table 8. Distribution of reaction against plant trafficking according to income level and occupation

What do you do if you saw a man gathering plants?	I'd not meddle	I'd grass on	I'd help	Total
Level of income				
to 1000 TL	-	-	1	1
between 1001 and 2000 TL	8	-	1	9
between 2001 and 3000 TL	9	3	-	12
over 3000 TL	2	6	2	10
Total	19	9	4	32

Table 8. (continued)

Job	I'd not meddle	I'd grass on	I'd help	Total
Retired	2	7	1	10
House wife	14	1	2	17
Laborer	1	-	1	2
Officer	1	1	-	2
Freelancer	-	1	-	1
Total	19	9	4	32

Discussion, Results and Suggestions

The problems are being told in recent years which based upon the unnaturally foods and medicine raw materials. The tendency to natural products and nature is increasing for covering the demands of medicine and secure food under these circumstances, that are seen as many pitiless diseases. There is an important tendency in our country also has a rich flora due to its geographical position. Tendency to organical products needs the new precautions for saving the plants in environment and in point of sustainable utilization.

The finding of this study is the community lives in research field does not know the important part (66%) of medical plants. They are utilizing from vey few numbers of plants for both feeding and healing in spite of rich plant variety. There is not an industrial plant for this subject either. Following plants are used for healing by locals; Prunus Laurocerasus (*Lauroceracus officinalis*) for stomache diseases, Winter cherry (*Physalis alkekengi*) increases the body resistance- colloquially named physalis, *Urtica Urens* (*Urtica dioica*) strengthens the immune system against cancer and increases the body resistance, Blackberry (*Rubus canescens* var. *Glabratus*), Huckleberry (*Vaccinium arctostaphylos*, *Vaccinium myrtillus*) and Lime tree (*Tilia rubra* subsp. *Caucasica*) heals cold, cough, softing the chest. Plantago and round coral plant are known in 2 cities and used for medically. Telehas plant is commonly grown in Şavşat and used for both feeding and healing as well. Moreover, some of attenders mentioned that they used foalfoot, round coral and plantago species to dermatotherapy for wound, acne and boils disease.

They have not enough sensitiveness about saving the unknown plants as well. 28% of attenders have'nt any knowledge about plant smuggling. Again, 66% of community

mentioned that they will remain insensitive if any smuggling happens.

Firstly, there must be provided the knowledge for local community about rich flora. To realise this, public institutions (Ministry of Environment and Urbanisation, Ministry of Forestry and Water Affairs, Ministry of Food Agriculte and Livestock, etc.) relevant rurals and community colleges in cooperation with. At the same time the plant species variety and prevalence status must be determined. And then, the plans must be created that provides sustainable utilization from natural plants. By this means, the sensitiveness of community will increase if their knowledge and conscioussness increase as well. This development will provide the local community become an effective shareholder for taking precautions against plant smuggling.

References

- Eminağaoğlu, Ö., 2005, Medicinal and Economic Plants of Şavşat (Artvin)region, İstanbul University, Faculty of Forestry Journal, Serial: B, 55 (1): 87-111.
- Eminağaoğlu, Ö., 2012, Natural Heritage in Artvin- Natural Plants of Artvin, İstanbul: Promat.
- Eminağaoğlu, Ö. (Ed.), 2015, Natural Plants of Artvin, İstanbul: Promat.
- Karunamoorthi, K. And Tsehaye, E. 2012, Ethnomedicinal knowledge, belief and self-reported practice of local inhabitants on traditional antimalarial plants and phytotherapy, Journal of Ethnopharmacology.
- Shil, S., Choudhury, M. D., Das, S., 2014, Indigenous knowledge of medicinal plants used by the Reang tribe of Tripura state of India, Journal of Ethnopharmacology.
- Vitalini, S., Puricelli, C., Mikerezi, I., Iriti, M., 2015, Plants, people and traditions: ethnobotanical survey in the Lombard Stelvio National Park and neighbouring areas (Central Alps, Italy), Journal of Ethnopharmacology

PES Mechanisms as Financing Source for Forest Resource Management and Their Applicability in Turkey

*Ufuk DEMİRÇİ¹, Atakan ÖZTÜRK¹, İnci Zeynep AYDIN¹

¹Artvin Çoruh University, Faculty of Forestry, Artvin / TURKEY

*Corresponding Author: udemirci08@hotmail.com

Abstract

Forests provide a wide range of goods and services such as food, fresh water, raw material, climate regulation, disease regulation, soil formation and recreation that people and societies rely on. In recent years, sustainable forest management has become more important especially in less developed and developing countries as a result of increase in awareness about multiple benefits of forest resources. However financing sources necessary for ensuring sustainability of ecosystem services provided by forest resources are insufficient. As revenue from forestry sector is not sufficient for financing of forestry activities, new financial resources and instruments are being developed at national and international level. As being one of these instruments, payments for ecosystem services (PES) become more popular. PES provides important opportunities for the financing of forestry sector through new payment instruments such as watershed protection payments, carbon payments, biodiversity, landscape, recreation and so on. In Turkey almost 99.9% of the forest are state owned. Therefore forestry activities are mainly financed by state budget and public revenue resources. Like in other developing countries, Turkish forestry sector needs new financial resources. In this study, it is aimed to review emerging financing sources and instruments for the world and Turkish forestry sector and determine and evaluate opportunities provided by PES mechanisms. Within this scope, applicability potential of PES mechanisms in Turkey and financial opportunities for the forestry sector are evaluated.

Keywords: Payments for ecosystem services (PES), Financing mechanisms, Forestry sector, Forest management

Orman Kaynaklarının Yönetiminde Finansman Kaynağı Olarak PES Mekanizması ve Ülkemizde Uygulanabilirliği

Özet

Ormanlar besin, temiz su, hammadde temini, iklim düzenleme, sel ve erozyon kontrolü, toprak formasyonu ve rekreasyon gibi insanların ihtiyaç duyduğu birçok ürün ve hizmet sunmaktadır. Son yıllarda orman kaynaklarının sahip olduğu çok yönlü faydalara yönelik artan farkındalık neticesinde özellikle az gelişmiş ve gelişmekte olan ülkelerde sürdürülebilir orman yönetimi giderek önem kazanmıştır. Lakin orman kaynaklarının sahip olduğu ekosistem hizmetlerinin sürdürülebilirliği için gereksinim duyulan finansal kaynakları yetersizdir. Ormanlıktan elde edilen gelirler, ormanların ve ormancılığın finansmanı için yeterli olmadığından, ulusal ve uluslararası düzeyde yeni finansman kaynakları ve araçları geliştirilmeye çalışılmaktadır. Bu araçlardan biri olan ekosistem hizmetleri için ödemeler (PES) son yıllarda giderek yaygın kullanım alanına sahip olmaktadır. Su havzası koruma ödemeleri, karbon ödemeleri, biyoçeşitlilik koruma ödemeleri ile peyzaj ve ekoturizm gibi yeni ödeme araçları ormancılık sektörü finansmanı için önemli fırsatlar sunmaktadır. Ülkemizde ormanların yaklaşık %99,9'u devlete aittir. Bu nedenle, ormancılık faaliyetleri esas olarak devlet bütçesinden ve kamu gelir kaynaklarından finanse edilmektedir. Diğer gelişmekte olan ülkelerde olduğu gibi, ülkemiz ormancılık sektörünün de yeni finansal kaynaklara ihtiyacı vardır. Bu çalışmada dünya ve ülkemiz ormancılığında yeni gelişmekte olan finansman kaynakları ve araçları ele alınarak, PES'lerin Türkiye ormancılık sektörü için sunmakta olduğu fırsatların tespiti ve değerlendirilmesi amaçlanmıştır. Bu bağlamda, ülkemiz ormancılık sektörü için bu mekanizmaların uygulanabilme potansiyelleri ve bu sayede sağlanabilecek finansal imkânlar değerlendirilmeye çalışılacaktır.

Anahtar Kelimeler: Ekosistem hizmetleri için ödemeler, Finansman mekanizmaları, Ormancılık sektörü, Orman yönetimi

Introduction

Ecosystem services are the benefits people obtain from ecosystems. These services can be listed as below (MA, 2003):

➤ *Provisioning services*: food, fresh water, fuelwood, genetic resources, biochemicals, fiber

➤ *Supporting services*: soil formation, primary production, nutrient cycling

➤ *Regulating services*: climate regulation, water regulation, water purification, disease regulation

➤ *Cultural services*: spiritual and religious, recreation and ecotourism, aesthetic, educational

Due to excessive demand for ecosystem services stemming from economic growth, demographic changes, and individual choices, ecosystem services are degraded (MA, 2003). The most comprehensive assessment of ecosystem services (Millennium Ecosystem Assessment), which was carried by over 1,300 scientists from 95 countries found that over 60% of the environmental services studied are being degraded faster than they could recover (Waage et al., 2008).

As being one of these ecosystems, forest ecosystems provide a wide range of environmental, economic, social and cultural goods and services such as food, fresh water, raw material, climate regulation, disease regulation, soil formation and recreation that people and societies rely on (Türker, et al., 2005). Like other ecosystems, forest ecosystems are being degraded. The global forest area fell by 129 million hectares (3.1 percent) in the period 1990–2015 (FAO, 2015). In that period, while 93 countries recorded net forest losses (242 million hectares), 88 countries had net gains in forest area (almost 113 million hectares) (FAO, 2016).

As awareness and social demand for national, regional and global benefits of forest resources has increased, sustainability of financial resources, needed for sustainable forest management, has become a highly controversial topic especially in less developed and developing countries. In this regard, new financial sources and

instruments are being developed (Ok et al., 2013).

In order to preserve forests, efforts are put in such as establishing national parks and private reserves and promoting sustainable forest management for a wide range of goods and services (such as timber, recreation/ecotourism, and pharmaceuticals). Additional efforts are needed to stop deforestation and unsustainable use of forest resources. Traditionally, as forest landowners have not been paid for providing ecosystem services, many communities, industries, and individuals act as if these services have no value (Mercer et al., 2011).

Many of these benefits are public goods and landowners and communities protecting these ecosystem services are often not compensated. In other words, there is a market failure as the value of the services is not recognized (Balderas Torres et al., 2013). There has been an increasing awareness about the importance of ecosystem services including their significant economic value among policymakers and the public. Benefits of many of these ecosystem services flow primarily to others and this leads to conflict between public interest and the interest of resource manager. This difference in private and social benefits, or in other words, the problem of externalities, results in a classic market failure. It has become necessary to search for policy solutions to realign the relationship between the private incentives and social benefits of forest conservation and management (Jack, et al., 2008; Mercer et al., 2011).

There are some potential policy solutions to externalities problems such as public provision of goods and services, private contracts between the provider and the beneficiaries, encouragement of voluntary efforts by firms and individuals, direct government regulation, and hybrid mechanisms. Many government interventions to control externalities are as command-and-control regulation, which mandates that actors undertake specific actions and applies sanctions if they do not comply. On the other hand, incentive-based policies reduce externalities by altering the economic incentives for private actors. Incentive-based mechanisms include charges (such as taxes,

user fees, and deposit–refund systems), subsidies, tradable permits (including markets for pollution reduction and tradable development rights), and market friction reduction (liability rules and information programs) (Panayotou, 1994; Jack, et al., 2008).

As being one of these incentive based instruments, payments for ecosystem services (PES) become more popular in recent years. PES has emerged as a policy solution for realigning the private and social benefits of environmental services. A PES is defined as a voluntary transaction where a well-defined ecosystem service is being bought by a (minimum one) buyer from a (minimum one) provider if and only if the ecosystem service provider secures its provision (Wunder, 2005). PES have attracted increasing interest as a mechanism to translate external non-market values of the environmental services into real financial incentives for local actors to ensure sustainability of such services (Engel et al., 2008).

In this study, it is aimed to review emerging financing sources and instruments for the world and Turkish forestry sector and determine and evaluate opportunities provided by PES mechanisms. Within this scope, PES initiatives samples for forestry sector around the world is analyzed and applicability potential of PES mechanisms in Turkey and financial opportunities for the forestry sector are evaluated.

Financing Sources and Instruments in Forestry Sector

Financing in world forestry

There are various financing sources and instruments used in forestry sector in the world. These resources are classified as public or private at national and international level. While public sources include general government revenue, revenue from state-owned forests and international official

development assistances (ODA), private sources consist of forest owners, the forest industry, philanthropic funds and NGOs. PES are considered as a different financing source class (Simula 2008; AGF 2012; Ok et al., 2013).

PES at domestic level include payments to carbon, watershed protection, water supply and recreation. Carbon payments through voluntary and regulatory markets, biodiversity payments, ecotourism and bioprospecting are international PES samples.

Financing in Turkish forestry

In Turkey, almost 99.9% of the forest are state owned, so forestry operations are planned and executed by state forest enterprises since 1937. There are two types of financing sources for forestry sector. These are internal and external financial resources. Internal financial resources include budgets (such as general budget, General Directorate of Forestry (GDF) special budget, GDF working capital budget and working capital budget of Ministry of Forestry and Water Affairs (MFWA)), contributions of non-governmental organizations and aids of development agencies. Beside, external financial resources include resources from international organizations such as GEF, World Bank, EU funds, funds from FAO and UNDP and national organizations (Türker, 2008; Daşdemir 2011).

There is self-financing in Turkish forestry sector, as most of revenue comes from sales of wood and non-wood forest products and services provided by forests. As being public institutions, state forest enterprises are mainly financed by state budget and public revenue resources (taxes, charges, etc.). Currently, external financial resources are limited and Turkish forestry sector does not benefit from these resources at desired level (Türker, 2008; Daşdemir 2011).

Table 1. Forest financing sources and instruments

Financing Sources	Domestic	International	
Public	Governments	<ul style="list-style-type: none"> • Investments by national and local governments through subsidies, soft loans, non-monetary incentives and direct investments 	<ul style="list-style-type: none"> • Bilateral ODA (grants, recoverable grants) • Multilateral ODA institutions: GEF, ITTO, FAO, UNEP, UNDP, etc. and regional development banks • Multilateral targeted programmes (PROFOR, FLEG, CGIAR, BPF and NFP) • Multilateral financial institutions (IFC, IBRD and regional development banks)
	Forest industry	<ul style="list-style-type: none"> • Direct investments 	<ul style="list-style-type: none"> • Foreign direct investment
Private	Financial institutions and institutional investors	<ul style="list-style-type: none"> • Short and long-term credit • Portfolio investments • Targeted credits • Insurance and re-insurance 	<ul style="list-style-type: none"> • Short and long-term credit • Portfolio investments • Export credits • Guarantee instruments • Insurance and re-insurance
	Philanthropic	<ul style="list-style-type: none"> • Financial support to national NGOs and targeted beneficiary groups 	<ul style="list-style-type: none"> • Financial support to international NGOs and targeted beneficiary groups
	Conservation NGOs	<ul style="list-style-type: none"> • Financial support to national NGOs and targeted beneficiaries 	<ul style="list-style-type: none"> • Financial support to international NGOs (programme/project funding) • Twinning arrangements
	Other NGOs	<ul style="list-style-type: none"> • Financial support to national CSOs and targeted beneficiaries 	<ul style="list-style-type: none"> • Financial support to international CSOs (programme/project funding) • Twinning arrangements
	Payments for environmental services (PESs)	<ul style="list-style-type: none"> • Watershed protection payments • Carbon payments • Fresh water supply payments • Nature-based/eco-tourism • Landscape, recreation, and other payments for services 	<ul style="list-style-type: none"> • Carbon payments (regulatory and voluntary market) • Biodiversity • Nature-based/eco-tourism • Bioprospecting

Payments for Ecosystem Services

Payments for ecosystem services, have become very popular in the last 10 years. The most used definition of PES in the literature is that PES is a voluntary transaction between a buyer and a seller of a well-defined environmental service, whereby the sellers promise service provision in exchange for some type of conditional payment (Wunder, 2005; McElwee, 2012). PES is a mechanism aiming to translate external, non-market values of the environment into real financial incentives for local actors to provide such services (Engel et al., 2008).

There are two different approaches in conceptualization of PES. A common conceptual approach underlying PES is based on Coasean market economics approach. The

Coase Theorem argues that given low to no transaction costs and clearly defined and enforceable property rights no governmental authority is needed to overcome the problem of internalizing external effects. Instead, private market negotiations among social actors will lead to an optimal allocation of resources, as the beneficiary will compensate the provider for the externality (Schomers and Matzdorf, 2013). Based on Coasian approach, PES are likely to be efficient, as the actors with the most information about the value of the service are directly involved, have a clear incentive to ensure that the mechanism is functioning well, can observe directly whether the service is being delivered, and have the ability to re-negotiate

(or terminate) the agreement if needed (Engel et al., 2008).

The other approach about PES is Pigouvian concept. Governmental payment programs are commonly referred to as the Pigouvian concept of PES. The Pigouvian conceptualization is based on the Pigouvian philosophy of taxing negative or subsidizing positive externalities within existing product markets. In government-financed PES programs, the buyers are a third party acting on behalf of service users. This can be a government agency, an international financial institution or conservation institution in the case of global externalities (Engel et al., 2008; Schomers and Matzdorf, 2013).

We can compare PES to other conservation approaches based on two criteria: first, the degree to which they rely on economic incentives; second, the extent to which conservation is targeted directly rather than integrated into other development approaches (Figure 1). At the south-eastern corner of the diagram, command and control regulations locate. These regulations aim to protect the resource directly, without using economic incentives. Sustainable forest management (SFM) and similar resource-use improvements also directly pursue conservation by influencing production and extraction processes. Environmental taxes and subsidies stand in north-western corner and they based on economic incentives (Wunder, 2005).

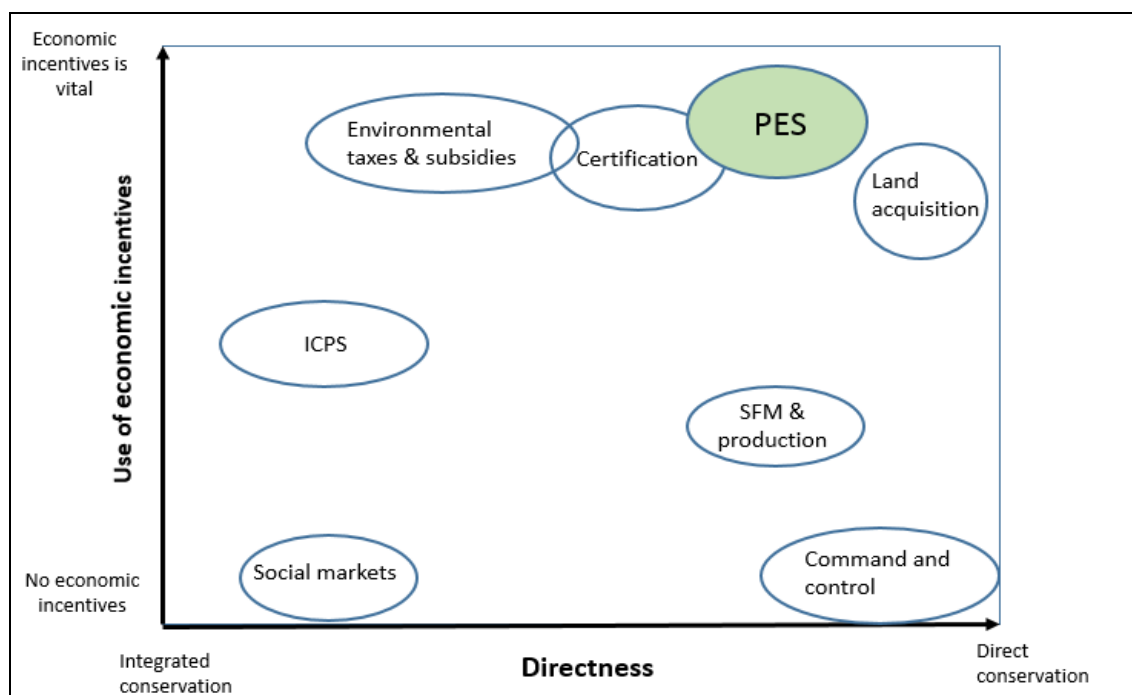

Figure 1. Comparing PES to other conservation approaches

As a result of increase in awareness and demand for goods and services of forest resources, especially in less developed and developing countries additional efforts are put in to preserve forests. In order to provide sustainable forest management and stop deforestation, sustainability of financial resources is vital. In this regard, new financial sources and instruments are being developed. As being one of incentive based

instruments, PES programs are established and implemented in many countries to preserve forest resources and benefits.

PES programs in forestry sector are implemented in such areas (Wunder, 2005; Mercer et al., 2011):

➤ **Carbon sequestration and storage:**

Carbon sequestration and storage are among the most well-known ecosystem services provided by forests. Carbon sequestration is

unique among other ecosystem services in that its benefits accrue globally. Carbon offsets projects about forestry including afforestation or reforestation, improved forest management and avoided forest conversion, offer businesses and individuals the opportunity to invest in projects to offset their own greenhouse gas emissions. As a result, carbon markets have emerged.

➤ **Biodiversity protection:** Payments for biodiversity services occur in all three PES categories: public payments to land owners, voluntary payments, and payments in compliance markets. Also a private market exists for biodiversity services through the purchase of hunting leases and the payment of entrance fees for hunting and wildlife viewing on private lands.

➤ **Watershed protection:** Forests play a critical role in protecting water quality by absorbing excess nutrients, reducing soil erosion, and controlling the water flows. For these reasons, forestland owners could receive significant revenues for the watershed services that their lands provide. However, in comparison carbon sequestration services, which are global, watershed services markets are tend to be small and local. PES for watershed services are playing a crucial role in watershed protection in some countries.

➤ **Bundled services:** Most forest-based payments for conservation are made to produce a bundle of ecosystem services. There are several traditional government conservation programs that pay for bundled services in different countries. Also significant voluntary payments are made to landowners from non-governmental land trusts and other organizations to preserve these services.

Many PES programs about forestry was implemented worldwide. These programs are established either through governmental financial incentive programs or through financial incentives beyond Coase and Pigou. While the history of governmental incentives to promote conservation efforts in the US dates back to 1930s, in European Union PES implementations started in 1970s (Schomers and Matzdorf, 2013).

Most of forestry related PES are established in Latin America countries. For

instance, in Costa Rica, a system of payments for reforestation and forest management developed in the 1970s. Based on this system, a national PES program called 'Pagos por Servicios Ambientales (PSA) was established in 1996. PSA aimed four ecosystem services (1) greenhouse gas mitigation; (2) hydrological services; (3) scenic beauty and (4) biodiversity. Similar national PES program was implemented in Mexico to provide payments were linked to the conservation of existing forests (Schomers and Matzdorf, 2013).

In China, six key forest conservation programs are in practice. Two of these are the Natural Forest Conservation Program (NFCP) and the Grain to Green Program (GTGP). These programs are among the biggest programs in the world because of their goals, scales, huge payments, duration and impacts. The NFCP aims to conserve natural forests through logging bans and afforestation with incentives to forest enterprises, whereas the GTGP targets to convert cropland on steep slopes to forest and grassland by providing farmers with grain and cash subsidies (Liu et al., 2008).

There are some PES programs based on financial incentives beyond Coase and Pigou. For instance, a joint PES experimental scheme by the International Fund for Agricultural Development (IFAD), the World Agroforestry Centre (ICRAF) and a partnership of local, national and international partners, "The Rewarding Upland Poor for Environmental Services (RUPES)" program was established in 2002. Program covers Indonesia, the Philippines and Nepal. RUPES aims to conserve environmental services at the local and global levels in Asia. Main environmental services targeted in the program include watershed management to enhance water flow and qualities, biodiversity protection and carbon sequestration (Pascual and Perrings, 2007).

International carbon payments are referred to as International Payments for Ecosystem Services (IPES). IPES are thought as probably the only mechanism likely to be effective in ensuring the provision of global ecosystem services. As part of carbon markets, The Clean Development

Mechanism (CDM) and Reduced Emissions from Deforestation and Degradation (REDD) are developed to make payments for forestry projects aiming restoration of degraded lands and reforestation (Farley et al., 2010; Schomers and Matzdorf, 2013). By using these mechanisms, countries and firms can invest in different forestry-related projects (afforestation, reforestation, improved forest management and avoiding deforestation).

PES mechanism as a viable financial instrument for Turkish forestry sector

In Turkey, 27.8% of the total land area (21.7 million hectares) is covered by forests (TSI, 2016). Almost half of the forests are degraded. It is possible to convert 4.2 million hectares of degraded forests to productive forest areas via afforestation, rehabilitation, and erosion control works. National inventories show that total forest area has increased by almost 1.2 million hectares since 1973 (Khan 2010, MoEF 2010).

In Turkey, scientific studies focusing on determining value of ecological benefits of forest resources started in 1990s. However, these studies are very limited. As being pioneer studies, a project was realized aiming valuation of forest resources in Turkey towards total economic value approach (Türker, et al., 2005; Pak, et al., 2010). Most of the other studies are about valuation of recreation function of forests. In these studies, economic value of recreational activities in protected areas are tried to be determined (Pak, 2002; Pak and Türker, 2006; Başar, 2007; Ateşoğlu, 2008; Dönmez, 2013). The others are about habitat and wildlife protection (Gürlük, 2006, Kaya et al., 2009; Kaya, 2012).

In recent years, there is a trend in presenting ecosystem services. In this context, studies about valuation, benefit-cost analysis and ensuring sustainability of ecosystem services are carried out by General Directorate of Forestry and other related institutions (Balkız, 2015). In this context, a study was carried out in a pilot study area (Bolu Forest Area), to value forest products and services provided by forests (World Bank Group, 2015). In a similar study, socio economic values of forest

ecosystems in Düzlerçamı Forest area, are tried to be determined (Balkız, 2016).

All the studies mentioned above indicate that, in Turkey, there is an increase in awareness about goods and services of forest resources. However, we may say that Turkey is at early stages in such projects and studies. Although, PES offer good alternatives for financing forestry sector projects, up to now, any PES program related forestry is established or implemented. In order to support sustainable forest management, afforestation/reforestation and watershed management activities, PES programs should be considered carefully and new initiatives should be brought. All PES implementation fields (carbon sequestration and storage, biodiversity protection, watershed protection and bundled services such as landscape, recreation and nature-based/eco-tourism) are viable areas to invest and finance.

Conclusion

This study shows that, Turkey's forestry sector could benefit from various PES mechanisms and could provide a large financial resource for the forestry sector. In order to benefit from PES mechanisms as a financial instrument in forestry sector, Turkey would have to carry out the following strategies and actions:

- PES programs implemented worldwide should be investigated and strategies should be developed to apply similar projects.
- Firstly, ecosystem services provided by forest resources should be defined, measured. Then valuation studies should be carried out to determine value of these services. In this context, comprehensive academic studies should be carried out in pilot areas.
- An institutional framework should be established to participate in PES programs. In line with this purpose, legal framework and rules for PES schemes should be determined.
- A management plan about PES programs should be developed and some pilot programs should be implemented.
- In this context, initially government-financed PES programs should be executed.

After that, incentive-based mechanisms should be developed.

➤ Success and benefits of these programs should be monitored and reported regularly.

References

AGF, 2012. 2012 Study on forest financing. Advisory Group on Finance Collaborative Partnership on Forests, June 2012, <http://www.un.org/esa/forests/index.html>.

Ateşoğlu, İ., 2008. Bartın Balamba orman içi dinlenme yeri rekreasyon hizmetlerinin ekonomik değerinin belirlenmesi. Yüksek Lisans Tezi, Zonguldak Karaelmas Üniversitesi, Fen Bilimleri Enstitüsü, Orman Mühendisliği Anabilim Dalı, Zonguldak.

Balderas Torres, A., MacMillan, D.C., Skutsch, M., Lovett, J.C., 2013. Payments for ecosystem services and rural development: Landowners' preferences and potential participation in western Mexico. *Ecosystem Services*, <http://dx.doi.org/10.1016/j.ecoser.2013.03.002>.

Balkız, Ö. 2015. Ekosistem hizmetleri ve havza yönetimi. Doğa Koruma Merkezi, (available at http://suyonetimi.ormansu.gov.tr/Libraries/su/EkosistemHizmetleri_OzgeBalkiz_20151216.sflb.ashx).

Balkız, Ö., 2016. Assessment of the socio economic values of goods and services provided by mediterranean forest ecosystems Düzlerçamı forest-Turkey. "Optimizing the Production of Goods and Services by Mediterranean Forest Ecosystems in a Context of Global Changes" Project, Plan Blue, Valbonne.

Başar, H., 2007. Dilek Yarımadası-Büyük Menderes Deltası Milli Parkının rekreasyon amacıyla kullanımının ekonomik değerinin saptanması: bir seyahat maliyeti yöntemi uygulaması. Yüksek Lisans Tezi, Ege Üniversitesi, Fen Bilimleri Enstitüsü, Tarım Ekonomisi Anabilim Dalı, İzmir.

Daşdemir, İ. 2011. Ormancılık İşletme Ekonomisi. Bartın Üniversitesi Yayın No: 5, Orman Fakültesi Yayın No: 3, ISBN: 978-605-60882-3-0, Sürat Matbaacılık, Bartın.

Dönmez, R., 2013. Trabzon İli Uzungöl Doğa Parkı'ndan rekreasyonel ve turizm amaçlı yararlanmanın ekonomik değerinin belirlenmesi: seyahat maliyeti yöntemi uygulaması. Yüksek Lisans Tezi, Atatürk Üniversitesi, Fen Bilimleri Enstitüsü, Tarım Ekonomisi Anabilim Dalı, Erzurum.

Engel, S., Pagiola, S., and Wunder, S., 2008. Designing payments for environmental services

in theory and practice: An overview of the issues. *Ecological Economic* 65: 663-674.

FAO. 2015. Global forest resources assessment 2015. Rome (available at www.fao.org/forest-resources-assessment/en).

FAO. 2016. State of the world's forests 2016. Forests and agriculture: land-use challenges and opportunities. Rome.

Farley, J., Aquino, A., Daniels, A., Moulart, A., Lee, S., Krause, A., 2010. Global mechanisms for sustaining and enhancing PES schemes. *Ecological Economics* 69, 2075-2084.

Gürlük, S., 2006. Manyas Gölü ve Kuş Cenneti'nin çevresel değerlemesi üzerine bir araştırma. Doktora Tezi, Uludağ Üniversitesi, Fen Bilimleri Enstitüsü, Tarım Ekonomisi Anabilim Dalı, Bursa.

Jack, B. K., Kousky, C. and Sims, K.R.E. 2008. Designing payments for ecosystem services: lessons from previous experience with incentive-based mechanisms. *Proceedings of the National Academy of Sciences* 105:9465-9470.

Kaya, G., Yıldız, Y., Şaltu, Z., Yaman, F., Ateşoğlu, İ., 2009. Koşullu değer belirleme çalışmalarında bilgi kısıtının aşılması için bir öneri: yaban hayatının ekonomik değerinin belirlenmesi örneği. *Bartın Orman Fakültesi Dergisi*, Cilt:11, Sayı: 16, 45-59.

Kaya, G., 2012. Türkiye'de ekosistem hizmetlerinin ekonomik değerini belirlemeye yönelik çalışmalar ve değer tahminlerinin kaynak yönetimine entegrasyonunu engelleyen darboğazlar. Workshop on Ecosystem Services Assessment and Capital Accounting for Turkey, West Balkans and Caucasus Countries, 20-22 November 2012, Antalya.

Khan, M.A.A. 2010. Turkey's forestry sector and the carbon market report. United Nations Development Programme, Project of Capacity Building for Climate Change Management in Turkey, Ankara, Turkey.

Liu, J., Li, S., Ouyang, Z., Tam, C., Chen, X., 2008. Ecological and socioeconomic effects of China's policies for ecosystem services. *Proceedings of the National Academy of Science of the United States of America* 105, 9477-9482.

MA, 2003. Ecosystems and Human Well-being: A framework for assessment. Millennium Ecosystem Assessment, Island Press, Washington, DC.

McElwee, P.D. 2012. Payments for environmental services as neoliberal market-based forest conservation in Vietnam: Panacea or problem?. *Geoforum* 43:412-426.

Mercer, D. E., Cooley, D., & Hamilton, K. (2011). Taking stock: Payments for forest ecosystem services in the United States. *Forest*

Trends Ecosystem Marketplace and US Department of Agriculture Forest Service.

MoEF. 2010. Outlook on forestry sector in carbon markets. General Directorate of Environmental Management, Climate Change Department, Ministry of Environment and Forestry, Ankara, Turkey.

Ok, K., G. Kaya, Y. Güneş, S. Koçer, B. Kayacan, Ö. Eker, B. Çağdaş, Z. Koşdemir, E. Yılmaz, B. Bakır, and Ü. Turhan. 2013. Ormancılığın finansmanı raporu. Birleşmiş Milletler Orman Forumu 10. Oturumu (UNFF10, İstanbul 2013) İçin Hazırlanan Rapor, İstanbul.

Pak, M., 2002. Orman kaynağından rekreasyonel amaçlı yararlanmanın ekonomik değerinin tahmin edilmesi ve bu değer üzerinde etkili olan değişkenler üzerine bir araştırma (Doğu Akdeniz ve Doğu Karadeniz Bölgesi orman içi dinlenme yerleri örneği). Doktora Tezi, Karadeniz Teknik Üniversitesi, Fen Bilimleri Enstitüsü, Orman Mühendisliği Anabilim Dalı, Trabzon.

Pak, M., Türker, M.F., 2006. Estimation of recreational use value of forest resource by using individual travel cost and contingent valuation methods (Kayabaşı Forest Recreation Site sample), *Journal of Applied Sciences* 6(1): 1-5.

Pak, M., Türker, M.F., Öztürk, A., 2010. Total economic value of forest resources in Turkey, *African Journal of Agricultural Research*, 5:1908-1916.

Panayotou, T. 1994. Economic instruments for environmental management and sustainable development. (UN Environment Program/Nairobi, Geneva), Environmental Economics Paper No 16.

Pascual, U., Perrings, C., 2007. Developing incentives and economic mechanisms for in situ biodiversity conservation in agricultural landscapes. *Agricultural Ecosystems and Environment* 121, 256–268.

Schomers, S. and Matzdorf, B. 2013. Payments for ecosystem services: a review and comparison of developing and industrialized countries. *Ecosystem Services* 6: 16-30.

Simula, M. 2008. Financing flows and needs to implement the non-legally binding instrument on all types of forests. Prepared For The Advisory Group on Finance of the Collaborative Partnership on Forests. PROFOR, 108 pages, World Bank, Washington DC, USA.

TSI, 2016. Agricultural land and forest area, 1988-2015, Turkish Statistical Institute (available at www.tuik.gov.tr/PreIstatistikTablo.do?istab_id=53).

Türker, M. F., Pak, M., Öztürk, A., 2005. Turkey. In: *Valuing Mediterranean Forests: Towards Total Economic Value*, M. Merlo ve L.

Croitoru (Editors), CABI Publishing, Wallingford, Oxfordshire, UK, pp.195-211.

Türker, M.F. 2008. Ormancılık İşletme Ekonomisi. Derya Kitabevi, Trabzon.

Waage, S., C. Bracer, and M. Inbar. 2008. Payments for ecosystem services: getting started, A primer. Forest Trends, the Katoomba Group, and UNEP.

World Bank Group, 2015. Valuing Forest products and services in turkey: a pilot study of Bolu forest area. *Financing & Global Knowledge: Bringing the Best to Turkey and Sharing the Best of Turkey with the World*, World Bank's Turkey Environment and Natural Resources Technical Assistance Program, World Bank Group.

Wunder, S. 2005. Payments for environmental services: Some nuts and bolts. *CIFOR Occasional Paper no. 42*, Center for International Forestry Research, Indonesia.

Determination of Bay Leaf Production-Marketing Possibilities and Profile of Bay Leaf Collector (Case Study of Aladag District)

Ahmet ŞAHİN¹, Yeşim AYTOP², *Yunus ŞAHİN³, Tuğba YILDIZ¹

¹Kahramanmaraş Sutcu Imam University, Faculty of Agriculture, Kahramanmaraş/TURKEY

²Kahramanmaraş Sutcu Imam University, Department of Foreign Trade,
Kahramanmaraş/TURKEY

³Kahramanmaraş Sutcu Imam University, Faculty of Forestry, Kahramanmaraş/TURKEY

*Corresponding Author: ysahin@ksu.edu.tr

Abstract

The bay laurel is an important plant which be used for spices, cosmetics, herbal treatment, and pharmaceutical industry by collecting method from the nature. In this study, it is aimed that present state of the bay plant, which is an important livelihood for collectors at Aladag district in Adana province, is revealed and its production-marketing possibilities are interrogated. Parent material of the research consists of data from face to face surveys and 70 collectors at Aladag district in Adana province. The descriptive statistics were used for analyzing of the data. According to findings, it was determined that the collectors collected the bay leaf average 4.3 years, and that they sold the bay leaf average 275.2 kg/year and 0.25 TL/kg). The collectors stated that 98.6% of them sold the bay leaf to suppliers, and that 95.7% of them undersold their products. 58.6% of the collectors collected the bay leaf a few days a week, and all of them didn't use any tool and equipment when collecting the bay leaf. According to five point Likert scale, they stated that collected the bay leaf for the most contribution on income (4.81) and evaluating of labor (4.26). The results of the research will be composed a source to decision-makers and related shareholders about this subject in respect to the present state of the bay leaf collectors for revealing.

Keywords: Bay leaf, Collecting, Adana

Adana İli Aladağ İlçesinde Defne Yaprağı Toplayıcı Profili ve Üretim-Pazarlama Olanaklarının Belirlenmesi

Özet

Defne, toplayıcılık yöntemiyle doğadan elde edilen baharat, kozmetik, bitkisel tedavi ve ilaç yapımında kullanılan önemli bir bitkidir. Bu çalışmanın amacı Adana ili Aladağ ilçesindeki toplayıcıların ek gelir kaynağını oluşturan defne bitkisinin mevcut durumunu ortaya koymak ve üretim ve pazarlama olanaklarını sorgulamaktır. Araştırmanın ana materyalini Adana İli Aladağ ilçesinde 70 toplayıcı ile yüz yüze yapılan anketlerden elde edilen veriler oluşturmaktadır. Verilerin analizinde tanımlayıcı istatistiklerden yararlanılmıştır. Araştırma bulgularına göre toplayıcıların ortalama 4.3 yıldır defne yaprağı topladığı, yılda ortalama 275.2 kg sattıklarını belirtmişlerdir. Toplayıcıların %98.6'sı defne yaprağını araçlara sattıklarını, %95.7'si aracının ürünü ucuza aldığını bildirmiştir. Toplayıcıların %58.6'sı haftada birkaç gün defne yaprağı topladıklarını ve tamamı defne yaprağı toplarken hiçbir alet ve ekipmandan yararlanmadıklarını, defne yaprağı toplayıcılığını en çok gelire katkı (4.81) sağladığı için ve emeği değerlendirmek (4.26) için yaptıklarını ifade etmişlerdir. Araştırma sonuçları, defne toplayıcılarının mevcut durumunu ortaya koymasından bu konu ile ilgili paydaşlara ve karar vericilere bir kaynak oluşturacaktır.

Anahtar Kelimeler: Defne Yaprağı, Toplayıcılık, Adana

Introduction

Bay laurel from the lauraceae family is a plant which sheds its leaves in each season of a year. It is grown particularly in Turkey's Mediterranean coasts, then in the Aegean, Marmara, Black Sea coasts and their inlands. Bay laurel is used as an aromatic plant and consumed in the Mediterranean cuisine

frequently due to its sharp smell and aroma. Bay oil and soaps, shampoo, massage oils produced from the said oil are utilized in cosmetics and medicine. Although it is most widely used as a seasoning; it has other fields of use such as treating headaches and acnes, preventing insect infestation in dry legumes

and preventing dandruff (Anonymous, 2016a; Anonymous, 2016b).

Capitalizing on the production and marketing potentials of non-wood products (laurel, lime, thyme, chestnut, painted sage, flower bulb, fungus etc.) will provide a source of income to forest villagers, as well as foreign currency inflow to the national economy as a source of raw material supply via export (Anonymous, 2016c).

Many studies have been conducted which examined the collection profile and production-marketing procedures of non-wood products. In the research that Altunel, (2012) conducted in the Aegean region; they concluded that thyme, bay laurel and chestnut collectors sold almost all of their products mainly to middlemen and merchants without caring about to whom they sold it, and only kept about 1-2% of these products to themselves.

In the research that Durgun et al. (2014) conducted to examine work accidents of laurel collectors in the Samandağı district of the province of Hatay; they found out that the collectors did not use working clothes, half of whom did not even carry required equipment when working. Thereby, 76,7% of the laurel collectors ended up with hand cuts, 66,3% were cut by twigs, 63,3% had back pain, and 60% had nape-shoulder aches. In the research that Bilgin et al. (2006) conducted on 104 laurel collectors around the perimeters of the Regional Directorate of Forestry of the provinces of Balıkesir, Izmir and Muğla; they concluded that the collectors had insufficient knowledge in laurel production, 78% were not content with their receiving prices, and 72% regarded the destruction of laurel fields as the most important negation, while 67% regarded the lack of continuous profit as the most important negation.

This research provides interpretation of the data obtained from the survey conducted on 70 laurel collectors in the Aladağ district of the province of Adana. As this research on this subject is the first one to ever be conducted in said district, it is quite important. The research purpose is to put forth the current situation of the bay plant, which is a meal ticket for collectors in the Aladağ district; and to question its production-marketing possibilities. By also putting forth the current

situation of laurel collectors, the research results will be a source of information for related shareholders and decision-takers.

Material and Method

Data produced from surveys done face to face with 70 collectors at Aladağ district in Adana. The data were collected from January 2014 until March 2014. The data was analyzed by descriptive statistic.

Likert-type questions ;

5= Agree completely

4= Agree relatively

3= Agree moderately

2= Disagree completely

1= Disagree completely

Developed a scale in the interpretation of results at all mean Likert-type questions (Palaz and Boz, 2008).

0-1.49 Disagree completely

1.50 – 2.49 Disagree completely

2.50 – 3.49 Agree moderately

3.50 – 4.49 Agree relatively

4.50 – 5.00 Agree completely

Results

Socio-demographic features

Socio-demographic features of surveyed collectors are given in Table 1. Average age of the surveyed is 33.4, 50% are males, 68.6% are married, 35.7% are primary-school graduates, 23.3% are farmers, 94.3% have social security. Monthly household income is 2715.9 TL (Turkish liras); and number of family members, number of children, number of working members, number of collectors are 4.7; 2.7; 1.2; 1.8 respectively. Collectors have an average of 4.3 year experience in laurel collection.

Laurel collection

All of the collectors stated that they collected laurel from mountains 33.2 days a year on average and, 58.6% stated collecting a couple of times in a single week (Table 2). According to them, they mostly spend their earnings from laurel bay on buying food

Table 1. Socio-demographic features of surveyed collectors

	Mean	Std. Deviation	Min.	Max.	Percent(%)
Age (year)	33.4	8.735	18	60	
Gender					
Male					50.0
Female					50.0
Marital status					
Married					68.6
Single					31.4
Income	2715.9	1376.351	900	7500	
Education					
Illiterate					10.0
Primary-school graduate					35.7
Middle-school graduate					18.6
High-school graduate					25.7
Undergraduate					2.9
Bachelor's degree					7.1
Occupation					
House-wife					32.9
Farmer					23.3
Student					7.1
Artisan					7.1
Worker					21.4
Retired					2.9
Freelance					2.9
Other					1.4
Number of family members	4.7	1.247	1	8	
Number of children in family	2.7	1.145	0	6	
Number of working family members	1.2	0.382	1	2	
Number of collectors in family	1.8	0.644	1	3	
Social security ownership					
Yes					94.3
No					5.7
Experience in laurel collection (year)	4.3	1.576	1	8	

Table 2. Frequency of laurel collection

	Frequency	Percent
Daily	27	38.6
Once a Week	2	2.9
A Couple of Times a Week	41	58.6
Total	70	100.0

The collectors stated that they collect 275.22 kg laurel a year on average, that its 200.63kg laurel turns up moist and the rest 74.69 kg turns up dry; they also kept 5.44 kg

laurel a year on average for self-consumption. The collectors sell moist bay leaves 0.25 TL on average, whereas dry ones are sold for 3 TL on average (Table 3).

Table 3. Income from laurel collection

	Total	Moist	Dry
Sold unit (kg)	275.22	200.63	74.69
Selling price (TL)		0.25	3.00
Income (TL)	274.23	50.16	224.07

The items of Table 4 is advised to determine the reasons for collectors preferring laurel collecting. They agreed to the following items respectively; extra income (4.81), to capitalize on their efforts

(4.26), no expense (4.14), traditional collection (1.21), and self-consumption (1.31).

Table 4. Reasons for preferring laurel collection

	Mean	Level of Agreement	Std. Deviation	Minimum	Maximum
Extra income	4.81	Agree completely	0.728	1	5
To capitalize on their efforts	4.26	Agree relatively	0.896	2	5
No expense	4.14	Agree relatively	0.748	2	5
Easy collection	2.50	Agree moderately	0.717	1	4
Good selling price	2.30	Agree slightly	0.874	1	5
Easy market	2.03	Agree slightly	0.593	1	5
Self-consumption	1.34	Disagree completely	0.796	1	5
Traditional Collection	1.21	Disagree completely	0.413	1	2

1>disagree completely 2>agree slightly 3>agree moderately 4>agree relatively 5>agree completely

62.9% of surveyed collectors carry out the process of collecting without receiving information from anyone, 27.1% receive information from neighbors and clique, 10% receive information from provincial and district directorates of agriculture (Table 5).

Table 5. Information reception on how to collect laurel

	Frequency	Percent
I receive information from my neighbors and clique	19	27.1
I receive information from provincial and district directorates of agriculture	7	10.0
I receive no information	44	62.9
Total	70	100.0

98.6% of surveyed collectors stated that they sell laurel to middlemen; 1.4% sell laurel in bazaars, on roadsides, on purchase order (Table 6).

Table 6. Product marketing

	Yes (%)	No (%)	Total (%)
I sell on bazaar	1.4	98.6	100.0
I sell on roadside	1.4	98.6	100.0
I sell to middlemen	98.6	1.4	100.0
I sell on purchase order	1.4	98.6	100.0

95.7% of surveyed collectors complain about middlemen buying the product cheap, 90% complain on their lack of marketing skills, and 41.4% complain on the lack of co-operation (Table 7).

Table7: Problems in marketing

	Yes (%)	No (%)	Total (%)
Middlemen buying the product cheap	95.7	4.3	100.0
Lack of marketing skills	90.0	10.0	100.0
Lack of co-operation	41.4	58.6	100.0

Conclusion

Average age of the surveyed is 33.4, 50% are males, 68.6% are married, 35.7% are primary-school graduates, 23.3% are farmers, 94.3% have social security. Monthly household income is 2715.9 TL; and number of family members, number of children, number of working members, number of collectors are 4.7; 2.7; 1.2; 1.8 respectively. Collectors have an average of 4.3 year experience in laurel collection.

According to the research results, it was determined that the income of laurel collectors in the Aladağ district of the province of Adana is very low. One of the most important factors for this is how cheap middlemen purchase the product. Aside from main sources of income, the biggest reason for collecting laurel, as mentioned above, is to bring extra money to the table. Bringing effective cooperative understanding and being on equal terms with middlemen should mean an increase in laurel prices and this will amount to better income for collectors, which contributes to the regional and national economy.

By establishing regional drying plants, there will be new work areas and more profit from the product, as moist laurel is sold at a higher price. Consecutively, creating new regional work areas for processing laurel will bring important contributions to regional economy.

References

- Anonymous 2016a. What is bay? What are the benefits?<http://www.saglikaktuel.com/bitki-ansiklopedisi-defne-nedir-faydalari-nelerdir-1514.htm> (Access date:: 18.07.2016), in Turkish.
- Anonymous 2016b. Laurel, <http://www.defneyaprasi.gen.tr/defne-agaci.html> (Access date::18.07.2016), in Turkish.
- Anonymous 2016c. Non-Wood Forest Products and Services Directorate General of the Department of Non-Wood Forest Products,

<http://ormuh.org.tr/arsiv/files/Odun%20Disi%20Orman%20Urunler%20Ders%20Notu.pdf> (Access date:: 18.07.2016), in Turkish.

Altunel TA.. 2012. Socioeconomic Importance of Non Wood Forest Products in Terms of Gatherer/Producer, Journal of the Faculty of Forestry, Istanbul University, 62(1):85-99), in Turkish.

Bilgin F., Şafak İ., Kiracıoğlu Ö. 2006. Profile of Producer Bay in the Aegean Region 1st International Non-Wood Forest Products Symposium, Trabzon, Türkiye, 1-4 November, 2006, 1(1):60-65), in Turkish.

Durgun M., Şahin Y., Serin H. 2014. A Research on Laurel Leaf Collector's Occupational Health and Safety II. Mediterranean National Forest and Environment Symposium, 22-24 October, Isparta, S:619-623. http://ormanweb.sdu.edu.tr/ormanvecevre/belgeler/bildiriler/62_A5-2.pdf, in Turkish.

Palaz S., Boz İ. 2008. Factors Influencing College Graduate Adults To Provide Volunteer Service in Different Organizations, Journal of the Institute of Social Sciences, Balıkesir University, 11(19): 95-106), in Turkish.

Economics and Industry of Non-Wood Forest Products in Turkish Forestry

Mustafa Fehmi TÜRKER¹, *Emine Nur YEŞİLYURT¹

¹Karadeniz Technical University, Faculty of Forestry, Trabzon / TURKEY

*Corresponding Author: eminenkoyuncu@ktu.edu.tr

Abstract

The forest resources of our country support sustainable development via the provision of wood as raw material, non-wood forest products and services in order to meet the needs of the community. In our country, due to the gradual increase in the demand for non-wood forest products in parallel with the discovery of new areas of usage, it becomes evident that forestry sector could not ensure its continuity through solely producing wood as raw material. It is also important to consider the existing resources such as non-wood forest products as a side income, besides the main income sources that ensure the sustainability of the revenue for the forestry sector. This study, conducted based on the three years of data from the General Directorate of Forestry, aims to assess the income obtained from the non-wood forest products (NWFP) besides the income from the wood raw material in ensuring the sustainability of the forestry sector and to bring forward suggestions depending on these assessments. The results of the conducted studies indicated that General Directorate of Forestry has an average of 2,551,824,524.83£ total revenue in three years, where 20,480,645.35 £ of this revenue is derived from the NWFP. The nominal contribution of the NWFP, as 0.86%, in the total income of the forestry sector demonstrates that problems might be experienced in providing the continuity of revenue of the sector. In order to improve this situation, inventory should be completed as immediate as possible, NWFP sales should be made with actual stumpage and the necessary significance should be attributed to the foreign trade of NWFP and it is essential to conduct studies that are encouraging in the area.

Keywords: Turkish Forestry Sector, Non-Wood Forest Products, Sustainability, Income, Secondary Income

Introduction

A operation which is defined as an economic unit that produces or distributes a product or a service on a regular basis to profit by addressing the needs of individuals of society (Turan, 2013) has to generate a revenue to ensure its own sustainability. The revenue of a business can be categorized as primary income and secondary income in terms of its issue of production. The income obtained through the main production issue in a operation is called the primary income source. Other incomes obtained besides the main production issue of a management are defined as the secondary incomes. Operations need the side incomes that are acquired through the sales of their subsidiary products in order to with stand the changes in the market and the decrease in their primary income over a long period of time (Türker, 2013). On the other hand, forestry operations which are economic units that operate over the forests with limited resources in order to satisfy the needs for the products of and

forest itself directly or indirectly on a regular basis (Fırat, 1971) also are in need of side incomes in addition to the primary source of income to ensure their sustainability. However, the sustainability in Turkish forestry has always been associated with the regularity of wood products. Whereas the increase in demand for various products and services from the forest ecosystems suggests that forestry operations are unable to provide their sustainability through only wood production.

On the other hand, forests, considered as an ecosystem, are imperative natural resources as an instrument in sustainable development with respect to their functional values such as soil protection, regulation of water regime, cleaning the air, the country's defense and positive contributions to mental health, and the maintenance of wildlife and biological diversity development, as well as the provided wood and non-wood forest products for the society (DPT, 2001). Nonetheless, preventing the disruption of

sustainable development depends on the sustainability of forest resources. Therefore, it becomes crucial to place emphasis on the principle of multidimensional benefit through the use of existing resources such as non-wood forest products, by changing the one-track, namely wood raw material oriented, management approach of the forest resources. Hence, the reason for the nominal 0.2% (Yeşilyurt, 2015) contribution of the forestry sector, which occupies the 28.6% (OGM,2015a) of the country's area, to the country's economy is that several services including the NWFPs which are obtained from the forest resources yet are not priced or hard to be priced, are unrecorded and are not taken into account in calculations.

In addition to the aforesaid issues, it is mentioned in management literature that in order to regard an income obtained from the secondary products as a significant rate of at least 20% is necessary in terms of providing the business sustainability by the economics and management department of authorities. As the forest management are scrutinized in this respect, it is observed that NWFPs have a very low rate, 0.86%, of the total revenues and this situation indicates that problems could be experienced in ensuring the sustainability of the forestry sector.

The current study aims to evaluate the significance of NWFPs in providing the sustainability of forestry sector with reference to financial statements of the years 2013, 2014 and 2015 of the General Directorate of Forestry (GDF) which is one of the top most institutions responsible for the industry and managements of forestry resources and to develop strategic suggestions based on these evaluations.

Material and Method

In this paper, circulating capital budget data for the years 2013, 2014 and 2015 of the General Directorate of Forestry, which is a senior unit responsible for managing and operating the forestry resources and has significant functions both for the national economy and the life of all living things, are used as the main material. The data used in the study was obtained from the

Administrative and Financial Affairs of the General Directorate of Forestry. On the other hand, all types of scientific studies conducted on the subject, both on national and international level, were benefited from. Furthermore, the weight of the NWFPs in the total income was determined through percentage analysis, via the determination of the total revenue of GDF for the years 2013, 2014 and 2015, based on the relevant data.

Results and Discussion

According to the No. 302 notification of GDF, non-wood forest products (NWFPs) are defined as; biological and mineral-based products other than the wood obtained from the forests and trees, other products such as bark, wood chips, shrubs, roots, stumps, pine cones, that are released during the production of wood, mushrooms, forest humus and cover (OGM, 2016). However, since the concept of non-wood forest products necessitates the inclusion of all benefits other than wood products, this definition comprises several shortcomings. From this point of view, non-wood forest products, in general sense, are comprised of "benefits such as recreation of the forest resources, grazing, carbon dioxide retention, creating oxygen, providing genetic resources, utilization for scientific purposes, water reserves and erosion control, etc. along with the whole plant and animal products apart from the wood products that are produced in forests and clearings (Özügürü and Düzgün, 2000).

Although various benefits are mentioned in the definitions of NWFPs, NWFP identifications in the financial tables of the General Directorate of Forestry (GDF) are listed as: Side Product Sales Revenues, Forest Tree Seedling Sales Revenues, Ornamental Plants Sales Revenues, Seed Sales Revenues, Forest Recreation Area Revenues and Other Forest Income (OGM, 2014a).

On the other hand; the results for NWFP income obtained via the examination of the circulating capital budget data for the years 2013, 2014 and 2015 for GDF are presented below.

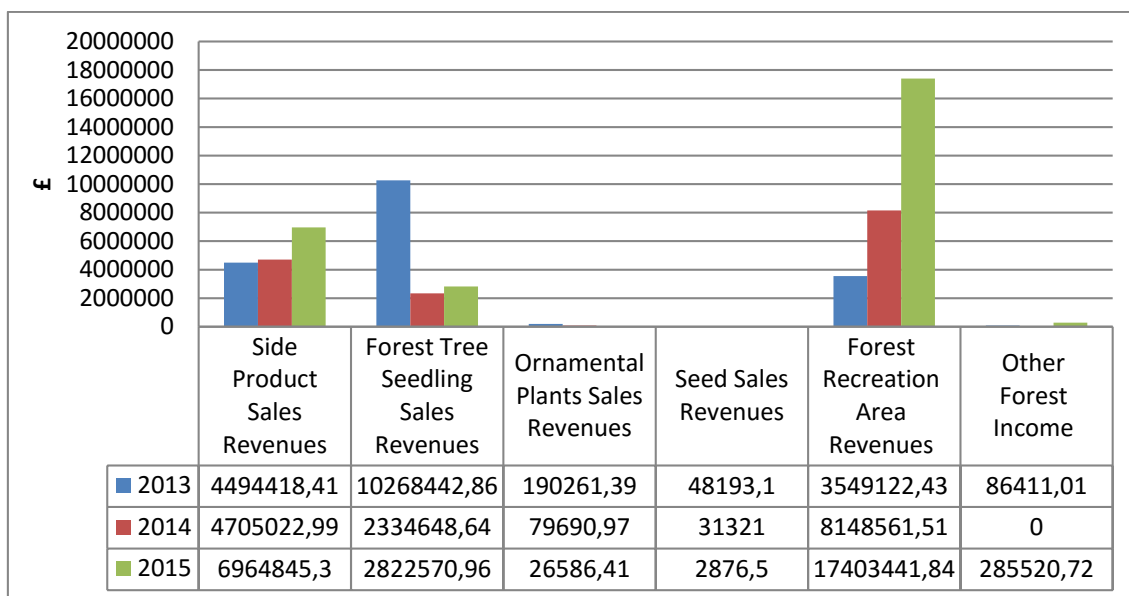

Figure 1: General directorate of forestry non-wood forest products income distribution by year

Once the financial tables of the years 2013, 2014 and 2015 for the General Directorate of Forestry are examined, it is possible to observe that the sum of the obtained revenues are 2,033,468,192.42 £, 2,901,561,302.63 £ and 2,720,444,079.43 £ respectively. However, as the same items are scrutinized in terms of NWFP for the relevant years, the revenues obtained from the NWFP are determined to be 18,636,849.2 £, 15,299,245.11 £ and 27,505,841.73 £, respectively. On the other hand, NWFP Given the relative situation of total income; Sini 0.92% of total income in 2013, while in the 0.65% to 1.01% in 2014 and 2015 is determined to create the NWFP. Hence, given the relative proportional situation for NWFP in the total revenue, it constitutes; 0.92% of the total revenues in 2013, 0.65% of the total revenues in 2014, and 1% of the total revenues in 2015.

NWFP income for GDF in the year 2013

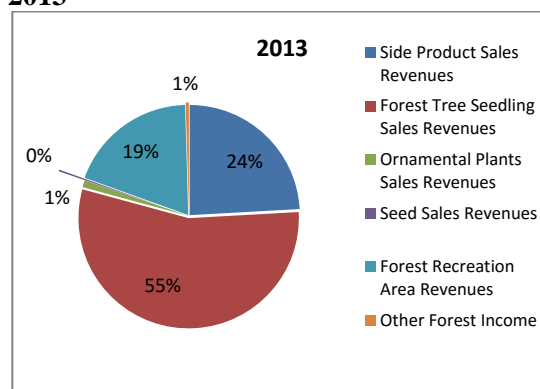

Figure 2: General directorate of forestry proportional distribution of income items NWFP in 2013

GDF obtained a total of **18,636,849.2 £** income from the NWFP in the year 2013 (OGM, 2013). 55% of this income is obtained from Forest Tree Seedling Sales Revenues, 24% of is from Side Product Sales Revenues, 19% is from Forest Recreation Area Revenues, 1% is from Ornamental Plants Sales Revenues, and 1% of this income is obtained from Seed Sales Revenues. On the other hand, the investigations conducted based on the regional directory of forestry in 2013 pointed out that the most income, obtained in terms of NWFPs, are from the Regional Directorate

of Forestry of Erzurum, Adana, Antalya, İstanbul and Bolu provinces.

NWFP income for GDF in the year 2014

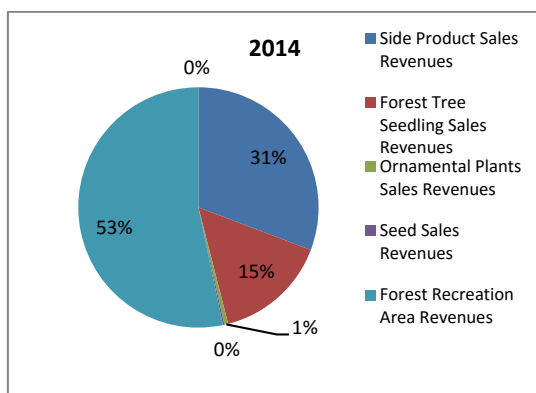

Figure 3: General directorate of forestry proportional distribution of income items NWFP in 2014

GDF obtained a total of **15,299,245.11 £** income from the NWFP in the year 2014 (OGM, 2014a). 53% of this income is obtained from the Forest Recreation Area Revenues, 31% is from Side Product Sales Revenues, 15% is from Forest Tree Seedling Sales Revenues and 1% of this income is obtained from the Ornamental Plants Sales Revenues. On the other hand, the first five Regional Directorate of Forestry in terms of the highest income from the NWFPs are determined as the directorates of Adana, İstanbul, Antalya, İzmir and Bolu.

NWFP income for GDF in the year 2015

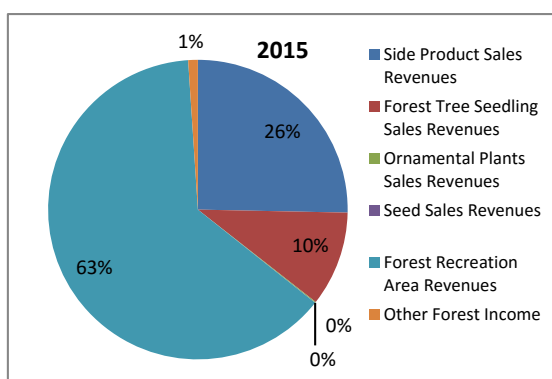

Figure 4: General directorate of forestry proportional distribution of income items NWFP in 2015

GDF obtained a total of **27,505,841.73 £** income from the NWFP in the year 2014 (OGM, 2015b). 63% of this income is obtained from the Forest Recreation Area Revenues, 26% is obtained from the Side Product Sales Revenues, 10% is from the Forest Tree Seedling Sales Revenues and 1% of this income is obtained from the Other Forest Income. On the other hand, the first five Regional Directorate of Forestry in terms of the highest contribution to the total income via the income obtained from NWFPs in 2015 were determined as the directorates of İstanbul, Adana, Muğla, Antalya and Sakarya.

Conclusion

Non-boundary effects of the new developments and changes of the societies necessitate that forests should be evaluated in terms of non-wood forest products, services and functions rather than considering the forests as wood raw material, that policies, which facilitate the multi-purpose utilization of the forest resources, should be developed, and that the forest resources should be managed through the resource management plans, which are developed in line with the sustainable forestry principles, in our country as well as the rest of the world (DPT, 2001). However, once the current state of the Turkish forestry sector is assessed, it appears that wood based product management outstands. On the other hand, it is possible to observe that the one-track, namely wood raw material oriented, management approach of the forest resources draws the forestry into an important bottleneck in terms of economic, environmental and social aspects (Türker et al., 2006). Furthermore, it was revealed by this study that the average share of non-wood forest products in the total income is 0.86%, according to the circulating capital budget data for the years 2013, 2014 and 2015 for GDF. Thus, with reference to the necessity that in order to regard an income obtained from the secondary products as a significant rate of at least 20% is essential in terms of providing the business sustainability, it becomes evident that difficulties in maintaining the sustainability of the forestry sector are substantial given the fact that the

rate of NWFPs are at such a low level of 0.86%.

Moreover, the reason that NWFPs' contribution is that low in the forestry sector depends on several problems arise starting from the planning phase to the production in the NWFP management process, such as lack of a comprehensive and sufficient inventory on the NWFPs, lack of actual stumpage in NWFPs sales. Strategic solutions to such problems are proposed below in bullets.

- Forest resources, in the light of the principle of sustainability, should be planned by taking into account the production options that provide more income and wealth for the society. In this context, forest managements should compromise objectives, should be planned and managed that are taking the NWFPs into account.

- Inventory studies concerning NWFPs should be meticulously conducted, these inventories should be repeated in time intervals and technical and legal legislations aimed to reduce undeclared production should be revised.

- Actual stumpage should be determined and applied instead of the central stumpage for NWFPs sales.

- Studies to increase the foreign trade options for NWFPs should be conducted and preparing these products according to the world standards should be elaborated.

- Especially forest villagers should be endorsed to culture the NWFPs that are of high economic value and they should be provided technical and financial support.

- In order that the prosperous potentiality of NWFPs in our country would be able to compete with the foreign countries' certified products, the certification system should at once be prepared.

- Small scale businesses, aimed to process NWFPs, should be endorsed in order to provide a higher added value to the national economy by exporting processed goods rather than raw materials and in order to create new areas of investment. In such an approach, the rural industry and SME type of business would have the opportunities for significant investments (Türker et al., 2006).

- Once the GDF financial charts are investigated, it became evident that NWFPs

are commonly evaluated as non-wood plant products, and the services are not taken into consideration in such scope. Turkey would continue to have the importance in ensuring the sustainability of revenues through the consideration and monetarization of the animal products and services as well as the plant products in NWFPs administration and management.

As a result, since the biodiversity and vast cultural heritage of Turkey's forests increase the production ability of non-wood forest products, the production of non-wood forest products is a subject that needs attention both in terms of demand and the production capabilities of the country, as well as the production of forest products based on wood (Kalkınma Bakanlığı, 2014). However, this study demonstrated that forestry sector at its present state could not benefit from the NWFPs sufficiently. Forestry sector that occupies the 28.6% of the country's lands could not benefit from these resources efficiently although it has rich plant and animal resources in terms of non-wood forest products. As the suggestions provided in this study are met, the sustainability of the forestry sector would be ensured through obtaining side income besides the main income and the contribution of the sector into the country's economy would increase.

References

DPT, 2001 VIII. Beş Yıllık Kalkınma Planı Ormanlık Özel İhtisas Komisyon Raporu, Yayın No: DPT: 2531-ÖİK: 547, Ankara.

Fırat, F., 1971. Ormanlık İşletme İktisadi, İstanbul Üniversitesi Orman Fakültesi, Yayın no: 1541, 336s, Kurtulmuş Matbaası, İstanbul.

OGM, 2013. Orman Genel Müdürlüğü Döner Sermaye Bütçesi Ayrıntılı Mizanı, OGM İdari ve Mali İşler Daire Başkanlığı, Ankara.

OGM, 2014a. Orman Genel Müdürlüğü. Döner Sermaye Bütçesi Detaylı Hesap Planı,

OGM İdari ve Mali İşler Daire Başkanlığı, Ankara.

OGM, 2014b. Orman Genel Müdürlüğü Döner Sermaye Bütçesi Ayrıntılı Mizanı, OGM İdari ve Mali İşler Daire Başkanlığı, Ankara.

OGM, 2015a. Türkiye'deki Orman Varlığı, Orman Genel Müdürlüğü, Ankara.

OGM, 2015b. Orman Genel Müdürlüğü Döner Sermaye Bütçesi Ayrıntılı Mizanı, OGM İdari ve Mali İşler Daire Başkanlığı, Ankara.

OGM, 2016. Odun Dışı Orman Ürünlerinin Envanter ve Planlaması ile Üretim ve Satış Esasları, Tebliğ No: 302, Orman Genel Müdürlüğü, Ankara

Ozuğurlu E., Düzgün M., 2000. Policies to Promote Sustainable Operations and Utilization Non-Wood Forest Products in Turkey, Seminar Proceedings “Harvesting of Non-Wood Forest Products”, Ministry of Forestry of Turkey (2-8 October 2000), İzmir, Turkey

TC Kalkınma Bakanlığı, 2014. Sürdürülebilir Orman Yönetimi, X. Kalkınma Planı Ormancılık Özel İhtisas Komisyon Raporu, Ankara

Turan, N., 2013. İşletme İlkeleri, 2. Baskı, I. Ünite TC. Anadolu Üniversitesi Web-Ofset Tesisleri, Eskişehir.

Türker, M.F., 2013. Ormancılık İşletme Ekonomisi, 2. Baskı, Celepler Matbaası, 287s, Trabzon.

Türker, M.F., Pak, M., Öztürk A., Durusoy İ., 2006. Odun Dışı Organik Orman Ürünleri Ve Yönetimi, Sürdürülebilir Rekabet Avantajı Elde Etmede Organik Tarım Sektörü: Sektörel Stratejiler ve Uygulamalar, URAK Yayınları, ss.499-543, İstanbul.

Türker, M.F., Pak, M., Öztürk A., Durusoy İ., 2006. Sustainable Management of Non-Wood Forest Goods and Services in Turkey: Current Situation, Problems and Solutions, 1st International Non-wood Forest Products Symposium, Karadeniz Technical University Faculty of Forest(1-4 November 2006), Trabzon.

Yeşilyurt, E.N.,2014. Orman Kaynaklarının Yönetimi ve İşletmeciliği dersi kapsamında, TÜİK 2002 Arz-Kullanım ve Girdi- Çıktı Tabloları yardımıyla hazırlanmış Girdi-Çıktı Analizi Seminer Çalışması (Basılmamıştır), K.T.Ü. Fen Bilimleri Enstitüsü,Orman Mühendisliği A.B.D. , 36s, Trabzon.

Resolution of Turkish Forestry's Non-Wood Forest Products Management Issues with the Root Problem Approach

*Mustafa Fehmi TÜRKER¹, Canan YILMAZ¹, Emine Nur YEŞİLYURT¹

¹KTU Forest Faculty, Department of Forest Engineering

*Corresponding Author: mft@ktu.edu.tr

Abstract

Turkey, with the intent of establishing social welfare and peace by supplying economic, social and cultural developments, has entered into the process of organization of the development plans since 1963 and 10 development plans have been worked out until now. When the development plans are examined, it is seen that the managership of non-wood forest products (NWFP) are given importance with considering the principles such as ecosystem approach in Turkish forestry, multi-purpose utilization and sustainability since the fifth FYDP. Besides, problems such as failure to fulfillment of NWFP's inventory, in the administration and management of NWFP, the lack of the plans which organize the utilization of these products, remaining unfulfilled of manufactured or semi-manufactured goods instead of unprocessed raw materials in NWFP exportation, the lack of skilled workman in the managership of the aforesaid products are common and irresolvable problems in all development plans. The failure of arriving at a solution of these problems is originated from root causes such as not being understood completely of the importance of forest ecosystem, the forestry understanding of the raw wood material, the non-existence of a unit responsible for the managership of these products and considerably low price list to the production of NWFP. Root causes, the main tool to the solution of the problems that arise out of the managership of NWFP, should be supplied to the solution by making modern forestry understanding dominant over Turkish forestry.

Keywords: Development plans, Turkish Forestry, Non-wood Forest Products, Problems, Root Causes

Introduction

Recently, along with principles like sustainability, ecosystem approach and multipurpose utilization are becoming more and more apparent in Turkish forestry, the importance of non-wood forest products (NWFP) is increased. NWFP is a concept that includes benefits derived from forest resources such as recreation, grazing, absorbing carbon, producing oxygen, providing genetic resources, solidifying earth except wood.

When examining ten development plans issued until today; it is seen that, management plans, cadastre of forest areas, reforestation works and forest road construction were given priority and emphasized in the first four Five Year Development Plans (FYDP) and goals, principles and policies were established related to these subjects. In addition to that, in the mentioned development plans NWFP was labeled as secondary products or by-products and nothing else for these products beyond manufacture and export estimations.

On the other hand, with new notions entering Turkish forestry, products labeled as secondary products or by-products were

begun being labelled as NWFP since V. FYDP and then principles, policies and goals were beginning to be established towards NWFP management. When all of the development plans were to be reviewed, the fact that NWFPs were not documented and accompanying this problem issues like plan shortage, using raw materials rather than refined or half-refined products in exports, lack of experts and educated workers on NWFP resulted in being issues experienced in NWFP management. At the foundation of these unresolved issues may be much deeper problems. It is within this research's proposal that by resolving the core issues known as "The Root Problem": not fully comprehending the importance of forest ecosystem, forestry understanding consisting only of timber producing and producing NWFP with cheap receipt rates; it is possible to say that the issues experience in NWFP management will resolve itself.

With this work, determining problems related to NWFP activities occurring in the development plans and root problems at the foundation of these problems and bringing solutions to the root problem in order to

achieve an efficient and productive NWFP management is aimed.

Material and Method

Basic material of this study is consisted by 10 development plans to which Turkish forestry sector's targets, principles and policies in macro level belongs, specialization commission reports which embrace these development plans detailed based on the sector of forestry, and scientific studies that have been carried out. With the usage of these materials, each of the development plans has been examined; and in these plans administration and management of the non-wood forest products' prominent common problems and root causes that lead to these problems have been determined and examined.

Results and Discussion

In the first FYDP, the targets of farm policy are expressed as to organize the increase in consumption to remove the wage gap, to help to remove the unemployment and to maintain the long standing targets of the plan by providing long standing balance. In addition to this, in the 1st Five Year Development Plan (FYDP) involving the years 1963-1967, while profiting from the raw wood gathered in forests are given first priority and emphasized, policies towards realizing these goals were established. In the same development plan, the fact that NWFP were labeled as "secondary forest products" seems as the results of that particular approach. When examined in terms of NWFP, in the I. FYDP estimations of producing 83 thousand ton NWFP in 1967 and exporting 60 thousand ton NWFP again for the same year were given (State Planning Organization (DPT, 1963). Also production targets aimed at the produce of NWFP, such as resin, crude levant storax etc, are identified to take place between %30-50 and it is also identified that it could not achieve the aim that is determined about NWFP expectation (DPT, 1967).

In the second FYDP, which involves the years of 1968-72, the principles of the forestry sector is indicated as to protect forests, ensure its continuity and managing in the best way to contribute the development, establishing new forests with afforestation, increase the debit

by zoning and improving the forests, organizing the relationships between forests and society in the aspect of managing and protecting the forests, and reconfirming the borders of forests in regard to forest existence and landuse capability. Moreover, it is stated in the plan that Turkey, which has capacity of 150 tons of sweetgum oil, 10-12 thousand tons of resin, 30-40 thousand tons of acorn in the secondary product content, cannot evaluate its whole production capacity because the products like sweet gum oil and resin slip when they are kept waiting in the storage. NWFP was still labeled as secondary forest products, a manufacture and an export estimation for sweetgum oil, resin and acorn were given. Thus, at the time of the 2 nd FYDP, producing 60 ton of sweetgum oil, 7.5 ton of resin and exporting 60 ton of sweetgum oil and 3 ton of resin were estimated to happen (DPT, 1967). However, it could not be possible to get information about the grade of the determined production and exportation rates. On the other hand, in the following development plan, actualizations of NWFP that belong to the period of second FYDP have been given in the basis of the gained income; produced and exported amount and sort of NWFP have never been mentioned (DPT, 1973).

In the third FYDP, which belongs to the period between 1973 and 1977, it is indicated that export of processed of forest and animal products would be given importance, and afforestation in forestry investment and construction of forest road would be given primacy. In addition to these, the annual average of NWFP which is mentioned as secondary product is predicted as %5.1 speed-up, %3.1 domestic demand increase, and %10 export increase (DPT, 1973). Looking to the realization that determining these goals, %1.6 speed-up, 1.1% of exports and 2.4% domestic demand in the rate reached thus it remained below the target that has been identified in the realization.

4th FYDP involving the years of 1979-1983 labeled the non-wood forest products as "by-products". In the mentioned FYDP, an increase in forest products of 7.4% was predicted while this number was 2.1% for the by-products (DPT, 1979). In the plan, the

speed-up in relation to NWFP occurred at the rate of %1.6 (DPT, 1985).

The fact that SPO 5th FYDP planned for the 1985-1989 period decided that it was within its policy to dictate that forests should be operated to fulfill the needs of food for the population, conservation of soil, wild life, water production, recreation and aesthetic values shows that a forestry approach just focusing on producing raw wood was further distanced from in Turkey (DPT, 1985). In the period of plan, while the products like resin, bay leaf, sweetgum leaf and boxwood are manufactured related to the annual production and sale program; the large part of them including pine kernel, fennel, thyme, mahaleb and clary are produced without program. Besides, the first NWFP inventory in which 38 plants are discussed is taken and this inventory is planned to be taken with time sharing. Also in the same period, it is seen that the exportation is performed which is depending upon unimproved NWFP (DPT, 1990).

Mentioned for the first time the notion of "non-wood forest product" as a result of "secondary product" and "by-product" approaches, in the 6th FYDP involving the years 1990-1994 the principals of sustainability and multipurpose utilization for profiting from forest resources are emphasized. In addition, objectives of completing the non-wood forest products inventory first and concentrating more on exporting refined products rather than raw materials are set (DPT, 1990a). In the sixth plan period, as NWFP, annually 500-650 tones of resin, a ton of sweet gum oil, 800 tons of bay and 25 tons of boxwood and at the rate of %10 to 15 income growth obtained by exportation are targeted (DPT, 1990b). On the other hand; at the first three years of the sixth plan, it is established that boxwood production was not occurred, 140 tons of resin in average was produced, and the production was failed to reach the target but sweetgum oil reached the designed production amounts and bay leaf production is beyond the target (DPT, 1995).

7th FYDP involving the 1996-2000 period includes that: forests will be planned in consideration with the ecosystem approach due to fact that forestry and silviculture plans

will be reorganized in accordance with the wood and non-wood forest products and services and management objectives (DPT, 1996).

In the eight FYDP which consists the years from 2001 to 2005 and shows similarity with the sixth and seventh FYDP, the main problems of the sector are qualified as the deficiency of cadastres, the lack of skilled staff and worker, the lack of a comprehensive inventory of habitat, the uncertainty of managership, the fail of plans to the study of rejuvenation and the scantiness of afforestation caused by financial inefficacy. Besides, in the plan, the necessity of herbal resources of domestic consumption and foreign trade, and precautions to preserve herbal resources and natural mushrooms, The Green Certification which expresses the production of forest productions with environmental and social responsibility understanding are indicated (DPT, 2000). The inadequacy of NWFP's inventory and research that shows its present situation, being collected and consumed unconsciously by public and institutive inadequacy become the problems in the managership of NWFP (DPT, 2001).

In the ninth development plan that belongs to the period between 2007 and 2013, NWFP is stated to involve all kinds of volatile oils, fruits, seeds, flowers, leaves, hulls, roots, green branches, onions, bumps and rhizorns, and mushrooms but trees, small trees, bushes and woods of herbaceous plants. In addition to these in the ninth plan, it is stated that biological diversity of Turkish forests enables rich sources of NWFP which is spread at the different regions of the country to take place but the importance and emphasis given to the management of the sources of NWFP and the institutional capacity in this area are remarked as insufficient (DPT, 2006).

On the other hand, in the ninth development plan, it is touched on the significance of the importance of NWFP in the foreign trade and in NWFP trade, it is declared that from the year 2002, there has occurred a 1,5 times increase than the year of 1992. Also, it is predicted that 1 billion Turkish liras will be gained from NWFP transport that is going to be produced in the period of plan. Besides, in the SWOT analysis

that determines the strong and weak sides, and occasion and threat of the sector, NWFP's inadequacy of inventory and the continuance of irregular and subversive utilization are qualified as the thread of the sector. One of the policies of utilization of forests in the ninth development plan constitutes the satisfying need and demand of non-wood forest productions in the best way, standardization and authentication of NWFP, to discipline trade and encouragement of the finished product instead of raw material (DPT, 2006).

On the other hand, it is scrutinized which level these objectives in the ninth development plan are accomplished. Also, it is designated that NWFP is studied only on the range subject while in the tenth development plan, to the Forestry Specialization Commission Report, functional planning on an ecosystem basis, cadastral work, fire fighting, afforestation, erosion control and development works are given place (Kalkınma Bakanlığı, 2014).

The tenth development plan is evaluated as an important milestone to supply welfare to the Turkish society in accordance with Turkey's 2023 target. Besides, to adopt a concept of plan that studies economic, social and ecologic function and to manage NWFP production and to market wood products play a part in the purpose and target of the plan (Kalkınma Bakanlığı, 2013). On the other hand, in the SWOT analysis that is made to identify the situation of forestry, record absence related to the NWFP inventory and utilization level is expressed as a blind side while the interest rise aimed at NWFP in national and international levels is expressed as an opportunity (Kalkınma Bakanlığı, 2014).

Conclusions

When all of the ten development plans until now are evaluated as a whole, it can be said that the first four development plans aim to supply economic income from forest ecosystems. With this purpose, studies such as road making, to increase the raw wood material income, preparing the amenajman plans, and completing the cadastres are given importance and priority. Because in this period, producing raw wood material is the initial aim above all forest ecosystems, NWFP

is named as a secondary or a by-product. In the same period, the approach to NWFP is economical intentional and in the plans, production, consumption, exportation and income of these products are given place.

On the other hand, in Turkish forestry from the fifth FYDP period, principles such as maintainability, ecosystem approach, and multipurpose utilization are given place and with considering them, managership of forest ecosystems are carried out. Thanks to the change of perspective in forest ecosystem, imputed values of NWFP's production and exportation in development plans and also the problems in the managership of NWFP are given place. In parallel, it is seen that NWFP is evaluated as a part of forest ecosystem, not a by-product, Turkey's ownership of rich NWFP sources is implied thanks to the proper ecological conditions and the importance of NWFP in Turkish forestry especially in the employment of the countryside and in endowment.

When the appraised value of the production and exportation of NWFP which is determined in the development plans, it is determined that most of the objectives were not accomplished, the realizations were below the targets but some realizations were above the targets. Even in some development plans, the information about the actualization of the production and exportation amounts of NWFP are not given in number but money value which is gained. This situation can be explained by because of being not understood the importance of NWFP thus being unplanned of the production and being not prophetic of the committed estimations even if some targets concerning NWFP are set in the development plans.

In other respects, it can be understood in the development plans that targets, principles, and purposes devoted to NWFP are mostly related to non-wood herbal products. However, when NWFP description is considered, it is necessary to evaluate not only non-wood herbal products but also animal products and services in the content of NWFP.

Besides, it is indicated that in almost all of the plans that Turkey has rich sources of NWFP and these sources should be evaluated. Additionally, from the first to the last development plans, the problems such as lack

of NWFP's inventory and plan, not to export semi-processed or processed product instead of raw product in NWFP exportation, the lack of skilled workman in the managership of aforesaid products are established without solving. These problems constitute big impediments to carry out active and fertile managership of NWFP. The failure to resolve NWFP problems in Turkish forestry make us think that there could be greater problems that lie behind these ones which can be named as root causes.

The main root cause that lies behind the failure to resolve NWFP managership is being unrealized of the importance of forest ecosystem. Because the society has not the system awareness, thus does not pay attention to the cause effect relationship, they approach to the gained benefits as a part of short term and immediate interest. For example, they do not care about this source except clear and direct benefits like farm lands, game animals, firewood and fodder. That is to say, long termed and indirect benefits in the managership of forest source are not taken in consideration (Geray, 1988).

Yet, forest ecosystems are important unions that influence all the living creatures in the world and their development. Forests that supply the needs of people, initially raw wood material, have become remarkable because of the other functions arising out of environmental effects which is resulted from deforestation. The society eventually has realized there are also other effects of the forest sources like environmental protection, not only main crops it offers (DPT, 2001).

In other words, mankind has exercised control over the forests to extend the living place, to obtain cultivated area, and to graze. Mankind who had considered the forests as the source of raw wood material or terrain with amputating the trees has just realized that forests are producing some ecological values. But when the importance of the subject is revealed, it is faced that how dramatically forests of the world are damaged (DPT, 2001).

Another root cause which is encountered within the managership of NWFP is derived from Turkish forestry's understanding of administration and managership. Thus, forestry occupation is considered as an economical field of activity, even by foresters

to make profit by the production of raw wood material. In parallel with this, the plans that aim to make use of forests are prepared towards the production of raw wood material and non-wood forest products are slighted (Türker et al, 2006). The description of NWFP as a secondary or a by-product for a long time is a product of this understanding. As well as in the scholarship of business, being primary or secondary should be identified to the aim of managership but in Turkish forestry, the raw wood focused managership understanding led these products to be evaluated as secondary products.

These foresaid root causes led a lack of a unit responsible for the managership of NWFP in forestry organization and this lack triggered the existence of a root cause which is NWFP oriented. Besides, after the change in the organizational structure of OGM in 2011, establishment of a unit which is in the same degree with the head of department who is responsible for the managership is an important step to get rid of this lack.

Another root cause in this content is NWFP production which is made with a very low price list. When the price list is set in the actual way, the contribution of NWFP to the sector of forestry and the sector of forestry to the national economy will rise, thus both NWFP and the sector of forestry will gain the value they deserve.

To sum up, the modern forestry understanding, which means to generate alternatives whose economic, social and biophysical results are different, and to make choice amongst them, considering the constraint of the country and the sector, to equalize the material benefits with other benefits, and to resolute the problem of the allotment of sources to different economic activities (Geray, 1989), should be supplied to dominate Turkish forestry either. Following, the other products and services of the raw material production of forest ecosystem should be attached to the NWFP planning and thanks to this; active and fertile managership of NWFP should be carried out. Besides, implementation of Functional Planning on Ecosystem Basis in Turkey since 2008 and the study of trying to constitute BIYOD database to identify the variety of plants, animals and

mushrooms should be evaluated as promising steps in the managership of NWFP.

References

- DPT, 1963. I. Beş Yıllık Kalkınma Planı (1963-1967), TC Başbakanlık Devlet Planlama Teşkilatı, Ankara
- DPT, 1967. II. Beş Yıllık Kalkınma Planı(1967-1972), TC Başbakanlık Devlet Planlama Teşkilatı, Ankara
- DPT, 1973. III. Beş Yıllık Kalkınma Planı (1973-1977), TC Başbakanlık Devlet Planlama Teşkilatı, Ankara
- DPT, 1979. IV. Beş Yıllık Kalkınma Planı (1979-1983), TC Başbakanlık Devlet Planlama Teşkilatı, Ankara
- DPT, 1985a. V. Beş Yıllık Kalkınma Planı (1985-1989), TC Başbakanlık Devlet Planlama Teşkilatı, Ankara
- DPT, 1985b. V. Beş Yıllık Kalkınma Planı, Ormancılık Özel İhtisas Komisyon Raporu, YAYIN NO: DPT: 2872 - ÖİK: 310, Ankara
- DPT, 1990a. VI. Beş Yıllık Kalkınma Planı (1990-1994), TC Başbakanlık Devlet Planlama Teşkilatı, Ankara
- DPT, 1990b. VI. Beş Yıllık Kalkınma Planı Ormancılık Özel İhtisas Komisyon Raporu, TC Başbakanlık Devlet Planlama Teşkilatı, Ankara
- DPT, 1996. VII. Beş Yıllık Kalkınma Planı (1996-2000), TC Başbakanlık Devlet Planlama Teşkilatı, Ankara
- DPT, 2000. VIII. Beş Yıllık Kalkınma Planı (2001-2005), TC Başbakanlık Devlet Planlama Teşkilatı, Ankara
- DPT, 2001 VIII. Beş Yıllık Kalkınma Planı Ormancılık Özel İhtisas Komisyon Raporu, Yayın No: DPT: 2531-ÖİK: 547, Ankara
- DPT, 2007a. IX. Kalkınma Planı (2007-2013), TC Başbakanlık Devlet Planlama Teşkilatı, Ankara
- Geray, A.U., 1989, Ormancılığın Çağdaş Çerçevesi, İÜ Orman Fakültesi Dergisi, Seri B, 39,4, 17-27, İstanbul.
- Geray, A.U., 1998, Ulusal Çevre Eylem Planı-Orman Kaynakları Yönetimi, DPT Yayını, ISBN 975-19-1917-7, Ankara.
- TC Kalkınma Bakanlığı, 2013. X. Kalkınma Planı (2014-2018), Ankara.
- TC Kalkınma Bakanlığı, 2014. Sürdürülebilir Orman Yönetimi, X. Kalkınma Planı Ormancılık Özel İhtisas Komisyon Raporu, Ankara

Determination of the Competition Level inside the Organization in the Marketing Activities: The Case Study in Kastamonu Forest Regional Directorate

Seda ERKAN BUĞDAY¹, *Sezgin ÖZDEN²

¹ Kastamonu University, Faculty of Forestry, Kastamonu/TURKEY

² Çankırı Karatekin University, Faculty of Forestry, Çankırı/TURKEY

*Corresponding Author: ozden@karatekin.edu.tr

Abstract

In Turkey, sources of supply in the market of wood based forest products are divided into three groups as following; General Directorate of Forestry (GDF), importers and private sector. GDF realizes 76% of industrial wood sales and 50% of fuel wood sales in the wood based forest products markets. Although GDF has a significant market share, GDF has taken into account the increasing market share of importers in two decades. Therefore; GDF has been working to increase its competitiveness via changed in product differentiation and sales procedures in an increasingly competitive market environment. It is required to identify and analysis within the organization to improve competitiveness and to provide a competitive advantage. GDF should benefit from the advantage of competition by means of regional structuring at the provincial organizations. In this study, 21 Forest District Directorates in Kastamonu Forest Regional Directorate are designated as the sample area. We aimed to determine the constraints which reveal competition within the organization and individual competitiveness. Factor analysis was applied to identify these constraints. According to the analysis result, Kastamonu FRD is divided into clusters in terms of constraints affecting competition. In this way, units which are advantages and disadvantages in competition were determined at the regional level. Also; Kastamonu OBM is provided opportunity for developing strategies with more rational approaches in the wood-based forest product markets.

Keywords: Forestry organization, Competitiveness, Wood based forest product, Market, Turkey

Pazarlama Faaliyetlerinde Örgüt İçi Rekabet Düzeylerinin Belirlenmesi: Kastamonu Orman Bölge Müdürlüğü Örneği

Özet

Türkiye’de oduna dayalı orman ürünleri pazarının arz kaynakları; Orman Genel Müdürlüğü (OGM), ithalatçı işletmeler ve özel sektör olarak üç grupta toplanmıştır. Oduna dayalı orman ürünleri iç piyasasında endüstriyel odun satışlarının %76’sını, yakacak odun satışlarının %50’sini OGM gerçekleştirmektedir. Genel anlamda piyasa payının önemli bir bölümüne hâkim olan OGM; ithalatçı işletmelerinin son yirmi yılda artan pazar paylarını dikkate alarak; pazarda artık var olan rekabet ortamında; genel anlamda ürün farklılaşması ve satış usullerindeki değişikliklerle rekabet edebilirliğini artırmaya çalışmıştır. Rekabet edebilirliği ve rekabette üstünlüğü sağlamak için örgüt düzeyinde de tanımlama yapılması gerekmektedir. OGM’nin taşra örgütünde bölgesel düzeydeki yapılanmasından faydalanarak; OGM, rekabetten maksimum şekilde yararlanmalıdır. Bu çalışmada Türkiye’de OGM örgütünde örgüt içi rekabet ve piyasada bireysel rekabet edebilirliği ortaya koyacak kısıtların belirlenmesi amaçlanmıştır. Kastamonu Orman Bölge Müdürlüğü (OBM)’ne bağlı 21 Orman İşletme Müdürlüğü örnek alan olarak belirlenmiştir. Bu örnek alanda belirlenen kısıtlar, faktör analizi ile değerlendirilmiştir. Analiz sonucunda rekabete etki edebileceği tahmin edilen kısıtlar bakımından Kastamonu OBM kümelerine ayrılmıştır. Bu sayede örgüt içinde rekabette avantajlı ve dezavantajlı olan birimler bölgesel düzeyde tespit edilmiştir. Ayrıca Kastamonu OBM’nin oduna dayalı orman ürünleri pazarında daha rasyonel yaklaşım ile stratejiler geliştirmesine imkân sağlanmıştır.

Keywords: Ormanlık örgütü, Rekabet, Oduna dayalı orman ürünleri, Pazar, Türkiye

Introduction

Supply sources of wood-based forest products market are divided into three groups as General Directorate of Forestry (GDF), importers and private sector enterprises in

Turkey. GDF holds 76% of industrial wood sales and 50% of its sales firewood of wood-based forest products in the domestic market (OGM 2013). GDF has a dominant producer position in the market in the current situation

Therefore, it can be mentioned “*imperfectly competitive conditions*” in the market of forest-based wood products, today (Daşdemir 2015). At the same time, GDF is a large organization consists of subunits. According to data from 2016, GDF is an organization consisting of 28 Forest Regional Directorate (FRD) and 243 Forest District Directorates (FDD) (URL 1). The spread of forest assets on the country is an important factor on the basis of organizational structure. (Özdönmez vd 1998). When that is reduced from general to specific, GDF is managing 243 FDD which they are adjacent to each other, engaged in manufacturing and offering these products to the market.

Until recently, 279. Notification “Standardization and Sales Principles of Forest Assets” contained the wood-based forest products marketing principles for FDD (Anonim 1987). Since 2015, 303. Notification “Selling Principles and Procedures of Wood-Based Forest Products” is in force (Anonim 2015).

When examining the general framework of Notification; the emphasis on market and customer demand is observed. Also, according to notification; FDD should adopt flexible marketing policy and adapt open market condition (Anonim 2015). Customer base - oriented approach leads to a move away from production-oriented approach to marketing and raises the efforts to meet expectations. Essentially; customer-oriented approach in GDF's marketing policy in this paper brings up these questions: “*In the marketing process, Could to expect the same performance from 243 FDDs be right?*” or “*Although FDD supplies products with similar characteristics to the market, Could it expected the same marketing skills of all FDD?*” Also “*Has the difference in general characteristic of FDDs an effects on their marketing activities?*”.

To answer these questions and also to determine place of FDD in the wood base-

forest products market was carried out this study. In other words, to reveal the degree of competitiveness of FDD is aimed for a decent marketing policy.

In Turkey, studies has been done by scientists in order to reveal measure of success in terms of forest-wealth, population density and influence, administrative and technical specifications of FDDs (Çağlar and Öncer 1990, Daşdemir 1996, Daşdemir 1998, Şentürk 2007, Şafak 2009, Öztürk and Türker 2010, Korkmaz 2012). In this study, unlike others we have focused on only marketing functions of businesses. Also, the FDDs' degree of competitive is tried to determine in terms of the factors of market-marketing.

Material and Method

KOBM, the number of products and sales seen as the first place among FRD in Turkey, selected as sample area in this study. It has 21 FDDs. This study is decided to examine on 48 variables in the marketing of wood based forest products (Field properties; crown-closure^{1,2,3}; economic, ecological and socio-cultural function; (non)productive growing stock and annual increment; production estimates for 2016, the amount of production- sales in 2015 and average sales price in 2015 (log, mining pole, utility pole, paper pulp wood, fibre/chip wood and fire wood); the amount of stumpage sales; distance to major market places (Ankara, İstanbul, Kayseri and Adana)). Simple pearson correlation analysis were done on these variables. The results of these analysis indicates that 17 variables which is about each other's above + 0,25 and under - 0,25 were found (Özdamar 2002). The variables and abbreviations is given in Table 1. In this study, factor estimations of 17 variables are made. After the factor estimations, factors coefficients and factor scores were determined. In this study, SPSS 20 and ArcGIS software packages were used.

Table 1. The variable and abbreviations

N.	Abbreviations	Unit	Descriptions
1	FOREST_LAND	ha	Forested Area
2	CROWN_CLOSURE_3	ha	Crown-closure-3 Forested Area
3	ECONOMIC_FUNCTIONS	ha	Forested Area in Economic Function
4	TOTAL_FINAL_YIELD	m3	Foreseen to be taken amount of regeneration prescribed cut in planning period
5	TOTAL_INTERMEDIATE_YIELD	m3	Foreseen to be taken amount of improvement prescribed cut in planning period
6	PRODUCTIVE_GROWING_STOCK	m3	The amount of growing stock in productive forest area
7	PRODUCTIVE_ANNUAL_INCREMENT	m3	The amount of increment in productive forest area
8	SALVAGE_LOGGING_2015	m3	The amount of unregulated felling in 2015
9	LOG_2016	m3	The amount of projected timber harvest in 2016
10	PULPWOOD_2016	m3	The amount of projected pulpwood in 2016
11	FIBRE_CIPH_2016	m3	The amount of projected fibre cips in 2016
12	INCOME_2015	TL	Total income in 2015
13	PRODUCTION_COST_2015	TL	Production costs in 2015
14	TOTAL_COST_2015	TL	Total costs in 2015
15	LOG_SALES_2015	m3	The amount of log sold in 2015
16	PULPWOOD_SALES_2015	m3	The amount of pulpwood sold in 2015
17	FIBRE_CIPS_SALES_2015	m3	The amount of fibre cips sold in 2015

Results

17 variables of 21 FDDs, they affect the competition of the wood based forest product markets, were identified. Properties of forest asset, incomes and expenses (2015) of FDDs, amount of production and sales (2015),

estimated production level of 2016 has been identified as independent variables. Pearson correlation analysis was applied to this variables. The results obtained are given in Table 2.

Table 2. The result of Pearson correlation analysis

NUMBER	FOREST_LAND	CROWN_CLOSURE_3	ECONOMIC_FUNCTIONS	TOTAL_FINAL_YIELD	TOTAL_INTERMEDIATE_YIELD	PRODUCTIVE_GROWING_STOCK	PRODUCTIVE_ANNUAL_INCREMENT	SALVAGE_LOGGING	LOG_2016	PULPWOOD_2016	FIBRE_CIPH_2016	INCOME_2015	PRODUCTION_COST_2015	TOTAL_COST_2015	LOG_SALES	PULPWOOD_SALES	FIBRE_CIPS_SALES
1	1	.782**	.812**	.576**	.715**	.539*	.779**	.643**	.590**	.592**	.874**	.590**	.604**	.636**	.402	.830**	.759**
2		1	.824**	.541*	.790**	.859**	.930**	.462*	.780**	.785**	.878**	.843**	.848**	.806**	.640**	.758**	.822**
3			1	.393	.824**	.637**	.819**	.538**	.558**	.558**	.897**	.712**	.710**	.714**	.508*	.720**	.900**
4				1	.435*	.422	.423	.699**	.629**	.650**	.586**	.583**	.562**	.526*	.488*	.730**	.448*
5					1	.578**	.852**	.538*	.374	.378	.828**	.566**	.562**	.532*	.440*	.615**	.757**
6						1	.853**	.263	.841**	.827**	.743**	.874**	.842**	.809**	.758**	.587**	.646**
7							1	.405	.631**	.622**	.880**	.758**	.755**	.745**	.573**	.680**	.822**
8								1	.505*	.513*	.667**	.511*	.512*	.478*	.583**	.782**	.426
9									1	.996**	.686**	.888**	.845**	.815**	.833**	.770**	.518*
10										1	.687**	.890**	.854**	.791**	.824**	.763**	.526*
11											1	.782**	.809**	.790**	.613**	.808**	.873**
12												1	.961**	.905**	.883**	.740**	.742**
13													1	.908**	.813**	.672**	.790**
14														1	.748**	.748**	.781**
15															1	.660**	.419
16																1	.633**
17																	1

** . Correlation is significant at the 0.01 level (2-tailed)/ * . Correlation is significant at the 0.05 level (2-tailed).

The moderate and high levels relationship between 17 variables, applied correlation analysis, were identified. The intercorrelated 17 variables were applied factor analysis in order to create new and fewer dimension-variable (Özdamar 2002, Büyüköztürk 2012). The Kaiser_Meyer_Olkin measures of

sampling adequacy were 0.729 and Bartlett's test of sphericity was significant at a level of 0.000.

Obtained as a result of factor analysis, the eigenvalues and percentage of variances are given in Table 3.

Table 3: Variance explained.

Component	Initial Eigenvalues		
	Total	% of Variance	Cumulative %
1	12,127	71,336	71,336
2	1,716	10,092	81,428
3	1,320	7,765	89,194

As the presents of the Table 3, initial eigenvalues of the three components are greater than one. Factor_1 included 2/3 of total variance. In other words, Factor_1 is an important factor obtained in this study. Even

so Factor_2 and Factor_3 was evaluated because of their eigenvalues >1. Factor analysis' result of 21 units and 17 variables are shown Table 4.

Table 4: The result of factor analysis

Communalities	Common factor variance	Unrotated Factor_1 loading	Rotated Factor loadings		
			Factor-1	Factor-2	Factor -3
LOG_2016	.950	.860	.877	.213	.367
PULPWOOD_2016	.943	.859	.867	.213	.381
INCOME_2015	.955	.929	.839	.434	.253
LOG_SALES_2015	.825	.782	.830	.163	.331
PRODUCTIVE_GROWING_STOCK	.926	.854	.826	.494	-.009
PRODUCTION_COST_2015	.911	.917	.796	.477	.224
TOTAL_COST_2015	.849	.896	.742	.494	.231
TOTAL_INTERMEDIATE_YIELD	.846	.751	.137	.869	.267
ECONOMIC_FUNCTIONS	.891	.850	.308	.855	.254
FIBRE_CIPS_SALES_2015	.873	.834	.345	.854	.157
PRODUCTIVE_ANNUAL_INCREMENT	.920	.881	.471	.829	.108
FIBRE_CIPH_2016	.949	.937	.422	.780	.403
FOREST_LAND	.853	.816	.213	.733	.520
CROWN_CLOSURE_3	.925	.938	.595	.725	.211
SALVAGE_LOGGING_2015	.885	.650	.179	.279	.880
TOTAL_FINAL_YIELD	.768	.664	.365	.176	.777
PULPWOOD_SALES_2015	.895	.867	.447	.461	.694

As the presents on Table 4, competitiveness level of 21 FDDs are consist of three Factors. The common factor variance explained by the three factors are between 77-% 96%. Factor_1 consists of the following variable; LOG_2016, PULPWOOD_2016, INCOME_2016, LOG_SALES, PRODUCTIVE_GROWING_STOCK, PRODUCTION_COST_2015, TOTAL_COST_2015.

Factor_2 consist of the following variable; TOTAL_INTERMEDIATE_YIELD, ECONOMIC_FUNCTIONS, FIBRE_CIPS_SALES, PRODUCTIVE_ANNUAL_INCREMENT, FIBRE_CIPH_2016, FOREST_LAND, CROWN_CLOSURE_3. Factor_3 consist of the following variable; SALVAGE_LOGGING, TOTAL_FINAL_YIELD, PULPWOOD_SALES. Factor scores according to 21 FDDs are given Table 5.

Table 5: The factor scores

N.	Units	Factor_1	Units	Factor_2	Units	Factor_3
1	AYANCIK	3.79614	TASKOPRU	3.00599	BOYABAT	3.40969
2	SINOP	0.80364	SINOP	1.36229	ARAC	0.78632
3	KARADERE	0.51448	KURE	1.18942	IHSANGAZI	0.65181
4	ARAC	0.50071	INEBOLU	0.56780	KARADERE	0.50308
5	DADAY	0.30923	BOYABAT	0.48893	SINOP	0.46458
6	AZDAVAY	0.24845	AZDAVAY	0.42313	DURAGAN	0.34318
7	TURKELI	0.01758	KARADERE	0.40193	TOSYA	0.32952
8	KURE	-0.01864	DADAY	0.37289	DADAY	0.26846
9	TOSYA	-0.04033	CIDE	0.11445	SAMATLAR	0.20057
10	BOYABAT	-0.11751	KASTAMONU	-0.12143	TASKOPRU	0.12696
11	TASKOPRU	-0.16539	PINARBASI	-0.17502	HANONU	0.06990
12	CIDE	-0.21063	TOSYA	-0.21491	TURKELI	-0.07910
13	KASTAMONU	-0.24682	BOZKURT	-0.54672	KASTAMONU	-0.07971
14	SAMATLAR	-0.35071	DURAGAN	-0.64013	AYANCIK	-0.57902
15	IHSANGAZI	-0.39817	TURKELI	-0.65930	BOZKURT	-0.64364
16	HANONU	-0.54969	ARAC	-0.78052	CATALZEY TIN	-0.68211
17	PINARBASI	-0.56520	HANONU	-0.80676	PINARBASI	-0.78422
18	CATALZEY TIN	-0.73579	CATALZEY TIN	-0.84056	CIDE	-0.99126
19	INEBOLU	-0.80039	AYANCIK	-0.87465	INEBOLU	-1.03708
20	BOZKURT	-0.82985	SAMATLAR	-0.90598	AZDAVAY	-1.07837
21	DURAGAN	-1.16111	IHSANGAZI	-1.36086	KURE	-1.19954

According to factor_1 score; in Kastamonu FRD, Ayancık FDD is the most powerful competitor and Durağan FDD is the weakest competitor. According to factor_2 score; in Kastamonu FRD, Taşköprü FDD is the most powerful competitor and İhsangazi FDD is the weakest competitor. According to factor_3 score; in Kastamonu FRD, Boyabat

FDD is the most powerful competitor and Küre FDD is the weakest competitor.

To separate the clusters according to their level of competitiveness of 21 FDDs, hierarchical cluster analysis was applied to the obtained factor scores. The results obtained in Figures 1, 2 and 3 are given.

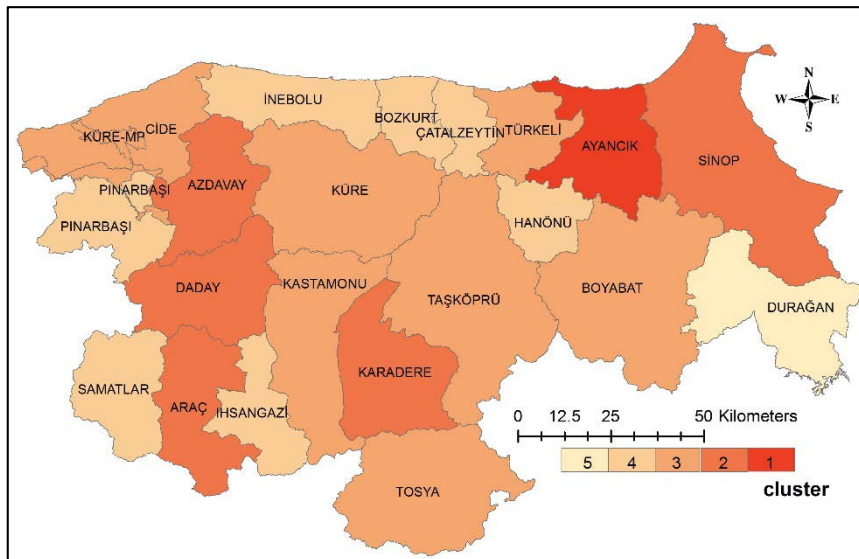

Figure 1. The result of cluster analysis (Factor_1)

According to Factor_1 score; 5 significant cluster (Wilks' Lambda $p < 0.05$) has been formed. Ayancık FDD is included in the first cluster. Sinop, Azdavay, Daday, Arac and

Karadere FDDs are included in the second cluster. Boyabat, Taşköprü, Tosya, Küre, Kastamonu, Türkeli and Cide FDDs are included in the third cluster. Pınarbaşı,

Samatlar, İhsangazi, İnebolu, Bozkurt, Çatalzeytin and Hanönü FDDs are included

in the fourth cluster. Durağan FDD is included fifth cluster.

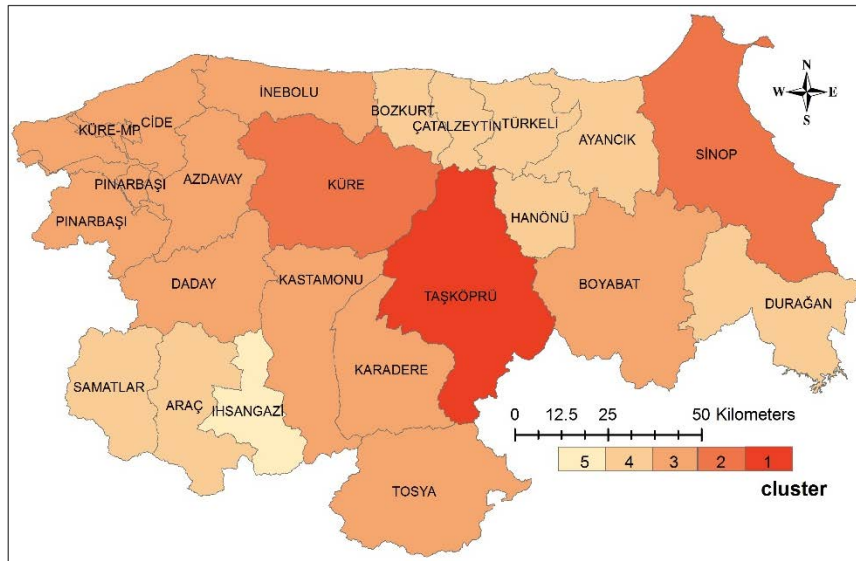

Figure 2. The result of cluster analysis of (Factor_2)

According to Factor_2 score; 5 significant cluster (Wilks' Lambda $p < 0.05$) has been formed. Taşköprü FDD is included in the first cluster. Sinop and Küre FDDs are included in the second cluster. İnebolu, Cide, Azdavay, Pınarbaşı, Daday, Kastamonu, Karadere,

Tosya and Boyabat FDDs are included in the third cluster. Bozkurt, Çatalzetin, Türkeli, Ayancık, Hanönü, Durağan, Samatlar and Araç FDDs are included in the fourth cluster. İhsangazi FDD is included fifth cluster.

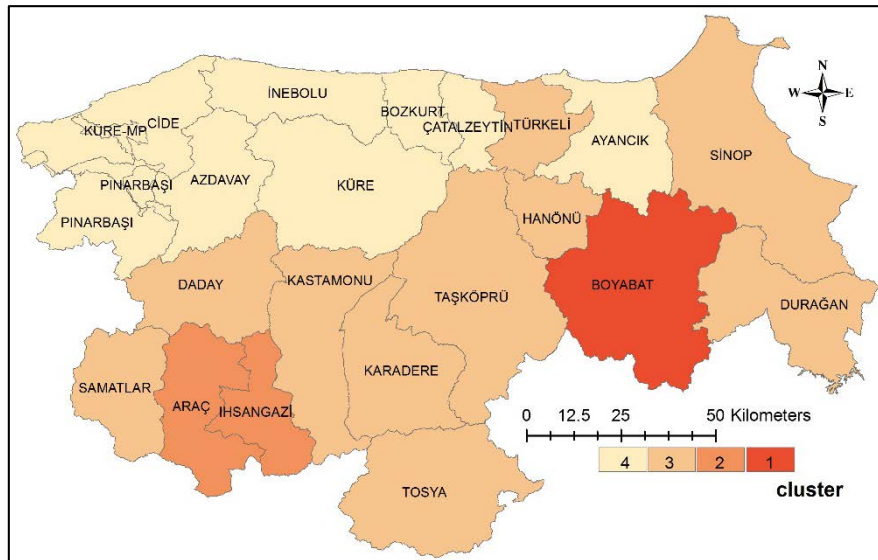

Figure 3. The result of cluster analysis of (Factor_3)

According to Factor_3 score; 4 significant cluster (Wilks' Lambda $p < 0.05$) has been formed. Boyabat FDD is included in the first

cluster. Araç and İhsangazi FDDs are included in the second cluster. Türkeli, Sinop, Hanönü, Durağan, Taşköprü,

Karadere, Tosya, Kastamonu, Daday and Samatlar FDDs are included in the third cluster. Cide, Pınarbaşı, Azdavay, İnebolu, Küre, Bozkurt, Çatalzeytin and Ayancık FDDs are included in the fourth cluster.

Discussion and Conclusion

21 FDDs which are significant role in wood based forest product market, were examined in terms of competitiveness. Features of forest assets (7 variables), the estimate of 2016 (3 variables), production quantities of 2015 (4 variables), financial value of 2015 (3 variables) were analyzed. Three new variables in the analysis results were obtained. When the three factor scores were examined, Factor_1 was observed to be related with measurement unit m³. Factor_2 was observed to be related with the market of fibre-chips and Factor_3 was observed to be related with the salvage logging.

In the market of measurement unit m³ products, Ayancık, Sinop and Karadere FDDs have the competitive advantage. In the market of fibre-chips, Taşköprü, Sinop and Küre FDDs have the competitive advantage. According to factor 3; respectively, Boyabat, Tools and İhsangazi FDDs is in the first place. Whereas; the study of Çağlar and Öncel (1990), 18 FDD of Kastamonu RDF were analyzed in terms of determining the success of FDDs. Tosya FDD was determined the most successful and İnebolu FDD was determined the most failed among the others. The cause of the differences in the studies results are the number of variables, working years, different objectives etc. 21 FDD clustered in proportion to product types and production quantities by Erkan Buğday (2016). According to the study Ayancık and Taşköprü FDDs were included in the first cluster. The similar results were obtained in both Erkan Buğday (2016)'s study and this study.

According to this result; the market of wood based forest product should be considered divided into sub-(units) markets. FDDs overall situation and competitiveness are to be determined in terms of business functions. Depending on the competitiveness of FDDs, planning should be done and strategies should be set.

References

- Anonim, 1987. Orman Emvali Standardizasyonu ve Satış Esaslarına Ait Tebliğ. 279 Sayılı tebliğ. T.C. Tarım Orman ve Köy İşleri Bakanlığı Orman Genel Müdürlüğü İşletme ve Pazarlama Dairesi Başkanlığı. 288. Ankara.
- Anonim, 2015. Oduna Dayalı Orman Ürünlerinin Satış Usul Ve Esasları (303 Sayılı Tebliğ). T.C. Orman ve Su İşleri Bakanlığı Orman Genel Müdürlüğü İşletme Pazarlama Daire Başkanlığı. 111. Ankara.
- Büyüköztürk, Ş., 2012. Sosyal Bilimler İçin Veri Analizi.(17. baskı) Pegem Akademi. ISBN 978-975-6802-74-8, s:201. Ankara.
- Çağlar, Y., ve Öncel, M., 1990. Devlet Orman İşletmelerinde Başarı Düzeyinin Belirlenmesi Milli Produktivite Merkezi Yayın No:420 s:52 Ankara.
- Daşdemir, İ., 1996. Orman İşletmelerinin Başarı Düzeylerinin Belirlenmesi (Kuzeydoğu Anadolu ve Doğu Karadeniz Bölgesi Örneği). Orman Bakanlığı, DA Ormancılık Araştırma Müdürlüğü Yayını Teknik Bülten No:1 ISSN:1300:9478, s:162 Erzurum.
- Daşdemir, İ., 1998. Devlet Orman İşletmelerinin Yönetmelik ve Örgütsel Boyutlarının Belirlenmesi. Orman Bakanlığı, DA Ormancılık Araştırma Müdürlüğü Yayını Teknik Rapor No:3, ISSN:1300-9486, s:70, Erzurum.
- Daşdemir, İ., 2015. Ormancılık İşletme Ekonomisi, (3. Baskı) ISBN:978-605-60882-8-5 Bartın Üniversitesi Yayın No:10 Orman Fakültesi Yayın No:6, s:407, Bartın.
- Erkan Buğday, S., 2016. Oduna Dayalı Orman Ürünlerinde Stratejik Pazarlama Analizi (Kastamonu Orman Bölge Müdürlüğü Örneği). Çankırı Karatekin Üniversitesi Fen Bilimleri Enstitüsü. Doktora Tezi.s:300. Çankırı.
- Korkmaz, M., 2012. Orman İşletmelerinde İktisadilik Düzeyinin TOPSIS Yöntemi ile Analizi. SDÜ Orman Fakültesi Dergisi, (13) s:14-20.
- OGM, 2013. Orman İşletmeciliğinde Üretim Pazarlama Faaliyetleri. Orman ve Su İşleri Bakanlığı. Orman Genel Müdürlüğü. İşletme Pazarlama Daire Başkanlığı. s:83. Ankara
- Özdamar, K. 2002. Paket Programlar ile İstatistiksel Veri Analizi-2 Çok Değişkenli Analizler SPSS-MINITAB. Kaan Kitabevi. 975-6787-00-7 s:512 Eskişehir.
- Özdönmez, M., Akesen, A., Ekizoğlu, A., 1998. Ormancılık Yönetim Bilgisi. İstanbul Üniversitesi Orman Fakültesi Yayınları. ISBN 975-404-535-6, s:357, İstanbul.
- Öztürk, A., ve Türker, M. F. 2010. Devlet Orman İşletmelerinin Gruplandırılmasında Çok Değişkenli İstatistiksel Analizlerin Kullanımı.

Artvin Çoruh Üniversitesi Orman Fakültesi
Dergisi, 11 (2) s:20-29.

Şentürk, G. 2007. Devlet Orman İşletmelerinde Verimlilik ve İktisadilik Analizi (İstanbul Orman Bölge Müdürlüğü Örneği). İstanbul Üniversitesi Orman Fakültesi Dergisi; Seri:A, Cilt: 57(2); s:21-41.

Şafak, İ. 2009. Orman İşletmelerinin Etkinlik Düzeylerinin Klasik ve Bulanık Veri Zarflama Analizi İle Değerlendirilmesi (Denizli, İzmir ve Muğla Orman Bölge Müdürlüğü Örneği). T.C. Çevre ve Orman Bakanlığı Ege Ormancılık Araştırma Müdürlüğü Teknik Bülten:48 ISSN 1300-9508 s:234, İzmir.

URL 1: <http://www.ogm.gov.tr/Documents/Kurulusumuz/TeskilatSema.pdf>(erişim 02/10/2016)

Developing and Prioritizing Alternative Strategies for Establishing Honey Forests (Sample of Bartın)

*Ersin GÜNGÖR¹, Elif ÖZKAN GÜNGÖR²

¹Bartın University, Faculty of Forestry, Department of Forest Engineering, Forestry Economics, Ağdacı Campus, 74100 Bartın/TURKEY

²Bartın Department of Forestry, Directorate of Afforestation and Soil Conservation, 74100 Bartın/TURKEY

*Corresponding Author: ersingngr@yahoo.com

Abstract

In this study, it was aimed to develop, prioritize the alternative strategies for honey forests to be established in Bartın province and to reveal the opinions of related groups (local people, public institutions and NGOs' representatives) based on their contribution for the best selection of them. In order to achieve these goals, it was tried to develop a new management model by taking into consideration ecological, social and economic values concomitantly. In this research, the potential for honey forests in Bartın was stated through SWOT analysis and outstanding new strategies have been developed for the establishment of honey forests in light of the findings obtained. As (1) trees where honey is produced or plant species containing honey, (2) bee products, (3) the length of honey production season and (4) type of beekeeping, the four main factors, each of which has 3 sub-levels, were taken into consideration for these strategies. The order of preference for the strategies were provided by offering these factors and 9 orthogonal alternative strategies based on their sub-levels to a total of 110 participants selected through simple random selection method with a face-to-face interviews from the related groups. The results were assessed through Conjoint Analysis. According to this, the preferred strategy for Bartın is as follows: "prioritizing chestnut species yielding honey in high economic return, preparing the fields in a way to increase especially the yield of honey and bee milk, highlighting the fields where honey is produced especially for a six-month period in selecting the fields and forming the fields that can support migratory beekeeping". Putting the strategies into action will enable us to better determine the location and properties of honey forests planned to be established in Bartın; therefore, the relationship among species selection, bee product range and honey yield will be able to be developed. Moreover, it will increase the sources of income and opportunities for employment by supporting rural development thanks to beekeeping activities in the region.

Keywords: Rural development, Honey forest, Beekeeping, Participation, Conjoint analysis

Introduction

Effective and productive use of natural sources in return for increasing population, needs and expectations is one the fundamental subjects which are sought for solutions in today's world. Human being is on the basis of this subject. The planners and practitioners are striving for meeting the needs of human beings whose demands are constantly changing and increasing. With this changing and developing process, people's expectations for natural resources, especially forests, are increasing.

Traditional forestry in the scope of wood raw material production gives a way to modern forestry that interprets today's changing requirements and expectations in terms of multidimensional utilization, sustainability and protection-usage principle.

From this aspect, forests subject to functional planning according to their usage and management aims. Honey production is one of these functions. Becoming increasingly important as a result of population rise all around the world, honey production has been one of the ultimate goals to be achieved for the forestry in Turkey, as well.

Our forests are an important source for producing quality honey. Moreover, forests offer a low investment climate for beekeeping activities; on the other hand, it creates an income channel and becomes an important source of income for villagers. In this respect, beekeeping can be considered to be one of the important rural development ways (Korkmaz et al., 2015). On the other hand, forests helps avoid pollination and

erosion, protects and develops biodiversity as well as contributing honey production.

When the public institutions' studies for establishing honey forests are examined, it is understood that economic and social criteria are ignored. Likewise, it is not very clear how the participation is managed although it is emphasized in these plans.

On the other hand, in the studies which honey forests are defined in (e.g. OGM, 2011; 2012; BOEP, 2013), it is seen that these definitions are made generally considering ecological basis. That is to say, ecological criteria is put forward rather than economic and social criteria. Hence, it needs a more comprehensive definition in order to fill this gap in defining honey forests in this study. In this regard, the term "honey forest" is broadly defined as follows:

"Honey forests are the fields where multidimensional principle, biological, social and economic criteria are taken into consideration with a participatory approach in allocating forests for beekeeping activities. Furthermore, these fields are where the suitable places are formed for beekeeping activities with the suitable trees, herbaceous plants and shrubs, which it contributes to beekeeping, soil conservation, employment, rural development and national economy".

In this study, it is also discussed to develop and prioritize the alternative strategies in establishing honey forests. For this reason, the alternative strategies were developed considering a number of factors determined in line with the ecological, social and economic criteria. Also, the opinions and preferences related to these strategies were offered to the related groups and the results were assessed via Conjoint Analysis, one of the multidimensional decision making techniques and the most appropriate strategy for establishing honey forests was determined in the sample of Bartın province.

Materials and Methods

This study was carried out in the province of Bartın which is of the most virgin forests in Europe (FAO, 2015), that is to say, it is of a rich flora and fauna (Figure 1).



Figure 1. Study area.

The management plans (BOİM, 2005), OGM Honey Forest Action Plan (BOEP, 2013), Bartın Honey Forest Project (BBOP, 2013; BAKKA, 2011; TÜİK, 2015; FAO, 2015) and honey forests projects carried out in several cities (OGM, 2011; OGM, 2012) were utilized in order to determine the potential of honey in Bartın and achieve the various economic data.

SWOT analysis was used in order to reveal the current situation. In this light, related scientific studies (Genç, 2003; Mısır, 2011; Doğaroğlu, 1999; Tutkun and Boşgelmez, 2003; WWF-Türkiye, 2003; Güngör, 2005, Güngör and Ayhan, 2016 etc.), related projects (BBOP, 2013; BAKKA, 2011) and statistics (TÜİK, 2015; FAO, 2015) were utilized. So, the current situation was presented thanks to SWOT (Strengths, Weaknesses, Opportunities and Threats) Analysis.

Conjoint Analysis (CA) is used in the phase of prioritizing the developed strategies as a result of SWOT Analysis. The questionnaire for the related analysis was administered through the face-to-face method.

CA interviews were held with the local people, public institutions and NGO representatives in Bartın in 2016. The number of target population was calculated through the formula showing the sample size in restricted communities (Orhunbilge, 2000; Daşdemir, 2016). According to this, the interviews were held with a total of 110 participants: 50 participants, 10 participants representing public institutions, 50 participants representing Bartın Beekeepers Association (BBA).

In accordance with CA, 9 cards primarily describing the strategies (each card presenting strategies and factors and their sub-levels defining these strategies) and they were given to the participants through personal interview technique. They were asked to put the strategies in order from the best to the worst by means of the cards and so it was aimed to determine the most appropriate strategies.

A sample model of Conjoint Analysis that is generally used to comprehend the responds of consumers to a product or service (Malhotra, 1996; Daşdemir, 2012) is as follows:

$$U(X) = \sum_{i=1}^m \sum_{j=1}^{k_i} a_{ij} X_{ij} \quad (1)$$

Where;

$U(X)$: A total utility from an alternative,

a_{ij} : utility value of i factor in the j matrix

X_{ij} : 1 for j . level of i . factor, dummy variable taking 0 value for other levels,

k_i : level number of i . factor ($j=1,2,\dots,k_i$),

m : Factor number ($i=1,2,\dots,m$)

In Conjoint Analysis, where quantitative and qualitative data was used including statistical analyses such as correlation and

regression, by generally approaching utility function as a dependant variable, the impact of a number of independent variables on this is investigated. Thus, the impact of each variable on consumer preference structure is determined (Tatlıdil, 1995; Daşdemir, 2012).

In this research, it was tried to determine each factor and their sub-level influencing the participant preferences (utility, weight) via CA, thus suggesting management strategies that are important and primary (or mostly preferred) for the participants, also interpreting and discussing by evaluating its validity from different various perspectives.

The analyses were made in the study through CA by writing under the menu File-New-Syntax of SPSS (Statistical Package for Social Science) 21.0 package programme.

Findings and Discussions

Findings from SWOT Analysis

The strengths and weaknesses with regard to the phase of establishing honey forest in Bartın and the possible opportunities or threats by the external environmental conditions were determined in Table 1.

Table 1. SWOT Analysis Results in the phase of establishing honey forest in Bartın.

SWOT Analysis	
STRENGTHS	WEAKNESSES
<ol style="list-style-type: none"> 1. The existence of natural forests to increase honey yield in Bartın, 2. The richness of honey plants contributing to pollen quality in the regional flora, 3. The production of chestnut honey in the region that is highly demanded and of high common price, 4. Long-lasting season for honey production in the region, 5. The potential for production of bee products, especially honey and bee milk, 6. The availability of the ecological structure and vegetation of the regional topography for migratory beekeeping , 7. The number of beekeepers in Bartın above the national average, 8. Virgin forests contributing to organic honey production in the region, 9. Regional honey beekeeping with disease resistant bee races, 10. Academicians specialising in beekeeping in the region. 	<ol style="list-style-type: none"> 1. The level of honey yield below the national average, 2. Limited organic honey production in the region, 3. Uncommon migratory beekeeping being of high economic income in the region, 4. A small number of branded companies in beekeeping, 5. Beekeeping activities with a limited capital, 6. Local people’s understanding of beekeeping as a hobby, 7. The lack of registered beekeepers in Bartın, 8. Lack of information in food security for beekeeping in the region, 9. In the region, the limited beekeeping trainings held by the institutions, 10. Inefficient use of marketing channels with regard to bee products in Bartın.
OPPORTUNITIES	THREATS
<ol style="list-style-type: none"> 1. Potential human existence for beekeeping activities, 2. Specialised institutions and organisations in beekeeping, 3. The availability of financial support to be provided by various institutions and organisations for beekeeping 4. Increasing demand in bee products in domestic and foreign markets, 5. The critical role of beekeeping to reduce migration in the region, 6. Etkin pazarlama kanallarıyla arı ürününden elde edilecek gelirden artış, 7. Inactive honey production potential in regional forests, 8. The appropriate structure of regional forests for honey production, 10. The proximity of the region to intensive markets in the big cities, 11. The recent policies of OGM in favour of beekeepers. 	<ol style="list-style-type: none"> 1. The communal insecurity about honey products because of the news about cut-rate honey, 2. The lack of branded companies for honey production, 3. The accumulation of middle-aged and elder people involved in beekeeping, 4. Rapid migration from the region, 5. High rural poverty in the region, 6. Financial bottleneck in national beekeeping activities, 7. Insufficient appreciation of beekeeping in the rural development, 8. Uncontrolled beekeeping activities in the region, 9. The limited beekeeping trainings held by the institutions and organisations, 10. Lack of data for honey production and sales values,

Developing Strategies

With reference to the findings obtained from SWOT Analysis, four factors were determined to be effective in establishing honey forests as “*type of honey, bee product, honey production season and type of beekeeping*”, each of which has three sub-levels (Table 2).

Table 2. Determined factors and their levels.

Factor Name	Factor Level
Type of Honey	1. Linden + False Locust Honey 2. Chestnut Honey 3. Rhododendron Honey
Bee Product	1. Honey + Bee Milk 2. Propolis + Bee Venom 3. Pollen + Beeswax
Honey Production Season	1. Up to 3 months 2. Approximately 6 months 3. 9 month and more
Type of Beekeeping	1. Beekeeping using fixed comb hives in the same field 2. Migratory beekeeping in the same field 3. Migratory beekeeping in different fields

In fact, a lot of factors could have been taken into consideration that bee yards should be close to natural water sources, there should be a route density to travel although the beekeepers are low in number, and the fields should be in a minimum distance to the main roads and disinfected agricultural terrains. However, it was approved to take into consideration only the factors in Table 2 because of either the restraints of Conjoint Analysis or the framework determined in the study.

Considering the factors and their sub-levels in Table 2, it is possible to develop a total of $3^4=81$ combinations (strategies) based on full design (Green and Sirinivasan, 1978; Tatlđil, 1995; Malhotra, 1996; Çemrek, 2001; Güngör, 2005). Yet, since it was difficult and time consuming that the participants grade or list 81 strategies in order of priority, based on the factors and their sub-levels in Table 2, 9 alternative strategies were develop according to the non-

correlational orthogonal design (Hair et al., 1995; Smith, 1999) where these combinations are of special subsets and each factor and sub-level are independent from each other (Table 3).

The participants were presented the special cards about the strategies in Table 3 through personal interviews. Assessed through CA, the results were interpreted and discussed. Thus, benefit factors, the importance of factors and the best strategy for establishing honey forests were determined.

Prioritizing Strategies

In accordance with CA model, considering the most negative level of each factor according to the goal as a reference value (rhododendrons honey for the type of honey factor, pollen + beeswax for bee product factor, 3 months at the latest for the honey production season, fixed in the same field for the type of beekeeping), it was defined 8 dummies taking the values 0 or 1 for the rest of the levels.

According to the results with CA, “Honey Production Season” ranks first with 34.44%, “Type of Beekeeping” ranks the second place with 28.15%, “Type of Honey” is in the third place (22.66%) and “Bee Product” ranks the fourth with 14.75% in the strategies developed in the phase of establishing honey forest (Table 4).

With a benefit factor “0.421” in the factor “Honey Production Season”, the most important or mostly preferred one, “*Honey production season for about 6 months*” ranks the first, “*Honey production season for 9 months or more*” ranks second with a benefit factor “0.327” and “*Honey production season up to 3 months*” is in the third place with a benefit factor “-0.748”. According to these results, the participants desire the honey production season to be about 6 months.

The honey production season, less than 3 months, refers to a low income for beekeepers, which leads them to waste their time or deal with another job for the rest of year. This also avoids them specialising in beekeeping and lets them see it as a hobby.

Table 3. Strategies for establishing alternative honey forest developed according to orthogonal design.

Factors and Levels				
Strategy No	Type of Honey	Bee Product	Honey Production Season	Type of Beekeeping
1	Linden + False Locust Honey	Pollen + Beeswax	About 6 months	Beekeeping using fixed comb hive in the same field
2	Linden + False Locust Honey	Propolis + Bee Venom	Up to 3 months	Migratory beekeeping in the same field
3	Chestnut Honey	Honey + Bee Milk	About 6 months	Migratory beekeeping in the same field
4	Linden + False Locust Honey	Honey + Bee Milk	9 months and more	Migratory beekeeping in different fields
5	Rhododendrons Honey	Pollen + Beeswax	9 months and more	Migratory beekeeping in the same field
6	Rhododendrons Honey	Propolis + Bee Venom	About 6 months	Migratory beekeeping in different fields
7	Chestnut Honey	Propolis + Bee Venom	9 months and more	Beekeeping using fixed comb hive in the same field
8	Chestnut Honey	Pollen + Beeswax	Up to 3 months	Migratory beekeeping in different fields
9	Rhododendrons Honey	Honey + Bee Milk	Up to 3 months	Beekeeping using fixed comb hive in the same field

In case the honey production season lasts for 9 months or more, although the beekeepers leant towards this situation at first, they later stated that it would not be possible in Bartın and neighbouring regions. Likewise, experienced beekeepers and institutional authorities stated that there was decrease in honey yield, especially in chestnut production, because of the long season.

In the circumstantial factor “Type of Beekeeping” of the strategy, “Migratory beekeeping in the same field” is mostly preferred with the benefit factor 0.565. It is succeeded by “Migratory beekeeping in different fields” with the benefit factor “0.428”. The least preferred is “Beekeeping using fix com hives in the same field” with -0.993. According to this result, it is seen that the participants prefer migratory beekeeping more than the other type. The relevant

literature review (OGM, 2011; OGM, 2012; BAKKA, 2011; BOEP, 2013; BBOP, 2013; Güngör and Ayhan, 2016) reveals that it is required a transition from the beekeeping with fix comb hives to migratory one.

What is needed to take into consideration is to prefer “migratory beekeeping in the same field” instead of “migratory beekeeping in different fields” which is more extensive instead of the limited capital and labour force. Considering the regional topography and ecological structure, different vegetation seasons may be encountered even in a single honey forest. Therefore, firstly beekeeping should be provided with a certain amount of capital and labour force, and then migratory beekeeping, a professional type, should be passed on to.

Table 4. CA results displaying benefit factor belonging to factor levels and the weights of factors.

Factor Name	Factor Levels	Benefit factor	Significance Degree (%)
1. Type of Honey	1.1. Linden + False Locust Honey	-0.151	22.66
	1.2. Chestnut Honey	0.572	
	1.3. Rhododendrons Honey	-0.421	
2. Bee Product	2.1. Honey + Bee Milk	0.507	14.75
	2.2. Propolis + Bee Venom	-0.363	
	2.3. Pollen + Beeswax	-0.144	
3. Honey Production Season	3.1. Up to 3 months	-0.748	34.44
	3.2. About 6 months	0.421	
	3.3. 9 months and more	0.327	
4. Type of Beekeeping	4.1. Beekeeping using fixed comb give in the same field	-0.993	28.15
	4.2. Migratory beekeeping in the same field	0.565	
	4.3. Migratory beekeeping in different fields	0.428	

In the third important factor “Type of Honey”, “Chestnut Honey” level is mostly preferred while others are preferred less. According to the market honey sale prices in the region, chestnut honey is seen to be the top-grossing product (BAKKA, 2011; TÜİK, 2015; FAO, 2015; BAB, 2015; Güngör and Ayhan, 2016). This naturally draws the interest of beekeepers to chestnut honey. A similar interest of beekeepers is drawn to Anzer honey in Rize. The questionnaire results confirms the interest in chestnut honey in Bartın. However, the chestnut production values vary from year to year because of climate conditions. Recently, the region has experienced falls in chestnut honey production (BAB, 2015) due to irregular precipitation and drought (BMİ, 2015) and many beekeepers have suffered from this. To avoid this kind of suffering, beekeepers must enrich the types of honey considering climate conditions and take protective and preventive measures against the fluctuations in the honey prices as in the portfolio range in economy. Based on all this, it will be appropriate to take into consideration other honey types in addition to chestnut honey in honey diversity.

In the fourth and least important factor, “Honey Product”, the mostly preferred one is “Honey + Bee Milk” (0.507 benefit factor) while the least preferred level is “Propolis + Bee Venom”. The results show the interest of local people and beekeepers in bee products and how well they are informed about them.

When it comes to beekeeping, honey firstly comes to mind. In fact, this result from the questionnaire is so natural because honey is of the most economic return among bee products. Nevertheless, it is totally necessary to product other bee products such as propolis and bee milk in the region in order to either provide sustainability of the production or increase income from the bee products and decrease the possible risks.

It is also necessary to make some progress in beekeeping for bee product range. For example, letting alone the approach considering it as a hobby or a secondary occupation, beekeepers should increase the capital set aside for this job and do specialised and quality beekeeping. Moreover, they also need to be have a comprehensive knowledge about beekeeping to produce all range of bee products.

When we compare the honey yield in the world, Turkey and Bartın, the average honey yield in Turkey (15 kg) is so below the average in the world (22 kg) (FAO, 2015). The average yield in Bartın (14 kg), already below the world average, is also below the average in the country (TÜİK, 2015). Compared with the ones in the world, although the hives in Bartın and Turkey are many, it does not correspond to honey production values and honey yield (Güngör and Ayhan, 2016).

On the other hand, the production increase of the plants provided by bees through pollination is 10-12 times (Yakovleva, 1975) and even 20 times more (Crane, 1972; 1975).

Results

In this study, firstly the current situation was tried to be revealed through SWOT Analysis in the phase of establishing honey forest in Bartın.

According to SWOT Analysis, the following results stand out: “the existence of natural forests and honey plants increasing the yield of honey, the production of chestnut honey in the region that is in demand and of high market price, the long lasting honey season and the production potential of bee products such as pollen, beeswax and propolis.

Taking account of the data from the SWOT Analysis, as a result of CA Analysis of 9 alternative management strategies composed of orthogonal design of 4 factors *type of honey, bee product, honey production season and type of beekeeping* which are of three sub-levels and are considered to be effective in establishing honey forest, the mostly preferred (optimum) management strategy is as follows:

“A priority should be given to the chestnut species yielding high amount of honey in Bartın, the places that are rich in honey plants should be selected as honey forest fields, these fields should be prepared in a way to increase the yield of honey and bee milk, the fields suitable for 6-month honey production season should be highlighted and the honey forest fields should be in a way to support migratory beekeeping”.

The strategy developed should be taken into account for prioritising the possible honey forest fields and deciding them. Thus, this kind of honey forest will be able to achieve a dynamic structure, the possible conflicts among the beneficiaries, local people and local government will be avoided since the opinions of the related groups, the participants, have been taken while planning. What is more, the strategy developed will also contribute to the sustainability of established honey forests, regional beekeeping and rural development.

References

- BAB, 2015. Bartın Arıcılar Birliği Üretici Verileri, <http://www.bab.org.tr/veriuir>, Retrieved:15.10.2015.
- BAKKA, 2011. TR81 Bölgesi İstatistikleri. Batı Karadeniz Kalkınma Ajansı Yayınları, Zonguldak.
- BBOP, 2013. Bartın Bal Ormanı Projesi. Orman ve Su Bakanlığı, Bartın Orman İşletme Müdürlüğü Yayınları, Bartın.
- BMİ, 2015. Bartın Meteoroloji İstasyonu Verileri. <http://www.mgm.gov.tr/tahmin/il-ve-ilceler.aspx?m=BARTIN>, Erişim:18.11.2015.
- BOEP, 2013. Bal Ormanı Eylem Planı. Orman ve Su Bakanlığı, OGM Yayınları, 136 s. Ankara.
- BOİM, 2005. Zonguldak Orman Bölge Müdürlüğü, Bartın Orman İşletme Müdürlüğü Amenajman Planı (2006-2025), II. Yenileme. (Tüm Şeflikler), Bartın.
- Crane, E., 1972. Bees in the pollination of seed crops. J. Royal Agri.Soc., England., 19:133-135.
- Crane, E., 1975. Honey a Comprehensive Survey. Heinemann, London.
- Çemrek, F., 2001. Tüketici Tercihlerinin Belirlenmesinde Kullanılan Konjoint Analizi ve Kredi Kartı Tipi Tercihine İlişkin Bir Uygulama, Yüksek Lisans Tezi, Osmangazi Üniversitesi, Fen Bilimleri Enstitüsü, Eskişehir, 62 s.
- Daşdemir, İ., 2012. Orman Mühendisliği İçin Planlama ve Proje Değerlendirme (2. Baskı), Bartın Üniversitesi, Bartın Orman Fakültesi, Yayın No:6/4, Bartın, 168 s.
- Daşdemir, İ., 2016. Bilimsel Araştırma Yöntemleri, Nobel Akademik Yayıncılık, Yayın No: 1536, ISBN: 978-605-320-442-8, 210 s., Ankara.
- Doğaroğlu, M., 1999. Modern Arıcılık Teknikleri. Anadolu Matbaası, İstanbul.
- FAO, 2015. Food and Agr. Org. Honey Inf . <http://www.fao.org>. Erişim:17.11.2015.

Genç, Y., 2003. Iskalan Bölgesi (Bartın) Ballarında Polen Analizi. Yüksek Lisans Tezi (Yayımlanmamış) ZKÜ, Fen Bilimleri Enstitüsü, Bartın.

Green, P. E. and V. Srinivasan, 1978. Conjoint Analysis in Consumer Research: Issues and Outlook, Journal of Consumer Research, Vol: 5, USA, pp. 103-123.

Güngör, E., 2005. Kastamonu-Bartın Küre Dağları Milli Parkı'nın Optimum Yönetim Stratejisinin Geliştirilmesi, ZKÜ, Fen Bilimleri Enstitüsü, Yayımlanmamış Yüksek Lisans Tezi, 136 s. Bartın.

Güngör, E., Ayhan, A. B., 2016. Bartın Yöresi Orman Kaynaklarının Bal Üretim Potansiyeli ve Ekonomik Değeri, SDÜ, Turkish Journal of Forestry , 17 (1), 108-116.

Hair, J. F., R. E. Anderson, R. L. Tatham, and W.C. Black, 1995. Multivariate Data Analysis: With Readings. McMillan Book Company, London, 745 p.

Karasar, N. 1994. Bilimsel Araştırma Yöntemi: Kavramlar, İlkeler, Teknikler. ISBN 975-954-32-1-6, Ankara, 292 s.

Korkmaz, M., Avcı, M., Özdemir, İ., 2015. Kızılçam Ormanlarında Çam Balı Üretimine Yönelik Sorunlar ve Çözüm Önerileri, IV. Ormancılıkta Sosyo-Ekonomik Sorunlar Kongresi, 15-17 Ekim 2015, Trabzon, s.202-213.

Malhotra, N., 1996. Marketing Research: An Applied Orientation, Prentice-Hall, Inc., USA, 122 p.

Mısır, M, 2011. Arıt Bölgesi (Bartın) Ballarında Polen Analizi. Yüksek Lisans Tezi (Yayımlanmamış), ZKÜ, Fen Bilimleri Enstitüsü, Bartın.

Smith, S., 1999. The Concepts of Conjoint Analysis, <http://www.marketing.byu.edu/thml/pages/tutorials/conjoint.htm> m. 01.03.2004.

OGM, 2011. Arhavi Bal Ormanı Projesi. <http://balormani.ogm.gov.tr>, Erişim:09.11.2015.

OGM, 2012. Bayat Bal Ormanı Projesi. <http://balormani.ogm.gov.tr>, Erişim: 15.11.2015.

TAB, 2015. 2015 yılı Bal Üretim Değerleri. Türkiye Arıcılar Birliği. <http://www.tab.org.tr>, Erişim: 14.10.2015.

Tatlıdil, H., 1995. Konjoint Analizi, Hacettepe Üniversitesi, İstatistik Bölümü Ders Notları, 25 s.

Tutkun, E., Boşgelmez, A., 2003. Bal Zararlısı ve Hastalıkları Teşhis ve Tedavi Yöntemleri. Bizim Büro Basımevi, Ankara.

TÜİK, 2015. Arıcılık İstatistikleri. <http://www.tuik.gov.tr>, Erişim: 11.10.2015.

WWF-Türkiye, 2003. Türkiye'nin Dünyaya Armağanları, WWF-Türkiye yayınları, Ankara, 8 s.

Yakovleva, L. P., 1975. Utilization of bees for pollination of entomophilous farm crops in the USSR. III. Sym. Int. Pollination. Prague, 15-18 Mai 1974, pp.199- 208.

Contributions of Recreational Hunters in Sustainable Forestry Resources Management and in National Economy

Sultan BEKİROĞLU

Istanbul University, Faculty of Forestry, Forestry Economics Department, Istanbul-TURKEY
sulbekir@istanbul.edu.tr

Abstract

Invention of weapons such as stone blades and hammers allowed mankind to move from gathering to the hunting. Game hunting was firstly a means to provide food needs then it became a means of subsistence. Later game hunting became a pleasure, a way to prepare for combats and then finally, a sport. The size of the interest created by multi-purposeful aspect of the activity caused developed states to take a close interest in the game hunting.

The oldest and most extensive study on the game hunting was published in United States of America in 1955. Starting from this date, quinquennial studies examined the socio-economic structure and hunting behaviors of the hunters to determine the methods to increase their contributions to the national economy and to the sustainable wildlife management. The number of countries conducting similar studies on game hunting has been ever increasing. In present study, the contributions of game hunting in sustainable forestry resources management and in the economy were examined with a perspective to spatial and temporal aspects based on findings from studies conducted in multiple countries including Turkey. The study concludes that game hunting offers significant contributions to national economy and sustainable forestry resources management which can be further improved by taking necessary measures.

Keywords: Hunting, Sustainability, Forest resources management, Contribution to economy.

Rekreasyonel Avcılığın Sürdürülebilir Orman Kaynakları Yönetimine ve Ülke Ekonomisine Katkısı

Özet

İnsanoğlu, taş kama, taş çekiç gibi silahları icat ederek toplayıcılık dönemine son vermiş ve avcılık dönemini başlatmıştır. Önceleri yalnızca besin ihtiyacını karşılamak için yapılan avcılık, sonraları geçim, haz, savaşa hazırlık ve sportif vb. çeşitli amaçlar için gerçekleştirilmiştir. Bu çok sayıdaki amaç doğrultusunda yaratılan faydanın büyüklüğü gelişmiş ülkelerin avcılıkla yakından ilgilenmesini sağlamıştır.

Avcılıkla ilgili en eski ve kapsamlı çalışma Amerika Birleşik Devletleri'nde 1955 yılında yapılmıştır. Bu ülkede bu tarihten itibaren her beş yılda bir avcılarının sosyoekonomik yapısı ve avlanma tutumları incelenmiş, avcılarının ülke ekonomisine ve sürdürülebilir yaban hayatı yönetimine katkısını artıracak önlemler belirlenmiştir. Avcılıkla ilgili benzer araştırmaları yapan ülke sayısının giderek arttığı gözlenmiştir. Bu çalışmada avcılığın sürdürülebilir orman kaynakları yönetimine ve ekonomiye etkisi mekân ve zaman boyutu da göz önüne alınarak, Türkiye de dâhil olmak üzere çok sayıdaki ülkede yapılan araştırma bulgularından yararlanılarak incelenmiştir. Sonuç olarak avcılığın ülke ekonomisine ve sürdürülebilir orman kaynakları yönetimine katkısı yüksektir ve gerekli önlemler alınarak katkı düzeyi artırılabilir.

Anahtar kelimeler: Avlanma, Sürdürülebilirlik, Orman kaynakları yönetimi, Ekonomiye katkı

Introduction

Notwithstanding their actual status of economic use, all assets in the world are resources. The resource can be divided in to three subcategories which are: human resources, cultural resources and natural resources. The mankind constitutes the sine qua non for first two subcategories while the same does not apply for the latter. Nonetheless, the mankind has significant

impacts on the natural resources to which it depends for survival (Geray, 1999; Geray, 1995; Geray, 1993; Kula, 1994). In fact, these impacts are so extreme to a degree that triggered the chain of events that will eventually result in extinction of the natural resources.

The sustainable development is an approach that emerged as the natural resource-related problems, such as depletion of natural resources and increase in environmental pollution reached the global level. This new developmental approach is adopted based on the belief that regarding the sustainability of economic production and use of natural resources, equality will be provided between generations and environmental pollution will be prevented. However, there is no simple solution for protection of natural resources and prevention of environmental pollution; it takes a long and complex process. In fact, even though the sustainable development approach has been around for about 3-4 decades, these problems are still some of the major items in global agenda (UN, 2010; Oğurlu, 2008; UN, 2000; Geray, 1999; Platt-McGinn, 1998; Geray, 1995; Geray, 1993; Kula, 1994; UN, 1987). The sustainable development approach aims at minimizing negative human impacts on natural resources and obliges denouncing the consumption

policies and replacing them with the conservation policies in management of natural resources. However, in order to achieve success this policy requires participation of all stakeholders in sustainability of natural resources. This is why the present study's objective is to determine the contributions by one of the most effective stakeholders of natural resource management practices, namely the recreational hunters, in sustainable forestry resource management and in national economy.

General information

In order to facilitate the discussion, this section is reserved for explaining various concepts including: natural resource; sustainable development; sustainable forestry resources management; hunting and sustainable hunting. The consumption policy stipulates using the natural resources as much as possible while the protection policies provides sufficient use for as long as possible (Figure 1, Figure 2).

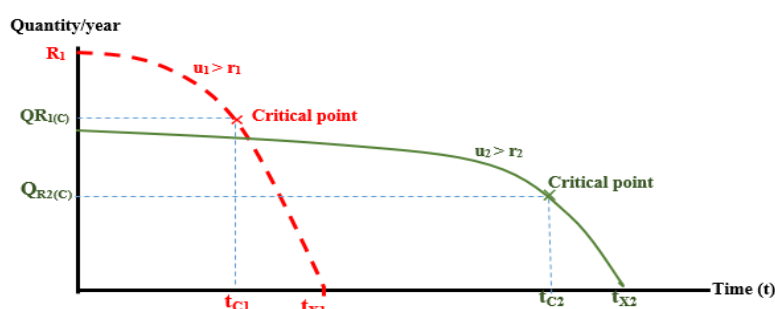

Figure 1. Effects of consumption policy in management of natural resources (Özşabuncuoğlu and Uğur, 2005)

R_1 & R_2 in Figure 1 shows that the resources are managed through a consumption policy as their usage rates (u_1 and u_2) are greater than renewal rates (r_1 and r_2) ($u_1 > r_1$; $u_2 > r_2$). The figure shows that the Resource R_1 reached the critical threshold in rather short time (precisely in the year t_{C1}) and completely depleted in the year t_{X1} ; while R_2 took a relatively longer time to

reach the critical threshold (in the year t_{C2}) and depleted in the year t_{X2} ($Q_{R1}=0$; $Q_{R2}=0$). However, protection policies could be employed before or as the resource reaches the critical threshold. Figure 2 below shows the results of the protection policy that was applied when the Resource R_2 reached the critical level.

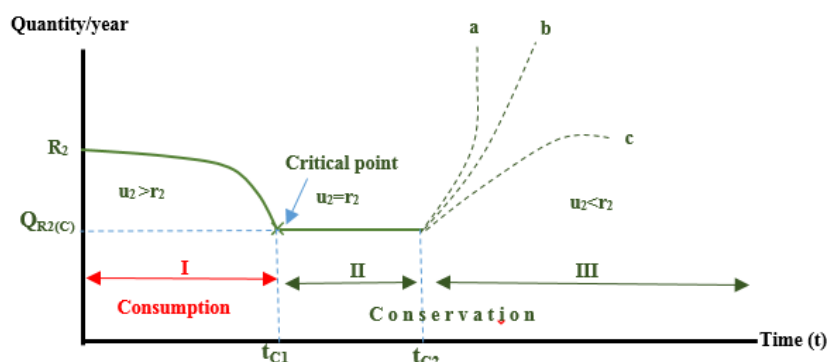

Figure 2. Effects of protection policy in management of natural resources (Özşabuncuoğlu and Uğur, 2005).

When $u_2=r_2$ is applied, the amount of R_2 is fixed to $Q_{R_2(C)}$ so long as the protection policy is applied (Figure 3, see section II). However, when $u_2<r_2$ is applied, the amount of R_2 increases starting from the year t_{C2} in proportion to the difference between $r_2 - u_2$ (Figure 3, see section III). As it is seen, protection policy allows increase of the renewable natural resources.

Sustainable development: The first study on the subject was “the Human Environment Conference” (1972). After a decade, World Commission on Environment and Development (WCED) was established (1983). The purpose of the commission constituted by the representatives of the developed and developing countries was to determine “the results of the rapid deterioration of human, environment and natural resources for economic and social development”. The commission prepared the report titled “Our Common Future” (UN, 1987; Harris, 2000). Hence the concept of “sustainable development” was first introduced in the World.

The concept of sustainable development was defined as “the development that meets the needs of current generations without compromising the ability of future generations to meet their own needs”. Even though it has a very simple and clear definition, it is not an easy task to implement and achieve sustainable development for there are contradictions amongst economic, environmental and social aspects of sustainability. For instance, the soil is to be used for the economic sustainability while it

is not to be used for environmental sustainability (Harris, 2000; UN, 1987).

Sustainable forest resources management: Forests and wild life (natural fauna and natural flora) are natural resources which are affected by human activities and which are subjected to critical thresholds. Since these resources had been subjected to anthropocentric usage, save for the last four or five decades, (i.e. subjected to consumption policy) these resources have already reached critical thresholds and are now facing extinction. For this reason, today, sustainable development approach based on principle of protection of natural resources is adopted. In fact, “sustainability” is not a new concept for the field of forestry. On the contrary, it is a principle that have been implemented for many centuries (Türker, 2015; Daşdemir, 2015; Pak et al., 2010; Özşabuncuoğlu and Uğur, 2005; Geray, 1995; Kula, 1994; Geray, 1993).

Forest is a complex ecosystem that includes many intermingled sub-systems. It is an ecosystem that is usually created through natural processes by trees, shrubs, herbaceous plants, fungi, microorganisms, insects and animals. A balanced and mature forest (the climax) can only be created over barren lands through succession of different plant and animal species over long periods of time.

Existence of key species is extremely important in creation and continuity of climax forest. Should these species diminish or extinct, many plant-animal species depending on these species would also extinct. This interrupts the natural course of

succession. Human-related or natural factors (such as fires, floods or droughts) can trigger these circumstances. Thanks to the technical superiority, the mankind has excessively used the forests since the Bronze Age, thus affecting the continuity and the very existence of climax forests.

Rio Summit, which was held in the year 1992 is a turning point in institutionalization of sustainable development. Two declarations were prepared in the Summit. These are: “the Rio Declaration on Environment and Development” and “Agenda 21 Global”. The Rio Declaration states 27 principles on the social and economic aspects of the sustainable development. Agenda 21, on the other hand, includes separate chapters explaining the social and economic aspects of the sustainable development, *protection and management of natural resources*, role of the main groups and implementation tools. This Summit also provided three international instruments of environmental governance: the UN Framework Convention on Climate Change (UNFCCC), the Convention on Biological Diversity (CBD), and non-legally binding Statement of Forest Principles (UN, 2010).

The forest principles are explained under “Non-Legally Binding Authoritative Statement of Principles for A Global Consensus on The Management, Conservation and Sustainable Development of All Types of Forests”. 14 principles related to sustainable management of forests are summarized below (UN, 2010):

1. The sovereign rights to exploit natural resources must be respected.
2. It is global responsibility to protect natural resources.
3. The forests should be managed in pursuance with the multi-faceted utilization principle.
4. Biodiversity of the forests should be preserved.
5. Cultures and rights of the local indigenous communities should be protected.
6. Rural development should be supported.
7. Participatory practices should be developed.

8. Social awareness and political will should be increased.
9. Institutional and legal legislation should be improved.
10. National forestry plan-programs should be prepared.
11. Efforts should be made to decentralize the responsibilities and authorities.
12. Forestry researches and inventory studies should be strengthened.
13. Criteria and indicators for sustainable forest management should be developed and certification should be stressed.
14. The forestry products trade should be exercised freely in a competitive environment.

These principles also prove that the sustainable forestry management stipulates a multifaceted and very complex network of interactions (Önder and Önder, 2009; UN, 2000; Geray, 2001).

Hunting: Hunting is the activity of capturing animals dead or alive with limitations as to the place and time of the activity. This activity is a direct intervention to the fauna (animal biodiversity) of the ecosystem. This intervention should be carefully conducted in a way that will not interrupt the normal development (succession) of the ecosystem. Because the hunting can affect the national economies in a positive way and ensure continuity of climax forest only if it is conducted in a balanced and controlled manner (FACE, 2016a; FACE, 2016b; Çanakçıoğlu and Mol, 1996).

It is a known fact that every society has shown interest in hunting. However the benefits expected of hunting are diversified and increased today. In earlier eras, the main motivation of hunting was subsistence and war preparation while today the hunting is conducted for recreational purposes or for the purpose of integration with nature or for gaining psychological strength or knowledge (Şafak et al., 2013; Iğırıcık, 2001).

Hunting activities can be categorized according to the area of the hunting activity, the qualities of the hunt and the purpose of the hunt. Hunting by locations is divided into

two groups: land hunting and hunting in aquatic environments. The first group includes all terrains while second group covers water areas such as seas, lakes, streams, etc. The hunting is also divided according to the qualities in three groups: - hunting of large wild animals (animals such as mountain goat, bear, mountain sheep are hunted at latitudes around 2000 meters)- Hunting of animals in aquatic environments and wetlands (miscellaneous wild animal species resident and/or migrating through wetlands are hunted) and mountain hunting (where the wild animals living in mountains and forestry areas are tracked and hunted).

According to the objectives, the hunting can be divided in 5 groups: hunting for subsistence (food for survival), commercial hunting (animal products for sale or barter), recreational hunting, hunting for scientific researches and hunting for culling pest species; 1) Subsistence hunting: where the hunters' main motivation is to provide for the protein needs of the hunter and his/her family. 1) Hunting for sport-recreation: Hunting is conducted for leisure and to recreate in wilderness as a means to spend free time. 3-Commercial hunting: This type of hunting involves commercial ventures (trade or barter of animal products) for profit. 4-Hunting for scientific purposes: the activity is conducted to learn the unknown. 5-Culling pest species: the activity is conducted to reduce or to completely eliminate the populations of the wild animals legally determined as pest species (Ojasti, 1996). Among these groups, recreational hunting is directly related to the subject of the present study and can also be defined in more detail: outdoors hunting activities conducted for leisure, recreation and motivation in free time.

Sustainable Hunting: This approach advocates not harming the biodiversity in long term and not preventing the wild species' rejuvenation while utilizing the wild game animal species and their habitats. Only this way the potential biodiversity can be preserved and the hunting needs of both present and future generations can be satisfied at desired levels. In line with this thought, starting from 1960s various international efforts have been made to protect

the wild animals and their habitats. Some examples are: in 1973, the Agreement of the Convention on International Trade in Endangered Species of Wild Fauna and Flora; in 1979 Birds Directive of EU; in 1992 Natura Directive of EU; in 2000 Natura 2000 Networking Initiative in EU; in 2004 EU Sustainable Hunting Initiative; in 2000 the Federation of Associations for Hunting and Conservation of the EU (European Commission, 2010).

The societies, who realized the positive impacts of hunters on the economy, the health and continuity of ecosystems, carefully define and monitor their huntsmen populations. For instance, in USA the hunters are monitored with all their characteristics since 1955. Similar practices are found in European countries (such as France, United Kingdom, Germany, and Italy). However in Turkey and in many more countries, sufficient attention is not paid to the contributions of hunting to the economy and to the sustainability of the ecosystems. Nonetheless, it is a fact that there is a recent increase in the studies on sustainable hunting and sustainable wildlife.

Impacts of Recreational Hunting on Sustainable Forest Resources

Recreational hunting activities can be classified based on the place of the activity (outdoor recreation and indoors recreation), purpose of activity (adventure recreation, artistic recreation, therapeutic recreation, campus recreation and educational recreation) or the number of the individuals taking part in the activity (individual recreation and group recreation). It is also possible to further categorize each of the recreation groups named above in line with the purpose of such categorization. For instance, the outdoors recreation group can be further categorized according to the source of the activity (nature studies, camping, trekking, mountain biking, rock climbing, fishing and hunting) and the tools used for the activity (water skiing, sailing, picnics, swimming, cycling). According to these classification criteria, recreational hunting belongs to source-based outdoors recreation group (Clawson and Knetsch, 2011; Akesen, 1984).

Outdoors recreation can be held in various ecosystems yet the most preferred medium is forestry areas. In fact the hunters constitute one of the most active and largest groups of forestry resource stakeholders. Furthermore, recreational hunters constitute the largest part of all of hunter groups (see. 1.1). Besides the recreational hunters have very strong nongovernmental organizations compared to those of other hunter groups. It is a known fact that these NGOs have remarkable impacts on policy makers, legislators and merchants. For this reason it can be safely stated that the recreational hunters directly affect the sustainable forest resources management (DKMP, 2015; Finch, et al., 2014; Baxter, et al., 2012; Küçükosmanoğlu and Arslangündoğdu, 2009).

Each creature has a unique value (intrinsic value-asset value) to the nature and this value is vital for the ecosystem. Yet, the value

attributed to the creatures by humans usually differs from their intrinsic value. According to anthropocentric ecosystem approaches, the wild animals are roughly divided into two groups; useful animals (valuable) and pest animals. From this point of view, mankind hunts the animal populations so as to use the useful (valuable) animals and to eliminate the threats posed by harmful animals according to human needs. In both cases the wild animal populations in the forests diminish.

Any increase of reduction of animal populations in time is called fluctuation. Any increase in the population of game animals will also result in an increase of the number of hunters while an increase in the number of hunters will result in a decrease in the number of game animals. Under normal circumstances, this process continues as shown in the Figure 3.

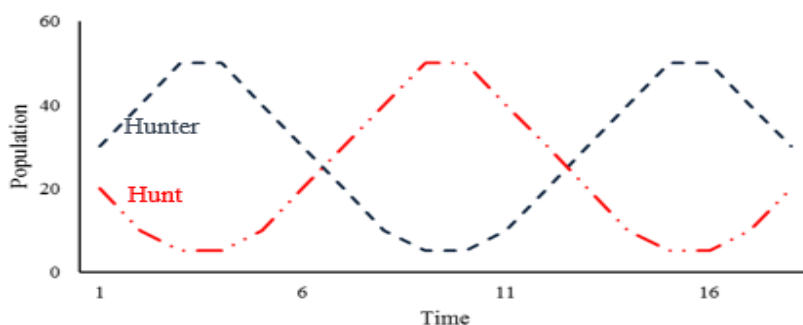

Figure 3. Balanced correlation between the game and the hunter

However once the number of game animals goes below the critical threshold (due to excessive changes in the number of hunters and/or games) the animals will firstly

become an endangered species and then they will extinct unless necessary measures are taken (Figure 4).

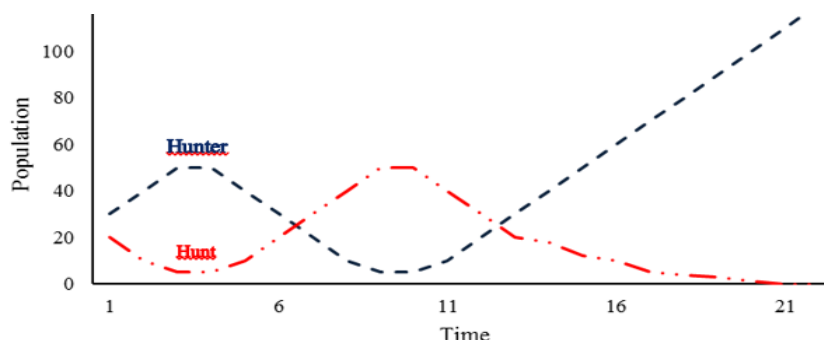

Figure 4. Unbalanced correlation between the game and the hunter

Mankind is sensible and willing to take measures against diminishing of wild animal populations which are deemed valuable for human while indifferent and finds it unnecessary to take measures against diminishing or extinction of pest species. However, an animal, which is deemed harmful for human, can have significant impacts in continuity of an ecosystem for there is a strong correlation between the balance and health of the ecosystem and the food chain evolved throughout the history. Below there are some examples of the impacts of sustainable hunters' intervention in the food chain on management of natural (forest) resources:

A) In USA, in the Yellowstone National Park (YNP), which was established in the year 1872, there were no restrictions on hunting Rocky Mountain Wolves (*Canis Lupus*) in 1900s since they were deemed pest species. However, the wolves were at the top of the food chain in the area. After this decision, which was adopted due to pressure by livestock sector, the wolves had been hunted along with other predators. In 1926 last wolves of YNP were killed which started an era of no-wolves in YNP wherein numerous negative events occurred. For instance many wild animal and plant species started to disappear from the ecosystem while the water levels in streams and lakes started to gradually reduce. The researches showed that these events were all related to the termination of wolf existence in the area. In 1940s studies to re-introduce the wolves in the area were commenced. Yet, in 1973 the wolves were taken into the list of endangered species. Fortunately, after 22 years of efforts, the wild wolves were successfully re-introduced to YNP where many measures are taken to increase their populations. After wolves' return, many plant-animal species, which had been missing in YNP for many years, have started to re-appear in the area and the forests, which had been thinning, started to bloom again. Furthermore, the lake-stream water levels significantly increased ever since (National Park Service, 2016).

B) The salmon fish needs clean and fast-flowing fresh water streams for reproduction.

Such streams can only exist in healthy forests. According to this fact, the existence of salmon directly depends on health of forests. A 2001 study showed that the forests need salmons almost as much as the salmons need the forest. The correlation between the salmon and the forest occurs through other animals, chiefly bears, which feed on salmon. According to the study 70% of annual protein needs of bears is provided by salmons. The bears do not eat all of the fishes they hunted and bring some of them back into the forest with them. The fishes and their leftovers left by bears in forests also feed animals such as eagles, weasels, crows, ravens and gulls and insects such as flies. Thus, the droppings of the animals feeding on the salmon, including bears, provide the forest with 120 kg/ha nitrogen per year. In British Columbia, it is estimated that the 80 000-120 000 bears in the country transfer 60 Mil. Kg nitrogen to rain forests from the salmons they hunt (Reimchen et al., 2002). Furthermore, the analyses proved that the nitrogen found in the trees in the area derive from the salmons. Besides, dendrochronological analyses showed that the trees grow three times faster in salmon-rich periods compared to the periods where the salmons are scarce. However, excessive hunting and other reasons caused a 90% reduction in salmon stocks and extinction of many salmon subspecies. The study states that the forests, which were once very healthy thanks to salmon, are now under risk (Helfield and Naiman, 2001).

C) Undoubtedly, the hunters play an important role in terminating the predators at the top of the natural food chain. Once these animals go extinct, increase in the number of animals that have negative impacts on reproduction and rejuvenation of trees and animals such as boar and gazelle is inevitable. In this case the hunters replace the primary predators and contribute in development and protection of forests by reducing the populations of such pest animals.

Poaching has an important role in failure of sustainable wild life management. Intended or in deliberate poaching is very

common in Turkey just like in everywhere else. For this reason many wild animal species are now extinct or near-extinct in Turkey. As of the year 2015 there are 761 wild animal species in Turkey (150 mammal, 481 bird, 130 reptile species) and 82.7% of these animals (121 mammals, 378 bird and 130 reptile species) are under protection. According to this data, maximum 13.2% of existing wild animal species in Turkey can be hunted. However, in some years this figure is further decreased. For instance, in the 2013-2014 hunting season, hunting of only 5% (7 mammal and 31 bird species) of wild animal species was allowed. This clearly shows the importance of sustainable wild life and sustainable hunting for Turkey (DKMP, 2015; Küçükosmanoğlu and Arslangündoğdu, 2009).

Contributions of Recreational Hunters to the National Economy

There is a consensus that the forestry sector is a strategically important sector which excites entire national economy since it provides inputs for many other sectors. However, the monetary equivalence of many contributions by the forestry sector in the social prosperity (such as non-wood forestry products and positive externalities) is yet to be determined. For this reason, the contribution of forestry sector in the national economy is usually calculated as very little. As an economic activity, the hunting has external impacts (Şafak, 2006; Şafak, 2002; Güven and Hergüner, 1999; Ojasti, 1996). When sustainability is achieved in hunting positive external impacts (stable and climax ecosystems) occurs while only negative external impacts (unstable ecosystems) are expected when it is not achieved.

The contribution of forestry in the national economy is calculated somewhere between 0.3% to 2% in Turkey (Daşdemir, 2015; Türker 2015; Önder and Önder, 2009; Çakır, 1984). A 2013 study by Türker (2013) referring to Bann&Clemens (1999) and Türker at al., (2001) indicates the proportion of the hunting activity amongst total economic value of Turkish forests as 3.35% (in terms of total revenues generated by hunting permits and hunting licenses of 350000 hunters). It is possible to conclude

that the contribution of hunting activities in national economy is between 0.01- 0.07% based on this ratio. In fact, Uzuner Aydın (2016) calculates the share of hunting activity expenses of 189234 licensed hunters in Turkey as 0.01-0.1% in Turkey. In this study, it is also stated that the share of the hunting activity in national income can be increased up to 2% when unlicensed hunters (4037792 hunters) are included. However, there is more than a decade time difference as well as differences regarding hunting income/expense types considered between the studies referred above. Therefore the conclusions of these studies do not contradict each-other. On the contrary, if anything, they support each-other.

The countries which acknowledge the hunting activity as a hobby with high economic contribution, and the hunters as one of the parameters with highest impacts on wildlife management practices, carefully determine and monitor the characteristics of hunter population (FACE, 2016a). Also there is a recent and increased interest in hunting, wildlife and hunters in an increasing number of countries. Table 1 shows the proportions of recreational hunters to the overall populations as well as their contributions in the national economy in 9 countries, including Turkey (Uzuner Aydın 2016; FACE, 2015; US Census Bureau, 2014; FACE, 2013a; FACE, 2013b; Pinet, 1995).

It is not possible to compare the countries according to the data of Table 1 for the number of hunters is an estimated figure for some countries (like Turkey) while it is proved by concrete census data in some others. Furthermore there are differences regarding hunting expenses, hunting types and hunting characteristics. Nonetheless, ignoring such differences, it can be stated that the Hunters' contributions to national economy in Turkey is at par with those of hunters in other countries.

Discussions and Conclusions

Human activities disrupt the balance of forest ecosystems. Nevertheless, an increasing number of people wish to spend their free times in forests. One of the most preferred recreational forest activities is hunting. For this reason there is an ever-

increasing attention on the subject of sustainable hunting.

The objective of the present study is to determine the contributions of recreational hunting activities in sustainable forest resources management and in national economy so as to prove the recreational hunters' status as an important factor that can play a key role in economy and natural resources management (Okan et al., 2014; Şafak et al., 2013; FACE, 2016 a, b, FACE, 2013a, b; Uzuner Aydın, 2016; Ok, 2010;

Bekiroğlu and Okan, 2009).

It is a well proven fact that there is a close interaction between the development of trees in the forest and the wildlife (flora and fauna) living in those forests. For this reason it is important to avoid any intervention that can disrupt the balance of climax forests which can only be created through succession through a very long process (Reimchen et al., 2002; Kandır, 2016; Helfield and Naiman, 2001).

Table 1. Number of recreational hunters and their contributions to national economies in certain countries

Country	Year	Number of hunters	Proportion of hunters to overall population %	Hunting expenses' share in national income %	Annual hunting expenses (Per hunter) US\$
Turkey*	2013 2000	189234- 4037792* 350000	0.3 -5.3 0.5	0.09- 2.1 0.04	2 378 -
Germany	2013 1995	338580 326000	0.4 0.4	0.023 -	1 737 -
Denmark	2013 1995	163000 177000	3.3 3.4	0.21 -	2 194 -
Finland	2013 1995	297110 300000	5.7 5.9	0.41 -	2 169 -
Ireland	2013 1995	300000 120000	6.7 3.3	0.05 -	286 -
France	2013 1995	1313000 1650000	2.1 2.8	0.077 -	936 -
USA	2011 2001	13700000 13000000	4.3 4.9	0.22 -	2 407 2015
Australia*	2012 2000	300000 900000	1.3 5.0	0.05 -	2 010 -
Canada	2012 1996	300000 514000	1.3 5.0	0.05 -	2 010 -

*Estimated figures

Upon examination of the Table 1 on economic contributions of recreational hunters, it is seen that the share of hunter populations in these countries did not change (in quantitative terms) in the last 15-20 years. Yet, when longer periods of time are considered (like 50 to 100 years) it is seen that the number of hunters increased in parallel to the growth of population. A similar tendency occurs in hunting expense

types and expense levels. However, contributions by hunting expenses in national economy vary in different countries because the different countries have different types and levels of hunting and wildlife resources. Nonetheless it is an obvious fact that the hunters' contribution to national economy will increase should the value and care attributed to hunting increased (Uzuner Aydın, 2016; Geray, 2001; Iğircık, 2001). In

Turkish example, it can be stated that the contribution of hunters to national economy increased by at least 100% in last-years (Table 1).

As a result in order to achieve sustainability in hunting, the activity must be planned (regarding the types and numbers of the game animals to be hunted, hunting methods and periods). However, these plans

References

- Akesen A. 1984. Açık hava rekreasyonunda bazı temel kavramlar ve özellikleri. İ.Ü. Orman Fakültesi Dergisi, Seri B, 34(1), 132-137 [Certain basic concepts and their properties in outdoor recreation, Journal of Istanbul University Faculty of Forestry, Series B, 34 (1), pp. 132-137 – in Turkish], İstanbul.
- Baxter G., Finch N., Murray P., Hoy J. 2012. Attitudes and characteristics of Australian recreational hunters. Proceedings of the Queensland Pest Animal Symposium, 30 July-2 August 2012, ISBN 978-0-646-58346-4, Australia.
- Bekiroğlu S., Okan T. 2009. Avcıların demografik ve sosyoekonomik yapısı: Marmara ve Ege Bölgesi Örneği [Socio-economic and demographic structure of hunters: Case of Marmara and Aegean Regions – in Turkish], ACTA TURCICA Online Thematic Journal of Turkic Studies, 1 (1), 295-308, İstanbul.
- Clawson M., Knetsch J.L. 2011. Economics of Outdoor Recreation. Reff Press, 326 p., ISBN: 978-1-61726-034-6, London.
- Çakır M. 1984. Ormanlık Sektörünün Ulusal Gelirdeki Önemi, Orman Mühendisleri Odası Yayın No 9 [The Importance of Forestry Sector in the National Income. Forest Engineers Association Publication, No 9 – in Turkish], Ankara.
- Çanakçıoğlu H., Mol T. 1996. Yaban Hayvanları Bilgisi. İstanbul Üniversitesi Yayın No 3948, Fakülte Yayın No 440, 550s [Wild Animal Information İstanbul University Pub. No 3948, Faculty Pub. No 440, 550p-in Turkish], ISBN 975-404-424-4, İstanbul.
- Daşdemir İ. 2015. Ormanlık İşletme Ekonomisi. Bartın Üniversitesi 10, Orman Fakültesi Yayın 6, ISBN: 978-605-60882-8-5 [Forestry Administration Economics. Bartın Uni. Pub. No 10, Faculty Pub. No 6 – in Turkish] Trabzon.
- DKMP, 2015. T.C. Orman ve Su İşleri Bakanlığı Sürdürülebilir Av Yönetimi Eğiticiler Eğitimi. Eğiticinin El Kitabı [T.R. Ministry of Forestry and Water Affairs, Sustainable Hunting Management, Training for Trainers Manual – in Turkish], Ankara.
- European Commission, 2010. Sustainable Hunting and Natura 2000. <http://ec.europa.eu/environment/nature/info/pubs/docs/factsheets/hunting.pdf>, (accessed 16 May 2016).
- FACE, 2016a. The FACE Diversity Manifesto and its contribution to the EU Biodiversity Strategy 2020 Reporting 2015, http://face.eu/sites/default/files/documents/english/bdm_report_pdf_en_web_version.pdf, (accessed 18 May 2016).
- FACE, 2016b. European hunting, [www.Face-europe.org](http://www.face-europe.org), (Accessed 21 May 2016).
- FACE, 2015. The FACE Diversity Manifesto and its contribution to the EU Biodiversity Strategy 2020. Reporting. http://face.eu/sites/default/files/documents/english/bdm_report_pdf_en_web_version.pdf, (Accessed 19 March 2016).
- FACE, 2013a. Hunters in Europe. http://face.eu/sites/default/files/attachments/data_hunters-region_sept_2010.pdf, (Accessed 4 March 2016).
- FACE, 2013b. Hunting in Germany. http://www.face.eu/sites/default/files/germany_en.pdf, (Accessed Verified 4 March 2016).
- Field B.C. 1994. Environmental Economics, an introduction. McGraw-Hill, Inc. ISBN 0-07-020797-6, New York.
- Finch N., Murray P., Hoy J., Baxter G. 2014. Expenditure and motivation of Australian recreational hunters. Wildlife Research 41, 76–83.
- Geray U. 1993. Türkiye’de orman kaynakları yönetiminin geliştirilmesine ilişkin sorunlar. İ.Ü. Orm. Fak. Dergisi, Seri A, Cilt 43, Sayı 2 [Problems regarding developing forestry resources management practices in Turkey, Journal of I.U. Faculty of Forestry, Series: A, Volume 43, Issue 2 – in Turkish], İstanbul.
- Geray U. 1995. Orman kaynaklarının yönetimi. DPT Yayını [Management of forestry resources, State Planning Agency Publication – in Turkish], Ankara.
- Geray U. 1999. Av raporu yaban hayatı

yönetiminde yeni yaklaşım. Orman Mühendisliği Dergisi, (7) 26-32 [Hunting report: new approach in management of wildlife, Forestry Engineering Journal, 7, 26-32 – in Turkish], Ankara.

Geray U. 2001. Av ve yaban hayatı kaynaklarının sürdürülebilir yönetimi, sürdürülebilir avcılık için temel eğitim kitabı, MP Yayını, [Sustainable management of game and wildlife resources, training book for basic training for sustainable hunting, National Parks Service Publication – in Turkish], Ankara.

Güven Ö., Hergüner G. 1999. Türk kültüründe avcılığın temel dayanakları. Eğitim. Fak. Derg. (5) 33-47, [Fundamental foundations of hunting in Turkish Culture, Education Faculty Journal (5) 33-47 – in Turkish] <http://pauegitimdergi.pau.edu.tr/Makaleler/>, (Accessed 29 May 2016).

Harris J.M. 2000. Sürdürülebilir kalkınmanın temel prensipleri (Basic Principles of Sustainable Development), Türkçeye çeviren Emine Özmete, Global Development and Environment Institute Working Paper:00-04, Tufts University, USA, <http://www.sdergi.hacettepe.edu.tr/makaleler/EmineOzmet2eviri.pdf>, (Accessed 29 June 2016).

İğircik M. 2001. Türkiye'nin av Potansiyelinin geliştirilmesine ilişkin sosyoekonomik çözümleme. İstanbul Üniversitesi Fen Bilimleri Enstitüsü, Basılmamış Doktora Tezi [A socioeconomic analysis on improving the hunting potential of Turkey, Istanbul University, Faculty of Sciences, unpublished doctoral thesis – in Turkish], İstanbul.

Helfield, J. M., and R. J. Naiman. 2001. Effects of salmon-derived nitrogen on riparian forest growth and implications for stream productivity. Ecology 82(9), 2403–9.

Kandır E.H. 2016. Ey insanoğlu avcı mısın yoksa av mı? Dergi Ayrıntı Göller Bölgesi Ekonomi ve Kültür Dergisi, 4 (37)11-16 [Thou mankind! Are you hunter or the kill? Ayrıntı, Economy and Culture Publication of Lakes Region, 4 (37) 11-16 – in Turkish], Burdur.

Kula E. 1994. Economics of Natural Resources, the Environment and Policies. Second Edition, Chapman&Hall, ISBN 978-0-412-57640-9, London.

Küçükosmanoğlu A., Arslangündoğdu Z. 2009. Türkiye'de avcılığın geleceği [Future of hunting in Turkey – in Turkish]. ACTA TURCICA Online Thematic Journal of Turkish Studies, 1(1), 358-366, İstanbul.

National Park Service, 2016. Wolves in Yellowstone. <https://www.nps.gov/yell/learn/nature/wolves.htm>, (Accessed 13 May 2016).

Oğurlu İ. 2008. Yaban hayatı kaynaklarımızın yönetimi üzerine. Süleyman

Demirel Üniversitesi Orman Fakültesi Dergisi Seri: A, Sayı: 2, Yıl: 2008, ISSN: 1302-7085, Sayfa: 35-88 [On the management of wildlife resources, Suleyman Demirel University, Journal of Faculty of Forestry, Series: A, Issue: 2, Year: 2008, ISSN: 1302-7085, Pages: 35-88 – in Turkish], Isparta.

Ok K. 2010. Türkiye ormancılık sektörü açısından ekoturizm. Orman Ekosistemlerinde Ekoturizm Çalıştayı ve 10. Yılında TODEG [Ecotourism in terms of Turkey's forestry sector. Ecotourism in Forest Ecosystems Workshop and 10th year TODEG – in Turkish], Türkiye Ormancılar Derneği, Diğer Yayınlar Serisi No 10, Ankara.

Ojasti J. 1996. Wildlife Utilization in Latin America: Current Situation and Prospects for Sustainable Management (FAO Conservation Guide-25). <http://www.fao.org/docrep/t0750e/t0750e00.htm#Contents>, (Accessed 9 May 2016).

Önder K., Önder E. 2009. Ormancılık sektörünün ekonomik büyüme üzerine etkisi: Türkiye Örneği. II. Ormancılıkta Sosyo-Ekonomik Sorunlar Kongresi (19-21 Şubat 2009), [Impacts of forestry in economic growth: Turkish Example. 2nd Congress on Socioeconomic Problems in Forestry (19-21 February 2009) – in Turkish], Isparta.

Özabuncuoğlu İ.H., Uğur A. 2005. Doğal kaynaklar ekonomisi, yönetim ve Politika. İmaj Yayınevi, ISBN 975-8752-31-6, [Natural resources: economy, management and policies, İmaj Publications, ISBN 975-8752-31-6 – in Turkish], Ankara.

Pak M., Türker M.F., Öztürk A. 2010. Total economic value of forest resources in Turkey, African Journal of Agricultural Research Vol. 5(15), pp. 1908-1916, 4 August, 2010 Available online at <http://www.academicjournals.org/AJAR> DOI: 10.5897/AJAR10.018 ISSN 1991-637X ©2010 Academic Journals, (Accessed 19 April 2016).

Pinet J.M. 1995. The hunters in Europe. Report: 1-12. Federation of Associations for Hunting and Conservation of the E.U. http://www.kora.ch/malme/05_library/5_1_publications/P_and_Q/Pinet_1995_The_hunters_in_Europe.pdf, (Accessed 19 April 2016).

Platt-McGinn A. 1998. Rocking the boat: conserving fisheries and protecting jobs. Worldwatch Institute, worldwatch paper 142, Washington D.C.

Şafak İ. 2006. Ege Bölgesinde Av ve Yaban Hayatı Yönetimindeki Sorunlar ve Çözüm Önerileri. 1. Uluslararası Odun Dışı Orman Ürünleri Sempozyumu (1-4 Kasım 2006), 66-73,

[Problems in Hunting Animals and Wildlife in Aegean Region and Solution Proposals, 1st International Symposium on Non-wood Forestry Products (1-4 November 2006), 66-73– in Turkish], Trabzon.

Şafak İ. 2002. Özel Avlakların Sağlayabileceği Yararlar Ve Karşılaştığı Darboğazların Sosyo-Ekonomik Açından Çözümlemesi. İstanbul Üniversitesi Fen Bilimleri Enstitüsü Basılmamış Yüksek Lisans Tezi [The Benefits that Private Game Ranches can Provide and a Social Economic Analysis of The Bottle-Necks Met by Them. Istanbul University, Faculty of Sciences, Unpublished doctoral thesis – in Turkish] 161p, İstanbul.

Şafak İ., Okan T., Hızal E., Keçecioglu T., Işık C., Acar S. 2013. Determination of cultural characteristics of hunters for hunting and wildlife management (The case of Istanbul Province), International Conference on Economic and Social Studies, 10-11 May, 2013, Sarajevo.

Okan T., Şafak İ., Hızal E. 2014. Socio-economic Research on Hunting and Wildlife Management: The Turkish Case. The Sustainability Knowledge Community, Tenth International Conference on Environmental, Cultural, Economic, and Social Sustainability (22-24 January 2014), Croatia.

Reimchen T. E., Mathewson D., Hocking M. D., and Moran J. 2002. Isotopic evidence for enrichment of salmon-derived nutrients in vegetation, soil and insects in riparian zones in Coastal British Columbia. American Fisheries Society Symposium 34:59-69, <http://www.sfu.ca/~ianh/geog315/readings/Reimchen.pdf>, (Accessed 19 May 2016).

Türker M.F. 2015. Ormancılık İşletme Ekonomisi. Ormancılık ve Tabiatı Koruma Vakfı Yayın No 5, ISBN: 978-605-85748-0-9, 287 p. [Forestry Administration Economics – in Turkish], Trabzon.

UN, 2010. Sustainable development: from Brundtland to Rio 2012. Background paper prepared for consideration by the High Level Panel on Global Sustainability at its first meeting, 19 September 2010 by John Drexhage and Deborah Murphy, http://www.un.org/wcm/webdav/site/climatechange/shared/gsp/docs/GSP1-6_Background%20on%20Sustainable%20Devt.pdf, (Accessed 19 May 2016).

UN, 2000. Report of the United Nations Conference on environment and development. Rio de Janeiro, 3-14 June 1992, <http://www.un.org/documents/ga/conf151/aconf15126-3annex3.htm>, (Accessed 19 May 2016).

UN, 1987. Report of the World Commission

on Environment and Development: Our Common Future. <http://www.un-documents.net/wced-ocf.htm>, (Accessed 19 May 2016).

US Census Bureau, 2014. National survey of fishing, hunting, and wildlife-associated recreation. <https://www.census.gov/prod/2012pubs/fhw11-nat.pdf>, (Accessed 19 May 2016).

Uzuner Aydın Z. 2016. Avcıların Harcama Eğilimlerinin Belirlenmesi ve Milli Gelire Katkısı (İstanbul Örneği). İ.Ü. Fen Bilimleri Enstitüsü, Orman Mühendisliği Anabilim Dalı, Basılmamış Yüksek Lisans Tezi, [Determination of Expenditure Tendencies of Hunters and Its Contributions in National Income (Example of Istanbul) I.U. Faculty of Sciences, Department of Forestry Engineering, Unpublished Graduate Thesis – in Turkish], İstanbul.

Evaluations on Stumpage Sales in Turkey

*Adem GENÇ¹, Tevfik DEDEBAŞ¹, Rüknettin TEKDEMİR¹

¹ Kastamonu Entegre Ağaç San.Tic.A.Ş. 37100 KASTAMONU/TURKEY

*Corresponding Author: agenc@keas.com.tr

Abstract

The General Directorate of Forestry (GDF) is trying to reduce its costs via preventing duplication of costs in recent years. While the distance between the production area and sales area is increasing, costs are also increasing. Therefore, GDF is trying to shorten the distance between the production site and selling point. For this purpose, policies are developed on enhancing ramp sales and stumpage sales, rather than store sales. Thus, more fresh produce will be offered for sale very quickly. However, a number of structural problems of GDF and customers prevent development of stumpage sales. In this study, problems are evaluated on stumpage sales in the environment of the GDF and the customers. Structural problems of GDF include a lack of staff, shortcomings in the legislation, inadequate infrastructure and road network. No corporate enterprises lack of working capital and lack of machinery are among the structural problems of customers come to the fore. In this study, the structural problems which have an impact on the development of stumpage sales management are elaborated and tried to bring solutions.

Keywords: stumpage, Turkey, reduction of costs

Introduction

The General Directorate of Forestry (GDF) have rapidly increased its production since last 14 years. Besides, the costs have continued to increase too. The GDF is trying to reduce its costs via preventing duplication of costs in recent years. For this purpose, policies are developed on enhancing ramp sales and stumpage sales, rather than store sales. In turkey, generally non-professional forest villagers is engaged in manufacturing. The number of forest villagers is decreasing as a result of migration to the big cities. The remaining population in the village is also old. This situation hampers investment to reduce costs. Important part of GDF staff does not believe importance of the stumpage sales. Stumpage sales have increased with the top managements pressure. This situation prevents the development of stumpage sales and legislation. In this study, problems are evaluated on stumpage sales in the environment of the GDF and the customers.

Material and Methods

In the preparation of this "Evaluations on stumpage sales in Turkey" report, it is based on long years of professional experience. The authors have been gained from the experience at GDF by working for long years. It also has experience in the supply of raw materials in the private sector.

The results of this experience are summarized in this report.

Results

The General Directorate of Forestry (GDF) is trying to reduce its costs via preventing duplication of costs in recent years. For this purpose, policies are developed on stumpage sales, rather than store sales. However, a number of structural problems of GDF and customers prevent development of stumpage sales.

Structural problems of GDF include a lack of staff, shortcomings in the legislation, inadequate infrastructure and road network. Important part of GDF staff does not believe importance of the stumpage sales. Stumpage sales have increased with the top managements pressure. This situation prevents the development of stumpage sales and legislation.

No corporate enterprises lack of working capital and lack of machinery are among the structural problems of customers come to the fore. In turkey, generally non-professional forest villagers is engaged in manufacturing. The number of forest villagers is decreasing as a result of migration to the big cities. The remaining population in the village is also old. This situation hampers investment to reduce costs.

Discussion and Conclusion

GDF the number of personnel has decreased in recent years. The number of forest villagers is decreasing as a result of migration to the big cities too. For all that, The General Directorate of Forestry (GDF) have rapidly increased its production. Besides it has increased Stumpage sales. Besides, the number of jobs per person has increased by reason of the joining of afforestation unit and non-wood products unit the establishment.

This situation has caused extreme fatigue and protection problems of the forest. Therefore, important part of GDF staff does not believe importance of the stumpage sales. Nevertheless, stumpage sales have increased with the top managements pressure. This situation prevents the development of stumpage sales and legislation. For to increase stumpage sales, as well as increasing the number of personnel, received for violation of terms quarantee amount should be increased too much. If it is determined of illegal logging, specifications should be abolish.

Because of lack of staff , the stumpage sales amount not be properly identified. First, the stumpage sales amount must be properly identified.

Instead dedicated stumpage sales should increase stumpage sales by auction. Taxes from sales of forest products should be reduced. GDF distribution expenses should be covered from the general budget. To determining of the allocation price, should be used annual inflation rates.

Amount of work with the machine has increased. This case should be taken into account in determining prices. Whereas, price should be determined by considering a minimum 10 percent profit buyer.

Legislation should be developed for the formation of corporate buyers. In addition,

legislation should be developed to make stumpage sales of professional firms. So should not be sold to people and firms without adequate conditions. Thus, job security, insurance work, ecology respectful work will increase. The number of machines, working capital educated workforce should be qualification criteria.

The effectiveness of Forest Engineers should be increased to stumpage sales made in forest. Thus, will increase of respect for ecology and efficient production. Professional labor is quite important for occupational safety and respect for the ecology. For this purpose, Forestry labor department should be established at universities.

The percentage of yield determination is made for price determining .In practice, usually set high the yield percentage and it sets the standard very high because harm of the state of fear. Besides, current market conditions are generally ignored.

Thus reducing the buyer's earnings from the start. In this case, buyers are orientation to irregularities. Administrations are prejudiced act while determination to price. participation of stakeholders and impartial comissions could be provided for yield percentage and price determining.

In addition, working time should be gave according to the geographic and climatic conditions of the work area and amount of work. Buyers are slog to transport and not produce the products they want. Forest roads are not enough to the current a transport vehicle.

The aim of stumpage sales be able to sales for fast and fresh products. Products that can be sold should be produced by normal production. But, unsold product it can be producing forests should be made stumpage sales.

Evaluations of Relations Between the Wood-Based Panel Sector and State in Turkey

*Tevfik DEDEBAŞ¹, Adem GENÇ¹, Rüknettin TEKDEMİR¹

¹ Kastamonu Entegre Ağaç San.Tic.A.Ş. 37100 KASTAMONU/TURKEY

*Corresponding Author: tdedebas@keas.com.tr

Abstract

In Turkey, the installed capacity of the wood-based panel sector is increasing each passing day. Today, the wood-based panel sector's installed capacity reached approximately 11.7 million m³ (6.6 million m³ Middle Density Fiberboard and 5.1 million m³ Chipboard). Wood-based panel industry uses about 14 million tons raw wood material per year. In addition, the panel exports is also increasing day by a remarkable pace. The total wood raw material requirement of approximately 3 million tons is provided from overseas sources. Besides the supply gap; forestry businesses are subject to annual production of nearly half of the increment. Not adequately to meet demand from domestic market and the accumulation of wealth in forest have become one of the most important issues to be solved in Turkey forestry. In this study, the wood based panels industry in Turkey has been evaluated from past to today. At the same time, expectations from the General Directorate of Forestry of the wood-based panel sector are put forward. The solutions were offered the supply gap which is the most important problem of the wood-based panel sector in Turkey.

Keywords: Chipboard, Middle Density Fiberboard, Turkey, the wood -based panel sector

Introduction

In Turkey, the installed capacity of the wood-based panel sector is increasing each passing day. Today, the wood-based panel sector's installed capacity reached approximately 11.7 million m³ (6.6 million m³ Middle Density Fiberboard and 5.1 million m³ Chipboard).(Anon.2015a)

With the furniture industry contributes more than 8 billion dollars to the national economy. But the contribution of this sector in Italy are more than 30 billion dollars. Wood-based panel industry uses about 14 million tons raw wood material per year. (Anon. 2015b)

General Directorate of Forestry depending on the data , forest wealth of approximately 1.5 billion m³ and increment of about 42 million m³ / year . Besides the supply gap; forestry businesses are subject to annual production of nearly half of the increment.(Anon.2012a)

The total wood raw material requirement of approximately 3 million tons (300 million dollar) is provided from overseas sources. In addition, the panels are imported 550 million dollar a year. In total, it consists of 850 million dollars deficit in this sector.).(Anon.2015c)

The aim of this study, the necessary raw materials, contribute to providing from domestic.

Material and Methods

In the preparation of this " Evaluations of Relations Between the Wood-Based Panel Sector and state in Turkey" report , it is based on over 40 years of professional experience . The authors have been gained from the experience at GDF by working for 30 years. It also has nearly 10 years experience in the supply of raw materials in the private sector. The results of this experience are summarized in this report.

Results

There is about 42 million m³ / year increment in Turkey forest. Despite the raw materials are imported. Whereas the raw materials can be obtained from internal sources.

Discussion and Conclusion

The following precautions should be taken by the government.

About 50% of the forests is unproductive. This rate should increased with reforestation and rehabilitation studies. There are 5.5 million hectares of Pinus brutia forest in Turkey. The productivity of this areas should be

reevaluated and management time should be reduced . Also a similar study should be conducted to the Pinus pinaster.).(Anon.2012b)

Employee forest villagers are reduced each passing day. In forest, working of only forest villagers and cooperative members, must be removed from in law .There is a confusion in standardization. Wood of the same diameter, can be in different standards. Therefore, should be created a new standard that covering of all industrial woods. Biomass support for renewable energy will adversely affect the supply of raw materials panel sector. Sales revenue of 2B area should be used for the development of forest roads and machinery. Lack of forest guards must be completed in all forest directorates. According to the legislation; if lost the wood in forest that buyer is responsible. This matter should be rearranged according to weather and road conditions. For private forestry development should be made improvements in the forest and tax laws. Structural problems which have negative impact on the development of stumpage sales are must be solved.

The wood raw material prices are quite high in Turkey. Therefore, measures should be taken for lowering wood costs. Taxes from sales of forest products should be reduced. GDF distribution expenses should be covered from the general budget. To determining of the allocation price, should be used annual inflation rates. Qualification certificate for participation in the tender should be requested.

Forestry workmanship training camps should be opened again. Forest roads are must be adapted that for pass large and long trucks. The number of machines in forest directorates is not enough.

References

- Anonymous (2015a). *Tuik Verileri-2015*
Anonymous (2015b). *Tuik Verileri-2015*
Anonymous (2015c). *Tuik Verileri-2015*
Anonymous (2012a). *Türkiye Orman Varlığı-2012*. T.C. Orman ve Su işleri Bakanlığı Orman Genel Müdürlüğü Orman İdaresi ve Planlama Daire Başkanlığı. 31, Ankara.
Anonymous (2012b). *Türkiye Orman Varlığı-2012*. T.C. Orman ve Su işleri Bakanlığı Orman

Genel Müdürlüğü Orman İdaresi ve Planlama Daire Başkanlığı. 31, Ankara.

A Research on Previously Estimated the Cost of Fire Fighting (The Case of Taşköprü)

*Gökhan ŞEN¹, Seda ERKAN BUĞDAY¹

¹Kastamonu University, Faculty of Forestry 37150, Kastamonu/TURKEY

*Corresponding Author: gusen@kastamonu.edu.tr

Abstract

Fires with the biotic and abiotic factors are very important place in harmful factors that damage to forests. Therefore, forest fire fighting is one of the importance issue of forest protect. Forest fire fighting is evaluated as two sections. First one is “measures taken before the fire” and the second one is “Interventions during and after the fire”. Fire safety roads, afforestation made with fire resistant species and trainings can be considered as the prevention activities. Interventions during and after the forest fire are accepted as the firefighting operations.

As with every activity, fire-fighting operations are also needed for planning and evaluation in order to fulfill the most effective and efficient way. In addition to plans and projects are carried out on many variables such as fire behavior, effects and the activity of fire prevention teams. However, economic pillar of the prepared the plans and projects are being ignored because of fire is a sensitive issue.

In this study, we try to estimate economic size of the fire-fighting via modelling in Taşköprü which is the most forest fires in the last 20 years in the Kastamonu city. In this context we use many data such as geographical, climatic, fire-fighting equipment and labors. In this study, simple correlation analysis and regression analysis were performed. 38 variables used in the study, but 16 of them were found to be statistically significant. According to the results, estimation model of firefighting expenses was created. In this way, we can assisted decision makers in terms of selecting the most economical alternative strategies during the fire-fighting interventions.

Keywords: Forest Fire Economics, Economic model, Kastamonu, Turkey

Yangınla Savaş Harcamalarının Önceden Tahmini Üzerine Bir Araştırma (Taşköprü Örneği)

Özet

Ormanlara zarar yapan etmenler içerisinde gerek biyotik gerekse abiyotik etkilerle ile çıkan yangınlar önemli yer tutmaktadır. Bu nedenle yangınlarla mücadele ormanların korunmasında önem verilen hususlardan birisidir. Yangınlarla mücadele yangın öncesi önleme ve yangın anında ve sonrasında müdahaleler olarak ayrılmaktadır. Yangın emniyet yolları, yangına dayanıklı tür ağaçlandırmaları, eğitim gibi faaliyetler önleme faaliyeti olarak değerlendirilirken, yangınla mücadele anındaki yapılanlar ve sonrasında soğutma faaliyetleri yangınla savaş faaliyetleri olarak kabul edilmektedir.

Her faaliyette olduğu gibi yangınla mücadele faaliyetlerinin de en etkin ve verimli şekilde yerine getirilebilmesi için planlama ve değerlendirmeye ihtiyaç duyulmaktadır. Yangın önleme faaliyetlerinin planlanması, projelendirilmesi ve uygulanması yanında yangın anında yangın davranışlarının ve yangın ekiplerinin çalışmaları ile alakalı olarak birçok değişken üzerinde plan ve proje yapılmaktadır. Ancak yangın hassas bir konu olduğundan hazırlanan bu plan ve projelerin ekonomik ayağı biraz göz ardı edilmekte ve fazla üzerinde durulmamaktadır.

Bu çalışmada, Kastamonu ilinde son 20 yılda en fazla orman yangını çıkan ilçesi olan Taşköprü’de meydana gelen orman yangınları üzerinden bir modelleme yapılarak yangınla savaş anındaki müdahalelerin ekonomik büyüklüğü tahmin edilmeye çalışılmıştır. Bu kapsamda coğrafi, iklimsel ve yangın söndürme de kullanılan ekipman ve iş gücü gibi birçok veriden yararlanılmıştır. Çalışmada basit korelasyon ve çoklu regresyon analizi kullanılmıştır. Bağımlı değişken olan yangın harcama maliyetini tahmin etmeye yönelik belirlenen 38 adet değişkenin 16 adedi istatistiksel olarak anlamlı bulunmuştur. Bu anlamlı değişkenler regresyon modelinde kullanılarak iki model elde edilmiştir. Elde edilen sonuçlar yangınla savaş müdahaleleri yapılırken eldeki alternatif stratejilerin en ekonomik olanının bulunması açısından karar vericilere destek olması açısından önem arz etmektedir.

Anahtar kelimeler: Orman yangınları ekonomisi, Ekonomik model, Kastamonu, Türkiye

Introduction

Planning, for performing a specific purpose, what, how, why, when, where and who will be made in determining the optimum actions is a conscious process for the future (Tosun, 1990; Daşdemir, 2005).

It is necessary to prepare appropriate plans for these purposes determining the alternative options in planning. Plans are documents consisting of many decisions according many alternative results (Daşdemir, 2005). Planning will provide a positive impact for the least successful part of reducing the proportion of the estimated order thereby the uncertainty of the plan of effective planning possible event occurring in the future can be made that there is a process to determine in advance the steps to be taken in the future (Kavcar, 2004). The most important problem is the uncertain future in the planning process. Therefore, it is very important in the planning process to predict the future. At this point, difficulties of analysis of the influential variables to be estimated on desired results are encountered. In this context, determining the correctly decision variables will emerge and ensuring participation in the decision-making process of these variables and this will increase the accuracy of the results.

It is utilized in single or multi-dimensional analysis for the independent factors to be estimated the impact on the results to show the desired event. One-dimensional analysis of the independent variables that only examined the effect of the event is considered one of the effects of other variables constant (Daşdemir and Güngör, 2002). However, the events are also effective on many factors and it is effective in different sizes on the result of these factors. Therefore, it is a more efficient way to estimate multi-level analysis of the results depends on several factors.

Forests, which animate and inanimate many factors intertwined and affect each other and there is living ecosystem sustainability, the use of multi-dimensional decision-making methods in studies associated with our forests are getting more accurate results and more accurate estimates in the planning work are helping us

improve. In the one-dimensional approach, success is accidental (Gümüş, 1996).

Preservation of forestry with numerous economic and ecological benefits is important. Fires, is one of the most important elements that threaten forests. In this context, there are many activities and having been made in the fight against forest fires. However, popular approaches to forest conservation can lead to waste our scarce resources. Protection activities, such as prevent, combat, restoration and awareness projects are carried out in different ways and also produced implemented. But the thing here is ignored; the cost-benefit calculation cannot be made good, and sometimes cannot be done at all. Projects are used as inputs and allow the use of various resources in accordance with the intended purpose of these resources. In this context, countries such as unlimited use of the resources it can cause damage to the national economy. Fire precision is one of the important points in the studies of the fight against forest fires. Various studies have been conducted accordingly calculated fields of fire sensitivity grades (OGM, 1995). However, many factors as the geographical factors and the forest structure affect the susceptibility to of fire. However, in the current system of forest management district, fire classification is determined as same planning and measures for the very large and variable areas. Despite the budget planning is done in this study, there is no planning based on economic data, literally.

The factors causing the fire spending with this study, multi-dimensional analysis to assess the technical and expenditure pattern will be formed. Thus, the difference resulting from the possible fire scenarios that may arise in planning costs can be made in advance predict and budgeting accordingly. In fact, these plans will be able to plan on a smaller scale, thereby allowing more effective use of funds.

Materials and methods

Between the years 2005-2014, Taşköprü has most burning area of 133 ha. among Kastamonu towns. So, we chosed Taşköprü, as a study area because it is very important and risky district in terms of forest fire. This

district is located in the north-east of the city and it is 42 km from the city center (figure 1). The altitude is approximately 500 meters. Taşköprü was established around the edge of the ancient city of Pompeiopolis and on the side of Gökırmak (Anonymus, 2016). Taşköprü has 113518.9 ha forest area (OGM, 2016). To test the hypothesis which identified in the study, we used fire data sheets of Taşköprü Forestry Directorate, between the years 2005-2014. The fire data sheets; which official documents prepared by fire chiefs; contains a lot of data such as the size of the fire area, climatic and geographical features of the area, the fire-fighting activities and fire-fighting expenses etc.

Depending on the purpose of the study was primarily created the following hypothesis.

H₀: Environmental conditions, equipment and all the people in the burning area is not effective on fire-fighting expenditures.

H₁: Environmental conditions, equipment and all the people in the burning area is effective on fire-fighting expenditures.

The relationship between independent variables and the dependent variable were examined for the purpose of testing the hypotheses. At first a simple correlation analysis (SCA) has been used. SCA reveal direction, size and important of relationship between two variable (independent or dependent) the effect of independent variables on the dependent variable were examined with Enter Multiple Regression Method. The independent variables associated with the dependent variable was determined via correlation analysis. Then to determine the relationship between this independent variables and dependent variable, Enter Multiple Regression Method was used. In this study we aim to create a model like this $Y=b_0+b_1X_1+b_2X_2+.....+b_zX_z$ (Özdamar, 2002; Kalaycı, 2006; Çimen, 2015).

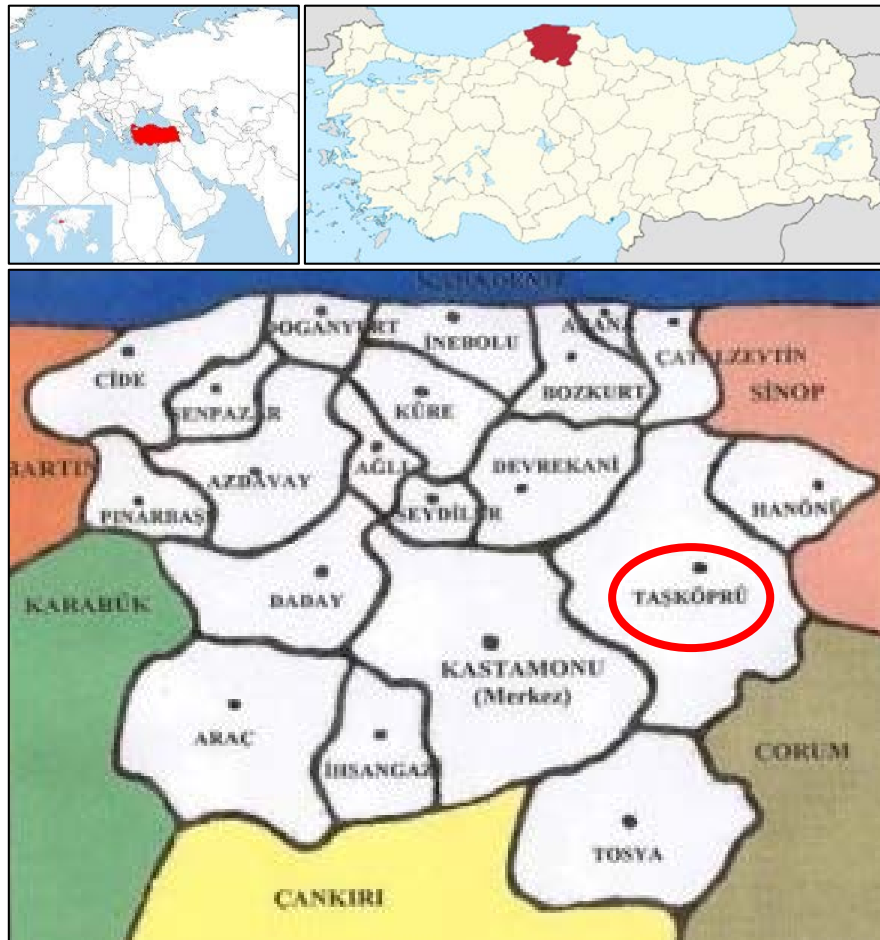

Figure 1. The location of the town

Fire data sheets were evaluated and then it was decided to carry out an analysis of 38

independent variables. The variables used in this study are listed in Table 1.

Table 1: Variables and their abbreviations

No	Variable	Abbreviation	Meaning
1	Dependent	YSONMAL	Fire-fighting cost (It is indexed to USD)
2	Independent	GUNSAY	occurred fire when day of the year
3	Independent	YSAAT	fire starting time (in minutes)
4	Independent	ILKMUD	the period between the fire start time and the time of the first intervention (in minutes)
5	Independent	YSURE	the period between the fire start time and the finish time (in minutes)
6	Independent	YANYÜK	The altitude of the burned area (meter)
7	Independent	YEGİM	The slope of the burned area
8	Independent	YOVER	The efficiency of the burned area
9	Independent	ORMKAR	The mixture status of the burned area
10	Independent	ORMYTIP	leaf type of the burned forest-tree
11	Independent	ORTVO	During the grassland fires, damaged productive forest area (ha)
12	Independent	TEPVO	During the tree fires burned productive forest area (ha)
13	Independent	TOPVO	Total burned productive forest area (ha)
14	Independent	ORTBO	During the grassland fires, damaged non-productive forest area (ha)
15	Independent	ORTBALTO	During the grassland fires, damaged non-productive coppice forest area (ha)
16	Independent	YTOPORM	Total burned forest (non-productive and productive) area (ha)
17	Independent	NSPNEM	During the fire, relative humidity (%)
18	Independent	RUZHIZ	During the fire, wind speed (knot)
19	Independent	SICAK	During the fire, temperature (C ⁰)
20	Independent	YAGGUN	The number of days between the fire day and The latest rains day
21	Independent	TEKNİKE	The number of technical elements involved in the firefighting operations
22	Independent	MEMUR	The number of official involved in the firefighting operations
23	Independent	SONİSC	The number of forest-firefighter involved in the firefighting operations
24	Independent	MUKLEF	The number of amenable involved in the firefighting operations
25	Independent	ASKER	The number of soldier involved in the firefighting operations
26	Independent	JANDRM	The number of gendarme involved in the firefighting operations
27	Independent	DIGKISI	The number of the other people involved in the firefighting operations
28	Independent	TOPKISI	The total number of people who participated in the firefighting operations
29	Independent	PİKAP	The number of pickup used in firefighting operations
30	Independent	İLKMUD	The number of the first intervention vehicle used in firefighting operations
31	Independent	ARZOZ	The number of sprinkler used in firefighting operations
32	Independent	SUIKM	The number of water supply means used in firefighting operations
33	Independent	TRKTR	The number of tractor used in firefighting operations
34	Independent	DOZER	The number of dozer used in firefighting operations
35	Independent	GRYDR	The number of digger used in firefighting operations
36	Independent	TRYLR	The number of trailer used in firefighting operations
37	Independent	HLKPTR	The number of helicopter used in firefighting operations
38	Independent	DIGARC	The number of the other vehicle sprinkler used in firefighting operations
39	Independent	TOPARC	The number of total vehicle used in firefighting operations

Result

Between 2005 and 2014 a total of 93 forest fires have occurred in Taşköprü. Rates per year of the fire shown in Fig.2.

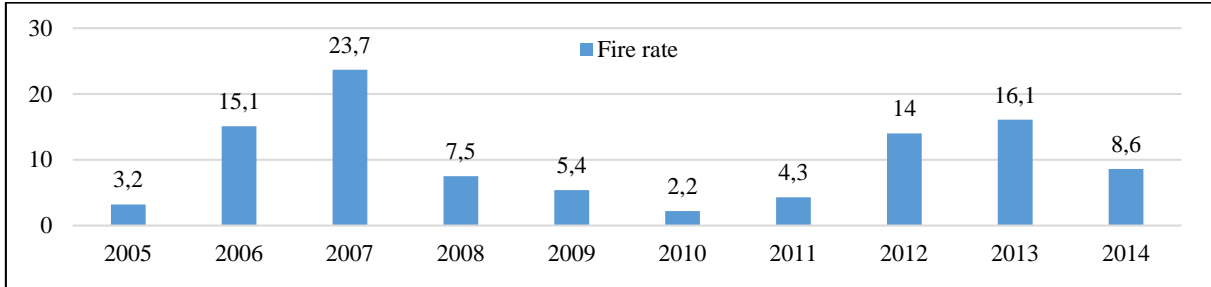

Figure 2: The distribution of forest fires

The figure 2 is observed that most fires occur in 2007. The fire of the month the

distribution is analyzed, it is seen that most fires occur in August (Figure 3).

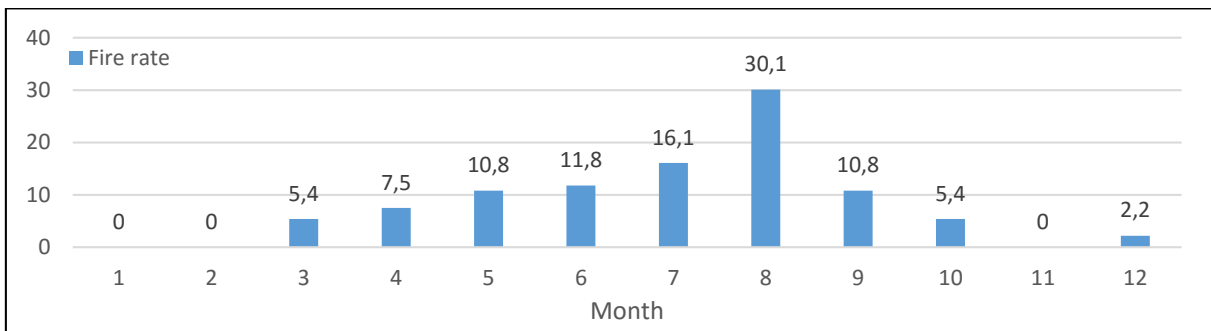

Figure3: forest fire distribution according the months

According to information and data obtained from the fire data sheets, forest fires has continued between 1 hour and 15 minutes and 12 hours. Forest fires have

made the first intervention (in 4 minutes at the earliest and at the latest within 4 hours). The distribution of the first interventions time is shown in Figure 4.

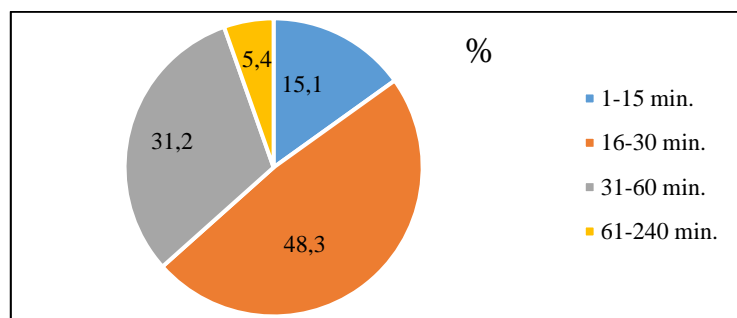

Figure 4: The distribution of the first interventions time

Environmental factors and the properties of forest areas affect the character of the forest fires. Thus, some environmental factors and

the measurable properties of forest areas are shown in figure 5-13.

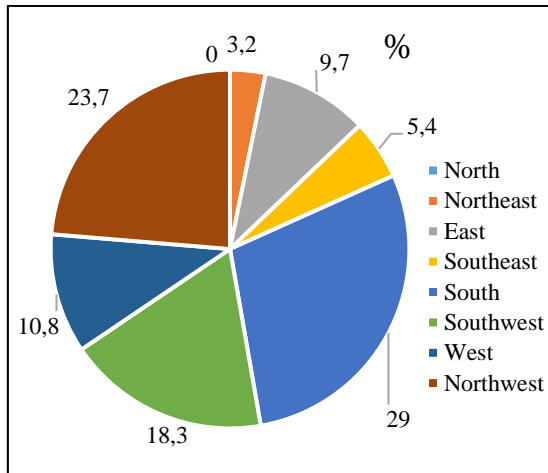

Figure 5. The aspect of burned forest area

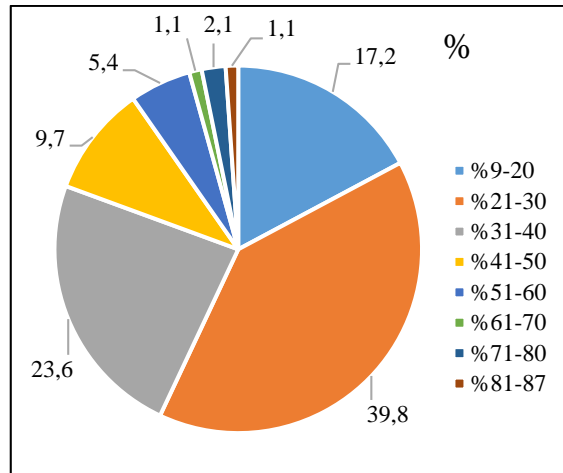

Figure 6. Relative humidity of burned forest area

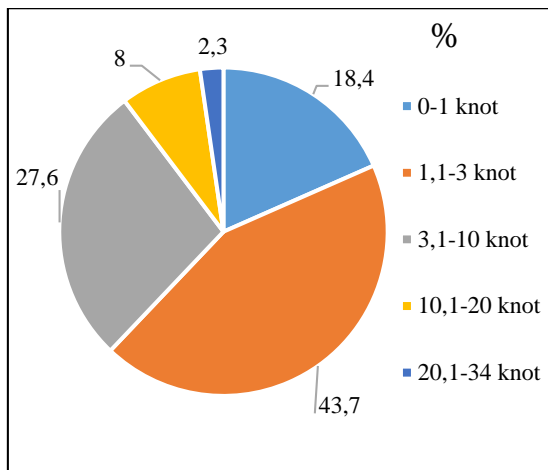

Figure 7. Wind speed during the fire (knots)

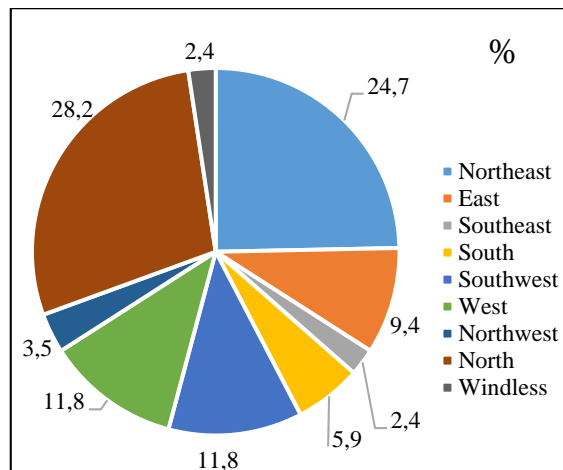

Figure 8. Wind direction during the fire

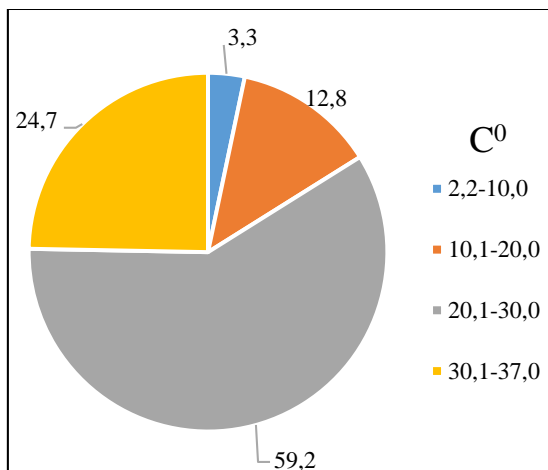

Figure 9. Temperature during the fire

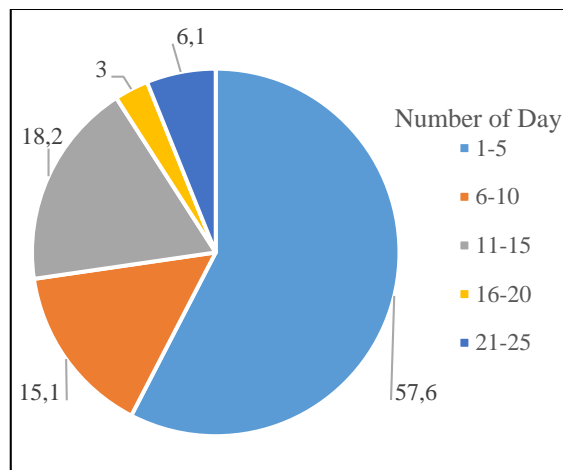

Figure 10. The time between the last rain and the fire

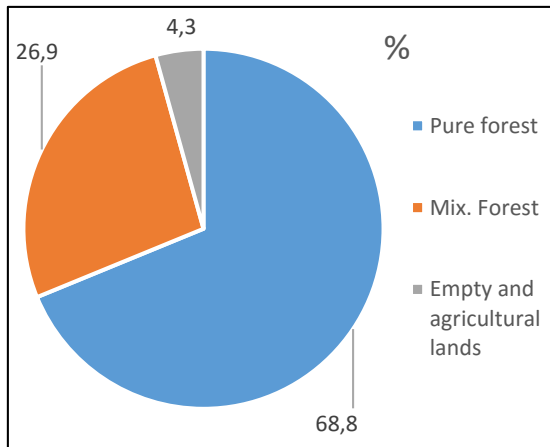

Figure 11. The mixture status of the burned forest

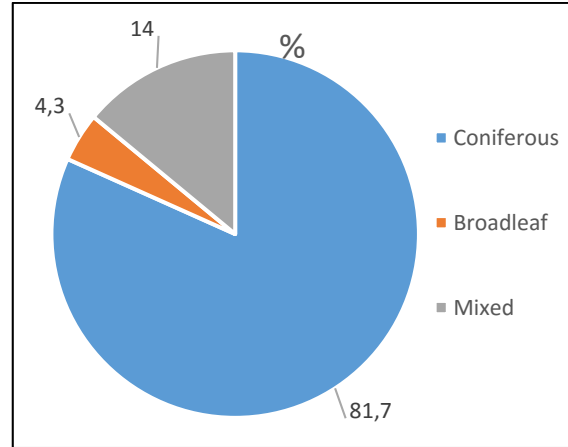

Figure 12. The leaf type of the burned forest

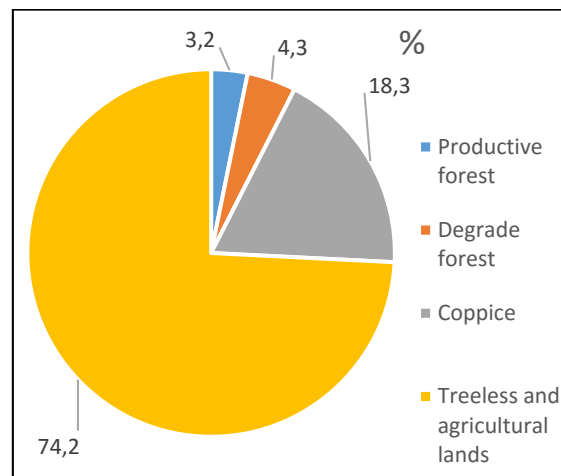

Figure 33. Fertility status of burning forest

350063,9 \$ was spend on 93 units in forest fire case in Taşköprü. In Taşköprü, forest fire cost are consist of %4,4 subsistence costs, %4 employee premiums, %3,6 fuel cost and %88 transport costs. Post-fire afforestation and other expenses is

added to during the fire-cost, The total cost of fire-fighting is reached 902736,3 \$.

The cost of fire fighting model is shown as tables. The data on the relationship between independent variables and the dependent variable is given in Table 2.

Table 2. The result of simple correlation analysis

Dependent Variable	Independent Variables	N	Pearson Correlation	Sig. (2-tailed)	Significant Difference
YSONMAL	GUNSAY	93	0.071	0.500	No
	YSAAT	93	-0.098	0.348	No
	ILKMUD	93	0.075	0.473	No
	YSURE	93	**0.885	0.000	Yes
	YANYÜK	78	-0.038	0.740	No
	YEGİM	93	0.029	0.784	No
	YOVER	93	0.059	0.0576	No
	ORMKAR	93	-0.069	0.511	No
	ORMYTIP	93	-0.056	0.593	No
	ORTVO	93	**0.981	0.000	Yes
	TEPVO	93	**0.996	0.000	Yes
	TOPVO	93	**0.996	0.000	Yes
	ORTBO	93	-0.021	0.839	No
	ORTBALTO	93	-0.017	0.875	No
	YTOPORM	93	**0.995	0.000	Yes
	NSPNEM	93	-0.076	0.46	No
	RUZHIZ	87	-0.015	0.893	No
	SICAK	93	0.096	0.359	No
	YAGGUN	33	0.110	0.543	No
	TEKNİKE	93	**0.862	0.000	Yes
	MEMUR	93	**0.834	0.000	Yes
	SONİSC	93	-0.005	0.962	No
	MUKLEF	93	**0.700	0.000	Yes
	ASKER	93	-0.007	0.947	No
	JANDRM	93	**0.461	0.000	Yes
	DIGKISI	93	**0.440	0.000	Yes
	TOPKISI	93	**0.857	0.000	Yes
	PIKAP	93	**0.698	0.000	Yes
	İLKMUD	93	-0.034	0.746	No
	ARZOZ	93	**0.929	0.000	Yes
	SUIKM	93	-0.023	0.828	No
	TRKTR	93	0.167	0.109	No
	DOZER	93	**0.952	0.000	Yes
	GRYDR	93	**0.785	0.000	Yes
	TRYLR	93	**0.919	0.000	Yes
	HLKPTR	93	**0.995	0.000	Yes
	DIGARC	93	-0.029	0.782	No
	TOPARC	93	**0.809	0.000	Yes

**Correlation is significant at the 0.01 level (2-tailed).

Independent variables found significant relationship with dependent variable are used in the multiple regression models. Two models are created as a result of analysis performed. In the first model all

independent variable were included their original forms. In the second model, all independent variables were included as subgroups. Regression analysis results of two models are given Table 3 and 4.

Table 3. Simple regression analysis results (model 1)

Model Summary						
Model	R	R Square	Adjusted R Square	Std. Error of the Estimate		
1	0.999 ^a	0.997	0.997	1494,97565		
ANOVA ^a						
Model		Sum of Squares	df	Mean Square	F	Sig.
1	Regression	59164907138.372	14	4226064795598	1890.897	0.000 ^b
	Residual	174326271.462	78	2234952.198		
	Total	59339233409.834	92			
Coefficients ^a						
Model	Unstandardized Coefficients			Standardized Coefficients	t	Sig.
	B	Std. Error	Beta			
1	(Constant)	644.655	373.377		1.727	0.088
	YSURE	0.298	0.234	0.023	1.273	0.207
	ORTVO	1129.506	292.862	0.140	3.857	0.000
	TEPVO	2002.197	1121.909	0.572	1.785	0.078
	TEKNİKE	-330.451	180.915	-0.044	-1.827	0.072
	MEMUR	128.972	126.941	0.018	1.016	0.313
	MUKLEF	18.958	18.060	0.010	1.050	0.297
	JANDRM	-68.496	53.056	-0.011	-1.291	0.201
	DIGKISI	-15.648	197.702	-0.001	-0.079	0.937
	PİKAP	113.108	177.480	0.012	0.637	0.526
	ARZOZ	-295.976	153.274	-0.060	-1.931	0.057
	DOZER	5961.785	944.282	0.182	6.314	0.000
	GRYDR	592.029	635.880	0.012	0.931	0.355
	TRYLR	301.586	644.693	0.008	0.468	0.641
	HLPTR	18184.074	38350.243	0.148	0.474	0.637

Table 4. simple regression analysis resultsn (model 2)

Model Summary						
Model	R	R Square	Adjusted R Square	Std. Error of the Estimate		
2	0.995 ^a	0.991	0.990	2526.17323		
ANOVA ^a						
Model		Sum of Squares	df	Mean Square	F	Sig.
2	Regression	58777656906.122	4	14694414226.530	2302.640	0.000 ^b
	Residual	561576503.712	88	6381551.179		
	Total	59339233409.834	92			
Coefficients ^a						
Model	Unstandardized Coefficients			Standardized Coefficients	t	Sig.
	B	Std. Error	Beta			
2	(Constant)	-1002.426	441.862		-2.269	0.026
	YSURE	0.659	0.309	0.050	2.134	0.036
	YTOPORM	2301.746	58.493	0.939	39.351	0.000
	TOPKISI	3.233	19.151	0.006	0.169	0.866
	TOPARC	26.334	96.519	0.008	0.273	0.786

Conclusions

Taşköprü is a significant district in terms of forest fire in Kastamonu. In this context between the years of 2005-2014, 1251999,6 \$ (349263,3 \$ in case of fire and 902736,3 \$ after fire) total forest fire cost occur in the course of the forest fire in Taşköprü. When detailing the cost of forest fire, It seems to be the most important expenses of vehicle and fuel costs. Especially the use of helicopters increases costs. According to data obtained from the fire data sheets, the estimated cost of forest fire model-1 and 2 are given below.

Model 1: $y = 644,655 + 0,298 * YSURE + 1129,506 * ORTVO + 2002,197 * TEPVO - 330,451 * TEKNİKE + 128,972 * MEMUR + 18,958 * MUKLEF - 68,496 * JANDRM - 15,648 * DIGKISI + 113,108 * PİKAP - 295,976 * ARZOZ + 5961,785 * DOZER + 592,029 * GRYDR + 301,586 * TRYLR + 18184,074 * HLKPTR$

Model 2: $y = -1002,426 + 0,659 * YSURE + 2301,746 * YTOPORM + 3,233 * TOPKISI + 26,334 * TOPARC$

Important issues of finance and planning for forest businesses. However, they generally take into account the data of the previous year at this issues. Whereas OİM have many inter-related data. As in this study, finance and planning can be supported by mathematical models. Decision makers and managers are required to support the implementation and performance of this models. Finding the right model and method is a time consuming process. However, it is quite important in terms of resource management and conservation. In addition to this, accurate and reliable data store is very important in terms of reliability of models.

References

- Anonymus, 2016. Taşköprü, Resources: <https://tr.wikipedia.org/wiki/Ta%C5%9Fk%C3%B6pr%C3%BC>, Kastamonu Accessed on: April 13, 2016.
- Çimen, M., 2015. Fen ve Sağlık Bilimleri Alanlarında SPSS Uygulamalı Veri Analizi, Palme Yayıncılık, ISBN: 978-605-355-366-3, Ankara.
- Daşdemir, İ. and Güngör, E., 2002. Multivariate Decision-Making Methods and their using areas in forestry, ZKU Bartın Orman Fakültesi Dergisi, 4, 4, 1-19.
- Daşdemir, İ., 2005. Orman Mühendisliği İçin Planlama ve Proje Değerlendirme Ders Notu, ZKÜ Bartın Orman Fakültesi Ormancılık Ekonomisi ABD, Üniversite yayın No: 30, Fakülte yayın No: 16, Bartın.
- Gümüş, C., 1996. Orman köyleri Kalkınma Planlarında Çok Boyutlu Yöntemlerden Yararlanma Olanakları (Gümüşane ili Orman Köyleri Örneği), Ekspres Ofset, İstanbul.
- Kalaycı, Ş., 2006. SPSS Uygulamalı Çok Değişkenli İstatistik Teknikleri, Baran Ofset, ISBN: 975-9091-14-3, Ankara, 85-167.
- Kavcar, B., 2004. Simülasyon yöntemi kullanılarak yapılan satış tahminleriyle satış bütçesi hazırlanması, Master Thesis, Ankara University, Ankara, Turkey.
- OGM, 1995. 285 Sayılı Tasnif No IV-1427, Orman Yangınlarının Önlenmesi ve Söndürülmesinde Uygulama Esasları, Orman Koruma ve Yangınla Mücadele Dairesi Başkanlığı, Ankara.
- OGM, 2016. Taşköprü Orman İşletme Müdürlüğü Orman Varlığı, Resources: <http://kastamonuobm.ogm.gov.tr/TaskopruOIM/Lists/OrmanVarligi/AllItems.aspx> Accessed on: September 02, 2016.
- Özdamar K., 2002. Paket Programlar Ile İstatistik Veri Analizi II, (Multivariate Statistical Analysis), Kaan Kitabevi 4. Baskı, ISBN 975 6787 02 3, P:385
- Tosun, K., 1990. İşletme Yönetimi. İstanbul Üniversitesi, İşletme Fakültesi Yayın No:226, İstanbul
- TÜİK, 2016. "2015 General population census data ", Resources: www.tuik.gov.tr (This is not a direct source. Related to achieve data inquiries should be made). Turkish Statistical Institute. Accessed on: November 01, 2016.

The Impacts of FSC Certification Process on Keles Forest Enterprise^(a)

Özgen DURSUN¹, *İsmet DAŞDEMİR²

¹ Keles Forest Enterprise, Keles-Bursa/TURKEY

² Bartın University, Faculty of Forestry, Bartın/TURKEY

*Corresponding Author: isdasdemir@hotmail.com

Abstract

The Forest Stewardship Council (FSC) certification studies, which had been introduced in Turkey in 2010, were initiated in Keles Forest Enterprise (KFE) of Bursa Regional Directorate of Forestry in 2013. The enterprise was undergone the preliminary and main inspections in the same year and received FSC certificate in early 2014. The aim of this paper is to investigate and evaluate the ecological, economic, social and managerial impacts of FSC certification process on KFE. For this aim, the data is derived from the monitoring of field studies on the FSC and the enterprise database. Objective and scientific evaluations and comments have been made through analyzing and comparing the situations of before FSC and after FSC. The ecological, economic, social and managerial impacts of the studies completed in accordance with FSC's 10 principles, 56 indicators and 216 criteria have been presented. Thus, the effects created by the certification process on forest maintenance, silviculture and reforestation activities, forest roads building and maintenance, stakeholder participation, performing risk analysis, product classification and standardization, business income and marketing activities, business management approach and etc. issues were identified and discussed. In conclusion, it has been determined after the FSC certification studies in KFE that environmental consciousness and awareness are increased, biodiversity, nature, and forest resources are better protected, the classification of the product and standardization are cared, the production and marketing issues are improved, the enterprise are increased, occupational health and safety issues are gained importance through risk analyzes, the business employees are trained, participation in cooperation with stakeholders is provided, opportunities of employment and income to the local people are provided, successful in regeneration and sustaining of forests by reduced social pressures are provided, the positive changes in management mentality of the enterprise for sustainable forest management occurred. Based on the research results, some suggestions related with the FSC process for the sustainable management of forest resources have been developed.

Keywords: Forest Stewardship Council, Certification, Certification Impacts, Sustainable Forestry, Turkey.

FSC Sertifikasyon Sürecinin Keles Orman İşletmesindeki Etkileri

Özet

Ülkemizde 2010 yılında başlatılan Orman Yönetim Konseyi (Forest Stewardship Council-FSC) sertifikasyon çalışmalarına, Bursa Orman Bölge Müdürlüğüne bağlı Keles Orman İşletmesinde 2013 yılında başlanmıştır. İşletme aynı yıl ön ve ana denetimden geçerek 2014 yılı başında FSC sertifikası almıştır. Bu çalışma; FSC sertifikasyon sürecinin Keles Orman İşletmesindeki ekolojik, ekonomik, sosyal ve yönetsel etkilerini incelemek ve değerlendirmek amacıyla ele alınmıştır. Bu amaçla FSC ile ilgili yapılan arazi çalışmalarının izlenmesinden ve işletme kayıtlarından elde edilen bilgiler veri olarak kullanılmıştır. FSC öncesi ve sonrası durum karşılaştırmalı olarak analiz edilerek, objektif ve bilimsel değerlendirmeler ve yorumlar yapılmıştır. FSC'nin 10 prensip, 56 gösterge ve 216 kriteri doğrultusunda yapılan çalışmaların ekolojik, ekonomik, sosyal ve yönetsel etkileri ortaya konmuştur. Böylece orman bakım, silvikültür ve gençleştirme faaliyetleri, orman yolu yapımı ve onarımı, paydaş katılımı, risk analizlerinin yapılması, ürünlerin sınıflandırılması ve standardizasyonu, işletmenin gelirleri ve pazarlama faaliyetleri, işletme yönetim anlayışı vb. konularında sertifikasyon sürecinin yarattığı etkiler belirlenmiş ve irdelenmiştir. Çalışma sonucunda; Keles Orman İşletmesinde FSC çalışmaları sayesinde, çevre bilinci ve farkındalığın arttığı, biyolojik çeşitliliğin, doğanın ve orman kaynaklarının daha iyi korunduğu, ürünlerin sınıflanmasına ve standardizasyona gereken önem verildiği, üretim ve pazarlama konularında olumlu gelişmeler olduğu, işletme gelirlerinin arttığı, risk analizleri yapılarak iş sağlığı ve güvenliği konularına önem verildiği, işletme çalışanlarının eğitildiği, paydaşlarla işbirliği yapılarak katılımı sağlandığı, yöre insanına iş ve gelir olanağı sağlandığı, sosyal baskılar azaltılarak ormanların geliştirilmesinde ve devamlılığının sağlanmasında başarılı olduğu ve işletme yönetim anlayışında sürdürülebilir orman yönetimi doğrultusunda olumlu değişimlerin olduğu saptanmıştır. Araştırma bulguları doğrultusunda, FSC süreciyle bağlantılı olarak orman kaynaklarının sürdürülebilir yönetimi için bazı öneriler geliştirilmiştir.

Anahtar Kelimeler: Orman Yönetim Konseyi, Sertifikasyon, Sertifikasyonun Etkileri, Sürdürülebilir Ormanlık, Türkiye.

(a) This study was produced as part of a Master's Final Project concluded in 2015 at Bartın University, Graduate School of Natural and Applied Sciences, Department of Forest Engineering.

Introduction

Nowadays, gradually increasing environmental consciousness has brought the precision and protection on environmental values. In this regard, the society has become more conscious on these issues. For years, discussions have continued on environmental awareness and economic development to be considered together. Development efforts were continued by the adoption of these concepts. Thus, whole world has now been accepted that development to be sustainable at the basis of environmental awareness. This environmental awareness has evolved over more natural forests in time and the result was reached to ensure development and growth that it would be appropriate in priority the protection of forests.

It has brought efforts to seek solutions at the international level because of the emergence of the pressures and problems occur on world forests, increased deforestation and quality losses. In this quest, issues such as a secure future, a healthy environment and economic development are being discussed. Thus, to seek the creation of local and national politics were encouraged for the operation of forest resources in a sustainable way by developing multi-faceted ideas and concepts (Şener et al., 2011).

One of these concepts developed is sustainable forestry. Sustainable forestry is defined as *“to meet the optimal and sustainable manner the needs of the forest products and services of both today and for future generations without compromising forest resources and their ecological, economic and social functions* (Daşdemir, 2015).

Forests constituting the natural resource base are the ecosystems having sensitive and high of organization level, providing multiple benefits and renewable that's too many variables associated with each other within a system. At the same time, it is an important resource providing goods, services and benefits to both present and future generations. From this point, sustainable forestry is important for the sustainable development. Therefore, discussing whether the forest resources are managed or not in a sustainable way and monitoring with a system

the production of goods and services in this process have now become an obligation.

Forests having very important ecological functions must be managed as to be useful to humanity considering both environmentally and economic and social conditions. Therefore, certification systems have been developed to ensure management of forest resources by international environmental non-government organizations (NGO) taking into consideration social, environmental and economically criteria. Thus, hereafter the existing forests can be systematically managed, accurate, continuous and healthy applications can be developed, any action illegally threatening the forests can be avoided, and continuous utilization of forests can be ensured. The future of the forests are tried to be secure through developing international standards, certificating forests and their managements with the organizations having advanced environmental awareness (Türkoğlu, 2009; Türkoğlu and Tolunay, 2014). With the certification of forests, it becomes possible to create an efficient and strong communication between the customers having high environmental awareness and the administrations implementing sustainable forest management. Thus, it tried to put forward the better styles of sustainable management by referring also to the ideas of stakeholders (Durusoy, 2002; Türkoğlu, 2009).

Certification based on the principles of voluntariness and priority of the quality system plan, focuses on the quality control of the products. Certification fitted to quality control system is documented by providing the control of products and services according to the sustainable forestry criteria and indicators. For this purpose, the main international certification organizations operating in the world are: FSC (Forest Stewardship Council), SFI (Sustainable Forestry Initiative), CSA (Canadian Standards Association), MTCC (Malaysian Timber Certification Council), PEFC (Pan-European Forest Certification), AFS (Australian Forestry Standard) (Genç, 2014; Dursun, 2015).

The certification process in accordance with scientific and technological developments provided significant gains at

the sustainable management of forests by considering of society's demands and minimal impact on the environment. In the five-year certification process, it will make important contributions to the establishment of reasonable management mentalities by providing administrators control in application with interim audits (Akyol, 2004; Akyol and Tolunay, 2006; Türkoğlu, 2009).

It is thought that the certification process would be useful for the improvement of sustainable forest management, the development of the accounting system according to this concept, the continuity of planning and controlling, the exact determination and identification of the borders of forested areas (Türkoğlu, 2009). Consulting to stakeholder opinions and managing the process within the framework of participatory and healthy communication are also found meaningful in terms of sustainable management approach.

The certification process in our country has been launched by General Directorate of Forestry (GDF) in 2010 and the Forest Stewardship Council certification system was preferred in the process. The abbreviation of the system is FSC that was established in 1993 with the name of Forest Stewardship Council. It has become a system developed by environmental organizations, forestry companies, social and environmental think tanks and individuals interested in world forestry together. It has been understood that it was established as a stakeholders system to be managed the world forests in a sustainable manner appropriate to the mind and generalized the environmentally friendly applications to international arena.

The FSC certification process in our country was launched the first time in 2010 with a pilot study in Bolu Aladağ Forest Management Chieftaincy and certificate was given for 9152 hectares forest area in 2011. Later, GDF was received FSC certificate for

Material and Methods

Keles Forest Enterprise (KFE) which is being carried out the intensive forestry activities and obtained FSC certificate in 2014 in Bursa Regional Directorate of Forestry (BRDF) was selected as study area in this

the 2,367,000 ha forested area covering 29 forest enterprise directorates in the period of 2010-2014. In additionally, certification processes were performed by making intermediate certification exams at 500,000 ha in 2015. Forest areas taken FSC certificate cumulatively are as years: 93,000 ha in 2011, 1,424,773 ha in 2012 ha, 1,796,279 ha in 2013 and 2,367,000 ha in 2014. Also, GDF was initiated a study together with PEFC and TSE (Turkish Standards Institute) about standards of forest management certification. At the end of this study, a protocol was signed between GDF and TSE for developing Standards of National Sustainable Forest Management (Anon., 2016).

The aim of this study is to investigate and evaluate the ecological, economic, social and managerial impacts of FSC certification process on Keles Forest Enterprise which is being carried out the intensive forestry activities in Bursa Regional Directorate of Forestry. Subsequently, the forestry activities before, during and after the certification process were evaluated and their ecological, economic and social impacts have been demonstrated. With FSC consciousness developed by the certification process, the differences caused by the processes on issues such as in making well-groomed forests, regeneration activities, construction of new forest roads and their repairs, stakeholders participation and risk analysis were identified and discussed. In addition, the value increases caused by the classification and standardization of wood productions obtained from silviculture and maintenance studies in forest were compared. The effects of the FSC process on the enterprise's revenues and marketing efforts were evaluated. Similarly, effects of the certification process on the idea system of sustainable management of the management team of the enterprise were also examined in this study.

research (Figure 1).Information from observing the work done in the field in relation to the FSC certification process and obtained by examining the records in the process in KFE Directorate is used as data in the study.

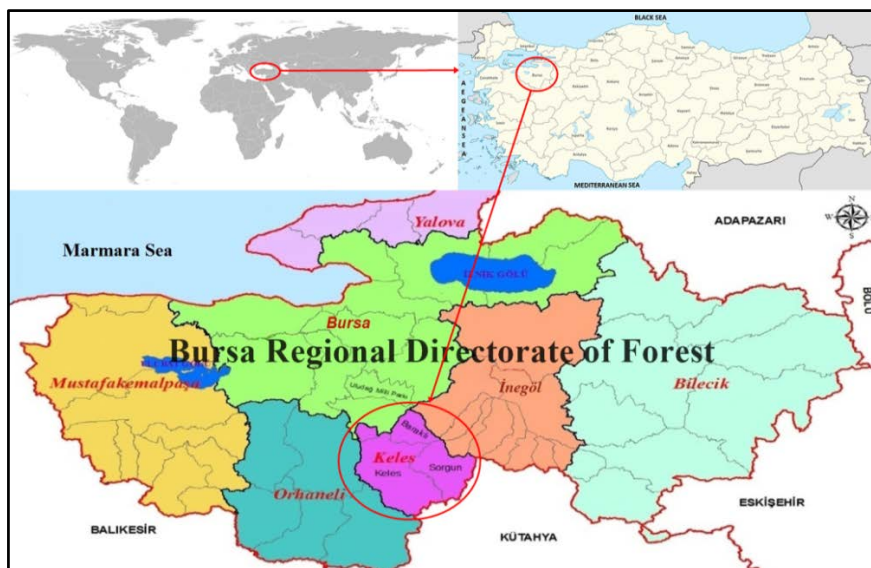

Figure 1. Study area

The standards consisting of 10 principles, 56 criteria and 216 indicators in FSC certification process have been inspected based on the works done both in the office and field. Also, in the stage of obtaining a certificate (main control) and after certification, the opinions of a total of 136 randomly selected stakeholders (forest production workers, forest workers and public servants' unions, forestry cooperatives, village headmen, hunting clubs, environmental representatives, government agencies, municipalities and other organizations etc.) have been received and evaluated in each three enterprises.

The obtained information and data were examined and evaluated objectively with all scientific understanding. Evaluations and comments have been made through analyzing and comparing the situations of before FSC and after FSC. For this purpose, the effects of certification process on KFE were revealed by comparing the information obtained, monitoring through the land process, and following of the all works of the certification process. In addition, the certification works

and their effects were visualized with some photos.

Results and Discussion

FSC certification studies in Bursa Regional Directorate of Forestry

Bursa Regional Directorate of Forestry (BRDF) was established in a total area of 1,574,760 ha; 759,105 ha (48%) of this area are woodland and its 815,655 ha (52%) are open area. The certification studies started in three enterprises (Keles, İnegöl, Yalova) of BRDF with seven enterprises in 2013. By inspecting these tree enterprises through the preliminary and main control at the same year, FSC certification process is completed and they have received the certificate.

Total area of the three enterprises received the certificate is 322,056 ha; 150,823 ha (47%) of this are woodland and its 171,233 ha (53%) are open area (Table 1). The 269 ha of total 150,823 ha woodland kept outside the scope of the certificate for that area is Yenişehir Forest Nursery Directorate's area in İnegöl and 150,554 ha are certified. Accordingly, the rate of the certified forest area in BRDF is 19.86%.

Table 1. Area status of the three enterprises received FSC certificate (Dursun, 2015)

Enterprise	Woodland		Open Area		Total	
	ha	%	ha	%	ha	%
Keles	36,666	57	27,761	43	64,427	20
İnegöl	67,544	38	110,899	62	178,443	55
Yalova	46,613	59	32,573	41	79,186	25
Total	150,823	47	171,233	53	322,056	100

All three enterprises have received FSC certificate in early 2014 at the end of the certification studies and evaluations. Interim controls of FSC certificate given for five years are conducted every year to this day. Similar controls over the remaining years through the certification process will be made. The views of a total of 62 stakeholders in the stage of getting certificate (main control) and the

views of a total of 74 stakeholders during interim controls have been received (Table 2). These stakeholders were randomly selected and their opinions and observations were recorded. Thus, as well as the works done in the field and the inspection results of these studies have been matured with views of stakeholders and FSC certification process is renewed each year (Anon., 2014; 2015).

Table 2. Numbers of the interviewed stakeholders in FSC controls of Keles, İnegöl and Yalova forest enterprises

Controls-Stakeholders	Main Control (2013)	Interim Controls		Total
		December 2014	November 2015	
Interviewed Stakeholders	62	54	20	136

The workers and civil servants union officials are stated that FSC certification known by top executives of workers and union officials during interviews with stakeholders in the pre-2013 main control. The presidents of forest cooperatives' union are expressed that FSC certification process would be positive and they supported the process. In addition, it has been understood that they are satisfied from the payments of the enterprise and received a training certificate by participating to the occupational health and safety trainings held by the enterprise. The National Park Directorate has stated that there is no record of illegal hunting. It has not been recorded any negative stakeholders' view during the main control. During interim controls of 2014 and 2015, the forestry cooperatives' unions and forest workers reported that personal protective

equipment was taken for chainsaw operators and assistants, and the first aid medical kits delivered. In addition, it was stated that the payments are made on time and the occupational health and safety trainings are given. Hunting clubs, public education centers, village headmen and environmental representatives have not stated a negative opinion (Anon., 2014; 2015).

FSC certification studies and their effects in Keles Forest Enterprise

KFE Directorate is programmed together with İnegöl and Yalova Forest Enterprise Directorates to the FSC certificate in 2002 and it has been begun preparations for pre-audit in early 2013. For this, the trainings were given to the managers of the enterprise and the FSC certification process has been introduced to stakeholders. In May of 2013, FSC information and publicity meetings were

organized for the enterprise staff, forest cooperative members, village headmen, district governor, chief of the government offices and district shopkeepers. Subsequently, the preparatory works were carried out according to the FSC principles, criteria and indicators. KFE has successfully completed the certification process through pre-audit on June 4, 2013 and a daily main control on November 21, 2013. Document reviews, interviews with stakeholders and inspections in the field were conducted during the controls. FSC certification studies and their effects on KFE were investigated and evaluated under the following headings.

Control results of the FSC certification process

The controls are carried out each year both during the certification process and after receiving the certificate in KFE. At the end of main and intermediates controls within three years, *major error* which is unsuitable with the FSC principles, criteria and indicators is not occurred. However, time to time *minor errors* (corrective action request-CAR) were identified (Table 3). These errors are corrected in the process and were not observed during the audits of following year (Anon., 2014; 2015).

Table 3. The minor errors (corrective action request-CAR) in KFE

Principle No	Indicator No	Unsuitability	Objective Evidence	Corrective Action
Principle:6 Environmental Impact	Indicator 6.5.4: Protection against damage to the soil, forests and water resources during the operations	Operators are aware from the appropriate emergency procedures after accidental oil and chemical spills, but effective implementation is not available (from the interim control in 2014)	It is understood from results of interviews with employees that equipment against oil spills which may be a tractor accident is not available in the 25 th division of Sorgun Forest Management Chieftaincy in KFE (from the interim control in 2014)	Training is done in pre-production in cambers, and provided information about the oil spill in the training. Plastic bags are distributed against oil spills (from the interim control in 2015)
Principle:6 Environmental Impact	Indicator 6.7.2: Disposal and use of chemicals, liquid and non- solid wastes	Foresters are not sure that all the non-recyclable including paper waste generated by contractors is disposed of in environmentally appropriate ways (from the interim control in 2014)	It has been observed that household wastes are randomly thrown in the 163 rd division of Sorgun Forest Management Chieftaincy and waste is thrown into forest areas outside of designated areas (from the interim control in 2014)	Trainings related to waste management are given to workers before production. Protocols were made together with Keles Council. Waste collection areas have been identified in Baraklı and Sorgun Forest Management Chieftaincies and the written vests were distributed to the workers (from the interim control in 2015)
Principle:8 Monitoring and Evaluation	Indicator 8.2.4: Research and data collection for monitoring	Data is not collected about changes in flora and fauna and especially rare species that are under threat and danger (from the main control in 2013)	Monitoring of species that are under threat and danger and dynamics of monitoring are no in practice	Monitoring species that are under threat and danger is carried out according to the plan in the monitoring program. Status of the population of the species in flowering season is followed (from the interim control in 2014)
Principle:9 High Conservation Value Forests	Indicator 9.4.1: Monitoring of evaluating the activity	Monitoring indicators and frequency has not been established by together with specialists, local and national stakeholders (from the main control in 2013)	Minor (CAR-06): To identify indicators related to monitoring of High Conservation Value Forests was not consulted stakeholders (from the main control in 2013)	Monitoring indicators and frequency of High Conservation Value Forests has been identified with local stakeholders (from the interim control in 2014)

Monitoring studies in the process of FSC certification

After receiving FSC certificate, *Annual Monitoring and Evaluation Plans* are made by KFE for five years in the scope of Principle 8-Monitoring and Evaluation. These plans have been made for 2014, 2015 and 2016. According to these plans, in accordance with the scale and intensity of forest management; forests are monitored, controlled, observed and measured to assess with regards to nature and soil conservation, aesthetic value, hydrological function, production of forest products and production risks, protection and management activities, social and environmental impacts. Obtained data from this process are recorded. These all records are essential for inspections carried out in the office and field during the year in the scope of the FSC certification process.

Accordingly, there is a total of 7039.5 ha nature conservation area in KFE. Monitoring studies are carried out in accordance with the plan in the representative areas that will be chosen in the context of the *nature protection function*, and as suitable for the purpose of this function. Monitoring studies related to health of stand are continued by the chief of forest management and related forest guards at regular intervals. The records are established on these monitoring studies and observations. Likewise, similar monitoring studies are carried out in the 4306.5 ha forest land which is under the *soil protection function* in the scope of high conservation value forests (HCVF) of KFE. In those areas designated as representative, the observations made by the chief of forest management and forest guards and factors such as erosion, insects, fungi and so on that adversely affect the health of stands are recorded by monitoring. For the periods with high rainfall, monitoring studies are made once a month.

The same way, the *hydrological functional* forest which is the HCVF has been included in these monitoring. In hydrological functional forests, making necessary correspondences with the State Water Works (SWW), measurements and observations are carried out in the creek basin in wooded areas. Also, whether the water is polluted or not during the works in the forest, the turbidity of water, which carries sediment material,

increase flow and etc. issues are monitored by a forest management chiefs and guards in every three months. In these studies, more accurate data is obtained with the support of technicians from SWW. Likewise, observations after the heavy rains are recorded.

According to the plan, monitoring studies are carried out in the 311 ha *recreational and aesthetic functional forests* in the scope of high conservation value forests (HCVF) of KFE. By identifying data related to the stand health, the number and capacity of visitors, etc. and they are recorded in these areas. Another area of HCVF is the *seed stands*. There are a total of 197.5 ha seed stands in KFE. These areas are being monitored for health and strength of a stand every six months and the data obtained are recorded.

On the other hand, making environmental impact assessments under the FSC principles, data identified for environmental and social risk levels of the activities are being created. Employees are trained to protect against the risk of accident and take effective preventive measures by making *risk assessment analyses* in the production divisions and forest stores in the context of both FSC principles and Occupational Health and Safety Law numbered 6331. Risk assessment analyses made in each production division are hung as a table in the production division of land. Additionally, what would be the risks is described before starting production in land by business chiefs and forest guards for the production workers. Brochures prepared related to the standards and quality of the production, and Occupational Health and Safety Law are distributed to the employees. The danger, severity, the probability of risk, its damage and what preventive actions are written in more detail in risk analysis tables. Also, effective measures are an attempt to take against accidents in stores by analyzing risk assessments in the same way. In terms of creating an example, the results of risk analysis made in 2015 in Pınarcık Store of Baraklı Forest Management Chieftaincy are given in Table 4.

Besides, some measures are taken to reduce the risks by preparing the follow-up documents of environmental and social risk levels during studies in forest such as making

new road, major repairs, and art structures and so on. For example, effective preventive measures are taken to prevent harm to the environment of the machineries used during road construction and confusion of waste oil into soil and water. Therefore, trainings are given to employees on topics such as environmental awareness, change of waste oil

and collection of waste oil into containers. Positive feedbacks are taken by holding informational meetings with stakeholders in the region in both road planning and road construction phase. Thus, risk assessment analyses are placed to the files and announced to employees by determining the risks against unforeseen hazards during road work.

Table 4. The results of risk analysis in Pınarcık Store of Baraklı Forest Management Chieftaincy

Danger	Risk Level	Measures
		*No one should be between truck with bucket during loading
		*Loading should be done with approved and tractor cabin
		*Individual protective equipment (hard hats, steel-tipped boots etc.) must be used
		*First, the heavy logs should be loaded
		*Storage that loaders run must be kept clean
Loader	High	*Overload should not be done
		*It must be vigilant against the possibility of rolling when the logs are removed from the stack
		*It always should be viewed back when going to back
		*Alarm and signals of vehicles should be working when going to back
		*Loader should not use its fork for carrying people and stairs
		*Appropriate space should be left between the stacks
		*It should not be strolled among the stacks
		*Stacks should not be too large or high
Stacker	High	*It should not be exceed on the stacks
		*Stack should not be made in rainy weather
		*Wedge should be used to prevent collapse of stacks
		*Individual protective equipment must be used.

Efficient measures are also developed to prevent damage to the gardens, sowing and planting areas, fields of environment and local people in the scope of FSC certification process. For example, the additional channels are opened for excavation from during repairing major road for not closing the water flow channels, gaining flow of water and

preventing damage to the garden of the locals in Düvenli neighborhood of Forest Management Chieftaincy in 2015. Thus, importance is given to develop and keep healthy communication between forest and people by consulting stakeholders while realizing the enterprise's annual work programs.

Production and marketing studies in the FSC certification process

Practices are done in issues such as making silvicultural stamp, treating more precise and scientific in the production and standardization, production of goods in accordance with the standards for quality and occupational health every year since 2014 which is the time for receiving the FSC certificate in KFE Directorate. Importance is given to separation into classes, production of goods according to the standards and quality during production. For this aim, memorable and visual trainings are done by the practices that all the technical staffs, production workers, forest guards are participated in (Figure 2). The messages on creating

awareness and sensitivity to the environment, providing a clean and livable environment awareness, conservation of ecosystem and biodiversity are given while making effective practices for all employees.

As a result of all this sensitive works, it was started to produce first class normal sized (I.CNS) timber for the first time in 2014 in KFE Directorate after receiving the FSC certificate. Together with the well being of market conditions in 2014, the 323 m³ of I.CNS black pine timber were produced and its cubicmeter had been sold for £ 603 which was the highest current price. This price was the record price for KFE in that day's conditions.



Figure 2. The production and standardization exercise in KFE (2015)

However, demand was reduced for pine class timbers and prices had fallen in the winter of 2015 at the end of both placing more goods on the market because of fallens and broken trees occurred due to more snow and storms and adverse market conditions in the second six months of the year. Separation of class timber in black pine timber production was limited due to the contraction in sales in

2015. The productions of class timber in black pine were given in Table 5 by years in KFE Directorate. KFE is an enterprise working mainly black pine production and yield obtained from other tree species is low. For example, the timber produced in 2015 consists of 93% black pine, 4% fir, 2.4% beech and 0.6% red pine.

Table 5. The class timber productions in black pine by years in KFE Directorate

Product Type	Production Volume (m-3) and Ratio (%)					
	2010	2011	2012	2013	2014	2015
I.CNS Black Pine Timber	-	-	-	-	323	222
II.CNS Black Pine Timber	408	855	818	426	2005	1996
III.CNS Black Pine Timber	14,879	18,715	13,904	14,593	20,472	31,117
Total Black Pine Class Timber Production (I.+II.CNS)	408	855	818	426	2328	2218
Total Black Pine Timber Production	15,287	19,570	14,722	15,019	22,800	33,335
Total Black Pine Class Timber Production/Total Black Pine Timber Production x100 (%)	2.67	4.37	5.56	2.84	10.21	6.65

As it is seen, the share of class production of black pine in total black pine timber production increased in 2014 because of the FSC certification process in KFE. This share arised to 10.21% in 2014 and it remained at 6.65% in 2015 due to the reasons mentioned above. Nevertheless, these values are above the average of the realization of GDFclass timber (approximately 6%). Increases in the quantity of class timber in 2014 and 2015 due to FSC certificate have led to an increase in the enterprise income (Table 6). The development of the level of awareness of quality class separation in the production, thereby strive to produce quality goods according to the standards and implementation of sales policy focused customer satisfaction have been effective in this increase.

It has been a marked increase in both quantity of class timber production and income from the sales of class timbers after switching to the certification process in KFE. Also, the training programs on effective marketing techniques and customer satisfaction were given and information activities continued for both technical staff and all employees of the enterprise by the enterprise directoriate. Thus, the executive team of the enterprise gave importance to the classification and standarts of produced goods and customer-oriented marketing activities are given and acted sensitive on these issues after receiving FSC certificate. Consequently, it was understood that the enterprise developed a sustainable management taking into account the scientific, technical, ecological, economic and social conditions due to the FSC process.

Table 6. The sale incomes of black pine class timbers by years in KFE Directorate

Type and Class	Sale Income (£ with the current prices of 2015 year)					
	2010	2011	2012	2013	2014	2015
Black Pine Class Timber	150,988	317,247	291,576	141,967	774,244	749,279
Total Black Pine Timber	1,207,400	1,475,642	1,135,943	1,284,022	1,872,114	2,527,085

Regeneration studies in the FSC certification process

In the scope of FSC certification process, the old-growth black pine forests that their regeneration was before unaccepted by local society due to social pressure were naturally regenerated by taking the participation and support of local people as a result of interviews with stakeholders in 2014 in KFE

Directorate. Regeneration works in the forests with FSC process was carried out with a more scientific and precise recipient approach. A desire and enthusiasm was created in issues of the development of accurate methods and tillage of soil carefully (Figure 3). Thus, in the autumn of 2014, the success was achieved in bringing youth in the field at the end of results of seeding cut and soil tillage.



Figure 3. Natural regeneration studies in the scope of FSC certification process in KFE

Forest maintenance works in the FSC certification process

With the FSC certification process, the awareness and notion levels of the enterprise's executives further increased on the subject of making neglected forest into tended forests. The idea of sustainable forest management has been effective on the young stands, and transforming the neglected young stands into more healthy and more resistant stands is considered important. Forest maintenance works (youth care, spacing, thinning etc.) were accelerated with the certification process to get quality primary products, to provide interim revenue and to increase the strength of the remaining stands in neglected areas or delayed maintenance areas for any reason, and it has been contributed to the sustainability of the forest by making successful maintenance works.

Biodiversity and wildlife studies in the FSC certification process

The planning, implementation, control, monitoring, evaluation and development phases of the management are carried out more effectively and efficiently because of the FSC certification process. Multiple studies have been developed on the protection of biodiversity of forests and wildlife. One of them is the joint study made with together Keles Governorship and Keles Municipality in the scope of the project named *A Handful Fidelity* for wild animals in 2015. Feeding studies were performed for wild animals and birds in heavy snowfall days of winter in this project. Also, 16,500 pear, wild plum, wild medlar, wild apple, wild cherry, hawthorn and rowan saplings were planted in forest clearance, rehabilitation, reforestation and afforestation areas to continue extinction of wild animals and to prevent their damage to the fruits and vegetables produced by local people. Thus, the works were conducted both to protect biodiversity and to benefit multi-purpose. Additionally, 382 kg of wild fruits were collected in 2015 and they were delivered to the Bursa Directorate of Forest Nursery to obtain seed.

Economic development studies of the local people in the FSC certification process

In the scope of FSC certification process, the planting of income-generating species have been encouraged in the degraded forest areas of the forest villages to support local people as economic, to ensure the integration of forest and people, to support participation, to constitute a unit of healthy common sense for conservation and development of forest. By these studies, it has been benefited economically effective from degraded forest areas and worked to enhance the biodiversity of degraded forest land. Also with this consciousness, a very meaningful way was taken for the development of sustainable forest management and ensuring union of hearts by giving credits related with the forest and village relations (ORKÖY) to forest villages for dairy cattle, dairy sheep, solar energy and enrichment of handicrafts.

Subsequently, the important steps have been taken to develop a useful mentality of sustainable forest management to society in accordance with environmental, social, economic, technical and scientific requirements in the context of scientific concept and principles of FSC certification process in KFE.

Conclusions and Recommendations

In recent years, climate change, global warming, energy, a healthy environment, a secure future and sustainable development issues are discussed. In this context, on one hand while the international development and contracts are made, on the other hand some strategies and policies are developed to manage natural resources in protection-usage balance. Therefore, the concept of *sustainable development* has been raised. Sustainable development has three dimensions: environment, economy and social. Terrestrial ecosystems and forest resources with the largest share in the ecosystems are located in the environmental dimension. Especially for wood raw material, non-wood forest products, social and cultural services-benefits (regulation of climate and water regime, prevent erosion, conservation biodiversity, contribution to society health, nature conservation, carbon storage, hunting, recreation services etc.) are provided from the

forest resources and their sustainable management in watershed integrity is extremely important. Thus, the studies are conducted in order to provide the goods and services that are expected of both present and future generations from the forest resources and their ecological, economic and social functions optimally and a sustainable manner. To meet this requirement, the certification process of forest resources management has been initiated by independent organizations and Turkey has been involved in this process.

İnegöl, Yalova and Keles Forest Enterprises received FSC certificate in the certification process of management of forests started in Bursa Regional Directorate of Forestry in 2013. The impacts of FSC process on KFE have been explained in this paper. Leaving into the future without the least amount and impairing of Keles Forest on 1200 meters average altitude is extremely important because of their beauties, values, benefits and natural structure. Therefore, with regard to the sustainable management of these resources; the construction of the pond, mining operations and any facility on the healthy forest areas, and no activity distorting the natural structure should not be allowed. However, suitable areas are more for trekking and ecotourism activities in the boundaries of KFE Directorate and it should be benefited in a planned way from these areas without distorting the natural structure and suitable for protection-usage balance.

In this study, firstly the monitoring and control phases of FSC certification process studies in KFE were evaluated. Especially correcting minor errors, taking the views of stakeholders and ensuring participation in this process contribute to the sustainable management of the enterprise. For example, natural regeneration is done through FSC while not making natural regeneration before FSC due to social pressures. Therefore, the requirements of the results of the main and intermediate controls in the FSC process must be fulfilled. In this context, participation by developing must be continued to manage in a sustainable way of the forest resources and the environment by protecting and developing.

Furthermore, the factors threatening the health and stability of forests were identified in the scope of FSC, and things to be done

against them were designated. Tracings are concentrated when a situation of threatening the stand health occurs. Risk analyses were conducted for production, storage and road construction works, and the risk level of each of work, the results of them and precautions to be taken against risks have been revealed. To comply with these precautions will contribute to both the certification process and the sustainable management.

Required importance was given to the classification and standardization works in order to produce ICNS timber by means of FSC, and some practices were made for this aim. Therefore, the 323 m³ of ICNS black pine timber were first time produced in KFE Directorate in 2014 and the incomes of class timber sales increased approximately three-fold according to the 2010-2013 average income because of the class timber production. Also, the trainings on effective marketing techniques and customer satisfaction were given to the enterprise employees. The classification and compliance with standards in production and implementation of effective marketing techniques will contribute to the economical sustainable of the enterprise. Therefore they should be made permanent.

The environmental consciousness of the enterprise employees and of local people increased and awareness of environmental consciousness has been created because of FSC process. Furthermore, the wildlife and the conservation of biological diversity (feeding, planting fruit seedlings etc.) and social studies for the development of a local community have been applied too. Therefore, the continuity of this kind trainings and works should be ensured.

In conclusion, the environmental consciousness and awareness increased, it was started behaving respectfully to the protection of biodiversity, and nature and forest resources, an importance was given to the classification and standardization of products, some improvements were provided in production and marketing, the enterprise incomes increased, the value was given to human health by making risk analyses, the enterprise employees were trained, participation was ensured by collaborating stakeholders, jobs and income opportunity to

the local people were provided, the social pressures was reduced, it has been successful in ensuring the continuity and regeneration of forests, consequently the contributions have been made to the sustainable management of forest resources because of FSC studies in KFE.

References

Anonymous, 2014. Bursa Regional Directorate of Forestry, Forest Management Certification Report. Johannesburg, 115 s, Afrika.

Anonymous, 2015. Bursa Regional Directorate of Forestry, Forest Management Certification Report. Johannesburg, 74 s, Afrika.

Anonymous, 2016. Administration Annual Report (2015) of General Directorate of Forestry. 87 s, Ankara.

Akyol A. 2004. Principles, indicators and applications of sustainable forest research management in Turkey. Yüksek Lisans Tezi, SDÜ Fen Bilimleri Enstitüsü, 121 s, Isparta.

Akyol A., Tolunay A. 2006. Principles, indicators and applications of sustainable forest research management in Turkey. SDÜ Fen Bilimleri Enstitüsü Dergisi, 10 (2), 221-234.

Daşdemir İ. 2015. Ormançılık İşletme Ekonomisi Kitabı (3. Baskı). Bartın Üniversitesi Yayın No: 10/6, 407 s, Bartın.

Dursun Ö. 2015. The evaluation and implementation of FSC (Forest Stewardship Council) certification process in Bursa Regional Directorate of Forestry. Yüksek Lisans Dönem Projesi, BÜ Fen Bilimleri Enstitüsü, 70 s, Bartın.

Durusoy İ. 2002. Sertifikalandırma ve Türkiye ormancılığında gerekliliği, olabilirliği, uygulanması sürecinde karşılaşılması muhtemel darboğazların ve fırsatların irdelenmesi. Yüksek Lisans Tezi, KTÜ Fen Bilimleri Enstitüsü, 174 s, Trabzon.

Genç A. 2014. Orman yönetim sertifikası uygulamalarında karşılaşılan sorunlar ve çözüm önerileri (Kastamonu Orman Bölge Müdürlüğü Örneği). Yüksek Lisans Tezi, KÜ Fen Bilimleri Enstitüsü, 122 s, Kastamonu.

Şener F. N., Tolunay A., Görücü Ö. 2011. Certification and accreditation of sustainable forestry management applications: Case studies for Andırın and Göksun State Forestry Enterprises. SDÜ Orman Fakültesi Dergisi, 12: 115-125, Isparta.

Türkoğlu T. 2009. Forest and forest products certification in Turkey. II. Ormançılıkta Sosyo-Ekonomik Sorunlar Kongresi (19-21 Şubat 2009), 378-388, Isparta.

Türkoğlu T., Tolunay A. 2014. The qualitative research of the FSC forest management certification effect on Muğla Forests. II. Ulusal Akdeniz Orman ve Çevre Sempozyumu (22-24 Ekim 2014), 506-517, Isparta.

Thoughts and Challenges on Forest Certification in Turkey

Ahmet SIVACIOĞLU

Kastamonu University, Faculty of Forestry, Kastamonu / TURKEY

asivacioglu@kastamonu.edu.tr

Abstract

Forest Certification concept as to the international standards started in 2010 and still the process is going on forest area of app. 2.3 million ha in Turkey. In this study some of the issues such as the importance of certification, the role of certification on forest management system, the reason of corrective action request (CAR) and closing out of CARs, were evaluated. So far, totally 67 of CARs have been raised in the 6 of the certification project in Turkey. Most of the raised CARs are related to ecological concerns. Most of the ecological CARs improved the respecting streams, buffer zones, identification of RTE species and habitats (biodiversity), HCVF management, monitoring and indicators, waste management, and EIA (Environmental Impact Assessment). This improvement was achieved by instructions and training of workers as well as by specific legislations/ documents except for regular ones, like specific agreement include main criterion and indicators.

Keywords: Forest, Management, Certification, FSC

Introduction

Sustainability of forest management systems can be assessed and certified based on the definite standards by various certification schemes. Some of this systems like PEFC (Programme for the Endorsement of Forest Certification) act from national standards while the others like FSC (Forest Stewardship Council) system act from international standards. In Turkey, the forest certification process started in 2010 based on FSC (Forest Stewardship Council) system which is well-known and the most commercially widespread system. Briefly, the forest certification process is to assess and confirm of forest and forest management in compliance to the standards (Engür and Sivacıoğlu 2013, Sivacıoğlu 2013a, 2013b). In Turkey, the forest certification projects started in 2010, based on FSC system. Firstly, this process had started with Bolu-Aladağ FMU (Forest Management Unit) pilot project in Turkey. After that the forest area of Kastamonu FRD (Forest Regional Directorates)-Daday FDD (Forest

District Directorate); Zonguldak FRD-Karabük and Yenice FDDs, Kastamonu FRD-Ayancık, Tosya, Taşköprü and Tosya FDDs, Muğla FRD-1 all FDDs, Istanbul FRD- Kırklareli, Demirköy and Vize FDDs, Bursa FRD-Yalova, Keles and İnegöl FDDs were certified as to the standard of FSC scheme (Table 1). Currently 8 of FSC certificates (on Forest Management) are issued in Turkey as mentioned above, covering 2.3 million hectares. By the end of 2019, 5 million ha of forest area want to be certified as to the performance plan of General Forest Directorate (GFD) (Anon, 2016).

In this study, environmental and social progress of certified forest management system was analysed based on corrective action request (CARs) raised by the certifying bodies at the Main Assessment (MA) and annual Surveillance Audits (SA). The findings of these audits are listed in public summary reports and these reports are available on the Public Search Home Webpage of FSC (<http://info.fsc.org/>).

Material and Methods

In the study public summary reports of audits for 6 of the projects were used as material. (Table 2). Based on public summary reports of these projects CARs were analysed as to the Principle, Criterion and Indicators. All these projects are

conducted based on SGS (Certification Body) Qualifor Forest Management Certification Programme. During the audits, the checklist of SGS Forest Management Standard (AD33) adapted for Turkey, version 05 (23.02.2015) was used by the assessors.

Tablo 1. Certified forest areas in Turkey based on FSC scheme

FRD	FMU/FDD	Productive forest (ha)	Degraded forest (ha)	Total forest (ha)	Non-forest (ha)	Overall (ha)
Bolu	Aladağ FMU	7.532,4	213,4	7.745,8	1.406,2	9.152,0
Bolu	Aladağ FDD	55.143,8	6.844,9	61.988,7	26.709,1	88.697,8
	Bolu FDD	48.891,3	3.732,2	52.623,5	28.448,4	81.071,9
	Gerede FDD	69.232,3	14.114,6	83.346,9	15.926,3	29.812,1
	Seben FDD	15.649,1	22.278,9	31.523,6	22.520,5	60.448,5
Bursa	İnegöl FDD	27.091,8	40.637,8	67.729,6	110.898,5	178.628,1
	Keles FDD	14.666,4	21.999,6	36.666,0	27.661,5	64.327,5
	Yalova FDD	18.645,2	27.967,8	46.613,0	32.572,5	79.185,5
İstanbul	Demirköy FDD	73.908,1	1.667,4	75.575,5	8.836,5	84.412,0
	Kırklareli FDD	76.968,5	33.470,0	110.438,5	344.564,0	455.002,5
	Vize FDD	66.211,8	5.495,9	71.707,7	32.627,5	104.335,2
Kastamonu	Daday FDD	52.422,9	11.444,9	63.867,8	21.597,8	85.465,6
Kastamonu	Araç FDD	35.264,0	15.360,0	50.624,0	25.438,0	76.062,0
	Ayancık FDD	54.189,0	4.869,0	59.058,0	21.137,3	80.195,3
	Taşköprü FDD	82.469,5	31.049,4	113.518,9	63.129,0	176.647,9
	Tosya FDD	55.503,0	24.804,1	80.307,1	42.331,7	122.638,8
Muğla	Fethiye FDD	54.354,6	43.234,5	97.589,1	37.144,6	134.733,7
	Köyceğiz FDD	68.709,5	27.605,0	96.314,5	22.763,5	119.078,0
	Marmaris FDD	44.360,5	65.965,0	110.325,5	28.067,5	138.393,0
	Muğla FDD	49.812,0	31.898,0	81.710,0	36.611,0	118.321,0
	Nazilli FDD	92.970,0	60.937,0	153.907,0	192.107,5	346.014,5
	Yılanlı FDD	53.459,0	11.962,0	65.421,0	10.610,5	76.031,5
	Kavaklı FDD	28.570,5	7.663,5	36.234,0	11.340,5	47.574,5
	Dalaman FDD	35.656,0	21.649,0	57.305,0	30.398,0	87.703,0
	Kemer FDD	46.201,5	33.687,0	79.888,0	74.093,0	153.982,0
	Aydın FDD	64.536,5	92.288,0	160.825,0	310.213,0	471.038,0
	Milas FDD	82.482,5	72.235,0	154.717,5	117.650,5	272.368,0
Yatağan ÖİM	34.095,0	21.869,0	55.964,0	27.401,5	83.365,5	
Zonguldak	Karabük FDD	60.347,6	15.863,2	76.210,8	24.874,9	105.756,9
	Yenice FDD	77.080,9	7.040,3	84.121,2	9.753,7	96.843,9
Total certified area		1.546.425,2	779.846,4	2.323.867,2	1.758.834,5	4.027.286,2

Results and Discussion

The 10 Principle (P) of FSC can be listed as follow; P1-Compliance with laws and FSC Principles, P2-Tenure and use rights and responsibilities, P3-Indigenous peoples' rights, P4-Community relations and worker's rights, P5-Benefits from the forest, P6-Environmental impact, P7-Management plan, P8-Monitoring and assessment, P9-Maintenance of high conservation value forests (HCVF) and P10-Plantations. Whereas the distribution of CARs under the principles; 1 for P1, 2 for P3, 8 for P4, 6 for

P5, 19 for P6, 21 for P8, 8 for P9 and 2 for P10, totally 67 CARs are raised. Then, most of CARs intensified under P4, P5, P6, P8 and P9. There is no CAR under P2 and P7 (Table 2). Moreover, the number of CARs during the MA is highest level and this level is decreasing gradually, together with next SAs. Averagely, after SA1 most of the CARs are closed out with measures. Only, Major CARs raised for the trademark use (8.3.3 and 8.3.5) and monitoring indicators of HCVF (9.4.1).

Table 2. The CAR list of the FSC Project in Turkey based on principles, criteria, indicators (as to SGS Forest Management Standard (AD33) adapted for Turkey, version 05 of 23.02.2015) and audits.

		P1	P3	P4	P5	P6	P8	P9	P10
Daday FDD (2279-TR)	MA			4.2.3/4.4.1	5.6.2	6.4.1/6.5.2	8.2.9/8.5.1¹	9.3.3	
	SA1			4.2.5		6.5.4			
	SA2*								
	SA3*								
	SA4*								
Araç, Ayancık, Tosya, and Taşköprü FDDs (2493-TR)	MA			4.2.2/4.4.1		6.4.1/6.7.2	8.2.4	9.4.2	
	SA1				5.5.2		8.1.5/8.3.3		
	SA2						8.3.3		
	SA3*								
Karabük, Yenice FDDs (2866-TR)	MA				5.5.2	6.2.2/6.2.3	8.2.4/8.2.7	9.4.2	
	SA1		3.3.2			6.7.2	8.1.4/8.3.3/ 8.3.5	9.4.1	
	SA2*								
	SA3					6.1.2	8.1.2/8.1.5		
Aladağ FMU (1982-TR)	MA			4.4.1	5.5.2	6.5.3/6.5.4/ 6.7.4	8.5.1		
	SA1						8.2.4		
	SA2						8.3.5		
	SA3*								
	SA4*								
Yalova,Keles and İnegöl FDDs (2671-TR)	MA	1.3.1		4.2.7/4.4.1		6.1.3	8.2.4	9.4.1	10.2.3
	SA1					6.5.4/6.7.2		9.4.1	
	SA2						8.3.5		
Kırklareli, Demirköy and Vize FDDs (2699-TR)	MA		3.3.1		5.3.2/5.5.2	6.5.2/6.7.2		9.2.1/9.4.1	10.2.3
	SA1					6.1.3/6.5.4	8.3.5		
	SA2						8.2.7		

*In this audit no CAR raised by the audit team. ¹ Underlined CARs mean Major.

The distribution of raised CARs in 6 of the certification project in Turkey as to the criteria and indicators are shown on Table 3. As shown on Table 3, mostly due to ecological issues and monitoring of these issues are the reason of raising CARs. Most of the ecological CARs improved the respecting streams, buffer zones, identification of RTE species and habitats (biodiversity), HC VF management,

monitoring and indicators, waste management, EIA (Environmental Impact Assessment). This improvement was achieved by instructions and training of workers as well as by specific legislations/ documents except for regular ones, like specific agreement include main criterion and indicators. Certification as to the FSC enforced the protection of biotopes and habitats by inventories and monitoring of

key species habitats and also assessment of valuable natural features prior to commencement of forestry operations and after operations (e.g. post-harvest monitoring).

Table 3. The explanation of the raised CARs based on criteria and indicators.

Principle	Number of raised CAR	Explanation of CAR based on criterion and indicator
1	1	Unawareness of foresters about CITES species (1.3.1)
3	2	Noncompliance on identification of important sites for local people (3.3.2 and 3.3.1),
4	8	Insufficient training (4.2.3), lack of stakeholder (villagers, NGOs, land owners etc.) consultation for EIA and SIA (4.4.1), unavailability of first aid kits (4.2.5), inappropriate risk assessment on occupational health (4.2.2), lack of updated H&S records
5	6	Not easily availability of thinning intensity (5.6.2); gravel uploading close to stream, passing of stream without culvert, negative impact to watershed during road construction, left branches in the stream (5.5.2); damage to standing trees (5.3.2)
6	19	Not fully identification of representative samples (6.4.1), blocked culverts (6.5.2), not awareness to oil and other chemical spillage (6.5.4), not environmentally dispose of wastes (6.7.2), identification and marking of RTE species (6.2.2), insufficient procedures to safeguard RTE species and habitats (6.2.3), no site specific EIA (6.1.2), no defining of buffer zones (6.5.3), no adequate on-site facility for easy waste collection (6.7.4)
8	21	No monitoring of cooperative workers regarding insurance (8.2.9), insufficient data on monitoring of RTE species on HCVF (8.5.1), noncompliance on RTE monitoring (8.2.4), no follow-up identified CARs (8.1.5), noncompliance on trademark use (8.3.3 and 8.3.5), not effective post harvest monitoring ((8.2.7), unavailability of monitoring records (8.1.4), nonconformity on monitoring intensity (8.1.2), nonconformity on public summary of RTE and H&S monitoring (8.5.1)
9	8	Improperly describing of measures on HCVF (9.3.3), missing of monitoring records on HCVF (9.4.2), nonconformity on monitoring indicators (9.4.1), no stakeholder consultation in the time of HCVF description (9.2.1)
10	2	Unrespecting of buffer zones during mechanized soil cultivation in plantation sites (10.2.3).
Total	67	

Most of the social CARs requested additional training of employees and contractors on the general requirements of FSC as well as specific issues like dead trees, biodiversity, buffer zones and waste management. Stakeholder consultation one of the most important point caused to have raised CARs. Anyway the social aspects of forestry is being respected by all the foresters due to forestry features of Turkey (app. 7 million people are living in or close to the forest lands). Moreover, stakeholder consultation is compulsory during the forest management plan designing phase.

But, there is a problem on documentation of these consultation. Together with FSC process the foresters understood the importance of documentation and to follow-up the raised social CARs.

From ecological and social point of view, it is understood that FSC process positively supported the forest management system of Turkey. Also, the benefits of this process will serve the integration of Turkish Forestry to European forestry system. Briefly, to extent FSC process to wider forest lands will be useful for reasonable forestry system of Turkey.

References

Anon, 2016. Orman Genel Müdürlüğü 2016 yılı Performans Programı, Strateji Geliştirme Daire Başkanlığı, Ankara.

Engür,M.O; Sıvacıoğlu A.2013. Forest Certification in Turkey and the issues to be considered by decision makers, International Conference Forest certification and protection from illegal logging – International and Russia aspect, St. Petersburg State Forest Technical University,St. Petersburg/Russia,13-15 November 2013, ICFFI News p.12

Sıvacıoğlu, A.2013a.Evaluation of key shortfalls in Forest Management Certification Projects in Turkey, International Conference Forest certification and protection from illegal logging – International and Russia aspect, St. Petersburg State Forest Technical University,St. Petersburg/Russia ,13-15 November 2013, ICFFI News p.60.

Sıvacıoğlu,A.2013b. Evaluation of Forest Management Certification Projects in Turkey in terms of Silviculture, International Caucasian Forestry Symposium, 24-26 October, 2013, Proceedings p. 227-231.

Examination of Protected Areas in Turkey in the Context of National Forestry Program

*İnci Zeynep AYDIN¹, Atakan ÖZTÜRK¹, Mustafa Fehmi TÜRKER², Ufuk DEMİRCİ¹

¹Artvin Çoruh University, Faculty of Forestry, Artvin/TURKEY

²Karadeniz Technical University, Faculty of Forestry, Trabzon/TURKEY

*Corresponding Author: iza@artvin.edu.tr

Abstract

Due to rapid population increase and rising needs, natural resource destruction has increased so much in recent decades. As a result, sustainable management of natural resources has become main concern. In order to conserve these resources, various protection systems have been developed. To manage their own natural resources, countries establish protected areas depending on international protection approaches and they prepare plans and programs for management of such protected areas. Like in other countries, in Turkey there are many protected area categories such as national parks, natural parks and natural reserve areas and plans are prepared and carried out to ensure sustainability, protection and continuity of these areas. As being foremost natural resources, forests and protected areas in these forests have to be managed in a planned way. Accordingly numerous plans and programs have been prepared such as forestry main plan, forestry specialization commission reports of national development plans. One of these plans is Turkey National Forestry Program and it aims to contribute to public welfare and sustainable development of country by providing sustainable management of forest resources. This program includes forestry principles, aims, policies, strategies and actions for the 2004-2023 period. In this study it is aimed to determine and examine principles, aims, policies, strategies and actions about protected areas mentioned in national forestry program.

Keywords: Forest resources, Protected areas, Turkey national forestry program, Policies

Türkiye’de Korunan Alanların Ulusal Ormancılık Programı Bağlamında İrdelenmesi

Özet

Son yıllardaki hızlı nüfus artışı ve artan ihtiyaçlara bağlı olarak, doğal kaynaklar üzerinde yoğun baskılar ve tahribat meydana gelmektedir. Bu durumun neticesi olarak doğal kaynaklardan sürdürülebilir bir şekilde yararlanması gündeme gelmiştir. Bu kaynakları korumak amacıyla özellikle son yıllarda dünya genelinde çeşitli koruma sistemleri geliştirilmiştir. Günümüzde ülkeler kendi doğal kaynaklarının yönetimi hususunda uluslararası koruma yaklaşımlarına bağlı olarak korunan alanlar belirlemekte ve bu alanların yönetimi için plan ve programlar geliştirmektedirler. Ülkemizde de bu kapsamda milli parklar, tabiat parkları, tabiatı koruma alanları ve benzeri koruma statüsü bulunan alanlar belirlenerek, bu alanların sürdürülebilirliğini, mutlak korunmasını ve gelecek nesiller için sürekliliğini sağlamak amacıyla planlama yapılmaktadır. En önemli doğal kaynaklardan olan ormanların ve ormanlık alanda yer alan korunan alanların da planlı bir şekilde yönetilmesi gerekmektedir. Bu doğrultuda günümüze kadar ormancılık ana planı, kalkınma planlarının ormancılıkla ilgili ihtisas komisyonu raporları vb. pek çok plan ve program hazırlanmıştır. Bunlardan biri de ülkemizde orman kaynaklarının sürdürülebilir bir şekilde yönetilmesi ve bu sayede toplum refahına ve ülkenin sürdürülebilir kalkınmasına katkı sağlamasını amaçlayan Türkiye Ulusal Ormancılık Programıdır. Söz konusu program 2004-2023 dönemi için ulusal ormancılık ilke, amaç, politika, strateji ve eylemleri içermektedir. Bu çalışmada, ulusal ormancılık programında korunan alanlarla ilgili belirlenen ilkeler, amaçlar, politikalar, stratejiler ve eylem programları ortaya konularak, irdelemek amaçlanmıştır.

Anahtar Kelimeler: Orman kaynakları, Korunan alanlar, Türkiye ulusal ormancılık programı, Politikalar

Introduction

Depends on fast increasing of world population in recent years, natural and cultural sources were started to be destroyed because of the growing demand on them. It is thought

as a solution about to take precautions for saving these natural sources and sustainability and a need to classify these areas within the context of protected areas (Strickland-Munro et al., 2010).

At the present time, protected areas are raised as a common purpose of international conventions and institutions. Two important applications that define the international frame in this subject are: the sanctions by Biological Diversity Contract in 1992 in Rio Conference and management classes of protected areas that are developed by IUCN (World Conservation Union) (Thomas, 2006). The protected areas are defined as "lands and piece of marine that are managed by laws and other effective tools with the aim of saving and providing sustainability for biological diversity and natural & cultural sources" in the definition of IUCN who were accepted in 1969 by worldwide and performs activities to save the natural sources as well (URL1, 2016). Concordantly, the protected areas by IUCN were classified to management classes as absolute nature conservation reserve/wild area, national park, habitat/sort management area, protected land/marine area and managed source protected area.

Protected areas were classified into different parts within the context of at the national level various international conventions (Ramsar, Bern, contracts about saving world's cultural and natural heritage etc.) and our national legislation also (2873 numbered National Parks Law, 6831 numbered Forest Law, 2863 numbered Code of Protection of Cultural and Natural Properties, 4915 numbered Law of Land Hunting, etc.). It is possible to alien these subjected classes main ones like: biosphere reserve areas, national parks, nature reserve areas, natural monuments, protection forests, gene protection forests, seed stands, in-forest resting areas, specially protected environment areas, natural protected areas (GDNCNP, 2016).

On the other hand, various planning activities are the point in question on the purpose of providing sustainability, absolute saving of protected areas and ensuring their continuity for next generations either. It is probable to make mention of various plans for forests where are one of the most important sources and protected areas in forests. Hence, there were determined strategies about saving, developing of biological diversity and available forests and defined activities for these strategies as well in the Program of

National Forestry (2004-2023) that were prepared by the aim of saving-using equilibrating of the forest sources that Turkey has and submit to benefit of community within the frame of international contracts (Anonymous, 2004).

The determined strategies and activities about protected areas in National Forestry Program which were prepared for dominating the forestry and Turkey forests that are shaped based on changing and developing world conditions will be showed and evaluated with this research/study. Moreover, some proposals will be improved to ensure the sustainability and continuity of protected areas depending upon the strategy and action plans within this program.

Method and Scope of Research

In this study, as a basis for Turkey National Forestry Program that contains 2004-2023 years, relevant article, notification and scientific studies like theses etc. were used as written sources and examined by the aid of these sources. For this reason, there are emphasized on main strategies that are related to protected areas about forest sources management in relevant plan.

It is possible to collect the points under 4 titles that are especially about protected areas in determined strategies with the aim of reaching national forestry purposes and realizing the national forestry policies in Turkey National Forestry Program (2004-2023). These are;

- Strategies for saving the forest's biological diversity
- Strategies for benefiting from forest's socio-cultural services
- Strategies for benefiting from protective and environmental functions of forests
- Strategies for respect to local residents, improve the living conditions of forest villagers and reduction the poverty.

Besides, the point in first item about saving the biological diversity of forests are more important in specific to protected areas. Therefore, the strategies and actions about them only for protected areas in subjected strategy group were discussed and examined.

The status of protected areas in Turkey

A significant part of our country's rich and globally importance biological diversity is in forest areas that contain more than one fourth of country area and sources. Keeping biological diversity of forests, generates the main conditions of forest's sustainability management. As stated in National Forestry Program (2004-2023), the general strategy about saving the biological diversity in our country's forests is getting the forests which have special diversity value and richness into

the statue of protected areas and managing with the relevant planning, applying and evaluating studies (Anonymous, 2014). All these progresses make the saving of natural sources or managing the protected areas in a larger frame a current issue in our country.

It is shown about various fields distribution that are protected by forestry institutions or in forest area in Turkey. As is seen on Table1, approximately 25% of forest areas are protected under various status by different units.

Table 1. Status of protected areas

Responsible unit	Status of protected area	Number	Total area (Thousand hec.)	Forest area (Thousand hec.)	Forest area/protected area ratio(%)	Ratio in country forest area(%)
GDNCNP	Natural Park	40	848	403	48	2
	Nature Park	182	81	37	45	-
	Natural Conversation Area	31	64	20	31	-
	Natural Monument	106	6	1	13	-
	Development Area of wild life	80	1187	588	50	3
	Wetland area	135	2341	134	6	1
	Sub Total	574	4527	1183	26	6
GDF	Protection Forest	54	364	0.2	-	-
	Forest that parted to protect-running class	-	3186	3186	100	15
	Seed stand and garden	551	48	48	100	-
	Gene protection forest	239	44	44	100	-
	Sub Total	844	3642	3278.2	90	15
MEU	Natural Protected Area	1273	1311	857	65	4
	Special environmental protection region	15	1335	-	-	-
	Sub Total	1288	2646	857	32	4
Grand Total		2706	10815	5318.2	49	25

Source: Collation of MFWM head of Department Ministry District Offices by GDF, DKM (Anonymous, 2014).

As is seen on above Table, totals 2706 protected areas in different statuses take approximate 10.815 million hectare fields and 49% of these subjected fields are in forest areas. When looking at the distribution of protected areas as units; GDNPNC is responsible for total 4.5 million hectare, GDF is responsible for 3.6 million hectare and

MEU is responsible for 2.6 million hectare fields as well (Anonymous, 2014).

In our country, protected areas are divided into several management classes and made remarks in various plans, report and academic studies (reports of specialization commission related forestry of development plans, council reports about forestry, forestry research and

development master plan, strategically plans about forestry, several scientific studies etc.) considering strategies and policies that will be applied in this subject.

Strategies and actions for saving the biological diversity of forests

The general strategy about protecting the biological diversity in our forests is; taking the forest areas which have special biological diversity value and richness into the status of protected areas and to manage it by planning, applying and utilisation missions relevantly.

Main strategies about saving the biological diversity of forests in National Forestry Program are collected under 10 points below:

i. To develop an informing & consciousness program till 2008 in forest organization, in society, in community of interests about the value of biological diversity of forests and necessity for saving, further to continue the applications regularly,

ii. To develop the the proper indicator and national standards compatible with international standards also for protected areas facility and sustainable management (planning, applying, watching and evaluation) orders as attender for these areas till the end of 2008,

iii. Developing the relevant legislation about protected areas appropriately to country's changing conditions, strengthening GDNCNP's institutional capacities as rural predominantly considering the relevant international contracts and processes, improving the financial resources,

iv. Popularizing the Protected Areas Network with new protected areas facility in proper fields in the manner of representing the country's biological diversity and providing sustainable methods,

v. Realizing the management studies of protection areas for saving and benefiting from the genetic variability of forest trees and other sorts by MFWM and respective departments and also relative other institutions.

vi. Saving the game and wild animal species genetic variability in cooperation with relevant institutions and organizations in the manner to not to cause to genetic pollution,

vii. Realizing the methodology, institutional capacity and legislation

development studies for integration of forests biological diversity saving studies inventory, planning, watching and evaluating systems properly,

viii. To provide the necessary care for saving the biological diversity in planting and other public works. For this reason, to develop and continue the education and institutional capacity development studies in cooperation with forest establishment, universities, non-governmental organizations till 2008,

ix. Improving the studies about determining, saving, zoning and benefiting of the biological diversity values of forests. For this reason, developing the dialog and cooperation between forest establishment and faculty of forestry, other universities and research institutions; preparing and realizing the joint projects; collecting the research results and building a database to benefit,

x. Popularizing the revenue generating activities for local community in protected areas; giving priority in rural development support studies by forest establishment and other relevant institutions for local community who lost revenue.

Actions for determined strategies are shown on Table 2.

Table 2. Actions for saving the biological diversity of forests

Strategy	Action	Responsible Institutions	Responsible	Priority	Type of Action	Application Period	
						Short period (2004-2009)	Long period (2004-2023)
(i)	To develop and apply the consciousness & education programs for occurring the necessary awareness, interest and support about the importance and necessity of saving the biological diversity value of forests in forest establishment society, relevant public bodies and communities live in or around the protected areas.	MFWM Scientific Institutions CSO cooperation	GDNCNP	1	Consciousness		2005-2023
(ii)	To occur the national proper standards compatible with international standards for protected area management classes. Reviewing and organizing the statuses of existed protected areas based on these standards.	MFWM Scientific Institutions CSO cooperation	GDNCNP	1	AR-GE, Application	2004-2009	
	Providing the participation at every level of "Saving Biological Diversity Project" which was started with the help of GEF to develop the proper attender management models for national parks and other protected areas, using the obtained knowledge's and experiences in the education of GDNCNP and other relevant institution employees.	In cooperation with FRAGD CSO and Other relevant institutions by GDNCNP	GDNCNP	1	AR-GE, Education	2004-2009	
(iii)	To develop the relevant legislation about saving the biological diversity as proper to changing conditions; to develop considering our country's responsibilities and commitments in international contracts and processes.	MFWM Scientific Institution CSO other community of interest	GDNCNP	1	Legislation development	2004-2009	
	To strengthen the GDNCNP establishment's institutional capacity as rural predominantly; to provide sufficient number of staff depending upon job definitions and programs; to realize the proper education programs for increasing their knowledge and experience.	MFWM Scientific Institutions CSO	GDNCNP	1	Institutional Education	2004-2009	
	Increasing the budget allocations based on work program and projects. Attempting by MFWM	MFWM, relevant Public institutions	GDNCNP	2	Financing	2004-2009	
(iv)	Preparing and applying the management plans for important and primary protected areas which have no management plan or have outdated plans as well.	By GDNCNP relevant MFWM units, local community, universities CSO	GDNCNP	1	Planning		2004-2015

	Populating the protected areas network as represented our country's biological diversity; make an inventory-evaluation study to determine the new protected areas.	GDNCNP CSO Universities Other community of interests	GDNCNP	1	Research and Development (R&D)	2004-2010
	Applying and preparing the management plans as attender, establishing new protected areas in proper fields.	In cooperation with CSO, universities, local community, other community of interests, by GDNCNP	GDNCNP	1	Planning, Applying	2005-2023
(v)	Establishing and managing the protection areas in-situ and ex-situ for saving/benefiting from forest trees and other species.	OATIAM Headship, In cooperation with PGD and GDF.	OATIAM	1	Application Research and Development (R&D)	2004-2023
(vi)	Occurring the conservation and development the wild life facilities in essential places to save the game and wild animals in manner to not to occur genetic pollution; and if required, occurring rescue centers for regaining, curing of animals and making management studies.	In cooperation with GDNCNP and other relevant institution and organizations	GDNCNP	1	Application, Research and Development (R&D)	2004-2009
(vii)	Developing well methods (about to determine the biological diversity based on proper indicators, measuring-evaluating), to integrate the forest sources inventory, planning and evaluating studies into saving biological diversity properly. For that purpose, benefiting from the opportunities of Biological Diversity Project. Educating the planning units & committees and application employees in the light of knowledges and experiences. Realizing the legislation development studies.	In cooperation with universities, Research institutions and CSO by different units of MFWM	GDNCNP	1	Pilot project R&D Education Legislation development	2004-2009
(viii)	Preparing and applying well education programs for employees of PGD and GDF to give their full treatments in saving biological diversity in civil cultural applications, planting and other public works.	In cooperation with universities, searching institutions and CSO, by MFWM	GDFPGD	1	Education	2004-2009 2004-2023

(ix)	Evaluating the research results which are founded by different institutions about biological diversity of forests (determining, evaluating, saving, restoration, utilization, etc.); collecting these results in a database of "Biological Diversity Database); to provide the related institution and organizations to reach this database and benefit from as well.	In cooperation with other research institutions and other community of interests, by MFWM (GDNCNP, forestry research units)	GDNCNP	1	R&D	2004-2009
			GDNCNP			2004-2023
	To determine the research requirements about biological diversity subjects, updating them periodically and making them real. Providing the transfer of results to relevant institutions and appliers and providing to make benefit also.	In cooperation with other research institutions and other community of interests, by MFWM.	R&D Office.	2	R&D	2004-2023
(x)	To determine the forest villages in protected areas which are seriously affected from the restrictions that make pressure and threat; making them avail of economical encouragement mechanisms; giving priority to these villages for rural development activities by FRAGD, Ministry of Agriculture and Rural Affairs.	In cooperation with local community and other relevant communities. By FRAGD, TKB, CSO	GDNCNP	1	Institutional	2004-2008

Source: Anonymous, 2004

- *Within the context of 1st strategy for saving the biological diversity of forests*, between the years 2004-2009, the actions are shown on Table2 which need to be realized firstly. "Education Information System" were realized aimed at speeding the transaction and decision processes up and made in-service training in this system. Educations are planned and applied in these trainings as effective consciousness (Anonymous, 2015b).

- *Within the context of 2nd strategy for saving the biological diversity of forests*, between the years 2004- 2009, there are 2 actions primarily (Table 2). Only 2010 targets about Biological Diversity Contract (2006-2010) were adopted. But, there is not any study about defining standard and indicators

will be determined in national standard for providing sustainability and continuity of protected areas in our country. There are only studies by head offices about to collect the features of protected areas by GDNCNP on the purpose of collecting the numeric data about protected areas on national basis, then recorded to data basis (Anonymous, 2013).

A project was developed which has the characteristics of base of the national monitoring system for all monitoring purposes about "Saving the Biological Diversity Project" by GEF in 2012. It was submitted to "National Biological Diversity Inventory and Monitoring Project" in 2013 and approved. The project started in the early 2013 and will be completed within 2018 (Anonymous, 2013). As a result, there were not started to studies directed to determined

actions or there were not actions in the years that determined.

- *Within the context of 3rd strategy for saving the biological diversity of forests*, there were 2 primary actions that must be realized between 2004-2009 and even one more action were existed that must be realized in the same direction with others (Table 2). MFWM started the studies about previsioning of “National Biological Diversity Action Plan” what was prepared for applying effectively the United Nations Biological Diversity Contract (2004) in our country as well (Anonymous, 2016). It was updated again in 2007 with a participating period within “Biological Diversity Contract Applying Project” conducted with the grant support of UNEP/GEF. “Saving Nature and Biological Diversity Draft Law” about developing the legislation could be prepared in 2015 (Anonymous, 2015b). Again, it was discussed to prepare “Protected Area Work Program” in 2010 within the limits of Biological Diversity Contract Parties Conference decisions in 2004 (WWF, 2005). As a consequence, limited number of targets were reached about subjected actions.

In addition, there is need for increasing the budget allocations for GDNCNP based on research programme and projects and realizing the required efforts by MFWM to that end. Because the forest organization expenses in Turkey are partially made by resource allocations from government budgets and their own incomes as well. For instance, wood sales revenues are still formed the big part of forest organization budget revenues. Moreover, the tariff cost revenues of wood and non-wood forest products are collected in GDF annexed budget; the sales of seed and sapling, hunting revenues are collected in MFWM circulating capital budget also. The revenues from these public utilities are used for activities about subjected services. By virtue of the fact that, GDF annexed budget with PGD are used for resource allocation from government budget while resource allocation for the activities of GDNCNP and FRAGD is provided by Ministry general budgets, and a bitty amount is reserved for all these activities finally. In these circumstances, there occurs a constraint about not to be able to recompense the

multiple benefit and services of forestry and not to use with the aim of managing forest products. Thereby, only limited goals were achieved about protected areas in our country.

- *Within the context of 4th strategy for saving the biological diversity of forests*, there were determined 3 actions that is thought to make happen in long term (Table 2). Regarding these actions, GDNCNP developed an information management system to watch all protected areas considering geographical datas and their alterations in time. According to 2015 datas, this system’s inventory studies are still continuing. There are studies about declaring the important ecosystems, wetland areas, caves, sensitive marine areas and remarkable landscapes as Protected Areas. MFWM evaluated 23 sensitive areas in 2015, 9 of them were declared as protected areas (6 nature parks, 1 national park, 2 natural monuments). Moreover, indicator value of registered places by the aim of ecotourism and recreation actualized over the targeted level, which’s purposes are benefiting the society from social, cultural, scientific, sporty and esthetic services of forests (Anonymous, 2015b). 2012-2017 Ecotourism Action Plan for protected areas was prepared and introduced. The context of National Ecotourism Strategy is prepared as draft. The inventory stage of Beyşehir Lake National Park Ecotourism Plan is completed within technical specification (Anonymous, 2013).

The planning workouts in Turkey forestry are prepared and applied by different departments of forest organization (GDF, PGD, GDNCNP, FRAGD) in several stages and issues. Each department does activities which have different levels, application areas and periods. And consequently, there could not be created the necessary participation and transparency between all departments. After all, the applications for multi directional benefiting from forests in inter-enterprise coordination problem and planning workouts could not be realized up to the mark (Anonymous, 2004). That’s why the researches move slowly and there are difficulties about achieving expected goals because of the completely unremoved constraints.

- *Within the context of 5th strategy for saving the biological diversity of forests*, there are actions about establishing and managing in-situ and ex-situ protection fields for saving/benefiting the genetic variability of forest trees and other species. The studies for these actions are continuing.

- *Within the context of 6th strategy for saving the biological diversity of forests*, there are actions about game and wild animals protection. It was thought to make them happen in long term. Some scientific research were made regarding this action. For instance, saving these species biological diversity, supporting the wildlife development and using these species in landscape are targeted with "Seed Orchard Facility of Large Leafed and Fruitful Species Action Plan (2014-2018)", these studies are still continuing (Anonymous, 2015b). Once again, inventory studies are continuing in 64 Wild Life Development Fields in totally 934.825 hectares area. Monitoring studies were started by producing native leashes (GPS-GSM-UHF) to watch the wild animals in 2012 (Anonymous, 2013).

- *Within the context of 7th strategy for saving the biological diversity of forests*, there are actions about benefiting from the opportunities of current Biological Diversity Project. It was targeted to make these actions happen between 2004-2009 years. The studies for this action was started in 2010. Necessary audit and control studies were actualized by preparing forms under the names of "Environmental Cleaning and General Care Audit", "Following Allowance Statutes", "Following Long Term Development Plan Applications" and "Following the Management Activities" (Anonymous, 2013). So, it is seen that the goals which were planned to realize in 2004- 2009 could not be real by the time.

- *Within the context of 8th strategy for saving the biological diversity of forests*, there are actions directed to prepare and apply well education programs in cooperation with PGD and GDF for saving species and biological diversity civil culturally. One of the studies called "Catchments Green Belt Planting Action Plan was applied (2013-2017). The studies about this subject are still continuing.

- *Within the context of 9th strategy for saving the biological diversity of forests*, there are action plans about generating "Biological Diversity Data Base". Research and development studies for generating biological diversity data base action plan in 2007 by collecting the informations in "Noah's Ark Biological Diversity Data Base". Studies and evaluating are still continuing as of 2015 year. It was only seen that the action is thought to start in 2004 could not be happen by the time.

- *Within the context of 10th strategy for saving the biological diversity of forests*, there are actions about rural development activities of forest villagers. It was targeted to finish these between 2004-2008. To reach this aim, firstly inventory-searching-evaluating studies regarding socio cultural services of forests were done. In this regard, "Nature Tourism Master Plans" were prepared, but these were barely completed at the end of 2015.

Additionally, several action plans (walnut action plan, almond action plan, berry action plan, truffle forest plan, sahlelep action plan, gummi action plan, honey action plan, wild fruity species action plan, etc.) were prepared because of our country's NWFP richness to save the biological diversity and diversify the sources of income of rural population. As a result, these activities could not become an action in determined years.

Conclusion and Suggestions

Protected areas increasingly become important in consequence of destructions resultant by misuse of forest sources worldwide. Today, the protected areas are accepted as the areas where contribute human welfare, reducing poverty and sustainable development in addition to nature conservation function. These areas are beneficial about many subjects like saving the species and genetic variability, continuing the ecosystem services, creating income sources for local community, providing tourism and recreation opportunities.

We have 14 different protected status laid down by the laws in Turkey. Many natural species and living spaces are getting lost or

diminishing because of the threats they faced day by day in spite of all protection works to recover and save the natural values (Anonymous, 2015a).

In our country, on the purpose of shaping the 2004-2023 years development about Turkey forestry and related terms, NFP was prepared which contains provisions concerning multiple benefiting and well-using of forest sources that remain on the agenda by socio cultural and environmental services. In this research, there are targets, principles and policies about protected areas and strategies & action plans for reaching them as well.

There were occurred a number of strategy and action plans like; such institution and organizations will take place in researches about protected areas in NFP, what will the financing sources be for managing the protected areas, determining-planning and well using the places that lost their importance or need to define as protected areas, applying the education and consciousness studies for shareholders for sustainability of protected areas, doing necessary inventory-etude works and realizing the projects about ecotourism, recreation activities in rural development that consider to local communities requirements. These determined strategy and action plans divided into 2 parts as short term plans 2004-2009 and long term plans (2004/2005- 2023).

But when observing the targeted strategy and action plans, it is seen that strategy and action plans for short term did not become real or the studies which need to start in this period were not started either. There could be told that, discussions and uncertainties about short term activities are still continuing. There are contradictions in terms even in pilot works that must be realized as attender and research & development studies. It is clearly seen that there will be malfunctions at applying level for long run action plan without solving these problems. As a result, some activities are still in start-up phase in this period.

Therefore firstly, standards and indicators in national standards must be raised to provide sustainability and continuity of protected areas in our country. As a starting point for these studies, various standard and indicator sets should be improved which were developed by international processes and

institutions for measuring the sustainability of tourism areas and natural sources.

Over and above, there must be absolutely obeyed information's show which target will be realized when. To develop these applications; inventory-etude works should be done and speed up the processes of determining the places where will be defined as protected areas, following and evaluating.

Using protected areas in a balance of using-saving could not become a responsibility status for community's relevant shareholders despite of some determined strategy and action plans existence. There are still conflicts about protection subject studies. This problem based upon the undeveloped sensibility in relevant people and lack of knowledge and consciousness. For that reason, protected areas subject must take place in legislation as is required and application stage must be audited.

Large majority of protection plans are realized by a central unit. There must be encouraged the participation of all sides (universities, public institution and organizations, CSO and especially forest villagers) with a jointly move at area planning level and need them to dominate the plan also. There should be make proper pilot projects in some local region for model applications (recreation, ecotourism, landscape, game-wild animal, hunting, education, etc.) in compatible with nature.

References

- Anonymous, 2004. Türkiye Ulusal Ormançılık Programı, T.C. Çevre ve Orman Bakanlığı, Ekim, 2004.
- Anonymous, 2013. Biyolojik Çeşitliliği İzleme ve Değerlendirme Raporu, Orman ve Su İşleri bakanlığı, Doğa Koruma ve Milli parklar genel müdürlüğü, Ankara, 2013.
- Anonymous, 2014. Onuncu Kalkınma Planı Sürdürülebilir Orman Yönetimi Özel İhtisas Komisyonu Raporu, T.C. Kalkınma Bakanlığı, Ankara, 2014.
- Anonymous, 2015a. Ormançılık Araştırma ve Geliştirme Master Planı 2016-2017, T. C. Orman Genel Müdürlüğü, Ankara, Aralık, 2015.
- Anonymous, 2015b. Orman Genel Müdürlüğü, 2014 Yılı İdare Faaliyet Raporu, Şubat, 2015.
- Anonymous, 2016. T.C. Orman ve Su İşleri Bakanlığı, Orman Genel Müdürlüğü, 2015 Yılı İdare Faaliyet Raporu, Şubat, 2016.

GDNCNP, 2016.
<http://www.milliparklar.gov.tr/korunanalanlar/korunanalan1.htm>, Erişim Tarihi: 08.06.2016.

Strickland-munro Jennifer K.; Allison, Helen E.; Moore, Susan, 2010. Using Resilience Concepts to Investigate The Impacts of Protected Area Tourism on Communities, *Annals of Tourism Research*, V: .37, N.2, 499–519.

Thomas, L., 2006. IUCN Category System of Protected Area Management in Turkey.

URL1,http://www.iucn.org/about/work/programmes/gpap_home/gpap_quality/gpap_pacategories/, IUCN Protected Areas Categories System, Erişim Tarihi: 09.06.2016.

WWF, 2005. Etkin Korunan Alan Sistemlerine Doğru, Biyolojik Çeşitlilik Sözleşmesi, Korunan Alanlar İş Programı Uygulama Kılavuzu, ISBN: 92-9225-031-0.

Monitoring within the Protected Areas; Case of Küre Mountains National Park

*Ercan GÖKYER¹, Melih ÖZTÜRK¹

¹Bartın University, Faculty of Forestry, Department of Landscape Architecture,
Bartın/TURKEY

*Corresponding Author: egokyer@bartin.edu.tr

Abstract

In recent years, population of the world has steadily increased. Environmental resources have been affected by unsustainable development and human activities as a result of population growth. Besides, the importance of protected areas is steadily increased including important forest areas and habitats. In this study, Bartın part of Küre Mountainous National Park selected for research area. The research area which covers approximately 624 km² including rural settlements. Human activities and natural processes within the protected area should be evaluated to analyze protection process. Geographical Information System (GIS) techniques, the superimposition of the satellite data and digital land use maps revealed that the monitoring from past to present. In this study, results indicate that, the agricultural areas have been converted to the forest that will no longer be used for the agricultural purposes. This situation had provided positive impacts on forest by mitigating social pressures. On the other hand, in this study, importance of monitoring within the protected areas is highlighted.

Keywords: Protected areas, Küre Mountains National Park, GIS, Monitoring.

Korunan Alanlarda İzleme; Küre Dağları Milli Parkı Örneği

Özet

Günümüzde dünya nüfusu sürekli olarak artmaktadır. Bununla ilişkili olarak insan aktiviteleri ve plansız gelişimden çevresel kaynaklar etkilenmektedir. Orman alanları ve habitatları içeren korunan alanlarda sürekli olarak önem kazanmaktadır. Bu çalışmada Küre Dağları Milli Parkı'nın Bartın bölümü araştırma alanı olarak seçilmiştir. Araştırma alanı 624 km² alan kaplamaktadır. Korunan alanlarda insan aktiviteleri ve doğal süreçler analiz edilerek koruma sürecinde değerlendirilmelidir. İzleme için gerekli bilgiler Coğrafi Bilgi Sistemleri teknikleri kullanılarak uydu görüntülerinden elde edilen arazi kullanım haritaları ve dijital veri tabanları kullanılarak elde edilebilmektedir. Bu çalışmanın sonuçlarına göre araştırma alanında tarımsal faaliyetler için kullanılmayan tarım alanları orman alanlarına dönüşmüştür. Bu durum orman alanları üzerindeki sosyal baskıyı hafifleten olumlu bir etki sağlamıştır. Aynı zamanda bu çalışma ile korunan alanlarda izlemenin önemine vurgu yapılmıştır.

Anahtar Kelimeler: Korunan alanlar, Küre Dağları Milli Parkı, CBS, İzleme.

Introduction

Conservation of the natural resources have gained significance with the emergence of the environmental problems, global climate change and population increase (UN, 2014; Karl and Trenberth, 2005). Associated with these issues, there are worldwide studies in order to conserve and monitor the natural resources. The "Natura 2000 Network" has been established for the member countries of the European Union in order to follow and evaluate the conservation, management and monitoring procedures (Ostermann, 1998; Gökyer, 2009).

The monitoring allows the conserved land managers conceive the processes, monitor

the situation of the resources and make decision within the land. The monitoring involves the evaluation about the dwellers and neighbors of the conserved land. Besides, monitoring considers the environmental quality (Fancy et al., 2009). During the monitoring processes, satellite data and analysis of these data with the remote sensing techniques supply substantial contribution for the determination of the land use and landscape change (Kennedy et al., 2009; Fraser, 2009; Gökyer, 2013; Gökyer, 2014).

Landscape ecological principles have been provided to important progress in conservation, management and monitoring

studies (Gökyer 2009). In order to comprehend the three characteristics of the landscape; structure, function and change, remote sensing and landscape metrics compatible with Geographical Information System (GIS) are very important. Evaluation and interpretation of the data that are calculated by the landscape metrics from the land cover maps enables the determination of the landscape characteristics and processes. Hence, significant data will ready to be used during the conservation, management and monitoring studies (Forman and Godron, 1986, Dramstad et al., 1996; Odum and Barrett, 2008).

The data acquired as a result of the landscape metric calculation allow us to evaluate land processes and human activities within that land. After the conservation status is initiated within the protected lands, land use maps of definite time intervals (1, 5 or 10 years) produced using the satellite data provide us the opportunity to monitor the land and the vicinity. In this way, the success of the conservation and the impacts of the activities can be determined (Gökyer, 2009; Gökyer, 2013).

In this study, it was aimed to evaluate monitoring in the Bartın part of Küre Mountainous National Park and effects of the protection process within the National Park. This paper's objectives are: (1) it was aimed to analyze changes within the Bartın part of Küre Mountainous National Park. (2) Importance of the monitoring in protected areas were highlighted and discussed in the study area.

Materials

In this study, Bartın part of Küre Mountainous National Park selected for research area. Study area is located on the north-eastern part of the Bartın Province (Figure 1). The area is surrounded by the Kurucaşile settlement in the north, central part of the Bartın Province in the west, Ulus settlement in the south and Kastamonu part of the Küre Mountainous National Park, respectively.

Climate of the study area is dominated by humid mesothermal climate regime. Study area is rainy throughout the year due to the airflows which comes from north. The average annual temperature and precipitation of the area are 12.6 C° and 1029.9 mm, respectively (Atalay, 2011; MGM, 2016).

Küre Mountains National Park includes east part of the Bartın Province. Black Sea humid forests on karstic mountains expand within the National Park. National park and its surrounded area identified by the World Wide Fund Nature (WWF) in 1988 as one of the Forests Hot Spots of Europe. Küre Mountains and its buffer zone have important plant species including endemic plant species, important mammals (*Urcus arctos*, *Felix sylvestris* and *Lynx lynx*) and bird species (KDMP, 2015).

Methods

Research starts with the determination of the main land use characteristics of the research area for two periods (2000 and 2014). Land cover maps were obtained through the supervised classification (Jensen et al., 2009) using maximum likelihood algorithm under the ERDAS Imagine. Four main land use types were identified including forestland, cropland, urban or built up land and water surfaces (Table 1).

Table 1. Descriptions of the land use types within the study area.

Land Use Category	General Description
Forestland	Deciduous forest, coniferous forest, mixed forest
Cropland	All cultivated lands and vegetable lands
Urban and/or built up land	Residential areas, industrial land, roads and mine land, rural settlements, sandy areas
Water surfaces	River and other water surfaces

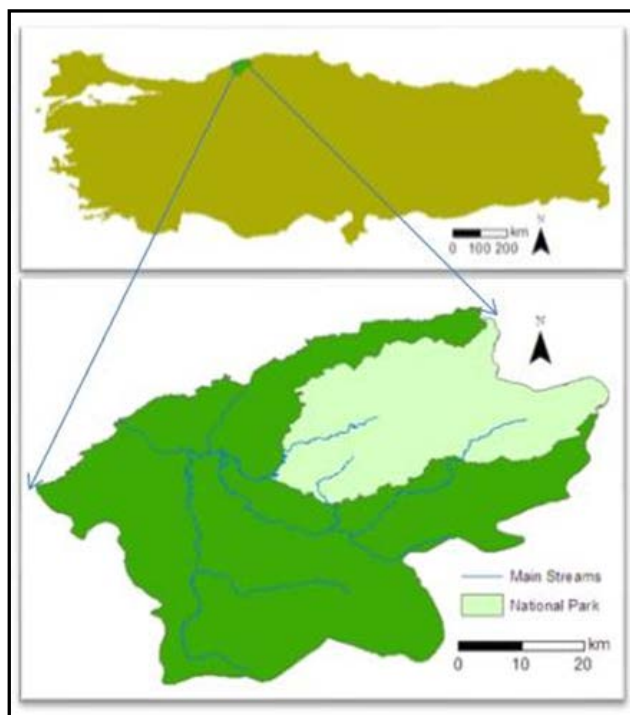

Figure 1. Location of the research area in Turkey

The accuracy of classified products was assessed by verifying the general land cover delineations on topographical maps, municipal maps, field survey and Google Earth.

Landscape metrics were used to quantify the landscape structure and to analyze landscape change. Two landscape metrics are calculated using Patch Analyst extension for ArcMap Version 5.1. Related descriptions on landscape metrics are given below;

1. **Class Area (CA):** Total area belongs to a land cover class
2. **Total Landscape Area:** The total area of the landscape.

Results and Discussions

Results indicate that significant changes have been occurred in 14-year period from 2000 to 2014. Land use maps related to 2000 and 2014 presented in Figure 2 and 3. Also, results of the landscape metrics are presented in Table 2. In 2000, the forestland coverage occupying 65% of the total area was 40481 ha. The forestland coverage achieved to 45151 ha. In 2014, the forestland coverage occupying 73% of the total area was largest land cover class. On the other hand, the agricultural areas have reduced in size.

Table 2. Calculation results for TCA by the year, 2000 and 2014.

Land Cover Classes	2000		2014	
	TCA (ha)	%	TCA (ha)	%
Forestland	40481	65	45151	73
Cropland	21264	34	15191	24
Urban and/or built-up land	635	1	2042	3
Water surfaces	4	-	1	-
TLA	62384	100	62384	100

TCA: Total Class Area, TLA: Total Landscape Area

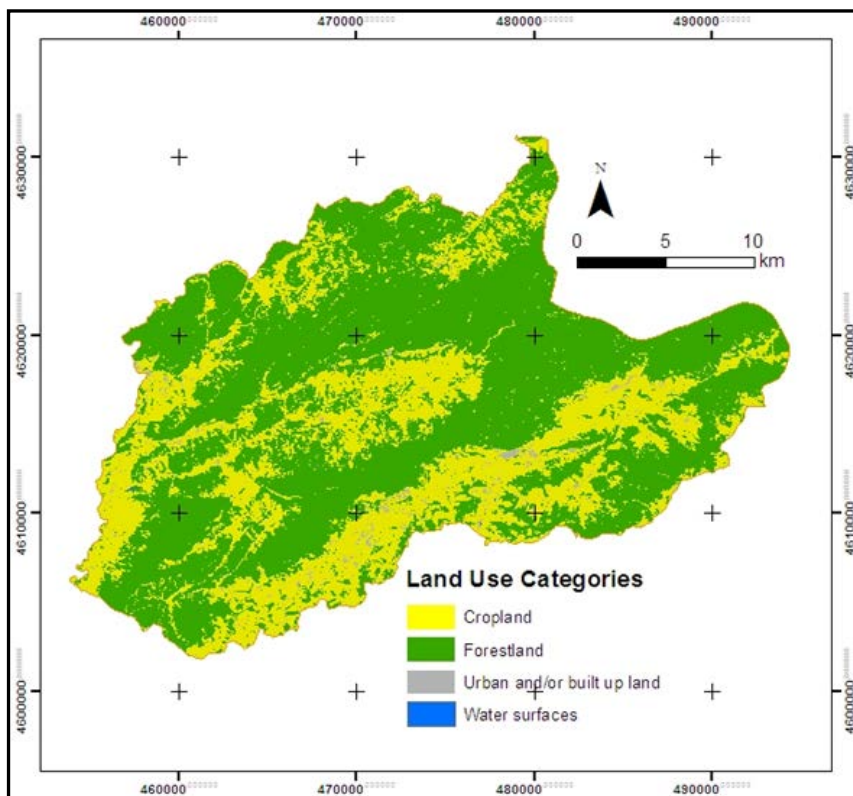

Figure 2. Land cover map (2000) of the research area

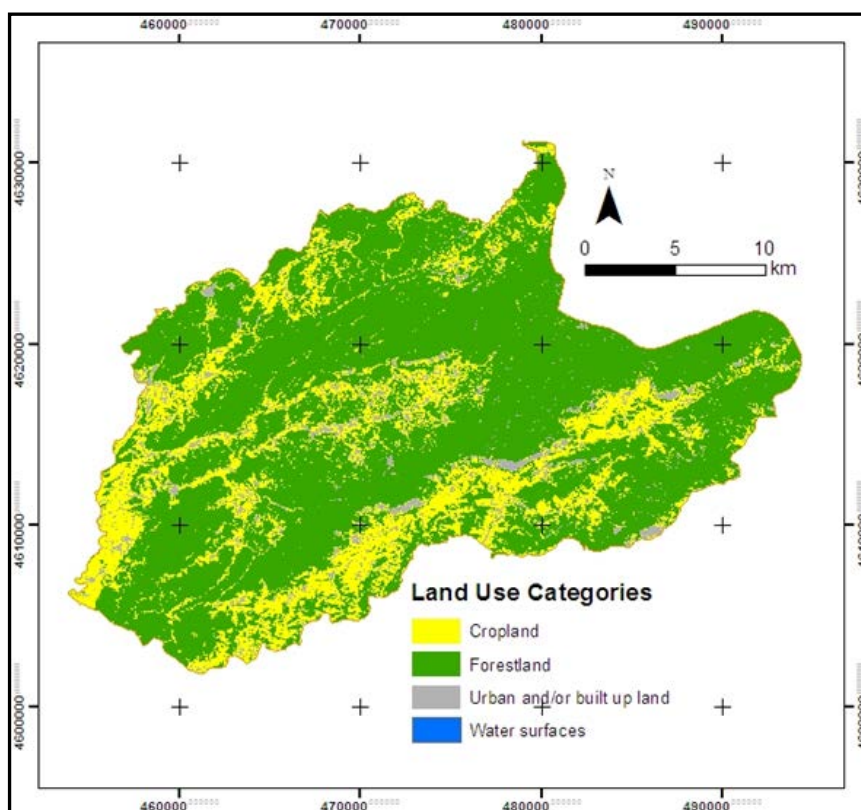

Figure 3. Land cover map (2014) of the research area

Conclusions

In recent years, climate changes and natural hazards have had negative impacts on human life. In order to mitigate these adverse effects, people have preferred natural and rural lands. As a consequence of the human intervene into the places they reached, conservation measures had to be taken within these natural and rural lands. Monitoring the protected areas is an important factor for the determination of the success for the land management and conservation. Besides, monitoring applications contribute to the activity preferences. In this study, land use cover change analysis and evaluation which constitute part of the monitoring applications within the Bartın section of the Küre Mountains National Park were conducted

Monitoring helps us to emerge the effects of the conservation process in over time. Küre mountainous was granted national park status in 2000. After 14 years until 2014, the forest lands have increased whilst the agricultural lands have diminished within the borders of the Bartın section of the Küre Mountains National Park. The situation indicates that the human activities have lowered within the area. Thus, advantageous circumstances have emerged for the wild animals while human induced negative impacts have reduced. On the other hand, governmental proposals should be developed in order to sustain the rural identity of the land and to supply the respectful facilities of the dwellers to the natural resources. Constructive consequences have occurred while approaching the changes within the land from the point of landscape health. The significance of the monitoring processes on the conserved lands is revealed with this study. However, more delicate and detailed analyses that consider human activities and wildlife are necessary in order to assist monitoring processes.

References

Atalay, İ. 2011. Türkiye İklim Atlası (Climate Atlas of Turkey), İnkılap Kitabevi Yayınları, İstanbul.

Dramstad, W., Olson, J.D. and Forman, R.T. 1996. Landscape ecology principles in landscape architecture and land-use planning. Island press.

Fancy, S. G., Gross, J.E. and Carter, S.L. 2009. Monitoring the condition of natural resources in US national parks. *Environmental Monitoring and Assessment*, 151(1-4), 161-174.

Forman, R.T. and Godron, M. 1986. *Landscape ecology*. 619 pp. Jhon Wiley and Sons, New York.

Fraser, R.H., Olthof, I. and Pouliot, D. 2009. Monitoring land cover change and ecological integrity in Canada's national parks. *Remote Sensing of Environment*, 113(7), 1397-1409.

Gökyer, E. 2014. Monitoring landscape change and urban growth of Bartın, Turkey, and its environmental effects, *Fresenius Environmental Bulletin*, 23, 10, 2407-2414.

Gökyer, 2013. Understanding landscape structure using landscape metrics, *Advances in Landscape Architecture*, Dr. Murat Ozyavuz (Ed.), InTech, DOI: 10.5772/55758.

Gökyer, E. 2009. Bartın İli Kent Merkezi ve Arit Havzası'nda Peyzaj Değerlendirme, (Doktora Tezi, Basılmamış), Ankara Üniversitesi Fen Bilimleri Enstitüsü Peyzaj Mimarlığı Anabilim Dalı, Ankara.

Jensen, R.J., Im J., Hardin, P., and Jensen, R.R. 2009. Image Classification of the SAGE Handbook of Remotes Sensing, 269-282.

Karl, R.T. and Trenberth, K.E. 2005. What is Climate Change? (Chapter 2) *Climate Change and Biodiversity* (Edited by Lovejoy, T. E. and Hannah, L.), Yale University Press, London, UK.

KDMP, 2015. kdmp.gov.tr, Küre Dağları Milli Parkı Küre (Mountaionus National Park), Kastamonu

Kennedy, R.E., Townsend, P.A., Gross, J.E., Cohen, W.B., Bolstad, P., Wang, Y.Q. and Adams, P. 2009. Remote sensing change detection tools for natural resource managers: Understanding concepts and tradeoffs in the design of landscape monitoring projects. *Remote sensing of environment*, 113(7), 1382-1396.

MGM, 2016. mgm.gov.tr, T.C. Çevre Ve Orman Bakanlığı Devlet Meteoroloji İşleri Genel Müdürlüğü (Turkish State Meteorological Service), Ankara.

Odum, P.E. and Barrett, W.G. 2008. *Ekolojinin temel ilkeleri (Fundamentals of ecology)*. Çeviri editörü: Prof. Dr. Kani Işık. Palme Yayıncılık, Ankara.

Ostermann, O.P. 1998. The need for management of nature conservation sites designated under Natura 2000. *Journal of Applied Ecology*, 35(6), 968-973.

UN, 2014. The World population situation in 2014, A Concise Report, Department of Economic and Social Affairs, Population Division.

Plant Diversity Assessment in Critically Threatened Forests to Inform Policy in Kenya-A Case Study of Nyekweri Forest

*Vincent MAINGA¹, William OJWANG¹, Christopher CHESIRE²

¹World Wide Fund for Nature (WWF-Kenya)

²The National Museums of Kenya

*Corresponding Author: vmainga@wwfkenya.org

Abstract:

Nyekweri forest forms an important dispersal area for wildlife species in Masai Mara game reserve in Kenya providing critical ecological services in form of water storage; river flow regulation; flood mitigation; conservation of biodiversity; and microclimate regulation. A Plant diversity assessment was carried out in 2 forest blocks (Oloirien and Kimintet) forming Nyekweri forest. Six belt transects spanning 2km long were established to collect data from 24 plots set equidistant at 500m intervals. At each of the established plots, all tree species greater than 5cm in diameter at breast height (DBH) were enumerated and recorded. Tree regeneration (seedlings and saplings) was tallied by species. The Shannon-Weiner Index was used to calculate species diversity and evenness. The derived Shannon's indices were further converted into effective numbers to show the magnitude of differences in species biodiversities. To evaluate differences in species diversities, one way ANOVA was conducted and to separate the means, Tukey's HSD and Duncan's tests were used for even and uneven number of samples respectively. Jaccard's similarity index was used to assess species similarities. A total of 267 species belonging to 74 families were recorded. Some of the most frequent species and in the order of abundance included; *Trichocladus ellipticus* (Hamamelidaceae), *Diospyros abyssinica* (Ebenaceae), *Drypetes gerrardii* (Euphorbiaceae), and *Euclea divinorum* (Ebenaceae).

Significant differences existed between species diversities in the two forest blocks. Overall, Asteraceae was the most diverse family, contributing to 21 species while other well represented families included Papilionaceae, Orchidaceae, Poaceae, Rubiaceae and Apocynaceae. More than 35 % of all recorded families were represented by a single species, *Psychotria lauracea* (Rubiaceae). Three distinct plant community associations including *Trichocladus-Diospyros-Olea community*; *Euclea-Trichocladus community* and *Pennisetum community* were observed. These findings indicate that Kimintet block of Nyekweri forest which was less disturbed was more species diverse

Keywords: plant community; abundance

Introduction:

Plants and plant resources have been utilized by communities for subsistence and commercial values since time immemorial. Plant diversity and in general the biological diversity forms an important aspect of natural resource base for the entire planet. They hence play an important function of maintaining the world's ecological integrity and balance as well as other ecosystem based and life support functions. In addition, they harbour diverse number of wildlife and provide habitats for world biodiversity that offer populations with economic and cultural value through provision of food, shelter

materials, income, medicine, clothing among other benefits.

Despite the importance of these resources, a complete inventory of the world's plant resources has not yet been done but an estimated 270,000-420,000 species of vascular plants are known to occur (Goverts, 2001). Two thirds of these species are in danger of extinction, threatened by degradation of the biodiversity resources and transformation of natural ecosystems, deforestation, overexploitation, pollution and climate change. This trend poses one of the greatest challenges in today's conservation efforts and to many researchers and pro-conservation organizations. Conducting

biodiversity assessments of different ecosystems offers perfect opportunities to contribute towards this global database and creating that much needed information towards conservation and protection of the plant diversity.

Nyekweri forest is among the few remaining indigenous forest patches scattered adjacent to the Masai Mara National reserve in Kenya, a world heritage site due to its numerous biodiversity resources. The forest is located five kilometers from the Siria-Ololo Escarpment at the Northern tip of the Mara triangle, and the Mara National Reserve, forming the largest remaining indigenous forest in Trams Mara west Sub County. The forest stands at 1,740m.a.s.l and covers an estimated area of 2,861ha (TRDP, 1995). Over the years, this forest has undergone different levels of disturbance and degradation. Increased human population leading to forest clearings for agriculture, firewood collection and charcoal production has posed an immense threat to its sustainable management.

Alterations in species composition emanate from forest degradation which affects biodiversity. There are several ways in which forest degradation occurs at the global scale (Krishnaswamy and Hanson 1999; Rogers 1996) or at the local scale (Foley et al. 2007). Decreased forest cover is a type of forest degradation which not only leads to biodiversity loss but also the loss of ecosystem functions (Foley et al. 2005), such as pest control and pollination (Kremen et al. 2007), seed dispersal (Howe and Smallwood, 1982), and provision of water resources (Scott and Lesch 1997; Laurance et al. 2002). Other forms of degradation occur when forest systems experience human induced disturbance (Chazdon 1998) or natural disturbance (Fox 1979), which may result in increased species diversity. Improved diversity in such situations is attributed to species resilience to regenerate or to other factors such as increased light to the forest floor (Senbeta et al. 2002), which favor regeneration of diverse species through new canopy gaps.

These forest resources face serious risk of elimination through anthropogenic pressures and it was against this emerging

threat to this important forest that this study was borne. The objective of this study was to assess species biodiversity and similarities between and within the two distinct forest blocks forming Nyekweri forests. This comparative assessment was aimed at gathering the initial biodiversity data for this forest that is currently not available, compare plant species diversity in the two forest blocks and their causal factors for decision support and sustainable management.

Materials and Methods

Study area

Nyekweri forest is located in Transmara sub-county, South-Western Kenya (**Latitude:** -1° 00' 0.00" S **Longitude:** 34° 52' 59.88" E) and forms part of the Mara-Serengeti ecosystem. It has an estimated area of 2,900 km² and neighbors the world famous Masai Mara National Reserve (MMNR). This dense indigenous forest is of high ecological and socio-cultural importance to the traditional Maasai people and also an important feeding and breeding ground for large mammals such as elephants. The Forest acts as a dispersal area for Masai Mara Game reserve wildlife and more importantly, serves as an elephant maternity for Masai Mara game reserve in Kenya and Serengeti National Park in Tanzania. The area has two rain seasons namely, the long rains (March to June) and the short rains (October to December). This research was confined to two forest blocks of Oloirien and Kimindet dominated by the semi-nomadic and agro-pastoral Maasai people.

Data collection and vegetation sampling

Data collection was carried out by establishing 24 replicate plots along 6 belt transects running NE-SW direction of the forest and spanning 2km equidistant at 500m from each. The starting point was the boundary of the two selected forest blocks-Oloirien and Kimindet running towards the forest edge. 20m by 20m plots were then established and biodiversity data was collected. GPS information from the 24 plots was collected using hand held Germin GPS. In each plot, plants were recorded in order to provide plant diversity and composition as

well as population structure. Plant specimens that could not be identified in the field were confirmed at the East African Herbarium. Plant nomenclature of Beentje (1994) and Flora of Tropical East Africa (FTEA's) served as guides. The canopy cover within the three life form layers i.e. herb, shrub, tree layers and tree heights were estimated in each plot.

Data analyses

Species diversity in each of the forests was calculated using a Biodiversity Calculator (Danoff-Burg and Xu 2006) in which the Shannon's index (H') was chosen. This method was selected because it provides an account for both abundance and evenness (Magurran 1988). It also does not disproportionately favor some species over others as it counts all species according to their frequencies (Lou 2006; Danoff-burg and Xu 2008). Other parameters such as species richness, (S) and species evenness (H'E) were derived from the same calculator. In addition, the Shannon's indices obtained were converted into *effective numbers* using a method by Lou (2006). This was done in order to analyse the magnitude of the differences in species diversities. To obtain similarities between species, Jaccard's index (Krebs 1989) was used between the two forest blocks.

Shannon's index, (H') is defined by:

$$H = - \sum_{i=1}^s p_i \ln p_i \quad (1)$$

where, i is the proportion of the species relative to the total number of species (p_i) multiplied by the natural logarithm of this proportion ($\ln p_i$) and the final product multiplied by -1. The Shannon's index ranges typically from 1.5 to 3.5 and rarely reaches 4.5 (Gaines et al. 1999).

Species richness (S) is defined by:

$$S = \sum n \quad (2)$$

Where, n is number of species in a community. Species evenness is often assessed by Shannon's equitability index (H'E) which is calculated by:

$$H'E = H' / H_{max} \quad (3)$$

Where, H_{max} is defined as $\ln S$. H'E values ranges from 0 to 1, in which 1 indicates complete evenness. The Shannon's index values obtained were further converted to effective numbers using a method by Lou et al. (2006) in order to analyze the magnitude of the differences in species diversities.

The effective numbers are calculated as an exponential of the Shannon's index as:

$$E_{\text{Effect}} \text{ of species } (P_i) = \exp \left(H = - \sum_{i=1}^s p_i \ln p_i \right) \quad (4)$$

The Jaccard's index (Krebs, 1989) was used to calculate the species similarities between the two forest blocks. Jaccard's index (Cj) is defined by

$$C_i = a / (a + b + c) \quad (5)$$

The values for each variable was derived on per subplot basis, however, they were averaged across the plots. Densities of commonly found indigenous tree species were calculated on a per hectare basis to show the different regeneration levels in the two forest blocks. Analyses of variance using one way ANOVA by SPSS 15 for windows were applied (SPSS 2006). To separate the means, Tukey's HSD or Duncan's tests were used in the case of equal and unequal samples respectively.

Species similarity between the survey sites and zones: Relationship and similarity of plants of different study sites was tested using PRIMER (Plymouth Routines In Multivariant Ecological Research) analytical software. Here, Ordination using non metric multi-dimensional scaling (MDS) and linkage clusters was used to show dispersion of sampling zones and plots based on their species similarity. To expound more on the inter-plot similarities, Jaccards similarity indices were assessed using equation 5 above.

Where: j is the number of species found in both samples,
 a is the number of species in sample a ,

while b is the number of species in sample b *Botanical Uniqueness (endemic & threatened plants)*: The updated IUCN Redlist of plants and the List of East African Plants databases were used to identify endemic and threatened plant species in the sampled area.

Species area curve: The species-area curve was used to evaluate the adequacy of the sample size used for this survey. It was generated using analytical software and was based on cumulative species numbers over sampled area.

Vegetation structure

tree population structure: Diameter at breast height (DBH) of trees were categorized into DBH classes and presented in dendrograms to assess the succession and health of trees in the ecosystem.

Canopy cover: Estimated percentage cover for each plant layer, ie herb, shrub, and tree canopies were recorded.

vegetation composition: The most dominant plants in each of the life-form and canopy

strata were recorded so as to understand plant distribution and plant communities.

Results and discussion floristic composition

A total of 267 species belonging to 74 families were recorded in the entire sampling. Some of the most frequent species and in the order of abundance included; *Trichocladus ellipticus* (Hamamelidaceae), *Diospyros abyssinica* (Ebenaceae), *Drypetes gerrardii* (Euphorbiaceae), *Euclea divinorum* (Ebenaceae), *Olea capensis* (Oleaceae), *Vepris nobilis* (Rutaceae), *Elaeodendron buchananii* (Cellastraceae), *Turraea robusta* (Meliaceae) and *Psychotria lauracea* (Rubiaceae).

Overall, Asteraceae was the most diverse family, contributing to 21 species. Other well represented families included Papilionaceae, Orchidaceae, Poaceae, Rubiaceae, Apocynaceae, Acanthaceae, Cellastraceae, Crassulaceae and Aspleniaceae. More than 35 % of all recorded families were represented by a single species.

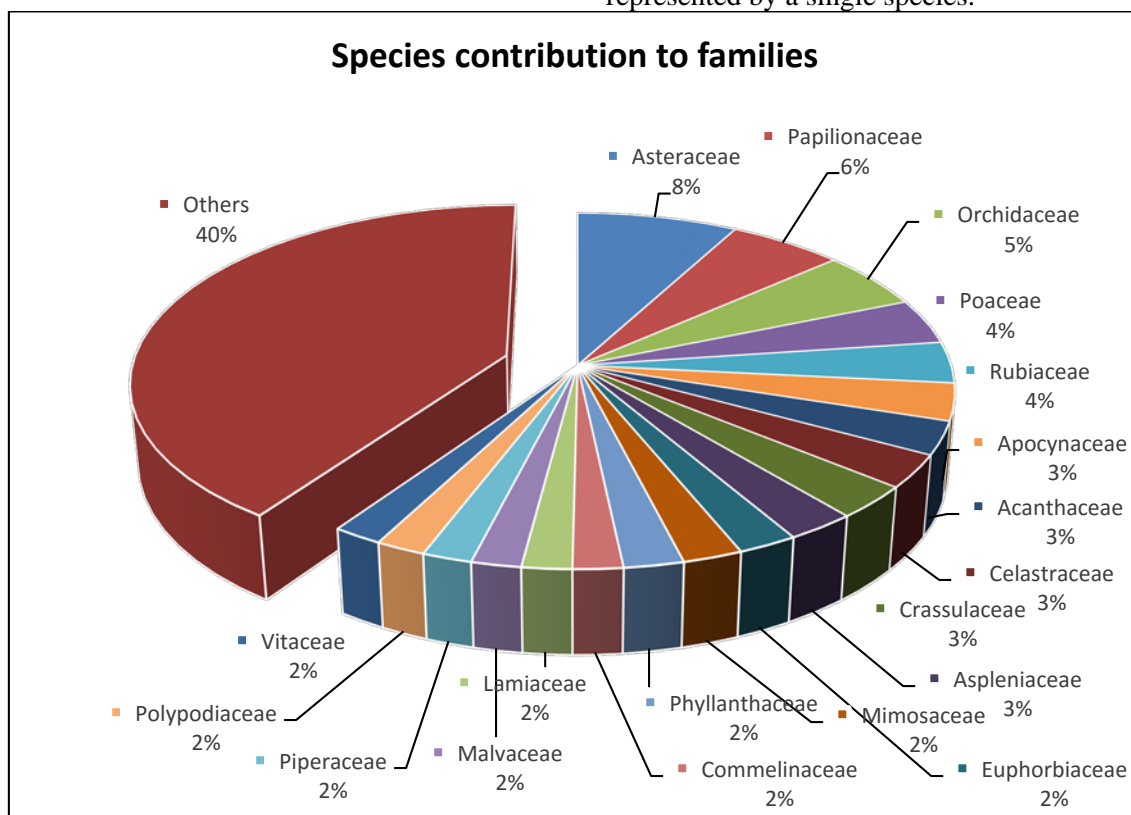

Figure 1: Species contribution to families

Life form spectrum

Majority of species recorded in Nyekweri forest were herbaceous. This is an

indication of considerable openness of the canopy. Nyekweri forest was observed to be an ecosystem with several glades and other open areas due to settlement and more notably, anthropogenic destruction for

agriculture and charcoal burning. While climbers were least represented, its number was significantly high as compared to other ecosystems recently studied.

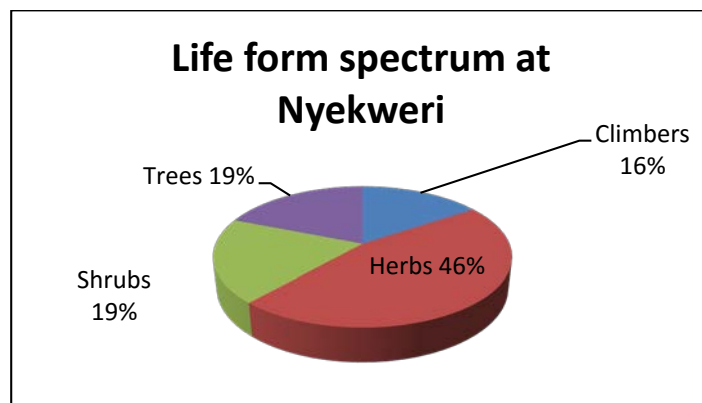

Figure 2: Life form spectrum

Species diversity

Species diversity, evenness and richness of each transect of the two sites was computed for comparative analysis. Transect O-T 2 (Salt lick) on the Oloirien side was found to be the most diverse in species composition. Due to lack of diverse vegetation types and for the homogenous nature of vegetation in O- T3 (Oloirien), it was found to be least diverse. Species in O- T3 also had the least even distribution. Overall, Oloirien side of Nyekweri forest

was found to be the most diverse. Species were equally evenly distributed for the two sides. This phenomenon can be attributed to the fact that on the Oloirien side, communities living around the forest are purely pastoral and do not practice destructive land use practices like farming while on the Kimintet side of the forest, agropastoral communities inhabit the area and agricultural extension and charcoal burning has contributed to depletion of forest resources.

	Oloirien			Kimintet			Overall	
	O- T1	O- T2	O- T3	K- T4	K- T5	K- T6	Oloirien	Kimintet
Species richness (S)	72	135	33	28	76	74	191	130
Evenness (J')	0.96	0.98	0.89	0.95	0.96	0.97	0.91	0.91
Diversity (H')	4.13	4.82	3.12	3.18	4.16	4.17	4.81	4.44

Table 1: Species Diversity

Species similarity

Multi- dimensional scaling (MDS) of Nyekweri plots was done to establish dissimilarity of plots based on species composition. In a MDS ordination, the distances between plots on the graph

represents similarity. The closer the plots are to each other, the higher the similarity between them. The stress value of 0.08 indicated a relatively reliable set of data.

Figure 5: Multi-dimensional scaling (MDS) of plots

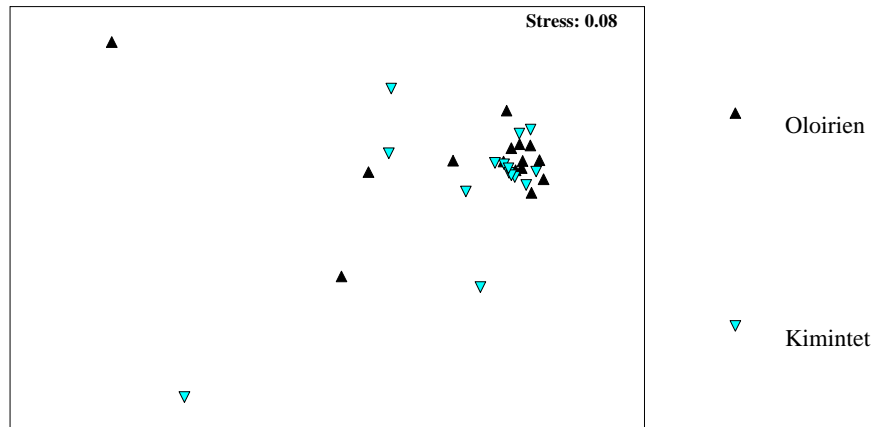

Figure 3: Species similarity

Jaccards similarity index

To understand the contribution of particular transects to the similarity entire Nyekweri forest, Jaccards similarity indices obtained by pairing transects against each other were analyzed. In average, species similarity between transects was very low as indicated by the Jaccards index. Jaccards index was derived by comparing the differences between species unique to each transect and present in both transects being paired. Species present in both areas were termed as ‘common’ whereas the sum of

species unique to each were termed as ‘different’. Transect T3 (Oloirien) and T4 (Kimintet) had the highest similarity, with a Jaccards index of 50. Transects T1 and T2, both oriented to Oloirien had the least species similarity with an index of 13.5. Oloirien block portrayed high human disturbances supporting similar studies where disturbances have been observed to stimulate regeneration of varied species through intermediate succession stages (Chadzon 1998, Hobbs and Huenneke 1992 and Fox 1979)

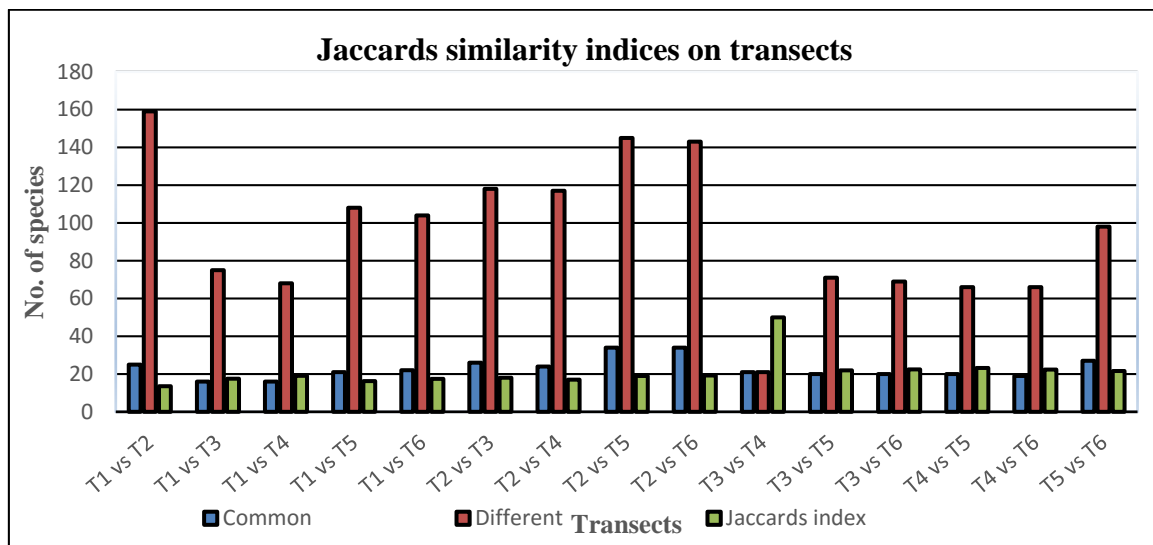

Figure 4: Jaccards similarity indices on transects

Overall, 136 species were found to be unique to Oloirien, a notably high number compared to 75 unique to Kimintet. Only 56

species were found to occur in both blocks. The jaccards similarity between the two sides was a low 20.9

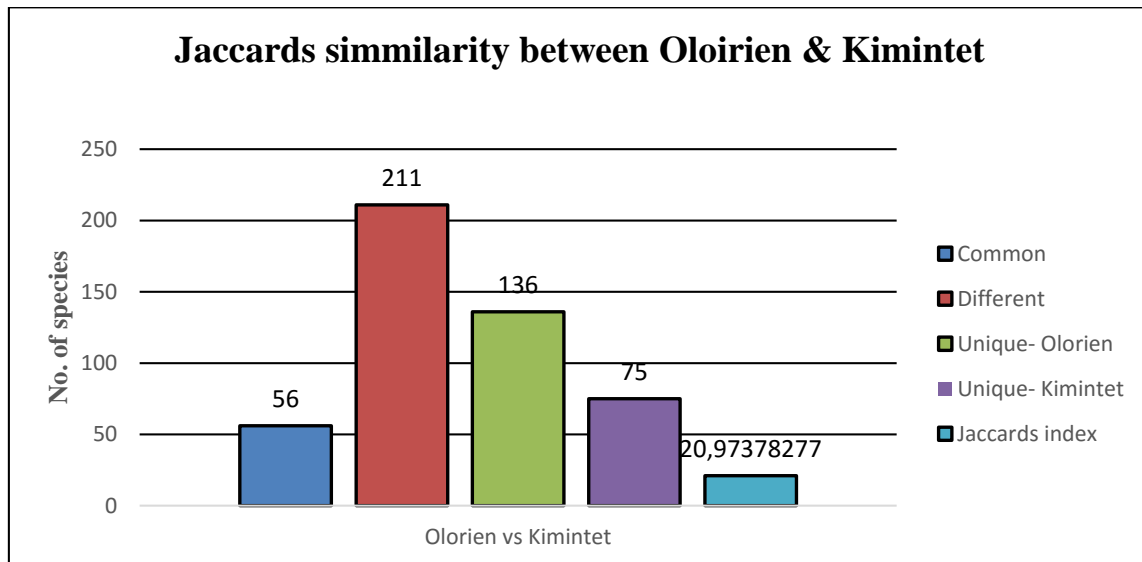

Figure 5: Jaccards similarity between Oloirien and Kimintet

Species accumulation curve

From the recorded species, species accumulation curve was generated to test the adequacy of selected samples. The curve did not reach an asymptote, an indication that the 30 sample points were not adequate to effectively yield enough species to represent the actual diversity of Nyekweri. During the survey, herb diversity or annual herbs were

rarely encountered due to the prolonged drought and considering the vast nature of Nyekweri forest. In an ecosystem, there are always unique species that are known to occupy specialized microhabitats. The short duration of the work could not allow intensive venture into these habitats.

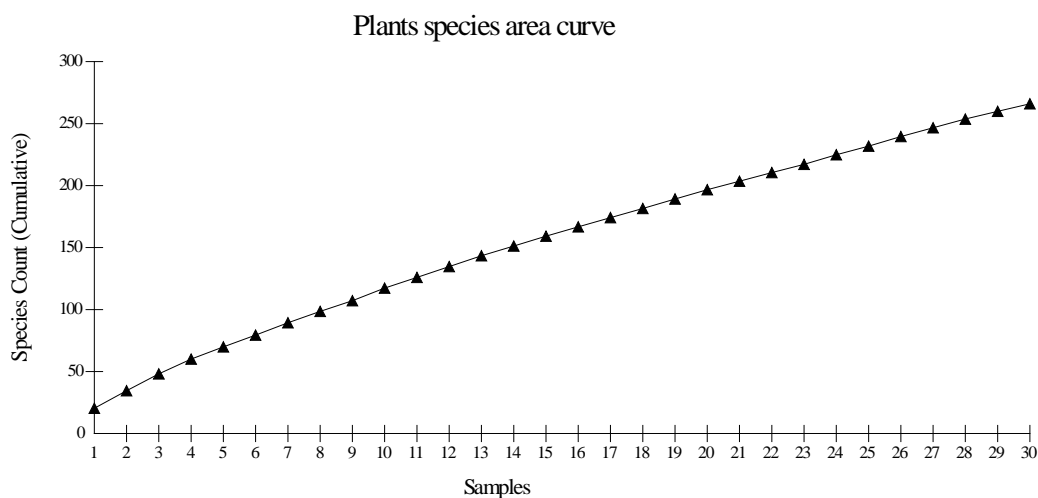

Fig 6: Species accumulation curve

Botanical uniqueness

Among the recorded species were a few with botanical significance. Fourteen orchid species were encountered, an indication of the moist nature of Nyekweri forest. Importantly, all Kenyan orchids are protected and restricted for trading by CITES (Convention on International Trade in Endangered Species). Apparently, a bulk of these were recorded within settlement areas in the Kimintet side. Being in an area exposed to human interference puts these valuable plants at risk of elimination as orchids are known to have high sensitivity to environmental changes.

Carpolobia goetzei, a shrub was encountered during the assessment, a first record for the K6 floral region. Botanists have partitioned Kenya into 7 floral regions and Transmara and its surroundings, including Mau Forest Complex is the 6th region. This species is known to be a predominantly K7 plant; the region that covers the Kenyan coastal although it is reported to have been collected only once in Port Victoria, the K5 zone (Beentje, 1994). Other first records for the K6 region which were recorded in Nyekweri forest included, *Oeceoclades ugandae* (an orchid), *Oxyanthus goetzei* ssp *keniensis* (also a Kenyan endemic). Herbarium specimen of *Pristimera polyantha* collected became the third ever collection from the vast region. This work was therefore a significant contributor towards botanical documentations in plant distribution.

From known plants knowledge and as observed during the expedition, some of the most threatened species of Nyekweri forest were identified. They included *Olea capensis*, *Olea europaea* and *Elaeodendron buchananii* that are being massively debarked, probably for medicinal use and hive protection. *Diospyros abyssinica* was being massively felled in Kimintet for charcoal burning. Other rare plants such as *Margaritaria discoidea* and *Fagaropsis angolensis* were being targeted for their valuable timber. *Vepris nobilis* on the other hand was being uprooted for the purpose of making the popular Maasai club (Rungu). The swollen underground root area is being preferred for the best of these products.

Forest structure

tree population structure

In each of the sample plots, diameters of trees that exceeded 5cm were measured in order to evaluate the extent of dominance and their succession trend through the various growth stages. The diameters at breast height (DBH) were then classified into categories at class intervals of 5cm then represented in a dendrogram. The graph shape depicted an inverse J shape, an interpretation that there exists a fairly positive succession. The high species diversity and high abundance of indigenous tree saplings and seedlings is very encouraging in terms of conservation efforts. In such a situation, given minimal anthropogenic interference, the forest can regenerate itself-sustainably over long a period owing to the high regeneration potential.

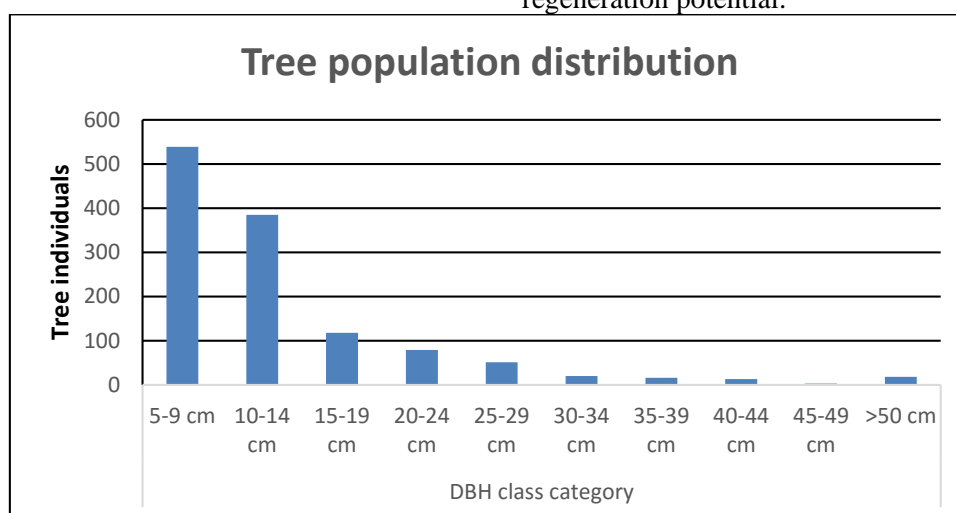

Figure 7: Tree population distribution

In the other hand on comparing the two territories, Kimintet had fewer numbers of individuals on the lowermost diameter categories. During the survey, we noticed a lot of human activities that can be linked to the destruction of younger plants, which are naturally in their most fragile stages. Despite

the noted destruction that included uprooting and general clearing, more of larger diameter plants were found in Kimintet. This was attributed to the high levels of disturbance and selective removal of trees for timber, charcoal and construction material in the Oloirien side of the forest block.

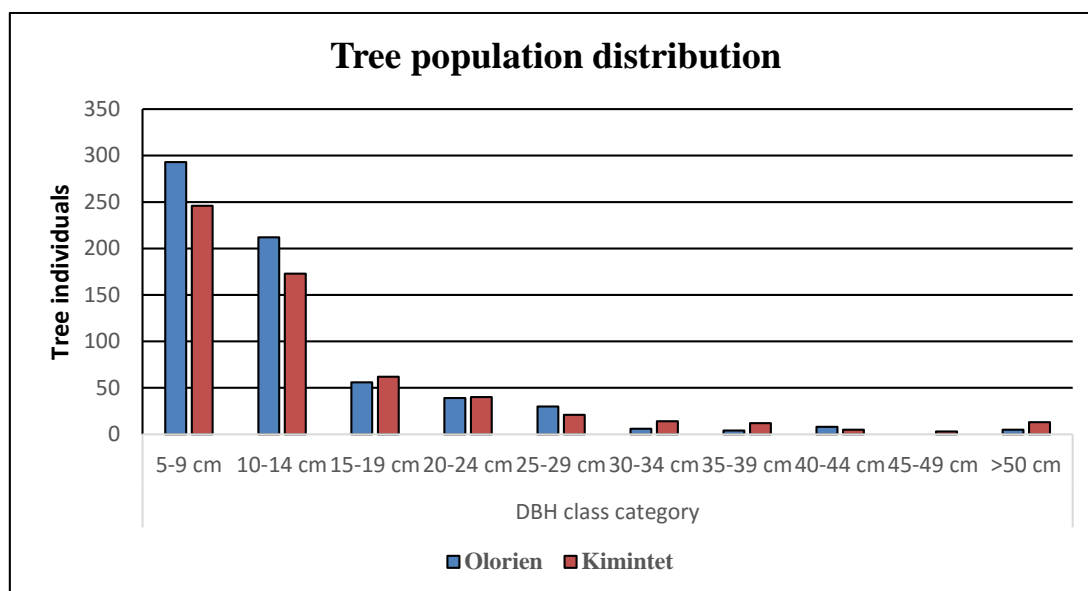

Figure 8: Tree population distribution

Tree canopy structure

In all sampled transects, mid canopy (10-20 meters) was the most dominant. This layer was almost entirely composed of *Trichocladus ellipticus*, which grows as a scrambling tree. It has a high coppicing and multi-stem habit that ensures its outstanding dominance. Tall trees making up the uppermost canopy as well as other trees exceeding 5 meters height were more dominant in Oloirien than in Kimintet. In

transect T3 (Oloirien), upper canopy was highest when compared to other transects. In the contrary, transect T4 (Kimintet), which is adjacent to T3 had an insignificant upper canopy. Shrubs and herbs dominated Transect T4 more than in any other transect. Overall, shrubs and herbs dominated in Kimintet block. This was attributed to the high level of disturbance as observed by (Chadzou 1998, Hobbs and Huenneke 1992 and Fox 1979)

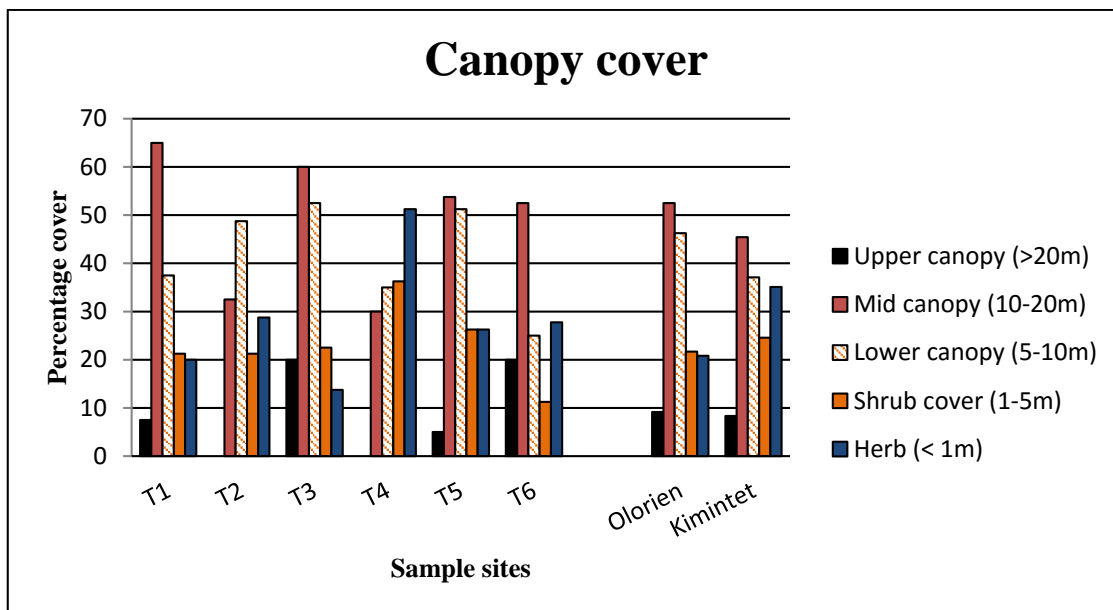

Figure 9: Canopy cover

Height structure

On average, the tree height at Nyekweri forest was 11 meters. Transect T6 on the Kimintet side had the tallest trees and was the only site with an average height exceeding 12 meters. Overall, Olorien was slightly short statured compared to Kimintet. Transect T4 (Kimintet) had the shortest trees. During sampling, we observed that two factors- human settlement and natural phenomenon- were responsible for the observed shortness. In the latter, prevailing

vegetation type towards the forest periphery was predominantly grassed woodland. Besides, there were several natural glades oriented to this transect. In all sites, tall trees included *Diospyros abyssinica*, *Olea europaea*, *Drypetes gerrardii* and *Turraea holstii*. Median height between seven and ten meters was dominated by *Trichocladus ellipticus*. Nyakweri forest can be classified as a typical dryland forest and hence the recorded heights were within documented ranges.

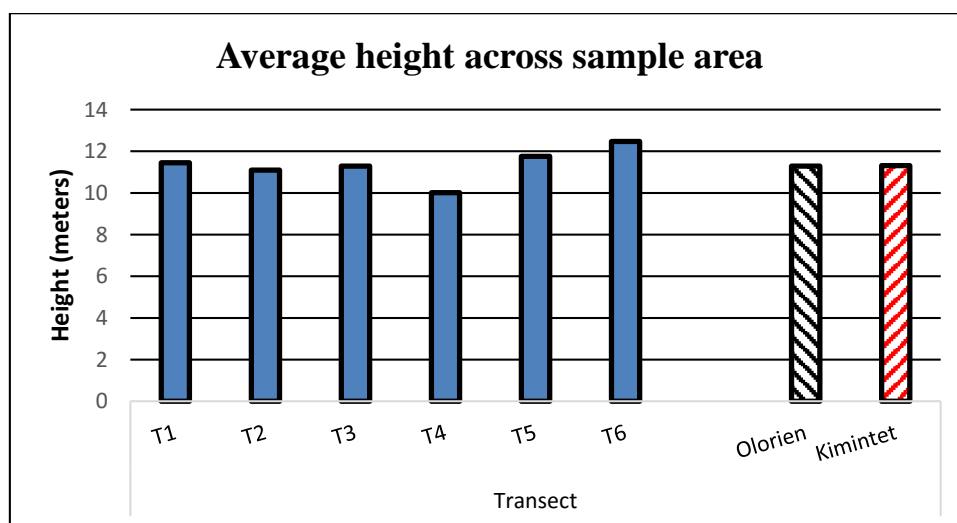

Figure 10: Average height across sample area

Tree density, dominance and regeneration

Having recorded all trees with diameters exceeding 5cm in all the 24 plots, an assessment of their density was done. Twenty species of trees constituted the forest structure. Oloirien side had a higher tree density than Kimintet. *Trichocladus ellipticus* had the overall top density of 67% and accounted to an estimated 868 individuals

per hectare. It also had the highest dominance of 88%, occupying an area of the ecosystem nearly 5800M². Other densely distributed species included *Diospyros abyssinica*, *Euclea divinorum*, *Drypetes gerrardii* and *Turraea holstii*. Of the trees with outstanding densities all but *E. divinorum* were more in Oloirien.

Table 2: Tree density per ha (M²)

	Density/Ha (m2)		
	Overall	Kimintet	Oloirien
<i>Trichocladus ellipticus</i>	868.75	777.08	960.42
<i>Diospyros abyssinica</i>	118.75	100.00	137.50
<i>Euclea divinorum</i>	65.63	77.08	54.17
<i>Drypetes gerrardii</i>	52.08	41.67	62.50
<i>Turraea robusta</i>	45.83	39.58	52.08

Based on the enumerated seedlings, *T. ellipticus*, *D. gerrardii* and *V. nobilis* were found to be actively regenerating. In each hectare of Nyekweri, it is estimated that over 24,000 seedlings of the dominant *Trichocladus ellipticus* alone is likely to be encountered. Taking the season during sampling as constant, a projected 60,000

seedling of 21 species can be found. Although more seedlings were found in Oloirien, its diversity was lower than in Kimintet. Nyekweri forest was found to have a very healthy regeneration trend despite the prevalent habitat threats, a good indicator for conservation through natural regeneration

Table 3: Summaries of some of the analyzed parameters

	Tree den/ha	Tree basal area (M2)	Seedlings Den/ Ha	Seedlings diversity (H')
Kimintet	1227.08	5,677.19	46,250	1.82
Oloirien	1360.42	5,631.87	70,000	1.75
Overall	1293.75	22,618.02	58,125	1.84

Conclusion

The biodiversity assessment identified plant species of Nyekweri forest that will offer an important baseline upon which to continuously monitor changes in biodiversity trends. The high disturbance levels witnessed in Oloirien side of Nyekweri forest poses a serious threat to the survival of the forest and its biodiversity resources and has impacted negatively on the tree species diversity.

This scenario presents an opportunity for regeneration owing to the fact that there is sufficient seedling and sapling stocks, an

indication that without further disturbance, the forest may regain their status.

References

- Beentje H.J., 1994. Kenya, Trees, Shrubs and Lianas. National Museums of Kenya, Nairobi
- Danoff-burg J, Xu C. 2008. Measuring Biological Diversity. <http://www.columbia.edu/itc/cerc/dunoffburg/MB D/LINK.html> (accessed on 15th April 2008).
- Chazdon RL.1998. Tropical forests - Log 'Em or Leave 'Em? Science, 281: 1295–1296.
- Fox JF. 1979. Intermediate-Disturbance Hypothesis. Science, 204: 1344–1345
- Foley JA, Asner GP, Costa MH, Coe MT, DeFries R, Gibbs HK, Howard EA, Olson S, Patz J, Ramankutty N, Snyder P. 2007. Amazonia revealed: forest degradation and loss

of ecosystem goods and services in the Amazon Basin. *Ecological Society of America, ESA online Journal*, 5: 25–32.

Gaines WL, Harrod RJ, Lehmkuhl JF. 1999. *Monitoring Biodiversity: Quantification and interpretation*. USDA Forest Service. Pacific North-west Research Station. General Technical Report, PNW-GTR-443.

Govaerts R., 2001. How many species of seed plants are there?. *Taxon* 50 (4): 1085-1090.

Hobbs RJ, Huenneke LF. 1992. Disturbance diversity and invasion: implications for conservation. *Conservation Biology*, 6: 324–337

Howe HF, Smallwood J. 1982. Ecology of seed dispersal. *Annual Review of Ecology Evolution and Systematics*, 13: 201–218.

Krebs CJ. 1989. *Ecological methodology*. New York: Harper and Row publishers, 550pp.

Kremen C, Williams NE, Aizen MA, Gemmill-Herren B, LeBuhn G, Minckley R, Packer L, Potts SG, Roulston T, Steffan-Dewenter I, Vázquez DP, Winfree R, Adams L, Crone EE, Greenleaf SS, Keitt TH, Klein A-M, Regetz J, Ricketts TH. 2007. Pollination and other ecosystem services produced by mobile organisms: a conceptual framework for the effects of land-use change. *Ecology Letters*, 10: 299–314.

Krishnaswamy A, Hanson A. 1999. *Our forest our future*. Summary Report of the World Commission on Forest and Sustainable Development. World Commission on Forests and Sustainable Development. Manitoba, Canada.

<http://www.iisd.org/pdf/wcfsdsummary.pdf>
(Accessed 9th March, 2008)

Laurance WF, Nascimento HEM, Laurance SG, Andrade A, Ribeiro J, Giraldo JP, Le Maitre DC, van Wilgen BW, Gelderblom CM, Bailey C, Chapman RA, Nel JA. 2002. Invasive alien trees and water resources in South Africa: case studies of the costs and benefits of management. *Forest Ecology and Management*, 160: 143–159.

Lou J. 2006. Entropy and Diversity. *Oikos*, 113(2): 363–375.

Magurran AE. 1988. *Ecological Diversity and its Measurement*. Princeton: Princeton University Press, 192 pp.

Senbeta F, Teketay D, Näslund B-A. 2002. Native woody species regeneration in exotic tree plantations at Munessa-Shashemene forest, Southern Ethiopia. *New Forests*, 24: 131–145.

SPSS 2006. *SPSS 15 for windows*. Release 15.0.0 SPSS Inc., Chicago.

Scott DF, Lesch W. 1997. Streamflow responses to afforestation with *Eucalyptus grandis* and *Pinus patula* and to felling in the Mokobulaan experimental catchments, South Africa. *Journal of Hydrology*, 199: 360–377.

Evaluation of Forest Villagers' Perceptions about Protection Activities in Kastamonu Region and Their Integration Possibilities to Forest Planning

*Gonca Ece ÖZCAN¹, Oytun Emre SAKICI²

¹Kastamonu University, Faculty of Forestry, Department of Wildlife Ecology and Management, Kastamonu/TURKEY

²Kastamonu University, Faculty of Forestry, Department of Forest Engineering, Kastamonu/TURKEY

*Corresponding Author: goncaece@kastamonu.edu.tr

Abstract

Forests, which are one of the most important renewable natural resources, are managed by taking economical, ecological, social and cultural functions into consideration. The forests inside the planning units are planned according to management purposes determined by these main functions and the mentioned utilizing activities are carried out considering these plans. Planning applications, based on the principle of sustainability, are realized by a participatory approach where the opinions of all stakeholders who are related to forests are considered. Forest protection priorities and relations of forest villagers, who are one of main stakeholders of forest management, with the surrounding forests, are very important in terms of protection activities, which are required to be practices in relation to sustainability principle. The participation levels of forest villagers on planning of forests and their perceptions and expectations related to forests have an important place in forest protection. In this study, it is aimed to identify and evaluate the perceptions related to protection activities carried out regarding the forests surrounding the forest villagers of Kastamonu region. Face to face interviews were made with 1281 forest villagers living in 283 forest villages chosen from the 19 districts of Kastamonu province. In this context, the threats deemed important for the forests of region and expected to be taken precaution by the forest villagers were evaluated. Besides that, determinations were made towards the opinion and expectations on whether the protection activities that needs to be carried out by Forest Enterprises are carried out or not, these protection activities are sufficient or not and what these protection activities should be. Within the scope of the study, the relations between the recent changes observed in forest areas and protection activities were tried to be revealed from the viewpoint of forest villagers. The changes of obtained findings according to Forest Enterprises were tried to be explained according to demographical attributes of survey participants. After that, integration possibilities of the perceptions determined in this study were evaluated for forest planning.

Keywords: Forest protection, Forest villager, Forest planning, Kastamonu

Kastamonu Yöresi Orman Köylülerinin Koruma Faaliyetleri Algısının ve Orman Planlamaya Entegrasyon Olanaklarının Değerlendirilmesi

Özet

En önemli yenilenebilir doğal kaynaklarından olan ormanlar ekonomik, ekolojik, sosyal ve kültürel fonksiyonları dikkate alınarak işletilmektedir. Planlama üniteleri içerisindeki ormanlar bu ana fonksiyonlara göre belirlenen işletme amaçları doğrultusunda planlanmakta ve söz konusu işletmecilik faaliyetleri bu planlara bağlı olarak yürütülmektedir. Sürdürülebilirlik ilkesinin esas alındığı planlama uygulamaları, işletilecek ormanlarla ilgisi bulunan tüm paydaşların görüşlerinin dikkate alındığı katılımcı bir yaklaşım ile gerçekleştirilmektedir. Ormanlara ilişkin koruma öncelikleri ve orman işletmeciliğinin temel paydaşlarından olan orman köylülerinin çevrelerindeki ormanlarla olan ilişkileri sürdürülebilirlik ilkesine bağlı olarak uygulanması gereken koruma faaliyetleri açısından oldukça önemlidir. Orman köylüsünün ormanlarla ilgili algı ve beklentileri ile ormanların planlanması ve işletilmesindeki katılımcılık düzeyleri ormanların korunmasında önemli bir yere sahiptir. Kastamonu yöresi orman köylülerinin çevrelerinde bulunan ormanlarla ilgili yürütülen koruma faaliyetlerine ilişkin algılarının tespit edilip değerlendirilmesinin amaçlandığı bu çalışmada Kastamonu iline bağlı ilçelerin 19'unda bulunan köyler arasından seçilen 283 orman köyünde yaşayan 1281 orman köylüsü ile yüz yüze anket yapılarak elde edilen veriler kullanılmıştır. Bu kapsamda orman köylülerinin yaşadıkları bölgelerdeki ormanlarda önemli gördükleri ve öncelikli olarak önlem alınmasını bekledikleri tehlikeler değerlendirilmiştir. Bunun yanında, bağlı oldukları Orman İşletme Müdürlükleri tarafından yürütülmesi gereken koruma faaliyetlerinin yapılıp yapılmadığı, gerçekleştirilen koruma faaliyetlerinin ise yeterli olup olmadığı ve koruma faaliyetlerinin neler olması gerektiği konusundaki görüş ve beklentilerine yönelik tespitler yapılmıştır. Çalışma kapsamında ayrıca son yıllarda orman varlığında gözlenen değişimler ile koruma faaliyetleri arasındaki ilişkiler orman köylüsünün gözüyle ortaya konulmaya çalışılmıştır. Elde edilen bulguların, ankete katılanların demografik özelliklerine ve Orman İşletme Müdürlüklerine göre değişimleri de açıklanmaya çalışılmıştır. Ayrıca, çalışma sonuçlarının orman amenajman planlarına entegrasyonu olanakları da değerlendirilmiştir.

Anahtar kelimeler: Orman koruma, Orman köylüsü, Orman planlama, Kastamonu

Introduction

One of the renewable and sustainable natural resources, forests are natural resources providing economic, ecological and socio-cultural benefits in combination. Forests has important functions, primarily economic services such as wood raw material and non-wood forest products production, as well as ecological services such as protection of nature, prevention of erosion, protection of biodiversity, storing carbon, protection of water and protection of earth and socio-cultural services such as ecotourism, recreation, potable water supply, work opportunities for forest villagers. The planning of the world's forests were made as to 34,1% for production, 33,8% for multi-purpose benefits, 11,7% for protection of biological diversity, 9,3% for protection of earth and water, and 3,7% for social services (Anonymous, 2013a). As for Turkey, 50% of the forests were operated according to economic, 42% ecological and 8% socio-cultural functions (Anonymous, 2015).

The forests of West Black Sea Region, constituting about 13% of Turkey forests and this ratio increases to 18% when normal crown closure forests are considered. Total area of Kastamonu province, which has an important place in the region in terms of forestry activities, is 1.339.223 ha overall, with 892.102 ha forest and 447.121 ha open area, and 66.6% of the province consists of forests. This ratio is quite above the ratio of Turkey's forests to the area of the country (28.6%) (Anonymous, 2015).

In human-environment relationship, forest-villager relationship has an important place and a significant amount of population in Turkey lives dependent of forests (Solmaz, 2007). The relationship of forest villagers with the forests has begun with irregular utilizing of forests for centuries long, reached the amounts today (İnce and Tolunay, 2009), and still intensely continues.

Forest village and forest villager definitions were based on the legal foundations. According to "*Basis and Procedures on Forest Villagers Development Services*" published on Official Gazette dated 31.12.2005 and numbered 26040, the definition of forest village is a village inside or adjacent to forest; forest villager is public resident of these villages and registered in the

civil registry for these villages. Previously divided into two groups as "in-forest village" and "adjacent to forest village", forest villages were gathered under one name as "Forest Village" in accordance with "*Regulations on Activities to Support Development of Forest Villagers*" published in Official Gazette dated 13.06.2012 and numbered 28322. According to the data of 2015, there are 22.343 forest villages present in Turkey and 7.096.483 forest villager are living in these villages (Anonymous, 2016).

In Turkey, forest villagers live by limited resources and in generally closed economic conditions such as lack of infrastructure, divided agricultural lands, etc. (Anonymous, 1997). These villagers, living closely with forest resources depending on their local cultures and habits developed from past to present, have utilized forest resources for their livelihoods (Durkaya et al., 2013). The majority of human-based damage in the forests is made by the forest villagers living in the region (Şen, 2002). Solmaz (2007), reports that forest villagers cause pressures on the forest resources that may end up with negative results, and usually irregular, insensible and uncontrolled utilizing of forests is in question (Özcan et al., 2011). Despite the positive results of the studies performed by General Directorate of Forestry, aiming to remove the poverty of forest villagers (Solmaz, 2007) and legal regulations on the utilization of forests by forest villagers, forests are continue to be damaged (Avcı, 2005; Tolunay and Korkmaz 2005).

In Anonymous (2013a), it was emphasized that "sustainable forest management proposes to guarantee biological diversity, efficiency, renewability and life energy, potential ability to perform ecological, economic and social functions of forests and forest areas, now and in the future, against any threats and hazards, in local, national and international levels". Protection of forests and at the same time planning and management of forest resources for society to utilize them optimally, are important in development of the country (Şenyaz et al., 2005). In management of these resources, solutions should be found to the problems between the forest administration and forest villagers by considering the life styles and beliefs of forest villagers (Durkaya

et al., 2013). Besides all these, the positive direction in the forest-public relationship is quite effective in protection of forests (Uslu and Enez, 2002).

Planned through classic planning approach up to 2000's, the forests of Turkey have begun to be planned through functional planning approach from the beginning of 2000's. Different from classic planning, functional planning aims to have all the interest groups such as forest administration, non-governmental organizations and forest products/services consumers and users, that have a relation with forest resources to participate to the planning process (Yılmaz et al., 2015). Ensuring participation of the mentioned interest groups is quite important for the effective and sustainable forest management (Daşdemir and Güngör, 2010). According to "Forest Management Regulation" published on Official Gazette dated 05.08.2008 and numbered 26778 and still in effect, forest management plans are required to be regulated according to participation basis. Taking the local public which also includes forest villages in interest groups into consideration is quite important in terms of protection of forests. Because, forest villagers whose expectations and opinions are taken into consideration in planning are an important helper in achieving the protection objectives of forest administration. Revealing the perceptions on forests which subject to planning and any kind of forestry activities performed in these forests, awareness in such matters and expectations of forest villagers, like all the partners who were asked their opinions in preparation of forest management plans according to functional planning principals, will also contribute to the process of preparation of plans.

The forest existence in Turkey which was 20,2 million ha in 1973 reaching 22.3 ha today shows the total forest area of the country had considerable increase but the human pressure on the forests still continues. While the forest area per person in the world is 0,60 ha (Keenan et al., 2015) , the forest area per person is about 0.28 ha in Turkey, which has 22,3 million ha forest existence and 78,7 millions of population according to 2015 survey and General Directorate of Forestry. As for Kastamonu, which has a total forest

area of 892.102 ha and a population of 372.633 according to 2015 survey, this number is 2,39 ha/person. As it is understood from the numbers, despite Turkey average being about half as world average, Kastamonu average is about 4 times to the world average and about 8,5 times to Turkey average.

In Kastamonu, due to both the number of forest villages and the population living in forest villages being high and the main livelihood of this population is the forest, forest villagers providing an organic integration with the forests in ensuring protection and sustainability of forests, which are one of the renewable natural resources, stands out. Forest villagers' life styles, activities, awareness levels, viewing points towards forest and determination of their roles in protection of forests have a great importance. In this context, revealing the perceptions and expectation of the forest villagers living within Kastamonu about the threats which considered important and expected measures to be taken with priority and protection activities to be performed by relevant Forest Enterprises and their competence levels are the main purpose of this study. Besides, evaluation of integration possibilities of mentioned perceptions of forest villagers which are one of the main partners of the participatory approach to planning of forests is another purpose of this study.

Material and Method

This study was performed on the forest villagers living in forest villages of Kastamonu province. According to 2015 statistics of General Directorate of Forestry, there are 22.343 forest villages in Turkey and 1.035 of these are in Kastamonu and there are 7.096.483 forest villagers living in Turkey general and 141.935 in Kastamonu (Anonymous, 2016).

Data obtained within scope of the study were provided by conducting face to face interviews with the forest villagers living in forest villages of Kastamonu. In determination of the minimum number of forest villages to be sampled and number of forest villagers to be interviewed, the following sample calculation equation was utilized.

In this equation; n: Sample size, N: Total size (Forest village=1035, Forest villager=141.935 people), CV: Coefficient of variation (used as 50% since society variation is unknown), t: Student's t table value for proposed confidence level (for 95% confidence level t=1,96) and E: Accepted sampling error (5%).

$$n = \frac{N(CV^2 t^2)}{NE^2 + CV^2 t^2} \quad (1)$$

According to calculations performed, the number of forest village to be sampled was determined as 281 and the number of forest villager required to be interviewed was determined as 384. These calculated numbers represent the minimum number of samples required to be sampled from the society according to proposed error level. Increasing these numbers will improve the reliability of the study.

Survey applications were made with the forest villagers living in the forest villages within Kastamonu province of Kastamonu Regional Directorate of Forestry covering two provinces as Sinop and Kastamonu. For this purpose, surveys were made with 1281 forest villagers through face to face interviews in the 283 forest villages of 15 Forest Enterprises out of 16 total, excluding Samatlar Forest Enterprise. The number of sampled forest village is near the calculated sample number and corresponds to 27,3% of the forest villages located in the province general. As for the number of forest villagers surveyed, it was kept a lot higher than the determined number due to the size of study area and to improve the reliability of the obtained results. The distribution of forest villages sampled and forest villagers surveyed according to Forest Enterprises was given in Table 1. Despite a survey could not be made in forest villages affiliated with Samatlar Forest Enterprise within borders of Araç district, inclusion of a number of forest villages (32) affiliated with Araç Forest Enterprise, which falls into same district borders removes this deficiency.

In the study, required forest areas about current and previous periods related to the Forest Enterprises were taken from forest management plans prepared for current and previous planning periods for Forest

Management Planning Units in each enterprise. However, some past numerical values of Taşköprü and Hanönü Forest Enterprises, which were one enterprise integrated as Taşköprü Forest Enterprise until 2011, not being available separately have forced the evaluation of Taşköprü and Hanönü Forest Enterprises as a whole.

Table 1. Distribution of surveys conducted according to Forest Enterprises

Forest Enterprises	Sampled Forest Villages		Surveyed Forest Villagers	
	Number	%	Number	%
Araç	32	11,3	107	8,4
Azdavay	5	1,8	44	3,4
Bozkurt	17	6,0	113	8,8
Cide	18	6,4	151	11,8
Çatalzeytin	5	1,8	66	5,2
Daday	25	8,8	95	7,4
Hanönü	18	6,4	50	3,9
İhsangazi	12	4,2	30	2,3
İnebolu	20	7,1	97	7,6
Karadere	18	6,4	52	4,1
Kastamonu	20	7,1	95	7,4
Küre	39	13,8	93	7,3
Pınarbaşı	21	7,4	80	6,2
Taşköprü	19	6,7	162	12,6
Tosya	14	4,9	46	3,6
Total	283	100	1281	100

Data obtained from the surveys made were transferred into a data file and statistical evaluations were made in evaluation of the results. Frequency tables were utilized in revealing of various demographical characteristics of forest villagers who have participated in the survey. Besides, the relations of the various characteristics that were queries within scope of the study were analyzed with the help of Chi-square Test. Statistical analyses were performed with the help of IBM SPSS Statistics 20 package.

Results and Discussion

In this study, the view point of forest villagers living in Kastamonu, which has an important place in terms of forestry in Turkey and forestry activities have an important place, to the protection of forests and protection activities were evaluated with the help of data obtained from the surveys made with them. For this purpose, sufficient number of villages (283) were determined from the forest villages located in study area and interviews were made with sufficient number of forest villagers (1281 in total) living in these villages.

Distribution of the forest villagers participated in the survey according to age, gender, marital status, education, job and income level were given in Table 2.

When Table 2 is examined, it is understood that 91,6% of the participants were between ages 18 and 65 and had the capability of labor. Median age of Kastamonu province is 37,2 (URL-1, 2016). Median age of the forest villagers participating in the survey is 45 and was found 21% higher than of Kastamonu province. When the distribution for gender is checked, 92,1% of the participants are male and 7,9% are female. Whatever the development level, women has an important role in agriculture and rural development in many countries of Asia-Pacific Region (Prakash, 2002). Despite the important role in the economies of developed and developing countries (Anonymous, 2008), it is understood that women are more abstaining and hesitant in contributing to the study. It was determined that 83,6% of the participants were married and 16,4% were single. Besides, it was also obtained that more than half of the participants were primary school graduates (57%) and 3% have university diplomas, but however, more than 10% didn't even have primary school diplomas.

Table 2. Demographical characteristics of forest villagers participated in survey

Demographical characteristics	Group	n	%
Age group	18-30	221	17,3
	31-50	599	46,8
	51-65	354	27,6
	over 65	107	8,4
Gender	Male	1179	92,0
	Female	102	8,0
Marital status	Single	210	16,4
	Married	1071	83,6
Educational status	Illiterate	38	3,0
	Literate	97	7,6
	Primary school	730	57,0
	Middle school	238	18,6
	High school	140	10,9
	University	38	3,0
Job	Employee	279	21,8
	Officer	48	3,7
	Retired	240	18,7
	Self-employed	234	18,3
	Farmer	367	28,6
	Unemployed	113	8,8

Table 2 (continued)

Demographical characteristics	Group	n	%
Income level (Turkish Lira, TL)	below 500 TL	434	33,9
	500-1.000 TL	459	35,8
	1.000-1.500 TL	236	18,4
	1.500-2.000 TL	101	7,9
	over 2.000 TL	51	4,0

When the data on the Table 2, regarding the jobs and income levels of the participants are examined, it is understood that the participants lived on agriculture most (28,6%) and this is followed by those living on employment and retirement incomes, but 8,8% were unemployed. These findings correspond with the information of the livelihood of the forest villagers in Kastamonu are mostly forestry, livestock and a bit of agriculture, expressed by Uslu and Enez (2002). The income of more than half of the participants (69,7%) is below 1.000 TL. Solmaz (2007) reports that the living standards of the forest villagers is below than Turkey average, even than rural region average. Poverty line, which was established by using 40% of available median income of equivalent household for 2015, is 4,997 TL (URL-1, 2016), hunger limit is 1.385,26 TL (URL-2, 2016).

According to these numbers, almost all of the participants try to live under

poverty line and 70% below hunger limit. Korkmaz and Alkan (2015) also report that forest villagers living in Turkey were poor.

When the participants were asked which of the hazards classified as (i) beetle damage, (ii) illegal cutting, (iii) overcutting, (iv) forest fire, (v) erosion and (vi) unawareness were considered as most important regarding the forests in their environments, 72,3% (926 people) of them replied with forest fire, 11,9% (152 people) erosion, 10,5% (135 people) beetle damage, again 10,5% (134 people) illegal cutting, 9,3% (120 people) overcutting and 2,1% (27 people) unawareness. The dependence of forest villagers on forest resources cannot be denied where the rural population is quite high

in Turkey. Accordingly, despite many legal regulations made by governments for long years, crimes such as illegal cutting and pasturage cannot be fully prevented (Tolunay and Korkmaz, 2005).

The mentioned threats are also seen by forest villagers participating to study as factors threatening the forests. According to the Chi-square test results, the answers regarding the most important hazards for forest villagers were identified significantly different according to the Forest Enterprises ($p < 0,05$). In all of the Forest Enterprises evaluated, forest fire is considered as the most important threat in ratios varying between 50% to 72,2%. When the Forest Enterprises where the study was conducted are evaluated according to the forest fire risk map given in Anonymous (2013b), Forest Enterprises in coastal regions (Cide, İnebolu, Bozkurt ve Çatalzeytin) fall into 4th degree, other enterprises fall into 2nd or 3rd degree forest fire risk groups. Forest fires considered as one of the most important threats even in the villages that are affiliated with Forest Enterprises within low risk group shows that sensitivity of the participants in this matter are high. As second degree important threats, forest villagers from Çatalzeytin, Hanönü, Pınarbaşı and Tosya Forest Enterprises consider beetle damage, from Azdavay, Cide, İnebolu and Tosya Forest Enterprises consider illegal cutting, from Araç, Daday, Kastamonu and Karadere Forest Enterprises consider overcutting and from Bozkurt, İhsangazi, Küre and Taşköprü Forest Enterprises consider erosion (Figure 1). According to Forest Enterprises, even though the priority order of the threats other than forest fire differ, being aware of the threats found in the surrounding forests and known by forest administration, except overcutting, shows that they are sensible about the matter. Besides, intensive production activities by forest administration are considered as overcutting by the forest villagers. However, Kastamonu forests are managed areas where wood raw material function is intense and production is made in accordance with the plans made by considering the sustainability and renewability of the forest ecosystem.

Continuous production depending on the forest management plans causes forest villagers to perceive this situation as a threat to the existence of forests.

While 74,8% of participants (958 people) consider the forests in the region they live are protected by Forest Enterprises, 7,9% (101 people) consider the forests are not protected and 17,3% (222 people) consider the forests are partially protected. According to the Chi-square test results, this perception differs for Forest Enterprises ($p < 0,05$). All the participants in the villages within Çatalzeytin and İhsangazi Forest Enterprises consider that forests in their surroundings are protected, while 31,3% of participants in Pınarbaşı Forest Enterprise consider forests are not protected. The ratio of those who consider the forest are protected (52,2%) is the lowest in Bozkurt Forest Enterprise among all the Forest Enterprises, also in the same enterprise the ratio of those who consider they are partially protected (43,4%) is the highest. This can be interpreted as the participants from Bozkurt Forest Enterprise do not consider protection activities as sufficient. It is not possible to evaluate all the activities performed in the forests, which most of them having benefits and functions in numerous amounts and are primarily a resource themselves, apart from forest villagers. The efforts directed to identification and prevention of current and future situations that may pose a threat are also under the control of forest villagers.

Forest Enterprises and the affiliated Forest Management Planning Units are taking necessary preventive and response measures in the forests they are responsible of. It is known that sufficient protection is made for all of the Kastamonu Regional Directorate of Forestry, which also includes study area. When the perception status of participants for these protection activities were evaluated, 92,1% are observed to perceive correctly. When the perception in question is evaluated according to Forest Enterprises, it can be said that the perception ratios of this perception vary between 68,8% and 100,0%, and even in Pınarbaşı Forest Enterprise villages, where the

correct perception is at the lowest level, more than half of the participants perceptions are correct.

When the participants are queried about the sufficiency of protection activities implemented by Forest Enterprises, 63,3% (735 people) consider the protection is sufficient, 9,5% (110 people) consider insufficient and 27,2% (316 people) consider partially sufficient. This perception also differs according to the Forest Enterprises ($p < 0,05$). 93,9% of the participants in the villages of Çatalzeytin Forest Enterprise consider the protection is sufficient in the highest level, and participants of Pınarbaşı Forest Enterprise consider the protection is not sufficient in the highest level with a ratio of 20,4% (Figure 2).

As a result of the Chi-square tests performed to reveal the effects of ages and education levels of participants on the awareness about the protection activities carried out by Forest Enterprises, neither criteria were effective on the mentioned awareness ($p > 0,05$). It was identified that the ratio of correct perception of protection activities of the participants aged 51 and above was 94% and this ratio was 92,3% at 18-30 age group and 90,5% at 31-50 age group. When the education levels were evaluated, it was seen that the awareness of the uneducated group was at the lowest level with 84,2% and all the other education levels were above 90%. Although the age and education levels of forest villagers prominently do not affect the perceptions about the protection activities carried out, as the age increases, the ratios of awareness about the protection activities also increase, even if slightly. When the effect of the duration of living in the forest village of the participants on the perception of protection activities performed, the awareness of those who constantly live in the village (93,2%) is revealed to be statistically higher than the awareness of those who live in the village in some periods of year (84,3%) ($p < 0,05$). The results concerning the tests explained are given in Table 3. Especially the duration of living in the village being distinctly effective, can be interpreted as those constantly living in the

village having the opportunity to closely monitor and observe all the activities.

The deficiencies participants have observed in the protection activities carried out in the forests and their expectations in this regard were queried and a reply could be obtained from only 55,6% of them (712 people). Of the participants who answered this question, 27% (192 people) consider controls and supervision should be increased, 24% (171 people) increase forest fire measures and precautions, 15,7% (112 people) emphasize public relations, 14,9% (106 people) increase forestation works, 7,6% (54 people) control beetles and again 7,6% (54 people) perform more effective activities regarding forest maintenance and 3,2% (23 people) act more sensible regarding management.

Forest existence of Turkey, which was 20,2 million ha in 1970's, has reached 22,3 million ha today; in other words, it increased 2,1 million ha in the last 40 years (Anonymous, 2015). When the total forest areas obtained for two different planning terms (current and previous) of Forest Management Planning Units affiliated with Forest Enterprises in Kastamonu for current and previous terms are compared, it is understood that in all Forest Enterprises forest areas have increased between 2,2% and 39,7%, and with the help of these data, the total forest area in province general has increased 9,7%. In the query made to reveal the perception levels for the mentioned increase in forest areas in the surroundings of the participants, it was seen that only 34,1% (437 people) could interpret the increase correctly, however 26,5% (339 people) stated no change and 39,4% (505 people) have provided opinion of a decrease. As a result of the Chi-square test, the awareness of the participants on the increase of forest areas were identified significantly different according to Forest Enterprises ($p < 0,05$). Accordingly, the increase in forest existence was perceived correctly by the forest villagers of Çatalzeytin (50,5%), Küre (49,5%), Bozkurt (46,9%), Cide (45,0%), Tosya (43,5%) and Kastamonu (34,7%) Forest Enterprises, whose ratios were higher than the general correct perception ratio (34,1%).

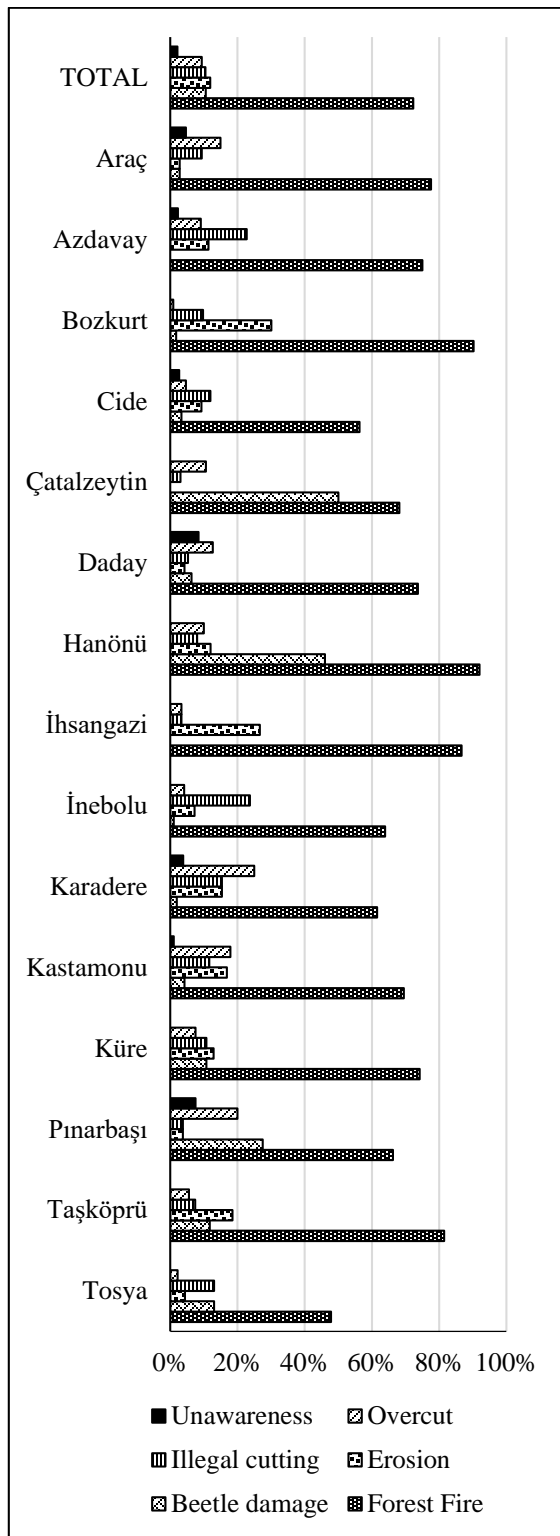

Figure 1. Distribution of threats considered important by participants according to Forest Enterprises

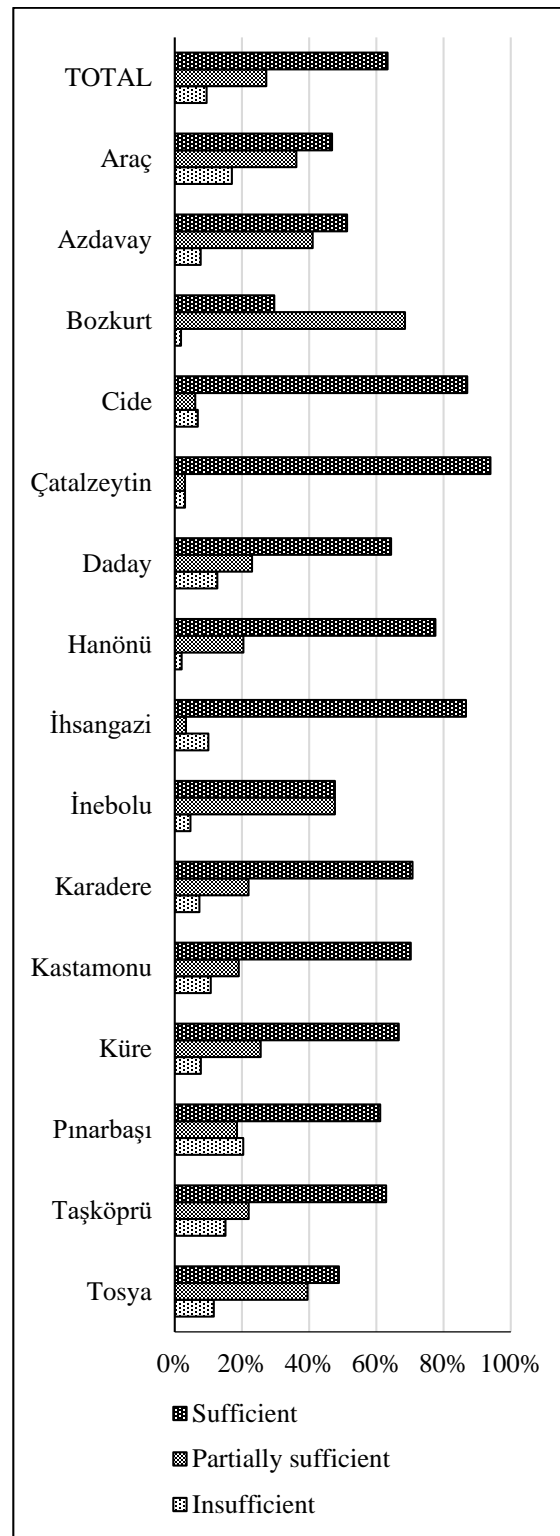

Figure 2. Distribution of perception of participants on the sufficiency of protection activities according to Forest Enterprises

Table 3. Chi-square test results on perception of protection activities

	Group	Perception of protection activities				X^2	P
		True		False			
		n	%	n	%		
Age group	18-30	204	92,3	17	7,7	4,828	0,185
	31-50	542	90,5	57	9,5		
	51-65	33	94,1	21	5,9		
	over 65	101	94,4	6	5,6		
Educational status	Illiterate	32	84,2	6	15,8	6,309	0,277
	Literate	93	95,9	4	4,1		
	Primary school	675	92,5	55	7,5		
	Middle school	217	91,2	21	8,8		
	High school	127	90,7	13	9,3		
	University	36	94,7	2	5,3		
Living duration at village	Constantly	1046	93,2	76	6,8	15,358	0,000
	Periodically	134	84,3	25	15,7		

However, the participants who consider forest areas as decreased by not perceiving the increase in question are from Araç (68,2%), Azdavay (52,3%), Karadere (51,9%) and Kastamonu (49,5%) Forest Enterprises. According to the result of Chi-square Test performed to identify whether there is a significant relationship between the awareness

regarding the increase of forest existence and protection activities performed in the forests, it was identified that there is a significant relationship between the both perceptions of the participants ($p < 0,05$) and those with the awareness regarding protection also have a higher awareness regarding the increase (Table 4).

Table 4. Chi-square test result between perceptions of forest increase and protection activities

Perception of protection activities			Perceptions of forest increase		X^2	P
			True	False		
			True	n		
	% (Protection)	35,5	64,5			
	% (Increase)	96,1	90,1			
False	n	17	84			
	% (Protection)	16,8	83,2			
	% (Increase)	3,9	9,9			

Conclusions

Among the many factors determining the development and quality of forests, forest villagers' irregularly and insensibly utilizing forests as traditionally has an important place. Besides, for the forest existence to be transferred to future generations without decrease, and if possible, with increase, the forests should be operated and protected as planned. Although forest protection activities are carried out by authorized units of forestry organization, the contribution of forest

villagers, who live together with forest cannot be underestimated. In parallel to the developments in the world, reasons such as forest fires, natural disasters, windfalls and snow downs, unsuccessful forestry practices, forestry areas being assigned to tourism activities or converted to agricultural lands, illegal pasturage and illegal cutting in Turkey negatively affect the forest existence. Living in Kastamonu which has rich forest existence and where forestry activities have an important place in parallel to this, a considerable amount

of forest villagers can be considered to be aware about the factors effective on the deforestation and showing necessary sensitivity. Creating the perception of sufficient level protection is being made on the villagers who are concerned about the protection activities and informing them to ensure getting rid of the negative thoughts will especially ensure them to think more positively about the future of forests. Protection activities required and carried out in the regional forests should also be evaluated by taking their expectations into consideration. In situations differing according to the Forest Enterprises, identification of the reasons causing the problems and taking measure should be priority. Nevertheless, reasons such as the shortage of agricultural lands, unemployment problem of forest villagers, disputes between the state and forest villagers, traditional utilization of forest in the forest villages found in the region continue to threaten the existence of forests. Without ignoring the ongoing relation between the forest and forest villagers, current problems should be identified, solutions should be provided and applicability of these should be supervised through interdisciplinary studies. Briefing of the regional public about the forestry activities carried out in the forests of the region has great importance in terms of establishing cooperation between the forest administration and villagers in performed protection activities.

According to the functional planning basis applied in the planning of Turkey forests, when the requirement of interest groups to be included in planning process of forest resources, knowledge, perception and awareness of the partners in question regarding the forests subject of planning have great importance. Because, the participants can only contribute positively about the fact they have information and knowledge of. Knowledge and perceptions of one of the participants in question, local public, in other words, forest villagers, is quite important in the planning process of forests. Expectations and contributions to forest of forest villagers shape according to the knowledge and perceptions, and both their expectations and contributions are optimal is proportional to the correctness of their

knowledge and perception. According to the evaluations made within aim of this study, forest villagers living in Kastamonu province are sufficiently aware of the threats on the surrounding forests and the activities of the forest administration against these threats. On the other hand, awareness concerning the shortages seen in the forest protection activities and the expectations regarding may be considered as low. Also, the awareness regarding the increase of the surrounding forest areas from past to present is at low level. In other words, forest villagers of Kastamonu province cannot observe the increase in forests. In the light of these summary information obtained within this study, it can be said that forest villagers, who are an interest group to be consulted of their opinions and expectations in planning activities to be performed at the Forest Enterprises within borders of Kastamonu province, are not appropriate to include them into the planning process without training about the subjects on which the forest villagers have insufficient knowledge. Therefore forest villagers should be trained in the functions of the surrounding forests, forestry activities oriented to these functions, time-based changes occurring in the forests, threats and hazards on forests and measures to be taken against these threats. Thus participation of forest villagers to planning process will be made more effective and efficient.

Acknowledgement

This study has been supported by Kastamonu University Scientific Research Projects Management Office (Project No: KÜBAP-01/2012-23).

References

Anonymous 1997. Ulusal çevre eylem planı – arazi kullanımı ve kıyı alanlarının kullanımı, Danışman: Semra Ener Ogan, Odak Noktası Kuruluş İller Bankası-Mart, 84 s.

Anonymous 2008. Women 2000 and Beyond. Rural women in a changing world: opportunities and challenges. United Nations, Division for the Advancement of Women, Department of Economic and Social Affairs.52 p

Anonymous 2013a. Ormancılık ve su şurası, ormanların korunması, Şura Çalışma Belgesi, 21-23 Mart 2013. T.C. Orman ve Su İşleri Bakanlığı. Ankara.

Anonymous 2013b. Orman atlası. T.C. Orman ve Su İşleri Bakanlığı, Orman Genel Müdürlüğü, Ankara, 107 s.

Anonymous 2015. Türkiye Orman Varlığı 2015. T.C. Orman ve Su İşleri Bakanlığı, Orman Genel Müdürlüğü, Ankara, 32 s.

Anonymous 2016. Ormancılık İstatistikleri 2015, T.C. Orman ve Su İşleri Bakanlığı, Orman Genel Müdürlüğü, Ankara.

Avcı M. 2005. Burdur ili ormanlarında koruma sorunları. I. Burdur Sempozyumu. Burdur, 15-19 Kasım, 1161-1167ss.

Daşdemir İ., Güngör E. 2010. Çok kriterli ve katılımcı yaklaşımla orman kaynaklarının işlevsel önceliklerinin belirlenmesi: Ulus Devlet Orman İşletmesi örneği, Bartın Orman Fakültesi Dergisi, 12 (17): 11-25.

Durkaya A., Kaptan S., Durkaya B. 2013. Determination and analysis of forest villager- forest management confliction threatening sustainable management of forest research: Alabarda case study. The International Journal of Social Sciences, 14, 1: 57-66.

İnce Y., Tolunay A. 2009. Orman köylülerinin orman kaynaklarından yapacak odun yararlanma haklarının ekonomik boyutu (Isparta ili orman köyleri örneği). II. Ormancılıkta Sosyo-Ekonomik Sorunlar Kongresi, 19-21 Şubat, Isparta, 206-215.

Keenan R.J., Reams G.A., Achard F., de Freitas J.V., Grainger A., Lindquist E. 2015. Dynamics of global forest area: Results from the FAO Global Forest Resources Assessment 2015. Forest Ecology and Management, 352: 9-20.

Korkmaz S., Alkan H., 2015. Orman köylerinde kadının toplumsal yaşamdaki rolü: Isparta Orman İşletme Şefliği örneği, Turkish Journal of Forestry, 16 (2): 141-151.

Özcan G.E., Alkan Akıncı H., Eroğlu M. 2011. Ladin ormanlarında yaralı ağaçların kabuk böceği zararına duyarlılığı. Orman Mühendisliği Dergisi, 48, Sayı: 4-5-6, Nisan, Mayıs, Haziran, 20-23.

Prakash D. 2002. Rural women, food security and agricultural cooperatives, Rural development and management centre 'The Saryu', J-102 Kalkaji, New Delhi 110019. India.

Solmaz E. 2007. Muğla orman köylerinin kalkınmasına yönelik uygulanan politikaların yoksulluk düzeyi ve orman kaynaklarının kullanıma etkisi, Muğla Üniversitesi Sosyal Bilimler Enstitüsü Dergisi (İLKE), Sayı:19.

Şen G. 2002. Kastamonu ormanlarındaki koruma sorunları ve alınması gereken önlemler, Gazi Üniversitesi, Fen Bilimleri Enstitüsü, Yüksek Lisans Tezi. 106 s.

Şenyaz A., Sülüsoğlu M., Yılmaz E., 2005. Akdeniz ormancılığı açısından Mersin ili, Tarsus ilçesi bazı orman köylerindeki sosyo-ekonomik yapı ve ormancılık faaliyetlerinin değerlendirilmesi, T.C. Çevre ve Orman Bakanlığı, Doğu Akdeniz Araştırma Enstitüsü, Tarsus. 88s.

Tolunay A., Korkmaz M. 2005. Orman köylerinin orman kaynaklarından yararlanma haklarının tarihsel gelişimi. 1. Çevre ve Ormancılık Şurası, Tebliğler, 4. Cilt, 1559-1566.

Uslu N., Enez K. 2002. Kastamonu orman köylerindeki tarımsal kalkınma kooperatifleri ve ormanların korunmasına etkileri, Türkiye Koop., Türkiye Milli Kooperatifler Birliği Yayın Organı, Sayı:42, 4-5.

Yılmaz E., Abbak A., Kırış R., Sayın M.A. 2015. Orman amenajman planlamasının sosyal boyutu: Pozantı Orman İşletme Şefliğinde örnek uygulama. Ormancılık Araştırma Dergisi, 1 (2A): 35-50.

URL-1, 2016. TÜİK, Temel İstatistikler, <http://www.tuik.gov.tr/UstMenu.do?metod=temelist> (07 October 2016).

URL-2, 2016. <http://www.turkis.org.tr/> (07 October 2016).

Chemical Silviculture for Wildlife Management in Forestry

Derya EŞEN

Düzce University, Faculty of Forestry, Düzce/TURKEY
deryaes@duzce.edu.tr

Abstract

Wildlife management is now an important function of forest management. Forests provide wildlife cover, food, and water resources. Herbaceous and woody plant species are important component of the forests for wildlife as food and cover. Weeds are a significant impediment to fulfilling wildlife management goals. Unwanted vegetation is often of little nutritional value for wildlife species. In addition, due to their aggressive life traits, weeds quickly dominate forest sites and site resources, preventing the establishment and growth of the other plant species that are of high value as food and cover source for wildlife. Chemical silviculture offers foresters an effective and cost-efficient alternative tool in managing wildlife and wildlife habitats alone or in combination with other management tools. Herbicide foliar, basal, cut-stump, and hack-and-skirt applications can help foresters reach their objectives on wildlife sites effectively and cost-efficiently. For instance, hack-and-skirt is successfully employed on various wildlife management sites around the globe to create deadwood and snags that provide valuable habitat for birds and small mammals. This paper discusses various chemical silviculture practices used in the globe for controlling unwanted vegetation on wildlife management sites.

Keywords: Chemical silviculture, Herbicides, Wildlife management

Ormanlıkta Yaban Hayatı Yönetimine Yönelik Kimyasal Silvikültür

Özet

Artık yaban hayatı yönetimi önemli bir orman işlevi haline gelmiştir. Ormanlar yaban hayatına örtü, besin ve su sağlamaktadır. Örtü ve besin olarak, ormanda bulunan otsu ve odunsu vejetasyon yaban hayatı için oldukça önemli bir kaynaktır. Zararlı bitkiler (diri örtü) yaban hayatı işlevlerinin yerine getirilmesinde önemli sorunlar çıkarmaktadır. İstenmeyen bitkiler yaban hayatı için çok az ya da hiç bir besin değeri taşımazlar. Bunun yanında, saldırgan özellikleri nedeniyle, orman sahalarını ve saha kaynaklarını ele geçirerek yaban hayatı için önemli besin ve örtü işlevine sahip diğer bitki türlerinin yetişmesine ve büyümesine engel olurlar. Kimyasal silvikültür, tek başına veya diğer yöntemlerle bütünlük olarak yaban hayatı yönetiminde yöneticilere etkili ve ekonomik alternatif yöntem sunmaktadır. Yaprak, gövde, kesik yüzey, yar-ve-uygula herbisit yöntemleri yaban hayatı yöneticilerine amaç ve beklentilerine etkili ve ekonomik biçimde ulaşma imkânı sağlayabilmektedir. Örneğin, dünyada yar-ve-uygula yöntemi, kuş ve küçük memeliler için önemli habitat oluşturan dikili ve yatık kuru ve ölü odun oluşturulmasında başarıyla kullanılmaktadır. Bu makalede, dünyada yaban hayatı yönetiminde zararlı bitki mücadelesinde kullanılan kimyasal silvikültürel yöntemler tartışılmaktadır.

Anahtar kelimeler: Herbisitler, Kimyasal silvikültür, Yaban hayatı

Wildlife Management

Forests provide wildlife cover, food, and water resources and space (Yahner, 1995; Nyland, 2002). Herbaceous and woody vegetation in the forest understory is the important sources of food (fodder and browsing) for the wildlife. Woody plants including trees provide nutrient-rich food to the wildlife during especially the mast years. A dense (2500 stems ha⁻¹ or higher) stand consisting young stems (dbh less than 3 cm) is particularly useful to the wildlife as the cover to predators. Cavities in living or dead tree boles and logs are shelter, den, and nest

for many wildlife species in the forest. Particularly, the deadwood (snags and deadwood) in the forest particularly is critical for biodiversity in the forest (Healy, 1987; Nyland, 2002).

Conceptually, wildlife management embraces game management, wildlife conservation, and pest control with the aim of bridging the requirements of the wildlife with those of the human communities through the best practices (Potter et al., 1973). Wildlife management has largely focused on game animals and management till 1960s (Yahner, 1995). Now, it deals with

various issues that affect both the forest and the wildlife including habitats and humans. Habitat fragmentation is a contemporary issue that has negative or positive impact on the wildlife depending on species (Yahner, 1995; Nyland, 2002). The wildlife directors may need to alter habitats to better serve the needs of the wildlife and put under strict preservation to decrease anthropogenic influence. Increasing awareness and information about wildlife and their habitats is also among the responsibilities of the wildlife directors (Yahner, 1995; Nyland, 2002). The foresters take into consideration wildlife and their needs in all aspects of forest management including forest establishment, tending, utilization, regeneration, and harvesting (Uğurlu, 2004). Therefore, wildlife management essentially lies in the working area of the silviculture. The silviculturalist carries out practices to modify habitats in order to improve wildlife population(s) on a forest site (Nyland, 2002). The managers must sustain the forest as the most critical resource for the wildlife (Nyland, 2002).

Wildlife gaming is now considered an important national economic resource (Uğurlu, 2004). In the US, hunting activities generate 700000 jobs and yearly revenue more than USD 60 billion directly and indirectly (URL₁, 2016). Sustainable management of wildlife therefore is critical from both ecological and economical perspectives (Nyland, 2002; Uğurlu, 2004).

As mentioned before, pest control is an important responsibility of the wildlife managers and foresters (Potter et al., 1973). Weeds constitute an, if not the most, important pest in agriculture and forestry around the world (Radosevich et al., 2007). Wildlife management is now an important component of today's forestry in Turkey (Uğurlu, 2004). It is incorporated into the recently revised Forest Management Plans of the General Directorate of Forestry as the "Wildlife Enhancement Function". Wildlife is also a significant constituent of many national parks, nature parks, nature conservation areas, wildlife protection areas, game production areas, game areas, and wetlands (Uğurlu, 2004).

Weed Competition and Control

Weeds compete with the primary plant species for site resources including light, soil water and nutrients, and space, and reduce their establishment and growth (Radosevich et al., 2007). Weeds also pose significant problems on wildlife management sites (Wigley et al., 2002; Miller and Miller, 2004; Radosevich et al., 2007; Carlos et al., 2014). Many times, native plant species are extirpated due to severe competition from unwanted vegetation. One common feature of herbaceous and woody weeds is that they are not palatable to wildlife. They drive out palatable plants to wildlife on wildlife management sites, modifying habitat and reducing food quality of the site for the wildlife. Dense populations of weeds also hinder the free movement of wildlife and increase fire risk and diseases (Wigley et al., 2002; Miller and Miller, 2004; Radosevich et al., 2007).

Weed control is carried out in the world mostly by manual, mechanical, burning, flooding, chemical, and biological control methods (Radosevich et al., 2007):

Manual Control

Labor force is utilized for manual control where weeds are eliminated by hand or simple tools such as hoes (Radosevich et al., 2007). It has long been used on agricultural and forest sites in the world and Turkey. For instance, grubbing has been the traditional woody control method for Turkish foresters on eastern beech sites invaded by rhododendron (Figure 1) (Saatçioğlu, 1957; Eyüboğlu and Karadeniz, 1987; Eşen et al., 2006; Asma, 2016, pers. comm.). However, short-term effects, rise of labor cost, and decreasing availability of labor force over the years have made manual control less attracted by managers in Turkey (Eyüboğlu and Karadeniz, 1987; Eşen, 2000; Eşen and Yıldız, 2000; Eşen et al., 2005). Manual control may however be only viable solution to weed problems for sites with reservations for the other methods (Zedaker, 1986; Radosevich et al., 2007). For instance, use of mechanical (dozers, excavators, etc.) and burning would not be preferred on high-slopes with erosion and fire escape risks.



Figure 1. Manual control (grubbing) or rhododendron in the understory of eastern beech (Photo: Derya Eşen) (on the left) and manual control of competing vegetation with a scythe (on the right) in the Black Sea Region of Turkey.

Presence of water courses or sensitive areas can limit use of some chemical control methods such as aerial spraying, foliar spray, and soil applications. In those cases, use of labor force would be the least site-disturbing and most environmentally friendly method to eliminate weeds. Manual control is also logical should there be scattered and low-density weeds on the site (Zedaker, 1986; Radosevich et al., 2007).

Burning

Burning has long been used to shape habitats for centuries for forage, gaming, and housing. Early settlers (for example native Americans) burned up closed forests to increase light and rain reaching the ground and increase establishment and growth of herbaceous vegetation and fruiting as important habitat features for the wildlife (Wigley et al., 2002; Miller and Miller, 2004; Radosevich et al., 2007). From the weed control point of view, burning can effectively and economically control existing vegetation but the effect is mostly short-lived. Due to abundance of soil nutrients, moisture, and light, a surge in herbaceous weed establishment and growth can recapture site even more rigorously. Also, difficulty in

taking official permission from local authorities, risk of an escape fire, occasional unsuccessful weed control, off-target damage to other vegetation of interest, narrow time window for safe burning, risk of fire turning into a high-intensity event and its long-term negative effects on site productivity especially on soil are other concerns associated with burning for site preparation and weed control (Wigley et al., 2002; Miller and Miller, 2004; Radosevich et al., 2007).

Mechanical Control

Low-to-heavy weight machinery is employed to eradicate the existing weed problems on the sites of interest (Radosevich et al., 2007). Heavy bulldozers equipped with solid blades have long been utilized for mechanical control of weeds and soil preparation around the world including Turkey. It controls weeds especially woody weeds, root systems in the soil effectively and cheaper (Sarginci, 2005; Radosevich et al., 2007; Yildiz et al., 2007; Yildiz et al., 2009; Asma, 2016, pers. comm.). The General Directorate of Forestry has been using this method extensively for effectivity on weeds, low-cost, and very high success rate of natural tree regeneration, especially



Figure 2. Mechanical control of rhododendron in the understory of eastern beech in the Black Sea Region of Turkey using bulldozer (on the left) and excavator (on the right) (Photo Source: Erdoğan Asma).

on rhododendron-invaded (*Rhododendron ponticum* L.) eastern beech (*Fagus orientalis* Lipsky.) sites (Figure 2) (Sarginci 2005; Yildiz et al., 2007; Yildiz et al., 2009; Asma, 2016, pers. comm.). On the other hand, mechanical scarification with heavy machinery has serious concerns in respect to sustainable soil productivity (Ballard, 2000, Sutherland and Foreman, 2000; Radosevich et al., 2007; Yildiz et al., 2009). This practice scarifies the organic matter in the A-horizon, which is critical supplier of soil fertility, aeration, and water-holding and carries them off site. Heavy machines also damage the long-term soil productivity by compacting the soil, which increases soil bulk density, decreases soil porosity and in turn aeration (Ballard, 2000, Sutherland and Foreman, 2000; Yildiz et al., 2009). Use of brush rake instead of solid blade might decrease amount of top soil off site (Yildiz et al., 2009). The Turkish foresters have recently used lower-weight excavators for woody weed control especially rhododendron control in the Black Sea Region. These excavators are much handier on rough terrain with fewer concerns with long-term site sustainability (Asma, 2016, pers. comm.; Figure 2).

Chemical Control

Herbicides are synthetic compounds to eliminate unwanted vegetation, which negatively affects crop species. Herbicides are now part of the establishment and tending of forest sites and wildlife habitats in the industrialized countries (Zedaker, 1986;

Miller and Miller, 2004; Radosevich et al., 2007). Herbicides are particularly used on sites with intensively managed fast-growing southern pines for timber production. Many silvicultural treatments including site preparation, herbaceous and wood weed control, crop release from competing vegetation, mid-rotation release of crops growing in the overstory and understory are now carried out by herbicides (Wigley et al., 2002; Radosevich et al., 2007; Miller and Miller, 2004). Yearly, almost 1 million ha is treated with chemicals for site preparation in the southern US (Dubois et al., 2003; Miller and Miller, 2004).

According to application methods mostly used in forestry, aerial, foliar, cut-stump, basal, and soil applications are recognized (Zedaker, 1986; Radosevich et al., 2007).

Foliar applications

In the foliar spray technique, herbicide(s) is (are) mixed with water in a tank, and this mixture is sprayed on to the foliage of the target (Figure 3) (Radosevich et al., 2007; Ferrel et al., 2015). Surfactants can additionally be added to the tank mixture to increase chemical leaf absorption and efficacy. It is the most suitable technique, in terms of efficacy and economics, for control of herbaceous weeds and woody weeds with heights of 1.8-2.5 m and high densities ($\geq 8,000$ stems ha^{-1}) (Zedaker, 1986; Ferrel et al., 2015). This technique is easy to apply and is time-effective. It is important to cover the entire foliage system for the best results.

Consecutive applications may be needed for complete eradication depending on herbicide, plant species, or time of application (Radosevich et al., 2007; Ferrel et al., 2015).

Basal applications

This technique is for control of woody weeds with smooth bark and groundline diameters or diameters at breast height 15 cm or less (Zedaker, 1986; Ferrel et al., 2015). Herbicides are mixed with oil for bark penetration and directly applied onto the complete lower 12-45-cm part of the bole using backpack sprayer or squirt bottles (Figure 4). Dyes can be added to the mixture for delineation of the applied area on the bole (Zedaker, 1986; Ferrel et al., 2015).

Cut-stump applications

In this technique, herbicide either diluted with water or undiluted is applied to the cambium zone of the cut surface of woody weeds/trees for maximum amount of chemical translocation to the root system (Figure 5) (Zedaker, 1986; Ferrel et al., 2015). The technique is appropriate when

density of the target plant is low and glds and dbhs were greater than 30 cm. Using this technique on greater stem densities and smaller stems usually result in ineffective woody weed control and chemical wastage, creating environmental pollution and economic loss with this technique as manifested in the chemical control of rhododendron with this technique in the eastern beech forests in the Black Sea Region of Turkey (Esen, 2000; Eşen and Zedaker, 2004; Eşen et al., 2006; Yildiz et al., 2010). The technique prevents the target plant resprout and ensures long-term weed control. In summary, the technique is basically cutting the stem of the target plant near the groundline and instantly applying chemicals to the cambium. Delays in chemical application to the cut surface often result in cavitation, limiting translocation of active ingredients to the root. The technique discharges very small amount of chemicals to the environment and therefore do not cause serious environmental concerns (Zedaker, 1986; Ferrel et al., 2015).



Figure 3. Foliar spraying of weeds growing in high densities (URL₁, 2016).



Figure 4. Basal bark application of herbicides (left photo: Stephen Enloe in Ferrel et al., 2015; right photo: URL₂, 2016).



Figure 5. Cut-stump application of herbicides onto the cambium area of cut-stump (on the left) and hack-in-squirt application into the bark of a tree (on the right) (Photos: Stephen Enloe in Ferrel et al., 2015).

Hack-in-squirt

This technique is most suited when large trees/woody plants are intended to be controlled. In this technique, an angled (45°) cut is made through the bark of the target tree using hatchet, axe or machete and a certain amount of undiluted chemical is instantaneously injected into the cut using regular squirt bottles (Figure 5) (Zedaker, 1986; Ferrel et al. 2015). Injected chemicals are aimed to move down through the phloem into the root system and kill the root. This application discharges the least amount of chemicals without giving any off-target damage to the neighboring plants and the

environment so it is an environmentally friendly herbicide application. (Zedaker, 1986; Ferrel et al. 2015).

Chemical Weed Control and Wildlife Management

Herbicides are commonly employed in natural systems for weed control (Pearson and Ortega, 2009). Chemicals used for weed control can provide important services in the wildlife management including elimination of invasive plant species and restoration of native plant community, creation snags and other dead wood for habitat, opening up gaps in the closed forests to favor regeneration of

the early successional plant species, increasing herbaceous vegetation for herbivory and hiding, favoring browsing, releasing conifers (Lautenschlager et al., 1995; Wigley et al., 200; Miller and Miller, 2004). For example, chemicals enhanced the habitat for red-cockaded woodpecker (*Picoides borealis*) in hardwood stands in the southern US (Conner, 1989; Jones, 1992; Miller and Miller, 2004). Modern selective chemicals applied in late summer effectively controlled ferns invading the undersories of the northern hardwoods stands in the US and restored functional (layers) and compositional diversity in the stand, enhancing forage function for the wildlife (eg. songbirds) (Wigley et al., 2002). Songbirds choose tree canopies (eg. beech or birch) made up by slender, multiple branches rather than less complex, thicker branches (eg. maple). Species composition can be altered using chemical control methods to favor songbirds (Wigley et al., 2002). Knowing what the wildlife species of the interest necessitates in terms of habitat features and how plant species on a particular site will react to herbicides will increase benefits of chemical weed control for wildlife management (Lautenschlager et al., 1995; Miller and Miller, 2004).

Fire and mechanical control can disturb site and even kill slow-moving wildlife (Anonymous, 2009). Chemical weed control with selected herbicides and techniques can on the other hand create greater restoration area with less disturbing effects (Anonymous, 2009). Long-term studies in the southern US suggested that eliminating competing woody vegetation on intensively managed sites using herbicides has enhanced or not significantly affected plant richness and abundance in the lower stratum of tree stands. On the other hand, eliminating only herbaceous weeds has conferred an upper hand to broadleaves which prohibited sunlight reaching in the lower strata and reduced plant richness in these strata (Miller et al., 2003; Miller and Miller, 2004). In the long-term study, eliminating both herbaceous and arborescent weeds however reduced plant biodiversity (Miller and Miller, 2004). Application of hexazinone herbicide demonstrated little reductions in woody plant

diversity (Zutter and Zedaker, 1988; Miller and Miller, 2004). Also, seven years after treatment, no glyphosate, hexazinone, and imazapyr herbicides showed significant changes in plant diversity (Boyd et al., 1995; Miller and Miller, 2004).

The key to successful chemical weed control on wildlife management sites is to choose appropriate herbicide and application rate, technique, and time (Miller and Miller, 2004). Herbicides with broad-spectrum efficacy may be detrimental to all vegetation. Herbicide selectivity can on the other hand give the wildlife manager great maneuverability in shaping community composition in space and time on the wildlife management sites and enhancing wildlife functions (Boyd et al., 1995; Miller et al., 1999; Miller and Miller, 2004). Selective herbicides help the manager in eliminate or favoring specific plant species and specific physiognomies. For instance, imazapyr herbicide controls many plant species but usually let legumes and blackberries grow. Legume and blackberries are on the other hand sensitive to triclopyr, methsulfuron, and picloram applications (Wigley et al., 2002; Miller and Miller, 2004).

Invasive herbaceous weeds pose a significant problem for the most of the wildlife habitats. They quickly capture site resources on wildlife sites and drive out the native plants with high forage value for the wildlife (Wigley et al., 2002; Radosevich et al., 2007). Wildlife managers can use spot herbicide applications to control these weeds on wildlife management sites and allow the native plants reestablish and regrow in nonsprayed areas, which benefit the native wildlife (Zedaker, 1986; Radosevich et al., 2007; Pearson and Ortega, 2009; Ferrel et al., 2015) without serious environmental concerns (Pearson and Ortega, 2009).

Other types of weed problems may require use of other weed control methods. Basal bark or cut-stump applications can allow the wildlife managers to control woody weeds with scattered distribution and medium- or large-diameters, respectively (Zedaker, 1986; Ferrel et al., 2015). Basal bark application can be preferred to eliminate small-to-medium sized woody weed stems growing in low densities when snags (dead

standing stems) are considered part of the desired wildlife habitat without resprouting. Cut-stump or hack-in-squirt applications may be the choice when the wildlife manager has medium-to-large sized woody weeds growing in very low densities in hand depending upon snags are wanted (Zedaker, 1986; Conner, 1989; Wigley et al., 2002; Ferrel et al., 2015). If no snags are wanted, cut-stump can serve the purpose whereas hack-and-squirt can kill trees but retain snags as important habitat for the wildlife especially for small mammals and birds. Both applications discharge a minimum amount of chemicals without off-target damage in the neighborhood and minimum environmental concerns (Zedaker, 1986; Wigley et al., 2002; Ferrel et al., 2015).

References

- Asma, E. 2016. Branch Director of Silviculture, Regional Forest Directorate of Bolu, Bolu, Turkey, personal communication.
- Anonymous, 1987. Human health risk assessment for the use of pesticides in USDA Forest Service nurseries. USDA Forest Service, FS-412. Executive summary, ES 1-7, USA.
- Anonymous, 2009. Vegetation treatments using herbicides on BLM lands in Oregon. Draft Environmental Impact Statement, US Department of Interior Bureau of Land Management, 9015(OR932), Oregon, USA.
- Ballard, T.M. 2000. Impacts of forest management on northern forest soils. *Forest Ecology and Management*, 133, 37–42.
- Boyd, R. S., Freeman J.D., Miller J.H., Edwards M.B. 1995. Forest herbicide influences on floristic diversity seven years after broadcast pine release treatments in central Georgia, U.S.A. *New Forests* 10, 17–37.
- Carlos E.H., Gibson M., Weston M.A. 2014. Weeds and wildlife: Perceptions and practices of weed managers. *Conservat Soc.*, 12, 52-64.
- Conner, R. N. 1989. Injection of 2,3-D to remove hardwood midstory within red-cockaded woodpecker colony areas. United States Forest Service, Research Paper SO-251, Washington, D.C., USA.
- Dubois, M.R., Straka T.J., Crim S.D., Robinson L.J. 2003. Costs and cost trends for forestry practices in the South. *Forest Landowner* 62, 2, 3–9.
- Eşen, D. 2000. Ecology and control of rhododendron (*Rhododendron ponticum* L.) in Turkish eastern beech (*Fagus orientalis* Lipsky) forests. Dissertation, Virginia Polytechnic Institute and State University, Blacksburg, Virginia, USA, 122 pp.
- Eşen D., Yıldız O. 2000. Otsu ve odunsu diri örtü mücadelesinin meşcerelerin gençleştirilmesi ve büyümesine etkileri. *TBMMO Orman Mühendisleri Odası Dergisi* 37, 28-32.
- Eşen, D., Yıldız O, Sargıncı M., Güneş N. 2005. Ormanlıkta zararlı ot ilaçlarının kullanımı ve riskleri. *A.İ.B.Ü. Ormanlık Dergisi* 1,2,51-58.
- Eşen, D., Zedaker, S.M. 2004. Control of rhododendron (*Rhododendron ponticum* L. and *R. flavum* Don.) in the eastern beech (*Fagus orientalis* Lipsky) forests of Turkey. *New Forests*, 27(1):69-79.
- Eşen D., Yıldız O., Kulaç Ş., Sargıncı M. 2006. Controlling *Rhododendron* spp. in Turkish Black Sea Region. *Forestry*, 79, 2, 177-184.
- Eyüboğlu A.K. and Karadeniz A. 1987. Doğu kayınında (*Fagus orientalis* Lipsky.) dikim anında fidan boy ve çapı ile üç yıllık boy büyümesi arasındaki ilişkiler. *Ormanlık Araştırma Enstitüsü Yayınları. Teknik Bülten Serisi* 185, 1-13.
- Ferrell J., Enloe S., Sellers B. 2015. Herbicide application techniques for woody plant control. IFAS Extension University of Florida, SS-AGR-260. 5 pp.
- Healey, W.M. 1987. Habitat characteristics of uneven-aged stands. *Managing Northern Hardwoods*. (Ed: R.D. Nylan. SUNY Coll. Environ. Sci. and For. Misc. Publ. No:13 (ESF 97-002) Soc. For. Publ. No: 87-03), pp. 338-347.
- Jones, E. P. JR. 1992. Silvicultural treatments to maintain red-cockaded woodpecker habitat. (Ed.: Brissette, J.C. Proceedings of the Seventh Southern Silvicultural Research Conference. United States Forest Service, General Technical Report SO-93, pp 627–632, Washington, D.C., USA.
- Lautenschlager, R. A., T. P. Sullivan, R. G. Wagner. 1995. Using herbicides for wildlife management in Northern ecosystems. (Ed.: Gaskin, R.E., Zabkiewicz, J.A., Second International Conference on Forest Vegetation Management. New Zealand Forest Research Institute, Bulletin Number 192, pp. 152–154, Rotorua, New Zealand.
- Miller, J. H., Zutter B.R, Zedaker S.M., Edwards M.B., Newbold R.A. 1995. Early plant succession in loblolly pine plantations as affected by vegetation management. *Southern Journal of Applied Forestry* 19, 109–126.
- Miller, J. H., Zutter B.R., Newbold R.A., Edwards M.B., Zedaker S.M. 2003. Stand dynamics and plant associates of loblolly pine plantations to midrotation after early intensive vegetation management– a southeastern U.S.A.

regional study. Southern Journal of Applied Forestry 27, 221–236.

Miller, K.V., Miller J.H. 2004. Forestry herbicide influences on biodiversity and wildlife habitat in southern forests. Wildlife Society Bulletin 32, 4, 1049-1060.

Nyland, R.D. 2002. Silviculture: Concepts and applications. Waveland Press. Long Grove, IL. 2ed.

Pearson D, Ortega Y. 2009. Managing invasive plants in natural areas: Moving beyond weed control. (Ed.: Kingley R.V. In: Weeds: Management, Economic Impacts and Biology. In: Weeds: Management, Economic Impacts and Biology. ISBN: 978-1-60741-010-2. 1-21 pp.

Potter, D.R., Kathryn M.S., Hendee, J. C. 1973. human behavior aspects of fish and wildlife conservation - An annotated bibliography. U.S. D.A. Forest Service Gen. Tech. Rep. PNW-4. pp.290,

http://www.fs.fed.us/pnw/pubs/pnw_gtr004.pdf.

Radosevich SR, Holt J, Ghersa CM 2007. Ecology of weeds and invasive plants. Relationship to agriculture and natural resource management, 3rd Ed., John Wiley and Sons, Inc., New York.

Saatcioglu, F. 1970. Belgrad Ormani'ninda kayının (*Fagus orientalis* Lipsky) büyük maktalı siper metodu ile tabii olarak gençleştirilmesi üzerine yapılan deney ve araştırmaların on yıllık (1959-1969) sonuçları. J. Faculty of Forestry, Univ. of Istanbul A, 20.

Sargıncı, M. 2005. Batı Karadeniz kayın (*Fagus orientalis* lipsky) ekosistemlerinde diri-örtü kontrol yöntemlerinin toprak verimliliğine etkisi. Yüksek Lisans Tezi, Abant İzzet Baysal Üniversitesi Fen Bilimleri Enstitüsü, Düzce, Turkey.

Sutherland, B., Foreman, F.F. 2000. Black spruce and vegetation response to chemical and mechanical site preparation on a boreal mixedwood site. Canadian Journal of Forest Research, 3, 1561–1570.

Uğurlu, İ. 2004. Ormancılıkta yaban hayatı ders notu. SDÜ Orman Fakültesi, Isparta, Turkey, 67 pp.

URL₁, 2016. The economic importance of hunting. California Department of Fish and Wildlife.

<http://www.dfg.ca.gov/wildlife/hunting/econ-hunting.html>.

URL₂ 2016. Secrets of foliar spraying, <http://www.saosis.com/the-secrets-of-foliar-spraying>.

URL₃, 2016. Illinois invasive species month, <http://illinoisisam.blogspot.com.tr/2012/12/identification-and-control-of-woody.html>.

Wigley, T. B., Miller K.V., Decalesta D.S., Thomas M.W. 2002. Herbicides as an alternative to prescribed burning for achieving wildlife management objectives. (Edit.: Ford W.M., Russell K.R., Moorman C.E. The role of fire in nongame wildlife management and community restoration: traditional uses and new directions, Proceedings of a Special Symposium. United States Forest Service, General Technical Report NE-288), pp. 124–138, Washington, D.C., USA,.

Yahner, H. R. 1995. Eastern deciduous forest: Ecology and Wildlife Conservation, 2nd Edition, Univ of Minnesota Press, Minneapolis,

Yildiz O., Sargıncı M., Eşen D., Cromack Jr. K. 2007. Effects of vegetation control on nutrient removal and *Fagus orientalis* Lipsky regeneration in the western Black Sea Region of Turkey. Forest Ecology and Management. 240, 1-3, 186-194.

Yildiz, O., Eşen D., Sargıncı M. 2009. Long-term site productivity effects of different rhododendron control methods in eastern beech (*Fagus orientalis* Lipsky) ecosystems in the western Black Sea region of Turkey. Soil Use and Management, 25,1, 28-33.

Yildiz, O., D. Eşen, S. M. Zedaker. 2010. Five-year effects of cutting and herbicide treatments on control of *Rhododendron flavum* Don. and macronutrient pools in eastern beech (*Fagus orientalis* Lipsky) forests of Turkey. New Forests. 40, 2, 175-184.

Zedaker S.M. 1986. Herbicides and application techniques for managing immature hardwoods. (Editör: Smith H.C. and Eye M.C. Proc., Guidelines for Managing Immature Appalachian Hardwood Stands. SAF Publications).

Effects of Seedling Age on Survival and Growth Performance in Artificial Regeneration Practices of Oriental Beech (*Fagus orientalis* Lipsky.)

*Halil Barış ÖZEL¹, Nebi BİLİR², Uğur ÇAKMAKLI¹

¹Bartın University, Faculty of Forestry, Bartın /TURKEY

²Süleyman Demirel University, Faculty of Forestry, Isparta /TURKEY

*Corresponding Author: halilbarisozel@yahoo.com

Abstract

Conversion of unproductive forestlands to productive by artificial regeneration is an important ways for protecting the ecological balance and ensuring the sustainability of services and products produced from the forests. Besides the land preparation technics, also the factors such as the seed quality, genetic structure of the seed, and seedling's age and quality have important effects on the success of artificial regeneration via cultivation and plantation. In regions, where the open area conditions are dominant together with the deterioration of stand's natural structure, in order to succeed in artificial regeneration activities for the species growing slowly in youth period, the quality standard of seedlings should be high. Within this context, the leading factor that directly affects the seedling quality standards is the age of seedling. In this study, within the scope of Turkish-German Forestry Joint Project, we aimed to determine the effects of success and growth performance at the end of 21st year and the effects of seedling's age on these parameters in artificial regeneration activities performed on 8.4ha of land in division number 124a of Devrek-Akçasu Forest Sub-District Directorate established in year 1994 by using 1+0, 2+0 and 3+0 year-old, naked-rooted and Dirgine-origin seedlings with 1.5x2m distances. The triplicated parcels were established for every age groups of seedlings used in those artificial regeneration activities. In this parallel, 50 seedlings have been planted in each of parcels for each of age groups. So, 150 seedlings have been planted in triplicated experiment parcels for each of age groups. A total of 450 beech seedlings have been planted in experiment for 3 different age groups. After the number, height, diameter and stem form measurements that have been performed in triplicate for each of age groups, Variance analysis and Duncan test were used for comparing the data obtained. According to the analysis results, the highest value in terms of survival percentage was achieved in parcel established by using 2+0 year-old seedlings (78.5%), followed by the parcel established by using 1+0 year-old seedlings (51.3%). Third group was found to be the experiment parcel established by using 3+0 year-old seedlings with survival percentage of 32.8%. On the other hand, the first group in terms of height increase and diameter development was the parcel established by using 3+0 year-old seedlings with values of 14.6m and 28.7cm, respectively. From the aspect of stem form, the first group was the parcel established by using 2+0 year-old beech seedlings. According to these findings, it is concluded that, when the naked-rooted saplings of beech will be used, it would be better for the success of artificial regeneration to utilize 2+0 year old seedlings in this region and the regions having similar habitat conditions.

Keywords: Oriental beech, Artificial regeneration, Seedling age, Survival percentage, Growth

Doğu Kayını (*Fagus orientalis* Lipsky.) Yapay Gençleştirme Çalışmalarında Fidan Yaşının Yaşama Yüzdesi ve Büyüme Performansı Üzerindeki Etkileri

Özet

Bozuk orman alanlarının yapay gençleştirme çalışmaları ile yeniden verimli hale getirilmesi ekolojik dengenin korunması ve ormanlardan sağlanan ürün ve hizmetlerin devamlılığının sağlanması açısından büyük önem taşımaktadır. Ekim ve dikim yapmak suretiyle gerçekleştirilen yapay gençleştirme çalışmalarının başarısı üzerinde arazi hazırlığı tekniklerinin yanı sıra tohum kalitesi, tohumun genetik yapısı, fidan yaşı ve kalitesi gibi unsurların önemli etkisi bulunmaktadır. Meşçere doğal yapısının bozulmasıyla birlikte açık alan koşullarının hakim olduğu alanlarda gençlikte yavaş büyüyen türlerin yapay gençleştirme çalışmalarında başarılı olunabilmesi için fidan kalite standartlarının yüksek olmasını gerektirmektedir. Bu kapsamda fidan kalite standartlarını doğrudan etkileyen faktörlerin başında fidan yaşı gelmektedir. Bu araştırmada da Türk-Alman Ormancılık Projesi kapsamında Devrek-Akçasu Orman İşletme Şefliği 124a nolu bölmecikte 8.4ha alanda 1994 yılında 1+0, 2+0 ve 3+0 yaşlı, çıplak köklü ve Dirgine orijinli kayın fidanları kullanılarak 1.5x2m aralık-mesafe ile yapılan yapay gençleştirme çalışmalarında 21. yıl sonundaki başarı durumu, gelişim performansı ve kullanılan fidan yaşının bu parametreler üzerindeki etkileri belirlenmeye çalışılmıştır. Söz konusu bu yapay gençleştirme çalışmalarında kullanılan farklı yaştaki fidan grupları için 3 tekrarlı olacak şekilde parseller kurulmuştur. Bu doğrultuda her bir fidan yaş grubu için kurulan tek bir parselde 50 adet fidan dikilmiştir. Bu nedenle her bir yaş grubu için kurulan 3 tekrarlı deneme parsellerinde toplam 150 fidan kullanılmıştır. 3 farklı yaş grubu için tesis edilen denemede toplam 450 adet kayın fidanı dikilmiştir. Her bir yaş grubundaki kayın fidanları üzerinde 3 tekrarlı olarak yapılan sayım, boy, çap ve gövde düzgünlüğü parametrelerine ilişkin ölçümlerden sonra elde edilen verilerin karşılaştırılması için varyans analizi ve Duncan testi uygulanmıştır. İstatistik analiz sonuçlarına göre yaşama yüzdesi yönünden en yüksek değer 2+0 yaşlı fidanlar dikilerek yapılan deneme parsellerinde tespit edilmiştir (%78.5), bu grubu %51.3 yaşama yüzdesi ile 1+0 yaşlı fidanlar dikilerek tesis edilen parsel izlemiştir. 3. grubu ise %32.8 yaşama yüzdesi ile 3+0 yaşlı fidanlar dikilerek oluşturulan deneme parseli takip etmiştir. Diğer taraftan boy büyümesi ve çap gelişimi yönünde birinci grubu 14.6m ve 28.7cm ile 3+0 yaşlı fidanlar kullanılarak oluşturulan deneme parseli oluşturmuştur. Gövde düzgünlüğü yönünden ise 2+0 yaşlı kayın fidanları kullanılarak yapılan yapay gençleştirme parselleri birinci grupta yer almışlardır. Bu tespitlere göre yörede ve benzer yetişme ortamı koşullarına sahip yörelerde kayın türü ile yapılacak yapay gençleştirme çalışmalarında çıplak fidanların kullanılmasının söz konusu olması halinde genel olarak 2+0 yaşlı fidanların tesis edilmesi çalışmaların başarısı açısından faydalı olacağı düşünülmektedir.

Anahtar Kelimeler: Doğu kayını, Yapay gençleştirme, Fidan yaşı, Yaşama yüzdesi, Büyüme

Introduction

In our country, due to the differences of geographical conditions, there are various habitat conditions, which are divided by certain borders and have characteristics that are specific to them. Under the effects of these habitat conditions called ecotype, the organism structures having different life forms and development processes emerge. This is seen more significantly in plants. Within this context, the significant differences are observed in forests, which are constituted by the trees named high-structure vegetative organisms and shaped under the effects of many biotic and abiotic factors and living in perfect balance (Mayer and Aksoy, 1998). Turkey's forests involve very wide variation in terms of species diversity and structural properties. Especially the mixed forest forms are very valuable from ecological and silvicultural aspects (Ata, 1995). According to the recent official statistics, total forest area of our country is 22.7 million ha. But, 50% of this forest land is in degraded form due to various reasons such as forest fires and deforestation activities (Anonymous, 2016). Rehabilitation of these degraded forest lands and making them productive again is of significant importance for national economy and ensuring the sustainability of the products and services expected from the forests. In order to achieve this important objective, successful rehabilitation, artificial regeneration, and forestation activities are needed.

There are many factors affecting the success of artificial regeneration and forestation practices (Ürgenç, 1998). One of these main factor groups is the factors constituted by the issues about the seedling material. Especially in countries such as ours, where there are important problems in establishing the seedling quality classes, this matter becomes more important. In establishing the seedling quality classes and selecting the seedling material to be used in field implementations, it is very important to accurately analyze the qualitative and quantitative properties such as seedling age, seedling height, root neck diameter, crown form, stem form, root volume, root-stem

ratio, wet and dry weights of stem and body and the multiplicity and robustness indices (Genç, 2007). But, among these variables related with the seedling material, the seedling age is seen to be an important characteristic since it directly affects both of seedling development and establishment and also the seedling quality (Boydak and Çalışkan, 2014).

Study objective

In this study, it was attempted to determine the level of success of artificial regeneration activities, developmental performance, and the effects of the age of seedling on these parameters at the end of 21st year during the artificial regeneration (a Turkish-German Forestry Joint Project) project started on 8.4 ha artificial regeneration area established in year 1994 by using 1+0, 2+0 and 3+0 year-old oriental beech (*Fagus orientalis* Lipsky.) seedlings with 1.5x2m distance in Compartment 124a of Akçasu Forest Range District affiliated to Devrek Forest Enterprises.

Material and Method

Material

This study, where the effects of sapling age on the establishment success and development of oriental beech seedlings were examined, was carried out on 8.4 ha artificial regeneration area established in year 1994 by using 1+0, 2+0 and 3+0 year-old oriental beech seedlings in Compartment 124a of Akçasu Forest Range affiliated to Devrek Forest Department. This area has been established for experimental purposes within the scope of Turkish-German Forestry Joint Project (Anonymus, 2000).

Identification of study area

Akçasu Forest Range is located within the borders of Devrek district of Zonguldak city and affiliated with Devrek Forestry Department. Plan unit is located in Compartments F27-c₂, F28-d₁, F28-a₃ and F28-a₄ 1/25000 topographic map of Zonguldak city. Accordingly, Akçasu region is located between 31° 58' 19" - 32° 09' 38"E and 41° 09' 46" - 41° 18' 32"N. Horizontal

distance of plan unit from the sea is 65 km. Mean altitude of Akçasu Forest Range, which has generally rough land structure; the lowest point (50m) is the border of Brook Buldan with the plan unit and the highest point is Göktepe (1100m) (Anonymous., 2012). The forests of plan unit belong to, according to the forest population classification of Mayer and Aksoy (1998), the *northwestern euxin* sub-forest class of *euxin* forest belt. From the aspect of climatic conditions, according to the long-term data (45 years), the study area is rainy in every season, while the highest precipitation level is observed in November (123.4 mm) and the lowest level in July (45.2 mm). On the other hand, the annual mean temperature in Akçasu region is 11.7 °C, while the minimum temperature is measured in January (2.0 °C) and maximum level in July (20.8 °C) and August (20.7 °C). Furthermore, the vegetation period in study area is 6 months (May-October) (Anonymous, 2015).

The geological structure in Akçasu planning unit has formed in sub-cretaceous period of 2nd time (Mesozoic era). For this reason, the man rocks in this region have metamorphic structure. In steep sides of the region, there are limestone, andesite, and flysh structures. In less sloped regions, there

are granite, cyanite, and andesite formations (MTA, 2012). But in the plan being applied, the general soil structure of planning unit located in Akçasu Forest Range is reported to be stony and mid-deep alkaline, clay, clay loam, and sandy clay loam (Anonymous, 2015).

Silvicultural practices in study area

The pre-study stand type of study area, where the study was carried out and was shown as Compartment 23 in previous management plan, has been reported to be BKNDy. Stand is in Site Class III, its general exposure is northwest, and general land form is mid-shoulder (Anonymous, 1998). In 8.4 ha of study area, the clear cutting was performed in August 1994 in order to create equal front within the scope of Turkish-German Forestry Joint Project, and totally 4.56 m³ final harvesting yield. The removal of living cover consisting of rhododendron in striped form was made and mineral soil was revealed. And then, in September 1994, the naked root Dirgine-origin beech seedlings grown in Gökçebey Forestry Nursery aged 1+0, 2+0 and 3+0 were planted with 1.5x2m distance in harmony with randomized blocks pattern in triplicated (Figure 1) (Anonymous, 2000).

1+0 Aged Sapling Parcel	3+0 Aged Sapling Parcel	2+0 Aged Sapling Parcel
3+0 Aged Sapling Parcel	2+0 Aged Sapling Parcel	1+0 Aged Sapling Parcel
2+0 Aged Sapling Parcel	1+0 Aged Sapling Parcel	3+0 Aged Sapling Parcel

Figure 1. Experimental design of the study

For different sapling age groups used in this artificial regeneration studies, the parcels were created in triplicated. In this parallel, 50 seedlings were planted in each of the compartments created for each of the seedling age groups. For this reason, a total of 150 seedlings were used in triplicated experiment compartments established for each of the age groups. 450 seedlings were used totally for 3 different age groups.

Method

In this section, the methods used for measurements and determinations within the scope of this study are explained.

Determining the quantitative characteristics

As quantitative characteristics, the height, diameter at breast height, and survival percentage variables were determined. The height measurements were performed by using laser bot-meter having 1-cm sensitivity, while the diameter at breast

height was measured using 1mm-sensitive diameter measurer. Survival percentage was determined as a result of inventories utilizing the distance of plantation and considering the compartment size.

Determining the qualitative characteristics

Only the stem form was determined as the qualitative characteristic within the scope of this study. For this purpose, the index consisting of 5 categories was utilized (Table 1).

Table 1. Stem form index

Index Value	Index Explanation
1	Very Sloped
2	Sloped
3	Mildly Uniform
4	Uniform
5	Very Uniform

Statistical analyses

In this study, in order to determine if the raw data regarding the measured and determined variables are distributed normally, Kolmogorov-Smirnov test was applied. On the other hand, in order to determine if there is any significant difference between the mean values of qualitative and quantitative characteristics examined in terms of the planted saplings' age, variance analysis ($P < 0.05$) and Duncan test were applied. The values determined for stem form were exposed to Arc.Sin. conversion, and then analyzed. SPSS

package software was utilized for all these statistical analyses.

Results and Discussion

Height growth

The results of variance analyses and Duncan test applied at the height measurements, which were performed in triplicated at the end of 21st year, to the experiment parcels that have been established by using oriental beech trees at different ages are presented in Table 2.

Table 2. Variance analysis and Duncan test results of height values by the age groups of seedlings

Age Groups	$F=101.46^*$ Height (m)
3+0	14.6 ^a
2+0	13.9 ^b
1+0	8.5 ^c

*: $P < 0.05$; a, b, c: Different letters indicate different groups.

According to the results of variance analyses applied to the data obtained from height measurements made in parcels, it was found that there was a statistically significant difference ($p < 0.05$) between the beech individuals from 3 different age groups in terms of mean height growth at the end of 21st year. From this aspect, at the end of Duncan test at $p < 0.05$ level, the first group

was found to be the parcel established by using 3+0 year-old beech seedlings; mean height growth was found to be 14.6 m. Second group was found to be the parcel established by using 2+0 year-old beech seedlings (mean height growth of 13.9 m). The latter group was found to be the parcel that has been established by using 1+0 year-old beech seedlings, where the mean height

growth was found to be 8.5 m (Table 2). Since the seedling materials used in plantations are at different ages, it is normal that these results obtained at the end of 21st year regarding the mean height growth are in parallel with the expectations. But, it is an especially important result that there was not large difference between the mean height growths of 3+0 and 2+0 year-old seedlings. In a study carried out on this matter using European beech (*Fagus sylvatica* L.), it has been determined that, depending on the age of seedling planted, the height growth reached at high levels in the early years but the growth decreased during the following years and the seedlings planted at younger ages closed the gap and showed higher growth performance in later years (Davis and Jacobs, 2005). On the other hand, in another study carried out on black pine, it has been reported that the age has important effects on the growth performance of seedlings after the plantation, but these effects disappeared in following years and the effects of seedling nursery methods came to the forefront in the

course of time (Çolak, 1991). In another study carried out on Taurus cedar, it has been found that the nursery and planting intensity were effective on the seedling quality and growth after plantation more than the age of seedlings was (Çatal, 2002). Besides these studies, when the general growth performances of the oriental beech individuals examined in this study were considered, the height growth values of all the seedling oriental beech individuals from different age groups in the field were found to be low. In this case, it is possible that this is originated from the area's low fertility level.

Diameter growth

The results of variance analyses and Duncan test applied at the measurements of diameter at breast height, which were performed in triplicated at the end of 21st year, to the experiment parcels that have been established by using oriental beech trees at different ages are presented in Table 3.

Table 3. Variance analysis and Duncan test results of diameter values by the age groups of seedlings

Age Groups	<i>F=114.67*</i>
	Diameter (cm)
3+0	28.7 ^a
2+0	26.4 ^b
1+0	18.6 ^c

*: P<0.05; a, b, c: Different letters indicate different groups.

According to the results of variance analyses applied to the data obtained from diameter measurements made in parcels, it was found that there was a statistically significant difference (p<0.05) between the beech individuals from 3 different age groups in terms of mean diameter growth at the end of 21st year. From this aspect, at the end of Duncan test at p<0.05 level, the first group was found to be the parcel established by using 3+0 year-old beech seedlings; mean diameter growth was found to be 28.7 cm. Second group was found to be the parcel established by using 2+0 year-old beech seedlings (mean diameter growth of 26.4cm). Despite the fact that they were found to be in 2 different groups, there was not large difference between the mean height growths of 3+0 and 2+0 year-old seedlings. The age

of seedling is a variable that is very important for overcoming the post-plantation adaptation shock and for the development (Genç, 2007). But, in the studies on seedling physiology, it has been determined that the effect of seedling's age decreased in time and was replaced by the complicated physiological activity during the growth season (Duryea and Brown, 1984). In a study carried out on this topic, it has been reported that, even though the seedling's height and diameter are important indicators of growth, the seedling age should not be considered separately in evaluating these variables but the seedling quality classes, where all the qualitative and quantitative characteristics are discussed together, should also be considered (Mattsson, 1996). In a study, where some of the morphological and

physiological characteristics of Taurus cedar have been investigated, it has been determined that age-related differences in seedling diameter disappeared after the plantation, that the seedlings planted at earlier ages exhibited better growth performance since they more rapidly overcame the planting shock, and that this is obviously seen in seedling diameter (Semerci, 2002).

Survival percentage

One of the most important variables used in determining the success level of forestation studies and revealing the effects of seedling quality classes is the seedlings' survival percentage (Boydak and Çalışkan, 2014). Within this context, in this research, also the effects of seedling material at different ages on the survival percentage were examined. The results of variance analysis and Duncan test applied to survival percentages calculated as a result of inventories made are presented in Table 4.

Table 4. Variance analysis and Duncan test results of survival percentage values by the age groups of seedlings

Age Group	<i>F=98.74**</i>
	Survival Percentage (%)
2+0	78.5 ^a
1+0	51.3 ^b
3+0	32.8 ^c

*: $P < 0.05$; a, b, c: Different letters indicate different groups.

According to the results of variance analyses applied to the data obtained from survival percentage calculations made in parcels, it was found that there was a statistically significant difference ($p < 0.01$) between the beech individuals from 3 different age groups in terms of the survival percentage. From this aspect, at the end of Duncan test at $p < 0.05$ level, 3 groups were found. The first group was found to be the parcel established by using 2+0 year-old beech seedlings with survival percentage of 78.5%. Second group was found to be the parcel established by using 1+0 year-old beech seedlings (survival percentage of 51.3%). Despite the fact that they were found to be in 2 different groups, there was not large difference between the mean height growths of 3+0 and 2+0 year-old seedlings. This group was followed by the parcel that have been established by using 3 year-old seedlings, where the survival percentage was found to be 32.8% (Table 4). According to these results, although there are important differences between the different age groups of seedlings, it can be said that the most successful group in terms of the adaptation is the group established by using 2+0 year-old oriental beech seedlings. Ürgenç (1998) has recommended that the young seedlings,

which have not been waited under nursery conditions for a long time, should be used in overcoming the planting shock and in initializing the field adaptation. On the other hand, in a study of Suner (1978), it has been reported that it would be more appropriate to use 2+0 year-old beech seedlings from the same origin in order to close the large gaps in stand emerging as a result of natural regeneration activities performed on oriental beech. In another study carried out on this topic in oriental beech forests of Bolu region, it has been determined that the seedling age should not be 3+0 but the best result (85.7%) in terms of the establishment success was obtained from the stand zones, where 2+0 year-old beech seedlings were used 2+0 (Tosun et al., 2002). Under the lights of results obtained from this study and the comparisons made, it can be stated that the success level of plantations executed by using 2+0 year-old oriental beech seedlings is high and it is easier to overcome the planting shock with minimum damage. On the other hand, as well as in height and diameter growth, it can be said that the establishment success is low in all the age groups. As a reason for this result, it can be specified that the fertility level of the stand area is low and the cultivation maintenances

were not executed in time and in harmony with the appropriate technique.

Stem Form

Regarding determining the qualitative and quantitative characteristics of different beech individuals planted, only the variable of stem

form was investigated. For this purpose, a stem form index consisting of 5 categories was utilized. The results of variance analysis and Duncan test applied to stem form values found as a result of inventories made are presented in Table 5.

Table 5. Variance analysis and Duncan test results of stem uniformity values by the age groups of seedlings.

Age Groups	<i>F=95.16*</i>
	Mean Stem Uniformity
1+0	4.1 ^a
2+0	3.8 ^a
3+0	1.7 ^b

*: $P < 0.05$; a, b, c: Different letters indicate different groups.

According to the results of variance analyses applied to the data obtained from mean stem form measurements performed in parcels, it was found that there was a statistically significant difference ($p < 0.05$) between the beech individuals from 3 different age groups in terms of the stem form. From this aspect, at the end of Duncan test at $p < 0.05$ level, 2 groups were found. The stem form values obtained from the parcels established by using 1+0 and 2+0 year-old beech seedlings were found to be very close to the level of uniform stem. On the other hand, the mean stem form of parcels established by using 3+0 year-old oriental beech seedlings was found to be very close to the class of curved stem (Table 5). According to these results, it can be said that the stem uniformities of parcels established by using 1+0 and 2+0 year-old oriental beech seedlings were better than those of parcels established by using 3+0 year-old seedlings due to the start of adjacency relations and cooperation from the early ages and also the shorter time of adaptation. Hence, in artificial regeneration studies carried out on European beech forests in Italy, it has been determined that, depending on the origins and genetic structures of the seeds used for growing the seedlings, more uniform stems were obtained because of high level of cooperation in course of time and faster adaptation of planted saplings to the planting areas (Mugnozza, 1995). In another study carried out in Sweden on examining the

artificial regeneration studies on European beech, similar results have been obtained (Ekö and Johansson, 1995).

Conclusions

According to the results obtained from this study, where the 21st year results of experiment that has been set by using Dirgine-origin oriental beech seedlings (1+0, 2+0 and 3+0 year-old) within the scope of Turkish-German Forestry Joint Project were examined, in case that it is necessary to plant naked root seedlings in oriental beech's artificial regeneration, rehabilitation and forestation activities in regions having habitat conditions similar to the study area, it would be better to plant 2+0 year-old seedlings in order to achieve better growth performance (height and diameter), higher survival percentage, and high-quality stems (uniform stems) of beech individuals. On the other hand, according to the results of this study, in cases where enough number of 2+0 year-old high-quality oriental beech seedlings cannot be procured, 1+0 year-old seedlings can be utilized. Besides that, although the growth performance (diameter and height) of 3+0 year-old seedlings is good, the post-planting adaptation and stem quality of these seedlings were found to be low. Within this context, the use of 3+0 year-old naked root oriental beech seedlings in artificial regeneration, rehabilitation, and forestation activities should not be preferred unless compulsory. Moreover, as in other

slow-growing forest tree species, the site selection is very important for oriental beech artificial regeneration, rehabilitation, and forestation activities, and the protective upper and side shield effect of even old beech trees, which have bad phenotypic properties, should be benefited. On the other hand, regardless of the age, after planting the seedlings, the appropriate cultivation maintenance methods should be utilized in order to struggle with negative factors such as living cover.

Acknowledgments

We would like to thank Ministry of Forests and Water Affairs that gave us permission for determining the study topic and executing the study, Ahmet Sırrı BEŞEL, who is the Zonguldak Regional Forest Manager, and the personnel of Akçasu Forest Range for their continuous support to us.

References

- Anonymous 1998. Yapraklı Karışık Ormanlarda Silvikültürel Hedefler Semineri Çalışma Grubu Raporu, Orman Genel Müdürlüğü ve Türk-Alman Ormancılık Projesi, Zonguldak, 45 s.
- Anonymous 2000. Yapraklı Ormanlarda Modern Silvikültür Teknikleri Semineri Çalışma Grubu Raporu, Orman Genel Müdürlüğü ve Türk-Alman Ormancılık Projesi, Zonguldak, 23 s.
- Anonymous 2012. Devrek Orman İşletme Müdürlüğü, Akçasu Orman İşletme Şefliği Model Amenajman Planı (2003-2012), Ankara, 633 s.
- Anonymous 2015. Devrek Orman İşletme Müdürlüğü, Akçasu Orman İşletme Şefliği Model Amenajman Planı (2015-2024), Ankara, 756 s.
- Anonymous 2016. Türkiye Orman Varlığı, Orman ve Su İşleri Bakanlığı, Orman Genel Müdürlüğü, 66 s., Ankara.
- Ata C. 1995. Silvikültür Tekniği, Z.K.Ü Bartın Orman Fakültesi, Üniversite Yayın No: 4, Fakülte Yayın No: 3, Bartın, 453 s.
- Boydak M., Çalışkan S. 2014. Ağaçlandırma, Işık Üniversitesi Güzel Sanatlar Fakültesi, İstanbul Orman Fakültesi, OGEM-VAK Yayınları, CTA Tanıtım Rek. Hiz. Org. Basın Yayın Bil. San. ve Tic. Ltd. Şti, İstanbul, 714s.
- Çatal Y. 2002. Toros Sediri (*Cedrus libani* A.Rich.)'nde yetiştirme sıklığının bazı morfolojik fidan özelliklerine etkisi. Süleyman Demirel Üniversitesi Fen Bilimleri Enstitüsü, Yüksek lisans tezi. Isparta.
- Çolak A.H. 1991. Karaçam'da bazı yetiştirme tekniklerinin fidan kalitesi sınıflamasına temel

teşkil eden morfolojik etkileri. Yüksek lisans tezi. İstanbul Üniversitesi, Fen Bilimleri Enstitüsü, Orman Mühendisliği Anabilim Dalı, Silvikültür Programı, İstanbul.

Davis A.S., Jacobs D.F. 2005. Quantifying root system quality of nursery seedlings and relationship to outplanting performance. *New Forests* 30: 295–311, USA.

Duryea, M.L., Brown, G.N. 1984. Seedling physiology and reforestation success. Society of American Foresters National Convention, October 16-20, Portland, Oregon, USA.

Ekö P.M., Johansson U. 1995. A method for extensive regeneration of European beech (*Fagus sylvatica* L.) in Southern Sweden, Genetics and Silviculture of Beech, In Proceedings from the 5th Beech Symposium of the IUFRO Project Group P1.10-00, Denmark, 137-145.

Genç M. 2007. Fidan standardizasyonu, fidan yetiştiriminin biyolojik ve teknik esasları, Süleyman Demirel Üniversitesi Yayınları, No:75, Isparta, 555s.

Mattsson A. 1996. Predicting field performance using seedling quality assessment. *New Forest* 13: 227–252.

Mayer H., Aksoy H. 1998. Türkiye Ormanları, Orman Bakanlığı, Batı Karadeniz Ormancılık araştırma Enstitüsü Müdürlüğü, Muhtelif Yayın no:1, Bolu, 291 s.

MTA 2012. Türkiye'nin Jeolojik Yapısı ve Jeoloji Haritaları, Maden Tetkik ve Arama Kurumu, Genel Rapor No: 7, Ankara, 108 s.

Mugnozza G.S. 1995. Ecology and Genetics of Italian Beech Forests: An Example of Integrated Forest Research, Genetics and Silviculture of Beech, In Proceedings from the 5th Beech Symposium of the IUFRO Project Group P1.10-00, Denmark, pp.189-195.

Suner A. 1978. Düzce, Cide ve Akkuş Mıntıklarında Saf Doğu Kayını Meşcerelerinin Doğal Gençleştirme Sorunları Üzerine Araştırmalar, Ormancılık Araştırma Enstitüsü, Teknik Bülten Serisi No: 107, Ankara, 60 s.

Semerci A. 2002. Sedir (*Cedrus libani* A. Rich.) fidanlarına ait bazı morfolojik ve fizyolojik karakteristikler ile İç Anadolu'daki dikim başarısı arasındaki ilişkiler. İç Anadolu Ormancılık. Araştırma Enstitüsü Yayınları, Teknik Bülten No: 279, 142 s, Ankara.

Tosun S., Özpay Z., Serin M., Karatepe H. 2002. Doğu Kayını (*Fagus orientalis* Lipsky.) ve Meşe (*Quercus petraea* (Matt.) Lieb., *Quercus hartwissiana* Stev.) Türlerinde Boylu Fidan Üretimi ve Plantasyon Tekniğinin Araştırılması, Orman Bakanlığı, Batı Karadeniz Ormancılık Araştırma Enstitüsü Müdürlüğü, Teknik Bülten No: 6, Bolu, 53 s.

Ürgeç S. 1998. Ağaçlandırma Tekniđi, İ.Ü Orman Fakültesi, İ.Ü Rektörlük Yayın No: 3994, Orman Fakültesi Yayın No: 441, Emek Matbaacılık, İstanbul, 600 s.

Effect of Water Stress of the Substrate on Seeds Germination of *Abies numidica* De Lannoy in Algeria

*Malika HACHI-ILLOUL¹, Arezki DERRIDJ², Bruno FADY³

¹Département des Sciences Agronomiques, Université H. B. Bouali, Chlef, ALGERIA

²Département des Sciences Agronomiques, Université M. MAMMERI de Tizi-Ouzou, ALGERIA

³Institut National de Recherche Agronomique, URFM d'Avignon, FRANCE

*Corresponding Author: illoulma@yahoo.fr

Abstract

Abies numidica De Lannoy is a forestry species, endemic Mountains Babors (eastern Algeria), it is classified as a rare and endangered species. The purpose of this study is to test the germination capacity of seeds in water deficit conditions of the substrate. To simulate water stress polyethylene glycol (PEG 600) was used to prepare the different levels osmotic water stress: 0.2, -0.4, -0.6 and -0.8 Mpa. The average rate of germination is between 41.56% (control) and 19.77% (-0.8 Mpa). There is a decline in the average rate of germination gradually as the water potential of the substrate decreases. There are significant differences between treatments, but the 0 threshold has not been reached -0.8 Mpa. In the same population, variations time of germination is not very important. The average rate of germination, however, is more variable, ranging between 12.22% and 75.56% for the witness treatment and between 0 and 64% for the -0.8 Mpa treatment. This result revealed a significant heterogeneity between trees. Some of them have low germination is some treatment, others observe a gradual decline as the water deficit increases for others, germination rates remain high even at -0.8 Mpa (64%). Within a same population, some trees may ensure natural regeneration and maintain populations of *Abies numidica* in drought conditions. This species can be considered tolerant to water stress at the germination stage.

Keywords : Water stress, seeds, germination, PEG, trees, population.

Résumé

Le Sapin de Numidie est une essence forestière algérienne, endémique des monts des Babors, classée comme une espèce rare et menacée. Le but de cette étude est de tester les capacités germinatives des graines dans les conditions de déficit hydrique du substrat. Pour simuler le stress hydrique le polyéthylène Glycol (PEG 600) a été utilisé pour préparer les différents niveaux le stress hydrique osmotique : 0,2 , -0,4, -0,6 et -0,8 Mpa. Les taux moyens de germination varient en moyenne entre 41,56% (témoin) et 19,77% (-0,8 Mpa). On note une baisse progressive du taux moyen de germination au fur et à mesure que le potentiel hydrique du substrat diminue. Il existe des différences significatives entre les différents traitements mais le seuil 0 n'a pas été atteint à -0,8 Mpa. Les résultats comparant les arbres entre eux à l'intérieur de la même population font apparaître que les variations du temps moyen du temps moyen de germination ne sont pas très importantes. Le taux moyen de germination est en revanche plus variable, variant entre 12,22% et 75,56% pour le traitement témoin et entre 0 et 64% pour le traitement -0,8Mpa. Ce résultat révéla une importante hétérogénéité entre arbres, certains présentent des germinations faibles quelques soit le traitement, d'autres observent une baisse progressive au fur et à mesure que le déficit hydrique augmentent pour d'autres en l'occurrence, les taux de germination restent élevés même à -0,8 Mpa (64%). A l'intérieur d'une même population, certains arbres pourraient assurer la régénération naturelle et maintenir des populations d'*Abies numidica* en condition de sécheresse, cette espèce peut être considérée comme une espèce tolérante à la sécheresse au stade de la germination.

Mots clés : Graines, germination, arbres, stress hydrique, population, Polyéthylène-glycole

Introduction

Abies numidica de Lannoy is an Algerian forestry species, endemic to the Babors mountain in eastern of Algéria, where he covers an area of 300 ha (Kolai, 1986). This is a kind of mountain, like all Mediterranean

firs where the natural area is located in areas exceeding 2000 m with cold winters and very cold (Duckrey, 1998), it is met from 1650m and goes up to 2000m (Gherzouli and Djellouli, 2005), and is adjacent to *Abies*

marocana located between 1600 and 2000m (Quezel and Barbero, 1975).

In the natural environment, *Abies numidica* is mixed with other species such as *Cedrus atlantica M.*, *Taxus baccata*, *Acer obtusatum*, *Populus tremula*, *oxycedrus Juniperus*, *Juniperus phoenicea* ... etc (Gherzouli and Djellouli, 2005).

These species occupying the bioclimatic humid with rainfall between 800 mm and 1500 mm, minimum temperatures vary between -2.2°C and 1.5°C and maximum average between 25.8°C and 29°C (Gherzouli and Djellouli, 2005). Duckrey (1998) reports that *Abies numidica* is well suited to stations well supplied with water but is drought tolerant, it is an intermediate species between *Abies nordmaniana*, *Abies marocana*, *Abies pinsapo* and *Abies cilicica*, *Abies concolor* and *Abies cephalonica*.

It was reported by Duckrey (1998) Trees that are suited to Mediterranean varying degrees of drought based on the ecology of their area of origin, *Abies marocana* and *Abies numidica* well optimize their water consumption, while that *Abies cephalonica* and *Abies nordmaniana* least optimize the consumption, which allows him to say that *A. pinsapo*, *A. marocana* and *A. numidica* are well adapted to drought. Aussenac (2002) specifies that *A. numidica* and *A. cephalonica* have a better resistance to drought, allowing them to withstand drought linked to climate change and would not be threatened by a movement of their potential range.

Abies numidica is a rare and endangered species, classified in the list of species protected and non-cultivated plant. High pressure anthropozoic associated with a drought that has lasted several years make the maintenance of this species, like many other hypothetical, Drought may be a factor which can then limit seed germination in Algeria where the importance of this study.

Specie to the dry substrate is the main objective of this study, because the success of this phase of plant development is crucial to the survival of naturally regenerated stands, moreover, is not sprouting only regulated by genotypic characteristics but also by the environmental conditions and in particular the availability of water in the soil.

On an experimental basis and the purpose of conservation, *A. numidica* was introduced outside its natural range in some arboreta (Chr ea, Djbel Ouahch and Serraidi) in Algeria. The results seem interesting perspective: fruiting, natural regeneration with recruitment of new individuals including planting Serraidi.

Material and methods

Cones were collected in Serraidi forest, this forest is located in the mountains of the Edough in eastern Algeria; it belongs to the sub-sector which is the district Numidian B ne (Maire, 1926). This forest is located between 7° and 36°38'Est 54'Nord at an average altitude of 856 m, a distance of about 7km from the sea, in the bioclimatic variant Wet to temperate with Q₂ calculated equal to 148 , 06. The average annual rainfall is 984.25 mm. *Abies numidica* has been introduced in 1968, from seeds from the stand Babors.

After disarticulation of cones, seeds were separated by densmetric sorting in ethanol 90°C to retrieve filled seeds. Seeds were first subjected to a wet cold pretreatment at 6°C for 07 days and then lots of 30 seeds repeated 03 times, were steeped in boxes with the substrate coated cotton and filter paper sprayed with distilled water containing PEG at various concentrations. Control plots were watered by distilled water.

To simulate water stress osmotic pressure of -0.2 Mpa, -0.4 Mpa, -0.6 Mpa and -0.8 Mpa were performed according to the model of Nguyen (1986). Two tests were performed, the first was used to test the ability of seeds of all people to resist water stress and the second inter-tree variability was tested. The experiment was conducted in a germination chamber at 22°C.

We considered the average rate of germination in different treatments as the percentage of seeds capable of germinating in well-defined conditions (COME, 1970). Speed or mean germination time is calculated using the following formula:

$$TMG = \frac{N1T1 + N2T2 + \dots + NnTn}{N1 + N2 + \dots + Nn}$$

O  TMG : germination time means

N1 : Number of germinated seed at time T1

N2 :: Number of germinated seed at time Tn

To compare the average germination of different treatments and different trees, we applied the method of variance analysis and

Results

1- Effect of osmotic treatments on seed germination

The average rate of germination ranged from 41.56% (control) and 19.77% (-0.8 Mpa). The average rate of germination decrease progressively as osmotic pressure increases -0,2, -0.4, -0.6 and -0.8 Mpa but without reaching the value 0. Analysis of variance showed significant differences (P <0.05) among treatments (table 1).

Table 1. Variance analyses

Variation sources	Sum of squares	ddl	Mean squares	F
inter groups	10021,16	4	2505,29	12,21
Within groupes	38958,64	190	205,04	
Total	48979,81	194		

Table 2. Comparison of different osmotic treatments

Treatments	average rate of germination	homogeneous groups
T0	41,56	A
T(-2bars)	31,79	B
T(-4bars)	27,05	B
T(-6bars)	27,16	B
T(-8bars)	19,77	C

Newman and Keuls (Table 2) distinguished three homogeneous groups, the control treatment is significantly different from other treatments. Treatments -0.2, -0.4 and -0.6 Mpa constitute a homogeneous group, where rates of germination substantially identical. The lowest rate is obtained at -0.8 Mpa, which is also one group that stands out. There is 23% decrease between the control treatment and treatment to -0.2 Mpa, 34.91% to -0.4 Mpa, -0.6 Mpa to 34.64% and 52.43% to -0.8 Mpa. It is only -0.8 Mpa the germination is reduced by half, there is indeed a gradual decline and not very intense germination.

graphs analysis using Excel and Statistf logiciels

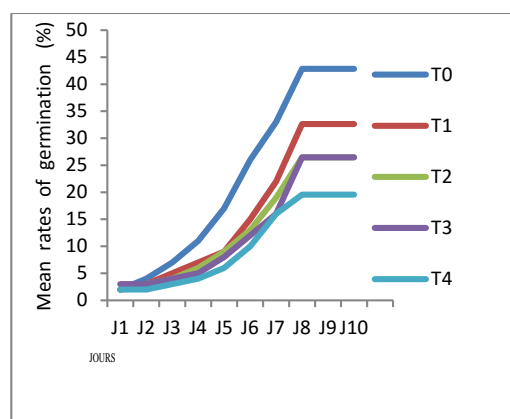

Figure 2. Dynamic of seed germination under water stress

(T0) : 0 bars (témoin) ; (T1) : -2 bars ; (T2) : -4 bars ; (T3) : -6 bars ; (T4) : -8 bars

Germination dynamics is more accelerated in processing seeds witness the seeds that have undergone the treatment with PEG (Figure 2).

2- Variation in germination capacity and mean time germination between trees

The average time of germination is the lowest recorded in the seeds of the control treatment (5.25 days) ranging between 3.96 and 8.36 days. For -0.8 Mpa the time is 6.14 days with a minimum of 4.13 and a maximum of 10 days. Variation between trees is not very important after the results of the coefficient of variation ranging between 16.21% and 23.24% (table3).

Table 3. Minimum and maximum values of the time and average rates of germination

Treatments	Mean germination time (days)	Mean Germination rate (%)
T0	5.25 ±1.01	40.85±17.74
T (-0,2 Mpa)	5.97±0.97	32.62 ±16.90
T (-0,4 Mpa)	6.03±1.40	26.55 ±11.64
T (-0,6 Mpa)	5.73±0.95	26.47±12.61
T (-0,8 Mpa)	6.14±1.12	19.60±13.91

The average rate of germination in control treatment is 40.85%, ranging between 75.56% and 12.22%. The lowest rate of germination is 19.59%, observed at -0.8 Mpa, ranging between 0 and 64, 44%. There are significant variations between trees given

values of the coefficient of variation (43.42 and 71.05) in processing particular to -0.8 Mpa (figure 3). Analysis of variance showed

significant differences ($P < 0.05$) between trees for each level of water stress (Table 4).

Table 4: Variance Analyses of Time and rate of seed germination between trees

Treatments	variation Source	Sum of squares	ddl	Mean square	F	F.t
T0	-between trees	33537.3	37	906.4	12.7***	1.6
	-same trees	5444.4	76	71.6		
	-Total	38981.8	113			
-0,2 Mpa	-between trees	28737.89	38	756.2	11.7***	1.5
	-same trees	5051.85	78	64.7		
	-Total	33789.73	116			
-0.4 Mpa	-between trees	14805.8	38	389.6	7.3***	1.6
	-same trees	4140.5	78	53.1		
	-Total	18946	116			
-0.6 Mpa	-between trees	15203.4	36	422.31	6.7***	1.6
	-same trees	4692.6	74	63.41		
	-Total	19896	110			
-0.8 Mpa	-between trees	21721.7	38	571.62	12.6***	1.6
	-same trees	3538.9	78	45.37		
	-Total	25260.6	116			

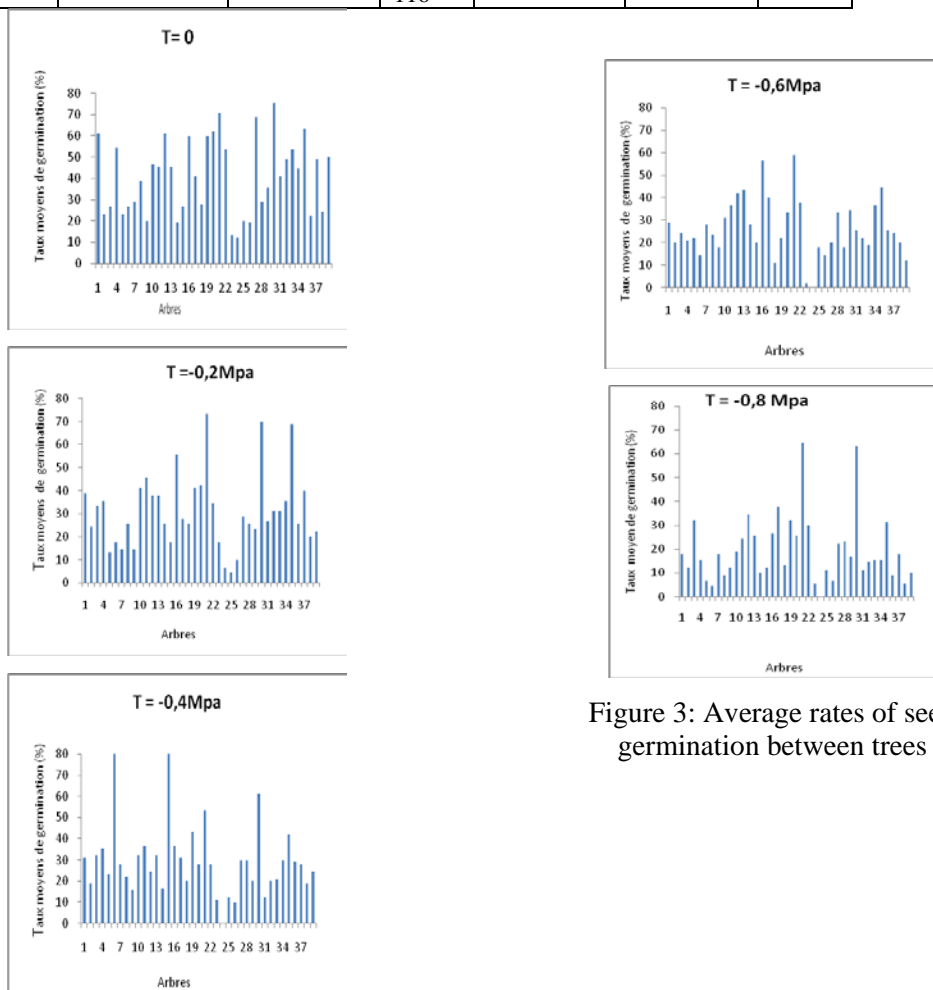

Figure 3: Average rates of seed germination between trees

Germination capacity of seeds reveals significant heterogeneity between trees for resistance to water stress (Figure 3). 82.05% of trees are sensitive from -0.2 MPa however rates germination remain significant and do not reach low values, 10.25% are sensitive from -0.4 MPa and 2.56% from -0.8 MPa. Some trees showed a resistance strategy with significantly higher rate (64% and 63.33%) in -0.8 MPa.

Discussion

The average germination of control treatment ($T = 0$) is 42.56%, in genus *Abies* rarely average germination exceeds 50% (Hickel, 1911 Franklin, 1974 in Fady, 1990 and Fady, 1991). On three years of testing, we have indeed achieved rates of 39.46%, 42.56% and 32.18%. These rates may result from the fragility of the seeds, also, in isolated plantations genetic base is narrow, germination is low (Dirik, 2000). Mother trees allow individuals resource allocation to produce many seeds, which allows these trees to contribute to germination under stress conditions. The germination rate gradually decreases with the increase of osmotic water stress of the substrate, similar results were obtained in many species, Falusi and al. (1981) in *Pinus halepensis*, Hallgren (1989) in *Pinus elliotii* and *Pinus taeda*, Fady (1990 and 1991) on *Abies cephalonica*, Falleri (1994) in *Pinus Contorta*, Dirik (2000 and 2002) in the *Cedrus libani*, Calamassi and al. (2001) in *Pinus halepensis*, Ladjal (2001) in the Cedars Mediterranean, Boydak and al. (2003) in *Pinus brutia*, Tazi and al. (2003) on the Argan tree (*Argania spinosa*), Tilki and Dirik (2007) in *Pinus sylvestris*, Tanoh Kouakou and al. (2008), and Ahmadloo and al. (2011) in *Cupressus arizonica* and *Cupressus sempervierens*.

The decrease in water potential in the substrate reduces the germination from 23% to -0.2 MPa, 34.91% to -0.4 MPa, 34.64% to -0.6 MPa and 52.43% to -0.8 MPa, compared to the control treatment. Boydak and al. (2003) argue that at -8 bar germination is reduced by 50% in *Pinus brutia*, Falusi and al. (1983) reported that the same threshold (50%) was observed in *Pinus halepensis* to -2 bar. in *Cedrus libani* the germination rate decreases from 48% to -2

bar, and 61% to 75% at -4bar to -6bar (Dirik, 2000). To -0.7 MPa. Fady (1992) obtained 18.30% in *Abies cephalonica*, *Abies numidica* while the result is 24.47% to -0.6 MPa and 19.59% to -0.8 MPa, the seeds of *Abies numidica* are more resistant to drought as *Abies cephalonica*, Dubos (2003) reported that the metabolism that is highly regulated during water stress is that sugars. A sugar preferentially accumulated in plants subjected to water stress is sucrose. This seems to be the case in maritime Pine (over-expression of sucrose phosphate synthase and sucrose synthase) thus limiting the damage to cellular structures. The results show clear differences faculties' germination of seeds from trees in the different treatments showing significant heterogeneity inside a same population. Some trees are indeed a group in which the seeds are very sensitive to water deficit, others are less sensitive, although decreased germination rate from -0.2 MPa rates remain attractive (40 and 55%). For other trees, the germination rate was not affected in a remarkable way, the relationship between germination and reduced water potential of the substrate is not clear. Trees whose germination rates are high at T_0 do not maintain the same germination capacity from -0.2 MPa, the threshold sensitivities appearance of the first and last trees that maintain the same germination important to -0.8 MPa, also increases the rate of germination when the osmotic pressure increases has been reported by Fady (1992) in *Abies cephalonica*, it would be an adaptation of seeds to the osmotic pressure that exists in the solution of ground. The threshold for these trees would be more important. The ability to germinate on dry physiologically allowed to high a significant genetic variability in *Abies numidica* this variability is even more evident when water stress is more pronounced. Climatic conditions and the genetic heritage of each tree can therefore act on germinating seeds skills in drought conditions. Within the same population, some trees may provide regeneration in drought conditions and long term natural selection act on maintaining them. As Dirik (2000), we can assume that the frequencies of genes

controlling resistance to water stress of the substrate in the heart of the germination of seeds, increased under the effects of natural selection from generation to generation, for maintaining populations in terms dry. Dubos and al. (2003) have in turn identified and characterized genes whose expression is regulated during water stress in the Maritime Pine. Following this, many changes occur in the expression of genes that affect the level of primary metabolism (Deepika and Anil, 1999 in Dubos, 2001). It has been revealed through this study a significant genetic variability of *Abies numidica* for resistance to water stress, Fady (1992) reached the same conclusion on *Abies cephalonica*, these results resemble the two species as was suggested Aussenac (2002). Water potential is greater than that tested (-1.2 Mpa) for Aussenac (2002).

Conclusion

These results suggest that *Abies numidica* could resist drought regeneration now provided by some individuals within a same population and may be considered as a drought tolerant species.

References

- Ahmadloo F., Tabari M., Behtari B., 2011 : Effect of drought stress on the germination parameters of *Cupressus* seeds. International Journal of Forest, Soil and Erosion, 1 (1):11-17.
- Almansouri M., Kinet J.M., Lutts S. 2001 : Effect of salt and osmotic stress on germination in durum wheat (*Triticum durum* Desf). Plant and soil 231: 243-254.
- Aussenac G., 2002: Ecology and ecophysiology of circum-Mediterranean firs in the context of climate change. Ann.For.Sci ; 59 823-832.
- Barbero and Quezel, 1975 : Les forêts de Sapin sur le pourtour méditerranéen. Anal.Inst.Bot. Cavanilles 32 (2) 1245-1289.
- Boydak M., Dirik H, Tilki F., Calikoglu, 2003 : Effects of water stress on germination in six provenances of *Pinus brutia* seeds from different bioclimatic zones in Turkey. Turk. J. Agric. For. 27 : 91-97
- Calamassi R., Rocca G.D., Falusi M. Paoletti E. and Strati S., 2001: Resistance to water stress in seedlings of eight European provenances of *Pinus halepensis* Mill. Ann. For. Sci. 58 : 663-672.
- Côme D., 1970 : Les obstacles à la germination des graines. Ed. Masson et Cie. Paris, 10P.
- Dirik H., 2000: Effet du stress hydrique osmotique sur la germination des graines chez les provenances de Cèdre du Liban (*Cedrus libani* A. Rich.) Ann. For.Sci. 57 : 361-367.
- Dubos C., 2001 : Réponse moléculaire de jeunes plants de Pin maritime soumis à un stress hydrique en milieu hydroponique. Thèse Doc. U. Henri Poincaré, Nancy-I (France), P.292.
- Dubos C., LeProvost G., Pot D., Salin F., Lalane C., Madur D., Frigerio J.M. and Plomion C. 2003 : Identification and characterization of water stress responsive genes in hydroponically grown Maritime pine (*Pinus pinaster*) seedlings. Tree Physiology 23, 169-179.
- Duckrey M., 1998 : Aspects écophysologiques de la réponse et de l'adaptation des sapins méditerranéens aux extrêmes climatiques : gelée printanières et sécheresse estivale. Forêt méditerranéennes t.XIX, n°2.
- Fady B., 1990 : Variabilité génétique du Sapin de Grèce, Thèse Doc. , spécialité Biologie et physiologie Végétale, Univ. De droit, d'économie et des sciences d'Aix-Marseille. 116P.
- Fady B., 1992: Effect of osmotic stress on germination and radical growth in five provenances of *Abies cephalonica* Loud. Acta Aecologica, , 13 (1) 67-79.
- Fady B., 2005 : Biodiversité des populations de conifères existe-t-il une spécificité méditerranéenne. Mém. Habilitation à diriger des recherches. U.R.F.M., INRA (France)
- Falleri E., 1994: Effect of water stress on germination in six provenances of *Pinus pinaster* Ait. Seed Science Technology, 22 (2), 591-599.
- Falleri E., Muller C. and Laroppe E., 2004: Effect of water stress on germination of beechnuts treated before and after storage. Canadian Journal of Forest Research, 34(6), 1204-1209.
- Falusi M., Calamassi R. and Tocci A., 1983: Sensitivity of germination and seedling root growth to moisture stress in four provenances of *Pinus halepensis* Mill. Silvae Genetica 32,1-2
- Franklin J.F. Ritchie G.A., 1970 : Phenology of cone and shoot development of noble fir and some associated true firs. Forest Sci.,16, 3,356-364.
- Franklin J.F., 1974 : *Abies*. In "Seed of woody plants in the United States", USDA forest service, Agricultural Handbook n°450,168-183.
- Gharzouli R. et Djellouli M., 2005 : Diversité floristique de la kabylie des Babors (Algérie). Sécheresse Vol. 16, n°3.

Hallgren S.W., 1989 : Effects of osmotic priming using earated solutions of polyethylene glycol on germination of pine seeds. Ann. Sci. For. 46, 31-37.

Hickel R., 1911 : Graines et plantules des conifères. Bull.Soc.Dendrol.Fr.,19, 13-115 et 20,134-204.

Kolai L., 1986 : La sapinière d'*Abies numidica* dans le mont Babor. Ann. Rech. For, INRF Bainem (Algérie) : 85-97.

Kolb P.F. and Robberecht R., 1996: High temperature and drought stress on survival of *Pinus ponderosa* seedlings. Tree Physiology 16, 166-672 :

Ladjal M., 2001 : Variabilité de l'adaptation à la sécheresse des Cèdres méditerranéens (*Cedrus atlantica*, *C.brevifolia*, *C.libani*) aspect éco physiologique. Thèse Doc.Bio.For.U.H.P. de Nancy I, 212P.

Maire R., 1926 : Notice de la carte phytogéographique de l'Algérie et de la Tunisie. Ed. Baconier, 75P.

Nguyen A., 1986: Effet d'une contrainte hydrique racinaire sur de jeunes plants de Pin maritime (*Pinus pinaster* Ait). Thèse de Doctorat, Université de Bordeaux1, Talence, France..

Kouakou T.H., Kone M., Kone D., Kouadio Y.J. et Zouzou M., 2008: Réponse physiologique au stade juvénile du génotype R405-2000 de cotonnier (*Gossypium hirsutum* L.) au déficit hydrique induit par le polyéthylène glycol. Sci. Nat. Vol.5 N°1 : 81-87.

Tazi M.R., Berrichi A., et Haloui B., 2003 : Effet du stress hydrique par le PEG sur la germination et la croissance de l'Arganier in vitro. Sécheresse vol.14n°14, PP23-27.

Tilki F., Dirik H., 2007: seed germination of three provenances of *Pinus brutia* (Ten) as influenced by stratification, temperature and water stress. Journal of Environmental Biology, 28(1), 133-136.

Vickers A.D., Palmers S.C.F., 2001: The influence of canopy cover and other factors upon the regeneration Scots pine and its associated ground flora within Glen Tanar National Nature Reserve. Forestry, 73, 37-49.

Determination of Potential Rehabilitation Areas Using by Dynamic Analytical Hierarchy Process (DAHP) Method and Geographic Information Systems (GIS) in the Bartın-Sökü Forest Range District in Turkey

Selman KARAYILMAZLAR¹, *Halil Barış ÖZEL¹, Tuğrul VAROL¹,
Hande Nur VAROL²

¹Bartın University, Faculty of Forestry, Bartın / TURKEY

²Bartın Forestry Directorate, Bartın / TURKEY

*Corresponding Author: halilbarisozel@yahoo.com

Abstract

Turkey have 22.7 million hectares forest area and 50% degraded state of this forest area. In this context the success artificial regeneration, afforestation and rehabilitation treatments must be made for conversion of degraded forest area to production level. In this study, potential pure and mixed oriental beech (*Fagus orientalis* Lipsky.) areas, which are suitable of rehabilitation treatments because of low stand dynamics were determined using by DAHP and GIS in the Bartın-Sökü Forest Range District. According to the results there are 408.2 hectares potential rehabilitation areas in Sökü planning unit. This field is 10.68% of the total area of Sökü District. On the other hand the most effective factors were determined by DAHP; 1. Stand Canopy (SC), 2. Stand Density (SD), 3. Soil Production (SP), 4. Altitude (A), 5. Aspect (As), 6. Stand Age (SA), 7. Weed Control (WD), 8. Seedling Quality (SQ), 9. Transport Opportunities (TO), 10. Machine and Equipment (ME), 11. Rainfall (R), 12. Protection Measures (PM) and 13. Economical Problems (EP) respectively at the $P < 0.01$ significance level. Accordingly, all of these variables taking into account the dismantling of the region by making the degraded beech-oak and forest gaps the were added will be included in the rehabilitation work to be carried out in a total of 2594.3 hectares of re-efficient society stands will be provided benefits and services.

Keywords: Rehabilitation, DAHP, GIS, Oriental beech, Silviculture, Sökü

Bartın-Sökü Yöresinde Potansiyel Rehabilitasyon Sahalarının Dinamik Analitik Hiyerarşi Prosesi (DAHP) ve Coğrafi Bilgi Sistemleri İle Belirlenmesi

Özet

Türkiye orman alanı 22.7 milyon ha olup, bu orman alanının yaklaşık %50'si verimsiz durumdadır. Bu kapsamda bozuk orman alanlarının verimli hale getirilebilmesi için başarılı yapay gençleştirme, ağaçlandırma ve rehabilitasyon çalışmalarının yapılması gerekmektedir. Bu çalışmada Bartın-Sökü yöresinde bulunan ve yapısal özellikleri itibarıyla rehabilitasyon çalışmalarının yapılmasına imkan sağlayacak olan potansiyel saf ve karışık kayın orman alanlarının dinamik analitik hiyerarşi prosesi (DAHP) ve coğrafi bilgi sistemleri yardımıyla belirlenmesi amaçlanmıştır. Çünkü Sökü yöresi zengin orman varlığı ile kayının optimale yakın doğal yayılış yaptığı sıcak noktalardan birisidir. Yöredeki potansiyel rehabilitasyon alanlarının belirlenmesine yönelik anket uygulaması ile elde edilen veriler DAHP metodu ile değerlendirilmiş olup coğrafi bilgi sistemleri yardımıyla plan ünitesine ait harita ve diğer görseller üzerinde gösterilmiştir. Arazi incelemeleri ve paydaşlara uygulanan anket sonuçlarına göre Sökü yöresinde potansiyel rehabilitasyon alanının 408.2 ha olduğu, bu alanın Sökü plan ünitesinin yaklaşık % 10.68'ini oluşturduğu belirlenmiştir. Sonuç olarak, potansiyel rehabilitasyon alanlarının belirlenmesinde $p < 0.01$ güven düzeyinde % 93.4 başarı ile elde edilen değişken ağırlıklarına göre en önemli faktörler sırasıyla; 1. Meşcere Kapalılığı (MK), 2. Meşcere Sıklığı (MS), 3. Toprak Verimliliği (TV), 4. Rakım (R), 5. Bakı (B), 6. Meşcere Yaşı (MY), 7. Diri Örtü Kontrolü (DÖK), 8. Fidan Kalitesi (FK), 9. Transport İmkanları (Tİ), 10. Makina ve Ekipman (ME), 11. Yağış (Y), 12. Koruma Tedbirleri (KT) ve 13. Ekonomik Sorunlar (ES) şeklinde belirlenmiştir. Tüm bu değişkenler dikkate alınarak Sökü yöresinde bozuk nitelikli kayın-meşe meşcerelerinde yapılacak rehabilitasyon çalışmalarına orman içi açıklıklarda eklenecek olursa toplam 2594.3 ha alanın yeniden verimli hale getirilerek toplum fayda ve hizmetine sunulması sağlanmış olacaktır.

Anahtar Kelimeler: Rehabilitasyon, DAHPM, CBS, Doğu kayını, Silvikültür, Sökü

Introduction

Turkey is of a wide range of forests in terms of species composition and establishment characteristics by the effect of various ecological conditions in the region. According to recent data provided by the General Directorate of Forestry, a total area of forestlands is approximately 22.7 million hectare in Turkey and this area constitutes 27.8% of the total acreage of the country (GDF, 2015). Especially the productive parts of these forestlands preserving their nature are managed mainly with an attempt to produce wood as raw material. The vast majority of the particular silvicultural practices aim to obtain wood as raw material. As a result of the negative effects of many biotic and abiotic factors such as improper silvicultural activities, illegal loggings, forest fires, insect and fungal pests, about 50% of the existent national forests are of low or no yield. The most important objectives of Turkey's national forestry in short and long term are to make these degraded forestlands reproductive and increase their contributions to the national economy. Therefore, it will enable not only the productive forests to increase in number but also the community health services by forests to maintain. With this aim, it needs afforestation and rehabilitation practices through natural and artificial regeneration (Saatçioğlu, 1979). Rehabilitation works differ, to some extent, from those for artificial regeneration and afforestation in terms of quality and techniques. Within this scope, it is aimed to increase productivity of the existent stand by filling in the forest glades through cultivation as well as regenerating those which are capable of shooting forth well but distribute unevenly in rehabilitation works (GDF, 2016a). In this respect, according to the latest statistical data, rehabilitation works were carried out in a total area of 98.771 ha in Turkey by 2015 (GDF, 2016b). However, it needs rehabilitation in much wider open spaces in Turkey so as to increase productivity especially in mixed and pure leaved forests and assure the sustainability of other protective functions provided by forests (Odabaşı et al., 2004; Genç, 2004). In this regard, the foremost problem is the site selection. A number of factors play roles in

site selection for the works of rehabilitation where various joint silvicultural practices are carried out (Sungur and Bilir, 2015). For that reason, it has a vital importance to utilize multi-dimensional decision making methods in the site selection for rehabilitation entailing intensive practices for forestry in terms of not only making objective decisions but also selecting the suitable sites.

In this research, it was aimed to identify the suitable sites for the works of rehabilitation among potential pure beech forests and mixed beech forests (*Fagus orientalis* Lipsky) existing in Bartın-Sökü Forest Sub-District Directorate and the forest glades in the planning unit through Dynamic Analytic Hierarchy Process, one of the multi-dimensional decision making methods.

Material and Method

Sökü Forest Sub-District Directorate within the territorial borders of the district of Ulus in Bartın province is administratively affiliated to Ulus Forest Enterprises Directorate. The planning unit takes place in the map sections of F29-a₁, F29-a₂ ve F29-a₄ in the 1/25.000 scale topographic map of Zonguldak. According to this, Sökü region is located between the east longitudes of 32° 27' 55" - 32° 40' 43" and north latitudes of 29° 18" - 41° 22' 18". The horizontal distance of the planning unit to the sea level is 50 km. the approximate altitude of Sökü Forest Sub-District Directorate, being of mainly rugged terrain, is 789 m. While the lowest part is 165 m high on the border between the planning unit and Kumluca creek, the highest part is the altitude of 1413 m on the Tepelicek Hill (Anon., 2013). Sökü planning unit forests, according to the forest communities classifications by Mayer and Aksoy (1998), are placed at the *north-west euxin* sub-forest belt under the *euxin* forest belt. Considering the forests in Sökü region in terms of stand structures, it is seen that an area of 2999 ha in regional forests is in a mixed stand structure whereas 387 ha of it is in pure stand structure. The region receives rain in each season and the peak month of average precipitation is December (162,3 mm) while the lowest rain is seen to be in May (88,0 mm). The annual average temperature is 10,6 °C in Sökü region; the lowest temperature is seen in

January (0,0 °C) and the highest temperature is seen in July (19,8 °C) and August (19,7 °C). Moreover, the vegetation period in the research area is for 6 months (May-October) (Özel, 2007). The geological structure in Sökü region was formed in the cretaceous and subdivision periods of the Mesozoic Era. Therefore, the bed rocks are in metamorphic and sedimentary forms in the region. In especially steep lands of the region are found limestone, clay, marl, schist and flysh. In

lower pitched parts are seen sandstones and conglomerates (MTA, 2002). What is more, in the management plan and detailed silvicultural plan, the general soil structure in the planning unit of Sökü Forest Sub-District Directorate is stated to be medium deep and mainly of rocky, alkaline, sandy clay, clay loam and sandy clay loam texture (Anon., 2016). Figure 1 displays the location of the research area in Turkey and Sökü planning unit.

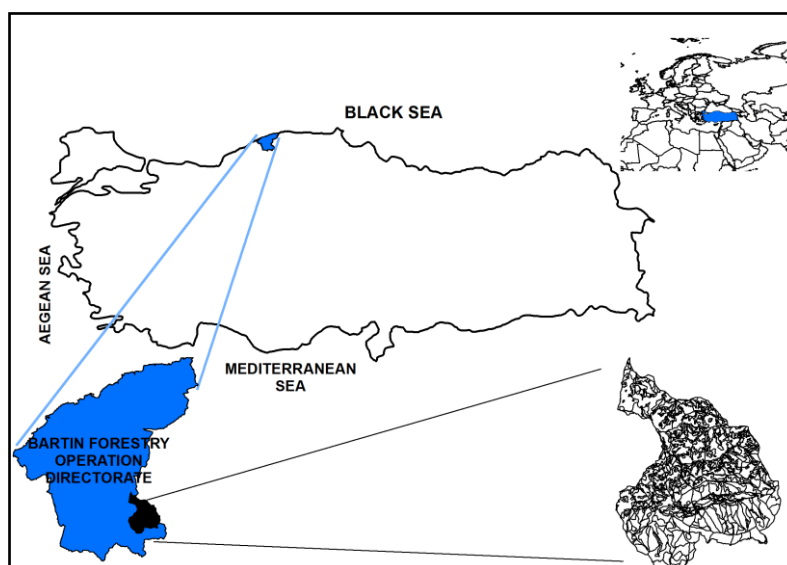

Figure 1. The location of the research area in Turkey and Sökü planning Unit

Many factors play a role in suitable site selection for the works of rehabilitation. The internal and reciprocal influences of those factors are too complex. In the framework of these complex influences, it is possible to use several methods to determine the sites of energy plantations. These methods are mathematical methods, financial methods, simulation method, and Analytic Hierarchy Process (AHP) that take hierarchy into consideration, TOPSIS, Fuzzy TOPSIS and Fuzzy AHP and DAHP as multi-criteria decision making methods (Eleren, 2006; Ho, 2008; İmren, 2011; Özel et al., 2014).

AHP technique is implemented in four phases; establishing decision hierarchy, paired comparison of decision elements, prioritizing decision elements and determining their priorities among others (Daşdemir and Güngör, 2010; Yılmaz and Surat, 2015). AHP based on fragmentation and synthesis is a system of logical

determinations and classifications for the compared options or elements in terms of their levels of superiority and significance (Yılmaz and Surat, 2015).

The overall data for soil structure belonging to degraded and severely degraded forest lands as the material of research area was obtained from land use and geological maps prepared by General Directorate of State Hydraulic Works and General Directorate of Mine Research and Exploration. On the other hand, climatic data for research material was obtained from the average observation values for many years at Bartın Meteorological Station in order for the interpolation of temperature and precipitation (Özyuvacı, 1999) because there were no mobile or fixed meteorological stations at each point of the research area.

In this study, Analytic Hierarchy Process Method was carried out in two phases for the selection of site establishment of energy forest

plantations. In this regard, the criteria mostly based on the selection of site establishment were determined thanks to questionnaire-driven statistical studies. In this phase, 16 criteria affecting the site selection in

supplying energy plantation were evaluated. The responses were received based on the 11 multiple-choice alternatives. The variables used in the study are displayed in Table 1.

Table 1. Parameters used in this study and their symbols

Variable No	Variables Name	Symbol
1	Stand Canopy	SC.
2	Stand Density	SD
3	Soil Production	SP
4	Altitude	A
5	Aspect	As
6	Stand Age	SA
7	Weed Control	WD
8	Seedling Quality	SQ
9	Transport Opportunities	TO
10	Machine and Equipment	ME
11	Rainfall	R
12	Protection Measures	PM
13	Economic Problems	EP
14	Ground Vegetation Density	GVD
15	Labor Opportunities	LO
16	Social Problems	SP
17	Cadastral Problems	CP

These variables were aligned according to the level of significance for the use in the AHP method in Table 2. It is important to determine the sample size, depending on the aim of research, in terms of the proper implementation and reliable results of the study (Kalıpsız, 1994). For that reason, the number of participants for the questionnaire as the sample size was determined via the formula below (Daşdemir and Güngör, 2015).

$$n \geq \frac{Z^2 \times N \times p \times q}{N \times D^2 + Z^2 \times p \times q} \quad (1)$$

In this formula, significations are as follow: n signifies sample size, Z signifies confidence coefficient (Z= 1,96 for a 95% confidence). N: the size of the total population, p: prevalence of the sample size in N (p=0.05), q: 1-p and D: sampling error tolerated (10%) (Daşdemir and Güngör,

2010). In this study aiming at determining the suitable site selection for energy forest plantations through AHP method as a result of this formula, it was needed at least 100 participants via random sampling. However, a total of 130 people from different participants were interviewed and administered a questionnaire in order to increase the reliability of the research results. Besides, it was examined at 148 points including pure beech and mixed oriental beech forests and glades at a medium altitude zone (500-700m), a potential area for rehabilitation works in the Sökü planning unit, and some determinations were made regarding the current stand habitat conditions. Determining statistical parameters belonging to the variables were calculated using SPSS package programme (Table 2).

Table 2. Statistical parameters for variables

Variables	N	Mean	Standard Deviation
SC.	130	16.7	0.632
SD	130	16.2	0.624
SP	130	15.8	0.587
A	130	15.3	0.563
As	130	14.9	0.521
SA	130	14.7	0.498
WD	130	14.2	0.483
SQ	130	13.5	0.445
TO	130	13.1	0.412
ME	130	12.6	0.375
R	130	12.3	0.368
PM	130	11.5	0.357
EP	130	11.2	0.324
GVD	130	10.8	0.291
LO	130	10.5	0.287
SP	130	9.6	0.275
CP	130	9.3	0.262

According to the values in Table 2, the weight values of 17 variables having impact on site selection were determined to use DAHP. The number of values to be used in decision making process as a result of weight

values determined was reduced to 13. In this regard, the weight values of 13 variables, effective in decision making process, are shown in Table 3.

Table 3. Weights of variables

Variables	Rank of Variables	Weight (%)
SC.	V1	17.7
SD	V2	14.2
SP	V3	12.6
A	V4	11.8
As	V5	11.5
SA	V6	9.3
WD	V7	7.1
SQ	V8	6.7
TO	V9	3.2
ME	V10	2.4
R	V11	1.3
PM	V12	1.2
EP	V13	1.0

In order to receive more detailed and realistic results from the values in decision making process via AHP method, it is of high significance that the scale used is related to the subject of the study (İmren, 2011; Özel et al., 2014). With this regard, a scale having 11

levels was made us of in the questionnaire evaluation system in this research carried out for site selection of energy plantations. These utilized evaluation values are shown in Table 4.

Table 4. Scale levels used in evaluations

Importance Level	Scope
1	Unimportant
2	Equally Important
3	Medium-Level Important
4	Important
5	Significantly Important
6,7,8,9,10,11	In case of indecision

It was paid a special attention to administer the questionnaire prepared to achieve raw data underlying the research to all the participants who were interested or involved in the study subject. Therefore, the questionnaires were administered to the senior students and interested academic staff in the subject from the Department of Forest Engineering of the Faculty of Forestry at Bartın University; the students and academic staff taking interest in the subject at several departments of the Faculty of Engineering, Bartın University; Forest Engineers working in the fields and Forest Guard Officers at the Bartın and Ulus Directorate of Forestry Operation; the members of Forest Development Cooperatives making money by logging; the owners and employees of small, medium and large scale lumber companies; some NGOs, the villagers residing either in or by forests and dwellers around that could be reached. According to the variables embodied as a result of the study, it needs measuring the level of consistency of the points scored to the alternative areas having the potential of establishing energy plantation in determining the site of energy forest plantations. For this reason, the consistency indicator and consistency rate parameters were measured through the formulas below considering the random indicators (Saaty, 1985; Eleren, 2006; İmren, 2011).

$$\text{Consistency Index (CI)} = \frac{\lambda_{\text{Max}} - N}{N(N-1)} \quad (2)$$

When random indicators are shown as (RI)

$$\text{Consistency Rate (CR)} = \text{CI(RI)}^{-1} \quad (3)$$

The closer to zero consistency rate (CR) is, the more consistent the comparison results are proportionally.

Results and Discussion

The first phase for solving the problem relating to site selection for the works of rehabilitation in the planning unit of Bartın-Söke is to compare the corrected criteria. According to this, the comparison of corrected criteria measured by using related formulas is shown in Table 5. The term “correct” used here in signifies the proportion of the each criteria score to the total score of those in the same column. Criteria weights are acquired through the mean proportion of the corrected scores values in the same line (İmren, 2011; Özel et al., 2014).

Table 5 reveals that the comparison chart is coherent with $\text{CR}=0.06 < 0.10$. Thus, It is achieved the corrected tables of all alternative sites of establishment for each criterion. CR values less than 0.10 for each criterion in Table 5 show that the assessment table is coherent, too. However, the criteria weights and values of coherence in Table 5 are not merely sufficient for deciding the site selection of energy forest plantation. The weighted scores and ranking table is also needed. In this regard, the weighted scores and rankings relating to alternative stand types and criteria proposed for the works of rehabilitation are shown in Table 6.

Table 5. Corrected criteria comparisons

Variables	Criteria Weight	Consistency Criteria
V1	0.87	8.92
V2	0.83	8.87
V3	0.76	8.69
V4	0.74	8.62
V5	0.67	8.57
V6	0.61	8.53
V7	0.59	8.51
V8	0.53	8.47
V9	0.48	8.45
V10	0.43	8.40
V11	0.39	8.37
V12	0.35	8.33
V13	0.29	8.30

(n=13, CI=0.10, CR=0.04<0.10: Comparison is consistent.)

Table 6. Weighed scores and ranking of establishment locations

Forest Stand Types	Alternative Establishment Locations	Criterion Weight	Rank	CR
FST1	1.95	0.36	1	0.09
FST2	1.91	0.34	2	0.09
FST3	1.87	0.31	3	0.08
FST4	1.82	0.27	4	0.08

FST1: Degraded pure oriental beech stand,
FST2: Degraded oriental beech and oriental hornbeam mixed stand
FST3: Degraded oriental beech and Uludağ fir mixed stand,
FST4: Forest gap

Examined the data and ranking in Table 6, it is seen that the most convenient place for the works of rehabilitation in the Bartın-Sökü planning unit are degraded pure beech forests. Then, degraded beech-hornbeam leaved mixed forests and degraded beech-Uludağ fir forests come respectively in the second and third place for ranking of suitable stand types for rehabilitation works. The least convenient place for this is glades in forests. The areas identified by DAHP method and convenient for the works of rehabilitation in Bartın-Sökü planning unit are displayed in stand type map in Figure 2.

Considering the research results, many factors which are effective in suitable site selection for the rehabilitation in research area are listed first under 17 main titles (Table 1). Then, it was stated that 13 factors are the most effective ones in selecting the convenient places for the works of rehabilitation as a result of weight calculations (%) using the AHP method (Table 13). The following items

are these 13 main factors: stand closure (SC), stand density (SD), soil productivity (SP), altitude (A), stand age (SA), weed diagnosis (WD), seed quality (SD), transportation opportunities (TO), mechanics and equipment (ME), rain (R), protection measures (PM) and economic problems (EP). In another research carried out in the region under similar ecological conditions, analytic hierarchy method was utilized for site selection of afforestation with calabrian pine and stone pine and the most effective factors in selecting sites for afforestation with these species were identified to be soil structure, proximity to seeds, transportation opportunities and budget criteria (Özel et al., 2014). As a result of the comparison of the research results, the majority of the most effective criteria in site selection are seen to be the variables depending on the ecological conditions. Moreover, the findings of a study carried out in Australia show that ecological conditions came before economic and social

criteria when the functional properties and management of forest resources were examined via AHP method considering the multi-dimensional criteria (Ananda and Herath, 2009). In another study about this issue in Isparta-Senirkent, it was also identified that the selection of species and origin and quality seed production would directly be the success-oriented factors in the works of rehabilitation (Sungur and Bilir, 2015).

According to the results of AHP method used in the research, the most suitable stand types for the works of rehabilitation in the research area are degraded pure oriental beech, degraded oriental beech+oriental

hornbeam, degraded oriental beech+Uludağ fir and forest glades (Table 6). According to this result, it is an expected result that degraded pure and mixed stands of beech, capable of stooling and stem sprout in particular, take place on the top in the forest establishments for the works of rehabilitation because the protection and rehabilitation of quality and well rooted offshoots form the combined silvicultural methods for the works of rehabilitation. Thus, a study carried out in oak coppices in Adıyaman region states that the oak forestlands which had been formed by the healthy and quality shoots, tending to generate more independent roots, were chosen for the works of rehabilitation (Tunç, 2011).

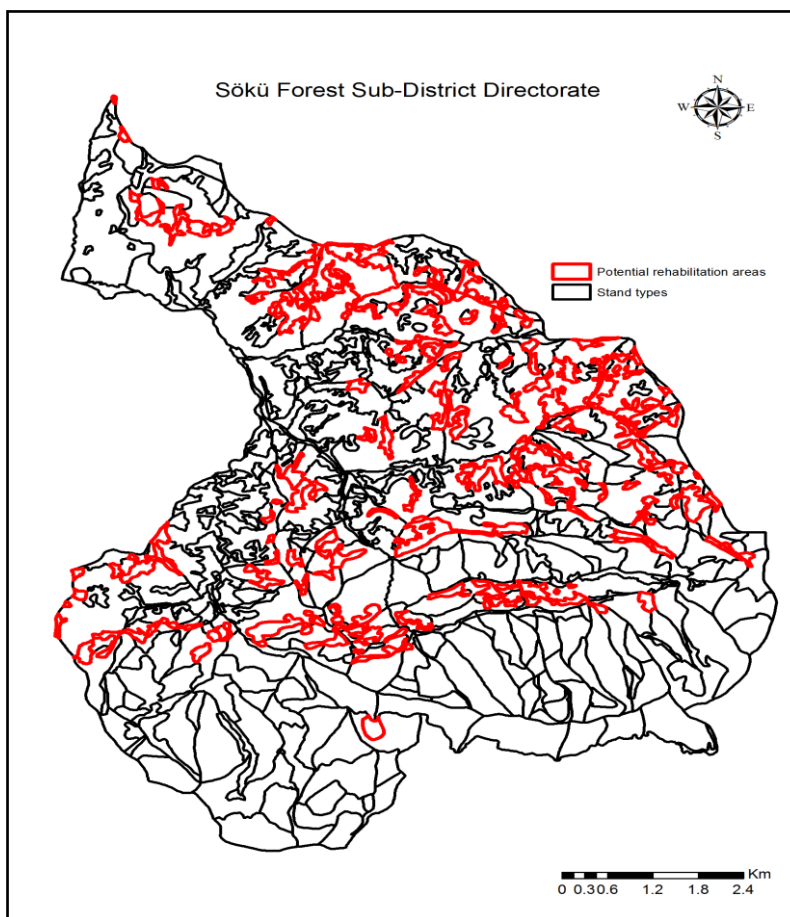

Figure 2. The convenient areas for the works of rehabilitation in the planning unit of Bartın-Sökü

Conclusion

As a result of this research carried out to determine the convenient places for the works of rehabilitation via DAHP method in the Bartın-Sökü planning unit, a total of 2594.3 ha on a moderate zone at low and medium

altitude levels in research area is expecting to be made reproductive. Therefore, this area needs a spatial and temporal plan and rehabilitation through a suitable combination of silvicultural techniques without losing time. In this regard, the equipment and labor

force should be provided for the rehabilitation works in a very short time and the required budget should be allocated for such works. Otherwise, these areas will continue losing value in terms of the products and services they will provide. On the other hand, it will be fruitful to use efficiently the multi-

References

Ananda J., Herath, G. A. 2009. Critical review of multi-criteria decision making methods with special reference to forest management and planning, *Ecological Economics* 68, 2535-2548.

Anon., 2013. Ulus-Sökü Orman İşletme Şefliği, Model Amenajman Planı, Ankara, 235s.

Anon., 2016. Ulus- Sökü Orman İşletme Şefliği Detay Silvikültür Planı, 25 s.

Daşdemir İ., Güngör E. 2010. Determination of functional priorities of forest resources by multicriteria and participatory approach: Case of Ulus State Forest Enterprise, *Bartın Journal of Forestry Faculty*, 11-25.

Eleren A. 2006. Kuruluş Yeri Seçiminin Analitik Hiyerarşi Süreci Yöntemiyle Belirlenmesi; Deri Sektörü Örneği, *İktisadi ve İdari Bilimler Dergisi*, 20 (2), 405-416

GDF, 2015. Türkiye Orman Varlığı, Orman Genel Müdürlüğü, Ankara, 56 s.

GDF, 2016a. Ormanların Rehabilitasyon Eylem Planı, OGM, Ankara, 32 s.

GDF, 2016b. 2015 Yılı Ormancılık Faliyet Raporu, OGM, Ankara, 134 s.

Genç M. 2004. Silvikültür Tekniği, S.D.Ü Orman Fakültesi, Yayın No: 46, Isparta, 357s.

Ho W. 2008. Integrated analytic hierarchy process and its applications, *European Journal of Operational Research* 186, 211-225

İmren E. 2011. Mobilya Endüstrisinde Analitik Hiyerarşi Prosesi (AHP) Yöntemi İle Kuruluş Yeri Seçimi, Bartın Üniversitesi, Fen Bilimleri Enstitüsü, Orman Endüstri Mühendisliği Anabilim Dalı Yüksek Lisans Tezi, 112 s, Bartın.

Kalipsız A. 1994. Statistical Methods, İstanbul University, Faculty of Forestry, 3835/427.

Mayer H., Aksoy H. 1998. Türkiye Ormanları, Orman Bakanlığı, Batı Karadeniz Ormancılık araştırma Enstitüsü Müdürlüğü, Muhtelif Yayın no:1, Bolu, 291 s.

MTA, 2002. Batı Karadeniz Bölgesi'nin Jeolojik Yapısı ve Jeoloji Haritaları, Maden Tetkik

dimensional decision making techniques such as geographical information systems and dynamic hierarchy process method in order to make more suitable decisions in the phase of site selection especially for the works of rehabilitation and restoration in future.

ve Arama Kurumu, Genel Rapor No: 3, Ankara, 30 s.

Odabaşı T., Bozkuş H.F., Çalışkan A. 2004. Silvikültür Tekniği, İ.Ü Orman Fakültesi, İ.Ü Yayın No: 4459, O.F Yayın No: 475, İstanbul, 314 s.

Özel H.B. 2007. Bartın ve Devrek doğu kayını (*Fagus orientalis* Lipsky.) Ormanlarında meşcere kuruluşları ve grup gençleştirme uygulamalarının başarısını etkileyen faktörler, Zonguldak Karaelmas Üniversitesi Fen Bilimleri Enstitüsü Doktora Tezi (yayımlanmamış), Bartın, 272 s.

Özel H.B., Karayılmazlar, S., Demirci, A. 2014. Location Selection for Afforestation Activities Using Mediterranean Pine Species (*Pinus brutia* Ten. and *Pinus pinea* L.) in Bartın Watershed by Analytical Hierarchy Process (AHP) Method, II. National Mediterranean Forestry and Environmental Symposium Proceedings, 104-110.

Özyuvacı N. 1999. Meteorology and Climatology, İstanbul University, Faculty of Forestry, 4196- 460

Saatçioğlu F. 1979. Silvikültür II (Silvikültürün Tekniği), İ.Ü Orman Fakültesi, İ.Ü Yayın No: 1648, O.F Yayın No: 172, İstanbul, 562 s.

Sungur N., Bilir N. 2015. Isparta-Senirkent Yöresi Orman Rehabilitasyon Sahalarının Başarı Durumu, Süleyman Demirel Üniversitesi Fen Bilimleri Enstitüsü Dergisi, Vol.19(1), 107-111.

Saaty T.L. 1985. Analytic Planning, RSW Publications, 155 p, New York Publisher

Tunç E., 2011. Adıyaman orman işletme şefliklerinde meşe baltalıklarında yapılan rehabilitasyon çalışmalarının değerlendirilmesi, Kahramanmaraş Sütçü İmam Üniversitesi Fen Bilimleri Enstitüsü, Yüksek Lisans Tezi, Kahramanmaraş, 86 s.

Yılmaz H., Sürat H. 2015. Determination of the most convenient ecotourism activity by using analytic hierarchy process, *Turkish Journal of Forestry*, 164-176.

Effect of Crown Position on Midday Water Potential of *Cedrus libani* Trees

*Ayşe DELİGÖZ¹, Esra BAYAR¹, Fatma Gökçe CANKARA¹
¹Suleyman Demirel University, Faculty of Forestry, Isparta/TURKEY
*Corresponding Author: aysedeligoz@sdu.edu.tr

Abstract

In this study, changes of midday shoot water potential (Ψ_{md}) in Taurus cedar (*Cedrus libani* A. Rich) trees along a vertical crown positions were investigated in an afforestation area during the spring and summer season. Midday shoot water potential was measured to two sample shoots per crown position at midday (between 12:00 and 14:00 h) with a Scholander-type pressure chamber at the upper, middle and lower position in the north and south side of sample trees. The same sample dates, soil moisture content and soil temperature were determined. The results of this study showed that midday shoot water potential in different crown positions was significantly affected by the sample dates. In the every two sides of trees, midday water potential was lower in the summer season. While soil moisture content decreased from spring to summer, soil temperature increased. Midday shoot water potential was significantly lower in the upper crown position than in the other crown positions in the both north and south side of trees. However, there was not significantly different between north and south side of trees in the all crown positions in midday shoot water potential.

Keywords: Canopy, *Cedrus libani*, Dry season, Plant water potential

Toros Sediri Ağaçlarının Gün Ortası Su Potansiyeli Üzerinde Tepe Pozisyonunun Etkisi

Özet

Bu çalışmada, dikey tepe pozisyonları boyunca Toros sediri (*Cedrus libani* A. Rich) ağaçlarının gün ortası sürgün su potansiyelindeki (Ψ_{md}) değişimler bir ağaçlandırma alanında ilkbahar ve yaz döneminde araştırılmıştır. Seçilen örnek ağaçların kuzey ve güney bakılarından alt, orta ve üst tepe pozisyonlarında gün ortası su potansiyeli ölçümleri, Scholander tipi basınç odası cihazı ile tepe pozisyonu başına iki sürgün örneğinde gün ortasında (12:00 ile 14:00 arasında) gerçekleştirilmiştir. Aynı örnekleme tarihlerinde toprak nem içeriği ve toprak sıcaklığı belirlenmiştir. Bu çalışmanın sonuçları farklı tepe pozisyonlarında ölçülen gün ortası su potansiyeli üzerinde örnekleme zamanlarının önemli etkilerinin olduğunu göstermiştir. Ağaçların her iki bakısında gün ortası su potansiyeli yaz döneminde daha düşüktür. İlkbahardan yaz aylarına doğru toprak nem içeriği düşerken, toprak sıcaklığı yükselmiştir. Ayrıca, ağaçların kuzey ve güney bakısında üst tepe pozisyonunda gün ortası su potansiyeli diğer tepe pozisyonlarından önemli şekilde daha düşüktür. Bununla birlikte bütün tepe pozisyonlarında ağaçların kuzey ve güney bakıları arasındaki farklılık ise önemsiz bulunmuştur.

Anahtar Kelimeler: Tepe çatısı, *Cedrus libani*, Kurak dönem, Bitki su potansiyeli

Introduction

Although water is the most abundant molecule on the earth's surface, water availability in terrestrial ecosystems is the most important the factor limiting CO₂ fixation and growth of the individual plants, as well as ecosystems net productivity (Lambers et al., 1998; Horton and Hart 1998). Plant-water relations concern how plants control the hydration of their cells, including the collection of water from the soil, its transport within the plant and its loss by evaporation from the leaves (Passioura, 2010). The status of water in soils, plants,

and atmosphere is usually expressed as water potential (Chavarria and Pessoa dos Santos, 2012). The water potential gradient between the soil, the tree and the atmosphere allows water to be transported through the xylem elements in trees (Peiffer et al., 2014). Water potential is continuous decreased from soil through the plant to the leaves. However, components of water potential can show differences at different point of the pathway (Taiz and Zeiger, 2008).

During forest maturation, trees grow taller and, at the same time, environmental conditions change within the canopy.

Branches located at various positions in the crown are exposed to different environmental conditions due to the great sizes of trees and remarkable environmental gradients within forest canopies (Sellin and Kupper, 2007). Diurnal and seasonal changes in the environment within the canopy affect the physiological activities of trees (Koike et al., 2001). As a rule, in upper branches within crowns exposed to higher irradiance, vapour pressure deficit and winds exhibit higher rates of sap flow associated with greater water loss from foliage than in lower branches within crowns (Sellin and Lubenets, 2010). Crown position is related to drought stress. High levels of solar radiation in the upper crown are associated with desiccation, and so the responses to intense light and scarce water are often similar (Richardson et al, 2000). Plants are under a minimal water deficit at predawn while they are subjected to maximum stress at midday (Blum, 2011). With increasing proximity to the canopy top, leaf water stress may limit photosynthetic activity (Koike et al, 2001).

Cedrus libani A. Rich (Taurus Cedar) is one of the most important tree species of Turkey. It is commonly found in the Taurus Mountains of southern Turkey, where it covers 463.521 ha (Anon., 2014). This species is widely used in afforestation and reforestation of degraded areas because of its drought resistance (Urgenc, 1986; Boydak, 2003; Boydak and Calikoglu, 2008). The purpose of this study was to examine the differences in midday shoot water potential of trees depending on crown position in an afforestation area of Taurus cedar (*Cedrus libani* A. Rich) during the growing season. The results of this study can be used in further studies of trees' water relations and other related subjects.

Material and Method

Study area and sample trees

The study area is located very close to the campus of Suleyman Demirel University within the central district of Isparta province in the south of Turkey (37° 50' 30" N, 30° 31' 42" E). The average altitude of the area is 1008 m. The climate of Isparta has a transitional climate between Mediterranean

and continental. Mean annual temperature is 11.9 °C, and the mean annual precipitation is about 537 mm. The study was carried out on mean 23-year-old *Cedrus libani* A. Rich trees growing mixed afforestation area consisting of *Cedrus libani* and *Pinus nigra* Arn. subsp. *pallasiana* (Lamb.) Holmboe trees. 10 trees in the study area were chosen as sample trees. Height of the sample trees is approximately 7 m. The crown of each tree was divided into three sections of equal depth: upper, middle and lower crown.

Measurements

Midday shoot water potential (Ψ_{md}) measurements were taken between 12:00 h and 14:00 h from April to August 2015. Ψ_{md} was measured to two sample shoots tips per crown position with a Sholander-type pressure chamber at the upper, middle and lower crown positions from north and south side of the ten sample trees. The measurements of soil moisture content and temperature were made at 0-20 cm depth at the same time. Soil temperature was measured with digital thermometer. Soil moisture content was determined using gravimetric method.

Statistical analysis

Differences among the crown positions were tested for statistical significance at $P < 0.05$ by variance analysis (ANOVA). The Student's *t*-test was carried out to determine whether there was a difference (at $P < 0.05$) between south and north side of trees in the same crown position.

Results

Figure 1 shows soil moisture content and soil temperature during sampling periods. Mean soil moisture content on sample dates in April, June and August of 2015 were 14.9, 11.4 and 7.4 %, respectively. Mean soil temperatures from 0 to 20 cm depth during sampling periods were 11.3, 17.8 and 21.6 °C on the April, June and August, respectively. Both soil moisture content and soil temperature were significantly affected by the sample dates (Figure 1).

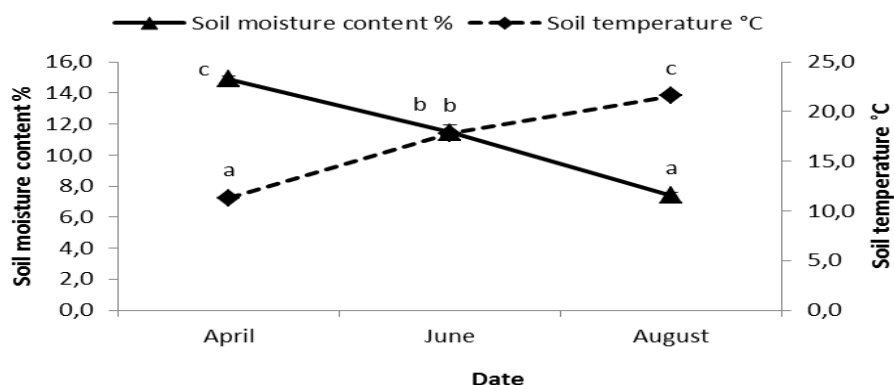

Figure 1. Seasonal variation of soil moisture content and soil temperature at soil depth 0-20 cm

The seasonal variations of Ψ_{md} at the lower, middle and upper crown positions for north and south side of trees were showed in Figure 2 and Figure 3. Ψ_{md} in different crown positions were significantly affected by the sample dates (Figure 2-3). In the south side of trees, Ψ_{md} ranged from -2.03 to -2.54 MPa in the lower crown position, from -2.00 to -

2.82 MPa in the middle crown position, and from -2.07 to -3.12 MPa in the upper crown position in the sample dates. In the north side of trees, Ψ_{md} on sample dates in April, June and August were ranged from -1.98 to -2.71 MPa, from -2.12 to -2.78 MPa, and from -2.30 to -2.99 MPa in the lower, middle and upper crown positions, respectively.

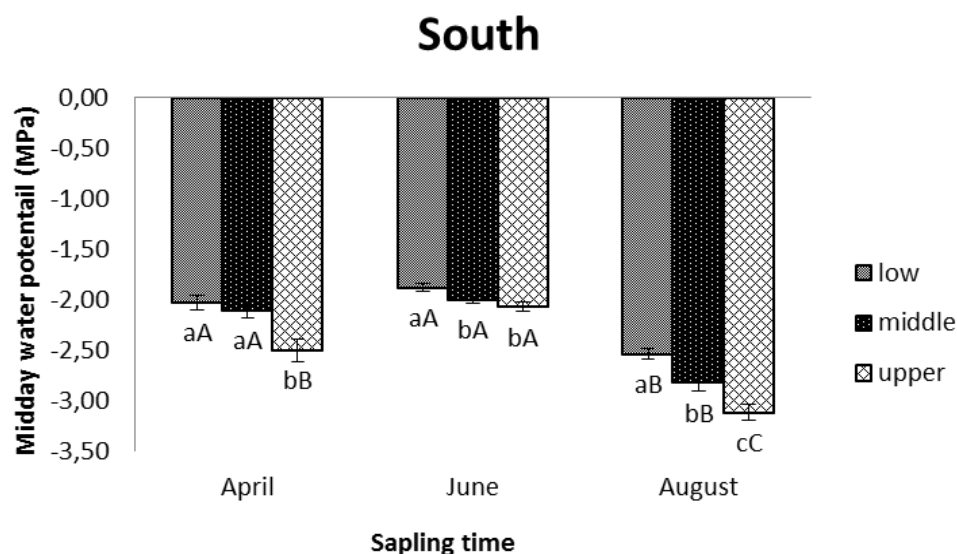

Figure 2. Midday shoot water potential (Ψ_{md}) at the lower, middle, and upper crown positions in the south side of the trees

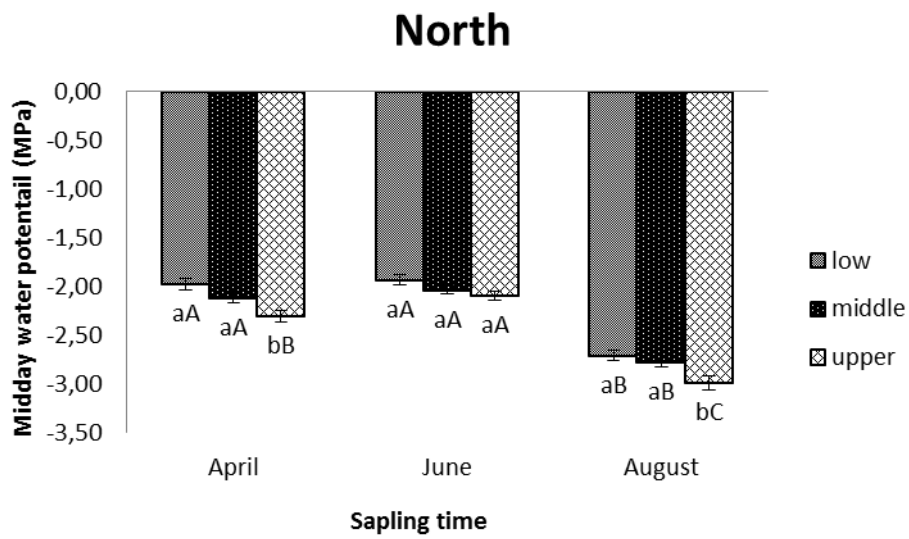

Figure 3. Midday shoot water potential (Ψ_{md}) of lower, middle, and upper crown positions in the north side of the trees

Ψ_{md} were significantly affected by crown position ($P < 0.05$). In April, Ψ_{md} ranged from -2.03 to -2.50 MPa among the lower, middle and upper crown positions in the south side of trees, while Ψ_{md} ranged from -1.98 to -2.30 MPa among different crown positions in the north side of trees. The lowest Ψ_{md} was determined at the upper crown positions in August. In the dry season (August), Ψ_{md} at the upper crown positions decreased to -3.12

MPa in the south side of trees and -2.99 MPa in the north side of trees. In the south side of trees, Ψ_{md} at the lower crown position was higher than the upper crown in April, June and August. The similar results were found in the north side of trees except for June (Figure 3). Midday water potentials were similar for the north and south side of trees in the same crown position (Figure 4).

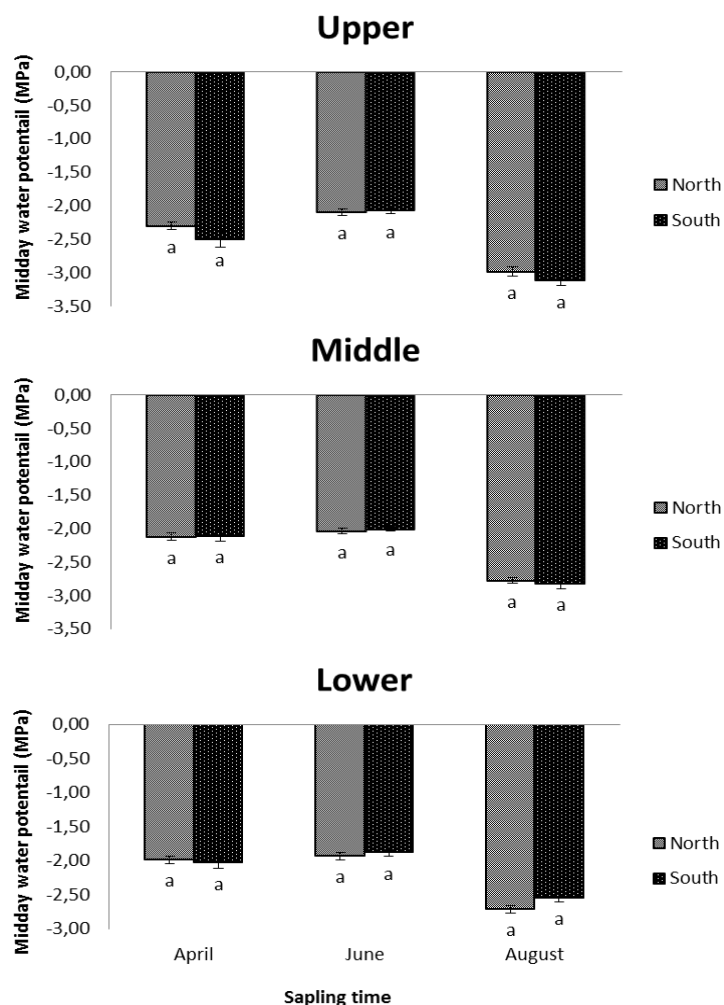

Figure 4. Midday water potentials for north and south side of trees at the lower, middle, and upper crown positions

Discussion and Conclusion

Canopy position affects the structural and physiological performance of leaves in trees, particularly in coniferous trees (Zha et al., 2002). In this study, Ψ_{md} differed significantly among sampling dates in the upper, middle and lower crown positions. In the south and north side of trees, Ψ_{md} at the lower and middle crown positions were similar in April and June, but decreased in August. Ψ_{md} at the upper crown position was lowest in August than in April and June. The eight savanna tree species include *Eucalyptus tetradonta* F. Muell. and *Eucalyptus clavigera* A. Cunn. ex Schauer showed a decline in midday leaf water potential as the dry season progressed (Eamus et al., 1999).

This pattern reflects the decline in water available to roots over the dry season (O'Grady et al., 1999). Likewise, in this study, the same sample dates, soil moisture content decreased from April to August, but soil temperature increased. In the many study was reported that leaf water potential or stem water potential decreased with decreasing soil moisture (Sdoodee and Somjun, 2008; Gallego et al., 1994; Deb et al., 2012; Andrews et al., 2012).

Effects of crown position on Ψ_{md} were significant in the south and north side of trees, but no in June in the north side of trees. While Ψ_{md} at the upper crown position was significantly lower than other the positions all samples dates in the south side of trees, it

was significantly lower in April and August than other positions in the north side of trees. Similarly, Gallego et al. (1994) reported that the lowest leaf water potential values were found in the upper of the canopy in the natural forests of *Quercus pyrenaica* and differences among canopy levels were greatest when soil water availability was low.

In this study, differences among crown positions in the south side of trees were greatest in the dry season (August). In a four-year-old stand of hybrid *Populus* during midsummer, water loss rates were highest for upper-canopy branches and lowest for lower-canopy branches (Hincley et al., 1994). Climatic factors such as temperature, vapor pressure deficit and solar radiation play an important role in transpiration (Vose et al., 2003). The plants were subjected to the highest transpiration stress during midday due to increase in temperature and solar radiation (Kırnak and Short, 2001). Niinemets and Valladares (2004) was reported that as an outcome of higher maximum temperatures, relative air humidity is lower and vapour pressure deficit larger in the upper canopy. Thus, Ψ_{md} at the upper crown position was lower than the middle and lower positions. In addition, it reported that water potential declines more steeply with tree height at midday because of both frictional and hydrostatic components of water transport (Kitahashi et al., 2008). However, midday water potential did not differ significantly between the north and south sides of trees in the lower, middle and upper crown. The similar results were determined in *Pinus ponderosa* (Boniello 2008).

Midday water potentials generally were showed values below -2.0 MPa at the middle and upper crown positions in the north and south sides of trees in April and June. The physiological activity such as photosynthesis and cell development of *Cedrus libani* trees can dramatically affect the values below -2.0 MPa of midday water potential in the stages of new shoot growth under field conditions. Our results indicate that the Ψ_{md} at the upper crown position of *Cedrus libani* trees was significantly lower during the growing season, so it appears that these shoots

experienced more pronounced water stress during growing season.

References

- Andrews, S.F., Flanagan, L.B., Sharp E. J., Cai, T., 2012. Variation in water potential, hydraulic characteristics and water source use in montane Douglas-fir and lodgepole pine trees in southwestern Alberta and consequences for seasonal changes in photosynthetic capacity. *Tree Physiology*, 32(2), 1-15.
- Anonymous, 2014. Orman Varlığımız, Orman ve Su İşleri Bakanlığı OGM Orman idaresi ve Planlama Dairesi Başkanlığı Yayını, NO:115, Envanter Serisi No: 17, s. 28, Ankara.
- Blum, A., 2011. Plant Water Relations, Plant Stress and Plant Production (Chapter 2). In: plant breeding for Water-limited environments. Springer, Heidelberg, 11-52.
- Boniello, R. A., 2008. Variation in foliar structure and function within the crowns of conifers growing in the central Sierra Nevada, CA. Ph.D., University Of California, Berkeley, 163 pages, 3353112.
- Boydak, M., 2003. Regeneration of lebanon cedar (*Cedrus libani* A. Rich.) on karstic lands in Turkey. *Forest Ecol and Management*, 178, 231-243.
- Boydak, M., Calıkoglu, M., 2008. Biology and Silviculture of Lebanon Cedar (*Cedrus libani* A. Rich). 1. Baskı, Ögem-Vak Yayını, 228 p, Ankara.
- Chavarria, G., Pessoa dos Santos H., 2012. Plant Water Relations: Absorption, Transport and Control Mechanisms, (Ed. Montanaro G., Advances in Selected Plant Physiology Aspects), ISBN:978-953-51-0557-2, 388 pages, InTech. Croatia.
- Deb, S.K., Shukla, M.K., Mexal, J. G., 2012. Estimating midday leaf and stem water potentials of mature pecan trees from soil water content and climatic parameters. *Hortscience*, 47(7), 907-916.
- Eamus, D., Myers, B., Duff, G., Williams, D. 1999. Seasonal changes in photosynthesis of eight savanna tree species. *Tree Physiology*, 19, 665-671.
- Gallego, H.A., Rico, M., Moreno, G., Regina, I.S., 1994. Leaf water potential and stomatal conductance in *Quercus pyrenaica* Willd. forests: vertical gradients and response to environmental factors. *Tree Physiology*, 14, 1039-1047.
- Hincley, T.M., Brooks, J.R., Čermak J., Ceulemans, R., Kučera, J., Meinzer, F.C., Roberts D.A., 1994. Water flux in a hybrid poplar stand. *Tree Physiology*, 14, 1005-1018.
- Horton, J., Hart, S.C., 1998. Hydraulic lift: a potentially important ecosystem process. *Tree*, 13 (6), 232-235.

- Kırnak, H., Short, T.H., 2001. An Evapotranspiration model for nursery plants grown in a lysimeter under field conditions. *Turk J Agric For*, 25, 57-63.
- Kitahashi, Y., Ichie, T., Maruyama, Y., Kenzo, T., Kitaoka, S., Matsuki, S., Chong L., Nakashizuka, T., Koike, T. 2008. Photosynthetic water use efficiency in tree crowns of *Shorea beccariana* and *Dryobalanops aromatica* in a tropical rain forest in Sarawak, East Malaysia. *Photosynthetica*, 46 (1), 151-155.
- Koike, T., Kitao, M., Maruyama, Y., Mori, S., Lei, T.T., 2001. Leaf morphology and photosynthetic adjustments among deciduous broad-leaved trees within the vertical canopy profile. *Tree Physiology*, 21, 951-958.
- Lambers, H., Chapin, FS III, Pons, TL. 1998. *Plant Physiological Ecology*. Springer-Verlag, New York. 540 p.
- Niinemets, Ü., Valladares, F., 2004. Photosynthetic acclimation to simultaneous and interacting environmental stresses along natural light gradients: Optimality and Constraints. *Plant Biology*, 6, 254-268.
- O'Grady, A.P., Eamus, D., Hutley, B., 1999. Transpiration increases during the dry season: patterns of tree water use in eucalypt open-forests of northern Australia. *Tree Physiology*, 19, 591-597.
- Passioura, B. J., 2010. Plant Water Relations In: *Encyclopedia of Life Sciences (ELS)*. John Wiley & Sons, Ltd: Chichester. DOI: 10.1002/9780470015902.a0001288.pub2 .
- Peiffer, M., Bréda, N., Badeau, V., Granier, A., 2014. Disturbances in European beech water relation during an extreme drought. *Annals of Forest Science*, 71 (7), 821 - 829.
- Richardson, A.D., Berlyn, G.P., Ashton, P.M.S., Thadan, i R., Cameron, I.R., 2000. Foliar plasticity of hybrid spruce in relation to crown position and stand age. *Can.J. Bot.*, 78, 305-317.
- Sdoodee, S., Somjun, J., 2008. Measurement of stem water potential as a sensitive indicator of water stress in neck orange (*Citrus reticulata* Blanco). *Songklanakarin J. Sci. Technol.* 30 (5), 561-564.
- Sellin, A., Kupper, P., 2007. Effects of enhanced hydraulic supply for foliage on stomatal responses in little-leaf linden (*Tilia cordata* Mill.). *Eur J Forest Res*, 126, 241-251.
- Sellin, A., Lubenets, K., 2010. Variation of transpiration within a canopy of silver birch: effect of canopy position and daily versus nightly water loss. *Ecohydrol.* 3, 467-477.
- Taiz, L., Zeiger, E. 2008. *Bitki Fizyolojisi*. Çeviren: İ. Türkan. 690 s, Palme Yayıncılık, Ankara.
- Urgenc, S., 1986. *Ağaçlandırma Tekniği*, İ.Ü. Orman Fakültesi Yayını, Yayın No: 3314/375, İstanbul.
- Vose , J. M., Harvey, G. J., Elliotti, K. J., Clinton, B. D., 2003. Measuring and modeling tree and stand level transpiration, (eds. Steven C. McCutcheon and Jerald.L. Schnoor, *Phytoremediation: Transformation and Control of Contaminants*), 263-282. ISBN 0471-39435.
- Zha, T., Wang, K., Ryyppö, A., Kellomäki, S., 2002. Needle dark respiration in relation to within-crown position in Scots pine trees grown in long-term elevation of CO2 concentration and temperature. *New Phytologist* 156, 33-41.

Potential of Wild Service Tree (*Sorbus torminalis* L. Crantz) for Turkish Forestry

Derya EŞEN

Duzce University, Faculty of Forestry, Düzce/TURKEY

deryaes@duzce.edu.tr

Abstract

Demand for quality wood is increasing both regionally and globally. Current projections indicate that price of industrial hardwood will increase, and countries will turn into their own forest resources to supply for their domestic wood demand in future. With attractive flowers, fruit colours, and aesthetic architecture, wild service tree (*Sorbus torminalis* L. Crantz), increasingly attracts attention of foresters worldwide. Wild service tree has high ecological (e.g. biodiversity, wildlife habitat, bio indicator for ozone) and economic (e.g. high-valued industrial wood, medicinal plant) values. It typically has a scattered distribution in natural forests of Europe and Turkey. Due to its great values, wild service tree was first listed in the Europe's "Valuable Broadleaves" and then "Scattered Broadleaved Tree Species". This important tree species is recommended to be mixed into natural forests. Establishing industrial plantations with this significant tree species is also suggested on selected sites for production of quality wood. On the other hand, there is still a broad information gap on the ecology and silviculture of wild service trees in Europe and especially in Turkey. This paper reviews the current knowledge on the ecology and silviculture on management of wild service tree and aims to provide Turkish foresters a basis for sustainable management of the tree species.

Keywords: Ecology, Silviculture, *Sorbus torminalis*

Türk Ormancılığında Akçaağaç Yapraklı Üvezin (*Sorbus torminalis* L. Crantz) Potansiyeli

Özet

Ülkemizin odun hammadesi darboğazı nitelik ve nicelik yönünden giderek artmaktadır. Gelecekte, yapacak yapraklı odun fiyatları hızla artacağı ve her ülkenin odun talebini giderek artan bir oranda öz kaynaklarından karşılamak zorunda kalacağı öngörülmektedir. Dikkat çeken çiçek ve meyve renkleri ve estetik mimarisi (taç yapısı) ile, akçaağaç yapraklı üvez (*Sorbus torminalis* L. Crantz), yüksek ekolojik (biyoçeşitlilik, yaban hayatı, ozon için biyo-gösterge) ve ekonomik (yapacak odun, tıbbi bitki) değere sahip doğal ormanlarda serpili olarak yayılış yapan yapraklı ağaç türümüzdür. Bugüne kadar ihmal edilen ve tahriplere maruz kalan üvez, sağladığı ekolojik, ekonomik ve kültürel faydalarından dolayı, Avrupa'da "Değerli Yapraklı" ve daha sonrada "Dağınık Yayılışlı Ağaç Türleri" listesinde yer almaktadır. Bu türün, doğal ormanlarda karışıma katılması ve ayrıca belirlenecek orman ve verimi düşük tarım alanlarında, kaliteli yapacak odun üretimi amaçlı kurulacak endüstriyel plantasyonlarda kullanılması önerilmiştir. Avrupa'da ve özellikle de ülkemizde, üvezin ekolojisi, silvikültürü ve yetiştirme tekniği hakkında büyük bilgi eksikliği bulunmaktadır. Bu çalışmada, üvezin ekolojisi ve silvikültürü ile ilgili literatür değerlendirilmiştir.

Anahtar kelimeler: Ekoloji, Silvikültür, *Sorbus torminalis*

Introduction

Hardwoods including *Fraxinus excelsior* (L.), *F. angustifolia* (Vahl.), *Alnus glutinosa* (L.) Gaertn., *Betula pendula* (Roth.), *B. pubescens* (Ehrh.), *Ulmus glabra* (Huds.), *U. laevis* (Pall.), *U. minor* (Mill.), *Tilia cordata* (Mill.), *T. platyphyllos* Scop.), *Acer campestre* (L.), *A. platanoides* (L.), *A. pseudoplatanus* (L.), *Prunus avium* (L.), *Sorbus domestica* (L.), *Juglans regia* (L.), *J.*

nigra (L.), and *Sorbus torminalis* ((L.) Crantz)) are now considered important components of European forests (Hemery et al., 2008, 2009; Spiecker et al., 2009). Once-called "valuable broadleaves" now termed "scattered broadleaves" have long been neglected and subject to anthropogenic disturbance in both Turkey and Europe (Eşen et al., 2005; Hemery et al., 2008, 2009; Spiecker et al., 2009). According to EUFORGEN, these tree species are unique

group of trees with scattered distribution in the forest and require specific site conditions and habitats (Hemery et al., 2009; Spiecker et al., 2009). These trees face with significant genetic erosion risk and require a silviculture and management scheme that is quite different from stand-forming trees including oaks and beech. Moreover, global climate change poses a greater risk for scattered broadleaves than other hardwoods (Hemery et al., 2009; Spiecker et al., 2009).

Wild service tree (WST, *Sorbus torminalis* L. Crantz) is a relatively fast-growing, ecologically (biodiversity, wildlife, bio-indicator for ozone) and economically (industrial wood, medicinal plant) important native tree species (Gültekin, 2007; Hemery et al., 2008; Nicolescu et al., 2009; Welk et al. 2016). Due to its significance, WST is included to the list of the Europe's valuable broadleaves and recommended to be incorporated into natural forests in order to form natural stands adapted to the global climate change. Establishment of industrial plantations with WST on marginal agricultural lands and forest sites with low productivity is advised for production of industrial wood (Paganova, 2008; Hemery et al., 2009; Spiecker et al., 2009, Nicolescu et al., 2009).

WST's wood has a fine grain and high density with the preferred strength of bending (Welk et al., 2016). Its wood is very valuable in the (veneer) market (Oosterbaan et al., 2008; Hemery et al., 2008; Wilhelm, 2008; Nicolescu et al., 2009; Welk et al., 2016).

Ecology and Silviculture of WST

WST has a wide distribution range in Europe, northwestern Africa and southwestern Asia (Figure 1), and its vertical range is between 100-2200 m asl (Nicolescu et al., 2009; Welt et al. 2016). The tree species has low inter-species competitiveness yet high cold, frost, and drought tolerance. It scatteredly grows on high elevations and southern and south-west slopes in Europe without forming pure stands (Pagonova, 2008; Nicolescu et al., 2009; Welt et al., 2016). This valuable broadleaved tree species has scattered distribution throughout Turkey excepting the

southeastern part of the country, extending to Iran (Gökşin, 1983; Demesure et al., 2000; Gültekin et al., 2007; Gültekin, 2007). In Iran, it mixes with *Fagus orientalis* Lipsky., *Quercus castaneifolia* C.A.M. and *Carpinus betulus* L. (Espahbodi et al., 2008). Similarly, WST is mixed with *Fagus orientalis*, *Castanea sativa*, *Carpinus betulus*, *Picea orientalis*, *Tilia rubra* in the Black Sea Region of Turkey (Gökşin, 1982). Due to its light-demanding nature, sites with high solar radiation including edges of forest roads, edges and gaps favor this tree species (Welk et al., 2016). Forest edges and The distribution of WST is expected to move in northern and northwestern directions slowly due to the global climate change (Rasmussen ve Kollmann 2004; Hemery et al., 2009). However, its scattered distribution, inadequate generative reproduction and seed dissemination, and low competitive ability put WST in great risk before the global climate change and habitat fragmentation (Hemery et al., 2009; Mala et al., 2009). WST is a sensitive tree species to biotic agents. The global climate change is expected to increase this sensitivity to biotic agents such as *Nectria galligena*, *Venturia inaequalis* and *Verticillium* sp. (Hemery et al., 2009).

WST has long been neglected by foresters and subject to anthropogenic disturbance (Nicolescu et al., 2009). In Turkey, naturally regenerated seedlings are mostly not recognized by foresters or laborers on the forest sites and weeded out during tending operations (Gültekin et al., 2007; Gültekin, 2007). This broadleaved tree has a wide pH range (pH 3.5-8) (Sevrin 1992; Nicolescu et al., 2009; Welk et al. 2016). It is a pioneer species with intermediate light demand, which increases with age (Hemery et al., 2008). Nicolescu et al. (2009) and Wilhelm (2008) reported that this tree shows a fast height growth in optimum site conditions with ample light in the early period (40-100 cm per year). Hemery et al. (2008) on the other hand stated that WST has slower growth pace in all ages when compared to other valuable broadleaves (*Fraxinus excelsior*, *Acer pseudoplatanus*, *Alnus glutinosa*, and *Prunus avium*), which demonstrate fast growth in the early ages

(Hemery et al., 2008). In addition, Aas et al. (1993) and Hemery et al. (2008) reported that WST is a semi shade-tolerant tree species and sensitive to shade more than ash, maple, linden, and hornbeam in France. Nicolescu et al. (2009) reported height growth slows down at ages 20-30 and culminates at ages 60-60 cm. Although WST can survive the dense canopy of European beech for long time (100 years), it is crushed at the end if not intervened (Wilhelm 2008). WST's competitiveness in the canopy increases with increasing droughtness (Aas et al. 1993). With retreat of moisture-demanding tree species as resultof the global climate change, WST is expected to share more ratios in the stand mixture on certain sites (Hemery et al., 2009). Annual precipitation, solar radiation, soil nutrients and temperature are important for the height and diameter growth of WST (Rasmussen 2007). Although diameter growth is slower than height growth, WST can reach 50-80 cm diameter (ONF, 1999;

Nicolescu et al. 2009). Having a good self-pruning ability in optimum stand densitites, the tree species does not form epicormics branches even after heavy thinnings and respond to late thinnings (Lanier et al., 1990; Bastien, 1997; Nicolescu et al., 2008). Without nurse trees or optimum densities, it requires artificial pruning for quality stem (Wilhelm, 1993; Nicolescu et al., 2009). WST has good generative and vegetative production abilities, which explains the high adaptability of the species across various site conditions (Hemery et al., 2008; Wilhelm 2008; Nicolescu et al., 2009; Welk et al. 2016).

WST also has high wildlife values (Hemery et al., 2008) (Figure 2). Following maturation, bright fruits attract many wild life species including birds and squirrels.

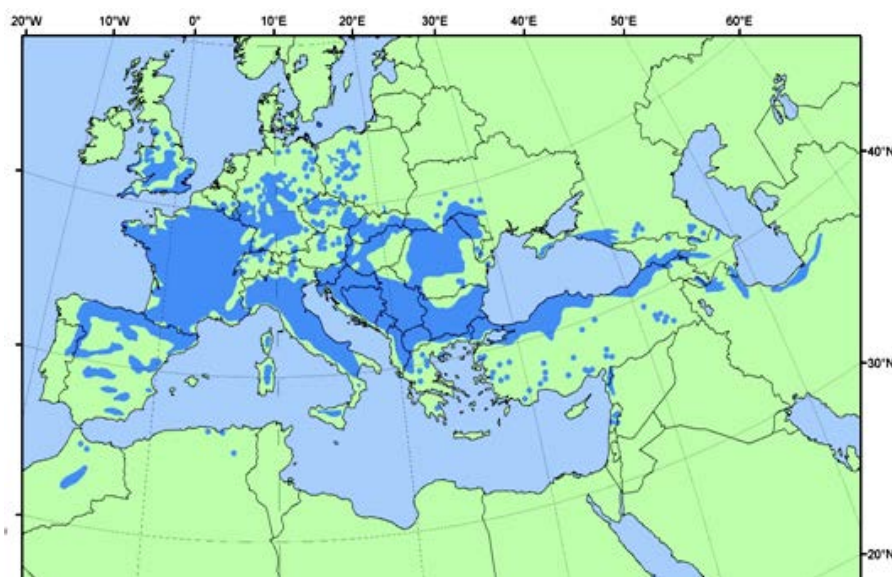

Figure 1. The general distribution range of WST (*Sorbus torminalis*) in Europe and Turkey.
(Source: EUFORGEN URL₁, 2016)



Figure 2. Mature fruits of WST (*Sorbus torminalis*) (Source: Emma Silviana Mauri: CC-BE in Welk et al. 2016).

Stratified by the digestive system of birds, seeds are spread across vast territories (Gültekin et al., 2005; Gültekin et al., 2007; Gültekin, 2007; Hemery et al., 2008). Seed dissemination by birds mostly explains the typical scattered distribution of the broadleaf tree species across its natural range in contrast to stand-forming broadleaves including beech and oaks (Hemery et al., 2008; Nicolescu et al. 2009). Gültekin (2007) stated that WST is good candidate species for mixing cedar forests in the Mediterranean Region of Turkey.

Silvicultural operations speed up the process of stand development, channel site resources to selected individuals in the stand, and shorten the rotation length for trees (Newton et al., 2002). Producing large stems without branches is the primary aim of wood-production-oriented silviculture, especially for veneer and furniture industries (Oosterbaan et al., 2008; Nicolescu et al., 2009). Optimum density, effective weed control, and thinnings help reach this goal. Form prunings in conjunction with thinnings shape stem quality. In Europe, silviculture of valuable broadleaves does not focus on the stand in contrast to stand-forming broadleaves including beech and oak (Oosterbaan et al., 2008; Nicolescu et al. 2009). Silvicultural operations rather focus on individuals for valuable broadleaves with

scattered distribution in the forest. One can see this in the targeted final crop tree density figures per ha for valuable broadleaves. The aim is to grow very few yet ($40-60 \text{ ha}^{-1}$) very high-valued individuals of these tree species. Operations focus on the selected most potentially high-valued individuals (Oosterbaan et al., 2008; Nicolescu et al., 2009).

WST is one of the most quality timber tree species of the world (Oosterbaan et al., 2008; Hemery et al., 2008; Wilhelm, 2008; Nicolescu et al., 2009; Welk et al., 2016). The first class WST veneer timbers with 45 cm dbh finds customer at €3000-10000 m^{-3} in the joint French-German high quality timber auctions (Figure 3) (Wilhelm, 2008). Most of WST timber sold in France is grown in coppices with the standards (Wilhelm, 2008; Nicolescu et al., 2009). WST consists of only 10% of the systems (Wilhelm, 2008). Having a vigorous sprouting ability, WST can stand the competition of the coppice well during the first 20-30 years of establishment. WST individuals are harvested once they reach the age of 60 and 18-26 (35) m height. In France, 10-20 groups consisted of 15 hornbeam or hazelnut seedlings are formed per ha, and in each group 2-4 one or two-year old WST seedlings are planted (Wilhelm, 2008).

In mixtures, scattered WST trees can thrive under large openings yet should be protected from light competition from the surrounding trees especially shade-tolerants including beech and maple (Nicolescu et al., 2009). On the other hand, presence of nurse trees with small-to-medium size including hornbeam is needed for good self-pruning or artificial pruning is carried out (Nicolescu et al., 2009). Forking is frequently seed for WST; therefore, formative pruning is advised after trees are 2-3 m high (Nicolescu et al., 2009). Later, high pruning is recommended in order to have at least 3 m stem without branches (Nicolescu et al. 2009).



Figure 3. A large WST growing in a natural forest near Oxford (İngiltere)(Photo: Derya Eşen).

Implications for the Turkish Forestry and Conclusions

This neglected native broadleaved tree species has significant potential for the Turkish forestry (Gökşin, 1983). It can add the Turkish forestry important economic values in the form of quality and high-value timber in addition to its ecological (biodiversity, wildlife foot) and social (beekeeping) values (Nicolescu et al., 2009). Similar to European practice, planting WST seedlings in large openings (Nicolescu et al., 2009) in the existing pure or mixed eastern beech forests on the mesic sites of the Black Sea Region is one way to enrich the Turkish

forests. WST is easily naturally regenerates in the existing forests especially in the BSR where it finds sufficient light and free-growth conditions (Nicolescu et al., 2009). Favoring and focusing on these individuals through “tree-based” or “high-resolution” silviculture in tending operations – especially weed control – is another and the natural way of increasing the presence of this important broadleaved tree species in Turkish forests (Nicolescu et al., 2009). WST might also be important part of the recent policy of the General Directorate of Forestry of Turkey in converting the coppices and the coppices with the standards to the high forests, especially on “degraded” oak sites. Drought tolerance can also provide WST an important edge over the existing moisture-demanding trees (Nicolescu et al., 2009) including eastern beech in the face of the global climate change. Increasing WST in the stand will certainly benefit the high conservation values including “wildlife enhancement”, “biodiversity”, “beekeeping forest”, “erosion-control” that are expected of the forests (Nicolescu et al., 2009).

References

- Aas G., Sieber M., Schütz J.P., Bran G P. 1993. *Sorbus torminalis* (L.) Crantz. Mitteleuropäische waldbaumarten. artbeschreibung und ökologie unter besonderer berücksichtigung der Schweiz, [Professur für Waldbau und Professur für Forstschutz und Dendrologie der EiTH Zürich.] Eidgenössische Technische Hochschule, Zürich.
- Bastien, Y. 1997. Sylviculture des feuillus précieux. ENGREF, Nancy.
- Demesure-Musch B., Oddou-Muratorio, S. 2004. EUFORGEN technical guidelines for genetic conservation and use for wild service tree (*Sorbus torminalis*). International Plant Genetic Resources Institute, 6 pp., Rome, Italy.
- Espahbodi K., Mirzaie-Nodoushan H., Tabari M., Akbarinia M., Dehghan-Shuraki Y., Jalali S. G.2008. Genetic variation in early growth characteristics of two populations of wild service tree (*Sorbus torminalis* (L.) Crantz) and their interrelationship, *Silvae Genetica*, 57, 6, 340-348.
- Eşen D., Yıldız O., Kulaç Ş., Sargıncı M. 2005. Türkiye ormanlarının ihmal edilen değerli yapraklı türü yabancı kiraz, *Orman Mühendisleri Odası Dergisi*, 4,5,6,18-22.
- Gökşin A. 1983. Türkiye’de doğal olarak yetisen üvez (*Sorbus* L.) taksonlarının yayılışları

ile önemli bazı morfolojik ve anatomik özellikleri üzerine araştırmalar, Ormancılık Araştırma Enstitüsü Yayınları, Teknik Bulten, Seri No: 120, 84 pp., Ankara.

Gültekin H. C., Divrik A. 2005. Üvez (*Sorbus L.*) taksonlarında (*S. torminalis* (L.) Crantz, *S. aucuparia* L., *S. umbellata* (Desf) Fritsch var. *Umbellata*, *S. domestica* L.) fidan üretim çalışmaları hakkında bazı tespitler, Orman ve Av Dergisi, 2,40-4.

Gültekin H. C. 2007. Üvez (*Sorbus L.*) Türlerimiz ve Fidan Üretim Teknikleri, Çevre ve Orman Bakanlığı Ağaçlandırma ve Erezyon Kontrolü Genel Müdürlüğü Fidanlık ve Tohum İşleri Daire Başkanlığı, ISBN 978-605-393-001-3, Ankara.

Gültekin H. C., Gülcü S., Çelik S., Gürlevik N., Öztürk G. 2007. Katlama sürelerinin üvez (*Sorbus L.*) tohumlarının çimlenmesi üzerine etkisi, SDÜ Orman Fakültesi Dergisi, A, 2, 42-50.

Hemery G., Spiecker H., Aldinger E., Kerr G., Collet C., Bell S. 2008. Cost Action E42 Growing Valuable Broadleaved Tree Species, Final Report, http://www.cost.eu/COST_Actions/fps/E42.

Hemery G. E., Clark J. R., Aldinger E., Claessens H., Malvolti M. E., O'connor E., Raftoyannis Y., Savill P.S., Brus R. 2010. Growing scattered broadleaved tree species in Europe in a changing climate: a review of risks and opportunities, *Forestry*, 83, 1, 65-81.

Lanier L., Rameau J.C., Keller R., Joly H.I., Drapier N., Sevrin E. 1990. L'alisier torminal *Sorbus torminalis* (L.) Crantz. *Revue Forestière Française XLII*, 1, 13-34.

Mala J., Machova P., Cvrckova H., Karady M., Novak O., Mikulí J., Hauserova E., Greplova J., Strnad M., Dolezal K. 2009. Micropropagation of wild service tree (*Sorbus torminalis* [L.] Crantz): the regulative role of different aromatic cytokinins during organogenesis, *Plant Growth Regul.*, 28, 341-348.

Newton L. P., Robison D. J., Hansen G., Allen H. L. 2002. Fertilization and thinning in a 7-year-old natural hardwood stand in Eastern North Carolina, (Editor: OUTCALT, Kenneth W Proceedings of the 11th Biennial Southern Silvicultural Research Conf.) Gen. Tech. Rep. SRS-48. Asheville, NC. US. Department of Agriculture, Forest Service, Southern Research Station. 622, USA.

Nicolescu V. N., Hochbichler E., Coello J., Ravagni S., Giulietti V. 2009. Ecology and silviculture of wild service tree (*Sorbus torminalis* (L.) Crantz): A literature review. *Bodenkultur*, 60, 3, 35-44.

Oosterbaan A., Hochbichler E., Nicolescu V. N., Spiecker H. 2008. Silvicultural principles, phases and measures in growing valuable

broadleaved tree species, <http://www.valbro.uni-freiburg.de/> 11.

ONF.1999. Le Conservatoire génétique des arbres forestiers. Bulletin technique de l'ONF, 38, 9-11.

Paganova V. 2008. Ecological requirements of wild service tree (*Sorbus torminalis* [L.] Crantz.) and service tree (*Sorbus domestica* L.) in relation with their utilization in forestry and landscape. *J. Forest Science*, 54, 5, 216-226.

Rasmussen, K.K., Kollmann J. 2004. Poor sexua reproduction on the distribution limit of the rare tree *Sorbus torminalis*. *Acta Oecologica*, 25, 211-218.

Sevrin, E. 1992. L'alisier torminal (*Sorbus torminalis* (L.) Crantz). Qualité du bois et conditions de croissance. *Forêt-entreprise* 87, 14-25.

Spiecker H., Sebastian Hein, Kaisu Makkonen-Spiecker, Michael Thies. 2009. Valuable broadleaved forests in Europe. EFI Research Report 22 Brill: Leiden, Boston, Köln.

URL1, 2016. European Forest Genetic Resource Programme, Distribution maps, http://www.euforgen.org/fileadmin/templates/euforgen.org/upload/Documents/Maps/PDF/Sorbus_torminalis.pdf.

Wilhelm, G.J. 1993. L'alisier torminal dans les forêts limitrophes de la Lorraine, de la Sarre et du Palatinat. *Revue Forestière Française XLV*, 3, 364-370.

Wilhelm G. J. 2008. Management of wild service tree for premium quality timber, International Conference on Growing Valuable Broadleaved Tree Species (October 6-8, 2008), Albert Ludwigs University Freiburg, Germany.

Welk, E., de Rigo, D., Caudullo, G., 2016. *Sorbus torminalis* in Europe: distribution, habitat, usage and threats. (Ed.; San-Miguel-Ayanz, J., de Rigo, D., Caudullo, G., Houston Durrant, T., Mauri, A., European Atlas of Forest Tree Species. Publ. Off. EU, Luxembourg, pp. e01090d+.

Identifying the Potential of Old Growth Forest Area in Altıparmak Forest Planning Units

Hacı Ahmet YOLASIĞMAZ¹, *Burak ÇAVDAR¹

¹Artvin Çoruh University, Faculty of Forestry, Artvin / TURKEY

*Corresponding Author: burakcavdar60@gmail.com

Abstract

In our country forest resources are planned according to Ecosystem Based Multiple Use Management approach. One of the most important stages of planning is the digital bases prepared during and after forest ecosystem inventory. These bases are stand map, forest function map and management class maps. While preparing function maps the areas with high preservation value, old growth forests, water-bank forests and similar special ecosystems are identified by experts. Due to the importance they carry and the societal demands, such areas are separated functionally, and criteria and indicators are determined for identification of each of the foregoing.

Old growth forests (OGF) which is the topic of this paper present biodiversity values in terms of diversity of ecological processes in addition to the types of plants and wild animals that they host. It is seen that several studies are being conducted on the identification of OGFs in the world, and that such areas are identified and evaluated for ecological and social goals. In our country such special ecosystems are evaluated in planning units under the ecological-purpose and especially nature-preservation management classes. According to forestry legislation in our country it is envisaged that OGF areas in our country will be determined and 8% of these areas will be evaluated with ecological purposes as per preservation goals. However, criteria and indicators for separating these areas are not provided. For this reason there are problems as to the size of OGF potential and which areas can be evaluated for this purpose.

Forest management plan of Altıparmak forest management unit, which are chosen as research area, have been prepared with a special project with the purpose of reflecting biodiversity to forest management plans based on a cooperation of NGO and university. In planning unit, experts performed evaluation of plant and wildlife; in addition, old growth forests were also determined and grouped into management classes in line with natural preservation goals. In the study, using forest management plan data, geographical database will be reevaluated with the purpose of determining old growth forests and the deficiencies will be completed. Then, type of tree, age, diameter class, number of trees, closure, distance of forest area from road among stand parameters will be used as measures to determine the old growth forest potential of both forest management units. In the next stage the results will be compared with the old growth forest areas determined in the forest management plans in application.

Keywords: Forest management, Old growth forest, Ecosystem based multiple use management, Geographical information systems

Altıparmak Orman İşletme Şefliğinde Potansiyel Doğal Yaşlı Orman Alanlarının Belirlenmesi

Özet

Planlamanın en önemli aşamalarından biri orman ekosistem envanteri ve sonrasında hazırlanan sayısal altlıklardır. Bu altlıklar; meşcere haritası, orman fonksiyon haritası ve işletme sınıfı haritalarıdır. Fonksiyon haritaları hazırlanırken; yüksek koruma değeri taşıyan alanlar; doğal yaşlı ormanlar, su kenarı ormanları gibi özel ekosistemler, uzmanlar tarafından tespit edilmektedir. Taşıdıkları önem düzeyi ve toplum talepleri gereği bu tip alanlar fonksiyonel olarak ayrılmakta; her birisinin belirlenmesine ilişkin ölçüt ve göstergeler belirlenmektedir.

Bildirinin konusunu oluşturan doğal yaşlı ormanlar (DYO); içinde barındırdıkları bitki türleri ve yaban hayvanlarının yanı sıra ekolojik süreç çeşitliliği açısından da önemli biyoçeşitlilik değer sunmaktadırlar. DYO alanlarının tespitine yönelik dünyada çok sayıda çalışmaların yapıldığı, bu tip alanların belirlenerek ekolojik ve sosyal amaçlarla değerlendirildiği görülmektedir. Ülkemizde bu özel ekosistemler planlama ünitelerinde, ekolojik amaçlı, özellikle de doğa koruma işletme sınıfı adı altında değerlendirilmektedir. Ülkemizdeki ormancılık mevzuatına göre DYO alanlarının belirlenerek %8'inin koruma hedeflerine uygun olarak ekolojik amaçlı değerlendirilmesi öngörülmektedir. Ancak bu alanların ayrılmasına yönelik ölçüt ve göstergeler belirlenmemiştir. Bu yüzden DYO potansiyelinin ne kadar olduğu ve hangi alanların bu amaçla değerlendirileceğine ilişkin sorunlar bulunmaktadır.

Araştırma alanı olarak seçilen Altıparmak Orman İşletme Şefliği orman amenajman planı, STK ve üniversite işbirliği ile biyolojik çeşitliliğin orman amenajman planlarına yansıtılması amacıyla, özel bir proje ile hazırlanmıştır. Plan ünitelerinde, uzmanlar bitki ve yaban hayatı değerlendirmeleri yaparken, doğal yaşlı orman alanları da belirlenerek doğa koruma hedefleri doğrultusunda işletme sınıflarına ayrılmıştır. Çalışmada orman amenajman planı verilerinden yararlanılarak coğrafi veri tabanı doğal yaşlı orman alanlarının belirlenmesine yönelik olarak yeniden değerlendirilerek eksiklikleri tamamlanacaktır. Ardından meşcere parametrelerinden, ağaç türü, yaş, çap sınıfı, ağaç sayısı, kapalılık, orman alanının yoldan uzaklığı gibi ölçütler kullanılarak, orman işletme şefliğinin doğal yaşlı orman potansiyeli belirlenecektir. Bir sonraki aşamada uygulamada olan orman amenajman planlarında belirlenen doğal yaşlı orman alanları ile karşılaştırılacaktır.

Anahtar Kelimeler: Orman amenajmanı, Doğal yaşlı orman, Ekosistem tabanlı çok amaçlı planlama, Coğrafi bilgi sistemleri

Introduction

In our country, forest resources in planning units are planned according to Ecosystem Based Multiple Use Management Approach. The first phase of the planning is the inventory of forest ecosystem, second phase is the set-up of geographical data base through GIS and others consist of reproducing base fittings (stand map, forest function map, map of management unit), developing planning strategy, regulation of utilization and preparation of silviculture plan, application and audit. The most important base while preparing the plans is forest function maps. Besides herbalists and zoologists; many participants such as data process expert, sociologists, NGOs and local administrators contribute to the preparation of the plans. In this maps, forest ecosystems are divided into economic, ecological and social functions. For each functional field are determined management goal or protective targets and they are divided into management units depending on such criteria as type of tree, rotation age, site conditions, management goal. Special forest ecosystems such as riparian forests, fields having historical and esthetical value, old growth forests, rocky places hosting waterfalls and wild animals and open areas near forest are separated functionally due to public demand and importance they have in national and international and add value to ETÇAP. Criteria and indicators are determined in defining each special ecosystem and research activities are carried out. One of these eco-systems is old growth forests which are important values in terms of plant diversity, ecological process diversity and ecological diversity besides hosting wild animals. As per the regulation, % 8 of old growth forests has to be valued to this end (GDF, 2014). However, there are uncertainties in our country about how much is the current OGF and according to what criteria they are to be divided.

In many forest planning units in our country OGF fields are divided depending on such criteria as stand age, breast diameter due to growth age. (Yolasıǧmaz et. al., 2006; Bařkent et. al., 2002; Bařkent et. al., 2008).

Old Growth Forests are generally multi-layered and different multi aged dynamic

fields which form the top layer of the forests, make numerous contributions to ecosystem, are consisted of mostly old and naturally mature-overmature individuals, have high level planted value, contain deadwoods such as woody debris and sanags, are biologically rich; obviously different from production forest with its structure, in which human effect is not to such extent as to ruin ecosystem (Franklin, 1986; Haynes, 1986; Franklin and DeBell, 1988; Brag, 1999; Anonymus referring to 2001, 2002, Sivrikaya et. al., 2004; Kurdoǧlu and Zeydanlı, 2008). For short, they are ecologically mature foreststs, which are in the 4. stage of stand growth and in which intervention effect is insignificant. (Davis et. al., 1998; Franklin, 1986).

Live components of old growth forests consist of type composition and richness, crown closure diversity, understory and herbaceous layer; plant and animal species dependent on old growth structure (Martin, 1992); age, diameter, density, crown closure, succession, breast height diameter of trees, stand age and structure having small and big bodies (Schmelz and Lindsey, 1965; Weaver and Ashby, 1971; Martin, 1992).

As for abiotic structural features, an important component, contain volume and distribution of coarse woody debris; large falling trees, snags and their places between dimension and decay classes; clearances formed as result of falling trees in various dimension and ages: undisturbed soil structure, soil macrospores and small evidences of human intervention (Martin, 1992; Keenan ve Ryan, 2004).

Management plan of research field, Altıparmak Forest Planning Unit, has special plan which is prepared participation of TEMA (Turkish Foundation for Combating Soil Erosion, for Reforestation and Protection of Natural Habitats), and in which herbalist and wild life experts participated and biological diversity is reflected in forest management plans. Old Growth forest fields are determined in planning unit and separated as ecological management unit.

In this paper, the OGF fields were determined according to such stand parameters as age, diameter class and age class by taking advantage of forest

management plan data, i.e geographical data base besides parameters concerning such positional structure such as altitude and distance to road. The differences between OGF fields in the current plan and fields determined according to indicated criteria were revealed.

Material and Method

Introducing Research Field

The research field is Altıparmak Forest Planning Unit belonging to Yusufeli Directorate of Forest Enterprise in Artvin Regional Directorate of Forestry. The research field was selected due to the fact that it has very special, sensitive, target ecosystems and species and it has found. Also the other factors are, it is neighbouring National Parks of Kaçkar Mountains, it is in the inventory studies of herbalist and wild life experts, target species and ecosystems were confirmed and they prepared numerical bases in it. The current forest management plan were prepared with a special project in frame with Project for Kaçkar Mountains Sustainable Forest Utilisation and Protection financed by European Union European Commission and TEMA in cooperation with TEMA and University with the aim of reflecting biological diversity to forest management areas.

Planning unit are between $41^{\circ} 06' 56''$ – $40^{\circ} 48' 03''$ and $41^{\circ} 08' 33''$ latitude, $41^{\circ} 28' 54''$ longitude according to topographical map with scale 1/25000. Elevation from sea level is between 930m-3932m. Total forest area is 14065,3 ha. There is 7757,1 ha high forest and

6308,2 ha degraded forest. The open areas outside the forest status is 31427,6ha and total planning unit area is approximately 45.492,9 hectare. Also, 4907,2 ha area of Kaçkar Mountains National Park is within this area. There are 75 different stand types in plan area with 454 compartments and 2687 sub-compartments (GDF, 2011)

Kaçkar Mountains, one of the charming destinations that have biological diversity, provide living space for a great number of plant and animal species with its broken field structure and its altitude of up to 4000m. There is transition zone to Alpin between 2000-2300m and beech in bush form, alders and birch, old growth forest and great number of endemic plants and high diversity of plant. The mammals, great number of species of reptile, bird and butterfly indicate that the planning units are very rich in terms of species, genetics and process diversity. For this reason, the study area is classified as one of 200 ecological areas on the world by WWF. Birdlife International accepted the area as one of the 217 prioritised bird protection region. The area is located in Kolşik subregion of Europe-Siberian plant geography region. It is attraction especially in terms of alpine grassland and muchness of endemic plants. Another feature of the area in terms of plant richness is its richness of flora it has. Scotch pine (*Pinus Sylvestris* L.), fir (*Abies nordmanniana subsp.nordmanniana*), beech (*Fagus Orientalis* Lipsky), birch (*Alnus glutinosa*) are main tree species in the area (GDF, 2011).

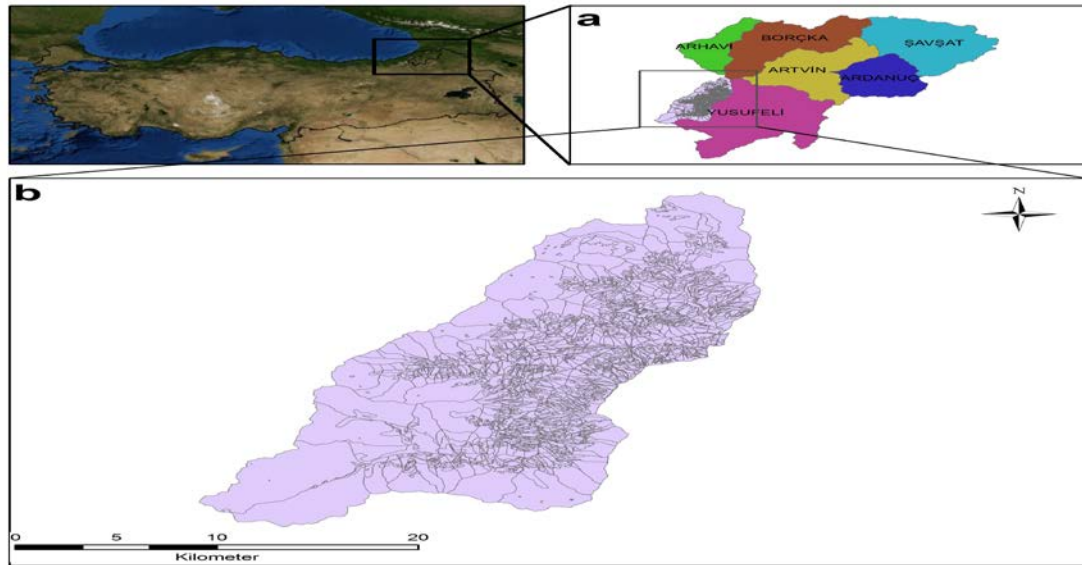

Figure 1. Study Area a: Directorates of Forest Enterprise b: Altıparmak FPU

Method

In the study, firstly the data of Forest Management Plan of Altıparmak Forest Planning Unit were analysed, the areas separated as old growth forests (managment unit) were studied in terms of stand parameters and topographical structure. The areas separated as old growth forests managment unit under the nature protection function in the current forest management plan were presented in terms of their such featutes as age classes, altitude levels, tree numbers, tree species, situation of crown closure, diameter classes and the distance of the areas from the road.

The database was redesigned by making required correction and additions in the GIS belonging to forest planning unit. Old growth forest areas were re-determined by using age class, development stage class, diameter class and distance from the road from stand parameters and compared to current old growth forest areas. The areas above 110 years and more for age class, “cd,d,e” class areas for development stage class, areas in 3. and 4. diameter class were determined, the stand introduction tables for these areas were studied (Table 13). The areas, tree number in 3. and 4. diameter class should be above % 15

of total tree number and approximately two tree length (60m) and above areas included in İğneada and Camili planning application and GDF planning criteria were determined as old growth forest areas (GDF, 2014, Çakır et. al., 2005; Terzioğlu et. al., 2010). The arising differences were compared to acquired findings.

Findings and Discussion

Findings According to Plan Data

Altıparmak Forest Planning Unit were dividen to 10 management unit under the economic, ecological and social functions. One of them is economical function, one is social and cultural function, eight of them is in ecological functions because of the geographical position, field conditions and biological diversity the area has.

% 64 of the toral forest planning unit is open area, % 13 is degraded forest and % 4 is agriculture and settlement. % 5.6 of high forest areas are IV age class, % 4.3 V. age class, % 5.8 VI age classes. (Figure 2). When we look at the development stage classes in the stand types of high forest areas, % 6,3 of it remarkanly “bc” development stage class, % 9,9 “cd” development stage class (Figure3).

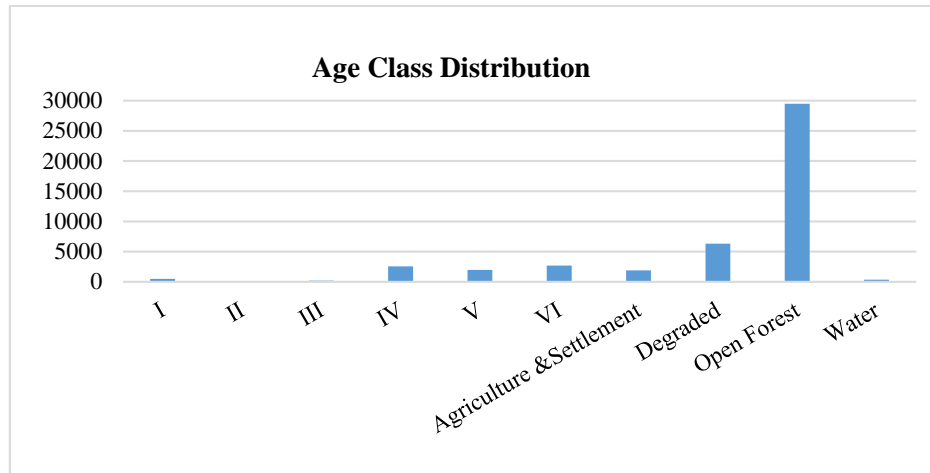

Figure 2. Age Class Distribution Of Altıparmak FPU

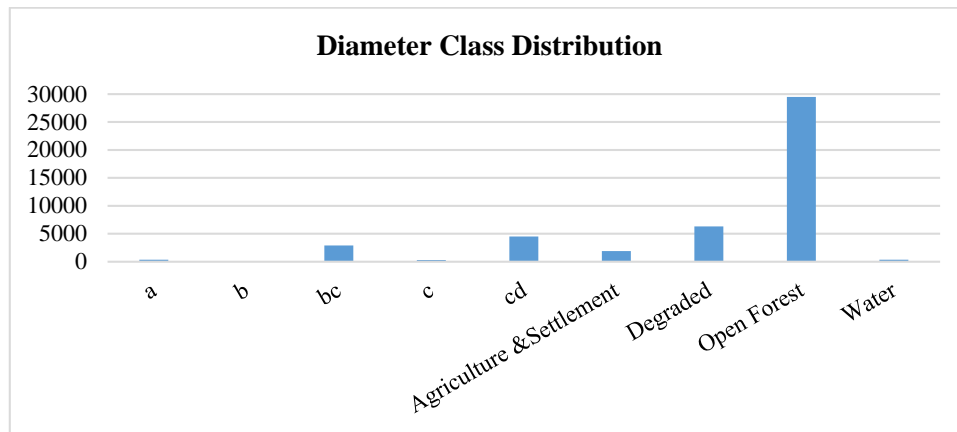

Figure 3. Diameter Class Distribution Of Altıparmak FPU

Table 1. Management Classes Area Distribution of Altıparmak FPU

Management Units	Function	High Forest	Degraded	Total Area
A Wood Production	Production of Wood Products	214,2	14,6	228,8
National Park		-	-	4907,2
B Old Growth Forest	Nature Protection	503,7	16	519,7
C Critical Ecosystems		319,8	-	319,8
D High Protection Value		2648,4	4289	6937,4
E Mountain Forest		3009,1	990,2	3999,3
F Wildlife Protection & Managemet	Erosion Prevention	230,2	448,2	678,4
G Avalanche prevention		232,9	18,6	251,5
H Soil conservation		330,6	-	330,6
I Aesthetic appearance	Aesthetic Function	268,2	531,6	799,8
J				

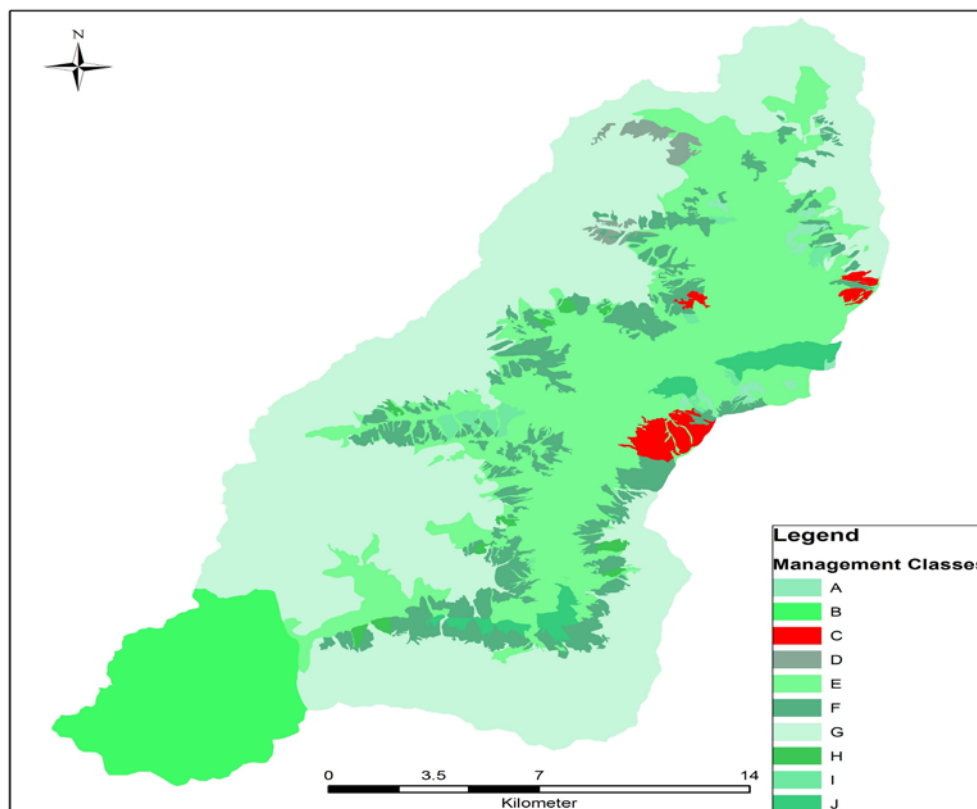

Figure 4. Management Units of Altıparmak FPU

Of total area of forest planning unit, %0,5 was allocated for wood production, %9 for national park management unit, % 86,6 for nature protection function, % 1,7 for esthetical function and % 1,3 erosion prevention function.

The area was divided to 5 management units in the nature protection function due to field conditions, altitude and rare plant species.

- Totally 65 stand were allocated for old growth forest management unit.

- Approximately % 6,4 of high forest areas is old growth forests. In other words, % 3,7 of total forest area and %1,2 of total planning unit area is allocated as old growth forest area.

- % 16 of OGF consists of three closed areas, % 74 of two closed areas and % 7 consists of one closed area.

- Areas determined as OGF are generally composed of mixed forests formed among coniferous trees. Of these areas, % 55,4 is scotch pine-fir stand; % 34,2 is fir-beech mixed stand and % 6,5 is scotch pine-fir-beech mixed stands.

- % 3,5 of OGF areas consist of degraded forest areas and open areas which has no age class. Degraded forest areas constitutes %3 and open areas constitutes % 0,4 of OGF areas.

- V. age class constitutes % 46,9 of OGF areas and VI. age class areas constitutes % 46,9 of it.

- The Ration age for old growth trees in current forest management plan was determined as 240 years.

- Also, all of these areas are in cd development stage class (dbh; 20-51,9cm)

- They densify heavily in altitude of 1900-2100 m with an average altitude of 1840-2490m.

- % 21 of areas in this management unit is in II. site class, % 28,3 is in III: site class, % 11,1 is in IV site class, % 36,1 is in V. site class. The site class of % 3,5 is not certain (OT-OT-T, BG,BÇs)

- OGF areas have to be distand from the road so they are not subject to production or intervention. However, this criteria was not taken into consideration while allocation old growth forest area. Forest path pass through

30 stands. 4 of them are degraded stands. The average distance of other old growth forest areas to forest path is 358 meters and 4 stands are neighbouring meadows used by local people.

- According to biological diversity inventory during the planning phase, *lynx lynx*, *rupicapra rupicapra* ve *cabra aegagrus* were determined in these areas. This indicates wild animals generally prefer forest which has I and II crown closure.

- When the structure of these areas in stand introduction table is analysed; (table 13); Total tree number is 526 and approximately % 10 of them (57pcs) consists of trees in 3. and 4. diameter class trees.

- Also, the average amount of snags in these areas is 8,8 pcs and 5,02m³.

Findings According to OGF Criteria

- The data in the plan were re-analysed according to age class, development stage class, diameter class and distance to road (untouchedness) criteria which are common features of old growth forest areas and the area was re-evaluated according to criteria that the 3. and 4. diameter class tree has to be at least % 15 of total tree number..

- There are 90 pcs stands which qualify development stage class, diameter class and age class criteria according to acquired data.

- Total OGF area is 522,81ha. It constitutes % 1,07 of high forest areas, % 0,59 of total forest area and %0,18 of total planning unit area.

- OGF area in current forest management plan does not match up with OGF areas determined according to criteria determined in the paper. Approximately % 7 of OGF areas (5,76ha) is for wood production, % 50 (41,5ha) is for area management

objective having high protection value, % 28,5 of it (23,6ha) is for mountain forest ecosystem management objective, % 11 of it is (9,1) for protecting wild life and administration area management objective, % 3,5 is (2,8) for preventing avalanche objective.

- The altitude of these determined areas varies generally between 1830-2460m and densify intensively in altitude 2100-2200 as they cover mountain forest and areas allocated for protecting wild life forest.

- The total average tree number of stands meeting the criteria is 298pcs and approximately % 25 of them (75) consists of 3. and 4. class diameter trees.

- All of the stands in the OGF area consist of Çscd1 ve ÇsLcd1 symbols. % 75 of it consists of pure scotch pine stand and % 25 of it consists of scotch pine-spruce mixed stand.

- All of OGF stands have crown closure one1.

- Average snags amount in OGF stands is 9,8 pcs and 7,02m³.

- According to wild life inventory during the planning phase, *Lynx lynx* and *Capra aegagrus* were identified in these areas.

- When an additional evaluation is made according to road distance criteria, the number of OGF stand decreases and 27 stands and 83,01 ha area meets these criteria. All of these are high forest area. All of them are in 6. age class or above areas. All of them are in "cd" development stage.

- When the criteria for distance to road and other criteria are evaluated together, OGF are will decrease even further, 14 stands and 94,58 ha area will have OGF potential.

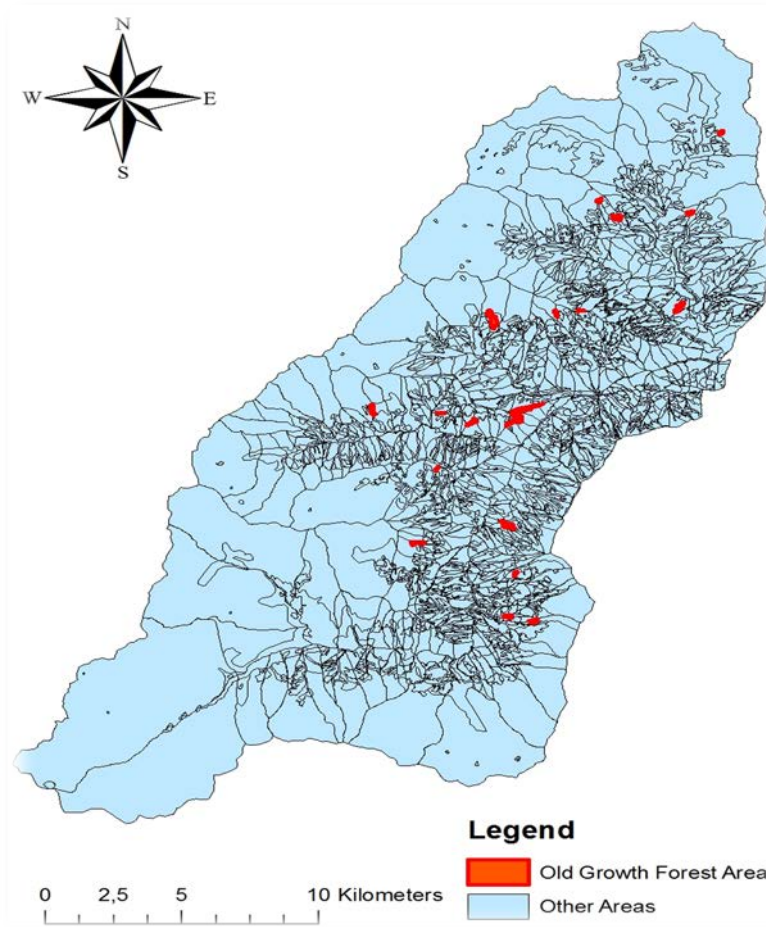

Figure 5. OGF Area According to General Criteria

Results and Suggestions

In this paper, OGF area potential of the current forest management plan of Yusufeli Altıparmak Forest Planning Unit, which was selected as research area, was analysed by taking advantage of data base of GIS. First of all, by taking advantage of stand structure and topographical features of OGF areas (OGF management unit) in the current forest management plans, criteria for allocation were tried to be presented. With the help of OGF allocation criteria (of stand parameters: age class, development stage, diameter class and tree numbers in 3. and 4. diameter class, related threshold tree number rate and additionally criteria for distance to road) a new evaluation was made and compared. According to evaluation, the current OGF areas do not match up with the determined areas in any way.

Also, there are open areas and degraded forest areas in the allocated areas. These areas having no old growth forest item have to be

evaluated in another management unit. These kind of areas, as long as they are next to the old growth forest areas, can be utilized as buffer zone in order to decrease the effect of intervention in management forests.

In its literature definition, OGF concept has to be firstly natural, consist of thick diameter individuals. However, the continuation of a forest existence in form of circulation for long years may require that a forest area especially in Europe be defined as OGF. OGF areas both in the current forest management plans and those determined according to criteria in this study have to be analysed in the area and be subject to additional evaluations.

References

- Anonim, 2001. What is an Old-Growth Forest ?, <http://www.pond.net>.
- Anonim, 2002. Old Growth Forest, <http://www.green.net.au/adan/oldgr.htm>.

Baskent, E.Z., Terzioğlu, S., Başkaya, Ş., Developing and implementing multiple use forest management planning in Turkey Environmental Management., 42 (2008), pp. 37–48.

Bragg, D. 1999. Fuzzy set classification for old-growth southern pine. U.S. Department of Agriculture Forest Service, Southern Research Station, Monticello, Ariz.

Çakir G., Başkaya Ş., Yolasiğmaz H., Sivrikaya F., Başkent E.Z., Terzioğlu S., "Biyçeşitlilik Ve Çok Amaçlı Planlama (İğneada-Bulanıkdere Uygulama Örneği)", Korunan Doğal Alanlar Sempozyumu, Protected Natural Areas Symposium, , Isparta, 2005, ss.1-10.

Davis, M.B., Calcote, R.R., Sugita, S., and Takahara, H. 1998. "Patchy invasion and the origin of a hemlock-hardwoods forest mosaic", Ecology, 79 : 2641–2659.

Franklin, J.F., Old Growth Definition Task Group. 1986. Interim definitions for old-growth Douglas-fir and mixed-conifer forests in the Pacific northwest and California. Old-growth definition task group. USDA Forest Service, Pacific Northwest Research Station, Portland, Oregon. Research Note PNW-447.

Franklin, J. F., and D. S. DeBell. 1988. Thirty-six years of tree population change in an old-growth Pseudotsuga- Tsuga forest. In: Can. J. For. Res. 18:633-639.

Franklin, J.F., Thomas A., Spies, T., 1991. Composition, function, and structure of old-growth Douglas-fir forests, Wildlife and Vegetation of Unmanaged Douglas-fir Forests, USDA Forest Service General Technical Report PNW-GTR-285: 71-80.

Haynes, R.W. 1986. Inventory and value of old-growth in the Douglas-fir region. USDA Forest Service, Pacific Northwest Research Station, Portland, Oregon. Research Note PNW-437.

Keenan, J.,R. and Ryan, F., M. 2004. Old Growth Forests İn Australia, Science for Decision Makers, Revised Edition.

Kurdoğlu, O. ve Zeydanlı, U. 2008, En bilge Ormanlar Doğal Yaşlı Ormanlar, sayfa 97-116, Orman ve Biyolojik Çeşitlilik. Doğa Koruma Merkezi, Ankara

Martin, W.H. 1992. "Characteristics of old growth mixed-mesophytic forests", Nat. Areas J. 12: 127-135.

GDF, 2011. General Directorate of Forestry, Forest Administration and Planning Department Altıparmak Forest Management Plan.

GDF, 2014. General Directorate of Forestry, Forest Administration and Planning Department, Principles and Procedures Relating to the Preparation of Functional Ecosystem-Based Forest Management Plans, Notification No.: 299 Ankara.

Perera, A., Baldwin, D., Yemshanov, D., Schnekenburger, F., Weaver, K., Boychuk, D. 2003. "Predicting the potential for old-growth forests by spatial simulation of landscape ageing patterns", The Forestry Chronicle 79(3):621–631.

Schmelz, D.V., Lindsey, A.A. 1965. "Size-class structure of old-growth forests in Indiana", For. Sci. 11:258–264.

Spies, T., Franklin, J.F., 1988..Old Growth and Forest Dynamics in the Douglas-Fir Region of Western Oregon and Washington Natural Areas Journal 8/3.

Sivrikaya,F.,Yolasiğmaz, H.A., Başkent, E.Z. 2004.Doğal Yaşlı Ormanlar ve Coğrafi Bilgi Sistemleri Yardımıyla Belirlenmesi, KSÜ Fen ve Mühendislik Dergisi 7(1)-2004.

Terzioğlu S., Başkent E.Z., Sivrikaya F., Cakir G., Kadioğullari A.İ., Başkaya Ş., et al., "Monitoring Forest Plant Biodiversity Changes And Developing Conservation Strategies: A Study From Camili Biosphere Reserve Area In Ne Turkey", BIOLOGIA, vol.65, pp.843-852, 2010.

Weaver, G.T., Ashby, W.C. 1971. "Composition and structure of an old-growth forest remnant in unglaciated southwestern Illinois", Am. Midl. Nat. 86:46–56.

Yolasiğmaz, H.A, Yavuz,M.,Keleş, S. 2006. Spatial distribution and temporal change of old-growth forest: A case study in the Balci forest management unit, Turkey, Sci. Res. Essays Vol. 5 No. 19.

Effects of Precipitation on the Soil at Pure and Mixed Stands of Black Pine and Scotch Pine (The Case of Daday)

*Senem GÜNEŞ ŞEN¹, Miraç AYDIN¹

¹Kastamonu University, Faculty of Forestry, Kastamonu / TURKEY

*Corresponding Author: sgunes@kastamonu.edu.tr

Abstract

In this study, the effects of precipitations on the some soil properties were investigated; pure black pine stand and scotch pine stand with mixed stands under similar conditions in Kastamonu-Daday. pure black pine and scotch pine stand was compared with mixed stand. Soil samples were collected from 0-20 cm soil depth and analyzed for soil pH, organic matter, texture, utilizable moisture quantity and colloidal moisture equivalents ratios.

Compared to mixed stand with pure stands, the mixed stands had higher pH and dust content, the scotch pine stands had higher sand and clay content and the black pine stands had higher organic matter and utilizable moisture quantity. Colloidal moisture equivalents rates were found to be very low than the critical value for all studied sites. This indicates that all studied areas are under erosion risk.

Keywords: Blackpine, Scottpine, Soil properties, Daday, Kastamonu

Karaçam ve Sarıçamın Saf ve Karışık Meşcerelerinde Yağışın Toprak Üzerindeki Etkileri (Daday Örneği)

Özet

Bu çalışmada, Kastamonu-Daday yöresinde benzer koşullar altındaki saf karaçam, saf sarıçam ve karaçam-sarıçam karışık meşcerelerinde yağışın, bazı toprak özellikleri üzerine olan etkileri araştırılarak, bu özellikler bakımından meşcereler arasındaki farklılık ve benzerlikler analiz edilmiştir.

0-20 cm derinlik kademesinden alınan toprak örneklerinin pH, organik madde, tekstür (kum, toz, kil), yararlanılabilir su miktarı oranları ile erozyon eğilim indeksi olarak kolloid-nem ekivalanı oranları belirlenmiştir.

Saf meşcereler ile karışık meşcere karşılaştırıldığında, pH ve toz değerleri bakımından karışık meşcere, kum ve kil değerleri bakımından Sarıçam meşceresi, organik madde ve yararlanılabilir su miktarı bakımından da Karaçam meşceresi en yüksek değerlere sahip olduğu tespit edilmiştir. Kolloid-nem ekivalanı oranları, hem saf meşcerelerde hemde karışık meşcerede kritik değerden oldukça düşük bulunmuştur. Buda bize bu toprakların erozyon riski altında olduğunu göstermektedir.

Anahtar Kelimeler: Karaçam, Sarıçam, Toprak özellikleri, Daday, Kastamonu

Introduction

Soil, as one of the most natural resources on the earth and basic components of life; is a tri-dimensional substance which, covers the earth's surface as a thin layer, formed as the composition of the various products of the disintegration of rocks and organic materials, hosts the world of the living creatures in and on itself, a resting place and source of nutrition for the plants, contains certain amounts of water and air inside (Akal, 1998). And it is formed as the result of the physically disintegration and chemically decomposition of the solid bedrock, and the material known as parent-material's loosening and turning into soil. (Kantarcı, 2000)

In a well-developed forest soil, there can be formed horizons like, organic layer (O), mineral layer which is organically rich (A), the leaching horizon (E), accumulation horizon (B) and parent material (C), respectively from top to down. Soils are of vital importance in the development of forests. Soil, was formed from the different mineral combination of bedrock and as the result of this difference the composition and growing ratio of the forests is significantly affected by the soil properties (Fisher et al., 1999).

The development of forest vegetation and soil is a complex and continuous process. Many factors are influential in the development of the forest but and soil, however, none of them is important as the

climate. Climate, vegetation and soil is a structure which is cohesive, complex and dynamic. If any of these changes, others will also change, and a new balance will be formed (Fisher et al., 1999).

A lot of research that was done showed that, having a good litter layer covering the surface of the soil will lead to the soil surface to retain its structure, and also decreasing the surface flow due to the high water-holding capacity of litter layer, whereas increasing the amount of water infiltrating into the soil. Additionally, litter also has a water quality increasing effect (Asan et al., 1987).

In this study, by researching some of the properties of different stand soils, the differences and similarities between stand have been analyzed. By determining the colloid-humid equivalent ratio, which is the erosion tendency index, it was determined that whether these stand soils are under the threat of erosion or not.

Study Area

The study area is the basin of Bezirgan, which is located within the boundaries of the Daday district of Kastamonu province (Figure 1). Located at an altitude of 800m from the sea level, Daday district is surrounded by Ballıdağ Mountains on the north and SarıCam Mountains on the south (İşler, 2010; Kuzka, 2013). The Daday Brook which is a tributary of Devrekane Brook and Koldan Creek irrigate the area of the district. And also there are dams of Yumurtacı, TaşCılar and Bezirgan with the purpose of irrigation (URL 1). Bezirgan Basin extends at approximately 7 km in length from northwest to southeast direction. The basin area starts from the altitude of 950 meters and rises up to 1515 meters high. The average height of the basin is 1211 meters, while the average slope is 36.84%, however it has a steep terrain structure.

When the data obtained from General Directorate of Meteorology - Kastamonu Meteorology Station are analyzed, the average annual rainfall is over 500 mm according to the average data between the years of 1980-2014. The annual average temperature is 9.8°C, the maximum temperature is 42.2°C (in July), and the

minimum temperature is -20.9°C (in February).

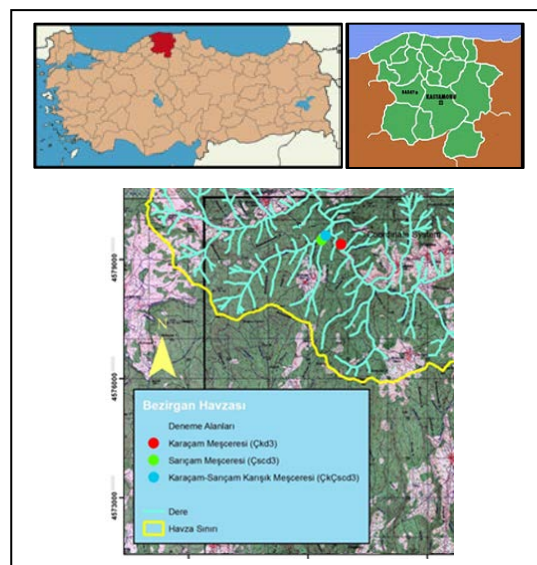

Figure 1. The location of the research area

According to water balance document prepared with the Thornthwaite method, Kastamonu Daday region is a semi-humid and semi-arid, moderate temperature (mesothermal) area, having no or very less excessive water, and a climate type close to the oceanic climate (C1 B'1 d b'3). According to the geology map prepared by General Directorate of Mineral Research and Exploration, Bezirgan Basin is formed of a structure that is consisted of non-fragmentized gneiss, migmatite, metagranite, schists, amphibolites and marble. The soil of Bezirgan Basin has reddish maroon color, generally shallow soil structure (50-20 cm) with a slope of 12-20% and moderate water erosion risk. The lands are suitable for soil cultivation agriculture (Anonymous, 1993).

When the basin's situation of overall usage of land is considered; it is seen that the majority (54.77%) of the land is comprised of forested land area, and the fields for agriculture are generally located around the habitation areas. And it is seen that a large proportion of the forests are in good property, and approximately 1/5 of total forest area (19.42%) is the disordered section of the forest (Anonymous, 2010). When evaluated with regard to the types of stands and closure, the pure stands of Black Pine, which is the dominant type of tree,

constitutes 44.28% of the total forest area, and together with this, the 11.62% percent is formed by mixed stands that are comprised of other species of trees. And, it is found that oak, which is one of the leaved-tree species, stands are in a small area (1.39%) of the overall basin. And also, Oak trees are located in the 22.92% part of the basin with Black Pines and Scotch Pines in a disordered form as coppice, and *Fagus* trees are located in the 22.92% part of the basin again with Scotch Pines in a disordered form as coppice (Anonymous, 2010).

The basin is generally formed of areas in the category of abrupt and steep slope (66.20%), plain and mild slope areas are

normally seen on watersheds and flat areas on the high tops. In general, there isn't any predominant exposure in Bezirgan basin, the areas of sunlit and shadow are in the close ratio to each other (Anonymous, 2010).

The closure, altitude, slope, aspect, stand type and geological structure properties of Black Pine (Ck), pure Scotch Pine (Cs) and Black-Scotch Pine Mixture (CkCs), which are selected as the area of study, are presented in Table 1.

Table 1. General characteristics of the trial area

Trial area	Closure (%)	Altitude (m)	Slope	Aspect	Stand Type	Geological structure
Ck	71-100	1097	Steep	Sunny	Ckd3	Marble
Cs	71-100	1054	Flat	Sunny	Cscd3	Marble
CkCs	71-100	1042	Steep	Sunny	CkCscd3	Marble

Material and Method

Material

Research material is consisted of precipitation measurements made in Black Pine (Ck), pure Scotch Pine (Cs) and Black-Scotch Pine Mixture (CkCs) stands determined in Bezirgan Basin of Daday District in Kastamonu Province, the soil samples taken from these stands and the results of the laboratory analysis of these soil samples.

Method

The method used in the study consists of two parts. In the first part, precipitation measurements were made and soil samples were collected by determining the area of study, the stands in the study area, and trial areas. And in the second part, the laboratory analysis of the soil samples collected from the terrain was carried out. In this context, the effects of the precipitation on texture of the soil, amount of the organic materials, pH, amount of utilizable moisture and colloid moisture equivalent rate were identified during this study.

Soil samples were taken for identifying the effects of the precipitation; from the

ground level (0-20 cm) of soil after cleaning the areas that were used to get the sample in order to neutralize the effects of the live cover and the litter, at the points close to the root collars where the body of the tree and the soil unite, from the determined trial areas inside the Ck, Cs and CkCs stands (Özyuvacı, 1978; Zengin, 1997). Also, in order to determine the differences between the amounts of precipitations of trial areas, measurements on precipitation, throughfall and stemflow with the mechanisms which were set up to each one of the trial areas.

After drying the samples in the laboratory till they become air-dry, they were prepared for the analyses by filtrating in the size of 2 mm. The pH of soil is measured with soil-pure water suspension of 1/2.5 (Özyuvacı, 1971), soil texture was evaluated with the hydrometer method of Bouyoucos (GülCur, 1974), determination of organic materials was carried out with Walkley Black method (Kalra et al., 1991), and the amount of utilizable moisture was determined under 1/3 atm pressure with the Ceramic Plate device of Soil Moisture Equipment Co. The ratio of colloid-moisture equivalent was calculated by dividing the amount of the clay derived at

the end of the mechanical analysis to the same soil's moisture equivalent ratio (Özyuvacı 1978, Baver 1956).

Kruskal Wallis test is used in determining the differences between the precipitation measurements and the soil properties of different types of stands, and the Mann-Whitney U test is used in order to determine which groups have significant differences. In analyzing the data, especially because of the number of examples is less than 30, Bonferroni correction was carried out. The Bonferroni correction was made by the utilization of "significance level/number of groups" formula (Vialat et al., 2008).

Findings

The values belonging to the precipitation measurements made in the research field are given in Table 2. The results of the laboratory studies on the sand, clay and dust percentage, organic material, pH, utilizable water quantity and colloidal moisture equivalents of the soil samples taken from the trial area are presented in Table 3, and Kruskal-Wallis and Mann-Whitney U test results analyzing the differences between the stands in terms of the variables that are evaluated are shown in Table 4.

Table 2. Result of the precipitation measurements on trial area

		Ck	Cs	CkCs
precipitations	(mm)	1083.24	1083.24	1083.24
throughfall	(mm)	755.62	800.47	840.67
	(%)	69.756	73.896	77.607
stemflow	(mm)	27.85	63.62	33.69
	(%)	2.571	5.873	3.110

Table 3. Soil properties

	Ck	Cs	CkCs
Sand (%)	72.40	73.48	62.43
Clay (%)	3.55	7.02	3.96
Dust (%)	24.05	19.50	33.61
Organic material (%)	28.15	16.64	24.85
pH	5.75	5.40	6.47
Utilizable moisture quantity (%)	5.79	2.43	0.56
Colloidal moisture equivalents	0.11	0.35	0.15

Table 4. Kruskal-Wallis and Mann-Whitney U-test results

	Kruskall Wallis			Sig. (p<0.05)	Mann-Whitney U	
	Stand groups	N	\bar{X} (mean)		Stand groups	Sig. (p<0.0167)
Sand	Ck	10	72.4	0.055 ^{ns}		
	Cs	10	73.48			
	CkCs	10	62.43			
Clay	Ck	10	3.55	0.002*	Ck-Cs	0.003*
	Cs	10	7.02		Ck-CkCs	0.005*
	CkCs	10	3.96		Cs-CkCs	0.049 ^{ns}
Dust	Ck	10	24.05	0.404 ^{ns}		
	Cs	10	19.50			
	CkCs	10	33.61			
Organic material	Ck	10	28.15	0.031*	Ck-Cs	0.008*
	Cs	10	16.64		Ck-CkCs	0.131 ^{ns}
	CkCs	10	24.85		Cs-CkCs	0.326 ^{ns}
pH	Ck	10	5.75	0.014*	Ck-Cs	0.173 ^{ns}
	Cs	10	5.4		Ck-CkCs	0.112 ^{ns}
	CkCs	10	6.47		Cs-CkCs	0.004*
Utilizable moisture quantity	Ck	10	5.79	0.897 ^{ns}		
	Cs	10	2.43			
	CkCs	10	0.56			
Colloidal moisture equivalents	Ck	10	0.11	0.001*	Ck-Cs	0.001*
	Cs	10	0.35		Ck-CkCs	0.004*
	CkCs	10	0.15		Cs-CkCs	0.762 ^{ns}

ns: p>0.0125; nonsignificant

*: p<0.0125; significant

Results And Discussion

The general exposure for the research basin was determined as south. This situation leads to the change of hydro physical properties of the soil by the impact of microclimatic factors (Okatan et al., 2001). According to the precipitation measurement results of the trial areas, the throughfall value is the highest in mixed stand with 840.67 mm., and the stemflow is highest in Scotch pine stand with 63.62 mm. In the Scotch pine stands, it is easier for the rain water kept on the top to be delivered to the stem, and prevented reaching the soil, due to having a narrower angle of branches to the stem compared to the other species of coniferous

trees. In contrast, as the Black Pine has a wider angle of branches to the stem, the delivering of the rain water on the top to the body is less. And having thicker branches and barks and deeper fractures on the barks on Black pine decreases the stem flow (Cepel, 1965). As the barks of the Black Pine are thicker, having deep fractures, and keep the water on themselves by absorbing during the soaking, this situation results in decreasing the flow of the water on the stem (Özhan, 1982).

In the soils of the study area, rate of sand is higher in Ck and Cs stands, when compared to mixed stands. The dust rate in mixed stand is higher compared to pure

stands. And the rate of clay values are found to be lower in Ck stand compared to the others and it is found out that there is a statistically significant difference between Cs and CkCs stands. Irmak (1968), stated that, the materials of sand and dust are formed as the result of partially fragmentation of the minerals that are forming the bedrock, and the clay as the result of chemically disintegration of the minerals in the bedrock. In this case, it can be said that, the changes in the rates of dust and sand in the area of study results from the structure of the bedrock, and the change in the rates of the clay results from the chemical disintegration conditions. The difference between the sand, dust and clay rates which differentiate according to the types of the stands is also due to the selection of trial areas from different altitudes and different slopes (Zengin, 2010). According to the statistical evaluation results, there is no statistically significant difference ($p > 0.05$) between the stands regarding sand and dust values, however, when analyzed regarding the clay values, there is a statistically significant difference ($p < 0.05$) between the stand types. When Mann-Whitney test and Bonferroni correction is applied for the clay values of the groups, it was found that there are statistically significant differences between Ck and Cs; and Ck and CkCs stands ($p < 0.0167$). Shrestha and Lal (2008), have found; the sand rate 17.6% in forest, 27.1% in meadow, and 9.6% in agricultural area at 0-5 cm depth level, and 17.6% in forest, 9.8% in meadow, and 10.0% in agricultural area at 5-15 cm depth level; the clay rate 46.8% in forest, 25.0% in meadow, and 37.7% in agricultural area at 0-5 cm depth level; the dust rate 3.56% in forest, 4.79% in meadow, and 5.27% in agricultural area at 0-5 cm depth level, and 3.76% in forest, 5.81% in meadow, and 4.83% in agricultural area at 5-15 cm depth level; as a result of a study they have conducted in Ohio-USA on the effects of the utilization of the lands on the physical properties of the soil. In the study that was conducted by Tüfekcioğlu and Küçük (2004), analyzing the soil respiration on young and old oriental spruce stands and meadow areas next to the stands, they have found: for meadow areas, the sand rate 66.4%, clay rate

16.8%, and dust rate 16.9% at 0-15 cm depth level, the sand rate 44.9%, clay rate 30.7%, and dust rate 24.4% 15-35 cm depth level; and for the areas of old spruce stands, the sand rate 57.5%, clay rate 25.5%, and dust rate 17.1% at 0-15 cm depth level, the sand rate 53.2%, clay rate 27.0%, and dust rate 19.8% at 15-35 cm depth level. In a study conducted by Yüksek (2009) at a pasture inside forest field, for 0-5 cm depth level, they found that; in the control area without activity, sand rate 70.21%, clay rate 11.54% and dust rate 18.25%; in the control area with medium density level of activity, sand rate 67.35 %, clay rate 14.15% and dust rate 18.50%; and in the control area with high density level of activity, sand rate 65.73%, clay rate 17.33% and dust rate 16.94%.

The highest level of organic materials is detected in Ck, and the lowest level is in Cs. The values for the organic materials show similarity between Ck and CkCs stands. Generally, the organic substance amounts in shadow exposures are higher than the ones in sunlit exposures. Because, the moisture in the air is a fact that accelerates the disintegration. Boerner (1984) have stated that the soils of the northern exposures have higher organic substance of soil than the southern exposures. Kırış (2009) have stated that generally the amount of organic substances in the upper layer of the soil than the lower level. Aydın (2000) have indicated that the average organic substance amount in upper layer of soil (0-20 cm) was 8.85% in forest areas, 10.43% in meadow areas and 8.53% in agricultural areas. In the study conducted by Polat et al., (2014) on the plantation areas of pure Black Pine and mixed Black Pine-Cedarwood stands, the amount of the organic substances have been determined as 4.4% at the samples of the soils taken from the 0-15 cm depth. Similarly, in the study conducted by Colak (2016), the organic substance amount in *Picea Orientalis* was identified as 2.38%. In the study Bellitürk et al., (2009) carried out in order to identify the mineralization of nitrogen, which was in an organic form in the soil sample, and the relations of it with the physical and chemical features of these soils, they identified the average organic substance amount in the soil samples as 1.44%. In the study carried out by

Göl et al., (2004) in order to research the effects of different kinds of utilization of the lands, and the exposure on the hydro physical properties of the soil, the organic substance amounts on northern exposure for 0-15 cm depth are; 1.17% in field, 2.18% in meadow, 3.18% in plantation and 6.25 in natural forest; and in southern exposure, 1.72% in field, 1.43% in meadow, and 1.66% in plantation. In the study that Dindaroğlu and Canbolat (2012) have conducted for evaluation of the physical and chemical properties of the soils that develop under the cover of forest, forage and meadow vegetations, with regard to current utilization of the lands, they have determined that the organic substance amount is lowest %0.1 and highest 8.9% as the result of the analyses on the soil samples from the forest areas. In their study, Tüfekcioğlu ve Küçük (2004) have found the organic substance amount, for meadow areas, 5.58% in 0-15 cm dept, 2.90% in 15-35 cm depth; for the old spruce stands, 7.57% in 0-15 cm dept, 4.43% in 15-35 cm depth. In the study carried out by Yüksek (2009), the organic substance amount for 0-5 cm depth level was found to be; in the control area of no activity 6.71%, in the area of middle density level activity 4.39%, and in the area of high level activity 1.77%. In the analyses made with the soil samples taken from the trial areas, it was identified that there are significant differences between Ck and Cs stands regarding the amount of organic substances. The organic substances in the area of study have a large contribution on the water production of the basin by slowly leaking (Özhan et al., 2008) the excessive water they keep to the ground and minimizing the surface flow.

The soil reaction is an important variable which effects the genetic development of the soil and physical, chemical and biological specialties of the soil. The pH of the soil strongly effects; obtaining the plant nutrient elements in the soils, the productivity of the soil, the spreading of the plants together with the litter decomposition, the composition of the species and the microbial activities on the soils (Kantarıcı, 2000; Ergene, 1997; Brady et al., 1999). The factors that are effective in the formation of the soil are also effective in

reaction of the soil. Climate, change of seasons and the vegetation are the most important factors for pH in forest soils (Fitzpatrick, 1986; Foth, 1990; Miller et al., 1990). When we examine the studies on this issue, the soils in the humid regions are seen to be having strongly acidic structure. This is because the precipitation washes the basic cations (Ca, Mg, K and Na) in the soil and leaving the Al and H ions, which are dominant in conversion complexes. (Eriksson et al., 1992). In autumn, the pH value of the soil increases due to the deceleration of the vegetation activities and litter cations', which decompose with the defoliation, reaching the soil; and in spring, pH value of the soil decreases due to the obtaining of the cations from the soil after the start of the vegetation activities, the formation of CO₂ as a result of the respiration of roots and other organisms, and the production of H₂CO₃, which is a weak acid in soil (Bergvist et al., 1995). Soils' having different pH values under different types of plants is a situation related to the plants' tendency of receiving cations and using them (Beier et al., 1998). The excessive amount of the cations that are brought in the soil by the decomposition of the litter of the plant species which have more tendencies to use cations, increases the pH level of the soil. It is known that, the decomposition of the litter of the coniferous tree species, especially Scotch Pine, Spruce and Black Pine, the acid products are formed and the soil gets more acidic (Barner et al., 1998; Kantarıcı, 2000). Thus, due to the higher decomposition at the upper level of the soil, the acidity rate will be higher and accordingly the pH level will be lower. With the effect of the precipitation, the basic cations are washed from the upper level of the soil to the lower levels (Zengin, 2010). The pH value in CkCs stand is relatively higher from the other stands. The reason for this might be the highness of the stem flow in the mixed stand compared to the other stands. And it was found to be lower in Scotch Pine stand. The reason for this might be the fact that the decomposition in Cs stand is relatively higher. And, the higher moisture in the shadow exposures compared to the sunlit exposures, also cause more acidity

(Zengin, 2010). Additionally, also Boerner (1984) have stated that the soils of southern exposures have lower pH values than that of northern exposures. According to the results of the statistical analysis regarding the pH values, it is identified that there's a significant difference between the Cs and CkCs stands. The pH values of the soils are important variables that affect the physical, chemical and biological characteristics of the soils. The pH of the soil controls the receiving of the plant nutrition elements, the spreading of the plants, the species composition of plant assemblages, and the microbial activities in the soil to a large extent (Kantarci, 2000) In the study conducted by Akgül and Aksoy (1978), it is stated that the soil reaction for Scotch Pine varies between 5.00 and 6.90, thus, the upper level of the soil is temperately acidic. In the study that Tüfekcioğlu and Küçük (2004) have conducted, they have found the pH value; for meadow areas at 0-15 cm depth level as 5.33, at 15-35 cm depth level as 5.57; and for old spruce stands at 0-15 cm depth level as 5.29, 15-35 cm depth level as 5.32. In the study Yüksek (2009) carried out, the pH value was found as: 5.40 in the control area without activity, 4.71 in the area with middle level density of activity, 4.59 in the area with high level density of activity.

Although the value of utilizable moisture is relatively low at CkCs compared to other stands, there is no statistically significant difference between tree species. The values of the amount of utilizable water have changed proportionally according to the altitude levels of the trial areas. In the study that Yüksek (2009) conducted, the utilizable moisture value was found as: 15.78% in the control area without activity, 11.32% in the area with middle level density of activity, 7.50% in the area with high level density of activity.

Colloid moisture equivalents value of Cs was found relatively higher when compared to others, while it was found lower and significantly different in Ck. It is identified that there's a significant difference between Ck and Cs, and Ck and CkCs stands. The colloid moisture equivalent value is accepted as an index that shows the water permeability of the soil (Balci, 1996). The highness of this

value shows that the soil is more robust against the erosion, that is to say the infiltration will be higher and the surface flow will be lower. The given limit value for the colloid moisture equivalent is 1,5 and if this value is smaller than 1,5 it means the soil is vulnerable against the erosion, and if it is higher than 1,5 the soil is robust against the erosion (Erol et al., 2009). When evaluated according to these values, it can be said that the soils of the research area are vulnerable to erosion regardless of the type of the stand.

References

- Akalan İ., 1988. Toprak Bilgisi, Ankara Üniversitesi Ziraat Fakültesi Yayınları, Yayın No:1058, 8, Ankara.
- Akgül E., Aksoy C., 1978. Bolu-Şerif Yüksel Araştırma Ormanının genel toprak karakterleri ve toprak Haritaları. Or. Arş. Enst. Tek.Bül. No: 95.
- Anonymus 1993. Kastamonu ili arazi varlığı haritası, Baskı İşleri Şube Müdürlüğü, Baskı No:189, Ankara.
- Anonim 2010. 2010-2029 Daday Orman İşletme Müdürlüğü amenajman planı, Kastamonu Orman Bölge Müdürlüğü, Kastamonu.
- Asan Ü., Şengönül K. 1987. Orman formlarının fonksiyonel açıdan karşılaştırılması, İstanbul Üniversitesi Orman Fakültesi Dergisi, Seri: B, Cilt:37, Sayı:4.
- Aydın M. 2000. Giresun-Yağlıdere yağış havzasında farklı anamateryaller üzerinde gelişen toprakların erozyon eğilim değerleri ve vejetasyon yapısı üzerine araştırmalar. Yüksek Lisans Tezi, KTÜ Fen Bilimleri Enstitüsü, Trabzon.
- Balcı A. N. 1996. Toprak Koruması, İstanbul Üniversitesi Orman Fakültesi ders notları, Yayın No: 439, İstanbul.
- Barnes B.V., Zak D.R., Denton S.R., Spurr S.H. 1998. Forest Ecology. 4. Edition, John Wiley and Sons, New York.
- Baver L.D. 1956. Soil Physics. John Wiley and Sons Inc., New York.
- Beier C., Blanck K., Bredemeier M., Lamersdorf N., Rasmussen L. 1998. Responses of Soil and Vegetation to Reduced Input of S, N and Acidity to Two Norway Spruce Stands of the EXxman Project. Forest Ecology and Management, 101; 111-123.
- Bergkvist B., Folkesson L. 1995. The Influence of Tree Species on Acid Deposition Proton Budgets and Element Fluxes in South Swedish Forest Ecosystems. Ecological Bulletin, 44; 90-99.

- Bellitürk K., Danışman F. ve Sözübek B. 2009. Tekirdağ Yöresindeki Toprakların Bazı Fiziksel ve Kimyasal Özellikleri ile Mineralizasyon Kapasiteleri Arasındaki İlişkiler. Akdeniz Üniversitesi Ziraat Fakültesi Dergisi, 22 (2), 141-147.
- Boerner R.E. 1984. Nutrient fluxes in litterfall and decomposition in four forests along a gradient of soil fertility in southern Ohio. Can.J.For.Res. 14, 794-802.
- Brady N.C., Weil R.R. 1999. The Nature and Properties of Soils 12.h Edition, Prentice Hall, Upper Saddle River, New Jersey.
- Çolak G. 2016. Esenli (Giresun) orman işletme şefliği ormanlarında yetişme ortamı faktörlerine bağlı olarak bitkisel tür çeşitliliğinin değişiminin belirlenmesi. Yüksek Lisans Tezi. KTÜ Fen Bilimleri Enstitüsü, Trabzon.
- Dindaroğlu T., Canbolat M.Y. 2012. Kuzgun baraj gölü havzasında orman, mera ve çayır bitki örtüsü altında gelişen toprakların bazı fiziksel ve kimyasal özellikleri. ISSN:1307-3311, Alnteri 22(B), 1-9.
- Ergene A. 1997. Toprak Biliminin Esasları. Genişletilmiş yedinci baskı. Yayın No: 0027, Öz Eğitim Basım Yayın Dağıtım LTD. STİ., Konya.
- Eriksson E., Karlton E., Lundmark J.-E. 1992. Acidification of Forest Soils in Sweden. Ambiology, 21, 150-154.
- Erol A., Babalık, A.A., Sönmez K., Serin N. 2009. Isparta-Darıderesi havzası topraklarında erozyona duyarlılığın arazi kullanım şekillerine bağlı değişimi. Süleyman Demirel Üniversitesi Orman Fakültesi Dergisi, ISSN: 1302-7085, Seri: A, Sayı: 2, Sayfa: 21-36.
- Fisher F., Binkley D. 1999. Ecology and Management of Forest Soil. ISBN: 0-471- 19426-3, USA.
- Fitzpatric E.A. 1986. An Introduction to Soil Science. Second Edition, Longman Scientific and Technical, John Wiley and Sons, New York.
- Foth H.D. 1990. Fundamentals of Soil Science. Eighth Edition, John Wiley and Sons.
- Göl C., Ünver İ., Özhan S. 2004. Çankırı-Eldivan yöresinde arazi kullanma türleri ile yüzey toprağı nemi arasındaki ilişkiler. Süleyman Demirel Üniversitesi Orman Fakültesi Dergisi ISSN: 1302-7085, Seri: A, Sayı: 2, Yıl: 2004, 17-29.
- Gülçur F. 1974. Toprağın Fiziksel ve Kimyasal Analiz Metodları. 1. Baskı, İstanbul Üniversitesi, Yayın No: 1970, Orman Fakültesi Yayın No:201, İstanbul.
- İrmak A. 1968. Toprak İlmi, İstanbul Üniversitesi, Yayın No: 1268, Orman Fakültesi Yayın No: 121, Becid Basımevi, İstanbul.
- İşler E. 2010. Kastamonu Merkez, Daday ve Safranbolu geleneksel türk evi tavanları. Yüksek Lisans Tezi, Gazi Üniversitesi Fen Bilimleri Enstitüsü. Ankara.
- Kalra Y.P. Manyard D.G. 1991. Methods manuel for forest soil and plant analysis. Forestry Canada, Northern Forestry Publications, Alberta, Canada.
- Kantarıcı D. 2000. Toprak İlmi. İstanbul Üniversitesi Orman Fakültesi Yayınları, Orman Fakültesi, Yayın no: 462, İstanbul.
- Kırış K. 2009. Gümüşhane Torul Yöresi saf sarıçam meşcerelerinde kalın kök kütlesi değişiminin ve bazı toprak özelliklerinin belirlenmesi. Yüksek Lisans Tezi, Artvin Çoruh Üniversitesi Fen Bilimleri Enstitüsü, Artvin.
- Kuzka 2013. TR82 Düzey 2 Bölgesi (Kastamonu, Çankırı ve Sinop İlleri) Bölge Planı 2014-2023.
- Miller R.W., Donahue R.L. 1990. Soils. Sixth Edition, Prentice Hall, Englewood Cliffs, New Jersey.
- Okatan A., Reis M., Yüksel, A., Aydın M. 2001. Çorum-Karhın çayı yağış havzasında dere akımlarını etkileyen fizyografik etmenler ile bazı hidro-fiziksel toprak özellikleri arasındaki ilişkiler üzerine bir araştırma. Fen ve Mühendislik Dergisi, Cilt 4, Sayı 2, syf: 16-29.
- Özhan S. 1994. Havzalarda orman ve otlak alanları amenajmanlarının su verimine ve su kalitesine etkileri adlı makaleye ilişkin bir açıklama. İstanbul Üniversitesi Orman Fakültesi Dergisi, Seri: B, Cilt: 44, Sayı:3-4, 65-76, İstanbul.
- Özhan S., Hızal A., Gökbulak F., Serengil Y. 2008. Ormancılık ve Su Üretimi İlişkisi, Baraj Havzalarında Ormancılık I. Ulusal Sempozyumu, (29-30 Nisan 2008), 57-75, Kahramanmaraş, Turkey.
- Özyuvacı N. 1971. Topraklarda erozyon eğiliminin tesbitinde kullanılan bazı önemli indeksler. İstanbul Üniversitesi Orman Fakültesi Dergisi, B, 21 (1), 190-207, İstanbul.
- Özyuvacı N. 1978. Kocaeli yarımadası topraklarında erozyon eğiliminin hidrolojik toprak özelliklerine bağlı olarak değişimi. İstanbul Üniversitesi, Yayın No: 2328 Orman Fakültesi Yayın No: 233, İstanbul.
- Polat S., Polat O., Kantarıcı D., Tüfekçi S., Aksay Y. 2014. Mersin-Kadıncık Havzası'ndaki Sedir (Cedrus libani A. Rich.) ve Karaçam (Pinus nigra Arnold.) ağaçlandırmalarının boy gelişimi ile bazı yetişme ortamı özellikleri arasındaki ilişkiler. Ormancılık Araştırma Dergisi. 2014 (1), A, 1:1, 22-37.

Shrestha R. K., Lal R. 2008. Land use impacts on physical properties of 28 years old reclaimed mine soils in Ohio, *Plant Soil*, 306, 249-260.

Tüfekçioğlu A., Küçük M. 2004. soil respiration in young and old oriental spruce stands and in adjacent grasslands in Artvin. *Turkish Journal Agriculture Forestry*, 28, 429-434.

URL1, 2014. Kastamonu ili genel özellikleri, <http://www.tumkasder.com/index.php?Git=kastamonu&sayfa=cografya>

Vialatte F. B., Cichocki A. 2008. Spit test bonferonni correction for QEEG statistical maps. *Biological Cybernetics*, 98, 208-303.

Yüksek T. 2009. Effect of visitor activities on surface soil environmental conditions and aboveground herbaceous biomass in Ayder Natural Park, *Clean Journal*, 37 (2).

Zengin M. 1997. Kocaeli yöresinde orman ekosistemlerinin hidrolojik ağaçlandırmalar yönünden karşılaştırılması. Orman Bakanlığı Yayın No:055, İzmit.

Zengin N. 2010. Giresun ili Alucra Yöresi saf ve karışık sarıçam meşçerelerinde bazı toprak özelliklerinin belirlenmesi. Yüksek Lisans Tezi, Artvin Çoruh Üniversitesi Fen Bilimleri Enstitüsü, Artvin.

Effect of Different Land Uses on Soil Erosion Losses in Semi-Arid Region: Idris Mountain-Ankara

Ali Uğur ÖZCAN¹, *Semih EDİŞ¹

¹Çankırı Karatekin University, Faculty of Forestry, Çankırı / TURKEY

*Corresponding Author: semihedis@gmail.com

Abstract

Soil erosion losses has increased significantly with industrial revolution through rapid deforestation, changes in land uses, improper and excessive agricultural practices and now it has reached to threatening levels. Universal Soil Loss Equation (USLE) and Revised Universal Soil Loss Equation (RUSLE) are commonly used to estimate total annual soil losses from different land uses. USLE/RUSLE technology is composed of combination of six input factor as of; rainfall erosivity (R), soil erodibility (K), slope length (L), slope steepness (S), cover management (C) and support practice (P). RUSLE-C factor is especially significant in estimation of the effects of land use over soil erosion. In this study, potential average annual soil losses for six different lands uses of İdris Mountain-Ankara was estimated by using RUSLE model integrated with GIS and spatial distribution of risky areas within the was determined. R, K, LS, C factors were found to be 1202 MJ ha⁻¹ mm hour⁻¹ year⁻¹, 0.086 t ha hour ha⁻¹ MJ-1 mm⁻¹, 3.87 and 0.395, respectively. P factor was taken as a unit assuming no erosion control practices. Predicted potential soil losses was found to be 140.83 ton ha⁻¹ year⁻¹ by using independent factors. Resulting potential soil loss map found out that spatial average soil loss in terms of the land uses were 64.11, 163.74, 150.20 and 100.46 t ha⁻¹ year⁻¹ for the forest, grassland, cropland and others (urban, quarry and water), respectively. This results showed that soil losses in study area were higher more than 1 ton ha⁻¹ y⁻¹ which was irreversible soil loss for Central Anatolia of Turkey.

Keywords: İdris Mountain, RUSLE, Semi-arid region, Soil erosion, GIS

Yarı-kurak Bölgede Toprak Erozyonu Kayıpları Üzerine Farklı Arazi Kullanımlarının Etkisi

Özet

Toprak erozyonu kayıpları sanayi devrimi ile birlikte hızlı ormansızlaşma, arazi kullanımlarında değişiklik, aşırı tarımsal uygulamaların artışıyla önemli derecede artmış ve tehdit seviyesine ulaşmıştır. Evrensel Toprak Kayıpları Eşitliği (ETKE) ve Yenilenmiş Evrensel Toprak Kayıpları Eşitliği (YETKE) farklı arazi kullanımlarında toplam yıllık toprak kayıplarının hesaplanmasında yaygın olarak kullanılmaktadır. ETKE/YETKE teknolojileri yağış erozivitesi (R), toprak erodibilitesi (K), eğim uzunluğu (L), eğim dikliği (S), bitki yönetimi (C) ve koruma uygulamaları (P) olmak üzere altı faktörün birleşiminden oluşmaktadır. YETKE C faktör toprak erozyonu üzerinde arazi kullanımlarının etkisinin hesaplanmasında önemli bir özelliktir. Bu çalışmada, İdris Dağı-Ankara'nda altı farklı arazi kullanımı için potansiyel ortalama toprak kayıpları CBS ile YETKE modeli kullanılarak hesaplanmış ve riskli alanların konumsal dağılımı belirlenmiştir. R, K, LS, C faktörler sırasıyla 1202 MJ ha⁻¹ mm saat⁻¹ yıl⁻¹, 0.086 t ha saat ha⁻¹ MJ-1 mm⁻¹, 3.87 ve 0.395 bulunmuştur. P faktör erozyon kontrol uygulamaları olmamasından dolayı 1 olarak alınmıştır. Tahmini potansiyel toprak kayıpları bağımsız değişkenler kullanılarak 140.83 ton ha⁻¹ yıl⁻¹ bulunmuştur. Sonuç olarak arazi kullanımları açısından potansiyel toprak kayıpları haritasına göre ortalama toprak kayıpları orman, mera, tarım alanı ve diğerleri (yerleşim, maden ve su) için sırasıyla 64.11, 163.74, 150.20 and 100.46 t ha⁻¹ yıl⁻¹ bulunmuştur. Bu sonuçlar çalışma alanında toprak kayıplarının Merkez Anadolu için tolere edilebilecek toprak kaybı olan 1 t ha⁻¹ yıl⁻¹ daha yüksek olduğunu göstermiştir.

Anahtar kelimeler: İdris Dağı, YETKE, Yarı kurak bölge, Toprak erozyonu, CBS

Introduction

Soil is the main resource not only agricultural production and sustaining food production but also forest and grassland so it has to be well managed and preserved. Soil and vegetation degradation can lead to a

significant reduction of the ecosystem functionality, with unfavourable effects on biodiversity, desertification, and water resource quality. Undoubtedly, soil erosion is the most extensive process of land degradation, particularly in arid and semi-

arid regions (Ravi et al. 2010; Saygın et al., 2011). In these conditions, quantitative evaluation of the spatial distribution of the erosion risk in any watershed or ecosystem is one of the most important for environmentalists, conservationists and engineers to plan natural resource management for the sustainable environment in a long-term.

Soil erosion has been studied by several researchers and several models were developed to estimate soil lost (Wischmeier and Smith, 1978; Shen et.al, 2003). Universal Soil Loss Equation (USLE) is the most commonly used experimental soil loss estimation model (Lu et.al, 2004). USLE (Wischmeier and Smith, 1978) and Revised Universal Soil Loss Equation (RUSLE) (Renard et al., 1997) are able to estimate long-term annual soil lost by using relationships among land use and cover, topography, soil type, precipitation. USLE was used to calculate soil erosion over agricultural land areas with low slopes (Wischmeier and Smith, 1978). RUSLE has a wider range of application including degraded lands, pastures and forests (Renard et.al, 1997). RUSLE estimates the soil loss by multiplying six parameters as of rainfall factor (R), soil erodibility factor (K), slope length factor (L), slope steepness factor (S), cover management factor (C) and support practice factor (P). Values of these parameters are determined by field and laboratory studies (Renard et.al, 1997). Among these parameters, C and P vary with type of land use and R,K,L and S vary with general ecology of the site (Sonneveld and Nearing, 2003).

Geographical Information Systems (GIS) and Remote Sensing (RS) technologies are successfully applied in national, regional and watershed-based implementations of USLE/RUSLE technology. (Kinnell, 2000; Ozcan et.al, 2008). USLE/RUSLE equation is used with GIS and RS techniques to create erosion risk maps of large watersheds in an accurate, economical and rapid fashion (Molnar and Julien, 1998; Kinnell, 2000; Mati et.al, 2000; Join et.al, 2001; Lufafa et.al, 2003; Wang et.al, 2003; Amore, 2004; Erdogan et.al, 2007; Ozcan et.al, 2008). Generally, land use/cover (Ismail and

Ravichandran, 2008; Bescow et.al, 2009) canopy cover, under canopy cover, and overall vegetation cover (Lu et.al, 2004; Zhou et.al, 2008) were used by remote sensing technology to determine C for soil losses. Beside GIS and RS, geostatistical techniques are also commonly used evaluation method to determine the spatial distribution of soil characteristics (Basaran et.al, 2006; Ozcan et.al, 2008) and vegetation cover (Wang et.al, 2002). Krigging maps created by using variogram models and parameters of geostatistical methods can be transferred into GIS and significant data about change in soil and vegetation cover can be produced (Wang et.al, 2002; Basaran et.al, 2006; Ozcan et.al, 2008).

In this study, annual sediment losses ($t\ ha^{-1}$) were estimated for different land uses by the RUSLE/GIS Technology in a semi-arid region, İdris Mountain-Ankara-Turkey.

Method

Study area is on the east border of Ankara where is the central of Turkey and is about 529 km². The average annual rainfall is 422 mm and the average annual temperature is 10.1 C°. In the area, elevations vary from 629 to 1991 m above the sea level and the slopes range from 12 to 36 %. Geologic structure of study area consists of Paleozoic and Mesozoic units. Paleozoic schist is the oldest series in area that Paleozoic limestone blocks rise to the surface (Erol 1954). Limestone, schist and serpentine are dominant in area. In study area, there are forest and grassland as natural land uses. Common forest formation of the Central Anatolia steppe forests consist of oak (*Quercus pubescens* Willd.), black pine (*Pinus nigra* Arn. subsp. *Nigra*) and juniper (*Juniperus oxycedrus* L. subsp. *Oxycedrus*). Dominant forest of study area is pure oak, oak-juniper and pure juniper unities as depending on height and aspect. There are residential, agriculture, dam and mine as artificial land use.

The combined RUSLE/SDR methodology was used for this study to estimate sediment flux rates ($ton\ ha^{-1}\ y^{-1}$) in İdris Mountain-Ankara-Turkey. A SDR value was added as a multiplier to the well-known Revised Universal Soil Loss Equation (RUSLE)

(Wischmeier and Smith, 1978; Renard et al. 1997) (Eq. (1)).

$$A = R \times K \times L \times S \times P \quad (1)$$

A is the mean annual soil loss ($t \text{ ha}^{-1} \text{ year}^{-1}$), R is the rainfall erosivity factor ($\text{MJ mm ha}^{-1} \text{ h}^{-1} \text{ y}^{-1}$), K is the soil erodibility factor ($t \text{ ha h ha}^{-1} \text{ MJ}^{-1} \text{ mm}^{-1}$), L is the slope length factor, S is the slope steepness factor, C is the cover management factor, and P is the support practice factor.

The digital databases (raster and vector) used for together with the USLE/RUSLE technology are following:

- Topographical maps (1:25.000)
- Digital elevation models (1:25.000)
- Forest maps (1:25.000)
- Soil maps (1:25.000) (Anonim, 1982)

R factor or rainfall erosiv factor is calculated as the highest rainfall intensity of 30 minutes (I30) and the product (EI30) of the total energy of the rainfall (E) (Wischmeier et al. 1958; Foster et al. 1981). In this study, R factor was directly taken by Kaya (2008) and Erpul (2009) in İdris Mountain. Because there are insufficient meteorology stations around study area for kriging, taking account of the effect of elevation on actual amount of precipitation (Toy and Foster, 1998), To form spatial R surface, the Digital Elevation Model (DEM) of the study area was used. Corrections were made by taking the equality in the rainfall amount depending on the elevation in the catchment basin by Toy and Foster (1998), Erdogan et al. (2007) and Ozcan et al. (2008, 2015). The elevation of the İdris Mountain changes between 629-1991 m (mean:1239 m, sd dev:278 m). The elevation of Ankara meteorology station, which was taken as the reference station, is 785 m, and R values were calculated for the unknown unities from DEM with ArcView 9.2 where rainfall would increase with 50 mm in every 300 m height difference.

K factor map, which is also defined as the resistance of soil against erosion, 1:25000 scaled Turkish Land Database (1982) was used. The soil unities were digitized by using the RUSLE K equation, which was suggested

by Romkens et al. (1986) and revised by Renard et al. (1997), by associating the vector layers that have the polygons of soil classes, erosion and texture combinations with the separation of different K classes (Erdogan et al., 2007).

LS factor, as a resultant of the slope length and slope steep, was found by using the DEM of the catchment basin and Arcview 9.2 Hydraulic Accumulation module.

The C factor is cover management factor and depending on type and cover of vegetation. In generally, vegetation decrease the kinetic energy of the raindrop before impact of raindrops on soil surface. C factor values were identified by scienties for each land use. Especially, C factor values for forest and grassland land uses were fitted by Özcan et al. (2008; 2011) and Saygin et al. (2014) due to same forest region (*Pinus nigra- Quercus pubescens Willd. Forest*) and for agriculture, land use were fitted by Wischmeier and Smith (1978) and Gabriels et al. (2003).

Table 1. C factor values (adopted from Wischmeier and Smith (1978), Gabriels et al. (2003), Ozcan et al. (2008; 2011) and Saygin (2014))

Land Use Type/Land Cover (LUT/LC)	C Factor Value
Forest	0.01
Grassland	0.3
Agriculture	0.5
Water	0
Quarry	1
Urban	0.05

RUSLE, enabling the annual soil loses to be predicted, was acquired by combining R, K, LS, and C factors, which forms RUSLE with ArcGIS. Since there is no different land uses or any support practices; the factor P is taken as 1.

Results and Discussion

Annual soil losses over research site according the RUSLE model were estimated by using GIS. All parameters converted into 10x10 girds and multiplied. Then, spatial distribution of soil loses from study area was obtained.

The layer of the USLE-R factor calculated by Kaya (2008) and Erpul et al. (2009) and using the DEM of the watershed. RUSLE-R factor of research site varied between 763-1833 MJ ha⁻¹ mm hour⁻¹ year⁻¹ with a mean value of 1202± 214 MJ ha⁻¹ mm hour⁻¹ year⁻¹. Because the highest point of İdris Mountain is 1991 meter, R factor values were high. Compared to European R-factor values of 0-900 MJ ha⁻¹ mm hour⁻¹ year⁻¹ (Van der Kniff, 2000), it was observed that the research site had high erosion potential. Bayramin et al. (2006), Ozcan et al. (2008; 2015) and Saygin et al. (2014) showed that R factor is very remarkable for the semi-arid region of Central Anatolia. The substantial sign of the potential risk in these semiarid regions of Central Anatolia is very high climatic unevenness in which extreme events occur and rainy and vegetative seasons hardly concur (Ozcan et al. 2008).

The K factor values varied from 0 to 0.092 t ha h ha⁻¹ MJ⁻¹ mm⁻¹ and the mean value is 0.0826 t ha h ha⁻¹ MJ⁻¹ mm⁻¹. The standard deviation (SD) is 0.022. The most of study area consist of brown soils (84.92%) and their K factor values depending on texture and soil depth (horizons) varied from 0.025 to 0.092 t ha h ha⁻¹ MJ⁻¹ mm⁻¹ and mean value is 0.073 t ha h ha⁻¹ MJ⁻¹ mm⁻¹. Similar to the Brown Soils, K factor values of Reddish Brown Soils varied from 0.025 to 0.092 t ha h ha⁻¹ MJ⁻¹ mm⁻¹. But their K Factor mean value was 0.084 t ha h ha⁻¹ MJ⁻¹ mm⁻¹. This results showed that K factor values of the study area have high soil erodibility.

LS factor map was calculated using DEM of The İdris Mountain and considering the interactions between topography and flow accumulation. LS factor values ranged from 0 to 17.165 with a mean value of 3.87 ± 2.68. Actually, the dominant classes were 0-2, 2-5 and 5-8 with areal ratios of 30.69%, 36.56% and 24.63%, respectively, totalling 91.88%. The spatial analysis of LS factor suggested that topography of the İdris Mountain mostly supported less erosion, meaning that in only very small part of the İdris Mountain the steeper slopes collecting more runoff would result in greater erosion.

RUSLE-C generated by reclassification of each land-use/land-cover type using values

given in Table 1. The watershed was composed of six land use types, which were agriculture (53.24%), grassland (29.03%), forest (15.01%), urban (1.4%), quarry (0.3%) and water (1.2%), having the USLE-C values of 0.5, 0.3, 0.01, 0.05, 1 and 0.

The map of the potential soil losses predicted by Eq. (1) is given by Fig. 1, and annual soil losses (A, ton ha⁻¹ year⁻¹) in terms of the different land use/land-cover types are given in Table 2. As a base of discussing the potential soil erosion, the amount of 1 ton ha⁻¹ year⁻¹ was taken as an upper bound of soil erosion rate in determining the soil loss classes.

This limit is the one still tolerable to sustain the soils of the watershed since the rate of soil formation was expected to be so slow in semiarid environments like Central Anatolia of Turkey. Therefore, any soil loss of more than 1 ton ha⁻¹ year⁻¹ over 50–100 years is considered as irreversible (EEA 1999; Renard et al. 1997).

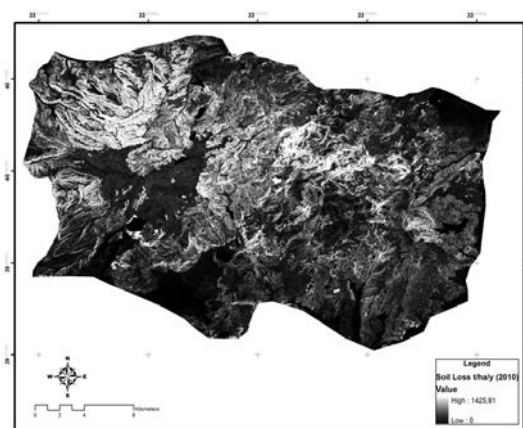

Figure 1. Soil Losses map in study area

In figure 1, annual soil losses for six different land uses are predicted by RUSLE consisting six factors. Annual soil losses vary between 0-1425 t ha⁻¹y⁻¹ (Table 2). Predicted potential soil losses were found to be 140.83 ton ha⁻¹ year⁻¹ by using independent factors. Resulting potential soil loss map found out that spatial average soil loss in terms of the land uses were 64.11, 163.74, 150.20 and 100.46 t ha⁻¹ year⁻¹ for the forest, grassland, cropland and others (urban, quarry and water), respectively.

Table 2. Soil losses in study area

Potential Soil Losses (t/ha/y)	Forest		Grassland		Agriculture		Others		Total	
	Area (Ha)	Area (%)	Area (Ha)	Area (%)	Area (Ha)	Area (%)	Area (Ha)	Area (%)	Area (Ha)	Area (%)
0-5	124,11	0,23	293,13	0,55	1983,69	3,75	514,13	0,97	2915,06	5,51
5-10	130,30	0,25	111,22	0,21	1179,22	2,23	95,81	0,18	1516,55	2,87
10-20	409,89	0,78	250,10	0,47	1627,92	3,08	152,21	0,29	2440,12	4,62
20-50	2393,42	4,53	990,00	1,87	3585,82	6,78	162,62	0,31	7131,86	13,49
50-100	3839,20	7,26	2399,11	4,54	4697,94	8,89	135,06	0,26	11071,31	20,94
100-250	1035,11	1,96	7806,92	14,77	8821,97	16,69	190,29	0,36	17854,29	33,78
250-500			3476,03	6,58	5535,22	10,47	130,97	0,25	9142,22	17,29
500-1000			17,67	0,03	709,47	1,34	57,02	0,11	784,16	1,48
1000-1425					0,11		6,14	0,01	6,25	0,01
Total	7932,03	15,01	15344,18	29,03	28141,36	53,24	1425,63	2,73	52861,84	100,00

Conclusion

In the research site which is located in İdris Mountain in Ankara; the potential soil erosion is predicted for different land uses with the help of GIS technologies and RUSLE model. Among the modelling parameters: RUSLE maps obtained by soil map for K factor; forest management maps for determining the land use classes in factor C; climate data and DEM for factor R; DEM and LS map made in hydraulic flow deposit module, are analysed in ArcGIS 9.2. to find annual soil losses. Since there is no support practice in the area and different land uses exist, the factor P is taken as 1. With the assistance of GIS and RUSLE model will create a better interference with erosion at a higher speed and lower cost at larger areas of different land uses.

References

- Amore, E.; Modica, C.; Nearing, M.A.; Santoro, C.V., 2004. Scale effect in USLE and WEPP application for soil erosion computation from three Sicilian basins. *Journal of Hydrology*, 293: 100-114
- Basaran, M.; Ozcan, A.U.; Erpul, G.; Çanga, M.R., 2006. Spatial variability of organic matter and some soil properties of mineral topsoil in Çankiri İndagi blackpine (*Pinus nigra*) plantation region. *Journal of Applied Sciences*, 6(2): 445-452
- Bayramin, İ., Erpul, G., Erdoğan, H. E. 2006. Use of CORINE methodology to assess soil erosion risk in the semi-arid area of Beypazari, Ankara. *Turkish Journal Of Agriculture And Forestry*, 30(2), 81-100.
- Beskow, S., Mello, C. R., Norton, L. D., Curi, N., Viola, M. R., Avanzi, J. C. 2009. Soil erosion prediction in the Grande River Basin, Brazil using distributed modelling. *Catena*, 79(1), 49-59.

EEA (1999) Environment in the European Union at the Turn of the Century, Environmental assessment report 2. Office for Official Publications of the European Communities, Luxembourg, pp 44.

Erdoğan, E.H.; Erpul, G.; Bayramin, İ., 2007. Use Of USLE/GIS methodology for predicting soil loss in a semiarid agricultural watershed. *Environmental Monitoring and Assessment*, 131:153-161.

Erpul, G., Bayramin, I., Topcu Kaya, P., Saygın D.S. (2009) Türkiye’de Su Erozyonu Çalışmaları için Uzun Dönem Meteoroloji Verileri Kullanarak Ulusal Ölçekte Yağış Enerji ve Şiddetlerinin Belirlenmesi. TÜBİTAK Project (107Y155), Ankara, Turkey (in Turkish).

Erol, O. 1954. Ankara civarının jeolojisi hakkında rapor. MTA Rapor, (2491).

Foster, G. R.; McCool, D. K.; Renard, K. G.; Moldenhauer, W. C., 1981. Conversion of universal soil loss equation to SL metric units. *J. Soil Water Conserv.*, 36: 355-359.

Gabriels, D., Ghekiere G., Schiettecatte W., Rottiers, I. 2003. Assessment of USLE cover-management C-factors for 40 crop rotation systems on arable farms in the Kemmelbeek watershed, Belgium. *Soil and Tillage Research* 74:47–53.

Join, S.K.; Kumar, S.; Varghese, J., 2001. Estimation of soil erosion for a Himalayan Watershed using GIS technique. *Water Resources Management*. 15: 41-54.

Ismail, J., Ravichandran, S. 2008. RUSLE2 model application for soil erosion assessment using remote sensing and GIS. *Water Resource Management* 22:83–102.

Kaya, P. 2008. Türkiye’de uzun dönem yağış verileri kullanılarak ulusal ölçekte RUSLE-R faktörünün belirlenmesi. Ankara Üniversitesi Fen Bilimleri Enstitüsü Yüksek Lisans Tezi Ankara.

Kinnell, P.I.A., 2000. AGNPS-UM: Applying the USLE-M within the agricultural nonpoint

source pollution model. *Environmental Modelling & Software*, 15 (2000) 331-341, Australia.

Lu, D.; Lu, G. L.; Valladare, S.; Batistella, M., 2004. Mapping soil erosion risk in Rondonia, Brazilian Amazonia: using RUSLE, Remote Sensing And GIS. *Land Degradation and Development*. 15: 499–512

Lufafa, A.; Tenywa, M.M.; Isabirye, M.; Majaliwa, M.J.G.; Woome, P.L., 2003. Prediction of soil erosion in a Lake Victoria basin catchment using a GIS-based universal soil loss model. *Agricultural Systems*. 76: 883-894

Mati, B.M.; Morgan, R.P.C.; Gichuki, F.N.; Quinton, J.N.; Brewer, T.R.; Liniger, H.P., 2000. Assessment of erosion hazard with the USLE and GIS: a case study of the upper Ewaso Ng'iro North basin of Kenya. *JAG*. 2(2):78-86

Molnar, D.K. and Julien, P.Y., 1998. Estimation of upland erosion using GIS. *Computer and Geosciences*, 24(2), p. 183-192.

Ozcan, A.U., Erpul, G., Basaran, M., Erdogan, E. H. 2008. Use of USLE/GIS technology integrated with geostatistics to assess soil erosion risk in different land uses of Indađı Mountain Pass—Cankırı, Turkey. *Environmental Geology*, 53:1731–1741.

Özcan, A.U., Başaran, M., Saygın, D.S., Yılmaz, F.E., Dölarıslan, M., Timur, Ö.B., Erpul, G. 2011. Yarıkurak ve kurak bölgelerde orman ve orman içi-üstü mera kullanımlarının erozyona karşı koyma gücünün belirlenmesi. Kurak ve Yarı Kurak Alan Yönetim Çalıştayı, Çölleşme ve Erozyonla Mücadele Genel Müdürlüğü, 8-11 Aralık 2011, Nevşehir.

Özcan, A. U., Uzun, O., Başaran, M., Erpul, G., Akşit, S., & Palancıođlu, H. M. 2015. Soil erosion risk assessment for volcano cone of Alıdađı Mountain by using USLE/RUSLE, GIS and geostatistics. *Fresenius Environmental Bulletin*, 24(6):2090-2100.

Ravi, S., Breshears, D. D., Huxman, T. E., D'Odorico, P. 2010. Land degradation in drylands: Interactions among hydrologic–aeolian erosion and vegetation dynamics. *Geomorphology*, 116(3), 236-245.

Renard, K.G.; Foster, G.A.; Weesies, D.A.; McCool, D.K.; Yoder, D.C., 1997. Predicting soil erosion by water: a guide to conservation planning with the revised universal soil loss equation (RUSLE). *Agriculture Handbook No. 703*. USDA, Washington, DC.

Romkens, M.J.M., Prasad, S.N., Poesen, J.W.A. 1986. Soil erodibility and properties. In: *Proceedings of 13th Congress. International soil science society*. Hamburg, Germany, vol 5, pp 492–504

Saygın Deviren, S., Basaran, B., Ozcan A.U., Dolarslan, M., Timur, O.B., Yilman, F.E., Erpul,

G. 2011. Land degradation assessment by geospatially modeling different soil erodibility equations in a semi-arid catchment. *Environmental Monitoring and Assessment* 180 (1-4), 201-215.

Saygın, S. D., Ozcan, A. U., Basaran, M., Timur, O. B., Dolarslan, M., Yılmaz, F. E., & Erpul, G. 2014. The combined RUSLE/SDR approach integrated with GIS and geostatistics to estimate annual sediment flux rates in the semi-arid catchment, Turkey. *Environmental Earth Sciences*, 71(4), 1605-1618.

Shen, D.Y.; Ma, A.N.; Lin, H.; Nie, X.H.; Mao, S.J.; Zhang, B.; Shi, J.J., 2003. A new approach for simulating water erosion on hillslopes. *International Journal of Remote Sensing*, 24: 2819–2835.

Sonneveld, B.G.J.S. and Nearing, M.A., 2003. A nonparametric/parametric analysis of the universal soil loss equation. *Catena*. 52 (1): 9-21.

Van der Knijff, J. M., Jones, R. J. A., Montanarella, L. 2000. Soil erosion risk assessment in Europe.

Wang, G., Wentz, S., Gertner, G.Z., Anderson, A.B., 2002. Improvement in mapping vegetation cover factor for the universal soil loss equation by geostatistical methods with Landsat Thematic Mapper images. *Int. J. Remote Sensing*, 23(18): 3649-3667.

Wang, G.; Gertner, G.Z.; Fang, S., Anderson A.B., 2003. Mapping multiple variables for predicting soil loss by geostatistical methods with TM images and a slope map. *Photogrammetric Engineering and Remote Sensing*, 69: 889-898.

Wischmeier, W.H., Smith, D.D. 1958. Rainfall energy and its relationship to soil loss. *Eos, Transactions American Geophysical Union*, 39(2), 285-291.

Wischmeier, W.H. 1975. Estimating the soil loss equations cover and management factor for undisturbed lands. In *Present and Prospective Technology for Predicting Sediment Yields and Sources*, pp. 118-125. US. Dep. Agric., Agric. Res. Serv., ARS-S-40.

Wischmeier, W.H., and D.D. Smith. 1978. Predicting rainfall erosion losses: A guide to conservation planning. U.S. Dep. Agric., Agric. Handb. No. 537.

Zhou, P., Luukkanen, T., Tokola, T., Nieminen, J. 2008. Effect of vegetation cover on soil erosion in a mountainous watershed. *Catena*, 75:319–325.

Creating Erosion Risk Map Using Remote Sensing Techniques and ICONA Method: A Case Study of Bertiz Stream Watershed

*Mahmut REİS¹, Nedim KAYA¹, Hurem DUTAL¹, Nurşen BOLAT¹

¹Kahramanmaraş Sutcu Imam University, Faculty of Forestry

*Corresponding Author: mreis@ksu.edu.tr

Abstract

Turkey is one of the countries exposed to the most soil erosion in the world due to improper land use with adverse topographic structure, soil and climate characteristics. Soil erosion, in addition to many negative results, causes filling the dams with sediment and completing their economic life in sooner than anticipated. For this reason, this study was carried out in Bertiz Stream Watershed, which is located 21 km away from Kahramanmaraş province, and carries sediment to Menzelet Dam. The main objective of this study was to create Erosion Risk Map using remote sensing techniques and ICONA method. In order to produce erosion risk map by ICONA method, existing land use and vegetation cover were overlaid in ArcGIS 9.3 and soil protection map was generated. Then, erodibility map was created by overlaying geological map with slope index map in ArcGIS 9.3. In the final stage, potential erosion risk map was generated by overlaying soil protection map with erodibility map. Results indicate that 74.18 % of the area was subject to very high risk of erosion, while 13,28%, 8.7 %, 3,56% and 0,29% were subject to high, medium, low and very low risk of erosion, respectively in the study area.

Keywords: ICONA, Soil Erosion, Land Use, NDVI

Bertiz Yağış Havzasında Uzaktan Algılama Teknikleri ve ICONA Metodu ile Erozyon Risk Haritasının Belirlenmesi

Özet

Türkiye, uygun olmayan arazi kullanımından kaynaklanan sorunlarla birlikte olumsuz topoğrafik yapı, toprak ve iklim özellikleri nedeniyle dünyada en çok toprak erozyonuna uğrayan ülkelerden biridir. Toprak erozyonu oluşturduğu pek çok olumsuz sonuçların yanında özellikle barajların sediment ile dolmasına ve ekonomik ömürlerini öngörülenden daha kısa sürede tamamlamalarına neden olmaktadır. Bu nedenle, araştırma Kahramanmaraş iline 21 km uzaklıkta bulunan ve Menzelet Barajına sediment taşıyan Bertiz Deresi Yağış havzasında gerçekleştirilmiştir. Uzaktan Algılama Teknikleri Ve ICONA Sınıflandırması Kullanılarak Erozyon Risk Haritasının Oluşturulması amaçlanmıştır. ICONA yöntemiyle erozyon risk haritasını belirlemek amacıyla güncel arazi kullanım durumu haritası ile bitki örtüsü haritası ArcGIS 9.3 ortamında çakıştırılmış ve toprak koruma haritası oluşturulmuş. Jeoloji haritası ile eğim haritası ArcGIS 9.3 ortamında çakıştırılarak erodibilite haritası oluşturulmuştur. En son aşamada, toprak koruma haritası ile erodibilite haritası çakıştırılarak potansiyel erozyon risk haritası oluşturulmuştur. Elde edilen verilere göre, Bertiz Deresi Yağış havzasındaki alanın %74.18' i çok şiddetli, %13.28' i şiddetli, %8.7' si orta, %3.56' sı düşük ve %0.29'u çok düşük erozyon riski taşıdığı görülmüştür.

Anahtar Kelimeler: ICONA, Toprak Erozyonu, Arazi Kullanımı, NDVI

Introduction

Erosion is accelerated by soil weathering and transportation due to humankind activities damaging vegetation cover and retaining soil that is the most important component of natural balance (Balci, 1996). Soil amount transported by erosion depends on vegetation, topographic properties, climate parameters and soil properties. Human activities and large scale infrastructures investments intensify erosion by changing vegetation (Jinren and Yingkui, 2003).

Erosion, as experienced in some region of the World, is one of the most important ecological problems to threaten natural resources in Turkey too. According to sediment measures performed in 26 large watersheds, sediment amount transported to sea and lakes is about 50 billion ton per year (Dogan et al., 2000). Sedimentation leads to great damages in particularly catchments. There is a strong relationship between economic life of a dam and soil erosion. Therefore, erosion is one of the natural factors which plays important role in

planning phase of any dam project. Vegetation, fauna, sedimentation and dam life are also influenced by erosion. So, erosion must be considered when analyzing valuable area (Sahin and Kurum, 2002). For these reasons, areas that are exposed to erosion must be determined, and proper protection measures must be taken (Mitra et al., 1998).

Determining areas susceptible to erosion by producing erosion risk map provides important information that can be used in developing environmental policies. Sensitive areas are detected with the help of erosion risk maps and, the importance of forests in erosion control and combating desertification is clearly revealed (Fernandez and Nunez, 2011). Soil erosion risk and prognosis maps are often used in action plan with regard to soil protection. Especially in Europe, demand for these maps quickly increase in concept of water frame directive. Soil erosion risk and prognosis map are generally produced by using models (Prasuhn et al., 2013).

Various methods such as RUSLE, EPIC, ANSWERS, CORINE, ICONA, WEPP, GEOWEPP, CREAMS, MOSES, GLEAMS, WATEM/SEDEM, AGNPS, EGEM, EUROSEM, SWAT, KINEROS have been developed to determine soil loss amount, actual or potential erosion risk, sediment yield and runoff. Each model has typical parameters. In countries where erosion is one of the great problems, necessary data used in some erosion models are usually insufficient and obtaining data needed is a costly and time-consuming process. Therefore, data preparation for any models is vital. In this context, ICONA method enables to evaluate erosion risk in large areas (Sahin and Kurum, 2002).

In Kahramanmaras region whose climate type is between semi-arid and semi-humid, determining amount, severity and location of erosion causing land degradation and sedimentation is very important in terms of operations will be performed for preventing desertification and conserving economic life of dams in the region. For this reason, erosion risk map of Bertiz Stream Watershed located in Kahramanmaras city of Mediterranean Region of Turkey was

produced by using ICONA method in this study.

Material and method

Study area

Study area is 21 km away from Kahramanmaras in Eastern Mediterranean Region of Turkey. The study area covers forest, agricultural areas and rangelands of Ahir Mountain. The watershed is located within $37^{\circ} 49' 43'' - 37^{\circ} 38' 07''$ north latitude and $36^{\circ} 56' 25'' - 37^{\circ} 14' 56''$ east longitude (Figure 1). Elevation ranges from 600 m to 2814m. Bertiz Stream Watershed conveys water and sediment to Menzelet Dam. Total area of the watershed is about 31150 ha. Study area has semi-humid climate type according to Thorntwaite and Erinc formulas, while it has arid climate according to Erinc formula revised by Kantarcı. Study area comprises of brown forest soil, red brown forest soil and colluvial soil.

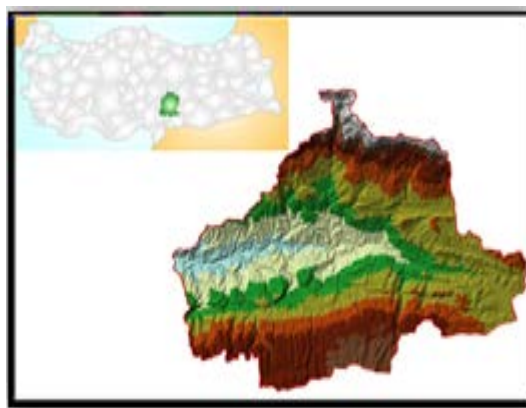

Figure 1. Digital elevation model and location of the study area

Method

ICONA method

Generating erosion risk map by using ICONA method consists of 7 phases (Figure 2). Each phase includes a map production process necessary for the method. So, 7 maps are created in total. These maps are geology, slope, land use, vegetation density, soil erodibility generated by overlaying geology map with slope map, soil protection generated by overlaying land use with vegetation density and, finally erosion risk map produced by overlaying soil erodibility map with soil protection map. All these maps were generated by using geographic

information systems and remote sensing technologies.

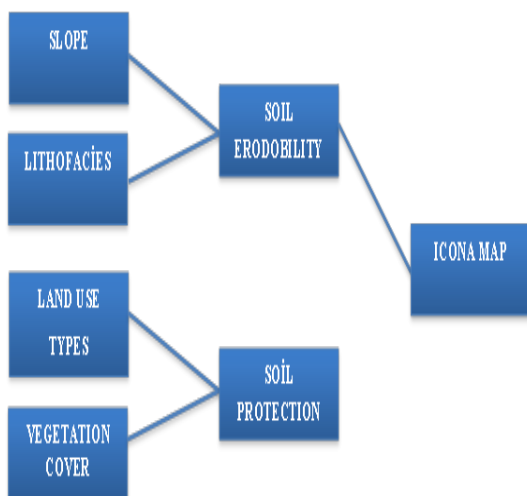

Figure 2. ICONA flow diagram (ICONA 1997)

In order to generate these map, 1/25000 scale topographic map taken from Regional Directorate of Forestry, 1/500000 scale parent material map provided from General Directorate of Mineral Research Exploration and Landsat TM satellite imagery (August 2009 dated) were used as raw data (Table 1).

Table 1. Data type, data source and produced data used in the study

Data type	Data source	Produced data
Topographic map (Scale: 1/25.000)	Regional Directorate of Forestry	Slope map
Parent material map (Scale: 1/500.000, raster format)	General Directorate of Mineral Research Exploration	Geology map
Landsat TM Satellite image (Date:August 2009)	USGS(General Directorate of Mineral Research Exploration)	Vegetation density and land use maps

Results and Discussion

In this study potential soil erosion risk maps were determined using ICONA method by gathering required data (geology, slope, land use, and vegetation density).

A great part of study area comprises sandstone bedrock (Figure 3). 29.2% and 7.0% of study area comprise limestone and conglomerate respectively (Table 2).

Table 2. Distribution of bedrock in study area

Bedrock	Area	Percent (%)
Sandstone	19876	63.8
Conglomerate	2192	7.0
Limestone	9085	29.2
TOTAL	31153	100

These 3 bedrocks are among the sedimentary rock in terms of their origin. Bayramin at al. (2003) reported that bedrocks abovementioned were susceptible to erosion.

Balcı (1973) stated that soil developed on conglomerate had higher erodibility compared to soil developed on sandstone. Bedrock influences not only soil productivity and pedogenesis but also soil erodibility (Sanroque et al., 1990; Chevigny et al., 2014). Therefore, study area has property intensifier to erosion in terms of geological formation.

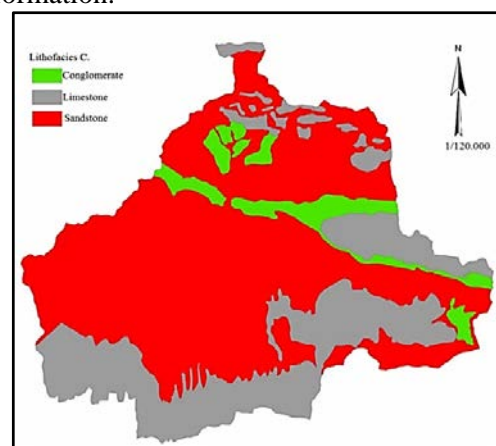

Figure 3. Geology map of study area

Steep, very steep and extreme slope classes constitute 84.47% of the study area (Figure 4, Table 3). This situation is attracted attention as an important factor increasing erosion risk in study area. Previous studies revealed that erosion increases along with increasing gradient.

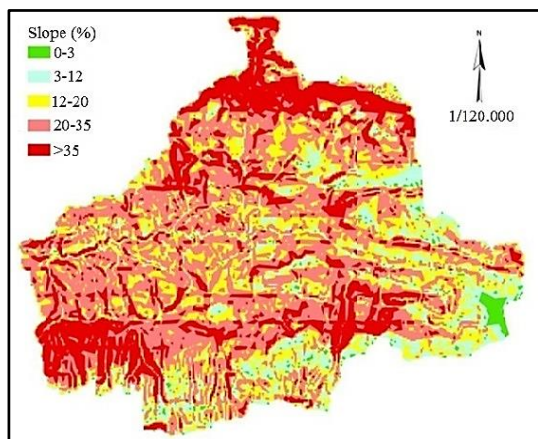

Figure 4. Slope map of study area

Balcı and Okten (1987) indicated that increase in slope from 5% to 10% and 15%, increase erosion 3 and 5 times, respectively. Slope is an essential factor determining relationship between runoff and soil loss. Various researchers determined that erosion increases with slope under the same condition. Under the same condition, as the slope gets steeper, erosion increases due to the higher overland flow velocity (Ekinçi, 2006).

Table 3. Distribution of slope classes in study area

Slope Classes	Area (ha)	Percent(%)
Flat and gentle	421	1.35
Moderate	4416	14.18
Steep	7053	22.64
Very Steep	12549	40.28
Extreme	6714	21.55
TOTAL	31153	100

A soil erodibility map generated by overlaying geology map with slope map was illustrated in figure 5 below. When the map was evaluated, 66.5% of study area has high and extreme risk of erodibility (table 4).

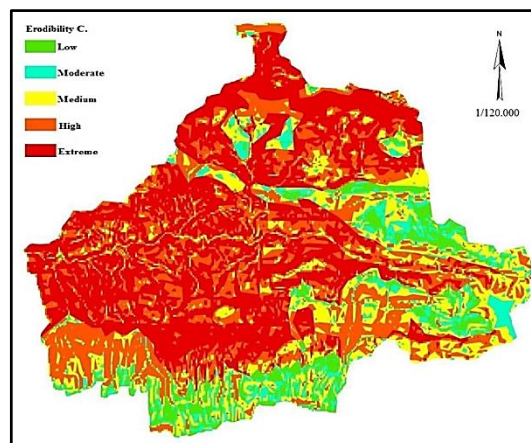

Figure 5. Erodibility map of study area

Table 4. Erodibility classes distribution of study area

Erodibility Classes	Area (Ha)	Percent (%)
Low	1850	5.9
Moderate	2435	7.8
Medium	6148	19.7
High	7874	25.3
Extreme	12846	41.2
Total	31153	100

Study area comprises of 41.95 % forest, 23.66% rangeland, 33.98% dry farming and % 0.41 irrigated farming (Figure 6).

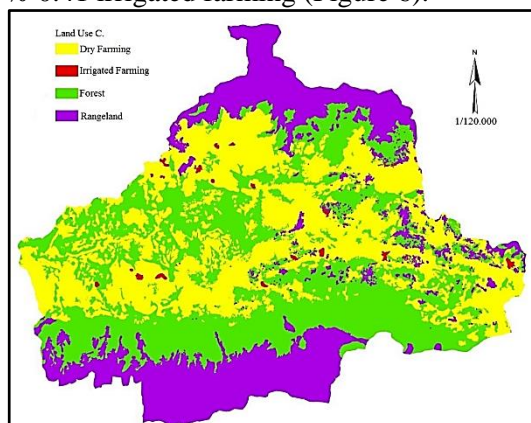

Figure 6. Land use map of study area

Karagul (1994) investigated soil erodibility under different land use, and concluded that land use had impact on erosion. Land use types are among the factors affecting soil loss in watershed. Differences in land use types influence both erosive effect of rainfall and runoff (Okatan et al. 2007; Yuksel et al. 2008).

Vegetation density was low (<25%) in the large part of study area (Figure 7, Table 5).

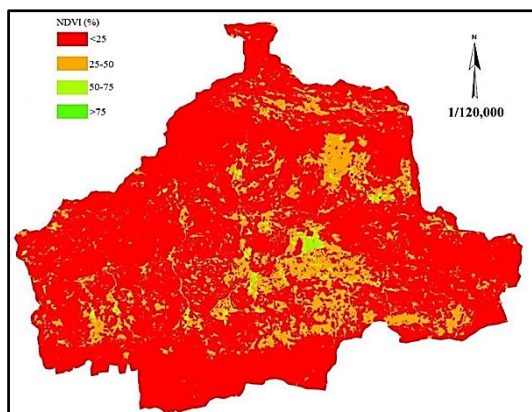

Figure 7. Vegetation density map of study area

This situation causes that soil is exposed to erosive effect of rainfall, and transported easily. Vegetation prevents that raindrop crashes soil particle, so devastates surface soil (Dogan et al., 1976; Dekui Niu, 2003). In area covered by dense vegetation, part of rainfall is intercepted by branches and leaves of plants, and some raindrop can't reach to soil (Ekinci, 2006). Low vegetation density in study area causes to decrease interception, thus this situation increases runoff. Besides, low vegetation density means fewer roots strengthening soil stabilization in soil (Xu et al., 2012).

Table 5. Vegetation density distribution in study area

Vegetation density	Area (ha)	Percent (%)
<25%	24542	78
25-50%	6093	20
50-75 %	491	2
>75%	27	0
Total	31153	100

Soil protection map produced by overlaying land use map with vegetation density map in arcGIS 10.0 was shown in figure 8.

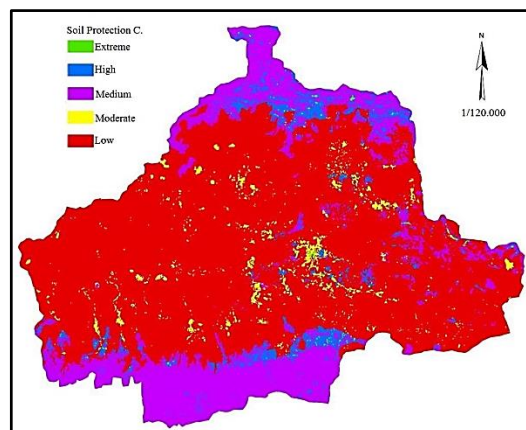

Figure 8. Soil protection map of study area

74.5% of study area had low soil protection in terms of soil protection. Soil protection class was high and extreme in 3.23% of study area only (Table 6).

Table 6. Distribution of Soil protection classes study area

Soil Protection Classes	Alan (Ha)	Oran (%)
Low	23210	74.50
Moderate	564	1.81
Medium	6373	20.46
High	973	3.12
Extreme	33	0.11
Total	31153	100

ICONA risk map was produced by overlaying erodibility map with soil protection map (figure 9).

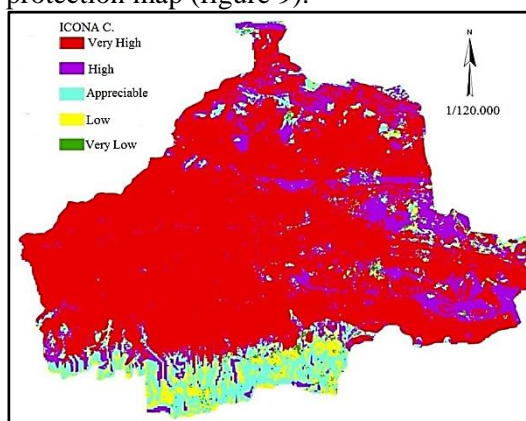

Figure 9. Erosion risk map of study area

According to erosion risk map (Figure 9) on which common effects of factors abovementioned can be observed, it was determined that 74.18% of study area was subject to very high risk of erosion (Table 5).

Table 7. Distribution of erosion risk classes in study area

Erosion risk	Area (ha)	Percent (%)
Very High	23109	74.18
High	4136	13.28
Medium	2709	8.70
Low	1109	3.56
Very Low	90	0.29
TOTAL	31153	100

Results

It was determined that erosion risk in the study area was very high according to potential erosion risk map generated by using GIS and remote sensing technologies. This result was not surprising when status and effects of geology, slope, land use and vegetation density factors in the watershed were considered. Because soils susceptible to erosion, areas with extreme slope and low vegetation density covers great part of the watershed. Terrestrial structure of Mediterranean ecosystems has been exposed to long and intensive interaction between nature and human activities. In the result of this interaction, soil one of the essential components in ecosystem has been extremely damaged (Priority actions programme regional activity center split, 1997; Bermudez et al., 1998). When land use types were investigated, forest has the largest area in study area but unfortunately forest areas have sparse vegetation. Ouyang et al. (2010) reported that vegetation had an important impact on erosion and sediment yield. In another study showed that soil loss in dense forest area which has very high NDVI values was fewer compared to non-forested land (Parsakhoo et al., 2014). However, conservative effects of forest decreased because of large areas with very steep slope and soil susceptible to erosion, so erosion risk increased in study area. If no required measures will be taken in the watershed, it will be inevitable that watershed will lose soils in near future. Therefore, soil protection measures must be immediately taken to prevent erosion in the watershed.

References

- Balcı, A.N., 1973. Influence of parent material and slope exposure on properties of soils related to erodibility in North-Central Anatolia. Istanbul University Publication No.: 44, Faculty of Forestry Publication No.:195.
- Balcı N., Ökten, Y., 1987. Sel Kontrolü, KTÜ Basımevi, Trabzon.
- Bayramın, Ü., Dengiz, O., Başkan, O., Parlak, M., 2003. "Soil erosion assessment with Icona Model Case Study: Beypazarı Area." Volume: 27, Number: 2, 105-116. T.BÜTAK.
- Bermudez, F. L., Diaz, A. R., Fernandez, J. M. and Fernandez, J. M., 1998. Vegetation and Soil Erosion Under A Semi-Arid Mediterranean Climate: A Case Study From Murcia (Spain). *Geomorphology* 24: 51- 58.
- Chevigny E., Quiquerez A., Petit C., Curmi P. 2014. Lithology, landscape structure and management practice changes: Keyfactors patterning vineyard soil erosion at metre-scale spatial resolution. *Catena* 121 354–364
- Doğan, O., Güçer, Ç., 1976. Su Erozyonunun Oluşum Nedenleri Ve Ünlversal Denklem İle Toprak Kayıplarının Saptanması. T.C. Köy İşleri Bakanlığı Yayın No: 41, Ankara.
- Doğan, O., Küçükçakar, N., Özel, M. E. and Yıldırım, H., 2000. Erosion Risk Mapping of Dalaman Basin Located in West Mediterranean Region Using Corine Method. In International Symposium on Desertification, Konya, Turkey.
- Dekui NIU, H.W., Lifang L., 2003. Cause of soil erosion (Erişim Tarihi 23.07.13) <http://159.226.205.16/curriculum/3w/01/cause/index.html>
- Ekinci, D., 2006. CBS Tabanlı Uyarlanmış RUSLE Yöntemi ile Kozlu Deresi Havzasında Erozyon Analizi, *Türk Coğrafya Dergisi*, 13, s. 109-113, İstanbul.
- Fernandez, L.M., Nunez, M.M., 2011. An empirical approach to estimate soil erosion risk in Spain. *Science of the Total Environment*, 409: 3114–3123.
- ICONA, 1997. For Mapping And Measurement Of Rainfall-İnduced Erosion Processes In The Mediterranean Coastal Areas Priority Actions Programme Regional Activity Centre Split.
- Jinren RN, Yingkui KL (2003) Approach to soil erosion assessment in terms of land-use structure changes. *J Soil Water Conserv* 58: 158–169
- Karagül, R., 1994. Trabzon Söğütlüdere Havzasında Farklı Arazi Kullanım Şartları Altındaki Toprakların Bazı Özellikleri ile Erozyon Eğiliminin Araştırılması. Doktora Tezi. Karadeniz Teknik Üniversitesi Orman Fakültesi. 165s Trabzon.

Mitra, B., Scott, H.D., Dixon J.C., Mckimmey J.M., 1998. Applications of fuzzy logic to the prediction of soil erosion in a large watershed. *Geoderma* 86: 183-209.

MTA, 2000. K.Maraş İli Sayısal Jeoloji Haritaları, Maden Tetkik ve Arama Genel Müdürlüğü, Ankara.

Okatan, A., Aydın, M., Urhan, O.G., 2007. Coğrafi Bilgi Sistemlerinin Havza Amenajmanında Kullanımı Ve Önemi. TMMOB Harita ve Kadastro Mühendisleri Odası Ulusal Coğrafi Bilgi Sistemleri Kongresi 30 Ekim -02 Kasım 2007, KTÜ, Trabzon.

Ouyang, W., Hao, F., Skidmore, A. K., and Toxopeus, A. G., 2010. Soil erosion and sediment yield and their relationships with vegetation cover in upper stream of the Yellow River. *Science of the Total Environment*, Vol. 409, pp. 396-403.

Parsakhoo, A., Lotfalian, M., Kavıan, A. and Hosseini, S. A., 2014. Prediction of the soil erosion in a forest and sediment yield from road network through GIS and SEDMODL. *International Journal of Sediment Research* 29: 118-125.

Prasuhn, V., Liniger H., Gisler, S., Herweg, K., Candinas, A. and Clément, J. P., 2013. A high-resolution soil erosion risk map of Switzerland as strategic policy support system. *Land use policy* 32: 281-291.

Priority actions programme regional activity centre split, 1997. Guidelines for for mapping and measurement of rainfall-induced erosion processes in the Mediterranean coastal areas. *Mediterranean Action Plan*.

Sanroque, P., Rubio, L., Izquierdo, L., 1990. Relationship among erodibility, parent material and soil type in areas of the Valencia province (Spain). *Soil Technology* 3 (4), 373-384.

Şahin, Ş. and Kurum, E., 2002. Erosion Risk Analysis By GIS In Environmental Impact Assessments: A Case Study: Seyhan Köprü Dam construction. *Journal of Environmental Management* 66: 239-247.

Xu, L., Xu, X. and Meng, X., 2012. Risk assessment of soil erosion in different rainfall scenarios by RUSLE model coupled with Information Diffusion Model: A case study of Bohai Rim, China. *Catena* 100: 74-82.

Yuksel, A., Gündoğan, R., Akay, E.A., 2008. Using the Remote Sensing and GIS Technology for Erosion Risk Mapping of Kartalkaya Dam Watershed in Kahramanmaraş, Turkey-Sensors 8, s.4851-4865; Switzerland.

Effects of River Type Hydropower Plants on Water Quality in Solaklı Watershed

*Necla KORALAY¹, Ömer KARA¹, Uğur KEZİK¹

¹Karadeniz Technical University, Faculty of Forestry, Trabzon / TURKEY

*Corresponding Author: nkoralay@ktu.edu.tr

Abstract

In recent years, Turkey has turned its attention to alternative energy sources rather than fossil fuels. The Black Sea Region (EBSR) of Turkey has steep mountains and hilly topography. On account of this, EBSR has high potential in terms of energy production with river type hydropower plants (HEPP). In this study, the effects of two river type hydropower plants (Arca and Camlıkaya HEPPs) on some water quality parameters were examined in Solaklı watershed. This research was conducted for 12 months (January - December 2014). Totally 12 sampling points were selected and some water quality parameters such as temperature (T, °C), pH, dissolved oxygen (DO, ppm) and total suspended solids (TSS, ppm) parameters were measured at the each point.

Our results suggest that HEPPs negatively effect on water quality and quantity in the main stream in both operational and constructional phase. Statistically, significant changes were occurred in water quality parameters such as TSS, pH and temperature. It was concluded that these negative changes were caused by the sand mine in construction phase of HEPPs. Furthermore, aquatic ecosystems and riparian zone may negatively affected by reduction of the amount of water released into the river during the operational phase of HEPPs.

Keywords: Water Quality, River Type Hydropower Plants, Watershed management

Solaklı Havzasında Nehir Tipi Hidroelektrik Santrallerin Su Kalitesine Etkileri

Özet

Ülkemizde son yıllarda, fosil yakıtlar dışında alternatif enerji kaynaklarından faydalanma yoluna gidilmektedir. Doğu Karadeniz bölgesi, dağlık ve engebeli bir yapıya sahip olduğundan, bu bölgenin nehir tipi hidroelektrik santralleri (NHES) ile enerji üretme potansiyeli yüksektir. Bu çalışmada, Solaklı deresi havzasındaki nehir tipi HES'lerin (Arca HES ve Camlıkaya HES) bazı su kalite parametreleri üzerine etkisi incelendi. Araştırma Ocak 2014 - Aralık 2014 tarihleri arasında 12 ay süreyle yürütüldü. Toplam 12 örnekleme noktası seçildi. Örnekleme noktalarında; sıcaklık (°C), pH, çözülmüş oksijen (ppm) ve askıda katı madde (AKM, ppm), parametreleri ölçüldü.

Sonuç olarak NHES'lerin işletme ve inşaat aşamasında ana dereadaki suyun kalite ve miktarını olumsuz yönde etkilediği gözlemlendi. AKM, pH ve sıcaklık gibi suyun kalite parametrelerinde istatistiki olarak anlamlı değişimler meydana geldi. Bu olumsuz değişimlere, inşaat aşamasındaki kum ocağından dereye bırakılan atık ve sedimentli suyun büyük etkisi olduğu sonucuna varıldı. İşletme aşamasında ise dereye bırakılan suyun miktarının azalmasıyla birlikte sulcul ekosistem ve su kenarı yaşam alanları olumsuz etkilenecektir.

Anahtar Kelimeler: Su Kalitesi, Nehir Tipi Hidroelektrik Santraller, Havza Amenajman

Introduction

Turkey's population is rapidly increasing day by day. That high population growth rate in Turkey is an important parameter in the sharing of electricity consumption. Turkey's population is thought to be 100 million in 2030. The energy deficit will occur because of considering the increase electricity consumption with population growth in the future. Turkey has revealed the necessity of the full assessment of hydropower capacity

which can be economically operated owing to increasing dependence on foreign sources of electricity generation. One of the referenced solution to close this energy deficit is the construction of river type hydropower plants which are established on streams. These structures produce energy by utilizing the energy of the water and are known as a renewable energy source. However, installation and operation of these plants occur in nature which has terrestrial

and aquatic ecosystems inhabited by living wild animal. Thus, assessing effects of HEPP on environmental especially on wetland ecosystems are the most important. One of the studies about it is investigated the effects of the river type hydropower plant on water quality. Hydroelectric power plants give some damage to the area which was built during the construction phase such as disrupt the terrain, changing the soil and vegetation, once significantly changing the quality of water due to construction materials as well as concrete, cement, oil etc. Consequently, forms of land use, residential areas, industrialization and built hydropower plants on rivers have a significant impact on water quality. Hydroelectric power plants which are located in different places also has a significant impact on the quality of water.

Total 36 River Type HEPPs are planned to make in Solaklı watershed stream which is our research area. One of this river type HEPP is in the preliminary investigation stage, 14 of them are in the planning stages, ten of them are stage of the Project, 7 of them are the construction stage and 4 of them are operating stage (DSI, 2013). Solaklı Watershed stream is the most important area because of recreation, tourism, wildlife, fish fauna, biodiversity and the ecological aspect (Terzioğlu 1998; TUBITAK, 2009; URL1, 2014). Furthermore, Solaklı stream which is planned to make on most construction river type hydropower plants in Turkey is significant river.

The purpose of this study determine the effects of river type hydroelectric power

organisms such as trees, insect, human or plants which are built on the main stream in different places (in the downstream and upstream) on water quality. Hence, this effects of type of hydroelectric power plant on water physical and chemical properties such as pH, temperature, dissolved oxygen or suspended solids were examined for 12 months.

Materials and Methods

Study Site

Study area whose name is Solaklı Watershed is founded in Trabzon which is founded the Eastern Black Sea region in Turkey. The Solaklı watershed consists of topographic maps Trabzon G44-H44. The total area of solaklı watershed is 758.822 km² (Figure 1). The actual land use ratio in watershed: forest 70%, agriculture 17%, pasture 11%, residential area 2% are covered seriatim. The total forest area of Solaklı Watershed consists of broad-leaved forest 16.98%, coniferous forest 27.65% and mixed forest 54.90% (Koralay, 2015). Solaklı watershed has Alluvial Soils, Red-Yellow Podzolic Soils, Grey-Brown Podzolic Soils, Brown Forest Soils, High Mountain-Meadow Lands and Colluvial soil (GDSW, 1981). Generally, Trabzon has mild maritime climate type (Ayaz, 2009). Furthermore, according to thornthwaite method, Solaklı watershed has "Damp, medium temperature (mesothermal), with little or no water deficiency and ocean (sea) climate type" (Koralay, 2015).



Figure 1. Satellite image of the study area (Google Maps, 2016).

Sampling method

We selected two HEPPs, Camlıkaya HEPP which is established upstream and Arca HEPP which is established downstream. We selected 12 points taking into account the location of the HEPP, structure of HEPP, land use of watershed,

residential areas and other environmental conditions. Furthermore, names of the points are respectively C1, C2, C3, C4, C5, C6 which Camlıkaya HEPP has and A1, A2, A3, A4, A5, A6 which Arca HEPP has (Figure 2-3).

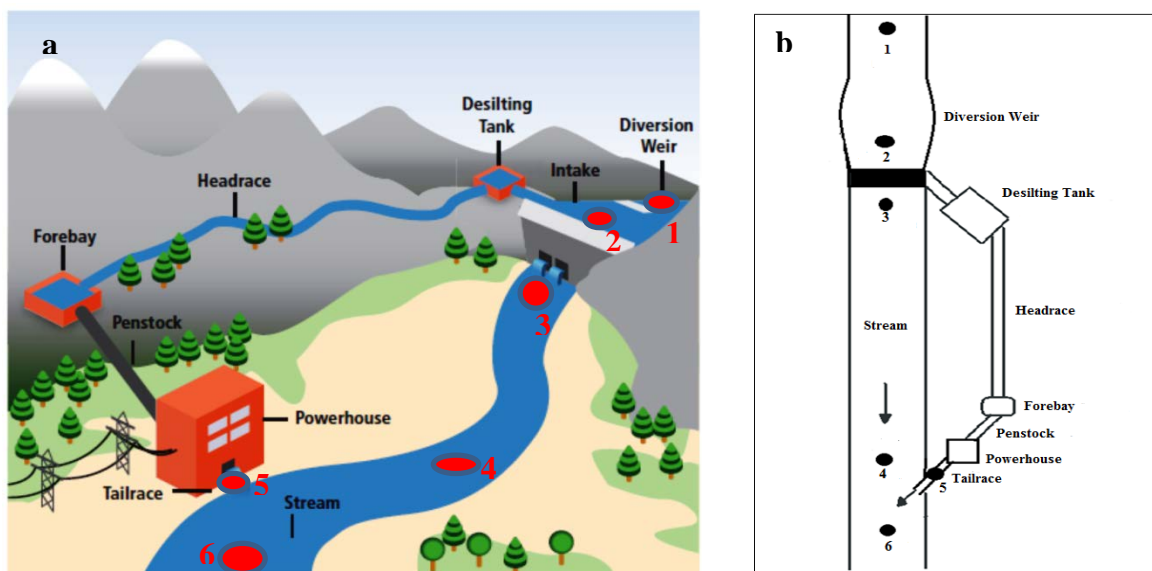

Figure 2. Sample points of HEPPs: a) Spatial view of the hydropower plants
b) Cross-section of the hydropower plants

The study was conducted between 2014 January-2014 December for a year and the measurements were performed in the middle of each month. We measured indicator water quality parameters such as temperature ($^{\circ}\text{C}$), pH, dissolved oxygen (ppm), TSS (ppm) via YSI profesyonel plus device in the field, directly. The data obtained from the survey results were evaluated according to Classes of Water Resources in the Water Pollution Control Regulation in Water Quality Criteria (WPCR, 2004)

Laboratory analysis

Water samples were taken in the middle of each month for doing TSS analysis. We used plastic bottles when the water samples were taken. After water samples were taken, TSS analysis was made in the laboratory within the shortest time. Different methods have been used for determining the amount of suspended solid such as not only spectrometry method (Parsons et al., 1984) but also gravimetric method which are the most common method for direct

measurement and empirical methods that is the indirect method (Ülke et al., 2011). That study was used a direct measurement with gravimetric method (EPA, 1989). In addition to that we used Whatman No. 42 filter papers for the determination of suspended solids.

Statistical analysis

The statistical analysis of the data obtained was used SPSS software 15.00. The Simple Paired t test was used to determine whether the difference in the water quality characteristics and Pearson correlation analysis was used to find the correlation between variables (Table 3-4).

Results

The temperature values of Arca HEPP and Camlıkaya HEPP ranged from 6.3 to 24.4 $^{\circ}\text{C}$ and 2.5 to 21.5 $^{\circ}\text{C}$, respectively. The pH values of Arca HEPP and Camlıkaya HEPP ranged from 8 to 9.12 and 7.55 to 9.68, respectively. The lowest dissolved oxygen value was found to be 5.8 ppm and the highest dissolved oxygen was found to be

14.1 ppm in Arca HEPP. The lowest dissolved oxygen value was found to be 5.5 ppm and the highest dissolved oxygen was found to be 14.1 ppm in Camlıkaya HEPP.

The Suspended Solid values ranged from 10 to 440 ppm in Arca HEPP. The lowest Suspended Solid value was found to be 10 to 350 ppm in Camlıkaya HEPP (Table 1-2).

Table1. Characterization of water quality parameteres of the Arca HEPP's sample points

Water Parameters	Months												
	I	II	III	IV	V	VI	VII	VIII	IX	X	XI	XII	
T (°C)	min	6.3	7.7	6.5	6.5	15.5	16.8	19.8	22.5	17.3	11.1	10.3	9.2
	max	6.9	9.1	10	14.8	17.3	19.4	20.3	24.4	18	13.4	11	10.5
	mean	6.6	8.37	7.77	12.22	15.9	18.15	19.95	23.45	17.71	11.8	10.57	9.52
pH	min	8.75	8.7	8.69	8	8.24	8.29	8.3	8.45	8.03	8.27	8.38	8.13
	max	9.12	8.9	8.85	8.84	8.72	8.87	8.75	8.81	8.9	8.4	8.65	8.35
	mean	8.9	8.81	8.76	8.6	8.38	8.62	8.47	8.61	8.24	8.35	8.47	8.25
TSS (ppm)	min	70	40	80	100	10	20	10	10	210	60	40	50
	max	150	200	160	280	60	100	70	90	440	130	210	130
	mean	128.3	133.3	120.0	205.0	41.6	56.0	31.7	56.7	315.0	85.0	90.0	90.0
DO (ppm)	min	13.2	10.5	7.9	5.8	9.3	9.2	8.1	6.4	7.8	9.2	9.6	8.7
	max	14.1	11	9	7.5	10	9.9	9.7	6.9	8.5	9.8	10.1	9.6
	mean	13.4	10.8	8.63	6.77	9.55	9.5	8.75	6.65	8.08	9.4	9.8	9.23

Table 2. Characterization of water quality parameteres of the Camlıkaya HEPP's sample points

Water Parameters	Months												
	I	II	III	IV	V	VI	VII	VIII	IX	X	XI	XII	
T (°C)	min	2.5	4.2	2.8	7.6	12.6	11	15.4	17.8	14.9	7.8	6.8	5.9
	max	3.2	4.6	4.5	9.3	13.5	14.4	18.1	21.5	15.2	8.7	7	7
	mean	2.9	4.5	3.62	8.6	13	12.7	17.25	19.15	15.1	8.08	7.25	6.2
pH	min	8.77	8.62	8.3	8.16	8.06	8.1	7.95	7.86	7.75	8.22	7.55	7.6
	max	9.04	9.22	8.95	8.51	8.81	8.26	8.32	9.02	8.24	9.68	8.59	8.22
	mean	8.85	8.8	8.52	8.35	8.31	8.22	8.11	8.36	8.04	8.7	7.97	7.97
TSS (ppm)	min	10	160	140	200	40	50	10	50	20	40	90	80
	max	100	220	180	250	350	170	120	110	140	90	270	160
	mean	58.3	187	162	230	123.3	90	31.66	78.33	93.3	76.7	143.3	136.7
DO (ppm)	min	13	10.6	9.1	5.5	9.3	9.6	7.9	6.2	6.8	8.7	9.3	9.1
	max	13.7	12	9.5	7.7	9.7	10.9	8.8	6.9	7.4	9.5	9.9	9.7
	mean	13.43	11.4	9.32	6.7	9.55	10.22	8.42	6.5	7.15	9.13	9.52	9.4

Discussion

Temperature

When examined measurements which were made during 12 months, water temperature values especially not only increased in May when the trout juvenile newly hatched but also exceeded temperature values for the survival of trout juvenile and the temperature was found 17.3 °C at the A4 point that is the second point of Arca HEPP minimum discharge, particularly. In addition to this, water temperature values approached upper level of acceptable limits for the survival of trout juvenile at the C3 and C4 points, which are the minimum discharge

points of Camlıkaya HEPP, in May. The reason of this, either the stream's flow rate may be reduced because of not supplied with enough water in the minimum discharge section of river type hydroelectric power plants or the water temperature may be increased owing to the change in the hydrological regime (Jackson, 2006). The amount of suspended solid also increased that section. The water temperature may be increased due to amount of suspended solid (MacDonald et al., 1991). Aksungur et al., (2007), suggest that water temperature values of downstream approached upper level of acceptable limits for the survival of trout in

July and August thanks to built HEPP. Furthermore, they stressed in the same study that fish population was quite impoverished because of built HEPPs which were established İyidere and Solaklı streams.

pH

According to statistical analysis, when C1 point of Camlıkaya HEPP was taken into account as control point, statistically significant differences was only detected between C1 and C4 points. Similarly, when A1 point of Arca HEPP was taken into account as control point, statistically significant differences was only detected between A1 and A4 points. The pH values of the C4 and A4 points were greater than the other points. The pH values of the C4 and A4 points which were second points of HEPP's minimum discharge section can be attributed to some reasons such as the decrease of discharge level (Kurunç et al., 2005), geological structure or the high amount of suspended solids occurring due to sand quarry operations and working of rehabilitation in this section. Hauraki (2003) suggested that the pH level of the water in a watershed is significantly determined by not only the soil structure but also geology and the pH depending on the geology generally range from 6.0 to 9.0 in a watershed and the pH level of the water in the region which has the limestone bed is quite higher than the other regions (Hem, 1986). In other words, Volare et al. (2014) revealed that significant differences between the pH values and the points were found out while the HEPPs were been under construction. In addition to that, Volare et al. also added the construction of HEPPs effected the pH level of water in river because of concrete, cement, containing abrasive (calcium hydroxide etc.) as other construction materials that had been used during construction and he stressed that the pH level was affected by the bedrock structures of region.

Dissolved oxygen (ppm)

The lowest dissolved oxygen levels of points which Camlıkaya and Arca HEPPs had were found in August and April. The reasons of low value in August can be based on both the high temperature and the

decrease at the flow level. Furthermore, the reasons of low value in April can be based on rising of flow level due to snow melting in April and the amount of oxygen was decreased owing to this reason (Kurunç, 2005). According to correlation analysis were found out the negative correlation between water temperature and dissolved oxygen. Hem (1986) suggested that the concentration of dissolved oxygen in river in winter is higher than in summer as the cold water can hold more oxygen than hot water. Therefore, the lowest oxygen concentration occurs in summer because of water temperature (Ging and Otero, 2003). When an evaluation according to the water quality control regulations, all points of our study were found in the First Class water quality characteristics in terms of dissolved oxygen values. Volera (2012) found to be high dissolved oxygen values in winter while he found to be low dissolved oxygen values in summer. The dissolved oxygen values reduce as long as both increasing altitude and decreasing the atmospheric pressure according to altitude (Atay and Pulatsü, 2000). According to our study, the dissolved oxygen values in the region which is founded Arca HEPPs that is located in the downstream of watershed is higher than the dissolved oxygen values in the region which is founded Camlıkaya HEPPs that is located in the upstream of watershed.

According to statistical analysis, when C1 point of Camlıkaya HEPP was taken into account as control point, statistically significant differences was only detected between C1 and C4 points. The dissolved oxygen value of the C3 sample point was higher than the other sample points. Similarly, when A1 point of Arca HEPP was taken into account as control point, statistically significant differences was only detected between A1 with A4 and A5 points. The dissolved oxygen values of the A1, A4 and A5 sample points were higher than the other sample points. The reason for the high rise of third sample points in both HEPPs may be due to extreme aeration of water after the water leave from the HEPPs. Birol (2007) founded that the dissolved oxygen level of next sample point on the dam which is under the section of dam is higher than the upper

sample points which are located upper section of dam. In the following points have reported decreasing of dissolved oxygen levels. The reasons for the high dissolved oxygen value of A5 sample point may be due to either decreasing water temperature or the amount of suspended solids which is contamination factor. Although both of reservoir of HEPPs are low dissolved oxygen, there was no significant difference between the control points. Sale et al. (1991) reported that the most important environmental changes related to HEPPs are the reservoir section of hydroelectric power plant that especially contain low oxygen in summer when warm climates have.

According to our study, the dissolved oxygen values in all sample points ranged from 5.50 to 14.10 ppm. The min. dissolved oxygen value in order to maintain the presence of aquatic organisms must be 5 ppm (Atay and Pulatsü, 2000). The values founded are a critical situation for the demands of trout.

Total suspended solids (ppm)

The amount of suspended solids occurred irregular increases and decreases in throughout the year. The lowest suspended solid value was found not only C6 sample point, which is sixth sample point of Camlıkaya HEPP, in February but also C5 and C6, which are respectively fifth and sixth sample points of Camlıkaya HEPP, in July as 10 ppm. On the contrary, the highest suspended solid value was found C4 sample point, which is fourth sample point of Camlıkaya HEPP, as 350 ppm in May. The lowest suspended solid value was found A2 sample point, which is second sample point of Arca HEPP, in May, A2, A3 and A5, which are respectively second, third and fifth sample points of Arca HEPP, in July and A1 and A2, which are respectively first and second sample points of Arca HEPP as 10 ppm. On the contrary, the highest suspended solid value was found A6 sample point, which is sixth sample point of Arca HEPP, as 440 ppm in September. The reason of high value in May in C4 sample point of Camlıkaya HEPP can be based sand quarry activities that are immediately carried out above this point. Similarly, the reasons of

high value in September in A6 sample point of Arca HEPP can be based sand quarry activities that are immediately carried out above this point, rehabilitation works and increasing in the amount of suspended solids due to high rainfall.

According to statistical analysis, when C1 point of Camlıkaya HEPP was taken into account as control point, statistically significant differences was only detected between C1 with C2 and C5 points. The suspended solid values of the C2 and C5 sample points were lowest than the control point and the other sample points. The highest suspended solid value was found C4 sample point. Similarly, when A1 point of Arca HEPP was taken into account as control point, statistically significant differences was only detected between A1 with A2. The highest suspended solid value was found A6 sample point. C2 and A2 points which are hydroelectric reservoir section where the water is collected have less suspended solid value according to the first points which are respectively C1 and A1. Researchs suggested that the suspended solid value in reservoir section of HEPP reduce because of rest of the water (Snouss et al., 2002; Bayram, 2011). However, the suspended solid values increase owing to founded sand quarries and continued construction work in the minimum discharge of stream section that is crucial in terms of the sustainability of stream ecosystem. The amount of suspended solid which after relaxing given back to the river and expected decrease in water are adversely affected with structures such as sand quarries. The reason of the high value at that point can be either founded sand quarries or construction of rehabilitation activities.

The amount of suspended solids which is recommended for optimum conditions for fish range from 30 ppm to 100 ppm (Chang, 2003). The amount of suspended solids for trout species in Turkey must be less than 50 ppm (Atay and Pulatsü, 2000). The suspended solid values in the period when we measured in our study is higher than 50 ppm. The high amounts of suspended solids clog the gills of fish, hamper breathing of fish and removed fish from their habitat (Reynolds et al., 1989). The amount of suspended solid on water increased due to

hydropower construction and sand quarry activities on stream and around stream. The suspended solids in water settle hollow where the trouts swamp and the trout hide to be protected from predators. Hence, The habitat area of the trouts species are restricted.

All in all, according to the data obtained river type hydroelectric power plants are adversely affected water quality parameters such as especially TSS, pH, temperature and quantity when the HEPPs are both operation phase and construction phase. When it is integrated with structures such as sand quarry

in construction phase, the water quality parameters were adversely affected. Furthermore, the amount of water which was given back to stream reduced in operation phase. Therefore, It is inevitable that affected the trout population. The mininum discharge is inadequate for terrestrial and especially aquatic ecosystems. That state will be changed habitats, composition, type and amount of aquatic organisms such as fish, invertebrates. would cause the type and amount of change by affecting the morphology of the river. Thus, it may lead to changes in stream morphology.

Table 3. Correlation analysis of Arca HEPP and Regulator

	T	pH	DO	TSS
T	1			
pH	-0.23	1		
DO	-0.595(**)	0.317(**)	1	
TSS	-0.154	-0.104	-0.124	1

*. Correlation is significant at the 0.05 level (2-tailed),

** . Correlation is significant at the 0.01 level (2-tailed), N = 72

Table 4. Correlation analysis of Camlikaya HEPP and Regulator

	T	pH	DO	TSS
T	1			
pH	-0.325(**)	1		
DO	-0.648(**)	0.385(**)	1	
TSS	-0.322(**)	0.132	-0.142	1

*. Correlation is significant at the 0.05 level (2-tailed),

** . Correlation is significant at the 0.01 level (2-tailed). N = 72

Conclusions

In Turkey, river type hydroelectric power plants (HPP) studies demonstrating the effects on the water quality is very limited. Therefore, effects of the river type hydropower plants in different places which are in downstream and upstream on water quality was investigated in this study.

The amount of mininum discharge should be not only determined by considering the flora and fauna living in the rivers and riparian ecosystem but also regularly checked by the authorities. According to the application of mininum discharge in Turkey is not given enough water which is mininum discharge in the river. Moreover, amountof the mininum discharge also doesn't be correctly controled in Turkey. Each watershed in Turkey has

unique characteristics according to topography, climate, rainfall, soil characteristics or settlements. The amount of water that is necessary for aquatic and terrestrial ecosystem is determined according to any watershed in the application. Then it is applied to the whole watershed. The sufficient amount of water is required to leave the stream to both the sustainability of ecological life and protect natural balance. Therefore, determining the amount of mininum discharge not for a watershed and it should be determined according to the current status of the selected watersheds such as topography, climate, rainfall, settlements, socio-economic structure and the request of aquatic ecosystems. Solaklı watershed stream is an area which prones to landslides. The construction of Hydroelectric power plant

should be carefully done without disturbing the natural balance of the slopes and the possibility of landslides in the hillside should be carefully built road and excavation works. Thus, the necessary measures must be taken as soon as possible.

References

- Atay D. ve Pulatsü S., 2000. Water Pollution and Controls Textbook, pp 292. Ankara University, Faculty of Agriculture, Ankara.
- Ayaz, E., 2009. Monthly and Annual Flow Duration Curve Analysis with Normalization Method in Solaklı Watershed. Master Thesis. Institute of Science and Technology, Istanbul Technical University, Istanbul.
- Bayram, A., 2011. A study on seasonal variation of the stream Harsit water quality and estimation of the suspended sediment concentration using artificial neural networks Institute of Science and Technology, Karadeniz Technical University, Trabzon.
- Birol, N., 2007. Determination of benthic macroinvertebrata of Dipsiz-Çine River. Master Thesis. Institute of Science and Technology, Mugla University, Mugla.
- Chang, M., 2003. Forest Hydrology : An Introduction To Water And Forests, 373.
- DSI, 2013. General Directorate of State Hydraulic Works. Hydroelectric Power Plant Projects List based on Electricity Market Law in the number of 4628. Ankara.
- DSI, 2015. General Directorate of State Hydraulic Works, Soil and Water Resources, Ankara.
- Ging, P.B. ve Otero, C.L., 2003. Comparison of Temperature, Specific Conductance, pH and Dissolved Oxygen at Selected Basic Fixed Sites in south-Central Texas, 1996-98. U.S. Geological Survey Open-File Report, 03-087.
- Grant, C.G.J. ve Lee,E.M., 2004. Life History Characteristics of Freshwater Fishes Occurring in Newfoundland and Labrador, with Major Emphasis on Riverine Habitat Requirements, Canada.
- EPHA, 1989. Standard Methods for the Examination of Water and Wastewater, 20th edition, APHA, AWWA, WEF, 2, 540.
- HDC., 2003. Water Quality Parameters, Chemical and Physical Factors Influencing Water Quality in Rivers and Streams. Hauraki District Council, 38.
- Hem, J.D., 1986. Study and Interpretation of the Chemical Characteristics of Natural Waters. U.S. Geological Survey Water-Supply Paper, 2254.
- Jackson H.M., 2006. The impact of hydroelectric power operations on the invertebrate fauna of the river Lyon, Perthshire, Scotland. Doctor thesis, University of Aberdeen.
- Koralay N., Kara O. ve Kezik U., 2014. Temporal changing of Suspended Solid Matter level in Solaklı Stream. First National Watershed Symposium. Proceedings Book;365-370.Cankiri.
- Koralay N., 2015. Effects of River Type Hydroelectric Power Plants on Water Quality in Solaklı Watershed, Institute of Science and Technology, Karadeniz Technical University, Trabzon.
- Kurunç A.,Yürekli K. ve Öztürk F., 2005. Effect of Discharge Fluctuation on Water Quality Variables from the Yeşilirmak River,Journal of Agricultural Sciences 11:2 (189- 195).
- MacDonald, L.H., Smart, A.W, ve Wissmar, R.C., 1991. Monitoring Guidelines to Evaluate Effects of Forestry Activities on Streams in the Pacific Northwest and Alaska, EPA 910/9-91-001, U.S. Environmental Protection Agency.
- Parsons, T., Maita, Y. ve Lalli, C.M., 1984. Manual of Chemical and Biological Methods for Sea Water Analysis, Pergamon Press, Grait Britain, 173.
- Reynolds, J.B., Simmons, R.C., ve Burkholder, A.R., 1989. Effects of placer mining discharge on health and food of Arctic grayling, *Water Resour. Bull.*, 25, 625-635.
- Sale, M.J., Cada, G.F., Chang, L.H., Christensen, S.W., Railsback, S.F., Francfort, J.E., Rinehart, B.N. ve Sommers, G.L. 1991. Environmental Mitigation at Hydroelectric Projects. Volume 1. Current Practices for Instream Flow Needs, Dissolved Oxygen, and Fish Passage; U.S. Department of Energy: Washington, DC, USA.
- Snoussi M., Haida S. ve İmami S., 2002. Effects of the construction of dams on the water and sediment fluxes of the Moulouya and the Sebou Rivers, Morocco, 5-12.
- Terzioğlu, S., 1998. Flora and Vegetation of Uzungol (Caykara-Trabzon) and Its Environment. PhD thesis 308 pp. Institute of Science and Technology. Karadeniz Technical University, Trabzon.
- GDSW, 1981., Eastern Black Sea Basin Soils,. General Directorate of Soil and Water. Publication number:310.
- TUBITAK, 2009. Determination of Technical Hydropower Potential in Watershed with non-flow Measurement. TUBITAK Research Team Final Report, Istanbul.
- URL1,<http://www.fondriest.com/environmental-measurements/parameters/waterquality/conductivity-salinity-tds/#cond1,19> Şubat 2015.

lke, A., zkul, S., Tayfur, G., 2011. Estimation of Suspended Solids by Empirical Methods for Gediz River. Journal of Chamber of Civil Engineering, 348; 5387-5407.

Valero, E., 2012. Characterization of the Water Quality Status on a Stretch of River L rez around a Small Hydroelectric Power Station, Water, İspanya, 4, 815-834.

Valero, E., Alvarez, X. ve Picos, J., 2014. Influence of a Small Hydroelectric Power Station on the River Ecosystem, European Journal of Sustainable Development, 3, 4, 175-180.

WPCR, 2004. Water Pollution Control Regulations. Ministry of Turkey Forestry and Water Affairs, Ankara.

Comparison of Water Quality Regulation Service of Different Ecosystems

*Betül UYGUR¹, Yusuf SERENGİL¹

¹Istanbul University, Faculty of Forestry, Istanbul/TURKEY

*Corresponding Author: uygurb@istanbul.edu.tr

Abstract

Ecosystem services are the goods and benefits people need and obtain from ecosystems' functions and processes. Additionally, ecosystem services play a crucial role in human well-being by meeting several public demands. The objective of this study was to quantify water quality regulation service of different ecosystems which is one of the most important ecosystem services as we observe a clean water scarcity worldwide. We investigated the effects of land use types on water related ecosystem service in watershed scale. Alibeyköy dam watershed, which is located on the European side of Istanbul was selected as the study area. The watershed was divided into 10 sub-watersheds and land use types in these watersheds were classified into four groups as forests, rangelands, agricultural and urban areas. Their stream waters were sampled for analysis of physical water quality parameters. Coefficients were estimated between land use types and each water quality parameters by using a mathematical equation. Thus, relevant capacity of each land use type was determined by a simple scoring method. Results showed that forest dominated sub-watershed (86 % forested) had the lowest electrical conductivity (460 $\mu\text{S cm}^{-1}$) and total suspended solid particles (0.362 mg l⁻¹) whereas lowest forested sub-watershed (2 % forested) had the highest electrical conductivity (786 $\mu\text{S cm}^{-1}$) and total suspended solid particles (0.914 mg l⁻¹) among the 10 sub-watersheds. pH values varied between 7.14 and 7.74 in all sub-watersheds. These results revealed that forested sub-watersheds have high capacity while urbanized sub-watersheds have low capacity of providing water quality regulation service. In other words, land use types have important impacts on providing ecosystem services. Therefore, water quality management approaches should be evaluated in the context of ecosystems and their services.

Keywords: Ecosystem services, Water quality regulation, Forests, Watersheds

Farklı Ekosistemlerin Sunduğu Su Kalitesini Düzenleme Hizmetinin Karşılaştırılması

Özet

Ekosistem hizmetleri insanların ihtiyaç duyduğu ve ekosistemlerin fonksiyonlarından ve süreçlerinden elde ettikleri ürün ve faydalardır. Bunun yanında, ekosistem hizmetleri kamunun çeşitli taleplerini karşılayarak toplumun refah seviyesi üzerinde önemli bir rol oynamaktadır. Bu çalışmanın amacı, dünya çapında gözlemlendiğimiz temiz su kıtlığı açısından en önemli ekosistem hizmetlerinden biri olan su kalitesini düzenleme hizmetinin niceliğinin farklı ekosistemlerde incelenerek karşılaştırılmasıdır. Arazi kullanım şekillerinin su ile ilgili ekosistem hizmetleri üzerindeki etkileri havza ölçeğinde incelenmiştir. İstanbul'un Avrupa yakasında bulunan Alibeyköy Baraj Havzası çalışma alanı olarak seçilmiştir. Havza 10 alt havzaya ayrılmış ve havzadaki arazi kullanım şekilleri orman, mera, tarım ve kentsel alanlar olmak üzere dört grup olarak sınıflandırılmıştır. Fiziksel su kalitesi parametrelerinin analizi için bu havzaların dere suyu örneklenmiştir. Matematiksel bir denklem kullanılarak arazi kullanım şekilleri ile her bir su kalitesi parametresi arasında katsayılar hesaplanmıştır. Böylece, arazi kullanım şekillerinin ilgili kapasiteleri basit bir puanlama metodu ile belirlenmiştir. Sonuçlar, hakim arazi kullanım şekli orman olan alt havzanın (% 86 ormanlık) düşük elektriki iletkenliğe (460 $\mu\text{S cm}^{-1}$) ve toplam askıda katı madde miktarına (0.362 mg l⁻¹); buna karşılık 10 alt havza içerisindeki en az orman alanına sahip alt havzanın (% 2 ormanlık) daha yüksek elektriki iletkenliğe (786 $\mu\text{S cm}^{-1}$) ve toplam askıda katı madde miktarına (0.914 mg l⁻¹) sahip olduğunu göstermiştir. pH değerleri tüm havzalar için 7.14 ve 7.74 arasında değişmiştir. Sonuçlar kentsel alt havzaların su kalitesini düzenleme hizmetini sağlama kapasitesinin ormanlık alt havzalara göre daha düşük olduğunu göstermiştir. Başka bir ifadeyle, arazi kullanım şekilleri ekosistem hizmetlerinin sağlanmasında önemli etkilere sahiptir. Bu nedenle, su kalitesi yönetim planları ekosistemler ve onların hizmetleri bağlamında değerlendirilmelidir.

Anahtar Kelimeler: Ekosistem hizmetleri, Su kalitesini düzenleme, Ormanlar, Havzalar

Introduction

Ecosystems are complex environments with specific physical living spaces (niches) and function as a consequence of interaction between the living and non-living elements (Çepel, 1983). In other words, ecosystems are the main supporters of human life in the context of providing living spaces, goods, benefits and services. Millennium Ecosystem Assessment (2003) has divided ecosystem services into four groups as supporting (nutrient cycling, soil formation, etc), provisioning (food, water, wood, etc), regulating (climate, flood regulation, etc), and cultural (aesthetic, recreational, spiritual, etc) services. An early definition of the relation between human and ecosystems has been mentioned by Marsh (1864) in *Man and Nature*. And he argued that earth's surface (soil, water, forests, etc.) was effected severely according to human activities. Since the beginning of industrial revolution, alteration and degradation of ecosystems and their functions have been rapid and significant. As a result of this, approximately 60% of ecosystem services have been destroyed or used in unsustainable manner (Millennium Ecosystem Assessment, 2005). Also, a number of studies can be found about anthropogenic impacts on ecosystems, which especially indicate land use change and its effects on ecosystem services (World Resources Institute, 2002; Millennium Ecosystem Assessment, 2003; 2005; Martinez et al., 2009; Wang et al., 2014; Clerici et al., 2014). Among the affected ecosystem services by land use change, one group has become more prominent, which is consisted of water related ecosystem services within the context of clean water scarcity worldwide. Thereby, to support the supply-demand balance, ecosystem service based approaches and management strategies have begun to make sense in the process of conserving biodiversity, ecosystems and services. On the other hand, quantification of ecosystem services has been highlighted in case of integration into management plans (Bingham et al., 1995; Daily et al., 2009; Nelson et al., 2009; Maes et al., 2012; Logsdon and Chaubey, 2013).

The objective of this study was to compare the capacity of different ecosystems for

providing water related ecosystem services. In other words, determining the relationship between land use types and water related ecosystem services in watershed scale was investigated and discussed. The water production services of ecosystems can be further grouped as water yield, quality and regime (Serengil, 2007). For this case, we focused on water quality regulation service. The effects of land use types on water quality regulation service were investigated by quantification of this service in the watershed. Furthermore, this study was implemented to estimate a practical ecosystem services based approach for decision makers to incorporate water quality into management plans.

Material and Method

Material

Alibeyköy dam watershed which is one of three important watersheds on the European side of Istanbul was selected as the study site. It is located between 41° 05' - 41° 16' N latitude and 28° 40' - 28° 40' E longitude (Figure 1). The watershed has 158 km² area and drains into a reservoir that has an area of 4.66 km². Upland of the watershed is covered by forests while lowland is occupied by residential areas and other land use types like rangelands. Average annual precipitation ranges between 800 and 1100 mm. The main parent materials of the region is Neogen Belgrad and Carboniferous formations while andesites and alluvial zones can be seen locally in some parts of watershed (Çokoyoğlu, 2008; Serengil et al., 2012).

This watershed was selected as study area because it provides fresh water to the city for domestic use and it is under the threat of urbanization.

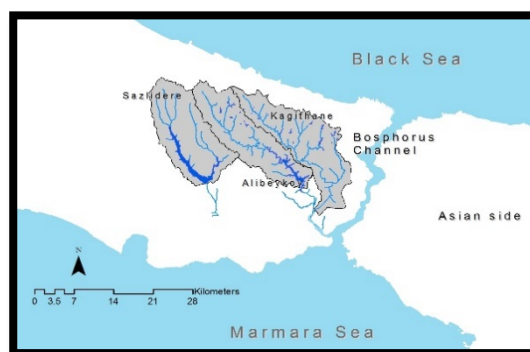

Figure 1. The study watershed

Methods

A total of 10 sub-watersheds were selected in Alibeyköy dam watershed which were located in both up and downstream of the main watershed (Figure 2).

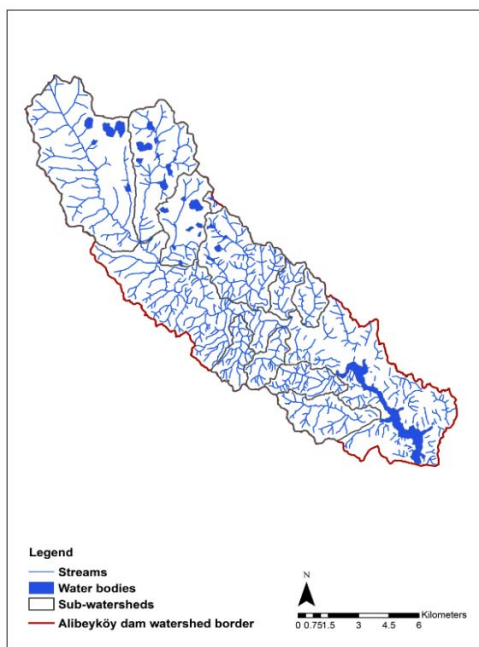

Figure 2. The sub-watersheds selected in Alibeyköy dam watershed

Alibeyköy dam watershed was divided into 10 sub-watersheds based on land use types. ArcGIS was used to determine the sub-watersheds and their land use types. For spatial analysis, land use types were classified in four groups as forest, rangeland, agricultural and urban areas by using CORINE 2006 as base maps (Figure 3).

Estimation of water related ecosystem services depends on ecological characteristics such as water quality parameters. In this study, pH, electrical conductivity ($\mu\text{S cm}^{-1}$), turbidity (NTU), dissolved oxygen (mg l^{-1}) and total suspended solid particles (mg l^{-1}) were selected as physical water quality parameters to analyze and quantify. Except for total suspended solid particles, water quality parameters were analyzed in the field. Stream waters were sampled and analyzed for total suspended solid particles in the laboratory. This was not a monitoring study. Therefore, streams were sampled one time for analyzing the water quality parameters.

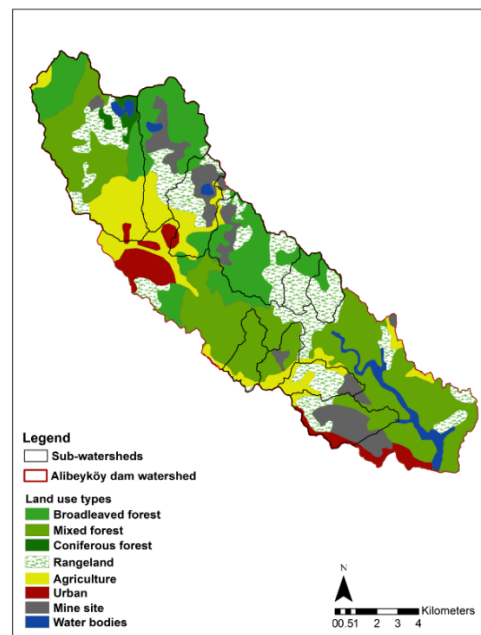

Figure 3. Land use types of the sub-watersheds

Correlations between land use intensities and water quality parameters were investigated and significant relations were determined between them.

Relations between water quality parameters and land use types were determined based upon coefficients by using a mathematical equation. It was implemented as;

$$Y = a * X_1 + b * X_2 + c * X_3 + d * X_4 \quad (1)$$

Where,

X_1 : Forest area as a percentage of sub-watershed (%)

X_2 : Rangeland area as a percentage of sub-watershed (%)

X_3 : Agricultural land area as a percentage of sub-watershed (%)

X_4 : Urban area as a percentage of sub-watershed (%)

a, b, c, and d: Estimated coefficients for water quality parameters

Y: pH, electrical conductivity, turbidity, dissolved oxygen and total suspended solid particles.

Estimated coefficients for water quality parameters were the coefficients for each land use type at the same time. Additionally, that provide a way to change the scale from point to watershed. Also, this model was validated

in other watersheds for the reliability of the coefficients. This model was calibrated in 27 sub-watersheds and validated in other 10. Correlations between estimated and measured values of water quality parameters were statistically significant.

After computing new coefficients of each watershed related to their land use types, water quality parameters were assessed by a simple scoring method, which was aimed to determine the ranges of parameters (Serengil, 2010) (Table 1).

Table 1. Scoring method for water quality parameters (Serengil, 2010)

Water Quality Parameters				
Electrical Conductivity ($\mu\text{S cm}^{-1}$)				
<u>0-250</u>	<u>250-750</u>	<u>750-2000</u>	<u>2000-3000</u>	<u>3000-</u>
0	1	2	3	4
pH				
<u>5.5-7.5</u>	<u>4-5 V</u>	<u>7.5-</u>		
0	1			
Turbidity (NTU)				
<u>0-5</u>	<u>5-10,0</u>	<u>10-15,0</u>	<u>15,0-</u>	
0	1	2	3	
Dissolved Oxygen (mg l^{-1})				
<u>5<</u>	<u>2-5,0</u>	<u>2></u>		
0	1	2		
0	2	4		
Total Suspended Solid Particles (mg l^{-1})				
<u>0-1</u>	<u>1-5,0</u>	<u>5+</u>		
0	1	2		

In all sub-watersheds, each water quality parameter had a score and sum of those scores defined the sub-watersheds' water quality scores. Here, high total scores indicate worse water quality and vice versa.

In order to quantify the water quality regulation service of different land use types, their relevant capacities were revealed by using the data as a basis in the classification

These values were representing measured water quality parameters of sampling points in sub-watersheds. Therefore, as a result of using

So that, after implementing the mathematical equation with these coefficients

which has a scale consisting of: 0 = no relevant capacity, 1 = low relevant capacity, 2 = relevant capacity, 3 = medium relevant capacity, 4 = high relevant capacity and 5 = very relevant capacity (Burkhard, 2012). As a consequence of these computations water quality regulation service was mapped in watershed scale.

Results and Discussion

Size of the sub-watersheds varied between 337.86 and 3176.55 hectares consisting of different land use types such as forest, rangeland, agricultural and urban areas. Some of these sub-watersheds included only one land use type while some included more than one land use types. Thus, proportion of land use types were changed in the sub-watersheds (Table 2).

On the other hand, results of field surveys and laboratory analyses showed that the water quality parameters had different values related to sampling points in sub-watersheds. In other words, values of parameters were changed from site to site depending on land use types (Table 3).

Table 3: Values of selected water quality parameters (*EC*: Electrical Conductivity, *DO*: Dissolved Oxygen, *TSS*: Total Suspended Solid Particles) in sub-watersheds (SW)

Sub-watersheds	pH	EC	Turbidity	DO	TSS
SW-1	7.60	1291	1.78	11.42	0.997
SW-2	7.70	1328	5.81	9.57	0.897
SW-3	7.09	1352	4.78	7.38	1.076
SW-4	7.66	1119	16.10	8.64	0.841
SW-5	6.90	335	11.04	6.23	0.239
SW -6	7.32	1182	12.81	7.54	0.824
SW -7	7.56	1012	20.84	7.69	0.571
SW -8	7.63	1132	7.22	7.89	0.761
SW -9	7.76	922	190.00	7.14	0.771
SW -10	7.90	220	298.90	7.79	1.958

these values as inputs of implemented mathematical equation, the coefficients for both water quality parameters and land use types were estimated.

which was used to link the land use types with these water quality parameters in watershed

scale, the values of selected water quality parameters have changed related to land use types of sub-watersheds as expected (Table 4).

Table 2. Selected sub-watersheds' areas and land use type

Sub-watersheds	Area of land use types as a percentage of sub-watershed area (%)							Sub-watershed area (ha)
	Forest				Rangeland	Agriculture	Urban	
	Coniferous	Broadleaved	Mixed	Total				
Alibeyköy-1	4.50	20.37	35.86	0.61	0.14	0.21	0.02	3176.55
Alibeyköy-2	0.07	50.62	0.00	0.51	0.14	0.16	0.17	1526.46
Alibeyköy-3	0.00	15.34	0.02	0.15	0.30	0.26	0.26	917.37
Alibeyköy-4	0.00	58.71	0.20	0.59	0.28	0.02	0.11	1398.33
Alibeyköy-5	0.00	0.00	85.86	0.86	0.02	0.12	0.00	426.73
Alibeyköy-6	0.00	35.12	0.00	0.35	0.65	0.00	0.00	340.39
Alibeyköy-7	0.00	18.66	1.94	0.21	0.79	0.00	0.00	337.86
Alibeyköy-8	0.00	0.00	63.10	0.63	0.04	0.22	0.11	387.45
Alibeyköy-9	0.00	0.00	2.22	0.02	0.48	0.35	0.15	493.29
Alibeyköy-10	0.00	0.00	24.33	0.24	0.19	0.04	0.52	810.02

Table 4. Estimated values of selected water quality parameters (*EC*: Electrical Conductivity, *DO*: Dissolved Oxygen, *TSS*: Total Suspended Solid Particles) in sub-watersheds (SW) scale

Sub-watersheds	pH	EC	Turbidity	DO	TSS
SW-1	7.14	539	12.24	7.48	0.475
SW-2	7.29	646	44.15	7.05	0.698
SW-3	7.38	798	66.04	6.36	0.943
SW-4	7.36	533	31.47	7.49	0.67
SW-5	7.19	460	5.64	7.97	0.362
SW -6	7.37	463	11.91	7.55	0.723
SW -7	7.42	480	13.63	7.41	0.811
SW -8	7.34	618	30.09	7.43	0.558
SW -9	7.59	786	46.05	6.67	0.914
SW -10	7.74	911	118.41	6.13	1.242

highest value was estimated for turbidity with a value of 118.41 NTU in the same sub-watershed (SW-10) which was 52 % urbanized. Beside all these, pH values varied between 7.14 and 7.74 while dissolved oxygen changed between 6.13 and 7.97 in all sub-watersheds.

Scoring all these values according to the range scale provided to obtain the map of water quality parameters in watershed scale. When examining the scores of water quality parameters, 2 was considered as the minimum while 7 was the maximum score in the sub-watersheds (Figure 4). Following that, the scoring map has been transformed to the ecosystems' capacity map which shows service provision capacity of ecosystems by using Burkhard's capacity classification.

Results showed that forest dominated sub-watershed (SW-5) (86 % forested) had the lowest electrical conductivity (460 μ S cm⁻¹) and total suspended solid particles (0.362 mg l⁻¹) whereas lowest forested sub-watershed (SW-9) (2 % forested) had the highest electrical conductivity (786 μ S cm⁻¹) and total suspended solid particles (0.914 mg l⁻¹) among the 10 sub-watersheds. The highest value of total suspended solid particles (1.242 mg l⁻¹) was computed in urbanized sub-watershed (SW-10) (52 % urban). Another

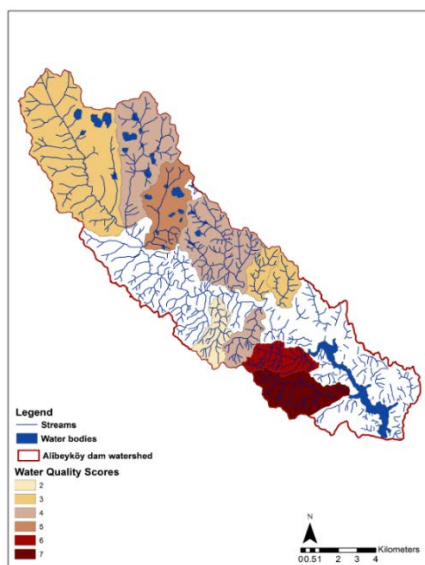

Figure 4. Map of water quality scores related to land use types of the sub-watersheds

The classification of ecosystems' capacity in the sub-watersheds varied between relevant capacity and high relevant capacity. When the land use types and capacities were analyzed together, results showed that forested sub-watersheds had high relevant capacity whereas urbanized sub-watersheds had relevant capacity to provide water quality regulation service (Figure 5).

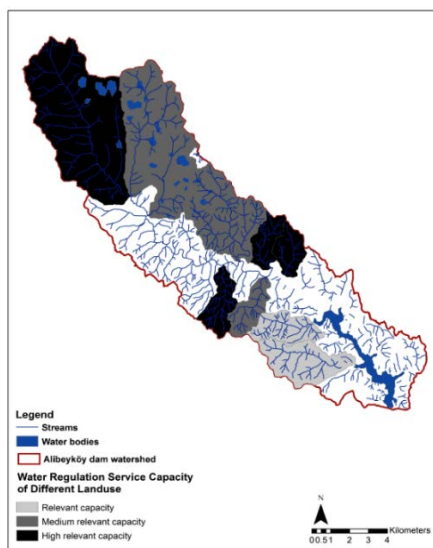

Figure 5. Map of water quality regulation service capacity of sub-watersheds

Conclusion

Results of this study indicated that water quality regulation service was affected by land use types and that was ranked as altering regional hydrological ecosystem services by changing the way of land using (Jin et al., 2015), modifying the ecosystem services by conversion of lands (Costanza et al. 1997; DeFries and Eshleman, 2004; Li et al., 2014). Additionally, in this study, forest was determined as the most effective land use type in case of providing this water related ecosystem service. Also, the role of forests on hydrological processes is well documented in many studies. On the other hand forests (Carvalho-Santos et al., 2014) and vegetation types (Brauman et al., 2007) were considered as the main components of provisioning hydrological services among the multiple ecosystem services such as providing wood, clean air, recreation, nutrient cycling, disturbance control and resilience to climate change (WRI, 2002; Hanson et al., 2011; Amacher et al., 2014). Brauman et al., (2007) mentioned forests as the ecosystems which improve water quality in a catchment (. However, the water quality scores and capacities of forests in providing water quality regulation service in sub-watersheds have been different from each other. The difference in hydrological services should be analyzed regionally (Brauman et al., 2007) which can be attributed to land use intensity (Bolund and Hunhammar, 1999) in addition to ecological conditions such as soil and climate. Comparing the capacities of sub-watersheds to provide water quality regulation service showed that forested sub-watersheds with a percentage of 86 (SW-10) and 61 (SW-1) have high relevant capacities whereas the forested sub-watersheds with a percentage of 51 (SW-2), 59 (SW-4) and 63 (SW-8) have medium relevant capacities to provide this service. In other respects, these sub-watersheds (SW-2, SW-4 and SW-8) have urban areas with a percentage of 17, 11 and 11 respectively and this can be stated as the reason of having medium capacity to provide this service. Also, Serengil et al. (2012) found that forest intensity and settlement intensity were the significant factors in the context of affecting stream water quality and stream ecosystem functionality on the opposite way.

Indeed, hydrological ecosystem services were related with urbanization in many studies and the relations were generally determined as negative (Borris, 2000; Ren et al., 2003; DeFries and Eshleman, 2004; Ya et al. 2012; Jin et al., 2015). As an example of this relation, in the sub-watershed 9 with a forest percentage of 2 and sub-watershed 10 with an urban percentage of 52 had the lowest relevant capacity to provide water quality regulation service among 10 sub-watersheds in this study. That negative relation was similarly determined for the water quality scores with the highest values of 6 and 7, respectively.

The distribution of land use intensity in sub-watersheds 5 and 6 indicated that mix of rangelands and forests provide a better relevant capacity than the other compositions. That was consistent with the study of Havstad et al. (2007) based on the provisioning services of rangelands.

As a conclusion, it has been focused on quantifying the relationships between different ecosystems or land use types and their service of water quality regulation in watershed scale. However, it has concluded that the land use impacts have been playing a significant role on providing water quality regulation service. According to all these outputs of this study, understanding the relation exactly and implementing new approaches depend on valuation and quantification of parameters that identify the service of ecosystems. On the other hand, quantification of ecosystem services leads to define possible utilization of ecosystems that provides sustainable human well-being. So, integrating ecosystem services to both environmental and urban plans becomes a necessity. Thus, ecosystems should be planned in the context of conservation of their services. Therefore, as the recent study indicated basic quantification models should be improved for each ecosystem service to insert them in plans.

Acknowledgements

The study was supported by TUBITAK with the project number 112Y096.

References

- Amacher G.S., Ollikainen M., Uusivuori J. 2014. Forests and ecosystem services: Outlines for new policy options. *Forest Policy and Economics*, 47, 1-3.
- Bingham G., Bishop R., Brody M., Bromley D., Clark E.T., Cooper W., Costanza R., Hale T., Hayden G., Kellert S., Norgaard R., Norton B., Payne J., Russell C., Suter G. 1995. Issues in ecosystem valuation: improving information for decision making. *Ecological Economics*, 14, 73-90.
- Borris A., 2000. Urbanization and water quality. CAE working paper series. 22 s. American Farmland Trust's Center for Agriculture in the Environment.
- Boulard P., Hunhammar S. 1999. Ecosystem services in urban areas. *Ecological economics*, 29, 293-301.
- Brauman K.A., Daily G.C., Ka'eo Duarte T., Mooney H.A. 2007. The nature and value of ecosystem services: an overview highlighting hydrologic services. *The annual review of environment and resources*, 32, 67-98.
- Burkhard B., Kroll F., Nedkov S., Müller F. 2012. Mapping ecosystem service supply, demand and budgets. *Ecological Indicators*, 21, 17-29.
- Carvalho-Santos C., Honrado J.P., Hein L. 2014. Hydrological services and the role of forests: Conceptualization and indicator-based analysis with an illustration at a regional scale. *Ecological Complexity*, 20, 69-80.
- Clerici N., Paracchini M.L., Maes J. 2014. Land-cover change dynamics and insights into ecosystem services in European stream riparian zones. *Ecohydrology and Hydrobiology*, 14, 107-120.
- Costanza R., D' Arge R., De Groot R., Farber S., Grasso M., Hannon B., Naeem S., Limburg K., Paruelo J., O' Neil R.V., Raskin R., Sutton P., Van Den Belt M. 1997. The value of the world's ecosystem services and natural capital. *Nature*, 387, 253-260.
- Çepel N., 1983. Genel Ekoloji. İstanbul Üniversitesi Yayın no: 3155, Orman Fakültesi Yayın no: 352, İstanbul.
- Çokoyoğlu S., 2008. Alibey ve Kağıthane havzalarında arazi kullanımı ve sorunlarının 50 yıllık değişimi, Yüksek Lisans Tezi, İstanbul Üniversitesi Fen Bilimleri Enstitüsü, 82 s. İstanbul.
- Daily G.C., Polasky S., Goldstein J., Kareiva P.M., Mooney H.A., Pejchar L., Ricketts T.H., Salzman J., Shallenberger R. 2009. Ecosystem services in decision making: time to deliver. *Frontiers in Ecology and Environment*, 7 (1): 21-28.

- DeFries R., Eshleman K.N. 2004. Land-use change and hydrologic processes: a major focus for the future. *Hydrological Processes*, 18, 2183-2186.
- Hanson C., Talberth J., Yonavjak L. 2011. Forests for water: Exploring payments for watershed services in the U.S. South. *World Resources Institute Issue Brief 2*, 1-16.
- Havstad K.M., Peters D.P.C., Skaggs R., Brown J., Bestelmeyer B., Fredrickson E., Herrick J., Wright J. 2007. Ecological services to and from rangelands of the United States. *Ecological Economics*, 64, 261-268.
- Jin G., Wang P., Zhao T., Bai Y., Zhao C., Chen D. 2015. Reviews on land use change induced effects on regional hydrological ecosystem services for integrated water resources management. *Physics and Chemistry of the Earth*, 89-90, 33-39.
- Li F., Ye Y.P., Song B.W., Wang R.S., Tao, Y. 2014. Assessing the changes in land use and ecosystem services in Changzhou municipality, Peoples' Republic of China, 1991–2006. *Ecological Indicators*, 42, 95-103.
- Logsdon R.A., Chaubey I. 2013. A quantitative approach to evaluating ecosystem services. *Ecological Modelling*, 257, 57-65.
- Maes J., Egoh B., Willems L., Liqueste C., Vihervaara P., Schagner J.P., Grizzetti B., Drakou E.G., La Notte A., Zulian G., Bouraoui F., Paracchini M.L., Braat L., Bidoglio G. 2012. Mapping ecosystem services for policy support and decision making in the European Union. *Ecosystem Services*, 1, 31-39.
- Marsh G.P., 1864. *Man and nature; or physical geography as modified by human action*. 593 s. New York.
- Martinez M.L., Pe'rez-Maqueo O., Va'zquez G., Castillo-Campos G., Garc'a-Franco J., Mehlreter K., Equihua M., Landgrave R. 2009. Effects of land use change on biodiversity and ecosystem services in tropical montane cloud forests of Mexico. *Forest Ecology and Management*, 258, 1856-1863.
- Millennium Ecosystem Assessment, *Ecosystems and Human Well-being*. 2003. ISBN: 1-55963-402-2, Island Press.
- Millennium Ecosystem Assessment. 2005. *Ecosystems and human well-being: wetlands and water synthesis*. ISBN 1-56973-597-2, World Resources Institute, Washington DC.
- Nelson E., Mendoza G., Regetz J., Polasky S., Tallis H., Cameron D.R., Chan K.M.A., Daily G.C., Goldstein J., Kareiva P.M., Lonsdorf E., Naidoo R., Ricketts T.H., Shaw M.R. 2009. Modeling multiple ecosystem services, biodiversity conservation, commodity production, and tradeoffs at landscape scales. *Frontiers in Ecology and Environment*, 7 (1): 4-11.
- Ren W., Zhong Y., Meligrana J., Anderson B., Watt W.E., Chen J., Leung H.L. 2003. Urbanization, land use, and water quality in Shanghai 1947–1996. *Environment International*, 29, 649-659.
- Serengil Y., 2010. Kentsel havzalar için gıs tabanlı basit bir kanal duyarlılıđı tahmin modelinin geliştirilmesi projesi sonuç raporu. TÜBİTAK proje no: 107Y149.
- Serengil Y., İnan M., Yurtseven İ., Kılıç Ü., Uygur B. 2012. Stream corridors as indicators of watershed land use: A case study in İstanbul. IUFRO Landscape Ecology Conference, Bosque, 33 (3), 345-352.
- Serengil Y., Gökbülak F., Özhan S., Hızal A., Şengönül K., Balcı N., Özyuvacı N. 2007. Hydrological impacts of a slight thinning treatment in a deciduous forest ecosystem in Turkey. *J. of Hydrology*, 333, 569-577.
- Wang W., Huaicheng G., Chuai X., Dai C., Lai L., Zhang M. 2014. The impact of land use change on the temporospatial variations of ecosystems services value in China and an optimized land use solution. *Environmental Science and Policy*, 44, 62-72.
- World Resources Institute. 2002. *World resources 2000-2001: People and ecosystems: Fraying web of life*. ISBN: 1-56973-443-7, 10 G St., NE, Washington, DC.
- Ya L., Youpeng X., Yi S. 2012. Hydrological effects of urbanization in the Qinhuai River Basin, China. *Procedia Engineering*, 28, 767-771.

A Working Framework of Non Wood Forest Products Integrated Forest Management Planning Concept

*Emin Zeki BAŞKENT¹, Derya Mumcu KÜÇÜKER¹

¹KTU, Faculty of Forestry, Trabzon/TURKEY

*Corresponding Author eminzekibaskent@gmail.com

Abstract

Managing the forest resources for multiple uses based on ecosystem approach is the basic principle of sustainable forest management. One of the fundamental components of sustainable forest management is to develop conceptual framework of integration of forest values in the form of management objectives and conservation targets. Non-wood forest products (NWFP) are vital forest values that have to be taken into account in multiple use forest management planning. This paper tries to develop NWFP integrated forest management planning concept and touches upon the possible management strategies during the integration process. This paper concludes that; NWFP inventory should be carried out in accordance with biodiversity inventory, spatial distribution of NWFP should be mapped with a spatial database built-in, market chain analysis for prominent NWFPs has to be analyzed and productivity analyses be developed for management plans need to be prepared with decision support system.

Key words: Forest management, Non-Wood Forest Products, Multiple use planning

Odun Dışı Orman Ürünlerinin Amenajman Planlarına Yansıtılmasında Kavramsal Çerçeve

Özet

Orman ekosistemlerinin çok amaçlı planlanması ve işletmeciliği sürdürülebilir ormancılığın başlıca unsurudur. Bu sürecin önemli bileşenlerinden biri de başlıca orman fonksiyonlarının belirlenerek ilgili işletme amaçları ve koruma hedefleri şeklinde planlara entegrasyon kavramının ortaya konulmasıdır. Ekosistem tabanlı ve çok amaçlı planlamada geleneksel işletme amaçları ve koruma hedeflerinin yanı sıra, odun dışı orman ürünlerinin (ODOÜ) de planlamada dikkate alınacak hedefler arasında yer almaktadır. Bu eserde amenajman planlarının hazırlanmasında ODOÜ'nün nasıl ele alınacağı bir sistem dahilinde incelenmiş, kavramsal çerçevesi ortaya konulmuş ve ODOÜ entegre planlamanın uygulamaya nasıl aktarılacağı hakkında da planlama stratejilerine yer verilmiştir. Sonuçta; ülkemiz için son derece önemli olan ODOÜ envanterinin öncelikle biyoçeşitlilik envanteri ile eşzamanlı yapılması, verilerin sayısallaştırılıp veri tabanına aktarılarak haritalandırılması, ürün zinciri pazar analizlerinin yapılması ve buna göre öne çıkan ODOÜ'nün verimlilik modellerinin geliştirilmesi, geliştirilecek karar destek sistemi ile planlama stratejilerinin geliştirilmesi işlemlerinin bu entegrasyon sürecinde dikkate alınması gerekli aşamaları olduğu ortaya konulmuştur.

Anahtar Kelimeler: Orman amenajmanı, Odun Dışı Orman Ürünleri, Çok amaçlı planlama

Introduction

Forest management planning targets to consider both products and services inherited within the forest ecosystems on a sustainable basis. Integration of those multiple values offered by the forests is a great challenge of contemporary forest management planning. Nowadays, forest management planning concept has changed towards ecosystem based multiple use approach considering multiple objectives, various stakeholders and multiple sectors. Such new approach requires, first of all, identification and characterization of different products and

services, defining criteria and indicators for quantifying those values, determining appropriate silvicultural prescriptions for each forest use and determining the best alternatives with the use of appropriate Decision Support Systems (DSS). Here in this process, one of the primary stage of ecosystem based multiple use forest management planning concept is the collection of multipurpose data through forest ecosystem inventory. Integrated management of multiple forest values depends highly on the availability of comprehensive data gathered from the field.

Based on the topographic, vegetation and soil data, alternative silvicultural prescriptions can be defined for each forest stands before decision making. One of the important steps for the ecosystem based forest management process is the development of potential planning strategies to test for understanding forest dynamics and choosing the best scenario. Preparing forest management plans according to such planning process helps create spatial database and lays out the principles of sustainable forest management concept in a national forestry sector. The characterization and integration of Non-Wood Forest Products (NWFP) within the forest management planning concept is of a great importance to realize the national forest management targets within the national policies. The challenge is how to integrate NWFP into forest management plan.

The forests of Turkey have been managed under the ecosystem based multiple use forest management approach since 2008 with the introduction of new management guidelines. The new approach was powered with the operational rules within the management acts no 299 (Anonim, 2014). With these legal documents, criteria and indicators were set to stratify the forest for different forest uses under ecological, economical and socio-cultural values part of sustainable forest management initiatives. Biodiversity assessment and conservational practices were developed and implemented in few case study areas across the country. Participatory planning approach has been adopted in preparing new forest management plans. While a new department was founded to manage the NWFP and services in 2011 and a strong interest was shown towards the management of NWFP, a comprehensive framework of managing NWFP within the Turkish forest services was not well outlined. Thus, we will try to lay out the conceptual framework of integrating NWFPs into forest management plans and will show the important steps of the process.

Material and Methods

Conceptual framework

We experience some problems and bottlenecks in integrating NWFP into forest management planning. The traditional use of

some NWFPs, the seasonal production, unknown site productivity for each products, absence of field inventory and the related database are some of the emerging problems in the optimal utilization and management of NWFP. The complications such as different kinds of products requiring various other inventory techniques and sample design as well as requirement of temporal measurements acerbate the integration process (Küçüker, 2014; Küçüker and Başkent, 2015). Following on that, the spatial distribution of products are not homogeneous, there are not enough number of experts, hard to collaborate with different sectors, and special technical experts on NWFP were not trained well to work in the field and office. Such additional difficulties have complicated the integration process. Given these and other non-mentioned difficulties in the integration of NWFP into forest management planning, we formulate and develop relatively systematic process that would work with the new planning approach, ecosystem based multiple use forest management planning concept.

The integration calls for a certain process to follow. The conceptual flow of the process is given in Figure 1. Within the process, first of all, a comprehensive base line survey covering market opportunities and demands is conducted. The results help provide a preliminary idea on the development of management policies and strategies for the integration. With this study, in one hand, the demands for specific products are determined on the other hand, the necessity and rational of managing NWFP are laid out. As a result, the first stage figures out the prominent NWFP that have the high potential market values.

The second stage of the integration process is the inventory of NWFP in a given forest ecosystem to obtain the spatial distribution. The inventory depends on the features and the used parts of the species (Küçüker, 2014; Küçüker and Başkent, 2015). For that reason, species having the similar features are grouped to define a specific inventory method. Whatever the inventory method is chosen, present/absent analysis has to be conducted to see the spatial distribution of all potential NWFP in a given

area of interest. There are potentially two alternative approaches in conducting the present/absent analysis. The first one is more of a practical approach that calls for the implementation of present/absent analysis in accordance with the forest management survey teams. At least one special expert would be provided for each management team to systematically scan the area for identifying potential species. Or, if one of the management team is capable or trained with the NWFP that member would also do the job in the field. Other approach is to form a separate NWFP inventory team and scan the areas of interest. Whatever the approach is taken, the underlying process is to cruise the forest ecosystems that are of interest. Depending on the budget, availability of experts or administrative reason one approach is selected. Here in this stage of the process the other important point is to develop a digital database with the input of the inventory and locational data with the use of geographic information system. The spatial data base where both locational and attribute data for NWFP are in place will allow the user to analyze the presence/absence as well as map out the spatial distribution of each NWFP within the ecosystems. With the development of comprehensive database the current status of NWFP will be identified and analyzed. Once the inventory is conducted and the associated database is built, then it would take much longer time to renew the inventory. Thus, the inventory system has to be carefully designed and conducted once through the country.

The third stage of the integration process is the modeling of productivity of the related product. Depending on the spatial distribution and the market analysis, only the prevailing NWFP are primarily considered in this stage. Thus the areas where the principal species grow are selected for the productivity analysis. The objective of the productivity analysis is to figure out the per area yield annually of each product with its associated used parts in a given site condition. For instance, the per area yield of Bay leaves in degraded Calabrian pine stands in medium site is about 3 tons. Similarly, to determine the amount of yield of thyme per ha. The hurdle here in this stage is to develop and

conduct another inventory method to gather data to model the productivity of each specific NWFP. Such inventory process is conducted in the areas where the subject species exists. The probable sample design needs to be supervised accommodating the parameters such as species, site, climate and the topographic structure. One of the other important point is to consider the temporal change of the yield of each species as the productivity varies depending on climate change over time. When the temporal change is taken into account, then the productivity analysis would be much better and sound in terms of the accuracy of the analysis. Thus, permanent sample plots should be established for productivity inventory of NWFPs.

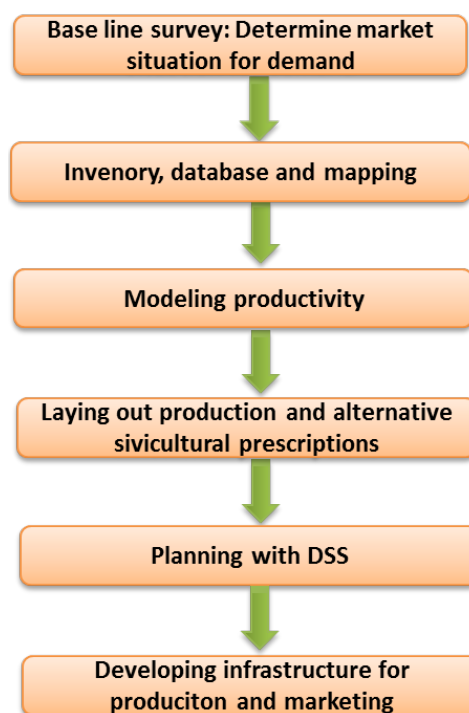

Figure 1. The flow of the conceptual framework of NWFP integrated management process

The fourth step of the integration process relates to the production or renewal capabilities and the potential lay out of silvicultural prescriptions on the allocated areas. Here, it is decided how to grow and produce a specific NWFP whether in nature or in cultural environment. The appropriate silvicultural prescriptions including the method, timing, amount, level and the

intensity are designed for each specific NWFP for the time span from the initiation of a plant to the harvesting time. This is the hardest part of the integration process because alternative silvicultural actions on the production of each part of NWFP have to test and the appropriate one should be selected for implementation. This can only be conducted with the use of an appropriate DSS that accommodates NWFP into the forest management planning process. Here the causative basis (cause and effect relationships) has to be analyzed at a stand level before expanding the actions to a forest landscape level. Such analysis will require a stand growth model to estimate the growth and yield of stand type. The analysis will eventually result in a set of appropriate and sound management strategies that can be integrated into a DSS. In the meantime, the alternative set of management strategies should be able to reflect rural development policies that is the one of the crucial objectives of NWFP management. Here, alternative development choices or living conditions are to be observed during the integration process.

The fifth step of the integration process is to design a concept to harmonize the production of NWFP with other wood products in a holistic approach. As a number of NWFPs can potentially be integrated, a comprehensive design is required with a system analysis approach. Given the fact that there are a number complex issues such as emergence of multiple objectives, optimization of those objectives, need for a longer time forecasting of forest development, larger areas, increasing number of various stands/Sand types, few silvicultural actions/prescriptions to be applied for each stand and the economic output of the management plan, necessitates the use of efficient DSS. Thus a comprehensive and a functional DSS is required to carry out the long term projection of forest ecosystems under the given conditions and a set up. Such DSS will be able to both allocate land for efficient use and generate optimal harvest schedule with the best alternative. To do that, potential management alternatives have to be developed to test and find out the best among

the number of larger management options. The management strategies consist of various objective functions, such as maximization of timber production, maximization of the amount of NWFP or maximization of net-present-value for all forest values, management constraints such as total area, production flow, or some other political or legal limitations and other planning parameters. The development of comprehensive and functional DSS will be able to provide opportunities to deliver outputs in the form of a management plan for each planning strategy. Such DSS then will generate the results for each strategy and provide opportunities to see and analyze the dynamics between the commodity productions including NWFPs and services before implementing any management decision. The examination of forest dynamics with the results produced by the DSS will provide understanding of the reciprocal effects of commodity production and conservation of ecosystems to be able to select the best options based on the given management policies, objectives, constraints and conservation targets. With such process only can one be sure to feel and realize the realization of sustainable forest management concept with multiple objectives including the control of NWFP. When desired, the cause-and-effect analysis of long term forest management planning would also provide opportunities to test the effects of various development policies for rural areas and the people before formulating incentives towards the development of rural people.

The final step for the integration concept is to develop infrastructure for process and marketing of both goods and services. This step is the combinatorial process for both economic and social values of society appeared when management plans are implemented in the field. In fact, collection, process and marketing of NWFP are as important as integrated planning of both goods and services. Therefore, in order to complete the planning process, the final step needs to be explored further in association with the planning process.

Results and Discussion

This study tried to develop a conceptual framework of an integrated forest management planning concept that accommodates both goods (wood and NWFP) and services focusing on the management of NWFP. IN order to realize this process in the field in Turkey, for instance, the following actions need to be taken into account.

1. First of all, base line survey and market analysis need to be conducted to formulate appropriate policies and strategies in order to prioritize the potential NWFP. For example, the presumable products such as bay leaves, pine cones, chestnut, mushroom etc. That provide income to the rural community and the industry are to be at the top priority.

2. All NWFPs coming from plants and animals have to be determined for each state forest enterprise in a regional directorate of forestry and market analysis and appropriate inventory/sampling methods have to be determined for each group of NWFP to conduct NWFP inventory.

3. The capacity have to be built with both visual and written training materials in association with the interested stakeholders such as universities, exports associations and other NGOs with the NWFP experts trained.

4. Appropriate growing or production alternatives need to be developed for each part of NWFP. Here, again experts are to be trained about the production techniques.

5. Appropriate collections methods are to be determined for each product in wild environment and harvesting plans have be prepared for sustainable production of products.

6. The organization capacity for the sustainable management of NWFP has to be developed in association with universities, research institutes, private sectors and other related organization or NGOs.

7. The ownership issues need be respected and solved, if exists, before the initiation of comprehensive management plan during the inventory and utilization of NWFPs in any forest ecosystems.

8. The request / demands coming from the tourism industry that process or uses plant based cosmetic, medicinal plants, food

sector and any others that utilize wood and its produces such as resin, cones and seeds, need to be taken into account in policy and strategy design.

9. The potential damage in state forests ecosystems due to political decision and/or technical inappropriateness and the benefits to the society need to be harmonized in order to find out the appropriate management approach

10. Last and not the least, the willingness and persuasion of policy makers and managers are to be present always to put strong emphasis on the sound and integrated management of NWFP and wood production throughout the country by training enough number of experts and developing up-to-date legal guidelines (Anonim, 2016.) to carry out the management of NWFP in reality in the field.

Acknowledgement

We greatly acknowledge the data, material and the idea developed by both the 114O868 coded TUBİTAK-COST project and "Integrated forest management" GEFV Project of supported by UNDP and GDF.

References

- Anonim 2014, Ekosistem Tabanlı Fonksiyonel Orman Amenajman Planlarının Düzenlenmesine Ait Usul Ve Esaslar, Tebliğ No: 299, Orman Genel Müdürlüğü, Odun İdaresi ve Planlama Dairesi Başkanlığı, Aralık 2014, Ankara.
- Anonim 2016. Odun Dışı Orman Ürünlerinin Envanter ve Planlaması ile Üretim ve Satış Esasları. Tebliğ No: 302, Orman Genel Müdürlüğü, Odun Dışı Ürün ve Hizmetler Dairesi Başkanlığı, 2016 Ankara.
- Mumcu-Küçükler D.M. 2014.Odun dışı orman ürünlerinin ekosistem tabanlı çok amaçlı planlara yansıtılması: Kanlıca Mantarı (*Lactarius sp.*) örneği, Doktora tezi, KTÜ, Fen Bilimleri Enstitüsü, Trabzon.
- Küçükler DM, Başkent, EZ. 2015. Amenajman Planlarının Yapım Süreciyle İlişkili Bitkisel Kaynaklı Odun Dışı Orman Ürünlerinde Envanter, 3. Doğa ve Ormanlık Sempozyumu (26-29 Kasım 2015), 201-218, Antalya, Türkiye.

Optimum Cutting Ages Including Wood Production and Carbon Sequestration Benefits in Maritime Pine Reforestations

Sedat KELEŞ

Çankırı Karatekin University, Faculty of Forestry, Çankırı / TURKEY

dr.sedatkeles@gmail.com

Abstract

Determining optimum cutting ages including various forest ecosystem benefits together with wood production is vital important in forest management. This study presents the optimum cutting ages in maritime pine (*Pinus pinaster Ait.*) reforestations including wood production and carbon sequestration benefits. It also evaluates the effects of different discount rates and carbon prices on the optimum cutting ages. Net present value approach was used to determine optimum cutting ages and to analyze the effects of discount rates and carbon prices on these ages. Main materials used in this study are growth and yield curves, wood assortment tables, reforestation costs, and biomass/carbon conversion factors for maritime pine tree species. Results of the case study showed that the integration of carbon sequestration benefits into wood benefits increased the optimum cutting ages of maritime pine forests from 37 years to 44 years depending on different carbon prices. Total net present value obtained from wood production and carbon sequestration benefits increased between 5-37% compared to net present value of wood production in a discount rate of 3%. Depending on the increase in discount rates, optimum cutting ages decreased from 37 years to 28 years in wood-based management and from 39 years to 30 years in multiple-use management of wood and carbon benefits.

Keywords: Cutting age, Forest management, Global warming, Net present value, Carbon sequestration

Odon Üretimi ve Karbon Birikimi Faydalarını İçeren Sahilçamı Ağaçlandırmalarında Optimum Kesim Yaşlarının Belirlenmesi

Özet

Odon üretimi ile birlikte diğer orman ekosistem fonksiyonlarını içerecek şekilde optimum kesim yaşlarının belirlenmesi orman amenajmanında son derece önemli bir konudur. Bu çalışma da sahilçamı ağaçlandırmalarında, odun üretimi ile karbon birikimi fonksiyonlarının birlikte bulunması durumunda, optimum kesim yaşlarının ne olacağı ortaya konulmaktadır. Bu çalışma aynı zamanda, farklı faiz oranları ve karbon fiyatlarının optimum kesim yaşları üzerine olan etkilerini araştırmaktadır. Optimum kesim yaşlarına karar vermek ve bu kesim yaşları üzerine farklı faiz oranları ve karbon fiyatlarının etkilerini analiz etmek için net bugünkü değer yaklaşımı kullanılmaktadır. Çalışmada kullanılan ana materyaller; büyüme ve artım eğrileri, odun ürün çeşitleri tablosu, ağaçlandırma maliyetleri, biyokütle/karbon dönüşüm faktörleridir. Yapılan çalışma, sahilçamı ağaçlandırmalarında karbon birikimi fonksiyonunun odun üretimi fonksiyonuna entegre edilmesi ile birlikte optimum kesim yaşlarının, değişik karbon fiyatlarına bağlı olarak 37 yaşından 44 yaşına kadar arttığını göstermiştir. Odun üretimi ve karbon birikimi faydalarından elde edilen toplam net bugünkü değer, sadece odun üretiminden elde edilen net bugünkü değer ile kıyaslandığında, %3 faiz oranında, %5-37 oranında artış göstermiştir. Faiz oranlarındaki artışa bağlı olarak, optimum kesim yaşları odun üretimi eksenli planlamada 37 yaştan 28 yaşa kadar, odun üretimi ve karbon birikimini içeren çok amaçlı planlamada ise 39 yaştan 30 yaşa kadar düşmüştür.

Anahtar Kelimeler: Kesim yaşı, Orman amenajmanı, Küresel ısınma, Net bugünkü değer, Karbon birikimi

Introduction

Forest ecosystems present many ecological, economic and environmental functions. Climate regulation is one of the most important environmental functions of forest ecosystems. Forest trees absorb large

amounts of carbon from the atmosphere and store them in their biomass and soil. Depending on the increasing concentration of carbon dioxide in the atmosphere, the integration of carbon sequestration function into forest management has created a new

forest management objective (Liski et al., 2001).

The quality and quantity of forest ecosystem functions like carbon sequestration depend mainly on forest ecosystem structure and composition. Forest stand characteristics such as tree density, stand age, basal area, number of stems, growing stock and increment, tree species, crown closure and development stages affect the amount and quality of forest ecosystem benefits all together. Optimum cutting age (or rotation length) is an effective way to manage forest ecosystems for maximum carbon sequestration objective (Liski et al., 2001). In this context, several studies were made to determine optimum cutting ages including wood production and carbon sequestration in forest management (Diaz-Balterio and Rodriguez, 2006; Torres et al., 2010; Kula and Gunalay, 2012; Asante and Armstrong, 2012; Diaz-Balteiro et al., 2014). However, there is a need to consider new studies related to optimum cutting ages of various tree species in natural forest or plantation areas.

The aim of this study is to determine the optimum cutting ages in maritime pine (*Pinus pinaster* Ait.) reforestations including wood production and carbon sequestration

benefits. It also evaluates the effects of different discount rates and carbon prices on the optimum cutting ages. Net present value approach was used to determine optimum cutting ages and to analyze the effects of discount rates and carbon prices on these ages.

Material and Methods

Growth and yield curves of maritime pine plantations per hectare were used in the study (Özcan, 2003). The growth cycle of this species planted in good sites and its carbon sequestration amounts are given in Figure 1. Volumes of various timber assortments (sawlog, mining pole and industrial/fire wood) are determined by the values of Durkaya (2001). The net values of wood assortments are assumed to be 50, 50 and 10 US\$/m³, respectively. Table 1 also presents the estimated costs of an afforestation project with maritime pine plantations in Turkey as proposed by Birlir (1998) with up-to-date prices. To predict above-ground and below-ground biomass, biomass conversion factors and root-to-shoot ratios proposed by Tolunay (2014) were used. In order to estimate the carbon content of maritime pine plantations, a 0.5 conversion factor was used.

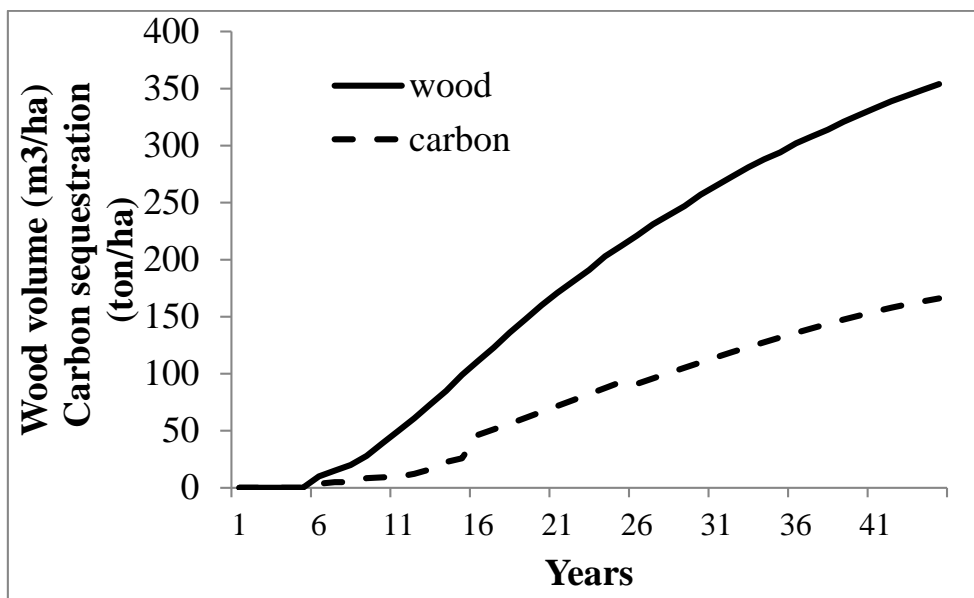

Figure 1. Wood volume and carbon sequestration of maritime pine plantations cultivated in good sites

Table 1. Standard operations and their costs by the years in maritime pine plantations

Operations	Cost Details	Operation Years	Cost (US\$/ha)
Establishment	Ploughing	0	44
	Planting	0	364
Maintenance	Beating up	2	68
	Hoeing	1,2,3	70
	Fertilization	3	68
	Wire fence construction	1	120
	Chemical intervention against pests	3	10
General Administration	Management, fire control, road maintenance etc.	Each year	26

To determine the optimal cutting age for maritime pine plantations including wood production and carbon sequestration benefits,

the methodology proposed by Cacho et al. (2003) was used. The model is as follow.

$$NPV_1(T) = v(T)xp_v(age(T))x[1 + r]^{-T} + \sum_{t=0}^T[\Delta b(t)xp_cx[1 + r]^{-t}] - c_E - b(T)xp_cx[1 + r]^{-T}$$

Here, NPV1(T) is the net present value of a forest harvested in year T after planting. The first term on the right-hand side corresponds to the value of the wood harvest. The second term corresponds to the sum of the annual net benefits from carbon captured in the interval (0-T). c_E is the forest establishment cost. p_v is the net value of wood assortments that depend on the stand age of trees at harvest. p_c is the price of carbon sequestration in tree biomass in tonnes per hectare, $v(T)$ and $b(T)$ are the wood volume in cubic meters per hectare and the carbon stock in tree biomass in tonnes per hectare, respectively. The last term in the equation corresponds to the assumption that credits obtained during forest growth have to be fully redeemed upon harvest.

Some assumptions were also taken into consideration in this study. It is supposed that no thinning regime is employed. Clear-cutting is only one silvicultural regime. Rental value of the land is not included to estimations of net present values for timber and carbon sequestration functions. The model uses the net present value approach. A discount rate of 3% was used, and a sensitivity analysis was also carried out. A

reference price of 20 US\$/ tonne for carbon sequestration was used in the analysis, and followed by a sensitivity analysis.

Results and Discussion

The results of optimum cutting ages of a maritime pine plantation for wood production, and carbon sequestration plus wood production benefits depending on various discount rates and carbon prices are given in Table 2. Results of the case study showed that the integration of carbon sequestration benefits into wood benefits increased the optimum cutting ages of maritime pine forests from 37 years to 44 years depending on different carbon prices. Total net present value obtained from wood production and carbon sequestration benefits increased between 5-37% compared to net present value of wood production in a discount rate of 3%. Depending on the increase in discount rates, optimum cutting ages decreased from 37 years to 28 years in wood-based management and from 39 years to 30 years in multiple-use management of wood production and carbon sequestration benefits.

Table 2. Optimum cutting ages for various discount rates and carbon prices

r (%)	t^w	t^{w+c}	Definition
1	>45	>45	Carbon price (20 US\$/ton)
2	42	43	
3	37	39	
4	32	34	
5	28	30	
Carbon Price (US\$)	t^w	t^{w+c}	Discount rate (3%)
10	37	38	Discount rate (3%)
20	37	39	
30	37	39	
40	37	39	
50	37	42	
60	37	43	
70	37	44	

The similar results for various tree species have also presented in some other studies (Romero et al., 1998; Diaz-Balteiro and Rodriguez, 2006; Sohngen and Brown, 2008; Torres et al., 2010; Asante and Armstrong, 2012; Kula and Gunalay, 2012; Diaz-Balteiro et al., 2014).

Conclusion

In recent years, reforestation and afforestation activities in forestry have received significant attention in prevention of global warming and climate change events in the world (Gunalay and Kula, 2012). Fast growing forest plantations provide many economic, ecological and environmental benefits like here carbon sequestration and wood production (Rodriguez et al., 2014). In this context, determining optimum cutting ages including wood and other forest ecosystem benefits for each fast growing tree species is very important for sustainable forest management in Turkey.

References

Asante, P., Armstrong, G. W., 2012. Optimal forest harvest age considering carbon sequestration in multiple carbon pools: A comparative statics analysis. *Journal of Forest Economics*, 18, 145–156.

Birler, A.S., 1998. Türkiye’de hızlı gelişen orman ağaçları ile endüstriyel plantasyon yatırımları için ön fizibilite çalışması. Kavak ve Hızlı Gelişen Orman Ağaçları Araştırma Enstitüsü Müdürlüğü, İzmit, Yayın No: 214, ISSN 1300-3933.

Diaz-Balteiro, L., Rodriguez, L. C. E., 2006. Optimal rotations on Eucalyptus plantations including carbon sequestration- A comparison of

results in Brazil and Spain. *Forest Ecology and Management*, 229, 247–258.

Diaz-Balteiro, L., Martell, D. L., Romero, C., Weintraub, A., 2014. The optimal rotation of a flammable forest stand when both carbon sequestration and timber are valued: A multi-criteria approach. *Natural Hazards*, 72(2), 375–387.

Durkaya, A. 2001. Endüstriyel Plantasyonlarda Yer Seçimi ve Planlama İlkeleri. İÜ Fen Bilimleri Enstitüsü Doktora Tezi, İstanbul, 149 s.

Gunalay, Y., Kula, E., 2012. Optimum cutting age for timber resources with carbon sequestration. *Resources Policy*, 37, 90–92.

Kula, E., Gunalay, Y., 2012. Carbon sequestration, optimum forest rotation and their environmental impact. *Environmental Impact Assessment Review*, 37, 18-22.

Liski, J., Pussinen, A., Pingoud, K., Makipaa, R., Karjalainen, T., 2001. Which rotation length is favourable to carbon sequestration? *Canadian Journal of Forest Research*, 31, 2004-2013.

Özcan, B.G., 2003. Sahil çamı (*Pinus pinaster* Ait.) ağaçlandırmalarında artım ve büyüme. Kavak ve Hızlı Gelişen Orman Ağaçları Araştırma Enstitüsü Müdürlüğü, İzmit, Yayın No: 238, ISSN 1300-395X.

Rodriguez, L. C. E., Pasalodos-Tato, M., Diaz-Balteiro, L., McTague, J. P., 2014. The importance of industrial forest plantations. In J. G. Borges, L. Diaz- Balteiro, M. E. McDill, & L. C. E. Rodriguez (Eds.), *The management of industrial forest plantations* (pp. 3–26). Springer Dordrecht Heidelberg New York London.

Romero, C., Rios, V., Diaz-Balteiro, L., 1998. Optimal forest rotation age when carbon captured is considered: theory and applications. *The Journal of the Operational Research Society*, 49(2), 121–131.

Sohngen, B., Brown, S., 2008. Extending timber rotations: Carbon and cost implications. *Climate Policy*, 8 (5), 435–451.

Tolunay, D., 2014. Coefficients that can be used to calculate biomass and carbon amounts from increment and growing stock in Turkey. *Proceedings of the International Symposium for the 50th Anniversary of the Forestry Sector Planning in Turkey*, 26–28 November, pp.240–251, Antalya, Turkey.

Torres, I. L., Perez, S. O., Fernandez, A. M., Belda, C. F., 2010. Estimating the optimal rotation age of *Pinus nigra* in the Spanish Iberian System applying discrete optimal control. *Forest Systems*, 19(3), 306–314.

The Statistical Investigation of Stand Type Discrimination of Pure Calabrian Pine Forests in Antalya and Mersin Region of Turkey

*Abdurrahman ŞAHİN¹, Aydın KAHRİMAN¹, Mehmet YAVUZ¹, Turan SÖNMEZ²

¹Artvin Coruh University, Faculty of Forestry, Artvin / TURKEY

²Bursa Technical University, Faculty of Forestry, Bursa / TURKEY

*Corresponding Author: asahin84@windowslive.com

Abstract

Forest ecosystems are different in terms of various stand characteristics such as tree species, development age, age class and density. By using these characteristics, forests can be divided into more manageable units called forest stands. In forestry practices, the precise distinction of each forest stand type helps forest managers to make better forest management plans and forestry operations to maintain forest health and fight with forest fires.

In this study, it was investigated that whether or not the pure Calabrian pine stand types used in the currently implemented forest management plans in Antalya and Mersin region of Turkey differ from those that were discriminated by using number of trees, age, basal area, stand density, volume, mean diameter and mean height of each stands in the same area. For this purpose, number of trees, age, basal area, stand density, volume, mean diameter and mean height of each forest stands were measured in the 486 temporary sampling plots obtained from 21 different pure Calabrian pine forest stands. Then, the stand type differences for the same area were investigated using discriminant analysis.

The results showed that the success rate of the stand type discrimination was found to be 43.8%. The low success rate was attributed to the transitional, non-homogenous stand types. After eliminating the transitional stand types, the success rate was increased to 64%. It can be concluded that using transitional stand types decreases discrimination of the pure Calabrian pine stand types. Therefore, additional forest stand parameters must be taken to minimize identifying transitional stand types during the forest inventory data collection process.

Keywords: Stand type distinction, Calabrian pine, Discriminant analysis

Antalya ve Mersin Yöresi Saf Kızılçam Ormanlarındaki Meşcere Tipi Ayırımının İstatistiksel Olarak Değerlendirilmesi

Özet

Orman ekosistemleri; ağaç türü, meşcere gelişim çağı, yaş sınıfı ve sıklık derecesi gibi çeşitli özellikler bakımından farklılık gösterebilmektedir. Bu özelliklerin kullanılmasıyla da, benzer yapıdaki orman parçaları diğerlerinden ayrılarak, meşcere tipleri ayırımı yapılmaktadır. Orman yöneticilerinin planları daha etkin yapabilmeleri ve yangınlarla mücadele edip ormanın sürekliliğini koruyabilmeleri için ormancılık uygulamalarında her bir orman parçası farklı meşcere tiplerine ayrılmıştır. Bu şekilde de ormancılık çalışmaları daha verimli ve etkin olarak yapılabilir.

Bu çalışmada, Antalya ve Mersin Bölgesi Orman Amenajman Planlarında uygulamada kullanılan meşcere tiplerinin; ağaç sayısı, yaş sınıfı, göğüs yüzeyi, sıklık derecesi, meşcere hacmi, orta çap ve orta boy bakımından aktüel meşcere tiplerini yansıtır yansıtmadığı araştırılmıştır. Bu amaçla, çalışma alanından alınan 486 adet geçici örnek alandaki 21 farklı meşcere tipinde; ağaç sayısı, yaş sınıfı, göğüs yüzeyi, sıklık derecesi, meşcere hacmi, orta çap ve orta boy ölçülmüştür. Bu ölçüm verileri kullanılarak, çalışma alanındaki meşcere tipi farklılıkları ayırma analizi yardımıyla incelenmiştir.

Yapılan istatistiksel analiz sonucunda, çalışma alanındaki meşcere tipi ayırımının başarı oranı %43.8 olarak bulunmuştur. Başarı oranının düşük olmasının, homojen olmayan geçiş (ara) meşcerelerinden kaynaklandığı düşünülmektedir. Bu geçiş meşcere tipleri çıkartılarak analiz tekrar yapıldığında başarı oranı %64'e çıkmıştır. Saf Kızılçam meşcere tiplerinin ayırımında geçiş meşcerelerinin kullanımı, meşcere tipleri ayırımındaki başarıyı düşürmektedir. Bu yüzden, orman envanteri çalışmalarında ek meşcere parametrelerinin ölçülmesiyle geçiş meşcerelerinin ayırımındaki hatanın azaltılabileceği düşünülmektedir.

Anahtar Kelimeler: Meşcere tipi ayırımı, Kızılçam, Ayırma analizi

Introduction

A stand is a fragmented forest that is distinguishable from their environment by all or some of these characteristics; age, tree species with the combination of growth and development (Forest Management Regulation Act, 2008). The existence of a forest is correlated to the foundation of a stand. The characteristics of different stands can either be similar or have significant differences. With this being said, to identify, comprehend and obtain accurate data from any characteristic of a stand, units that are considered homogenous need to be divided based on the characteristics (Kapucu, 2004). Furthermore, the first and most important researches that distinguish stand types are the simplification of the forest inventory and the decrease of the inventory cost (Özçelik, 2002). If the forests that form the forest district encapsulate different stand types then forests should be divided into sub-compartments. In other words, in the Forest Management Plan, the sub-compartments are divided into characterized areas based on the stand types. Reque and Bravo (2008) used forest inventory data to identify oak forest structure types.

In even-aged and coppice forests, the stand types are categorized by tree species, development age, horizontal crown closure and vertical stage measurements (Reque and Bravo, 2008). In the classification of the stand types, if needed, site index class and age related factors can also be included (Anonymous, 2014). The distinguishability of forest stand types is made with the

33°-35° East longitude and 36°-37° North latitudes. The total study area is 3,624,832 ha of which 1,986,532 ha (54.8%) is forested lands. The dominant tree species in the area are Calabrian pine, Black pine, Taurus cedar, Juniper spp., Taurus fir, Stone pine, Oak spp., Eucalyptus, Daphne, many Mediterranean shrubs and maquis species. The Calabrian pine (*Pinus brutia* Ten.) covers 39.7% of the forested areas of the study area (Anonymous, 2015). The mean annual precipitation for the region is 1069.8 kg/m² for Antalya and 585.4 kg/m² for Mersin (Kahriman, et al., 2016). The region has a Mediterranean climate with hot and humid summers and warm winters. The limestone as a geological formation

combination of on-the-ground field and remotely sensed methods (Eraslan, 1982; Mısır and Özçelik, 2002). Firstly, aerial photography or satellite images are used to create outlines of stand maps, and then field measurement techniques are used to accurately validate stand types (Sönmez et al., 2010). However, before establishing stand types, when field measurements are taken it is important to take in consideration that it is not possible to gather sample plots of every area of the forest. Thus, the outlines of the stand types that have been evaluated by using aerial photographs or satellite imagery can be confirmed without the validation of the ground truth measurements. In this circumstance it can also be said that the stand types that are written in the plan cannot always coordinate with current stand types. Many statistical analysis tools were used to separate those stands types and categorize them into similar ones (Torresan et al., 2014; Roberts, 2015).

For this purpose, effects of forest stand parameters such as number of trees (N), age (t), basal area (BA), volume (V), stand density (SD), mean diameter (d_g) and mean height (h_g) for discriminating pure Calabrian pine stand types were investigated in Antalya and Mersin region of Turkey.

Materials and Method

Study area

The study area is located in the provinces of Antalya and Mersin in Turkey extending

produces red Mediterranean soils under the forested areas.

The data used in this study came from the research project of “Yield Researches of the Pure Calabrian Pine Stands in the Antalya and Mersin Region” supported by TUBITAK, and were collected in years between 2013 and 2015 (Kahriman, et al., 2016). The spatial distribution of the pure Calabrian pine stands in the study area was depicted in Figure 1. The ArcGIS10 software from ESRI (2010) was used for determining the sampling plot locations and organizing the related data. MS Excel and SPSS 15.0 packet programs (2010) were also used for statistical analysis. The descriptive statistics of stand parameters, number of trees (N), age (t), basal area (BA),

volume (V), stand density (SD), mean diameter ($d\bar{g}$) and mean height ($h\bar{g}$) used in this study were depicted in Table 1.

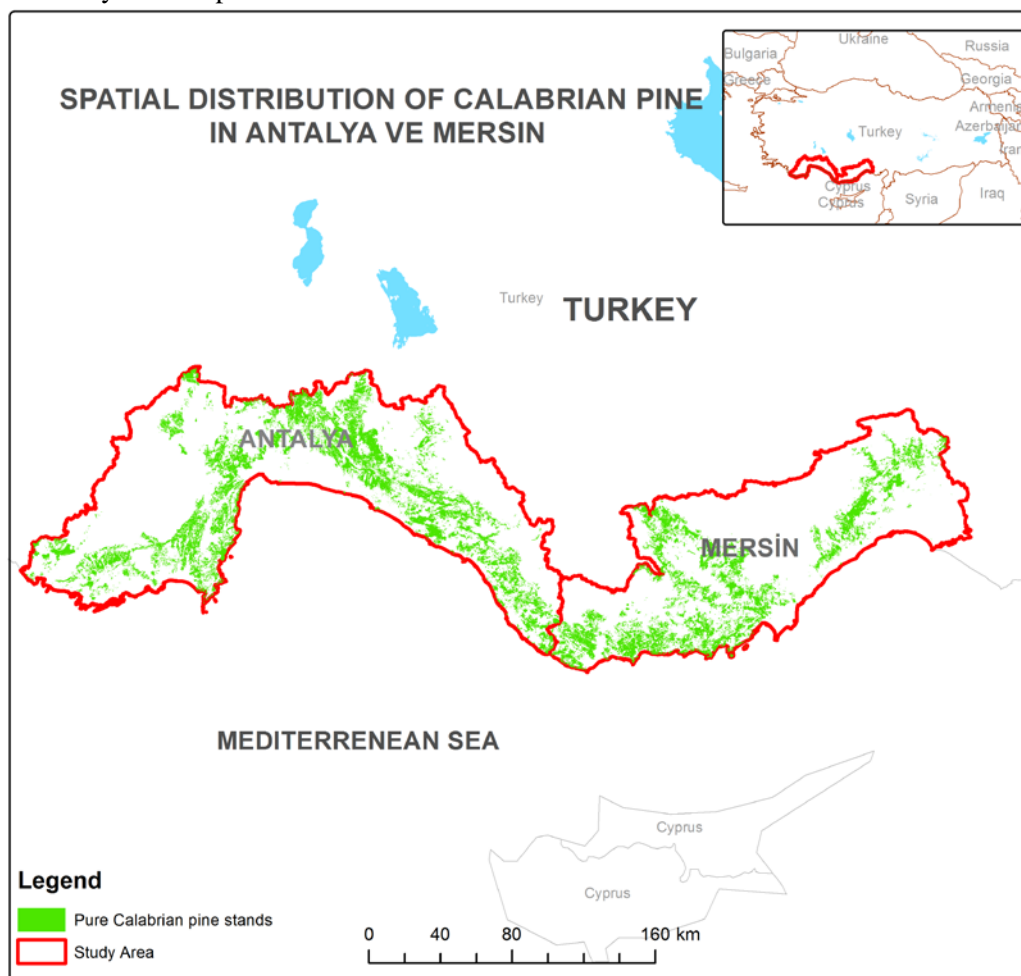

Figure 1. Spatial distribution of the Calabrian pine in the study area

Table 1. Descriptive statistics of stand types in the study area

Parameters	Stand Type																					
	Çza1	Çza2	Çza3	Çzab1	Çzab2	Çzab3	Çzb1	Çzb2	Çzb3	Çzbc1	Çzbc2	Çzbc3	Çzc1	Çzc2	Çzc3	Çzcd1	Çzcd2	Çzcd3	Çzd1	Çzd2	Çzd3	
N (trees/ha)	Min.	1125	1675	312	512	525	700	362	367	525	200	383	388	238	317	425	175	210	225	80	140	212
	Max.	4500	6400	7800	733	1150	2300	950	875	2050	1150	883	1475	500	833	1100	450	683	1250	475	617	600
	Mean	2470,8	4202,8	5223,1	652,4	776,0	1506,6	567,1	631,7	968,5	439,5	624,5	752,8	351,5	530,7	641,6	304,9	421,5	593,2	220,9	296,0	382,0
	Std.Dev.	1060,7	1548,3	2167,4	84,7	204,2	568,1	180,9	147,6	390,2	165,9	159,0	214,5	72,5	146,5	181,7	63,2	122,0	228,8	71,8	99,9	116,4
Age	Min.	7,0	6,0	6,0	13,2	13,8	13,8	15,0	14,8	17,0	19,2	19,0	16,0	23,5	22,5	16,5	34,7	34,2	33,7	66,7	45,8	53,1
	Max.	9,0	8,0	19,3	22,2	23,7	24,0	29,5	34,7	50,8	57,2	74,7	101,3	72,2	77,5	71,0	125,5	122,8	134,8	126,0	128,3	118,7
	Mean	7,7	7,4	8,4	16,4	18,0	20,2	19,1	22,2	29,4	31,3	33,1	41,5	45,9	45,3	46,0	65,6	69,5	76,4	89,3	89,3	89,2
	Std.Dev.	0,6	0,8	3,8	3,5	2,9	2,8	4,4	5,7	8,8	10,7	12,7	19,6	10,3	14,3	13,0	20,0	21,8	24,5	16,2	25,1	20,2
Basal Area (m ² /ha)	Min.	0,7	0,9	0,3	4,0	6,0	6,5	4,5	4,6	7,6	3,8	9,5	12,3	7,0	12,6	6,5	14,9	14,9	24,9	16,6	20,2	28,5
	Max.	10,6	9,7	12,9	6,3	9,2	31,6	27,5	17,3	36,0	31,2	39,4	46,7	45,6	41,3	64,1	42,1	51,0	74,0	66,6	65,6	73,0
	Mean	3,4	4,4	4,5	5,2	7,2	15,1	9,9	10,6	18,8	14,1	18,7	26,9	21,8	26,0	33,9	28,7	34,8	45,1	34,6	40,0	51,3
	Std.Dev.	3,2	3,1	4,5	0,8	1,0	8,5	7,3	3,8	8,1	5,8	7,4	8,7	9,2	6,5	13,8	6,5	8,3	12,9	10,1	9,0	14,1
Volume (m ³ /ha)	Min.	3,0	3,5	2,5	16,8	23,4	23,7	18,7	19,3	31,8	12,5	41,5	70,9	32,0	75,4	36,0	96,4	97,7	167,0	143,3	110,4	248,1
	Max.	35,1	45,5	54,3	30,0	35,3	207,6	138,5	93,4	278,3	268,4	406,1	473,2	425,2	342,9	598,9	371,8	517,2	844,6	617,4	579,4	983,7
	Mean	12,2	17,4	20,0	22,7	29,6	85,4	44,8	53,4	110,0	84,4	118,0	169,8	172,1	194,1	299,9	233,5	296,2	406,8	327,5	370,3	520,7
	Std.Dev.	10,6	12,3	17,4	4,9	4,6	62,7	38,4	25,7	62,9	50,0	75,0	81,0	99,3	72,2	149,4	76,0	103,0	166,1	107,6	107,6	194,1
Stand Density	Min.	0,5	0,7	0,3	1,4	1,7	2,0	1,3	1,3	2,4	1,0	2,6	3,2	1,6	2,9	1,8	3,1	3,1	4,5	2,4	3,4	4,5
	Max.	3,4	3,9	5,4	1,8	2,7	7,7	5,3	4,3	7,7	5,4	7,0	9,3	7,8	8,0	12,3	7,2	8,6	12,4	10,2	9,6	10,7
	Mean	1,5	2,1	2,1	1,6	2,2	4,4	2,5	2,7	4,6	3,1	4,1	5,7	4,1	5,1	6,6	4,8	6,1	7,9	5,1	6,2	7,8
	Std.Dev.	0,9	1,0	1,7	0,2	0,3	1,9	1,4	0,8	1,7	1,0	1,2	1,5	1,4	1,0	2,4	0,9	1,4	2,0	1,4	1,3	1,9
d_g (cm)	Min.	1,8	1,4	0,7	8,6	9,2	7,2	10,9	10,9	10,0	12,1	12,9	14,6	18,3	17,1	13,1	23,3	22,8	20,2	32,4	28,9	29,1
	Max.	9,9	8,6	15,7	12,5	12,7	16,7	26,4	21,0	26,5	33,1	31,8	32,2	34,7	32,7	33,9	51,3	47,1	45,7	61,8	58,3	53,7
	Mean	4,3	3,8	4,0	10,2	11,0	11,4	14,4	14,6	16,0	20,3	19,7	21,6	27,6	25,5	25,6	34,9	33,0	32,4	45,5	42,6	42,6
	Std.Dev.	2,7	2,1	4,0	1,5	1,1	3,2	4,7	3,0	4,1	4,3	4,8	4,4	4,9	4,9	5,4	5,4	5,4	6,4	6,4	6,9	6,5
h_g (m)	Min.	1,2	1,4	1,4	5,7	5,8	5,1	5,2	5,8	6,2	4,8	6,3	8,0	7,6	9,7	9,9	13,1	12,1	12,6	14,4	11,6	16,7
	Max.	3,7	3,2	6,8	7,7	8,8	13,0	10,8	14,9	16,8	19,4	23,1	22,6	22,9	23,7	24,3	24,2	28,7	28,4	31,1	31,2	28,5
	Mean	2,4	2,1	2,4	6,5	6,4	8,4	7,2	8,5	10,1	11,2	11,8	12,2	16,0	15,6	18,4	17,9	18,5	19,3	22,1	21,2	22,5
	Std.Dev.	0,9	0,7	1,6	0,8	1,0	3,2	1,6	2,5	2,7	3,3	4,1	2,9	4,7	4,0	4,5	3,2	4,0	4,1	3,8	4,3	3,2
Number of Stands	18	18	20	5	8	14	9	12	23	35	30	34	27	25	13	23	33	41	41	38	19	

Methods

Based on the different age classes, different crown closure and different site indexes, 486 sampling plots (243 from Mersin Province (Şahin 2015) and 243 from Antalya Province) were randomly selected from 21 different pure Calabrian pine stand types throughout the study area. In each sampling plot; every tree diameter and height and ages of at least 10 trees were measured. Then stand age, basal area, the trees mean diameter and height; volume, stand density and number of trees were calculated for each stand type.

In order to control the applicability of the categorization of stand types, the stepwise discriminant analysis tool was used in SPSS statistical software (SPSS 2010). As a first step, the measured data coming from 486 sampling plots were used as ground truth data for the analysis and 21 stand types were used as known stand type groups based on tree species, development age, and crown closure. Each stand type was assigned as one group for the discriminant analysis. The data consisting of number of trees (N), age (t), basal area (BA), volume (V), stand density (SD), mean diameter (d_g) and mean height (h_g) on these 21 individual stand types were used to estimate model parameters that will be used in linear score function. In the second step, the arbitrary priors were used regarding the relative population (group) sizes. In the third step, the Barlett's test (Barlett 1951) was

used to determine if variance-covariance matrices are homogeneous for the 21 stand types groups. The results of the test showed whether we use linear discriminant analysis (homogeneous) or quadratic discriminant analysis (heterogeneous) (Cohen et. al. 2013). As step four, the parameters of the conditional probability density functions were estimated. When estimating the parameters, we made the following assumptions: (a) the data from the stand type i has the mean vector μ_i , (b) the data from the stand type i has common variance-covariance matrix Σ , (c) the trees in 486 sampling plots were independently sampled, and (d) the data from each stand type was multivariate normally distributed. Then, as step 5, we computed the discriminant functions with the estimates of prior probabilities, population (group) means and variance-covariance matrices. We cross-validated each data to estimate the misclassified stand types and put them all results in an error matrix.

Results and Discussion

The discriminant analysis results of this study were shown in Table 2-3. There were five linear score functions were acquire from the discriminant analysis run (Table 2). With the exception of the function #5, it was found that all the functions were significantly different from each other.

Table 2. Statistical control of discriminant functions

Test of Function(s)	Wilks' Lambda	Chi-square	df	Significance
1	0,013	2061,417	100	0,000
2	0,115	1019,433	76	0,000
3	0,377	460,339	54	0,000
4	0,687	177,350	34	0,000
5	0,972	13,524	16	0,634

Table 3. Results of discriminant analyses

Test of Function(s)	Eigenvalue	% of Variance	Cumulative %	Canonical Correlation
1	8,094	69,6	69,6	0,943
2	2,269	19,5	89,1	0,833
3	0,821	7,1	96,2	0,672
4	0,415	3,6	99,8	0,542
5	0,029	0,2	100,0	0,168

As it is known; every one of these functions has a representation rate of variability in amongst the stand types which can be expressed as the square of the Canonical Correlation value. Therefore, when analyzing Table 3 it can be seen that the 1st discriminant function can explain 88.9% (square of Canonical Correlation) of the

variability in the all stand type. The least representative function was function#4 that has a variance representation rate of 29.4%. Therefore, the first linear discriminant function was chosen as the primary stand type discrimination function. The all discriminant functions and their parameters can be found in the following:

$$F1= -4,053+ 0,128d\bar{g}-0,001N+0,273SD-0,033G+0,019t \quad (\text{Eq.1})$$

$$F2= -3,967+0,103d\bar{g}+0,002N-0,386SD+0,044G+0,012t \quad (\text{Eq.2})$$

$$F3= -1,661-0,095d\bar{g}+0,00012N+0,715SD-0,006G+0,014t \quad (\text{Eq.3})$$

$$F4= -5,551+0,234d\bar{g}+0,00041N+2,424SD-0,473G-0,009t \quad (\text{Eq.4})$$

After carefully investigating the Table 4, 43.8% of the stand types were correctly estimated while 273 out of 486 stand types were misclassified. Furthermore, the volume (V) and the stands mean height (h \bar{g}) variables were eliminated by the discriminant analysis itself. The most successful parameter for estimating stand type was tree development. The most successful stand type was the Çzbc1 (74%) and the least successful stand type was the Çzc3 (0.0%).

The success rate (43.8%) for the discriminant analysis of this study was more successful than the studies done by Mısır and Özçelik (2002) on 132 pure oriental spruce

stands (30.5%) with 12 different stand types and by Sönmez et al. (2010) on 234 pure oriental spruce stands (30.5%) with 10 different stand types. Özçelik's (2003) study on 30 pure black pine stands, on the other hand, reached a success rate of 50.0% with 10 different stands types. The number of training data that Özçelik (2003) sampled was considered insufficient to discriminate 10 different stand types and his success rate will be lowered if he could take number of samples close to that of in this study. The linear discriminant functions created in this study however was higher than other studies.

Table 4. Stand type transitions as an analysis result

Stand Types	Predicted Group Membership																				Total	
	Çza1	Çza2	Çza3	Çzab1	Çzab2	Çzab3	Çzb1	Çzb2	Çzb3	Çzbc1	Çzbc2	Çzbc3	Çzc1	Çzc2	Çzc3	Çzcd1	Çzcd2	Çzcd3	Çzd1	Çzd2		Çzd3
Çza1	10	4	0	0	2	2	0	0	0	0	0	0	0	0	0	0	0	0	0	0	0	18
Çza2	3	7	6	0	0	2	0	0	0	0	0	0	0	0	0	0	0	0	0	0	0	18
Çza3	0	6	12	0	0	0	1	0	0	1	0	0	0	0	0	0	0	0	0	0	0	20
Çzab1	0	0	0	1	3	0	0	1	0	0	0	0	0	0	0	0	0	0	0	0	0	5
Çzab2	0	0	0	0	5	0	0	3	0	0	0	0	0	0	0	0	0	0	0	0	0	8
Çzab3	0	0	0	0	2	8	0	1	1	0	1	1	0	0	0	0	0	0	0	0	0	14
Çzb1	0	0	0	0	2	0	2	1	1	2	0	0	0	1	0	0	0	0	0	0	0	9
Çzb2	0	0	0	0	2	0	0	3	1	5	1	0	0	0	0	0	0	0	0	0	0	12
Çzb3	0	0	0	0	1	2	0	2	5	3	4	6	0	0	0	0	0	0	0	0	0	23
Çzbc1	0	0	0	0	1	0	0	1	1	26	1	1	3	1	0	0	0	0	0	0	0	35
Çzbc2	0	0	0	0	0	0	0	0	1	10	11	3	2	2	0	0	1	0	0	0	0	30
Çzbc3	0	0	0	0	0	0	0	0	2	4	5	17	0	2	0	0	0	4	0	0	0	34
Çzc1	0	0	0	0	0	0	0	0	0	9	0	0	10	1	0	3	3	1	0	0	0	27
Çzc2	0	0	0	0	0	0	0	0	0	2	3	5	5	1	0	1	7	1	0	0	0	25
Çzc3	0	0	0	0	0	0	1	0	0	0	1	7	0	0	0	0	1	3	0	0	0	13
Çzcd1	0	0	0	0	0	0	0	0	0	1	0	0	4	0	0	9	6	0	2	1	0	23
Çzcd2	0	0	0	0	0	0	0	0	0	1	0	1	2	2	0	2	11	7	2	5	0	33
Çzcd3	0	0	0	0	0	0	0	0	0	0	0	7	0	0	1	2	4	23	1	2	1	41
Çzd1	0	0	0	0	0	0	0	0	0	0	0	0	0	0	0	3	0	0	25	10	3	41
Çzd2	0	0	0	0	0	0	0	0	0	0	0	0	1	0	0	1	4	2	10	17	3	38
Çzd3	0	0	0	0	0	0	0	0	0	0	0	0	0	0	0	1	2	1	2	3	10	19
Success rate (%)	56	39	60	20	63	57	22	25	22	74	37	50	37	4	0	39	33	56	61	45	53	

Conclusion

According to the classification rules, the stand types were discriminated with the highest linear discriminant function available for the study area. Therefore, 43.8% success rate for all sampled pure Calabrian pine stands showed enough encouragement to take this study next level. Furthermore, after making the analysis, of the 486 sampling plots, 273 (56.2%) were found to belong to different stand types. It is thought that the main reason why the success rate resulted in a low value was because 46% of the stand types were transitional stands (e.g. ab, bc, cd). Therefore, by using stand types that has only one development age, the rerun discriminant analysis concluded a success rate that was found to be %64. The small openings that can affect the outcomes from crown closure parameter were not taken into while assigning crown closure values. Thus, especially fast growing species like the Calabrian pine; working more in scope and in detail of the forest inventory; obtaining data from sampling plots that fully represent the stand types when determining the stand types should be taken into account. In conclusion, it was shown that making the distinction of the stand types in the forest management plans was not sufficient enough and careful attention must be made for taking forest inventory measurements.

Acknowledgements

The data that was used in the study was part of the TÜBİTAK-TOVAG 112O808 project named “Yield Researches on Pure Calabrian Pine Stands in Antalya and Mersin Region of Turkey”. We thank employees of the Antalya and Mersin Regional Directorate of Forestry. We also thank technical support team of our project.

References

- Anonymous, 2014. Principles and Procedures Relating to the Preparation of Functional Ecosystem-Based Forest Management Plans. Notification Number: 299 (10 Dec 2014), 210 p.
- Anonymous, 2015. Forest Area of Turkey. Republic of Turkey General Directorate of Forestry Forest Management and Planning Department, Ankara.
- Bartlett, M.S., 1951. An inverse matrix adjustment arising in discriminant analysis. The Annals of Mathematical Statistics, 22(1): 107-111.
- Cohen, J., Cohen, P., West, S.G. and Aiken, L.S., 2013. Applied multiple regression/correlation analysis for the behavioral sciences. Routledge.
- Eraslan, I. 1982. Forest Management, Istanbul Univ., Faculty of Forestry, Istanbul. Pub.No: 318.
- ESRI, 2010. ArcGIS 10, ArcMap Version 10.0. Redlands, CA: Environmental Systems Research Institute.
- Forest Management Regulation Act, 2008. T.C. Official Newspaper, No: 26778, Pub. Date: 5 Feb 2008.
- Kahriman, A., Sönmez, T., Yavuz, M., Şahin, A., Yılmaz, S., Uzun, M., Kumaş, G. and Genç, Y., 2016, Yield Researches of the Pure Calabrian Pine Stands in the Antalya and Mersin Region, Technical Report (TÜBİTAK-TOVAG, Project Number: 112O808), Artvin Çoruh University, Faculty of Forestry, Artvin (in press).
- Kapucu, F., 2004. Forest Management, Karadeniz Technical Univ., Faculty of Forestry, Pub. No: 33, Trabzon, 515 p.
- Mısır, N. and Özçelik, R., 2002. Statistical Evaluation of the Stand Types Discrimination, Symposium on Conceptual Approaches in Forest Management and New Targets, 18-19 April 2002, İstanbul, p. 218-255.
- Özçelik, R., 2002. Arrangement of Yield Tables for Calabrian pine (*Pinus brutia* Ten.) Stand Types and the Use Facilities of Them in Forest Management Activities of Regional Forests Located in State-Owned of the Eastern and Western Mediterranean Regions. PhD. Thesis, Karadeniz Technical University, Institute of Natural Science, Trabzon, 307 p.
- Özçelik, R., 2003. To Evaluate the Success Rate of Forest Inventory at Stand-Type Distinctive of Discriminant Analysis. Statistics Research Symposium. Abstract Book. 10-12 December 2003, Ankara.
- Reque, J.A. and Bravo, F., 2008. Identifying Forest Structure Types Using National Forest Inventory Data: The Case of Sessile Oak Forest in the Cantabrian Range, Investigación Agraria: Sistemas y Recursos Forestales 17(2):105-113.
- Roberts, D.W., 2015. Potential natural vegetation and environment: a critique of Kusbach, Shaw & Long. Applied Vegetation Science, 18(4):733-738.
- Şahin A. 2015. Yield Researches of the Pure Calabrian Pine Stands in the Antalya and Mersin Region, PhD. Thesis, Artvin Çoruh

- University, Institute of Natural Science, Artvin, 331 p.
- Sönmez, T., Karahalil, U., Günlü, A. and Şahin, A., 2010. The Statistical Evaluation of the Discrimination of Stand type in Pure Oriental Spruce Stands, The Third National Black Sea Forestry Congress, 20-22 May 2010, Artvin. pages: 419-430.
- SPSS. 2010. IBM SPSS Statistics 19 Core System User's Guide, SPSS Programming and Data Management, 426 p.
- Torresan, C.L., Strunk, J., Zald, H.S., Zhiqiang, Y. and Cohen, W.B., 2014. Comparing statistical techniques to classify the structure of mountain forest stands using CHM-derived metrics in Trento province (Italy). *European Journal of Remote Sensing*, 47: 75-94.

Preparation of Olur Planning Unit's Silviculture Plan

*Hacı Ahmet YOLASIĞMAZ¹, Sinan GÜNER¹

¹Artvin Çoruh University, Faculty of Forestry, Artvin / TURKEY

*Corresponding Author: hayolasigmaz@gmail.com

Abstract

Forest resources in Turkey, according to the principles of ecosystem-based multiple use management approach, forest management chief office /planning units are managed by forest management plans. Forest management planning process; forest inventory, preparation of the database with GIS and preparation of the forest function map and forest management units map, determination of the silvicultural treatments and then writing the plan format consists of the preparation phase. In forest management plan, there are two different tables related to regeneration, reforestation and tending fields, the shape of silvicultural treatments, determined functional/decided allowable cut and their locations are stated. After the completion of the forest management plan begins the process of preparing silviculture plans. Silviculture plan, by forest administration chief officer, administrators and silviculture officers and directors, is preparing a series of new post-processing. Preparation of silviculture plans, enforcement has put additional workload to forest administration chief officers. In this paper; selected as pilot region, Olur Forest Planning Unit, it is aimed preparing of silviculture plan and monitoring of silvicultural application with geographic database. First of all, reforestation, regeneration and tending areas according to forest management plan will be made measurement and evaluation. Then, it will be held on reconsidering existing geographic database to prepare silviculture plan. Then silvicultural prescriptions and spatial and temporal arrangements to be prepared, and then all of them will be entered into the geodatabase. In the next step, allowable cut is to be calculated. Finally, silvicultural treatments at regeneration and tending areas will be illustrated with tables, graphs and maps. This is a case study at research area, consisting of mostly *Pinus sylvestris*, other tree species should be supported by a similar study in Turkey, particularly for mixed stands.

Keywords: Silviculture plan, Forest management plan, *Pinus sylvestris*, Geographical information systems

Introduction

According to the FAO (2015) data, the forestry areas in the world were 4.128 billion hectares in 1990, and this number has fallen to 3.99 billion hectares today. While the 31.6% of the land area in the world were forest areas in 1990, it is 30.6% today. When the fact that total forest area is 21.7 million hectares in Turkey is considered, the loss in the forest area in the world is nearly 6 times more than the whole of the forest areas in Turkey in the past 25 years (FAO, 2015; GDF, 2014). While the forests are becoming less in terms of total areas, they also experience corruption in structural forms, and fragmented forest areas increase, and many plant and animal species disappear.

The population of the human beings and their demands increase with each passing day. Because of the aforementioned reasons, the terms of sustainable forest use and management is handled in international platform, and this issue is evaluated in global

scale with the Convention on Biodiversity and similar other conventions. In this context, sustainable management of forest resources is shaped according to the criteria and indicators that are defined according to the forestry philosophy of each country. Each country has shaped the necessary legal regulations, technical and administrative infrastructures in accordance with its social and economic condition (Yolasıgımaz, 2013). 80% of the forests of the world belongs to public sector while this rate is 99.9% in Turkey. Forest areas are used for economic purposes both in the world and in Turkey mainly for production of wood (FAO, 2015; GDF, 2014). Forest areas in Turkey are administrated by the Ministry of Forestry and Water Affairs. The protected areas are managed with long-term development plans or master plans by the Nature Conversion and National Parks General Directorate. Forest areas that are used for multiple purposes such as wood, water and oxygen

production and conservation targets such as erosion control, biodiversity conservation, are managed by the General Directorate of Forestry (GDF) with forest management plans. Forest management plans are prepared with Ecosystem-based Multiple Use (Functional) Forest Management approach for each forest administration chief office/planning unit. While the plans are being prepared, firstly, the forest ecosystem inventory is prepared under eight headings (tree/stand volume and increment, the inventory of the non-wood forest products, ecological conditions inventory, biological diversity inventory, inventory intended for forestry service values, forest health inventory and the inventory of socio-cultural and socio-economic structure). Both during and after the forest inventory, information technologies (geographical information systems, remote sensing techniques, satellite images and air photographs) are used and combined with local measurements, and all the data obtained are inputted to computer and the geographical databases are thus established. Then, the forest function maps are prepared for each plan unit by making use of inventory data; and then the conservation targets and management objectives are determined in the direction of the functions and the demands of the society. Silvicultural treatments that will be applied to the forest areas in order to reach the spatial patterns, the form of the forest that is desired to reach in the direction of the social, economic, ecologic and social targets, the distribution of age classifications, the time of the silvicultural treatment, the amounts of the allowable cut, reforestation and rehabilitation areas are defined and placed in forest management plans via relevant tables. As a last item, these data are presented to the users in plan format. The plan generally consists of three parts. The first part; consists of the past and present general characteristics of the planning unit, and the attribute features and numerical data which show the socio-cultural and socio-economic structure in brief, the second part; consists of the tables and graphics that show the silvicultural treatments that need to be performed in order to achieve the defined targets and that define the forest ecosystem structure, and the third

part; consists in the form of printed-out stand maps showing the current status of the forest, the cutting map/silviculture map, and the flash disk containing digital data, which are given in the pocket in the back cover of the plan (Yolasiğmaz, 2013a; Yolasiğmaz et al., 2013; GDF, 2014b; Başkent et al., 2005; Başkent et al. 2008a; Başkent et al., 2008b; Asan, 1999).

The validity durations of the forest management plans are 10 years. The temporal projection, on the other hand, changes between 10 years (*Pinus brutia*, *Fraxinus ssp*, *Populus tremula*, etc.) depending on the biological characteristics of the tree species or 20 years (*Pinus sylvestris*, *Pinus nigra*, *Picea orientalis*, etc.). The 10-year plans are renewed when they expire, and the 20-year plans are either revised or replaced with a new plan after 10-year application process (GDF, 2014b).

Silvicultural treatments are made according to 3 different tables that are included in the forest management plans. While regeneration and tending are handled separately, reforestation is evaluated as a single table together with erosion and rehabilitation fields. The fields that will be regenerated and the total area that will be received from these fields in the 10 or 20 year plan period are given in the final yield harvesting plan table. In the intermediate yield cutting plan table, the tending areas and the allowable cuts decided on are given for the following 10 or 5 years (GDF, 2014b). Although these tables include the silvicultural treatment types, rough treatment times, and the allowable cut amounts; they do not include the silvicultural treatment methods and techniques, definite treatment times and the number of the treatments planned for the area. In addition, the data on abundant seed year in regenerations are not included in regenerations that will be applied in natural ways and additional inventory and assessments are required for the ecological conditions.

Because of the abovementioned reasons, the forest enterprise directorates, which are the appliers, need to prepare an additional silviculture plan. The validity time of the plan may cover one year, five years or twenty years depending on the conditions

like the technical team that prepare the plan, technical and economic capacity of the forest enterprise, the status of the roads, the biological needs of the tree species, the period of the regeneration, and the ecological conditions. Forest administration chief officers need to prepare silviculture plan as well as providing technical treatments that will be applied to the forest, construction of roads, cutting and extracting activities, legal regulations, communication with local people and administrations, other forestry services, etc. provided to the villages in or around the forests. This situation brings another burden to the practitioners who already have a high work load.

Once the forest management plan is completed, the silviculture plans are prepared according to the relevant silviculture regulation (GDF, 2014c). Again, the silviculture plan is prepared independently from the geographical database. Investigations that are intended to determine the ecological conditions and abundant seed year are performed in the areas where reforestation and regeneration are planned in the Forest Management Plan. The natural or artificial way of regeneration, and the silvicultural treatment methods are decided according to the ecological conditions (the characteristics of the soil, the slope, the elevation, etc.), the technical capacity of the forest enterprise, roads, transportation-marketing conditions and the existence of seed tree (Çolak and Odabaşı, 2014; Nyland, 2007).

The tending areas are the ones with productive forest areas excluding the Regeneration and Reforestation areas. Tending treatments are applied in these areas with intervals of five or ten years according to the biological characteristics of the tree species (GDF, 2014b; Odabaşı et al., 2004). The planning unit is separated into ten tending blocks, and the forest tending method to be applied to these areas, the allowable cut decided on in the forest management plan; and the years are given in the relevant tables (Saatçioğlu, 1971, Genç, 2004; GDF, 2014b; GDF, 2014c).

Geographical database has been intended especially for planning and aims to produce the baseline maps like stand map, forest

function map, forest management unit map and cutting map. The priority is forming the stand map, which is the basis of the process. There are the compartments, the stands, and the sub-compartments, the parts of the stands that are within the compartments, i.e. the coordinate and the attribute features of the sections in the forest stand map. The second stage consists of forming the forest function map and the forest management unit map. By making use of these basic data maps, the decisions will be made on how and for what purposes the forest area will be used. Only cutting maps are produced for silviculture plans. In the cutting maps (digital database), the data on the regeneration, reforestation, tending and rehabilitation areas are expressed in digital codes, but there are no data on the time of the silvicultural treatments for these areas, allowable cut amounts to be taken and the silvicultural methods. In the relevant tables that are prepared as independent from the database, this information is given roughly (Yolasıǧmaz and Keleş, 2009)

After silvicultural treatments are applied, records are kept in a compartment scale to measure the success. In these registers, which are called as the compartment record table, the silvicultural treatments to sub compartments/stands in the compartments and the number of the trees according to tree species, and the allowable cuts are given. The registers are in the type of tables and classical registry. The technological infrastructure for the monitoring and evaluating of the structural changes in the forest ecosystem and for measuring the success of the silvicultural treatments have not been established well.

Material and Method

Study Area: Olur Forest Planning Unit (OFPU) is an administrative unit of Erzurum Forest Regional Directorate, Oltu Forest Enterprise. The distance of it to Erzurum is 70 kilometers, and the minimum elevation is 1025 m, and the maximum elevation is 2842 m. The study area coordinates are ED 50 datum 37. zone 735000-784000 eastern longitudes and 4510000-4545000 northern latitudes according to UTM coordinate system (Figure 1). The total area of the forest

planning unit is 80861.51 hectares, and 28687.5 hectares of it consist of forests, 52174.01 hectares is non-forest area. In the planning unit, which consists of 615 compartments, 2237 sub-compartments and 29 different stand types have been defined for forest areas.

The areas that are the subject area for wood production are the areas where *Pinus sylvestris* is dominant. In degraded areas,

the dominant type is, again, the *Pinus sylvestris*, and there are also mixed stands where *Juniperus communis* and *Quercus pedunculata* are also included and some degraded *Juniperus communis* areas. According to OFPU's forest management plan data, eight different management units have been classified (Table 1) (GDF, 2015).

Table 1. Area distribution of the forest management unit in OFPU.

Forest Management Unit	Area (hectares)	%
A- Wood production	7281.64	9.01
B- Nature Conservation	51966.44	64.27
C- Ecological Conditions are very poor areas	6934.86	8.58
D- Forest Ecosystem Monitoring Areas	61.27	0.08
E- Erosion Control - Soil conservation	5412.33	6.69
F- Conservation of Water Sources	9149.37	11.31
G- Recreation	55.60	0.07
General Sum	80861.51	100.00

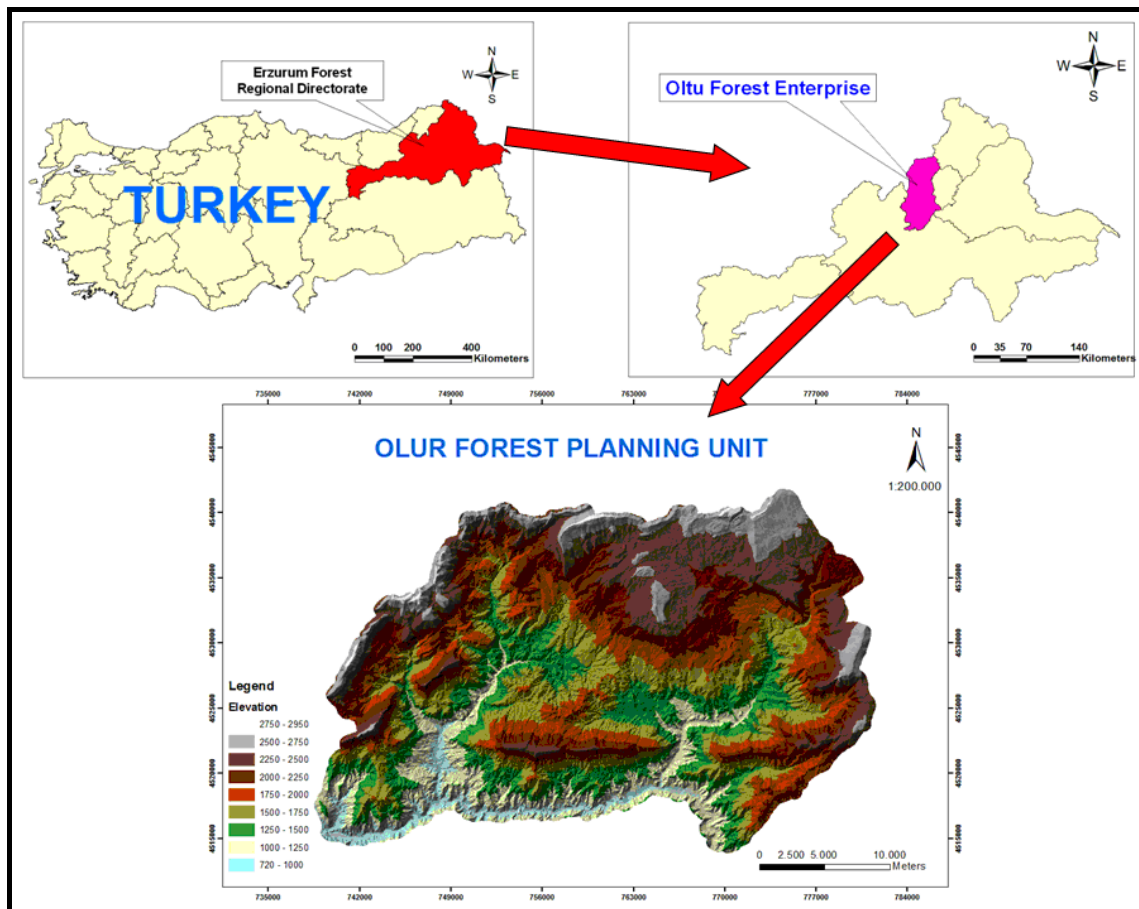

Figure 1. Study area

According to the meteorology data, average temperature is 9.8°C and annual precipitation is 393.3 mm. According to 2015 data, 6708 people live in the area (TSIE, 2016). Due to the highly-sloped topography and harsh winter conditions, the living conditions are hard in the area and the migration is still continuing (GDF, 2015).

35 different bird species have been observed in the study area, and it is expressed that the area is one of the important habitats of *Capra aegagrus* and *Ursus arctos* (Okutucu, 2007). In addition, there are thirteen different fish species living in the existing streams (Kuru, 1971, 1975; Aras, 1974 and Solak, 1977, GDF, 2015).

The endemic species in the area are as follows: *Allium incisum*, *Allium oltense*, *Astragalus acmophylloides*, *Astragalus nigrocalycinus*, *Astragalus oltensis*, *Bupleurum schistosum*, *Campanula sorgerae*, *Centaurea antiochia*, *Delphinium munzianum*, *Draba narmanensis*, *Elymus sosnowskyi*, *Hieracium caloprasinum*, *Hieracium hypopytyforme*, *Hieracium onosmaceum*, *Hieracium variegatisquamum* (Eken et al., 2006). Among these species, the endangered ones with narrow spread are the following 3 types: *Astragalus nigrocalycinus* (IUCN category: critical), *Centaurea antiochia* (endangered) and *Delphinium munzianum* (critical). In addition, the medical and aromatic use of 241 vascular plant taxons belonging to 66 families and 170 species have been defined (GDF, 2015; Önal, 2012).

Material: The forest management plan data of 2015, the geographical database, and the soil analyses in the area and the evaluations made during the inventory and observations have been used in the study. The forest management plan was prepared according to the forest inventory that was made during summer season of the year 2014. In order to prepare silviculture plan, the measurements and examinations were made in the area both in 2014 and in 2015 summer seasons. These examinations were intended to determine the ecological conditions in the areas where reforestation and regeneration areas would be made, to

define the actual stand structures and record the abundant seed year. In preparing the database, the ARC/GIS 10.0 (Arc/Info license level) software and modules, and the data analyses were used. The MS Office 2010 (MS Excel and MS Word) were also made use of in the preparation process.

Method

Database design: Silviculture plan database has been prepared by using the geographical information systems technology. The geographical database, which was prepared for forest management plan, has been used as the baseline, and the relevant data/silviculture plan data have been entered by adding the additional data fields. The area compartments, the sub-compartments, stand type data, age class and site index data, which already existed in the current database, have been made use of in preparing the silviculture plan.

In the table of final-yield cutting plan of the area, which will be included in the forest management plan, the areas where regeneration and reforestation will be applied are given. In the intermediate-yield cutting plan, on the other hand, the tending areas are shown. The tree volume and annual tree volume increment data have been added to the geographical database for silviculture plan. Then, the allowable cut data, which were previously determined, and the silvicultural treatment areas, which were previously decided on in the relevant tables, have been entered. In addition, the silvicultural treatment method, which is the basis for the silviculture plan, five different silviculture process types, five different silvicultural treatment times, the allowable cut amounts decided for each treatment, the number of the treatments, and the realized allowable cut amounts are added as data fields. After the regulation on preparing a silviculture discipline is examined, the data fields such as aspect, elevation, soil depth, soil texture, seed tree status, and actual stand structure have been added to the geographical database after the measurements and evaluations in the area.

Silvicultural prescriptions; while making forest management plan, primarily the stand map that is a baseline was prepared, and then the forest function maps were prepared. In the preparation of the forest function map, the inventory datum, requests and demands of the society, special ecosystem or species having sensitive, rare or critical importance according to the report prepared by plant and wildlife specialists were made use of. According to these maps, each functional area is defined as a management unit and when there are more than one forest functions, the main purpose or function becomes the management unit name. For each management unit, the main and secondary purposes are defined clearly. The silvicultural purposes are defined in the light of these purposes; and the purposes of the (re)establishment of the stand are determined, and the silvicultural treatment prescriptions that will be applied to each forest area (sub-compartment) are prepared in accordance with these purposes. The silvicultural treatments that will be applied to

the stands (sub-compartments) in Olur Forest Planning Unit are the reforestation, regeneration, tending and the areas that are other than treatment. In the silvicultural treatments to be applied to these areas, especially the biological features of the tree species and the stand parameters such as mixture, crown closer etc. and ecological condition such as elevation, slope, soil features (soil type, soil depth, etc.) and aspect besides the technical capacity of the forest planning unit, the potential labor force in forest villages located in forest planning unit, seedling supply and the situation of the roads have also been considered. Due to the unavailability of the roads, technical insufficiency of the forest enterprise and labor force capacity, some areas were excluded from the plan.

Reforestation areas; are the gaps and degraded forest areas that are suitable for reforestation in the forest. Silvicultural recipe to be applied to the gaps and degraded forest areas (Table 2, 3);

Table 2. Silvicultural prescriptions to the gaps

Silvicultural Treatment Numbers	Silvicultural Recipe
Silvicultural Treatment_1	Planting
Silvicultural Treatment_2	Weeding (1 years after planting)
Silvicultural Treatment_3	Weeding (2 years after planting)
Silvicultural Treatment_4	Release cutting (10 years after the second weeding)

Table 3. Silvicultural prescriptions to degraded forest areas

Silvicultural Treatment Numbers	Silvicultural Recipe
Silvicultural Treatment_1	Clear cutting +Planting
Silvicultural Treatment_2	Weeding (1 years after planting)
Silvicultural Treatment_3	Weeding (2 years after planting)
Silvicultural Treatment_4	Release cutting (10 years after the second weeding)

Regeneration areas; have been discussed as three different groups as "the fields in which regeneration has been continuing",

"crown closer degree 1" and "crown closer degree 2 and 3" (Table 4, 5, 6).

Table 4. Silvicultural prescriptions to the stands (Çsd1/Çsd0) in which regeneration has been continuing

Silvicultural Treatment Numbers	Silvicultural Recipe
Silvicultural Treatment_1	Removal Cutting (In 2015 or 2016 years)
Silvicultural Treatment_2	Weeding (1 years after the removal cutting)
Silvicultural Treatment_3	Release cutting (10 years after the weeding)

Pinus sylvestris stands in which crown closer degree is 1; it has been decided to make artificial regeneration since there is not sufficient amount of seed trees. Of these

stands, in the areas having no erosion danger and little slope, it was decided to make clear cutting. In high sloping areas having erosion danger, it has been decided to make planting under the forest canopy.

Table 5. Silvicultural prescriptions to be applied to stands in which crown closer degree is 1 (Çsd1)

Silvicultural Treatment Numbers	Silvicultural Recipe
Silvicultural Treatment_1	Clear cutting or planting under the forest canopy
Silvicultural Treatment_2	Removal cutting (Three years after the planting)
Silvicultural Treatment_3	Weeding (one year after the removal cutting)
Silvicultural Treatment_4	Release cutting (10 years after the weeding)

Pinus sylvestris stands in which crown closer degree are 2 and 3; it was decided to make natural regeneration and to use shelterwood

method since there is sufficient amount of seed trees.

Table 6. Silvicultural prescriptions to be applied to stands in which crown closer degrees are 2 and 3 (Çsd2 and Çsd3)

Silvicultural Treatment Numbers	Silvicultural Recipe
Silvicultural Treatment_1	Seed cutting (abundant seed year)
Silvicultural Treatment_2	Light cutting (3 years after seed cutting)
Silvicultural Treatment_3	Removal cutting (2 or 3 years after light cutting)
Silvicultural Treatment_4	Weeding (1 years after the removal cutting)
Silvicultural Treatment_5	Release cutting (10 years after weeding)

Tending areas: Tending is foreseen for all the forest areas except for the reforestation and regeneration areas as a requirement of the plan technique. During the preparation of spatial patterns of tending areas, primarily the spatial distribution of the tending areas and the size of annual tending areas are taken into consideration. In addition, the technical capacity of the forest administration chief office, the socio-cultural and socio-economic structures of the villages

in forest planning unit, their labor potentials, social problems and conflicts have been considered. It is foreseen in the twenty-year plan period that the tendings are performed in the area every ten years as a biological structure of the *Pinus sylvestris*. Although tending method changes depending on the development stages of the stands, low-cutting is applied to the *Pinus sylvestris* forests as a basis (Table 7).

Table 7. Silvicultural treatment methods to be applied to tending areas

Stand Symbol	Silvicultural Treatment -1	Silvicultural Treatment -2
Çsa0, Çsa	Release cutting	Release cutting
Çsb3, Çsbc3	Heavy low thinning	Moderate low thinning
Çsbc1, Çsd1	Weak low thinning	Weak low thinning
Çsbc2, Çsc3, ÇsKvbc2	Moderate low thinning	Moderate low thinning
Çscd1, ÇsKvbc1	Weak low thinning	Weak low thinning
Çscd2, Çscd3	Moderate low thinning	Moderate low thinning
Kvb2, Kvbc2, Kvcd2	Moderate low thinning	Moderate low thinning

The planning unit is divided into ten different tending blocks, each area is mapped

so as to receive two tending within the 20-year period, and then the tables are

organized. Ten different tending blocks have been formed in the study area, and each tending block has been divided into ten sub-blocks and given numbers. The treatment years have been determined according to the sub-blocks order in each tending block in such an order that the first treatments will be completed between the years 2015 and 2024, and the second treatments will be completed

Final Yield Allowable Cuts are the allowable cuts received from the areas that are the subject matter of regeneration. Since the shelterwood method or the planting under the forest canopy will be generally used in these areas, the whole of the volume in the area will be received within twenty year-period. After regeneration is applied in a healthy manner, the upper trees will be extracted with removal cutting. Within the seed cutting and removal cutting, the remaining trees will increase. For this reason, the allowable cut is calculated in the regeneration areas, and the half of the tree volume increase has been added to the existing tree volume. Depending on the silvicultural treatment method and cutting technique, the allowable cut amounts to be taken from these areas have been calculated as follows;

- In degraded stands, it has been foreseen that all of the growing stock will be cut by clear cutting and planting will be made instead of it.
- *Pinus sylvestris* stands in which crown closer is 1, if planting under the forest canopy is made, the available growing stock for the first treatment will be taken of 20%, and light cutting for the second treatment are foreseen. It was foreseen to cut 50% of the remaining growing stock, and 97% of the remaining growing stock in the removal cutting that is the following treatment.
- If clear cutting is made, 97% of the growing stock will be cut clearly in the first treatment, and planting will be made instead of it.
- *Pinus sylvestris* stands in which crown closer is 2, if shelterwood method is made in 20% of the available growing stock in the seed cutting that is the first treatment.

between the years 2025 and 2034. According to the legal regulations, the cutting works in the planning unit must be given to the local people living in the nearest residential area (forest village); and therefore, spatial arrangement has been regulated so as to provide employment for each village in each year.

It was foreseen to take 50% of the remaining growing stock in the light cutting that is the second treatment and 96% of the remaining growing stock in the removal cutting.

- If clear cutting is made, 97% of the growing stock will be cut clearly in the first treatment and planting will be made instead of it.
- If planting under the forest canopy is made as 20% of the available growing stock in the first treatment, it is foreseen to take 50% of the remaining growing stock in the light cutting that is the second treatment, and 97% of the remaining growing stock in the removal cutting.
- *Pinus sylvestris* stands in which crown closer is 3, shelterwood method will be applied as 40% of the available growing stock in the seed cutting that is the first treatment and it was foreseen to take 50% of the remaining growing stock in the light cutting that is the second treatment and 96% of the remaining growing stock in the removal cutting.
- The 3-4% of the growing stock left in the regeneration areas was left as a value tree for ecological and biological balance.

Intermediate Yield Allowable Cuts are the allowable cuts that are received from the areas where forest tendings are performed. When the forest management plan is prepared, the tree volume and increment inventory are made, and the trees in the sampling area are measured and evaluated one by one, and the intermediate allowable cuts are defined according to the silvicultural principles. The numbers of the trees that will be extracted in each stand according to the tree species, diameter distributions, and the tree volume values that will be extracted in the hectare are given in the relevant tables.

The crown closer and development stage, which are among the stand parameters, i.e. the structural properties of the stands, define the dosage and the tending method that are intended to be applied to these areas are defined. Allowable cuts for tending are calculated after the forest inventory, and are decided according to the forest function of the forest area, the management objectives and the conservation targets, social pressure, the ecological conditions, the situation of the roads, the technical capacity of the forest administrative chief office.

Results and Discussion

By using the digital database prepared with the geographical information systems, many maps, tables and graphics may be produced as outcome products. The stand map, forest function map, forest management units map, cutting map, land use maps, site index and age class maps, main tree species distribution and mixture maps, and the maps

showing the development stages and the relevant tables and graphics are among the first outcomes. Besides these, many data and graphics may be produced by making cross evaluation and analyses like the tree species according to the forest management units, age class, site index, or the distribution of silvicultural treatments according to the forest functions, the distribution of the tending areas or development stages according to the age classes. Especially in this section, the cutting plan map intended for the silviculture plan, which is the basic topic, the silvicultural treatment techniques that will be applied within the twenty-year plan period, the allowable cut distributions according to the silvicultural treatments years are given and evaluated in maps and tables (Figure 2).

According to the cutting map in the forest management plan, the areas for which reforestation, tending and regeneration foreseen are given in Table 8.

Table 8. Area distribution of silvicultural treatment according to the forest management plan.

Silvicultural Treatment	Area (ha)	%
Reforestation	181.85	0.22
Tending	6872.02	8.50
Regeneration	544.54	0.67
Non-treatment	64928.60	80.30
Other	91.18	0.11
Residential Areas	601.81	0.74
Agriculture Areas	7641.51	9.45
General Sum	80861.51	100.00

According to the forest management plan, 217417.481 m³ allowable cut is foreseen; and according to the silviculture plan, 215469.820 m³ allowable cut is planned. 1947.661 m³ allowable cut has been omitted from the plan due to the areas that were excluded from the study because of technical reasons, and the areas that were left for the conservation of wild-life. When the annual tree volume increment is 24055.838 m³/year, 44.78% of the annual increment will be taken as the allowable cut. The annual allowable cut taken from forests in Turkey is approximately 40% of the annual tree volume increment, which is similar to the value of the research (GDF, 2015).

While making treatment for two times each field with 10 year return time in 20-year plan period in the tending fields, it is foreseen to be made five treatments at most depending on the year in which the first treatment has been made. In the fields subjected to the tending, thinning and release cutting were foreseen in the treatments to be made for the first time. The second and third treatments were foreseen as weeding and release cutting. Shelterwood method was given weight due to the large part of the regeneration fields being high slope (Table 9).

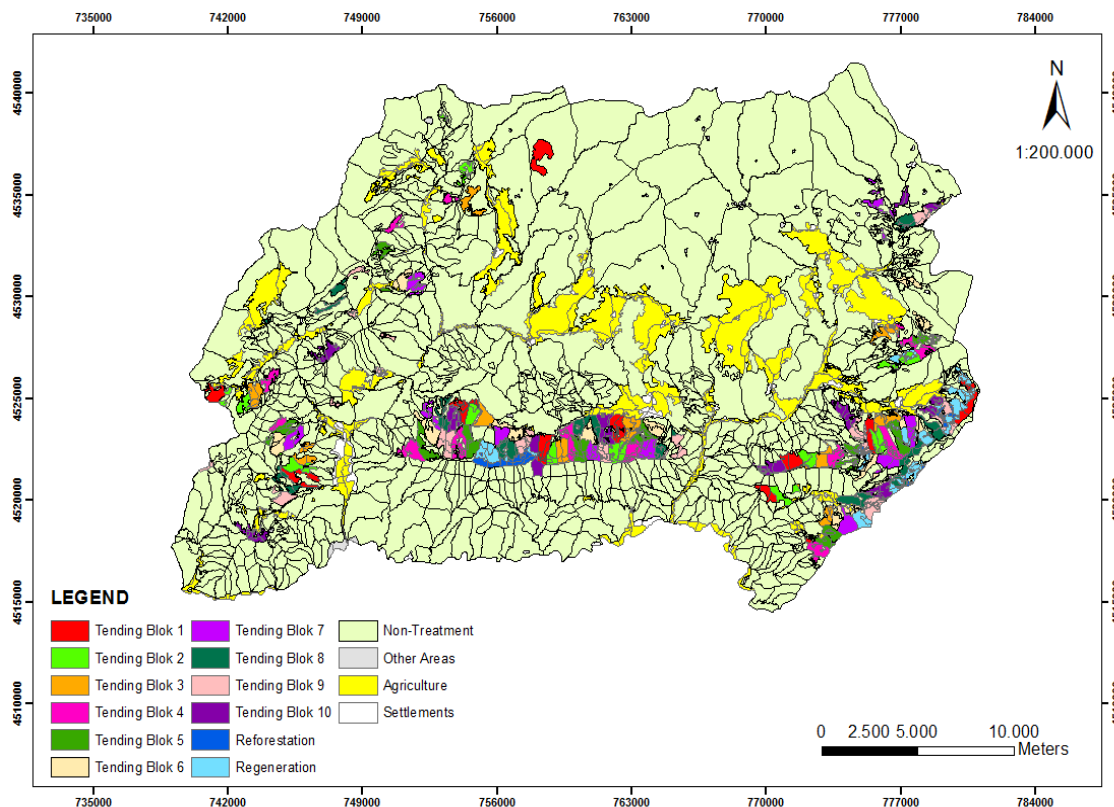

Figure 2. Silviculture treatment map according to Olur Silvicultural Plan.

Table 9. Area distribution of silvicultural treatment method according to silviculture plan.

Silvicultural Treatment Method	Area (ha)
Reforestation Areas	181.85
Planting	107.50
Artificial Regeneration_ Clear Cutting	74.35
Tending Areas	6872.02
Thinning	5321.53
Release cutting	1443.89
Non-treatments	106.60
Regeneration Areas	544.54
Natural Regeneration_ Shelterwood	356.61
Artificial Regeneration_ Clear Cutting	17.10
Artificial Regeneration _ Planting under The Forest Canopy	170.83

The areas where tending areas would be performed were distributed evenly for each year, and the average annual tending areas were 676.542 ha/year, the average annual allowable cut from tending areas was 4300.238 m³/year, and the allowable cuts from tending areas were 86004.768 m³ in total, and its rate in the total allowable cut was 39.91%. The allowable cut that will be obtained in regeneration areas constitutes the 60.09% of the total allowable cut amount. It

has been aimed that the annual treatment area and the annual allowable cut amount would be equal in the treatments in the regeneration areas and the annual average treatment area has been planned as 101.545 ha/year and the annual average allowable cut to be received from the regeneration areas would be 6437.192 m³/year. When the allowable cut and treatment area amounts are examined and evaluated according to the years together with the tending and regeneration, the

average annual treatment area is 787.197 ha and average annual allowable cut is 10773.491 m³/year (Table 10).

Table 10. Silvicultural treatment areas and the allowable cut distributions according to the treatment years.

Treatment Year	Reforestation		Tending		Regeneration		Total Treatment Area (ha)	Total Allowable cut (m ³)
	Area (ha)	Allowable cut (m ³)	Area (ha)	Allowable cut (m ³)	Area (ha)	Allowable cut (m ³)		
2015	-	-	670.87	3238.74	79.77	9088.65	750.64	12327.39
2016	67.09	216.02	580.75	3746.29	14.13	839.86	661.97	4802.17
2017	17.95	-	671.15	4037.39	73.34	2818.23	762.44	6855.62
2018	33.68	-	726.94	5052.62	81.66	6816.49	842.28	11869.11
2019	-	-	720.16	5013.34	93.99	8669.00	814.15	13682.34
2020	-	-	667.38	4439.61	83.68	7844.67	751.05	12284.29
2021	-	-	653.39	4551.59	113.26	6543.83	766.65	11095.42
2022	-	-	705.39	3967.01	161.52	7872.98	866.90	11839.99
2023	-	-	662.13	4448.49	93.73	7550.20	755.85	11998.69
2024	33.90	328.84	707.26	4507.28	53.15	2443.93	794.31	7280.04
2025	-	-	670.87	3238.74	95.00	5845.25	765.87	9084.00
2026	14.17	137.41	580.75	3746.29	152.39	4548.98	747.30	8432.68
2027	-	-	671.15	4037.39	90.43	9809.20	761.58	13846.59
2028	-	-	726.94	5052.62	38.52	5208.99	765.46	10261.62
2029	-	-	720.16	5013.34	120.55	8331.48	840.71	13344.82
2030	-	-	667.38	4439.61	141.23	7735.44	808.61	12175.06
2031	-	-	653.39	4551.59	102.80	6000.12	756.20	10551.71
2032	15.07	38.95	705.39	3967.01	139.80	1659.63	860.25	5665.60
2033	-	-	662.13	4448.49	107.63	7426.02	769.76	11874.52
2034	-	-	707.26	4507.28	194.35	11690.89	901.61	16198.17
General Sum	181.85	721.21	-	86004.77	-	128743.84	-	215469.82

Conclusion

In this review, the forest resources planning process in Turkey has been examined in terms of forest management and silviculture disciplines. The forest management plan for Olur Forest Planning Unit, i.e. the study area, and the silviculture plan and the database, which forms the baseline, have been prepared and introduced. The database is user-friendly and suitable for the forestry infrastructure in Turkey, and provides monitoring, evaluation, and reporting opportunities of the forest ecosystem in a flexible structure. Maps, tables and graphics may be produced in any desired size and detail by making use of the database based on many parameters like the stand type, the compartment, the development stage, the site index, the age

classes, the forest functions, the management units, the silviculture treatment years, the allowable cut forms, the stand volume, and the increment. The study area silviculture plan, the maps, the tables and the graphics have been prepared by making use of the database.

The silviculture plan has been prepared for the forest ecosystems where one single type is dominant generally in pure *Pinus sylvestris* stands. Silvicultural treatment prescriptions that are planned to be applied to the forest areas where there are mixed stands and which consist of a few tree species, the application techniques will be different. The numbers, years and the allowable cut amounts of the silvicultural treatments will also vary. For these reasons, similar studies must be conducted in other forest areas in our

country, and the silviculture plans and geographical databases for each forest

Acknowledgement

We owe gratitude to the 'ANÇEO Anatolian Environment Forestry Mapping Ltd. Inc.'; General Directorate of Forests; and to Artvin Çoruh University Forest Faculty for their helps and supports in preparing the silviculture plan and the forest management plan.

References

Aras, M. S., 1974. Bio-ecological Researches on the Trouts in Çoruh and Aras Basin, Phd. Thesis, Atatürk University Institute of Science and Technology, Erzurum, Turkey, p. 275

Asan, Ü., 1999. Multiple Use of Forest Resources and Planning Systems. In Proceeding of Meeting on the Multiple Use Forest Management Planning, Bolu, Turkey, 5–6 May, 33–40.

Başkent E. Z., S. Köse, S. Keles, 2005. Forest management planning system of Turkey: constructive criticism towards the sustainable management of forest ecosystems, *International Forestry Review*, 7 (3) 208–217.

Başkent, E.Z.; Ş. Başkaya,; S. Terzioğlu, 2008a. Developing and implementing participatory and ecosystem based multiple use forest management planning approach: Yalnızçam case study. *Forest Ecology and Management*, Volume 256, Issue 4, 798-807.

Başkent, E.Z.; S. Terzioğlu, Ş. Başkaya, 2008b. Developing and Implementing Multiple-Use Forest Management Planning in Turkey. *Environmental Management*, 42, 37-48.

Eken, G., M. Bozdoğan, S. İsfendiyaroğlu, D.T. Kılıç, Y. Lise, 2006. Important Natural Areas in Turkey (2 volumes). Association of Nature, Ankara.

Eraslan, İ., 1982. Forest Management, Istanbul University, Forth Press, İstanbul, p. 582.

FAO, 2010: Global Forest Resources Assessment 2010 Main Report, FAO Forestry Paper 163, Food and Agriculture Organization of the United Nations, Rome, p. 371.

FAO, 2015. Global Forest Resources Assessment 2015 How are the world's forest changing?, Food and Agriculture Organization of The United Nations, Rome, p. 56.

GDF, 2014a. Forest Inventory Results. Republic of Turkey Ministry of Forestry and Water Affairs General Directorate of Forestry, Forest Management and Planning Department, Ankara, p. 28

planning unit must be established.

GDF, 2014b. Preparation of Technical Principal of Forest Management Plan in Turkey. Notification Num: 299, Republic of Turkey Ministry of Forestry and Water Affairs General Directorate of Forestry Directorate of Silviculture, Ankara, p. 210.

GDF, 2014c. Technical Principal of Silviculture Applications. Republic of Turkey Ministry of Forestry and Water Affairs General Directorate of Forestry Directorate of Silviculture, Notification Nu: 298, January, Ankara, p. 144.

GDF, 2015. Olur Forest Management Plan. General Directorate of Forestry, Ankara, Turkey, p. 232.

GDF, 2015. Turkey Forest Wealth. Republic of Turkey Ministry of Forestry and Water Affairs General Directorate of Forestry, Ankara, p. 32.

Genç, M. 2001. Forest Tending. Süleyman Demirel Univ. Isparta, Turkey, Pub. Num: 14, p. 244.

Kuru, M. 1971. The fresh - water fish fauna of eastern Anatolia, İstanbul Univ., Serial: B, 36, 137–147.

Kuru, M. 1975. Systematic Assessment of Zoogeographical on fishes (Pisces) in the Dicle-Fırat, Kura-Aras, Lake Van and the Black Sea Basin. Assoc. Thesis, Atatürk University, Erzurum, Turkey, p. 180.

Nyland, R. D., 2007. Silviculture Concepts and Applications, Second Edition, State Univ. of NewYork, Collage of Environmental Science and Forestry, Long Grove Illinois, p. 682.

Odabaşı, T., A. Çalışkan, F. Bozkuş, 2004. Forest Tending Book. İstanbul University, Serial Nu: 4458, Volume: 474, İstanbul, Turkey, p. 235.

Okutucu, M. A. 2007. Population Studies on Capra aegagrus in Oltu Wildlife Development Area. Phd Thesis, Kafkas Univ., İnstitute of Science and Technology, Artvin, Turkey, p. 178.

Önal, M., 2012. Medicinal and Aromatic Plants in Olur, Oltu and Şenkaya Villages. Phd. Thesis, Artvin Çoruh University, İnstitute of Science and Technology, p. 215.

Saatçioğlu, F. 1971: Silvicultural Methods, İstanbul Univ, 1648/172, İstanbul, Turkey, p. 562.

Solak, K., 1977. Population Dynamics on Barbus Species in Çoruh-Aras River Basin, Ege Univ., Journal of Science Faculty., Serial Nu: B, 4, 361- 374.

TSIE, 2016. Population Statistics, Turkish Statistical Institute, http://www.nufusu.com/ilce/olur_erzurum-nufusu

Yolasıgmaz, H. A., 2013. Forestry in Turkey from the Forest Management Perspective. In Proceedings of the International Caucasian

Forestry Symposium, Artvin, Turkey, 24-26 October, 299-301.

Yolasıǧmaz, H. A., S. Keleş, 2009. Data Base Design with GIS in Ecosystem Based Multiple Use Forest Management in Artvin, Turkey: A Case Study in Balcı Forest Management Planning Unit. *Sensors*, 9, 1644-1661.

Yolasıǧmaz, H.A., N. Tüylü, E. Süner, B. Çavdar, 2013. The Evaluation of Forest Management Plans Prepared by Private and Public Institutions: Artvin-Şavşat and Yusufeli Samples. In *Proceedings of the International Symposium for the 50TH Anniversary of the Forestry Sector Planning in Turkey*, Antalya, Turkey, 26-28 October, 377-383.

Bulgarian Forests and Forest Management

Anna PETRAKIEVA¹, Neno ALEXANDROV², Marius DIMITROV², *Milko MILEV²

¹Executive Forest Agency, Sofia/ BULGARIA

²Forestry University, Faculty of Forestry, Sofia / BULGARIA

*Corresponding Author: m_milev@abv.bg

Abstract

Bulgaria is not a big country (11 099 400 ha) but its forests cover considerable part of the territory and preserve extremely diverse and rich biodiversity. Forest territories in the country increase continuously in the recent years and at the end of 2015 they amount to 4.222.874 ha, or more than 37 % of the territory of the country. Forests cover 91 % of this area. The Bulgarian forests are distinguished by very rich diversity of coniferous and deciduous species. The deciduous forests occupy 68.4 % of the total area of forests lands and continue to expand its share, while the coniferous forests occupy a bit more than 21 % of the forest area. More than 55 % of the forest territories are in NATURA 2000 and cover over 60 % of the priority for the preservation of species habitats.

Forest management in Bulgaria is aimed at protection and increasing the main functions of forests, giving priority to the natural renewal, conservation of genetic resources, maintenance and restoration of biological diversity, etc. The balance between the average annual increment and average annual use of timber is one of the most important indicators for the sustainable management of forests. The most impressive achievements of the Bulgarian foresters are the afforestation works, which amount, together with the forest shelter belts and the erosion control plantations, about 13.000 hectares.

The training of forestry expert is performed to date only in the Faculty of Forestry of the University of Forestry, Sofia.

Keywords: Bulgaria, Forests, Forest management, Forestry.

Introduction

Bulgaria is situated in the south-eastern part of Europe, in the central part of the Balkan peninsula with a total area of 11.073.350 ha (110.000 km²).

Although Bulgaria is a comparatively small country it possesses a rich biological diversity due to the interaction of different climatic, hydrological, geological and topographic conditions. The variety of altitudes and relief has its influence over temperature and precipitation and is another reason for the variety of climate conditions. About 73 % of the area is up to 600 m altitude while the mountain areas are about 27 %.

Structure of the forest ownership in Bulgaria

The area covered by forest territories as of 31.12.2015 is 4 222 874 ha. State owned

forests territories are 3.092.386 ha (73.23 %), of which 2.906.508 ha (68.83 %) are managed by the State Forest Companies, established under the Forest Act from 2011; 174.463 ha (4.13 %) are managed by the Ministry of Environment and Waters including National parks and reserves, 11.415 ha (0.27 %) are placed at Forest University's disposal as Forest Experimental and Training Centres.

Private forest territories cover 1.042.101 ha (24.68 %), of which 551.334 ha (13.06 %) are municipal, 470.422 ha (11.14 %) are owned by physical and legal persons and 20.345 ha (0.48 %) – owned by religious organizations (fig. 1).

The area of agricultural lands that had acquired character of forest according to the Forest Act is 88.387 ha (2.09 %) (EFA, 2015).

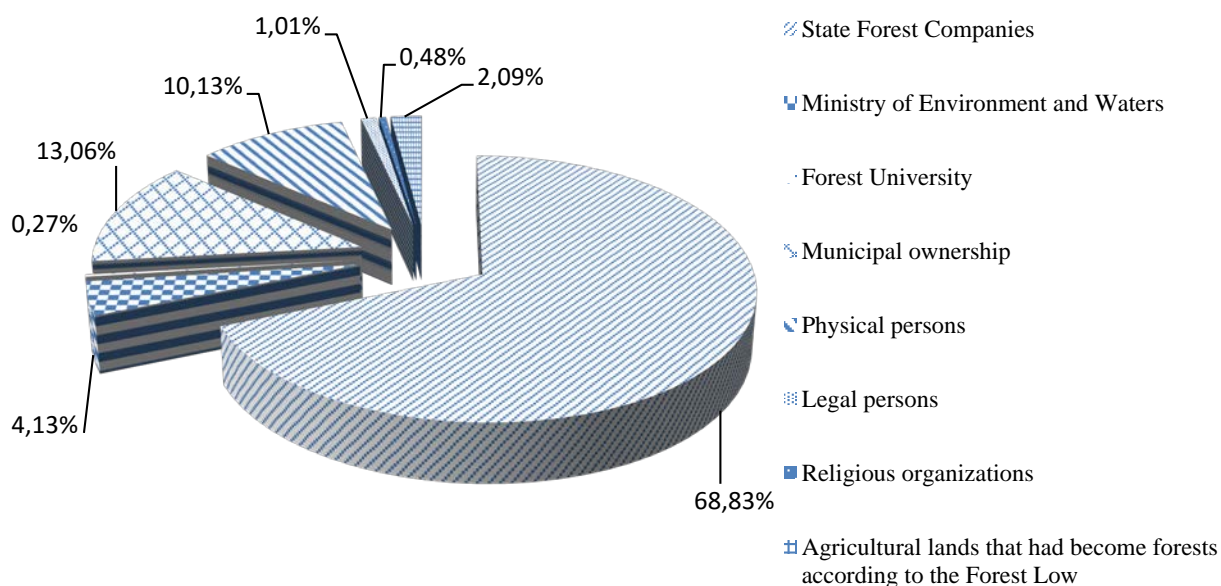

Figure 1. Distribution of forests territories according to types of ownership

Characteristics of the forest territories – area, growing stock, increment and main tree species

3.857.658 ha (91 %) of forest areas are occupied by forests. The area of free forest wood vegetation forest areas is 365.216 ha (9 % of the

total forest area), including unproductive forest areas 300.151 ha (7 %) and non-afforested areas for afforestation 65.065 ha (2 %).

The tendencies in the change of the forest territories in the last decades are positive, as it is visible in the graphics bellow (fig. 2) (EFA, 2015).

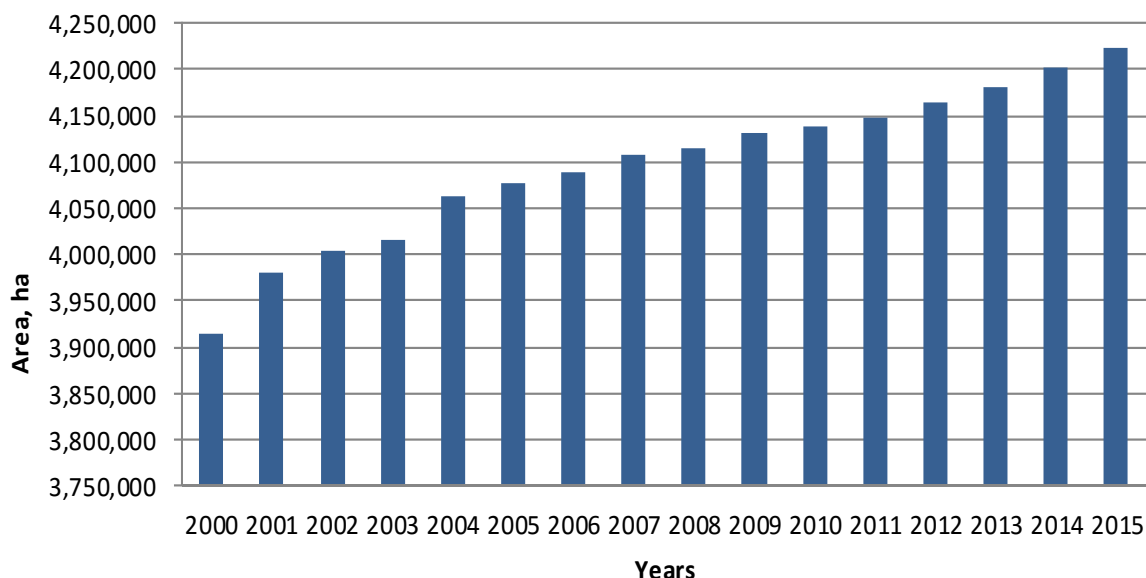

Figure 2. Change in area of forest territories for the period 2000 – 2015

The afforested area is growing faster than the total area of the forest territories as for the period 2000 – 2015 the general increase in forest areas is 308.519 ha, while

territories covered with forests have increased by 459.351 ha.

During the last years, the increase is mainly due to the conducted inventories, presenting as result additional forests and due to natural afforestation of agriculture territories, becoming forests (EFA, 2015).

The Bulgarian forests are distinguished with incredibly rich biological diversity, including of tree species. This determines the significant number of species with economic importance. Approximately 2/3 of the forests in Bulgaria are broad-leaved, predominantly coppice forests. These forests are result of several centuries of forestry activities. Because of their proximity to towns and villages and the easy access, the broadleaved forests (mainly oaks) were

subjected to strong anthropogenic influence in the past. Due to the widely applied clear cuts in the beginning of the last century, lots of the water-catchments in the lower forest-belt were strongly eroded. In the 50s of the last century, large-scale afforestations were carried out on the eroded areas, through establishment of coniferous plantations (mainly Scots and Austrian pine). In such a way the erosion was put under control and the forest environment was restored (EFA, 2013).

In the fig. 3 are presented only the main tree species, and should be pointed out that under “other” are included more than 30 species.

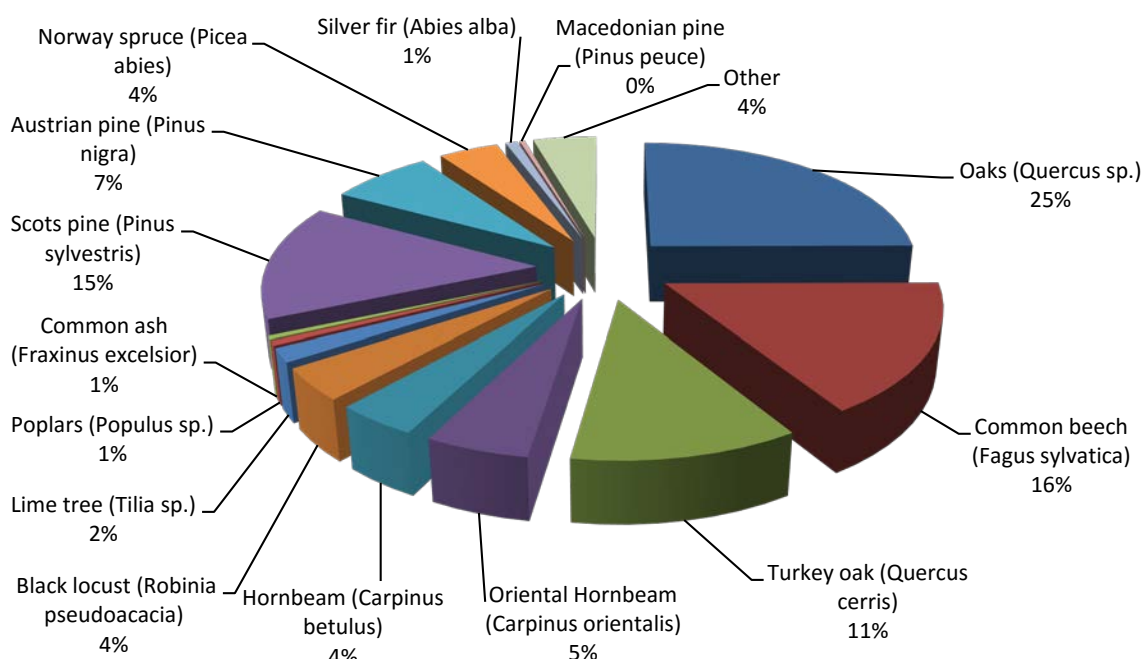

Figure 3. Distribution of tree species

Coniferous forests cover 28 % of the total forest area while deciduous forests – 72 % (fig. 4). Oak forests cover the zone up to 1200 m altitude; beech forests rise up to 1600 m, and the coniferous zone stretches to the upper forest limit.

Naturally regenerated forests or high forest cover 78.5 %, while forest plantations cover 21.5 % of the total forest area.

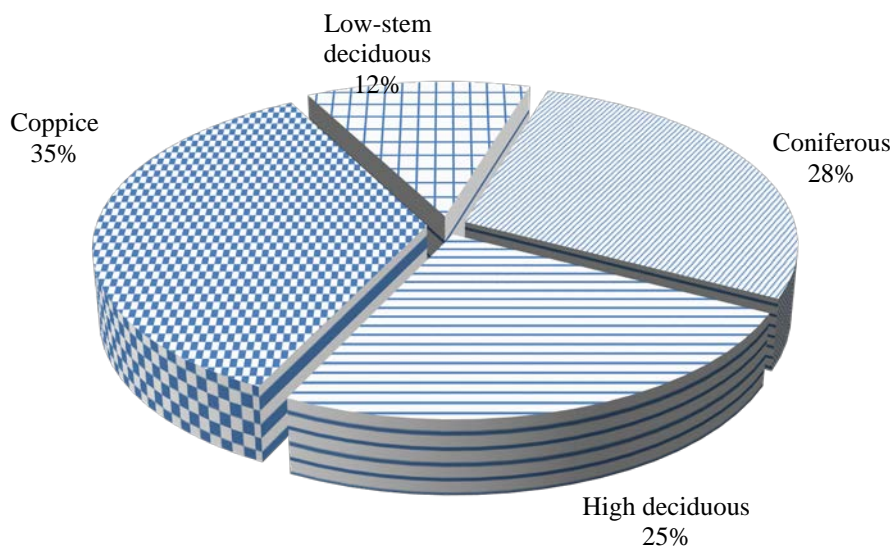

Fig. 4. Distribution of forests according their origin

The pure stands cover 45.2 % of the total area, while mixed forest cover 54.8 %.

Depending of their functions, forest territories in Bulgaria are divided into three categories – forest with productive functions (37.7 %), and the rest 62.3 % are with protective functions and special functions. Since 2010 the area of forests with special functions has increased mainly due to the newly declared protected areas (protected sites, landscapes and nature parks) and now the area of these forests cover 19.1 % of the total forest area.

Forests included in the Natura 2000 network are about 58 % of the forest area.

The average age of forests in the country is 57 years, and the total growing stock is 680,522 thousand m³, of which 64.8 % are in the protected and recreational forests. The average growing stock per ha is 178 m³. The annual increment is 14 mln.m³ (EFA, 2016).

Forests and climate

The significant forest resource in Bulgaria and its sustainable management are key factors for the reduction of greenhouse gasses. The prognoses of the dynamics of forest resources for the period 2015 – 2030, prepared according to the European forest information scenario model – EFISCEN, 2009, shows that at the moment the Bulgarian forests are a reservoir of 229 million tons of carbon, which in 2020 is

expected to reach 264 million tons, and in 2030 – 288 million tons (EFA, 2014).

According to the Third National Action Plan on Climate Change (MEW and ICC, 2012), in the last 21 years, the absorption of greenhouse gases by forests, pastures and meadows compensate between 11.35 % – 19.9 % of the total greenhouse gas emissions in Bulgaria. The forest areas have the biggest contribution for absorbing and storing carbon (94 – 95 % of the total absorption).

In the National Strategy for Development of the Forest Sector 2013 – 2020 the preservation of vital, productive and multifunctional forest ecosystems has been marked as a priority that helps for reduction of the negative consequences of the climate change.

The increase of the forest land through afforestation of abandoned agricultural lands, bare and deforested areas, eroded and threatened by erosion areas as well as the speeding of tending activities and improvement of forest condition will allow them to fulfil their productive, ecological and protective functions in a better way on one hand. On the other hand, this will have a positive effect on the absorption of carbon dioxide and the accumulation of carbon in the forests.

A lot of surveys and surveillance of the climate of Bulgaria have been conducted in the past few years (MAF 2013; Raev, 2015; Raev et al., 2011; Raykov et al., 2011). The results show that since the end of the 70s there has been a tendency to warming, positive anomalies of the average air temperature, decrease of the snow thickness and a shift of the border of deciduous forests towards a higher altitude. All these results has to be considered because it is probable that climate change could bring negative consequences for the forests which will probably include changes in their condition and productivity as well as changes in the geographical range of some types of trees.

Forest Management in Bulgaria

The modern silvicultural concepts applied in Bulgaria are based on the principles of close to nature and sustainable forest management. These trends were imposed on the one hand because of the higher expectation of the society for multifunctional use of forest resources, and on the other because more than 58 % of the forest territories are included in Natura 2000 European ecological network.

Over the last two decades a number of forestry practices used in the past were re-evaluated.

Some of them were assessed as unfriendly to nature and their application was terminated. The widely applied in the past reconstructions of coppice forests through clear-cuts combined with artificial regeneration through planting of coniferous species was suspended. The application of this practice had been motivated by the primary objective of increasing the forest productivity. The contemporary forestry science is more and more interested in other important objectives such as conservation of biodiversity, provision of forest ecosystem services, adapting of forests to projected climate change, etc. The productivity of forest is an important indicator but it is not an end in itself.

The expected climate change affects mostly the forests in the lowland zones. Here dominate coppice stands and forest

plantations which were established after reconstruction of coppice forests or in compliance with technical projects for erosion control. The increased risks of biotic and abiotic problems are already present. The Scots pine plantations under 1000 m. altitude largely suffer from attacks of various pests such as Pine processionary (*Thaumetopoea pityocampa*) and other species.

Dense schemes of planted forests, as well as the inadequate implementation of tending activities resulted in mass abiotic damages such as snow breaks, windbreaks etc. To adapt these stands to the expected climate change and to restore the natural broadleaved vegetation a transformation to continuous cover forestry (CCF) is practiced nowadays. CCF is applied also for enlargement of the share of the seed-broadleaved forest, which is achieved through a system of regeneration and tending activities.

The main silvicultural systems applied in Bulgaria are those that give priority to the natural regeneration. A priority is given to fellings with long regeneration period, which provide greater variation in stand structure, more species diversification and continuous forest cover. In natural pure or mixed coniferous forests of fir, spruce and beech a selection fellings are applied which provide the maintenance of their uneven-aged structure. In such a way the provision of forest ecosystem services such as water and soil protection, recreation etc. is guaranteed, and the optimal use of forest productivity ($10\text{--}12\text{ m}^3\text{ year}^{-1}$ growth) is ensured.

The analysis of data of forest resources on a national scale indicates that after 1980 the use of timber starts to lag seriously behind annual growth. Since 1990, the amount of the annual timber use varies from 33.7 % to 55 % of the total average annual increment of the forests in the country.

The average annual increment per hectare is 3.65 m^3 , compared to the average of $4.7\text{ m}^3\text{ ha}^{-1}$ for the countries of the EU. With the highest growth per ha are coniferous forests – $6.2\text{ m}^3\text{ ha}^{-1}$, followed by the high deciduous – $3.7\text{ m}^3\text{ ha}^{-1}$. The values of the average growth of coppice and low-stem forests are correspondingly 2.5 and $2.3\text{ m}^3\text{ ha}^{-1}$ (table 1).

Table 1. Forest in Bulgaria – average data

Forests	Afforested area		Total growing stock		Average age, years	Average growing stock, m ³ per ha	Average growth, m ³ per ha annually
	ha	%	thousand m ³	%			
Coniferous	1,078,368	28.0	302,615	44.5	61	281	6.22
High-stem broadleaved	645,728	24.5	201,191	29.6	76	312	3.74
Coppice for conversion	1,351,815	35.0	158,050	23.2	50	117	2.5
Low-stem	481,747	12.5	18,665	2.7	30	39	2.3
Total	3,857,658	100.0	680,522	100.0	57	178	3.65

The amount of harvested timber in 2015 of all forest territories is 8.389.273 m³ (standing volume), which represents 99.17 % of the planned quantities according to the forest management plans (FMP) (8.459.437 m³). The amount of harvested timber by regeneration fellings represents 47.87 % of the total volume, while the rest 52.13 % are from tendings (EFA, 2016).

Almost 2/3 of the annual volume of harvested timber is harvested in state forest areas. In the municipal forests the use during the period 2012 – 2015 is from 9.8 to 12 % of the total timber cut of all forest areas. The share of harvested timber from other non-state forests is 12.7 to 16.7 % of the total timber cut of all forest areas (EFA, 2016).

The implementation of tendings improves the future forest composition, structure, sustainability and productivity and is a priority in the forest management activities for the last years.

In 2015, the tendings aiming at regulation of tree species composition and improvement of growth conditions were implemented on an area of 42.955.1 ha state forests, which represents 59.6 % of the planned territories according to the FMPs (EFA, 2016).

From the implemented tendings 47.8 % are in coniferous forests, 34.4 % in deciduous high-stem forests and 17.8 % are in coppice forests for conversion into high stem forests.

Inadequate implementation of the planned tendings hides risks of worsening of the young stands species composition, declining the stand stability, deterioration of the timber quality and last but not least increases the risk of fires and insufficient timber use.

On the other hand, a wider use of irregular shelter wood fellings, and selection fellings such as single-selection and group-selection fellings as well as the selection tendings contributes to the establishing of multiaged stands. These fellings also support the development of local tree species and origins and preserve of the natural habitats.

According to the data of Executive Forest Agency tendings in non-state forest territories were implemented on 6012.2 ha in the municipal forests and on 5250.6 ha in the private forests.

The selection of appropriate tree species for afforestation or their support during the implementation of tendings is a very important measure for securing the forest sustainability.

In 2015 the support given to the natural regeneration was done on a total area of 5869.3 ha.

The provision of quality reproductive material, as well as the preservation of biological diversity and conservation of indigenous species improved by the methods of forest genetics and selection of genetic resources is of particular importance for the Bulgarian forests.

The area of seed stands occupies 1 % of the total forest area of the country and the number of basic seed-production sources is 5101 of 48 tree species, of which 15 coniferous and 33 deciduous (EFA, 2016).

Planning in the forest sector

The planning in the Bulgarian forest sector is conducted on three levels – national, regional and local.

The strategic documents on national level are defined in the Forest Act and are: the National Forest Strategy and the Strategic Plan. On regional level are introduced Regional plans for development of the forest territories, and on local level depending on the size of the relevant territory a forest management plans or a programme has to be developed.

All forest territories in the country are inventoried. All State Forest Enterprises and State Hunting Enterprises have current FMPs, while for approximately 90 % of the municipal forest territories FMPs are developed. Around 30 to 40 % of the forest territories owned by physical and legal persons and by religious organizations has FMPs or programmes developed (EFA, 2013).

The national forest inventory is also defined in the Forest Act and is expected steps for its realization to be undertaken in the near future.

Conservation of biological diversity in forests

Bulgaria is located at the junction of three climatic regions – Continental, Transcontinental and Trans-Mediterranean region. The complex topography of mountain chains, hills, valleys, lowlands and plains is another reason for the high diversity of habitats, from alpine forest zones, herbaceous lowlands and plains to the complexes of dunes at the Black sea coastline. The combination of types of habitats and climatic variations maintain a high level, one of the highest in Europe, of diversity and endemism of plant and animal species (EFA, 2014).

Forests and forest ecosystems are those, which keep the largest share of natural biological diversity.

Forest ecosystems may be significantly affected by possible changes in the climate. The different scenarios of climate change presented in the approved “Programme of measures for the adaptation of the forests in Republic of Bulgaria, and Mitigation of the Negative Impact of Climate Change on Them” foresees stronger or wicker drought in our region, which could lead to a significant change in biodiversity in the forests, and a number of species, requiring higher humidity for growth, will either disappear or will move, where it is possible, to a higher altitude. Since forests keep mostly natural biological diversity (forest territories of Bulgaria held 80 % of the protected species of plants; more than 60 % of endangered species of animals and over 60 % of the priority for the preservation of species habitats), attention to them must be increased (EFA, 2014).

In the analysis of the status of the forest sector in the period 2006 – 2011 of the National strategy for the development of the forest sector in the Republic of Bulgaria 2013 – 2020 is noted that, despite the increasing attention to the protection of biological diversity in the forest areas in the country, there are negative trends and factors, which in the context of a changing climate, could become a serious threat. The national economic development in the recent decades as well as the greater variety of harvested forest products have led to the use of wider forest territories and fragmentation of the forest ecosystems, which are factors that affect loss of biodiversity in the forests at genetic and ecosystem level.

Among the main threats for the biodiversity lost in these analysis are pointed also the delay of coppice forests conversion, the opening of the closed old-growth forests basins, illegal timber harvesting, poaching, unregulated harvesting or export of herbs, mushrooms and rare animals, the uncontrolled burning of stubble, the uncontrollable grazing.

At the base of some of the problems, especially in the mountain and rural areas, are the social and economic difficulties.

Other problems are related to insufficient integration of biological diversity in the forest planning and management. The forest inventory and planning of forest activities do not reflect adequately the biological diversity and do not set objectives in this field. There is no integrated system for the collection and exchange of information, assessment and monitoring of the biological diversity of forest ecosystems.

Dead wood and dying trees have an important role for the functioning and productivity of the forest ecosystems through their impact on biological diversity, the storage of carbon dioxide, protection of soil, regeneration of tree species, etc. This is the reason why the maintenance of a certain quantities of dead wood is set as an important condition for the sustainable management of forest ecosystems.

For the restoration and conservation of forest habitats, related to the conservation of endangered plant and animal species, the application sustainable forestry management practices is needed incl. the preservation of old-growth forests which has high conservation value.

Priority approach to the conservation of biological diversity in Bulgaria is the in-situ conservation of species and habitats through their inclusion in the National ecological network of protected areas and in the European ecological network Natura 2000 (EFA, 2014).

Conservation of biodiversity and the rational use of forests as a natural capital is particularly important for our country. The preserved Bulgarian nature and its unique biodiversity are a prerequisite not only for the provision of a favourable and healthy living environment, but also for the development of environmental perspective productions, such as sustainable forms of tourism (eco, spa, spa, etc.), protection of territories with high conservation value and protected areas, hunting and fishing, herbs and more.

Forest certification

The forest certification in Bulgaria is considered as a voluntary instrument, which is implemented by evaluation and validation of practices for forest management, on the basis of number of standards. It is conducted

by independent, non-state certification bodies, which issue certificates, with which is certified that, the management of the forest territories is conducted in responsible way, achieving balance between the ecological, economic and social benefits.

The total territory of the certified forests in the end of April 2016 is 789.644 ha or about 19 % of the forest territories). These territories are certified under the system FSC (EFA, 2016).

Tourism and recreation

The area of forest territories with recreational function is 243.727 ha, as for the period after 2005 it has decreased by 22.000 ha, mainly because part of them has been designated as territories with stricter conservation regimes.

Forest areas in the country provide good opportunities for the development of traditional forms of tourism, mountain tourism, rural tourism and eco-tourism as well as mountain biking, hunting and fishing. The main advantage is the preserved nature, including the system of protected areas and protected zones, included in the European ecological network Natura 2000.

However, the high potential for the development of tourism, which possesses the forest territories, is not used in sufficient degree as a source of income and livelihood.

According to data from the analysis of the status of the forest sector in the Republic of Bulgaria during the period 2006 – 2011 (EFA, 2013) obtained on the basis of expert knowledge of Nature Park Directorates and Executive Forest Agency for the period 2006 – 2011, the territories of the nature parks were visited by an average of 3710 thousand tourists per year.

Hunting and fishing tourism are the traditional and the most developed nature tourism in the Bulgarian forests with long lasting traditions. In the country there are excellent opportunities for hunting of large mammals (red deer, wild boar, roe deer, wolf, etc.) and fishing (carp, trout, perch, bream, etc.). Each year more than 3500 foreigners come for hunting in Bulgaria. Some of the world's records for red deer trophies, wild boar and wild cat are Bulgarian.

Mountain and ecotourism is another traditional branch in the Bulgarian tourism. In addition to the widespread network of huts and shelters, mountain homes and tourist paths, it has to note the development of modern touristic infrastructure, such as eco-trails, tourist information centres, etc. (EFA, 2014).

Hunting management in Bulgaria

The development of the hunting management is directly related to the development of social and economic relations in the society. It is a function of the culture, economy and the attitude of people towards nature. The analysis of the game stocks and development of legislation in Bulgaria clearly show that their development is a follow up of the economic and social changes in the society (EFA, 2013).

The hunting area of the country is 8.914.721 ha. According to hunting taxation for 2015 Bulgarian game treasure consists of over 24.435 red deer, 7338 fallow deer, 102.105 roe deer, 90.130 wild-boar, 3553 mouflons, 3000 capercaillies (wood grouse), 147.277 pheasant 323.744 English partridge and 19.919 rock partridge.

Until the end of 2015 the number of hunters in Bulgaria was 148.125.

As a result of regulatory changes in the last decade separate business entities were created. The aim for the establishment of these state hunting enterprises was to allow the introduction of new methods for game management.

Ecosystem services

In the contemporary world the protection of the environment is especially important for the provision of ecosystem services, which are essential for people and nature. Ecosystem services include all benefits – direct and indirect, which people derive from the ecosystems functioning, including provision of food and water, flood and diseases control, cultural services, such as recreation, spiritual and cultural benefits and supporting, such as ensuring the nutrient cycling, securing waste, maintenance of the biological diversity and landscape etc. (EFA, 2014).

All the above determine the introduction of payments for ecosystem services, including measures, by which the users of

ecosystem services reward by subsidies or market payments those farmers whose lands ensure protection of the river basins and forests, removal of carbon and preservation the landscape beauty (EFA, 2014).

Through payments of ecosystem services the maintenance of natural ecosystems by environmentally sound practices, without causing damage to other users of natural resources is promoted. Besides preserving the natural resources, payments for ecosystem services promote the development of rural areas and their livelihood.

The adopted in 2011 Forest Act, regulates for the first time that the public ecosystem services delivered from the forest territories, are the results from the specialized activities for their management. The act also delineates the conditions and order for determination of the compensations for ecosystem services and these are the cases when they are in favour of conducting commercial activities as a result from the management of the forest territories. At the present moment, a methodology for valuation of ecosystem services is under development.

The favourable natural conditions and the traditions in forestry and the forest industry in the presence of internal and external markets for forest products and services are the prerequisite for the development of activities, providing income from sales of timber and non-wood forest products, the provision of ecosystem services and biomass production. Although the forest sector forms a relatively small share of the gross domestic product, forestry and the forest industry as a traditional means of livelihood are of particular importance for the development of rural areas in Bulgaria and the improvement of the quality of life (EFA, 2014).

The accumulated scientific experience and results of the research should serve as a good basis in the development and introduction of the concept of ecosystem services and their sustainable and socially sustainable management.

Forestry education

The training of forestry expert is performed to date only in the Faculty of Forestry of the University of Forestry. The Faculty of Forestry is a successor of the Forestry Department of the Faculty of

Agronomy and Forestry of Sofia University “St. Kliment Ohridsky”, founded in 1925. The tradition and experience obtained during the 90-year history of the Faculty allow the staff to be proud of the achievements of the many generations’ graduates, more than 6500 (Milev et al., 2010). They work for establishing new forests and are responsible for the sustainable management of the “green gold” of the planet. The training of students is performed by highly qualified instructors. There are 8 full professors, 20 associate professors and 22 assistant professors in the Faculty, which are engaged both in teaching and in research activities. Thirty seven of them hold degrees PhD and DSc also more than 60 professors from other faculties are engaged in the training of students. Most of the Faculty and PhD students work within the frameworks of international projects and programs, many of them are members of international research and professional organizations. This is a prerequisite for sound teaching process and obtaining by students of a solid background, promoting the successful performance of the graduates in the conditions of free competition in the European Union.

The demographic problem decreases the competition and thus the quality of the entering students, but at the moment the Forestry major recruits students more successfully than most of the other specializations and universities in Bulgaria. A positive fact is also that in many regions (especially mountainous ones) this is one of the traditional professions. The share of the hereditary foresters is relatively high.

The Faculty of Forestry guides the Experimental and Training Forestry Services in Yundola and Petrohan and issues the journal *Forestry Ideas*.

The most impressive achievements of the Bulgarian foresters are the afforestation works, which amount, together with the forest shelter belts and the erosion control plantations, about 13.000 hectares. Large areas of abandoned land have been forested, the erosion around the dams was reduced. Also, vital and elite game populations are maintained. The forests are managed according to the concepts of close-to-nature forest management and appropriate practices

are applied for this purpose. This approach provides opportunities for sustainable development of the forest resources and biodiversity conservation. The forests keep balanced their ecological, economic and social functions. The afforestation and proper forest management have positive effects on the livelihood and landscape and on many other economic areas – agriculture and aquaculture, tourism, transport, energy production and the life of people in general. Therefore, the Bulgarian forestry education keeps high reputation and is recognized by the society.

References

- Executive Forest Agency (EFA). 2009–2016. Annual reports of Executive Forest Agency (in Bulgarian).
- Executive Forest Agency (EFA). 2013. National strategy for the development of the Forestry Sector in Republic of Bulgaria 2013–2020, 207 p.
- Executive Forest Agency (EFA). 2013. Forests in Bulgaria, Executive forest agency, 72 p.
- Executive Forest Agency (EFA). 2014. Strategic plan for the development of the forestry sector in Republic of Bulgaria 2014–2023. 110 p.
- Executive Forest Agency (EFA). 2016. Forest fund reporting sheets. Available at: <http://www.iag.bg/> (in Bulgarian).
- Executive Forest Agency (EFA). 2016. Data Base System www.system.iag.bg (in Bulgarian).
- Ministry of Agriculture and Foods (MAF). 2013. National strategy for the development of the forest sector in the Republic of Bulgaria 2013 – 2020. Ministry of Agriculture and Foods, 207 p.
- Ministry of Environment and Water and the Interinstitutional Commission on Climate Change (MEW and ICCC), 2012. Third National Action Plan on Climate Change for the period 2013–2020. Ministry of Environment and Water, 233 p.
- Milev M., Yurukov S., Lyubenov K., Zhelev P., 2010. Development of higher forestry education in Bulgaria. *Forestry Ideas* 16(2): 141–154.
- Raev I. 2015. Investigations of Global Climate Change Impacts on Forest Ecosystems in Bulgaria. Invited presentation at International Conference „Forestry: Bridge to the Future“, Sofia, May 6–9, 2015. Book of Abstracts: 41.

Raev I., Zhelev P., Grozeva M., Georgiev G., Alexandrov V., Jianski M., Markov I., Velichkov I., Miteva S. 2011. Programme of measures for adaptation of the forests in the Republic of Bulgaria and mitigation the negative effect of climate change on them. EU Interreg IVC, FUTUREforest, Sofia, 194 p.

Raykov R., Stefanov A., Milev M., Petrova R., Petkova K., Dobrichov I., Poryazov Ya., Yakimov M., Kalmukov K., Broshtilov K., Nalbantov G., Terziyski T., Stoykov S. 2011. Climate changes and its impact on forest vegetation in Bulgaria. In: 2011. Instructions for identifying and mapping of forest habitat types and determining the composition of tree associations.. Executive Forest Agency, Ministry of Agriculture and Foods: 19–27 (in Bulgarian).

Stump Diameter and Diameter at Breast Height Relationship for Chestnut (*Castanea sativa* Mill.) Stands in Kastamonu Coastal Region

*Fadime SAĞLAM¹, Oytun Emre SAKICI¹, Mehmet SEKİ¹

¹Kastamonu University, Faculty of Forestry, Department of Forest Engineering,
Kastamonu/TURKEY

*Corresponding Author: fsaglam@kastamonu.edu.tr

Abstract

Diameter at breast height is a main parameter of trees that can be measured accurately and easily and shows close relationship with the different many other features of trees. To determine the volume of stands as one of the most important issues of forest inventory, although there are many methods in forestry literature, in general volume tables are preferred because of their practicalities. In order to make it possible to calculate their volume by putting forward various properties of trees removed from forests as a result of planned silvicultural treatments or illegal cutting, it is of paramount importance to determine the relationship between stump diameter and diameter at breast height. Trees are cut approximately 30 cm above ground (stump height), hence the tree volume tables cannot be used to cut trees. Therefore, there is need to equations which estimate diameter at breast height using stump diameter as independent variable. Diameters at breast height to be calculated using these equations can be used in volume calculations. In this study, the relationships between stump diameter and diameter at breast height were analyzed for chestnut (*Castanea sativa* Mill.) stands. For this purpose, the diameter at breast height and stump diameter of sample trees taken from chestnut stands in Kastamonu coastal region were measured. Depending on the data obtained, various regression models were evaluated and power model according to statistical criteria were selected.

Keywords: Stump diameter, Diameter at breast height, Chestnut, Kastamonu

Kastamonu Sahil Bölgesi Kestane (*Castanea sativa* Mill.) Meşcerelerinde Dip Kütük Çapı-Göğüs Çapı İlişkisi

Özet

Göğüs çapı, ağaçların doğru ve kolay bir şekilde ölçülen ve ayrıca ağaçların farklı birçok özelliğiyle de yakın ilişki gösteren bir parametredir. Orman envanterinin en önemli konularından biri olan meşcere hacmini belirlemek için ormancılık literatüründe birçok yöntem bulunmasına karşın, pratik olmaları nedeniyle uygulamada genel olarak ağaç hacim tabloları tercih edilmektedir. Ağaç hacim tabloları, dikili ağaçların sadece göğüs çapı, göğüs çapı ile birlikte ağaç boyu ve ayrıca göğüs çapı ve ağaç boyuna ek olarak diğer bazı ağaç boyutlarının fonksiyonu olarak hacim değerlerini veren tablolardır. Planlı silvikültürel uygulamalar ile veya kaçak kesimler sonucu ormandan uzaklaştırılan ağaçların hacimlerinin hesaplanmasının mümkün kılınması amacıyla, dip kütük çapı ile göğüs çapı arasındaki ilişkinin belirlenmesi büyük önem arz etmektedir. Meşcere içerisinde bulunan ağaçlar yaklaşık olarak dip kütük yüksekliğinden (0.30 m) kolay ve hızlı bir şekilde kesildiğinden, bu kesimler kayıt altına alınmamakta ve bundan dolayı da kesik ağaçların hacimlendirilmesinde ağaç hacim tablolarından faydalanılmamaktadır. Bu nedenle dip kütük çapının bağımsız bir değişken olarak yer aldığı göğüs çapını tahmin eden denklemlere ihtiyaç duyulmaktadır. Bu denklemler yardımıyla hesaplanacak olan göğüs çapı değerleri hacim hesaplamalarında kullanılabilir. Bu çalışmada, kestane meşcerelerinde göğüs çapı ile dip kütük çapı arasındaki ilişkiler belirlenmeye çalışılmıştır. Bu amaçla, Kastamonu sahil bölgesi kestane meşcerelerinden alınan örnek ağaçların göğüs çapları ve dip kütük çapları ölçülmüştür. Elde edilen verilere bağlı olarak, çeşitli regresyon modelleri denenmiş ve bu modeller arasından çeşitli istatistiksel ölçütlere bağlı olarak en iyi sonucu veren denklemin üssel denklem olduğu belirlenmiştir.

Anahtar Kelimeler: Dip kütük çapı, Göğüs çapı, Kestane, Kastamonu

Introduction

The main way of obtaining information needed to ensure the sustainability of the

forest resource utilization is forest inventory (Köhl, 2004). The basis of all planning processes in forestry still constitutes the

forest inventory (Firat, 1973). One of the most important issues of forest inventory providing basic information is the stand volume. To estimate stand volume although there are several methods in the forestry literature, in general practice tree volume tables are preferred because of their practicalities. Tree volume tables, depending on the number of independent variables, are divided into three as single, double and multiple-entry tree volume tables. They called single-entry tree volume tables depending on only diameter at breast height (dbh) of trees, double-entry tree volume tables depending on tree height (h) with diameter at breast height, multiple-entry tree volume tables as a function of some other tree size as well as additional diameter at breast height and tree height (Kalipsız 1999).

In practise, it is more preferred single-entry volume tables in that a function of the diameter at breast height of trees, which is a parameter that can be measured easily and accurately (Vanclay, 1994; Kalipsız, 1999). However, many features of trees such as diameter at breast height and tree height removed from the field as a result of illegal cuttings cannot reveal and hence the tree volume cannot be calculated. Determination of relationships between stump diameter and diameter at breast height in order to compute the volume using the diameters at breast height of the trees is of very great importance (Yavuz, 2000).

There are many national and international researches on determination of relationships between stump diameter and diameter at breast height for various tree species (Alemdag and Honer, 1977; Bylin, 1982; Demaerschalk and Omule, 1982; Wiant and Williams, 1987; Omule and Kozak, 1989; Kozak and Omule, 1992; Weigel and Johnson, 1997; Corral-Rivas et.al., 2007; Uğurlu and Özer, 1977; Özer, 1981; Giray, 1982; Yavuz, 1996 ve 2000; Özçelik, 2005; Durkaya and Durkaya, 2011; Şenyurt, 2012; Ercanlı et.al., 2015).

Chestnut (*Castanea sativa* Mill.) which is one of the main forest tree species in Turkey is very important in terms of economically with valuable wood and fruit, ecologically because of erosion prevention feature with taproot, socio-culturally for local

communities to benefit from the fruits and in terms of recreation with visual.

Chestnut shows distribution in the entire Black Sea coast, Western Anatolia and the Marmara region in Turkey (Anşın and Özkan, 1993) (Figure 1). It has not yet received a research on the determination of relationships between stump diameter and diameter at breast height for chestnut in Turkey. In this study, it was studied to determine the relationships between stump diameter (ds) and diameter at breast height (dbh) for chestnut stands located Bozkurt Forest Enterprise in Kastamonu coastline. For this purpose, stump diameters and the diameters at breast height of the sample trees taken from the chestnut stands were measured. Depending on the data obtained, the various regression models were tested and the equation that giving the best results was determined.

Material and Method

With the aim of determining the relationships between stump diameter (ds) and diameter at breast height (dbh), it was benefited from the data obtained from measurements made in chestnut stands located within the boundaries of Bozkurt and Abana Planning Units in Bozkurt Forest Enterprise of Kastamonu Regional Directorate of Forestry (Figure 1). For this purpose, stump diameter and dbh measurements in a total of 309 sample trees including 264 trees from Bozkurt Forest Planning Unit and 45 trees from Abana Forest Planning Unit were made. About 75% of data (231 trees) obtained from the sample trees were used for model development, while remaining 25% (78 trees) were used for testing the validation of the developed models. Descriptive statistics of the model development and control data are given in Table 1. The table reveals that dbh values range from 4.5 cm to 70.0 cm for model data and from 4.5 cm to 60.0 cm for control data. When examining the stump diameter measurements, values range from 5.6 cm to 80.0 cm for model data and from 6.0 cm to 73.0 cm for control data.

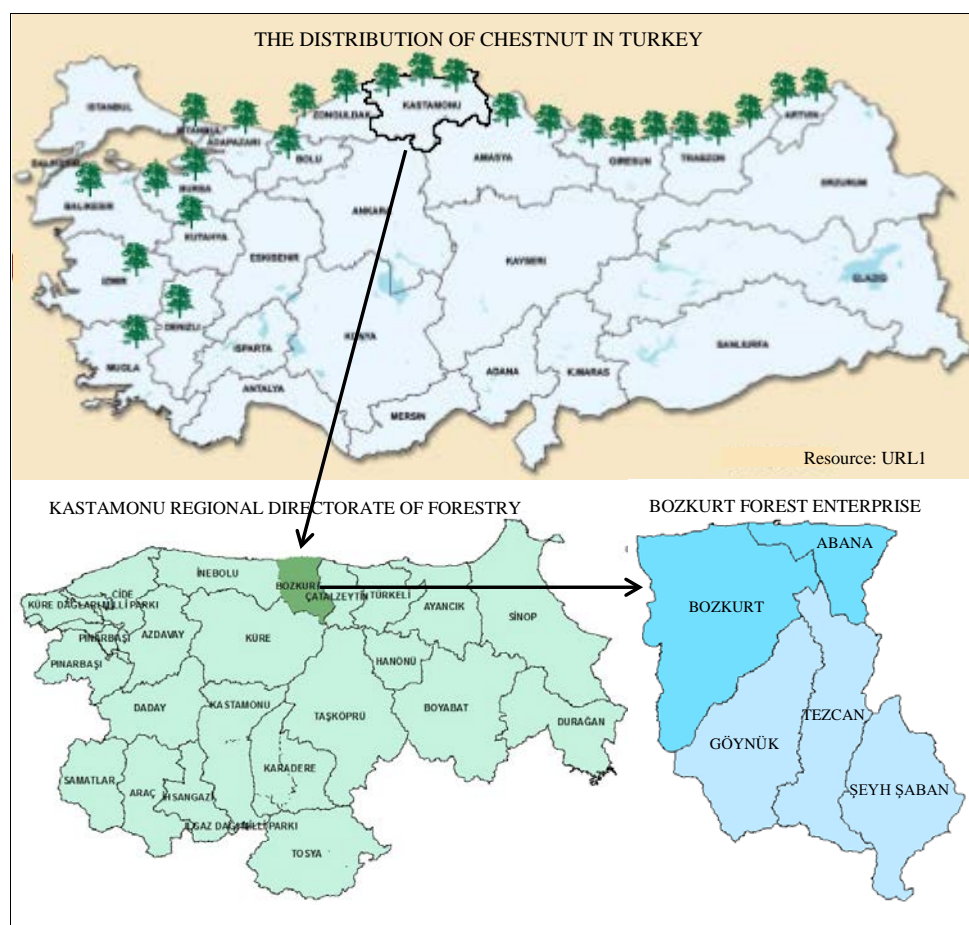

Figure 1. Study area

Table 1. Descriptive statistics for the model and control data

	Variable	Number of samples (n)	Minimum (cm)	Maximum (cm)	Mean (cm)	Standard deviation (cm)
Model	Stump diameter	231	5.6	80.0	28.0	14.9
	dbh		4.5	70.0	23.1	12.9
Control	Stump diameter	78	6.0	73.0	28.4	15.3
	dbh		4.5	60.0	23.1	13.3

Distribution of values of the stump diameter and the dbh obtained from sample trees is given in Figure 2. For the purpose of modeling this distribution, the following equations were tested.

$$dbh = b_0 + b_1 ds \quad (\text{Linear}) \quad (1)$$

$$dbh = b_0 + b_1 \ln(ds) \quad (\text{Logarithmic}) \quad (2)$$

$$dbh = b_0 + b_1 / ds \quad (\text{Inverse}) \quad (3)$$

$$dbh = b_0 + b_1 ds + b_2 ds^2 \quad (\text{Quadratic}) \quad (4)$$

$$dbh = b_0 + b_1 ds + b_2 ds^2 + b_3 ds^3 \quad (\text{Cubic}) \quad (5)$$

$$dbh = b_0 b_1^{ds} \quad (\text{Compound}) \quad (6)$$

$$dbh = b_0 ds^{b_1} \quad (\text{Power}) \quad (7)$$

$$dbh = e^{b_0 + b_1 / ds} \quad (\text{S}) \quad (8)$$

$$dbh = e^{b_0 + b_1 ds} \quad (\text{Growth}) \quad (9)$$

$$dbh = b_0 e^{b_1 ds} \quad (\text{Exponential}) \quad (10)$$

In these equations; ds : Stump diameter (cm), dbh : Diameter at breast height (cm), b_i : Equation parameters.

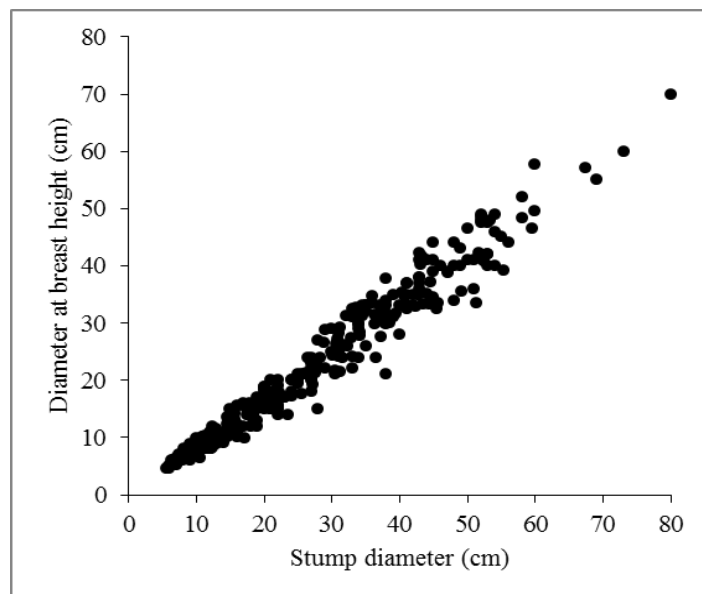

Figure 2. Stump diameter-dbh distribution for sample trees

For the selection of the most successful model from the developed equations, Coefficient of Determination (R^2) and Root Mean Square Error (RMSE) criteria in equations (11) and (12) were utilized. The regression model of the highest Coefficient of Determination and lowest Root Mean Square Error was selected as the most appropriate model.

Coefficient of Determination:

$$R^2 = 1 - \frac{\sum(y_i - \hat{y}_i)^2}{\sum(y_i - \bar{y})^2} \quad (11)$$

Root Mean Square Error:

$$RMSE = \sqrt{\frac{\sum(y_i - \hat{y}_i)^2}{n-p}} \quad (12)$$

In these equations;

y_i : Observed value,

\hat{y}_i : Estimated value,

p : The number of parameters,

n : The number of samples.

Validity of equations developed using the data obtained from 231 sample trees was tested using Paired Samples t Test applied using data for 78 sample trees allocated to control. SPSS 15.0 package was used for statistical analysis conducted during the study.

Results and Discussion

Values of the parameter estimates, Coefficient of Determination (R^2) and Root Mean Square Error (RMSE) values for the developed models to determine the relationship between stump diameter and dbh in chestnut stands located Bozkurt and Abana Forest Planning Units limits are given in Table 2.

When Table 2 is examined, it is seen that the large majority of these equations are successful and Power equation (Model 7) shows the best results for determining relationships between stump diameter and dbh. This equation provides better prediction in terms of having the highest Coefficient of Determination ($R^2=0,969$) and very low Root Mean Square Error (RMSE=2.57) than others. For some deciduous and coniferous tree species in Turkey, similar results were also obtained by Yavuz (1996) for Scots pine and Crimean pine, Yavuz (2000) for ash, Özçelik (2005) for cedar and Calabrian pine and Ercanlı et al. (2015) for Oriental beech using the power equations. On the other hand, quadratic equation was found successful by Özçelik (2005) for Crimean pine and Şenyurt (2012) for Scots pine.

The validity of the developed equations has been tested with Paired Samples t Test using an independent data set obtained from 78 sample trees. The estimated dbh values calculated with equations developed and dbh

values observed on sample trees were compared with this test and consequently it was decided that the equations which had statistically non-significant difference between estimated and observed values could be used (Table 3). When the table is examined, there is no statistical significant difference ($p > 0.05$) between observed and estimated values of the power equation

(Model 7) such as all other equations, and it can be used.

Residuals plot based on the difference between the observed and estimated diameter at breast height calculated with the Power equation for the entire sample trees is given in Figure 3. Examining the figure, residual in small diameters is low, with the increase of the diameter, it is observed that the residual value also increased.

Table 2. Parameter estimations and goodness of fit statistics of models

Model	b ₀	b ₁	b ₂	b ₃	F	p	R ²	RMSE
1	-0.607	0.849			5663.866	0.000	0.961	2.55
2	-40.949	20.218			1604.283	0.000	0.875	4.58
3	38.692	-306.931			420.071	0.000	0.647	7.70
4	-0.389	0.831	0.000		2821.851	0.000	0.961	2.55
5	-0.124	0.799	0.001	-0.000009	1873.820	0.000	0.961	2.58
6	6.472	1.040			2039.514	0.000	0.899	7.52
7	0.770	1.018			7048.192	0.000	0.969	2.57
8	3.824	-16.904			1364.339	0.000	0.856	5.91
9	1.867	0.039			2039.514	0.000	0.899	7.31
10	6.472	0.039			2039.514	0.000	0.899	7.31

Table 3. The t-test results for the equations tested

Model	1	2	3	4	5	6	7	8	9	10
t	-1.228	-0.575	-0.244	-1.227	-1.404	-0.923	-0.555	1.220	-0.722	-0.731
p	0.223	0.567	0.808	0.223	0.164	0.359	0.581	0.226	0.472	0.467

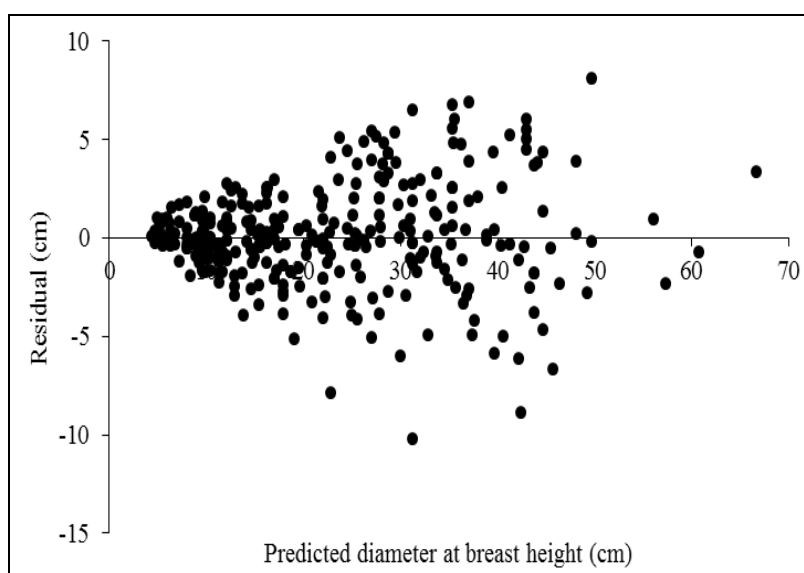

Figure 3. Residuals against dbh values

Conclusions

In order to determine stump diameter-dbh relationships for the chestnut stands in Bozkurt and Abana regions located Kastamonu coastline, 10 regression equations were tested and power equation which most successful was selected according to statistical criteria from among these equations.

Power equation developed is expressed as follows:

$$dbh=0.770 ds^{1.018}$$

In terms of convenience practitioners, the dbh values corresponding to 5-80 cm stump diameter values by using power equation are given in Table 4.

In this study, stump diameter-dbh relationships for the chestnut stands in

Kastamonu coastal region were investigated. With the results of this study will be able to reach dbh values of trees extracted from the stand for any reason with the help of equation obtained in the study. Again, in this way, it may be made in a practical way of volume estimates using single entry volume equations with the determination of dbh.

As in all other stand characteristics, relationships between stump diameter and dbh vary according to tree species and site. Therefore, it should be laid down relationships between stump diameter and dbh for different tree species and regions in order to reflect on the results of aforementioned differences and to obtain reliable results.

Table 4. Diameter at breast height-stump diameter values for chestnut stands in Kastamonu coastal region

Stump diameter (cm)	dbh (cm)	Stump diameter (cm)	dbh (cm)	Stump diameter (cm)	dbh (cm)	Stump diameter (cm)	dbh (cm)
5	4.0	24	19.6	43	35.4	62	51.4
6	4.8	25	20.4	44	36.3	63	52.3
7	5.6	26	21.2	45	37.1	64	53.1
8	6.4	27	22.1	46	37.9	65	54.0
9	7.2	28	22.9	47	38.8	66	54.8
10	8.0	29	23.7	48	39.6	67	55.6
11	8.8	30	24.6	49	40.5	68	56.5
12	9.7	31	25.4	50	41.3	69	57.3
13	10.5	32	26.2	51	42.1	70	58.2
14	11.3	33	27.1	52	43.0	71	59.0
15	12.1	34	27.9	53	43.8	72	59.9
16	13.0	35	28.7	54	44.7	73	60.7
17	13.8	36	29.6	55	45.5	74	61.6
18	14.6	37	30.4	56	46.4	75	62.4
19	15.4	38	31.2	57	47.2	76	63.3
20	16.3	39	32.1	58	48.0	77	64.1
21	17.1	40	32.9	59	48.9	78	65.0
22	17.9	41	33.8	60	49.7	79	65.8
23	18.7	42	34.6	61	50.6	80	66.7

References

Alemdağ İ.Ş., Honer T.G., 1977. Metric Relationships Between Breast-Height and Stump Diameter for Eleven Tree Species Form Eastern and Central Canada. Canadian Forest Service, Forest Management Institute, Information Report, FMR-X-.

Anşın R., Özkan, Z.C., 1993. Tohumlu Bitkiler (Spermatophyta) Odunsu Taksonlar. KTÜ Basımevi, Genel Yayın No: 167, Fakülte Yayın No: 19, Trabzon, 512 s.

Bylin C.V., 1982. Estimating dbh from stump diameter for 15 southern species. Res. Note 50-286. New Orleans, LA: U.S. Department of

Agriculture, Forest Service, Southern Forest Experiment Station:3

Corral-Rivas, J.J., Barrio-Anta, M., Agirre-Calderón, A.A., Diéguez-Arandam, U., 2007. Use of stump diameter to estimate diameter at breast height and tree volume for major pine species in El Salto Durango (Mexico). *Forestry* 80, 29-40.

Demaerschalk J.P., Omule S.A.Y., 1982. Estimating Breast Height Diameter Form Stump Measurements in British Columbia. *Forest Chronicle*, 58(3), 143-145.

Durkaya B., Durkaya A., 2011. Zonguldak-Ulus Orman İşletme Müdürlüğü Göknar, Kayın ve Karaçam Ağaç Türleri için Kütük Çapı ve Boyu ile Göğüs Çapı İlişkisi. *Kastamonu Üniversitesi Orman Fakültesi Dergisi*, 11 (1), 9 – 17.

Ercanlı İ., Günlü A., Başkent E.Z., 2015. Mixed effect models for predicting breast height diameter from stump diameter of Oriental beech in Göldağ. *Scientia Agricola*, 72(3), 245-251.

Fırat F., 1973. Dendrometri. Dördüncü Baskı, Kutulmuş Matbaası, İstanbul Üniversitesi Yayın No: 1800, Orman Fakültesi Yayın No: 193, İstanbul, 359 s.

Giray N., 1982. Ağaçlarda Kütük Çapı, Orta Çap, Göğüs Çapı İlişkisi. *O.A.E. Dergisi*, Temmuz Sayısı, Cilt:28, 69-79.

Kalıpsız A., 1999. Dendrometri. İstanbul Üniversitesi, Orman Fakültesi Yayını, No:3194/354, İstanbul.

Köhl M., 2004. Forest Inventory and Monitoring. *Encyclopedia of Forest Science*, Eds.: Burley, J., Evans, J., Youngquist, J.A., Elsevier, Spain, 403-409.

Kozak A., Omule S.A.Y., 1992. Estimating Stump Volume, Stump Inside Bark Diameter and Diameter at Breast Height form Stump Measurements, *Forestry Chronicle*, 68 (5), 623-627.

Omule S.A.Y., Kozak A., 1989. Stump and Breast Height Diameter Tables for British Columbia Tree Species. *FRDA Report 062*, 67s.

Özcelik R., 2005. Mut Orman İşletmesinde Karaçam, Sedir ve Kızılçam Ağaç Türleri için Dip Çap-Göğüs Çapı İlişkileri. *S.D.Ü. Fen Bilimleri Enstitüsü Dergisi*, 9-3, 83-91.

Özer E., 1981. Sarıçamlarda Kütük Çapından Yararlanarak Göğüs Çapının Bulunması. *O.A.E. Dergi No: 53, Cilt:27, s.20-23, Ankara.*

Şenyurt M., 2012. Batı Karadeniz Yöresi Sarıçam Meşcerelerinde Kütük Çapı-Göğüs Çapı İlişkileri. *Artvin Çoruh Üniversitesi Orman Fakültesi Dergisi*, 13(1),79-87.

Uğurlu S., Özer E., 1977. Kızılçamlarda Kütük Çapından Yararlanarak Göğüs Çapının Bulunması. *O:A.E. Dergisi, Cilt No: 23, Sayı:1, s.71-77, Ankara.*

URL1.2016.<http://www.ogm.gov.tr/Lists/Haberler/Attachments/457/KESTANE%20EYLEM%20PLANI.pdf>.

Vanclay J.K., 1994. Modelling forest growth and yield:Applications to mixed tropical forests. Wallingford CAB International.

Weigel D.R., Johnson P.S., 1997. Estimating dbh of southern Indiana oaks from stump diameter. Tech. Brief TB-NC4 USDA Forest Service North Central Forest Experiment Station.

Wiant H.U.Jr., Williams T.B., 1987. Lower Bole Diameter and Volume of Four Appalachian Hardwoods. *Northern Journal of Applied Forestry*, 4 (212), 85-98.

Yavuz H., 1996. Taşköprü Orman İşletmesinde Sarıçam ve Karaçam Ağaç Türlerine İlişkin Dip Çap-Göğüs çapı-Orta Çap İlişkileri ile Kabuk Hacminin Hesaplanması. *K.T.Ü Orman Fakültesi Bahar Yarı Yılı Seminerleri, Seminer No:2, 67-75s.*

Yavuz H., 2000. Dişbudak Ağaç Türü İçin Dip Kütük Çapı İle Göğüs Çapı Arasındaki İlişkinin Belirlenmesi. *K.T.Ü Orman Fakültesi Güz Yarı Yılı Seminerleri, Seminer No:7, 10s.*

Modeling Diameter Distributions of Black Pine Stands in Taşköprü Region

*Oytun Emre SAKICI¹, Mehmet SEKİ¹, Fadime SAĞLAM¹, Mehmet Hakan AKYILDIZ²

¹Kastamonu University, Faculty of Forestry, Department of Forest Engineering,
Kastamonu/TURKEY

²Kastamonu University, Faculty of Forestry, Department of Forest Industrial Engineering,
Kastamonu/TURKEY

*Corresponding Author: oesakici@kastamonu.edu.tr

Abstract

In this study, it is intended to model the diameter distribution by utilizing 9 different probability density functions including Beta, 2-parameter Gamma, 3-parameter Gamma, Johnson's S_B , 2-parameter Lognormal, 3-parameter Lognormal, Normal, 2-parameter Weibull and 3-parameter Weibull in even-aged and pure black pine (*Pinus nigra* J.F.Arnold) stands located within Taşköprü Forest Enterprise. For this purpose, 79 sample plots were taken in stands which have different age, site index and stand density values and diameter measurements on total 2422 trees in these sample plots were conducted. Number of trees in diameter classes were determined by making diameter distribution of trees in each sample plot and diameter distribution models of sample plots were developed with EasyFit 5.5 using this data. The most successful diameter distribution models were determined according to error index (e) calculated based on the differences between actual and predicted diameter distributions. According to the results, three parameter Gamma probability density function is the most successful function for pure black pine stands located in Taşköprü Forest Enterprise.

Keywords: Black pine, Diameter distribution, Probability density functions, Taşköprü

Taşköprü Yöresi Karaçam Meşcerelerinde Çap Dağılımlarının Modellenmesi

Özet

Bu çalışmada, Taşköprü Orman İşletme Müdürlüğü sınırları içerisinde bulunan eşityaşlı ve saf Karaçam (*Pinus nigra* J.F.Arnold) meşcerelerinde Beta, 2-parametrelili Gamma, 3-parametrelili Gamma, Johnson's S_B , 2-parametrelili Lognormal, 3-parametrelili Lognormal, Normal, 2-parametrelili Weibull ve 3-parametrelili Weibull fonksiyonları olmak üzere 9 farklı olasılık yoğunluk fonksiyonundan yararlanılarak çap dağılımlarının modellenmesi amaçlanmıştır. Bu amaçla farklı yaş, bonitet sınıfları ve sıklık derecelerindeki meşcerelerden 79 adet örnek alan alınmış ve bu örnek alanlarda bulunan toplam 2422 ağaçta çap ölçümleri gerçekleştirilmiştir. Her bir örnek alandaki ağaçların çap basamaklarına dağıtımı yapılarak çap basamaklarındaki ağaç sayıları belirlenmiş ve elde edilen bu veriler kullanılarak EasyFit 5.5 programı yardımıyla örnek alanlara ilişkin çap dağılım modelleri geliştirilerek bu modellere ilişkin parametreler tahmin edilmiştir. Meşcerelerdeki aktüel çap dağılımları ile olasılık yoğunluk fonksiyonları ile tahmin edilen çap dağılımları arasındaki farklara göre hesaplanan hata indeksi (e) değerlerine göre yapılan karşılaştırmalar ile en başarılı çap dağılım modelleri belirlenmiştir. Elde edilen sonuçlara göre; Taşköprü Orman İşletme Müdürlüğü saf karaçam meşcerelerinde çap dağılımlarının modellenmesinde 3 parametrelili Gamma olasılık yoğunluk fonksiyonu en başarılı fonksiyon olmuştur.

Anahtar Kelimeler: Karaçam, Çap dağılımı, Olasılık yoğunluk fonksiyonu, Taşköprü

Introduction

Diameter distributions of trees in a stand is of great importance as a stand feature giving important information about the stand structure (Loetsch et al., 1973; Bailey and Dell, 1973; Maltamo, 1997). Stand structure can be identified with both current and estimated future distributions diameter of stands (Gorgoso et al., 2007). The diameter distribution of the stand is an important tool in

multiple-use planning applications depending on management objective of forests (Kahriman and Yavuz, 2011). Modeling the diameter distribution can be used to estimate the range of products in forests managed for production (Laar and Akça, 2007) as well as to determine the compliance of the actual stand structure to the management objectives in forests managed with ecological functions and to plan in accordance with this objective.

In this regard, the diameter distribution models are invaluable information sources for the decision making process in planning of forests (Wang et al., 2008). Furthermore, determination of current structures or predicting of future structures of stands as a result of silvicultural interventions can be accomplished with the diameter distribution models. Considering the statistical relationships between diameter and other features such as height, form factor, basal area, volume, biomass, carbon storage and their increments, it is clear that the diameter distribution of trees is as important as the diameters.

Studies on the diameter distribution of trees dates back to before the 1900s (Loetsch et al., 1973). Packard (2000) state that the first studies on this subject were for beech stands (Gram, 1883) and uneven-aged fir stands (de Liocourt, 1898) and also said that various probability density functions (PDF) have been used for modeling diameter distributions since the 1960s.

The diameter distributions for stands are modeled with various PDFs depending on the stand structure. PDFs the most frequently used for even-aged stands are normal, lognormal, Beta, Gamma, Johnson's S_B and Weibull distributions, while the exponential and Weibull distributions for uneven-aged stands are generally preferred. There are many studies related to modeling of diameter distribution of various tree species and stand structures in international literature, although studies on this subject are limited in Turkey. The diameter distributions for uneven-aged fir (Saraçoğlu, 1988; Sakıcı and Gülsunar, 2012) and beech (Atıcı, 1998), even-aged beech (Carus, 1996), ash (Yavuz et al., 2002), Calabrian pine (Carus and Çatal, 2008), Oriental spruce (Sönmez et al., 2010) and black pine (Carus and Çatal, 2011) stands were analyzed, as well as diameter distributions for the Oriental spruce-Scots pine (Ercanlı and Yavuz, 2010) and Scots pine-Oriental beech mixed stands (Kahriman and Yavuz, 2011) were modeled. Sönmez et al. (2015) examined change of diameter distributions according to site quality and age classes in even-aged Oriental spruce stands.

In this study, modeling diameter distribution of even-aged and pure black pine

(*Pinus nigra* J.F.Arnold) stands located within Taşköprü Forest Enterprise connected to Kastamonu Regional Directorate of Forestry was aimed utilizing the Beta, 2- and 3-parameter Gamma, Johnson's S_B , 2- and 3-parameter Lognormal, Normal, 2- and 3-parameter Weibull PDFs. In addition, the variation of diameter distributions for different stand ages, site indexes and stand densities were also investigated.

Material and Methods

Taşköprü Forest Enterprise is located within the boundaries of the Kastamonu Regional Directorate of Forestry and located west of Hanönü and Boyabat, east of Küre, Kastamonu and Karadere, south of Bozkurt, Çatalzeytin and Türkeli and north of Tosya and Kargı Forest Enterprises (Figure 1). The total area of Taşköprü Forest Enterprise is 176.648 ha, and forest area is 113.519 ha (URL-1, 2016). According to data from the current forest management plans of planning units located in Taşköprü Forest Enterprise, black pine stands within the boundaries of Taşköprü Forest Enterprise are 39.129 ha of pure, 18.101 ha of mixed and 11.665 ha of degraded. In other words, 60.7% of forests in Taşköprü Forest Enterprise is composed of pure or mixed black pine stands.

The data used as study material was obtained from 79 sample plots taken from pure black pine stands located within 11 forest management planning units connected to Taşköprü Forest Enterprise. Sample plots were circular and their sizes were determined by considering the stand crown closure (800 m² for 11-40% crown closure, 600 m² for 41-70% and 400 m² for more than 70% crown closure). It was intended to distribute sample plots into stands from different ages, site indexes and stand densities. The length of a 20-year period was taken into account as age class width and the site index table developed for black pine stands by Kalıpsız (1963) was used for site classification. To determine stand ages, ages of 4-6 trees representing the stand were found and the average of them was calculated in each sample plot. The site classes were determined with the help of site index (SI) table developed by Kalıpsız (1963) using stand age and dominant height calculated by taking the average height of

dominant trees according to 100 trees per hectare method (4 trees for 400 m², 6 trees for 600 m², 8 trees for 800 m² sample plot) in each sample plot. The stand densities of sample plots were calculated using the following equation developed by Curtis et al. (1981) and distributed to groups formed as 0-2, 2-4, ...,10-12. Main characteristics of sample plots are given in Table 1 and distributions of

sample plots to age classes, site classes and stand densities are given in Figure 2.

$$SD = \frac{G}{\sqrt{\bar{d}_g}}$$

In this equation; *SD*: Stand density, *G*: Basal area (m²/ha) and \bar{d}_g : Quadratic mean diameter (cm) of sample plot.

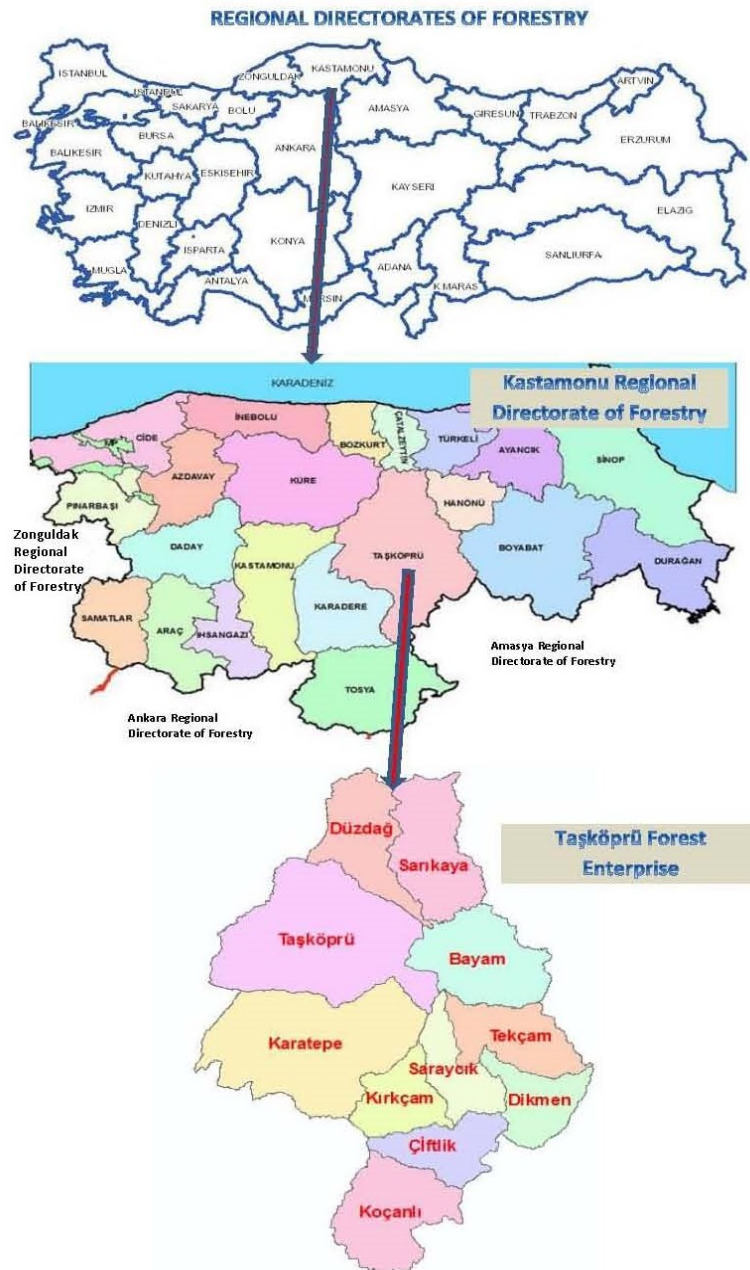

Figure 1. Study area

Table 1. Main characteristics of sample plots

Sample Plot	Planning Unit	Stand Age	Site Class	Stand Density	Sample Plot Size (m ²)	Quadratic Mean Diameter (cm)	Number of trees	Number of trees (per ha)	Sample Plot	Planning Unit	Stand Age	Site Class	Stand Density	Sample Plot Size (m ²)	Quadratic Mean Diameter (cm)	Number of trees	Number of trees (per ha)
1	Taşköprü	100	I	8,81	400	34,7	22	550	46	Çiftlik	64	II	2,66	800	25,5	21	263
2	"	71	IV	8,83	400	19,1	54	1350	47	"	45	III	3,64	800	27,3	26	325
3	"	122	V	8,34	400	27,2	30	750	48	Koçanlı	55	II	4,31	800	40,6	17	213
6	"	83	IV	3,65	600	22,0	27	450	49	"	65	III	2,66	800	27,3	19	238
7	Düzdağ	72	V	3,73	800	21,9	37	463	50	"	45	III	2,07	600	13,2	25	417
8	"	114	I	4,29	600	26,5	24	400	51	"	54	I	2,93	800	27,2	21	263
9	"	137	IV	3,74	800	27,1	27	338	52	"	53	II	3,14	600	18,1	31	517
10	"	73	V	2,99	800	33,1	16	200	53	"	112	I	8,22	400	36,5	19	475
11	Sarıkaya	126	IV	5,96	600	25,2	36	600	54	"	68	III	6,92	400	17,8	47	1175
12	"	126	III	5,62	600	37,1	19	317	55	"	73	II	7,05	800	38,6	30	375
13	"	120	IV	6,82	600	40,8	20	334	56	"	153	III	10,88	400	47,4	17	425
14	Tekçam	60	III	4,61	600	24,5	29	483	57	"	77	II	5,26	600	41,5	15	250
15	"	60	IV	3,14	600	25,1	19	317	58	Bayam	101	II	7,75	400	24,8	32	800
16	"	69	IV	8,67	400	23,8	41	1025	59	"	111	II	5,49	600	31,2	24	400
17	"	115	III	8,79	600	44,0	23	383	60	"	96	II	6,98	400	25,3	28	700
18	"	67	II	4,59	600	29,4	22	367	61	"	99	II	4,19	600	22,0	31	517
19	"	62	II	5,29	400	28,2	18	450	62	"	108	II	7,95	400	28,2	27	675
20	"	33	III	3,91	600	18,3	38	633	63	"	84	II	4,37	600	27,6	23	383
21	"	60	II	6,72	600	39,1	21	350	64	"	109	III	7,13	400	37,2	16	400
22	Kırkçam	86	IV	5,78	600	32,3	24	400	65	"	63	II	5,99	400	26,8	22	550
23	"	102	IV	8,98	400	24,8	37	925	66	"	68	III	8,23	400	15,1	71	1775
24	"	82	IV	5,89	600	30,3	27	450	68	"	73	III	5,67	600	24,8	35	583
25	"	71	IV	7,03	400	23,2	32	800	69	Karatepe	134	III	4,02	600	31,9	17	283
26	"	62	I	4,83	600	26,5	27	450	70	"	114	III	4,17	800	30,7	25	313
27	Dikmen	34	III	5,03	400	14,6	46	1150	71	"	117	IV	9,11	400	30,9	27	675
28	"	103	III	9,43	400	24,0	41	1025	72	"	43	V	2,55	600	14,3	36	600
30	"	35	II	7,59	400	18,2	50	1250	73	"	62	V	2,84	800	19,7	33	413
31	"	73	I	10,14	400	35,0	25	625	74	"	57	V	4,43	600	19,6	39	650
32	"	87	I	6,73	800	33,7	35	438	75	"	96	V	5,95	400	24,5	25	625
34	"	69	I	10,39	400	27,9	36	900	76	"	82	V	5,55	600	24,0	36	600
35	"	85	I	11,94	400	27,8	45	1125	77	"	105	V	8,49	400	26,4	32	800
36	Saraycık	42	III	3,98	400	15,9	30	750	78	"	82	IV	4,39	800	28,2	30	375
37	"	66	II	6,93	400	23,0	32	800	79	"	40	V	4,35	400	16,9	32	800
38	"	83	IV	5,27	800	26,7	39	488	80	"	72	III	7,41	400	34,1	19	475
39	"	77	IV	8,87	400	24,6	37	925	81	"	24	II	3,77	600	13,5	58	967
40	"	83	IV	8,04	400	17,5	56	1400	82	"	74	II	9,09	400	22,0	45	1125
41	"	48	IV	7,58	400	21,4	39	975	83	"	76	III	8,65	600	43,5	23	383
43	"	68	III	6,24	400	21,8	30	750	84	"	53	IV	2,55	800	29,8	16	200
44	Çiftlik	46	I	8,16	400	17,3	58	1450	85	"	80	IV	6,86	600	28,2	35	583
45	"	62	II	10,33	400	32,8	28	700									

Diameters at breast height (dbh) of trees with a diameter greater than 7,9 cm at breast height were measured in all sample plots. The total number of trees measured were 2422. Dbh measurements range from 8.0 cm to 77.5 cm and mean and standard deviation are 24.4 cm and 9.3 cm, respectively. Diameter classes with 4 cm intervals were defined and number of trees in each diameter classes were identified for sample plots. Thus, observed diameter distributions of sample plots were

created. To reveal estimated diameter distributions of sample plots, 9 different PDFs (Beta, 2- and 3-parameter Gamma, Johnson's S_B, 2- and 3-parameter Lognormal, Normal, 2- and 3-parameter Weibull functions) were evaluated. Equation forms of PDFs used in this study are given in Table 2. The parameters of the PDFs were fitted with Maximum Likelihood Estimation using *Easyfit 5.5* software (Mathwave Technologies).

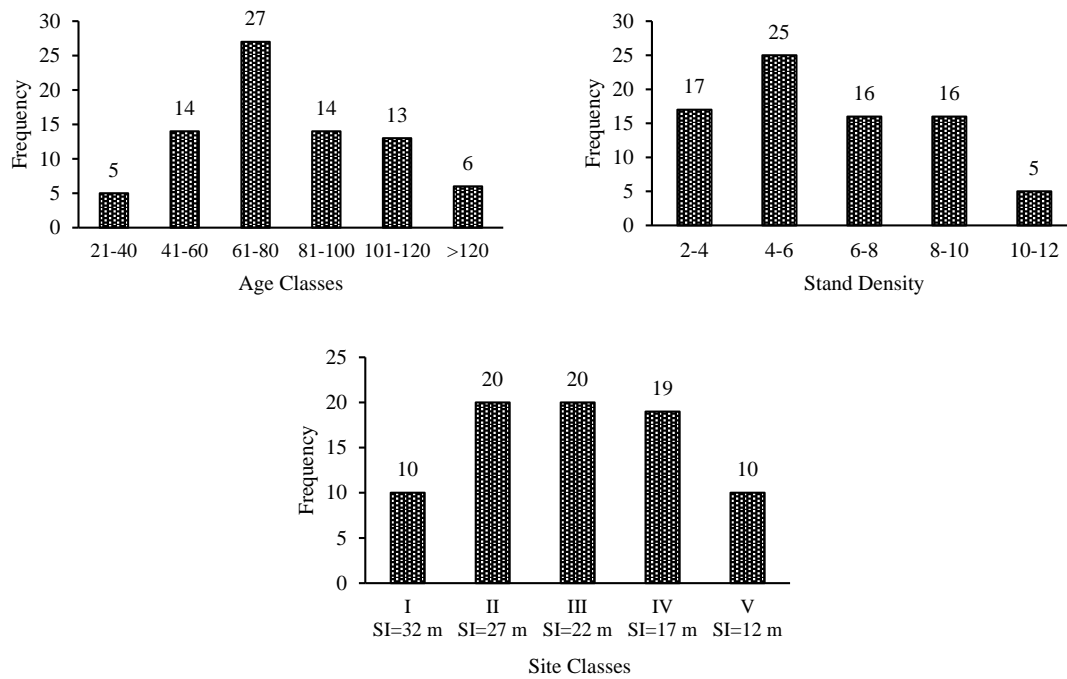

Figure 2. Distribution of sample plots to age, site and stand density classes

Table 2. Probability density functions evaluated in this study

Distribution	Probability density function	Parameters
Beta	$f(x) = \frac{1}{B(\alpha_1, \alpha_2)} \frac{(x-a)^{\alpha_1-1} (b-x)^{\alpha_2-1}}{(b-a)^{\alpha_1+\alpha_2-1}}$	α_1, α_2, a, b : Parameters $B(\alpha_1, \alpha_2)$: Beta function $a \leq x \leq b, \alpha_1 > 0, \alpha_2 > 0$
Gamma (2p)	$f(x) = \frac{x^{\alpha-1}}{\beta^\alpha \Gamma(\alpha)} \exp(-x/\beta)$	α, β : Parameters $\Gamma(\alpha)$: Gamma function $\alpha > 0, \beta > 0$
Gamma (3p)	$f(x) = \frac{(x-\gamma)^{\alpha-1}}{\beta^\alpha \Gamma(\alpha)} \exp(-(x-\gamma)/\beta)$	α, β, γ : Parameters $\Gamma(\alpha)$: Gamma function $\alpha > 0, \beta > 0, \gamma \leq x \leq +\infty$
Johnson's SB	$f(x) = \frac{\delta}{\lambda \sqrt{2\pi z(1-z)}} \exp\left(-\frac{1}{2}\left(\gamma + \delta \ln\left(\frac{z}{z-1}\right)\right)^2\right)$	$\delta, \lambda, \gamma, \xi$: Parameters, $z = \frac{x-\xi}{\lambda}$ $\xi \leq x \leq \xi + \lambda, \delta > 0, \gamma > 0$
Normal	$f(x) = \frac{1}{\sigma \sqrt{2\pi}} \exp\left(-\frac{1}{2}\left(\frac{x-\mu}{\sigma}\right)^2\right)$	μ, σ : Parameters
Lognormal (2p)	$f(x) = \frac{1}{x\sigma\sqrt{2\pi}} \exp\left(-\frac{1}{2}\left(\frac{\ln x - \mu}{\sigma}\right)^2\right)$	μ, σ : Parameters
Lognormal (3p)	$f(x) = \frac{1}{(x-\gamma)\sigma\sqrt{2\pi}} \exp\left(-\frac{1}{2}\left(\frac{\ln(x-\gamma) - \mu}{\sigma}\right)^2\right)$	μ, σ, γ : Parameters $\gamma \leq x \leq +\infty$
Weibull (2p)	$f(x) = \frac{\alpha}{\beta} \left(\frac{x}{\beta}\right)^{\alpha-1} \exp\left(-\left(\frac{x}{\beta}\right)^\alpha\right)$	α, β : Parameters $\alpha > 0, \beta > 0$
Weibull (3p)	$f(x) = \frac{\alpha}{\beta} \left(\frac{x-\gamma}{\beta}\right)^{\alpha-1} \exp\left(-\left(\frac{x-\gamma}{\beta}\right)^\alpha\right)$	α, β, γ : Parameters $\alpha > 0, \beta > 0, \gamma \leq x \leq +\infty$

Kolmogorov-Smirnov test was used to statistically control of PDFs fitted for each sample plots. To rank the statistically appropriate PDFs for each sample plots, error index (e) proposed by Reynolds et al. (1988) was used. For this purpose, the error indexes of PDFs were calculated by following equation and the PDFs ranked from 1 to 9 starting from the function had the smallest error index. Finally, the average ranks of the functions were determined separately based on the average of the ranks related to all sample plots for each function. The function which had the smallest average rank was concluded to be the most successful probability density function.

$$e = \sum_{j=1}^k |n_p - n_o|$$

In this equation; k : The number of diameter classes in sample plot, n_p : Estimated number of trees for j^{th} diameter class, n_o : Observed number of trees in j^{th} diameter class.

The process described above related to ranking of PDFs was firstly applied to all sample plots regardless any age classes, site classes and stand densities, and the most successful function was decided. Besides, the most successful PDFs were determined for each age, site and stand density classes.

Results and Discussion

According to Kolmogorov-Smirnov test results, for black pine stands in Taşköprü Forest Enterprise, 2-parameter Gamma, 3-parameter Gamma, 2-parameter Lognormal, 3-parameter Lognormal, Normal and 2-parameter Weibull functions were found to be statistically suitable ($p > 0,05$) for all of the sample plots, while Beta function was for 77, 3-parameter Weibull function was for 76 and the Johnson's S_B function was for 71 sample plots.

Error index (e) values calculated in order to compare PDFs' achievements to estimate the diameter distribution of sample plots and results related to ranks determined for each sample plots according to error indexes are given in Table 3. When these results are examined, it is seen that Beta function for 11, 2-parameter Gamma function for 4, 3-

parameter Gamma function for 12, Johnson's S_B function for 11, 2-parameter Lognormal function for 24, 3-parameter Lognormal function for 3, Normal function for 5, 2-parameter Weibull function for 1 and 3-parameter Weibull function for 9 sample plots take the first order.

Average ranks for PDFs are 5.0 for Beta function, 4.8 for 2-parameter Gamma function, 3.5 for 3-parameter Gamma function, 4.4 for Johnson's S_B function, 4.2 for 2-parameter Lognormal function, 4.4 for 3-parameter Lognormal function, 6.1 for Normal function, 7.6 for 2-parameter Weibull function and 4.4 for 3-parameter Weibull function. Based on these values, 3-parameter Gamma function is the most successful function in case of without any classification in terms of stand age, site and stand density for pure black pine stands in Taşköprü Forest Enterprise. However, 2-parameter Weibull function has the lowest achievement.

In order to reveal whether it shows any difference in terms of age classes, site classes and stand densities, the ranks of PDFs were evaluated separately dividing the sample plots into age classes, site classes and stand density degrees.

When examined the results obtained for the stand age classification, 2-parameter Lognormal function for stands in 21-40 age range, the 3-parameter Gamma function for stands in 41-60 age range, 2-parameter Lognormal function for stands in 61-80 age range, 3-parameter Gamma function for stands in 81-100 age range, 2-parameter Gamma function for stands in 101-120 age range and 3-parameter Gamma function for stands over 120 age have the lowest average ranks (Table 4). According to these results, 2-parameter Lognormal PDF for 21-40 and 61-80 age classes, 3-parameter Gamma PDF for 41-60, 81-100 and >120 age classes and 2-parameter Gamma PDF for 101-120 age class have been the most successful functions for modeling diameter distributions of pure black pine stands in Taşköprü Forest Enterprise.

According to the results obtained by the site class classification, 2-parameter Lognormal function has the lowest average rank for stands in best site, while 3-parameter Gamma function for remaining site classes

Table 3. Error indexes and ranks for diameter distributions of sample plots

Sample plot	Beta		Gamma (2p)		Gamma (3p)		Johnson's S_B		Lognormal (2p)		Lognormal (3p)		Normal		Weibull (2p)		Weibull (3p)	
	e	Rank	e	Rank	e	Rank	e	Rank	e	Rank	e	Rank	e	Rank	e	Rank	e	Rank
1	178,9	7	155,6	6	133,2	2	142,7	5	138,2	4	135,0	3	195,0	8	251,7	9	132,9	1
2	675,0	5	645,8	2	675,6	6	669,6	3	590,2	1	673,7	4	736,8	8	834,6	9	699,0	7
3	347,4	5	365,8	7	264,1	1	327,6	4	349,2	6	282,8	3	426,0	8	479,1	9	278,4	2
6	182,2	7	176,2	5	169,1	3	172,2	4	164,5	1	168,7	2	204,5	8	236,7	9	181,0	6
7	108,5	4	108,9	5	107,8	3	-	-	99,4	1	105,4	2	147,2	7	147,8	8	124,0	6
8	228,4	4	232,9	5	225,3	3	235,5	6	222,1	2	217,1	1	252,9	7	261,4	8	-	-
9	-	-	69,5	1	73,1	2	-	-	86,8	5	74,9	3	77,0	4	104,6	7	94,5	6
10	65,9	1	79,9	6	78,8	5	73,7	3	77,2	4	80,2	7	85,0	8	100,2	9	73,6	2
11	265,4	9	226,4	5	210,4	3	246,7	8	237,1	6	211,5	4	210,2	2	206,5	1	245,6	7
12	174,8	5	159,9	2	164,9	3	-	-	151,8	1	169,9	4	175,0	6	199,9	8	175,7	7
13	157,9	6	135,6	1	144,5	4	-	-	143,7	2	144,4	3	145,9	5	165,4	8	163,3	7
14	273,8	2	294,9	6	285,3	4	280,9	3	295,7	7	288,0	5	302,3	8	342,3	9	272,8	1
15	80,7	1	123,3	5	119,2	3	226,8	9	113,7	2	121,9	4	124,6	6	128,4	7	217,6	8
16	314,4	1	353,3	3	368,1	5	364,2	4	320,0	2	377,9	7	400,5	8	484,5	9	371,2	6
17	196,4	5	188,7	2	191,9	4	-	-	184,3	1	190,6	3	210,5	7	221,3	8	204,2	6
18	112,2	4	201,9	7	97,4	2	103,0	3	198,9	6	119,1	5	220,7	8	243,9	9	88,3	1
19	360,8	9	204,7	3	202,0	2	216,6	6	193,9	1	209,3	4	213,1	5	239,6	8	222,9	7
20	271,9	6	196,1	2	217,4	3	-	-	170,1	1	244,8	5	231,4	4	272,0	7	273,4	8
21	226,1	6	248,2	7	225,8	5	218,2	2	257,1	8	221,9	4	215,8	1	221,5	3	-	-
22	289,6	9	178,7	5	171,0	4	198,7	7	226,0	8	166,1	2	162,7	1	194,6	6	166,8	3
23	269,3	2	279,0	5	278,3	4	268,3	1	292,9	7	280,6	6	298,7	8	349,7	9	270,3	3
24	187,6	4	192,4	7	189,2	6	183,2	1	186,8	3	189,0	5	207,1	8	251,2	9	185,8	2
25	255,0	9	187,4	4	181,2	1	199,3	6	205,0	7	183,4	3	188,4	5	206,6	8	182,2	2
26	148,8	9	89,9	3	82,4	1	96,0	6	88,7	2	93,1	4	95,3	5	113,5	8	97,4	7
27	494,5	7	445,6	2	472,4	3	485,3	6	401,2	1	480,0	4	519,6	8	582,5	9	484,6	5
28	453,5	5	427,5	2	441,6	3	448,8	4	388,8	1	458,4	7	482,0	8	546,7	9	455,6	6
30	469,3	2	547,3	8	535,4	5	466,2	1	536,0	6	536,1	7	533,8	4	551,7	9	532,0	3
31	-	-	168,3	3	165,0	2	207,7	8	159,1	1	170,9	4	173,5	5	186,2	7	176,5	6
32	193,0	2	230,4	8	208,6	7	195,4	4	239,6	9	202,3	6	197,1	5	193,8	3	192,6	1
34	246,8	8	229,4	4	223,2	3	212,6	2	203,8	1	238,2	6	240,9	7	273,7	9	230,9	5
35	442,1	7	417,8	5	409,8	3	397,9	2	387,7	1	412,6	4	473,7	8	562,0	9	424,0	6
36	334,4	3	346,5	6	328,5	2	367,8	8	355,6	7	373,8	9	334,7	4	341,6	5	295,7	1
37	313,0	7	293,8	2	299,2	3	307,8	6	277,3	1	299,7	4	314,4	8	332,6	9	307,6	5
38	146,7	2	170,4	7	157,5	4	106,3	1	167,9	6	162,6	5	185,9	8	213,2	9	154,5	3
39	298,3	6	289,1	5	285,4	2	289,0	4	265,0	1	285,9	3	340,1	8	408,9	9	302,5	7
40	526,7	6	437,8	2	493,7	3	584,6	8	399,4	1	512,4	4	520,6	5	591,3	9	535,3	7
41	331,4	5	349,9	7	324,7	2,5	326,4	4	315,9	1	324,7	2,5	424,6	8	481,2	9	340,4	6
43	259,7	2	269,4	9	267,9	7	266,6	5	267,1	6	268,4	8	264,4	4	262,2	3	256,1	1
44	532,2	1	611,0	6	607,7	5	561,8	2	571,4	3	618,0	7	629,1	8	687,3	9	602,3	4
45	249,9	9	144,2	2	144,6	3	183,6	7	124,7	1	158,8	5	168,0	6	219,5	8	146,6	4
46	120,8	9	60,0	2	58,0	1	71,7	8	60,7	3	61,4	4	64,0	5	66,0	6	67,4	7
47	168,8	8	140,7	6	115,7	1	136,8	5	141,8	7	116,6	2	116,9	3	119,8	4	-	-
48	128,9	2	177,5	6	141,6	4	84,1	1	180,0	7	142,0	5	188,5	8	207,6	9	137,2	3
49	57,1	2	86,8	8	85,2	7	47,9	1	88,3	9	83,1	5	79,2	4	78,8	3	83,9	6
50	197,0	8	180,8	5	122,1	1	151,9	3	183,7	6	166,6	4	189,8	7	201,0	9	142,2	2
51	143,9	9	110,4	2	114,2	3	127,7	7	105,0	1	116,3	4	118,7	5	128,1	8	126,2	6
52	271,8	9	151,2	2	157,9	3	183,2	6	133,6	1	168,8	4	178,8	5	217,8	8	190,2	7
53	204,5	5	202,1	3	203,0	4	214,9	7	190,1	1	195,1	2	222,2	8	270,8	9	214,1	6
54	332,3	2	344,1	5	339,5	4	331,5	1	337,4	3	344,6	6	430,9	8	498,7	9	347,9	7
55	177,2	5,5	177,1	4	177,2	5,5	176,0	2	173,1	1	176,7	3	187,7	8	194,3	9	177,7	7
56	322,9	1	409,2	8	383,4	6	391,3	7	416,9	9	380,4	5	376,6	4	372,3	2	373,5	3
57	211,6	7	194,1	5	201,3	6	176,9	2	183,3	3	154,8	1	218,5	8	219,1	9	187,3	4
58	408,3	7	388,5	1	403,3	6	-	-	393,3	2	400,4	4	397,2	3	409,9	8	401,5	5
59	199,6	9	124,3	5	122,9	3	129,2	8	125,7	6	122,2	2	120,8	1	125,9	7	124,1	4
60	180,8	9	156,4	4	150,7	1	175,5	8	162,3	6	152,2	2	155,9	3	160,0	5	173,9	7
61	215,4	2	250,0	6	244,8	4	195,5	1	257,5	8	255,4	7	249,4	5	267,0	9	233,8	3
62	368,4	4	367,5	2	368,7	6	369,0	7	368,3	3	368,6	5	376,4	8	418,4	9	362,7	1
63	90,3	1	264,5	6	117,9	2	124,0	3	275,4	9	206,7	5	274,5	7	275,1	8	152,3	4
64	145,6	9	120,6	1	120,7	2	128,0	6	128,1	7	124,9	3	125,5	5	138,6	8	125,3	4
65	136,9	5	135,5	3	134,4	1,5	137,1	6	136,0	4	134,4	1,5	168,8	8	206,8	9	139,5	7
66	667,2	2	670,1	3	670,7	4	678,2	7	615,8	1	674,9	6	776,6	8	904,4	9	674,8	5

Table 3. (Continued)

Sample plot	Beta		Gamma (2p)		Gamma (3p)		Johnson's S_B		Lognormal (2p)		Lognormal (3p)		Normal		Weibull (2p)		Weibull (3p)	
	e	Rank	e	Rank	e	Rank	e	Rank	e	Rank	e	Rank	e	Rank	e	Rank	e	Rank
68	243,9	2	297,7	8	261,4	6	257,0	5	320,7	9	253,4	4	242,3	1	247,9	3	267,8	7
69	153,7	8	137,4	5	39,2	1	93,0	4	138,7	6	89,1	3	148,2	7	179,1	9	73,5	2
70	64,3	5	84,0	8	68,8	6	75,3	7	98,1	9	61,8	4	57,5	2	59,0	3	57,1	1
71	275,1	9	190,1	6	173,2	3	138,6	1	180,6	4	188,8	5	221,8	7	260,5	8	151,3	2
72	190,4	1	260,8	6	196,9	2	258,4	4	262,3	7	259,8	5	272,2	8	293,9	9	224,8	3
73	112,2	1	183,7	5	181,3	4	170,5	2	188,3	6	190,5	7	191,4	8	209,5	9	172,7	3
74	247,5	8	242,8	7	235,7	2	256,1	9	228,0	1	241,7	6	238,5	3	238,6	4	241,2	5
75	320,9	3	345,2	6	327,9	4	309,5	2	353,2	7	329,4	5	361,5	8	411,0	9	308,0	1
76	178,5	4	334,3	7	63,6	1	194,5	5	328,8	6	64,6	2	357,4	8	398,7	9	70,7	3
77	256,7	2	344,6	7	258,9	3,5	239,3	1	327,7	6	258,9	3,5	398,9	8	465,9	9	266,6	5
78	100,2	4	110,7	7	91,4	1	94,1	2	102,6	5	104,1	6	127,5	8	153,0	9	98,3	3
79	422,6	9	368,7	3	419,9	8	377,8	5	376,5	4	379,1	6	361,0	1	366,8	2	405,9	7
80	117,8	1	167,8	8	161,4	7	120,5	2	175,6	9	158,3	6	153,9	5	130,7	3	134,4	4
81	368,7	5	374,1	6	202,8	1	343,3	4	398,5	7	333,0	3	416,8	8	469,3	9	226,2	2
82	207,7	1	374,3	7	310,2	3	280,1	2	350,3	5	355,0	6	401,4	8	419,3	9	313,7	4
83	219,7	1	229,6	2	234,4	4	259,9	8	238,2	5	239,2	6	256,7	7	266,3	9	233,9	3
84	119,8	7	111,2	2,5	111,2	2,5	-	-	109,2	1	111,6	4	116,5	6	122,6	8	115,1	5
85	197,1	3	213,6	7	198,7	4	178,8	1	202,3	5	204,3	6	238,8	8	293,8	9	196,4	2
Mean		5,0		4,8		3,5		4,4		4,2		4,4		6,1		7,6		4,4

have the lowest average ranks (Table 5). According to these results, the most successful function for best site class is 2-parameter Lognormal PDF and is 3-parameter Gamma PDF for remaining site classes for modeling diameter distributions of pure black pine stands in Taşköprü Forest Enterprise.

According to the results obtained for the stand density classification, 3-parameter Gamma function for stands having 2-4 and 4-6 stand density degrees, the Johnson's S_B function for stands having 6-8 stand density degrees and 2-parameter Lognormal function for stands having 8-10 and 10-12 stand density degrees have the lowest average ranking (Table 6). According to these results, the most successful functions are 3-parameter Gamma PDF for stands having stand density less than 6, Johnson's S_B PDF for stands having stand density between 6-8 and 2-parameter Lognormal PDF for stands having stand density more than 8 for modeling diameter distributions of pure black pine stands in Taşköprü Forest Enterprise.

In order to visual compare of observed and estimated diameter distributions with the most successful PDFs, diameter distribution graphs of some sample plots were drawn for different age, site and stand density classes. Observed and estimated diameter distributions for sample plots in different age classes, site

classes and stand densities are given in Figure 3, Figure 4 and Figure 5, respectively.

When the results obtained in this study compared to the results of Carus and Çatal (2011), the most successful PDF to model the diameter distribution of black pine stands in Taşköprü region is 3-parameter Gamma function, while the most successful for black pine stands in the Mediterranean region is Lognormal function. Considering also the results of studies for even-aged stands of other tree species in Turkey, Gamma for beech (Carus, 1996), Weibull for ash (Yavuz et al., 2002), Lognormal for Calabrian pine (Carus and Çatal, 2008) and Johnson's S_B for Oriental spruce (Sönmez et al., 2010) have been successful. For Oriental spruce stands, Sönmez et al. (2015) found that Johnson's S_B for 20-40, 101-120 and 141-160 age ranges, 3-parameter Weibull for 41-100 age range and over 160 age and Beta function for 121-140 age range were found successful according to age classes, whereas Beta for site classes I and II, Johnson's S_B for site class III and 3-parameter Weibull for site class IV and V according to site classes. The diameter distributions for the stands vary according to tree species, site and stand structure. In other words, the diameter distributions are depended on various stand characteristics and other environmental conditions and it takes

shape according to changes in stand characteristics and conditions. It can be said that, the differences between the results of this

study and the results obtained in other studies are caused by these reasons.

Table 4. Ranks of probability density functions for age classes

Sample Plot	Rank order by PDFs									Sample Plot	Rank order by PDFs								
	Beta	Gamma (2p)	Gamma (3p)	Johnson S _B	Lognormal (2p)	Lognormal (3p)	Normal	Weibull (2p)	Weibull (3p)		Beta	Gamma (2p)	Gamma (3p)	Johnson S _B	Lognormal (2p)	Lognormal (3p)	Normal	Weibull (2p)	Weibull (3p)
<i>21-40 ages</i>										<i>81-100 ages</i>									
20	6	2	3	-	1	5	4	7	8	1	7	6	2	5	4	3	8	9	1
27	7	2	3	6	1	4	8	9	5	6	7	5	3	4	1	2	8	9	6
30	2	8	5	1	6	7	4	9	3	22	9	5	4	7	8	2	1	6	3
79	9	3	8	5	4	6	1	2	7	24	4	7	6	1	3	5	8	9	2
81	5	6	1	4	7	3	8	9	2	32	2	8	7	4	9	6	5	3	1
Mean	5,8	4,2	4,0	4,0	3,8	5,0	5,0	7,2	5,0	35	7	5	3	2	1	4	8	9	6
<i>41-60 ages</i>										<i>101-120 ages</i>									
14	2	6	4	3	7	5	8	9	1	38	2	7	4	1	6	5	8	9	3
15	1	5	3	9	2	4	6	7	8	40	6	2	3	8	1	4	5	9	7
21	6	7	5	2	8	4	1	3	-	60	9	4	1	8	6	2	3	5	7
36	3	6	2	8	7	9	4	5	1	61	2	6	4	1	8	7	5	9	3
41	5	7	2,5	4	1	2,5	8	9	6	63	1	6	2	3	9	5	7	8	4
44	1	6	5	2	3	7	8	9	4	75	3	6	4	2	7	5	8	9	1
47	8	6	1	5	7	2	3	4	-	76	4	7	1	5	6	2	8	9	3
48	2	6	4	1	7	5	8	9	3	78	4	7	1	2	5	6	8	9	3
50	8	5	1	3	6	4	7	9	2	Mean	4,8	5,8	3,2	3,8	5,3	4,1	6,4	8,0	3,6
51	9	2	3	7	1	4	5	8	6	<i>>120 ages</i>									
52	9	2	3	6	1	4	5	8	7	3	5	7	1	4	6	3	8	9	2
72	1	6	2	4	7	5	8	9	3	9	-	1	2	-	5	3	4	7	6
74	8	7	2	9	1	6	3	4	5	11	9	5	3	8	6	4	2	1	7
84	7	2,5	2,5	1	4	6	8	5	12	5	2	3	-	1	4	6	8	7	
Mean	5,0	5,3	2,9	4,8	4,2	4,7	5,7	7,2	4,3	56	1	8	6	7	9	5	4	2	3
<i>61-80 ages</i>										69	8	5	1	4	6	3	7	9	2
2	5	2	6	3	1	4	8	9	7	Mean	5,6	4,7	2,7	5,8	5,5	3,7	5,2	6,0	4,5
7	4	5	3	-	1	2	7	8	6										
10	1	6	5	3	4	7	8	9	2										
16	1	3	5	4	2	7	8	9	6										
18	4	7	2	3	6	5	8	9	1										
19	9	3	2	6	1	4	5	8	7										
25	9	4	1	6	7	3	5	8	2										
26	9	3	1	6	2	4	5	8	7										
31	-	3	2	8	1	4	5	7	6										
34	8	4	3	2	1	6	7	9	5										
37	7	2	3	6	1	4	8	9	5										
39	6	5	2	4	1	3	8	9	7										
43	2	9	7	5	6	8	4	3	1										
45	9	2	3	7	1	5	6	8	4										
46	9	2	1	8	3	4	5	6	7										
49	2	8	7	1	9	5	4	3	6										
54	2	5	4	1	3	6	8	9	7										
55	5,5	4	5,5	2	1	3	8	9	7										
57	7	5	6	2	3	1	8	9	4										
65	5	3	1,5	6	4	1,5	8	9	7										
66	2	3	4	7	1	6	8	9	5										
68	2	8	6	5	9	4	1	3	7										
73	1	5	4	2	6	7	8	9	3										
80	1	8	7	2	9	6	5	3	4										
82	1	7	3	2	5	6	8	9	4										
83	1	2	4	8	5	6	7	9	3										
85	3	7	4	1	5	6	8	9	2										
Mean	4,4	4,6	3,8	4,2	3,6	4,7	6,6	7,7	4,9										

Table 5. Ranks of probability density functions for site classes

Sample Plot	Rank order by PDFs								Sample Plot	Rank order by PDFs									
	Beta	Gamma (2p)	Gamma (3p)	Johnson S _B	Lognormal (2p)	Lognormal (3p)	Normal	Weibull (2p)		Weibull (3p)	Beta	Gamma (2p)	Gamma (3p)	Johnson S _B	Lognormal (2p)	Lognormal (3p)	Normal	Weibull (2p)	Weibull (3p)
<i>Site Class I (SI=32 m)</i>									<i>Site Class IV (SI=17 m)</i>										
1	7	6	2	5	4	3	8	9	1	2	5	2	6	3	1	4	8	9	7
8	4	5	3	6	2	1	7	8	-	6	7	5	3	4	1	2	8	9	6
26	9	3	1	6	2	4	5	8	7	9	-	1	2	-	5	3	4	7	6
31	-	3	2	8	1	4	5	7	6	11	9	5	3	8	6	4	2	1	7
32	2	8	7	4	9	6	5	3	1	13	6	1	4	-	2	3	5	8	7
34	8	4	3	2	1	6	7	9	5	15	1	5	3	9	2	4	6	7	8
35	7	5	3	2	1	4	8	9	6	16	1	3	5	4	2	7	8	9	6
44	1	6	5	2	3	7	8	9	4	22	9	5	4	7	8	2	1	6	3
51	9	2	3	7	1	4	5	8	6	23	2	5	4	1	7	6	8	9	3
53	5	3	4	7	1	2	8	9	6	24	4	7	6	1	3	5	8	9	2
Mean	5,8	4,5	3,3	4,9	2,5	4,1	6,6	7,9	4,7	25	9	4	1	6	7	3	5	8	2
<i>Site Class II (SI=27 m)</i>									<i>Site Class V (SI=12 m)</i>										
18	4	7	2	3	6	5	8	9	1	38	2	7	4	1	6	5	8	9	3
19	9	3	2	6	1	4	5	8	7	39	6	5	2	4	1	3	8	9	7
21	6	7	5	2	8	4	1	3	-	40	6	2	3	8	1	4	5	9	7
30	2	8	5	1	6	7	4	9	3	41	5	7	2,5	4	1	2,5	8	9	6
37	7	2	3	6	1	4	8	9	5	71	9	6	3	1	4	5	7	8	2
45	9	2	3	7	1	5	6	8	4	78	4	7	1	2	5	6	8	9	3
46	9	2	1	8	3	4	5	6	7	84	7	2,5	2,5	-	1	4	6	8	5
48	2	6	4	1	7	5	8	9	3	85	3	7	4	1	5	6	8	9	2
52	9	2	3	6	1	4	5	8	7	Mean	5,3	4,6	3,3	4,0	3,6	4,1	6,4	8,0	4,8
55	5,5	4	5,5	2	1	3	8	9	7	<i>Site Class V (SI=12 m)</i>									
57	7	5	6	2	3	1	8	9	4	3	5	7	1	4	6	3	8	9	2
58	7	1	6	-	2	4	3	8	5	7	4	5	3	-	1	2	7	8	6
59	9	5	3	8	6	2	1	7	4	10	1	6	5	3	4	7	8	9	2
60	9	4	1	8	6	2	3	5	7	72	1	6	2	4	7	5	8	9	3
61	2	6	4	1	8	7	5	9	3	73	1	5	4	2	6	7	8	9	3
62	4	2	6	7	3	5	8	9	1	74	8	7	2	9	1	6	3	4	5
63	1	6	2	3	9	5	7	8	4	75	3	6	4	2	7	5	8	9	1
65	5	3	1,5	6	4	1,5	8	9	7	76	4	7	1	5	6	2	8	9	3
81	5	6	1	4	7	3	8	9	2	77	2	7	3,5	1	6	3,5	8	9	5
82	1	7	3	2	5	6	8	9	4	79	9	3	8	5	4	6	1	2	7
Mean	5,6	4,4	3,4	4,4	4,4	4,1	5,9	8,0	4,5	Mean	3,8	5,9	3,4	3,9	4,8	4,7	6,7	7,7	3,7
<i>Site Class III (SI=22 m)</i>																			
12	5	2	3	-	1	4	6	8	7										
14	2	6	4	3	7	5	8	9	1										
17	5	2	4	-	1	3	7	8	6										
20	6	2	3	-	1	5	4	7	8										
27	7	2	3	6	1	4	8	9	5										
28	5	2	3	4	1	7	8	9	6										
36	3	6	2	8	7	9	4	5	1										
43	2	9	7	5	6	8	4	3	1										
47	8	6	1	5	7	2	3	4	-										
49	2	8	7	1	9	5	4	3	6										
50	8	5	1	3	6	4	7	9	2										
54	2	5	4	1	3	6	8	9	7										
56	1	8	6	7	9	5	4	2	3										
64	9	1	2	6	7	3	5	8	4										
66	2	3	4	7	1	6	8	9	5										
68	2	8	6	5	9	4	1	3	7										
69	8	5	1	4	6	3	7	9	2										
70	5	8	6	7	9	4	2	3	1										
80	1	8	7	2	9	6	5	3	4										
83	1	2	4	8	5	6	7	9	3										
Mean	4,2	4,9	3,9	4,8	5,3	5,0	5,5	6,5	4,2										

Table 6. Ranks of probability density functions for stand densities

Sample Plot	Rank order by PDFs									Sample Plot	Rank order by PDFs								
	Beta	Gamma (2p)	Gamma (3p)	Johnson S _B	Lognormal (2p)	Lognormal (3p)	Normal	Weibull (2p)	Weibull (3p)		Beta	Gamma (2p)	Gamma (3p)	Johnson S _B	Lognormal (2p)	Lognormal (3p)	Normal	Weibull (2p)	Weibull (3p)
<i>Stand density: 2-4</i>										<i>Stand density: 6-8</i>									
6	7	5	3	4	1	2	8	9	6	13	6	1	4	-	2	3	5	8	7
7	4	5	3	-	1	2	7	8	6	21	6	7	5	2	8	4	1	3	-
9	-	1	2	-	5	3	4	7	6	25	9	4	1	6	7	3	5	8	2
10	1	6	5	3	4	7	8	9	2	30	2	8	5	1	6	7	4	9	3
15	1	5	3	9	2	4	6	7	8	32	2	8	7	4	9	6	5	3	1
20	6	2	3	-	1	5	4	7	8	37	7	2	3	6	1	4	8	9	5
36	3	6	2	8	7	9	4	5	1	41	5	7	2,5	4	1	2,5	8	9	6
46	9	2	1	8	3	4	5	6	7	43	2	9	7	5	6	8	4	3	1
47	8	6	1	5	7	2	3	4	-	54	2	5	4	1	3	6	8	9	7
49	2	8	7	1	9	5	4	3	6	55	5,5	4	5,5	2	1	3	8	9	7
50	8	5	1	3	6	4	7	9	2	58	7	1	6	-	2	4	3	8	5
51	9	2	3	7	1	4	5	8	6	60	9	4	1	8	6	2	3	5	7
52	9	2	3	6	1	4	5	8	7	62	4	2	6	7	3	5	8	9	1
72	1	6	2	4	7	5	8	9	3	64	9	1	2	6	7	3	5	8	4
73	1	5	4	2	6	7	8	9	3	80	1	8	7	2	9	6	5	3	4
81	5	6	1	4	7	3	8	9	2	85	3	7	4	1	5	6	8	9	2
84	7	2,5	2,5	-	1	4	6	8	5	Mean	5,0	4,9	4,4	3,9	4,8	4,5	5,5	7,0	4,1
Mean	5,1	4,4	2,7	4,9	4,1	4,4	5,9	7,4	4,9	<i>Stand density: 8-10</i>									
<i>Stand density: 4-6</i>										<i>Stand density: 10-12</i>									
8	4	5	3	6	2	1	7	8	-	1	7	6	2	5	4	3	8	9	1
11	9	5	3	8	6	4	2	1	7	2	5	2	6	3	1	4	8	9	7
12	5	2	3	-	1	4	6	8	7	3	5	7	1	4	6	3	8	9	2
14	2	6	4	3	7	5	8	9	1	16	1	3	5	4	2	7	8	9	6
18	4	7	2	3	6	5	8	9	1	17	5	2	4	-	1	3	7	8	6
19	9	3	2	6	1	4	5	8	7	23	2	5	4	1	7	6	8	9	3
22	9	5	4	7	8	2	1	6	3	28	5	2	3	4	1	7	8	9	6
24	4	7	6	1	3	5	8	9	2	39	6	5	2	4	1	3	8	9	7
26	9	3	1	6	2	4	5	8	7	40	6	2	3	8	1	4	5	9	7
27	7	2	3	6	1	4	8	9	5	44	1	6	5	2	3	7	8	9	4
38	2	7	4	1	6	5	8	9	3	53	5	3	4	7	1	2	8	9	6
48	2	6	4	1	7	5	8	9	3	66	2	3	4	7	1	6	8	9	5
57	7	5	6	2	3	1	8	9	4	71	9	6	3	1	4	5	7	8	2
59	9	5	3	8	6	2	1	7	4	77	2	7	3,5	1	6	3,5	8	9	5
61	2	6	4	1	8	7	5	9	3	82	1	7	3	2	5	6	8	9	4
63	1	6	2	3	9	5	7	8	4	83	1	2	4	8	5	6	7	9	3
65	5	3	1,5	6	4	1,5	8	9	7	Mean	3,9	4,3	3,5	4,1	3,1	4,7	7,6	8,9	4,6
68	2	8	6	5	9	4	1	3	7	<i>Stand density: 10-12</i>									
69	8	5	1	4	6	3	7	9	2	31	-	3	2	8	1	4	5	7	6
70	5	8	6	7	9	4	2	3	1	34	8	4	3	2	1	6	7	9	5
74	8	7	2	9	1	6	3	4	5	35	7	5	3	2	1	4	8	9	6
75	3	6	4	2	7	5	8	9	1	45	9	2	3	7	1	5	6	8	4
76	4	7	1	5	6	2	8	9	3	56	1	8	6	7	9	5	4	2	3
78	4	7	1	2	5	6	8	9	3	Mean	6,3	4,4	3,4	5,2	2,6	4,8	6,0	7,0	4,8
79	9	3	8	5	4	6	1	2	7										
Mean	5,3	5,4	3,4	4,5	5,1	4,0	5,6	7,3	4,0										

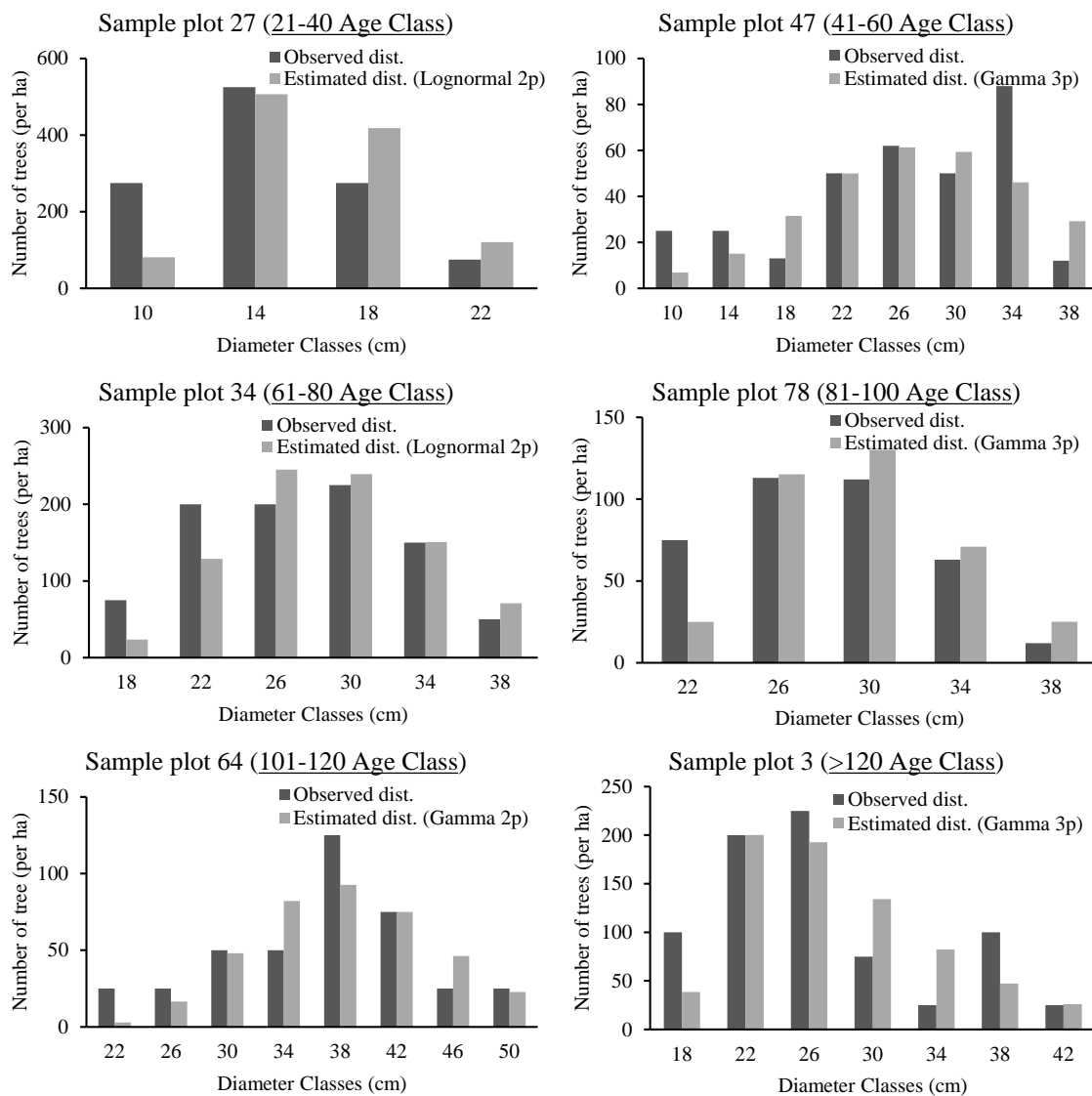

Figure 3. Observed and estimated diameter distributions of sample plots in different age classes

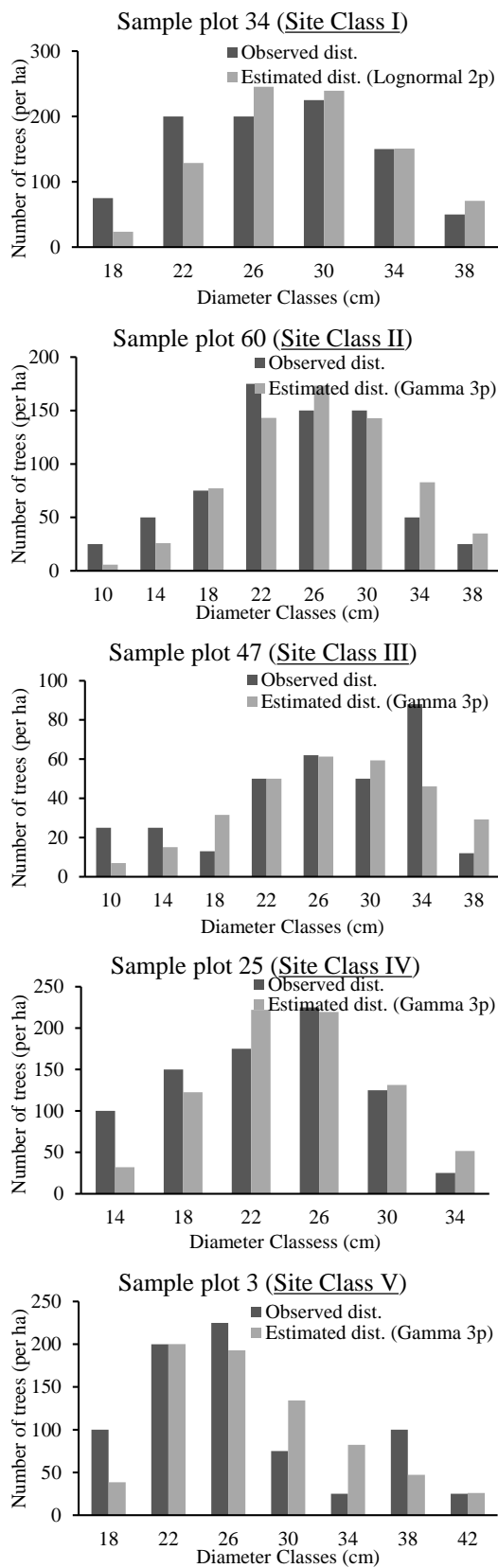

Figure 4. Observed and estimated diameter distributions of sample plots in different site classes

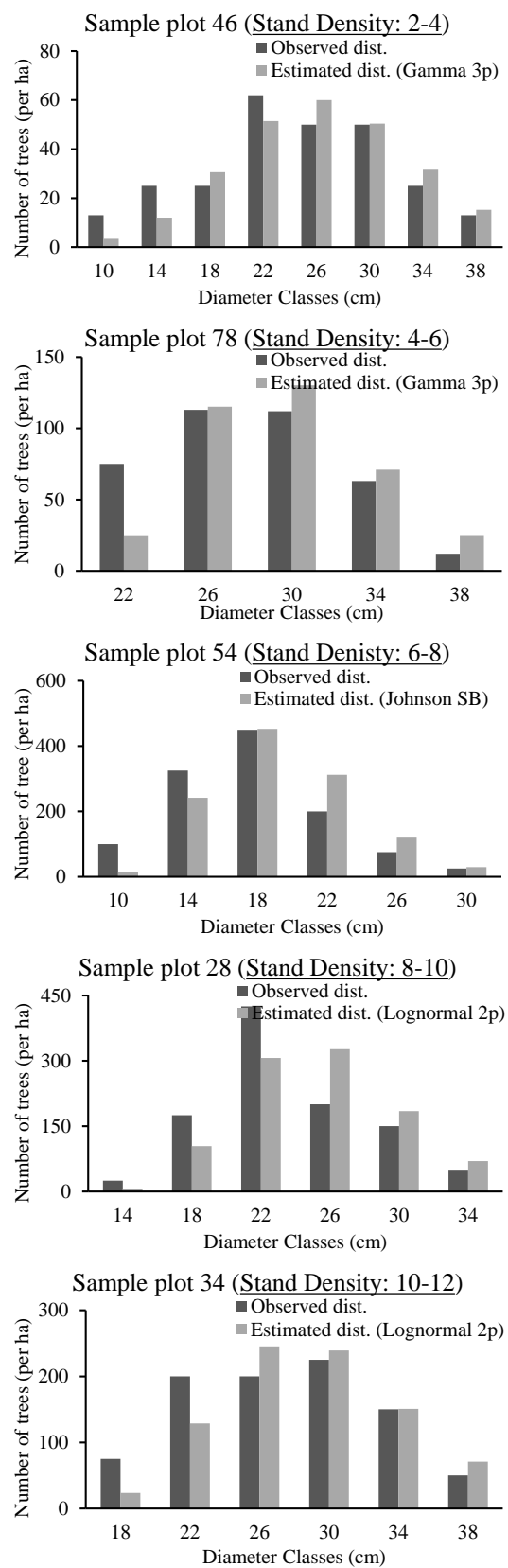

Figure 5. Observed and estimated diameter distributions of sample plots in different stand densities

Conclusions

In this study, it is intended to model diameter distributions for pure black pine stands in Taşköprü Forest Enterprise. Beta, 2- and 3-parameter Gamma, Johnson's S_B , 2- and 3-parameter Lognormal, Normal, 2- and 3- parameter Weibull probability density functions were analyzed based on the data from 79 sample plots and 3-parameter Gamma function was found the most successful function according to the error index (e) comparisons. In comparisons depending on stand ages, site classes and stand densities, 3-parameter Gamma function is also found successful for most of the stand structures.

For stands with different ecological conditions of main forest tree species distributed in Turkey, continuation of studies on estimation and comparison of the diameter distributions which is one of the main tools for revealing the projections relating to stands will provide important data for the forestry sector. In order to be made more effective and consistent estimates about the diameter distribution of the stands, preference of permanent sample plots would be appropriate instead of temporary sample plots preferred often many studies on this subject. Thus, stands will be monitored periodically and effects of various changes occurring in the stand characteristics and environmental conditions on the stand diameter distribution can be put forward.

Acknowledgement

The data used in this study were taken from research project (Project ID: 214O217) supported by The Scientific and Technological Research Council of Turkey (TÜBİTAK). We thanks to TÜBİTAK for financial and technical supports.

References

- Atıcı, E., 1998. Değişikyaşlı Doğu Kayını (*Fagus orientalis* Lipsky.) ormanlarında artım ve büyüme, Doktora Tezi, İstanbul Üniversitesi, Fen Bilimleri Enstitüsü.
- Bailey, R.L., Dell, T.R., 1973. Quantifying diameter distributions with the Weibull function, *Forest Science*, 19, 97-104.
- Carus, S., 1996. Aynı yaşlı Doğu Kayını (*Fagus orientalis* Lipsly.) meşcerelerinde çap dağılımının bonitet ve yaşa göre değişimi, *İstanbul*

Üniversitesi Orman Fakültesi Dergisi, 46, 171-181.

Carus, S., Çatal, Y., 2008. Kızıldağ (*Pinus brutia* Ten.) meşcerelerinde 7-ağaç örnek nokta yöntemiyle meşcere ağaç sayısının çap basamaklarına dağılımının belirlenmesi, *Süleyman Demirel Üniversitesi Orman Fakültesi Dergisi*, 2, 158-169.

Carus, S., Çatal, Y., 2011. The alteration of diameter distribution by site quality and age in even aged Crimean pine (*Pinus nigra* Arnold) stands in southern Turkey, Conservation, Ecology, Restoration and Management of Mediterranean Pines and Their Ecosystems: Challenges under Global Change, June 6-10, Petit Louvre, Avignon, France.

Curtis, R.O., Clendenan, G.W., Demars, D.J., 1981. A new stand simulator for Coast Douglas-fir: DFSIM Users Guide, U.S. Forest Service Technical Report, PNW-128.

Ercanlı, İ., Yavuz, H., 2010. Doğu Ladini (*Picea orientalis* (L.) Link)-Sarıçam (*Pinus sylvestris* L.) karışık meşcerelerinde çap dağılımlarının olasılık yoğunluk fonksiyonları ile belirlenmesi, *Kastamonu Üniversitesi Orman Fakültesi Dergisi*, 10 (1), 68-83.

Gorgoso, J.J., Alvarez Gonzalez, J.G., Rojo, A., Grandas-Arias, A., 2007. Modeling diameter distributions of *Betula alba* L. stands in northwest Spain with the two-parameter Weibull function, *Investigación Agraria: Sistemas y Recursos Forestales*, 16 (2), 113-123.

Kahriman, A., Yavuz, H., 2011. Sarıçam (*Pinus sylvestris* L.) – doğu kayını (*Fagus orientalis* Lipsky.) karışık meşcerelerinde çap dağılımlarının olasılık yoğunluk fonksiyonları ile belirlenmesi, *Artvin Çoruh Üniversitesi Orman Fakültesi Dergisi*, 12 (2), 109-125.

Laar, A., Akça, A., 2007. Forest mensuration: in: Managing Forest Ecosystems, Dordrecht, The Netherlands: Springer. 383 s.

Loetsch, F., Zöhrer, F., Haller, K.E., 1973. Forest Inventory, Volume II, BLV Verlagsgesellschaft München Bern Wien, München.

Maltamo, M., 1997. Comparing basal area diameter distributions estimated by tree species and for the entire growing stock in a mixed stand, *Silva Fennica*, 31 (1), 53-65.

Packard, K.C., 2000. Modeling tree diameter distributions for mixed-species coniferforests in the northeast united states, Master Thesis, State University of New York.

Reynolds, M.R., Burke, T.E., Huang, W., 1988. Goodness-of-tests and model selection procedures for diameter distribution models, *Forest Science*, 34, 373-379.

Saraçoğlu, Ö., 1988. Karadeniz Yöresi Gökmar Meşcerelerinde Artım ve Büyüme, Orman Genel Müdürlüğü Yayınları, 312 s.

Sakıcı, O.E., Gülsunar, M., 2012. Diameter distribution of bornmullerian fir in mixed stands, *Kastamonu Üniversitesi Orman Fakültesi Dergisi*, Özel Sayı, 263-270.

Sönmez, T., Günlü, A., Karahalil, U., Ercanlı, İ., Şahin, A., 2010. Saf doğu ladini meşcerelerinde çap dağılımının modellenmesi, III. Ulusal Karadeniz Ormancılık Kongresi, Artvin, 388-398.

Sönmez, T., Karahalil, U., Günlü, A., Şahin, A., 2015. Aynı yaşlı ve saf doğu ladini (*Picea orientalis* (L.) Link.) meşcerelerinde çap dağılımının bonitet ve yaş sınıfları için değerlendirilmesi, *Kastamonu Üniversitesi Orman Fakültesi Dergisi*, 15 (1), 26-36.

URL-1, 2016. Taşköprü Orman İşletme Müdürlüğü Orman Varlığı, <http://kastamonuobm.ogm.gov.tr/TaskopruOIM/Lists/OrmanVarligi/AllItems.aspx> (September 05, 2016)

Wang, M., Rennols, K., Tang, S., 2008. Bivariate distribution modeling of tree diameters and height: Dependency modelling using copulas, *Forest Science*, 54 (3), 284-293.

Yavuz, H., Gül, A.U., Mısıır, N., Özçelik, R., Sakıcı, O.E., 2002. Meşcerelerde çap dağılımlarının düzenlenmesi ve bu dağılımlara ilişkin parametreler ile çeşitli meşcere öğeleri arasındaki ilişkilerin belirlenmesi, Orman Amenajmanı'nda Kavramsal Açılımlar ve Yeni Hedefler Sempozyumu, İstanbul, 203-212.

Using Artificial Neural Network in Describing Diameter Distribution in an Even-Aged Forest

*Ferhat BOLAT¹, İlker ERCANLI¹

¹Çankırı Karatekin University, Faculty of Forestry, Çankırı / TURKEY

*Corresponding Author: fbolat@karatekin.edu.tr

Abstract

Knowledge on stand diameter distribution (SDD) is important to effective forest management and planning. SDD provides detailed outputs for stand volume ($\text{m}^3 \text{ha}^{-1}$), basal area ($\text{m}^2 \text{ha}^{-1}$) and number of trees (ha^{-1}) by diameter classes. SDD can be quantified by using many probability density functions (PDFs) such as Weibull and Johnson's S_B . With PDFs, relative tree frequency by diameters classes can be obtained and distributed into several diameter classes. The tree parameters of the Weibull function seem to be adequately appropriate for fitting various stand compositions regarding diameter in even-aged forest stands. The objective of the study was to evaluate artificial neural networks (ANNs) in predicting the parameters of the Weibull function. Forest inventory data collected from various stands located in Bursa, northwest Turkey were used in this study. The material for the study included 398 sample plots. The parameters of the Weibull function were estimated using ANNs and percentile estimation method (PEM). The criteria used to assess the performance of the parameter estimators were the Coefficient of determination (R^2), Mean absolute error (MAE) and Root mean square error (RMSE). The results showed that ANNs had more accurate results for estimating the parameters of the Weibull than PEM in terms of all the criteria (R^2 was 0.70 and 0.94, MAE was 49.68 and 28.37, RMSE was 92.31 and 41.07 for PEM and ANN, respectively). The study indicate that ANN can be used more effectively than classical methods for describing SDD in even-aged stands.

Keywords: Diameter distribution, Weibull, Artificial neural network, Stand structure

Introduction

Diameter distribution models (DDMs) have been used basically to determine range of wood products. Also, DDMs can be useful for many purposes such as classification of growing stocks, analysis of stand structure, and assessment of silvicultural treatments (Fonseca et al., 2009). In Turkey, new forestry management concept aims to maintain many management objectives such as wood production, water production, and soil prevention (Başkent, et al., 2007). Therefore, DDMs seem to be beneficial to achieve those the purposes. Tree diameter distributions are described many probability density functions such as Weibull, Johnson S_B , Gamma, and Beta. Bailey and Dell (1973) investigated the Weibull function to describe diameter distribution of Slash pine plantations. Johnson (1949) investigated Johnson S_B probability density function with four parameter. Weibull and Johnson S_B probability distribution have been preferred widely in forestry due to their ability to describe flexibly various diameter distributions (Cao, 2004; Mateus and Tomé, 2011; Lima, et al., 2014). Recently, priority of Weibull probability function has been proved

in forestry. Nowadays, parameter prediction methods have been discussed for achieving more accurate estimates. Until today, many parameter estimators such as nonlinear regression, maximum likelihood estimator, percentiles, moment estimation, and cumulative distribution function have been used for fitting accurately diameters. Especially method of percentile was preferred chiefly for fitting diameter distributions due to its simplicity (Gorgoso, 2015). Lohrey and Bailey (1977) used Weibull function based on 24th and 93rd percentiles to describe diameter distributions. Bailey et al. (1989) used minimum diameter, quadratic mean diameter, 25th, 50th, and 95th percentiles to describe diameter distributions. Nowadays, artificial neural network approach has been used for many objectives: estimation of Weibull function parameters (Diamantopoulou, et al., 2015), total-tree height estimation (Diamantopoulou and Özçelik, 2012), and estimation of inside-bark and heartwood diameter (Leite, et al., 2011), bark volume estimation in pine stands (Diamantopoulou, 2005), and forest characteristics prediction (Moisen and Frensino, 2002). The objective of

this study is to describe diameter distributions based on method of percentile and artificial neural network.

Material and Methods

The study area is located at Kestel Forest Enterprise in Bursa, northwest Turkey, at $29^{\circ}13'00'' - 29^{\circ}21'54''E$ and $40^{\circ}00'00'' - 40^{\circ}12'10''N$, an elevation of 1250 m above sea level. The selected study

area is presented in Figure 1. The study area covers different tree species including *Pinus nigra*, *Pinus brutia*, *Abies bornmülleriana*, *Fagus orientalis*, *Quercus petraea*, *Carpinus betulus*, and *Castanea sativa*. A total of 398 sample points were used to develop the models in this study. Data are described some descriptive statistics including minimum, maximum, mean, standard deviation, and coefficient of variation (Table 1) (Bolat, 2015).

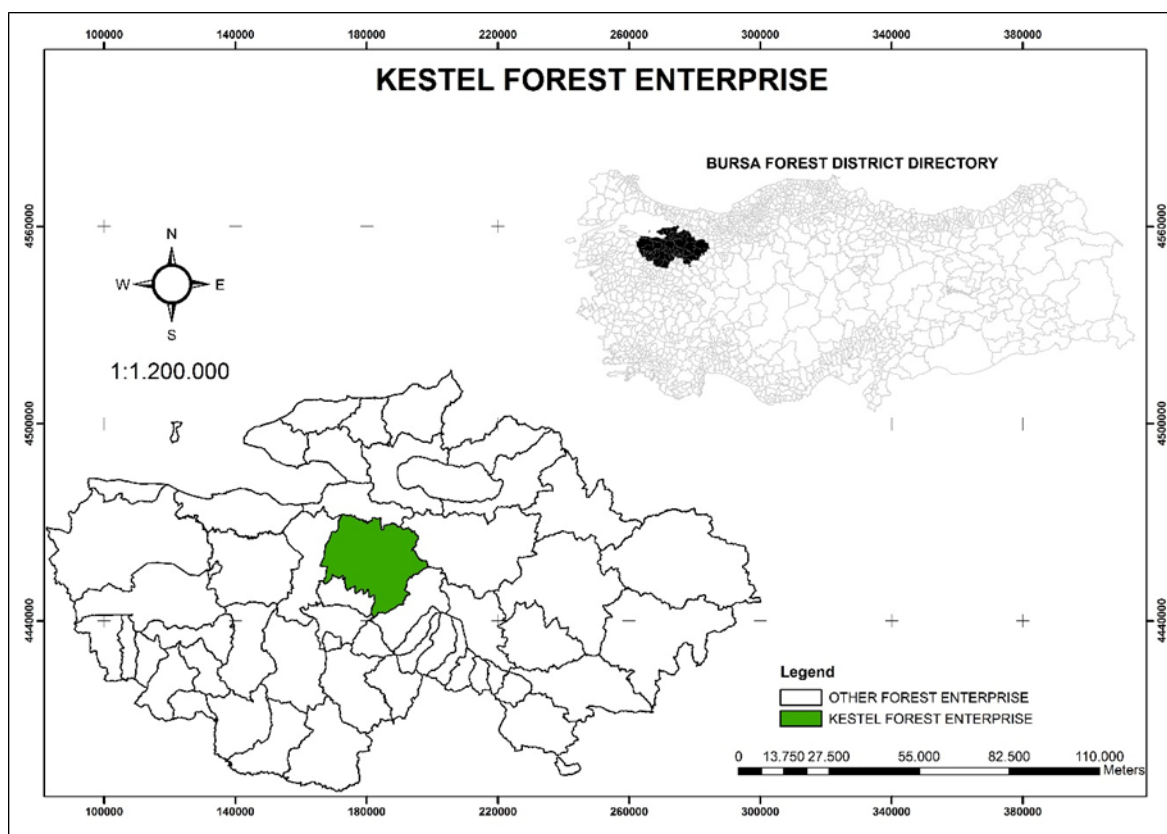

Figure 1. The study area (Kestel Forest Enterprise)

Table 1. Descriptive statistics based on stand types

Variable	Min.	Max.	Mean	Std.Deviation	Cv (%)
Diameter at breast height	8	147	16.85	9.29	55.14

Cv= the coefficient of variation

In this study, the parameters of Weibull function were calculated using 31th and 63rd percentiles. The 3-parameters Weibull

probability density function and method of percentile were given in Equation 1 and Equation 2, respectively.

$$F(x, \alpha, \beta, \gamma) = \frac{\alpha}{\beta} \cdot \left(\frac{x - \gamma}{\beta}\right)^{\alpha-1} \cdot \exp\left(-\left(\frac{x - \gamma}{\beta}\right)^\alpha\right) \quad \text{Eq. 1}$$

Where: x is diameter at breast height, α , β , and γ are location, scale, and shape parameters, respectively.

$$\alpha = 0.5 \cdot d_{min} \quad \gamma = \frac{\text{Ln}\left(\frac{\text{Ln}(1-0.63)}{\text{Ln}(1-0.31)}\right)}{\text{Ln}(d_{63\%}-\alpha) - \text{Ln}(d_{31\%}-\alpha)} \quad \beta = \frac{d_{63\%}-\alpha}{(-\text{Ln}(1-0.63))^{\frac{1}{\alpha}}} \quad \text{Eq. 2}$$

Where: $d_{31\%}$ and d_{63} are percentiles

In this study, multiple layer network (MLN) was used to calculate the parameters of Weibull function. MLN is basically consist of input, hidden, and output layers. In each layer, there are neurons called process unit. Each process element has an input and an output. The neurons among layers are connected hierarchically one to another. Formal definition of a neuron is presented in Figure 2. MLN was run based on supervised training strategy. MLN is mainly comprised of two processes. In the first processes, both

inputs and outputs are provided for training network. In second process, the improved network compares to its own outputs and network's output during training and residuals are propagated back to adjust weights for better outputs. The weights between hidden and output layers can change until producing the best results. In this study, inputs were 31th and 63rd percentile and mean diameter of size class. Output was relatively tree frequency.

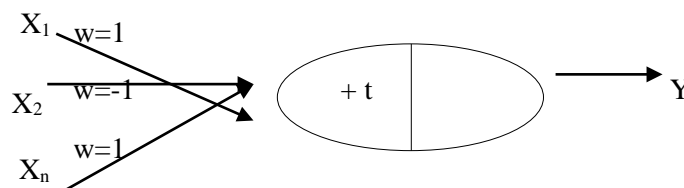

Figure 2. Mc Culloch-Pits model (Nabiyev, 2012)

In this study, outputs of MLN are calculated as follows:

$$\text{NET} = \sum_{k=1}^n A \times W \quad \text{Eq. 3}$$

$$W = \frac{1}{1 + e^{-(\text{NET} + \beta)}} \quad \text{Eq. 4}$$

A weight at time $(t+1)$ is computed as follow:

$$\Delta W_{jk}(t + 1) = \lambda \delta_k Z_j + \alpha \Delta W_{jk}(t) \quad \text{Eq. 5}$$

$$\delta_k = Z_k(1 - Z_k)E_k \quad \text{Eq. 6}$$

Where: A is input data, W is weight, β is threshold value, Z is output; λ is training coefficient, α is momentum coefficient, and E is error.

MATLAB software was used for calculating the percentiles. At first, data were normalized using Eq. 7:

$$X_{\text{new}} = \frac{X - X_{\min}}{X_{\max} - X_{\min}} \quad \text{Eq. 7}$$

Coefficient of determination (R^2), root mean square error (RMSE) and absolute mean error (AME) were evaluated for determination of the best method.

$$R^2 = 1 - \left(\frac{\sum_{i=1}^n (Y_{\text{measured}} - Y_{\text{predicted}})^2}{\sum_{i=1}^n (Y_{\text{measured}} - Y_{\text{mean of measured}})^2} \right) \quad \text{Eq. 8}$$

$$\text{RMSE} = \sqrt{\frac{1}{n} \sum_{i=1}^n (e_i)^2} \quad \text{Eq. 9}$$

$$\text{AME} = \frac{1}{n} \sum_{i=1}^n |e_i| \quad \text{Eq. 10}$$

Where: n is the number of data, e_i is the residuals; Y_{measured} is dbh observed in sample plots, $Y_{\text{mean of measured}}$ is the arithmetic mean of observed dbh in sample plots, $Y_{\text{predicted}}$, is predicted dbh by Regression analysis and ANNs

Results

The method of percentile (PM) and multiple layer network (MLN) were used to calculate relatively tree frequency. Relatively tree frequency was calculated for each tree size class. The results showed that MLN that explain 94 % of total variation in diameter was better than PM in terms of the coefficient of

determination (R^2), mean absolute error (MAE), and root mean square error (RMSE) (Table 2). Both methods were compared based on mean absolute error in terms of development stages (Table 3). Observed and predicted the number of tree were presented in Figure 2 and 3.

Table 2. Comparisons of ANN and PM

Methods	R^2	MAE	RMSE
ANN	0.94	28.37	41.07
PM	0.70	49.68	92.31

Table 3. The accuracy of methods based on MAE

Development stages	MAE	
	ANN	PM
b	45.01	78.74
c	28.76	48.83
d	14.31	21.92

b=young stands (8-19.9 cm), c=mature stands (20-35.9 cm), d=over mature stands (>36 cm)

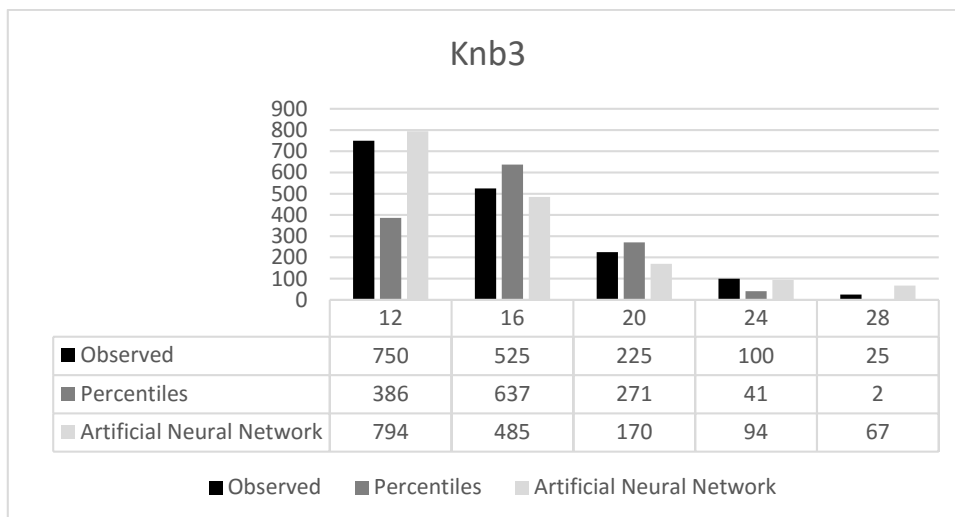

Figure 2. Observed and predicted the number of tree for Knb3 (in young stand)

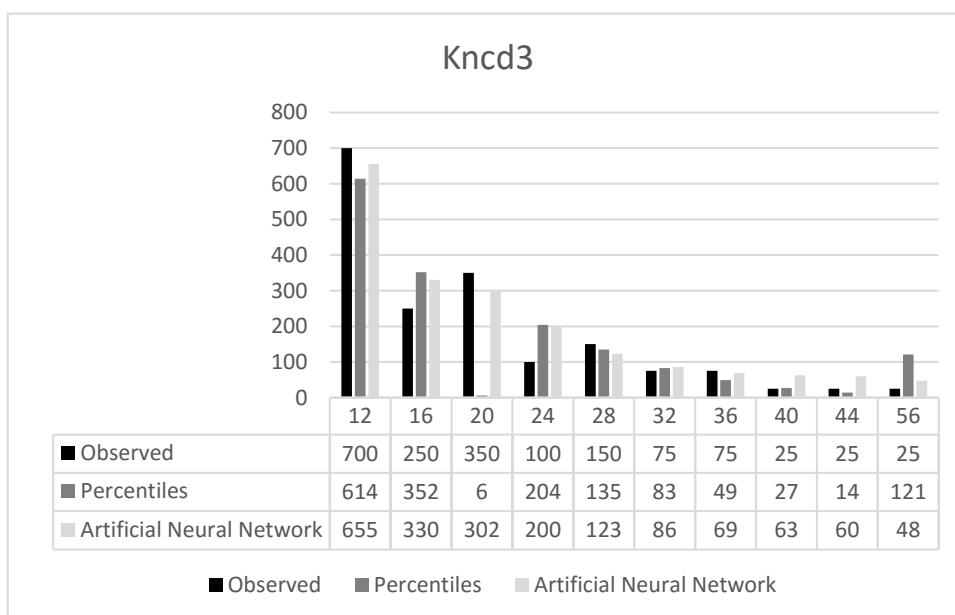

Figure 3. Observed and predicted the number of tree for Kncd3 (in mature stand)

Discussion and Conclusion

Diameter distributions of stands can show differences under many site-specific factors. The different probability density functions have been developed to describe diameter distributions. In this study, Weibull probability density function was performed for fitting diameter distributions due to its ability to describe satisfactory various types of distributions regarding diameter. The success of Weibull function can change based on its parameters. Therefore, estimation of the parameters is significant for obtaining better

results. In this study, percentiles (PM) and multiple neural network (MLN) were used to distribute adequately diameters across size classes. Burkhart and Tomé (2012) expressed that Weibull function is not sufficient to describe distributions of diameter in multi-storied stands. Eriksson and Sallnäs (1987) indicated that Weibull function doesn't fulfill expectations in young and multi-storied stands. However, this study indicated that the ability of Weibull function can increase when the parameters is predicted based on multiple layer network. Especially, the difference

between MLN and PM was remarkable in young and young-mature stands. The literature indicated that ANN can be utilized in different applications such as estimation of tree volume and description of forest structure, determination of site index. It is expected that this study will make a valuable contribution to forestry literature.

References

- Bailey R.L., Dell, T.R. 1973. Quantifying diameter distributions with the Weibull function. *Forest Science*, 19(2), 97-104.
- Bailey R.L., Burgan T.M., Jokela E.J. 1989. Fertilized midrotation-aged Slash pine plantations-stand structure and yield prediction models. *Southern Journal of Applied Forestry*, 13(2), 76-80.
- Başkent E.Z., Terzioğlu S., Başkaya Ş. 2007. Developing and implementing multiple-use forest management planning in Turkey. *Environmental Management*, 42, 37-48.
- Bolat F., 2015. Bursa-Kestel Orman İşletme Şefliği içerisindeki meşcereler için çap dağılım modellerinin geliştirilmesi. Yüksek Lisans Tezi, ÇNÜ Fen Bilimleri Enstitüsü, 77 s. Çankırı.
- Burkhardt H.E., Tomé M. 2012. Modeling forest trees and stands. ISBN: 978-94-007-1597-4, 457p. Springer Netherlands.
- Cao, Q.V. 2004. Predicting parameters of a Weibull function for modelling diameter distribution. *Forest Science*, 50(5); 682-685.
- Diamantopoulou M. J., 2005. Artificial neural networks as an alternative tool in pine bark volume estimation. *Computers and Electronics in Agriculture*, 48: 235-244.
- Diamantopoulou M.J., Özçelik R. 2012. Evaluation of different modeling approaches for total tree-height estimation in Mediterranean Region of Turkey. *Forest Systems*, 21, 3, 383-397.
- Diamantopoulou M. J., Özçelik R., Crecente-Campo F., Eler Ü. 2015. Estimation of Weibull function parameters for modeling tree diameter distribution using least squares and artificial neural networks methods. *Biosystem Engineering*, 133, 33-45.
- Eriksson L.O., Sallnäs O. 1987. A model for predicting log yield from stand characteristics. *Scandinavian Journal of Forest Research*, 2(1-4), 253-261.
- Fonseca T.F., Marques C.P., Parresol B.R. 2009. Describing Maritime pine diameter distributions with Johnson's S_B distribution using a new all-parameter recovery approach. *Forest Science*. 55(4), 367-373.
- Leite H. G., Marques da Silva M. L., Breda Binotti D. H., Fardin L., Takizawa F. H. 2011. Estimation of inside-bark diameter and heartwood diameter for *Tectona grandis* Linn. Trees using artificial neural networks. *European Journal of Forest Research*, 130, 263-269.
- Gorgoso-Varela J.J. 2015. Comparison of estimation methods for fitting Weibull distribution to the natural stand of Oluwa forest reserve, Ondo State, Nigeria. *Journal of Research in Forestry, Wildlife and Environment*, 7(2), 81-90.
- Moisen G. G., Frescino T. S. 2002. Comparing five modeling techniques for predicting forest characteristics. *Ecological Modelling*, 157, 209-225.
- Johnson N.L. 1949. System of frequency curves generated by methods of translation. *Biometrika*, 36(1/2), 149-176
- Lima R.A.F., Batista J.L.F., Prado P.I. 2014. Modeling tree diameter distributions in Natural Forests: an evaluation of 10 statistical models. *Forest Science*. 61(2), 320-327.
- Lohrey R.E. and Bailey, R.L. 1977. Yield tables and stand structure for unthinned longleaf pine plantations in Louisiana and Texas. USDA Forest Service Research Paper SO-133, 53 pages. Southeastern Forest Experiment Station, Asheville, NC.
- Mateus A., Tomé M. 2011. Modelling the diameter distribution of eucalyptus plantations with Johnson's S_B probability density function: parameters recovery from a compatible system of equations to predict stand variables. *Annals of Forest Science*. 68, 325-335.
- Nabiyev V.V. Yapay Zeka. ISBN: 978-975-02-2034-0. 776 s, Seçkin Yayıncılık, Sıhhiye/Ankara.

Single and Double Entry Tree Volume Equations for Crimean Pine Trees in Çankırı-Eldivan Forest Areas

*Muammer ŞENYURT¹, İlker ERCANLI¹, Ferhat BOLAT¹

¹Çankırı Karatekin University, Faculty of Forestry, Çankırı / TURKEY

*Corresponding Author: mseyurt@karatekin.edu.tr

Abstract

In this study, it is proposed to construct single and double entry tree volume equations for Crimean Pine Trees located in Eldivan Forests in the Çankırı Forest District Enterprise. The single entry tree volume equation developed under study has % 96.9 model explanatory and double entry tree volume equation has % 97.5 model explanatory. According to total percentage error of the two equations were determined by the total error close to 0. The average error of the single entry tree volume equation is 15.5404 % and the average error of the double entry tree volume equation is % 8.6355. Developed equations were tested with an independent data set and concluded that these equations can be used for these stands at the 0.05 significant levels.

Keywords: Crimean pine, Single and double entry tree volume equations, Çankırı, Turkey

Introduction

Tree volume is the most commonly used measure of wood quantity and is usually estimated for the assessment of economic value or forest applications. For standing trees, aboveground volume production is generally based on stem wood volume. Volume is always a cubic measure, and usually expressed in cubic meters. Merchantable volume, however, is sometimes expressed in other units related to commercial use (Skovsgaard 2004).

Sustainable forest management planners involve predictions in growing stock including stem volume and biomass, this information guides forest management activities in timber estimate for cutting areas (Laar and Akça, 1997). However, tree volume can be obtained from measurements of destructive samplings, the most common procedure is that tree volume values have been estimated by the volume equations based on relationships between volume and variables such as diameter and height in traditional forest inventories (Loetsch et. al., 1973) . In forest inventories, there is a significant need for equations that enable estimations for tree volume located in various forest areas with the different varieties of wood that can be obtained from trees.

A volume table of a specific species is defined as a table showing the average volume of trees for one or more given

characteristics such as DBH alone or DBH and height or DBH, height and form or taper. There are three types of volume equations based on the number of variables and objectives: (i) Local volume equation: Local volume equations are appropriate for a small forest or land area and are based on only one variable, i.e. DBH. The basic assumption is that trees of a given species, at a given location, with the same DBH, will have the same height and form. (ii) Regional volume equation: This type of equation is normally based on two variables (e.g. DBH and height) and covers a larger geographical area. Regional volume equations are standard volume equations with limited application. (iii) General or standard volume equation: This is an even wider area of the species and it is normally based on two variables such as DBH and height (Firat, 1973; Kalıpsız, 1984; Kapucu et. al., 2004).

Crimean pine trees [*Pinus nigra* Arnold. subsp. *pallasiana* (Lamb.) Holmboe] is one of the most economically and ecologically important forest tree species for forest areas located in Çankırı Province with its valuable wood for many commercial uses. Despite the importance of these stands, only a few studies concerning the tree volume equations that qualify estimations for tree volume exist, thus In this study, single and double entry volume tables were developed for Crimean pine trees located in Eldivan forests in Çankırı Forest District Enterprise.

Material and Method

The study was performed using data from 210 trees that were cut in Crimean Pine Stands of Eldivan Forests located in the Çankırı Forest District Enterprise, Çankırı Forest Management Directorate, Çankırı Province, Turkey. The sample trees obtained from the study area were selected from trees with characteristics that best represented the variability in volume development. Attention was specifically paid to ensuring that none of the collected sample trees had damaged tips, damaged wood (broken tips or cracked and dried wood), insect-related damage, fungus-

related damage, or injuries (caused by whichever reason) that led to stem rot.

In this study, sample trees were felled at the height of 0.3 m (the base of the trunk), and the stem taper was first measured at this height. Following this, measurements were continued at regular intervals of one meter by using a steel measuring tape, such that measurements were taken at 1.3 m, 3.3 m, 5.3 m, etc. In addition, the total height of the trees was also measured with a steel measuring tape. Table 1 provides certain statistical values regarding the sample trees.

Table 1: Descriptive statistics for sample trees

	Dbh (cm)	h (m)	V (m ³)
Min	4.0	3.75	0.00458
Max	48.6	17	1.27423
Mean	21.80	11.21	0.27179
Standart Deviation	9.76	2.31	0.24179

Tree volume estimations were obtained based on the below formulas by using these diameters measured along sample trees;

$$\text{For butt of trees; } V_{butt} = \frac{\pi}{4} \cdot d_{0.3}^2 \cdot 0.3 \quad (1)$$

$$\text{For tree section volume with Huber formula; } V_{section} = \frac{\pi}{4} \cdot (d_{1.3}^2 + \dots + d_n^2) \cdot 2 \quad (2)$$

$$\text{For tip of tree volume; } V_{tip} = \frac{1}{3} \cdot \frac{\pi}{4} \cdot d_{tip}^2 \cdot h_{tip} \quad (3)$$

In these formulas; V_{butt} : volume of tree stem section 0-0.3 meters, $d_{0.3}$; diameter at 0.3 meter height of tree, $d_{1.3}$; diameter at breast height, d_n ; diameter at n meter height of tree, V_{tip} : volume of tree tip stem section, d_{tip} : diameter at tip of tree.

After calculating tree volume with these formulas, the relationships between tree volume and diameter (single entry table) or diameter and height (double entry table) were modeled by using multiple regression technique. The multiple stepwise regression analysis was carried out by SPSS (SPSS Institute Inc 2007). In these models, single entry volume model was defined as:

$$V = b_0 \cdot d_{1.30}^{b_1}$$

Double entry volume model was defined as:

$$V = b_0 \cdot (d^2 \cdot h)^{b_1}$$

In these models, V: tree volume (m³) calculated by above formulas, d: diameter at breast height (cm), h: total tree height (m), b_0 and b_1 were parameters of models. This regression analysis was utilized to determine the best predictive variables that were significant ($p < 0.05$), with the highest value of the determination of coefficient (R^2) and the lowest values of the Root-Mean-Square Error (RMSE), the Mean Error (ME), the Mean Absolute Error (MAS), the Total Error percentage (TEP) and the Mean Absolute Error Percentage (MAEP).

the determination of coefficient (R^2);

$$R^2 = 1 - \left(\frac{\sum (V_i - \hat{V}_i)^2}{\sum (V_i - V_{ort})^2} \right) \quad (5)$$

$$\text{the Root-Mean-Square Error (RMSE)} = \sqrt{\frac{\sum (V_i - \hat{V}_i)^2}{N - p}} \quad (6)$$

$$\text{the Mean Error (ME)} = \frac{(\sum D)}{N} \quad (7)$$

$$\text{the Mean Absolute Error (MAS)} = \frac{(\sum |D|)}{N} \quad (8)$$

$$\text{Total Error percentage (TEP)} = 100 \cdot \frac{\sum_{i=1}^n \hat{V}_i - \sum_{i=1}^n V_i}{\sum_{i=1}^n V_i} \quad (9)$$

$$\text{Mean Absolute Error Percentage (MAEP)} = 100 \cdot \frac{\sum_{i=1}^n |\hat{V}_i - V_i|}{\sum_{i=1}^n V_i} \quad (10)$$

In the formulas listed above; V_i represents the calculated volume; \hat{V} represents the predicted volume with diameter or diameter and height, n represents the number of data, and p represents the number of parameters within the model.

The 210 sample plots were randomly split into two data sets such as model fitting and the validation data using Select Cases Procedure in SPSS (SPSS, 2007). About 85% of total data (178 sample plots) was used to develop the models based on data. The remaining 32 sample plots, about 15% of total data as independent data set, were randomly reserved for calibration process

Results

The parameter estimations, standard error values, t-calculation values and significance levels for the three different

$$V = 0.0002918 \cdot d^{2.1513}$$

$$V = 0.01894 + 0.0000364 \cdot (d^2 \cdot h)$$

The success criteria of single entry volume equation were R^2 0.969, RMSE: 0.1836 m³, ME: -0.002833 m³, MAS: 0.04171 m³, TEP: % 1.055 and MAEP: % 15.5404, while those for double entry volume

of these models and were not used in fitting and developing the models.

In this study, model validation was performed based on the difference (residual values) between observed and predicted values for validation data set including 32 sample plots as independent data. The student's t-test, also called paired sample t test, was used to evaluate the null hypothesis at the 95% significance level for mean value of residual equal to zero. If the students' t tests revealed that the null hypothesis cannot be rejected and mean residuals statistically are not significantly differ from zero, thus the developed models is statistically suitable for estimates of the tree volume in studied forest stands.

models used in this study are all shown in Table 2. Also, the single and double entry and model with parameter estimations used in this study was given in below:

equation were R^2 : 0.975, RMSE: 0.03804 m³, ME: 8.7x10⁻¹⁷ m³, MAS: 0.02318 m³, TEP: % 0.0 and MAEP: % 8.6355. All parameters of these models were determined to be statistically significant, with p value <0.05. The graphical trend for single and double

volume equations were respectively shown in fig. 1. and fig 2.

Table 2: The parameter estimations with the goodness-of-fit statistics for single and double entry volume equations used in this study.

Single Entry Volume Equation				
Parameter	Estimate	Standard Error	<i>t</i>	<i>p</i>
b ₀	0.0002918	0.02877	74.59	<0.0001
b ₁	2.1513	0.000025	11.546	<0.0001
Double Entry Volume Equation				
b ₀	0.01894	0.004133	4.584	<0.0001
b ₁	0.0000364	0.00000044	83.401	<0.0001

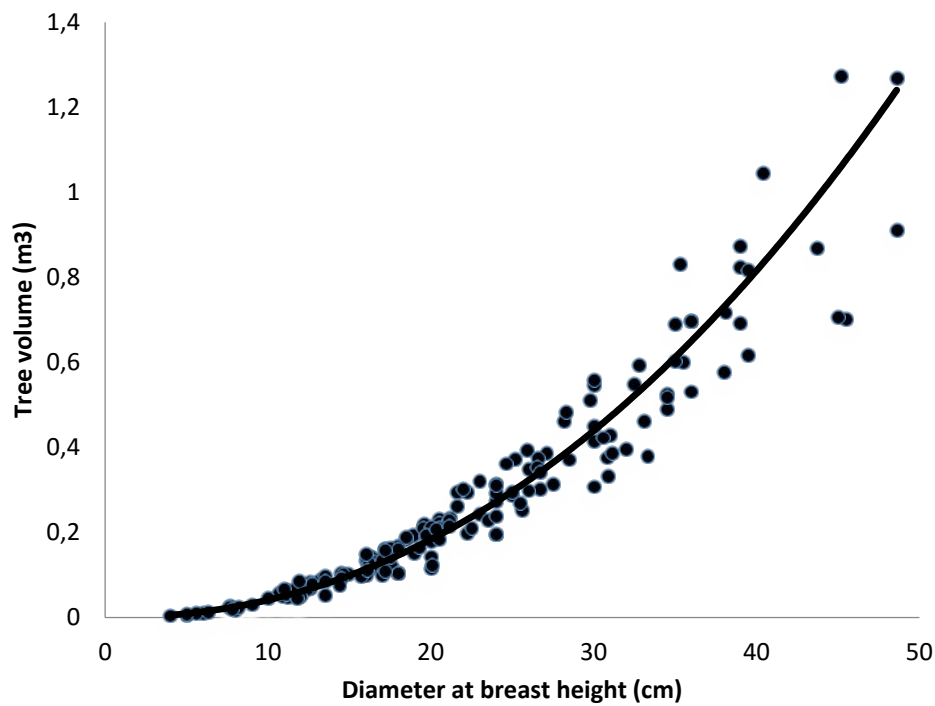

Fig. 1. Single entry volume predictions

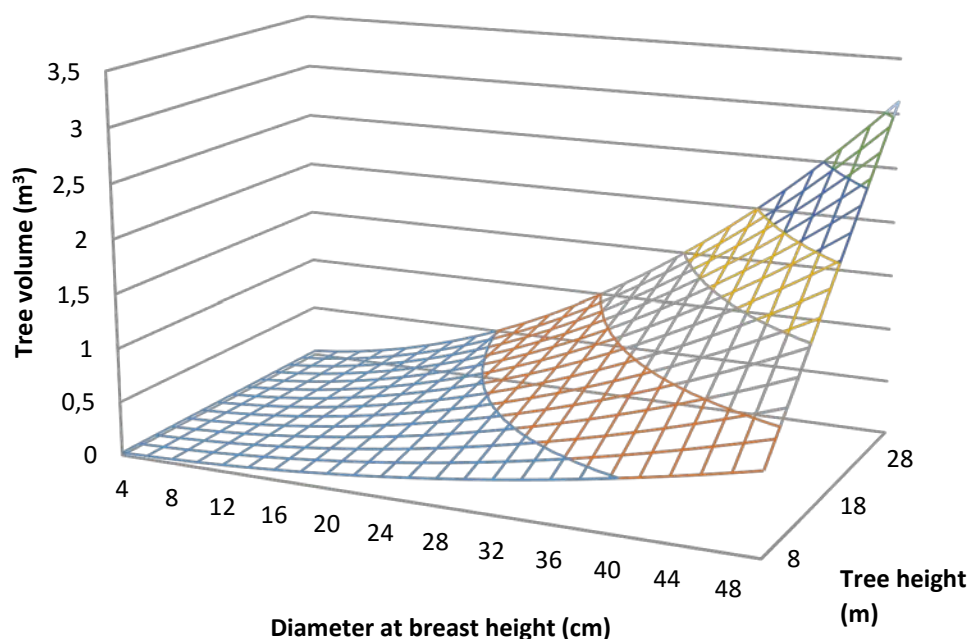

Fig. 2. Double entry volume predictions

In the validation process, values for the t-test showed that these developed equations are unbiased; that is, the mean errors from the models are not statistically significantly different from zero, t value=-0.829, $p=0.413$ for single entry volume equation and t value=-0.80, $p=0.937$ for double entry volume equation, respectively. Thus, these equations including diameter, single entry volume equation, or diameter and height, double entry volume equation, as predictor variables were statistically acceptable and suitable for predicting the tree volume values.

Discussions

In this study, single and double entry volume equations were developed using data for 210 Crieman Pine obtained from forest stands at the Çankırı Forest District Enterprise, the Çankırı Forest Management Directorate, located within the Ankara Regional Forest Directorate. To model the stem volume of the trees from their base to their tip, the multiple linear regression equations were used. Compared to the single entry equation, which predicts the tree volume by using only diameter at breast

height, the double entry volume equation, which models the tree volume with diameter at breast height and total height, has provided fairly better results in many studies in terms of modeling the tree volume. With this double entry volume equation; it can be predicted % 97.5 of the total variance of tree volume with % 0.0 of Total Error percentage (TEP) and %8.6355 of Mean Absolute Error Percentage (MAEP). The single entry volume equation predicted the %96.9 of the total variance of tree volume with % 1.055 of Total Error percentage (TEP) and % 15.5404 of Mean Absolute Error Percentage (MAEP). The double entry volume equation against to single entry volume equation can be explained by its ability to properly reflect the variability in volume owing to its joining height values to equation.

Using these double volume equations provides objectively predictive results than single volume equations when estimating stem volumes. Single entry tree equations are preferred in many forestry applications such as forest management plans, owing to their practicality. Double volume equations may provide Turkish forestry operations to estimate volume more

accurately and consistently. In Turkey, in which rising importance of the forest sites, there is a growing need to have accurate volume estimations of different forest sites; in this respect, the use of double entry volume equations including tree total tree height showing the effect of forest sites on volume values becomes even more important. Developing double entry volume equations in which different forest sites, are grown is a significant priority. In this respect, one of the main tasks of Turkey's foresters should be to place greater emphasis on these studies concerning the development of double entry volume estimation systems.

References

- Fırat F. 1973. Dendrometri, İ.Ü.O.F. Yayınları, İ.Ü. Yayın No:1800, O.F. Yayın No:193, Dördüncü Baskı, Kutulmuş Matbaası, İstanbul, 359 s.
- Kalıpsız A. 1984. Dendrometri. İ.Ü. Orman Fakültesi Yayın No: 3194/354, 407 s.
- Kapucu F., Yavuz H., Gül A. U. ve Mısır N. 2004. Kestane Meşcerelerinin Hasılatıve Amenajman Esasları, Tübitak TAGTOG TARP-2229 No'lu Proje, 118 s.
- Laar A., and Akça, A. 1997. *Forest mensuration*. Göttingen, Germany: Cuvillier Verlag.
- Loetsch F., Zöhrer F. and Haller, K.E. 1973. Forest Inventory, Volume II, ISBN 3-405-10812-8, BLV Verlagsgesellschaft München Benn Wien, München.
- Skovsgaard J. P. 2004. Forest measurements. Encyclopedia of Forest Sciences. Academic Press, New York
- SPSS. 2007. Institute Inc. SPSS Base 15.0 User's Guide.

Altitude Based Leaf Area Index Analysis for a Pure Stand of *Quercus petraea* [Matt.] Liebl. Along a Mountain Transect in Bartın Forestry Administration of Turkey

*Melih ÖZTÜRK¹, İlyas BOLAT², Ercan GÖKYER¹, Ömer KARA³

¹Bartın University, Faculty of Forestry, Department of Landscape Architecture, Bartın/TURKEY

²Bartın University, Faculty of Forestry, Department of Forest Engineering, Bartın/TURKEY

³Karadeniz Technical University, Faculty of Forestry, Department of Forest Engineering, Trabzon/TURKEY

*Corresponding Author: melihozturk@bartin.edu.tr

Abstract

Leaf Area Index (LAI) is a vegetation parameter that indicates one-sided area of leaves over the projected crown area of a canopy. LAI is commonly used in landscape ecology, forest stand growth and health, and vegetation hydrology studies. The analysis of LAI parameter along the altitudinal gradients allows the investigation of the forest stand responses against possible climate change. Consequently, in this study, the LAI of pure sessile oak (*Quercus petraea* [Matt.] Liebl.) stand were identified at various altitudes within Bartın region of Turkey. In total, from 7 altitudinal gradients, 21 hemispherical photographs were taken under the dense canopies (>70% closure) of this pure stand. The analysis of these hemispherical photographs was conducted using the image processing technique. As a result, the mean LAI of this pure stand were determined for each altitudinal gradient. The mean LAI of pure sessile oak stand was its maximum with 2.66 m².m⁻² at 590 m asl. which then dropped gradually down to minimum with 2.06 m².m⁻² at 815 m asl. However, the mean LAI displayed slight increase just to 2.15 m².m⁻² at 858 m asl. These results particularly remark the ecology of *Quercus petraea* [Matt.] Liebl. Furthermore, the outcomes of this study signal for the optimum growth altitudes where the sessile oaks can inhabit. On the other hand, similar LAI analyses are necessary for the pure stands of *Quercus petraea* [Matt.] Liebl. at alternative mountain transects of Turkey in order to determine their optimum habitat. In addition, subsequent analyses will explore the possible shifting of their altitudinal growth ranges along the transects due to climate alterations.

Keywords: Sessile oak, LAI, Hemispherical photograph, Altitudinal gradients, Mountain transect.

Bartın Orman İşletmesi'nde (Türkiye) bir Dağ Kesitinde *Quercus petraea* [Matt.] Liebl. Saf Meşçeresi için Yükseltiye Bağlı Yaprak Alan İndisi Analizi

Özet

Yaprak Alan İndisi (YAI), bitki örtüsü yapraklarının tek tarafları yüzey alanlarının tepe çatısı izdüşümüne oranını ifade eden bir vejetasyon parametresidir. YAI genellikle peyzaj ekolojisi, orman meşçere gelişimi ve sağlığı ile vejetasyon hidrolojisi çalışmalarında kullanılmaktadır. YAI parametresinin yükselti basamakları boyunca analiz edilmesi, muhtemel iklim değişikliğine karşı orman meşçerelerinin tepkilerinin araştırılmasına imkân sunar. Dolayısıyla, bu çalışmada Bartın Yöresinde (Türkiye) farklı yükseltilerde, saf sapsız meşe (*Quercus petraea* [Matt.] Liebl.) meşçeresinin YAI'si tespit edilmiştir. Toplamda bu saf meşçerenin 7 farklı yükseltide bulunan tam kapalı tepe çatıları (>70% kapalılık) altından 21 adet yarı-küre fotoğraf çekilmiştir. Bu yarı-küre fotoğrafların analizi görüntü işleme tekniği kullanılarak gerçekleştirilmiştir. Sonuç olarak, her bir yükselti basamağı için ortalama YAI belirlenmiştir. İlk basamak olan 590 m yükseltide 2.66 m².m⁻² ile en yüksek değerine ulaşan ortalama YAI, kademeli olarak azalarak, 815 m yükseltide en düşük değeri olan 2.06 m².m⁻²'ye inmiştir. Bununla birlikte, ortalama YAI 858 m yükseltide az bir artış sergileyerek sadece 2.15 m².m⁻²'ye çıkmıştır. Bu sonuçlar, bilhassa *Quercus petraea* [Matt.] Liebl.'nin ekolojisi hususunda işaretler arz etmektedir. Üstelik, bu çalışmanın neticeleri, sapsız meşçelerin mekan edinebilecekleri optimum gelişme yükseltileri için belirleyici niteliktedir. Öte yandan, Türkiye'nin alternatif dağ kesitlerindeki saf *Quercus petraea* [Matt.] Liebl. meşçereleri için benzer YAI analizlerinin yapılması, onların optimum yaşam ortamlarının tespiti açısından gereklidir. İlave olarak müteakip analizler, iklim değişikliğinden kaynaklanan, dağ kesitleri boyunca bu saf meşçerelerin yükseltiye bağlı gelişme kuşaklarının muhtemel kaymasının keşfedilmesini sağlayacaktır.

Anahtar Kelimeler: Sapsız meşe, YAI, Yarı-küre fotoğraf, Yükselti kuşakları, Dağ kesiti.

Introduction

Quercus petraea [Matt.] Liebl.; the sessile oak is relatively well-known tree species which constitute pure and mixed forest stands as well as is used for landscape planning and design thanks to its' decorative silhouette. Therefore, the sessile oaks are composed among the forested landscapes; however, they distinguish with the seasonal alternating colour patterns throughout the year. They have glossy green 6-17 × 3-9 cm dimensioned leaves with pale hairy beneath (Yaltırık, 1993). Not only their leaves attract people but also their gray-brown regular and narrow fissured bark on twisted trunk together with the pale brown buds and reddish-yellowish brown shoots (Yaltırık, 1993) display art during the leafless period in late winter. Hence, Öztürk and Gökyer (2016) emphasized these visual arts for a coastal zone at the western Black Sea Region of Turkey.

In order to refer to the ecology of the sessile oak, this deciduous tree with the mean height of 35 m and tap root system demands direct sunlight (Çepel, 1994). The habitat of the sessile oak spreads from the western Europe (Bréda and Granier, 1996), passes throughout the western Turkey and western Black Sea, and ultimately reaches eastern and southeastern (Atay, 1988). Since the sessile oak is relatively more tolerant to the shade (Thomas and Packham, 2007) and water deficiency (Çepel, 1983) compared to the pedunculate oak (*Quercus robur* L.), it can grow at the arid crests (Anşın and Özkan, 1997). Although the mixed forest stands of sessile oak particularly with oriental beeches (*Fagus orientalis* Lipsky) and European hornbeams (*Carpinus betulus* L.) climb up to 1200 asl. (Güngör et al., 2002), Atalay (2008) mentioned about 500-1000 m asl. altitudinal gradients particularly at the coastal zones of the Black Sea region.

Climatic and local factors play significant role on the optimum altitudinal growth gradients of forest stands (Pretsch, 2009). The sessile oak is relatively sensitive to the environmental factors involving primarily cold climate (Saatçioğlu, 1976) and soil. The vegetation parameters that indicate the total growth of a stand are scarce. A vegetation parameter; Leaf Area Index (LAI) is to some

extent used in some literatures (e.g. Čermák et al., 2008; Bequet et al., 2012; Öztürk et al., 2016) in order to determine the stand growth. Bonan (2008) described the LAI as the cumulative one-sided surface area of leaves over the projected crown area. In this study, the LAI of a pure sessile oak (*Quercus petraea* [Matt.] Liebl.) stand were determined for the altitudinal ranges 590 m asl. and 858 m asl. between within the Bartın region of northwestern Turkey.

Material and Method

Site Characteristics

The *Quercus petraea* [Matt.] Liebl. stand where the hemispherical photographs were taken is located in between the 41°36' and 41°38' northern latitudes, and in between 32°45' and 32°46' eastern longitudes (Figure 1). The stand covers approximately 21.3 hectares and belongs to the Kozcağız District of the Bartın Forestry Administration at the northwestern of Turkey (Figure 1). The stand has grown on the eastern-southeastern facing transect of a mountain in the watershed (Figure 1). The altitude of the mountain transect ranges between 500 m asl. and 900 m asl. On the other hand, the slope of this mountain transect is nearly 42%. The mean length of the trees in the pure sessile oak stand is about 25 m whereas their mean diameter at breast height (DBH; 1.3 m) is around 28 cm (TGDF, 2011). The companion stands are predominantly composed of oriental beech (*Fagus orientalis* Lipsky) and European hornbeam (*Carpinus betulus* L.) trees (TGDF, 2011).

Shallow (20 cm) brown forest soils (TMFAL, 2005) have formed on the sandstones, mudstones and gravels (TGDMRE, 2007) at the transect of the mountain. Based on the meteorological data (between 1982 and 2012) of the Bartın Meteorological Station, the mean annual temperature is 12.6°C (TSMS, 2014). January is the coldest month with the mean temperature of 4.1°C whereas July is the warmest month with the mean temperature of 22.3°C. On the other hand, the average annual total precipitation is 1046 mm (TSMS, 2014). October is the wettest month with the average total precipitation of 121 mm whereas May is the driest month with

the average total precipitation of 49 mm. According to the duration of the winds, the dominant wind directions are form Black Sea

at the west-northwest and north-northeast (TSMS, 2014).

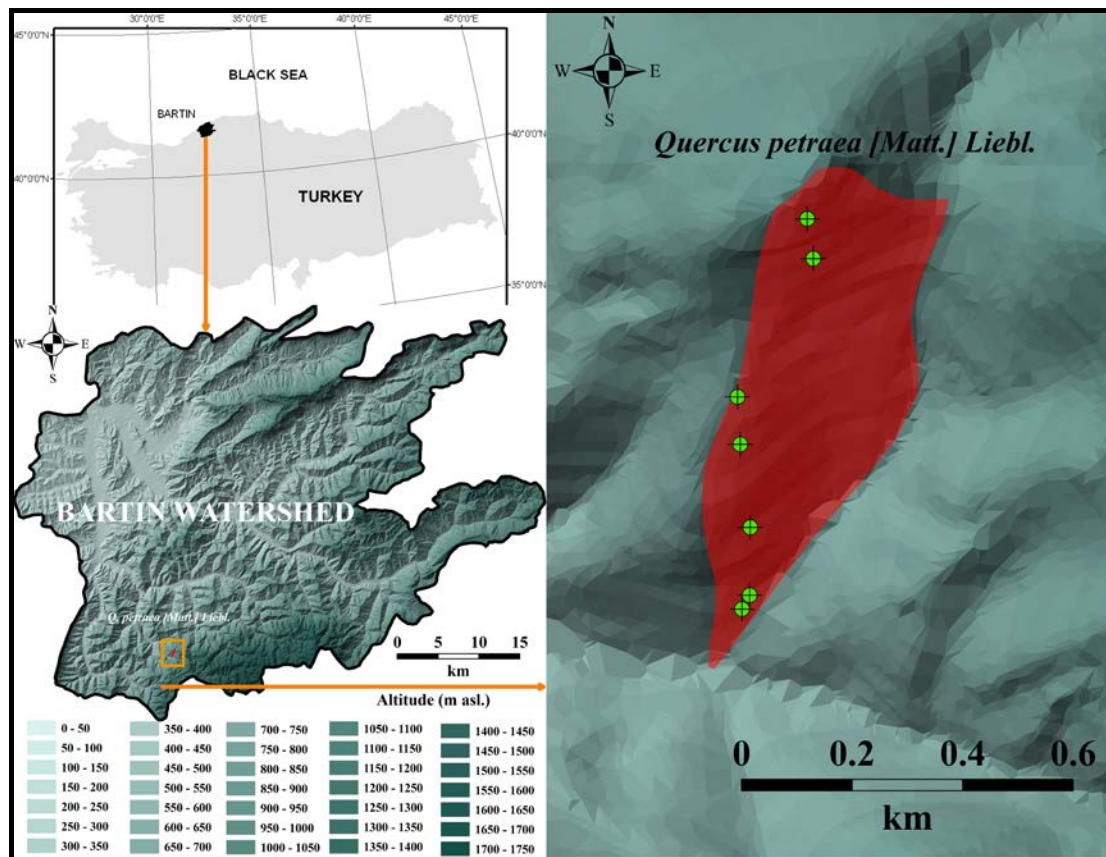

Figure 1. Hemispherical photographing points and location of *Quercus petraea* [Matt.] Liebl. within Bartın watershed and Turkey

Methods

Based on the suggestions by Kantarcı (2005), the lapse rate was assumed to 0.5°C/100 m asl. whereas the precipitation was assumed to be increasing 54 mm/100 m asl. Thereby, the distribution of the temperature and precipitation along the altitudinal gradients of the mountain transect was provided. Hemispherical photographing technique was used in order to determine the LAI. In total, 21 hemispherical photographs were taken from 7 different altitudinal gradients. The hemispherical photographs were taken in June, 26th of 2013 using the 8 mm fisheye objective (Sigma F3.5 EX DG) mounted on a digital SLR camera (Canon

EOS 5D Mark II). The analysis of the hemispherical photographs was conducted using Hemisfer 1.5.3 software which was developed by the Swiss Federal Institute for Forest, Snow and Landscape Research (Schleppi et al., 2007). For the automatic thresholding of the analysis, the method of Nobis and Hunziker (2005) was used. On the other hand, the LAI was derived based on the study of Lang (1987). The corrections for non-linearity and slope were performed according to Schleppi et al. (2007). The methodology of Chen and Cihlar (1995) was preferred in order to avoid stem and branch impacts on LAI for the clumping effect.

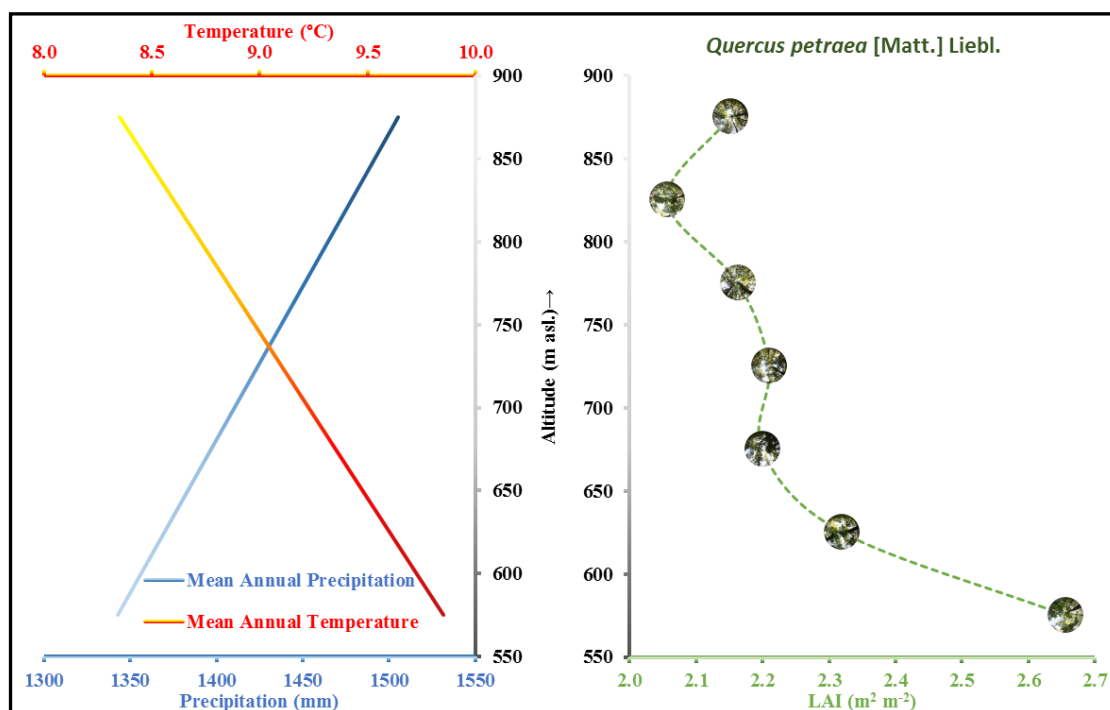

Figure 2. Altitudinal variation of mean annual temperature-precipitation (left) and mean LAI values (right)

Results and Discussion

In a French forest, at the low altitude (237 m asl.), Bréda and Granier defined that the maximum LAI changed between 3.3 and 6.0 for the pure sessile oak (*Quercus petraea*) stands. On the other hand, Wiman and Gaydarova (2008) found the LAI above 4.0 at a lower altitude (150 m asl.) in Black Sea coast of Bulgaria where mixed stand of dominant *Fagus orientalis* with *Quercus frainetto* exists. According to the results of our analysis, for the overall data, the mean LAI was around 2.25 whereas it was minimum with 2.06 at 815 m asl. and maximum with 2.66 at the lowest altitude; 590 m asl. (Figure 2). Besides, for the lowest altitude at 590 m asl., the maximum LAI reached 3.13 being the highest value for the overall data. The mean annual temperature was 9.9°C for that lowest altitude whereas the average annual total precipitation was 1343 mm (Figure 2). The mean LAI dropped to 2.32 at the 604 m asl. where the mean annual temperature and average total precipitation were 9.6°C and 1370 mm respectively (Figure 2). On the other hand, the mean LAI fluctuated at the altitudes 654 m asl. and 718 m asl. being 2.20 and 2.21 respectively. The mean annual temperatures

were 9.4°C and 9.1°C respectively whereas the average annual total precipitations were 1397 mm and 1424 mm respectively for those altitudes (Figure 2). Then the mean LAI dropped gradually to 2.16 at the 746 m asl. and to 2.06 at the 815 m asl. where the mean annual temperatures were 8.9°C and 8.6°C respectively (Figure 2). Meanwhile the average annual total precipitations increased gradually to 1451 mm and 1478 mm respectively for those altitudes. However, the mean LAI again climbed to 2.15 at the altitude of 858 m asl. where the mean annual temperature was 8.4°C and the average annual total precipitation was 1505 mm (Figure 2). According to the analysis of Cutini et al. (1998) who used plant canopy analyser, the LAI of Turkey oak (*Quercus cerris*) at 900 m asl. in Italy, increased from 1.80 to 3.17 along the three years between 1993 and 1995. At the higher altitude (1100 m asl.) of a closer region within the same Bartın watershed, the maximum LAI was determined as 2.45 for the pure stands of sessile oak (*Quercus petraea* [Matt.] Liebl.) (Kara et al., 2008). Leuschner et al. (2006) indicated that the stand age was the most significant on LAI of the mixed European beech (*Carpinus betulus* L.) and sessile oak

stands. However, for the very low altitude (120 m asl.) of a French forest consisting of *Quercus petraea*, *Quercus robur*, *Fagus sylvatica* L., *Pinus sylvestris* L. and *Carpinus betulus* L. trees, Le Dantec et al. (2000) emphasized the importance of the forest management practices on the maximum LAI.

Conclusion

According to the overall results of the study, the mean LAI was maximum at the lowest altitude of the mountain transect. The mean LAI increased almost gradually at the higher altitudes with few exceptions. Although these overall results slightly indicate the optimum altitudinal growth gradients of the pure sessile oak stands, it can be concluded that the lower altitudes are relatively more convenient for those pure sessile oak stands. On the other hand, more frequent and comprehensive subsequent researches have to be conducted about the sessile oak stands within the watershed in order to achieve more data consistent with our results.

Furthermore, LAI analysis in association with the investigation of other ecophysiological characteristics of the sessile oak stands will allow thorough understanding of their habitat. Hence, the response of these sessile oak stands to the possible climate change can be more accurately be projected. Moreover, the shifting phenology of these sessile oak stands can be predicted within a landscape scale.

Acknowledgments

We would like to acknowledge the "Scientific Researches Project Unit of Bartın University" which supported the project of BAP-2011-028-Land Use Situation and Suitability Classification in Bartın Stream Watershed. Also, we appreciate The Turkish General Directorate of Forestry (TGDF) and Turkish State Meteorological Service (TSMS) which supplied data for this study.

References

Anşın R., Özkan Z.C. 1997. Tohumlu Bitkiler (Spermatophyta), Odunsu Taksonlar. Karadeniz Teknik Üniversitesi, Orman Fakültesi Yayınları, Trabzon, Türkiye.

Atalay İ. 2008. Ekosistem Ekolojisi ve Coğrafyası. Cilt II, Meta Basım ve Matbaacılık, Bornova, İzmir.

Atay İ. 1988. Kent Ormanlığı. İstanbul Üniversitesi, Orman Fakültesi Yayınları. İstanbul, Türkiye.

Bequet R., Kint ., Campioli M., Vansteenkiste D., Muys B., Ceulemans R. 2012. Influence of stand, site and meteorological variables on the maximum leaf area index of beech, oak and Scots pine. European Journal of Forest Research, 131, 283-295.

Bonan G. 2008. Ecological Climatology, Concepts and Applications, Second Edition. Cambridge University Press, New York, USA.

Bréda N., Granier A. 1996. Intra- and interannual variations of transpiration, leaf area index and radial growth of a sessile oak stand (*Quercus petraea*). Annals of Forest Science, 53, 521-536.

Chen J.M., Cihlar J. 1995. Quantifying the effect of canopy architecture on optical measurements of leaf area index using two gap size analysis methods. IEEE Transactions in Geoscience and Remote Sensing, 33, 777-787.

Cutini A., Matteucci G., Mugnozza G.S. 1998. Estimation of leaf area index with the Li-Cor LAI 2000 in deciduous forests. Forest Ecology and Management, 105, 55-65.

Čermák J., Tognetti R., Nadezhdina N., Raschi A. 2008. Stand structure and foliage distribution in *Quercus pubescens* and *Quercus cerris* forests in Tuscany (central Italy). Forest Ecology and Management, 255, 1810-1819.

Çepel N. 1983. Orman Ekolojisi, İkinci Baskı. İstanbul Üniversitesi, Orman Fakültesi Yayınları. İstanbul, Türkiye.

Çepel N. 1994. Peyzaj Ekolojisi. İstanbul Üniversitesi, Orman Fakültesi Yayınları. İstanbul, Türkiye.

Güngör İ., Atatoprak A., Özer F., Akdağ N., Kandemir N.İ. 2002. Bitkilerin Dünyası, Bitki Tanıtımı Detayları ile Fidan Yetiştirme Esasları. Lazer Ofset ve Matbaacılık. Ankara, Türkiye.

Kantarıcı M.D. 2005. Orman Ekosistemleri Bilgisi. İstanbul Üniversitesi Orman Fakültesi Yayınları. İstanbul, Türkiye.

Kara Ö., Bolat İ., Çakıroğlu K., Öztürk M. 2008. Plant canopy effects on litter accumulation and soil microbial biomass in two temperate forests. Biology and Fertility of Soils, 45, 193-198.

Lang A.R.G. 1987. Simplified estimate of leaf area index from transmittance of the sun's beam. Agricultural and Forest Meteorology, 41, 179-186.

Le Dantec V., Dufrêne E., Saugier B. 2000. Interannual and spatial variation in maximum leaf

area index of temperate deciduous stands. *Forest Ecology and Management*, 134, 71-81.

Leuschner C., Voß S., Foetzki A., Clases Y. 2006. Variation in leaf area index and stand leaf mass of European beech across gradients of soil acidity and precipitation. *Plant Ecology*, 182, 247-258.

Nobis M., Hunziker U. 2005. Automatic thresholding for hemispherical canopy-photographs based on edge detection. *Agricultural and Forest Meteorology*, 128, 243-250

Öztürk M., Gökyer E. 2016. Spatio-temporal Characteristics of Roadside Landscape Components Along the Coastal Zone Between Amasra and Kurucaşile Cities of Bartın Province, Turkey. *Landscapes and Greenways of Resilience* (Eds.: Jombach, S., Valánszki, I., Filep-Kovács, K., Fábos, J. Gy., Ryan, R. L., Lindhult, M. S., Kollányi, L.) "Proceedings of 5th Fábos Conference on Landscape and Greenway Planning (30 June-03 July; 2016)". Budapest, Hungary. pp. 293-302.

Öztürk M., Bolat İ., Gökyer E., Kara Ö. 2016. Growth gradients of multi-aged pure oriental beech stands along the altitudinal gradients within a mesoscale watershed landscape. *Applied Ecology and Environmental Research*, 14 (4), 101-119.

Pretzsch H. 2009. *Forest Dynamics, Growth and Yield*. Springer-Verlag, Berlin.

Saatçioğlu F. 1976. *Silvikültür I: Silvikültürün Biyolojik Esasları ve Prensipleri*. İkinci Baskı. İstanbul Üniversitesi Orman Fakültesi Yayınları. Sermet Matbaası. İstanbul, Türkiye.

Schleppi P., Conedera M., Sedivy I., Thimonier A. 2007. Correcting non-linearity and slope effects in the estimation of the leaf area index of forests from hemispherical photographs. *Agricultural and Forest Meteorology*, 144, 236-242

TGDF (Turkish General Directorate of Forestry), 2011. *Forest Management Plans of Bartın Forest Administration*. Ankara, Turkey.

TGDMRE (Turkish General Directorate of Mineral Research and Exploration), 2007. *Digital Geological Maps of Zonguldak F-29 Section*. Ankara, Turkey.

Thomas P.A., Packham J.R. 2007. *Ecology of Woodlands and Forests: Description, Dynamics and Diversity*. Cambridge University Press, New York, USA.

TMFAL (Turkish Ministry of Food, Agriculture and Livestock), 2005. *Digital Soil Maps of Bartın Stream Watershed*. Ankara, Turkey.

TSMS (Turkish State Meteorological Service), 2014. *Daily Meteorological Data*. Ankara, Turkey.

Wiman B.L.B., Gaydarova P.N. 2008. Spectral composition of shade light in coastal-zone oak forests in SE Bulgaria, and relationships with leaf area index: a first overview. *Trees-Structure and Function*, 22, 63-76.

Yaltırık F. 1993. *Dendrology, Angiospermae* (in Turkish), Volume: 2. İstanbul University, Faculty of Forestry Publications, İstanbul, Turkey.

Predicting Oriental Spruce and Scots Pine Tree Diameter Increments Based on Artificial Neural Network Located in Mixed Oriental Spruce-Scots Pine Stands at Trabzon and Giresun Forest District

*İlker ERCANLI¹, Aydın KAHRİMAN², Hakkı YAVUZ³

¹Çankırı Karatekin University, Faculty of Forestry, Çankırı/TURKEY

²Artvin Çoruh University, Faculty of Forestry, Artvin/TURKEY

³Karadeniz Technical University, Faculty of Forestry, Trabzon/TURKEY

*Corresponding Author: ilkerercanli@karatekin.edu.tr

Abstract

The predicting diameter increment and growth patterns for individual trees are essential elements for forest management primarily to: (i) choice tree species for logging; (ii) pick out tree species for protection; (iii) evaluation for cutting cycles and (iv) to suggest silvicultural treatments. Many statistical models based on linear and nonlinear regression analyze for predicting individual tree diameter increments from individual, stand attributes and other variables have been developed in forest literature until today. The regression analyze requires some statistical assumptions, normally distributed residuals and homoscedastic trends in predictions, and if these assumptions are violated, these increment predictions can be biased and erroneously obtained in forest applications. To overcome this challenge in tree predictions, Artificial Neural Network Analysis (ANN) has been successfully used in different fields and many situations for modeling these relationships. Although applications of Artificial Neural Network (ANN) have been presented in many scientific area, e.g., electronic simulations, health diagnosis predictions, climatic estimations and agricultural product estimations, there are few studies concerning tree height predictions using Artificial Neural Network (ANN). In this study, the objective is to obtain predictions of oriental spruce and scots pine tree diameter increments based on Artificial Neural Network (ANN) and to compare these tree predictions with ones obtained from the regression models using root mean square error (RMSE), the adjusted coefficient of determination (R^2_{adj}) and Akaike Information Criteria located in mixed oriental spruce-scots pine stands at Trabzon and Giresun forest district. Application of ANN was carried out using MATLAB-NNTOL module including the development data set that was further subdivided into three subsets for ANN training (75%), verification (15%), and testing (10%). Consequently, it will be discussed that the ability of Artificial Neural Network (ANN) for predicting the individual tree diameter increments using individual and stand attributes.

Keywords: Artificial Neural Network Analysis, diameter increment, regression, prediction, mixed stands.

Introduction

It is important that forest growth models provide means for predicting future yields in forestry, also they present significant inquiries for different forest management practices in forest management. These models can be used to evaluate various silvicultural and harvesting (Vanclay, 1994; Gadov and Hui, 1999). Growth and yield models have been widely used to update inventories, predict future yield and explore forest management alternatives and silvicultural options and they are thus used in providing important information for decision-making in pure stands (Burkhart, 1995; Vanclay, 1994). In historic evolution stages for forest growth model, the regression analysis and regression

models have been principal statistical methods for developing these models from empirical data obtained by sample plots and trees located in various forest areas. In these regards, regression analysis has been a famous and recognised procedure in fitting relationships between various tree, stand and forest attributes including predictable quantities. However, these predictive models are statistical equations and that are based on the some the assumptions that (i) the data are nondependent, normally distributed, and homoscedastic, (ii) derived relationships between dependent and independent variables are exact, and (iii) there are no measurement errors in independent variables (Liu et al. 2003; Weiskittel et al. 2011). Commonly,

these assumptions are not satisfied by these empirical data structures originating tree, stand or forest levels. Also, nonlinear and complex relationships between various variables may be rarely modelled by strike regression equations, or biased and nonsense predictions with measurement errors in both dependent and independent variables can be obtained by these statistical equations.

Artificial neural network (Ann) has been increasingly used as an alternative method to deal with these problems in predictive process of tree, stand and forest attributes in forest applications. Artificial neural network is a mathematical model of information processing, which is similar to the structure of the synapses of the brain, and it is constituted with a large number of interconnected nodes (or neurons) (Chaoui et al., 2009; Ghosal and Chaki, 2010). Due to their capability to model highly non-linear processes, purely based on measured data, Ann were considered a proper alternative to the not so successful multivariable linear regression. Recent publications have been carried out by involving artificial neural networks being applied to predictions of various tree, stand and forest attributes including empirical data obtained from different forest locations; modeling individual tree survival probabilities (Guan and Gertner, 1995), tree mortality (Hasenauer et al., 2001; Castro et. al., 2013), diameter growth based climatic variables (Zhang et. al., 2000); predicting parameters of Weibull (Leduc et. al., 2001; Abbasi et. al. 2008; Diamantopoulou et. al., 2015), tree volume (Diamantopoulou, 2005a; Diamantopoulou and Milios, 2010; Özçelik et. al., 2008; Özçelik et. al., 2010), tree stem diameters (Diamantopoulou, 2005b; 2006; Leite et. al., 2011), tree heights (Diamantopoulou and Özçelik, 2012; Özçelik et. al. 2013), diameter distributions (Cai et. al., 2012), tree basal area and volume increments (Asraf et. al., 2013).

This study examined the ability of an ANN model to predict diameter increments for

oriental spruce and scots pine mixed stands in Trabzon and Giresun Forest District Directorates, also, and compared the artificial neural network's predictions with classical regression model based on some statistical fitting criterions.

Material and Methods

In this study, 161 sample plots obtained by Ercanlı (2010) were used to model diameter increment of oriental spruce and scots pine trees. These sample plots were randomly selected to represent the range of site qualities and ages variability throughout Oriental spruce and Scotch pine mixed stands located in Trabzon and Giresun Forest Regional Directorate. These sampled mixed stands were naturally regenerated and uniformly stocked stands (60-90% tree layer cover), without any evidence of historical damage such as fire or storms. The plot size ranged from 0.06 to 0.12 ha, depending on stand density in order to achieve a minimum of 30-40 trees per species in sample plots. In these sample plots, diameter at breast height (dbh) were measured to the nearest 0.1 cm with calipers for every living tree with dbh>8.0 cm. Total tree heights (h) and tree ages with diameter increments were measured on a subset of trees selected by using the rule of two tree per each 4 cm diameter class with Blume-Leiss Altimeter with the 0.1 m precision. These oriental spruce and scots pine trees were bored using a Pressler increment borer to determine both the age at breast height and the periodic annual diameter increment. To avoid measurement errors of annual tree ring widths, the annual diameter increment of 5 years calculated by and then subtracting initial diameters at breast height at the starting of the 5 year period from last diameters at breast height at the finishing of the 5 year period ($dbh_{last}-dbh_{initial}$).

In this study, the model structure suggested by Ercanlı (2010) used to obtain the regression equations predicting diameter increment of oriental spruce:

$$\begin{aligned} \ln(Id) = & \beta_0 + \beta_1 \cdot CI(C66) + \beta_2 \cdot MR + \beta_3 \cdot \ln(d_{1.30}) + \beta_4 \cdot (1/t) \\ & + \beta_5 \cdot \ln(SI) + \beta_6 \cdot \ln(SD) + \beta_7 \cdot Dq \end{aligned}$$

Scots pine trees:

$$\ln(Id) = \beta_0 + \beta_1 \cdot CI(C66) + \beta_2 \cdot t + \beta_3 \cdot \ln(SI) + \beta_4 \cdot \ln(d_{1.30}) + \beta_5 \cdot (1/MR) + \beta_6 \cdot SD$$

These models were fitted by Ercanlı (2010) using linear regression technique for oriental spruce and scots pine trees in Trabzon and Giresun Forest Regional Directorate.

In the artificial neural network model building, both training, verification and testing data sets that randomly partitioned into training (75% of all data), verification (15% of all data) and test (the remaining 10% of all data) data sets were used for capturing general patterns between input variables (independent variables in regression analysis) and target variable (dependent variables in regression analysis). The types of training of ANNs selected for evaluation are the feed-forward backprop with training function of Levenberg-Marquardt and transfer function of purelin. In ANNs training process, the number of neurons is used as 10 with number of layers of 2 owing to fact that these parameters are the most frequently chosen values in ANNs. In these networks, diameter increment data from sample plots are reserved as target variable and input variables are competition index (C66), mixture ratio (MR), diameter at breast height (dbh), 1/stand age, site index (SI), stand density value (SD) and quadratic mean diameter (Dq) for oriental spruce and competition index (C66), stand age, site index (SI), diameter at breast height (dbh), 1/mixture ratio (MR) and stand density value (SD) for scots pine trees. All these applications for ANN was carried out using MATLAB-*nntool* module. Also, these artificial neural networks (ANNs) structure including the feed-forward backprop were compared with linear regression models

developed by Ercanlı (2010) using regression technique based on evaluations of the magnitudes and distributions of models' residual and four goodness-of-fit statistics: Akaike's information criterion (AIC), Root Mean Square Error (RMSE) and Adjusted Coefficient of Determination (R^2_{adj}).

Results

The values of goodness-of-fit statistics, i. e. Mean Error, Absolute Mean Error, Standard Error and R^2_{adj} , for these ANN based on feed-forward backprop and linear regression were given in table 1 for oriental spruce and table 2 for scots pine. For these tree species, these goodness-of-fit statistics proposed that the ANN based on feed-forward backprop has better predictive ability with R^2_{adj} (0.784 for oriental spruce and 0.752 for scots pine), Standard error (0.1852 for oriental spruce and 0.1758 for scots pine), Absolute mean error (0.5321 for oriental spruce and 0.3825 for scots pine), mean error (1.25×10^{-17} for oriental spruce and 1.85×10^{-18} for scots pine) than linear models with R^2_{adj} (0.691 for oriental spruce and 0.646 for scots pine), Standard error (0.2171 for oriental spruce and 0.2218 for scots pine), Absolute mean error (0.6621 for oriental spruce and 0.4436 for scots pine), mean error (3.23×10^{-15} for oriental spruce and 2.81×10^{-16} for scots pine). Fitting results in the ANN based feed-forward backprop accounted for more than 78 % for oriental spruce and 75 % for scots pine of total variance in diameter increments with some tree and stand attributes.

Table 1. The goodness-of-fit statistics for Prediction Method including the ANN and regression model for oriental spruce trees

Prediction Methods including the ANN and regression model	Mean Error	Absolute Mean Error	Standard Error	R^2_{adj}
ANN based on feed-forward backprop	1.25×10^{-17}	0.5321	0.1852	0.784
Linear Regression	3.23×10^{-15}	0.6621	0.2171	0.691

Table 2. The goodness-of-fit statistics for Prediction Method including the ANN and regression model for scots pine trees

Prediction Methods including the ANN and regression model	Mean Error	Absolute Mean Error	Standard Error	R _{adj} ²
ANN based on feed-forward backprop	1.85x10 ⁻¹⁸	0.3825	0.1758	0.752
Linear Regression	2.81x10 ⁻¹⁶	0.4436	0.2218	0.646

Discussion

The artificial neural network model based on the feed-forward backprop has effectively predicted the diameter increments of Oriental spruce and Scotch pine mixed stands located in Trabzon and Giresun Forest Regional Directorate. The goodness-of-fit statistics underlined that the ANN are able to predict the diameter increments of these tree species, Oriental spruce and Scotch pine, and to generate more accurate predictions than multiple linear regression approaches.

This empirical results for ANN helped to develop successfully for predicting diameter increments. Based on the results obtained from the research, forest managers could use ANN for estimating diameter increments and this information would also be beneficial for evaluating different management strategies and developing forest management plans. Thus, it is important that both the composition and configuration of forest ecosystems should be quantitatively evaluated using ANN for effective forest ecosystem management in a changing world. However, these predictions will be improved by the addition of permanent sample plots comparing alternative silvicultural treatments and alternatives. However, these results should be extrapolated to outside the studied forest area was further analyzed and evaluated at other forest sites since the results of this tree growth predictions are specific to this species and the type of forest structure that was studied.

References

Abbasi B., Rabelo L., Hosseinkouchack M. 2008. Estimating parameters of the three-parameter Weibull distribution using a neural network. *European Journal of Industrial Engineering*, 2, 428-445.

Ashraf M.I., Zhao Z., Bourque A., MacLean D.A., Meng F. 2013. Integrating biophysical controls in forest growth and yield predictions generated with artificial intelligence technology.

Canadian Journal of Forest Research, 43, 1162–1171.

Burkhardt H. 1995. Modeling Forest Growth. *Encyclopedia of Environmental Biology*, 2, 535-543.

Castro R., Soares C., Leite H., Lopes de Souza A., Nogueira G., Martins, F. 2013. Individual growth model for Eucalyptus stands in Brazil using Artificial Neural Network. *International Scholarly Research Notices Forestry*, 1, 1-12.

Cai S., Kang X., Zhang L. 2012. Simulation of Trunk diameter distribution for three broadleaved trees based on artificial neural networks. *International Journal of Advancements in Computing Technology*, 4, 520-527.

Chaoui H., Sicard P., Gueaieb, W. 2009. *IEEE Transactions on*, 56 (8), 3174-3187.

Diamantopoulou M.J. 2005a. Artificial neural networks as an alternative tool in pine bark volume estimation, *Computers and Electronics in Agriculture*, 48, 235–244.

Diamantopoulou M. J., 2005b, Predicting fir trees stem diameters using Artificial Neural Network models. *Southern Forests: a journal of Forestry Science*, 205, 39-44.

Diamantopoulou M.J. 2006. Tree-Bole Volume Estimation on Standing Pine Trees Using Cascade Correlation Artificial Neural Network Models. *Agricultural Engineering International: the CIGR ejournal. Manuscript IT 06 002. Vol. VIII.*

Diamantopoulou M.J., Milios, E. 2010. Modelling total volume of dominant pine trees in reforestations via multivariate analysis and artificial neural network models. *Biosystems Engineering*, 105, 306–315.

Diamantopoulou M.J., Özçelik R. 2012. Evaluation of different modeling approaches for total tree-height estimation in Mediterranean Region of Turkey. *Forest Systems*, 21, 3, 383-397.

Diamantopoulou M.J., Özçelik R., Crecente-Campo F., Eler Ü. 2015. Estimation of Weibull function parameters for modelling tree diameter distribution using least squares and artificial neural networks methods. *Biosystem engineering*, 133, 33-45.

Ercanlı, İ., 2010. Models for Oriental Spruce and Scots Pine Mixed Stands in Trabzon and Giresun Forest District Directorates. Phd Thesis,

KTÜ Natural and Applied Science Institute, Trabzon.

Gadow K.V., Hui G.Y. 1999. Modelling forest development, 213 p, Kluwer Academic Publishers, Dordrecht.

Ghosal S., Chaki S. 2010. The International Journal of Advanced Manufacturing Technology, 47 (9-12), 1149-1157.

Guan B.T., Gertner G. 1991. Modeling red pine tree survival with an artificial neural network. Forest Science, 37(5), 1429-1440.

Hasenauer H., Merkl D., Weingartner M. 2001. Estimating tree mortality of Norway spruce stands with neural networks. Advances in Environmental Research, 5 (4), 405-414.

Leduc D.J., Matney T. G., Belli K.L., Baldwin V.C. 2001. Predicting Diameter Distributions of Longleaf Pine Plantations: A Comparison between Artificial Neural Networks and other accepted methodologies. Southern Research Station Technical Report RS-25, 1-17.

Leite H.G., Marques da Silva M.L., Binoti D.H.B., Fardin L., Takizawa F.H. 2011. Estimation of inside-bark diameter and heartwood diameter for *Tectona grandis* Linn. Trees using artificial neural networks. European Journal of Forest and Research, 130, 263-269.

Liu C., Zhang L., Davis C.J., Solomon D.S., Brann T.B., Caldwell L.E. 2003. Comparison of neural networks and statistical methods in classification of ecological habitats using FIA data. Forest Science, 49, 619-631.

Özçelik R., Diamantopoulou M.J., Wiant H.R., Brooks J.R. 2008. Comparative study of standard and modern methods for estimating tree bole volume of three species in Turkey. Forest Products Journal, 58, 6, 73-81.

Özçelik R., Diamantopoulou M.J., Wiant H.V., Brooks J.R. 2010. Estimating tree bole volume using artificial neural network models for four species in Turkey. Journal of Environmental Management, 91, 3, 742-753.

Özçelik R., Diamantopoulou M.J., Crecente-Campo F., Eler U. 2013. Estimating Crimean juniper tree height using nonlinear regression and artificial neural network models. Forest Ecology and Management, 306, 52-60.

Vanclay J.K. 1994. Modelling forest growth-applications to mixed tropical forests. 312 p, CAB International, Department of Economics and Natural Resource, Royal Veterinary and Agricultural University, Copenhagen, Denmark, Wallingford, UK.

Weiskittel A.R., Hann D.W., Kershaw Jr. J.R., Vanclay J.K., 2011. Forest Growth and Yield Modeling. John Wiley & Sons Ltd., Chichester.

Zhang Q. B., Hebda R. I., Zhang Q.J., Alfaro R. I. 2000. Tree-Ring Growth Responses to

Climatic Variables Using Artificial Neural Networks. Forest Science, 46 (2), 229-239.

Variation in Soil and Forest Floor Characteristics and Soil Carbon and Nitrogen Stock Capacity with *Rhododendron* ssp.

Temel SARIYILDIZ¹, Gamze SAVACI¹

¹Kastamonu University, Forestry Faculty, Department of Forest Engineering
37100 Kastamonu, Turkey,

Corresponding Author: gsavaci@kastamonu.edu.tr

Abstract

Turkish rhododendron species are native to the Black Sea Region (BSR). They grow from sea level to altitudes of 3100 m and take the form of shrubs (*R. luteum* Sweet), dwarf shrubs (*R. caucasicum* Pallas) and large shrubs (*R. ponticum* L., *R. ungerii* Trautv., *R. smirnovii* Trautv.). Among them, purple-flowered rhododendron (*R. ponticum* L.) and yellow-flowered rhododendron (*R. flavum* Don.) are two dominant shrub species in the eastern and western BSR, respectively. Purple-flowered rhododendron grows in dense stands throughout the BSR and occurs at elevations up to 2100 m on the Northern Anatolian Mountains. Yellow-flowered rhododendron (*R. flavum*) rises to greater elevations before the subalpine zone begins, where coniferous forests begin to take over. Evergreen understory communities dominated by rhododendron species are an important but often overlooked component of the BSR forests. In the BSR rhododendron species are recognized as abundant and destructive weed in managed forests and in other countries such as in Britain and Ireland, it is invasive and severely ecologically damaging. They not only shade out native seedlings, but also secrete allelopathic acids which may inhibit the growth of competitors. Tissues contain acetylcholine, which is highly toxic if ingested by herbivores. On the other hand, in the dense thickets in which these species often occur, they can have high carbon sequestration potential and play important roles in nutrient storage and cycling since they produce leaf litter that decomposes slowly, thereby regulating seasonal nitrogen availability and influencing long-term patterns of organic matter accretion in early to mid-successional Black Sea Region forests. However, there is no detailed study available in Turkey on investigating the effect of rhododendron on soil properties and on soil organic carbon (SOC) and total nitrogen (TN) stock capacity. We therefore collected mineral soil samples from different tree stands (oriental beech and spruce) with and without rhododendron on the ground. The soil samples were taken from 0-10 cm, 10-20 cm, 20-30 cm, and analysed for pH, soil texture, bulk density, TOC and TN. The TOC and TN stock capacity were then calculated by multiplying soil volume, soil bulk density, and the TOC and TN. Analysis of variance (ANOVA) was applied for analysing the effects of rhododendron on soil properties, and TOC and TN stock capacity for each species using the SPSS program. Results showed that soil pH, bulk density, SOC and TN content, and SOC and TN stock capacity can significantly vary with soil depth, tree species, and rhododendron. In general, all those soil factors decreased with increasing soil depth. The SOC stock capacity was lower under spruce stands than under beech stands, whereas the TN stock capacity was lower under beech stands than under spruce stands. For each tree species, the SOC was higher under the stands with rhododendron on the ground, whereas the TN stock capacity was lower under the stands with rhododendron on the ground.

Keywords: Rhododendron Spp., Carbon and Nitrogen Stock Capacity, Soil Depth, Soil properties, Beech, Spruce

Toprak ve Toprak Yüzeyi Özellikleri ile Toprak Karbon ve Azot Depolama Kapasitesinin Rhododendron ile Değişimi

Özet

Ülkemizin Karadeniz Bölgesinde orman gülleri doğal olarak yayılış göstermektedir. Orman gülleri deniz seviyesinden 3100 m yüksekliğe kadar alanda yetişebilmektedir. Orman gülleri çalı formunda (*R. luteum* Sweet), çüce çalı formunda (*R. caucasicum* Pallas) ve büyük çalı formunda (*R. ponticum* L., *R. ungerii* Trautv., *R. smirnovii* Trautv.) olabilirler. Orman güllü türleri arasında, mor çiçekli ormangülü (*R. ponticum* L.) ve sarı çiçekli orman güllü (*R. flavum* Don.) Karadeniz Bölgesinde anılan sıralamaya göre doğu ve batı yörelerinde yaygın olan iki türdür. Mor çiçekli orman güllü Karadeniz Bölgesi boyunca yoğun bir şekilde yetişmekte olup, Kuzey Anadolu Dağlarında 2100 m yüksekliğe kadar çıkmaktadır. Sarı çiçekli orman güllü ise, iğne yapraklı türlerin hakim olmaya başladığı subalpin zon öncesi yükseltilere kadar çıkabilmektedir. Orman altını kaplayan herdem yeşil türler arasında baskın bir tür olan orman gülleri önemli olmakla beraber, Karadeniz Bölgesi ormanlarının bileşeni olarak dikkate alınmamaktadır. Karadeniz Bölgesinde yayılış gösteren orman gülleri, işletme ormancılığında yoğun ve tahrip edici zararlı ve bir çok ülkede ise örneğin, Britanya ve İrlanda, istilacı ve ekolojik olarak aşırı zarar veren çalı türü olarak tanımlanmaktadır. Orman gülleri sadece doğal fidelelere gölge yapmakla kalmaz aynı zamanda alelopatik asit salgılayarak çevresinde yetişen rakiplerinin büyümesini engeller. Dokuları, otçul hayvanlar tarafından sindirildiğinde oldukça toksik olan asetilandromedol içerirler. Öte yandan, yoğun çalılıklar şeklinde yetişen orman gülleri, yüksek karbon depolama kapasitesine sahip olabilir ve besin elementlerinin depolanmasında ve döngüsünde önemli yer tutabilirler çünkü orman gülleri ayrışması oldukça yavaş olan yapraklar üretirler ve dolayısıyla mevsimsel azot kullanımını düzenleme yanında, Karadeniz Bölgesi ormanlarının erken ve orta süksesyon dönemlerinde orman ekosistemlerine organik madde katılımını etkileyebilirler. Bununla beraber, Ülkemizde orman gülleri toprak özellikleri ve toprak organik karbon ve toplam azot depolama kapasitesi üzerine yapılmış çok az sayıda detaylı çalışma bulunmaktadır. Bu çalışmada, orman gülleri bulunduğu ve bulunmadığı ladin ve kayın ormanlarından mineral toprak örnekleme yapılmıştır. Toprak örnekleri farklı toprak derinlik kademelerinden (0-10 cm, 10-20 cm, 20-30 cm) yapılmış olup, alınan örneklerin pH, tekstür, hacim ağırlığı, organik karbon ve azot miktarları ve depolama kapasiteleri belirlenmiştir. Orman güllü olan ve olmayan alanlar arasındaki toprak özellikleri ile organik karbon ve toplam azot depolama kapasiteleri bakımından farklılıkların önemi SPSS programı kullanılarak ANOVA ile belirlenmiştir. Genel olarak sonuçlar incelendiğinde, çalışılan toprak özelliklerinin ve depolama kapasitelerinin toprak derinliği ile azaldığı belirlenmiştir. Ladin altındaki toprakların organik karbon depolama kapasitesi kayın türüne göre daha düşük, toplam azot depolaması ise kayın türüne göre yüksektir. Her iki tür içinde, toprak organik karbon depolaması orman güllü bulunan alanlarda bulunmayan alanlara göre daha yüksektir, fakat toplam azot depolaması ise orman güllü bulunan alanlarda daha düşüktür.

Anahtar Kelimeler: Orman Gülleri, Karbon ve Azot Depolama Kapasitesi, Toprak Derinliği, Toprak Özellikleri, Kayın, Ladin

Introduction

Understanding the role of nutrient uptake and carbon and nitrogen cycling in forest ecosystems has become increasingly important due to the concerns of the global climate change, sustainable forestry management, the air pollutants, desertification, water regimes etc. (Dixon et al., 1994; Barnes et al., 1998; Linder and Karjalainen, 2007). Under the influence of changing environmental conditions, the importance of gaining knowledge about effects of abiotic and biotic factors on the interrelationships in forest ecosystems is also growing (Yimer et al., 2006). The increased deposition of N compounds causes soil eutrophication and results in nutrient imbalances for various plant species. New aspects of environmental changes have become apparent more recently. Due to the increased emission of CO₂ and other potential greenhouse gases changes in temperature and water regimes and eventually also in nutrient cycles are expected (Curtis et al., 2002; Davidson and Ackerman, 1993).

Forests that contain evergreen shrubs may be characterized by slower nutrient and carbon cycling compared to purely deciduous and coniferous stands (White et al., 1988; Sariyildiz and Küçük 2009). Evidence suggests that some types of deciduous and coniferous trees tend to promote more rapid nutrient cycling in forest ecosystems while some types of evergreen shrubs tend to promote slower nutrient cycling by retaining nutrients in slower-decaying detritus on the forest floor (Aerts, 1995; Sariyildiz and Küçük, 2008). As a result, the amount and species composition of evergreen vegetation in eastern temperate forests are relevant to the nutrient cycling and C sequestration capacity of the forest as a whole. These capacities are expressly related to a forest's ability to protect water quality and to store atmospheric carbon. Many evergreen shrubs that grow in cold, mesic climates, including rhododendron, typically contain high concentrations of organic acids in their leaves and wood (Latham et al. 1996). Lowered soil pH as a result of exudation of these organic acids into the soil, as well as the cold, mesic character of the weather, reduce the rate of decomposition in the soil, resulting in debris accumulation on

the forest floor over time (Pritchett and Fisher 1987).

In Turkey, Black Sea Region forests often include broadleaf evergreen shrubs present in the understory stratum, which is often dominated by *Rhododendron* ssp. These evergreen understories often form continuous, dense thickets beneath deciduous and coniferous overstories. Evergreen understory shrub communities dominated by *Rhododendron* ssp. are an important but often overlooked component of Black Sea Region forests. In the dense thickets in which these species often occur, they have high carbon sequestration potential and play important roles in nutrient storage and cycling. As the largest genus of the Ericaceae family, *Rhododendron* includes 1200 species distributed mainly throughout Northeast Asia and Eurasia, Western Europe, and Eastern North America (Çolak 1997; Eşen, 2000). Among them, Purple-flowered rhododendron (*Rhododendron ponticum* L.) and yellow-flowered rhododendron (*R. flavum* Don.) are both native species of northern Turkey (Çolak 1997). Yellow-flowered rhododendron's natural range is smaller than that of purple-flowered rhododendron and most of its distribution is in the eastern Black Sea Region (Atalay 1992). Ecology, distribution, taxonomy, reproduction, site factors, controls, even aesthetic, sacred, and ethnomedicinal values of *Rhododendrons* has been extensively investigated by many researches in Turkey (Esen and Zedaker, 2004; Terzioğlu et al., 2001). However, effects of *Rhododendron* on soil organic carbon and nitrogen stock capacity have received less attention in Turkey.

Our objectives were to investigate the variation of soil properties and soil organic carbon and nitrogen stock capacity in spruce and beech forest sites with *Rhododendron* shrub cover in Black Sea Region forests. With increasing shrub cover we predicted: 1) soil organic carbon stock capacity would increase due to an accumulation of recalcitrant litter from *Rhododendron* shrubs, 2) pH and nutrient availability would decrease, 3) Nitrogen stock capacity would decrease with decreasing N availability due to lower decay

rates, and 4) these changes to be greater in plots for spruce than in plots for beech.

Material and Methods

Sampling site and soil collection

This study was carried out in Artvin province, northeast Turkey (41°51N, 41°06E), a mountainous region with steep slopes (range from 30 to 65%) and high elevations (up to 2,500 m). Study sites for spruce and beech tree species were selected at the altitude of between 1,500 m and 1,800 m. on the north aspect. The slope angle was 45%. At these altitudes, *Picea orientalis* (L.) Link, *Fagus orientalis* Lipsky, *Abies nordmanniana* (Stev.) Matt., *Pinus silvestris* L., *Castanea sativa* Mill. and *Quercus* spp. are generally the dominant species in either pure or mixed forms. Oriental spruce forms pure or mixed stands over a considerable area (ca 95,000 ha) in Artvin, while Oriental beech forms approximately 52,000 ha. Oriental spruce is often accompanied by Oriental beech in the area (ca 4,800 ha). The understory is generally occupied by grasses (e.g., *Festuca drymeja*, *Trifolium repens*, *Fragaria vesca*, *Vicia* sp., *Lotus corniculatus*), ferns (e.g., *Dryopteris dilatata*, *Asplenium adianthumnigra*, *Pteridium aquilinum*) and broad leaf herbaceous plants (e.g., *Rhododendron ponticum*, *I. colchica*, *Rubus phyllathyphyllos* sp.).

The climate is characterized by cold winters and semiarid summers in the region. The mean annual precipitation at the elevation of 1,200 m was 1,051 mm, with the highest amounts in January (139 mm), and the lowest amount in August (57 mm; Artvin meteorology station) between 1980 and 2005. The mean annual temperature was 8.9°C. The average monthly temperature ranges from 20°C in August to 3.2°C in January. At the elevation of 1,500 m the mean annual precipitation and temperature were 1,216 mm and 6.6°C, while at the elevation of 1,800 m the mean annual precipitation and temperature were 1,381 mm and 4.4°C. The mean temperature and mean rainfall during the 4 years of the investigation did not differ from the mean annual values. In winter, the ground was covered with snow, which accumulated more heavily on the upper elevations than on the lower elevations.

The parent rock of the study area was mostly granite covered with a sandy loam, shallow soil and an organic layer of the humus form more under spruce and mor-like moder under beech (Sariyildiz et al., 2005). The soil type of the study area is defined as Inseptisol according to the United States Department of Agriculture (USDA) soil taxonomy system, which is undeveloped soil characterized by undeveloping soil profile which shows distinct A- and C-horizons, but mineral B-horizon is almost absent in the studied areas. Soil samples were taken randomly from 0-10cm, 10-20 cm and 20-30 cm soil depths by digging four soil pits at each spruce and beech sampling site with and without *Rhododendron* cover on the forest floor. The samples were air-dried, ground and pass through 2 mm mesh-sized sieve. Two core samples from each soil pit were also taken and averaged to obtain representative bulk density. Soil pH was determined by a combination glass-electrode in H₂O (soil-solution ratio 1: 2.5). Soil texture was determined by Bouyoucos` Hydrometer Method. Soil organic matter (SOM) contents of the soils were determined according to wet digestion method described by Kalra and Maynard (1991) (Modified Walkley-Balck Method). Total N was determined by Kjeldahl digestion (Allen 1989) followed by analysis of ammonium by the indophenol method using an auto-analyzer. Concentrations of Ca, Mg, Na, Fe, Zn, Cu and Mn were determined in the Kjeldahl acid digest solution by atomic absorption spectrophotometer (AAS), K by flame emission spectrophotometer (FES) and P by continuous flow colorimetry using the molybdenum blue method (Allen, 1989). All analyses were carried out in triplicate.

Percent of SOC for the soil depths was calculated for each soil pit, based on SOC (%) = 0.58 x SOM.

The SC or nitrogen pool were calculated by multiplying soil volume, soil bulk density, and SC or nitrogen content and expressed as Mg ha⁻¹ (Lee et al., 2009). Soil mass was calculated as follows:

$$M_i = BD_i \cdot T_i \cdot 10^4$$

where M_i is dry soil mass (Mg ha⁻¹), BD_i is bulk density (Mg m⁻³), T_i is the thickness of the i -th soil layer (m), and 10^4 is the unit conversion factor (m² ha⁻¹). The fixed depth

(FD) determination of areal C or (N) stock is calculated as follows:

$$C_{i\text{-fixed}} \text{ or } N_{i\text{-fixed}} = ([C_i] \text{ or } [N_i]) \cdot M_i$$

where $C_{i\text{-fixed}}$ is the C (or $N_{i\text{-fixed}}$ is the N) mass to a fixed depth (kg C or N ha⁻¹) and $[C_i]$ or $[N_i]$ is the C or N concentration (kg C or N Mg⁻¹).

Differences in soil properties, soil carbon and nitrogen content and stock capacities between spruce and beech sampling sites with and without Rhododendron cover on the forest floor were tested for significance using ANOVA. Tukey's honest significance difference (HSD) test was used when statistically significant differences ($p < 0.05$) were observed.

Results

Mean soil pH, soil texture, soil organic carbon and total nitrogen, soil bulk density, and soil organic carbon and total nitrogen stock capacity from the three soil depths (0-10 cm, 10-20 cm and 20-30 cm) for spruce and beech sampling sites with and without Rhododendron cover on the forest floor are shown in Table 1 and Table 2.

In general, for all three soil depths studied, (0-10 cm, 10-20 cm and 20-30 cm), soil pH, soil bulk density and soil nutrients (P, K, Ca, Mg, Mn, Cu, Zn, Fe, Na) were lower at the sites with the Rhododendron on the forest floor than the sites without Rhododendron for both tree species. However, soil organic matter was higher with Rhododendron the forest floor than without Rhododendron cover (Table 1a, b, c).

Soil organic carbon content showed higher values with Rhododendron cover on the forest floor, whereas total nitrogen content was lower with Rhododendron cover for both tree species and three soil depths (Table 2a, b, c). However, at the upper soil (0-10 cm), soil organic carbon stock capacity for spruce and beech were higher with Rhododendron cover than without Rhododendron (Table 2a). However, at the depth of 10-20 cm, SOC stock capacity for spruce did not vary with Rhododendron, while it was higher with Rhododendron cover for beech (Table 2b). At the depth of 20-30 cm, for both tree species, SOC stock capacity showed higher values with Rhododendron cover on the forest floor (Table 2c). As for TN stock capacity, for each

tree species and at each soil depth, TN stock capacity always had lower values with Rhododendron on the forest floor (Table 2a, b, c).

Total soil organic carbon stock capacity in mineral soils (0-30 cm) under beech and spruce stands with and without rhododendron on the ground is shown in Figure 1 and total soil nitrogen stock capacity in Figure 2. Beech with Rhododendron site had the highest SOC stock capacity (99,5 Mg C ha⁻¹), followed by beech site (86,1 Mg C ha⁻¹), spruce with Rhododendron site (76,6 Mg C ha⁻¹) and spruce site (69,1 Mg C ha⁻¹). However, total nitrogen stock capacity was highest for spruce site (16,6 Mg N ha⁻¹), followed by beech site (15,4 Mg N ha⁻¹) and beech and spruce sites with Rhododendron cover on the forest floor which showed similar TN stock capacity (10,6 Mg N ha⁻¹).

Discussion

This present study quantified the variation in soil properties, nutrient content, organic carbon and nitrogen stock capacity by the evergreen understory Rhododendron species in spruce and beech forests. Soil pH, nutrients (P, K, Ca, Mg, Mn, Cu, Zn, Fe, Na) and bulk density significantly varied with Rhododendron cover compared to pure spruce and beech stands. Soil organic matter, however, had higher values with Rhododendron species. Total organic carbon stock capacity in the soil was also higher with Rhododendron species, whereas total nitrogen stock capacity in the soil was lower with Rhododendron species.

Black Sea Region forests are often dominated by broadleaved Rhododendron species, which can exert considerable influence over the chemical and physical make-up of the forest floor (Esen and Zedaker, 2004; Terzioğlu et al., 2001). Most people expect litter and humus depth to increase and that the quality of the forest floor components decreases with increasing shrub basal area. Ericaceous evergreen shrubs are known to have low-nutrient, recalcitrant litter (Horuz et al., 2012a,b). Therefore, it is also expected that these differences in litter and humus could be

associated with a lower soil pH and deplete soil nutrient resources as seen in this present study.

High phenolic compound concentration in *Rhododendron* species litter may have also slowed its decomposition (Sariyildiz and Küçük, 2008) and reduced rates of nutrient mineralization (Northup et al. 1998), thus resulting in accumulation of C and but decrease N in the humus layer and also in the soil. Additionally, much of the N in the humus layer may have been bound in recalcitrant organic compounds and unavailable to plants and also not leach to the soil profile. The site discrepancy in this relationship may have been due to differences in overstory species composition or microclimatic variables that affected decomposition and nutrient mineralization, but this present study did not intend to investigate these factors. The C and nutrient storage potential of the evergreen understory layer is small but in Black Sea Region forests it covers considerable areas, and in total it make some amount in total Carbon and nitrogen stocks. Forest managers and others involved in landscape management should therefore consider the capacity of such forests to retain additional C and nutrients when evaluating management plans.

In conclusion, evergreen understory communities dominated by *Rhododendron* species in Black Sea Region forests play a role in C and N sequestration that is out of proportion to their living biomass in the system, because the litter decomposes more slowly than that from the overstory trees. The presence of thickets of *Rhododendron* species in forest understories has been found to inhibit overstory tree regeneration and therefore lead to declines in timber output (Esen 2000; Nilsen et al., 2001; Chastain et al., 2006). However, the fact that these species account for a larger amount of the C and nutrient component of forests in proportion to their biomass suggests that they may provide an important ecological service with respect to water quality. These species may be able to partially attenuate stream nitrate export (Eshleman and Morgan, 1998; Eshleman, 2000), and other disturbances, such as wind or ice storm damage. In addition, their C and nutrient storage capacities may meaningfully contribute to the air quality maintenance and

climate change mitigation services provided by Black Sea Region forests. The trade-off involved in removing evergreen understory species to maximize timber output should be balanced against their role in the overall functioning of the forest with respect to other important societal services.

The effects of evergreen understory shrub species on the soil organic carbon and total nitrogen stock capacity and also its ecological service in a given region, is less well understood. So, we need more studies in future to fully understand the ecological roles of *Rhododendron* in forest ecosystem.

Table 1: Some soil properties in mineral soil of three depths, 0-10cm (a), 10-20 cm (b) and 20-30 cm (c) under beech and spruce stands with and without rhododendron on the ground. Tukey method of multiple pairwise comparison at $\alpha = 0.05$ used to determine significantly different means. Means with the same letter are not significantly different by columns.

(a) Soil Properties (0-10 cm soil depth)	Spruce	Spruce with rhododendron	Beech	Beech with rhododendron
pH (H ₂ O)	4,87b±0,08	4.27a±0.24	4,85b±0,52	4,47a±0,42
Kum (%)	72b±4,35	61a±3,0	67b±2,65	69b±4,11
Kil (%)	13a±1,63	14a±3,37	17b±1,41	18b±6,03
Toz (%)	15a±3,86	26b±1,73	17a±1,41	14a±4,99
Organik Matter (%)	4,31a±0,85	5,74b±0,53	6,10b±0,71	8,01c±0,51
Soil bulk density (g cm ⁻³)	1,02±0,10	0,89±0,12	1,11±0,07	0,98±0,14
Mn (mg kg ⁻¹)	26,7b±4,15	12,5a±2,83	47,8c±7,14	21,08b±6,75
Cu (mg kg ⁻¹)	0,87b±0,29	0,57a±0,24	1,52c±0,47	0,79b±0,12
Zn (mg kg ⁻¹)	2,67b±0,36	1,60a±0,59	2,97b±0,28	1,65a±0,31
Fe (mg kg ⁻¹)	281b±32,9	162a±34,2	359c±89,4	168a±43,4
Na (mg kg ⁻¹)	20,4b±2,04	16,1a±0,67	15a±2,52	13a±3,35
Mg (mg kg ⁻¹)	118c±12,5	28a±2,65	196d±43,4	71b±14,8
Ca (mg kg ⁻¹)	248c±95,1	228b±31,7	207a±44,1	260c±37,4
K (mg kg ⁻¹)	157c±18,3	70a±13,5	192d±36,6	109b±23,6
P (mg kg ⁻¹)	5,73b±0,76	4,85a±1,0	10,3c±3,04	6,95b±1,93

The Tukey's Honestly Significant Difference (HSD) test was used to determine significantly different means between the study stands. Means with the same letter are not significantly different by lines (n=5).

(b) Soil Properties (10-20 cm soil depth)	Spruce	Spruce with rhododendron	Beech	Beech with rhododendron
pH (H ₂ O)	4,94b±0,27	4,65b±0,23	4,74b±0,66	4,23a±0,41
Kum (%)	70±4,03	69±3,95	71±2,38	68±8,19
Kil (%)	12a±1,29	12a±2,16	13a±0,96	19b±5,57
Toz (%)	19±2,99	19±1,89	17±1,71	14±2,71
Organik Madde (%)	3,75a±0,50	5,02b±0,72	4,12a±0,36	5,55b±0,70
Soil bulk density (g cm ⁻³)	0,91±0,11	0,83±0,13	0,88±0,14	0,74±0,17
Mn (mg kg ⁻¹)	24,6b±1,65	20,9b±3,20	15,1a±2,25	21,7b±2,44
Cu (mg kg ⁻¹)	0,43a±0,06	0,40a±0,18	0,84b±0,31	0,45a±0,15
Zn (mg kg ⁻¹)	1,59b±0,25	1,42b±0,19	1,63b±0,40	0,92a±0,27
Fe (mg kg ⁻¹)	79a±7,6	72a±6,2	98b±10,8	165c±38
Na (mg kg ⁻¹)	17bc±1,35	17bc±3,54	20c±5,24	14a±4,32
Mg (mg kg ⁻¹)	90c±15,2	33a±10,7	82c±11,6	65b±5,80
Ca (mg kg ⁻¹)	153a±36,6	148a±36,4	159a±26,7	246b±43,2
K (mg kg ⁻¹)	86b±19,3	139d±19,1	106c±20,9	66a±18,8
P (mg kg ⁻¹)	9,15a±0,95	9,11a±2,46	12,8b±3,30	8,45a±2,22

(c) Soil Properties (20-30 cm soil depth)	Spruce	Spruce with rhododendron	Beech	Beech with rhododendron
pH (H ₂ O)	4,97a±0,18	4,84a±0,17	5,14b±1,01	4,44a±0,38
Kum (%)	70±3,32	69±3,37	66±1,91	66±5,07
Kil (%)	15a±1,71	13a±1,73	12a±2,22	21b±5,91
Toz (%)	16a±1,69	19b±2,65	20b±1,26	14a±1,50
Organik Madde (%)	3,07a±0,17	4,10b±0,58	3,15a±0,44	3,94b±0,46
Soil bulk density (g cm ⁻³)	0,86±0,06	0,73±0,09	0,82±0,11	0,65±0,16
Mn (mg kg ⁻¹)	27,5b±2,12	22,5a±4,27	27,2b±9,23	23,7a±10,80
Cu (mg kg ⁻¹)	0,32a±0,07	0,35a±0,10	0,66b±0,14	0,31a±0,06
Zn (mg kg ⁻¹)	0,67a±0,24	0,57a±0,31	1,01b±0,29	0,63a±0,23
Fe (mg kg ⁻¹)	59a±23,4	55a±16,9	73b±10,5	84b±57,7
Na (mg kg ⁻¹)	17b±1,26	17b±2,79	25c±2,14	12a±7,47
Mg (mg kg ⁻¹)	94b±19,9	40a±32,4	84b±8,96	90b±31,1
Ca (mg kg ⁻¹)	80a±14,5	73a±9,9	132b±37,2	360c±140
K (mg kg ⁻¹)	89a±18,1	82a±28,6	142b±13,5	90a±24,2
P (mg kg ⁻¹)	7,38a±0,70	7,04a±1,12	11,7b±3,68	7,92a±3,45

Table 2: Soil organic carbon (SOC) and total nitrogen (TN) content and stock capacity in mineral soils of three depths, 0-10cm (a), 10-20 cm (b) and 20-30 cm (c) under beech and spruce stands with and without rhododendron on the ground.

(a) Soil Properties (0-10 cm soil depth)	Spruce	Spruce with rhododendron	Beech	Beech with rhododendron
Organik Karbon (%)	2,50a±0,49	3,33b±0,31	3,54b±0,41	4,64c±0,29
N(%)	0,64c±0,08	0,50ab±0,04	0,56b±0,07	0,46a±0,05
SOC-stock capacity (Mg C ha ⁻¹)	25,6a±5,0	29,6b±2,71	39,3c±4,57	45,6d±2,92
TN-stock capacity (Mg N ha ⁻¹)	6,55b±0,55	4,41a±0,24	6,24b±0,41	4,46a±0,46

(b) Soil Properties (10-20 cm soil depth)	Spruce	Spruce with rhododendron	Beech	Beech with rhododendron
Organik Karbon (%)	2,17a±0,29	2,91b±0,42	2,39a±0,21	3,22b±0,41
N(%)	0,54c±0,08	0,40ab±0,04	0,46b±0,07	0,36a±0,05
SOC-stock capacity (Mg C ha ⁻¹)	25,5a±5,0	25,9a±3,70	26,5a±2,34	31,6b±4,01
TN-stock capacity (Mg N ha ⁻¹)	5,53b±0,32	3,52a±0,24	5,13b±0,31	3,48a±0,16

(c) Soil Properties (20-30 cm soil depth)	Spruce	Spruce with rhododendron	Beech	Beech with rhododendron
Organik Karbon (%)	1,78a±0,10	2,38b±0,34	1,83a±0,26	2,29b±0,27
N(%)	0,44c±0,08	0,30ab±0,04	0,36bc±0,07	0,27a±0,06
SOC-stock capacity (Mg C ha ⁻¹)	18,2a±0,99	21,2b±3,0	20,3ab±2,86	22,4b±2,61
TN-stock capacity (Mg N ha ⁻¹)	4,51b±0,52	2,63a±0,64	4,02b±0,91	2,67a±0,33

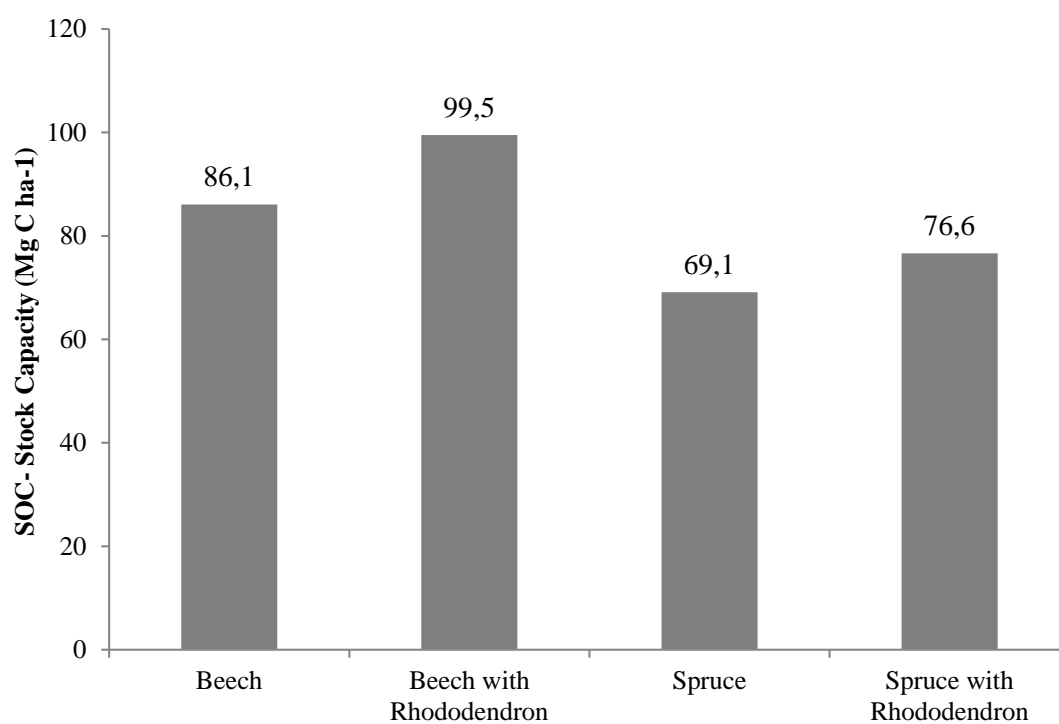

Figure 1: Total soil organic carbon (SOC) stock capacity in mineral soils (0-30 cm) under beech and spruce stands with and without rhododendron on the ground.

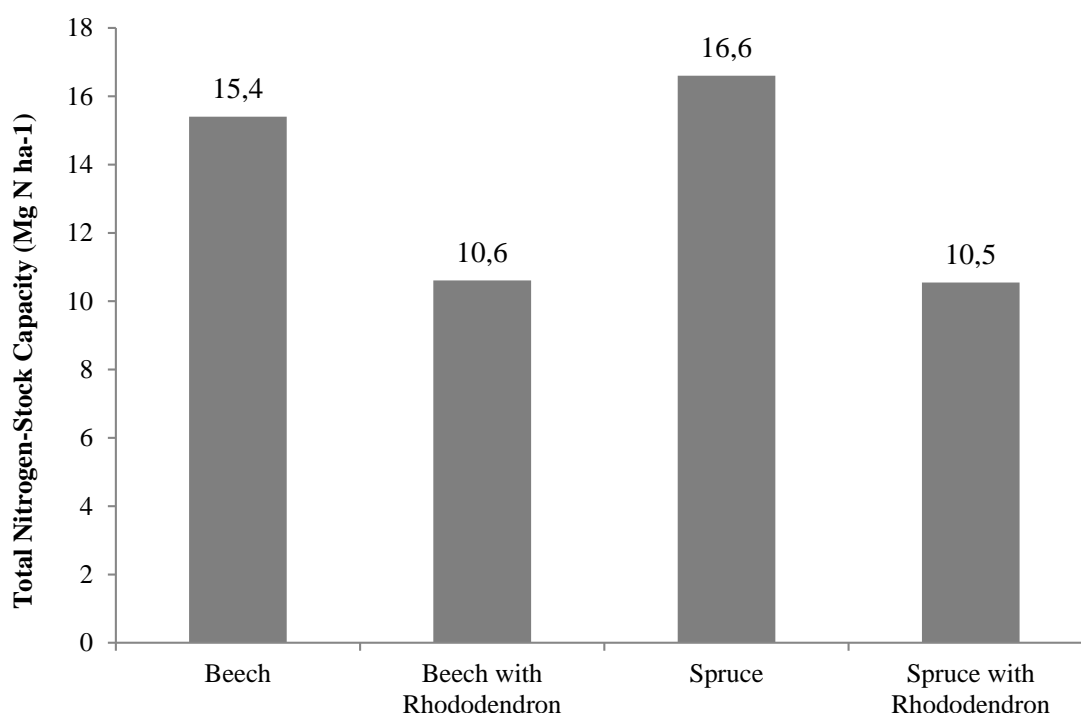

Figure 2: Total soil nitrogen stock capacity in mineral soils (0-30 cm) under beech and spruce stands with and without rhododendron on the ground.

References

- Aerts R. 1995. The advantages of being evergreen. *Trends in Ecology and Evolution*, 10, 402–407.
- Allen S.E. 1989. *Chemical Analysis of Ecological Materials*. Blackwell Scientific Publications, Oxford.
- Atalay I. 1992. The ecology of beech forests and their regioning in terms of seed transfer. Ministry of Forestry Research Institute of Forestry. *Trees and Seed Improvement*, 5:54-59.
- Barnes B.V., Zak, D.R., Denton S.R., Spurr S.H. 1998. *Forest Ecology*, fourth ed. Wiley, New York.
- Chastain R. A., Currie W. S., Townsend P. A. 2006. Carbon sequestration and nutrient cycling implications of the evergreen understory layer in Appalachian forest, *Forest Ecology and Management*, 231, 63–77
- Çolak A. H., Aksoy H. 1997. Investigations on the Silvicultural Characteristics of *Rhododendron ponticum* L. (purple-flowered forestrose). Ph.D. Dissertation, University of Istanbul, Turkey. 181 p.
- Curtis P.S., Hanson P.J., Bolstad P., Barford C., Randolph J.C., Schmid H.P., Wilson K.B. 2002. Biometric and eddy covariance based estimates of annual carbon storage in five eastern North American deciduous forests. *Agriculture and Forest Meteorology*, 113, 3–19.
- Davidson E.A., Ackerman I.L. 1993. Changes in soil carbon inventories following cultivation of previously untilled soils. *Biogeochemistry*, 20, 161–93.
- Dixon R.K., Brown S., Houghton R.A., Solomon A.M., Trexler M.C., Wisniewski J. 1994. Carbon pools and flux of global forest ecosystems. *Science*, 263, 185–90.
- Eshleman K.N., Morgan R.P. 1998. Temporal patterns of nitrogen leakage from mid-Appalachian forested watersheds: role of insect defoliation. *Water Resources Research*, 34 (8), 2005–2116.
- Eshleman K.N. 2000. A linear model of the effects of disturbance on dissolved nitrogen leakage form forested watersheds. *Water Resources Research*, 36 (11), 3325–3335.
- Eşen D. 2000. Ecology and Control of Rhododendron (*Rhododendron ponticum* L.) in Turkish Eastern Beech (*Fagus orientalis*

Lipsky.) Forests, Faculty of Virginia Polytechnic Institute and State University, Doctora Thesis (unpublished), Virginia, p.111.

Eşen D., Zedaker S.M. 2004. Control of rhododendron (*Rhododendron ponticum* and *R. flavum*) in the eastern beech (*Fagus orientalis* L.) forests of Turkey. *New Forests*, 27(1), 69-79.

Horuz A., Korkmaz A., Dizman M., Tutar, A. Karaman M.R., Karakaya S. 2012a. Batı Karadeniz Bölgesi Mor Çiçekli Ormangülü Plantasyonlarında Gelişen Humusun Bazı Fizikokimyasal Özellikleri ve Humik Madde Potansiyeli. *Sakarya Üniversitesi Fen Edebiyat Dergisi*, 1, 131-146.

Horuz, A., Korkmaz, A., Dizman, M., Tutar, A., Karaman, M.R., Karakaya, S., 2012b. Batı Karadeniz Mor Çiçekli Ormangülü Topraklarının Humik Madde İle Besin Element İçeriği Arasındaki İlişkiler *Sakarya Üniversitesi Fen Edebiyat Dergisi*, 1, 477-488.

Kalra Y.P., Maynard D.G., 1991. Methods manual for forest soil and plant analysis. In: *For. Can., Northwest Reg. North. For. Cent., Edmonton, Alberta. Inf. Rep. NORX- 319.*

Latham R. E., Thompson J. E., Riley S. A., Wibiralske, A. W. 1996. The Pocono till barrens: Shrub savanna persisting on soils favoring forest. *Bulletin of the Torrey Botanical Club*, 123, 330-349.

Lee J., Hopmans J.W., Rolston D.E., Baer S.G., Six J. 2009. Determining soil carbon stock changes: simple bulk density corrections fail. *Agriculture Ecosystems and Environment*, 134, 251-256.

Lindner M., Karjalainen T. 2007. Carbon inventory methods and carbon mitigation potentials of forests in Europe: a short review of recent progress. *European Journal Forest Reseach*, 126, 149–156.

Nilsen E. T., Clinton B. D., Lei T. T., Miller O.K., Semones S. W., Walker J.F. 2001. Does *Rhododendron maximum* L. (Ericaceae)

reduce the availability of resources above and belowground for canopy tree seedlings? *American Midland Naturalist Journal*, 145, 325–343.

Northup R. R., Dahlgren R.A. McColl J.G. 1998. Polyphenols as regulators of plant-litter-soil interactions in northern California's pygmy forest: a positive feedback? *Biogeochemistry*, 42, 239-257.

Pritchett W. L. Fisher R. F. 1987. *Properties and Management of Forest Soils*. 2nd Ed. John Wiley & Sons, New York. 494 pp.

Sariyildiz T., Anderson J. M., Kucuk M. 2005. Effects of tree species and topography on soil chemistry, litter quality and decomposition in Northeast Turkey. *Soil Biology and Biochemistry*, 37, 695-1706.

Sariyildiz T., Kucuk M. 2008. Litter Mass Loss Rates in Deciduous and Coniferous Trees in Artvin, Northeast Turkey: Relationships With Litter Quality, Microclimate and Soil Characteristics. *Turkish Journal of Agriculture and Forestry*, 32, 547-559.

Sariyildiz T. Küçük M. 2009. Influence of slope position, stand type and rhododendron (*Rhododendron ponticum*) on litter decomposition rates of Oriental beech (*Fagus orientalis* Lipsky.) and spruce (*Picea orientalis* (L.) Link). *European Journal of Forest Research*, 128 (4), 351-360.

Terzioğlu S., Meriv N. Anşın R. 2001. A study on Turkish Rhododendron L. (Ericaceae). *Turkish Journal of Agriculture and Forestry*, 25, 311-317.

White D. L., Haines B. L., Boring L.R. 1988. Litter decomposition in southern Appalachian black locust and pine-hardwood stands: litter quality and nitrogen dynamics. *Canadian Journal of Forest Research*, 18, 54–63.

Yimer F., Ledin S., Abdelkadir A. 2006. Soil organic carbon and total nitrogen stocks as affected by topographic aspect and vegetation in the Bale Mountains, Ethiopia Original Research Article. *Geoderma* 135, 335-344.

Slope Effect on Soil Microbial Biomass in Black Pine Stands Subjected to Ground Fire

*Musa AKBAŞ¹, Miraç KILIÇ¹, Aydın TÜFEKÇİOĞLU¹, Bülent SAĞLAM¹

¹Artvin Çoruh University, Faculty of Forestry, Artvin / TURKEY

*Corresponding Author: musakbas15@artvin.edu.tr

Abstract

Soil microbial biomass (SMB) is a sensitive indicator of soil quality and also has an increasing use for evaluating soil health. This study was done in ground fire applied different sloping areas and adjacent control areas in old Black Pine forest stands at Kunduz series in Osmancık Forest Sub-District Directorate (Vezirköprü/SAMSUN). Soil samples were taken from surface (0-5 cm) and sub-surface (5-10 cm) layers of soil in July'15. Chloroform-fumigation-extraction method was used to determine the microbial biomass C and microbial biomass N (MBC and MBN). MBC and MBN values were changed between 133.61 $\mu\text{g g}^{-1}$ – 1022.75 $\mu\text{g g}^{-1}$ and 18.09 $\mu\text{g g}^{-1}$ – 191.33 $\mu\text{g g}^{-1}$, respectively. SMB values were significantly lower in burned plots than in control plots. Fire had negative effect on SMB and this effect increased with slope. Negative effect of fire on SMB need to be considered in use of prescribed fire for regeneration of these sites.

Keywords: Soil microbial biomass, Slope, Ground fire, Black pine

Örtü Yangınına Maruz Kalmış Karaçam Meşcerelerinde Toprak Mikrobiyal Biyokütlesi Üzerine Eğimin Etkisi

Özet

Toprak mikrobiyal biyokütlesi (TMB) toprak kalitesinin hassas bir göstergesi olup aynı zamanda artan bir şekilde toprak sağlığının değerlendirilmesinde kullanılmaktadır. Bu çalışma Samsun ili Vezirköprü ilçesi sınırları içerisindeki Osmancık Orman İşletme Şefliği Kunduz serisindeki karaçam meşcerelerinde; farklı eğimli alanlarda, örtü yangını uygulanmış ve bitişindeki kontrol sahalarında yapılmıştır. Toprak örnekleri 2015 yılı Temmuz ayında üst topraktan (0-5 cm) ve alt topraktan (5-10 cm) alınmıştır. Mikrobiyal biyokütle karbon ve mikrobiyal biyokütle azotu (MBK ve MBA) belirlemek için kloroform-fumigasyon-ekstraksiyon metodu kullanılmıştır. MBK ve MBA değerleri sırasıyla, 133.61 $\mu\text{g g}^{-1}$ – 1022.75 $\mu\text{g g}^{-1}$ ve 18.09 $\mu\text{g g}^{-1}$ – 191.33 $\mu\text{g g}^{-1}$ arasında değişim göstermiştir. TMB değerleri yangın sahalarında kontrol sahalarından anlamlı şekilde daha düşük çıkmıştır. Yangının TMB üzerine negatif etkisi olmuş ve bu etki eğim ile artmıştır. Yangının TMB üzerine olumsuz etkisinin, bu sahalarda tensil çalışmalarında dikkate alınması gereklidir.

Anahtar Kelimeler: Toprak mikrobiyal biyokütlesi, Eğim, Örtü yangını, Karaçam

Introduction

Soil organisms have important role at change of soil system by their active livings at habitats which change with aeration, moisture, nutrient etc. factors. Yet 80-90% of soil processes are the reactions carried out by the microorganisms those microflora and micro fauna of soil organisms (Mataix-Solera et al., 2009). Soil microorganisms are responsible from decomposition of about all of the organic compounds, so they are essential and fundamental component at regulating of biochemical cycle at terrestrial ecosystems (Nannipieri et al., 2003). Because of the soil under the influence of many ecological factors is a habitat of micro

organisms those playing key role at ecological cycles, biomass of microorganisms is an important indicator for soil quality.

Fire has direct or indirect effect on soil or vegetation in forest ecosystems. Most important indirect effects are changing the structure and continuity of vegetation and running out of organic matter from forest soil (DeBano et al., 1998; Neary et al., 1999). Effect of fire on soil microorganisms varied with conditions and related to fire severity, to change of some soil properties and post-fire environmental conditions.

Microbial biomass is composed of soil microorganisms smaller than 5-10 μm^3 and

called living part of soil organic matter. This live biomass which includes bacteria, fungi, actinomycet and protozoa is involving 0.5-5% carbon of organic matter (Mataix-Solera et al., 2009).

Recolonization of soil microbial biomass (SMB) is related to fire severity, change of soil, recovery of vegetation and post-fire climate conditions. In addition, because of remained partially burned vegetation litter, degradable and enhanced organic matter may improve SMB level of before fire (Mataix-Solera et al., 2009). Many researchers suggested that recovery of SMB is with in a long time e.g. more than ten years (Fritze et al., 1993) and slowly and related to change of organic part (Vazquez et al., 1993; Prieto-Fernandez et al., 1998).

In this study post-fire change of SMB was investigated by prescribed fire at burned and adjacent control sites over flat and sloped areas.

Materials and Methods

Study area

The study area is located at county of Vezirköprü in city of Samsun in Turkey. Test sites were chosen from Kunduz serials with in boundaries of Osmancık forest sub-district directorate connected to forestry operation directorate of Corum and were determined from some black pine stands. Black pine stands in test sites are two over-storied (5-15 and 80 aged). Test sites are North and North-west aspected, and also at mean 1250 m elevation. Test sites are over two slope sites, flat and sloped areas. Slope degree of sloping areas was 50-60% and degree of flat areas was 5-10%.

Study area remains at Black sea transition zone (Between continental and temperate). Yearly mean precipitation is 527mm and yearly mean temperature is 11.4°C and relative humidity is 68% at study area.

Field studies

At test sites prescribed burning was applied as ground fire. For soil sampling 6 test sites from burned site and 2 sites as control were chosen from each slope group. Soil samples were taken from two layers of soil (0-5 and 5-10 cm) in July'15 (20 months after fire).

Laboratory studies

Soil samples were air-dried for chemical and physical soil analyses and passed through a 2 mm mesh-sized sieve. Organic matter contents of the soils were determined according to the wet digestion method described by Kalra and Maynard (1991) (modified Walkley-Black method). Soil texture was determined by Bouyoucos` Hydrometer Method described by Gülçur (1974). Soil pH was determined by a combination glass-electrode in H₂O (soil-solution ratio 1: 2.5) (Kalra and Maynard, 1991).

Soil microbial biomass Carbon (MBC) was estimated by extracting 30-g oven-dry equivalents of field-moist mineral soil samples in 0.5 M K₂SO₄ (1:4 w/v) by the chloroform-fumigation-extraction method described by Brookes et al., (1985) and Vance et al., (1987). MBC was calculated from the difference in extractable organic C between fumigated and unfumigated soil samples as follows: biomass C = 2.64 EC, where EC refers to the difference in extractable organic C between the fumigated and unfumigated treatments; 2.64 is the proportionality factor for biomass C released by fumigation extraction (Vance et al., 1987).

The Kjeldahl digestion-distillation-titration method was used to determine the total N in K₂SO₄ (Anderson and Ingram, 1993). Microbial N was calculated (Brookes et al., 1985) using the equation biomass N = FN/0.54, where FN = (total N from fumigated soil) - (total N from unfumigated soil).

Statistical analyses

Obtained values were analyzed statically by using SPSS™ 15 packet program. For variation and difference of fire effect and for interrelation of soil characteristics, t-test and Pearson correlation analyses were applied, respectively.

Results

Physical properties of soils

Sand, clay and silt contents of soils at 0-10 cm layer, changed between 62.62 – 87.18%, 3.89 – 14.34% and 6.89 – 26.26%, respectively. Sand content was found significantly higher at surface soil layer and

was not varied between burned and control sites at sub-surface soil layer (Figure 1). Sand content decreased with depth while clay content increased. Clay content was higher in control site except surface soil layer of flat area. Clay content at surface soil layer of flat area was significantly higher in burned site

(Figure 2). Silt content was higher in burned sites than in control especially at sloped area (Figure3). Kind of soils were found as “sandy-loam”.

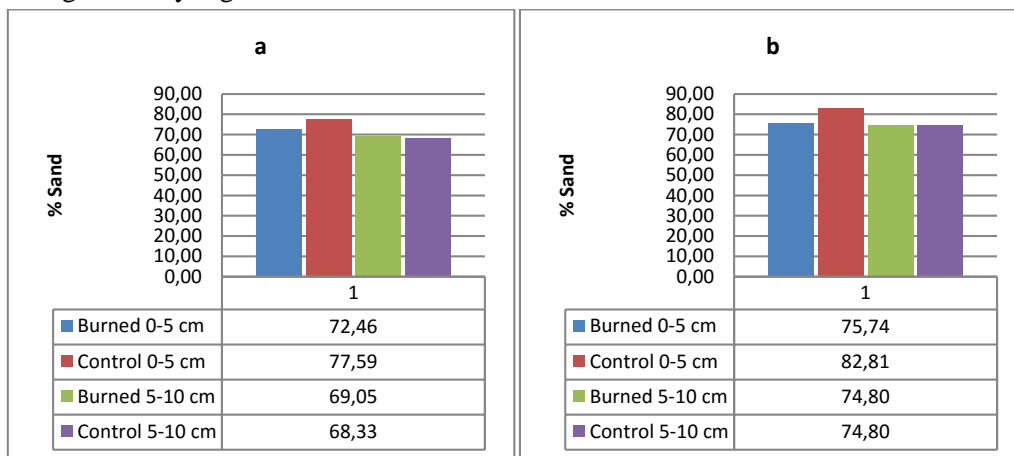

Figure 1. Sand contents of soils at both surface layers (a. Flat areas b. Sloped areas)

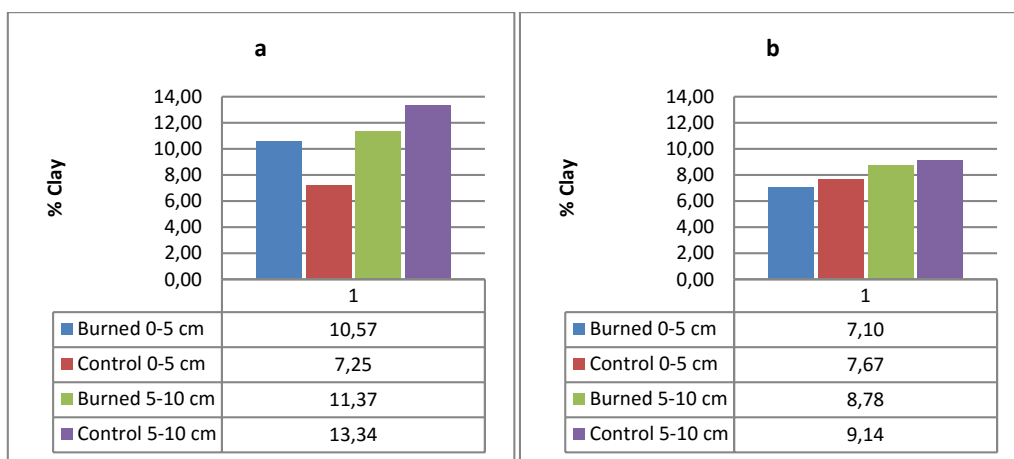

Figure 2. Clay contents of soils at both surface layers (a. Flat areas b. Sloped areas)

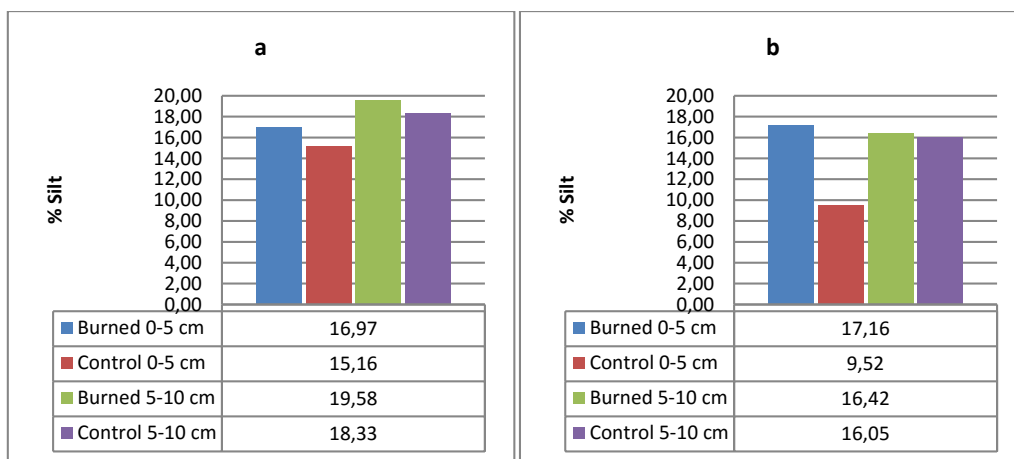

Figure 3. Silt contents of soils at both surface layers (a. Flat areas b. Sloped areas)

Chemical properties of soils

pH values of soils at 0-10 cm layer, changed between 5.48 – 7.68 pH mean values were higher in burned sites but not significantly. Mean pH values of flat and sloped areas were limitedly around 6 and 7 levels, respectively (Figure 4).

Soil organic matter (SOM) content of soils at 0-10 cm soil layer changed between 1.31 – 11.39%. SOM content was higher in control sites than in burned sites (but significant only at surface soil layer of sloped area) (Figure 5).

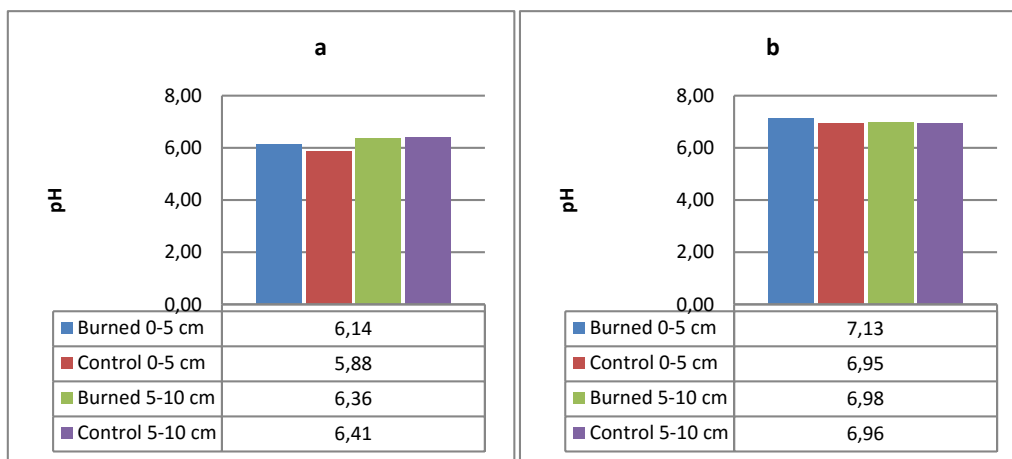

Figure 4. pH values (mean) of soils at both surface layers (a. Flat areas b. Sloped areas)

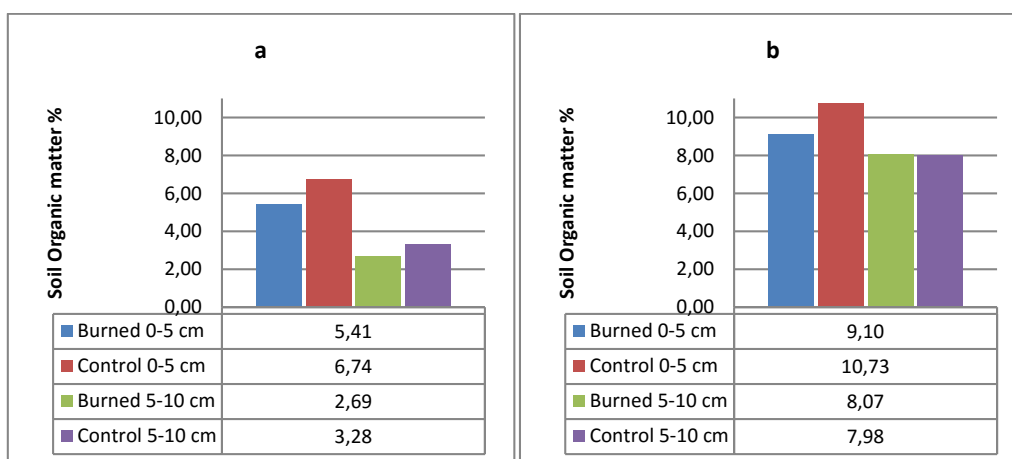

Figure 5. Soil organic matter content of soils at both surface layers (a. Flat areas b. Sloped areas)

Soil Microbial Biomass (SMB)

Microbial biomass carbon (MBC)

MBC values of soils changed between 328.54 – 1022.75 $\mu\text{g g}^{-1}$ at surface soil layers, between 133.61 – 410.51 $\mu\text{g g}^{-1}$ at sub-surface soil layers. MBC of surface soil layers were lower significantly in burned sites than in control sites (Figure 6), and MBC of sub-surface soil layers at sloped areas were too. (Figure 7).

Microbial biomass nitrogen (MBN)

MBN values of soils changed between 40.96 – 191.33 $\mu\text{g g}^{-1}$ at surface soil layers, and between 18.09 – 105.31 $\mu\text{g g}^{-1}$ at sub-surface soil layers. MBN of surface soil layers were significantly lower in burned sites than in control sites only at sloped areas. (Figure 8) MBN of sub-surface soil layers were lower significantly in burned sites than in control sites (Figure 9).

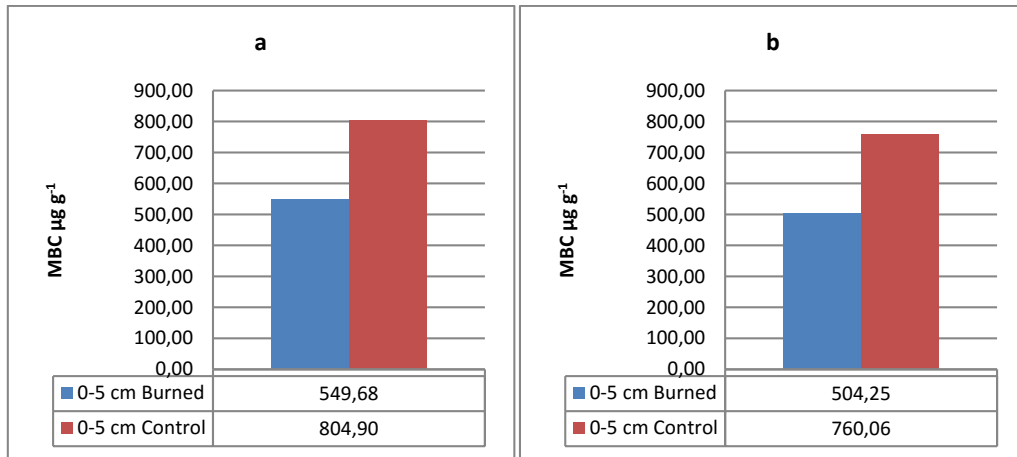

Figure 6. Microbial biomass carbon (MBC) at surface soil layers (a. Flat areas b. Sloped areas)

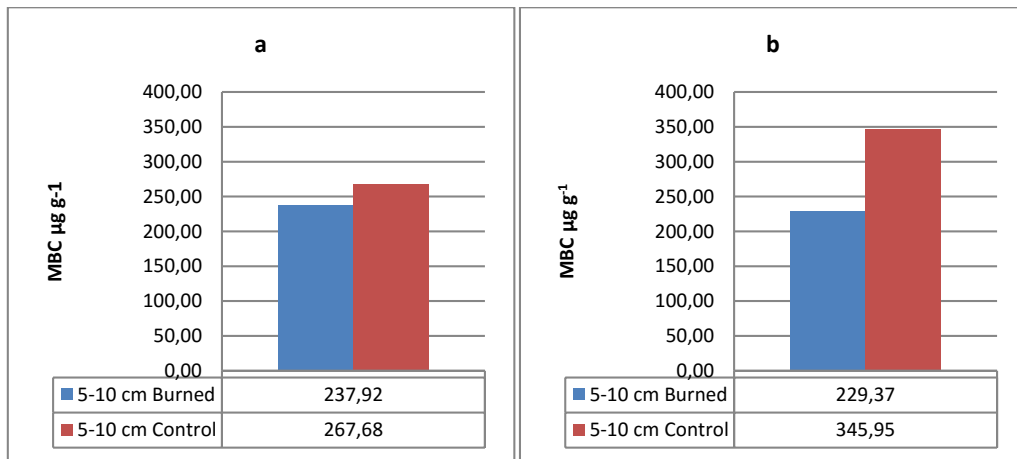

Figure 7. Microbial biomass carbon (MBC) at sub-surface soil layers (a. Flat areas b. Sloped areas)

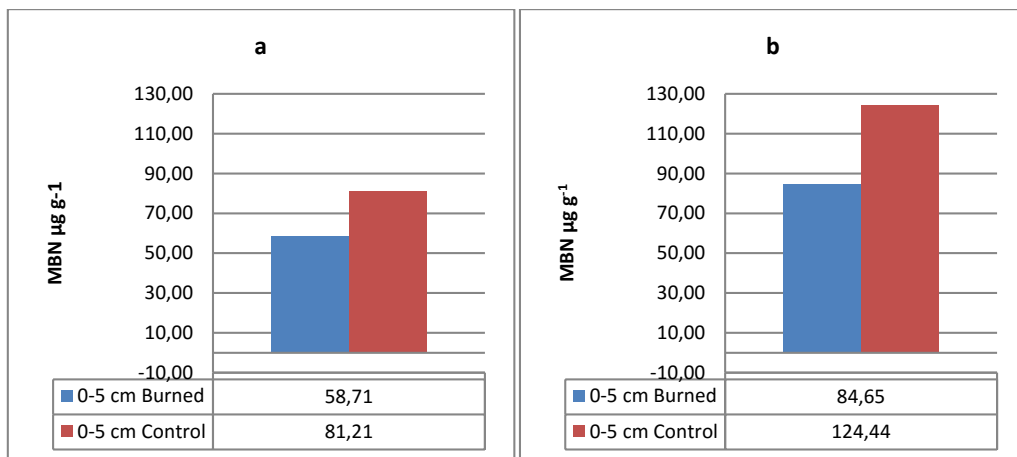

Figure 8. Microbial biomass nitrogen (MBN) at surface soil layers (a. Flat areas b. Sloped areas)

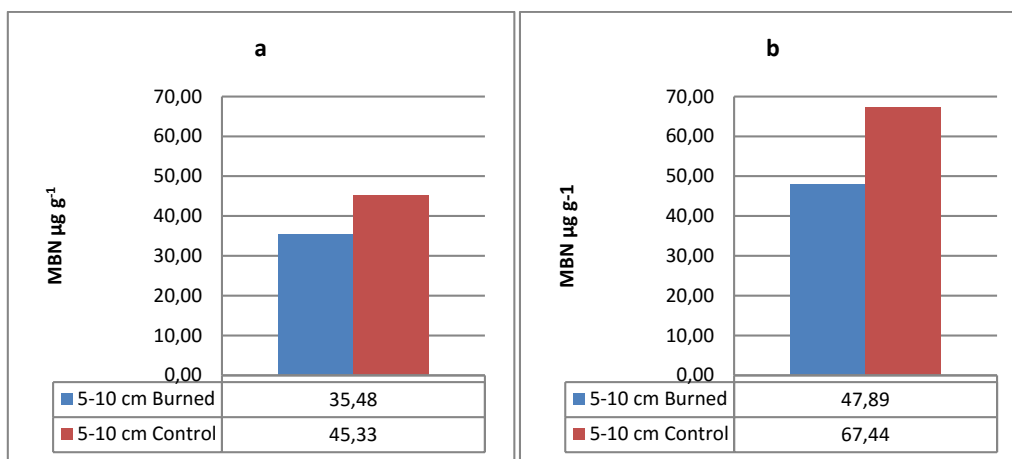

Figure 9. Microbial biomass nitrogen (MBN) at sub-surface soil layers (a. Flat areas b. Sloped areas)

Statistical Analyze

MBC and MBN values were analysed by t-test according to levene's homogeneity test and results were evaluated statistically and so significant differences were found between burned and control sites. Except sub-surface soil layer of flat area for MBC, significancy values were found smaller than 0.05 (between %95 confidence level) and there was a significant difference between burned and control sites values (Table 1).

Significance values for MBN at sub-surface soil layers of flat area and surface soil layers of sloped area were found smaller

than 0.05 (between %95 confidence level) and there was a significant difference between burned and control sites values. Also significance values for MBN at sub-surface soil layers of sloped area were found at the limit of confidence level ($p=0.051$), so a significant difference may be mentioned.

For other soil characteristics significant differences were not found so much between burned and control sites. Only for sand at surface soil layers, for clay at flat area and for SOM at surface soil layer of sloped area, significant differences between burned and control sites were found.

Table 1. Significance values and other data values of t-test and levene's test analysis for microbial biomass carbon (MBC) and microbial biomass nitrogen (MBN) (E.v.a=Equal variances assumed, E.v.n=Equal variances not assumed)

Depth	Slope	Levene's Test for Equality of Variances		t-test for Equality of Means								
		F	Sig.	t	df	Sig. (2-tailed)	Mean Difference	Std. Error Difference	95% Confidence Interval of the Difference			
									Upper	Lower		
0-5 cm	Flat	MBC	E.v.a.*	1.326	.262	-3.594	22	0.002	-255.22	71.02	-402.51	-107.93
		MBC	E.v.n.**			-3.868	9.843	0.003	-255.22	65.97	-402.54	-107.90
	Sloped	MBN	E.v.a.	7.021	.015	-2.783	22	0.011	-22.50	8.08	-39.26	-5.73
		MBN	E.v.n			-2.079	6.040	0.083	-22.50	10.82	-48.93	3.94
		MBC	E.v.a.	25.494	.000	-4.856	22	0.000	-255.80	52.68	-365.06	-146.55
		MBC	E.v.n			-3.116	5.411	0.024	-255.80	82.10	-462.12	-49.49
5-10 cm	Flat	MBC	E.v.a.	2.169	.155	-.942	22	0.357	-29.76	31.61	-95.31	35.78
		MBC	E.v.n			-1.271	16.963	0.221	-29.76	23.42	-79.19	19.67
	Sloped	MBN	E.v.a.	.812	.377	-2.768	22	0.011	-9.85	3.56	-17.22	-2.47
		MBN	E.v.n			-2.313	6.732	0.055	-9.85	4.26	-20.00	0.30
		MBC	E.v.a.	.081	.778	-4.543	22	0.000	-116.58	25.66	-169.79	-63.36
		MBC	E.v.n			-4.275	7.827	0.003	-116.58	27.27	-179.71	-53.44
Sloped	MBN	E.v.a.	1.647	.213	-2.060	22	0.051	-19.54	9.48	-39.21	0.13	
	MBN	E.v.n			-2.668	15.208	0.017	-19.54	7.32	-35.13	-3.95	

According to Pearson's correlation analyze, significant correlations were found between MBC, MBN and other soil characteristics. MBC had positive significant correlation with MBN at middle level, with sand and SOM at poor level. MBN had positive significant correlation with MBC, sand and SOM at middle level, with pH at

poor level, and negative correlation with clay at poor level. From other soil characteristics; clay content had negative significant correlation with sand at high level, with SOM at middle level, with pH at poor level. SOM had positive significant correlation with sand content at high level and with pH at middle level.

Table 2. Pearson's correlation analysis for soil properties (MBC=Microbial biomass Carbon, MBN=Microbial biomass nitrogen, SOM=Soil organic matter, **Correlation is significant at the 0.01 level (2-tailed)).

		MBC	MBN	Sand	Clay	pH	SOM
MBC	Pearson Correlation	1	0.547(**)	0.365(**)	-0.181	-0.056	0.287(**)
	Sig. (2-tailed)		0.000	0.000	0.078	0.588	0.005
	N		96	96	96	96	96
MBN	Pearson Correlation		1	.528(**)	-0.391(**)	0.462(**)	0.622(**)
	Sig. (2-tailed)			0.000	0.000	0.000	0.000
	N			96	96	96	96
Sand	Pearson Correlation			1	-0.708(**)	0.620(**)	0.719(**)
	Sig. (2-tailed)				0.000	0.000	0.000
	N				96	96	96
Clay	Pearson Correlation				1	-0.445(**)	-0.587(**)
	Sig. (2-tailed)					0.000	0.000
	N					96	96
pH	Pearson Correlation					1	0.657(**)
	Sig. (2-tailed)						0.000
	N						96
SOM	Pearson Correlation						1
	Sig. (2-tailed)						
	N						

Discussions

Sand content was significantly lower at surface soil layers of burned sites compared to control sites. These may be the result of increased decomposition in burned sites directed by ash effect. Clay content was significantly higher in burned sites compared to in control sites in surface soil layers of flat area. This also supports the idea of fire ash-directed accelerated decomposition in surface soil as we mentioned the above sentence.

Soil organic matter (SOM) varied significantly between burned and control sites. It was significantly lower in burned sites. This result indicates that decomposition of SOM accelerated by the fire.

In this study, at the end of 20 months period, soil microbial biomass (SMB) was found significantly lower (29%) in burned site than in control site. Similar results observed by the other researchers especially in boreal forests, in that 1- 2.5 years after fire significantly and considerably (31-69%) lower SMB were found at burned areas

(Baath et al., 1995; Fritze et al., 1994; Pietkainen and Fritze 1995; Swallow et al., 2009; Holden and Treseder 2013). This decrease after fire is direct effect of burning and also because of indirect effects of fire.

It is thought that fire annihilated SMB in this study too, because heat during fire has a sterilization effect over microorganisms (Bollen 1969, Dunn et al., 1985). It is believed that significantly lower SMB at burned site is indirectly related to decrease of SOM and lower moisture content. Fernandez et al., (1997) specified that decrease at SOM and decrease in labile part of organic C were chemical modifications at soil after fire. Pietkainen and Fritze (1995) indicated that change at structure of organic matter was an indirect effect on decrease of microbial biomass.

Microbial biomass carbon and nitrogen (MBC and MBN) were significantly varied between burned and control sites. They were significantly lower in burned areas than in

control areas. Lowness in sloped area (32.07%) was more than flat area (26.71%).

Surface runoff was higher at sloped sites compared to flat sites. As a result of this, soil moisture was lower. Also because of fire's damaging effect on structure of litter and understory, there may be a loss of organic parts together with slope.

Conclusions

As a result, 20 months period after prescribed fire SMB in burned sites was lower compared unburnt sites. This shows that fire may have negative effect on activities and biomass of soil microorganisms, this effect increases with slope in some sites. Foresters can use fire as a regeneration tool but they should consider its negative effect on soil microbial activities too.

Acknowledgement

This study is supported by The Scientific and Technological Research Council of Turkey, Project No: 213O193, titled «The effects of different fire intensities on soil erosion, soil respiration, nitrogen mineralization, microbial biomass and the other properties of the soil under the old Corsican pine (*Pinus nigra* Arn.) stands.

References

- Anderson, J., M., and J. S. I. Ingram. 1996. Tropical soil biology and fertility. A Handbook of Methods, Second Edition, Cab International Wallingford, UK, pp. 221.
- Bååth, E., Frostegård, Å., Pennanen, T., & Fritze, H. 1995. Microbial community structure and pH response in relation to soil organic matter quality in wood-ash fertilized, clear-cut or burned coniferous forest soils. *Soil Biology and Biochemistry*, 27(2), 229-240.
- Bollen, G. J. 1969. The selective effect of heat treatment on the microflora of a greenhouse soil. *Netherlands Journal of Plant Pathology*, 75(1-2), 157-163.
- Brookes, P. C., Landman, A., Pruden, G., & Jenkinson, D. S. 1985. Chloroform fumigation and the release of soil nitrogen: a rapid direct extraction method to measure microbial biomass nitrogen in soil. *Soil biology and biochemistry*, 17(6), 837-842.
- DeBano, L. F., Neary, D. G., & Ffolliott, P. F. 1998. Fire effects on ecosystems. John Wiley & Sons.
- Dunn, P. H., Barro, S. C., & Poth, M. 1985. Soil moisture affects survival of microorganisms in heated chaparral soil. *Soil Biology and Biochemistry*, 17(2), 143-148.
- Fernández, I., Cabaneiro, A., & Carballas, T. (1997). Organic matter changes immediately after a wildfire in an Atlantic forest soil and comparison with laboratory soil heating. *Soil Biology and Biochemistry*, 29(1), 1-11.
- Fritze, H., Pennanen, T., & Pietikäinen, J. 1993. Recovery of soil microbial biomass and activity from prescribed burning. *Canadian Journal of Forest Research*, 23(7), 1286-1290.
- Fritze, H., Smolander, A., Levula, T., Kitunen, V., & Mälkönen, E. 1994. Wood-ash fertilization and fire treatments in a Scots pine forest stand: effects on the organic layer, microbial biomass, and microbial activity. *Biology and Fertility of Soils*, 17(1), 57-63.
- Gülçur, F. 1974. Toprağın fiziksel ve kimyasal analiz metodları. İ. Ü. Orman Fakültesi Yayın, (201).
- Holden, S. R., Gutierrez, A., & Treseder, K. K. 2013. Changes in soil fungal communities, extracellular enzyme activities, and litter decomposition across a fire chronosequence in Alaskan boreal forests. *Ecosystems*, 16(1), 34-46.
- Kalra, Y. P., & Maynard, D. G. 1991. Methods manual for forest soil and plant analysis (Vol. 319).
- Mataix-Solera, J., Guerrero, C., García-Orenes, F., Bárcenas, G. M., Torres, M. P., & Barcenas, M. (2009). Forest fire effects on soil microbiology. Fire effects on soils and restoration strategies, 5, 133-175.
- Nannipieri, P., Ascher, J., Ceccherini, M., Landi, L., Pietramellara, G., & Renella, G. 2003. Microbial diversity and soil functions. *European Journal of Soil Science*, 54(4), 655-670.
- Neary, D. G., Klopatek, C. C., DeBano, L. F., & Ffolliott, P. F. 1999. Fire effects on belowground sustainability: a review and synthesis. *Forest ecology and management*, 122(1), 51-71.
- Pietikäinen, J., & Fritze, H. 1995. Clear-cutting and prescribed burning in coniferous forest: comparison of effects on soil fungal and total microbial biomass, respiration activity and nitrification. *Soil Biology and Biochemistry*, 27(1), 101-109.
- Prieto-Fernández, A., Acea, M. J., & Carballas, T. 1998. Soil microbial and extractable C and N after wildfire. *Biology and Fertility of Soils*, 27(2), 132-142.

Swallow, M., Quideau, S. A., MacKenzie, M. D., & Kishchuk, B. E. 2009. Microbial community structure and function: the effect of silvicultural burning and topographic variability in northern Alberta. *Soil Biology and Biochemistry*, 41(4), 770-777.

Vance, E. D., Brookes, P. C., & Jenkinson, D. S. 1987. An extraction method for measuring soil microbial biomass C. *Soil biology and Biochemistry*, 19(6), 703-707.

Vázquez, F. J., Acea, M. J., & Carballas, T. 1993. Soil microbial populations after wildfire. *FEMS Microbiology Ecology*, 13(2), 93-103.

Response of Soil Moisture, Temperature and Some Soil Properties to Forest Removal in a Broadleaf Forest Ecosystem

Mustafa AYTEKİN¹, *Ferhat GÖKBULAK², Hayati TEKİN³

¹ Istanbul University, Institute of Science, Istanbul / TURKEY

² Istanbul University, Faculty of Forestry, Department of Watershed Management, Bahçeköy
34473, Istanbul / TURKEY

³ Directorate of Marmara Forestry Research Institute, Istanbul / TURKEY

*Corresponding Author: fgokbulak@istanbul.edu.tr

Abstract

Objective of this study was to investigate effect of clearcutting on volumetric soil moisture, soil temperature (maximum, minimum and mean daily temperatures) and some selected soil properties. The study was carried out in Belgrad forest of Istanbul. An oak-hornbeam forest plot was selected and half of the plot was clearcut as a treatment site. Size of each plot was about 100 m by 100 m. Soil moisture at 1 m soil depth and temperature at 50 cm soil depth were recorded with hourly interval. Also, disturbed and undisturbed soil core samples were collected at the 0-5 cm soil depth and analyzed for hydraulic conductivity, texture, erodibility, pH, electrical conductivity, organic matter content, loss on ignition, bulk density, particle density, water holding capacity, and total porosity. Data were analyzed by using paired t-test at alpha level of 0.05. Results showed that average daily soil moisture increased significantly from 32% to 37%, mean daily temperature from 14.5 °C to 15.9 °C, mean daily maximum temperature from 14.6 °C to 16.2 °C, and mean daily minimum temperature 14.4 °C to 15.7 °C after tree removal. On the other hand, results revealed that clear cutting of forest vegetation did not have a significant effect on the soil texture and hydraulic conductivity, particle density, pH, and electrical conductivity values of the soils. In contrast, clearcutting caused a significant increase in the bulk density of the soils from 1.28 gr cm⁻³ to 1.48 gr cm⁻³, and decrease in the organic matter content values of the soils from 5.88 % to 2.47 %, loss on ignition from 16.57 % to 8.16 %, total porosity from 52.49% to 45.76 %, and water holding capacity from 33.07 % to 23.89 %.

Keywords: Clearcutting, Soil temperature, Soil moisture, Vegetation change

Yapraklı Orman Ekosisteminde Tıraşlamanın Toprak Nemi, Toprak Sıcaklığı ve Bazı Toprak Özelliklerine Etkisi

Özet

Bu çalışmanın amacı, Belgrad ormanı içerisinde meşe – gürgen karışık ormanında tıraşlama kesiminin toprak özellikleri, toprak sıcaklığı ve toprak nemi ile otsu vejetasyonun gelişimi üzerindeki etkisini belirlemektir. Toprak örnekleri birbiri ile komşu iki parselden, 0 – 5 cm toprak derinliğinden alınmıştır. Alınan toprak örneklerinin permeabilite, hacim ağırlığı, tekstür, erodibilite, tane yoğunluğu, boşluk hacmi, organik madde, toprak reaksiyonu, elektrik iletkenliği, toprak iskelet içeriği ve maksimum su tutma kapasitesi araştırılmıştır. Analizler sonucunda elde edilen veriler eşlenikli t testi ile istatistiksel olarak karşılaştırılmıştır. Toprak sıcaklığı 50 cm toprak derinliğinden ve toprak nemi 1 metre toprak derinliğinden 1 saat aryla 1 yıl boyunca hem açık alanda hem de ormanlık alanda ölçülmüş ve kayıt edilmiştir. Toprak nemi ve toprak sıcaklığı değerleri eşlenikli t testi ile istatistiksel olarak karşılaştırılmıştır. Analiz sonuçlarına göre tıraşlama kesiminin; ortalama, maksimum ve minimum toprak sıcaklıkları ile ortalama toprak nemi üzerinde istatistiksel olarak önemli etkisi bulunmuştur (P < 0.05). Sonuçlara göre, ortalama nem açık alanda volumetrik olarak % 37 ve ormanlık alanda % 32 bulunmuştur. Açık alanda; ortalama toprak sıcaklığı, maksimum toprak sıcaklığı ve minimum toprak sıcaklığı sırasıyla 15,9°C, 26°C, 5,3°C bulunmuştur. Ormanlık alanda ise ortalama toprak sıcaklığı, maksimum toprak sıcaklığı ve minimum toprak sıcaklığı sırasıyla 14,5 °C, 20,9 °C, 6,8 °C bulunmuştur. Toprak örnekleri analiz sonuçlarına göre ise permeabilite, tekstür, tane yoğunluğu, pH, EC ve toprak iskelet içeriği açık alan ve ormanlık alanda benzerlik göstermiştir (P > 0,05). Bunun aksine hacim ağırlığı, erodibilite, organik madde, boşluk hacmi ve maksimum su tutma kapasitesi açık alan ve ormanlık alanda istatistiksel olarak farklılık göstermiştir (P < 0,05).

Anahtar Kelimeler: Tıraşlama kesimi, Toprak sıcaklığı, Toprak nemi, vejetasyon değişimi

Introduction

Forest ecosystems have important effect on microclimate and soil characteristics. For instance, compared to other ecosystems, ambient and soil temperatures, soil moisture, and wind speed are lower (Morecroft et al., 1998; Hashimoto and Suzuki, 2004; Özkan, 2015; Aytekin, 2016) and bulk density, organic matter content, permeability, maximum water holding capacity, and total porosity of the soils are greater in the forest ecosystems (Hajabbasi et al., 1997; Rubio et al., 1999; Bock and Van Rees, 2002; Zhou et al., 2015; Aytekin, 2016). Therefore, changes in the vegetation cover from forest to herbaceous vegetation produce intense alterations in the soil characteristics and microclimatic condition of the forest sites. Several studies compared soil characteristics and soil climatic conditions in clearcut areas with those in adjacent uncut forest areas and showed that significant differences occurred in the absence of forest canopy. Rubio and Escudero (2003) found out that clear cutting of forest cover caused decreases in the organic matter and nitrogen content of the soils. In another study, Jehangir et al. (2012) compared clearcut and uncut forest sites and found that the soil in the clearcut area had greater air and soil temperatures, moisture content, and water holding capacity values than forest site. Although it is well known that clearance of forest vegetation influences soil conditions negatively, however, it is hard to make a generalization about effect of clear cutting on soil properties since the outcomes vary from site to site depending on several factors such as soil, topography, climate, and strategy and intensity of logging activities. In contrast, microclimatic conditions show changes in some degrees depending on forest management activities. In general, it can be said that the greatest changes occur in the soil moisture content and soil temperature after clear cutting due to increased solar radiation on the soil surface and decreased transpiration and interception capacities of the forest vegetation (Hungerford and Babbitt, 1987; Carlson and Groot, 1997; Bhatti et al., 2000; Smit and Rethman, 2000; Ritter et al., 2005; Scharenbroch and Bockheim, 2007).

Soil moisture and temperature are main factors playing important roles on chemical, hydrological, and biological processes in the soil because they affect organic matter decomposition, nutrient availability, and soil thermal dynamics (Yi et al., 2009), ecosystem stability and fertility (Lucas-Borja et al., 2010), runoff generation, erosion, microorganism activity, nutrient flux, seed germination, plant growth and their distribution patterns, and root activity (Hashimoto and Suzuki, 2004; Cornaglia et al., 2005; Wang et al., 2013). Vegetation density and height also affect soil temperature and moisture level. Morecroft et al. (1998) found out that grassland soils had the highest maximum temperature while coppice soils had the lowest maximum temperatures. Similarly, Ritter et al. (2005) compared forest gaps and forest areas in terms of soil moisture and temperature values and their findings revealed that the soils in the forest gaps had a higher soil temperature and moisture content than the soils in the forestland. Another study carried out in the Shoshone Mountain range of central Nevada also showed that soil moisture content and mean soil temperature at the 15-cm depth increased after Pinyon-Juniper harvesting (Everett and Sharrow, 1985). Moreover, compared to forest covered area, higher moisture content and temperature values were reported for the soils under herbaceous vegetation cover in several studies from around the world (Scharenbroch and Bockheim, 2007; Özkan, 2015; Aytekin, 2016). A number of studies dealt with effect of clear cutting on soil characteristics including soil temperature and moisture conditions but studies regarding clear cutting effect of coppice forest on soil properties are limited (Morecroft et al., 1998; Rubio et al., 1999; Rubio and Escudero, 2003). Moreover, it is assumed that clear cutting of high forest and coppice forest cannot have the same impact on soil characteristics because frequency of clear cutting in coppice forests is higher than that in the high forest. In another words, the time-rotation in the coppice forest is short relative to the high forests. For instance, the time-rotation in coppice forest varies from 20 to 50 years in the chestnut coppice forests in Spain (Rubio

and Escudeo, 2003) while it is 20 years in the oak and hornbeam coppice forests in Turkey. Therefore, influence of clear cutting can create different outcomes on soil conditions depending on which type of forest is subject to clear cutting. In Turkey, some deciduous forest are managed to meet fuel wood demand of local people and they are cut for every 20 years but no information is available about impact of management of coppice stands on soil properties. Therefore, main purposes of this study were to investigate impact of clear cutting in coppice forest on soil properties and to provide data to practitioners and decision makers for making them aware of consequences of managing forests as coppice stands in the forest ecosystems.

Study site

This study was carried out in Research forest of Istanbul University located in Belgrad forest in Istanbul between 28° 59' 17'' - 29° 32' 25'' eastern longitudes and 41° 09' 15'' - 41° 11' 01'' northern latitudes. Mean altitude is around 30 m above sea level with an average slope of 45%. Study plots were located under power transfer lines that pass through the study site. Clear cutting is applied in this part of the forest for every 20 years in a width of about 50 meters due to location of the power lines. Woody vegetation in the study plots was cleared in the late fall of 2012 and the study was implemented in the spring of 2014 and lasted for one year. A forest plot was also selected next to clearcut plot. Dominant vegetation in the forest site consists of mainly *Quercus sp.* and *Carpinus betulus* L. in addition to some maquies species including *Laurus nobilis* L., *Corylus sp.*, *Erica arborea* L., *Sorbus torminalis* (L.) Crantz, *Phillyrea sp.*, *Cistus sp.*, and *Arbutus unedo* L. (Yalçırık, 1966). Density of trees was around 2800 and 5600 per hectare for oak and hornbeam trees, respectively. The trees were about 6-7 m tall with a breast height diameter of 25-30 cm and crown closure of 2. Forest site has a mull type forest floor with an average depth of around 4.0-6.0 cm. Parent materials in the site are mainly carboniferous clay schists and Neogene loamy, gravelly deposits and soil types are Vertic Xerochrept soil types

(USDA 1996). Soil texture is silty clay. The study site has a humid, mesothermal and maritime climate with a moderate water deficit in the summer months according to the Thornthwaite method (Özyuvacı, 1999). Average annual precipitation is about 1129 mm and the mean annual temperature is about 12.3 °C. August is the warmest month with a daily average temperature of 21.7 °C whereas February is the coldest month with a daily average temperature of 4.2 °C. During the study period, mean annual temperature was 13.8 °C and average annual precipitation was 1044.5 mm.

Two transect lines were established in each plot and ten soil samples were randomly collected from topsoil (0-5 cm depth) along the line by inserting a soil core (5.3 cm diameter x 5 cm long) into the topsoil. Soil sampling was carried out on topsoil because this part of the soil experiences the most severe negative impact of forest harvest activities. Sampling was repeated in spring and fall and a total of 40 core samples from both plots were collected for the study. Soil samples were air-dried and sieved through 2 mm mesh and analyzed for some selected hydro-physical soil characteristics that affect directly water content of the soil and indicate effect of clearcutting immediately following the treatment. Soil properties subjected to analyses included hydraulic conductivity (cm min^{-1}) based on Darcy law and equation, bulk density (g cm^{-3}), sand (%), silt (%), and clay (%) content, particle density (g cm^{-3}) by using pycnometer, organic matter (%), loss on ignition (%), total porosity (%), pH, electrical conductivity ($\mu\text{S cm}^{-1}$), available water (%), and saturation capacity (%). Hydraulic conductivity was determined based on Darcy law and equation, bulk density with dividing mass of soil core content by core volume, sand, silt, and clay content by using Bouyoucos hydrometer method after removing organic matter, particle density (g cm^{-3}) by using pycnometer method, loss on ignition by maintaining soil samples at 700 °C for 4 hours and calculating weight loss as a percentage of oven dried soil sample, and total porosity with respect to an equation showing relationship between bulk density and particle density as explained by Özyuvacı (1976), pH and electrical

conductivity (soil/water ratio of 1/5) with the WTW Multiline P4 Universal Meter (WTW, Weilheim, Germany), saturation capacity as amount of water percent in the saturated core samples as described by Balcı (1973), and organic matter content by the Walkley-Black chromic acid method (Jackson, 1958).

Soil moisture was measured by using CS616 model soil moisture probes at 1m depth and soil temperature was determined with CS 107-L model probes at 0.5 m depth. The signals from all probes were recorded at 1 hour intervals on a CR1000 model data logger (Campbell Scientific Inc., Logan, USA). Values were averaged as daily values. Data were analyzed by using paired t-test ($P < 0.05$) (Zar, 1996).

Results and Discussion

Results showed that clear cutting of coppice forest significantly affected bulk density, organic matter content, loss on ignition, total porosity, and saturation capacity of the soils ($P < 0.05$) whereas it did not have any influence on hydraulic conductivity, sand, silt and clay contents, particle density, pH, and electrical conductivity of the soil (Table 1). Soil bulk density significantly increased from 1.28 (g cm^{-3}) to 1.48 (g cm^{-3}) while organic matter content of the soil significantly decreased from 5.88 % to 2.47 %, loss on ignition from 16.47 % to 8.16 %, total porosity from 52.49 % to 45.76 % (Table 1).

Table 1. Mean soil values (mean \pm standard deviation) in the clearcut area and forest land

Soil parameters	Clearcut area	Forestland	Significance level (P)
Hydraulic conductivity (cm min^{-1})	32.05 \pm 49.75	51.05 \pm 58.8	P = 0.055
Bulk density (g cm^{-3})	1.48 \pm 0.13	1.28 \pm 0.20	P = 0.002
Sand (%)	59.65 \pm 4.60	61.25 \pm 3.27	P = 0.270
Silt (%)	18.35 \pm 2.98	18.25 \pm 2.79	P = 0.908
Clay (%)	22.00 \pm 3.04	20.50 \pm 2.67	P = 0.083
Particle density (g cm^{-3})	2.73 \pm 0.12	2.72 \pm 0.34	P = 0.862
Organic matter (%)	2.47 \pm 1.83	5.88 \pm 1.21	P < 0.001
Loss on ignition (%)	8.16 \pm 4.22	16.57 \pm 3.09	P < 0.001
Total porosity (%)	45.76 \pm 5.51	52.49 \pm 8.10	P = 0.001
pH	6.05 \pm 0.42	5.77 \pm 0.65	P = 0.088
Electrical conductivity ($\mu\text{S cm}^{-1}$)	101.15 \pm 52.31	104.90 \pm 21.21	P = 0.779
Saturation capacity (%)	23.89 \pm 1.28	33.07 \pm 2.03	P = 0.003

Results of our study are consistent with results of other studies conducted in different ecological conditions. For instance, increases in the soil bulk density values were found in Canada (Bock and Rees, 2002), Southeastern China (Zhou et al., 2015), Iran (Hajabbasi et al., 1997) and India (Jehangir et al., 2012). Similar to our results, decreases in the organic matter content, water holding capacity, total porosity were determined after clear cutting in several studies from around the world (Rubio and Escudero, 2003; Jehangir et al., 2012, Zhou et al., 2015). Additionally, pH and electrical conductivity values did not show changes after clear cutting in present study as found by Rubio et al. (1999), Jehangir et al., (2012), and Albert

and Barness (1987). Contrary to our findings, Hajabbasi et al. (1997) observed a decrease in the clay content of the clearcut area and Albert and Barness (1987) did not observe any changes in the organic matter content and bulk density values of the soils in the clearcut area. As seen from these studies, it is hard to make generalizations about effect of clear cutting on all hydro-physical soil properties because of differences in climate, soil, topography, and mechanization procedures in harvest activities. However, some generalizations can be made for a few soil properties such as bulk density, total porosity, organic matter content, hydraulic conductivity which are mostly affected soil properties after clearcutting due to soil

compaction as a result of harvest activities in the site.

Clear cutting of coppice forest also caused a significant increase in the volumetric daily soil moisture content ($P < 0.05$). Average

daily soil moisture content was 37% and varied from 24% to 57% for the soils in the clearcut area while it was 32% and changed between 17% and 50% for the soils in forest area.

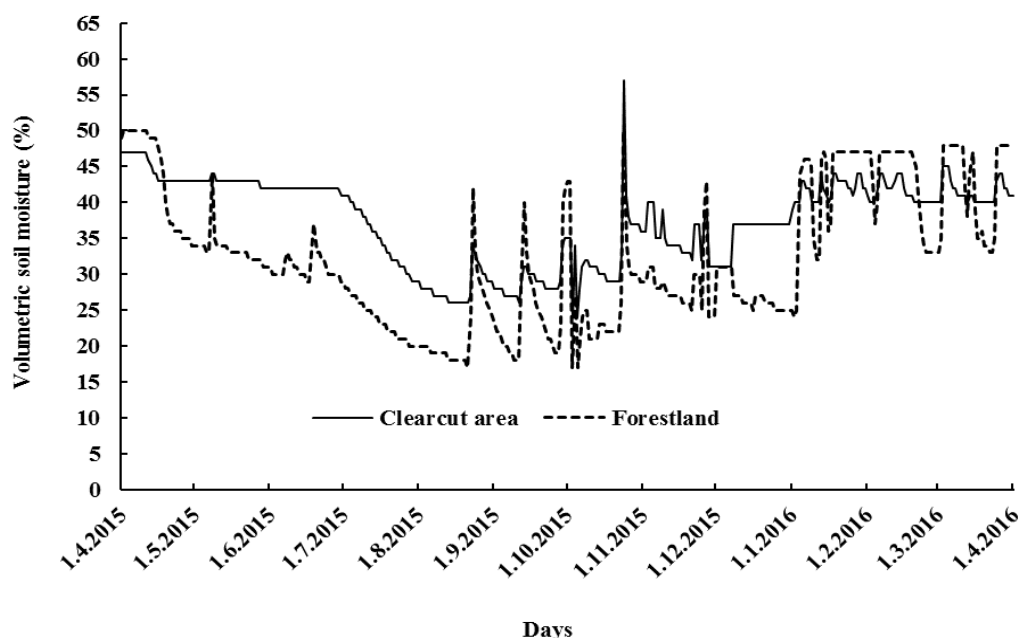

Figure 1. Trend of mean daily volumetric soil moisture content of the soils in the clearcut area and forestland

Mean daily moisture content of the soils followed similar trend in both clearcut area and forest area but soils in the forest land had always less moisture content than those in the clearcut (Figure 1). The differences between moisture contents of the soils from the clearcut and forest area was high during the vegetation period due to increased leaf area index which caused higher transpiration and interception losses from the forest canopy. In contrast, the differences between moisture content of the soils from both sites decreased in dormant season and even forest soils had greater moisture content during the rainy days when the trees had no leaves (Figure 1). Moisture increase took place after clear cutting as expected and results of different studies supported our findings that forest vegetation removal increased moisture content of the soils in the clearcut area compared to undisturbed forest area (Gray et al., 2002; Garduño et al., 2010; Özkan,

2015). In fact, in a study conducted in Oregon Cascade, clearcut in Douglas-fir forest resulted in over 10 cm moisture increase in the site (Adams et al., 1991). Also, Ritter et al., (2005) reported greater moisture content in the gaps created in Suserup forest in Denmark compare to the forest plot. Similarly, Jehangir et al. (2012) found higher moisture content in the soils from clearcut area than that from forest area. Moisture increase in the clearcut area can be attributed to decreases in the interception and transpiration capacities of forest canopy as a result of timber removal. On the other hand, coppice clearcut affected soil temperatures significantly and mean daily temperature increased from 14.5 °C to 15.9 °C (Figure 2), mean daily maximum temperature from 14.6 °C to 16.2 (Figure 3), and average daily minimum temperature from 14.4 °C to 15.7 °C (Figure 4).

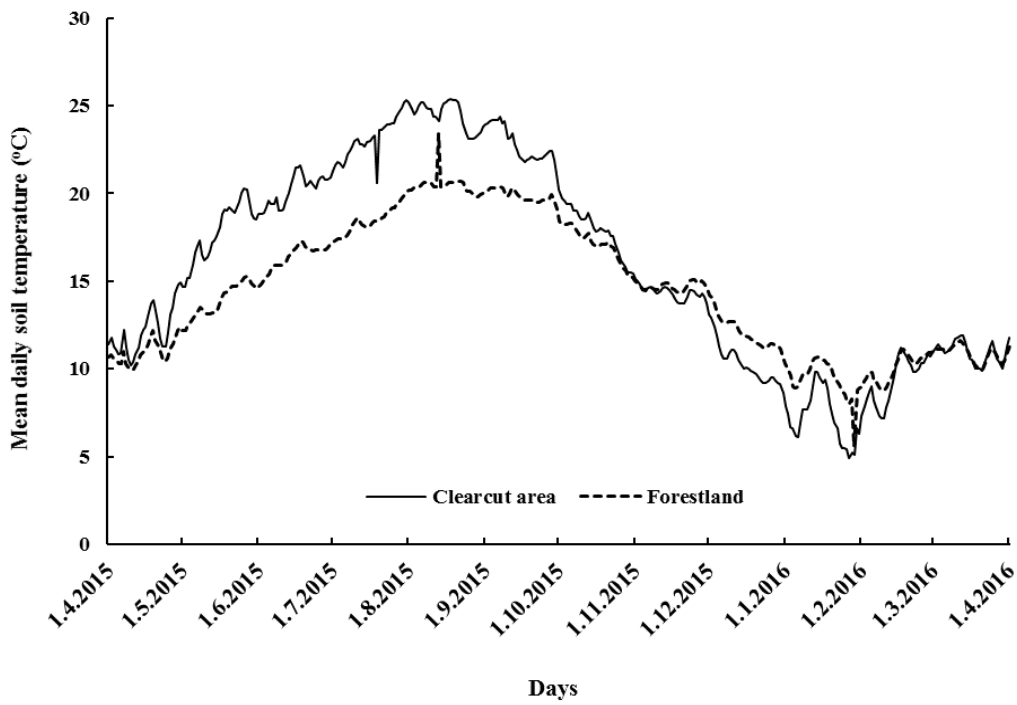

Figure 2. Trends of mean daily soil temperatures in the clearcut area and forest land

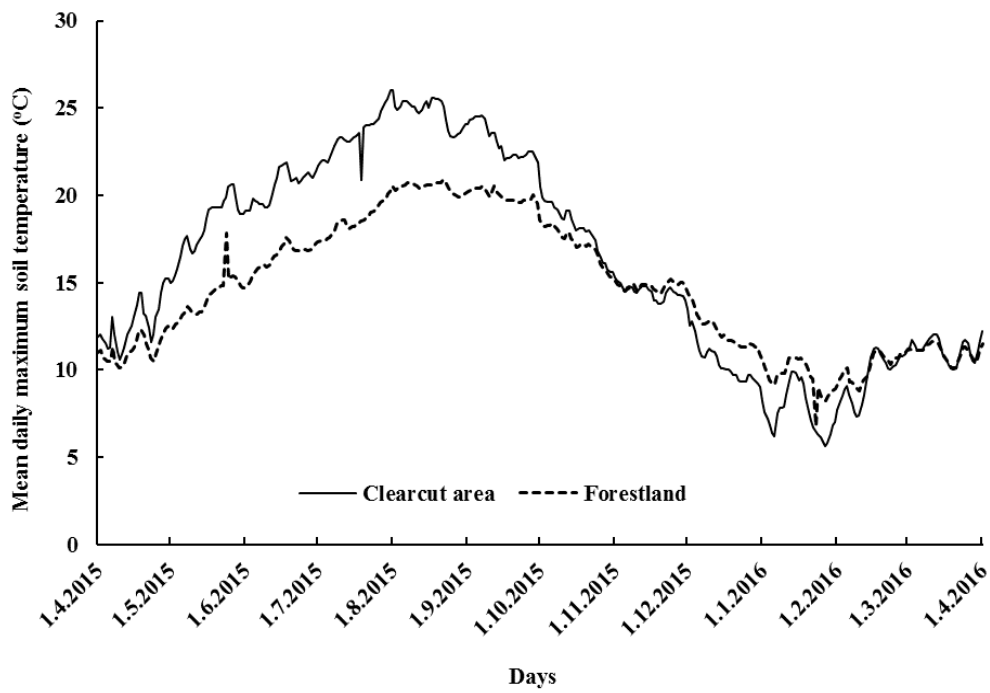

Figure 3. Trends of mean daily maximum soil temperatures in the clearcut area and forest land

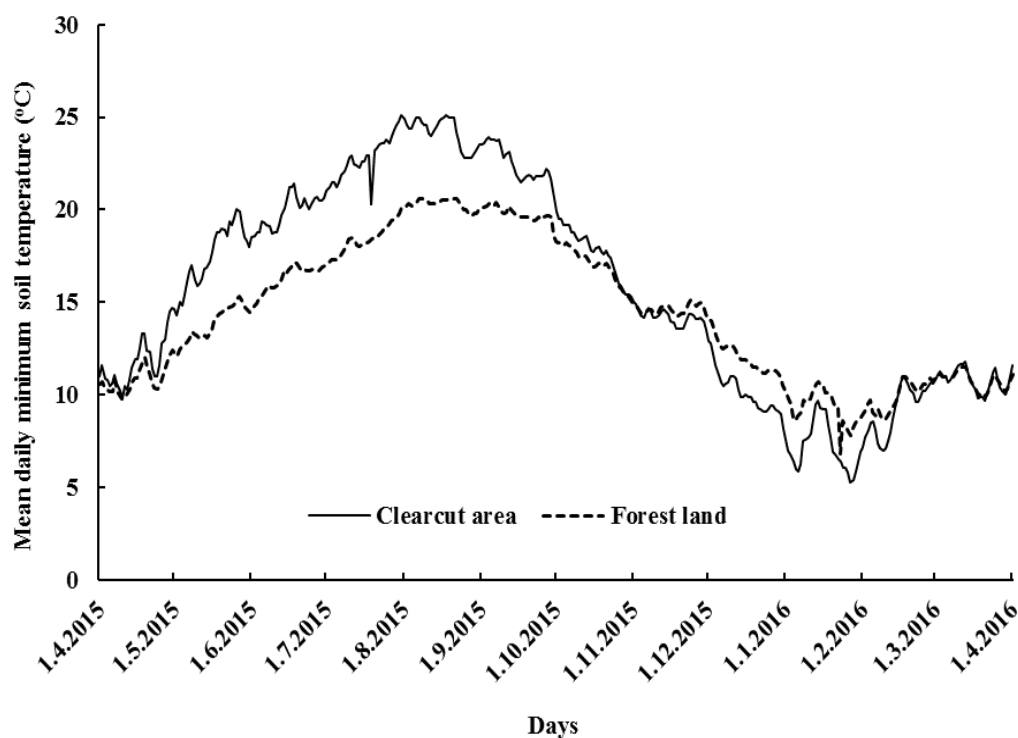

Figure 4. Trends of mean daily minimum soil temperatures in the clearcut area and forest land

As expected, mean daily, mean daily maximum and minimum soil temperatures increased after clear cutting and all temperatures followed the same trend in both soils of the clearcut area and forest area. The differences between soil temperatures of clearcut area and forest land started to increase as vegetation period progressed and leaf area index increased. In contrast, soil temperatures decreased in the clearcut area during the dormant season (Figures 2, 3, and 4). The results of present study are consistent with those studies by Carlson and Groot (1997), Morecroft et al. (1998), Bhatti et al. (2000), and Ritter et al. (2005) that coppice forest removal resulted in increases in the soil temperature and moisture but the level of the increases was not consistent among these studies. The inconsistencies can be attributed to the differences in ecological conditions such as climate, soil, and vegetation types in the study site (Song et al., 2013), length of study period, the size of the study plots, and the differences in study approaches. In general, increases found in the moisture content and temperature of the soils in clearcut area can be result of increased solar radiation on the soil surface and reduced

transpiration and interception capacities of the forest vegetation after forest canopy clearance (Hungerford and Babbitt, 1987; Carlson and Groot, 1997; Bhatti et al., 2000; Smit and Rethman, 2000; Ritter et al., 2005; Scharenbroch and Bockheim, 2007).

Conclusion

Results of this study showed that clearcutting of coppice forest have negative impact on soil properties and soil thermal conditions. All selected soil properties were influenced by tree harvest as found literature and results of previous studies have already shown differences from one region to the other depending on site conditions and harvest practices. Contrary to soil properties, soil temperature and moisture content are the soil characteristics that are certainly affected by forest removal. Soil moisture and temperature are important ecological factors because they have great impact on hydrological, biological and chemical processes taking place in the soil. Therefore, forestry professions and practitioners can consider both soil temperature and moisture parameters as an indicator in the recovery of degraded forest ecosystems because

biological, physical, and chemical soil characteristics can be changed by human intervention and these properties can be misleading for understanding recovery of degraded forest soils. Additionally, monitoring soil temperature and moisture is easy and simple rather than monitoring some vegetation attributes in order to find out recovery period of degraded lands. Since changes in the soil moisture and temperature in the clearcut areas influence most of the processes in the forest soils, forestry professionals should monitor soil temperature and moisture trend in these areas and they should be aware of consequences their forestry activities.

References

- Adams P.W., Flint, A. L., Fredriksen, R. L. 1991. Long-term patterns in soil moisture and revegetation after a clearcut of a Douglas-fir forest in Oregon. *Forest Ecology and Management*, 41(3-4), 249-263.
- Albert D.A. Barnes B. 1987. Effects of clearcutting on the vegetation and soil of a sugar maple-dominated ecosystem, Western upper Michigan. *Forest Ecology and Management*, 18,283-298.
- Aytekin M. 2016. Tıraşlama kesiminin toprak nemi ve sıcaklığı ile otsu bitkilerin gelişimi üzerindeki etkisi. Yüksek Lisans Tezi, İstanbul Üniversitesi Fen Bilimleri Enstitüsü, İstanbul.
- Balcı AN. 1973. Physical, Chemical and Hydrological Properties of Certain Western Washington Forest Floor Types. Istanbul University Publication No.: 1849, Faculty of Forestry Publication No: 200.
- Bhatti J.S., Fleming R.L., Foster N.W., Meng F.-R., Bourque C.P.A., Arp P.A., 2000. Simulations of pre- and post-harvest soil temperature, soil moisture, and snowpack for jack pine: comparison with field observations. *Forest Ecology Management*, 138, 413-426.
- Bock, M. D. And Van Rees K. C.J. 2002. Forest harvesting impacts on soil properties and vegetation communities in the Northwest territories. *Canadian Journal of Forest Research*. 32,713-724.
- Carlson D.W., Groot A., 1997. Microclimate of clear-cut, forest interior, and small openings in trembling aspen forest. *Agricultural and Forest Meteorology*, 87, 313-329.
- Cornaglia P.S., Schrauf G.E., Nardi M., Deregibus V.A. 2005. Emergence of dallisgrass as affected by soil water availability. *Rangeland Ecology and Management*, 58, 35-40.
- Everett R.L., Sharrow S.H. 1985. Soil water and temperature in harvested and nonharvested pinyon-juniper stands. USDA Intermountain Research Station Ogden, UT. Research Paper INT-342.
- Garduño H.R., Fernald A.G., Cibils A.F., VanLeeuwen D.M., 2010. Response of understory vegetation and soil moisture to infrequent heavy defoliation of chemically thinned juniper woodland. *Journal of Arid Environments*, 74, 291-297.
- Gray A. N., Spies T. A., Easter M. J. 2002. Microclimatic and soil moisture responses to gap formation in coastal Douglas-fir forests. *Canadian Journal of Forest Research*. 32:332-343.
- Hajabbasi M., Jalalian A., Karimzadeh H. R. 1997. Deforestation effects on soil physical and chemical properties, Lordegan, Iran. *Plant and Soil*, 190,301-308.
- Hashimoto S. Suzuki M., 2004. The impact of forest clear-cutting on soil temperature: a comparison between before and after cutting, and between clear-cut and control sites. *Journal of Forest Research*, 9 (2), 125-132.
- Hungerford R.D., Babbitt R.E. 1987. Overstory removal and residue treatments affect soil surface, air, and soil temperature: implications for seedling survival. USDA Intermountain Research Station Ogden, UT. Research Paper INT-377.
- Jackson M. L. 1958. Soil chemical analysis. Englewood Cliffs: Prentice Hall.
- Jehangir A., Yousuf A. R., Reshi Z. A., Tanveer A., Ahmad A. 2012. Comparison of physical, chemical and microbial properties of soils in a clear-cut and adjacent intact forest in North Western Himalaya, India. *International Journal of Soil Science*, 7(3),71-81.
- Lucas-Borja M.E., Bastid, F., Nicolás C., 2010. Influence of forest cover and herbaceous vegetation on the microbiological and biochemical properties of soil under Mediterranean humid climate. *European Journal of Soil Biology*, 46, 273-279.
- Morecroft M.D., Taylor M.E., Oliver H.R. 1998. Air and soil microclimates of deciduous woodland compared to an open site. *Agricultural and Forest Meteorology*, 90(1-2), 141-156.
- Özkan U. 2015, Orman ve otsu vejetasyonun toprak nemi, toprak sıcaklığı ve toprak suyu kalitesi üzerine etkisi. Yüksek Lisans Tezi, İstanbul Üniversitesi Fen Bilimleri Enstitüsü, İstanbul.
- Özyuvacı N., 1976. Hydrologic characteristics of the Arnavutköy Creek Watershed as influenced by some plant-soil-water relations. Ph.D. Thesis. Istanbul University Faculty of Forestry, Istanbul-Turkey.

Özyuvacı N. 1999. Meteorology and climatology. Istanbul University Publications No. 4196, Istanbul (in Turkish).

Ritter E., Dalsgaard L., Einhorn, K.S., 2005. Light, temperature and soil moisture regimes following gap formation in semi-natural beech-dominated forest in Denmark. *Forest Ecology and Management*, 206, 15-33.

Rubio A, Gavilán R., Escudero A. 1999. Are soil characteristics and understorey composition controlled by forest management? *Forest Ecology and Management*, 113,191-200.

Rubio A. Escudero A. 2003. Clear-cut effects on chestnut forest soils under stressful conditions: lengthening of time-rotation. *Forest Ecology and Management*, 183,195-204.

Scharenbroch B.C., Bockheim J.G. 2007. Impacts of forest gaps on soil properties and processes in old growth northern hardwood-hemlock forest. *Plant Soil*, 294, 219-233.

Smit G.N., Retman N.F.G. 2000. The influence of tree thinning on the soil water in a semi arid savanna of southern Africa. *Journal of Arid Environments*, 44, 41-59.

Song Y.T., Zhou D.W., Zhang H.X., Li G.D., Jin Y.H., Li Q. 2013. Effects of vegetation height and density on soil temperature variations. *Chinese Science Bulletin*, 58, 907-912.

U.S.D.A. 1996. Keys to soil taxonomy. 7th ed. Washington, DC

Wang Y., Shao M., Liu Z. 2013. Vertical distribution and influencing factors of soil water content within 21-m profile on the Chinese Loess Plateau. *Geoderma*, 193-194, 300- 310.

Yaltrık F. 1966. Floristic analysis of Belgrad Forest and main stand composition. General Directorate of Forestry Publication Number: 6, Ankara, Turkey (in Turkish).

Yi S., McGuire A.D., Harden J., Kasischke E., Manies K., Hinzman L., Liljedahl A., Randerson J., Liu H., Romanovsky V., Marchenko S., Kim Y. 2009. Interactions between soil thermal and hydrological dynamics in the response of Alaska ecosystems to fire disturbance. *Journal of Geophysical Research*, 114, 1-20.

Zar J.H. 1996. Biostatistical analysis. 3rd ed., NJ: Prentice Hall, Upper Saddle River, USA.

Zhou X., Zhou Y., Zhou C., Wu Z., Zheng L., Hu X., Chen H., Gan, J. 2015. Effects of cutting Intensity on soil physical and chemical properties in a mixed natural forest in Southeastern China. *Forests*, 6, 4495-4509.

Comparison of Water Consumption by Needle and Broad-Leaved Tree Species in the First Month of Growing Season

*Mehmet S. ÖZÇELİK¹, Kamil ŞENGÖNÜL¹, Ferhat GÖKBULAK¹

¹Istanbul University, Faculty of Forestry, Istanbul/TURKEY

*Corresponding Author: msaid.ozcelik@istanbul.edu.tr

Abstract

Water consumption by trees is one of the important components in water budget. The objective of this research was to compare water consumption of needle and broad-leaved tree species growing on the same site. Tree species and their wood physiologies are important factors influencing amount of water plants transpire. *Pinus nigra* Arn. subsp. *pallasiana* (Lamb.) Holmboe and *Quercus petraea* (Matt.) Liebl were selected as representatives of needle and broad-leaved tree species in the Atatürk Arboretum-Belgrad Forest. The study period was the first month of growing season. Two experimental plots next to each other were established and 6 trees from each plot were selected based on the quantiles of total method. Trunks of the sample trees were equipped with sap flow sensors measuring according to trunk heat balance method for estimating water uptake by each tree and stand. Oak trees had no foliage whereas pine trees had needle leaves at the beginning of the study. During the study period, total amount of precipitation was 18.7 mm and mean daily temperature was 13.8°C. Despite low amount of precipitation during the study period, moisture was high in the soil as a result of soil moisture discharge with sufficient winter precipitations and mean soil water potential was -0.20 bar. Results showed that daily water uptake by individual trees varied from 0.08 kg to 57.83 kg for pine trees while it changed between 0.05 and 52.55 kg for oak trees. Average daily uptakes were 1.43 mm m⁻² and 1.31 mm m⁻² for oak and pine stands, respectively. When whole study period was considered, water consumptions were 35.51 mm m⁻² for pine and 38.75 mm m⁻² for oak stands. Based on preliminary results of this study, it seems that higher transpiration rates will be observed from both study plots as vegetation period progresses and leaf area index increases.

Keywords: Sap flow, Trunk heat balance, Transpiration, Water uptake, Water consumption

İbrelili ve Geniş Yapraklı Ağaç Türlerinin Vejetasyon Periyodunun İlk Ayındaki Su Tüketimlerinin Karşılaştırılması

Özet

Ağaçların su tüketimi havzalarda su bütçesinin ortaya konmasında önemli bileşenlerinden biridir. Bu çalışmanın amacı, ibrelili ve yapraklı türlerin aynı yetişme koşullarındaki su tüketimlerini karşılaştırmaktır. Ağaçların türleri ve odun yapıları transpirasyonla meydana getirdikleri su kaybını etkileyen önemli faktörlerdir. İbrelili ve yapraklı türleri temsilen Belgrad Ormanı-Atatürk Arboretumu'nda bulunan Anadolu karaçamı (*Pinus nigra* Arn. subsp. *pallasiana* (Lamb.) Holmboe) ve sapsız meşe (*Quercus petraea* (Matt.) Liebl) türleri seçilmiştir. Araştırmanın süresi vejetasyon periyodunun ilk ayını kapsamaktadır. Karşılıklı iki deneme parseli alınmış ve toplamın dağılımı yöntemine göre 6' şar ağaç seçilmiştir. Seçilen ağaçların gövdelerine birey ve meşcere bazında su tüketimlerini hesaplamak için gövde ısı dengesi yöntemine göre çalışan bitki özsu akış ölçüm sensörleri yerleştirilmiştir. Çalışmanın başlangıcında çam ağaçlarında gelişmiş yapraklar bulunurken, meşe ağaçlarında tomurcuklar patlamış ve yapraklanma yeni başlamıştır. Çalışma süresi boyunca 18.7 mm yağış gerçekleşmiş, günlük ortalama sıcaklık ise 13.8°C olarak kaydedilmiştir. Araştırmanın yürütüldüğü süre içinde yağış miktarı az olsa da; kışın gelen yağışların etkisiyle toprak nemi yüksek seyretmiş ve toprak su potansiyeli -0.20 bar düzeyini aşmamıştır. Sonuçlar çam ağaçlarında günlük su tüketiminin 0.08 - 57.83 kg; meşe ağaçlarında ise 0.05-52.55 kg arasında değiştiğini göstermiştir. Çalışma periyodu boyunca su tüketimi çam meşceresinden 35.51 mm m⁻²; meşe meşceresinden ise 38.75 mm m⁻² olarak gerçekleşmiştir. Devam etmekte olan bu çalışma vejetasyon periyodu ilerledikçe ve yaprak yüzey alanı arttıkça her iki meşcereden de daha yüksek su tüketimi miktarlarının ölçüleceğini göstermektedir.

Anahtar Kelimeler: Bitki özsu akışı, Gövde ısı dengesi, Su tüketimi, Transpirasyon

Introduction

Water is one of the main component for all kinds of living organisms and it has an important role on the quality of life. Countries which have less water than 1000 m³/per year/per capita classified as “water poor country”. Turkey has 1519 m³ water per year per capita today (URL1, 2016). According to population grow projections by Turkish Statistical Institute, (URL2, 2016) water scarcity will be an important issue in 2030.

If a watershed considered as a factory, precipitation can be accepted as an input, and water flow as an output. Since the amount of precipitation cannot be increased by humans continuously, vegetation management practises are conducted to gain more water from watersheds. Hence, it is important to know consumption rates of tree species for vegetation management and plantations in these watersheds.

Variety of methods have been developed to measure transpiration of plants such as, transpirometer, lysimeter, tent, watershed water balance and sap flow methods (Özhan, 1982). Sap flow method has been developed after the pioneer work of Huber in 1932 and several methods have been announced based on different principals (thermodynamic, electric, magnetic resonance) ever since (Cermak, 2004). The primary of them are, trunk segment heat balance method (Cermak vd., 1973, 1982; Kucera vd., 1977), stem heat balance method (Sakuratani 1981,1984), heat dissipation method (Grainer, 1987) and heat field deformation method (Nadezdina, 2012). The advantages of the sap flow method can be summerized as being time and cost effectiveness, measurement directly in the pure nature without any restriction, mobility, simple setting and reliability of the results beside measuring without any damage to the trees.

The main goal of this study was to compare water consumption of needle and broad-leaved tree species in the same site in order to understand which one is more water efficient or which one consumes more water than the other.

Material and Methods

The study was carried out in Atatürk Arboretum - Belgrad Forest (41° 09' 48" - 41°

10' 55" N, 28° 57' 27" -28° 59' 27" E) on two experimental plots next to each other. Mean annual precipitation is around 1090.4 mm and mean annual temperature is 12.8 °C in the site. The warmest month is July and the coldest is February (Serengil et al; 2007).

Pinus nigra Arn. subsp. *pallasiana* (Lamb.) Holmboe and *Quercus petraea* (Matt.) Liebl were selected as representatives of needle and broad-leaved tree species, respectively (Figure 1). The oak stand was natural while pine stand was plantation. The study period covered the first month of the growing season (01.04.2016-30.04.2016). Six trees in both plots were selected as sample trees according to the quantil of total method (Cermak et al, 2004). Leaf area index (LAI) of the plots were 0.58 for pine and 0.54 for oak. The area of the pine plot was 800 m² while the oak plot was 1300 m².



Figure 1: The oak plot on the left and the pine plot on the right in Atatürk Arboretum-Belgrad Forest

The equipment used for this study were 12 EMS 81 sap flow sensors (six sensors per plot from Environmental Measuring Systems, Brno, Czech Republic) working according to the trunk heat balance method (Cermak vd., 1973, 1982; Kucera vd., 1977); 12 electronic dendrometers, one mini automatic weather station including pluviometer, solar radiation sensor, air humidity and air temperature sensor (EMS

Minikin RTHI and rain gauge) just next to the experimental plots, triple soil water potential sensors for each plot (EMS Microlog SP3) and one automatic meteorological station (Campbell Scientific GRWS 1000) 5

km far away from the study area. Leaf area index (LAI) was estimated by CL-110 plant canopy imager (Bio-science.inc).

In the trunk heat balance method, a section of a large tree trunk was heated from the inside by an electric current (with electrodes), which passes through the tissues. There were four electrodes and thermosensors in the system, all of them were placed into the tree trunk (Figure 2). Three of the electrodes were heated and positioned up to 10 cm above from one central electrode (Cermak et al., 2004).

The central electrode was not heated. The temperature difference (dT) between upper heated electrodes and reference end was measured by needle type thermosensors. Method was calculated the heat balance of a defined heated space according to the equation below (Cermak et al., 2004):

$$P= QdTcw+dT\lambda$$

Where P is input power (W), Q is the sap flow rate (kg s-1), dT is the temperature difference in the measuring point (K), cw is the specific heat of water (J kg-1 K-1) and λ is the coefficient of heat losses from the measuring point (W K-1).

After installation of the sensors, tree trunks were packed with polyuretan foams against direct heat of the sun and heat isolation. The data were evaluated by EMS Mini32 and Microsoft EXCEL softwares.



Figure 2: EMS 81 Sap flow system with electrodes and thermosensors on a tree trunk

Results

During the study period, total amount of precipitation was 18.7 mm and mean daily

temperature was 13.8°C. Even though low amount of precipitation during the study time, moisture was high in the soil as a result of soil moisture discharge with sufficient winter precipitations and mean soil water potential was -0.20 bar.

Results showed that daily water uptake by individual trees varied from 0.08 kg to 57.83 kg for pine trees while it changed between 0.05 and 52.55 kg for oak trees per day. Maximum daily uptakes were 3.93 mm m-2 and 1.91 mm m-2, average daily uptakes were 1.43 mm m-2 and 1.31 mm m-2 for oak and pine stands, respectively. When whole study period was considered water consumptions were 35.51 mm m-2 for pine and 38.75 mm m-2 for oak stands. At the beginning of the study period, oaks had no foliage while pines had already grown up leaves, but interestingly, water uptake of oak increased dramatically, only 8 days after the beginning of vegetation period, and never fell behind of the pine (Figure 3).

Discussion and Conclusion

There are not many research on transpiration and water uptakes of pine and oaks in our country. On the other hand, Anatolian black pine is a native tree species to Turkey. So results of this study were compared with the results of similar studies from all over the world. Results of this study was inconsistent with those carried out in different regions. For instance, Poyatos et al (2005) found that Scots pine (*P. sylvestris* L.) transpired almost twice more water than pubescent oak (*Q. pubescens* Willd.) with 3.7 mm and 1.4 mm maximum transpirations respectively for whole growing season. Other researchers reported also lower transpiration rates for pine, as 88 mm total in Austria (Weiser et al, 2014) and 25 kg daily maximum in Sweden (Cienciala et al, 2002), which are quite lower compared to ours, but mean annual temperature and precipitation was also lower (7.3°C and 718 mm) in the study carried out in Austria. Maximum stand transpiration for Scots pine reported 3.9 mm (Moore et al, 2004). The water uptake of our pine plot did not reach this value at the beginning of the vegetation period, but it may reach as vegetation period progresses.

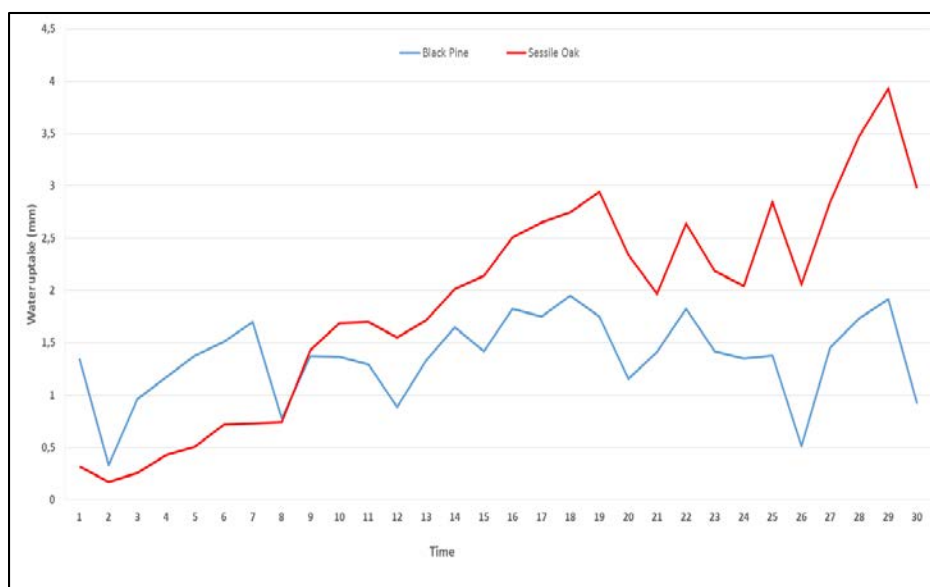

Figure 3. The water uptake comparison of black pine and sessile oak in the first month of vegetation period

Moreover; daily maximum transpiration rates reported as 71 kg for *Q. alba* L. and 46 kg for *Q. rubra* L. (Wuschlegger et al, 2001). One of the highest transpiration rate reported with 100 ears old *Q. robur* L. as 400 kg daily maximum and 39000 kg total for growing season per tree, in a floodplain forest, Czech Republic (Cermak et al, 1982). Compared our results, we have already seen or we were very close to these values in the beginning of the vegetation period except the one in floodplain forest, so it is obvious that we will see much higher amounts of transpiration rates in the sessile oak. These differences can be attributed to differences in both meteorological-geographical conditions and the difference of the species.

With considering the preliminary results of this study, higher amounts of water uptake can be expected for both species as air temperature raises, leaf area index increases and vegetation period progresses. It can also be expected that oak stand will transpire 2-3 times more water than pine stand for the whole vegetation period in the sub-humid region. It is also apparent that more researches should be done in Turkey about water consumption of trees in order to practise water efficient vegetation management studies for next years.

References

Cermak, J., Deml, M., Penka, M. 1973. A new method of sap flow rate determination in trees. *Biologia Plantarum*, 15 (3), 171-178.

Cermak, J., Ukehla, J., Kucera, J., Penka, M. 1982. Sap flow rate and transpiration dynamics in the full-grown oak (*Quercus robur* L.) in the floodplain forest exposed to seasonal floods as related to potential evapotranspiration and tree dimensions. *Ecologia Plantarum*, 24 (6), 446-460.

Cermak, J., Kucera, J., Nadezhdina, N. 2004. Sap flow measurements with some thermodynamic methods, flow integration within trees and scaling up from sample trees to entire forest stands. *Trees*, 18, 529-546.

Cienciala, E., Mellander, P.E., Kucera, J., Oplustilova, M., Ottoson-Löfvenius, M., Bishop, K. 2002. The effect of a north-facing forest edge on tree water use in a boreal Scots pine stand. *Canadian Journal for Forest Research*, 32, 693-702.

Granier, A. 1987. Evaluation of transpiration in a Douglas-fir stand by means of sap flow measurements. *Tree Physiology*, 3, 309-320.

Kucera J., Cermak, J., Penka, M. 1977. Improved thermal method of continual recording the transpiration flow rate Dynamics. *Biologia Plantarum*, 19, 413-420.

Moore, G.W., Bond, B.J., Jones, J.A., Phillips, N., Meinzer, F.C. 2004. Structural and compositional controls on transpiration in 40 and 450 year-old riparian forests in western Oregon, USA. *Tree Physiology*, 24, 481-491.

Nadezhdina, N. 2012. Sap flux density measurements based on the heat field deformation method. *Trees*, 26, 1439-1448.

Özhan, S., 2004. Havza Amenajmanı. İstanbul Üniversitesi Orman Fakültesi Yayınları, Yayın No: 481, İstanbul.

Poyatos, R., Llorens, P., Gallart, F. 2005. Transpiration of montane *Pinus sylvestris* L. And

Quercus pubescens Willd. Forest stands measured with sap flow sensors in NE Spain. *Hydrology and Earth System Sciences*, 9, 493-505.

Sakuratani, T. 1981. A heat balance method for measuring water flux in the stem of intact plants. *Journal of Agricultural Meteorology*, 37 (1), 9-17.

Sakuratani, T. 1984. Improvement of the probe for measuring water flow rate in intact plants with the stem heat balance method. *Journal of Agricultural Meteorology*, 40, 273-277.

Serengil, Y., Gökbulak, F., Özhan, S., Hızal, A., Şengönül, K. 2007. Alteration of stream nutrient discharge with increased sedimentation due to thinning of a deciduous forest in Istanbul. *Forest Ecology and Management*, 246, 264-272.

URL1, 2016. Devlet Su İşleri. Toprak ve Su Kaynakları. <http://www.dsi.gov.tr/toprak-ve-su-kaynaklari> Son erişim tarihi: 24.06.2016

URL2, 2016. Türkiye İstatistik Kurumu. Nüfus Projeksiyonları.2013-2075. Son erişim tarihi: 24.06.2016. <http://www.tuik.gov.tr/PreHaberBultenleri.do?id=15844>.

Weiser, G., Leo, M., Oberhuber, W. 2014. Transpiration and canopy conductance in an inner alpine Scots pine (*Pinus sylvestris*L.) forest. *Flora*, 209, 491-498.

Wullschleger, S.D, Hanson, P.J., Todd, D.E., 2001. Transpiration from a multi-species forest estimated by xylem sap flow techniques. *Forest Ecology and Management*, 143,205-21

Effect of Aspect and Soil Properties on Forest Road Platform Deformation

*Çiğdem ÖZER GENÇ¹, Burak ARICAK¹

¹Kastamonu University, Faculty of Forestry, Department of Forest Engineering, 37200,
Kastamonu / TURKEY

*Corresponding Author: cozer@kastamonu.edu.tr

Abstract

The platform surface of forest roads with soil superstructure, serving the putting into operation of the forested area is deformed depending on the ecological conditions and topography. The resulting deformation reduces the mobility of the cars, affects the safe driving of the vehicle laden, reduces the lifetime of the roads and causes to expensive maintenance costs.

In this study, whether the effect on deformation processing of aspect and general soil properties on the platform surface of the forest roads usually built in steep terrain was investigated. There are 46 + 122 m forest road located in Karacaoren Forest Enterprise that was chosen as study area. Deformation (pits and rut) has been observed very intense degree in 16 + 991 m of the forest roads. According to the results of statistical analysis "Chi-Square Test for Independence", it has been determined that aspect ($0,008 < p$) and soil properties (erosion levels $0,008 < p$, soil depth $0,000 < p$) are effective on forest road platform deformation formation.

Consequently, it has been determined that forest roads should be planned in the sunny aspect due to the drying effect of the sun and also according to the soil properties on areas with shallow soils and less erosion levels.

Keywords: Forest road, Deformation, Aspect, Soil properties

Toprak Özelliklerinin ve Bakımın Orman Yolu Platformu Deformasyonu Üzerine Etkisi

Özet

Ormanlık alanların işletmeye açılmasına hizmet eden ve en önemli transport tesislerinden olan orman yollarının platform yüzeyleri toprak üst yapıya sahiptir. Orman yollarının platform yüzeyleri ekolojik koşullara ve topografyaya bağlı olarak kolaylıkla deformasyona uğramaktadır. Platform üzerinde oluşan deformasyonlar araçların hareket kabiliyetini azaltmakta, yüklü araçların güvenli sürüşünü etkilemekte, yolların kullanım ömrünü azaltmakta ve pahalı bakım maliyetlerine neden olmaktadır.

Bu çalışma kapsamında bakı ve genel toprak özelliğinin çoğunlukla sarp arazi koşullarında inşa edilmiş olan orman yollarının platformları üzerindeki deformasyon oluşumuna etkisi olup olmadığı araştırılmıştır. Çalışma alanı olarak seçilen Kastamonu ili Karacaören İşletme Şefliği'nde yer alan toplam 46+122 m orman yolu üzerinde yapılan çalışmada orman yollarının 16+991 m'sinde çok yoğun derecede deformasyon (çukur ve tekerlek izi) olduğu gözlemlenmiştir. Yapılan Ki-kare istatistiksel analizi sonucunda yolun güneşlenme durumuna etki eden bakımın ($0,008 < p$) ve genel toprak özelliklerinin (erozyon durumu $0,008 < p$, toprak derinliği $0,000 < p$) orman yolu platformunun deforme oluşumuna anlamlı düzeyde etkisinin olduğu tespit edilmiştir.

Elde edilen sonuçlara göre orman yollarının mümkün olduğunca güneşin kurutma etkisinde dolayı güneşli bakılarda ve toprak özelliğine göre de mümkün olduğunca sığ topraklarda ve düşük erozyon derecesine sahip alanlarda planlanmalarının dikkate alınması gerektiği belirlenmiştir.

Anahtar Kelimeler: Orman yolu, Deformasyon, Bakı, Toprak özellikleri

Introduction

Forest roads are constructed to provide sustainable, safe access to forested lands for forest management activities such as logging operations, transportation of timber to mills, forest conservation, and forest planning (Hasmedi et al., 2008).

Forest roads, one of the biggest investments in forest management, are complex engineering structures that require proper construction methods. Proper road construction and maintenance activities are especially important in the case of forests that are located in mountainous areas, (Hasmedi et al., 2008). Jones et al., 2000; Girvetz and

Schilling, 2003 stated that roads create a variety of potential risks to the natural

As a result of selecting inappropriate road locations, adverse impacts on the natural environment emerge in conjunction with the occurrence of technical and economic problems (Gorcelioglu, 2004). Recently, forest engineers are searching for suitable approaches that reduce costs and increase efficiency, as well as those that minimize the adverse impact of roads on forests (Radfar et al., 2011)

Forestry works in our country are carried out on different topographic areas are dispersed in various parts of the country. Because forests are on so wide and generally the mountainous terrain, should be managed in accordance with the technical, first of all these areas must have a good road network. Forest roads play an important role about performing of forestry service such as delivered of main forest products to forest depots and factories, forest conservation, forest cadastre, forest maintenance, erosion control and planting works

Application of a road on landslide or weak bearing capacity ground will cause collapse of the road or formation of deformations on the road platform. Therefore, to continue without interruption of the forestry activities and services, roads must be planned in accordance with the nature, done good ground surveys.

Kramer (2001) stated that road maintenance, road drainage, pavement, and

ditch improvement activities must be surveyed in every year.

Superstructure of a forest road should be made to satisfy the deformation that will be created by heavy vehicles to be used for the transport of forest products (Gumus, 2009). Bayoglu (1997) stated requiring to be done continuous maintenance and repair of forest roads. Otherwise he emphasized the roads will be deformed and will become unusable.

This study was tackled mapping and determining of deformations occurring on forest roads that forest road network of Karacaoren Forest Management. According to the platform deformation condition, forest roads were assigned "1" (no deformation) or "0" (there is deformation) code value and so deformation condition assessment of 100 m section of existing each the forest road was conducted. Also, it was studied that impact of aspect (sunny-shady) and Soil properties (Soil Depth-Erosion Level) on platform deformation condition of the roads by GIS and SPSS.

Material and Method

Material

To obtain some database about the road platform deformation and to analyze this issue, normal B type secondary forest roads in Karacaoren Forest Sub-District Directorate, Daday, Kastamonu form the material of this study (Figure 1).

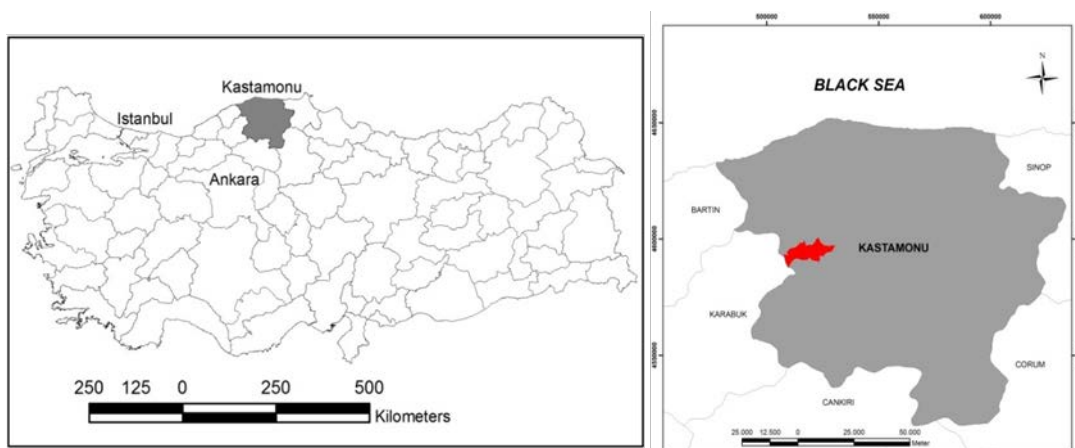

Figure 1. Location of Karacaoren Forest Sub-District Directorate

According to the forest road network plan renewed in 2008, the Enterprise that was

chosen for this study manages roads with total length of 96+689 m, which breaks down as

46+122 m of Normal B Type Forest Road and 50+567 m of motorway.

Method

Moreover, in order to create a digital terrain model of the study area, standard topographic maps of 1/25,000 scale of the area were used.

To assess the platforms deformation condition of forest roads in the area, observations and investigations were carried out about platforms deformation condition on 100 m section of existing each the road.

Codes representing to road segments condition made observation in 100 m were determined as '1' and '0' to be in the form of two values.

Forest roads were assigned code "1" if deformation not observed on the road platform and code "0" if they have visual degradation.

The data obtained from study area is saved as attributes to forest road network plan in the ArcGIS environment. Also performed analysis of existing forest roads, the roads

platform deformation condition was revealed on location basis.

It was studied whether or not aspect and soil structure properties, which are topographical factors, had any impact on platform deformation condition of the roads by "Chi-Square Test for Independence". Aspect factor was categorized as sunny areas (south, southeast, southwest, west facing areas) and shady areas (north, northeast, east, northwest facing areas). Also, soil structure factor was assessed in terms of Soil Depth (0-20 cm very shallow, 20-50 cm shallow, 50-90 cm medium deep, and >90 cm deep soils), and Erosion Levels (None to Very Little – Medium – Very Severe) (Anonymous, 2011).

Results

16+991 m of examined 46+122 m forest roads had numerous deep pit and track on the road platform. There were 29 + 131 m forest road that deformation wasn't not seen as effective and didn't create a visual impairment (Table 1). (Figure 2).

Table 1. Platform deformation condition table

Platform deformation condition			
Road code	"0"	"1"	Total
13	0+301	1+707	2+008
16	1+643	1+541	3+184
17	-	1+537	1+537
19	1+305	1+405	2+710
20	0+409	3+173	3+582
21	1+400	4+100	5+500
22	0+925	1+233	2+158
23	1+441	0+618	2+059
26	1+616	1+617	3+233
408	1+501	-	1+501
410	1+436	1+641	3+077
411	1+044	0+522	1+566
412	0+605	-	0+605
415	0+908	1+010	1+918
417	1+348	1+037	2+385
419	1+008	4+339	5+347
420	0+101	3+651	3+752
Total	16+991	29+131	46+122

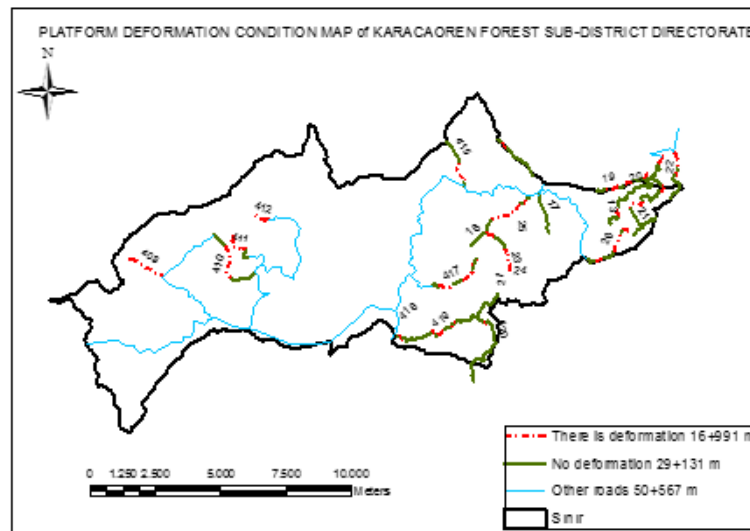

Figure 2. Platform deformation condition map

By examined density, size and depth of the deformation on the road alignment, deformation condition of the road that is an

important factor for road quality was evaluated for each 100 m road section (Figure 3).



Figure 3. Example images of deformation on the road surface

After platform deformation condition was determined as positional for each 100 m section of forest roads, as a result of the analysis aspect and soil structure properties

(soil depth - erosion), which are topographical factors has been found to be effective on the deformations (Table 2).

Table 2. Chi-square test for independence

Platform deformation condition		p	x ²	fd (degree of freedom)
Topographical factors				
Aspect		0,008*	6,937	1
Soil properties	Soil depth	0,000*	26,291	4
	Erosion	0,008*	6,991	1

*Significant at p<0.05

Evaluation of forest road platform deformation according to aspect condition

Because rain water pooling on the surface dry slowly on shady areas, these areas have greater landslide and surface soil loss risks (Satir, 2011). In addition, the formation of deformation of the road surface in the shadow

and as a result of these, maintenance cost is expected to be more than in sunny.

Lengths of forest roads in Karacaoren Forest Sub-District Directorate on sunny and shady parts of the area subject to this study were digitally identified and shown on the map (Figure 4).

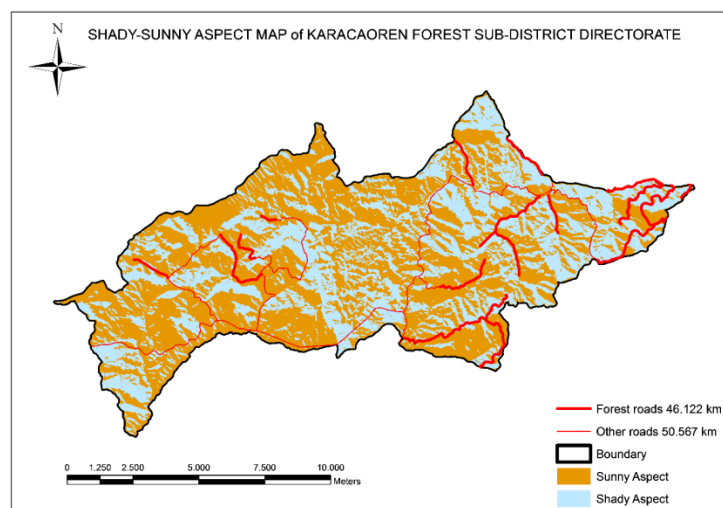

Figure 4 Roads shown on shady/sunny area map of Karacaoren Forest Sub-District Directorate

Table 3. Distribution of the existing roads according to the shady and sunny aspects

Aspects	Amount of road (m)	Amount of road (%)
Shady aspects (N+NE+E+NW)	14+445	31
Sunny aspects (S+SE+W+SW)	31+677	69
Total	46+122	100

After the platform deformation condition data of the forest road and data of sunny/shady area map of the study area was analyzed based on chi-square test for independence, a table was created meaningfulness values table (Table 2). Because “p” values of platform surface degradation condition (Asymp. Sig.=0.008) are smaller than 0.05, road platform degradation condition has meaningful correlation with shady/sunny areas

Evaluation of forest road platform deformation according to soil properties condition

Forest roads must be placed on strong soil structures in order to ensure that they maintain their continuity for long years (Acar, 2005). During forest road construction, soil properties are very important in terms of forest road construction cost and ease of production.

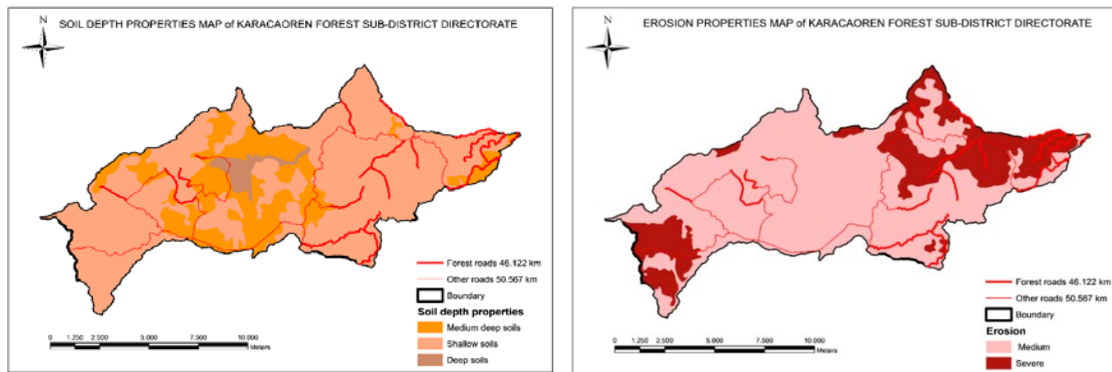

Figure 5. Roads shown on soil properties maps of Karacaoren Forest Sub-District Directorate

Soils are classified on basis of their soil depths as 0-20 cm very shallow, 20-50 cm shallow, 50-90 cm medium deep, and >90 cm deep soils (Anonymous, 2011). Forest roads in the study area is situated in medium deep and shallow soil types (Figure 5). Because “p” values of road platform degradation condition (Asymp. Sig.=0.000) are smaller than 0.05, it was found that road platform degradation condition have a meaningful correlation with Soil Depth. (Table 2).

Erosion levels represent soils’ level of proneness to water erosion, ranging as follows: none to very little, medium, severe and very severe (Anonymous, 2011). In analysis, it was found that the area was subject to medium and severe water erosion (Figure 5). Because “p” values of platform surface degradation condition (Asymp. Sig.=0.008) are smaller than 0.05, road platform degradation condition has meaningful correlation with erosion (Table 2).

Conclusions

Scope of work, deformation conditions of superstructure of forest roads in Karacaoren Forest Sub-District Directorate was identified as spatial by analyzing and creating thematic maps in the ArcGIS environment. Also, effect some soil properties and the aspect on deformations which occur on forest roads were revealed.

To be effective of aspect and soil structure properties, which are topographical factors on forest roads deformation were determined based on statistical analysis. Also a result of the observations, it was observed that other factors that could effect on the deformation

were drainage problems such as lack of roadside ditches, the lack of engineering structures and shade effect of trees in roadside

If forest roads are planned on sunny areas as much as possible, it is possible to prevent superstructure deformation due to the sunlight’s drying effect. Based on the “Soil Depth” properties, it was found in our analysis that it would be better to plan forest roads on shallow soil areas. Because soil stability is greater with shallow soil, platform stability will be easier. Based on the “Erosion Levels” factor of soil structure, cut stability becomes more difficult and deformation on platform increases as water erosion severity increases. Therefore, whenever possible, areas with less erosion levels must be preferred for planning forest roads.

In short, forest road routes must be planned as much as possible on sunny areas, shallow soils, and with “none to very little” erosion levels. Platform surface deterioration will have been prevented at the construction stage and during the use of the roads.

References

- Acar, H. H., (2005). "Orman Yolları." KTÜ Ders Teksirleri Serisi 82
- Anonymous, “National Soil Database,” 2011, <http://aris.cob.gov.tr/sites/default/files/lejant.pdf>, (23 June 2016)
- Bayoğlu, S. (1997). *Orman Transport Tesisleri ve Taşıtları*, İÜ Yayın No:3969, ISBN:975 404-430-9, İstanbul.
- Girvetz E, Shilling F (2003). Decision support for road system analysis and modification on the Tahoe National Forest. *Environ Manage* 32: 218–233.

Görcelioğlu E (2004). Orman Yolları-Erozyon İlişkisi. İ.Ü. İstanbul: Orman Fakültesi Yayınları No.: 4460/476, 184 s.

Gümüş, S. (2009). "Ktü Orman Fakültesi Araştırma Ve Uygulama Ormanı Yollarının Değerlendirilme ve Derecelendirilmesi", BAP Araştırma Projesi, 2007.113.01.12.

Hasnadi MI, Kamaruzaman J, Azizon JM (2008). Forest road assessment in Ulu Muda Forest Reserve, Kedah, Malaysia. *Modern App Sci* 2: 100–108.

Jones JA, Swanson FJ, Wemple BC, Snyder KU (2000). Effects of roads on hydrology, geomorphology, and disturbance patches in stream networks. *Conserv Biol* 14: 76–85.

Kramer, B.W. (2001). Forest Road Contracting, Construction and Maintenance for Small Forest Woodland Owners. Oregon State University, Forest Research Laboratory, Research Contribution 35, USA, 47-49.

Radfar I, Zolfani SH, Rezaciniya N, Shadifar M (2011). Using AHPCOPRAS-G method for forest road locating. In: Second IEEE International Conference on Emergency Management and Management Sciences (ICEMMS), Beijing, pp. 547–550.

Satır, O. (2011). "Dağlık arazide coğrafi bilgi sisteminden yararlanarak çevreye duyarlı orman yolu güzergahının belirlenmesi", *Yüksek Lisans Tezi A.Ç.Ü. Fen Bilimleri Enstitüsü*, Artvin.

Productivity of the MB Trac 900 Tractor at the Mixed Conifer Stands: An Example of Artvin Forest in Turkey

Sadık ÇAĞLAR

Kastamonu University, Faculty of Forestry, Kastamonu/TURKEY

sadikcaglar@hotmail.com

Abstract

Forest tractors are mostly used for transportation of the large volume harvesting materials such as logs, stems or full trees. Among the mechanized systems, MB Trac 900 forest tractor (skidders) have been employed for primer transportation of the raw wood materials in Turkey.

In this research, the productivity of MB Trac 900 tractors was studied at mixed stand with spruce (*Picea orientalis*) and scots pine (*Pinus sylvestris*) in Artvin-Turkey. The harvested logs was skidded from felling area to uphill landing areas. The average skidding distances was realized 47.14 m (minimum 20 m, maximum 80 m) from felling area to the forest road side landing place. The average slope of the harvesting area was %55 and the ground was covered by rhododendron intensively.

The time studies and other measurements was realized while the MB Trac 900 skidder was hauling the harvested materials in conifer stands. A cycle time prediction model was offered by using measured depended and independent variables.

Keywords: Time study, productivity, skidding, MB Trac 900

İğne Yapraklı Karışık Meşcere Koşullarında MB Trac 900 Orman Traktörü ile Çalışma Verimi: Artvin Ormanları Örneği

Özet

Orman traktörleri, çoğunlukla üretim faaliyetleri ile elde edilen tomruk, bütün gövde veya bütün ağaç gibi büyük hacimlerdeki odunsu materyallerin bölmeden çıkarılması amacıyla kullanılmaktadır. Mekanize sistemler arasından, MB Trac 900 orman traktörü (sürütücü) bu tür odun hammaddesi materyalinin bölmeden çıkarılmasında işlenmektedir.

Bu araştırmada, Artvin-Türkiyede ki Doğu ladini (*Picea orientalis*) ve Sarıçam (*Pinus sylvestris*) karışık meşcerelerinde kablo çekimi ve sürütme işlerinde çalıştırılan MB Trac 900 orman traktörünün çalışma verimi incelenmiştir. Orman traktörü ile kesim sahasında hazırlanan tomruklar, orman içinden kablo çekimi yapılmak suretiyle yamaç yukarısındaki istif yerine sürütülmüştür. Devirme yerinden orman yolu kenarına kadar olan ortalama kablo çekim mesafesi 47.14 m (minimum 20 m, maksimum 80 m) olarak gerçekleştirilmiştir. Üretim sahasının ortalama yamaç eğimi %55'dir. Sahada orman güllü zemini oldukça yoğun bir şekilde kaplamıştır.

MB Trac 900 orman traktörü kesimi ve hazırlanması tamamlanan iğne yapraklı ürünlerin kablo çekimi yapılırken zaman analizi ve çalışma veriminin belirlenmesine ilişkin ölçümler gerçekleştirilmiştir. Çalışmanın sonucunda belirlenen koşullara altında, çalışma zamanının tahminine ilişkin, bağımlı ve bağımsız değişkenlerle oluşturulan bir model ortaya konmuştur.

Anahtar kelimeler: Zaman analizi, Verimlilik, Sürütme, MB Trac 900

Introduction

Forestry activities, such as extraction, are heavy and quite costly in the mountainous terrain conditions. Because of difficulties in the primer transportation of harvested woody materials, machine usage has become more important during the harvested wood extraction at the steep terrain (Çağlar et al, 2007) for the productivity and safety of the both machine and workers.

Generally, there are two stages in the transportation of raw wood material from

forest. The first one is to transport the wood products from the place where it was originally cut down to main storage area, is known as primer transport (Figure 1). The second one is to transport the products from the stacked or main storage areas to trading storage and factories (Çağlar, 2004). Extraction is the process of moving trees or logs from the cutting site to a landing or road side where they will be processed in to logs or consolidated into larger loads for transport

to a processing facility or other final destination (Heinrich, 1995).

Especially the primer transportation of raw wood material and forest products is expensive and time consuming in the difficult terrain condition in Turkey. Due to these reason, mechanized transportation systems are needed at difficult terrain and mountainously areas (Çağlar et al, 2007). The secondary transportation of raw wood materials has been done by using truck, trailer or other small transportation vehicle from forest inside to landing areas or depots. But in the primary transportation of raw wood materials, there are different transportation vehicles in practice in Turkey.

S T A G E	TREE HARVESTING PROCESS		
	CUTTING	TRANSPORT STAGE	
		PRIMER TRANSPORT	SECONDER TRANSPORT
A	Cutting preparation	Preparation	Loading
C	Cutting-felling	Loading (fastening)	Transportation on road
T	Delimiting	Extraction (skidding, hauling)	Unloading
I	Topping	Unloading (untie)	
V	Measuring marking		
I	Bucking	Timber stacking (temporarily stacking)	Storage
T	Debarking		
E			
S			

Figure 1. Motor-manual tree harvesting and transportation in Turkey (Karaman, 1997)

Generally, in view of the power source of raw wood transportation methods from forest compartment, there are three different primer transportation systems. Those methods can be classified as human powered (by hand and gravity), animal powered and the machine powered transportation methods or the combination of all three methods in the primer transportation stage.

Heinrich (1995) implemented that the several classes of primer transportation systems are commonly recognized as: ground skidding systems, forwarders, cable systems, aerial systems, draught animals and the other extraction systems such as manual, pitsawing, chute, winch truck, water. From the extraction systems given above only the ground skidding systems (human, animal and the machine powered) and forest skyline systems have been used during the logging operations in Turkey. With paralleling the technological development in mechanized transportation systems at forestry, machine

powered primer transport systems have also been employed in Turkish forestry.

That mechanized primary transportation machines are farm tractors, forest tractors (MB Trac 800 and 900) and the forest skylines (Gantner, Urus MIII and Koller K300). The farm tractor types include Massey Ferguson, New Holland, and Fiat brand tractors. Generally farm tractors have been combined with the light scale drums to haul small diameter harvested trees.

The productivity of the tractors depends on various ecological factors and their positive and negative effects. There are some factors that have impact on productivity, these factors can be classified as machine and equipment's type, forest ground and stand conditions, weather conditions and the experience and skills of the machine operators (Gullberg, 1995; Öztürk, 2010).

Generally, technical phases for timber harvesting are; felling (cutting and falling, branch cleaning, topping, bucking and debarking), timber haulage (taking out the log by dragging it near the chopped wood and then carrying it) and transportation (taking it from the roadside to wood processing centers).

There are three different tree harvesting methods in practice in Turkey. These are Cut-To-Length (CTL), Whole Tree Harvesting (WTH) and the Whole Stem Harvesting (WSH) methods. Among these harvesting methods, the most common is CTL method in Turkey.

In this research, as a mechanized extraction system, the MB Trac 900 forest tractor were introduced and its productivity was calculated after the cable hauling and the skidding operation of the harvested trees in Artvin Regional Directorate in Turkey. The time studies and other measurements was realized while the MB Trac 900 skidder was hauling the harvested materials in conifer stands. A cycle time prediction model was offered by using measured depended and independent variables.

The main objective of this study were to calculate the productivity of MB Trac 900 forest tractor during the primer transportation harvested the woody materials at mixed stands with spruce (*Picea orientalis*) and scots pine (*Pinus sylvestris*) in Artvin

Regional Directorate of Forest (RDF) in Turkey.

In a study by using MB Trac 900, the hourly productivity was found as 6.360 m³ / hour for the 600 m skidding distance and for 300 m skidding distance was also found as 9.471 m³ / hour. The hauling productivity of MB Trac 900 for average 30 m was determined as 13.954 m³ / hour. Average cost per volume of MB 900 Trac is 9.80 \$/m³ for 600 m skidding, 7.31 \$/m³ for average 300 m skidding, and 4.65 \$/m³ for average 30 m hauling distance (Öztürk, 2005).

In another study conducted by Acar (1998) in Giresun Forests in Turkey, the hourly productivity of MB Trac 900 forest tractors was determined as 1.980 m³/hour. The average hourly cost of these tractors was found as 6.30 \$/hour

It is found by Acar (2004), the daily transport capacity of MB Trac 900 tractor is 40-60 m³ on the average. Generally two workers are employed in operating the tractor. One of them is attaching the logs and the other untying the load.

Öztürk (2005) stated that Mercedes MB Trac 900 tractor has 85 HP engine power. The hourly outputs is changeable between 3.30 – 8.40 m³.h⁻¹. It has two drums with 12 mm hauling cable diameter.

In a research conducted by Çağlar, (1998), the MB Trac 900 forest tractor was used for cable haulage and skidding for the beech logs (*Fagus orientalis*) in Gököy (Ordu) in Turkey. It was determined the daily productivity of MB Trac 900 was calculated as 45.29 m³.day⁻¹ for 33.14 m. average cable hauling distances.

In another study by Öztürk (2009) The beech logs (*Fagus orientalis*) was skidded different distances from 40 m to 140 m The productivity of the MB Trac 900 was determined as 14,410 m³.h⁻¹ for 55 m and as 8.700 m³.h⁻¹ for 105 m skidding distance.

The forest tractors in Turkey

There is two different types of forest tractors (skidders) for the primer transportation of harvested woody materials in Turkish forest. These forest tractors have been employed for hauling heavy logs in large volumes. These forest tractors are Mercedes brand and also named as MB Trac 800 and MB Trac 900. The technical details

of the MB Trac 900 forest tractors was given in Table 1.

Table 1. Technical specifications of the MB Trac 900 forest tractor (Çağlar, 1998)

Features Name	MB Trac 900
Machine power	85 HP (63 kw)
Weight	6360 kg
Drawing power	2 x 6083 daN
Cylinder	4 cylinder
Cylinder capacity	3780 cm ³
Cooling system	Water Cooling
Speed:	
-Forward	25 – 40 km.h ⁻¹
-Backward	20 km.h ⁻¹
Lift up power	2000 daN
Vinch mark	CG2M2ZD
Cable diameter	12 mm
Cable length	100 m
Cable speed:	
-540 tour	33 / 61 m.min ⁻¹
-1000 tour	19 / 65 m.min ⁻¹
Depot Capacity	120 lt
Engine type	OM 314
Output	3.30 – 8.40 m ³ .h ⁻¹

Materials and Methods

Materials

The total area of Artvin province is 710 973 ha and 56.8 % of this area is covered with forests [OGM, 2015]. The forested areas' trees species are spruce (*Picea orientalis*), scots pine (*Pinus sylvestris*), fir (*Abies nordmanniana*), and beech (*Fagus orientalis*) in Regional Directorate of Forestry (RDF).

This research was conducted in Taşlıca Forest District within the border of Artvin RDF located in mountainous Eastern Black Sea Region. The stand type of the working area is the mixed forest stands of spruce and pine. The spruce is dominant specie in forested area. The average slope of the research area is 55% with the 1423 m. altitude. The road density was 15 m/ha and the forest road spacing was 667 m. The GPS coordinates of research area was 41°08'44" North latitude, 41°44'23" East longitude. This coordinates was located in the 107 numbered compartment on the stand map of Taşlıca Forest District.

The MB Trac 900 used for the primer transportation has 2 different winches (drums) during the cable hauling of whole stem and logs. The cable lengths on the first winch has 100 m and the second one has 50 m cable length. During the primer transportation of logs MB Trac 900 forest tractor was positioned on the skid road side. Each cable was attached to the 2 different logs by a worker and then the two cables was hauled simultaneously (Figure 2).

The longitudinal slope of skid road was changed between 5-15 % in research area. The cable haulage distance was changed from 20 m to 80 m, after the cable haulage from compartment, the average skidding distance on skid road was 61.14 m. The skidding distance means that the distance from the place at road site to stacking site.

The ground cover on the cable hauling lane in research area was very intensive with ground cover. The living ground cover percentage on the cable hauling lane was 25%. The living ground covers are mostly rhododendron (*Rhododendron ponticum*) and common holly (*Ilex aquifolium*). Both these shrubs and the saplings of spruce and scots pine are very effective on the time consumption during the cable hauling operations. The stumps on the ground are another problem for the cable haulage.



Figure 2: MB Trac 900 at research area

During the cable haulage and primer transportation of harvested wood, there were 3 person in research area. Two of them cable setters (for attaching and untying of cables), the others was machine operators. The work experience of the machine operator was 18 years. The two worker are from the peasant of the Taşlıca village. This why, they were staying their houses near to reseach area. They cut trees by using their own chainsaws and skidded and prepared the logs for cable hauling lane for MB Trac 900 in forest inside.

The survey form were filled with measurement of dependent and independent variables. For every work circle time, the diameter with bark and the length of each piece measured by using caliper. The skidding distance by tractor was measured by measuring tape. The slope gradient for cable haulage direction longitudinal slope of skid road was measured by clinometer.

Method

The winching operation was realized from downhill to uphill direction. To calculate the operating efficiency during the primer transportation, the workplace conditions and the time measurement was realized as well. During the cable hauling of the harvested woody material, the efficiency of MB Trac 900 tractor was investigated by using the repetition time measurement method for the whole working day.

The time consumptions of each shift comprise the cable haulage time and skidding time on skid road. Time measurement was realized for each work stages by using digital chronometer.

The series of work phases for MB Trac 900 fores tractor at logging place constitutes the work cycle. A work cycle for each operation consisted of certain elemental functions and factors. The values of each variables were recorded in the field on survey forms.

Independent variables and dependent time variables were symbolized as X_i and T_i respectively. Since the goal of the MB Trac 900 operation is to collect the logs (timbers) from the logging area and transport it to the landing (stacking) area, each of the work cycle is a result of several work phases.

Explanation of work cycle is given below:

- T₁: Preparation time on skid road,
- T₂: Walking time to load from roadside,
- T₃: Hooking time,
- T₄: Haulage time of loaded hook,
- T₅: Skidding time on skid road,
- T₆: Unhooking (untying) time,
- T₇: Stacking time of logs,
- T₈: Delay time,
- ST: Shift Time,

The independent variables are generally belong to the ground, forest, stand, weather conditions and the specifications of the machine, equipments and the workers. Some of them changeable during the cable haulage and they have significant effect on the working productivity.

Independent variables that are effective on the working time are;

- X₁: Cable haulage distance,
- X₂: Log diameter,
- X₃: Log length,
- X₄: Log volume (for each shift).

Obtained data of time consumption and observations were evaluated by SPSS statistical software package. Analysis of Step-Wise regression and bivariate correlation were used to find the best prediction model.

Results and Recommendation

In this study, the productivity of MB Trac 900 tractors was studied at mixed stand with spruce (*Picea orientalis*) and scots pine (*Pinus sylvestris*) in Artvin-Turkey. The harvested logs was skidded from felling area to uphill landing (stacking) area.

In this study, 35 cycle time measured to determine the average shift (cycle) time and the productivity of MB Trac 90. The average hauling distance was calculated as 47.14 m and the average ground slope was measured 50 percent. Three personnel worked in the study area one of them was operator and 2 of them were workers (1 workers at down station and 1 worker at up station).

Work phases for transportation of prepared logs from compartment by using MB Trac 900 were measured and their average values were calculated. Work phases and their percentages in average shift time

consumption were calculated (Figure 3 and Table 4).

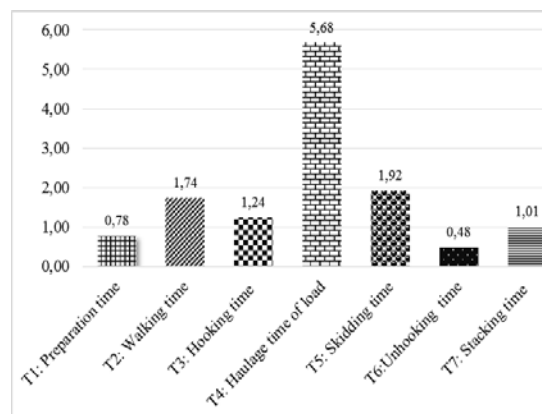

Figure 3. Work phases in average shift time of MB Trac 900

In this study for MB Trac 900 forest tractor, distribution of work phases in average shift (journey) time was determined as $T_4 > T_5 > T_2 > T_3 > T_7 > T_1 > T_6$. As shown Figure 3 the most effective work phase in average shift time is the phase “Haulage time of logs” (T₄). This means that, this work stage must be regulated for the more productive work by MB Trac 900 forest tractor. In additions to this, skidding trial (road) need to be carefully planned and applied to the ground. The effective independent variables belong to the ground condition such as ground cover, stump and tree density must be taken into account before the primer transportation.

The productivity values of MB Trac 900 were calculated for given conditions of research area. During the operations, there was not delay time. For the 35 cycle time, the worked did want to rest. The daily work time was assumed as 8 hours in a day. The productivity values of MB Trac 900 given below (Table 3).

Table 3. Average shift Time and Productivity of MB Trac 900 forest tractor.

Average shift time (minute)		12.84
Productivity of MB Trac 900 forest tractor	m ³ .shift ⁻¹	0.893
	m ³ .hour ⁻¹	4.172
	m ³ .day ⁻¹	33.376

Table 4. Work phases and their descriptive statistics

	Cable haulage distance	Diameter of logs	Length of logs	Log volume	T1: Preparation time on skid road.	T2: Walking time to load	T3: Hooking time	T4: Haulage time of loaded hook	T5: Skidding time on skid road to landing area	T6: Unhooking time	T7: Stacking time	ST: Shift Time
Units	m	cm	m	m ³	min.	min.	min.	min.	min.	min.	min.	min.
Average	47.14	39.54	6.94	0.893	0.78	1.74	1.24	5.68	1.92	0.48	1.01	12.84
Maximum	80.00	60	12	2.829	2.02	4.57	2.75	12.45	3.27	1.03	1.90	21.50
Minimum	20.00	30	4	0.363	0.33	0.02	0.60	1.05	0.57	0.23	0.30	5.62
Std. Dev.	13.85	5.60	1.76	0.45	0.30	0.96	0.51	2.80	0.69	0.20	0.44	3.72
Percentages of work stages (%)					6.1	13.6	9.6	44.2	15.0	3.7	7.8	100

The descriptive statistics of the independent variables was given the Table 4. It can be seen that the average cable hauling distance was calculated as 47,14m and its minimum and maximum was measured 20 m and is 80 m. respectively. The log volume was calculated for each cycle. Average log volume was calculated as 0.893 m³/shift. The average length of the hauled logs was calculated as 6.94 m with its minimum 4 m and maximum 12 m (Table 4).

For the cable haulage by MB Trac 900 forest tractor, it was found a positive correlation between shift time (ST) and hauling distance (X₁) at 99 % significant level. The same result was found between shift time (ST) and length of logs (X₃) at 95 % significant level. The biggest percentage is belong the haulage time of loaded hook (T₄) within the average shift time. This why, same results was found among the variables (Table 5). The graphical relationships was given between shift time (ST) and independent variables (cable hauling distance, and length of logs) in the Figure 4,5.

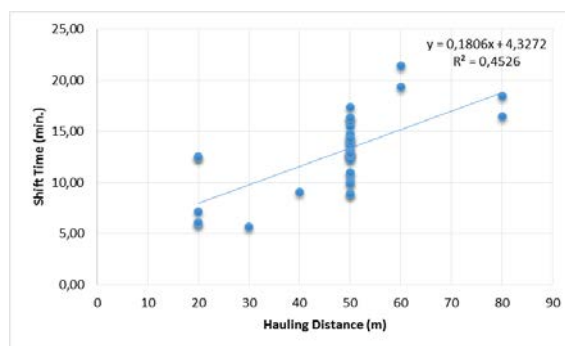

Figure 4. Shift time and cable hauling distance relationship

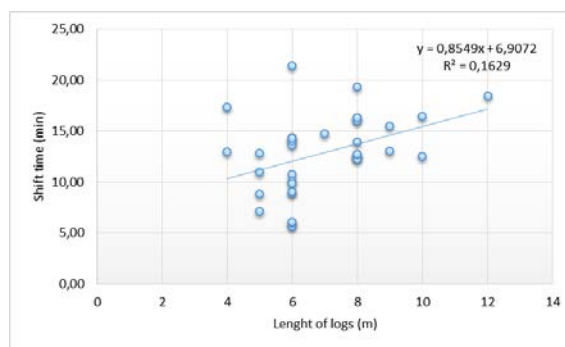

Figure 5. Shift time and length of logs relationships

Table 5. Correlations values among the dependent and independent variables

	Independent variables			
	Distance	Diameter	Length	Volume
Shift time	0.673**	0.101	0.404*	0.259
Haulage time	0.643**	0.059	0.351*	0.190

** Correlation is significant at the 0.01 level.

* Correlation is significant at the 0.05 level

Regression analysis (step-wise) was realized to find the best regression model. For extraction of harvested logs from the compartment by MB Trac 900 forest tractor, it was found a significant regression model at % 99 significant level for shift time (ST). The regression models founded in regression analysis were given as below:

$$ST = 2.289 + 0.182X_1 + 2.233 X_4$$

$$(R^2 = 0.524 \quad \text{Std. E} = 2.68)$$

Forest tractors are the most employed primer transport vehicles all around the Turkish forest. MB Trac 900 skidders are useful for the areas where have adequate forest road density. To get best regression model, same research should be done in different harvesting areas by the MB trac 900 forest tractors. In this study, the limited independent variables was measured and evaluated for the statistically. Nevertheless, the productivity results are similar to the other studies that are realized by MB Trac 900 forest tractors. The main differences are the transported tree species such as hardwoods. The other factors are the ground conditions.

To prevent decrease in machine efficiency and to reduce fuel consumption, the maintenance of machinery must be performed in time according to technical specification. In addition to this, adequate number of spare parts should be maintained to prevent any loss of time in case of urgent maintenance works.

Environmental sensitivity, safely work activities and productivity should be taken as a top priority while planning, renting and installation of primer wood transport machines.

The technical staff problem should be solved to increase of workers' productivity success. Workers' camping, nutrition and safely working condition should be provided. Persons who are not specialized in mechanized wood transport should not be employed for this purpose.

References

Acar, H.H., 2004, Transport in Forestry, Karadeniz Technical University, Faculty of Forestry, Forest Engineering Department, 270 p. Trabzon-Turkey (in Turkish).

Acar, H.H., 1998, Technical and Economical Analysis of Production Vehicles of Giresun Forest Regional Directorate, Turkish Journal of Agriculture and Forestry, 22 (1998) p. 143-149. (in Turkish).

Çağlar, S., 1998, An Investigation on The Cable Hauling and Skidding Operation by MB Trac 800 And Mb Trac 900 Forest Tractors in Gököy (Ordu) Region, Karadeniz Technical University, Faculty of Forestry, Forest Engineering Department, Bachelor of Forest Engineering Thesis, 66 p., Trabzon-Turkey

Çağlar, S., Acar, H.H., 2004, The Productivity of Koller K300 Yarder in Turkish Forestry, An International Scientific Conference, Forest Engineering: New Techniques, Technologies and The Environment, October 5 – 10, 2004, Lviv, Ukraine.

Çağlar, S., Acar H.H., Çalışkan E., 2007, An Examination on Machine Extraction Systems in Turkish Forestry, Annals Of Warsaw Agricultural University (SGGW), 6th Conference On Agricultural And Forest Engineering, 14-15 June 2007, pp.249, Warsaw, Poland.

Gullberg, T., (1995). Evaluating operator-machine interactions in comparative time studies. *J. For. Eng.* 7(1): 51-61.

Heinrich, R., 1995. FAO-ECE-ILO Proceedings, International Forestry Seminar, Exploring Multiple Use and Ecosystem Management: From policy to Operational Practices, September 9-15, 1995. Prince George, British Columbia, Canada.

Karaman, A., 1997 Determining The Effect of Working Difficulties on The Production and The Study on These Factors Relating The Logging Operations on The Working Conditions in The East Karadeniz Forest Region, 222 p, PhD Thesis, Karadeniz Technical University, Graduate School of Natural and Applied Sciences Trabzon-Turkey.

OGM, 2015, The Presence of Turkey's Forests, General Directorate of Forestry, Ministry of Forest and Water Management of Turkish Republic, 32 p., Ankara, Turkey.

Öztürk, T., Demir, M., 2005, Work Performance of MB Trac 900 Tractor on Mountains Terrain in Turkey, *American Journal of Applied Sciences* 2 (1): 363-366, ISSN 1546-9239

Öztürk, T., 2010, Productivity of MB Trac 900 tractor at beech stands on mountainous areas in Blacksea Region, *African Journal of Agricultural Research*, Vol. 5(1), pp. 028-033.

Customization and Automation of Geoprocessing with Python in ArcGIS for Natural Hazards and Forestry-related Applications

*Remzi EKER¹, Abdurrahim AYDIN¹

¹ Düzce University, Faculty of Forestry, Konuralp Campus, Düzce/TURKEY

*Correspondence Author: remziaker@duzce.edu.tr

Abstract

Today, GIS has been widely used by public and private forestry agencies. Geoprocessing, one of the basic functions of a GIS, is the processing of geographic information to create new information by applying an operation to existing data. Geoprocessing tasks tend to be time consuming and repetitive, and often need to be run on a periodic basis. And also, these geoprocessing tasks consist of various steps and combine many spatial layers in vector or raster format. That's why; numerous GIS software allows the users to create customizations at any level of expertise, across the entire spectrum of the software's functionality. Currently, ESRI has fully embraced Python as its scripting language of choice for geoprocessing and automation of map production and provides ArcPy site-package. In the present study, three custom scripts were developed using ArcPy in ArcGIS Desktop for automation of geoprocessing task in natural hazards and forestry-related applications to minimize user errors and to save time. While one of the developed scripts (called as "LSHM4ELBA+") works as ArcToolbox, remaining two (called as "AVALID Input Data Creator" and "AutorelforRAS") works as Add-in. Then case applications were carried out by using developed scripts.

Keywords: ArcPy, Custom Scripts, Forestry, GIS, Python

Doğal Afetler ve Ormancılık Uygulamalarında ArcGIS'te Python ile Coğrafi İşlemlerin Gereksinimlere Uyarlanması ve Otomasyonu

Özet

Günümüzde CBS, kamu ve özel ormancılık kurumları tarafından yaygın şekilde kullanılmaktadır. CBS'nin temel fonksiyonlarından biri olan coğrafi işleme (geoprocessing) mevcut veride işlem yaparak yeni bilginin çıkarılması için coğrafi bilginin işlenmesidir. Coğrafi işleme, zaman alıcı ve tekrarlı olmakta ve çoğunlukla periyodik olarak çalıştırılmayı gerektirmektedir. Ayrıca, coğrafi işleme çeşitli adımlardan oluşmakta ve raster ve vektör formatta pek çok katmanı kombine etmektedir. Bu yüzden, pek çok CBS yazılımı, kullanıcılara yazılımın bütün fonksiyonelliği ile birlikte bütün uzmanlık seviyelerinde gereksinimlere ilişkin uyarlamalar yapmaya imkân vermektedir. Günümüzde ESRI, coğrafi işleme ve harita üretimi otomasyonunda Python'u kodlama dili olarak tamamen benimsemiş olup bu kapsamda ArcPy paketini sağlamaktadır. Bu çalışmada ArcGIS Desktop içinde ArcPy ile kullanıcı hatalarını minimize etmek ve zaman kaybını düşürmek için doğal tehlikeler ve ormancılık uygulamalarının otomasyonuna yönelik gereksinimlere ilişkin uyarlamalar geliştirilmiştir. Geliştirilen kodlardan biri araç-kutusu (ArcToolbox) ("LSHM4ELBA+") olarak ve diğerleri eklenti (Add-in) ("AVALID Input Data Creator" ve "AutorelforRAS") olarak çalışmaktadır. Daha sonra geliştirilen kodlar kullanılarak örnek uygulamalar gerçekleştirilmiştir.

Anahtar Kelimeler: ArcPy, Uyarlanmış Kodlar, Ormancılık, CBS, Python

Introduction

Geospatial data have played a major role in human life for centuries because almost all human activities and decisions contain geospatial components. And also it seems like the need for geospatial data and use of geotechnologies will continue to grow in the future. Collecting, managing, processing, and representing various kinds of geospatial components are accomplished by various kinds of geotechnologies (Amirian, 2013).

Geographical Information System (GIS), which has emerged as a very powerful tool in the management of spatial information, is the heart of geotechnologies. The need of massive data management and its transformation into information requested by users with different goals of information make GIS a topic of intense interest for many academic disciplines, government organizations, as well as commercial enterprises. The development of cheap and powerful personal computers

and user friendly, readily available GIS software has increased the use of GIS technologies in almost every field (Apan, 1999). Forestry and natural hazards are the fields where GIS used intensively. Today, GIS has been widely accepted by public as well as private forestry agencies. It wouldn't be wrong to say that GIS has actually transformed into an indispensable tool for forestry applications, from resource inventory, natural hazards and monitoring, to analyzing, modelling, and forecasting for making decision (McKendry and Eastman, 1991), because GIS allows the users to analyze complex relationships among the data.

Geoprocessing, one of the basic functions of a GIS, is the processing of geographic information to create new information by applying an operation to existing data (McCoy, 2005). Any alteration or information extraction you perform on your data can be defined as geoprocessing task. Geoprocessing tasks tend to be time consuming and repetitive, and often need to be run on a periodic basis. Because these geoprocessing tasks consist of various steps and combines many spatial layers in vector or raster format (Dobesova and Dobes, 2012). Most of the GIS software and tools provide a large number of high-level algorithms to cover different GIS processing needs and also they are continually being improved and upgraded. Nevertheless, GIS software allows the users to create customizations at any level of expertise, across the entire spectrum of the software's functionality (Wunderlich, 2012). ArcGIS, developed by ESRI, Inc., is one of most frequently used software in GIS field (Amirian, 2013). With release of ArcGIS 10, ESRI has implemented many new features and updated components to their GIS software package. One of the most significant changes for power users is the way in which scripting, automations, and customizations (Wunderlich, 2012). Currently, ESRI has fully embraced Python as its scripting language of choice for geoprocessing and automation of map production and provides ArcPy site-package, which is installed with ArcGIS for desktop and ArcGIS for server (Toms, 2015), to improve the functionality of Python (Wunderlich, 2012, Amirian, 2013). In

addition, ESRI added a command-line Python scripting window to all ArcGIS applications in order to allow scripts to be loaded and run on-the-fly within the individual applications (Wunderlich, 2012) That's why, it seems like that the need for improving scripting abilities for the users has been emerging to control ArcGIS tools and Map Documents to produce geospatial data and maps in an organized and speedy manner using the ArcPy module.

In the present study, three custom scripts were developed using ArcPy in ArcGIS Desktop for automation of geoprocessing task in natural hazards and forestry applications to minimize user error and to decreasing consumed time. While one of the developed scripts (called as "LSHM4ELBA+") works as ArcToolbox, remaining two (called as "AVALID Input Data Creator" and "AutorelforRAS") works as Add-in ArcGIS. Then case applications were carried out by using developed scripts.

Introducing Developed Scripts

LSHM4ELBA+ (Large Scale Hazard Mapping for ELBA+)

ELBA+ (Energy Line Based Avalanche) software was developed at the University of BodenKultur according to the parametric calibrations of 147 well-recorded avalanche events throughout Austria (Volk and Kleemayr, 1999). ELBA+ has been commonly used for hazard mapping, avalanche protection measures and design purposes (Sauermoser and Illmer, 2002). Simulation results are saved to relevant database (Personal Geodatabase with extension ".mdb"). That's why for displaying avalanche flowing extents over the map, a conversion from table data to raster should be done. ELBA+ user-friendly GUI allows such a conversion one by one for each release zone within each simulation. Then an extra conversion from raster to vector format is required for hazard mapping. When this process is carried out for large areas which can have thousands of simulations, it will be time consuming. That's why, in order to automate all this process for avalanche hazard mapping, a simple script was carried out. This script works as toolbox under ArcGIS Desktop (Figure 1).

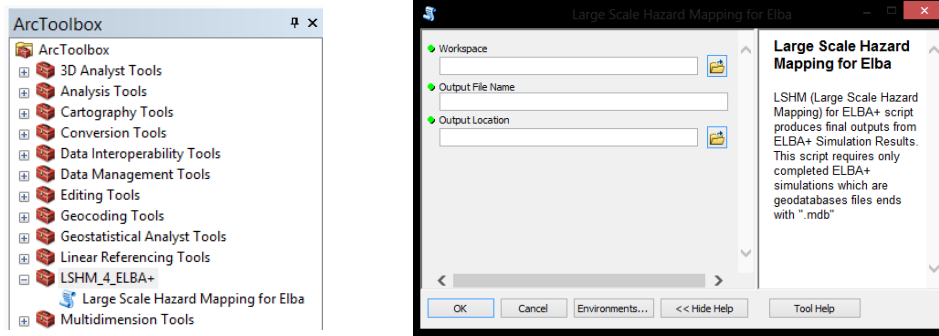

Figure 1. LSHM4ELBA+ script under ArcGIS (left) and GUI of developed script (right)

User has to define workspace in which ELBA+ simulations results (.mdb) is located, output file name in shapefile format, and location of output on the disk. Script automatically reads tables in Personal Geodatabases (.mdb) which includes simulations results and process for avalanche hazard mapping.

AVAL1D Input Data Creator

AVAL-1D is software developed for simulation of avalanches in one dimension from starting zone to runout (Christen et al. 2002, Oller et al. 2009). Users have to specify the required input data (topography, model and calculation parameters, initial conditions) for running simulation. There are three options for the users to specify a new topography (Christen et al. 2002): (1) by studying the avalanche track on a map, writing down the elevation and coordinates of all the topography-points and using the topography editing dialog window to specify all the points, interactively one by one, (2) by studying the avalanche track on a map, writing a text file on the computer (Figure 2) and reading this text file with AVAL-1D and (3) by using a digitized map of the avalanche area and specifying the avalanche track directly.

Developed script allows the automatic generation of input text file mentioned in option 2. This text file should include X, Y, Z coordinates of points located over avalanche path as well as width of avalanche (from center line to edge of avalanche flowing area as depicted in Figure 3). Developed script works in ArcGIS as Add-in (Figure 4). Avalanche paths are generally located over

mountainous areas with harsh topographical conditions where is mostly inaccessible. That's why; users prefer to generate input data from printout maps or digital data using GIS software depending on the availability of data. However, this manual data generation can cause user error and can be more time consuming than automatic data generation. Developed script requires only three inputs for automatic generation of input text file for AVAL-1D: 1) Digital Elevation Model (raster or TIN), 2) point vector data digitized over the center line of avalanche (e.g. shapefile) without additional field in database defined by user, and 3) digitized polygon vector which is avalanche flowing borders to calculate avalanche width.

Topography: Davraz1			
301945.3	4182086.4	2393.6	303.3
301881.8	4182151.5	2317.9	367.2
301834.7	4182222.4	2251.5	396.6
301793.2	4182277.5	2197.4	416.4
301754.8	4182326.4	2151.7	437.7
301703.2	4182411.1	2102.5	414.5
301671.5	4182470.6	2078.2	355.8
301642.0	4182531.5	2044.9	296.8
301605.3	4182610.8	2022.6	259.4
301574.9	4182686.2	1998.4	279.7
301573.6	4182781.5	1980.5	284.3
301578.9	4182871.5	1960.2	294.1
301647.7	4182921.7	1954.2	223.4
301700.6	4182954.8	1940.3	191.9
301838.2	4182970.7	1940.5	106.4

Figure 2. AVAL 1D input text file

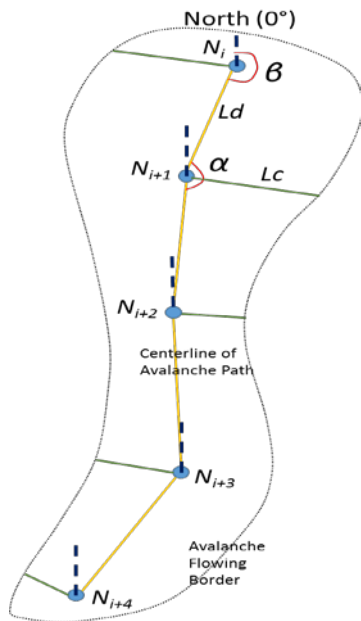

Figure 3. Parameters used in algorithm; N : points located over centerline of avalanche, L_d : length of lines between points, L_c : width of avalanche from centerline to flowing border, α : bisector between lines, β : azimuth angles of lines

The algorithm of developed script is depicted in Figure 5. According to algorithm, script firstly reads X, Y and Z coordinates of

points from overlapped elevation data. Then lines between points are generated and azimuth angles are recorded to database after calculation by using following equation:

$$\beta_i = \left(\text{ArcSin} \left(\frac{N_{i+1}(x) - N_i(x)}{L_d} \right) \right) \times \frac{180}{\pi} \quad (1)$$

where $N_i(x)$ is X coordinate (metric) of i^{th} point, L_d is length (m) between points, β_i azimuth angle of i^{th} line. Then each bisector angle between two lines is calculated using pre-defined methods in ArcPy module. That's why following transformation is necessary:

$$D_i = \frac{(180 - L_i(\beta) + L_{i+1}(\beta))}{2} \quad (2)$$

where $L_i(\beta)$ is azimuth angle of line at i^{th} point. Then bisector angles between two lines is calculated depending on the following condition:

$$\begin{cases} \text{IF } D_i \geq 90 \text{ ise,} & \alpha = \beta_{i+1} - D_i, \\ \text{ELSE,} & \alpha = (\beta_{i+1} - D_i) + 180, \end{cases} \quad (3)$$

where α is bisector angle. Then width of avalanche (L_c) is calculated in direction of bisector angles, from centerline to avalanche flowing border. After all calculations completed, a text file is created for AVAL-1D.

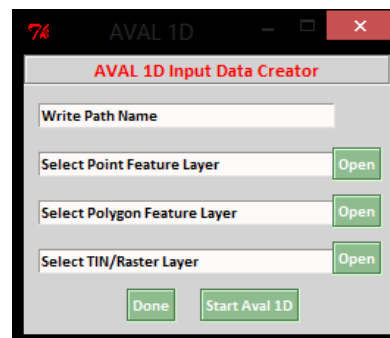
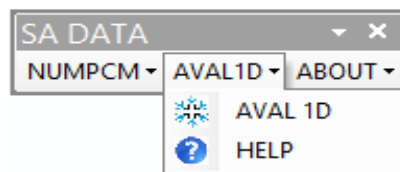

Figure 4. AVAL1D Input Data Creator Add-in (left) and GUI (right)

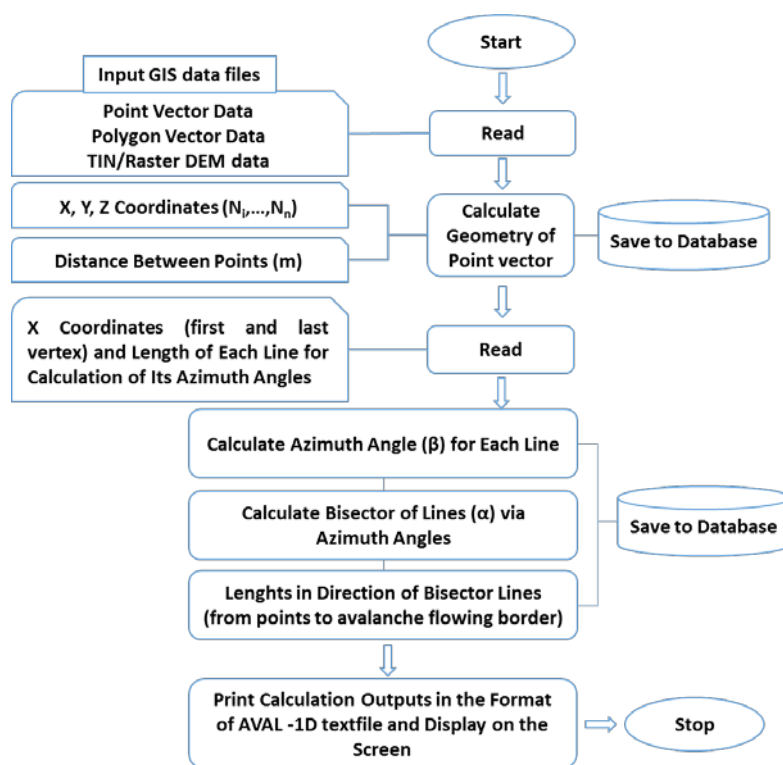

Figure 5. Algorithm of AVALL1D Input Data Creator

AutorelforRAS

Forested areas should not a priori be considered as areas not prone to avalanche due to complex relations between climatic, morphological and ecological factors (Viglietti et al. 2010). Under particular conditions, avalanches can be triggered in forested areas. That's why, forested areas should take into consideration in determination of avalanche release areas. GIS-based potential snow avalanche release zones determination can be carried out by using topographical parameters (Aydın and Eker, 2014). One of the important inputs is forest (land use) data in binary raster format (0 and 1). However, forest data, in general, is created and stored in vector format because it requires geodatabase to store different information related to forest stand in Turkey. That's why a conversion from vector to raster format after selection forest stand types with protective function has to be defined. For this aim, a simple script called as "AutorelforRAS" was developed as add-in in ArcGIS (Figure 6). AutorelforRAS add-in creates binary raster data depending on defined criteria from database of vector data. User adds rows to listbox called "Value:0

after selection related layer and field from database. Then rows including appropriate value in terms of user defined criteria is moved to second listbox called "Value: 1". Before run the script user should define a location in disk to save outputs and also can adjust cell size of output raster.

Case Applications of Developed Scripts

In the present study, a case application for avalanche hazard mapping using LSHM4ELBA+ was carried out in Vahkin Micro Catchment, located in Bingöl (Turkey). The area of catchment is 20424.9 ha. The catchment is located between 649423.5 - 4300891.2N and 671883.5 - 4284141.2E within ED50 UTM Zone 37 coordinate system. For this aim, ELBA+ simulations, made for 3799 potential avalanche release zone, were used to generate hazard map (Figure 7). In addition, for AVALL1D Input Data Creator case application, an avalanche path was determined in Vahkin Micro Catchment and 17 points were digitized over the centerline of avalanche path as well as avalanche flow area obtained from ELBA+ simulation (Figure 7). The length of centerline of selected avalanche path is 874 m.

Other study area, Artvin, located in East Black Sea region of Turkey was selected for AutorelforRAS case application (Figure 7). This study area is 7113.6 km² and includes, in total, 29 Forest Districts. A case application of AutorelforRAS was carried out based on criteria in classification and selection of forest stand type with respect to avoiding snow avalanche release. Forest criteria in this application are determined in the basis of literature. Forest stand structure (i.e. tree height, stem density, species composition, diameter at breast height (dbh), etc.) plays important role in snowpack stabilization (Bebi et al., 2001). According to McClung (2001), avalanche release zones within areas covered by vegetation were mainly characterized with tree height of less than 2 m. With respect to dbh, trees have to be with adequate diameter for resistance against snow cover static

pressure. According to Schneebeli and Meyer-Grass (1993), trees with less 16 cm diameter are not able to guarantee effective stabilization. However, for snowpack stabilization, trees with at least 8 cm diameter (Frehner et al., 2005) or 6-10 cm diameter (Johnson, 1987) are considered. Another important parameter is stem density, which is more effective than species combination (Schneebeli and Meyer-Grass, 1993), especially when the crown cover is less than 50-60% (Perzl, 2005). Minimum gap width required for avalanche release in forests with a crown cover of 60% and a slope angle of 35° is 10–15 m in deciduous broad-leave forests and 20 m in coniferous ones (Schneebeli and Bebi, 2004). In addition, generally, forests with gaps larger than 30 m along the slope have not capability of avoiding avalanche release (Brang et al., 2006).

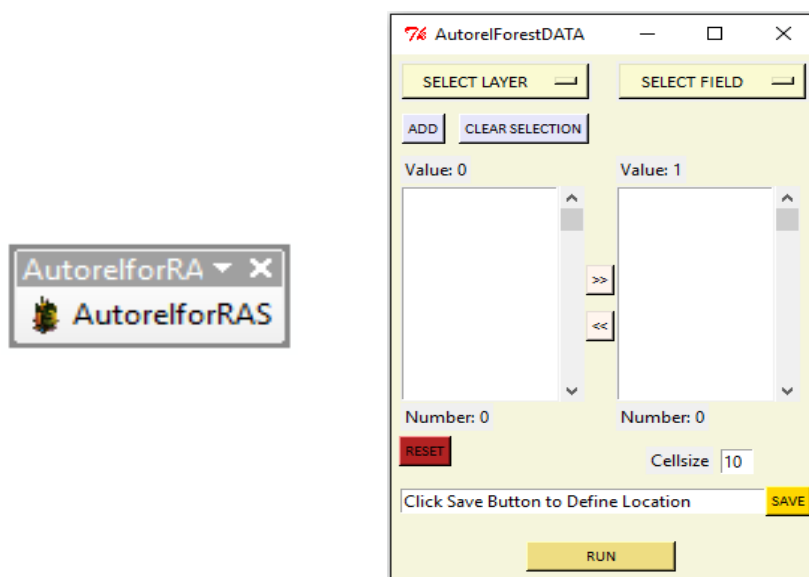
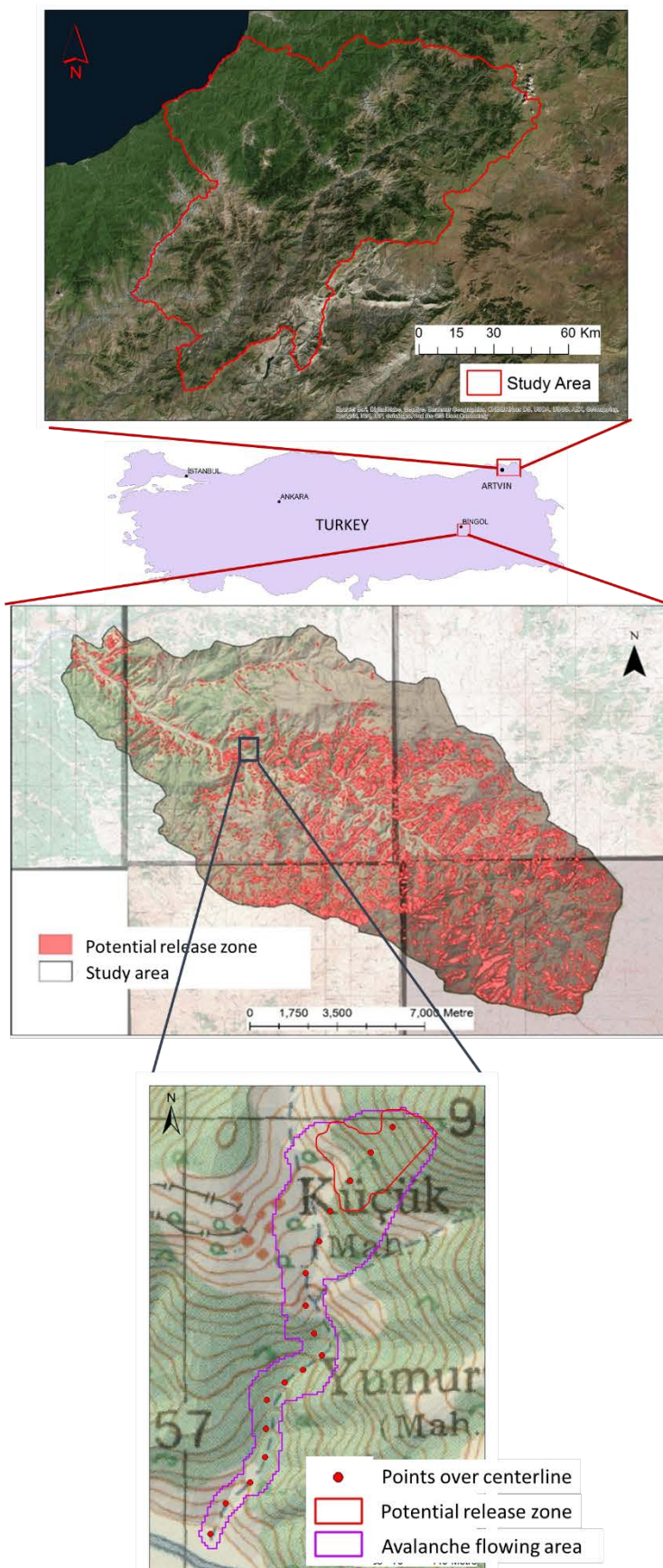

Figure 6. AutorelforRAS Add-in (left) and GUI (right)



Results of LSHM4ELBA+

Generated avalanche hazard map using LSHM4ELBA+ is given in Figure 8 and Figure 9. According to obtained hazard map,

size of hazardous areas varies between 0.58 ha and 30.42 ha. And also 44.8% of total area of Vahkin catchment remains under the avalanche hazard.

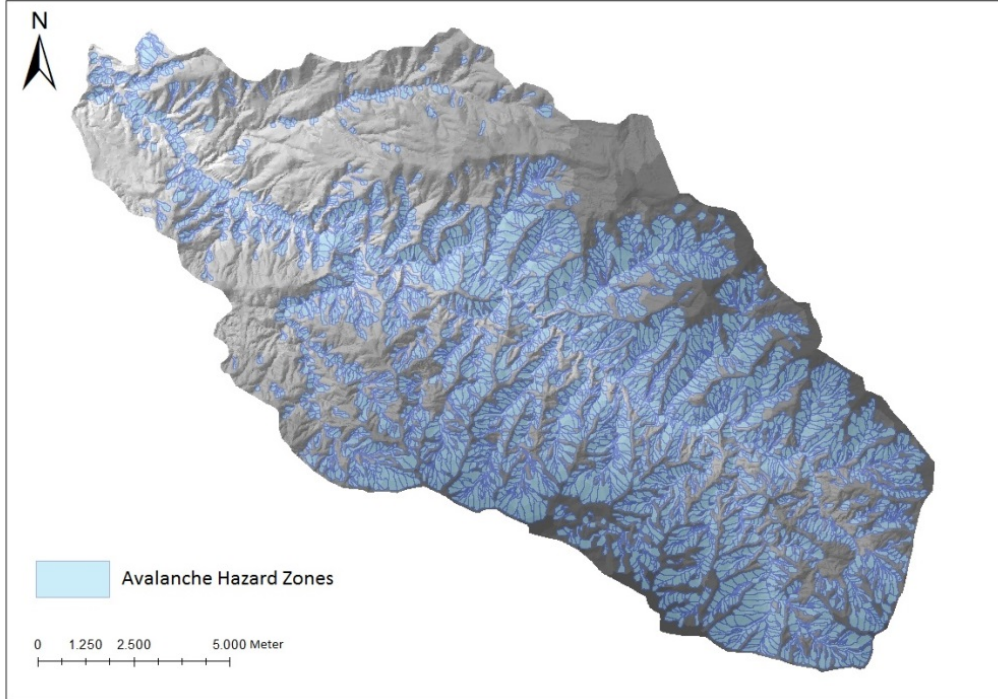

Figure 8. Avalanche hazard map obtained from ELBA simulations using LSHM4ELBA+

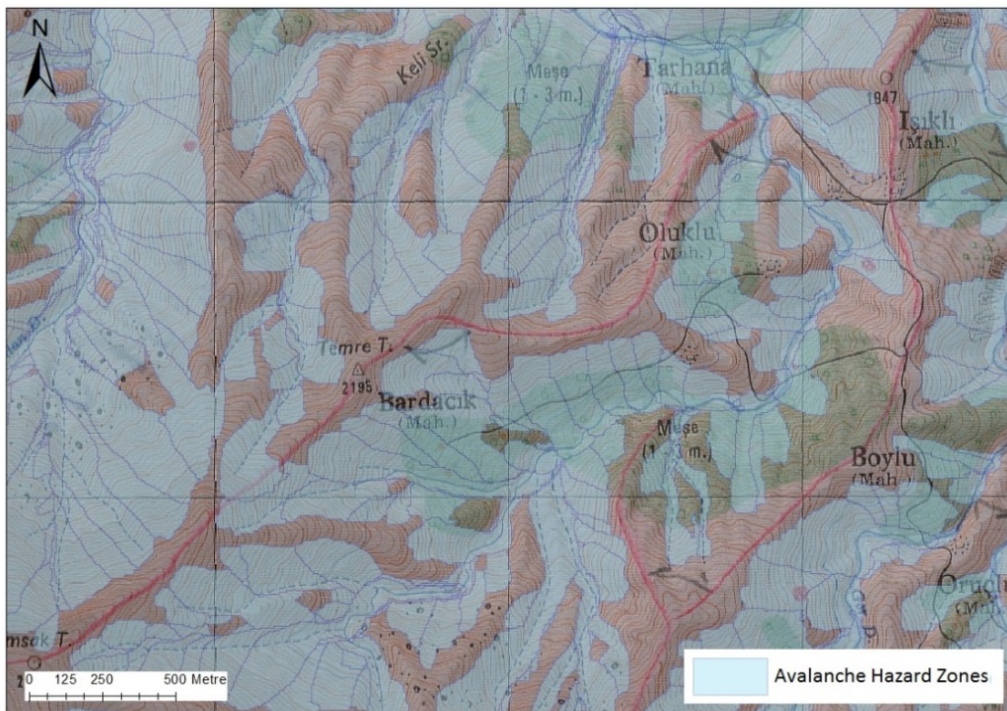

Figure 9. Avalanche hazard zones in more details

Results of AVAL1D Input Data Creator

The output of AVAL1D Input Data Creator is given in Figure 10. X, Y, and Z coordinate and width of avalanche path from centerline to flowing border were obtained automatically. Calculated width of avalanche path for each point varies between 16.9 m and 115.2 m.

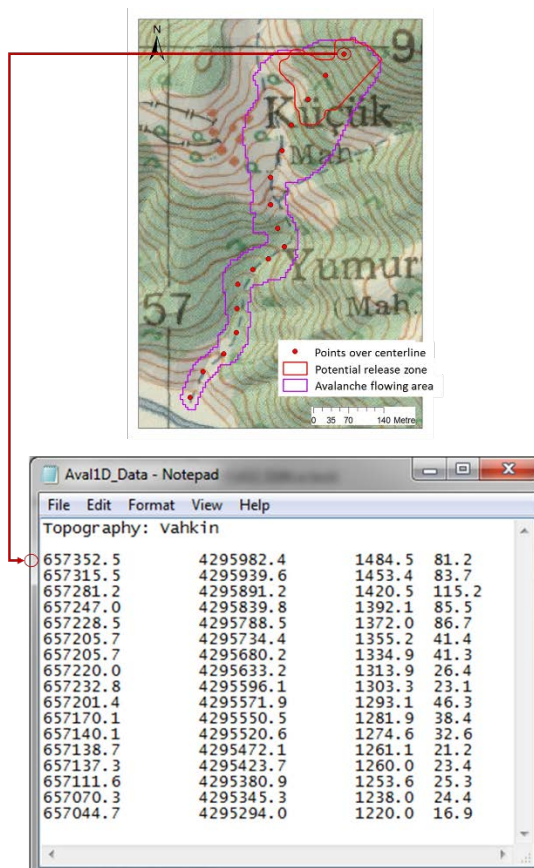

Figure 10. The output of AVAL1D Input Data Creator (X, Y, Z coordinates and width of avalanche for each point)

Results of AutorelforRAS

Geodatabase used for AutorelforRAS application has 60581 rows. In total, 785 different forest stand type exist in the database. According to classification based criteria mentioned before, 16489 of rows in database correspond 1 and remains are 0. In addition, 372 of all forest stand types corresponds 1. In Figure 11, an example of

classified forest types as 0 and 1 in AutorelforRAS was given. The output of this application is ready to use as input in determination of potential release zones (Figure 12).

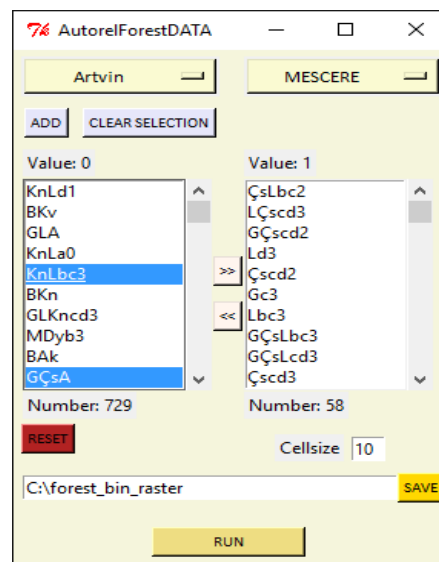

Figure 11. An example depiction of classified forest types as 0 and 1.

Conclusion

Even though many GIS software provides ready-to-use powerful tools for many geoprocessing task, they allow the users for customization in different ways. One effective way of customization and automation in GIS is scripting via usage of adopted programming languages. Python is one of the important language because it is well-adopted for geoprocessing task especially with ArcPy site-package in ArcGIS. In the present study, three custom scripts were shown. These custom scripts help to minimize user errors and required time for repetitive geoprocessing tasks in natural hazards and forestry as in all other fields. That's why, it seems like that the need for improving scripting abilities for the users has been emerging to control ArcGIS tools and Map Documents to produce geospatial data and maps in an organized and speedy manner using the ArcPy module.

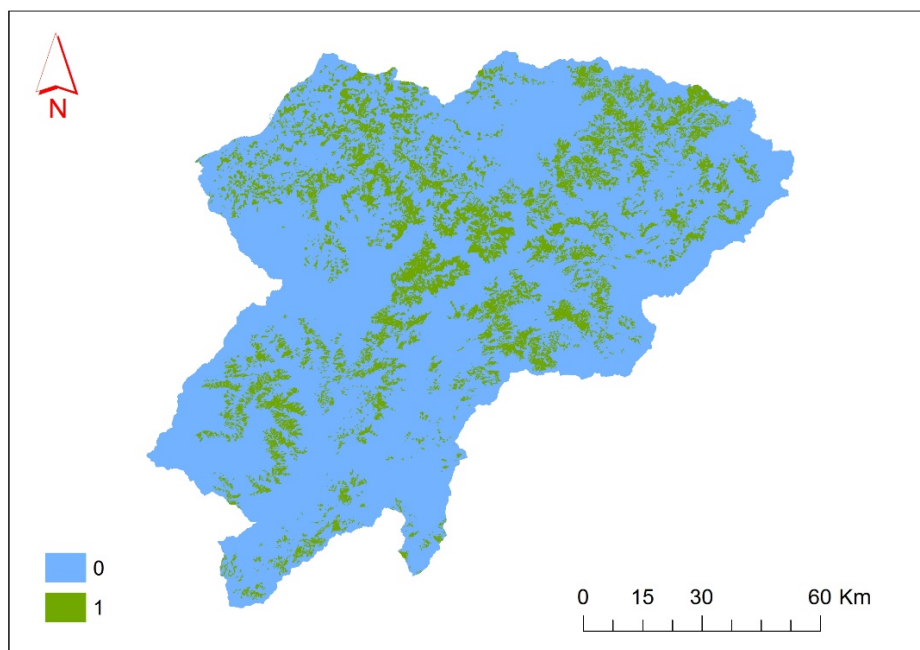

Figure 12. Output binary raster of AutoreforRAS. 0 is areas where has no forest with capability of avoiding avalanche release, 1 is areas where has forest with capability of avoiding avalanche release

References

- Aydın A., Eker R. (2014). Topografik parametreler kullanılarak potansiyel çığ başlama bölgelerinin CBS tabanlı olarak belirlenmesi. 2. Ulusal Akdeniz Orman ve Çevre Sempozyumu, 22-24 Ekim 2014, Isparta, 426-435.
- Amirian P. (2013). Beginning ArcGIS for Desktop Development Using .NET. John Wiley & Sons, Ltd. pp 499.
- Apan A. (1999). GIS applications in tropical forestry, Faculty of Engineering and Surveying The University of Southern Queensland, Toowoomba, pp 132.
- Bebi P., Kienast F., Schönenberger W. (2001). Assessing structures in mountain forests as a basis for investigating the forests' dynamics and protective function. *Forest Ecology and Management*, 145, 3-14.
- Brang P., Schönenberger W., Frehner M., Schwitter R., Thormann J., Wasser B. (2006). Management of protection forests the European Alps: an overview. *For. Snow Landsc. Res.* 80, 1: 23-44.
- Christen M., Bartelt P., Gruber U. (2002). AVAL-1D: an avalanche dynamics program for the practice. *Interpraevent 2002. Matsumoto – Japan. Congress publication*, 2, 715-725.
- Dobesova Z., Dobes P. (2012) Comparison of visual languages in Geographic Information Systems. In *IEEE Symposium on Visual Languages and Human Centric Computing (VL/HCC)*.
- Frehner M., Wasser B., Schwitter R., 2005. Nachhaltigkeit und Erfolgskontrolle im Schutzwald. *Wegleitung für Pflegemassnahmen in Wäldern mit Schutzfunktion, Vollzug Umwelt. Bundesamt für Umwelt, Wald und Landschaft, Bern*, pp. 564.
- Johnson E.A. (1987). The relative importance of snow avalanche disturbance and thinning on canopy plant populations. *Ecology* 68, 43-53.
- McCoy J. (2005). *Geoprocessing in ArcGIS*, ESRI Press.
- McClung D.M. (2001) Characteristics of terrain, snow supply and forest cover for avalanche initiation caused by logging. *Annals of Glaciology*, 32 223–229
- McKendry J.E., Eastman J.R. (1991). *Application of GIS in Forestry: A Review*. Available at www.nrac.wvu.edu/classes/for326/GISInForestryReviewPaper.pdf
- Oller P., Janeras M., Buen H., Arno G., Christen M., Garcia C., Martinez P. (2009). Using AVAL-1D to simulate avalanches in eastern Pyrenees. *International Snow Science Workshop, Davos 2009, Proceeding*, pp 524-528.
- Perzl F. (2005). Beurteilung der Lawinenschutzwirkung des Waldes BFW-Praxisinformation, 8, 27–31.
- Sauermoser S., Illmer D. (2002). The use of different avalanche calculation models practical experiences. In: *International congress INTERPRAEVENT. 2:741–750 (in the Pacific Rim-Matsumoto, Japan)*.

Schneebeli M., Meyer-Grass M. (1993). Avalanche starting zones below the timberline-structure of forest. Proceedings of the International Snow Science Workshop, Breckenridge, CO, 4-8 October 1992, 176-181.

Toms S. (2015). ArcPy and ArcGIS: Geospatial analysis with Python. Birmingham, UK: Packt.

Viglietti D., Letey S., Motta R., Maggioni M. Freppaz M. (2010). Snow avalanche release in forest ecosystems: A case study in the Aosta Vally Region (NW Italy), Cold Regions Science and Technology, 64, 167–173.

Volk G., Kleemayr K. (1999). ELBA - Ein GIS-gekoppeltes Lawinensimulationsmodell, Anwendungen und Perspektiven. Oesterr. Z. für Vermessung und Geoinformation 2, 84-92.

Wunderlich A.L. (2012) Automation in ArcGIS 10: Understanding Changes in Methods of Customization and Options for Migration of Legacy Code. “Digital Mapping Techniques “10—Workshop Proceedings” US Geological Survey Open-File Report 2012-1171, 81-92.

Automatic Extraction of Drainage Networks through Digital Elevation Models

Pakize TORUN¹, *Arif Oğuz ALTUNEL¹

¹Kastamonu University, Faculty of Forestry, Department of Forest Engineering, 37200, Kastamonu / TURKEY

*Corresponding Author: aoaltunel@kastamonu.edu.tr

Abstract

The progress and extend of Geographic Information Systems (GIS) and its application capabilities have broadened so much that the solutions which can be attained through this technology is especially invaluable in natural sciences and almost endless. One of the very practical applications involves extracting drainage networks from Digital Elevation Models, commonly known as DEMs or DTMs. Streams, rivers, creeks and similar waterways shape the landscapes and form obstacles that need to be addressed in any kind of planning, forest management included. Traditionally, drainage networks have been delineated and digitized from topographic maps. This is a rather time consuming and tedious process an analyst has to overcome just to include the waterways in a forest management plan. With the availability of widely available and proven DEMs, it is now a relatively easy process to extract such drainage networks, and up to %70 or better precision can be attained. DEMs are indispensable data sources in a wide array of applications ranging from 3D applications to watershed studies, etc. Delineations of macro and micro scaled watersheds, cut and fill calculations, watershed applications all need DEMs to proceed. In the context of this study conducted in the central Kastamonu township the extraction and comparison of some of the watershed characteristics were performed, using available DEMs such as DLR SRTM, quad maps and stereo aerial photography. Although the precision of above-mentioned DEMs are similar, the results varied.

Keywords: Hydrology, Digital elevation models, GIS

Introduction

Elevation data pertaining to any location on earth is generally depicted in the form of quad maps with different scales, i. e. 1:25000 Turkish or 1:24000 US quad map. Such maps with their intrinsic contour lines having distinct elevation values are digitized so they are stored in computers either in the form of vectorized line or point files, then, regularly spaced raster files, GRIDs, can be generated utilizing these files. GRID is a type of mesh draped over a surface. Each node on the mesh has distinct elevation values of the actual surface, so land surfaces can be modelled. The generated models are called Digital Elevation Models (DEMs). They enable the users to produce a matrix model with regularly spaced cells (Venkatachalam et. al., 2001).

DEMs are frequently used in engineering and hydrological studies to extract slope, aspect, elevation, cut and fill, ridge and water lines, micro and macro level catchment delineation, etc. The precision of such parameters is closely linked to the quality and sensitivity of DEMs. Quality of a DEM is the result of precise elevation values, sensitivity on the other hand is the result of GRID spacing (30mx30m vs 90mx90m). Smaller the GRID spacing, better the sensitivity of the DEM. These are the critical

two inputs while embarking any hydrology related study (Garbrecht and Martz, 1999).

There are numerous studies showing the usage of DEMs in the extraction of drainage networks, ridge lines and other hydrological properties. Majority of such studies do the analysis by taking a central cell surrounded by eight neighboring cells and analyze the entire data set (URL-1).

With the ever increasing capacity of GIS softwares, it is rather easy and convenient today to calculate hydrological properties of a watershed. There are many rather important factors such as catchment area, average slope, direction, drainage length affecting the calculations. Besides, many GIS softwares have intrinsic models/extensions specifically designed to deal with such analysis so they are handled easily and efficiently (Smemoe, 1997). There are many hydrological algorithms obtaining drainage networks through DEMs (Tribe, 1992).

In this study, it was intended to delineate watershed and sub-watersheds, extract flow directions and drainage networks as well as to compare the precision of flow directions which were obtained from different DEMs. The required input parameters which were used in hydrological modelling had previously been

prepared to suit into GIS environment. Three sets of data; two 1:25000 scaled Turkish quad map (for testing), one available Global DEM coverage, DLR_SRTM (25mx25m) (URL-2) and stereo aerial photography of the study area (both for comparison), were used for the purpose. ArcGIS Spatial Analysis module was used, and a tedious and time consuming task of drainage network digitizing over raster quad maps was eased up considerably. Thus, watershed and drainage network delineation can be made more conveniently.

Study Area

Study area was chosen depending upon the coverage dictated by aerial photography. Stereo air photo coverage forced us to study the area located west of Kuzykent district, central Kastamonu, a north-south oriented 6.5 km x 2 km rectangle swath (Figure 1).

Methodology

Delineating a watershed's ridge line is generally the first step in the generation of hydrology related data. These are the invisible lines running along the surrounding ridges directing the precipitation or melting snow water flow inside or outside the watershed. On inward slopes, water enters and contributes to the drainage network of the watershed, while on outward slopes, water does not enter the drainage system of the watershed in question. For irregular hydrologic models, "D8", eight flow direction approach, is a commonly used, accepted method (Jenson and Domingue 1988; Turcotte et. al., 2001). Study area delineation was accomplished, benefitting from "D8" approach. In this method, data stored in GRID form and each cell(s) forming the GRID are connected only to one adjacent cell (Tribe, 1992).

Implementation of "D8" method was accomplished in 4 stages; first water flow direction for each cell on GRID was calculated, second watershed delineation was materialized, third modelling of the drainage network was done and finally calculated water flow directions and modelled drainage network were paired together.

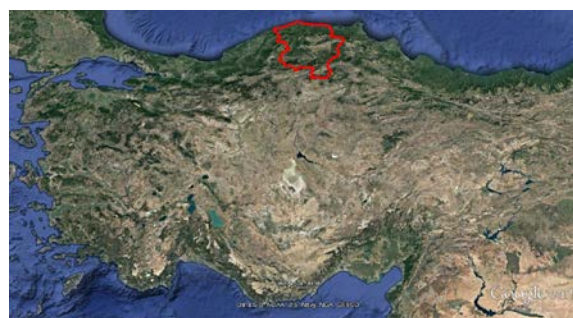

(a)

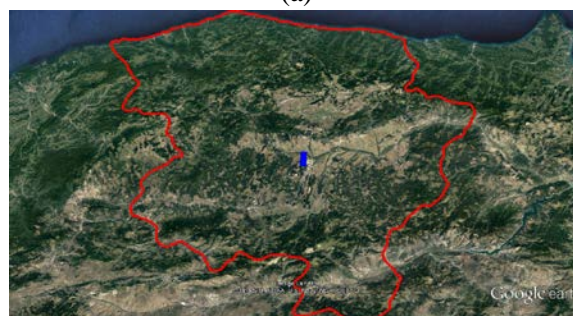

(b)



(c)

Figure 1. The province of Kastamonu (b), study area outlined inside blue rectangle (c)

Study area was located between two consecutive quad maps. The raster maps were first merged together, then coordinated, so an uninterrupted surface was obtained. Hands-on raster digitizing was performed on contour lines to generate Triangular Irregular Network (TIN) of the specified study area in ArcGIS. TIN to Raster conversion was the done prior to analysis. Aerial photography was aligned and DLR_SRTM data was cropped according to the study area.

Flow accumulation model was generated by using flow direction model. By taking the flow direction of each and every raster pixel on quad map, the amount of flow coming to each pixel was calculated and aggregated flow accumulation GRID was generated (Jenson and Domingue, 1988). Water flow directions were extracted from raster model and water flow directions model were generated. Starting from the upper right corner of this model, flow

accumulation values were calculated for each pixel. If there was no flow to a pixel from the surrounding pixels, flow accumulation value of such a pixel was denoted as “zero”.

In the determination of watershed delineation, water flow direction and flow accumulation models were jointly used. The pixel having the highest elevation value was regarded as the starting point of water flow inside the watershed. All GRID cells, raster pixels, having a flow direction towards this start point are related to this very watershed.

All grid cells having an exit direction towards this point are inside the watershed and their exterior borders define the outer perimeter of this watershed. Drainage network was generated over flow accumulation model. Depending upon the sensitivity and extend of any study done on this model, according to the highest pixel value obtained in water accumulation model, a threshold value was set. All pixels above this threshold value are designated, being a part of this drainage network. The materialized drainage network is vector based. In this drainage network, main and secondary channels of the drainage network were determined, taking the flow direction and accumulation models into consideration. On flow accumulation model, drainage network outputs were held by taking water flow values from smallest to highest (Venkatachalam et al., 2001).

A pair of stereo aerial photography was used in producing another terrain model for the study. Flow direction pertaining to the watershed was generated in the hydrology module of ArcGIS and flow accumulation function was used in this context. This function is used to calculate the water flowing inside each and every cell in the raster model. Starting with an assumption of each cell had a water existence of 1 unit, the accumulation cascades from the highest to lowest, multiplying the amount of water in the lower elevation pixels as at least 1 unit more than the higher elevation pixels. The feedback continues to the lowest pixel. Output GRID was based on the assumption of a continues precipitation. The average precipitation can be calculated through this method by interpolating actual meteorological data. Drainage right-of-passage was generated, using raster calculator in ArcGIS.

Results

Raster DEMs obtained from three different sources are shown below (Figure 2); (a) DLR_SRTM, (b) Quad map, (c) Stereo air photo. As expected, the highest and lowest elevations were different in each dataset (Table 1).

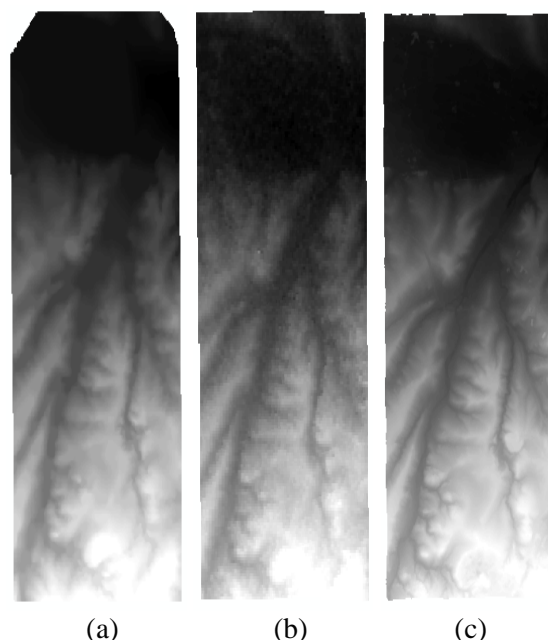

Figure 2. DEMs from three different data sources

Table 1. Elevation values from different DEMs

Model/Elevation	High	Low
Quad Map	950	720
DLR_SRTM	975	748
Stereo air photo	944	719

Illustration of water flow to or from a cell, is a good way of doing hydrological analysis. Flow direction function is a way to determine the flow direction by comparing the elevations of neighboring cells. In this context, the following flow direction maps were generated by using the previously produced DEMs (Figure 3).

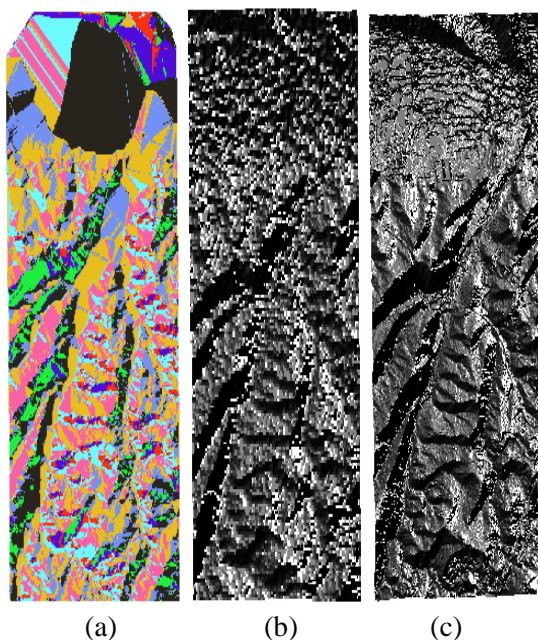

Figure 3. Flow direction detection maps of the study area (a) DLR_SRTM, (b) quad map and (c) air photography

Finally, flow direction maps regarding each data sources were generated in Figure 4. Each GRID cell had a value, starting from “0” to “112”. As the GDIS value rises, hue of each GRID cells gets lighter. The cells having the highest value were the most water flow accumulated points. As the results show, the degree of sensitivity obtained from different data sources are different. The sensitivity seemed very likely to relate to the resolution of the DEM. However, as the DEM resolution get even higher as in the case of stereo air photo produced DEM, the flow direction map gets kind of confused and the output start making not much sense. DLR_SRTM data produced the most promising model.

Conclusions

GIS is a very powerful planning tool in any kind of geographical related data analysis. Watershed is a large frame controlling the hydrological system. Defining the water sources within the ridgeline of a watershed provides the total understanding of the entire system and help better describe the progresses affecting the hydrological system (Nisançi et al., 2007). In this study, water flow direction and drainage network, which were two important parameters in defining a watershed, were investigated. It was concluded that rather than doing manual digitizing over quad maps, it's much easier to extract hydrological features of a watershed

from a DEM. Ready-made digital elevation data is available, however the sensitivity of the data is an issue if one wants to generate the ultimate hydrological model.

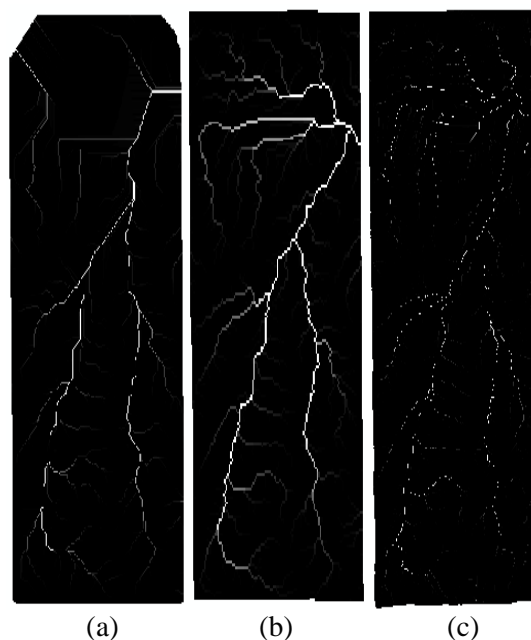

Figure 4. Flow accumulation models of the study area

References

- Douglas, D. H., 1986. Experiments To Locate Ridges And Channels To Create A New Type Of Digital Elevation Model: *Cartographica*, Vol. 23, No. 4, Pp.29-61.
- Garbrecht, J. And Martz, L.W., 1999. Digital Elavetion Model Issues In Water Resources Modelling. 19th Esri International User Conference, Environmental Systems Research Institute, San Diego, California, July 26-30, 1999.
- Jenson, S.K., Domingue, J.O., 1988. Extracting Topographic Structure From Digital Elevation Data For Geographical Information System Analysis. *Photogrametric Engng Remote Sensing* 54, 1593–1600.
- Nisançi, R. Yıldırım, V. Yıldırım, A. 2007. Su Havzalarına Yönelik Cbs Veri Tabanı Modellemesi: Trabzon Galyan Vadisi Örneği, Ulusal Coğrafi Bilgi Sistemleri Kongresi, KTU, Trabzon.
- Venkatachalam, P., Mohan, B.K.,Kotwal, A., Mishra, V., Muthuramkrishnan, V., Pandya M., 2001. Automatic Delineation Of Watersheds For Hydrological Applications Proc. Acrs 2001 - 22nd Asian Conference On Remote Sensing, 5-9 November 2001, Singapore. Vol. 2, Pp. 1096-1101.
- Smemoe, C. M., 1997. Linking Gis Data To Hydrologic Models. <http://Emrl.Byu.Edu/Chris/Documents/Watergis.Pdf>. (accessed on 17.03.2016)

Tribe, A., 1992. Automated Recognition Of Valley Lines And Drainage Networks From Grid Digital Elevation Models: A Review And A New Method. *J. Hydrol.* 139, 263–293.

URL-1

<http://portal.netcad.com.tr/pages/viewpage.action?pageId=106727005> (accessed on 04.05.2016)

URL-2

http://www.dlr.de/caf/en/desktopdefault.aspx/tabid-5515/9214_read-17716/ (accessed on 04.05.2016)

Assessing Productivity and Work Safety of a Mechanized Logging Operation

*Abdullah E. AKAY¹, Didem ÖZKAN¹, Ebru BİLİCİ¹

¹Bursa Technical University, Faculty of Forestry, 16330, Bursa/TURKEY

*Corresponding Author: abdullah.akay@btu.edu.tr

Abstract

Extraction of wood-based forest products is mostly conducted by traditional methods with limited mechanization in Turkey. Logging operations which does not involve sufficient usage of mechanized harvesting systems and adequate planning may reduce productivity and cause important work safety problems. Thus, optimum logging methods which not only maximize productivity but also minimize work safety risks should be implemented in extraction of wood-based forest products. This study aims to analyze capability of Tigercat 635D skidder which was subject to a scientific research in Turkey for the first time. In the study, logging operations conducted by utilizing Tigercat 635D was evaluated in terms of productivity and work safety issues during clear cut operations in Brutian pine stands of Çanakkale Forest Enterprise Chief of Çanakkale Forest Enterprise Directorate. In the field studies, productivity was computed based on time studies and then main factors that affect productivity were evaluated. These factors include skidding distance, ground slope, timber volume, and number of logs per turn. For assessment of work safety, work environment of skidder operators was investigated. For this purpose, a survey study was conducted considering working conditions, work safety, and workers health. The various statistical analysis was performed on the data collected during productivity analysis and survey study by using SPSS 16.0 software.

Keywords: Logging operations, Skidding, Productivity, Work safety

Mekanik Bölmeden Çıkarma Operasyonunun Verim ve İş Güvenliği Bakımında Değerlendirilmesi

Özet

Ülkemizde bölmeden çıkarma çalışmalarının büyük bir bölümü insan ve hayvan gücüne dayalı geleneksel yöntemlerle gerçekleştirilmektedir. Mekanik üretim yöntemlerinin yeterli düzeyde kullanılmadığı ve uygun planlamanın yapılmadığı bölmeden çıkarma çalışmaları operasyon verimini düşürmekte ve önemli iş güvenliği problemlerine neden olabilmektedir. Bu nedenle, bölmeden çıkarma çalışmalarında sadece verimi maksimize eden değil aynı zamanda iş güvenliği riskini en aza indiren optimum yöntemlerin kullanılması gerekmektedir. Bu çalışmada, bölmeden çıkarma çalışmalarında ülkemizde ilk defa kullanılan Tigercat 635D Sürütücünün performansının incelenmesi amaçlanmıştır. Bu kapsamda, Çanakkale Orman İşletme Müdürlüğü, Merkez Orman İşletme Şefliği sınırlarında bir Kızılcım meşceresinde gerçekleştirilen traşlama kesimlerinde, Tigercat 635D Sürütücü ile bölmeden çıkarma çalışmaları verim ve iş güvenliği açısından değerlendirilmiştir. Arazi çalışması sırasında verim, zaman etüdü yöntemi kullanılarak belirlenmiş ve daha sonra verim üzerinde etkili olan faktörler değerlendirilmiştir. Bu faktörlerin başında sürütme mesafesi, arazi eğimi, ürün hacmi ve ürün sayısı gelmektedir. İş güvenliği kapsamında özellikle sürütücü operatörlerinin çalışma koşulları araştırılmıştır. Bu kapsamda, çalışanlara çalışma koşulları, iş güvenliği ve işçi sağlığı gibi konuları içine alan anket çalışması uygulanmıştır. Gerek verim çalışmaları gerekse anket çalışması sonuçlarında elde edilen veriler üzerinde SPSS 22.0 paket programı kullanılarak bazı istatistiksel analizler gerçekleştirilmiştir.

Anahtar Kelimeler: Bölmeden çıkarma, Sürütme, Verimlilik, İş güvenliği

Introduction

Forest harvesting is mostly done by manual systems, while only limited amount of mechanized systems are implemented in Turkey. Timber extraction is the most difficult and costly stage in forest harvesting activities. In recent years, mechanized logging systems

have been used especially in intensive forestry operations. The mechanized logging provides important advantages such as minimizing environmental effects by operating in smaller areas, providing organic material to the forest by leaving logging residual on the ground, and

improving labour efficiency (Akay and Sessions, 2004).

In Turkey, mechanized logging systems are commonly implemented during skidding operations by employing farm tractor and forest tractor (MB-Track) (Öztürk, 2016). Thus, mechanized logging related studies have usually analysed these two types of tractors. Acar et al. (2010) conducted a study where productivity of MB-Tracks 800 and Mb-Track 900 were compared with cable logging systems (Urus MIII, Koller300, Gartner) in north-eastern part of Turkey. They reported that MB-Tracks were more productive especially in short skidding distances. Besides, MB-Track 900 with more power had the highest average productivity rate.

On the other hand, modified farm tractors are widely used in various operations of small scale forestry in Turkey. (Akay, 2005; Öztürk and Akay, 2007). These operations include skidding, loading, and forwarding. During modification process, farm tractors are improved by 4x4 drive feature, equal loads on both axles, and protected driver cabin. In a recent study, Türk (2011) studied farm tractor skidding operation considering technical, economic, and environmental aspects and proposed a new skidding model.

By implementing this model, it was found that skidding productivity was increased by 32.21%.

The skidders have been mostly preferred during skidding operation in countries where

mechanized forest operations are highly used. The logs are skidded by using chains or grapples attached to the skidders. The skidders are also divided into two groups based on movement elements; rubber tire skidders and crawler tractors (with tracks). When comparing rubber tire skidder and crawler tractor with similar horsepower, rubber tire skidders are more cost effective and environmentally friendly system (Akay and Yenilmez, 2008).

In order to take advantages of mechanized logging systems, their productivity and work safety issues should be carefully evaluated prior to skidding operation. In this study, it was aimed to evaluate productivity and work safety of Tigercat 635D skidder which was firstly used in Turkey. Besides, the main factors that affect productivity were analysed and alternative solutions were provided to increase productivity.

Material and Methods

Study area

The study was applied during a mechanized skidding operation in a Brutian pine stand in Çanakkale Forest Enterprise Chief of Çanakkale Forest Enterprise Directorate (Figure 1). The study area is located in Marmara region at elevation of 300-400 m. The geographic location was within 40°11'33" North and 26°34'51" East.

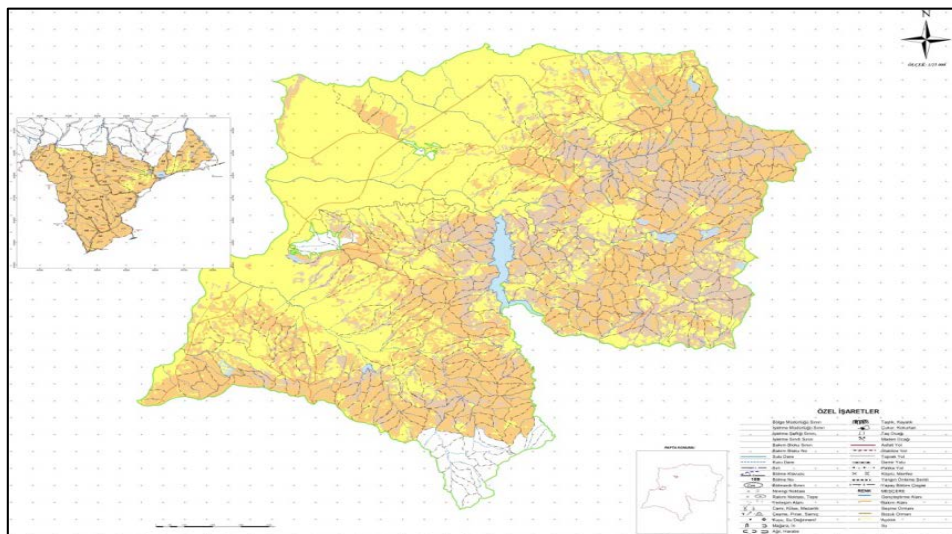

Figure 1. Study area

Field study

Tigercat 635D skidders, with 6x6 drive and functional cabin features, are designed to be used for timber extraction in highly productive stands (Figure 2). The logs are skidded by using high capacity grapple. Table 1 indicates technical features of Tigercat 635D.

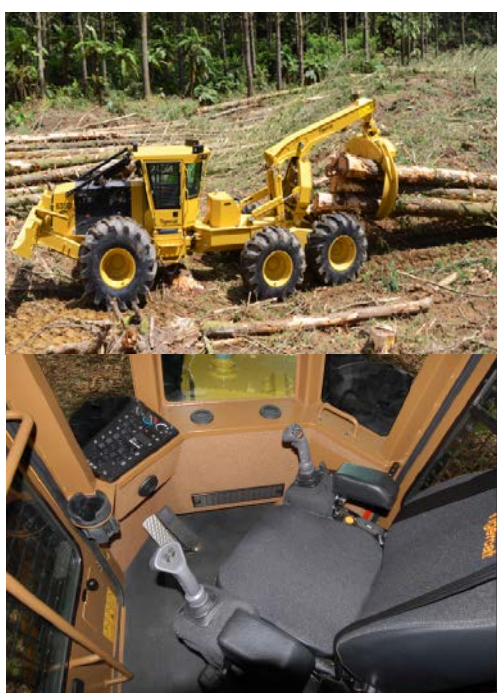

Figure 2. Tigercat 635D (up) and cabin view (down)

Table 1. Technical features of Tigercat 635D

Features	Values
Length	9350 mm
Axle distance	5105 mm
Width	3330 mm
Height	3150 mm
Ground clearance	635 mm
Weight	21430 kg
Engine	194 kW (260 Hp)
Max. speed	14 km hr ⁻¹
Fuel capacity	305 litre
Front wheel	30.5L x 32,26
Rear wheel	28L x 26,16
Grapple	
Standard	1.95 m ² - 3810 mm
Maximum	2.32 m ² - 3835 mm

In this study, timber extraction of forest products which were skidded by Tigercat

635D from stump to landing area were evaluated. Field measurements were performed by at least 30 repetitions based on stand characteristics and topographic features. Timber extraction activity starts with movement of skidder from landing area to stump and ends with unloading logs from grapple at the landing.

Statistical analysis

In time studies, SPSS 22 program was used for statistical analysis where average values and standard deviations were computed, the relation between volume classes and productivity was analysed by One-Way ANOVA at 0.05 confidence level. In order to determine if there is a correlation between total cycle time and decision variables (timber volume and skidding distance), Pearson Correlation Test was used. Then, Linear Regression Analysis was used to determine mathematical models for dependent and independent variables. In regression analysis, dependent variable was total cycle time (y), independent variables were skidding distance (x1), slope (x2), and timber volume (x3). Then, the effects of skidding distance, slope, and volume on production rate was analysed.

Productivity analysis

The productivity of mechanized systems used in timber extraction activities was determined based on operation time. In this study, repetitive timing method was used to compute productivity of skidding operation (Gülci, 2014). In order to prevent time losses between work stages, data logger with chronometer program was used in the field.

Skidding operation was also recorded with a camcorder to watch operation by using projector in the office, and time of each work stage was recorded again with high accuracy. Then, based on time values, hourly productivity of skidding operation (m³/hr) was computed as follows:

$$p = \frac{v}{t} * 60 \quad (1)$$

v = Average volume (m³)

t = Average cycle time (min)

60 = To convert from minute to hour

The timber volume (v) was computed by using Huber formula (Carus, 2002):

$$v = \frac{\pi}{4000} d^2 L \quad (2)$$

d = log diameter (cm)
 L = log length (m)

Work safety assessment

Work safety condition of skidder operators was evaluated. Operator and workers were monitored in each work stage and potential risk factors were determined. Then, suitable work procedure for skidding operation was suggested to prevent potential work related accidents due to these risk factors.

A face to face survey method was used to assess work safety of the operators. Based on

the survey, general information about operators, their social statuses, and previous accidents data were obtained.

Results and Discussion

Productivity

Tigercat 635D skidder was used to transport timbers from stump to landing area on skid trails. In harvesting operations, cut-to-length method was implemented by using feller-buncher. The skidding distance varied from 63 m to 200 m. Time study analysis took seven days and total of 33 cycles were recorded in the field (Table 2).

Table 2. The time study summary table

Trip No	Pieces by turn	Skidding Distance (m)	Slope (%)	Total Volume (m ³)	Moving unloaded (min)	Grapping loads (min)	Skidding loaded (min)	Total cycle time (min)
1	6	100	15	1.51	0.21	2.10	9.040	3.82
2	5	120	15	2.10	0.46	1.40	4.863	3.96
3	4	110	15	1.16	1.28	1.02	6.019	3.46
4	4	120	15	1.49	0.59	2.22	4.353	4.30
5	7	146	15	1.28	1.42	2.05	4.321	4.75
6	5	160	15	1.33	1.38	1.49	5.761	4.20
7	3	170	15	1.28	1.05	2.06	2.551	4.39
8	7	175	15	1.36	1.20	2.10	5.014	4.66
9	6	182	15	1.40	1.40	2.17	3.485	4.97
10	7	200	20	2.03	2.08	3.02	10.418	7.13
11	7	184	15	1.50	0.44	2.55	8.065	4.49
12	7	192	15	1.13	1.14	1.37	4.472	3.64
13	5	180	15	1.46	0.58	2.25	4.716	4.29
14	4	196	20	1.28	1.11	2.42	6.381	4.81
15	4	186	15	1.35	1.26	2.15	4.353	4.76
16	4	170	20	1.52	0.59	1.52	3.020	3.63
17	4	160	20	2.16	0.56	1.55	4.353	4.27
18	7	150	20	1.34	0.42	2.50	7.803	4.26
19	7	136	20	1.59	1.22	2.13	11.821	4.94
20	5	80	5	1.35	0.24	0.55	4.630	2.14
21	6	140	20	0.49	0.17	2.11	9.646	2.77
22	4	120	20	1.13	0.27	1.31	6.273	2.71
23	4	130	20	1.55	0.34	1.37	4.678	3.26
24	4	115	15	1.48	0.33	1.33	5.836	3.14
25	6	145	15	1.52	0.27	1.41	9.568	3.20
26	5	170	12	1.46	0.35	1.41	3.556	3.22
27	5	168	12	1.50	0.27	1.18	3.907	2.95
28	9	181	12	1.56	1.31	2.12	11.100	4.99
29	8	184	12	1.43	0.53	1.45	16.077	3.41
30	8	174	20	1.48	0.34	1.38	10.635	3.20
31	6	174	12	1.39	0.27	1.57	7.235	3.23
32	5	110	10	1.03	0.55	2.02	5.574	3.60
33	5	100	10	0.57	1.22	1.30	5.761	3.09

The cycle time included moving unloaded, grapping loads, and skidding loaded. Unloading time at the landing was insignificant, thus it was included into skidding time. The number of pieces, skidding distance, and ground slope data were obtained in the study.

The results indicated that average skidding distance, ground slope, volume per turn, and total cycle time were 152.36 m, 15.46%, 6.52 m³ and 3.93 minutes. The hourly production rate was found to be 104.50 m³/hr. Pearson Correlation Test results indicated that there was a significant (p<0.001) correlation between each variable and total cycle time at 99% confidence interval.

The regression analysis indicated significant (p<0.05) results for three independent variables at 95% confidence interval. The regression analysis graphic showed a normal distribution (Figure 3). The final regression model with a dependent variable of total cycle time (y) was indicated below:

$$y = 0,99 + 0,014x_1 + 0,05x_2 + 0,009x_3 \quad (3)$$

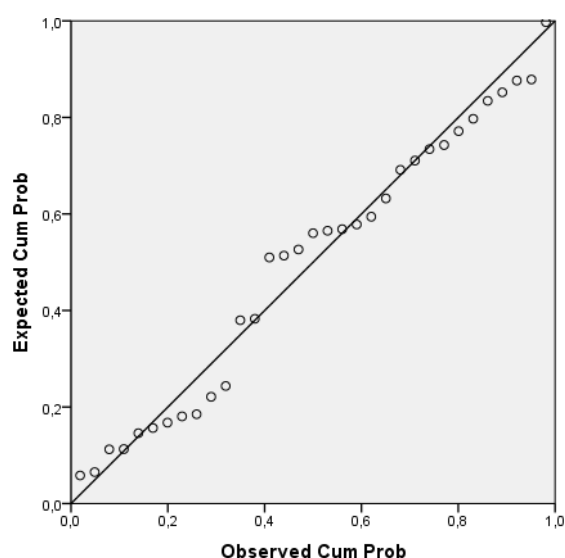

Figure 3. Regression analysis graphic

Work safety

The survey results indicated that operators were within the age group of 15-25. Their education varied from primary school to high school. Operators stated that they have work insurance and social benefits. However, they thought that their income was not a satisfactory for their jobs. It was found that

operators used to work on other heavy machinery before using skidder.

The operators suffer from occupational stress which then causes headaches. Besides, they claimed that they experience irritability and exhaustion due to stress. They also reported that they had no serious work related accidents.

The operators though that cabins are suitable for ergonomic and functional aspects. They stated that driver seat and control systems provide driving comfort during operation.

The operators indicated that there are blind spots around the skidders and these areas are the most dangers spots during logging operations. It was also reported that ground slope and broken terrain structures negatively affect working conditions and increase the risks of accidents and overturning.

The results suggested that it is necessary to provide operators with technical and practical training regarding with work safety and productivity aspects. Besides, the work conditions of the operators should be improved to increase productivity and work safety.

Conclusions

Mechanized timber extraction operations are implemented by using farm tractors, forest tractors, and cable yarding systems in Turkey. The main advantage of mechanized systems is to minimize manpower based application in forest operations, execute the job quickly and easily, and improve the work safety. This study evaluated the capability of Tigercat 635D skidder which was subject to a scientific research in Turkey for the first time.

Time study analysis was implemented to determine productivity and operator safety of the skidding operation performed by a Tigercat 635D skidder. Time study results indicated the main factor affected the cycle time was skidding distance, which was followed by timber volume. It was found that productivity ranges between 42.52 m³ hr⁻¹ and 243.59 m³ hr⁻¹. The average productivity of Tigercat 635D skidder was 104.5 m³ hr⁻¹.

In the field, a survey study was implemented to evaluate working conditions of the skidder operators. The main problem

related with operation productivity and work safety was lack of technical education and practical training. The results indicated that the risk of work related accidents was lower comparing with farm tractor and animal power based traditional methods. Besides, mechanized logging operations potentially decrease other negative effects on forest workers which are commonly experienced in manpower based traditional methods. Some of these effects include bad weather and terrain conditions on workers and inappropriate equipment and gears used in manual logging,

The results from this study suggested that optimum skidding distance should be implemented to minimize total cycle time. This leads to reduction in daily productivity of skidding operation. Besides, unit cost of skidding increases as skidding distance increases. Thus, alternative skidding trails should be evaluated to search for optimum distance.

The skidding operators should receive appropriate technical education and practical training in the field to increase productivity and work safety. Besides, social conditions of the operators should be improved in order to increase their motivation and work related stresses.

References

Acar H.H., Ünver S., Özkaya M.S. 2010. Investigation on efficiency of the harvesting machineries at Artvin Regional Directorate of Forestry. Artvin Çoruh University Journal of Forestry Faculty, 11 (2), 13-20.

Akay A.E., Sessions J. 2004. Identifying the factors influencing the cost of mechanized harvesting equipment. Journal of Science and Engineering, Kahramanmaraş Sütçü Imam University, 7 (2), 65-72.

Akay A.E. 2005. Using farm tractors in small-scale forest harvesting operations, Journal of Applied Sciences Research , 1 (2), 196-199.

Akay A.E., Yenilmez N. 2008. Harvesting machines used in forest operations in North America. Chamber of Forest Engineers, Forest Engineering Journal, 45 (1-3), 24-28.

Carus S. 2002. Comparison of some volume formulas regarding the stem, segments and fractions of the stem. Süleyman Demirel Üniversitesi Orman Fakültesi Dergisi, 2002, Seri: A (1), 101-114.

Gülci, N. 2014. Researches on precision forestry in forest planning. Ph.D. thesis, Kahramanmaraş Sütçü Imam University, Faculty of Forestry, Kahramanmaraş. 264 p.

Öztürk T., Akay A.E. 2007. Modifying Farm Tractors For Forest Harvesting Operations. International Symposium Bottlenecks, Solutions, and Priorities in the Context of Functions of Forest Resources. 17-19 October. İstanbul.

Türk, Y., 2011. Optimization of skidding trails in extraction of industrial wood products using farm tractors in forestry. Karadeniz Technical University, Ph.D. thesis, Trabzon. 145 p.

Genome Projects and Transcriptomics Studies in Forest Trees

Mehmet Cengiz BALOĞLU

Kastamonu University, Faculty of Engineering and Architecture, Department of Genetics and Bioengineering, Kastamonu/TURKEY

mcbaloglu@gmail.com

Abstract

Researches in forest tree genomics have accelerated from advent of next-generation sequencing technologies. In contrast to crop species, advance in genome studies of forest trees has been improved slowly because of long growth period and large genomes of trees. Although about 100.000 forest tree species are available on the world, there is a limited genomic research among them. Genome studies are mainly concentrated on families from Pinaceae, Salicaceae, Myrtaceae and Fagaceae. Genome size of forest trees are different. The biggest and smallest ones are *Picea* and *Populus* genomes, respectively. The first forest tree genome project belongs to Poplar and has been completed for more than one decade. Its complete DNA sequence has been determined and about 45.000 genes have been identified. A sequencing of the genome of *Populus trichocarpa* is a cornerstone of forest tree genomics. Because of its relatively small genome size and its potential economic importance used as biofuels, poplar was selected for genome sequencing. *Eucalyptus grandis* is the second tree whose genome was sequenced in 2014. About 37.000 genes have been predicted as protein-coding genes. Eucalypts are considered as renewable resource of fiber and energy. The genome projects of Fagaceae family members including chestnut, oak and beech have been still continued. Fagaceae Genomics Web provides information about genomic analyses, genetic and physical maps, transcriptomics and functional analyses. Transcriptome analyses of forest trees are mainly examined by microarray and RNA sequencing technologies. Although gene expression studies in forest trees are distributed among seven genera, the most popular and studied one is poplar tree because of its having a reference genome sequence and well-developed microarrays. In addition, gene expression profiles in *Pinus* and *Picea* have been investigated under various biotic and abiotic stresses. This study provides a general information about '-omics' technologies for forest tree species.

Keywords: Forest trees, Genome projects, Transcriptome analysis

Orman Ağaçlarında Genom Projeleri ve Transkriptomik Çalışmalar

Özet

Yeni nesil dizileme teknolojilerinin gelişimiyle birlikte orman ağaçlarında genomik araştırmalar hızlanmıştır. Bitki türlerinin aksine, uzun bir büyüme dönemi ve ağaçların büyük genomları nedeniyle orman ağaçları genom çalışmalarında ilerleme yavaş gerçekleşmiştir. Yaklaşık 100.000 orman ağaç türü dünya üzerinde mevcut olmasına rağmen, bunlardan sınırlı sayıda genomik araştırma yapılmıştır. Genom çalışmaları ağırlıklı olarak Pinaceae, Salicaceae, Myrtaceae ve Fagaceae aileleri üzerine yoğunlaşmıştır. Orman ağaçlarının genom büyüklüğü farklıdır. En büyük ve en küçük olanlar sırasıyla *Picea* ve *Populus* genomlarıdır. İlk orman ağacı genom projesi kavağa aittir ve tamamlanalı on yıldan daha fazla olmuştur. Kavağın tüm DNA dizisi belirlenmiş ve yaklaşık 45.000 gen tespit edilmiştir. *Populus trichocarpa* genomunun sekanslanması orman ağacı genomik çalışmalarında bir köşe taşıdır. Nispeten küçük genom boyutu ve biyoyakıt olarak potansiyel ekonomik öneme sahip olduğundan, kavak genom sekanslama için seçilmiştir. *Eucalyptus grandis*, genomu 2014 yılında sekanslanan ikinci ağaçtır. Yaklaşık 37.000 gen, protein kodlayan genler olarak tahmin edilmiştir. Okalıptüs, elyaf ve yenilenebilir enerji kaynağı olarak kabul edilmektedir. Kestane, meşe ve kayın olmak üzere Fagaceae aile üyelerinin genom projeleri halen devam etmektedir. Fagaceae Genomik internet sitesi genomik analizler, genetik ve fiziksel haritalar, transkriptomik ve fonksiyonel analizler hakkında bilgi vermektedir. Orman ağaçlarının transkriptomik analizi ağırlıklı mikroarray ve RNA dizileme teknolojileri tarafından incelenmektedir. Orman ağaçları gen ekspresyon çalışmaları genellikle yedi cinste çalışılmasına rağmen, referans genom dizisine sahip ve iyi geliştirilmiş mikroarraylerin varlığından dolayı en popüler ve en çok çalışılan kavak ağacıdır. Buna ek olarak, *Pinus* ve *Picea* gen ekspresyon profilleri çeşitli biyotik ve abiyotik stres altında incelenmiştir. Bu çalışma, orman ağaç türleri için '-omik' teknolojiler hakkında genel bir bilgi sağlamaktadır.

Anahtar Kelimeler: Orman ağaçları, Genom projeleri, Transkriptomik çalışmalar

Introduction

Forest trees are woody and perennial plants with an elongated stem, supporting branches and leaves in most species. They form about 82% of the continental biomass and provide more than 50% biodiversity among the all living terrestrial plants (Neale and Kremer, 2011). Genomics research in forest trees has some aims to better understand their evaluation and utilization in industry. Firstly, understanding the structure of tree genomes plays crucial roles for comparative evolutionary relationship analysis. This can be achieved with sequencing of whole genome. Secondly, identification of gene functions focuses on genotype–phenotype relationships which determines a long-lived, perennial and woody habit of trees. Another important objective is characterization of genetic diversity in domesticated and natural populations of forest trees. Lastly, development of genomics-based tools helps to genetically improve forest tree populations (Neale and Kremer, 2011).

Genome studies in forest trees are mainly focused on Pinaceae, Salicaceae, Myrtaceae and Fagaceae families. Up to this date, seven genera of forest trees genomes have been studied. These are *Pinus*, *Picea*, *Pseudotsuga*, *Populus*, *Eucalyptus*, *Quercus* and *Castanea*. Their genomes vary enormously in size and their chromosome numbers, as well. Because of availability of repetitive, non-coding and coding content of conifer genomes, they have large genomes when compared to others. *Arabidopsis thaliana* has the first complete genome sequence of a plant and its genome project was completed in 2000 (AGI, 2000). Compared to thousands of researchers for plant genomics community, forest tree genomics researchers are not enough. From the *Arabidopsis* genome releasing, only six years later black cottonwood (*Populus trichocarpa*) genome sequencing was finished (Tuskan et al., 2006). This situation is a cornerstone of forest tree genomics. The second genome project for tree genomics belongs to *Eucalyptus* which are the world's most widely planted hardwood trees. Its genome was sequenced in 2014 (Myburg et al., 2014). The ongoing genome projects of Fagaceae family members including chestnut, oak and beech have been still continued.

Fagaceae Genomics Web (<http://www.fagaceae.org/>) provides information about genomic analyses, genetic and physical maps, transcriptomics and functional analyses.

Recent reports of the sanger sequencing of *Picea glauca* and *Pinus taeda* indicated that there are known and novel conservative repeats which form a small part of the whole genome (Hamberger et al., 2009; Kovach et al., 2010).

Transcriptome analysis in forest trees have been started for several years ago. Advent of gene expression techniques such as Real-Time qPCR, blotting, microarray and next generation sequencing (NGS), researches have examined different genera of forest trees whose gene expression profile have been determined in response to biotic and abiotic stresses as well, different growth and wood properties.

In this study, key forest tree species used in genomic research have been briefly explained. In addition, transcriptome researches of them have been evaluated. Finally, potential future and outcomes of genomic research in trees have been deeply discussed.

Material and Methods

Some keywords including forest tree, genomics, transcriptomics, omics research and genome projects have been searched in Web of Science and Scopus.

NCBI (National Center for Biotechnology Information Genome), Phytozome, The Fagaceae Genome Web and Dendrome (A Forest Tree Genome Database) were used for examination of genome projects and transcriptome studies of forest trees.

Result and Discussion

Completed genome projects in forest trees

Studies in forest tree genomics has accelerated after improvement of next-generation sequencing technologies over the last 15 years (Neale and Kremer, 2011). This enables identification of function of hundreds of genes and molecular markers for breeding studies at the genome wide scale (Plomion et al., 2016). Up to date, more than 20 tree genome projects have been completed and six

of them belongs to forest trees (Neale et al., 2013)

The first tree genome, *Populus trichocarpa* genome was released in 2006 (Tuskan et al., 2006). Poplar is the third sequenced plant genome, after *Arabidopsis thaliana*, which is first sequenced model dicot plant (AGI, 2000), and rice which is the major economic crop (Goff et al., 2002; Yu et al., 2002; IRGSP, 2005). *Populus euphratica* is the second poplar species whose genome has been sequenced (Ma et al., 2013). Genome projects of the second angiosperm tree species, Eucalyptus (Myburg et al., 2014), and three conifers, Norway spruce (Nystedt et al., 2013), white spruce (Birol et al., 2013) and loblolly pine (Neale et al., 2014; Zimin et al., 2014) have been released.

As a first sequenced tree genome, poplar genome provides the initial information about gene function and genome structure of tree species. Poplar has a small genome (550 Mb) and a 19 chromosomes. Because of its small genome, rapid growth, easy clonal propagation, higher transformation and regeneration capacity, and availability of extensive genetic maps, the US Department of Energy (DOE, USA) has chosen poplar tree as a model plant for tree genomics. Genome of poplar is four times bigger than *Arabidopsis*, which results in having 1.6 times as many genes as the *Arabidopsis* genome (Plomion et al., 2016). The large genome of Poplar is arisen from availability of tandem-segmental duplication and chromosomal rearrangements, as shown by Tuskan et al. (2006). The poplar genome revealed that some gene families are related with tree-specific traits such as wood formation, cellulose or lignin biosynthesis They may also provide information for understanding of evolution tree biology.

The genus Eucalyptus belongs to Myrtaceae family whose members are evergreen and fast-growing tropical trees. Eucalyptus plays an important for medicinal, industrial and aromatic areas, making that it has a commercial value. Because of commonly selected for plantation of forestry, The International Eucalyptus Genome Network has selected *Eucalyptus grandis* for genome sequencing project. *E. grandis* genome has an 8x coverage which includes

approximately 46K protein-coding transcripts (Myburg et al., 2014).

Fagaceae family includes the chestnuts, oaks and beeches trees which are mainly distributed in northern hemisphere. The family of these tree species have an important economic and ecological value. The Fagaceae Project is funded by Plant Genome Research Program and American Chestnut Foundation. Project has examined construction and integration of genetic and physical maps for *Castanea* and development of comparative genomic resources for Northern red oak, White oak and American beech. Researchers in this project have completed physical map and genetic maps of Chestnut (Wheeler and Sederoff, 2009). They have also compared to transcriptomes of cankers and healthy stem tissues of American and Chinese chestnuts (Barakat et al., 2009).

Picea glauca is a gymnosperm tree whose draft genome has been sequenced and established as model for conifer genomics (Warren et al., 2015). They have assembled two white spruce genotypes namely, PG29 and WS77111. Genomes of these two genotypes reveals the fact that, white spruce genome is about 20 Gbp in size and shows broad synteny. Gene ontology analysis of *P. glauca* genome indicated that there are many gene families which are responsible for conifer defense metabolism, the terpene synthases and cytochrome P450s. In addition, mevalonate, methylerythritol phosphate and phenylpropanoid pathways have been identified in this study (Warren et al., 2015). Another predominant gymnosperm, loblolly pine (*Pinus taeda*) genome project has been completed and considered as a reference genome sequence for conifers. Up to date, the largest genome assemblies belong to loblolly pine genome whose genome size is approximately 22 Gbp (Zimin et al., 2014). The researches have been continued to lighten of loblolly pine genome details.

Transcriptome studies in forest trees

Transcriptome researches have been an active area for forest trees. In literature, traits can be grouped into four main sections namely, growth, wood properties, abiotic stress and biotic stress. In addition, widely studied families include Pinaceae (*Pinus*,

Picea), Salicaceae (Populus), Myrtaceae (Eucalyptus) and Fagaceae (Quercus, Castanea) (Neale and Kremer, 2011). Because of availability of reference sequence and well-developed gene expression arrays, Populus is the most popular tree for transcriptome analysis among the forest trees. Former studies disconcertingly indicated that Pinus and Picea are also widely used for transcriptome profiling because there are large number of EST collections for conifers. Despite of availability of many reports from other trait groups, wood forming is the most studied one in the transcriptome profiling of forest tree. In addition, details of gene expression analysis in forest trees have been continued and researchers have spent their time intensively to better understand complexity and network of gene expression analysis. Long life span of trees, different time demands and different ecological areas and funding are the main limitations for transcriptome researches in forest trees.

In addition to these constraints, lack of reference genome sequences and bigger genomes of forest tree, transcriptome analysis has not been performed accurately, resulting in uncharacterized or unidentified paralogous transcripts. Although Populus genome has been sequenced for more than 10 years, genome is not entirely annotated, which creates a problem for inference and comparison of transcripts (Neale and Kremer, 2011). Various studies showed that differences of gene expression levels in trees emerge from utilization of different tissues, divergent developmental state and response to conditions or traits. Although comparative analysis has been performed between Arabidopsis and Poplar (Quesada et al., 2008) or Picea (Pavy et al., 2008), researchers have not achieved finding of definitive or unique patterns among these species.

Next Generation Sequencing (NGS) provides sequencing of RNA molecules, which is also called RNA sequencing or RNA-seq technology. This technology enables gene expression profiling at genome scale. Because of rapid advent of NGS platforms, transcriptome studies in forest trees have increased. Transcriptome profiling of forest trees has been mainly focused on wood or secondary xylem formation (Qiu et al.,

2008; Paiva et al., 2008; Déjardin et al., 2010; Villalobos et al., 2012), bud dormancy (Rhode et al., 2007; Preston and Sandve, 2013; Ueno et al., 2013), root development and interaction with microbial symbionts (Felten et al., 2009; Sebastiana et al., 2014) embryo development in conifers (Klimaszewska et al., 2011; Lelu-Walter et al., 2013; Yakovlev et al., 2014; Klimaszewska et al., 2015).

Conclusion

After release of first forest tree genome sequence, genomic studies for trees have entered crucial and productive phase. Reasons of this situation is summarized like that; rapid development of next-generation sequencing technologies and bioinformatics tools, availability of reference genome sequences and genetic diversity in forest trees. Furthermore, transcriptome analysis of forest trees has opened new perspectives to better understand some questions such as how genes are regulated for reproduction, development, growth and responses to biotic and abiotic stresses in forest trees? We believe that omics technologies will undoubtedly play crucial roles for answering such questions. So, our knowledge will improve some issues such as the mechanisms underlying adaptation and evolution, genes and genomes of forest trees and their responsibility for growth, development, stress responses.

References

- AGI (Arabidopsis Genome Initiative), 2000. Analysis of the genome sequence of the flowering plant *Arabidopsis thaliana*. Nature, 408, (6814), 796-815.
- Barakat A., DiLoreto D.S., Zhang Y., et al. 2009. Comparison of transcriptome from cankers and healthy stems in American chestnut (*Castanea dentata*) and Chinese chestnut (*Castanea mollissima*). BMC Plant Biology, 9, 51.
- Birol I., Raymond A., Jackman S.D., et al. 2013. Assembling the 20 Gb white spruce (*Picea glauca*) genome from whole-genome shotgun sequencing data. Bioinformatics, 29, 1492-1497.
- Déjardin A., Arnaud D., Laurans F., et al. 2010. Wood formation in angiosperms. CR Biol., 333, 325-334.
- Felten J., Kohler A., Morin E., et al. 2009. The ectomycorrhizal fungus *Laccaria bicolor* stimulates lateral root formation in poplar and Arabidopsis through auxin transport and signaling. Plant Physiol., 151, 1991-2005.

- Goff S.A., Ricke D., Lan T.H., et al. 2002. A draft sequence of the rice genome (*Oryza sativa* L. ssp. japonica). *Science*, 296, 92-100.
- Hamberger B., Hall D., Yuen M., et al. 2009. Targeted isolation, sequence assembly and characterization of two white spruce (*Picea glauca*) BAC clones for terpenoid synthase and cytochrome P450 genes involved in conifer defence reveal insights into a conifer genome. *BMC Plant Biol.*, 9, 106.
- IRGSP, (International Rice Genome Sequencing Project), 2005. The map-based sequence of the rice genome. *Nature*, 436, 793-800.
- Klimaszewska K., Hargreaves C., Lelu-Walter M.A., Trontin J.F. 2015. Advances in conifer somatic embryogenesis since year 2000. In: *In vitro plant embryogenesis in higher plants*, Germanà MA, Lambardi M (eds), *Methods in molecular biology*, Springer Humana Press
- Klimaszewska K., Overton C., Stewart D., Rutledge R.G. 2011. Initiation of somatic embryos and regeneration of plants from primordial shoots of 10-year-old somatic white spruce and expression profiles of 11 genes followed during the tissue culture process. *Planta*, 233, 635-647.
- Kovach A., Wegrzyn J.L., Parra G., et al. 2010. The *Pinus taeda* genome is characterized by diverse and highly diverged repetitive sequences. *BMC Genomics*, 11, 420.
- Lelu-Walter M.A., Thompson D., Harvengt L., et al. 2013. Somatic embryogenesis in forestry with a focus on Europe: state-of-the-art, benefits, challenges and future direction. *Tree Genet Genomes*, 9, 883-899.
- Ma T., Wang J., Zhou G., et al. 2013. Genomic insights into salt adaptation in a desert poplar. *Nat Commun*, 4, 2797.
- Myburg A.A., Grattapaglia G.A., Tuskan U.E., et al. 2014. The genome of *Eucalyptus grandis*. *Nature*, 510 (7505), 356-362.
- Neale D., Langley C., Salzberg S., Wegrzyn J. 2013. Open access to tree genomes: the path to a better forest. *Genome Biol*, 14, 120.
- Neale D., Wegrzyn J., Stevens K., et al. 2014. Decoding the massive genome of loblolly pine using haploid DNA and novel assembly strategies. *Genome Biol*, 15, R59.
- Neale D.B., Kremer A. 2011. Forest tree genomics: growing resources and applications. *Nature Rev Genet*, 12, 111-121.
- Neale D.B., Kremer A., et al. 2011. Forest tree genomics: growing resources and applications. *Nat Rev Genet*, 12 (2), 111-122.
- Nystedt B., Street N.R., Wetterbom A., et al. 2013. The Norway spruce genome sequence and conifer genome evolution. *Nature*, 497, 579-584.
- Paiva J., Garcés M., Alves A., et al. 2008. Molecular and phenotypic profiling from the base to the crown in maritime pine wood forming tissue. *New Phytol.*, 178, 283-301.
- Pavy N., Boyle B., Nelson C., et al. 2008. Identification of conserved core xylem gene sets: conifer cDNA microarray development, transcript profiling and computational analyses. *New Phytol.*, 180, 766-786.
- Plomion C., Bastin C., Bogeat-Triboulot M.B., et al. 2015. Forest tree genomics: 10 achievements from the past 10 years and future prospects. *Annals For Sci.*, 73, 77-103.
- Preston J.C., Sandve S.R. 2013. Adaptation to seasonality and winter freeze. *Front Plant Sci.*, 4, 1-18.
- Qiu D., Wilson I.W., Gan S., et al. 2008. Gene expression in *Eucalyptus* branch wood with marked variation in cellulose microfibril orientation and lacking G-layers. *New Phytol.*, 179, 94-103.
- Quesada T., Li Z., Dervinis C., et al. 2008. Comparative analysis of the transcriptomes of *Populus trichocarpa* and *Arabidopsis thaliana* suggests extensive evolution of gene expression regulation in angiosperms. *New Phytol.*, 180, 408-420.
- Rhode A., Ruttink T., Hostyn V., et al. 2007. Gene expression during the induction, maintenance, and release of dormancy in apical buds of poplar. *J Exp Bot.*, 58, 4047-4060.
- Sebastiana M., Vieira B., Lino-Neto T., et al. 2014. Oak root response to ectomycorrhizal symbiosis establishment: RNA-Seq derived transcript identification and expression profiling. *PLoS ONE*, 9, e98376.
- Tuskan G.A., DiFazio S., Jansson J., et al. 2006. The Genome of Black Cottonwood, *Populus trichocarpa*. *Science*, 313 (5793), 1596-1604.
- Ueno S., Klopp C.L.J.C., Derory J., et al. 2013. Transcriptional profiling of bud dormancy induction and release in oak by next-generation sequencing. *BMC Genomics*, 14, 236-250.
- Villalobos D.P., Díaz-Moreno S.M., Said E.S., et al. 2012. Reprogramming of gene expression during compression wood formation in pine: coordinated modulation of Sadenosylmethionine, lignin and lignan related genes. *BMC Plant Biol.*, 12, 100.
- Warren R.L., Keeling C.I., Yuen M.M. et al. 2009. Improved white spruce (*Picea glauca*) genome assemblies and annotation of large gene families of conifer terpenoid and phenolic defense metabolism. *Plant J*, 83, 189-212.
- Wheeler N., Sederoff R. 2009. Role of genomics in the potential restoration of the American Chestnut. *Tree Genetics & Genomes*, 5 (1), 181-187.

Yakovlev I.A., Lee Y., Rotter B., et al. 2014. Temperature dependent differential transcriptomes during formation of an epigenetic memory in Norway spruce embryogenesis. *Tree Genet Genomes*, 10, 355-366.

Yu J., Hu S., Wang J., et al. 2002. A draft sequence of the rice genome (*Oryza sativa* L. ssp. *indica*). *Science*, 296, 79-92.

Zimin A., Stevens K.A., Crepeau M.W., et al. 2014. Sequencing and assembly of the 22-gb loblolly pine genome. *Genetics*, 196, 875-890.

Evaluating the Effects of Abiotic Stress Factors by Gene Level on Forest Trees

Yasemin ÇELİK ALTUNOĞLU

Kastamonu University, Faculty of Engineering and Architecture, Department of Genetics and Bioengineering, Kastamonu/TURKEY
yasemincelikbio@gmail.com

Abstract

Forest trees have exposed to many environmental stress factors such as drought, heat and salinity in their life span and these factors affect geographic expansion of species and forest productivity. In recent years, our understanding about molecular mechanisms under abiotic stress responses in trees was ascended by the advances in molecular biology, genomics, proteomics and bioinformatics. Stress signals caused by abiotic stress factors induce downstream signaling processes and transcriptional controls in the cell. These events trigger stress response mechanisms which enable to re-establish of cellular homeostasis, preserve or repair injured cellular membranes and proteins. Exiguous responses in signaling and stress related gene activation pathways may cause cell death, which is the result of destruction of structural proteins and membranes and irreversible damages in cellular homeostasis. Adaptation to abiotic stress is crucial for trees because they are sessile organisms. Some advances in determining stress responsive genes acting in molecular cascades in trees were made by using transcriptomics, proteomics and metabolomics approaches. Resolving the tree stress response mechanisms at molecular level is essential to improve the stress tolerance and plantation productivity. Besides, these attempts may enable new tools for selective breeding or directed modification of forest tree genotypes.

Keywords: Forest tree, Abiotic stress, Tolerance, Gene expression

Abiyotik Stres Faktörlerinin Orman Ağaçları Üzerinde Gen Düzeyinde Etkilerinin İncelenmesi

Özet

Orman ağaçları yaşam döngüleri boyunca kuraklık, sıcaklık ve tuzluluk gibi pek çok çevresel stres faktörüne maruz kalırlar ve bu faktörler de türlerin coğrafik dağılımını ve orman verimliliğini etkiler. Son yıllarda, moleküler biyoloji, genomik, proteomik ve bioinformatik alanlarındaki ilerlemeler aracılığıyla abiyotik stres cevaplarının moleküler mekanizmaları hakkındaki bilgimiz artmıştır. Abiyotik stres faktörlerince oluşturulan stres sinyalleri, hücredeki sinyal yollarını ve transkripsiyonal kontrolü uyarırlar. Bunlar ise, hücre zarı ve proteinlerin korunması veya tamir edilmesi ve hücresel dengenin yeniden kurulmasına olanak sağlayan stres cevap mekanizmalarını tetiklerler. Sinyal yolları veya stres ile ilgili genlerin aktivasyon yollarındaki yetersiz cevaplar, hücre zarı ve yapısal proteinlerin yıkımı ve hücresel dengede geri dönüşümsüz hasarların oluşumunun sonucu olan hücre ölümü ile sonuçlanabilir. Ağaçlar hareketsiz olduklarından dolayı abiyotik stres faktörlerine adaptasyon oldukça önemlidir. Transkriptomik, proteomik ve metabolomik yaklaşımlar kullanılarak ağaçlarda moleküler yollarda rol alan stres cevap genlerinin belirlenmesinde bazı ilerlemeler kaydedilmiştir. Ağaçlarda stres cevap mekanizmalarının moleküler düzeyde çözülmesi, stres toleransı ve fidanlık veriminin artırılması için gereklidir. Bunun yanında bu uygulamalar, orman ağaçları genotiplerinin seçici üretimi veya yönlendirilmiş modifikasyonu için yeni araçlar sağlayabilir.

Anahtar Kelimeler: Orman ağacı, Abiyotik stres, Tolerans, Gen ekspresyonu

Introduction

Trees are important organisms in terrestrial ecosystems. Forests ensure to protect land, water resources and biodiversity. Moreover, forests are the source of many commercial products (Harfouche et al., 2011). Forest trees encountered many environmental changes in their long lifespan. For example, global

carbon cycle is affected by the response of trees to climate change (Alberto et al., 2013).

Forest trees exposed to many environmental stress factors such as drought, heat and salinity in their life span and these factors affect geographic expansion of species and forest productivity. These abiotic stress factors also limit plant development and

growth. Water deficiency can affect homeostatic equilibrium in the cells and as a result increased levels of free radicals destroy membrane and photosynthesis mechanisms (Perdiguero et al., 2013). High salinity can cause molecular defects and mortality (Zhu, 2001). High temperature results protein degradation and loss of membrane maintenance (Berry and Bjorkman, 1980; Steponkus, 1981; Heremans and Smeller, 1998). Plants have composed of responses controlled by many genes to these stress factors (Wang et al., 2003).

According to model of abiotic stress responses, primary stresses (drought, cold or salinity etc.) cause cellular damage and secondary stresses (osmotic and oxidative stress etc.). Stress signals in the cell (damage of membrane and proteins, suffer of osmotic and ionic homeostasis) upregulate signaling pathways and transcriptional controls. Then, stress response mechanisms work to ameliorate cellular homeostasis and repair destroyed proteins and membranes. If there are missing responses in the signaling pathways or stress related gene activation process, this amelioration may not occur and cell goes to death (Vinocur and Altman, 2005; Harfouche et al., 2014).

Studies subjected to abiotic stress response of plants are common over the last decades. Omics technologies provide to solve plant abiotic stress responses (Urano et al., 2010). Metabolomics, transcriptomics and proteomics approaches are useful for determination of many genes which are upregulated by drought, cold or salinity stresses (Harfouche et al., 2012).

In this study we aimed to analyze studies which determined gene responses of different forest trees against to abiotic stress factors and to evaluate stress response mechanisms.

Material and Methods

Mainly, RNA sequence based transcriptome analysis, microarray-based transcriptome analysis, cDNA-AFLP-based transcriptome analysis, transcriptome and gene expression, gene and protein expression analysis or proteome analysis were utilized for determining responses of some members of *Salicaceae*, *Pinaceae*, *Myrtaceae* and *Fagaceae* families (*Populus*, *Pinus*, *Picea*,

Eucalyptus, *Quercus*, *Catsanea*) under drought, salinity and cold stresses in different studies.

Results and Discussion

LEA (late embryogenesis abundant) proteins were discovered from seeds (Dure and Galau, 1981). These proteins produced in high concentrations in the last steps of seed development (Baker et al., 1988). Then, these proteins determined in other plant tissues (Oztur et al., 2002; Dalal et al., 2009; Olvera-Carrillo et al., 2010). LEA proteins have important roles in drought, cold and salt stress responses of plants besides their roles in normal plant development. However, their function in stress response has not been understood clearly (Bray, 1993). Studies revealed that dehydrins, which is a subgroup of LEA proteins, may protect membranes and proteins and inhibit protein aggregation under drought conditions (Close, 1996; Goyal et al., 2005). They prevent water loss from tissues to protect the cell. A cDNA clone, namely FsDhn1 (codes for type-II LEA proteins) from *Fagus sylvatica* L. seeds was upregulated after ABA treatment under drought stress conditions (Jimenez et al., 2008). In addition, dehydrins proteins in poplar were determined in response to osmotic stress (Caruso et al., 2002). Besides, upregulated levels of LEA proteins were observed in *Picea abies* (Norway spruce) (Blodner et al., 2007).

Heat shock proteins (Hsp) are another group of stress response proteins. These protein group have important roles in normal cellular viability and development as well as their roles in low and high temperature, drought and salty conditions in plants (Krishna et al., 1995; Sabehat et al., 1998; Lopez-Matas et al., 2004; Swindell et al., 2007; Cho and Choi, 2009; Zou et al., 2012). Hsps act in new or stress denatured protein folding, protein disaggregation, translocation and degradation (Bukau and Horwich, 1998; Hartl et al., 2011). They classified into five different subgroups according to molecular functions and molecular weight. These subgroups are small Hsp proteins (sHsp), Hsp70 (DnaK/Ssa), Hsp60 (chaperonin), Hsp90 (HtpG) and Hsp100 (Clp). Hsp90 group proteins were most abundant transcripts

under salt stress conditions to maintain ionic and osmotic homeostasis in *Populus euphratica* (Gu et al., 2004). Yer et al. (2016) found that some members of Hsp70 group proteins in *Populus trichocarpa* (PtHsp70-16, PtHsp70-26, PtHsp70-25, PtHsp70-33) had high expression levels under water deficiency conditions and it may be attributed to Hsp70 proteins roles in response to drought stress.

Moreover, aquaporin proteins have roles under water deficiency conditions. They construct water channels in cellular membranes and provide water pass and water balance in the cell (Maurel et al., 2008). Some aquaporin membrane protein transcripts were induced after watering of white poplar trees which was before in water deficiency conditions (Berta et al., 2010). This can be attributed to the role of these proteins in water transport restoration under re-watered situation (Hamanishi and Campbell, 2011).

Besides, C-repeat-binding factor/dehydration-responsive element binding (CBF/DREB1) pathway was related to cold stress in model organisms (Thomashow, 1999; Yamaguchi-Shinozaki and Shinozaki, 2006). Gene orthologs of CBFs were determined in different trees (Benedict et al., 2006; El Kayal et al., 2006). Different poplar CRF genes were induced in stem and leaf tissues under cold stress (Benedict et al., 2006). Moreover, CBF1a, CBF1b, and CBF1d genes were upregulated by cold while CBF1c gene was induced preferentially by salt in *Eucalyptus gunnii*. This may be one of the reason of winter survival of this broad-leaved tree (Navarro et al., 2009; Harfouche et al., 2014).

Conclusion

Abiotic stresses are the main reason of plant loss. Tolerance to abiotic stresses in plants is regulated by molecular networks related with signal transduction and induction of stress response genes and metabolites (Vinocur and Altman, 2005).

Forest trees developed many response mechanisms to abiotic stresses. Molecular and physiological analyses provide to evaluate details of these response mechanisms and to determine stress related genes. Whole genome sequences of trees allow us to define features of stress related genes. In addition, RNA

sequence data which enables transcriptome profiling at an unprecedented level is a very useful and rapid tool for identification of stress responsive genes.

Abiotic stress tolerance includes many different genes, proteins and metabolic pathways in plants (Vinocur and Altman, 2005). Resolving the tree stress response mechanisms at molecular level is essential to improve the stress tolerance and plantation productivity. Manipulations in stress related genes can raise stress tolerance of plants. Besides, these attempts may enable new tools for selective breeding or directed modification of forest tree genotypes.

References

- Alberto F. J., Aitken S. N., Alía R., González - Martínez S. C., Hänninen H., Kremer A., ... & Savolainen O. 2013. Potential for evolutionary responses to climate change—evidence from tree populations. *Global Change Biology*, 19(6), 1645-1661.
- Baker J., Steele C., Dure L. 1988. Sequence and characterization of 6 Lea proteins and their genes from cotton. *Plant Mol Biol* 11:277–291.
- Benedict C., Skinner J. S., Meng R., Chang Y., Bhalarao R., Huner N. P. A., Finn C. E., Chen T. H., Hurry V. 2006. The CBF1-dependent low temperature signalling pathway, regulon, and increase in freeze tolerance are conserved in *Populus* spp. *Plant Cell Environ* 29:1259–1272.
- Berry, J. & Bjorkman, O. 1980. Photosynthetic response and adaptation to temperature in higher plants. *Annu. Rev. Physiol.* 31, 491–543.
- Berta M., Giovannelli A., Sebastiani F., Camussi A., Racchi M. L. 2010. Transcriptome changes in the cambial region of poplar *Populus alba* L. in response to water deficit. *Plant Biol* 12:341–354.
- Blodner C., Majcherczyk A., Kues U., Polle A. 2007. Early drought-induced changes to the needle proteome of Norway spruce. *Tree Physiol* 27: 1423–1431.
- Bray E. A. 1993. Molecular responses to water deficit. *Plant Physiol* 103:1035–1040.
- Bukau B. and Horwich A. L. 1998. The Hsp70 and Hsp60 chaperone machines. *Cell*, 92, 351-366.
- Caruso A., Morabito D., Delmotte F., Kahlem G., Carpin, S. 2002. Dehydrin induction during drought and osmotic stress in *Populus*. *Plant Physiol Biochem*, 40: 1033–1042.
- Cho E.K. and Choi Y.J. 2009. A nuclear-localized HSP70 confers thermo protective activity and drought-stress tolerance on plants. *Biotechnol Lett* 31, 597–606.

- Close T. J. 1996. Dehydrins: emergence of a biochemical role of a family of plant dehydration proteins. *Physiol Plant* 97:795–803.
- Harfouche A., Meilan R., & Altman A. 2011. Tree genetic engineering and applications to sustainable forestry and biomass production. *Trends in biotechnology*, 29(1), 9-17.
- Harfouche A., Meilan R., Kirst M., Morgante M., Boerjan W., Sabatti M., Scarascia Mugnozza G. 2012. Accelerating the domestication of forest trees in a changing world. *Trends Plant Sci*, 17:64–72.
- Dalal M., Tayal D., Chinnusamy V., Bansal K. C. 2009. Abiotic stress and ABA-inducible group 4 LEA from *Brassica napus* plays a key role in salt and drought tolerance. *J Biotechnol*, 139(2):137–145.
- Dure L. I., Galau G.A. 1981. Developmental biochemistry of cottonseed embryogenesis and germination XIII. Regulation of biosynthesis of principal storage proteins. *Plant Physiol*, 68(1):187–94.
- El Kayal W., Navarro M., Marque G., Keller G., Marque C., Teulieres C. 2006. Expression profile of CBF-like transcriptional factor genes from *Eucalyptus* in response to cold. *J Exp Bot*, 57:2455–2469.
- Gu R., Fonseca S., Puskás L. G., Hackler L. Jr, Zvara A., Dudits D., Pais M. S. 2004. Transcript identification and profiling during salt stress and recovery of *Populus euphratica*. *Tree Physiol*, 24:265–276.
- Hamanishi E., Campbell M. M. 2011. Genome-wide responses to drought in forest trees. *Forestry*, 84:273–283.
- Harfouche A., Meilan R., & Altman A. 2014. Molecular and physiological responses to abiotic stress in forest trees and their relevance to tree improvement. *Tree physiology*, 34(11):1181–1198.
- Hartl F.U., Bracher A., Hayer-Hartl M. 2011. Molecular chaperones in protein folding and proteostasis. *Nature*, 475:324–332.
- Heremans K. & Smeller L. 1998. Protein structure and dynamics at high pressure. *BBA-Protein struct. M.* 1386, 353–370.
- Goyal K., Walton L. J., Tunnacliffe A. 2005. LEA proteins prevent protein aggregation due to water stress. *Biochem J*, 388:151–157.
- Jimenez A. J., Alonso-Ramirez A., Nicolas C., 2008. Two cDNA clones (FsDhn1 and FsClo1) up-regulated by ABA are involved in drought responses in *Fagus sylvatica L* seeds. *J Plant Physiol*, 165(17):1798–1807.
- Krishna P., Sacco M., Cherutti J.F. and Hill S. 1995. Cold-induced accumulation of hsp90 transcripts in *Brassica napus*. *Plant Physiol*, 107,915–923.
- Lopez-Matas M. A., Nuñez P., Soto A., Allona I., Casado R., Collada C., et al. 2004. Protein cryoprotective activity of a cytosolic small heat shock protein that accumulates constitutively in chestnut stems and is up-regulated by low and high temperatures. *PlantPhysiol*, 134,1708–1717.
- Maurel C., Verdoucq L., Luu D. T., Santoni V. 2008. Plant aquaporins: membrane channels with multiple integrated functions. *Annu Rev Plant Biol*, 59:595–624.
- Navarro M., Marque G., Ayax C., Keller G., Borges J. P., Marque C., Teulieres C. 2009. Complementary regulation of four *Eucalyptus* CBF genes under various cold conditions. *J Exp Bot*, 60:2713–2724.
- Olvera-Carrillo Y., Campos F., Luis Reyes J., Garcarrubio A., Covarrubias A. A. 2010. Functional analysis of the group 4 late embryogenesis abundant proteins reveals their relevance in the adaptive response during water deficit in *Arabidopsis*. *Plant Physiol*, 154(1):373–90.
- Oztur Z. N., Talame V., Deyholos M., Michalowski C. B., Galbraith D. W., Gozukirmizi N., large-Tuberosa R., Bohnert H. J. 2002. Monitoring scale changes in transcript abundance in drought- and salt stressed barley. *Plant Mol Biol*, 48(5–6):551–73.
- Perdiguero P., del Carmen Barbero M., Cervera M. T., Collada C., & Soto A. 2013. Molecular response to water stress in two contrasting Mediterranean pines (*Pinus pinaster* and *Pinus pinea*). *Plant Physiology and Biochemistry*, 67: 199-208.
- Sabehat A., Lurie S., and Weiss D. 1998. Expression of small heat-shock protein at low temperatures. A possible role in protecting against chilling injuries. *Plant Physiol*, 117,651–658.
- Steponkus P. L. 1981. Responses to extreme temperatures. Cellular and sub-cellular bases. *Encyclopedia of Plant Physiology*, 12, 371–402.
- Swindell W.R., Huebner M., and Weber A.P. 2007. Transcriptional profiling of *Arabidopsis* heat shock proteins and transcription factors reveals extensive overlap between heat and non-heat stress response pathways. *BMC Genomics*, 8:125.
- Thomashow M. F. 1999. Plant cold acclimation, freezing tolerance genes and regulatory mechanisms. *Annual Review of Plant Biology*, 50:571–599.
- Urano K., Kurihara Y., Seki M., Shinozaki K. 2010. ‘Omics’ analyses of regulatory networks in plant abiotic stress responses. *Curr Opin Plant Biol*, 13:132–138.
- Vinocur B., & Altman A. 2005. Recent advances in engineering plant tolerance to abiotic

stress: achievements and limitations. *Current opinion in biotechnology*, 16(2): 123-132.

Wang W. X., Vinocur B. & Altman A. 2003. Plant responses to drought, salinity and extreme temperatures: towards genetic engineering for stress tolerance. *Planta*, 218, 1–14.

Yamaguchi-Shinozaki K., Shinozaki K. 2006. Transcriptional regulatory networks in cellular responses and tolerance to dehydration and cold stresses. *Annu Rev Plant Biol*, 57:781–803.

Yer E. N., Baloglu M. C., Ziplar U. T., Ayan S., Unver T. 2016. Drought-Responsive Hsp70 Gene Analysis in *Populus* at Genome-Wide Level. *Plant Mol Biol Rep*, 34:483–500.

Zhu, J. K. 2001. Plant salt tolerance. *Trends Plant Sci.*, 6, 66–71.

Zou J., Liu C., Liu A., Zou D., and Chen X. 2012. Overexpression of OsHsp17.0 and OsHsp23.7 enhances drought and salt tolerance in rice. *J Plant Physiol.*, 169, 628–635.

Determination of Dimensional Stability of Wood Bonded with the Combination of Phenol-Formaldehyde and Bio-oil

*Günay ÖZBAY¹, Nadir AYRILMIŞ²

¹Karabuk University, Faculty of Engineering, Karabuk / TURKEY

² Istanbul University, Faculty of Forestry, Istanbul / TURKEY

*Corresponding Author: gozbay@karabuk.edu.tr

Abstract

This study investigated the dimensional stability of wood bonded with phenol-formaldehyde (PF) resin containing different amounts of bio-oil. Pine wood sawdust was converted into renewable chemical feedstock for the production of bio-based phenolic resin. Fourier Transform Infrared Spectroscopy (FT-IR) analysis was performed to characterize the organic functional groups in the bio-oil. The PF resin formulations were mixed with various concentrations of bio-oil. The amount of bio-oil in the PF resin was gradually increased to 40 wt%. The effects of bio-oil additives on the dimensional shrinkage were determined. The results demonstrated that the incorporation of bio-oil into the PF resin can improve the dimensional stability of laminated wood.

Keywords: Bio-oil, Dimensional stability, Shrinkage ratio, Phenol-formaldehyde, Pyrolysis

Özet

Bu çalışmada farklı oranlarda biyoyağ içeren fenol-formaldehit tutkalı ile yapıştırılan ahşap malzemelerin radyal, teğet, boyuna ve hacimsel daralma oranları tespit edilmiş ve fenol-formaldehit tutkalı ile yapıştırılan numunelerle karşılaştırılmıştır. Biyoyağ üretimi çam yongalarından piroliz yöntemiyle elde edilmiştir. Biyoyağ %10, %20, %30 ve %40 oranlarında fenol-formaldehit tutkalına fiziksel olarak homojen bir şekilde karıştırılmıştır. Ahşap lamellar arasına uygulanan tutkallı taslaklar sıcak preste basınç ve sıcaklık altında preslenmiştir. Numunelerin, radyal, teğet, boyuna ve hacimsel daralma oranları tespit edilmiştir. Biyoyağ içeren fenol formaldehit tutkalı ile üretilen örneklerin daralma oranları, boyutsal yön hariç, kayda değer oranda düşük çıkmıştır. Biyoyağ artışı oranı örneklerin daralma oranı üzerine önemli bir etkisi olmamıştır.

Anahtar kelimeler: Biyo yağ, Boyutsal stabilizasyon, Daralma oranı, Fenol formaldehit, Piroliz

Introduction

Although phenol-formaldehyde (PF) resin having a high bond performance is widely used as a binder for exterior grade wood-based panels, phenol is produced primarily from petroleum, and its price and availability depend heavily on petroleum cost. Bio-oil derived from lignocellulosic biomass have been employed as potential sources of biophenols to replace phenol in the production of phenol formaldehyde (PF) resins. Bio-oil is mainly comprised of acids, alcohols, aldehydes, esters, ketones, sugars, phenols, guaiacols, syringols, and furans. The phenols are major components in the bio-oil (Özbay and Ayrilmis, 2015; Aslan et al., 2015). In particular, studies on the application of phenolic-rich bio-oil (or pyrolytic lignin) in the synthesis of phenolic resins has been conducted since the early 2000s (Choi et al., 2015). Therefore, efforts have been made to utilize the it's phenolic fraction as a phenol source for thermosetting PF resins.

As Turkey has limited production of petroleum, use of bio-oil in the production of PF resin will decrease in the demand for the petrol and improve the national economy. In addition, the lignocellulosic materials used in the production of bio-oil can be easily supplied from the wood industry. In this study, commercial PF resin was physically modified with different amounts of bio-oil obtained from pine sawdust. The shrinkage ratio (radial, tangential, longitudinal, and volumetric) of lap shear joints bonded with PF resin containing were investigated.

Materials and Methods

Biomass

Scots pine (*Pinus sylvestris* L.) sawdust was selected to produce bio-oil as biomass.

Biomass was ground and sieved to less than 2 mm, and it was then dried for 12 h at 100–105 °C prior to use as a pyrolysis experiment.

Wood lamellas

Beech wood (*Fagus orientalis* Lipsky) planks (60 mm × 120 mm × 3000 mm) were supplied by a commercial timber company in Karabuk, Turkey. The lamellas with dimensions of 5 mm × 20 mm × 150 mm were prepared from the planks using a planer saw. All the lamellas were planed in order to ensure smooth and flat surface prior to preparing of the lap joint specimen. The wood lamellas were conditioned in a climate room at 20 °C and 65% relative humidity.

PF resin

Commercial PF resin (solid content: 47.1 wt%) was supplied by Polisan chemical company in Izmit, Turkey. The density (20 °C), pH (20 °C), and viscosity (20 °C) of the PF resin were 1.201 g cm⁻³, 11, and 350 cPs, respectively.

Production of bio-oil

The pyrolysis process of pine wood sawdust was carried out in a fixed-bed reactor under a nitrogen atmosphere. The reactor had a stainless steel cylinder with an internal diameter of 60 mm and a height of 210 mm. A schematic diagram of the pyrolysis unit is presented in Figure 1. In the pyrolysis process, a sample of 50 g was weighed and placed into the reactor, which was heated by an electric furnace. During the experiments, the heating rate and pyrolysis temperature were controlled with a Proportional–Integral–Derivative (PID) controller. The temperature was measured every minute inside the bed with a K-type thermocouple. The purge gas used in the

pyrolyzer was nitrogen, and the heating rate was 15 °C/min. The pyrolysis final temperature was 500 °C and maintained for 30 min. The liquid product was collected from the condensers. It was extracted with diethyl ether in two stages to obtain an aqueous and an organic fraction. The ether-soluble fraction was evaporated in a rotary evaporator to completely remove the ether and then obtain a final bio-oil. The chemical properties the bio oil was reported by Özbay and Ayrilmis (2015) in a previous study.

Preparation of the PF resin/bio-oil mixtures

The PF resin was physically mixed with the bio-oil in a mixer with a stirrer. Pyrolysis bio-oil was poured into a beaker and mixed with the PF resin at various mixing ratios. The bio-oil/PF mixture by weight (0/100, 10/90, 20/80, 30/70, and 40/60) was stirred by hand to make it uniform. The mixture was stand at room temperature for 10 min. The experimental design is presented in Table 1.

Bonding of wood lamellas with adhesive mixtures

Two beech lamellas were bonded together with the resin mixtures having different amounts of the bio-oil and PF resin. The resin was applied on one surface (180 g m⁻²) of the lamella using a hand brush. The lamellas were planed to a thickness of 5 mm, bonded together into small samples. The press pressure, temperature and duration were applied as 0.2 N mm⁻², 120 °C, and 15 min, respectively.

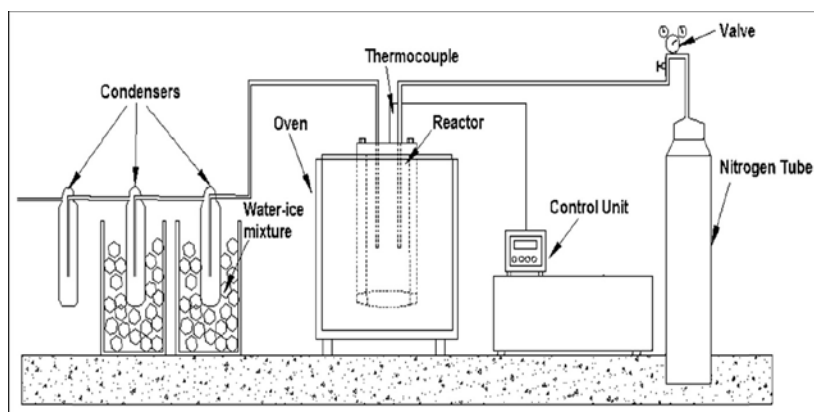

Figure 1. Schematic diagram of the pyrolysis unit

Table 1. Shrinkage values of the wood lamellas bonded with PF resin containing bio-oil

Type of resin mixture	Weight proportions of resin mixtures		Radial shrinkage (%)	Tangential shrinkage (%)	Longitudinal shrinkage (%)	Volumetric shrinkage (%)
	Phenol formaldehyde resin (% wt)	Bio-oil (% wt)				
	Bio-oil	0				
PF (control)	100	0	7.67 (0.33)	6.24 (0.49)	0.29 (0.11)	13.39 (0.48)
PF/bio-oil (90/10)	90	10	3.88 (0.47)	5.74 (0.29)	0.50 (0.14)	9.55 (0.61)
PF/bio-oil (80/20)	80	20	4.13 (0.82)	5.19 (0.21)	0.46 (0.23)	9.54 (0.88)
PF/bio-oil (70/30)	70	30	4.43 (0.55)	5.11 (0.32)	0.44 (0.16)	9.58 (0.69)
PF/bio-oil (60/40)	60	40	4.22 (0.59)	5.33 (0.17)	0.70 (0.27)	9.34 (0.78)

Determination of shrinkage ratio of wood specimens

The shrinking of the specimens was performed according to Turkish Standard (Anonymous, 1983). Test specimens with dimensions of 40 mm x 20 mm x 20 mm in axial, tangential and radial directions, respectively were soaked in water until a constant dimension were obtained. Then, the measured dimensions specimens were oven dried at 103±2 °C until a constant oven-dry weight was obtained. After drying, the dimensions were measured for the determination of tangential and radial, longitudinal, and volumetric shrinkage of test specimens. Shrinking of the specimens was calculated according to the following formula;

$$\beta = [(w_m - d_m) / w_m] \times 100 \quad (1)$$

Where:

β : Shrinking of the specimens (%),

w_m : Wet measurement of the specimens (mm)

d_m : Dry measurement of the specimens (mm)

Results and Discussion

The shrinkage ratios of the wood lamellas bonded with the PF resin containing different amounts of bio-oil is given in Table 1. The

highest radial, tangential, and volumetric shrinkage values, except for the longitudinal shrinkage, were found to be the samples bonded with the pure PF resin.

The shrinkage values of the samples bonded with the modified PF resin were considerably lower than those of the samples as compared to the samples bonded with the pure PF resin. However, the increment in the bio-oil content from 10 to 40 wt% slightly increased the shrinkage of the samples. There was no significant difference in the volumetric shrinkage values of the samples. However, the difference in the radial shrinkage values between the control and modified PF resins were higher than tangential shrinkage.

Conclusions

The following conclusions have been drawn from the results of the present work:

1. The shrinkage values of the wood samples bonded with PF resin containing the bio-oil was lower than that of the wood samples bonded with the pure PF resin.
2. Increasing bio-oil content in the PF resin did not considerably affect the shrinkage of the bonded wood samples.
3. It seems that 10 wt% bio-oil is the optimum amount of bio-oil in the PF resin based on the test results.

References

Anonymous, 1983. TS 4083 1983. Wood determination of radial and tangential shrinkage, TSE, Ankara, Turkey.

Aslan M., Özbay G., Ayırmis N. 2015. Resin characteristics and bonding performance of phenol formaldehyde modified with phenol-rich fraction of crude bio-oil. *Journal of Adhesion Science and Technology*, 29 (24), 2679-2691.

Choi G.G., Oh S.J., Lee S.J., Kim J.S. 2015. Production of bio-based phenolic resin and activated carbon from bio-oil and biochar derived from fast pyrolysis of palm kernel shells. *Bioresource Technology*, 178 (1), 99-107.

Özbay G., Ayırmis N. 2015. Bonding performance of wood bonded with resin mixtures composed of phenol-formaldehyde and bio-oil. *Industrial Crops and Products*, 66 (1), 68-72.

Elastic Constants of Calabrian Pine and Cedar

*Ergün GÜNTEKİN¹, Tuğba YILMAZ AYDIN¹, Murat AYDIN²

¹Suleyman Demirel University, Faculty of Forestry, Isparta / TURKEY

²Suleyman Demirel University, Keçiborlu Vocational School / TURKEY

*Corresponding Author: ergunguntekin@sdu.edu.tr

Abstract

Wood is un-isotropic material and its mechanical properties will vary with the grain orientation. This study investigated elastic constants of Calabrian pine (*Pinus brutia* Ten.) and Cedar (*Cedrus libani*) woods which are economic significance to the Forest Products Industry. Elastic engineering properties are required as input parameters for advanced computational models often used in civil engineering and material science, and their determination is therefore of significant importance. Young's modulus in three principal directions (E_L , E_R , E_T) and Poisson ratios (μ_{LR} , μ_{LT} , μ_{RL} , μ_{RT} , μ_{TL} , μ_{TR}) of the above wood species were determined in compression tests on 20x20x60 mm samples using bi-axial extensometer. Shear modulus (G_{LR} , G_{LT} , G_{RT}) of the wood species were determined on 20x20x20 mm samples using EPOCH 650 ultrasonic flaw detector with 1 MHz transverse transducers. Young's modulus of the Calabrian pine in L,R and T directions were 9200, 975 and 672 N mm⁻², respectively. Young's modulus of the Cedar in L, R and T directions were 7920, 1069 and 677 N mm⁻², respectively. Poisson's ratios of the Calabrian pine and Cedar wood ranged from 0.077 to 0.66 and 0.075 to 0.59, respectively. The calculated shear modulus in LR, LT and RT planes were 1150, 550, 430 N mm⁻², respectively for Calabrian pine and 1045, 605, 480 N mm⁻², respectively for cedar wood. The determined elastic constants can be used in computational modeling of load carrying wood members or structures constructed with the investigated wood species.

Keywords: Calabrian pine, Cedar, Elastic constants

Kızılçam ve Sedir Elastic Sabitleri

Özet

Ahşap anizotropik bir malzemedir ve mekanik özellikleri lif yönüne göre değişmektedir. Bu çalışmada orman endüstri sektöründe ekonomik öneme sahip Kızılçam ve Sedir odunlarının elastik özellikleri incelenmiştir. Elastik mühendislik özellikleri inşaat mühendisliği ve malzeme mühendisliği gibi alanlarda kullanılan gelişmiş sayısal modellerde girdi parametreleri olarak kullanılmaktadır ve bu yüzden belirlenmelerinin anlamlı bir önemi bulunmaktadır. Yukarıdaki ağaç türü odunlarının üç lif yönündeki Young modülü (E_L , E_R , E_T) ve Poisson oranları (μ_{LR} , μ_{LT} , μ_{RL} , μ_{RT} , μ_{TL} , μ_{TR}) 20 x 20 x 60 mm ebatlarındaki örnekler üzerinde basma testleri yapılarak belirlenmiştir. Örneklerde kesme modülleri (G_{LR} , G_{LT} , G_{RT}) 20 x 20 x 20 mm örnekler üzerinde EPOCH 650 hata dedektörü ve 1 MHz enine sensörler kullanılarak belirlenmiştir. Kızılçamda L,R,T yönlerindeki Young modülü değerleri sırasıyla ortalama 9200, 975 ve 672 N mm⁻², Sedirde ise sırasıyla 7920, 1069 ve 677 N mm⁻² bulunmuştur. Kızılçam ve Sedirde Poisson oranları 0.077 ile 0.66 arasında değişmektedir. Kızılçam için LR, LT ve RT düzlemlerinde kesme modülleri sırasıyla ortalama 1150, 550 ve 430 N mm⁻², Sedir için ortalama 1045, 605 ve 480 N mm⁻² olarak hesaplanmıştır. Ağaç türlerinin belirlenen elastik özellikleri yük altındaki yapıların veya elamanların sayısal modellenmesinde kullanılabilir.

Anahtar Kelimeler: Kızılçam, Sedir, Elastik sabit

Introduction

Elastic properties in the three principal directions are important in the design of wood members in structures and used to characterize materials. In general, there are many physical parameters that may affect the elastic properties, such as the moisture content (MC), specific gravity, temperature, creep, knots, number of annual growth rings,

and grain angle. Interest in the orthotropic behavior of wood is not new, but elastic constants in the R and T directions remains unrevealed for most wood species. The usable data is limited to a few references, while elastic properties for some wood species have also been reported (Ross, 2010). Elastic properties can be determined using

both static and dynamic methods. Use of destructive and non-destructive testing (NDT) in the field of wood and wood-based materials is advancing every day.

While the ultrasonic technique is expected to be dependable to predict the elastic and shear modulus, its reliability to measure the Poisson's ratios remains uncertain.

Ultrasonic wave velocity has advantages over other techniques in practical terms (Esteban et al., 2009). Determination of the ultrasonic modulus of elasticity in a solid depends on its elastic properties and its density (Oliveira et al., 2005). The velocity of sound in wood is influenced by factors such as MC, grain orientation, density, decay, temperature, and geometry (Oliveira and Sales, 2006).

Information on the elastic properties of wood in the orthotropic directions is not available for the majority of Turkish species. Most studies deal with bending modulus of elasticity (MOE) and bending, tensile, and compression strength at constant MC. Although data are needed for three-dimensional modeling of mechanical behavior, no information is available for this purpose. In this study, elastic constants for Anatolian black pine is determined by non-destructive testing under constant moisture conditions.

Materials and Methods

For this study, the sample trees were harvested from a red pine-cedar mixed stand in the Bucak Forest Region of the Southwest of Turkey. Calabrian pine covers the largest area among conifers grown in Turkey. Cedar is also one of the important species among conifers. The woods of both species are important raw material for various fields of forest industry and construction.

The logs were 57 to 70 cm in diameter at breast height. All the samples came from the trunk section 1 to 3 meters from the ground level. First, radial or tangential planks were sawn and planed from the logs. Then, small clear samples were cut. The dimension of the samples were 20x20x20 mm for the ultrasonic measurements. 20x20x60 mm samples were also prepared in L, R, T

directions in order to obtain elastic constants from static testing.

Compression tests (Figure 1) were conducted using a bi-axial extensometer with a loading speed of 2 mm minute⁻¹ on 20x20x60 mm samples (Figure 1). The stress-strain curves obtained were used in order to evaluate Young's moduli and Poisson ratios of the specimens. The Young's modulus was calculated from the ratio of the stress σ to the strain ϵ measured in the linear elastic range:

$$E_i = \frac{\Delta\sigma_i}{\Delta\epsilon_i} = \frac{\sigma_{i,2} - \sigma_{i,1}}{\epsilon_{i,2} - \epsilon_{i,1}} \quad i \in R, L, T$$

The Poisson's ratio ν , defined as:

$$\nu_{ij} = -\frac{\epsilon_i}{\epsilon_j}, \quad i, j \in R, L, T \text{ and } i \neq j$$

Where; ϵ_i represents the active strain component in the load direction and ϵ_j is the passive (lateral) strain component, which was determined in the linear elastic range from the linear regression of the passive-active strain diagram. Since the strength behavior of wood in R and T directions is obscure, maximum compression strength was calculated using 0.2% yield values using following formula.

$$\sigma_{UCS} = P_{max}/A$$

Where; σ_{UCS} represents compression strength, P_{max} is the yield load and A is the cross-sectional area of the specimen.

Six shear wave velocities propagating along the principal axes of anisotropy were measured using EPOCH 650 ultrasonic flaw detector. The transversal (shear) wave frequency was 1 MHz (Figure 2). Two Olympus V153-RM contact transducers for transversal waves were used to carry out the measurements. To ensure coupling between the specimen and the sensors during measurements, a gel medium was applied. Three modulus of rigidity (GLR, GLT, GRT) were determined based on the velocities using following formulas:

$$G_{RT} = \rho ((V_{RT} + V_{TR}) / 2)^2 10^{-6}$$

$$G_{LT} = \rho ((V_{LT} + V_{TL}) / 2)^2 10^{-6}$$

$$G_{LR} = \rho ((V_{RL} + V_{LR}) / 2)^2 10^{-6}$$

Where ρ (kg m⁻³) is the density of the wood, V_{ij} (m s⁻¹) is the shear wave velocity.

Analysis of variance (ANOVA) general linear model procedure was run for data with SAS statistical analysis software to interpret

effects of temperature and duration of exposure on the properties measured of the clear wood samples.

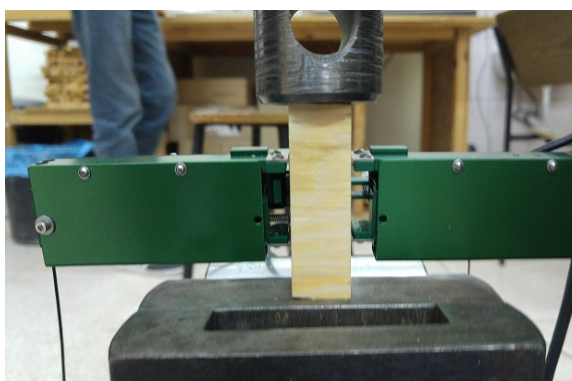

Figure 1. Compression test samples prepared for the study

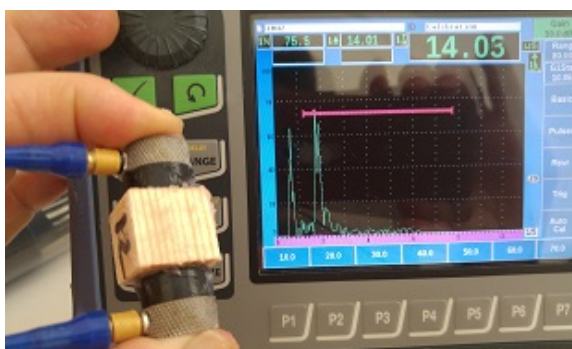

Figure 2. Measurement of shear waves

Results and Discussions

Average density of the Calabrian pine samples tested was 530 kg m^{-3} and the average moisture content was 12.5%. Average density of the Cedar samples was 550 kg m^{-3} and the average moisture content was 12.8%. In comparison to available literature references at 12% MC, the measured density values are comparable.

Average stress-strain curves used to calculate Young's modulus of the specimens tested is presented in Figure 3.

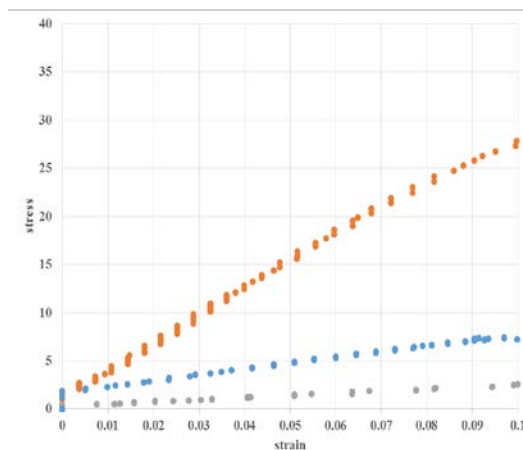

Figure 3. Average stress-stress curve in L, R, T directions

Poisson's ratios were calculated from the linear regimes of the vertical and horizontal strain graphs as shown in Figure 4.

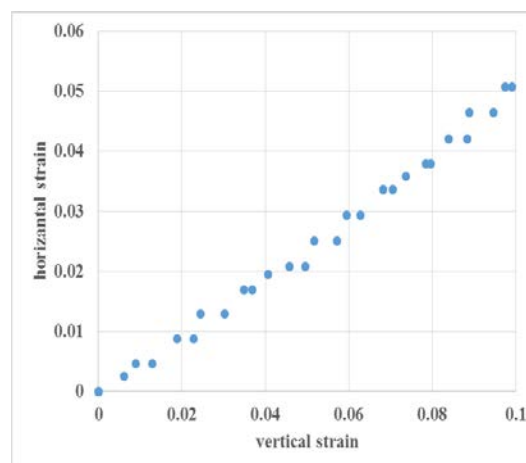

Figure 4. Example of stain graphs

Test results from static testing show that the EL, ER and ET values calculated from compression tests are 9200, 975, 672 N mm^{-2} , respectively for Calabrian pine, and 7920, 1069, 667 N mm^{-2} , respectively for Cedar. Full elastic constants for Calabrian pine and Cedar wood grown in Turkey is not available. In the previous research of Guntekin et al., (2015) the Young modulus in three principal directions determined from compression tests using VIC software at similar MC values were 8650, 917 and 624 N mm^{-2} . For the Cedar, the reported values were 7496, 974 and 663 N mm^{-2} (Guntekin et al., 2015). Since samples used in both testing come from same stand, similar values are

expected. Poisson ratios calculated from compression testing are presented in Table. Calculated average Poisson ratios seem to be higher than average Poisson ratios reported for softwood species (Ross, 2010). Coefficient of variations (%) for Poisson ratios ranged from 11-44%, which are seemingly high. High natural variance of the Poisson's ratios was also implied by Hering et al., (2012) and Guntekin et al., (2016). Poisson's ratios are less investigated elastic constants, because their determination requires delicate instruments. Poisson's ratios vary within and between species and are affected by moisture content and specific gravity (Ross, 2010).

Table 1. Poisson ratios calculated from compression tests

Poisson ratio	Calabrian pine	Cedar	Softwoods ¹
vLR	0.48	0.55	0.35
vLT	0.49	0.59	0.36
vRT	0.66	0.59	0.42
vRL	0.082	0.075	0.053
vTR	0.37	0.77	0.34
vTL	0.077	0.146	0.037

¹ Ross, 2010

Shear modulus determined from shear velocities in LR, LT and RT planes are presented in Table 2. In general, shear modulus of wood is positively affected by density and negatively affected by moisture content, temperature and loading direction (Brandner et al., 2007). The shear modulus of wood has practical importance, because 15 % of the deformation occurs because of shear in bending. In the structural design of wooden structures the dimensions of the beams are usually controlled by stiffness, not by strength (Divos et al., 1998). Comparing with the evaluation of the Young's modulus, determination of the shear modulus is complicated. The presence of secondary stresses makes it difficult to predict shear properties, and the comparison of shear properties collected from different test methods. Investigations have shown different shear moduli values from different test methods as a result of the stress distributions inherent to the test setups (Harrison, 2006).

Thus, it is difficult to make direct comparisons between the results of individual research efforts. In general, E:G ratio of 16 was commonly accepted for structural applications but researches has shown that the ratio will change depending upon testing method. Investigations have shown that the ratio of E:G varies between 8 and 65 (Harrison, 2006; Divos et al., 1998).

Table 2. Shear modulus values (N mm⁻²) calculated for Calabrian pine and Cedar wood

Shear modulus	Calabrian pine	Cedar	Softwoods ¹
GRT	235 (6)*	286 (5)	70-230
GLT	850 (6)	888 (7)	650-1050
GLR	1150 (8)	1036 (8)	700-1100

*values in parenthesis are the coefficient of variations

¹ Ross, 2010

It is known that dynamically determined elastic properties are 10-20% (or even more, depending on the frequency of ultrasonic waves) increased compared with statically calculated values (Keunecke et al., 2011).

Conclusions

Elastic properties in the three principal directions are important in the design of wood members in structures. In this study, elastic constants of Calabrian pine and Cedar were determined using both destructive and non-destructive methods. While the ultrasonic technique is expected to be dependable to predict the elastic and shear modulus, its reliability to measure the Poisson's ratios remains uncertain.

Results found in this study can be used in advanced computational models such as finite elements method where behavior of wood members or system is under load is investigated.

References

Brandner R., Gehri E., Bogensperger T., Schickhofer G. 2007. Determination of modulus of shear and elasticity of glued laminated timber and related examinations. CIB W 18-40-12-2, Bled, Slovenia.

Divos F., Tanaka T., Nagao H., Kato H. 1998. Determination of shear modulus on construction size timber. *Wood Science and Technology*, 32, 393-402.

Esteban L.G., Fernandez F.G., de Palacios P. 2009. MOE prediction in *Abies pinsapo* Boiss. timber: Application of an artificial neural network using non-destructive testing. *Comput. Struct.*, 87, 1360-1365.

Guntekin E., Yılmaz Aydın T., Niemz P. 2015. Prediction of compression properties in three orthotropic directions for some important Turkish wood species using ultrasound. *BioResources*, 10(4),7252-7262.

Guntekin E., Yılmaz Aydın T., Niemz P. 2016. Some orthotropic elastic properties of *Fagus orientalis* as influenced by moisture content. *Wood Research*, 61(1), 95-104.

Harrison S.K. 2006. Comparison of shear modulus test methods. Master Thesis, Faculty of Virginia Polytechnic and State University, Blacksburg, USA.

Hering S., Keunecke D., Niemz P. 2012. Moisture-dependent orthotropic elasticity of beech wood. *Wood Sci. Technol.*,45, 927-938.

Keunecke D., Merz T., Sonderegger W., Schnider T., Niemz P. 2011. Stiffness moduli of various softwood and hardwood species determined with ultrasound. *Wood Material Science and Engineering.*, 6, 91-94.

Oliveira F.G.R., Candian M., Lucchette F.F., Salgon J.L. 2005. Ultrasonic velocity in *Goupia glabra*. *Materials Research* 8(1), 11-14.

Oliveira F.G.R., Sales A. 2006. Relationship between density and ultrasonic velocity in Brazilian tropical woods. *Bioresource Technology*, 97, 2443-2446.

Ross R.J. 2010. *Wood Handbook: Wood as an Engineering Material*, General Technical Report FPL-GTR 190, USDA Forest Products Laboratory, Madison.

Some Physical and Mechanical Properties of Juvenile Chestnut Shoots

*Nusret AS¹, Hüseyin AKKILIÇ¹, Murat KÖSE²

¹Istanbul University, Faculty of Forestry, Istanbul / TURKEY

²Marmara Forestry Research Institute

*Corresponding Author: nusretas@istanbul.edu.tr

Abstract

Chestnut (*Castanea sativa* Mill.) is established to the assorted forests with especially hardwood species (oak, hornbeam, beech, basswood etc.) in Marmara and North Anatolia regions of our country. It is very important tree in term of both its wood and fruit. It is benefited to from the wood, as firewood and product, its fruits and its flowers in production of honey. But it has been greatly affected and damaged from chestnut cancer in everywhere located. When began to cut to the bottom part of dried and drying chestnut trees due to the disease, it is obtained to lots of the juvenile shoots because of given highly its shoot feature. It is necessary to re-cut to the growing shoots by reason of relapsed again of the disease some time later. But it is known exactly where use efficiently to this material obtained to fine-scale. It is known to the technological properties of chestnut wood in terms of the determination where the used. But these values are determined for chestnut woods which are reached to mature wood. Due to the physico-mechanical properties of the juvenile chestnut shoots grown in Turkey have not known, juvenile chestnut shoots are not known to the assessment facilities in the appropriate using place as dimension. The aim of this study is revealed to these physico-mechanical properties of the juvenile chestnut shoots, detected to the changes by comparing with the value of mature chestnut wood obtained in literature and provided to the information about possible using field of juvenile chestnut shoots. We used to body portion of the shoots which is 10-15 cm with a diameter, 1m in length total of 5 pieces (5-10 years old) from Istanbul-Bahçekoy region as research material. Physical and mechanical test samples were prepared in accordance with the relevant standards and tests were performed. As a result, the average value of the tested chestnut shoots is found out 0.58 g cm⁻³ oven-dry density, 0.62 g cm⁻³ of air-dry density, 5.38% of radial shrinkage, 8.35% of tangential shrinkage, 48.65 N mm⁻² of compressive strength, 98.90 N mm⁻² of bending strength, 10793.3 N mm⁻² of elasticity modulus of bending, 0.59 kN cm⁻¹ of dynamic bending.

Keywords: Chestnut, Juvenile wood, Physical properties, Mechanical properties, Using area

Genç Kestane Sürgünlerinin Bazı Fiziksel ve Mekaniksel Özellikleri

Özet

Kestane (*Castanea sativa* Mill.), yurdumuzda Marmara ve Kuzey Anadolu'da özellikle yapraklı türlerle (meşe, gürgen, kayın, ıhlamur vb.) karışık ormanlar kurmaktadır. Hem odunu ve hem de meyvesi yönünden çok önemli bir ağaçtır. Yapacak ve yakacak olarak odunundan, meyvesinden ve bal üretiminde çiçeğinden faydalanılmaktadır. Ancak bulunduğu her yerde kestane kanserinden büyük oranda etkilenmiş ve zarar görmüştür. Hastalıktan dolayı kuruma olan (ya da kuruması muhtemel olan) ağaçlar, dip kısımlarından kesilmekte ve yüksek derecede sürgün verme özelliğinden dolayı çok miktarda genç sürgünler elde edilmektedir. Büyüyen bu sürgünlerin bir zaman sonra hastalığın tekrar gelmesi nedeniyle yeniden kesilmesi gerekmektedir. Ancak elde edilecek ince çaplı bu materyalin gerektiği gibi verimli olarak nerelerde değerlendirilebileceği ise tam olarak bilinmemektedir.

Kestane odununun kullanım yerlerinin belirlenmesi açısından önem arz eden teknolojik özellikleri bilinmekle birlikte bu değerler olgun odun içeren bireyler üzerinden belirlenmiştir. Türkiye'de yetişen genç sürgünlerin sahip olduğu fiziko-mekanik özellikler bilinmediği için boyut olarak uygun kullanım yerlerinde değerlendirme imkanları bilinmemektedir. Bu çalışmanın amacı genç sürgünlerde bu fiziko-mekanik değerleri ortaya koymak ve olgun kestane odununa ait literatür değerleri ile karşılaştırarak değişimleri saptamak, muhtemel kullanım yerleri ile ilgili bilgi vermektir.

İstanbul-Bahçeköy bölgesinden 10-15 cm çapa sahip 1 m boyunda toplam 5 adet (5-10 yaşlarında) sürgün gövde kısmı araştırma materyali olarak kullanılmıştır. Fiziksel ve mekanik test örnekleri ilgili standartlara göre hazırlanıp, deneyleri yapılmıştır.

Sonuç olarak test edilen kestane sürgünlerinin ortalama değerler olarak tam kuru yoğunluğu 0.58, hava kuru yoğunluğu 0.62 g cm⁻³, radyal daralma değeri % 5.38, teğet %8.35, Basınç direnci 48.65 N mm⁻², Eğilme direnci 98.90 N mm⁻², Eğilmede elastikiyet modülü 10793.3 N mm⁻², dinamik eğilme 0.59 kN cm⁻¹ bulunmuştur.

Anahtar Kelimeler: Kestane, Genç odun, Fiziksel özellikler, Mekanik özellikler, Kullanım yerleri

Introduction

Chestnut (*Castanea sativa* Mill.) is established to the assorted forests with especially hardwood species (oak, hornbeam, beech, basswood etc.) in Marmara and North Anatolia regions of our country (Figure 1).



Figure 1: The distribution of chestnut forest (Kestane eylem planı 2013-2017)

It is known to be 10-12 species of chestnut in the World. Only one species, Anatolian chestnut (*Castanea sativa* Mill), distribute naturally in Turkey. These tree species are able to length up to 25-30 meters, can live to be 1.000 years old (Belen, 2001).

According to the management plans, chestnut forest distributed in approximately 262.000 hectares in our country (Kestane Eylem Planı 2013-2017).

It is very important tree in term of both its wood and fruit. It is benefited to from the wood, as firewood and product, its fruits and its flowers in production of honey.

It has been greatly affected and damaged from chestnut cancer in everywhere located. When began to cut to the bottom part of dried and drying chestnut trees due to the disease, it is obtained to lots of the juvenile shoots because of given highly its shoot feature. These shoots reach 5-10m in length, 5-15cm in diameter during 10-15 years (Picture 1).



Picture 1: Shoots in different diameters.

Wood of chestnut, well known for its good technological properties has various uses such as sawnwood, structures, windows, doors, parquets, furniture, etc. But these values are determined for chestnut woods which are reached to mature wood. However, chestnut shoots is still not used on a large scale as a raw material by the wood-processing industries. One of the main reasons is the insufficient knowledge of its properties. For example, there is not adequate information about the influence of juvenile wood on wood quality of chestnut shoots. Due to the physico-mechanical properties of the juvenile chestnut shoots grown in Turkey have not known, juvenile chestnut shoots are not known to the assessment facilities in the appropriate using place as dimension.

The aim of this study is revealed to these physico-mechanical properties of the juvenile chestnut shoots, detected to the changes by comparing with the value of mature chestnut wood obtained in literature and provided to the information about possible using field of juvenile chestnut shoots.

Materials and Methods

It was used bottom of stem of the chestnut trees (5-10 years old) which is 10-15 cm in diameter, 1m in length (total of 5 sections) from Istanbul-Bahcekoy region as research material. Physical and mechanical test samples were prepared and the following tests were done on these specimens according to the standards presented.

Density	TS 2472/1976
Shrinkage	TS 4083/1983
Bending strength	TS 2474/1976
Impact bending	TS 2477/1976

Modulus of elasticity in bending
TS 2478/1976
Compression strength parallel to grain
ISO-DIS 13061-17

Results and Discussions

Aritmetic mean, number of specimens, variance, coefficient of variation and Standard deviation in connection with the physico-mechanical properties of chesnut shoots were given on the Table 1.

The average value of the tested chestnut shoots is found out 0.58 g cm⁻³ oven-dry density, 0.62 g cm⁻³ of air-dry density, 5.38% of radial shrinkage, 8.35% of tangential shrinkage, 48.65 N mm⁻² of compressive strength, 98.90 N mm⁻² of bending strength, 10793.3 N mm⁻² of elasticity modulus of bending, 0.59 kN cm⁻¹ of dynamic bending. Oven dry density of chesnut wood changes between 0.389-0.756 g cm⁻³ and the place

where close to pith (which have wider anual rings), density is greater than the place which have narrow anual rings (Berkel, 1946).

In other research it has been stated that there was no statistically significant differences between juvenile and mature wood of black locust (*Robinia pseudoacacia* L.) in terms of wood density (Adamopoulos, S., 2007). Compressive strength is similar and there is no differances between juvenile and mature wood of black locust. But other mechanical properties are lover than mature wood at sytatistically confidance level %5. Similar results were found in other research (Thomas 1984).

Table 1. Some physico-mechanic properties of juvenile chesnut woods

Properties	Arithmetic mean	Standart Deviation	Variance	Min. value	Max. Value	Coefficient of variation (%)	Number of specimen
Density Oven dry (g/cm ³)	0.581	0.0336	0.00113	0.528	0.651	5.1	36
Density Air dry (g/cm ³)	0.623	0.0518	0.00268	0.575	0.727	8.06	32
Shirinkage (%) Radial	5.385	0.5293	0.28017	4.28	6.96	9.6	32
Shirinkage (%) Tangential	8.357	0.8983	0.80698	6.3	10.31	10.6	32
Compression (N/mm ²)	48.65	3.6930	13.6382	42.29	54.53	7.5	36
Bending (N/mm ²)	98.90	8.7586	76.7139	83.65	110.5	8.8	34
Mod.of Elasticity (N/mm ²)	10793.29	1260.21	1588129.3	8484.8	13336	11.6	34
Impact Bending (kN/cm)	0.596	0.11911	0.0141892	0.4082	0.9492	19.9	30

Founded mean values were compared with chesnut which has mature wood obtained from literature (As, Koç, Doğu, Aksu, Atik, Erdinler, 2002) (Table 2).

Table 2. Comparison of juvenile and mature chesnut wood's properties

Properties	Juvenile wood	Mature wood
Density Oven dry (g/cm ³)	0.58	0.59
Density Air dry (g/cm ³)	0.62	0.63
Shirinkage (%) Radial	5.3	4.3
Shirinkage (%) Tangential	8.3	6.4
Compression (N/mm ²)	48.6	50
Bending (N/mm ²) (MOR)	98.9	77
Mod.of Elasticity (N/mm ²) (MOE)	10793.2	9000
Impact Bending (kN/cm)	0.59	0.57

The degrading effect of juvenile wood on the mechanical properties is more pronounced in coniferous than in deciduous trees (Bendsten 1978; Bendsten and Senft 1986; Pearson and Gilmore 1971; Larson et al., 2001).

In our research, samples were taken from the bottom of trees which included lower juvenile wood than upside . It is considered that the values were found close to literature values for this reason. Even some mechanical values (MOR,MOE) are found higher. It is expected that it will find lover mechanical values if specimens is taken from the uperside of chesnut shoots which have more juvenile wood.

References

As, Koç, Doğu, Aksu, Atik, Erdinler, 2002: Türkiye'de Yetişen Endüstriyel Öneme Sahip Ağaçların Anatomik, Fiziksel, Mekanik ve Kimyasal Özellikleri. İ.Ü. Orman Fakültesi Dergisi, Seri B, Cilt 51, Sayı 1, İSTANBUL.

Belen, İ., 2001: Dünyada ve Türkiye'de Odun Dışı Orman Ürünü Olarak Kestanenin Değerlendirilmesi, Karadeniz Teknik Üniversitesi, Orman Mühendisliği Ana Bilim Dalı, Yüksek Lisans Tezi, Eylül 2001, Trabzon.

Bendsten, B. A. 1978. Properties of wood from improved and intensively managed trees. Forest Prod. J. 28(10): 61–72.

Bendsten,B.,A., and J. F. Senft. 1986. Mechanical and anatomical properties in individual growth rings of plantation-grown eastern cottonwood and loblolly pine. Wood Fiber Sci.18(1):23–38.

Berkel, A., 1946, Kestane Odununun Önemli Teknolojik Vasıfları ve Kullanma Yerleri Hakkında Araştırmalar, Orman ve Av, 18, 9, s.1-22.

ISO-DIS 13061-17: Physical and mechanical properties of wood -- Test methods for small clear wood specimens -- Part 17: Determination of ultimate stress in compression parallel to grain

Larson, P. R., D. E. Kretschmann, A. Clark III, and J. G. Isebrands. 2001. Formation and properties of juvenile wood in southern pines.

USDA, Forest Products Laboratory, General Technical Report, FPL-GTR-129. 42 pp.

Pearson, R. G., and R. C. Gilmore. 1971. Characterization of the strength of juvenile wood of loblolly pine (*Pinus taeda* L.). Forest Prod. J. 21:23–30.

Stergios Adamopoulos, 2007: Strength Properties of Juvenile and Mature Wood in Black Locust (*RobiniaPseudoacacia* L.) Wood and Fiber Science, 39(2), pp. 241 – 249

Thomas, R. J. 1984. The characteristics of juvenile wood. Proc. of the Symposium on Utilization Changes in Wood Research in the Southern U.S. North Carolina State Univ.Raleigh, North Carolina. Pp. 40–52.

TS 2472 (1976): Odunda, Fiziksel ve Mekanikse! Deneyler İçin Birim Hacim Ağırlığı Tayini,TSE, ANKARA

TS 4083 (1983): Odunda Radyal ve Teğet Doğrultuda Cekmenin Tayini, TSE .ANKARA

TS 2474 (1976): Odunun Statik Eğilme Dayanımının Tayini, TSE .ANKARA

TS 2477 (1976): Odunun Carpmada Eğilme Dayanımının Tayini, TSE .ANKARA

TS 2478 (1976): Odunun Statik Eğilmede Elastikyet Modülünün Tayini, TSE .ANKARA

Determination of Decay Resistance and Formaldehyde Content of OSB Produced with Different Adhesives

*Yasin KOÇ¹, Hacı İsmail KESİK¹, Sefa DURMAZ², Mahmut GÜR¹

¹Kastamonu University, Faculty of Forestry, Kastamonu / TURKEY

²Karadeniz Technical University, Faculty of Forestry, Trabzon / TURKEY

*Corresponding Author: yasinn_koc@hotmail.com

Abstract

The main purpose of the thesis was to investigate influence of different adhesives and their mixtures on decay resistance and formaldehyde content of OSB panels manufactured in laboratory scale. OSB boards were produced with following adhesives: urea formaldehyde (UF), melamin urea formaldehyde (MUF) and polymer diphenylmethandiisocyanat (PMDI) using 10% solid resin to dry weight of wood flakes. In order to increase performance and reduce formaldehyde emission 5% and 10% PMDI was added to UF and MUF resins. The mixture was used in core layer of OSB panels. Wood mixture contained 80% Black pine (*Pinus nigra* A.) and 20% Scots pine (*Pinus sylvestris* L.). In decay resistance test two different brown-rot fungi *Coniophera puteana* and *Trametes versicolor* were inoculated to samples. In addition formaldehyde content was determined. Statistical analysis of results was performed. The study showed that 5% addition of PMDI to core layer partially decreased formaldehyde content. At the same time 10% addition of PMDI to UF resin caused a prominent decrease. In decay resistance test the best results were obtained for samples made with mixture of MUF and UF with 5% PMDI.

Keywords: Oriented Strand Board (OSB), PMDI, decay resistance, synthetic adhesives.

Farklı Tutkallar ile Üretilen OSB'nin Çürüklük Direncinin ve Formaldehit İçeriğinin Belirlenmesi

Özet

Bu çalışmanın amacı, farklı tutkal ve karışımları kullanılarak laboratuvar şartlarında üretilen yönlendirilmiş yonga levhaların (OSB) çürüklük direncinin ve formaldehit içeriğinin belirlenmesidir. OSB levhaları, üre formaldehit (ÜF), melamin üre formaldehit (MÜF) ve polimerik difenilmetan diizosiyanat (P-MDI) tutkalları kuru yonga ağırlığına oranla %10 oranında ilave edilerek üretilmiştir. Buna ek olarak OSB levhalarının orta tabakasında %5 ve %10 oranında P-MDI tutkalı katkılı ÜF ve MÜF tutkalları kullanılarak levha özelliklerinin artırılması ve formaldehit emisyonunun azaltılması amaçlanmıştır. Levhalar, %80 Karaçam (*Pinus nigra* A.), %20 Sarıçam (*Pinus sylvestris* L.) karışımı kullanılarak üretilmiştir.

Üretilen levhaların çürüme direncinin belirlenmesi amacıyla levhalar *Trametes versicolor* mantarına maruz bırakılmıştır.

Sonuç olarak orta tabakada %5 P-MDI tutkalı katkılı ÜF ve MÜF tutkalı kullanıldığında formaldehit emisyonunun düşük oranda azaldığı, %10 oranında P-MDI tutkalı katkılı ÜF tutkalı kullanımında ise formadehit emisyonunun belirgin oranda azaldığı görülmüştür. Çürüklük testleri sonucu minimum ağırlık kaybı orta tabakada %5 P-MDI tutkalı ilave edilen MÜF ve ÜF tutkalları kullanılarak üretilen levhalarda elde edilmiştir.

Anahtar Kelimeler: Yönlendirilmiş tonga levha (OSB), çürüme direnci, sentetik tutkallar.

Introduction

OSB market is expected to grow owing to enhanced demand in structural and nonstructural applications. One of the most important problem to manage is to decrease formaldehyde emission during production process and indoor use.

Oriented strand board is manufactured from cross-oriented layers of wooden strands bonded together with synthetic resin adhesives. Resins typically used in OSB production are following: phenol

formaldehyde (PF), melamine-urea formaldehyde (MUF), urea formaldehyde (UF) or polymer diphenylmethandiisocyanat (PMDI).

OSB and other panels made using synthetic resins are the most significant source of formaldehyde indoors. The short-term formaldehyde exposure may cause health effects such as eye, nose, throat and skin irritation, coughing and headaches. Prolonged exposure to formaldehyde is linked to cause

nasopharyngeal cancer in humans. (Cogliano et al., 2005).

There has been recent interest in hybrid mixtures of formaldehyde based resins and polymeric diphenylmethane diisocyanate (PMDI).

The combination of PMDI and formaldehyde-based resins was first reported in the 1970's (Deppe, 1977). Several reports exist of PF/PMDI hybrid resins for panel production (Haider et al., 2001; Zhen, 2002; Rosthauser, 2001). Hybrid resins such as UF/PMDI ((Simon et al., 2002; Wang, 2004; Dziurka, 2010; Mansouri, 2006), MUF/PMDI (Pizzi et al., 1993) and PMUF/PMDI (Lei et al., 2006) resins have also been characterized.

PMDI has become important upgrading additive to formaldehyde-based resins. The reasons of these interest are:

- To lower cost of PMDI while still maintaining the PMDI performance
- To upgrade performance of cheaper adhesives
- To decrease formaldehyde emission (Belgacem and Pizzi, 2016)

The aim of this study was to produce OSB using UF and MUF resins with 5% and 10% addition of PMDI in order to reduce formaldehyde emission. In addition the decay resistance of produced panels was examined as an important factor in exterior OSB application.

Material

In the production of OSB, yellow pine flakes (5-7% moisture content), urea-formaldehyde resins (60% solid content) , melamine-urea formaldehyde resins (60% solid content), P-MDI resin, paraffin emulsions (40% solid content) and ammonium sulphate (20% solid content) were used. PMDI resin was supplied by Kronospan Bulgaria, rest of chemicals and flakes were donated by SFC Kastamonu.

Preparation of the OSB panels

The OSB panels were comprised of three layers. Outer layers of produced panels contained 60% and inner layer 40% of the total composite weight. Resins was added at a

loading of 10% of the total composite weight. Hardener was added at a loading of 1% of the total composite weight. Paraffin was added at a loading of 2,5% of the total composite weight.

Adhesives used in outer and inner layers of prepared panels are given in Table 1.

Table 1. Proportions of adhesives used in outer and inner layers of prepared panels

Test No	Inner layer	Outer layers
1	MUF	MUF
2	UF	UF
3	P-MDI	P-MDI
4	P-MDI	UF
5	P-MDI	MUF
6	%5 P-MDI/%95 MUF	MUF
7	%10 P-MDI/%90 MUF	MUF
8	%5 P-MDI/%95 UF	UF
9	%10 P-MDI/%90 UF	UF

Paraffin and resin were uniformly sprayed onto flakes. The outer and inner layer flakes were oriented in 31 x 36cm box. The direction of the wood flake length for the outer layer was perpendicular to that of the core layer. The target density of the OSB panels was 700kg/m³. The flake mat was placed in a hot press under 280 bar and 180°C for 300 sec. The edges of a plate were cut to achieve final dimension 30x35cm. The target thickness was 10 mm.

Results and Discussions

The results of formaldehyde content are shown in Table 2.

Table 2. Results of formaldehyde content test

Formaldehyde Content (mg/100g)			
1	5,86	6,55	6,11
2	6,68	6,45	7,22
3	0	0	0
4	3,55	4,18	3,43
5	4,24	3,79	3,91
6	5,70	5,89	4,81
7	6,27	5,35	6,42
8	6,51	6,05	6,88
9	3,49	3,72	3,17

The highest formaldehyde content was obtained for samples made with UF. Boards made with P-MDI showed no formaldehyde emission. The study showed that 5% addition of PMDI to core layer partially decreased formaldehyde content. At the same time 10% addition of PMDI to UF resin caused a prominent decrease (Fig 1).

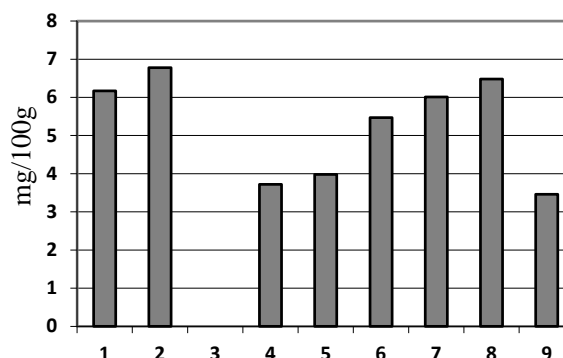

Figure. 1 Formaldehyde content values

In decay resistance test addition of 5% and 10% PMDI to UF resin in the inner layer caused prominent increase of decay resistance (test 8 and 9). The highest weight loss ratio was obtained for samples made with UF (test 2).

Table 3. Results of Decay Resistance test

	1	2	3	4	5	6	7	8	9
Weight	4,50	33,01	21,80	5,97	9,94	1,47	10,27	10,49	4,97
loss	2,05	26,22	25,15	3,68	17,54	1,04	14,40	4,15	12,08
ratio	6,03	27,30	26,25	6,52	16,56	3,05	5,48	4,35	11,86
(%)	5,32	30,90	15,90	8,20	9,12	0,60	4,73	2,53	11,82
	9,91	43,01	11,15	10,02	11,56	11,22	9,46	4,07	0,03
	9,45	31,28	14,83	1,96	8,21	12,78	6,64	15,15	4,85

Board produced with 100% MUF resin showed high decay resistance (test 1) however addition of 5% and 10% PMDI resin haven't improved the result (test 6 and 7).

Boards produced using only UF or P-MDI resin showed low decay resistance (test 2 and 3) in spite of that mixing UF and PMDI resins increased decay resistance (Figure 2).

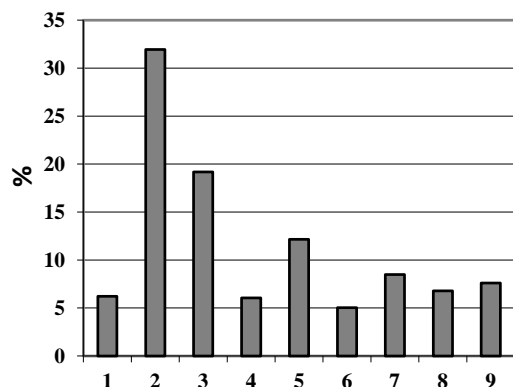

Figure 2. Weight loss ratio

Conclusion

The results showed that increase of PMDI in hybrid resin UF/PMDI and MUF/PMDI caused reduction of formaldehyde emission compared to boards made with UF or MUF without PMDI addition. Thus in production of OSB panels for interior use hybrid resins could be preferable.

Addition of PMDI in the inner layer increased resistance to rot fungi leading to decreased weight loss ratio. The most prominent difference in decay resistance was observed between OSB produced with UF and UF/PMDI. While very low decay resistance of

the OSB produced by only UF, addition of P-MDI in core layer increased resistance to rot fungi.

References

Deppe, H.J. 1977. In: Proc. 11th International Particleboard/Composite Materials Symposium, T.M. Maloney Ed., Pullman, WA, 13-3.

Dziurka, D., Radoslaw M. 2010. UF-pMDI hybrid resin for waterproof particleboards manufactured at a shortened pressing time. *Drvna Industrija* 61.4. 245-249.

Haider, K.W., Wittig, J.A., Dettore, Dodge J.A., and Rosthauser J.W. 2001. On the trail to isocyanate/phenolic hybrid wood binders: Model compound studies. *Wood Adhesives 2000. Proc. No. 7252. Forest Prod. Soc., Madison, WI. pp. 376-378.*

Lei H., Pizzi A., Guanben D. 2006. Coreacting PMUF/isocyanate resins for wood panel adhesives. *Holz als Roh-und Werkstoff* 64.2: 117-120.

Mansouri, H.R., Pizzi, A., Leban, J.M. 2006. Improved water resistance of UF adhesives for plywood by small pMDI additions. *Eur J Wood Prod*, 64 (3): 218-220.

Rosthauser, JW., Detlefsen WD. 2001. Mixed PMDI/resole resin binders for the production of wood composite products. U.S. Patent No. 6,214,265. 10 Apr.

Wang W., Zang X., Lu R. 2004. Low formaldehyde emission particleboard bonded by UF-MDI mixture adhesive. *Forest Products Journal* 54.9: 36.

Zheng, J. 2002. Studies of PF resole/isocyanate hybrid adhesives. Diss. Virginia Polytechnic Institute and State University.

Effects of Some Retention Chemicals on Physical Properties of Some Packing Papers

Ahmet TUTUŞ¹, Tamer SÖZBİR², *Mustafa ÇİÇEKLER¹

¹Kahramanmaraş Sütçü İmam University, Faculty of Forestry, Kahramanmaraş/TURKEY

²Kahramanmaraş Paper Mill, Kahramanmaraş /TURKEY

*Corresponding Author: mcicekler@outlook.com

Abstract

The importance of the packing papers is increasing day by day. Besides, quality and fiber quantity of waste papers are adversely affected. The objective of this study was to improve the properties of some packing papers produced from waste papers by using some commercial retention chemicals (10CE, 40CE, and Eka NP-PL-ATC). Grey cardboards with grammages of 320, 330, 340, and 360 gr/m² were produced by using the retention chemicals in certain rates. Then, the physical properties of the grey cardboards were determined and effects of the retention chemicals on the physical properties of the papers were examined. The results showed that the physical properties of the papers with Eka NP-PL-ATC retention chemical were better than those of the others. The machine and cross direction breaking length and bursting strength of the these grey cardboards were found to be 3066 m, 1544 m, and 4 kg/cm², respectively. Besides, white water was cleaned and contaminants of the discharged water were decreased by adding retention chemicals.

Keywords: Grey cardboard, Packing paper, Retention, Retention aids, Physical properties

Bazı Retansiyon Kimyasallarının Bazı Ambalaj Kağıtlarının Fiziksel Özellikleri Üzerine Etkileri

Özet

Ambalaj kağıtlarının önemi gün geçtikçe artmaktadır. Bunun yanında hammadde olarak kullanılan geri dönüşüm atık kağıt kalitesi ve atık kağıttaki elyaf miktarı düşmektedir. Bu çalışmanın amacı, atık kağıtlardan üretilen bazı ambalaj kağıtlarının fiziksel özelliklerini ticari retansiyon kimyasalları (10CE, 40CE ve Eka NP-PL-ATC) kullanarak iyileştirmektir. Belirli oranlarda retansiyon kimyasalları kullanarak 320, 330, 340, and 360 gr/m² gramajlarında gri karton üretimi yapılmıştır. Elde edilen gri kartonların fiziksel özellikleri belirlenmiş ve retansiyon kimyasallarının bu özellikler üzerine etkisi araştırılmıştır. Elde edilen sonuçlar doğrultusunda Eka NP-PL-ATC retansiyon kimyasalı kullanılarak üretilen gri kartonların fiziksel özelliklerinin diğer kimyasallara göre daha iyi olduğu tespit edilmiştir. Bu gri kartonların boyuna ve enine kopma uzunluğu ile patlama mukavemeti sırasıyla 3066 m, 1544 m, and 4 kg/cm² bulunmuştur. Bununla birlikte retansiyon miktarındaki artışa paralel olarak elek altı suları temizlenmiş, deşarj suyundaki kirlilik azalmıştır.

Anahtar kelimeler: Gri karton, Ambalaj kağıdı, Retansiyon, Retansiyon kimyasalları, Fiziksel özellikler

Introduction

Grey Cardboards (GC) are produced with waste papers such as office papers, old newspapers and magazine papers by fourdrinier paper machine. They are produced with grammages of between 140 gr/m² and 400 gr/m² based on the usage and requirements. Besides, these cardboards can be used in many sectors, such as core tubes, textile products, and separator production. GC is also evaluated as packing papers. Paper and cardboard used as packaging should be subjected to less deformation and included products should be less exposed to external factors during transports. For this reason,

materials used in the production of paper and cardboard should have maximum strength (Casey, 1960). Due to the fact that almost all paper and cardboard are manufactured from recycled paper in Turkey, strength values of the paper and corrugated packaging can be given any desired value. Some searches are being done to increase the strength values; and one of these is retention applications in the fiber suspensions.

Retention is an important issue for paper and cardboard production. Retention of a substance in a system is the ability of the system to retain the substance within the system limits. The efficiency by which components of paper making are retained in a

web of paper as it is being formed. The proportion of a component in a mixture which is found in the mixture in a later process stage (Fellers and Norman, 1998). Retention aids are used to retain filler and fines in the wet paper web during the forming process, by aggregating these stock components to larger units. Hence, retention aids also cause fibers to aggregate, which deteriorate mass formation (Lancaster, 1998).

The components of the paper structure are fibers, fillers, and chemicals. Since the components in the fiber suspension are almost all cationic, anionic chemicals have effects on the retention. There are lots of commercial retention aids for paper production. The objective of this study was to improve the properties of GC produced from waste papers by using some commercial retention chemicals (aids) (10CE, 40CE, and Eka NP-PL-ATC).

Material and Method

Material

GC with grammages of 320, 330, 340, 360 g/m² were manufactured at Kahramanmaraş Paper Mill. Three different retentions chemicals namely 10 CE, 40 CE, and Eka NP-PL-ATC were supplied from Akzo Nobel Chemicals and Archroma Turkey Chemicals.

Pulp preparation and GC production

Mixed office papers (67%) and grey wastes (33%) were used to produce GC. These waste papers were transported to pulper for recycling and pulpified at 4-5% consistency. Then, obtained pulps were beaten to specified freeness levels. The beaten pulps with chemicals and retention aids were subjected to paper machine. The paper machine parameters during the production were presented in Table 1.

According to the results of pretesting (data not shown), the optimum retention dosage was determined to be 400 g/ton. 10CE, 40CE, and Eka NP-PL-ATC retentions chemicals were applied to pulps in this determined dosage.

Table 1. Paper machine parameters during GC production

Grammages ±3	gr/m ²	320	330	340	360
Machine Speed ±10	m/dk	210	195	170	160
Paper Width ±50	mm	2300	2300	2300	2300
Machine Chest					
Cons.	%	4	4	4	4
Machine Chest SR ⁰	%	50	50	50	50
Head Box Cons.					
±0.2	%	1	1	1	1
Wire Pit pH ±0.1	pH	7.2	7.2	7.2	7.2
Wire Pit Conduct.	mS/cm	1300	1300	1300	1300

GC with four different grammages (320, 330, 340, and 360) were produced using fourdrinier paper machine. The Fourdrinier is the most common paper making machine in the world. Fig. 1 shows all of the major sections, but is simplified when compared to most machines in use today.

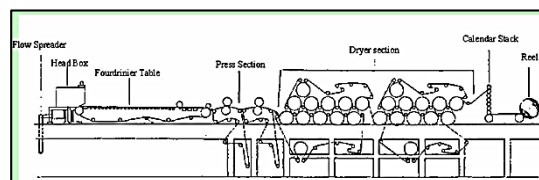

Figure 1. Fourdrinier paper machine

Papers and boards, being hydrogen-bonded assemblages of cellulose fibers, can be significantly affected by water vapor in the air surrounding the test specimen (Borch et al., 2001). For this reason, all GC were kept in conditioning room at 25 °C and 50% relative humidity for 24 hours accordance with TS 636 EN 20187 (TSE, 1996). Then, physical tests were applied to the GC.

Measurement of retention

Retention gives a practical indication of the efficiency by which fine materials are retained in a web of paper as it is being formed. First-pass retention values can be calculated from two consistency measurements, the headbox consistency, and the white water consistency. There is a very wide diversity of first-pass retention on different paper machines, from less 50% to almost 100%. Retention was calculated by the following equation (Kosonen, 2004);

$$\text{Retention} = [(C_{hb} - C_{ww}) / C_{hb}] * 100\% \quad (1)$$

C_{hb} : headbox consistency,

C_{ww} : white water consistency

Measurement of drainage performance

The drainage performance was evaluated by Schopper-Riegler degree ($^{\circ}$ SR), an important parameter to evaluate the drainage performance of pulp suspensions. When $^{\circ}$ SR is low, the dewatering of the pulp suspension is favorable (Chi et al., 2007). The $^{\circ}$ SR was measured by YT-DJ-100 beating tester, according to ISO 5267-1 (ISO, 1999). The drainage was measured by the amount of the water (ml) passing through sieve of SR tester in five minutes.

Determination of physical properties of GC

All conditioned GC were subjected to physical tests in laboratory. The physical properties of the GC in this study were determined according to the following standards: TS 3121-2 ISO 1924-1 (breaking length machine direction), TS 3121-2 ISO 1924-2 (breaking length cross direction) and TS 3123 EN ISO 2759 (burst strength) (Anon., 1997; Anon., 2004).

Statistical Analysis

The SPSS 15.0 statistical package was used. Data from physical properties of GC analyzed using a computerized statistical program to perform of variance and by carrying out the Duncan test at a $P \leq 0.05$ confidence level.

Results and Discussion

Retention and drainage results

Effects of retention aids on first pass retention during GC production were illustrated in Fig. 2. It can be observed that Eka NP-PL-ATC is more effective than the other retention aids. Besides, it can be clearly seen that there is an interaction between retention and grammage. Athley et al., (2012) reported that an increase in fiber grammage can lead to fewer and smaller pores in the fiber network and thus an increase in the mechanical retention of the particles.

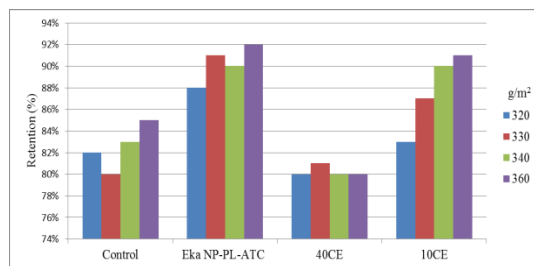

Figure 2. Effects of the retention aids on the retention during GC production with different grammages

According to Fig. 2, Eka NP-PL-ATC gave the best result in retention. The highest retention was found as 92% during GC production with 360 grammages and obtained by using 400 g/ton Eka NP-PL-ATC. When compared retentions for all grammages, Eka NP-PL-ATC was better than other retention aids as seen in Fig. 2.

The drainage (dewatering) of pulp suspension is an important parameter that has a direct influence on the speed of the paper machine and the energy consumption of the drying process (You et al., 2016). Hence, as the evaluating index of drainage performance, the $^{\circ}$ SR was measured (Fig. 3).

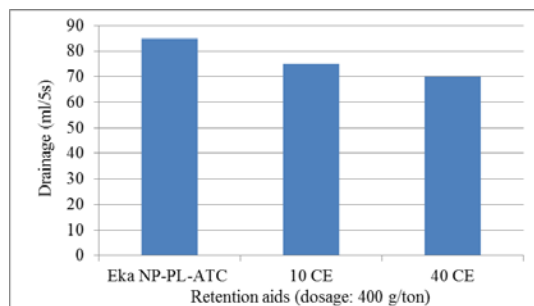

Figure 3. Effects of the retention aids on the drainage performance

According to Fig. 3, the drainage time was shortened by using Eka NP-PL-ATC when compared with 10 CE and 40 CE. The drainage performance with using Eka NP-PL-ATC was found as 85 ml/5s. The respective values for 10 CE and 40 CE were 75 and 70 ml/5s, respectively. Paper strength properties show improvement with the shortening of the drainage time (You et al., 2016). As shown in Fig.3, Eka NP-PL-ATC gave the best drainage performance.

Physical properties of GC

The physical properties of the GC produced by using different retention aids were given in Table 2. Pulps obtained from waste papers were beaten to 50 ± 3 °SR freeness level and GC with different grammages (320, 330, 340, 360 g/m²) were produced with the Fourdrinier Paper Machine.

In Table 2, GC produced by using 40 CE with 340 grammages and GC produced by using Eka NP-PL-ATC with 340 and 360 grammages gave the best result in breaking length (MD). When retention aids compared

to each other, Eka NP-PL-ATC gave the highest breaking length (MD). In order to determine statistical effects of retention aids on breaking lengths (MD), the Variance Analysis and Duncan Tests were applied. According to the statistical results, there are significant differences with each other on 5% level of Duncan's test. Roy et al., (2006) and Ordonez et al., (2009) reported that the physical properties of the papers were increased by using retention aids.

Table 2. The physical properties of the GC produced by using different retention aids

Grammages and Retention aids	Breaking Length MD (m)		Breaking Length CD (m)		Burst Strength (kg/cm ²)	
	Mean Value	Standard Deviation	Mean Value	Standard Deviation	Mean Value	Standard Deviation
320 g/m ² 10 CE	2518a	10.13	1238a	20.40	3.27a	0.17
320 g/m ² 40 CE	2568b	6.07	1302b	12.82	3.01a	0.11
320 g/m ² Eka NP-PL-ATC	2648c	6.58	1412c	3.00	2.90b	0.06
330 g/m ² 10 CE	2270a	12.52	1279a	33.18	3.37a	0.10
330 g/m ² 40 CE	2614b	4.91	1318b	17.41	3.19b	0.12
330 g/m ² Eka NP-PL-ATC	2663c	9.02	1470c	2.54	3.00c	0.08
340 g/m ² 10 CE	2059a	6.05	1220a	10.91	3.64a	0.09
340 g/m ² 40 CE	3261b	7.76	1451b	59.46	3.60b	0.08
340 g/m ² Eka NP-PL-ATC	3066c	7.38	1544c	2.71	3.00b	0.13
360 g/m ² 10 CE	2196a	8.69	1084a	27.01	4.00a	0.11
360 g/m ² 40 CE	2681b	10.23	1313b	22.04	3.77b	0.09
360 g/m ² Eka NP-PL-ATC	3106c	11.52	1512c	14.21	2.80c	0.12

*Mean values with the same lower-case letters are not significantly different according to Duncan's mean separation test

GC produced by using Eka NP-PL-ATC with 340 grammages gave the best result in breaking length (CD) as 1544 m. When retention aids compared to each other, Eka NP-PL-ATC gave the highest breaking length (CD) as breaking length (MD). According to the statistical results, there are significant differences with each other on 5% level of Duncan's test.

Eka NP-PL-ATC retention aid gave also the best result in the burst strength. Eka NP-PL-ATC shows an important improvement on burst strength. The highest burst strength was obtained by using this retention aid as 4.00 (kg/cm²). The statistical data showed that there is no significant difference between 10 CE and 40 CE and there are significant differences with Eka NP-PL-ATC for GC with 320 grammages. There is no significant difference between Eka NP-PL-ATC and 40 CE and there are significant differences with

10 CE for GC with 320 grammages. There are significant differences with each other for GC with 330 and 360 grammages.

Conclusion

1. Retention is an important parameter for paper making. It basically affects on drainage and paper strength properties. Accordingly, using retention aids has been a need in paper production. The results of this study showed that retention aids have positive effects on retention, drainage, and paper properties. When Eka NP-PL-ATC, 10 CE, and 40 CE retention aids compared with each other, Eka NP-PL-ATC gave the best retention for GC production.

2. The drainage (dewatering) refers to the removal of water from the wet web during the formation of paper and has a direct impact on machine speed. The machine speed affects the amount of production. Therefore, the low

drainage time is desirable for paper-makers and the best drainage performance was obtained by using Eka NP-PL-ATC in this study.

3. Packing papers are generally produced with using waste papers and must have high strength. For this reason, some chemicals are using in paper industry in order to increase strength properties. The retention aids have impact on the drainage which has effects on paper strength. The breaking length and burst strengths are important physical properties for GC. Eka NP-PL-ATC retention aid gave the highest breaking length and burst strength values when compared with other retention aids.

4. The results of this study indicated that using the retention aids in GC production has important roles in terms of paper strength properties and drainage performance. Besides, white water was cleaned and contaminants of the discharged water were decreased by adding retention chemicals.

5. Eka NP-PL-ATC is more suitable retention aids for GC production than 10 CE and 40 CE in terms of retention.

Acknowledgements

This research was supported by the Kahramanmaraş Sutcu Imam University, Research Project Coordination Unit, under project number 2014/1-10 YLS.

References

- Anonymous, 1997. ISO 1924 1 and 2- Paper and board -- Determination of tensile properties.
- Anonymous, 2014. ISO 2759 - Board - Determination of bursting strength
- Athley, K., Granlöv, L., Söderberg, D., Ankerfors, M., Ström, G., 2012. Mechanical retention – Influence of filler floc size and grammages of the fiber web, *Nordic Pulp and Paper Research Journal*, 27(2), 202-207.
- Borch, J., Lyne, M.B., Mark, R.E., Habeger, C.C., 2001. *Handbook of Physical Testing of Paper*, Volume 2, Second Edition, Marcel Dekker, INc., New York – Basel.
- Casey, J. P., 1960. *Pulp and Paper Chemistry and Chemical Technology*, Second Edition, Vol:1, New York.
- Chi, H., Li, H., Liu, W., and Zhan, H., 2007. The retention- and drainage-aid behavior of quaternary chitosan in papermaking system, *Colloids & Surface A*, 297(1-3), 147-153.
- Fellers, C., and Norman, B., 1998. *Pappersteknik*,

Institutionen för Pappersteknik, Royal Institute of Technology, Stockholm, ISBN: 91-7170-741-7, 100 pages, (In Swedish).

ISO, 1999. Determination of drainability - Part 1: Schopper-Riegler method, International Organization for Standardization, Vernier, Geneva Switzerland.

Kosonen, M., 2004. *Modelling and Online Control of Paper Machine Wire Retention*, Doctoral thesis, Tampere University of Technology, Finland, Publication 477, 142 p.

Lancaster, P., 1998. *Retention: Definition, Methods and Calculations in Retention of Fines and Fillers During Papermaking* (Ed. J. M. Gess) TAPPI Press. S:3-10.

Ordóñez, R., Hermosilla, D., Fuente, E., Blanco, A., 2009. Influence of water quality on the efficiency of retention aids systems for the paper industry, *Ind. Eng. Chem. Res.*, 48(1), 10247-10252.

Roy, S., Desrochers, M., Jurasek, L., 2006. Proteins as potential retention aids in the pulp and paper industry, *Journal of Wood Chemistry and Technology*, 9(3), 407-420.

TSE, 1996. *Paper, Board And Pulp-Standard Atmosphere For Conditioning And Testing And Procedure For Monitoring The Atmosphere And Conditioning of Samples*, Turkish Standards Institution, Ankara-Turkey.

You, Y., Sun, ., Cui, Q., Wang, B., a, J., 2016. The retention and drainage behavior of cross-linked gelatin with glutaraldehyde in a papermaking system, *Bioresources*, 11(3), 6162-6173.

An Overview of Non-Destructive Strength Grading of Structural Timber

Türker DÜNDAR

Istanbul University, Faculty of Forestry, Istanbul / TURKEY

dundar@istanbul.edu.tr

Abstract

Regardless of species and size, timber even if sawn from the same log, may show great variations in physical and mechanical properties due to its fibrous structure and the presence of irregularities. This is especially important for structural applications where the engineers are often frustrated with the performance variability found in structural members. Therefore, lumber used for structural applications must be graded and clearly marked to show it complies with the correct standards and strength requirements laid down by building codes and regulations. Strength grading of structural timber is a process by which lumber is sorted either by visual inspection or machine strength grading into strength classes- or strength grades- with ideally, similar structural properties in each group. In visual stress-grading, the lumber is sorted into groups based on the occurrences of strength-reducing features such as knots, slope of grain and splits. Machine strength grading is based on the relationship between the stiffness and strength properties of timber. The goal of this review study is to examine the latest developments in non-destructive methods for strength grading of structural timber.

Keywords: Non-destructive testing, Strength grading, Structural timber

Tahribatsız Direnç Derecelendirilme Yöntemi Kullanılarak Yapılarda Kullanılan Ahşaba Genel Bir Bakış

Özet

Ağaç türü ve boyutları önemli olmaksızın keresteler, lifsel yapıları ve sahip oldukları kusurlar nedeniyle aynı tomruktan biçilmiş olsalar bile fiziksel ve mekaniksel özellikleri bakımından büyük bir değişkenlik gösterebilirler. Bu durum özellikle yapısal amaçlı kullanımlar için büyük bir önem arz etmektedir. Çünkü bu kullanım alanında yapı elemanlarının mekanik performansındaki değişkenlikler mühendisler için önemli bir problem teşkil etmektedir. Böylece, yapısal amaçlar için kullanılacak kerestelerin, yapı standartları ve yönetmelikleri tarafından belirlenen doğru standart ve direnç gereksinimlerini karşıladıklarının bir göstergesi olarak sınıflandırılmaları ve açık bir şekilde etiketlenmeleri gerekmektedir. Yapı kerestelerinin direnç sınıflandırması, görsel muayene ya da sınıflandırma makineleri ile direnç sınıflarına ayrıldıkları bir prosestir. Görsel direnç sınıflandırmasında keresteler, budaklar, çatlaklar, lif kıvrıklığı gibi direnç azaltıcı özelliklerinin mevcudiyetine göre sınıflara ayrılmaktadır. Makine ile direnç sınıflandırması, kerestelerin elastikiyet ve direnç özellikleri arasındaki ilişkilere dayanmaktadır. Bu çalışmanın amacı, yapı kerestelerinin direnç sınıflarına ayrılmasında kullanılan tahribatsız muayene yöntemleri özetlemek ve bu alandaki son gelişmeleri incelemektir.

Anahtar Kelimeler: Mikro boyutlu test, Standart boyutlu test, Çekme direnci, Basınç direnci, Meşş odunu

Introduction

Regardless of species and size, lumber even if sawn from the same log, may show great variations in physical and mechanical properties due to its biological nature and the presence of irregularities. This is especially important for structural applications where the engineers are often confused with the performance variability found in structural members. Therefore, lumber used for structural applications must be graded and clearly marked to show it complies with the

correct standards and strength requirements laid down by building codes and regulations. This grading process is helpful for building complex structures such as buildings, bridges, ships etc.

Strength grading of structural lumber is a process by which lumber is sorted either by visual inspection or mechanical strength grading into strength classes or strength grades. The hybrid systems that involve both of visual and mechanical grading have also been used commonly. In visual strength-

grading, the lumber is sorted into groups based on the occurrences of strength-reducing features such as knots, slope of grain, splits etc. according to national or international standards. In mechanical strength-grading the lumber is graded into strength class described in building standards based on the bending strength (1) and bending stiffness (2) properties supplemented by density (3). According to EN 14081-2, these three properties are defined as “grade determining properties”. The European system defines twelve strength classes of sawn softwood timber in EN 338 ranging from C14 to C50, where the number after "C" refers to the characteristic value of bending strength (in MPa) of timber pieces graded to that particular class. The characteristic value corresponds to the 5-percentile bending strength value of all pieces graded into the class, which actually means that five percent of the pieces in a certain class may be weaker than the strength indicated by the class designation.

To measure the strength of a particular piece of lumber, conventional methods require to break the piece, but afterwards it is no more useable for its intended purpose as a load carrying component. True strength can only be determined in a destructive test. Actually, for strength grading purposes, it would not be necessary to test load the pieces to failure but only to the required value. Such a loading would knock off too weak pieces with 100% certainty, and such a method has been used in special cases. However, such a test loading could damage those pieces, whose strength is only slightly above the test load value and their residual load could be below the required value. Also, heavy test loading is not suitable for a fast manufacturing process.

Therefore, practically all strength grading is based on indirect methods, where measurements or observations of other properties of timber pieces are used to predict the strength. The measurements are made by some suitable *nondestructive testing* (NDT) methods. Nondestructive testing and grading techniques are based on the prediction of strength and stiffness of lumber by useful mathematical relationships between the measured nondestructive parameters and

the mechanical properties.

The exact (deterministic) relation cannot be formulated due to its complexity, but it can be established from empirical observations (results of experiments) using mathematical statistical methods, usually regression analysis. Measured nondestructive parameter is called as “indicating property”. In European Standard EN 14081-2, an indicating property is defined as a measurement or a combination of measurements that is made by a grading machine, and closely related to one or more of the grade determining properties.

Obviously, predicting strength of individual pieces with indirect methods always includes some uncertainty, because the capability of an indirect measurement to predict strength can never be perfect and always includes measurement errors. The whole development of strength grading system by the European system requires the demonstration that the required statistical properties can be met with sufficient confidence level by the NDT-measurements to be adopted.

Mechanical strength grading is based on the measurements of modulus of elasticity (MOE) and density by non-destructive methods. Today, most commonly used form of mechanical stress-grading is machine strength grading. The system measures the MOE (flat) as the lumber passes longitudinally through a machine. This can be done either by measuring the deformation of lumber subjected to constant loads, or by measuring the loads required to keep the lumber at a constant deformation (Leicester 2004). The measurement of MOE by dynamic techniques (vibration technique, stress wave) is another common method for mechanical strength grading of lumber in sawmills.

The goal of this study is to overview the nondestructive testing and evaluation techniques for strength grading of structural lumber. Much attention is devoted to latest development in strength grading.

Visual Strength Grading

The earliest nondestructive evaluation of wood was visual inspection, largely used for the selection of timber used as load bearing members for specific applications. Even

today, this method is extensively used for the grading of lumber. In visual stress-grading, the lumber is sorted into groups based on the occurrences of strength-reducing features such as knots, slope of grain, splits-checks, decay, heartwood-sapwood, pitch pocket, wane etc. The shortcomings of visual grading is rather obvious since only visible defects such as knots, cross-grained wood and compression wood can be regarded, whereas intrinsic timber properties such as density and various measures of MOE could not. Another point is that the grading process is reliant on the skill of the graders as the visual grading rules quite complex. There are many different characteristics that need to be checked.

This visual inspection is undertaken in accordance with either the hardwood or softwood visual grading standards, which define rules as to the types sizes and positions of physical characteristics that are allowed into each 'group' or structural grade of material. The first detailed rules concerning visual strength grading of structural timber were introduced in the USA in the beginning of the 1920s (Glos 1995) and an American standard laying down principles for such grading was published in 1927 (Madsen 1992). During the following decades, similar rules were implemented in European countries. Many visual strength grading rules implemented in Europe more than half a century ago are still in practice, most often in slightly developed editions (Oscarsson 2012). In Europe, there is a diversity of existing visual grading rules in use in different countries. This is a consequence of differences in species, geographic origin, dimensional requirements, quality of available material, historic influences and traditions, and varying requirements for different uses (EN 14081-1). However, many nationally applied visual grades are, on the basis of EN 1912, assigned to the common European strength classes defined as "C classes" in EN 338.

In order to ensure a certain degree, even if mechanical strength grading is applied by nondestructive techniques (NDT), visual inspection is still required to detect the strength-reducing defects that NDT in general are unable to detect, but the existence

of which are reason for downgrading. The visual inspection could be carried out either manually or by machinery in the form of optical or laser scanners. Image analysis of pictures obtained from an optical or laser scanner could be applied for determination of wood properties such as spiral grain, local grain deviations and occurrence of knots and other defects on the surfaces of a board. The general requirements laid down in EN 14081-1 comprise both visual and machine strength grading, the latter also including visual override requirements.

Mechanical Strength Grading by Nondestructive Tests

Machine strength grading (Measurements of static modulus of elasticity)

Machine strength grading of structural timber is based on application of theory of linear-elastic mechanics of materials, *i.e.* on the well-known Hooke's law which states that the strain of a material is directly proportional to the load that is applied to it. Grading procedures are also dependent on statistical theories applied to express relationships between strength and different measurable timber properties. Such relationships are described in terms of regression analyses.

The modulus of elasticity (MOE) can be measured in a variety of ways. Usually, the apparent static modulus of elasticity (MOEs), derived from three-point bending, is measured (Figure 1). Because timber is heterogeneous, the apparent MOEs depends on span, orientation (edge or flatwise in bending), load speed of test (static or dynamic), and method of loading (tension, bending, concentrated, or uniform). Machine stress grading is more objective and efficient than visual stress grading. Most grading machines are designed to detect the lowest local stiffness in flatwise bending, MOE_{min} , that occurs in any 1.2-m length as well as the average flatwise bending, MOE_{av} , for the entire length of the piece. Here the timber is fed continuously through the stress grader. The machine flexes each piece as a plank between two supports applying a fixed deflection (Figure 1) and measuring a load, or measuring the deflection under a particular

load.

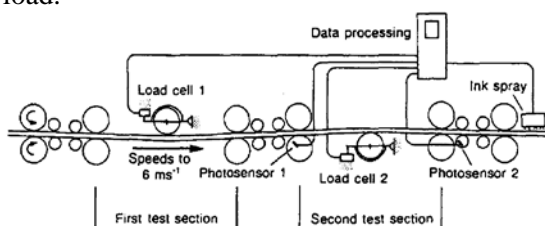

Figure 1. Measurement of apparent E by three point bending (Kretschmann and Hernandez 2006).

As a result of many researches, the MOEs measured by bending load was found the best single predictor of strength of the timber with a R^2 of 0.53 to 0.72 (Hoffmeyer 1984 and 1990, Lackner and Fosli 1988, Johansson et al., 1992, Fonselius et al., 1997). Machine graded timber should subject to a visual override because the size of knots in combination with MOEs is a better predictor of strength than is MOEs alone. It was stated that, the prediction capability was improved with a R^2 of 0.58 to 0.73 when the MOEs and the knot size were used together (Hoffmeyer 1984 and 1990, Johansson et al., 1992, Fonselius et al., 1997).

The rules concerning machine strength grading apply to grading systems that are either *machine controlled* or *output controlled*. Both types are based on so called *machine settings* which are determined on the basis of different procedures depending on which control system that is applied. The concept of settings, as defined in EN 14081-2, refers to values of parameters that are used to set a machine to grade timber.

Vibration methods (Measurement of dynamic modulus of elasticity)

Dynamic measurement of the MOE is based on measurement of the natural frequency of a timber piece. The idea is to hit the board or plank with suitable impact load and measure the natural frequency of the board or plank. The method has the advantage that forces needed and deflections induced are fairly small.

Vibration methods to predict static properties have been investigated since the 1950s (Kitazawa 1950; Bell et al., 1950; Fukada 1950; Matsumoto 1962). Jayne (1959) explicitly proposed a fundamental hypothesis of NDE of wood with regards to

dynamic methods: the energy storage and dissipation properties of wood materials are controlled by the same mechanisms that determine the static behavior. At the microscopic level, energy storage properties, measured as frequency of oscillation, are related to cellular orientation and material composition. Energy dissipation, measured by rate of decay, is controlled by internal friction characteristics, which is related to bonding behavior between constituents (Ross and Pellerin 1994). The natural frequency of vibration of an object serves as an indication of the energy storage and the logarithmic decay is a measure of the energy dissipation. Jayne hypothesized that energy storage was related to the modulus of elasticity and energy dissipation was related to modulus of rupture (Jayne 1959).

The relationship between dynamic E and static E was further validated and improved (Jayne 1959; James 1964; Pellerin 1965) but the relationship between energy dissipation and ultimate strength had not been verified until Pellerin (1965) accurately estimated the modulus of rupture by incorporating the energy dissipation of the material, represented by the damping coefficient expressed as the rate of decay of vibrations, also known as the logarithmic decrement.

The natural frequency of a timber can be measured either in transversal vibration or axial vibration. The determination of MOE using resonance frequencies for edgewise bending modes of vibration is more complicated in comparison with MOE determination using axial resonance frequencies, since transversal vibrations include shear, which means that the shear modulus, G , also has to be regarded. It should be noted that G has very little influence on resonance frequencies of lower bending modes. According to the Bernoulli-Euler beam theory, in which shear deformations are neglected, the edgewise MOE for free-free boundary conditions, meaning that the beam is floating, is determined by the equation below;

$$E_{b,n} = \frac{4mL_{tot}^4 f_{b,n}^2}{\gamma_n^2 \pi^2 I}$$

Where,

$$\gamma_n = \left[n + \left(\frac{1}{2} \right) \right]^2$$

and n is the number of the mode of vibration, m is the mass per length unit, ρ is the board density, L_{tot} is the total board length, I is the second moment of inertia in the edgewise direction. A simple setup for transversal vibration technique is shown in Figure 2.

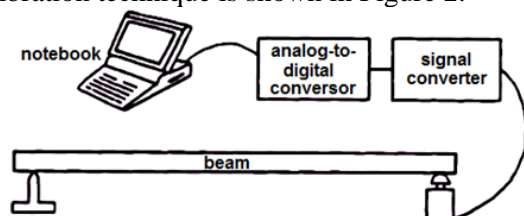

Figure 2. A simple setup for strength grading of timber by transversal vibration frequency.

In the late 1990s the axial dynamic excitation was introduced to strength grading system. A longitudinal vibration is generated in a board by a hammer blow at one of the board ends and information about the induced vibrations is captured by a microphone, a laser vibrometer or an accelerometer. The first one measuring the “sound” of the board and the two latter ones capturing the axial oscillation of one of the board ends. On the basis of measured vibrations and by application of so called Fast Fourier Transformation (FFT), resonance frequencies corresponding to axial modes of vibration are determined (Figure 3). On the basis of such frequencies, and in combination with measured length and determined density, a mean axial dynamic MOE of a board can be determined from the equation below (e.g. Ohlsson and Perstorper 1992);

$$E_{a,n} = 4\rho \left(\frac{f_{a,n} L_{tot}}{n} \right)^2$$

where $f_{a,n}$ is the axial resonance frequency that corresponds with the n th axial mode, ρ is the board density at the time of measurement of axial resonance frequency, and L_{tot} is the total length of the board.

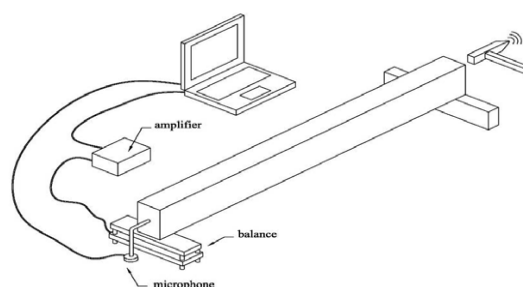

Figure 3. A simple setup for strength grading of timber by axial vibration frequency.

On a world-wide basis, utilization of the axial dynamic technique in strength grading of timber is gradually increasing. In 2012, a total of about 25 models of different makes of grading machines are approved for grading on the European market, and axial dynamic excitation is applied in about 60 % of them (Oscarsson 2012). The advantage of this technique is that the equipment needed is installed in production lines where the timber is transported transversely, which means that the grading is carried out at a moderate feed speed. Furthermore, the equipment is fairly simple and the space needed for its installation is limited.

Grading accuracy can be improved by combining vibration dynamic MOE with other indicating properties. For example, the X-ray scanning provides information about the density of a piece of timber and since there is a density difference between knots and clear wood, the scanning also gives information about knot size and knot position. When knot measures determined on the basis of the Xray scanning was combined with axial dynamic MOE, a coefficient of determination as high as 0.69 was achieved between indicating properties and tensile strength (Bacher 2008).

Stress wave method

The nondestructive stress-wave technique for wood quality assessment is based on the measurement of the velocity of propagation of a stress wave generated by a shock. This technique was developed in the USA at Washington State University for the determination of the dynamic elastic modulus of small clear specimens, for the assessment of strength properties of wood species (Ross and Pellerin 1991).

Ross and Pellerin (1991) have summarized the results of different research reports in the USA from 1954 to 1982 related to the relationship between the modulus of elasticity in static loading mode and dynamic mode and the stress-wave technique. The strong experimental correlation coefficient was between 0.87 and 0.99 and enabled the authors to conclude the validity of the stress-wave method as a nondestructive method for wood. The measured parameter is the time of propagation of the stress-wave signal. Furthermore, the velocity of propagation and the elastic modulus can be calculated.

Ultrasound method

The measurement of ultrasonic speed can also be categorised as a measure of the MOE, since speed of sound in wood material is proportional to its rigidity, in other words MOE. However, it should be noted that in principle ultrasonic speed is a separate property from MOE. Sandoz (1989) found r^2 values for a relation between strength and ultrasonic speed of approx. 0.45. The measurement functions by attaching two probes on the ends of the board. A low frequency ultrasonic sound pulse is excited to the board at one end. At the other end the transit time and transmitted energy is measured. The major problem in grading lumber using the ultrasonic transmission method is the very high rate of production. Figure 4 shows an ultrasonic automatic grading of boards (Sandoz 1994). Ultrasound has been used in industry today to grade the structural lumber by using the transit time and transmitted energy supplemented by local density and moisture content measurement.

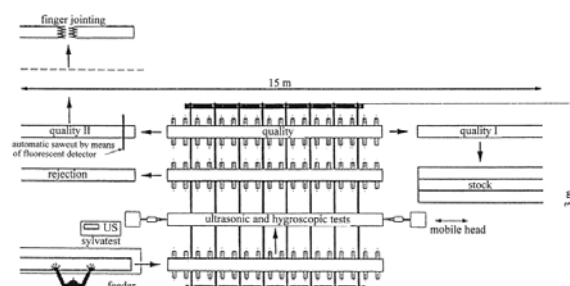

References

- Bacher, M. (2008) Comparison of different machine strength grading principles. In: Proceedings of 2nd Conference of COST Action E53 – Quality control for wood and wood products, Delft, the Netherlands, October 29-30.
- Bell, E. R., E. C. Peck, and N. T. Krueger. 1950. Young's modulus of wood determined by a dynamic method. U.S. Forest Products Laboratory Report 1775. WI: U.S. Department of Agriculture, Forest Service, Forest Products Laboratory.
- Fukada, E. 1950. The vibrational properties of wood. *Jour. Phys. Soc. Japan.* 5:321-7.
- Glos, P. (1995) Strength grading. STEP1, Lecture A6, Centrum Hout, The Netherlands.
- Hoffmeyer, P. (1984) Om konstruktionstræs styrke og styrkesortering I Skovteknologi. Et historisk og perspektivisk strejftog. Dansk Skovforening (in Danish).
- Hoffmeyer, P. (1990) Failure of wood as influenced by moisture and duration of load. Doctoral thesis, State University of New York, College of Environmental Science and Forestry, Syracuse, New York, USA.
- James, W. L. 1964. Vibration, static strength and elastic properties of clear Douglas-fir at various levels of moisture content. *Forest Prod. J.* 14(9):409-413.
- Jayne, B. A. 1959. Vibrational properties of wood as indices of quality. *Forest Prod. J.* 9(11): 413-416.
- Johansson, C.-J., Brundin, J., Gruber, R (1992) Stress grading of Swedish and German timber – A comparison of machine stress grading and three visual grading systems. SP Swedish National Testing and Research Institute, SP REPORT 1992:23.
- Kitazawa, G. 1950. Nondestructive testing for forest products. *Proceedings: Forest Products Res.Soc.* 4:191-197.
- Kretschmann, D.E., Hernandez, R., 2006. Grading timber and glued structural Members. In: *Primary Wood Processing Principles and Practice*, Chapter 10, 2nd edition, Dordrecht: Springer, pp 339-390.
- Lackner, R., Foslie, M. (1988) Gran fra Vestlandet – Styrke og sortering (Spruce from Western Norway – Strength, stiffness and grading). Report no. 74. The Norwegian Institute of Wood Technology (in Norwegian).
- Leicester, R.H., 2004. Grading for structural timber. *Programme Structural Engineering and Materials*; 6:69–78.
- Madsen, B. (1992) Structural behavior of timber. Timber Engineering Ltd, North Vancouver, British Columbia, Canada, ISBN 0-9696162-0-1.

Matsumoto, I. 1962 . Studies on the dynamic modulus E and logarithmic decrement of wood by transverse vibrations. Bull. of the Kyushu University Forests.36. Fukuoka, Japan.

Ohlsson, S., Perstorper, M. (1992) Elastic wood properties from dynamic tests and computer modeling. Journal of Structural Engineering, 118(10):2677-2690.

Oscarsson, J., 2012. Strength grading of structural timber and EWP laminations of Norway spruce –Development potentials. Licentiate Thesis, Linnaeus University, Report No. 15. ISSN: 978-91-86983-92-5.

Pellerin, R. F. 1965. A vibrational approach to nondestructive testing of structural lumber. Forest Prod. J. 15(3):93-101.

Ross, R. J. and R. F. Pellerin. 1994. Nondestructive testing for assessing wood members in structures: A review. Gen. Tech. Rep. FPL-GTR-70 (Rev.). Madison, WI: U.S. Department of Agriculture, Forest Service, Forest Products Laboratory.

Ross, R.J., Pellerin, R.F., 1991. Nondestructive testing for assessing wood members in structures. A review. Res. Pap. FPL-GTR-70. Forest Products Laboratory, USDA, Washington, DC.

Sandoz, J.L., 1989. Grading of construction timber by ultrasound. Wood Sci. And Technology 23: 95-108.

Sandoz, J.L., 1994. Valorization of forest products as building materials using nondestructive testing. Proc. 9th Int. Symp on Nondestructive Testing of Wood, Madison, pp. 103-109.

Determination of Minimum Bending Radius of Some Wood Species Grown in Turkey

*Nusret AS¹, Ümit BÜYÜKSARI²

¹Istanbul University, Faculty of Forestry, Istanbul / TURKEY

²Düzce University, Faculty of Forestry, Duzce / TURKEY

*Corresponding Author: nusretas@istanbul.edu.tr

Abstract

Bending of solid wood has been practiced for centuries. There is a need for research on bending radii of naturally grown wood species in Turkey which is an important issue developing the bending industry. The purpose of this study is to determine and compare minimum bending radii of some wood species grown in Turkey. The used wood species are Beech, Oak, Ash, Hornbeam, Chestnut and Scots Pine. One-inch thickness samples were cut from these species and been dried up to 20-25% moisture content. The prepared samples were steamed in an autoclave. After steaming, wood samples were bended in different radii forms. Bending operation has been performed by hand without strap and a bending machine with strap. In case more than 95% of all wood samples are bended without any break deformation, further tests using more radii have been performed. When bending ratio is lower than 95%, it has been decided that that wood species could be bended until upper radii. The results showed that hornbeam wood had best bending properties (lower bending radius) with and without metal strap bending. The worst bending properties (higher bending radius) were found for Chestnut without metal strap bending and for Scots pine wood with metal strap bending.

Keywords: Bending radii, Steaming, Hornbeam, Scots pine, Chestnut

Özet

Masif ağaç malzemenin bükülmesi, ağaç işleri ve mobilya endüstrisinde uzun yıllardan beri uygulanmaktadır. Bükme endüstrisinin gelişmesi için Türkiye'de yetişen ağaç türlerinin minimum bükülme yarıçapları araştırılması gerekmektedir. Bu çalışmanın amacı Türkiye'de yetişen bazı ağaç türlerinin minimum bükülme yarıçaplarının belirlenmesi kıyaslanmasıdır. Çalışmada Kayın, Meşe, Dişbudak, Gürgen, Kestane ve Sarıçam ağaç türleri kullanılmıştır. Bu ağaç türlerinden 1 inç (25.4 mm) kalınlığında hazırlanan örnekler %20-25 rutubete kadar kurutulmuştur. Denge rutubetine ulaşan örnekler buharlandıktan sonra farklı yarıçaplarda hazırlanmış olan kalıplar yardımıyla bükülmüştür. Elle ve makine ile bükme yapılmıştır. Makineyle yapılan bükmelerde destek şeridi kullanılmış, elle yapılan bükmelerde ise hem destek şeritli hem de destek şeridi olmaksızın bükme yapılmıştır. Bükülen örneklerin %95'inden daha fazlasının kırılmadan bükülebilmesi durumunda diğer yarıçaplar da sırayla denenmiş bükülme oranı % 95'in altına düştüğünde o ağaç türünün bir üstteki yarıçapa kadar bükülebildiği sonucuna varılmıştır. Kullanılan ağaç türleri arasında, destek şeritli ve destek şeritsiz bükmelerde gürgen odunun en iyi bükülme özelliklerine sahip olduğu, en kötü bükülme özelliği ise destek şeritli bükmelerde sarıçam odununda, destek şeritsiz bükmelerde ise kestane odununda bulunmuştur.

Anahtar Kelimeler: Bükme yarıçapı, Buharlama, Gürgen, Sarıçam, Kestane

Introduction

Bending of solid wood is a well-known process that has been used for many years. Bentwood are used in production of furniture, arched windows and doors, baskets, barrels, boats and ships, tool handles, sporting goods, agricultural implements and musical instruments (Stevens and Turner 1970). Generally, the bending quality of hardwoods is better than softwoods, while many exotic wood species cannot be bent to small radii (Shakri et al., 2004). Bent furniture parts are usually made from beech and oak because

these wood species are in reasonable supply, have good bending properties and are commonly used for the manufacture of furniture (Stevens and Turner, 1970). Some pre-treatments such as steaming, immersion in boiling water, pre-compression application and chemical substances are used to improve the bending qualities of wood. Steaming is the most commonly used method for softening of wood.

Bending of wood demonstrates variations depending on many factors such as radius of bending, species, moisture content, thickness

and width of wood, steaming time, fiber direction and defects (Niemiec and Brown 1995). Selected wood for bending must be defect-free and have straight fibers.

When a piece of wood is bent, tension stress occurs in the outer (convex) side due to fiber elongation while compression stress occurs in the inner (concave) side as the fibers contract (Stevens and Turner 1970). When wood is bent without restrained, tension and compression stresses are balanced on opposite sides of the centrally located neutral axis. A steel strap with end-block restraints added to the convex side the bend will carry most of the tension stress. This shifts the neutral axis toward the strap so the wood undergoes mainly compression strain (Hoadley, 2000). After being bent, the piece should be cooled and dried while held in by a setting method to maintain the curved shape (Rowell, 1999).

Previous research of solid wood bending is limited, with most articles related to suitability and determination of minimum bending radius of wood species (Wangaard 1952; Ayarkwa 2000; Ayarkwa et al. 2011; Shakri et al. 2004; Murakami et al. 2002; Whang et al. 2002; Bondad 2005; Kuljich 2015). Ayarkwa (2000) evaluated cold and steam bending properties from some lesser-used species of Ghana. Shakri et al. (2004) investigated the possibility of using some Malaysian timbers for bent wood. Murakami et al. (2002) demonstrated relationship between bending quality and wood species. Whang et al. (2002) evaluated bending quality of main Korean wood species. Bondad (2005) stated that radius of curvature of gubas (*Endospermum perlstatum* Merr.), mangium (*Acacia mangium* Wild.) and river red gum wood (*Eucalyptus camaldulensis* Dehnh.) was directly correlated with fiber length, fiber diameter, lumen width and cell wall thickness.

The minimum bending radius with and without strap of some wood species are shown in Table 1 (Stevens and Turner, 1970).

Table 1. The minimum bending radius without and with strap (Stevens and Turner, 1970)

Wood species	Minimum bending radius without strap (mm)	Minimum bending radius with strap (mm)
Oak (American White)	330	13
Oak (Europe)	330	51
Oak (Japanese)	320	38
Oak (Red)	290	25
Hornbeam	420	100
Beech (Denmark)	370	43
Beech (Romania)	410	41
Beech (Europe)	330	38
Pine	710	360
Ash (American)	330	110
Ash (Europe)	300	64
Ash (French)	340	51
Chestnut	380	150

In previous studies, minimum bending radius of some wood grown in different countries was determined. However, there is no information about the minimum bending radius of wood species grown in Turkey. It is recognized that growth conditions such as climate, soil characteristics, slope, altitude etc. affect the annual ring width, density and bending characteristic of wood. This paper aims to determine the minimum bending radii with and without strap of some wood species grown in Turkey.

Materials and Methods

Materials

In this study, Beech (*Fagus orientalis*), Oak (*Quercus spp.*), Ash (*Fraxinus excelsior*), Hornbeam (*Carpinus betulus*), Chestnut (*Castanea sativa*) and Scots Pine (*Pinus sylvestris*) wood species were used. Five trees from each wood species having straight stems were selected as sample trees. 25 mm by 25 mm cross-section and different lengths samples were cut from these species and been dried up to 20-25% moisture content.

Methods

The prepared samples were steamed in an autoclave. The steaming time were selected as 1.8 minute for each 1 mm thickness. After steaming, wood samples were bended in

different radii forms. Bending operation has been performed by hand without strap and a bending machine with strap. The bending molds were in semi-circular shape.

In case more than 95% of all wood samples are bended without any break deformation, further tests using more radii have been performed. When bending ratio is lower than 95%, it has been decided that that wood species could be bended until upper radii.

The 3-point bending test was performed in steamed and non-steamed samples. The span/thickness ratio was selected as 15. Elastic, semi-elastic and maximum deformations were measured. The theoretical bending radius was determined using maximum deformation values in bending test of steamed samples. The theoretical bending radius was calculated from the following equation:

$$r = \frac{a^2 + b^2}{2 * b}$$

where r is theoretical bending radius (mm), a is vertical distance (mm) and b is horizontal distance (mm).

Results and Discussion

The maximum, elastic and semi-elastic deformations of non-steamed samples are shown in Table 2.

Table 2. The maximum, elastic deformation and semi-plastic deformation of non-steamed samples

Wood species	Maximum deformation (mm)	Elastic deformation (mm)	Semi-elastic deformation (mm)
Oak	11.1	2.4	8.7
Hornbeam	14.2	2.6	11.6
Beech	11.9	2.2	9.7
Scots pine	10.3	1.8	8.5
Ash	9.7	2.4	7.3
Chestnut	9.9	2.0	7.9

The highest maximum deformation was found in Hornbeam wood with the value of 14.2 mm while the lowest maximum deformation was observed in Ash wood with the value of 9.7 mm. Similar findings were observed for semi-elastic deformation values.

Table 3 shows the maximum, elastic and semi-elastic deformations of steamed samples.

Table 3. The maximum, elastic deformation and semi-elastic deformation of steamed samples

Wood species	Maximum deformation (mm)	Elastic deformation (mm)	Semi-elastic region deformation (mm)
Oak	19.0	1.8	17.2
Hornbeam	23.1	2.2	20.9
Beech	18.8	2.6	16.2
Scots pine	17.9	1.7	16.2
Ash	15.2	3.2	12.0
Chestnut	15.4	2.7	12.7

In steamed wood, the highest maximum deformation was found in Hornbeam wood with the value of 23.1 mm while the lowest maximum deformation was observed in Ash wood with the value of 15.2 mm. Similar findings were also observed for semi-elastic deformation values in steamed wood. The steamed oak, hornbeam, beech, scots pine, ash and chestnut wood samples had 71.2%, 62.7%, 58.0%, 73.8%, 56.7% and 55.5% higher maximum deformation values compared to non-steamed wood, respectively. The highest improvement was achieved in scots pine wood with the steaming.

In case of semi-elastic deformation values, the steamed samples had higher values compared to non-steamed samples. The steaming improved the semi-elastic deformation values of oak, hornbeam, beech, scots pine, ash and chestnut wood with the value of 97.7%, 80.2%, 67.0%, 90.6%, 64.4% and 60.8%, respectively. The highest improvement was achieved in oak wood.

The theoretical minimum bending radius, minimum bending radius without strap and with strap are shown in Table 4.

Table 4. The theoretical minimum bending radius, minimum bending radius without strap and with strap

Wood species	Theoretical minimum bending radius (mm)	Minimum bending radius without strap (mm)	Minimum bending radius with strap (mm)
Oak	632.7	373	35
Hornbeam	595.4	321	35
Beech	626.9	389	38
Scots pine	660.8	483	400
Ash	819.1	381	40
Chestnut	639.4	520	180

The highest theoretical minimum bending radius value was calculated in Ash wood with the value of 819.1 mm while the lowest theoretical minimum bending radius value was calculated in Hornbeam wood with the value of 595.4 mm. The highest minimum bending radius without strap was determined in Chestnut wood with the value of 520 mm while the lowest minimum bending radius without strap was determined in Hornbeam wood with the value of 321 mm. Stevens and Turner (1970) reported that the minimum bending radius without strap of Oak (Europe), Hornbeam, Beech (Europe), Pine, Ash (Europe) and Chestnut wood was 330 mm, 420 mm, 330 mm, 710 mm, 300 mm and 380 mm, respectively. In this current study, higher bending radius without strap values were found in Oak, Beech, Chestnut and Ash wood while lower values were found in Hornbeam and Scots pine wood.

The highest minimum bending radius with strap was determined in Scots pine wood with the value of 400 mm while the lowest minimum bending radius with strap was determined in Hornbeam and Oak wood with the value of 35 mm. Stevens and Turner (1970) reported that the minimum bending radius with strap of Oak (Europe), Hornbeam, Beech (Europe), Pine, Ash (Europe) and Chestnut wood was 51 mm, 100 mm, 38 mm, 360 mm, 64 mm and 150 mm, respectively. In this current study, higher bending radius with strap values were found in Scots pine and Chestnut wood while lower values were found in Oak, Hornbeam and Ash wood. The

bending radius with strap values of Beech wood was similar.

The theoretical minimum bending radius values of all measured wood species were higher compared to minimum bending radius without strap. Hornbeam wood had 85.5% higher the theoretical bending radius compared to minimum bending radius with and without strap. This value was 115.0% in Ash wood and 23.0% in Chestnut wood.

In case of minimum bending radius without strap, all of the wood species used in this study have “moderate” bending quality. However, in case of minimum bending radius with strap, Oak, Hornbeam, Beech, Ash and Chestnut wood species have “very good” bending quality while Scots pine wood has “good” bending quality.

Conclusions

From this study, the below conclusions can be drawn:

1. The steamed wood samples had higher maximum deformation and semi-elastic deformation values compared to non-steamed wood samples.
2. Hornbeam wood had best bending properties (lower bending radius) with and without metal strap bending.
3. The worst bending properties (higher bending radius) were found for Chestnut without metal strap bending and for Scots pine wood with metal strap bending.
4. Oak, Hornbeam, Beech, Ash and Chestnut wood species have “very good” bending quality while Scots pine wood has “good” bending quality in respect to minimum bending radius with strap.

Acknowledgement

This work was supported by Scientific Research Projects Coordination Unit of Istanbul University. Project number 3330.

References

- Ayarkwa J., 2000. Cold and steam bending properties of some lesser-used species of Ghana. *Ghana J. Forestry* 9: 1-10.
- Ayarkwa J., Owusu F.W., Appiah J.K., 2011. Steam bending qualities of eight timber species of Ghana. *Ghana J For* 27:12–22.
- Bondad E.O., 2005. Properties of three plantation species: affecting solid wood bending.

48th Annual Convention Poster Presentation, 19 June 2005, Society of Wood Science and Technology, Québec City, Canada.

Hoadley R.B., 2000. Understanding wood: A craftsman's guide to wood technology. Taunton, USA.

Kuljich S., Caceres C., Hernandez R., 2015. Steam-bending properties of seven poplar hybrid clones. *Int J Mater Form* 8(1):67–72.

Mukarami R., Tanaka F., Norimoto M. 2002. Relationship between bending quality and wood species. *Wood Research No: 89*.

Niemiec S.S., Brown T.D., 1995. Steam Bending Red Alder. In: Green, D., W. von Segen, S. Willits, Western hardwoods-value-added research and demonstration program. Gen. Tech. Rep. FPL-GTR-85. Madison, WI: U.S. Department of Agriculture, Forest Service, Forest Products Laboratory. 43 p.

Rowell R.M., 1999. Specialty Treatments, Chapter 19. In: *Wood Handbook-Wood as an Engineering Material*, Forest Products Laboratory Gen. Tech. Rep. FPL-GTR-113, Madison.

Shakri M.S., David E.C.Y., Zaihan J. 2004. The Possibility of Using Some Malaysian Timbers for Bentwood, IUFRO Working Party 5-04.12, 3rd International Symposium on Surfacing and Finishing of Wood, Kyoto, Japan.

Stevens W.C., Turner N., 1970. Wood bending handbook. Woodcraft & Supply Corp., Parkersburg.

Wangaard F.F., 1952. The steam bending of beech. *Journal of FPRS* 35-41.

Whang K., Jung I., Lee W., Jang J., Bae H., Norimoto M., 2002. Bending quality of main Korean wood species. *Wood Research No:89*.

Investigation of the Corrosion Effect of CCB (Cooper, Chromium, Boron) Wood Preservative on Stainless Steels

*Çağlar AKÇAY¹, Hüsnü GERENGİ², Cihat TAŞCIOĞLU¹

¹Department of Forest Products Engineering, Faculty of Forestry, Duzce University, Duzce, Turkey

²Department of Mechanical Engineering, Corrosion Research Laboratory, Düzce, Turkey

*Corresponding Author: caglarakcay@duzce.edu.tr

Abstract

Corrosion can be defined as the degradation of metals due to electrochemical reactions in their environment. Corrosion process can be seen in various industrial areas including the forest products industry. In this study, the corrosion effect of CCB (cooper chromium boron) used as wood preservative in the wood protection industry was investigated on the most common stainless steel types AISI 304, 316L and 420 by Electrochemical Impedance Spectroscopy (EIS) and Tafel Polarization (TP) methods. The results showed that both of concentrations (2% and 4%) of CCB wood preservative were less corrosive than 3.5 % NaCl media for AISI 304, 316L and 420 stainless steels according to both electrochemical methods. AISI 420 Stainless steel was found as the most corroded metal while the least corroded metal was found AISI 316L among the steels tested in 3.5% NaCl media for applied method. SEM (Scanning Electron Microscope) images and EDS (Energy-dispersive X-ray spectroscopy) results demonstrated that CCB wood preservative protected the stainless steels against corrosion. According to this study, CCB wood preservative can also protect stainless steel metals against corrosion as well as protecting wood materials against biological decay hazards such as fungi, insect and termites.

Keywords: CCB, Corrosion, Stainless steel

Introduction

After The United States Environmental Protection Agency banned the use of CCA treated wood in 2003, Scientists tended the developing new generation wood preservatives (Zelinka et al. 2007). CCB wood preservative is a most common used wood preservative in wood protection industry. CCB wood preservative is produced at certain amounts as a dry mixture of copper sulphate, potassium and sodium dichromate and boric acid. These salts are used as wood preservative against fungi, insects, termites and marine borers in outdoor applications. At the same time they are used in impregnation of wood poles, fence posts, cooling tower, sea scaffold poles, scaffolding coverings, roof timbers in buildings (Bozkurt et.al.,1993).

Today, boron compounds are considered as one of the most environmentally wood preservative chemicals because they contain less toxic material than the other wood preservatives. Boron compounds are accepted as the most

important wood preservative in the future (Kartal and Unumura, 2004). It was started to using as wood preservatives since the early years 1900's, then replaced a lot of traditionally wood preservatives (Lloyd, 1998).

Material and Method Electrochemical Impedance Spectroscopy (EIS)

EIS method can give us detailed information about the corrosion mechanism. Various parameters such as electrochemical mechanism, reaction kinetics and corrosion rate can be determined by EIS method (Hamdy et. al., 2006). We have used EIS method to measure corrosion resistances and corrosion rates of metals used in CCB wood preservative chemical and 3.5% NaCl media in this study. The following formula was used to calculate the corrosion resistance of metals (Gerengi, 2008).

$$|Z| = \sqrt{Z_{im}^2 + Z_{Re}^2}$$

Where,

$|Z|$: Impedance

Z_{im} : Imagine impedance

Z_{Re} : Real impedance

$$i_{corr} = \frac{\beta_a \beta_c}{2,303(\beta_a + \beta_c)} \frac{1}{R_p}$$

W

here,

I_{corr} : Corrosion current

β_a and β_c :Tafel constants

R_p : Polarization resistance

Tafel polarization method

Tafel polarization method was also used to determine the corrosion effects of CCB wood preservative on metals. It is most common method used in industry because using Tafel Polarization method is easier than other corrosion measurement method (Gerengi et al.2012). Corrosion current density values are calculated using by fallowing formula;

Preparation of metal samples and corrosion cell design

Working electrodes (stainless steel AISI 304, AISI 316 L and AISI 420) were area 0.07, 0.12 and 0.28 cm², respectively. Around of the working electrodes was covered with thick polyester layer. Compounds of the working electrodes were showed on table 1.

Table 1: Chemical composition of working electrodes

Elements	Chemical composition of working electrodes (W%)		
	Stainless steel AISI 304	Stainless steel AISI 316L	Stainless steel AISI 420
C	0.032	0.021	0.19
Mn	1.53	1.26	0.74
Si	0.43	0.44	0.46
S	0.025	0.026	0.028
P	0.035	0.035	0.037
Cr	18.17	16.29	12.16
Ni	8.07	10.1	0.16
Cu	0.66	0.6	0.1
Mo	0.27	2.1	0.03
Co	0.14	0.22	-
Fe	69.46	68.85	86.095

Stainless steel, Ag/AgCl and Pt wire electrode were used as working electrode, reference electrode and counter electrode, respectively in the triple electrode system (Gerengi et. al., 2009). Before experiment, working electrode samples were sanded thoroughly with 800 and 1200 emery grit paper to ensure a smooth metal surface.

Then, working electrode surface was cleaned by distilled water, and dried thoroughly. EIS measurements were carried out using GAMRY PC3/600 Potentiostat / Galvanostat / ZRA system (Figure 1) and the data's were analysed with the software Gamry CMS-5:30.

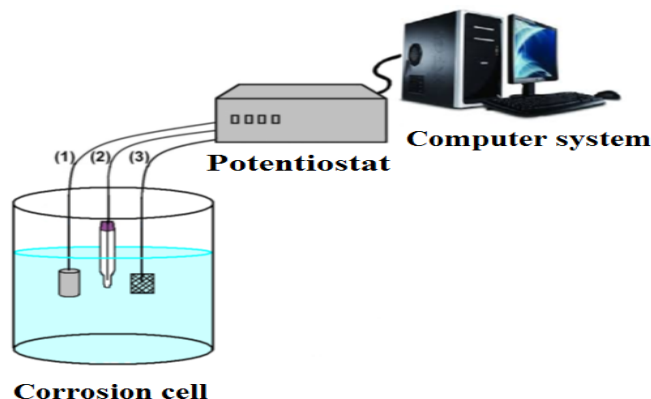

Figure 1: Corrosion measurement design (1: working electrode 2: reference electrode 3: platinum electrode)

Preparation of treatment chemical

CCB wood preservative solution was prepared according to TS EN 351-1 in this study. 4% concentration of CCB wood preservative is used in industry (TS EN 351-1, 1997). To compare the corrosion effect of different concentrations of CCB wood preservative, 2% and 4% concentrations of CCB wood preservative and 3.5% NaCl were prepared before the corrosion experiments. After CCB wood preservative was dissolved in water, corrosion potentials were measured by electrochemical impedance methods. The compound of CCB wood preservative used in this study is shown in table 2.

Table 2: Compound of CCB wood preservative chemical

	Compound	(%)
	CuSO ₄ .5H ₂ O	28
Wolmanit-CB	K ₂ Cr ₂ O ₇	48
	H ₃ BO ₃	24
		100

Corrosion data analysis

R(QR) equivalent circuit model was used to analyzed corrosion mechanism of the metals.

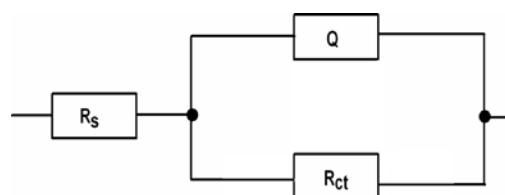

Figure 2: R(QR) equivalent circuit model

Solution resistance (R_s) is the resistance of the electrolyte between the working electrode and reference electrode. R_s is generally very low and can be ignored. Constant phase element (Q) instead of a capacitor was used to model the coating-metal interface in this study. Charge transfer resistance (R_{ct}) is a kind of resistance to mass transfer on the metal used in the solution.

Results and Discussion

Results of Electrochemical Impedance Spectroscopy

In order to determine corrosion effect of CCB on stainless steel AISI 304, stainless steel AISI 316L and stainless steel AISI 420 metals, electrochemical impedance spectroscopy measurements were performed by EIS method. Figure 3 showed that % 3.5 NaCl was more corrosive than 2% and 4% CCB for stainless steel AISI 304. Corrosion resistance increased with the increase of CCB concentration

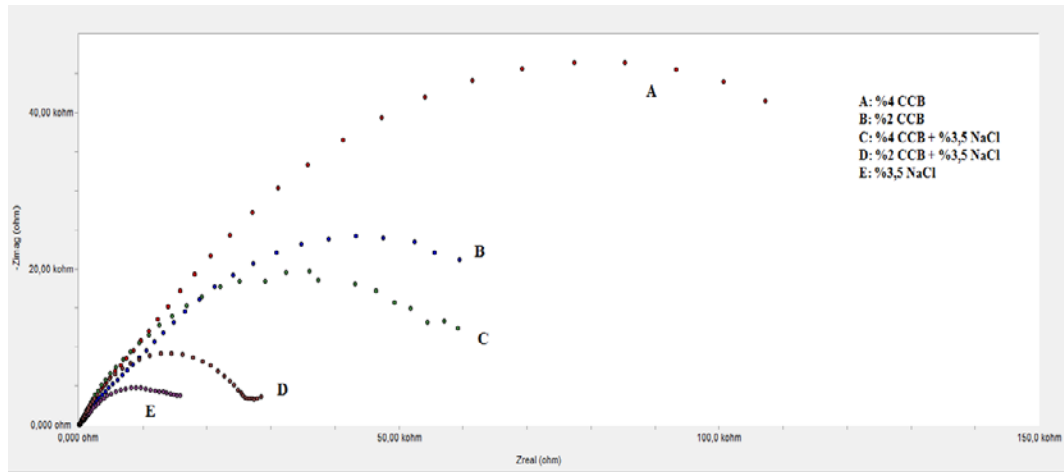

Figure 3. Nyquist plots for stainless steel AISI 304 in CCB wood preservative environments and comparison with 3.5 % NaCl environment

Table 3: Corrosion resistance values of stainless steel AISI 304 in CCB and NaCl medias

Experiment	R_s (ohm)	Q (CPE)	n ($0 < n < 1$)	R_{ct} (ohm)
2% CCB	5.87	4.69E-04	0.65	5816
4% CCB	7.66	3.91E-05	0.79	16750
3.5 % NaCl	1.29	8.47E-04	0.59	1232
2% CCB + 3.5% NaCl	1.60	6.67E-04	0.60	2092
4% CCB + 3.5% NaCl	6.08	5.16E-04	0.66	4844

Table 3 shows that the corrosion resistance value (R_{ct}) of stainless steel AISI 304 in 3.5% NaCl environment was measured 1232 ohm while the corrosion resistance values in 2% and 4% CCB environment were measured as 5816 and 16750 ohm, respectively. When 2% CCB and 4% CCB wood preservative added to the 3.5% NaCl environment, corrosion resistance values of AISI 304 decreased from 2092 ohm to 4844 ohm. Hence, CCB wood preservative acted like a corrosion inhibitor for AISI 304. With increasing CCB amount, R_s value increased while Q value decreased.

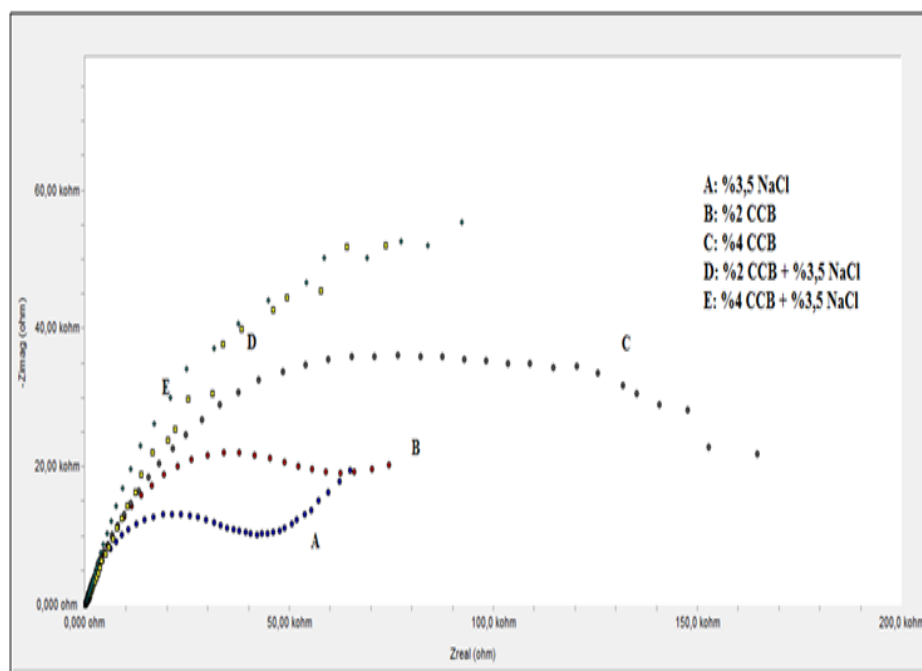

Figure 4. Nyquist plots for stainless steel AISI 316L in CCB wood preservative environments and comparison with 3.5 % NaCl environment

Figure 4 shows that Nyquist plots of stainless steel AISI 316L in 2% and 4% CCB media and 3.5 % NaCl solutions. Nyquist plots of stainless steel AISI 316 in 2%, 4 % CCB and their NaCl environments were observed higher Nyquist value than 3.5 % NaCl media.

Table 4: The values of corrosion effects of CCB wood preservative and 3.5% NaCl media on stainless steel AISI 316L determined by R(QR) circuit model

Experiment	R_s (ohm)	Q (CPE)	$n(0 < n < 1)$	R_{ct} (ohm)
%2 CCB	11.13	1.56E-04	0.70	9326
%4 CCB	12.47	2.09E-05	0.73	18070

%3.5 NaCl	2.281	1.93E-05	0.56	6211
-----------	-------	----------	------	------

The corrosion mechanism of AISI 316L in %2 CCB + %3.5 NaCl and %4 CCB + %3.5 NaCl media was found different from the AISI 304 and 420 stainless steels. R(C(R(C(R(CR)))))) circuit model was used to analyzed corrosion resistance of AISI 316L. The corrosion resistance results of AISI 316L metal was showed in figure 5. According to figure 5, R_{ct} values of AISI 316L in CCB media are higher than 3.5 % NaCl media. These values showed that CCB protected AISI 316L meal against corrosion in corrosive media.

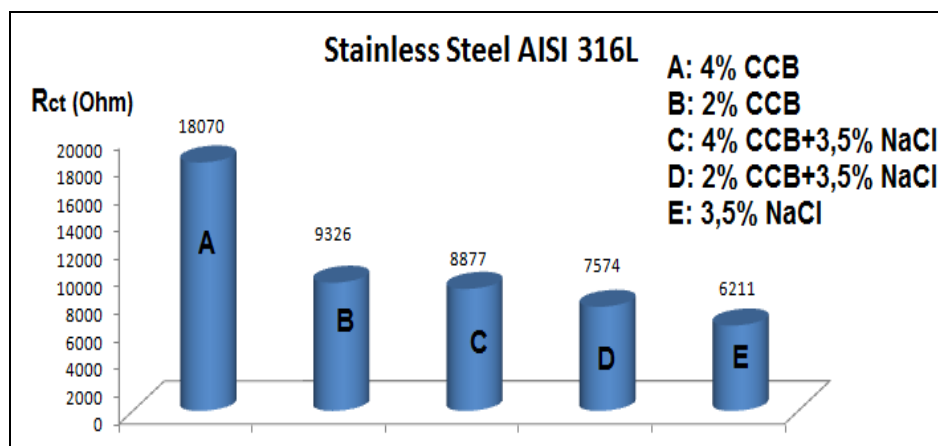

Figure 5: The values of corrosion effects of CCB wood preservative on stainless steel AISI 316L determined by R(C(R(C(R(CR)))))) and R(QR) circuit model

Figure 5 showed that when 2% and 4% CCB wood preservative added to the NaCl media the corrosion resistance values (R_{ct}) of

AISI 316L were increased from 6211 ohm to 7574 and 8877 ohm, respectively.

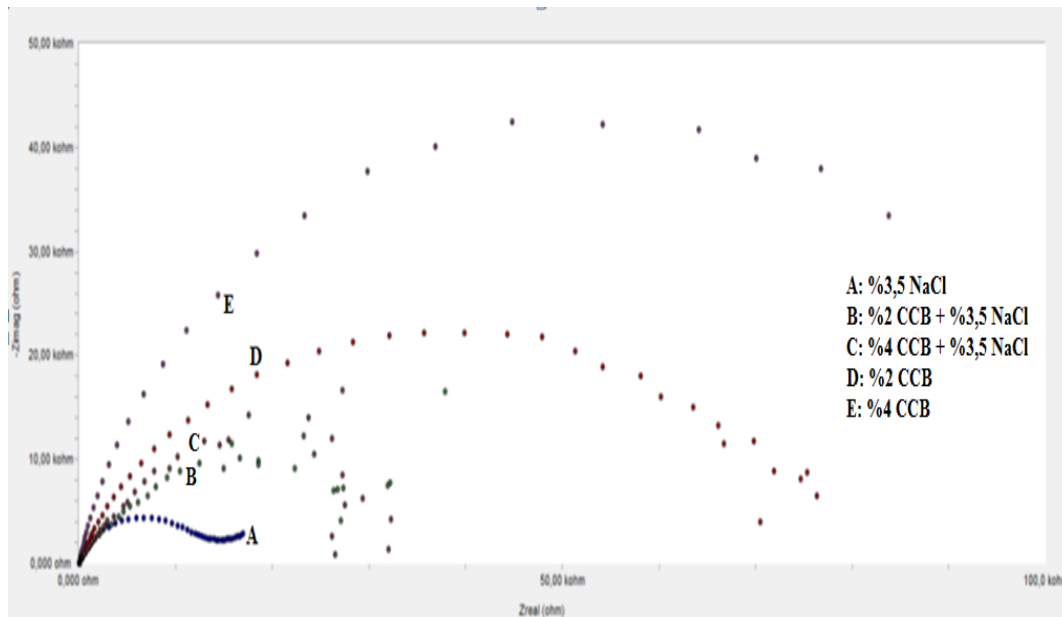

Figure 6. Nyquist plots for stainless steel AISI 420 in CCB wood preservative and comparison with 3.5 % NaCl environment

Figure 6 shows that Nyquist values of stainless steel AISI 420 in 4% CCB is much higher than 2% CCB wood preservative and 3.5 % NaCl solution

Table 5: The values of corrosion effects of CCB wood preservative and 3.5% media on stainless steel AISI 420 determined by R(QR) circuit model

Experiment	R_s (ohm)	Q (CPE)	$n(0 < n < 1)$	R_{ct} (ohm)
%2 CCB	19.95	2.11E-05	0.76	5310
%4 CCB	25.19	1.87E-05	0.79	9213
%3.5 NaCl	7.71	1.72E-02	0.58	875
%2 CCB + %3.5 NaCl	3.91	1.07E-04	0.69	1456
%4 CCB + %3.5 NaCl	4.08	1.01E-04	0.71	2375

CCB wood preservative chemical acted like corrosion inhibitor for AISI 420 stainless steel as well. In table 5, the corrosion resistance value (R_{ct}) of AISI 420 in NaCl media was found 875 ohm while the corrosion resistance values in the absence CCB in NaCl environments were found 1456 and 2375 ohm. It can be also showed that n

and R_s values were decreased while Q values increased. That is why the resistance values of AISI 420 increased against corrosion with the increasing CCB wood preservative chemical amount. When only CCB wood preservative used without NaCl, the corrosion resistance values of all metals increased with increasing CCB wood preservative chemical according to EIS method. Similar results were found by Gerengi et al. (2014) using DEIS method.

Tafel Polarization Results

Table 6: Corrosion parameters of stainless steel metals type of AISI in the absence of CCB wood preservative chemical according to Tafel polarization method

Experiment	AISI 304		AISI 316L		AISI 420	
	E (mV)	I_{corr} (μA)	E (mV)	I_{corr} (μA)	E (mV)	I_{corr} (μA)
%3.5 NaCl	-83.51	3.81	-143.98	3.2	-369.82	3.93
%2 CCB	-25.27	0.91	138.92	0.82	117.69	2.1
%4 CCB	210.41	0.4	256.08	0.32	347.08	0.89
%2 CCB + %3.5 NaCl	-137.3	2.16	-156.8	1.43	-336.47	3.30
%4 CCB + %3.5 NaCl	-135.04	1.52	-181.45	1.32	-318.37	2.76

Corrosion rates (I_{corr}) and potentials (E) of stainless steel metals type of AISI in various

concentrations of NaCl and CCB wood preservative medias (table 6). It can be observed that the highest corrosion rate (I_{corr}) was found in NaCl media of AISI 420 while the lowest corrosion rate was found in NaCl media of AISI 316L stainless steel when compared each other. At the same time most corrosion rate was found with 3.30 μA in NaCl media of AISI 420 in the presence of CCB while the lowest corrosion rate was found 1,40 μA in NaCl media of 316L. It is clearly showed that corrosion rates were decreased with increasing CCB wood preservative chemical concentration. Table 6 demonstrate that the increase of CCB leads to an increase of potential values for all metal types according to Tafel polarization method.

Results of Scanning Electron Microscopy (SEM) and Energy-Dispersive X-Ray Spectroscopy (EDS)

Scanning Electron Microscopy (SEM) and Energy-Dispersive X-Ray Spectroscopy (EDS) were utilized to examine the metal surfaces exposed to the wood preservative chemicals and NaCl media. SEM images of stainless steels in 3.5% NaCl media were shown in figure 7. It seems that AISI 420 is the most corroded metal in 3.5% NaCl media in the absence of CCB among the metals in the SEM figures (Figure 7).

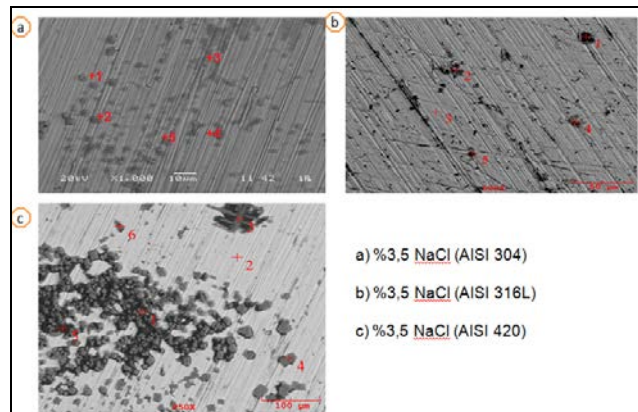

Figure 7: SEM images of stainless steels in 3.5% NaCl media in the absence of CCB

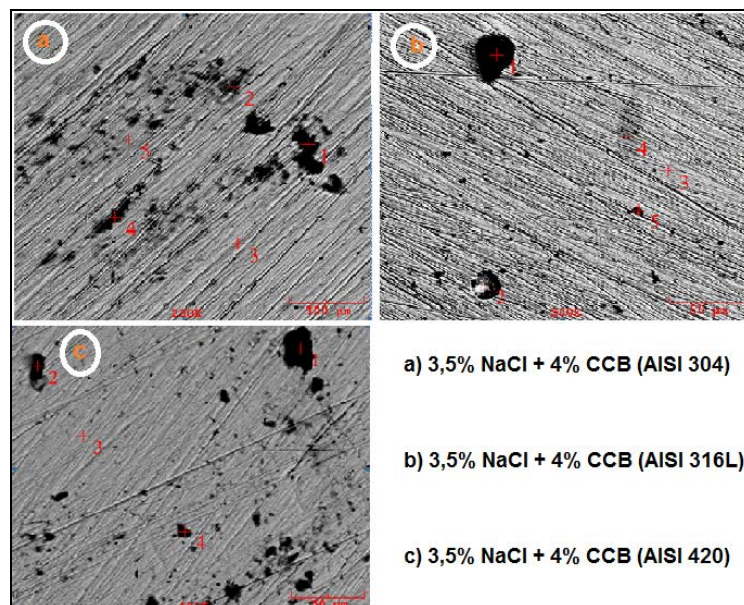

Figure 8: SEM images of stainless steels in 3.5% NaCl media in the presence of CCB

Figure 8 indicate that when CCB wood preservative added to the NaCl media, it can significantly influence surface of metals. It can be observed that the corrosion products on the

metal surfaces decreased if figure 7 and figure 8 compared to each other. As it can be seen in the figure 7, stainless steel AISI 316L has the smoothest surface.

Table 7: EDX analyze results taken from metal surfaces in 3.5% NaCl media in the presence of CCB

Element	Concentration (%)		
	AISI 304	AISI 316L	AISI 420
C	5.112	17.645	31.058
O	18.099	18.576	25.366
Si	10.425	2.156	0.951
Cl	0.331	3.012	3.632
Cr	12.292	12.405	5.521
Mn	0.597	0.322	0.047
Fe	47.693	35.053	29.993
Ni	4.746	3.807	0.302
Cu	0.385	1.357	1.757
Na	-	3.248	-
Mg	-	0.619	-
K	0.282	-	0.095
P	-	0.528	0.127
S	-	1.145	0.904
Ca	-	0.128	0.246
Total	100	100	100

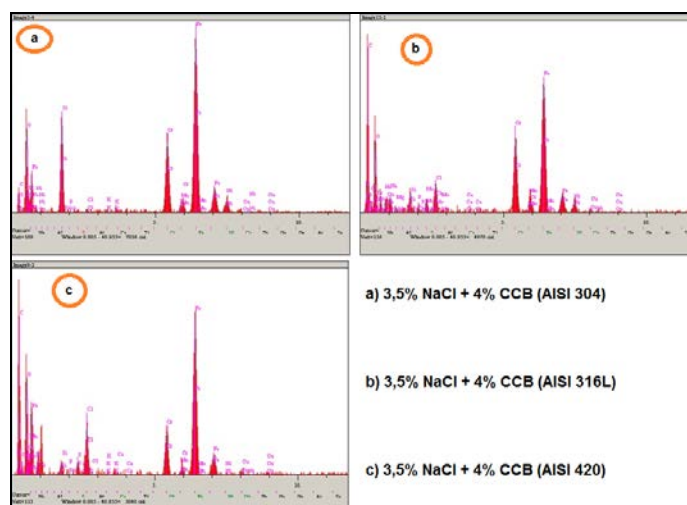

Figure 9: EDS analyzes of the stainless steels in 3.5% NaCl media presence of CCB wood preservative

Cr element which is found in the structure of CCB wood preservative chemical has been known as anti-corrosion material and creates a film against to corrosion on metal surface (Zelinka et. al, 2007). Table 7 showed that the highest Cr element rate was found on the AISI 316L metal surface. That is why it can be said the strongest metal is stainless steel AISI 316L against to corrosion while the weakest metal is

stainless steel AISI 420. In addition, table 7 showed that oxygen amount of AISI 420 is higher than AISI 304 and 316L. There is oxygen element in the form of corrosion products. Therefore, the most corrosion products were observed on the AISI 420 metal surface. Figure 9 shows EDS analyses of stainless steels in 3.5% NaCl media presence of CCB wood preservative.

Conclusion and discussion

The aim of this study to investigate the corrosion effects of CCB wood preservative chemical on metal alloys. Based on the results obtained in this work, the following conclusions can be drawn:

Stainless steel AISI 420 was found the most corroded metal while the lowest corroded metal was found AISI 316L among the steels tested in 3.5% NaCl media.

CCB wood preservative chemical significantly positive effected on all steels used in this study in 3.5% NaCl as it acted corrosion inhibitor.

With increasing CCB amount corrosion resistance values of metals has increased in the all environments in the presence of CCB wood preservative chemical.

Two electrochemical corrosion measurement methods (TP and EIS) could be successfully used to determine the corrosion effects of CCB and NaCl solutions on the steels. The results of both electrochemical methods were in a good agreement.

SEM images and EDS results also demonstrated that CCB wood preservative protected the metals against corrosion in NaCl media in this study.

This study showed that CCB is also a good corrosion inhibitor as well as protects wood material against wood decay hazards.

Acknowledgments

We would like to thank Erol BILCAN for his supporting to supply CCB wood preservative chemical. This work was supported by the Scientific Research Projects Council of Duzce University (BAP-2013.2.3.139 coded project).

References

Baker A. J. 1974."Degradation of wood by products of metal corrosion", pub Forest Products Laboratory, Madison, USA.
Baker A.J. 1978. Corrosion of metal in wood products, durability of building materials and

components-Proceedings of the First International Conference A-Symposium Presented at Ottawa, (21-23 Aug.1978). Canada.

Bozkurt Y., Göker Y., Erdin N. 1993. Impregnation Technique, Istanbul University, publication no:3779, Forest faculty pub. No:425, 429p. Istanbul.

Gerengi H. 2008. Investigation behaviour of low carbon steel (AISI 1026) and effect of benzotriazole on the corrosion of brass-mm55 and nikalium-118 alloys in artificial seawater by tafel polarization (TP), linear polarization (LP), harmonic analysis (HA) and dynamic electrochemical impedance spectroscopy (DEIS), PhD thesis, Eskisehir Osmangazi University, department of chemistry, p.65 Eskisehir, Turkey.

Gerengi H., Darowicki K., Bereket G., Slepiski P. 2009. Evaluation of corrosion inhibition of brass-118 in artificial seawater by benzotriazole using Dynamic EIS. Corrosion Science, 51, 2573-2579.

Gerengi H., Ozgan E., Akcay, C., Arslan I. 2012. Investigation on the Corrosion of Low Carbon Steel Placed in Asphalt Concrete in 3.5% NaCl Environment, Mehemet Akif Ersoy University, Journal of Sciences, 3 (1), 5-11.

Gerengi H., Tascioglu C., Akcay C. 2014. Kurtay M. Impact of copper chrome boron (CCB) wood preservative on the corrosion of st37 steel, Ind. Eng. Chem. Res., 53, 19192-19198.

Kartal S.N., Unumura Y. 2004. The use of boron as wood preservative systems for wood and wood-based composites, 3rd.International Boron Symposium , (23-25 September 2004), Eskişehir, Türkiye.

Kear G., Jones M.S., Haberecht P.W. 2005. Corrosion of mild steel hdg steel and 316 stainless steel in CCA, CuAz and ACQ treated *pinus radiata*, Corrosion & Prevention, 064.

Lloyd J.D. 1998. Borates and their biological applications. The International Research Group on Wood Preservation 29th Annual Meeting, Maastricht, Netherlands, (14-19 June 1998), IRG/WP/98-30178,24pp.

Zelinka S.L., Rammer D.R., Stone D.S., Gilbertson J.T. 2007. Direct current testing to measure corrosiveness of wood preservatives, *Corrosion Science*, 49, 1673– 1680.

Zelinka S.L., Rammer D.R. 2009. Corrosion rates of fasteners in treated wood exposed to 100% relative humidity, *Journal of Materials in Civil Engineering*, 21:12, 1s.

Zelinka S. L., Rammer D. R., Stone D.S. 2008. Electrochemical corrosion testing of fasteners in extracts of treated wood, *Corrosion Science*, 50, 1251-1257.

Zelinka S. L., Stone D.S. 2011. The effect of tannins and pH on the corrosion of steel in wood extracts, *Materials and Corrosion*, 56, 8.

Zelinka S.L., Rammer D.R. 2005. The use of electrochemical impedance spectroscopy (EIS) to measure the corrosion of metals in contact with wood. *TMS Letters*. 2(1), 15-16.

Mold Resistance of Scotch Pine (*Pinus sylvestris*) Sapwood Treated with Geothermal Water

Mesut YALÇIN¹, *Çağlar AKÇAY¹, Hüseyin SİVRİKAYA², Camille FREITAG³,
Jeffrey J. MORRELL³

¹Department of Forest Products Engineering, Faculty of Forestry, Duzce University,
81620 Duzce, Turkey

²Department of Forest Products Engineering, Faculty of Forestry, Bartın University,
Bartın, Turkey

³Department of Wood Science & Engineering, Oregon State University, Corvallis,
Oregon, USA

*Corresponding Author: caglarakcay@duzce.edu.tr

Abstract

Molds are very important problem for wooden buildings materials and various methods have been developed to protect wooden material against insects, termites, fungi and molds. Increases concerns about the risks associated with the use of synthetic preservatives have encouraged the development of more natural protective methods. The aim of this study was to evaluate the mold resistance of scots pine sapwood treated with geothermal water obtained from different regions of Turkey such as Ankara, Afyon, Eskişehir and Denizli. The highest retention (4.37 g cm⁻³) was achieved concentrated Ankara geothermal water while the lowest retention was achieved by natural water from Afyon. Maximum protection against mold was found with concentrated Denizli geothermal water. The best results were obtained at the end of the 2nd week. No statistically significant differences in mold resistance were observed on samples treated with geothermal water from all regions and exposed to fungal attack for longer time periods.

Keywords: Geothermal water, Mold test, Wood protection

Introduction

Wood is a widely used construction material (Hayoz et al., 2003; Turkoglu et al., 2015); however, wood is used in outdoor applications can be degraded by various biological organisms such as insects, termites, and fungi (Schultz and Nicholas 2002) and must be impregnated with wood preservatives. Wood preservatives like chromated copper arsenate (CCA) have been used to protect; however, some wood preservatives have environmental and human health effects (Zelinka et al., 2010) that have encouraged the development of more environmentally friendly wood protection strategies (Gerengi et al., 2014).

Geothermal water contains minerals and small amounts of heavy metals (Var, 2009) that might be effective against fungi (Var et al., 2012) or termites (Yalcin et al., 2016).

Turkey has a number of geothermal sources. Approximately 70% of the Turkey geothermal potential is in the Marmara

Region. These waters can contain boron (B), chloride (Cl), potassium (K), sodium (Na), fluoride (F), silicon dioxide (SiO₂), ammonia (NH₃) and sulfate (SO₄) (Var, 2009).

The purpose of this study, wood exposure the potential for using geothermal water as a wood protectant.

Materials and Methods

Geothermal water was obtained from Ankara, Eskişehir, Afyon and Denizli regions in Turkey. Half of the water from each source was evaporated by 75% to increase the concentration of elements present. The water was used without filtration or sterilization but was refrigerated prior to use to limit microbial growth.

Wood samples (12.5 mm thick, by 75 by 100 mm long) were prepared from Scotch pine (*Pinus sylvestris*). The samples were weighed, then immersed in a given solution and subjected to a 20 minute vacuum (675

mm Hg). The vacuum was released and then applied for a second time. The samples were then wiped clean of excess solution and weighed. The difference between initial and final weight was used to calculate net uptake. Samples were then oven dried (103 C) and weighed to determine net weight gain.

Mold test

A single mold box built according to the specifications in the American Wood Protection' Association Standard E 24 "Standard Method of Evaluating the Resistance of Wood Product Surfaces to Mold Growth" was used for all testing (AWPA, 2012). The plastic box contained water in the bottom with moist soil on a mesh rack above the water. The soil was inoculated with a suspension of spores and mycelium of appropriate mold fungi and incubated for 2 weeks before the samples were added. The fungi used in this test were species of *Trichoderma*, *Aspergillus*, *Alternaria*, *Penicillium* and *Aureobasidium*.

The samples were sprayed lightly with a freshly prepared suspension of the same fungi and suspended on rods across the top of the box so that the wide faces were in an upright position. Although the standard specifies rating the samples on both faces and all 4 edges, only the faces were rated. Mold coverage was rated at 2, 4, 6 and 8 weeks on a scale of 0-5 defined as follows;

Table 1. Scale used to evaluated degree of mold coverage on scots pine samples (AWPA, 2012).

Scales	Definition
0	No visible growth.
1	Mold covering up to 10% of surfaces providing growth is not so intense or colored as to obscure more than 5% of surfaces.
2	Mold covering between 10 and 30% of surfaces providing growth is not so intense or colored as to obscure more than 10% of surfaces.
3	Mold covering between 30 and 70% of surfaces providing growth is not so intense or colored as to obscure more than 30% of surfaces.
4	Mold on greater that 70% of surfaces

providing growth is not so intense or colored as to obscure more than 70% of surfaces.

5	Mold on 100% of surfaces or with less that 100% coverage and with intense or colored growth obscuring greater than 70% of surfaces.
---	-------------------------------------------------------------------------------------------------------------------------------------

Results and Discussions

Retentions

The highest retentions were found in samples treated with concentrated geothermal water from Ankara while the lowest retention was found in samples treated with natural geothermal water from Afyon. Retention all increased when concentrated water was employed, but the differences were not always proportional. Increases differed significantly between water from Denizli and Ankara (Table 2).

Table 2. Mass gains of Scotch pine blocks treated with normal or concentrated geothermal water from four sites in Turkey.^a

Regions	Evaporation Rate	Average total mineral retention (g/cm ³)	H.G
Afyon	0%	0.03 (0.01)	<i>a</i>
	75%	0.28 (0.02)	<i>ab</i>
Denizli	0%	0.38 (0.04)	<i>b</i>
	75%	1.63 (0.05)	<i>c</i>
Eskişehir	0%	0.04 (0.00)	<i>a</i>
	75%	0.09 (0.00)	<i>a</i>
Ankara	0%	1.20 (0.07)	<i>d</i>
	75%	4.37(0.70)	<i>e</i>

^aValues followed the same letters in each column do not differ significantly ($\alpha= 0.05$). Values in parenthesis are standard deviations.

Mold activity of the geothermal water

The ability of geothermal water to affect mold growth over 2 months is shown in Table 2. For practical purposes, the only differences between control and treated samples were observed at the 2 week evaluation. Samples treated with concentrated Denizli, Afyon or Ankara geothermal water were more resistant to

mold attack than those treated with natural geothermal water. Eskişehir geothermal water resulted in very low mold activity during the exposure periods. The highest mold activity of all the Geothermal Fluids occurred at the end of the 2nd week. Mold activity on samples treated with geothermal waters then gradually increased over the next 6 weeks.

The lowest decrease of mold attack at 2 weeks was observed with concentrated Denizli geothermal water. Similar results were found with Ankara and Afyon geothermal water.

There are a number of active chemical components in the geothermal waters that might affect fungal growth. The most important of these would be boron, which is widely present in much of Turkey and has a well-known ability to inhibit fungal growth. Previous studies have shown a linear relationship between biotic activity and mineral component in the water (Var et al., 2012). The same authors also found that geothermal water-treated kraft paper was resistant to fungal to attack (Var, 2012).

Table 3: Degree of mold attack on scots pine sapwood samples treated with normal or concentrated geothermal water from four sources in Turkey

	Mold Rating ^a								
	2 weeks		4 weeks		6 weeks		8 weeks		
	mean	H.G	mean	H.G	mean	H.G	mean	H.G	
Control	5.00 (0.00)	<i>e</i>	5.00(.00)	<i>e</i>	5.00(.00)	<i>e</i>	5.00(.00)	<i>e</i>	
Denizli	0%	3.33(1.15)	<i>abcd</i>	4.67(.58)	<i>de</i>	4.33(.58)	<i>cde</i>	5.00(.00)	<i>e</i>
	75%	2.33(.58)	<i>a</i>	4.00(1.00)	<i>bcde</i>	4.00(.00)	<i>bcde</i>	4.33(1.15)	<i>cde</i>
Afyon	0%	4.00(.00)	<i>bcde</i>	4.67(.58)	<i>de</i>	4.67(.58)	<i>de</i>	5.00(.00)	<i>e</i>
	75%	3.33(1.15)	<i>abcd</i>	3.67(.58)	<i>abcde</i>	4.00(1.00)	<i>bcde</i>	4.33(1.15)	<i>cde</i>
Ankara	0%	4.33(.58)	<i>cde</i>	4.67(.58)	<i>de</i>	4.67(.58)	<i>de</i>	5.00(.00)	<i>e</i>
	75%	2.67(1.15)	<i>ab</i>	3.67(1.53)	<i>abcde</i>	4.33(1.15)	<i>cde</i>	5.00(.00)	<i>e</i>
Eskişehir	0%	3.00(1.73)	<i>abc</i>	3.67(2.31)	<i>abcde</i>	3.67(2.31)	<i>abcde</i>	5.00(.00)	<i>e</i>
	75%	4.33(.58)	<i>cde</i>	4.67(.58)	<i>de</i>	5.00(.00)	<i>e</i>	5.00(.00)	<i>e</i>

H.G: Homogeneity group. Values followed by the same letters in each column do not differ significantly ($\alpha= 0.05$). Values in parenthesis are standard deviations

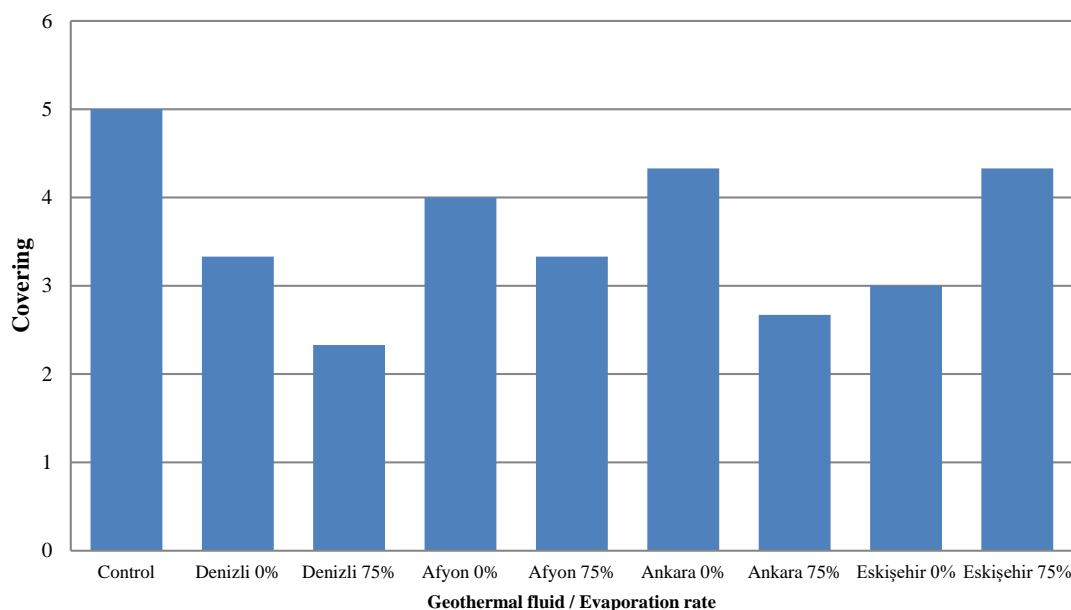

Figure 1. Degree of mold attack on scots pine sapwood samples treated with normal or

concentrated geothermal water from four sources in Turkey and exposed for 2 weeks in an AWPA E24 mold box test.

The lowest degree of mold development was observed on samples with concentrated Denizli water but the effect only differed significantly from the control at 2 weeks. Further incubation resulted in loss of protection. It is possible that geothermal water components diffused further inward into the wood and were no longer available for protection against fungal attack; however, the overall effect was a loss of protection.

Conclusions

The mold resistance of Scotch pine sapwood treated with geothermal water from different regions of Turkey was examined. The highest degree of protection against molds was found with concentrated Denizli geothermal water. Concentration clearly improved the ability of some waters to confer protection against fungal attack although the effect was temporary and specific to water source.

References

American Wood Protection Association. 2012. Standard E24-12. Standard method of evaluating the resistance of woods product surfaces to mold growth. In: AWPA Annual book of standards, AWPA, Birmingham, Alabama. Pages 506-510.

Gerengi H., Tascioglu C., Akcay, C., Kurtay M. 2014. Impact of copper chrome boron (CCB) wood preservative on the corrosion of St37 steel. *Industrial & Engineering Chemistry Research*, 53(49), 19192-19198.

Hayoz P., Peter W, Rogez D. 2003. A new innovative stabilization method for the protection of natural wood. *Prog Org Coat* 48, 297–309.

Turkoglu T., Baysal E., Toker H. 2015. The effects of natural weathering on color stability of impregnated and varnished wood materials. *Advances in Material Sci Eng* <http://dx.doi.org/10.1155/2015/526570>.

Var A.A., Yalcin M., Sen S., Tascioglu C., 2012. Antifungal activity of geothermal water from different regions of Turkey. *BioResources* 7(3), 4226-4236.

Var A.A. 2009. Jeotermal akışkanlarda potansiyel emprenye maddelerinin miktarı ve bunların ahşap emprenye işlemine uygunluğu. *SDÜ Orman Fakültesi Dergisi*, A/1: 184-197

Yalçın M., Akçay Ç., Troya T., Sivrikaya H., Ceylan H. 2016. Investigation of anti-termite activity of wood treated with geothermal fluids from different regions of Turkey, International Conference on Engineering and Natural Science, (24-28 May 2016), Sarajevo.

Zelinka S.L., Sichel R.J., Stone D.N. 2010. Exposure testing of fasteners in preservative treated wood: gravimetric corrosion rates and corrosion product analyses, *Corrosion Science*, 52, 3943–3948.

Effect of Adhesive Formulation on the Physical and Mechanical Properties of Particleboard

*Mehmet Erdal KARA¹, Nadir AYRILMIŞ²

¹SFC Integrated Wood Company, Baraj yolu, Killik Mevki,
Kastamonu/TURKEY

²Department of Wood Mechanics and Technology, Forestry Faculty, Istanbul University,
Bahcekoy, Sariyer, 34473,
Istanbul/TURKEY

*Corresponding Author: erdalkara37@hotmail.com

Abstract

In this research study, the effect of adhesive formulation on the physical and mechanical properties of particleboard were investigated. Four adhesive formulations (1) E1 grade urea-formaldehyde (UF) adhesive with 60% solid content, (2) E2 grade urea-formaldehyde (UF) adhesive with 60% solid content, (3) E1 grade urea-formaldehyde (UF) adhesive with 55% solid content, and (4) E1 grade melamine-urea-formaldehyde (MUF) with 60 wt% solid content were used in the production of particleboards. These adhesive formulations were differently used in the surface and core layers of the commercially produced particleboards (700 kg/m³) with dimensions of 8 mm x 2100 mm x 2800 mm. Based on the test results, it was concluded that the adhesive formulation had a significant effect on the physical and mechanical properties of the particleboard. The highest mechanical properties were found in the particleboards produced with E2 type adhesive and the best physical properties were found in the particleboards produced with the MUF adhesive.

Keywords: particleboard, adhesive, mechanical properties, physical properties

Yonga Levhanın Bazı Mekanik ve Fiziksel Özellikleri Üzerine Farklı Tutkal Kullanımının Etkisi

Özet

Bu çalışmada, lif levha endüstrisinde ticari olarak üretilen yonga levhaların mekanik ve fiziksel özellikleri üzerine dört tutkal formülasyonu kullanmanın etkisi araştırılmıştır. Bu amaçla, levhanın orta (MS) ve yüzey (DS) tabakalarında aynı miktarlarda %60'lık üre formaldehit ÜF-E1 ve ÜF-E2, %60'lık melamin/üre-formaldehit MÜF-E1, %55'lik üre-formaldehit ÜF-E2 tutkal türü kullanılarak (700 kg/m³) yoğunluğunda 8 mm x 2100 mm x 2800 mm ebatlarında deney levhaları üretilmiştir. Deney sonuçlarına göre, belirli özelliklerde tutkal kullanmanın levhaların mekanik ve fiziksel özellikleri üzerine önemli bir etkisinin olduğu tespit edilmiştir. Buna göre, en yüksek mekanik dirençlere %55'lik ÜF-E2 tutkalında, fiziksel dirençlere ise, %60'lık MUF-E1 tutkalı kullanılarak üretilen deney levhalarında görülmüştür.

Anahtar Kelimeler: yongalevha, yapıştırıcı, mekanik özellikler, fiziksel özellikler

Introduction

Urea-formaldehyde (UF) adhesive is the primary binder of interior-grade wood-based panels such as particleboard, fiberboard, and plywood due to its short press time, low cost, excellent adhesion, intrinsic cohesion, high reactivity and water solubility, and lack of color in the finished product. Because of its good bonding properties and low price.

However, the main disadvantages of UF adhesive are lack of resistance to water.

Wood-based panels are designed for interior use for a wide range of substrate applications including furniture, shelving and cabinets, flooring, tables, counters, office drivers, wall and ceiling, stair treads, bulletin boards, home constructions, sliding doors,

interior signs, kitchen worktops, and other industrial products (Atar et al., 2014).

The demand and consumption of particleboard show an increase in the sectors of furniture manufacturing, housing construction, and interior decoration, due to its low price, stability, etc (Atar et al., 2014). In addition, humidity changes cause splitting and wrapping in solid wood, but not particleboard (Baharoglu et al., 2014). One of the most important factors in this area is the mole ratio of formaldehyde to urea in UF adhesive. The formaldehyde content of UF adhesives has been gradually lowered over the years because it is one of the most effective ways of reducing formaldehyde emission (Que et al., 2007). The emission of formaldehyde from particleboard decreased as the mole ratio falls, but unfortunately, the

other physical and mechanical properties were influenced negatively at the same time (Zhang et al. 2013). In this research article, effect of resin type and its amount in the surface and core layers on the water absorption and mechanical properties of the particleboard were investigated.

Materials and Methods

Wood particles and adhesive

Beech (*Fagus orientalis*) and poplar round woods (*Populus tremula*) were supplied from Kastamonu Forest District. A commercial UF adhesive (E1 and E2 grade) and melamine-urea formaldehyde (MUF) were used in the production of particleboards. The adhesive types and their use in the particleboard production is presented in Table 1.

Tablo 1. The adhesive types and their use in the particleboard composition.

Particleboard type	Adhesive types and their use in the particleboard		Formaldehyde/urea ratio (%)	Adhesive density (g/cm ³)	Solid ratio (%)	Used quantity (kg/m ³)
	Surface Layer	Core Layer				
P1	ÜF - E2 (60 wt%)	ÜF - E2	1.3	1.26	60	65
P2	MÜF - E1	ÜF - E1	1.15 – 1.10	1.26	60	65
P3	ÜF - E1	MÜF - E1	1.10 – 1.15	1.26	60	65
P4	ÜF - E2 (55 wt%)	ÜF - E2	1.45	1.25	55	65

Production of particleboards

The particleboard were commercially produced in a particleboard manufacturer, SFC Integrated Wood Company in Kastamonu city, Turkey. A hombak chipper was used for chipping of the wood. In the particle production 40 wt% particles supplied from wood industry and 60 wt% particles from hombak chip were used. The chips were used until 1.8% moisture content based on the oven-dry weight of wood. The dried particles were classified in the sieves with the numbers of 4 mm x 4 mm, 1 mm x 1 mm, and 0.25 mm x 0.25 mm, respectively. The wood particles were stored in the silos of surface and core layer chips. The surface and core layer particles were glued with the

adhesives given in Table 1 in a adhesive blender. The amounts of the adhesives used in the face layers and core layer were 7% and 5%, respectively. 1 wt% paraffin based on the oven dry weight of particles was used in the production of particleboards. 1 wt% paraffin and ammonium sulphate. As a hardener, ammonium sulphate was used in the surface layers (1.5 lt) and the core layer (4.5 lt). The three layer particleboard mats were hot pressed at 280 bar and 195 °C, for 105 s in the Siempelkamp press with single layer. After the 9 mm thick particleboards with dimension of 2100 mm x 2800 mm were conditioned for one week, they were sanded in a sanding machine (Steinemann) in a sequence of sand papers of 60, 80, 100, and

120 grit number. The final thickness of the sanded particleboards were 8 mm and a density of 680 kg/m³.

Determination of physical and mechanical properties

The experimental panels were conditioned at 65% relative humidity and 20 °C until a constant weight was achieved before being subjected to the physical and mechanical

tests given in Table 2. Twenty samples were used for the thickness swelling and water absorption tests. Ten samples were used for the flexural strength and modulus tests. The physical and mechanical tests were performed according to the European standards. The tests methods are presented in Table 2.

Table 2. Physical and mechanical tests performed on the particleboards.

Test type	Standard number
Density	EN 323 (1993)
Water absorption	EN 317 (1993)
Flexural strength	EN 310 (1993)
Flexural modulus	EN 310 (1993)
Surface soundness	EN 311 (2002)



Figure 1. Laboratory test photos of the experimental particleboard specimens.

Results and Discussion

Physical and mechanical properties of the particleboards produced with different adhesives in surface and core layers are presented in Table 3. According to the test results mechanical properties of the particleboards produced with the UF adhesive having a higher formaldehyde/urea ratio (E2 grade UF adhesive with 55 wt%

solid content) had 10-15% better mechanical properties than those of other particleboards. As for the physical properties, the particleboards produced with a mixture of UF and MUF adhesives (60 wt% solid content) had higher water resistance than that of other particleboards.

Table 3. Physical and mechanical properties of the particleboards.

Particleboard type	Adhesive type in the layers of particleboard		Mechanical and physical properties of particleboards				
	Surface layer	Core layer	Water absorption	Internal bond strength	Bending strength	Modulus of elasticity	Surface soundness
			(24-h) %	N/mm ²	N/mm ²	N/mm ²	N/mm ²
P1	UF - E2 (60 wt%)	ÜF - E2	31.06 (2.89)	0.38 (0.01)	11.76 (0.74)	1801.0 (86.1)	1.05 (0.07)
P2	MUF-E1	ÜF - E1	29.53 (1.38)	0.40 (0.02)	12.02 (0.58)	1879.5 (87.8)	1.03 (0.02)
P3	UF - E1	MÜF - E1	27.81 (1.86)	0.37 (0.01)	12.50 (0.83)	1910.2 (76.5)	1.00 (0.05)
P4	UF - E2 (55 wt%)	ÜF - E2	30.72 (1.01)	0.43 (0.02)	13.11 (0.70)	2003.0 (157.3)	1.17 (0.12)

* The values in the paranthesis are standard deviations.

The IB strength of the particleboards improved as the formaldehyde/urea ratio of the adhesive. The highest IB strength with a value of 0.43 N/mm² was found in the particleboard (Type Y4) produced with the E2 grade UF adhesive with 55 wt% solid content in both surface and core layers. The lowest IB strength with a value of 0.37 N/mm² was found in the particleboard (Type Y3) produced with the E1 grade MUF adhesive (60 wt% solid content) in the core layer and the E1 grade UF adhesive (60 wt% solid content) in the surface layers. The IB values of all the panel formulations types P2 and P4 met minimum requirement (0.40 N/mm²) of load-bearing particleboards and interior fitments (including furniture) for use in dry conditions of EN 312 (2003). The IB values of all the panel formulations types P2 and P4 met minimum requirement (0.28 N/mm²) of general-purpose particleboards for use in dry conditions of EN 312 (2003). The IB strength improved as the MUF adhesive was applied in the core layer of the particleboard. This can be explained by the fact that the The MUF adhesive forms stronger wood-to-wood bonds than the UF adhesive. The bond quality between the particles in the particleboard improved as the MUF adhesive as incorporated into the core layer.

The solid content of the UF adhesive also affected bending properties. For example, as

the solid content of the E2 grade UF adhesive was 55 wt%, the bending strength and modulus of the particleboards (Type Y4) were found to be 13.11 N/mm² and 2003 N/mm² while it was found to be 11.76 N/mm² and 1801 N/mm², respectively, as the solid content of the E2 grade UF adhesive (Type Y1) was 60 wt%. The bending strength and modulus of elasticity in bending of the type P4 particleboard met minimum requirements (13 and 1800 N/mm²) of particleboard for interior fitments (including furniture) for use in dry conditions of EN 312 (2003). The bending strength of type P3 particleboard complied with the met minimum requirement (12.5 N/mm²) of particleboard for general-purpose particleboards for use in dry conditions of EN 312. The decrease in the internal bond strength, thickness swelling and water absorption values of the particleboards produced with the UF resin at higher mole ratios is mainly due to the insufficient cross-linking of formaldehyde. Similar results were reported in previous studies (Akbulut, 1995; Quea et al., 2007; Atar et al, 2014).

The incorporation of the MUF-E1 adhesive into the core layer more improved the bending properties as compared to the surface layer. At the same content, the bending strength and modulus of elasticity in bending of the particleboard produced with the MUF-E1 in the core layer were higher

than the particleboard produced with the MUF-E1 adhesive in the face layers. However, this was not observed for the internal bond strength. The incorporation of the MUF-E1 into the face more increased the internal bond strength. This can be explained by the particleboard production. The ratio of the surface layer in the 8 mm particleboard composition was 60 wt% while the core layer ratio was 40 wt%. The positive effect of the MUF-E1 resin used in the face layers can be due to higher amount of the face layers. The increment in the face layer content resulted in a higher internal bond strength. Similar results were observed in the surface soundness results. The improvement in the mechanical properties of the particleboards produced with the E2 grade UF adhesive can be attributed to the increase in the cross-linking of formaldehyde, which improves the bond performance between the particles. Surface soundness of the particleboards improved with increasing formaldehyde content in the UF adhesive, as expected. The highest value for the surface soundness was found to be 1.17 N/mm² for the particleboards produced with the E2 grade UF adhesive (55 wt% solid content) while the lowest surface soundness value was found to be 1.0 N/mm² for the particleboard produced with the UF adhesive in the face layer and MUF-E1 adhesive in the core layer. The results showed that the bond performance between the surface layer and core layer was improved by the incorporation of the E2 grade UF adhesive in the both surface and core layers.

As for the water absorption, the lowest value was found to be 27.81% for the particleboards (type P3) produced with the UF-E1 resin in the face layers and MUF-E1 in the core layer with a solid content of 60 wt%. The highest water absorption value was found to be 31.06 for the particleboards produced with the E2 grade UF resin with a solid content of 60 wt% solid content in both surface and core layers. The core layer significantly affects the water absorption of the particleboard. The MUF resin is more durable to water and humidity as compared to the UF resin. The bonding performance between the particles more increased as the

MUF adhesive was incorporated to the core layer, which decreased the water absorption.

Conclusions

The results of the present study showed that the resin type and its amount in the particleboard significantly affected the panel properties. The lowest water absorption was found to be particleboards produced with the E1 grade UF resin in the face layers and MUF-E1 resin in the core layer. The highest internal bond strength was found in the particleboards produced with the E2 grade UF adhesive. As the solid content of the UF resin decreased from 60 to 55 wt%, the mechanical properties of the particleboards improved. Use of MUF-E1 resin in the face layers more improved the internal bond strength and surface soundness of the particleboards as compared to its use in the core layer. The bending properties of the particleboards improved as the MUF-E1 resin in the core layer instead of the face layers. The resin type, formaldehyde/urea ratio, and solid content in the core layer and surface layers should be considered in the production of particleboard based on the requirements of physical and mechanical properties.

References

- Akbulut T., 1995. Effect of various factors on properties of flat pressed particleboard. Ph.D. thesis, Institute of Natural Sciences, Istanbul University, Istanbul.
- Atar I., Nemli G., Ayırlıms N., Baharoglu M., Sari B., Bardak S. 2014. Effects of hardener type, urea usage and conditioning period on the quality properties of particleboard. *Materials and Design* 56, 91-96.
- Baharoglu M., Nemli G., Sari B., Ayırlıms N., Bardak S., Zeković E. Effect of paraffin application technique on the physical and mechanical properties of particleboard. *Science and Engineering of Composite Materials* 21 (2), 191-19.
- Zhang H., Liu J., Lu X. 2013. Reducing the formaldehyde emission of composite wood products by cold plasma treatment. *Wood Research* 58 (4), 607- 616,
- Quea Z., Furunoa T., Katoha S., Nishino Y. 2007. Effects of urea-formaldehyde resin mole ratio on the properties of particleboard. *Building and Environment* 42(3):1257-1263.

The Selection of Samples with AHP Method in the Experimental Study: Bending Strength Test Sample

Erol İMREN¹, *Ahmet CAN¹, Rifat KURT¹, Hasan KURBAN¹

¹Bartın University, Faculty of Forestry, Bartın / TURKEY

*Corresponding Author: acan@bartin.edu.tr

Abstract

Many numerical methods are utilized in the decision-making stage. AHP, which being widely used in complex decision problems solving, is one of the multi-criteria decision-making methods. The selection of samples is extremely important for achieve to best test results in the wood protection field. In this study, the best samples were determined to be applied bending strength test according to particular criteria. Some effective sample election criteria are; spiral grain, the number of knots, annual ring width, rot, cracks, discoloration and resin. The best samples will be selected according to these criteria.

Keywords: Wood Protection, Analytic Hierarchy Process, Decision Making, Sample selection

Introduction

Decision-making process is defined as selecting one or some of the available alternatives in parallel with certain purposes from the aspect of determined criteria. When the number of criteria is more than one while evaluating the alternatives, it becomes difficult to make a decision, and the problem is named multi-criteria decision-making (Doğan and Gencan, 2013).

Multi-criteria decision-making methods are the analytical methods enabling simultaneous assessment of many measurable and unmeasurable strategic and operational factors and allowing us to involve multiple persons into decision-making process (Görener, 2009; Şenkayas et al., 2010).

There are many numerical methods developed for solution of multi-criteria decision-making problems. One of the most widely methods is the Analytical Hierarchy Process (AHP). AHP is a technique that has been structured for dealing with complex decisions (Kutlu, 2012). This method is an approach that measures the digitizable concrete and abstract criteria by comparing them and determines the order of priority by calculating the relative priorities of these criteria (Byun, 2001). While making decisions via AHP, on contrary with classical decision-making methods, also the subjective and objective judgments are taken into consideration (Yılmaz 1999).

For the scientific studies, having accurate knowledge and making accurate decision form the basis (Arıkan, 1994). In order to achieve accurate information, the main material to be used must be homogenous and prepared in the way representing the entire sample group. The more the results of a study can be generalized, the higher value they have, because the science is the unity of generalizable information (Karasar, 2015).

In order to achieve the most suitable results in experiments carried out under laboratory conditions, the selection of samples is of vital importance. In this study, it was aimed to select the samples to be exposed to bending resistance test by using AHP method in parallel with certain criteria. By selecting the suitable samples, the experiments will be more homogenous and allow less bias. Moreover, this study is also important because AHP method is used for selecting the sample for the first time.

Materials and Methods

Considering the bending resistance standards, 4 different study samples were selected in this study. The samples were labeled as S1, S2, S3, and S4, and their characteristics are presented in Table 1.

Table 1 General characteristics of the sample

Criteria	S ₁	S ₂	S ₃	S ₄
Knot	None knot	None knot	1 Knot	1 Knot
Annual Ring Width	Normal	Normal	Normal	Abnormal
Color	Normal	Normal	Normal	Abnormal
Rate of Resin	None resin	Resin	Resin	None resin
Spiral Grain	+	-	-	+
Crack	+	-	-	-

The characteristics of samples are the criteria that we determined. The importance level of criteria was determined by the experts as follows; Crack>Knot>Rate of Resin >Spiral grain>Color>Annual Ring Width. Which sample having these criteria will be suitable will be determined using Analytical Hierarchy Approach. The order of priority of the criteria by the samples is presented below.

- For Sample 1: Crack>Spiral grain>Rate of Resin >Color>Annual Ring Width>Knot
- For Sample 2: Rate of Resin >Spiral grain>Crack>Knot>Annual Ring Width>Color
- For Sample 3: Knot>Rate of Resin >Annual Ring Width>Color>Crack>Spiral grain
- For Sample 4: Knot>Annual Ring Width>Spiral grain>Color>Rate of Resin >Crack

Analytical Hierarchy Approach (AHA)

As consideration of several subjective criteria beside objective criteria, is required in sample selection, Analytical Hierarchy Process was selected for solution of the present problem. Effective factors were determined by percentage and frequency data in the conducted survey study. Checking the consistency of the comparison between each criteria is the most important factor affecting the validity of the obtained result. Therefore, consistency of relation matrices should be ensured. The consistency ratio (CO), developed by Saaty (2000), is found using Equation 2. CI: Consistency Index is calculated by Equation 3 and RCI: Rascal Consistency Index is calculated by Equation 4.

$$TO = TI/RTI \tag{2}$$

$$TI = (\lambda_{max} - n)/(n - 1) \tag{3}$$

λ_{max} : Relative weight of matrix

$$RTI = 1.98 \times (n - 2) \tag{4}$$

Consistency ratio (Equation 5) is obtained by putting Equation 3 and 4 in Equation 2.

$$TO = [(\lambda_{max} - n)/(n - 1)]/[1.98 \times (n - 2)] \tag{5}$$

The comparison matrix can be regarded consistent if the consistency ratio obtained using Equation 5 is under 0,1. (Saaty, 2000). The final stage of Analytical Hierarchy Process in this procedure is to find the product of importance weights of criteria and alternatives, and to determine the priority value for each alternative. Consequently, the alternative with the highest value is the best alternative for the problem (Toksarı, 2007).

Results and Discussion

As a result of the literature review, the factors that are most effective on sample selection were determined to be Crack, Curvature of Fiber, Rate of Resin, Color, Annual Ring Width, and Knot. In order to find the importance values of these criteria, the criteria assessment form was designed and applied to relevant individuals. The corresponding importance values and definitions were established. For the practice of AHP specified in Table 2, 1-9 Basic Scale developed by Saaty and accepted by the experts was utilized.

After determining the criteria for the selection of most suitable sample, then the establishment of hierarchy was initiated. It was shown in hierarchy what the decision problem is, according to which criteria the assessment would be made, besides the alternatives (Figure 1).

Table 2. Basic scale (Saaty, 2000).

1	Equal Importance
3	Moderate Importance
5	Strong Importance
7	Very Strong Importance
9	Extreme Importance
2,4,6 and 8	Intermediate values

Numerical scale	Verbal scale
-----------------	--------------

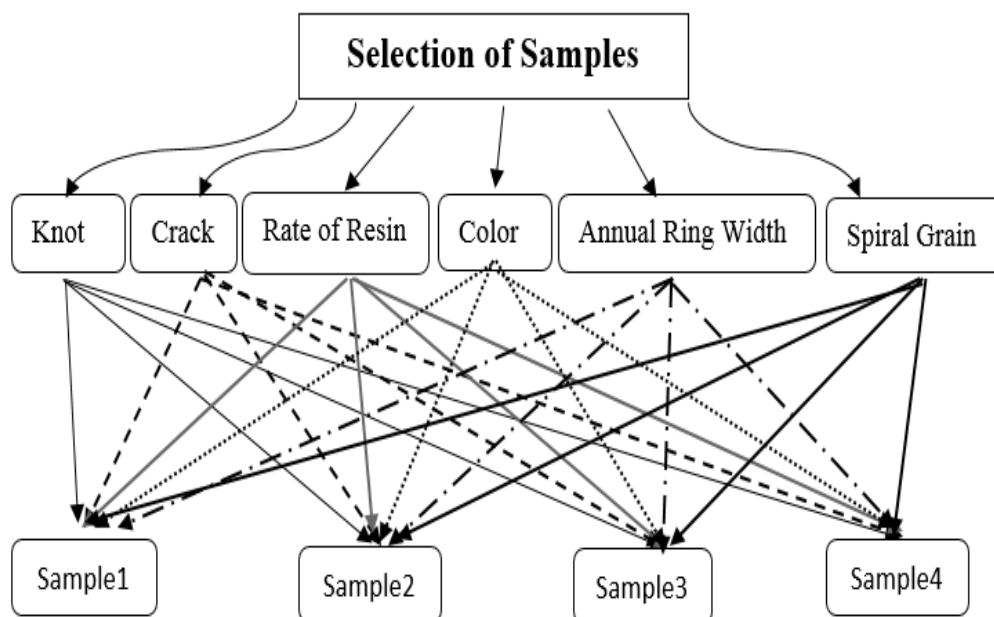

Figure 1. EC hierarchy model for sample selection.

The aim of hierarchy is to be able to select the most suitable sample to be used in laboratory studies. There are 6 criteria and, by assessing the samples from the aspect of these criteria, the most suitable one among 4 samples was selected.

According to Table 3, the order of importance levels of main criteria is as follows; Knot, Crack, Curvature of Fiber, Rate of Resin, Annual Ring Width, and Color. As it can be seen, the sum of weight values equals to "1". Since $TO = 0.06 < 0.1$ (given below the table), the study is considered consistent. In further steps, pairwise comparison matrices were used for assessing each of the criteria. Finally, the calculated weights were multiplied with the weights of alternatives. In other words, in final calculations, each value of each of the sample alternative matrix at the level of each criterion is multiplied with the weight of that criterion, and the sum of raw line is calculated. As a result of calculations, the sample alternatives that we had were observed to gain relative weight. When the order of AHP is considered, then the most suitable sample will be determined.

Table 3. Weight values of the main criteria.

The Importance Levels of	Weight (W)
Knot	0.309
Annual Ring Width	0.047
Color	0.029
Rate of Resin	0.159
Spiral Grain	0.228
Crack	0.229
T.O = 0.06	

Table 4. Decision matrix

Criteria / Alternatives	Knot	Annual Ring Width	Color	Rate of Resin	Spiral Grain	Crack	W
S1	0.654	0.390	0.140	0.274	0.079	0.055	0.290
S2	0.249	0.390	0.544	0.092	0.079	0.118	0.174
S3	0.048	0.152	0.158	0.117	0.635	0.262	0.244
S4	0.048	0.068	0.158	0.517	0.207	0.565	0.292
W	0.309	0.047	0.029	0.159	0.228	0.229	
T.O.	0.09	0.02	0.01	0.09	0.01	0.04	

Given Table 4, it can be seen that, among the samples to be exposed to bending resistance test in wood protection area, the most suitable sample was chosen as S4 (29.2%), followed by S1 (29%), S3 (24.4%), and S2 (17.4%). The performance graph of the sample selection modeled in Expert Choice software is presented in Figure 2. According to the performance graph, the most suitable sample for using in laboratory studies was determined to be S4 (29.2%).

When all of the results are combined, the criteria "Knot" has the highest level of importance (0.309) followed by Crack (0.229), Spiral grain (0.228), Rate of Resin (0.159),

Annual Ring Width (0.047), and Color (0.029). It is understood that the samples containing less knots are more important for the test. It was determined that the rate of knots was low and the most suitable sample for the test was Sample 4. Sample 2 was found to be least recommended sample. Considering the standards, it can be seen that the absence of knots and cracks is desired. It was shown in this study how to select the sample rapidly in studies to be carried out with high number of samples.

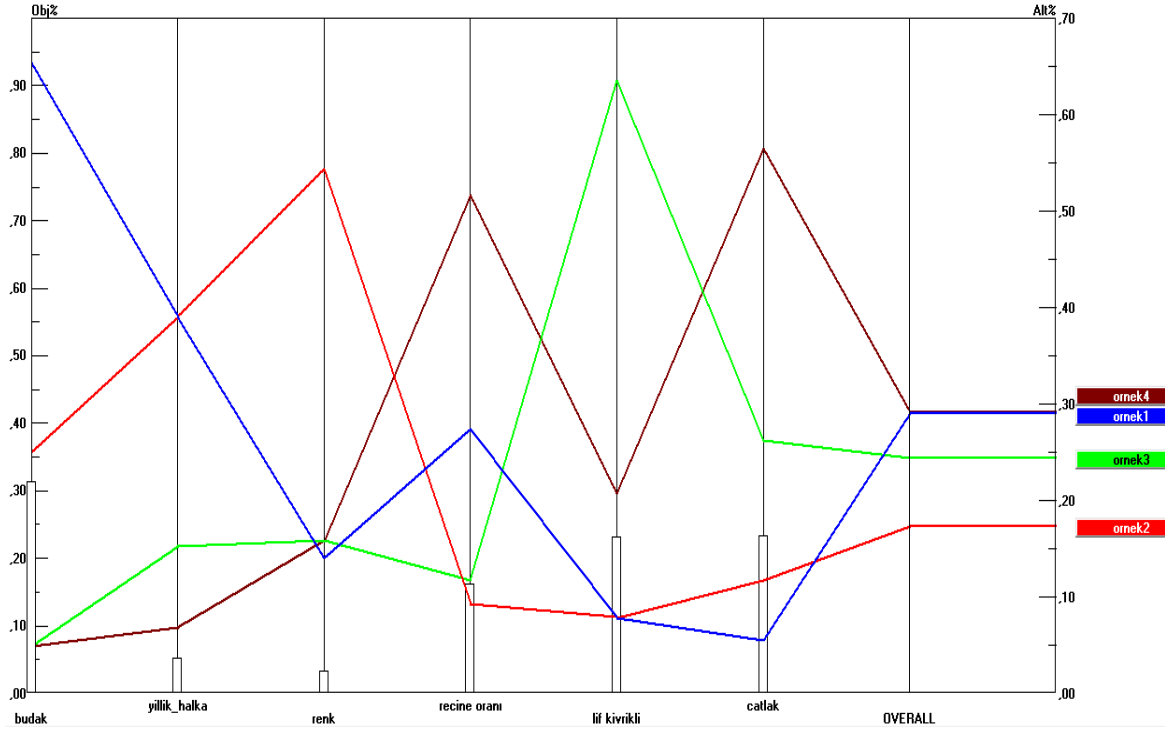

Figure 2. Performance graph of the samples

References

Kutlu B. S., Abalı Y. A., Eren T. (2012) Çok Ölçütlü Karar Verme Yöntemleri İle Seçmeli Ders Seçimi, sosybilimler, 2 (2):5-25.

Byun Dae-Ho (2001); "The AHP Approach For Selecting An Automobile Purchase Model", Information & Managment, 38 (2001) 289-297.

Doğan N.Ö., Gencan S. (2013). Seyahat Acentası Yöneticilerinin Bakış Açısıyla En Uygun Otel Seçimi: Bir Analitik Hiyerarşi Prosesi (Ahp) Uygulaması, Erciyes Üniversitesi İktisadi ve İdari Bilimler Fakültesi Dergisi, Sayı: 41, Ocak-Haziran 2013, s. 69-88.

Şenkayas H., Öztürk M., Sezen G., (2010). Lojistik tedarikçilerin seçiminde analitik hiyerarşi süreci (ahp) yöntemi: mondial şirketinde bir uygulama, Pamukkale Üniversitesi, Sosyal Bilimler Enstitüsü Dergisi, Sayı 5, Sayfa 161-175.

Görener A. (2009). Kesici Takım Tedarikçisi Seçiminde Analitik Ağ Sürecinin Kullanımı, Havacılık ve Uzay Teknolojileri Dergisi, 4(1), 99-110.

Yılmaz E.,(1999). Analitik hiyerarşi süreci kullanılarak çok kriterli karar verme problemlerinin çözümü, DOA dergisi, Doğu akdeniz ormancılık yayınları, No:5, s.96-122

Arıkan, R. (2004). Araştırma teknikleri ve rapor hazırlama. Ankara: Asil Yayın, 400 s.

Karasar, N. (2015). Bilimsel araştırma yöntemi. Ankara: Nobel Yayın Dağıtım, 310 s.

Toksarı, M. (2007). Analitik Hiyerarşi Prosesi Yaklaşımı Kullanılarak Mobilya Sektörü İçin Ege Bölgesi'nde Hedef Pazarın Belirlenmesi. Celal Bayar Üniversitesi İ.İ.B.F., Yönetim ve Ekonomi, 14 (1):171-180.

Saaty, T.L. (2000). Fundamentals of Decision Making and Priority Theory, 2. Edition. RWS Publications, Pittsburgh.

Micro-Mechanical Tension and Compression Strength of Oak Wood and Comparison with Standard Test Sample Results

*Türker DÜNDAR¹, Nusret AS¹, Ümit BÜYÜKSARI²

¹Istanbul University, Faculty of Forestry, Istanbul / TURKEY

²Düzce University, Faculty of Forestry, Duzce / TURKEY

*Corresponding Author: dundar@istanbul.edu.tr

Abstract

The aim of this study was to investigate micro-mechanical tension and compression strength of Oak wood (*Quercus petraea* Lieb.) and to compare with standard-size test specimens values. The compression strength and tensile strength were determined using standard-size and micro-size test samples. Micro-size tension test specimens were approximately 50 × 5.0 × 0.8 mm with dog-bone shape. Micro-size compression test specimens had dimensions of 3 × 3 × 5 mm. In the standard- and micro-size samples, tensile strengths as 93.8 and 98.7 N mm⁻² and compression strengths as 46.6 and 45.4 N mm⁻², respectively. The results showed that the compression strength of the micro samples was lower compared to the standard samples, while the tensile strength was higher in the micro samples. The tension strength values of micro-size and standard-size oak wood were significantly different. However, the compression strength values of micro-size and standard-size samples were not significantly different (p = 0.127). A positive linear regression presenting an R² of 0.514 for tension strength and 0.574 for compression strength was observed between the micro-size and standard-size samples.

Keywords: Micro-size test, Standard-size test, Tension strength, Compression strength, Oak wood

Meşe Odununun Mikro Mekanik Çekme ve Basınç Direnci Sonuçları ve Standart Test Örnekleri Sonuçları ile Karşılaştırılması

Özet

Bu çalışmanın amacı, Meşe (*Quercus petraea* Lieb.) odununun mikro-mekanik özelliklerini araştırmak ve standart boyutlu test örneklerinden elde edilen değerlerle karşılaştırmaktır. Mikro ve standart boyutlu örneklerde çekme ve basınç direnci değerleri belirlenmiştir. Mikro boyutlu çekme direnci örnekleri 50 x 5 x 0.8 mm boyutlarında ve genişlik yönünde inceltilecek hazırlanmıştır. Mikro boyutlu basınç direnci örnekleri 3 × 3 × 5 mm boyutlarında hazırlanmıştır. Standart ve mikro boyutlu örneklerde sırasıyla çekme direnci değerleri 93.8 and 98.7 N mm⁻² ve basınç direnci değerleri 46.6 and 45.4 N mm⁻² olarak bulunmuştur. Sonuçlar mikro boyutlu örneklerde basınç direncinin standart boyutlu örneklere göre daha yüksek, çekme direncinin standart boyutlu örneklerde daha yüksek olduğunu göstermiştir. Mikro ve standart boyutlu örneklerin çekme direnci değerleri istatistiki olarak farklıdır. Bununla birlikte, basınç direnci değerleri istatistiki olarak farklı değildir (p = 0.127). Mikro ve standart boyutlu örneklerin değerleri arasında pozitif doğrusal ilişki bulunmuştur. Belirlilik katsayısı çekme direnci için 0.514 ve basınç direnci için 0.574 olarak bulunmuştur.

Anahtar Kelimeler: Mikro boyutlu test, Standart boyutlu test, Çekme direnci, Basınç direnci, Meşe odunu

Introduction

Structural-size with defects and small-size clear samples (standard-size) have been used to determine the mechanical properties of wood. In recent years, micro-sized samples have been used to evaluate the mechanical properties of earlywood and latewood sections, wood flakes, strands, and fibers (Jeong 2008; Jeong et al., 2009; Groom et al., 2002; Mott et al., 2002; Kretschmann et al., 2006; Hindman and Lee 2007; Deomano and Zink-Sharp 2004).

There is no standard about the micro-size test samples. Therefore, sample dimensions and loading rates vary from one study to another study. In previous studies, different dimensions and loading rates were used by researchers. This obstructed comparison the results of previous studies (Jeong, 2008).

The tensile strength of micro-size wood samples was investigated by several researchers (Price, 1975; Hindman and Lee, 2007; Jeong et al., 2008; Cai et al., 2007; Hunt et al., 1989). The tensile properties of

willow (*Salix spp.*), yellow poplar (*Liriodendron tulipifera* L.), red oak (*Quercus spp.*) and loblolly pine (*Pinus taeda*) wood strands were investigated by Cai et al., (2007). They found that the tensile strengths of yellow poplar, loblolly pine, willow and red oak wood strands were 48.5, 58.7, 22.7 and 40.7 MPa, respectively. They concluded that for willow, yellow poplar, red oak and loblolly pine strands, the tensile strength was, respectively, 31.1, 44.2, 36.2 and 73.4% lower than for solid wood (using standard-size samples). Hunt et al., (1989) conducted tensile testing to determine the tensile strength and tensile modulus of yellow poplar strands (*Liriodendron tulipifera* L.) with a 2224 N load cell at a test speed of 1.9 mm/min. Their study revealed the average tensile strength and tensile modulus to be 70.3 MPa and 11.8 GPa, respectively.

The effect of several factors on the tensile properties of micro-size samples has been investigated by several researchers. Price (1975) investigated the effect of gage length on the tensile strength and he concluded that tensile strength increased as gage length increased. Jeong et al. (2008) investigated the effect of strand thickness and loading rates on the tensile strength and tensile modulus of southern pine (*Pinus spp.*) strands. The strand thickness varied from 0.381 to 3.81 mm, and the displacement rate ranged from 0.102 to 0.406 mm min⁻¹. They determined that the thickness of sample wood strands significantly affected the tensile strength of southern pine. In another study, Kohan et al., (2012) investigated the effect of geometry on tensile strength and tensile modulus of elasticity of wood strands. They compared the tensile strength and modulus of elasticity of rectangle-shape and tapered (dog-bone) shape wood strands.

The compression strength of micro-size wood samples was investigated by Zink-Sharp and Price (2006). They determined the compression strength of sweetgum (*Liquidambar styraciflua* L.), yellow poplar (*Liriodendron tulipifera* L.), and red maple (*Acer rubrum*) wood species using 1 × 1 × 4 mm specimens. The test was conducted with a loading speed of 0.029 mm min⁻¹. They found that the compression strength values of

sweetgum, yellow poplar and red maple wood were 39.2, 33.5 and 41.6 MPa, respectively.

There is limited information about the comparison of mechanical properties of micro- and standard-size samples. Moreover, in previous studies, authors have compared their findings for micro-size samples with the published values for the standard-size samples in the Wood Handbook (Cai et al., 2007; Deomano 2001; Zink-Sharp and Price 2006). Zink-Sharp and Price (2006) stated that the comparison of experimentally determined values with standard handbook values was often useful, although not all-encompassing. Cai et al., (2007) found that for willow, yellow poplar, red oak and loblolly pine strands, the tensile strength was, respectively, 31.1, 44.2, 36.2 and 73.4% lower than that of standard-size samples. This paper aims to evaluate the tension and compression strength of Oak wood (*Quercus petraea* Lieb.) using micro-size samples and to compare with standard-size samples.

Materials and Methods

Materials

Sample trees were harvested from the Duzce Forest Enterprises in the northwestern part of Turkey. Six trees having straight stems were selected as sample trees. Table 1 presents the properties of the sample trees and sampling area.

Table 1. Properties of the sample trees and sampling area

Tree no.	Diameter of tree at 1.30 m (cm)	Tree age (year)	Altitude (m)	Direction	Slope (%)
1	34	203	670	East	60
2	39	207			
3	38	138			
4	40	193			
5	41	214			
6	40	204			

Logs of 3 m in length were cut from each tree. Micro- and standard-size test samples were prepared from lumber cut from these logs. The cutting plan of the test samples is shown in Figure 1.

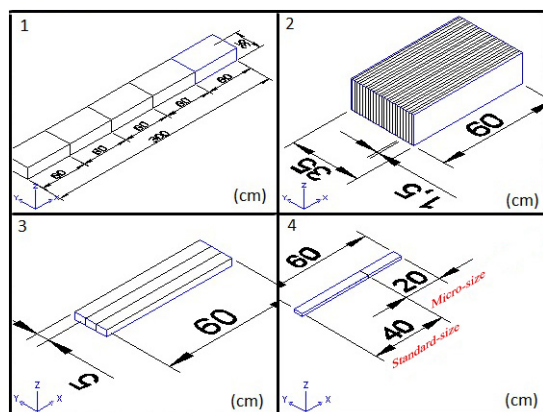
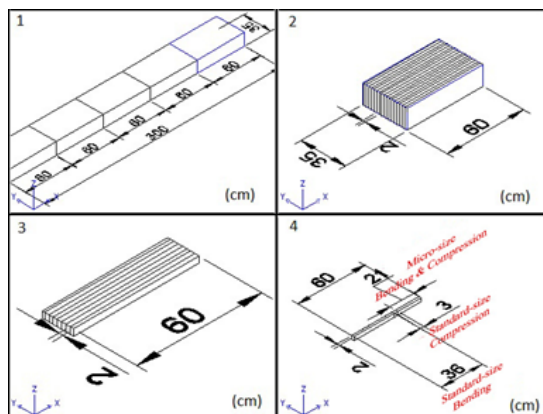

Figure 1. The cutting plan of the compression (upper) and tension (bottom) test samples

All specimens were conditioned in a climate chamber at a temperature of 20 °C and a relative humidity of 65% for three weeks before testing.

Methods

Standard-size test specimens were cut according to International Organization for Standardization (ISO) in order to determine the tensile strength parallel to grain (ISO 13061-6, 2014) and compression strength parallel to grain (ISO/DIS 13061-17, 2014). The standard-size test samples were prepared at measurements of 15 mm × 50 mm × 400 mm for tension and 20 mm × 20 mm × 30 mm for compression. A Lloyd universal test machine with a 10 kN load cell was used for the standard-size tests.

The same standards were used as a guide for the micro-size tests. Micro-size tension test specimens were approximately 50 × 5.0 × 1.3 mm and the width of the sample was reduced to 0.8 mm with a sanding drum. The gauge lengths were 3 mm for the micro-size

tension samples and 280 mm for the standard-size samples. Micro-size compression test specimens had dimensions of 3 × 3 × 5 mm. Micro-size tests were performed with a Zwick universal test machine using a 100 N load cell for compression tests and a 1kN load cell for tension tests. The testing speeds of the tensile and compression tests for the micro-size samples were 0.3 and 0.7 mm min⁻¹, respectively. The micro- and standard-size tension and compression test samples are shown in Figure 2.



Figure 2. The micro- and standard-size tension (upper) and compression (bottom) test samples

Data analyses and statistical methods

For the tensile and compression strength, all multiple comparisons were first subjected to an analysis of variance (ANOVA) at $p < 0.05$ considering two factors (sample size and tree number) and interactions. Post-hoc comparisons were conducted using Duncan's multiple range test. Regression analysis was used to determine the relationship between standard- and micro-size samples.

Results and Discussions

The average tensile strength values and Duncan test results of the standard- and micro-size Oak wood samples are shown in Table 2.

Table 2. The average tensile strength values and Duncan test results of standard- and micro-size wood samples

Tree No	Tensile strength (MPa)					
	Standard-size			Micro-size		
	N	Mean	Std. Deviation	N	Mean	Std. Deviation
1	68	91.5	27.8	64	99.8	36.2
2	42	96.4	23.2	41	108.6	42.6
3	76	113.4	28.8	75	106.8	34.9
4	21	78.4	21.2	19	90.1	37.3
5	53	88.9	28.3	50	97.5	33.8
6	48	77.2	27.9	44	78.8	22.0
Total	309	93.8	30.0	293	98.7	35.8

For individual trees, the tensile strength values ranged from 78.8 MPa (tree 2) to 108.6 MPa (tree 6) in the micro-size samples and from 77.2 MPa (tree 5) to 113.4 MPa (tree 6) in the standard-size samples. The highest tensile strength values were observed for tree 6 in both the micro- and standard-size samples. The average tensile strength value of the micro-size samples was determined as 98.7 MPa. The tensile strength of standard-size samples was found to be 93.8 MPa. The results showed that the tensile strength value of the micro-size samples was 5.2% higher compared to the standard-size samples. In previous studies, it was stated that the tensile strength of micro samples was lower compared to standard samples (Price 1975; Cai et al., 2007). Cai et al., (2007) reported that the tensile properties of willow, yellow poplar, red oak, and loblolly pine wood strands were significantly lower than those of solid wood. When compared to the tensile strength of solid wood (Green et al. 1999), those of wood strands from willow, yellow poplar, red oak, and loblolly pine were lower by 31.1, 44.2, 36.2 and 73.4%, respectively. They compared their findings with published values in Wood Handbook (Green et al., 1999) for the same wood species. This approach of comparing the values obtained from different trees is not valid for obtaining information about the presence of a correlation between micro-size and standard-size samples. It is recognized

that tree age and growth conditions such as climate, soil characteristics, slope and altitude affect annual ring width and the mechanical properties of wood. Also, gage length, sample thickness, loading rate and sample shape (dog- bone or rectangle shape) affect tensile strength of micro-size samples. In this current study, we used dog-bone shape samples unlike Price (1975) and Cai et al., (2007).

The higher tensile strength value in the micro samples could be attributed to the dimensions of the specimens, the loading speed, the ratio of earlywood and latewood and the gage length. Jeong (2008) pointed out that the results of previous studies are not directly comparable because of different loading conditions and different wood species. In that study, he indicated that the tensile strength of micro-scale pine wood samples reported by Hindman and Lee (2007) was 36% higher compared to the work of Cai et al., (2007). This comparison clearly shows the effect of sample dimensions and loading rate on the strength properties of micro-size samples. Price (1975) concluded that tensile strength increased as gage length increased. Jeong et al. (2008) determined that the thickness of sample wood strands significantly affected the tensile strength of southern pine.

The average compression strength values and Duncan test results of the standard- and micro-size Oak wood samples are shown in Table 3.

Table 3. The average compression strength values and Duncan test results of standard- and micro-size wood samples

Tree No	Compression strength (MPa)					
	Standard-size			Micro-size		
	N	Mean	Std. Deviation	N	Mean	Std. Deviation
1	80	46.3	6.8	78	44.8	9.6
2	61	48.2	8.1	61	44.9	9.2
3	88	52.1	6.5	86	49.2	7.2
4	47	42.0	6.5	43	44.9	9.1
5	59	44.6	7.8	59	45.1	9.3
6	63	43.3	7.1	61	42.2	9.6
Total	398	46.6	7.9	388	45.4	9.2

For individual trees, the compression strength values ranged from 42.2 MPa (tree 6) to 49.2 MPa (tree 3) in the micro-size samples and from 42.0 MPa (tree 4) to 52.1 MPa (tree 3) in the standard-size samples. The highest compression strength values were observed for tree 6 in both the micro- and standard-size samples. The average compression strength value of micro-size samples was found to be 45.4 MPa. Zink-Sharp and Price (2006) observed that compression strength values of sweetgum, yellow poplar and red maple wood species were 39.2, 33.5 and 41.6 MPa, respectively.

The average compression strength value of standard-size samples was found to be 46.6 MPa. The results of the present study showed that the compression strength value of the micro-size samples was 2.6% lower compared to the standard-size samples. Similar results were seen by Zink-Sharp and Price (2006) in sweetgum, yellow poplar and maple wood. They found that the compression strength of the micro-size samples was close to but lower than handbook values for all tree wood types. They explained that the exact cause of this difference was unknown, but that there were at least two probable explanations. A size effect was one possibility and the second was that damage created by specimen preparation had a more significant impact on the intraring specimens than on the standard specimens.

Statistical comparisons of the entire data set were made with regard to the main effects of sample size and tree number. The tension strength, sample size and tree number were significantly different ($p < 0.000$), while the interaction of sample size*tree number was not ($p = 0.147$). The compression strength values of micro-size and standard size samples were not significantly different ($p = 0.127$).

Regression analyses graphics for the tensile strength and compression strength of the micro-size and standard-size wood samples are shown in Figures 3 and 4, respectively. The regression analyses indicated that all mechanical properties of the micro-size samples were significantly correlated with the standard samples. The correlation between tensile and compression

strength values of the standard-size and micro-size samples showed a positive linear relation, presenting an R^2 of 0.514 and 0.574, respectively.

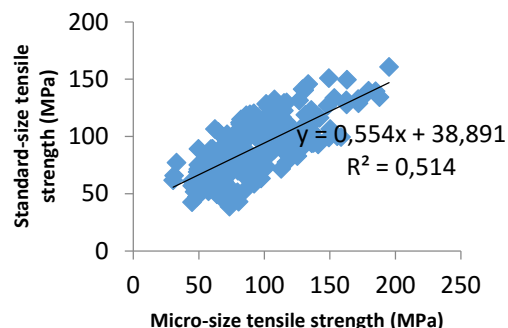

Figure 3. Regression analyses results for tensile strength of micro-size and standard-size wood samples

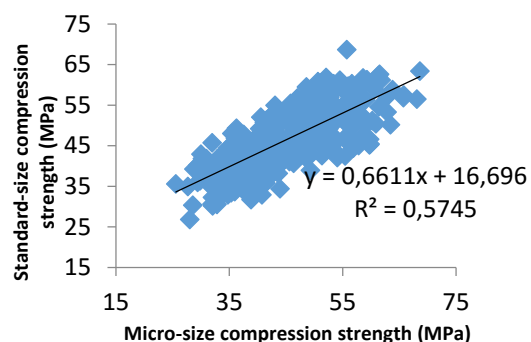

Figure 4. Regression analyses results for compression strength of micro-size and standard-size wood samples

Conclusions

From this study, the below conclusions can be drawn:

1. The compression strength of the micro-size samples was lower compared to the standard-size samples, while tensile strength was higher in micro-size samples.
2. The effects of sample size, individual trees and the interactions between size and trees on tensile and compression strength were statistically significant, except for the effect of the interaction of sample size and individual trees on tensile strength and sample size on compression strength.
3. The regression analyses indicated that tension and compression properties of the micro-size samples were significantly correlated with the standard-size samples. A positive linear regression between the micro- and standard-size samples was shown for

tension and compression strength properties.

4. Micro-size test samples can be used to estimate the standard-size test results for all measured properties of Oak wood.

Acknowledgement

This work was supported by the Scientific and Technological Research Council of Turkey (TUBITAK Project Number: 112O815).

References

- Cai Z., Wu Q., Han G., Lee J.N., 2007. Tensile and thickness swelling properties of strands from Southern hardwoods and Southern pine: Effect of hot-pressing and resin application. *Forest Products Journal* 57(5): 36-40.
- Deomano E.C. (2001). Mechanism of Flake Drying and Its Correlation to Quality. Ph.D dissertation, Virginia Tech, Blacksburg, VA.
- Deomano E.C., Zink-Sharp A., 2004. Bending properties of wood flakes of three southern species. *Wood Fiber Sci* 36(4): 493-499.
- Green D.W., Winandy J.E., Kretschmann D.E., 1999. Mechanical properties of wood. In: *Wood handbook-Wood as an engineering material*, Gen. Tech. Rep. FPL-GTR-113, Chapter 12. U.S. Department of Agriculture, Forest Service, Forest Products Laboratory: Madison, WI, 463 p.
- Groom L., Shaler S., Mott L., 2002. Mechanical properties of individual southern pine fibers. Part III. Global relationships between fiber properties and fiber location within an individual tree. *Wood Fiber Sci* 34(2): 238-250.
- Hindman D.P., Lee J.N. 2007. Modeling wood strands as multi-layer composites: bending and tension loads. *Wood Fiber Sci* 39(4): 516-526.
- Hunt M.O., Triche M.H., McCabe G.P., Hoover W.L., 1989. Tensile properties of yellow-poplar veneer strands. *Forest Products Journal* 39(9): 31-33.
- ISO 13061-6., 2014. Physical and mechanical properties of wood -- Test methods for small clear wood specimens -- Part 6: Determination of ultimate tensile stress parallel to grain. International Organization for Standardization, Geneva, Switzerland.
- ISO/DIS 13061-17., 2014. Physical and mechanical properties of wood -- Test methods for small clear wood specimens -- Part 17: Determination of ultimate stress in compression parallel to grain. International Organization for Standardization, Geneva, Switzerland.
- Jeong G.Y., 2008. Tensile properties of loblolly pine strands using digital image correlation and stochastic finite element method. Doctoral dissertation, Virginia Polytechnic Institute & State University, Blacksburg, VA
- Jeong G.Y., Hindman D.P., Finkenbinder D., Lee J.N., Lin Z., 2008. Effect of loading rate and thickness on the tensile properties of wood strands. *Forest Prod J* 58(10): 33-37.
- Jeong G.Y., Zink-Sharp A., Hindman D.P., 2009. Tensile properties of earlywood and latewood from loblolly pine (*Pinus taeda*) using digital image correlation. *Wood Fiber Sci* 41(1): 51-63.
- Kohan N., Via B.K., Taylor S., 2012. A Comparison of Geometry Effect on Tensile Testing of Wood Strands. *Forest Products Journal* 62(3): 167-170.
- Kretschmann D.E., Cramer S.M., Lakes R., Schmidt T., 2006. Selected mesostructure properties in loblolly pine from Arkansas plantations. In: Stokke DD, Groom LH (eds) *Characterization of the cellulosic cell wall*. Blackwell, Oxford, UK, pp. 149 – 170.
- Mott L., Groom L., Shaler S., 2002. Mechanical properties of individual southern pine fibers. Part II. Comparison of earlywood and latewood fibers with respect to tree height and juvenility. *Wood Fiber Sci* 34(2): 221 – 237.
- Price E.W., 1975. Determining tensile properties of Sweetgum veneer flakes. *Forest Products Journal* 26(10): 50-53.
- Zink-Sharp A.G., Price C., 2006. Compression strength parallel to the grain within growth rings of low density hardwoods. *Maderas: Ciencia y Tecnologia* 8(2): 117-126.

Some Mechanical Characteristics of Thermal Modified Poplar Wood Boards

*Ekrem DURMAZ¹, Tutku ÜÇÜNCÜ¹, Alperen KAYMAKCI¹

¹Kastamonu University, Faculty of Forestry, Department of Forest Industrial Engineering,
Kastamonu/TURKEY

*Corresponding Author: edurmaz@kastamonu.edu.tr

Abstract

The aim of this study was to research the influences of thermal modification by hot-pressing on the performance features of poplar wood boards. The boards were thermally modified by hot-pressing method under various pressure and temperature stages. As two boards for each modification group plus two for unmodified, totally 10 experimental wood boards were confected in this research. Bending and compressive tests were performed to appraise the performance features of the thermally modified or unmodified wood boards. The results achieved in this study demonstrate that surface density of the boards raised with raising press pressure. The thermal modification negatively influenced the TS and WA values of the boards. Hardness values of the wood boards were markedly progressed by the thermal modification. The results of this study indicated that the thermally compressing method could be preferred to advance end-usage features of low-density wood materials produced from fast-growing tree species like paulownia, poplar, eucalyptus etc. Consequently, sustainable management of natural resources could be supplied by using the thermal modification technical.

Keywords: Poplar wood, Thermal modification, Performance features

Isıl İşlem Uygulanmış Kavak Odunu Levhalarının Bazı Mekaniksel Özellikleri

Özet

Bu çalışmanın amacı, sıcak pres ile yapılan ısıl işlemin kavak odunu levhalarının çalışma özellikleri üzerine olan etkilerini incelemektir. Levhalar farklı basınç ve sıcaklıklarda sıcak pres ile muamele edilmiştir. Bu çalışmada her iki grup için muamele görmüş ve görmemiş olmak üzere 10'ar adet deney örneği hazırlanmıştır. Isıl işlem görmüş ve görmemiş levhaların çalışma özelliklerini değerlendirmek için eğilme ve basınç testleri uygulanmıştır. Bu çalışmadan elde edilen sonuçlar, artan pres basıncı ile levhaların yüzey yoğunluğunun da arttığını göstermektedir. Isıl işlem levhaların kalınlık şişkinliği ve su emme değerlerini negatif etkilemektedir. Levhaların sertlik değerleri ısıl işlem ile önemli derecede artmıştır. Bu çalışmanın sonuçları, ısıl-basınç işleminin kavak, pavlonya, okalıptüs gibi hızlı büyüyen ağaç türlerinden üretilen düşük yoğunluklu ağaç malzemelerin son kullanım özelliklerinin geliştirilmesi amacıyla tercih edilebileceğini göstermektedir. Sonuç olarak ısıl modifikasyon teknikleri kullanılarak doğal kaynakların sürdürülebilirliği sağlanabilir.

Anahtar Kelimeler: Kavak odunu, Isıl işlem, Çalışma özellikleri

Introduction

Thermal modification of wood and wood boards is thought to advance dimensional durability and fading (Giebelers, 1983; Yeo et al. 2010). Different heat processes like Thermowood Process, Retification Process, Oil-Heat Treatment Process, Plato Process and Boise Perdure are preferred in the wood products sector (Militz, 2002). Physical and mechanical characteristics of wood materials could be progressed with thermal modification method. Seborg et al (1945) and Stamm (1964) said *Staypak* to wood lumbers pressed and modified as thermal. Stamm and

Haris (1953) and Stamm (1964) treated wood materials with phenol formaldehyde and then they pressed boards. They were termed these materials as *Compreg*. Tarkow and Seborg (1968) conducted experiments about wood surface density. After 1980s due to their low density and cost, thermal modified wood boards achieved a big market in Asia (Norimoto, 1993; Norimoto, 1994; Wang et al. 2000). The thermal modified woods display improved physical and mechanical characteristics. By means of thermal and high pressure treatment, new materials can be derived from woods. To illustrate modified

wood materials as thermal can be utilized in environmental planning and architectural construction, furniture production, flooring materials, roof panelling, interior and exterior planking of structures, light and sound barrier, window and door carpentry (Korkut et al. 2008; Korkut and Kocaefe, 2009).

Many researches were conducted about wood features such as dimensional stability, bending characteristics, anatomical properties, drying characteristics, termite, insect, fungi and decay resistant, moisture desorption and absorption, surface corrosion strength, shearing strength, surface toughness, surface quality, specific gravity, nail/screw withdrawal strength by Tabarsa (1995), Tabarsa and Chui (1997), Navi and Girardet (2003), Kubojima et al. (2003), Blomberg et al. (2005), Wang and Cooper (2005a), Wang and Cooper (2005b) Unsal and Candan (2007), Yoshihara and Tsunematsu (2007), Unsal and Candan (2008), Welzbacher et al. (2008), Dogu et al. (2010), Abraham et al. (2010), Unsal et al. (2011a) Unsal et al. (2011b), Candan et al. (2013).

It is known as thermally modification of woods is a process in which is pressed the woods without any adhesives. Wang and Cooper (2004) investigated to surface plasticisation of spruce and fir with regard to vertical density profile. In another research Wang and Cooper (2005a, b) researched the influences of hot press temperature and time, wood preliminary dampness content and sample dimensions of thermal modified fir wood. It was seen that the density of produced materials is high on surface, while it is low internal part. Density of wood boards changes according to pressure parameters, wood dampness, temperature etc. These changes impress physical and mechanical properties of wood boards (Strickler, 1959; Kamke and Casey, 1988; Wang and Winistorfer, 2000; Candan, 2007; Candan et al. 2013).

Thermal modification treatment may influence like drying features, density, dimensional stability, surface quality and Janka hardness. Unsal and Candan (2008) researched physical and mechanical features of pine wood and they found that moisture content diminished, whereas Janka hardness and density rised. Unsal et al. (2009) conducted thermal modification with high

pressure with pine wood boards. They revealed the thickness swelling values of the boards progressed with increasing of temperature and pressure. Esteves et al. (2007) used a steam heating method for eucalyptus wood board. They found that dampness of wood decreased and dimensional stability improved. Furthermore it was determined that characteristics of density and compressive strength of eucalyptus wood panels with thermal modification (Unsal and Ayrilmis, 2005). They expressed that when time and temperature of pressure raised, wood density and pressure strength diminished. Unsal et al. (2003) investigated influences of thermal modification on mechanical and physical features of eucalyptus wood. As a result of this research it was found that swelling, Janka hardness and density values decreased once temperature increased.

In this research it was examined some physical and mechanical characteristics of thermal modified poplar wood boards with different temperature.

Material and Method

In this study, poplar wood (*Populus* spp) was preferred as samples. The woods were supplied from Araç in Kastamonu. The woods were waited in environment conditions during a month. Then the woods were cut 25 mm*100 mm*500 mm in size. The boards were pressed at 130°C, 150°C, 170°C, 190°C and 210°C with a laboratory type hot press. The pressure of press was adjusted as 1 atm. Treatment time was determined as 45 minutes. For each treatment 6 boards were pressed and totally 30 boards were hot pressed.

Control and modified samples were cut as 20 mm*20 mm*300 mm and 20 mm*20 mm*30 mm for mechanical properties. Compression and bending tests were performed according to TS 2595, 2474 and 2478. In addition, all of mechanical experiments were performed in Kastamonu University, Forest Faculty, Wood Chemistry and Wood Mechanic Labs. In mechanical experiments, a universal test machine was used. Compression test was conducted in 1,5 mm/min in room temperature and at breaking force (P_{max}) was measured. Compression

strength parallel to the fibres was calculated with this formula:

$$\sigma_{B//} = \frac{P_{max}}{a \times b}$$

- $\sigma_{B//}$: Compression strength parallel to the fibers (N/mm²)
- P_{max} : Strength at fracture (N)
- a, b : Sample cross-sectional dimensions (mm)

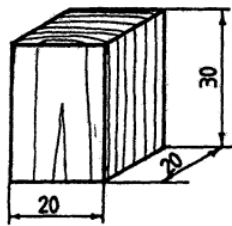

Figure 1. Sample sizes of the fibres parallel pressure test

Bending test was done in 4 mm/min and in room conditions. The load, to radial face of the test samples in the tangential direction of the annual rings and it was applied to centre of the test sample. At breaking force (P_{max}) was determined and bending strength values were calculated according to this formula:

$$\sigma_e = \frac{3 \times P_{max} \times L}{2 \times b \times h^2}$$

- σ_e : Bending strength (N/mm²)
- P_{max} : Strength at fracture (N)
- L : The gap between the fulcrums (mm)
- b : Sample width (mm)
- h : Sample height (mm)

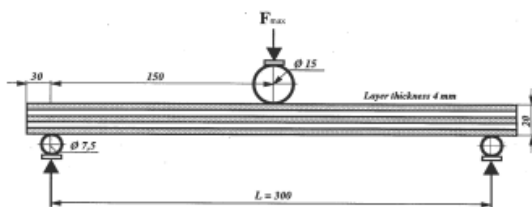

Figure 2. Sample sizes of bending strength test

It has benefited from samples of bending strength test to determine modulus of elasticity in bending and this formula was

used to calculate modulus of elasticity (Bozkurt and Göker, 1996):

$$E = \frac{P \times L^3}{4 \times f \times b \times h^3}$$

- E : Modulus of elasticity (N/mm²)
- P : The force in the elastic zone (N)
- L : The gap between the fulcrums (mm)
- b : Sample width (mm)
- h : Sample height (mm)
- f : The amount of deformation at the time of bending (mm)

Results and Discussion

In consequence of this study, by the time wood boards were modified as thermal, it was seen that the physical and mechanical characteristics of boards advanced. The results of compression strength, bending strength and modulus of elasticity were indicated in Chart 1, Chart 2 and Chart 3. In there;

1 = Control sample, 2 = Treatment in 130⁰C, 3 = Treatment in 150⁰C, 4 = Treatment in 170⁰C, 5 = Treatment in 190⁰C, 6 = Treatment in 210⁰C.

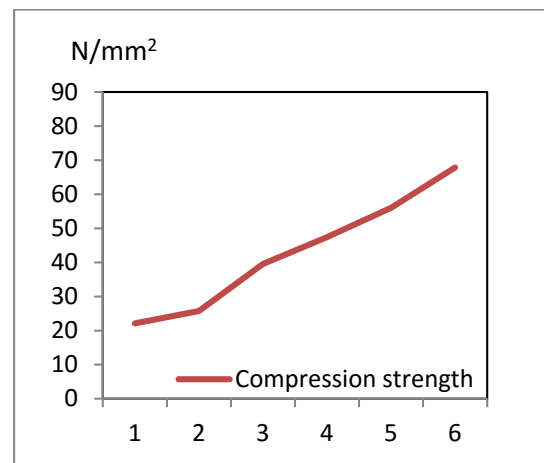

Chart 1. The results of compression strength tests

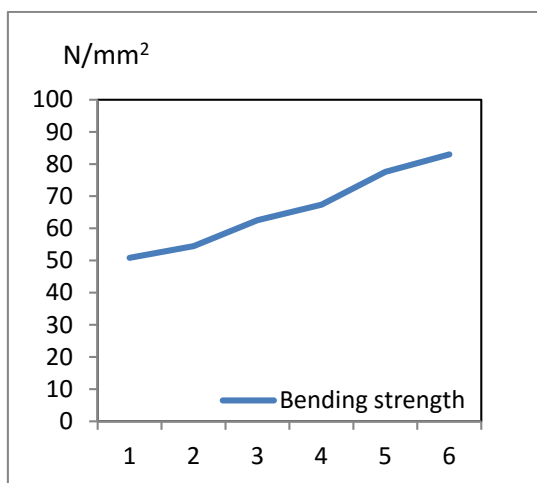

Chart 2. The results of bending strength tests

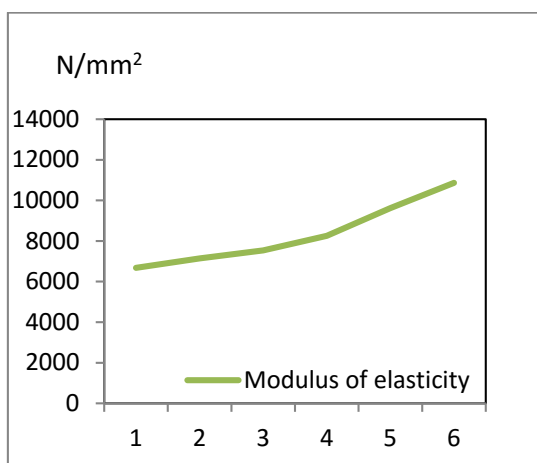

Chart 3. The results of modulus of elasticity

Provided that the charts were investigated, it was seen that the result values of all mechanical tests increased step-by-step depending on press temperature. When it was investigated the researches in the literature, it was seen that the thermal modification progressed the physical and mechanical properties of boards. Boonstra et al. (2007) determined that there is a small decrease (3%) in bending strength and a significant increase (28%) in compression strength after heat treatment in wood board samples. In addition, they noticed that the Brinell hardness parallel to the grain increased (48%) substantially after heat treatment in their samples. According to the results of this study, the modulus of elasticity increased about 26% after heat treatment. Kollmann and Schneider (1963) performed physical tests for pine, beech and oak after heat treatments. In

the result of this study, they determined the water absorption value and the dimension changes of the last samples. Jämsä and Viitaniemi (2001) stated that the thermal modified samples had low equilibrium moisture content owing to less water absorbed by the cell walls. Nikolov and Enceev (1967) and D'Jakonov and Konepleva (1967) arrived the similar results in their studies. Giebler (1983) explained that the swelling ratios of pine, birch, spruce, beech and poplar wood samples decreased between 50% and 80% as soon as the temperature increased. Dirol and Guyonnet (1993) found the same results in their researches. Moreover Tjeerdsma et al. (1998b) determined that swelling ratio of thermal modified *Fagus sylvatica* samples reduced from 7.3% to 5.7% and swelling ratio of thermal modified *Pinus sylvestris* samples decreased from 4.7% to 2.8. In the other studies, it was thought that equilibrium moisture content reduced due to the polycondensation reactions in lignin (Tjeerdsma and Militz 2005; Boonstra and Tjeerdsma 2006; Esteves et al. 2008b; Esteves and Pereira 2009). Inoue et al. (1993) determined as 20%, 45% and 80% the increases in the bending strength of the samples treated with 180°C, 200°C and 220°C during 8 hours, respectively. Candan et al. (2013) stated that the boards pressed at 2 MPa and in 150°C had maximum thickness swelling values. Besides, they found that the boards pressed with press pressure of 1 MPa in 150°C displayed maximum water absorption values, whereas the boards pressed with press pressure of 2 MPa in 170°C exhibited minimum water absorption values. They explained that thermally compressed samples with 2 MPa in 170°C had the highest density values. In addition to this, it was confirmed that when the highest pressure was treated to boards, it was seen Janka hardness values increased about 32% as compared to the unmodified control boards. In another study Candan et al. (2013) noticed that the vertical density profile values of thermal compressed boards were higher than values of controls. Clouter et al. (2008) saw that densification was the result of wrinkling of the cell walls after heat compression. They determined that the oven-dry density rised from about 374 to 924 kg/m³. Furthermore

with respect to mechanical properties, these researchers found that modulus of elasticity in tension and bending of thermal modified boards was approximately twice as much as for the control samples. It was noticed that Brinell hardness rised from 17 MPa for the control to 45 MPa for thermal modified wood at 200°C.

Conclusions

In consequence of this study, it was seen that thermal compression treatment was a suitable process for modification of wood boards. Mechanical characteristics of the thermal modified wood were progressed by this process. It is thought that the advanced properties of the thermally modified wood boards will bring new approaches to wood products industry.

References

Abraham J., Nemeth R., Molnar S. 2010. Thermomechanical densification of Pannonia Poplar. In: Proceedings of the final conference of cost Action E53: 'Quality control for wood & wood products' (4-7 May 2010), 282-292, Edinburgh.

Blomberg J., Persson B., Blomberg A. 2005. Effects of semi-isostatic densification of wood on the variation in strength properties with density. *Wood Science and Technology*, 39 (5), 339-350.

Boonstra, M. J., Tjeerdsma, B. F. 2006. Chemical analysis of heat-treated softwoods. *Holz Roh-Werkst.* 64, 204-211.

Boonstra, M. J., Acker, J. V., Tjeerdsma, B. F., Kegel, E. V. 2007. Strength properties of thermally modified softwoods and its relation to polymeric structural wood constituents. *Annals of Forest Science*, 64, 679–690.

Bozkurt, A., Y. ve Göker, Y., 1996. Fiziksel ve Mekanik Ağaç Teknolojisi, İstanbul Üniversitesi, Yayın No: 3944, Fakülte Yayın No: 436, İstanbul.

Candan Z. 2007. Effects of some production parameters on vertical density profile (VDP) and technological properties of medium density fiberboard (MDF). MSc Thesis, 400 p., Istanbul University, Istanbul, Turkey.

Candan Z., Korkut S., Unsal O. 2013. Effect of thermal modification by hot pressing on performance properties of paulownia wood boards. *Industrial Crops and Products*, 45, 461–464.

Candan Z., Korkut S., Unsal O. 2013. Thermally Compressed Poplar Wood (TCW): Physical and Mechanical Properties, *Drvna Industrija*, 64 (2) 107-211.

Clouter, A., Fang, C., Mariotti, N., Koubaa, A., Blanchet, P., 2008. Densification of wood veneers under the effect of heat, steam and pressure. In: Proceedings of the 51st International Convention of Society of Wood Science and Technology, November 10–12, 2008 Concepción, Chile.

Dirol, D., Guyonnet, R. 1993. Durability by reftification process. In: International Research Group Wood Pre, Section 4-Processes. N° IRG/WP 93-40015.

D'Jakonov, K., Konepleva, T. 1967. Moisture absorption by Scots Pine wood after heat treatment. *Lesn. Z, Arhangel'sk*, 10(1), 112-114.

Dogu D., Tirak K., Candan Z., Unsal O. 2010. Anatomical investigation of thermally compressed wood panels. *BioResources*, 5 (4), 2640-2663.

Esteves B., Marques A. V., Domingos I., Pereira H. 2007. Influence of steam heating on the properties of pine (*Pinus pinaster*) and eucalypt (*Eucalyptus globulus*) wood. *Wood Science and Technology*, 41(3): 193-207.

Esteves, B., Graça, J., Pereira H. 2008b. Extractive composition and summative chemical analysis of thermally treated eucalypt wood. *Holzforchung*, 62, 344-351. DOI 10.1515/HF.2008.057.

Esteves, B., Pereira H. 2009. Wood modification by heat treatment: A review. *BioResources*, 4(1), 370-404.

Giebeler E. 1983. Dimensional stabilization of wood by moisture-heat-pressure-treatment. *Holz als Roh-und Werkstoff*, 41, 87-94.

Inoue, M., Norimoto, M., Tanahashi, M., Rowell, R. 1993. Steam or heat fixation of compressed wood. *Wood and Fiber Science*, 25(3), 224-235.

Jämsä, S., Viitaniemi, P. 2001. Heat treatment of wood – Better durability without chemicals. In: *Proceedings of special seminar held in Antibes*, France.

Kamke F. A., Casey L. J. (1988). Fundamentals of flakeboard manufacture: Internal-mat conditions. *Forest Product Journal*, 38 (6), 38-44.

Kollmann, F., Schneider, A. 1963. On the sorption behaviour of heat stabilized wood. *Holz als Roh- und Werkstoff*. 21(3), 77-85.

Korkut D., Korkut S., Bekar I., Budakci M., Dilik T., Cakicier N. 2008. The effects of heat treatment on physical properties and surface roughness of Turkish Hazel (*Corylus colurna* L.) wood. *International Journal of Molecular Sciences (IJMS)*, 9 (9), 1772-1783.

Korkut S., Kocaefe D. 2009. Effect of heat treatment on wood properties. *Düzce University Journal Forestry*, 5 (2), 11-34.

Kubojima Y., Ohtani T., Yoshihara H. 2003. Effect of shear deflection on bending properties of

compressed wood. *Wood and Fiber Science*, 36, 210–215.

Militz H. 2002. Thermal treatment of wood: European processes and their background. In *Proceedings of the 33rd Annual Meeting*, (12-17 May 2002), 1-17. Cardiff, Wales.

Navi P., Girardet F. 2003. Effects of thermo-hydronechanical treatment on the structure and properties of wood. *Holzforschung*, 54, 287–293.

Nikolov, S., Enceve, E. 1967. Effect of heat treatment on the sorption dynamics of Beech wood. *Nauc. Trud. Lesoteh. Inst. Sofija (Ser. Meh. Tehn. Darv.)*, 14(3), 71-77.

Norimoto M. 1993. Large compressive deformation in wood. *Mokuzai Gakkaishi, The Japan Wood Research Society*, 39 (8), 867–874.

Norimoto M. 1994. Heat treatment and steam treatment of wood. *Wood Industry*, 49 (12), 588–592.

Seborg R. M., Millett M. A., Stamm A. J. 1945. Heat stabilized compressed wood (Staypak). *Mechanical Engineering*, 67, 25-31.

Stamm A. J., Haris E. E. 1953. *Chemical Processing of Wood*, New York, Chemical Publishing Company Inc. 165.

Stamm A. J. 1964. *Wood and cellulose science*. Ronald Press, 549, New York. USA.

Strickler M. D. 1959. Effect of press cycle and moisture content on properties of Douglas fir flakeboard. *Forest Product Journal*, 9 (7), 203-215.

Tabarsa T. 1995. The effects of transverse compression and press temperature on wood response during hot-pressing. Master Thesis of Science in Forest Engineering, 110 p, The University of New Brunswick, Canada.

Tabarsa T., Chui Y. H. 1997. Effects of hot-pressing on properties of white spruce. *Forest Products Journal*, 47 (5), 71–76.

Tarkow H., Seborg R. M. 1968. Surface densification of wood. *Forest Products Journal*, 18 (9), 104-107.

Tjeerdsma, B., Boonstra, M., Militz, H. 1998b. Thermal modification of non-durable wood species. Part 2. Improved wood properties of thermally treated wood. International Research Group on Wood Pre. Document No: IRG/WP 98-40124.

Tjeerdsma, B., Militz, H. 2005. Chemical changes in hydroheat wood: FTIR analysis of combined hydroheat and dry heat-treated wood. *Holz Roh-Werkst.* 63, 102-111.

T.S.E., 1977. Odunun Liflere Paralel Doğrultuda Basınç Dayanımı Tayini, TS 2595, Türk Standartları Enstitüsü, Ankara.

T.S.E., 1977. Odunun Statik Eğilme Dayanımının Tayini, TS 2474, Türk Standartları Enstitüsü, Ankara.

T.S.E., 1978. Odunun Statik Eğilmede Elastikiyet Modülünün Tayini, TS 2478, Türk Standartları Enstitüsü, Ankara.

Unsal O., Korkut S., Atik C. 2003. The effect of heat treatment on some properties and colour in eucalyptus (*Eucalyptus camaldulensis* Dehn.) wood. *Maderas. Ciencia y Tecnologia Journal*, 5 (2), 145-152.

Unsal O., Ayırmis N. 2005. Variations in compression strength and surface roughness of heat-treated Turkish river red gum (*Eucalyptus camaldulensis* Dehn.) wood. *Journal of Wood Science*, 51, 405-409.

Unsal O., Candan Z. 2007. Effects of press pressure and temperature on the moisture content, vertical density profile and janka hardness of pine wood panels, *Proceedings of 10 International IUFRO Division, Wood Drying Conference*.

Unsal, O., Candan Z. 2008. Moisture content, vertical density profile and janka hardness of thermally compressed pine wood panels as a function of press pressure and temperature. *Drying Technology*, 26 (9), 1165–1169.

Unsal O., Kartal S. N., Candan Z., Arango R. A., Clausen C. A., Green F. 2009. Decay and termite resistance, water absorption and swelling of thermally compressed wood panels. *International Biodeterioration & Biodegradation*, 63 (5), 548-552.

Unsal O., Candan Z., Korkut S. 2011a. Wettability and roughness characteristics of modified wood boards using a hot-press. *Industrial Crops and Products*, 34 (3), 1455-1457.

Unsal O., Candan Z., Buyuksari U., Korkut S., Chang Y. S., Yeo H. 2011b. Effect of thermal compression treatment on the surface hardness, vertical density profile, thickness swelling of eucalyptus wood boards by hotpressing. *Journal of the Korean Wood Science and Technology*, 39 (2), 148-155.

Wang S., Winistorfer P. M. 2000. Fundamentals of vertical density profile formation in wood composites, Part 2. Methodology of vertical density formation under dynamic condition, *Wood and Fiber Science*, 32 (3), 220-238.

Wang J. M., Guangjie Z., Lida I. 2000. Effect of oxidation on heat fixation of compressed wood of China fir. *Forestry Studies in China*, 2 (1), 73–79.

Wang J., Cooper P. A. 2004. Vertical density profiles in thermally compressed balsam fir wood. *Forest products journal*, 55 (5), 65-68.

Wang J., Cooper P. A. 2005a. Vertical density profiles in thermally compressed balsam fir wood. *Forest Products Journal*, 55 (5), 65–68.

Wang J., Cooper P. A. 2005b. Effect of grain orientation and surface wetting on vertical density

profiles of thermally compressed fir and spruce. *Holz als Roh- und Werkstoff*, 63 (6), 397-402.

Welzbacher C. R., Wehsener J., Rapp A. O., Haller P. 2008. Thermo-mechanical densification combined with thermal modification of Norway Spruce (*Picea abies* Karst) in industrial scale-dimensional stability and durability aspects. *Holz als Roh- und Werkstoff*, 66, 39-49.

Yeo H., Lee J. J., Choi I. G., Yoon K. J., Eom C. D., Park J. H., Chang Y. S. 2010. Color control of cedar wood and its durability improvement by neat and hot water treatment. In *Proceeding of 11th IUFRO Wood Drying Conference*, 277-284, Skelleftea, Sweden.

Yoshihara H., Tsunematsu S. 2007. Bending and shear properties of compressed Sitka spruce. *Wood Science and Technology*, 41 (2), 117-131.

The Effect of Heat Treatment and Coupling Agent on Long Term Water Absorption and Dimensional Stability of Wood Plastic Composites

*Mürşit TUFAN¹, Türker GÜLEÇ¹, Emrah PEŞMAN¹, Nadir AYRILMIŞ²,
Sezer SOLAK¹, Alperen KAYMAKCI³

¹Artvin Çoruh University, Faculty of Forestry, Artvin / TURKEY

²Istanbul University, Faculty of Forestry, Istanbul / TURKEY

³Kastamonu University, Faculty of Forestry, Kastamonu / TURKEY

*Corresponding Author: mtufan35@hotmail.com

Abstract

The present study aims to investigate the moisture absorption of wood plastic composites (WPCs) produced from high density polyethylene (HDPE) and alder wood flour and its effects on dimensional stability of the WPCs. Three different formulations of WPCs were produced from mixtures of heat treated and untreated alder wood flour (*Alnus glutinosa* L.) with and without coupling agent. The produced granulates using a single screw extruder were compression-molded into the 5 mm thick panels in a hydraulic hot press for 3 minutes at 170°C. Long term water absorption (WA) and thickness swelling (TS) were studied for a range of water immersion times. The WPCs were evaluated using Fourier Transform Infrared Spectroscopy (FTIR). The WA and TS values of all the samples increased with increasing immersion time. The highest WA and TS values were found in the specimens produced from untreated alder wood flour and HDPE without coupling agent samples. These values decreased with the incorporation of the heat treated alder wood flour and coupling agent. Based on the findings obtained from the study, it was concluded that the heat treated wood could be used as reinforcing filler against water absorption in thermoplastic composites.

Keywords: Wood plastic composites, Water absorption, Thickness swelling.

Odun Plastik Kompozitlerin Uzun Süreli Su Alma ve Boyutsal Stabilitesi Üzerine Isıl İşlem ve Uyumlaştırıcı Ajanın Etkisi

Özet

Bu çalışmanın amacı Kızılağaç odunu ile üretilen odun plastik kompozitlerin uzun süreli su alma davranışı ve boyutsal stabilitesi üzerine oduna uygulanan ısıtma işlemi ve uyum sağlayıcı ajanın etkisinin araştırılmasıdır. Bu bağlamda üç farklı üretim reçetesi oluşturularak ısıtma işlemi gören ve görmeyen odunlardan numuneler hazırlanmıştır. Üretimde tek vidalı ekstruder kullanılmış olup 5 mm kalınlığında örnekler 3 dakika süre ile 170 °C'de preslenerek üretilmiştir. Örneklerin uzun süreli su alma (SA) ve kalınlık artışı (KA) değerleri belirlenmiştir. Tüm örneklerin SA ve KA değerleri suda bekleme süresi ile doğru orantılı olarak artmıştır. En yüksek SA ve KA değeri uyum sağlayıcı ajan içermeyen ve ısıtma işlemi görmemiş Kızılağaç odunundan üretilen örneklerde tespit edilmiştir. Isıtma işlemi görmüş Kızılağaç ve uyum sağlayıcı ajan kullanımı ile bu değerler azalmıştır. Çalışmadan elde edilen bulgulara dayanarak, boyutsal stabilitenin iyileştirilmesi için ısıtma işlemi görmüş ağaç malzemenin OPK üretiminde kullanılabileceği belirlenmiştir.

Anahtar Kelimeler: Odun plastik kompozit, Su alma, Kalınlık artışı.

Introduction

Wood-plastic composites (WPCs) are made from lignocellulosic material fibers or flours, mixed with polyolefins, including polyethylene (PE) and polypropylene (PP). WPCs are one of the newest semi-structural composite materials used in various construction application such as decking, flooring and outdoor facilities, window

frames and garden furniture. WPCs have many advantages over raw lignocellulosic materials and plastics. They have low density, good thermal insulation, and mechanical properties, as well as being inexpensive (Chaharmahali et al., 2008; Tufan et al., 2015a). The use of lignocellulosic materials in WPCs has increased due to their low cost, low density,

low energy consumption, biodegradability and non-abrasive nature. Furthermore, they can have high specific strength and modulus, allowing the production of low density composites with high filler content. In addition to the increasing with the concerns about decreasing forest area and diminishing petroleum based product, the use of lignocellulosic materials as reinforcement in the thermoplastic resin matrix are becoming more and more prevalent (He et al., 2014). Even though WPCs are more durable to water absorption than lignocellulosic materials due to encapsulation of lignocellulosic by the plastic. However, it is necessary to improve their physical properties because lignocellulosic materials in WPCs susceptible to water absorption (Ghasemi and Kord, 2009).

Water absorption is one of the most important characteristics of WPCs exposed to environmental conditions that determine their end use applications. Generally, water absorption in WPCs is governed by two significant mechanisms: the hygroscopic nature of lignocellulosic and the penetration of water into the composites via micro gaps between lignocellulosic materials and polymer matrix (Markarian, 2008). Water absorption resistance of WPCs were affected by plastic monomers type, wood content, particle size, wood species, partly because they have different contents of cellulose, lignin hemicellulose and extractives, chemically modified of lignocellulosic fiber and additives such as lubricant, stabilizers, coupling agent (Jin and Matuana, 2008; Adhikary et al., 2008).

The objective of this study was determine the effect of heat treatment long term water absorption and thickness swelling of WPCs produced from heat treated alder wood flour using virgin high density polyethylene (HDPE) with and without coupling agent.

Experimental

Materials

Heat-treated and untreated alder wood (*Alnus glutinosa* L.) were used as filler

materials. The heat-treated wood samples were obtained from Nova Forest Products Industry Trade Inc. (Bolu, Turkey). For the heat-treatment process 50 (L) x 50 (W) x 5 (T) mm³ specimens were prepared. The Thermo-D heat-treatment method 212 °C for 2 h under saturated steam was applied to the samples in the Novawood factory located in Bolu, Turkey, as previously described by Navi and Sandberg (2012). Untreated alder wood samples were used as controls. The virgin high-density polyethylene (HDPE, type S0464) was supplied from Petrokimya Holding Corporation, Aliaga, Turkey. It had a melt flow index range of 0.25 to 0.40 g/10 min (2.16 kg and 190 °C, ASTM D1238-13 (2013)) and a density of 0.959 to 0.963 g cm⁻³. Maleated polyethylene (MAPE) was used as the coupling agent (Clariant Licocene® PE MA 4351 granules, Clariant International Ltd., Muttenz, Switzerland). Its viscosity and density were 200 mPA·s to 500 mPA·s (at 140 °C) and 0.98 to 1.00 g cm⁻³, respectively.

Preparation of compression-molded wood plastic composites

The air-dried, heat-treated and untreated alder wood samples were ground into small particles using a Willey mill (Fritsch, Pulverisette 19, Idar-Oberstein, Germany). The wood flour retained on an 80-mesh size sieve was dried in a laboratory dryer (Termal, A11680T, Istanbul, Turkey) to a moisture content of 0 to 1% at 103 ± 2 °C (about 24 h). The samples were mixed with the HDPE in a high-intensity laboratory mixer (Shini SVM-80U, Guangdong, China). This mixture was compounded in a single-screw laboratory extruder (Rondol linear 30, Stoke-on-Trent, UK, L/D, with a ratio of 30:1). The temperature profile was set at the die end for 170 °C to 175 °C to 180 °C to 185 °C. The screw speed was calibrated at 60 rpm. The extruded samples were collected and cut into pellets. Finally, the pellets were compressed into 150 mm × 170 mm × 5 mm WPC panels for 3 min at 170 °C. The formulations of the WPCs are given in Table 1.

Table 1. Composition of Hot-Press Molded WPCs.

WPC Code	Treated Alder Wood (TAW) (%)	Untreated Alder Wood (UAW) (%)	HDPE (%)	Coupling Agent (%)
A	-	50	50	-
B	-	50	47	3
C	50	-	50	-

Methods

Determination of dimensional stability

The TS and WA tests were carried out according to ASTM D 570 (2010) specifications. Before testing, specimens with dimensions of 50 mm × 50 mm × 5 mm were conditioned at 20 °C and 50% relative humidity to a constant weight according to ASTM D618-13 (2013). The conditioned specimens were entirely immersed for 1-day, 1-week, 4-weeks, 8-weeks, and 12-weeks in a container of water at 23 ± 2 °C. At the end of each immersion time, the specimens were taken out from the water and all surface water was removed with a clean dry cloth. The specimens were weighed to the nearest 0.01 g and measured to the nearest 0.001 mm immediately. Ten replicate specimens were tested for each WPC formulation. The values of the WA as percentages were calculated with Eq. (1):

$$WA_{(t)} = ((W_{(t)} - W_0)/W_0) \times 100 \quad (1)$$

Where, $WA_{(t)}$ is the water absorption (%) at time t,

W_0 is the initial weight of the specimen,

$W_{(t)}$ is the weight of the specimen at a given immersion time t.

The values of the TS as percentages were calculated with Eq. (2):

$$TS_{(t)} = ((T_{(t)} - T_0)/T_0) \times 100 \quad (2)$$

Where, $TS_{(t)}$ is the thickness swelling (%) at time t,

T_0 is the initial thickness of the specimen,

$T_{(t)}$ is the thickness at time t.

Fourier transform infrared (FTIR) spectroscopy

A Shimadzu IR Prestige-21 FTIR spectrometer (Tokyo, Japan) equipped with attenuated total reflectance (ATR) was used to characterize wood samples and WPCs. Spectra were recorded between 600 cm⁻¹ and 4000 cm⁻¹, with 16 scans per experiment and a resolution of 8 cm⁻¹. The spectra for each group were transformed into absorbance

spectra, which were averaged before the baseline correction and normalization.

Statistical analysis

A non-parametric one-way ANOVA was performed using SPSS software (SAS Institute Inc., Cary, NC, USA) and was used to compare the difference in average values of the various parameters at a 95% confidence level.

Results and Discussions

Dimensional stability

The long term WA and TS values of the WPCs are shown in Table 2 and 3. The highest WA and TS values were determined produced from the untreated wood and without coupling agent samples as 19.35% and 6.34%, respectively.

It appears that when coupling agent had relatively positive influence on dimensional stability of WPCs. When coupling agent was added into the samples their WA and TS values was reduced. Significant differences ($p < 0.05$) between group some group averages for the WA and TS values are shown in Table 2 and 3. Wood is a hydrophilic porous composite of cellulose, lignin and hemicellulose polymers that are rich in functional groups such as hydroxyls readily interact with water molecules by hydrogen bonding. These free OH groups interact with polar water molecules, leading to the weight gain of the composites. During immersion, the wood flour absorbed a significant quantity of water, while the plastics absorbed very little (Clemons, 2002; Migneault et al., 2014). The dimensional stability of the WPCs was significantly improved by adding the coupling agent (MAPE). The WA and TS values of the specimens (Group ID B) with the MAPE water immersion after 12 weeks decreased by 40.3% and 19.5% as compared to the specimens without the MAPE. This

behaviour was attributed to the reaction of the hydrophilic OH groups of the filler and the acid anhydride groups of the MAPE, as it has been proposed in the literature. The anhydride groups in the MAPE enter into an esterification reaction with the surface hydroxyl groups of wood fibers and covalently bond to the hydroxyl groups (Homkhiew et al., 2014; Tufan and Ayrilmis, 2016). The MAPE improves the interfacial adhesion between wood flour and polymer matrix, leading to less microvoids and fiber–polypropylene de-bondings in the interphase region (Tufan et al., 2015b). The chemical reaction (ester linkages) between the polymer matrix and Alder wood flour reduced the number of available hydrophilic groups (Ayrilmis and Kaymakci, 2013).

The WPCs produced with heat-treated alder wood flour had significantly lower WA and TS values compared with WPCs produced with the untreated alder wood flour (Table 2). The WA and TS values of the specimens (Group ID C) with the heat treated alder wood water immersion after 12 weeks decreased by 59.2% and 48.5% as compared to the specimens untreated alder wood. These differences were attributed to the thermal degradation of hemicelluloses, which were hydrolysed during the heat-treatment (Winandy and Krzysik 2007; Ashori and Sheshmani 2010, Tufan et al., 2016). Thus enhanced the compatibility between the matrix and filler improved water resistance of the WPCs.

Table 2. Water absorption values of WPCs.

WPC Code	1 day	1 week	4 weeks	8 weeks	12 weeks
A	3,43 b * (0,50)	6,98 b (1,13)	13,64 c (1,92)	17,35 c (1,90)	19,35 c (1,97)
B	2,10 a (0,22)	3,50 a (0,39)	6,75 b (0,57)	8,98 b (1,18)	11,55 b (1,22)
C	1,90 a (0,27)	3,06 a (0,58)	5,05 a (0,83)	6,57 a (0,97)	7,88 a (1,01)

*Note: Groups with the same letters in a column indicate no statistical difference ($p < 0.05$); the values in parenthesis are the standard deviations.

Table 3. Thickness swelling values of WPCs.

WPC Code	1 day	1 week	4 weeks	8 weeks	12 weeks
A	2,12 c (0,67)	3,98 c (0,82)	5,73 b (0,94)	6,16 b (1,04)	6,34 c (0,99)
B	1,26 b (0,63)	2,38 b (0,89)	3,84 a (1,42)	4,26 a (1,32)	5,10 b (1,52)
C	0,58 a (0,50)	1,63 a (0,58)	2,81 a (0,97)	3,21 a (1,14)	3,25 a (0,74)

*Note: Groups with the same letters in a column indicate no statistical difference ($p < 0.05$); the values in parenthesis are the standard deviations.

FTIR Spectroscopy Analysis

The FTIR-ATR spectra of the heat-treated and untreated alder wood are presented in Figure 1. Due to cleavage of acetyl side chains in hemicellulose the carbonyl absorption peak at 1720 cm^{-1} to 1740 cm^{-1} decreased after the heat treatment. (Kocaefe et al., 2008). The cleavage of the propyl groups in lignin show up intensity increase at 1602 cm^{-1} after heat-treatment (Ucar et al., 2005). The intensified peak at 1454 cm^{-1}

¹ denoted the formation of new conjugated double bounds due to the heat treatment (Chen et al., 2012). The benzene ring of stretching vibrations was observed in the band from 1505 cm^{-1} to 1515 cm^{-1} (Faix, 1991). The peak intensity at 1240 cm^{-1} decreased after the heat treatment. This band showed the lignin syringyl monomer and the C-O in xylan (Nuopponen et al., 2004; Temiz et al., 2007).

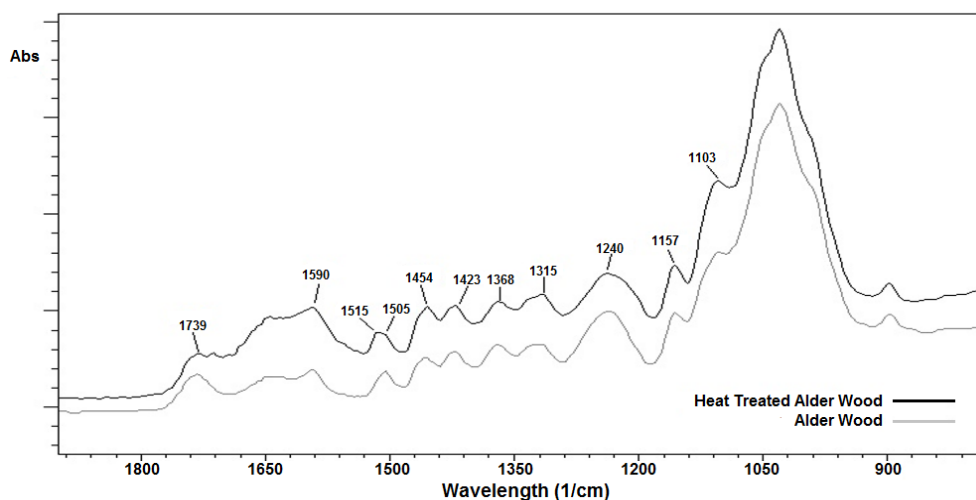

Figure 1. FTIR-ATR spectra of heat-treated and untreated alder wood

Conclusions

Compared to the control specimens, the WPC specimens produced with heat-treated wood showed a significantly lower water absorption and thickness swelling values. FTIR spectra showed that the heat treatment removed

References

- Adhikary KB., Pang S., Staiger MP. 2008. Long-term moisture absorption and thickness swelling behaviour of recycled thermoplastics reinforced with *Pinus radiata* sawdust. *Chemical Engineering Journal*, 142, 190-198.
- Ashori A., Sheshmani S. 2010. Hybrid composites made from recycled materials: Moisture absorption and thickness swelling behavior. *Bioresource Technology* 101(12), 4717-4720.
- Ayrlimis N., Kaymakci A. 2013. Fast growing biomass as reinforcing filler in thermoplastic composites: *Paulownia elongata* wood. *Industrial Crops and Products*, 43, 457-464.
- Chaharmahali M., Tajvidi M., Najafi SK. 2008. Mechanical properties of wood plastic composite panels made from waste fiberboard and particleboard. *Polymer Composites*, 29(6), 606-610.
- Chen Y., Gao J., Fan Y., Tshabalala MA., Stark NM. 2012. Heat-induced chemical and color changes of extractive-free black locust (*Robinia pseudoacacia*) wood. *BioResources* 7(2), 2236-2248.
- Clemons, C.M., 2002. Wood-plastic composites in the United States: the interfacing of two industries. *Forest Product Journal*, . J. 52 (6), 10-18.

hemicellulose and lignin from alder wood. Based on the findings obtained from the study, it was concluded that the heat treated wood could be used as reinforcing filler against water absorption in thermoplastic composites.

- Faix, O. 1991. Classification of lignins from different botanical origins by FTIR spectroscopy. *Holzforschung*, 45(1), 21-27.
- Ghasemi I., Kord B. 2009. Long-term Water Absorption Behaviour of Polypropylene/Wood Flour/Organoclay Hybrid Nanocomposite. *Iranian Polymer Journal*, 18(9), 683-691.
- He S., Zhou L., He., H. 2014. Preparation and properties of wood plastic composites based on tea residue. *Polymer Composites*, 36(12), 2265-2274.
- Homkhiew C., Ratanawilai T., Thongruang. 2014. Long-term water absorption and dimensional stability of composites from recycled polypropylene and rubberwood flour. *Journal of Thermoplastic Composites Materials*, DOI: 10.1177/0892705713518789.
- Jin S., Matuana LM. 2008. Improving water resistance of wood-plastic composites through co-extrusion. 66th Annual Technical Conference of the Society of Plastics Engineers (May 3-8, 2008), 19-23, Milwaukee, WI, USA.
- Kocafe D., Poncsak S., Boluk Y. 2008. Effect of thermal treatment on the chemical composition and mechanical properties of birch and aspen. *BioResources* 3(2), 517-537.
- Markarian J. 2008. Outdoor living space drives growth in wood-plastic composites. *Plastic Addition Compound*, 10, 20-25.

- Migneault S., Koubaa A., Perre P. 2014. Effect of fiber origin, proportion and Chemical Composition on the mechanical and physical properties of wood plastic composites. *Journal of wood Chemistry and Technology*, 34,241-261.
- Nuopponen M., Wikberg H., Vuorinen T., Maunu SL., Jämsä S., Viitaniemi P. 2004. Heat-treated softwood exposed to weathering. *Journal of Applied Polymer Science* 91(4), 2128-2134.
- Temiz A., Terziev N., Eikenes M., Hafren J. 2007. Effects of accelerated weathering on surface chemistry of modified wood. *Applied Surface Science* 253(12), 5355-5362.
- Tufan M., Akbaş S., Güleç T., Taşçıoğlu C., Alma MH. 2015a. Mechanical, Thermal, Morphological Properties and Decay Resistance of Filled Hazelnut Husk Polymer Composites. *Maderas: Ciencia y Tecnologia* 17(4), 865-874.
- Tufan M., Ayırlım N. 2016. Potential Use of Hazelnut Husk in Recycled High-Density Polyethylene Composites. *Bioresources*, 11(3), 7476-7489.
- Tufan M., Gülec T., Cukur U., Akbas S., Imamoglu S. 2015b. Some Properties of Wood Plastic Composites Produced from Waste Cups. *Kastamonu Univ Journal of Forestry Faculty*, 15 (2), 176-182.
- Tufan M., Güleç T., Peşman E., Ayırlım N. 2016. Technological and Thermal Properties of Thermoplastic Composites Filled with Heat-Treated Alder Wood. *Bioresources*, 11 (2), 3153-3164.
- Ucar G., Meier D., Faix O., Wegener G. 2005. Analytical pyrolysis and FTIR spectroscopy of fossil *Sequoiadendron giganteum* (Lindl.) wood and MWLs isolated hereof. *Holz Als Roh-Und Werkstoff* 63(1), 57-63.
- Winandy JE., Krzysik A. 2007. Thermal degradation of wood fibers during hot-pressing of MDF composites: Part I. Relative effects and benefits of thermal exposure. *Wood and Fiber Science*, 39(3), 450-461.

Feasibility of Incorporating *Ailanthus altissima* (Mill.) Swingle Wood in Particleboard Composite

*Selahattin BARDAK¹, Gökay NEMLİ²

¹Sinop University, Faculty of Engineering and Architecture, Department of Industrial Engineering, Sinop / TURKEY

² Karadeniz Technical University, Faculty of Forestry, Department of Forest Industrial Engineering, Trabzon / TURKEY

*Corresponding Author: sbardak@sinop.edu.tr

Abstract

The aim of this study was to determine some technological properties of particleboard made from *Ailanthus altissima* (Mill.) Swingle wood. The effects of panel density, shelling ratio, and adhesive amount on the physical, mechanical, and surface quality properties and formaldehyde emission of particleboard panels were investigated. Increasing panel density, shelling ratio and adhesive amount positively affected the mechanical properties (modulus of rupture, modulus of elasticity and internal bond strength), thickness swelling (2 h immersion) and surface quality properties. However, these applications significantly increased the formaldehyde emission. Thickness swelling of the panels after 24 h immersion was negatively affected by increasing panel density. Based on the results, it is proved that *Ailanthus altissima* (Mill.) Swingle wood has a potential as raw material for the manufacturing of particleboard composite.

Keywords: Particleboard, *Ailanthus Altissima* (Mill.) Swingle, Quality properties, Formaldehyde emission

Yongalevha Üretiminde *Ailanthus Altissima* (Mill.) Swingle Odununun Elverişliliği

Özet

Bu çalışmanın amacı *Ailanthus altissima* (Mill.) Swingle odunundan üretilen yongalevhanın bazı teknolojik özelliklerinin belirlenmesidir. Levha özgül ağırlığı, dış tabaka oranı ve tutkal miktarının yongalevhaların fiziksel, mekanik ve yüzey özellikleri ve formaldehit emisyonu üzerine etkileri araştırılmıştır. Levha özgül ağırlığı, dış tabaka oranı ve tutkal miktarı levhaların mekanik özellikleri (eğilme direnci, elastikiyet modülü ve yüzeye dik çekme direnci), 2 saatlik kalınlığına şişme ve yüzey özelliklerini olumlu yönde etkilemiştir. Fakat bu uygulamalar levhaların formaldehit emisyonunu olumsuz yönde etkilemiştir. Levhaların 24 saatlik kalınlığına şişmesi levha özgül ağırlığının artmasıyla olumsuz yönde etkilenmiştir. Sonuçlara bakıldığında, *Ailanthus altissima* (Mill.) Swingle odununun yongalevha üretiminde muhtemel hammadde olduğunu göstermiştir.

Anahtar kelimeler: Yongalevha, *Ailanthus Altissima* (Mill.) Swingle, Kalite özellikleri, Formaldehit emisyonu

Introduction

Particleboard is a very popular engineered wood based panel product manufactured from wood particles, synthetic resins, and other suitable binders. The most commonly used particleboard type has three layers (Baharoglu et al., 2014). Chipboard industry generally uses the forest and timber industry wastes. Moreover, the resulting improvement achieved by providing a rational use of the forest area has been fine-scale material. Thus, the world is moving on the acceleration of a growing production of particleboard in general. The most widely

used areas of particleboards are home and building elements, furniture construction and interior decoration. Future development of the particleboard industry has constantly be rationally connected to the wood raw material and the use of chipboard in different places. Today ensuring a continuous supply of wood raw material is very difficult due to poor wood resources and the result of the high demand for these resources. It plays an important role in industries such as particleboard for providing raw materials little-used species, agricultural waste, industrial waste and fast-growing tree species

(Nemli and Aydin, 2007). Today, a decrease of urbanization and industrialization have led to a gradual increase in fertile soil problems. Therefore, it is needed to the most unfavorable conditions and resistant species to acid rain in a large industrial zone. Because species such as *Ailanthus altissima* (Mill.) Swingle can be grown in infertile soil, naturally resistant to even the rain to bad weather, acid rains, and insects. Therefore, this species is very suitable for chipboard industry. Wood-based panels are widely used as substrate for thin overlays, such as resin-impregnated papers, vinyl films, etc., in the furniture industry. The surface roughness of particleboard plays an important role on the overlaying properties, since any surface irregularities reduce the final quality of the board (Baharoglu et al., 2014). Air pollution in buildings has become a matter of increasing concern. Pollutants such as formaldehyde are emitted into indoor air from the construction products and building materials. The formaldehyde causes health problems such as asthma and cancer (Sari et al., 2010).

Many researchers have investigated the effects of some manufacturing factors on the quality properties of particleboard: shelling ratio, panel density (Sari et al., 2010), moisture content of particleboard (Baharoglu et al., 2012), log position (Muhcu et al., 2015), wood extractives (Foster, 1967), residue type and tannin content (Moubarik et al., 2013), wood species and permeability of wood (Lynam, 1969), usage of wood bark and pine cone (Balanchet et al., 2000; Ayrimiş et al., 2009), mature and juvenile wood (Wasniewski, 1989), dimensions of the particles (Mottet, 1967), formaldehyde/urea mole ratio, resin level, catalyst level and composition, post treatment and formaldehyde scavengers (Que et al., 2007; Jizhi et al., 2011), cutting tool geometry, crushing conditions, particle compaction, fine screen usage, and press closing time (Hiziroglu and Graham, 1998; Hiziroglu et al., 2004). and pressing condition (Hiziroglu and Graham, 1998), hot press diagram, density profile (Bardak et al., 2011), waste sanding dust (Bardak et al., 2010).

In this study, we aimed to determine some technological properties of particleboard

made from *Ailanthus Altissima* (Mill.) Swingle wood. For this reason, flexural properties, internal bond strength (IB), thickness swelling (TS), surface roughness and formaldehyde emission of particleboards produced from *Ailanthus Altissima* (Mill.) Swingle wood were determined.

Material and Method

Five trees (14- years old and in 18 cm wide) were used for the production of particleboard. After the foliage was trimmed, all the trees were chipped using a ring type flaker. The chips were then reduced into smaller particles using a hammer mill. The wood particles were dried to 3% moisture content in a dryer. The dried particles were classified into two sizes using a 3.0–1.5–0.5 mm openings vibrating screen for the core and face layers. In the next process, resin was applied with a pneumatic spray gun. E1 type urea formaldehyde glue was used with a solid content of 65% and formaldehyde/urea molar ratio of 1.09. Three layer particleboards were produced with a thickness of 12 mm based on oven dry weight of the wood particle. Ammonium sulfate was added into the adhesive by about 1% based on the solid amount of adhesive as a hardener, with solid contents of 25% for the both face and core layers, respectively. The particleboard mats were hot pressed at 150°C under 25 kg/cm² for 360 s. A total of six particleboards with dimensions of 550 mm×600 mm×12 mm, three for each type of particleboard, were manufactured. The resulting boards were conditioned in a room with 60-70% relative humidity (RH) at 18-22°C and were then tested for modulus of rupture (MOR) and modulus of elasticity (MOE) (EN 310, 1993), internal bond (IB) (EN 317, 1993), thickness swelling (TS) after 2 h and 24 h immersion (EN 319, 1993), and formaldehyde emission (EN 120-1, 1993). The surface properties of the samples were determined by employing a fine stylus profilometer (Mitutoyo SJ-301, Mitutoyo Europe GmbH, Borsigstraße, Neuss, Germany). The samples with dimensions of 50 mm×50 mm×12 mm were conditioned in a climate chamber at 20°C and 65% RH. Thirty samples were used from each type of board for the surface roughness

measurements (DIN 4768, 1990). Moreover, examples of surface roughness were grinded with 220 numbered sandpaper. Three roughness parameters characterized by ISO 4287 standard (1987), average roughness (Ra), mean peak-to-valley height (Rz), and maximum peak-to-valley height (Ry), were considered to evaluate the surface properties of the boards. Thirty samples were used for determination of physical, mechanical, surface properties and formaldehyde emission of particleboards.

Table 1 shows the experimental design of the study. Two replicates were used for each panel type.

Table 1. Experimental design.

Panel Type	Adhesive Amount* (%)	Shelling Ratio** (%)	Panel Density (g/cm ³)
A (Control)	10-12	40	0.75
B	8-10	40	0.75
C	10-12	30	0.75
D	8-10	30	0.75
E	10-12	40	0.65
F	8-10	40	0.65
G	10-12	30	0.65
H	8-10	30	0.65

Table 2. Mean test values of physical and mechanical properties of particleboards.

Panel Type	MOR (N/mm ²)	MOE (N/mm ²)	IB (N/mm ²)	TS (%) ^a	TS (%) ^b
A	15.49	2278.99	0.517	13.65	24.96
B	14.51	2157.61	0.445	15.97	26.13
C	13.42	2010.32	0.377	16.26	27.05
D	11.86	1934.45	0.306	17.48	29.20
E	14.31	2025.11	0.441	15.24	22.49
F	13.16	1951.80	0.315	17.56	24.66
G	11.57	1804.34	0.313	18.78	25.56
H	10.56	1675.45	0.297	19.28	26.93

Note: ^a: After 2 h immersion, ^b: After 24 h immersion.

Note: * Based on the oven dry weight of the particles.

** : The ratio of the face thickness to the total thickness

Data for each test were statistically analyzed by using one-way analysis of variance to test for significant difference between factors.

Results and Discussion

The mean experimental values of physical and mechanical properties of particleboards are shown in Table2.

The statistical evaluation of the effects of the adhesive amount, panel density, and shelling ratio on mechanical and physical properties of particleboards was carried out by means of the analysis of variance (ANOVA).

Table 3 shows the results of the analysis.

Table 3. The results of ANOVA indicating the effects of panel density (A), shelling ratio (B), and adhesive amount (C) on the mechanical and physical properties of particleboards.

Source	Mechanical and physical properties	Sum of squares	Degrees of freedom	Mean Square	F value	Probability
A-Panel density	MOR (N/mm ²)	123.24	1	123.24	16.75	***
	MOE (N/mm ²)	3207310.44	1	3207310.44	57.34	***
	IB (N/mm ²)	0.302	1	0.302	50.03	***
	TS (%) ^a	210.53	1	210.53	261.44	***
	TS (%) ^b	189.46	1	189.46	207.02	***
B-Shelling ratio	MOR (N/mm ²)	373.20	1	373.20	50.71	***
	MOE (N/mm ²)	3614366.62	1	3614366.62	64.61	***
	IB (N/mm ²)	0.687	1	0.687	113.71	***
	TS (%) ^a	329.00	1	329.00	408.58	***
	TS (%) ^b	461.43	1	461.43	504.18	***
C-Adhesive amount	MOR (N/mm ²)	80.02	1	80.02	10.87	***
	MOE (N/mm ²)	600007.00	1	600007.00	10.73	***
	IB (N/mm ²)	0.292	1	0.292	48.40	***
	TS (%) ^a	151.27	1	151.27	187.86	***
	TS (%) ^b	148.43	1	148.43	162.18	***

***Significant at P≤0.05 level.

According to the results of the ANOVA, the effect of the parameters on mechanical and physical properties of particleboards was statistically with a 5% error margin.

Panels A, B, C, E, and F satisfied the minimum MOR requirements for interior fitments including furniture manufacture and general purpose use in the EN 312 Standard, and Panel A also had MOR for non-load-bearing in humid conditions (EN 312, 2005).

Panels A, B satisfied the minimum MOE requirements for non-load-bearing in humid conditions stated in the EN 312 Standard. All panels except H satisfied the minimum MOE requirements for interior fitments including furniture manufacture in the EN 312 Standard (EN 312, 2005).

Panels A satisfied the minimum IB requirements for non-load-bearing in humid conditions and load-bearing in humid conditions stated in the EN 312 Standard. Panels A, B, and E satisfied the minimum IB

requirements for load-bearing in dry conditions and interior fitments including furniture manufacture in the EN 312 Standard. All panels had IB for general purpose use (EN 312, 2005).

The mean experimental values of average roughness (Ra), maximum peak-to-valley height (Ry), and mean peak-to-valley height (Rz) of particleboards are shown in Table 4.

Table 4. Mean test values of surface properties of particleboards.

Panel Type	Ra (µm)	Ry (µm)	Rz (µm)
A	5.54	41.85	26.27
B	6.38	43.18	27.06
C	6.57	46.36	29.13
D	7.51	53.10	33.03
E	6.15	45.01	27.94
F	6.88	46.88	30.10
G	8.72	52.78	35.36
H	10.18	64.56	41.58

The statistical evaluation of the effects of the adhesive amount, panel density, and shelling ratio on surface properties of particleboards was carried out by means of the analysis of variance (ANOVA). Table 5 shows the results of the analysis.

Table 5. The results of ANOVA indicating the effects of panel density (A), shelling ratio (B), and adhesive amount (C) on the average roughness (Ra), maximum peak-to-valley height (Ry), and mean peak-to-valley height (Rz) of the of particleboards.

Source	Surface properties	Sum of squares	Degrees of freedom	Mean Square	F value	Probability
A-Panel density	Ra	87.96	1	87.96	28.83	***
	Ry	1530.23	1	1530.23	13.86	***
	Rz	950.63	1	950.63	20.64	***
B-Shelling ratio	Ra	161.02	1	161.02	52.78	***
	Ry	3975.34	1	3975.34	35.99	***
	Rz	1920.99	1	1920.99	41.70	***
C-Adhesive amount	Ra	39.61	1	39.61	12.99	***
	Ry	1178.80	1	1178.80	10.68	***
	Rz	426.93	1	426.93	9.27	**

***Significant at P≤0.05 level.

From the results of the ANOVA, it can be said that the effect of the parameters on surface properties of particleboards was significant statistically with a 5% error margin.

The mean experimental values of formaldehyde emission of particleboards are shown in Table 6.

Table 6. Mean test values of formaldehyde emission of particleboards.

Panel Type	Formaldehyde emission (mg/100g f.d.p.)
A	7.28
B	5.46
C	6.72
D	4.97
E	6.15
F	4.57
G	5.40
H	4.15

Note: f.d.p. Full dry panel

The effects of the adhesive amount, panel density, and shelling ratio on formaldehyde emission of particleboards were evaluated by

means of the analysis of variance (ANOVA). Table 7 gives the results of the analysis of variance.

Table 7. The results of ANOVA indicating the effects of panel density (A), shelling ratio (B), and adhesive amount (C) on formaldehyde emission of the of particleboards.

Source	Sum of squares	Degrees of freedom	Mean Square	F value	Probability
A-Panel density	6.46	1	6.46	267.06	***
B-Shelling ratio	1.84	1	1.84	76.19	***
C-Adhesive amount	15.41	1	15.41	637.14	***

***Significant at $P \leq 0.05$ level.

When the results of the ANOVA were examined, it was shown that the effect of the parameters on surface properties of particleboards was significant with a 5% error margin.

Maximum formaldehyde emission for E1 adhesives are 8 mg/100g f.d.p. (EN 120, 1993). All panels provided this standard.

Effect of panel density

Increasing panel density from 0.65 to 0.75 gr/cm³ significantly improved MOR, MOE, IB, and TS for 2 hours. This finding is attributable to the more compact and tighter structure of particleboard at high density. If the structure are more compact and tighter structure, particleboards have higher mechanical properties and this structure decreases water diffusion into panel (Larmore, 1959; Gatchell et al., 1966; Vital et al., 1980). Moreover, increased panel density, more adhesive is used in particleboards at higher densities. More amount of adhesive improves mechanical properties and thickness swelling (Ashori and Nourbakhsh, 2008). However, increasing panel density negatively affected the thickness swelling for 24 hours. Urea formaldehyde is not resistant to water for long time. Particleboards at high density consist of high amount of wood material. For this reason, the panels attracts more amount of water. Panel density positively affected surface roughness (Ra, Ry, and Rz). Panels at high density have less porous structure and smoother surface. Formaldehyde emission values of particleboards increased with increasing panel density. Particleboards at high density consist of high amount of wood material. The adhesive is used based on the weight of particles. For this reason, particleboard

panels at 0.75 gr/cm³ density consist of higher amount of adhesive. Increasing adhesive amount negatively affects the formaldehyde emission (Sari et al., 2010).

Effect of shelling ratio

Increasing shelling ratio from 30 to 40% positively affected the MOR, MOE, IB, TS, Ra, Ry, and Rz. This may be attributable the use in high amount of fine particle in the surface layer. Increasing the amount of surface layers causes tighter and more compact structure on the particleboard surfaces. This structure increases the heat transfer to the core layer of particleboard (Sari et al., 2010). For this reasons, mechanical properties of particleboard increase and water diffusion become difficult (Ramaker and Lehman, 1976). Because chips used in the outer layer have more smooth surfaces, porous in board surface reduces (Nemli et al., 2005). For this reason, particleboards have smoother surface. Increasing shelling ratio negatively affected the formaldehyde emission. At higher shelling ratio, the amount of adhesive is higher for surface layer particles compared to the core particles. In addition, the tighter and more compact structure on the surface of particleboard prevents smoother formaldehyde releasing during hot pressing. For this reason, an increased amount of formaldehyde stays in the particleboard (Sari et al., 2010).

Effect of adhesive amount

An increase in adhesive amount positively affected mechanical and physical properties, and surface roughness of particleboard. However, formaldehyde emission values of particleboards were affected negatively due to increasing adhesive amount. The similar

results were obtained from previous studies (Bektas at al., 2002; Goker and Akbulut; 1992; Maloney, 1977; Rachtanapun et al., 2012; Hus, 1979; Nemli et al., 2006; Colak and Nemli, 2001; Nemli and Ozturk, 2006). Increasing adhesive amount improves the connection and contact between the particles. For this reason, increasing adhesive amount improves surface roughness.

Conclusions

The main conclusions drawn from this study are as follows:

1. Panel density, shelling ratio, and adhesive amount were found to be effective on all properties of particleboards.

2. Increasing panel density from 0.65 to 0.75 gr/cm³ significantly improved MOR, MOE, IB, and TS for 2 hours. However, increasing panel density negatively affected the thickness swelling for 24 hours.

3. Increasing shelling ratio from 30 to 40% positively affected the MOR, MOE, IB, TS, Ra, Ry, and Rz. Increasing shelling ratio negatively affected the formaldehyde emission.

4. Increasing adhesive amount positively affected mechanical and physical properties, and surface roughness, and it negatively affected the formaldehyde emission of particleboard.

5. Based on the results, it is proved that *Ailanthus altissima* (Mill.) Swingle wood has a potential as raw material for the manufacturing of particleboard composite.

References

Ashori, A., Nourbakhsh, A., 2008. Effect of pres cycle and resin Content on physical and mechanical properties of particleboard panels made from the undeutilized low-quality materials. *Industrial Crops and Products*, 28, 225-230.

Ayrilmis N, Buyuksari U, Avci E, Koc E. 2009. Utilization of pine (*Pinus pinea* L.) cone in manufacture of wood based composite. *Forest Ecology Management*, 259, 65-70.

Balanchet P, Cloiter A, Riedl B. 2000. Particleboard produced from hammer milled black spruce bark residues. *Wood Science Technology*, 34, 11-19.

Baharoğlu, M., Bardak, S., Nemli, G., Sarı, B., Ayrılmış, N. 2012. The influence of moisture content of raw material on the physical and mechanical properties, surface roughness,

wettability, and formaldehyde emission of particleboard composite. *Composite: Part B-Engineering*, 43 (5), 2448-2451.

Baharoğlu, M., Nemli, G., Sarı, B., Ayrılmış, N., Bardak, S. and Zeković, E., 2014. Effect of paraffin application technique on the physical and mechanical properties of particleboard. *Science and Engineering of Composite Materials*, 21 (2), 191-195.

Bardak, S., Nemli, G., Sari, B. 2010. Baharoğlu, M., Zeković, E., Manufacture and properties composite from waste sanding dusts. *High Temperature Materials and Process*, 29 (3), 159-168.

Bardak, S., Nemli, G., Sarı, B., Baharoğlu, M., Zeković, E. 2011. Effect of density profile and hot press diagram on the some technological properties of particleboard composite. *High Temperature Material and Process*, 30 (1-2), 31-37.

Bektas, İ., Güler, C., Kalaycıoğlu, H., 2002. particleboard production from sunflower (*Helianthus annuus* L.) stalks with urea formaldehyde adhesive. *KSÜ Science and Engineering Journal*, 5 (2), 49-55.

Colak, S. ve Nemli, G., 2001. Formaldehyde emission and methods of reducing in wood board industry. *Furniture Decoration Journal*, Number: 44 (in Turkish).

DIN 4768, 1990. Determination of Values of Surface Roughness Parameters Ra, Rz, Rmax Using Electrical Contact (Stylus) Instruments, Concepts and Measuring Condition, Deutsches Institut for Norming, Berlin Germany.

EN 120-1. 1993. European Committee for Standardization, Brussels.

EN 310. 1993. European Committee for Standardization, Brussels.

EN 317. 1993. European Committee for Standardization, Brussels.

EN 319. European Committee for Standardization, Brussels, 1993.

EN 120. 1993. Determination of Formaldehyde Content in Fiberboard by Using Perforator Method. European Committee for Standardization, Brussels-Belgium.

EN 312. 2005. European Committee for Standardization. Brussels-Belgium.

Foster WG. 1967. Species variation. Proceedings of the WSU Particleboard Symposium, 13-20, Washington State University, USA.

Gatchell CJ, Heebink B.G., Hefty F.V. 1966. Influence of component variables on properties of particleboard for exterior use. *Forest Product Journal*, 16, 46-59.

Goker, Y., Akbulut, T. 1992. Factors affecting particleboard and plywood properties,

“Orenko 92” I. National Forest Products Industry Congress, Turkey (22-25 September 1992), 269-287, Trabzon, Turkey.

Hiziroglu S, Graham M. 1998. Effect of press closing time and target thickness on surface roughness of particleboard. *Forest product Journal*, 48 (3), 50-54.

Hiziroglu S., Jarusombuti S., Fuengvitat V. 2004. Surface characteristics of wood composites manufactured in Thailand. *Building and Environment*, 39, 1359-1364.

Hus, S., 1979. The effect of technological factors on properties of particleboard, *Istanbul University Forest Faculty Journal*, Serial B, 29, 2 (in Turkish).

ISO 4287. 1997. International standard geometrical products specifications (GPS) surface texture: profile method terms, definitions, and surface texture parameters. Geneva: International Organization for Standardization.

Larmore, F.D. 1959. Influence of specific gravity and resin content on properties of particleboard. *Forest Products Journal*, 9 (4), 131-134.

Lynam F.C. 1969. Factors influencing the properties of wood chipboard. In: Mitlin L, Editor. *Particleboard manufacture and application*. Pressmedia Books, p. 145-149, London.

Maloney, T., 1977. *Modern particleboard and dry-process fiberboard manufacturing*. ISBN: 0879300639, 672 p, Miller Freeman Publications, San Francisco-California.

Moubarik A., Mansouri H.R., Pizzi A., Charrier F., Allal A. 2013. Bertrand charrier corn flour-mimosa tanin-based adhesives without formaldehyde for interior particleboard production. *Wood Science technology*. 47, 675-683.

Motted A.L. 1967. The particle geometry factor. *Proceedings of the WSU particleboard Symposium*, 23-73, Washington State University, USA.

Muhcu S., Nemli G., Ayrimis N., Bardak S., Baharoglu M., Sari B., Gerçek Z. 2015. Effect of log position in European Larch (*Larix decidua* Mill.) tree on the technological properties of particleboard. *Scandinavian Journal of Forest Research*. 30 (4), 357-362.

Nemli, G., Ozturk, I., Aydin, I. 2005. Some of the parameters influencing surface roughness of particleboard. *Building and Environment*, 40 (10), 1337-1340.

Nemli, G., Ozturk, İ. 2006. Influences of some factors on the formaldehyde content of particleboard. *Building and Environment*, 41, 770-774.

Nemli, G., Demirel, S., Zekovic, E. 2006. The Effect on some technological properties of particleboard of chip moisture, use of paraffin, and tree type. *Kafkas University, Forest Faculty Journal*, 7 (2), 81-93 (in Turkish).

Nemli, G., Aydin, A., 2007. Evaluation of the physical and mechanical properties of particleboard made from the needle litter of *Pinus Pinaster* Ait. *Industrial Crops and Products*, 26, 252-258.

Jizhi, Z., Jianzhang, L., Shifeng, Z., 2011. Properties of particleboard manufactured with modified urea formaldehyde resin. *Advanced Materials Research*, 150-151, 1135-1138.

Que Z., Furunoa T., Katoha S., Nishinob Y. 2007. Effects of urea formaldehyde resin mole ratio on the properties of particleboard. *Building and Environment*, 42 (3), 1257-1263.

Rachtanapun, P., Sattayarak, T., Ketsamak, N. 2012. Correlation of density and properties of particleboard from coffee waste with urea-formaldehyde and polymeric methylene diphenyl diisocyanates, *Journal of Composite Materials*, 46 (15), 1839-1850.

Ramaker, T.J., Lehman, W.F., 1976. High-performance structural flakeboard from douglans-fir and lodgepole-pine forest residues. USDA Forest Service, Research Paper, FPL 286, Medison, Wis., USA.

Sari, B., Nemli, G., Bardak, S., Baharoglu, M. and Zekovic, E., 2010. Effect of formaldehyde/urea mole ratio, panel density, shelling ratio, and waste screen dust on the physical and mechanical properties, and formaldehyde emission of particleboard composite. *High Temperature Materials and Processes*, 29 (4), 287-294.

Vital B.R., Wilson J.B., Kanarek P.H. 1980. Parameters affecting dimensional stability of flakeboard and particleboard. *Forest Product Journal*, 30, 23-29.

Wasniewski, J.L., 1989. Evaluation of juvenile wood and its effect on Gouglas-fir structural composite panels. *Proceedings of the twenty-third Washington State University International Particleboard/Composite Materials Symposium USA* (4-6 April 1989), Washington, DC, USA.

Determination of Structural Changes under SEM on Heat Treated Wood Exposed to Accelerated Weathering

*Mehmet Hakan AKYILDIZ¹, Mehmet KARAMANOĞLU²

¹Kastamonu University, Faculty of Forestry, Kastamonu / TURKEY

²Kastamonu University, Tosya Vocational School, Kastamonu / TURKEY

*Corresponding Author: mhakyildiz@kastamonu.edu.tr

Abstract

Physical, chemical, biological and microscopic properties change in unprotected wooden material exposed to weathering conditions. Decay in weathering is a result of chemical change in the cell walls that caused by the activities of microorganisms and primarily starting with the decomposition of lignin. Besides, wood surfaces are ruined by some effects such as quickly wet and dry, daily and seasonal relative humidity changes, temperature changes, wind, atmospheric pollution, oxygen, and human activities. The aim of this study is to determine changes of surface properties of heat treated wood exposed to weathering. For this purpose, Calabrian pine and chestnut woods have been used. After the experimental samples have been cut, they were subjected to heat under atmospheric pressure at three different temperatures (130, 180 and 230 °C) and two different time levels (2 and 8 h). Then, heat treated samples have been exposed to accelerated weathering conditions at two different time levels (120 and 240 h) according to related standards. After ageing, the changes in wood surfaces were observed by scan electron microscope (SEM). Also, results have been compared with values of control samples belong to each group.

Keywords: Thermal treatment, Aging, Weathering, SEM examination in wood.

Introduction

Weathering is the general term used to define the slow degradation of materials exposed to the weather. The degradation mechanism depends on the type of material, but the cause is a combination of factors found in nature: moisture, sunlight, heat/cold, chemicals, abrasion by windblown materials, and biological agents. Weathering is surface degradation of wood that is initiated primarily by solar radiation, but other factors are also important (Karamanoğlu, 2012; Karamanoğlu ve Akyıldız, 2013; Williams, 2005). The wetting and drying of wood through precipitation, diurnal and seasonal changes in relative humidity (RH), abrasion by windblown particulates, temperature changes, atmospheric pollution, oxygen, and human activities such as walking on decks, cleaning surfaces with cleaners and brighteners, sanding, and power washing all contribute to the degradation of wood surfaces. Physical, chemical, biological and microscopic properties change in unprotected wooden material that is exposed to weathering conditions. Also, when wood is exposed outdoors, a variety of weathering factors degrades the main structural wood

compounds. The factors contributing most to wood degradation by weathering are irradiation (UV) and water. Weathering degradation is defined by colour changes of the wood surface, followed by loss of gloss, roughening and checking. The change of wood colour is explained by the fact that the UV component of sunlight, changes in moisture and temperature as well as that oxidative agents such as oxygen and/or ozone are able to depolymerise lignin and some polysaccharides in the wood cell wall (Karamanoğlu, 2012; Karamanoğlu ve Akyıldız, 2013; Temiz *et al.*, 2007). The heat treatment of wood is defined as the application of heat to wood in order to bring about a desired improvement in the performance of the material. Heat treatment serves to improve the natural quality properties of the wood, such as dimensional stability and resistance to bio-corrosion and resistance to outdoor weather conditions, biological resistance against fungi and insects, decorative colour variation and equip the wood material with new properties (Karamanoğlu ve Akyıldız, 2013; Gündüz *et al.*, 2007; Korkut and Kocaefe, 2009). Increasing environmental pressure has

appeared in recent years in many countries, leading to important changes in the field of wood preservation. Heat treatment of wood is an eco- friendly method to modify wood without the use of any toxic chemicals (Kol, 2010). Heat-treated timber is used in the construction of building cladding, interior paneling, parquet and plank flooring, park and garden furniture, garden fencing, children's playground equipment, window and window shutters, interior and exterior doors, sauna and sauna elements, interior furniture and musical instruments. Heat-treated timber surfaces naturally tend to age by the effect of sunlight, rain and wind. This condition does not affect the durability of the heat-treated timber but wood surface turns grey after a certain period (Korkut and Kocaefe, 2009). Some studies results about the micro structural properties of weathering and heat treated wood by means of SEM. D. Sandberg (1998) reported in study on related to weathering; on a microscopic level, it is also possible to see clear differences in degradation between radial and tangential surfaces. Tangential surfaces have more and deeper cracks than radial surfaces. The cracks on the tangential surfaces occur frequently in both early and latewood. On radial surfaces, cracks occur primarily at the annual ring border, but to a certain extent also in the earlywood. On an ultrastructural level, decomposition of the pits is the clearest difference between radial and tangential surfaces. In both radial and tangential surfaces, degradation of the cell wall takes place. Huang et al., (2012a-b-c) found that heat treated woods have better color stability during the early times of weathering, while the colors of heat-treated woods and untreated woods are very similar after the specimens have been subjected to long term artificial weathering. Degradation of middle lamellar, checking of cell wall and destruction of bordered pits occurred due to irradiation on heattreated wood surface. Photo-degradation occurred preferentially in middle lamella of wood surface where the lignin concentration was the highest in the cell wall. Lignin content increases slightly with heat treatment. Discoloration of wood was due to combination of the photodegradation of lignin and extractives on

wood surface during irradiation. B.M. Esteves and H.M Pereira (2009) reported that heat treatment changes the chemical composition of wood, leading mass loss. Hemicelluloses are the most affected compounds. Extractives are degraded or leave the wood at the same time that new extractable compounds emerge from wood degradation. Heat treatment affects the anatomical structure of wood, but the effects depend on the wood species and on the process conditions used. Tangential and radial cracks, deformation on libriform fibres and collapse of vessels.

The objectives of this study to determine and comparison the microstructural changes on the radial surface of heat treated wood exposed to weathering calabrian pine and chestnut woods with SEM microscope.

Materials and Methods

Wood materials

The Calabrian pine (*Pinus brutia* Ten.) and chestnut (*Castanea sativa* Mill.) trees were randomly selected and 3 stems at 5 meters, with a breast height diameter (DBH) of 30 – 40 cm, were obtained from forestlands of the Kastamonu province, Turkey. None of the trees has defects such as spiral grain and cracks. The lumber was cut from the logs in the sawmill, in parallel to grain direction, according to the Turkish standard, TS 4176. Afterwards, the lumbers were air dried until it reached approximately 12% MC. Then, the lumber was planed and cut into small clear specimens for heat treatment in the dimensions of 50×50×50 mm. Fifteen specimens for each species were prepared.

Heat treatment

The temperature of the oven was increased to the temperature at which the actual heat treatment occurs. Heat treatment applications were applied in a temperature controlled small heating unit. The treatment started by putting the samples at ambient temperature in the oven, and the period to reach the treatment temperature was about 1 hour for all trials. 3 different temperatures (130, 180 and 230°C) and 2 different durations (2 and 8h) were conducted to the specimens under atmospheric pressure and in the presence of inert (nitrogen) environment.

After treatment, the temperature was decreased to room temperature, which took about 24h. The same procedure was conducted for all experiments.

Accelerated weathering

The heat treated wood samples' surface was cut radially in the dimensions of

50×50×10mm for weathering. The outer surface of each of three replicates of each group of wood specimen was exposed for 120 and 240 hr. Fig. 1 shows the accelerated weathering test specimens with heat treatment before the experiment.



Fig. 1. Weathering test specimens and accelerated weathering tester.

Then, heat treated samples were exposed to accelerated weathering conditions at two different time levels (120 and 240 hr.) according to ASTM G 154 standard. Although not conclusive, 120 and 240 hours accelerated weathering, in general practice, is that which corresponds to 2.5 and 5 years (Browne, 1970; Mallon et al., 2002). The accelerated weathering cycle consist of three stages which are UV process (one hour in 60°C and 0.71w/m² light intensity), water spray (ten minutes in 20°C) and conditioning (four hours in 50°C), respectively.

Scanning electron microscopy (SEM) analysis

FEI Quanta FEG 250 model Scanning Electron Microscopy (SEM) has been used in order to determine micro-structure changes which have occurred on radial surfaces of the samples that have been heat treated wood exposed to weathering. After weathering and before SEM research, natural control and heat treated wood exposed to weathering samples cut radially in the dimensions of 5×5×2mm with the help of a razor blade. In all groups, longitudinal radial surfaces have been photographed by enlarging the samples

2500 times in 10kV voltage for observe the cell damage.

Results and Discussions

Visual evaluation of the surfaces

In Figure 2 and Figure 3, comparison of color and physical changes on the radial sections of calabrian pine and chestnut woods after heat treatment in different times and different heating and accelerating weathering in different times is shown. When we look at the natural control samples, the color has been observed to darkens in different ratios and the surface image has been observed to get deformed with increased time and heat in heat treatment. This can be explained by increasing the content of lignin depending on the heat treatment temperature and time (Akyildiz et al., 2009a, Akyildiz et al., 2009b, Ateş et al., 2009, Ateş et al., 2010). Samples with heat treated have been observed to have color stability in the first phase of the ageing. However, in samples which have been exposed to long time (8 hours) heat treatment, generally in 130 °C and 180 °C temperature, color lightening has been observed after 240 hours of heat treatment (Fig. 2-d-f-h). This situation has been

considered to occur because of the washing that has resulted from accelerated ageing after heat treatment. It is difficult to analyse the structural changes of the samples with their visual characteristics. For this reason,

for the determination and analyse of the structural changes of the samples, Scanning Electron Microscopy (SEM) study has been carried out and commented.

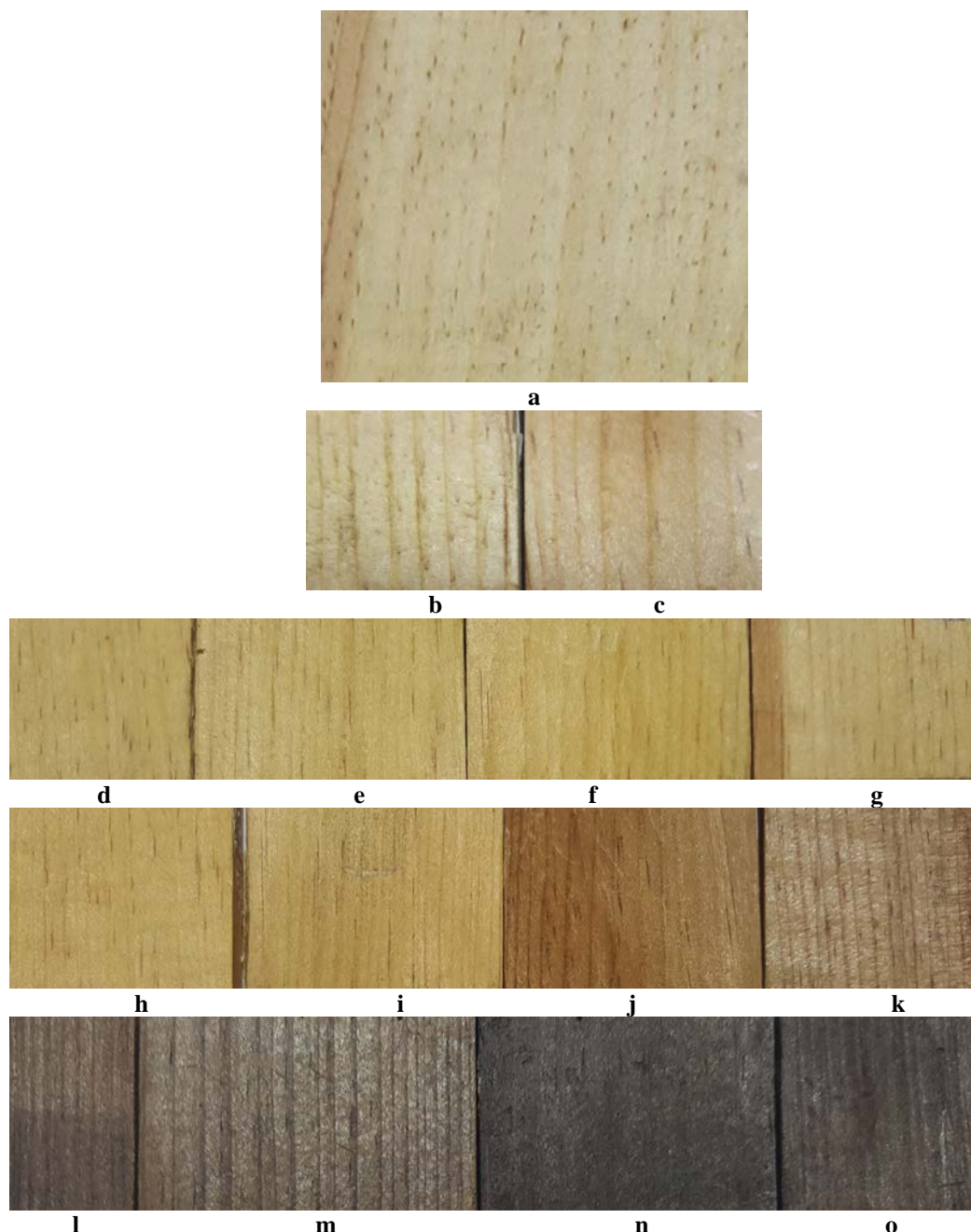

Fig. 2. Images on longitudinal radial surfaces of Calabrian pine specimens before and after artificial weathering; (a) natural control (b) natural and after weathering of 120 hr.; (c) natural and after weathering of 240hr; (d) heat-treated at 130 °C/2hr. and after weathering of 120 hr; (e) heat-treated at 130 °C/2hr. and after weathering of 240 hr; (f) heat-treated at 130 °C/8hr. and after weathering of 120 hr; (g) heat-treated at 130 °C/8hr. and after weathering of 240 hr; (h) heat-treated at 180 °C/2hr. and after weathering of 120 hr; (i) heat-treated at 180 °C/2hr. and after weathering of 240 hr; (j) heat-treated at 180 °C/8hr. and after weathering of 120 hr; (k) heat-treated at 180 °C/8hr. and after weathering of 240 hr; (l) heat-treated at 230 °C/2hr. and

after weathering of 120 hr; (m) heat-treated at 230 °C/2hr. and after weathering of 240 hr; (n) heat-treated at 230 °C/8hr. and after weathering of 120 hr; (o) heat-treated at 230 °C/8hr. and after weathering of 240 hr.

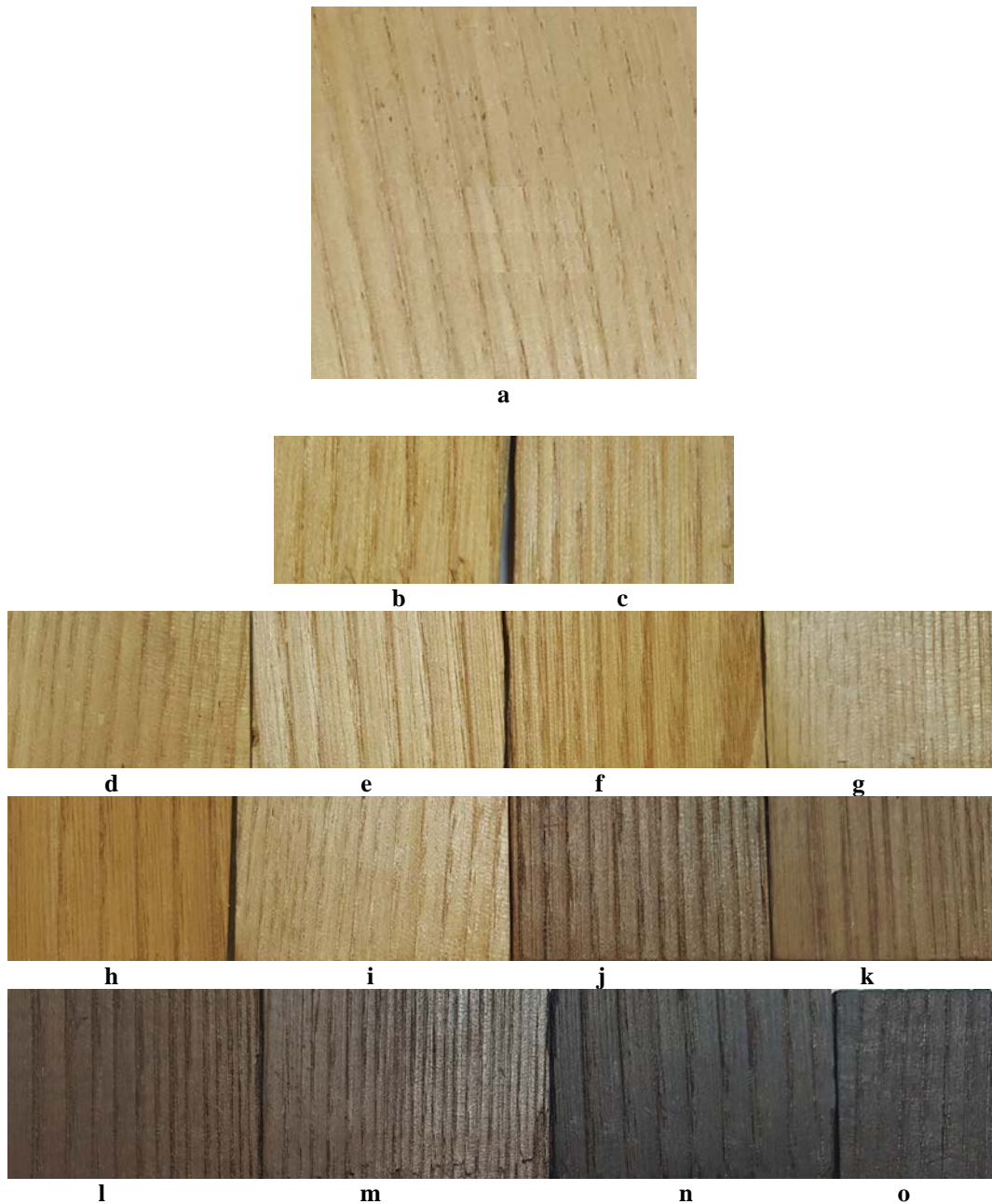

Fig. 3. Images on longitudinal radial surfaces of chestnut specimens before and after artificial weathering; (a) natural control (b) natural and after weathering of 120 hr.; (c) natural and after weathering of 240hr; (d) heat-treated at 130 °C/2hr. and after weathering of 120 hr; (e) heat-treated at 130 °C/2hr. and after weathering of 240 hr; (f) heat-treated at 130 °C/8hr. and after weathering of 120 hr; (g) heat-treated at 130 °C/8hr. and after weathering of 240 hr; (h) heat-treated at 180 °C/2hr. and after weathering of 120 hr; (i) heat-treated at 180 °C/2hr. and after weathering of 240 hr; (j) heat-treated at 180 °C/8hr. and after weathering of 120 hr; (k) heat-treated at 180 °C/8hr. and after weathering of 240 hr; (l) heat-treated at 230 °C/2hr. and after weathering of 120 hr; (m) heat-treated at 230 °C/2hr. and after weathering of 240 hr; (n) heat-treated at 230 °C/8hr. and after weathering of 120 hr; (o) heat-treated at 230 °C/8hr. and after weathering of 240 hr.

SEM research of calabrian pine and chestnut woods

SEM visuals of Calabrian pine

In Figure 4, micro-structure changes on the longitudinal radial sections of calabrian pine woods natural control and heat treated wood exposed to weathering with SEM microscope is shown.

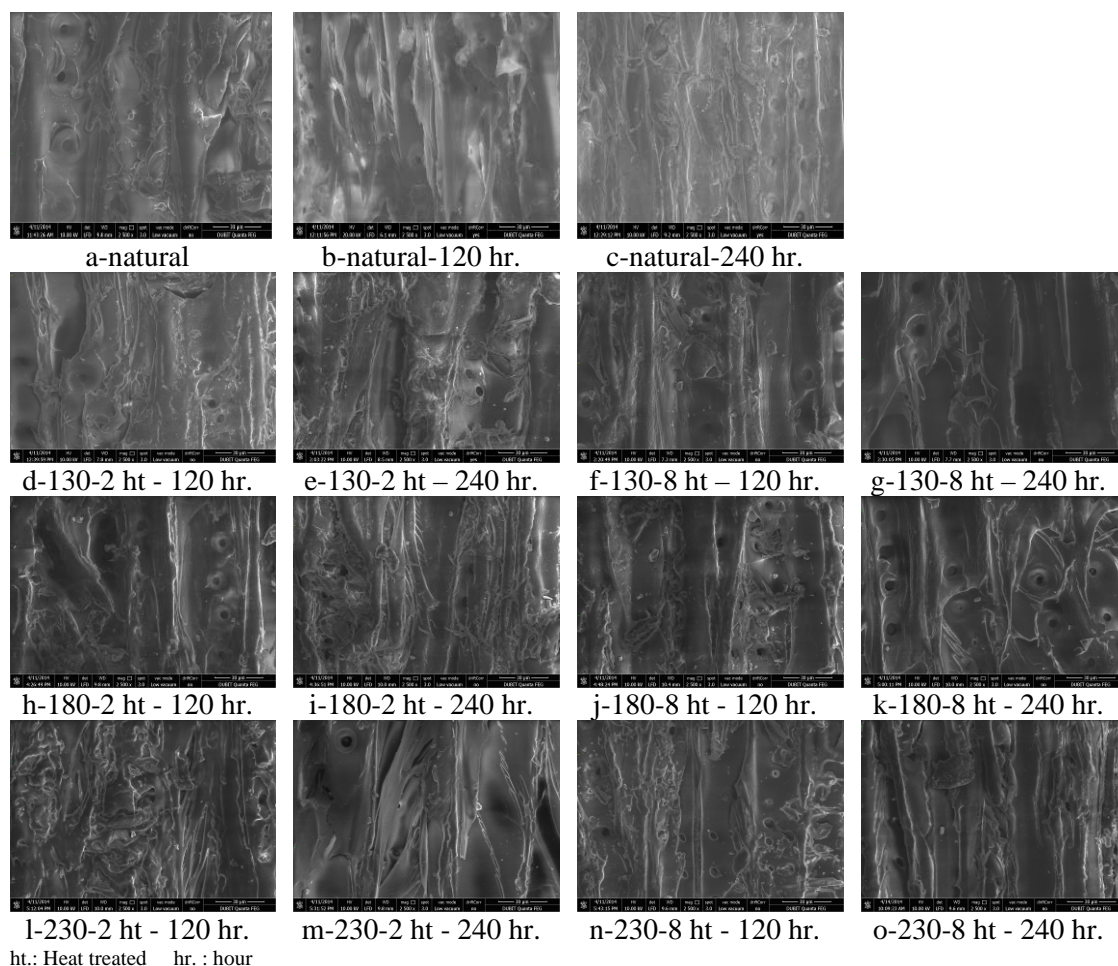

Fig.4. SEM images (x2500) on longitudinal radial surfaces of calabrian pine specimens before and after artificial weathering; (a) natural control; (b) natural and after weathering of 120 hr.; (c) natural and after weathering of 240hr; (d) heat-treated at 130 °C/2hr. and after weathering of 120 hr; (e) heat-treated at 130 °C/2hr. and after weathering of 240 hr; (f) heat-treated at 130 °C/8hr. and after weathering of 120 hr; (g) heat-treated at 130 °C/8hr. and after weathering of 240 hr; (h) heat-treated at 180 °C/2hr. and after weathering of 120 hr; (i) heat-treated at 180 °C/2hr. and after weathering of 240 hr; (j) heat-treated at 180 °C/8hr. and after weathering of 120 hr; (k) heat-treated at 180 °C/8hr. and after weathering of 240 hr; (l) heat-treated at 230 °C/2hr. and after weathering of 120 hr; (m) heat-treated at 230 °C/2hr. and after weathering of 240 hr; (n) heat-treated at 230 °C/8hr. and after weathering of 120 hr; (o) heat-treated at 230 °C/8hr. and after weathering of 240 hr.

In Figure 4, when natural control samples of calabrian pine woods (a); compared with samples which have been exposed to accelerated weathering in different times without any protection and which have been

heat treated woods exposed to weathering in different times, relatively, (b) pits of 120 hour aged sample of natural calabrian pine have been observed to narrow and resolve in microfibrils. In the sample of 240 hour aged

natural calabrian pine sample (c), cracks, resulted from decomposition between different cell layers and pit aspirations have been observed.

When all calabrian pine samples which have been exposed to heat treatment at 130 °C are examined (d, e, f, g), pits have been found to have similar characteristics with natural control sample (d,f,g). In samples, which have been exposed to two-hour heat treatment at only 130 °C and to 240 hour ageing later on, (e) pits have been observed to narrow. Insufficient duration of heat treatment has been thought to be the main effect of this situation. In samples, which have been exposed to the same heat treatment with different times and exposed to ageing with the same time (g) pits have been detected to be just the opposite.

When all calabrian pine samples which have been exposed to heat treatment at 180 °C are examined (h, i, j, k), pits have been found to have similar characteristics with natural control sample of all sample groups. In samples, which have been exposed to

eight-hour heat treatment at only 180 °C and to 240 hour ageing later on, (k) pits have been observed to narrow and torus has been observed to be deformed. Increased heat treatment and the combination of heat treatment duration and ageing duration have been thought to be the main effect of this situation.

When all calabrian pine samples which have been exposed to heat treatment at 230 °C are examined (l, m, n, o), pits have been either found to disappear totally or to be deformed. In addition, cracks on cell walls of samples which have been exposed to short term (2 hours) heat treatment have been observed to be highly intense.

SEM Visuals of Chestnut

In Figure 5, micro-structure changes on the longitudinal radial sections of chestnut woods natural control and heat treated wood exposed to weathering with SEM microscope is shown.

Figure. 5 (Continue)

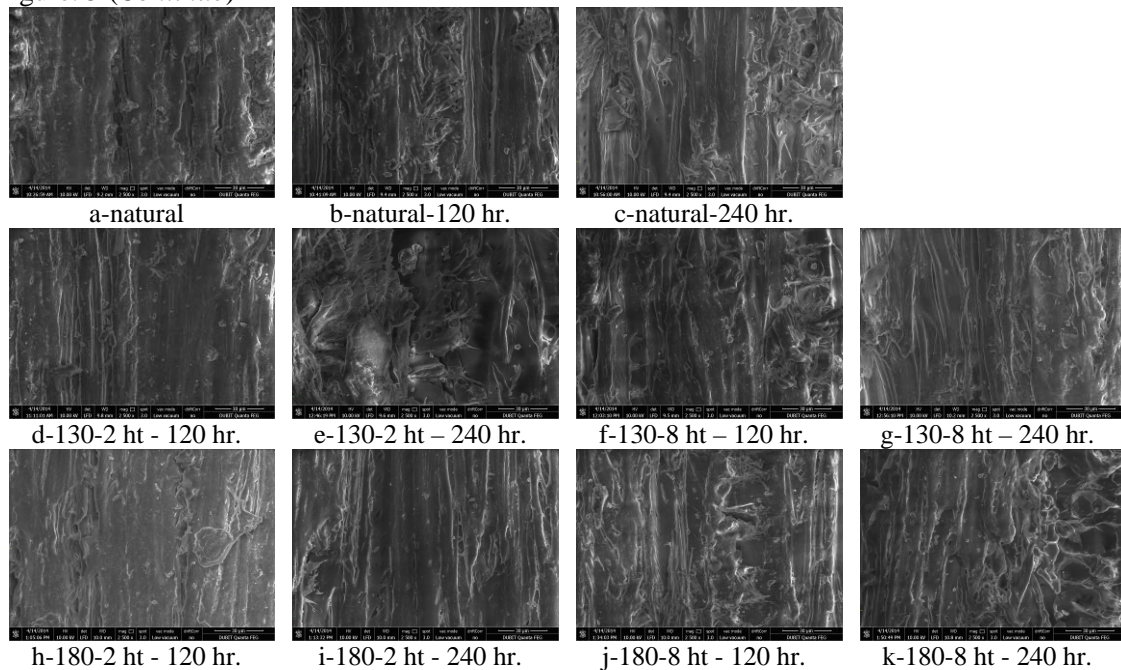

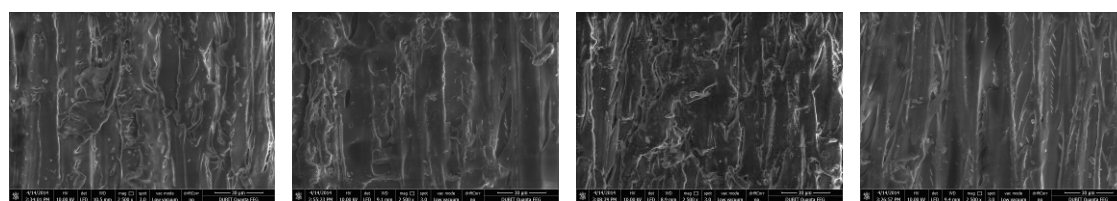

l-230-2 ht - 120 hr. m-230-2 ht - 240 hr. n-230-8 ht - 240 hr. o-230-8 ht - 120 hr.

Fig.5. SEM images (x2500) on longitudinal radial surfaces of chestnut specimens before and after artificial weathering; (a) natural control; (b) natural and after weathering of 120 hr.; (c) naturel and after weathering of 240hr; (d) heat-treated at 130 °C/2hr. and after weathering of 120 hr; (e) heat-treated at 130 °C/2hr. and after weathering of 240 hr; (f) heat-treated at 130 °C/8hr. and after weathering of 120 hr; (g) heat-treated at 130 °C/8hr. and after weathering of 240 hr; (h) heat-treated at 180 °C/2hr. and after weathering of 120 hr; (i) heat-treated at 180 °C/2hr. and after weathering of 240 hr; (j) heat-treated at 180 °C/8hr. and after weathering of 120 hr; (k) heat-treated at 180 °C/8hr. and after weathering of 240 hr; (l) heat-treated at 230 °C/2hr. and after weathering of 120 hr; (m) heat-treated at 230 °C/2hr. and after weathering of 240 hr; (n) heat-treated at 230 °C/8hr. and after weathering of 120 hr; (o) heat-treated at 230 °C/8hr. and after weathering of 240 hr. (ht.: Heat treated hr. : hour)

In Figure 5, when natural control samples of chestnut woods (a); compared with samples which have been exposed to accelerated weathering in different times without any protection and which have been heat treated woods exposed to weathering in different times, relatively, cell wall of 120 hour aged sample of natural chestnut (b) have been observed to be degraded. In the sample of 240 hour aged natural chestnut sample (c), in addition to cell wall degradation, pits have been observed to be narrowed.

When all chestnut samples which have been exposed to heat treatment at 130 °C are examined (d, e, f, g), more deformation on both cell walls and pits have been observed in accordance with the increased heat treatment and ageing durations. Meanwhile, according to control samples; in samples with heat treated and aged at 130 °C, less deformation of cell walls and pits has been observed.

When all chestnut samples which have been exposed to heat treatment at 180 °C are examined (h, i, j, k), compared with natural control samples and with heat treated samples at 130 °C, more degradation on cell walls and pits and new cracks have been detected. This situation has been thought to have related to heat treatment at 180 °C.

When all chestnut samples which have been exposed to heat treatment at 230 °C are examined (l, m, n, o), all pits have been

found to be totally disappeared due to the heat treatment and ageing. Also, the number of cracks around cell walls have been found to be increased and their diameter has been detected to be enlarged and deepened. It has also been observed that, almost all traheid cells have been weared with the effect of high heat treatment at 230 °C and ageing duration.

Conclusions

According to test results of SEM analysis, physical characteristics of softwoods and hardwoods have been changed during accelerated ageing process because of structural degradation.

The color of calabrian pine and chestnut woods which have been exposed to heat treatment with different heat and different times, has been detected to be darkens as the heat and expose time increased. However, related to the accelerated ageing that takes place after the heat treatment, color of the samples has lightened. Especially on samples which have been exposed to 8 hours heat tretament at 130 °C and 180 °C and exposed to 240 hour accelerated ageing, color has been lighter. According to Huang and *et.al.* (2012a); Heat treated woods have better color stability during the early times of weathering, while the colors of heat-treated woods and untreated woods are very similar after the specimens have been subjected to

long term artificial weathering. The results are consistent with the literature.

Microscopic structure of calabrian pine woods which have been exposed to heat treatment at 130 °C and 180 °C has very similar structure with natural control specimens. However, in calabrian pine samples which have been exposed to 2-hour heat treatment at 130 °C and 240-hour ageing, pits have been observed to narrow slightly and in calabrian pine samples which have been exposed to 8-hour heat treatment at 180 °C and 240-hour ageing, pits have been observed to narrow and torus has been observed to be deformed.

Microscopic structure of chestnut wood which have been exposed to heat treatment at 130 °C has very similar structure with natural control specimens. However, during the increasing heat treatment and ageing duration at 130 °C, deformation has increased. When

compared with natural control samples and samples that have been exposed to heat treatment at 130 °C, more degradation on cell walls and pits and new cracks have been detected in heat treated at 180 °C

When compared to natural control samples and heat treated groups, deformation on cell structures after heat treatment at 230 °C and ageing in both calabrian pine and chestnut woods has been found to be more. In outdoor and external environment conditions, calabrian pine wood should be exposed heat treatment process (more than 2 hours and less than 8 hours heat treatment at 130 °C and 180 °C). This process conditions would be protective enough against fungi, microorganisms, insects and weathering. For chestnut woods, better results can be gained by heat treatment experiments in different times at between 130 °C and 180 °C.

References

- ASTM G 154. 2012. Standard Practice for Operating Fluorescent Ultraviolet (UV) Lamp Apparatus for Exposure of Nonmetallic Materials. American Society for Testing and Materials, West Conshohocken, Pennsylvania, United States.
- Akyıldız M.H., Ateş S., Özdemir H. 2009a. Physical, Mechanical, Chemical Properties and Crystalline Structure of Heat Treated Oak (*Quercus petraea* Lieb.) Wood. Research Journal of Chemistry and Environment, 13(3), 39-48.
- Akyıldız M.H., Ateş S., Özdemir H. 2009b. Technological and Chemical Properties of Heat Treated Anatolian Black Pine Wood. African Journal of Biotechnology, 8(11), 2565-2572.
- Ateş S., Akyıldız M.H., Özdemir H. 2009. Effect of Heat Treatment on Calabrian Pine (*Pinus brutia* Ten.) Wood. BioResources, 4(3), 1032-1043.
- Ateş S., Akyıldız M.H., Özdemir H., Gümüşkaya E. 2010. Technological and Chemical Properties of Chestnut (*Castanea sativa* Mill.) Wood After Heat Treatment. Romanian Biotechnological Letters, 15 (1), 4949-4958.
- Browne F.L. 1970. Wood Properties and Paint Durability. Forest Products Journal 30, 45-55.
- Gündüz G., Korkut S., Korkut D.S. 2007. The effects of heat treatment on physical and technological properties and surface roughness of Camiyanı Black Pine (*Pinus nigra* Arn. subsp. *pallasiana* var. *pallasiana*) wood. Bioresource Technology, 99 (7), 2275-2280.
- Huanga X., Kocaefe D., Kocaefe Y., Boluk Y., Pichette A. 2012a. A spectrophotometric and chemical study on color modification of heat-treated wood during artificial weathering. Applied Surface Science, 258, 5360–5369.
- Huanga X., Kocaefe D., Kocaefe Y., Boluk Y., Pichette A. 2012b. Study of the degradation behavior of heat-treated jack pine (*Pinus banksiana*) under artificial sunlight irradiation. Polymer Degradation and Stability, 97, 1197-1214
- Huanga X., Kocaefe D., Kocaefe Y., Boluk Y., Krause C. 2012c. Structural analysis of heat-treated birch (*Betula papyrifera*) surface during artificial weathering. Applied Surface Science, 264, 117-127.
- Esteves B.M., Pereira H.M. 2009. Wood Modification by Heat Treatment: A review. BioResources. 4(1), 370-404.
- Karamanoğlu M. 2012. The Restoration of Some Wood Materials Exposed to Outdoor Conditions by Bleaching Process. Master's thesis. Institute of Science. Düzce University.
- Karamanoğlu M., Akyıldız M.H., 2013. Colour, Gloss And Hardness Properties of Heat Treated Wood Exposed To Accelerated Weathering. Pro Ligno, 9(4), 729-738.
- Kol H.S. 2010. Characteristics of heat-treated Turkish pine and fir wood after ThermoWood processing. Journal of Environmental Biology, 31(6), 1007-1011.

Korkut S, Kocaefe D. 2009. Effect of heat treatment on wood properties. *Düzce University Journal of Forestry*, 5(2), 11-34.

Mallon P.E., Li Y., Zhang R., Chen H., Wu Y., Sandreczki T.C., Jean Y.C., Suzuki R., Ohdaira T. 2002. Durability of polymeric coatings: effects of natural and artificial weathering. *Applied Surface Science*, 194(1-4), 176-181.

Sandberg D. 1998. Weathering of Radial and Tangential Wood Surfaces of Pine and Spruce. Royal Institute of Technology, Div. Wood Technology and Processing

Temiz A, Terziev N, Eikenes M, Hafren J (2007) Effect of accelerated weathering on surface chemistry of modified wood. *Science Direct Applied Surface Science* 253:5355–5362.

TS 4176. 1984. Wood-Sampling sample trees and logs for determination of physical and mechanical properties of wood in homogeneous stands. Ankara.

Williams R.S. 2005. Weathering of Wood. *Handbook of wood chemistry and wood composites* 7, 139-185.

Investigation of Dyestuff Obtained from Elderberry (*Sambucus nigra* L.) Seeds in the Coloring Process of Paper

*Ayhan GENCER¹, Ahmet CAN¹

¹Bartın University, Faculty of Forestry, Bartın / TURKEY

*Corresponding Author: agencer@bartin.edu.tr

Abstract

In order to improve aesthetic features and increase product range of paper by using dyestuff dates back to old. In this study, first dyestuff obtained from elderberry (*Sambucus nigra*) plants seeds incorporated in to pulp, then color measurement and accelerated weathering were performed on the produced papers. To increase the adhesion of dyestuff, aluminum sulfate was added as mordant when compared to control papers. The substance in different ratio was added in to fiber suspension to determine the effect of dyestuff. For each group, dyestuff was added 1, 2 and 3 gr as well as equal quantity of aluminum sulfate. Produced papers were exposed to accelerated weathering 100, 200 and 300 h respectively to examine the stability of dyestuff against UV light. It was not found the effect dyestuff alone in the color change. However, the addition of aluminum sulfate increased the adhesion of dyestuff.

Keywords: Dyestuff, Elderberry (*Sambucus nigra*), Paper, accelerated weathering

Mürver (*Sambucus nigra* L.) Tohumlarından Elde Edilen Boyarmaddenin Kağıt Boyama İşleminde Kullanılabilirliğinin Araştırılması

Özet

Kâğıdın estetik özelliklerini ve ürün çeşidini arttırmak için boyanarak kullanılması oldukça eskiye dayanır. Bu çalışmada, mürver (*Sambucus nigra*) bitkisinin meyvelerinden elde edilen boyar madde kağıt hamuruna ilave edilerek üretilen kağıtlar üzerinde renk ölçümü ve hızlandırılmış yaşlandırma yapılmıştır. Kontrol kâğıtlarına göre boyanın kalıcılığını arttırmak için mordan olarak alüminyum sülfat ilavesi yapılmıştır. Boyarmadde miktarının renge etkisini belirlemek amacıyla lif süspansiyonuna her bir kontrol kâğıdına 1, 2 ve 3g boyarmadde denk gelecek biçimde hazırlanmış ve eşit miktarda alüminyum sülfat ilave edilmiştir. Boyar maddenin ışığa karşı kalıcılığını irdelemek için elde edilen kâğıtlar 100, 200 ve 300 saat süreyle hızlandırılmış yaşlandırma işlemine tabi tutulmuştur. Tek başına boyarmadde kullanımı renk değişiminde etkili olamamıştır. Ancak, alüminyum sülfat ilavesi boyar maddenin tutunmasını arttırmıştır.

Anahtar kelimeler; Boyarmadde, Mürver (*Sambucus nigra*), Kağıt, Hızlandırılmış yaşlandırma

Introduction

In pulp production from any fibrous raw material, depending on the raw material and production method, the pulp has certain level of color. This color reflects directly on the paper. In current methods, the characteristic color of the papers produced without any bleaching process is between the light and dark sack color. But, however, different colors of papers are requested in market. In order to meet this demand, the papers are colored. Moreover, the papers are used after coloring for increasing the product range, and to provide aesthetic view and sight health. The coloring processes other than printing are achieved by

adding dyes into the pulp. In recent years, together with the increase in environmental consciousness, the use of natural materials in paper coloring became more common. In a study on natural dyestuffs, the usability of onion skin, henna, pomegranate juice, and rose leaf in paper coloring has been investigated (Çakar, 2012).

Dyestuffs execute the coloring process by attaching to the fiber surface or holding on the fiber membrane. The connection is established via the metallic ions known as mordant, and the mordant plays significant role in final color achievement. The mordant materials are divided into 2 groups as acidic and alkaline.

Aluminum sulfate is an important mordant that has been widely used before (Bechtold, 2009).

In pulp production history, there is no record regarding the addition of dyestuff into the pulp. In sections taken from dyed historical artifacts, the fibers in internal parts of the papers have been reported to be whiter than those on the surface of fibers. This indicates that the dye has not been added into the pulp but the paper has been colored later (Loveday, 2001). Natural dyes are widely used in coloring the fibrous materials. Most of the natural colors are obtained from roots, barks, leaves, flowers and stems of the plants.

The natural dyes obtained from annual and perennial plants, in proportion to non-toxic and non-carcinogenic synthetic dyes (Karadağ, 2007), have been demanded more frequently because they can be more easily obtained from natural sources such as plants, insects, minerals, and fungi that have lower allergic effects (Erdoğan, 2004). Considering the total color changes (ΔE) of paper samples dyed with natural materials, it has been determined that the total color changes were 8.47 for the sample dyed with onion skin, 7.05 for the sample dyed with henna, 29.87 for the sample dyed with pomegranate juice, and 15.41 for the sample dyed with rose leaf. While the post-aging color stability performance was shown by the sample dyed with henna, the lowest color stability performance was shown by the sample dyed with pomegranate juice (Çakar, 2012). The acidity of paper, under the effects of atmospheric oxygen, microorganisms and light, leads to micro- and macro-level changes in paper samples. The most important change observed in macro-level is the loss of papers' original color (Princi et al., 2008).

The aim of this study is to eliminate the printing process, which is traditionally used in colored paper production and requires a secondary process, by utilizing the environment-friendly organic dyes. For this purpose, the stability of dye was investigated by adding the dyestuff into fiber suspension before the paper production.

Materials and Methods

In this study, the seeds of elderberry plant, which was used as dyestuff, were collected from the Bartın River basin in 4th week of October, 2014. The seeds, which were shivered by using a mixer, were filtered through the sieve and the resultant colored liquid was used as dyestuff. The dyestuff yield of seeds was determined as 46% of the fresh weight. In pulp production, poplar wood was used. The ratio of chip/solution was set at 1/5, cooking temperature at $170 \pm 2^\circ\text{C}$, and maximum temperature was reached at 90 minutes. In soda (NaOH) method, the NaOH ratio was 22%, the duration of cooking at maximum temperature was set at 60 min. and 90 min., and the cooking process was triplicated. The mean sieved pulp yield was calculated as 46.30%. 5 groups of papers were produced by adding no additive (Control), 1ml (D1) dyestuff per paper, 1g aluminum sulfate and 1, 2, and 3 ml dyestuff (D1+A, D2+A, D3+A).

In CIEL $*a*b*$ color system (Commission Internationale de l'Éclairage (CIE)), the differences between the colors and their locations are determined according to color coordinates of L^* , a^* , b^* . Here, L^* is in black-white axis ($L^*=0$ for black, $L^*=100$ for white), a^* is in red-green axis (positive values indicate red, while negative ones indicate green), and b^* is in yellow-blue axis (positive values indicate yellow, while negative ones indicate blue) (Sivrikaya et al., 2015). The opacity and whiteness values were determined according to TAPPI T 411 om-97 and TAPPI T525 om-02 standards, respectively.

Results and Discussion

In order to determine the color values of the pulp obtained in this study, no dyestuff or aluminum sulfate was added into the pulp used for production of control papers. One group was added only the dyestuff, while other 3 groups were added various concentrations of dyestuffs and same concentration of aluminum sulfate.

Table 1. The effects of dyestuff on color change

	Control	D	D1+A	D2+A	D3+ A
L	95,40±0.49	91,75±0.41	77,89±0.19	74,81±0.14	74,98±0.10
a	-0,85±0.06	-1,32±0.10	2,79±0.06	3,40±0.05	3,36±0.03
b	4,89±0.45	4,27±0.55	14,99±0.15	16,29±0.11	16,00±0.09

Control: C, D: Dye, A: Alum, 1,2,3: ml

Table 2. The effects of accelerated weathering process on dyestuff-added papers

	T(h)	Control	D	D1+A	D2+A	D3+ A
ΔL	100	-0,99±0,65a	0,18±0,09a	6,56±0,69a	8,82±0,69a	10,02±0,22a
	200	-0,77±0,53a	1,31±0,20b	9,05±0,28b	11,20±0,46b	12,63±0,09b
	300	-0,66±0,68a	2,51±0,32c	10,14±0,29c	12,54±0,35c	14,00±0,17c
Δa	100	0,93±0,08a	0,14±0,03a	-0,62±0,06c	-1,01±0,07c	-1,34±0,05c
	200	1,13±0,06b	1,42±0,08b	-1,00±0,06b	-1,40±0,08b	-1,65±0,03b
	300	1,06±0,08b	1,44±0,10b	-1,30±0,07a	-1,71±0,07a	-2,01±0,02a
Δb	100	1,63±0,69c	3,01±0,17c	-0,82±0,26c	-1,88±0,31c	-3,48±0,17c
	200	2,08±0,48ab	-0,44±0,09a	-2,09±0,24b	-3,19±0,36b	-4,79±0,14b
	300	1,48±0,54a	-2,04±0,30b	-2,82±0,29a	-3,95±0,28a	-5,64±0,13a
ΔE	100	2,13±0,21a	0,95±0,09a	6,64±0,69a	9,08±0,71a	10,69±0,25a
	200	2,55±0,37b	3,59±0,13b	9,34±0,32b	11,73±0,53b	13,46±0,32b
	300	3,13±0,37c	3,55±0,27b	10,61±0,34c	14,86±0,84c	15,23±0,15c

A:Alum, T:time,

The color change values occurred as a result of 100, 200, and 300 h UV exposure of papers obtained by adding various concentrations of dyestuffs are presented in Table 1. L value of control papers decreased from 95.40 to 91.75 after adding the dyestuff. After adding the aluminum sulfate besides the dyestuff, L value decreased from 91.75 to 77.89. In this case, it can be said that addition of dyestuff as 1 ml (D1+A) was effective. 2 or 3 folds of increases in dyestuff level had no significant effect on L value. The colored structure of dyestuff material is the main reason of this. Considering a* and b* values, it can be seen that the increase in amount of dyestuff added led the color to tend to red color. Through the addition of aluminum sulfate besides the dyestuff, the samples tended to yellow color.

In all of the sample groups, it can be seen that ΔL value increased in parallel with the duration of UV exposure; in other words, the paper samples had tendency towards white

color. While the relation between the increase in duration and ΔL was not statistically significant in control group, the differences in other groups were significant.

a value increased in parallel with increase of dyestuff and concentration, and it transformed to red color. Given a* and b* values of the papers, a tendency towards -a (green) and +b (yellow) was observed. The lowest level of change in a* values was observed in control samples. The change increased in parallel with aluminum sulfate addition, but the color was still in blue scale. Through the dyestuff material addition, the color turned to green and the tone of green enhanced. While, in control samples and only-dyestuff added samples, the increase in UV exposure increased with Δa, Δa decreased in samples added dyestuff and screed.

In all of the variations of paper samples, the total color change (ΔE) increased in parallel with the duration and dyestuff level.

The changes in opacity values of the papers before and after weathering process are presented in Table 3.

Table 3. The effects of accelerated weathering process on opacity

Opaklık	Before weathering	After weathering
Control	91,57±1,08a	91,28±1,49a
D1	92,98±0,85a	92,38±0,79a
D1+A	96,28±0,36a	93,43±0,44b
D2+A	96,59±0,72a	93,70±0,45b
D3+ A	96,73±3,13a	94,22±0,41a

While the opacity took its lowest values in control samples before and after the UV exposure, the opacity increased with the addition of dyestuff and dyestuff + aluminum sulfate. The opacity value was observed to decrease with UV exposure in all of the samples. While the difference was not statistically significant in control (C), 1ml dyestuff (D1) and 3ml dyestuff (D3+A) groups, the decreases in 1ml dyestuff (D1) and 2ml dyestuff (D2+A) groups were statistically significant.

Table 4. The effects of accelerating weathering process on brightness

Whiteness	Before weathering	After weathering
Control	71,04±0,47a	74,15±1,64b
D	66,16±1,40a	72,33±1,13b
D1+A	39,30±0,58a	56,31±2,52b
D2+A	34,59±0,48a	55,33±0,58b
D3+ A	34,83±0,31a	60,04±0,18b

Control: C, D: Dye, A: Aluminum sulphate, 1,2,3: ml

While the whiteness value took its highest values in control samples before and after UV exposure, it decreased with the addition of dyestuff and dyestuff + aluminum sulfate. The brightness value was observed to increase with UV exposure and the difference was statistically significant.

Conclusion

The coloring in papers obtained by adding aluminum sulfate was higher when compared to control samples. This finding is also corroborated by the increase in opacity with increasing dyestuff level. The decrease in whiteness with addition of dyestuff indicates that the dyestuff is effective. In aged samples, the persistence of dyestuff was observed to be low. For this reason, we conclude that it would be useful to use different methods in obtaining dyestuff from elderberry and to utilize different mordant materials in coloring process.

References

- Bechtold T., Mussak R. 2009. Handbook of Natural Colorants, John & Wiley Sons Ltd., West Sussex 2008. The Influence of Pulp on the Color of Dyed Papers'', Fibers & Textiles in Eastern Europe, 16(1/66):103-107.
- Çakar E. 2012. Yazma Eserlerde Bakır Kaynaklı Pigmentler ve Boyarmaddelerin Etkisinin Araştırılması, Uzmanlık Tezi, T.C. Kültür ve Turizm Bakanlığı Süleymaniye Yazma Eserler Müdürlüğü, İstanbul.
- Erdoğan G., Karadağ R., Dölen E. 2004. The Determination of Stability Constants Mixed-ligand Complexes of Quercetin and Digallis Acid, 4th AACD Congress 29 Eylül-3 Ekim 2004, Kuşadası.
- Karadağ R. 2007. Doğal Boyamacılı, T.C. Kültür ve Turizm Bakanlığı Döner Sermaye İşletmesi Merkez Müdürlüğü, Ankara.
- Kulkarni S., Gokhale A.V., Bodake U.M., Pathade G.R. 2011. Cotton Dyeing with Natural Dye Extracted from Pomegranate (Punica granatum) Peel, Universal Journal of Environmental Research and Technology, 1(2):135-139.
- Loveday H. 2001. Islamic Paper, A Study of the Ancient Craft, Archetype Publications, London.
- Princi E., Vicini S., Marsano E., Trefiletti, V. 2008. Influence of the Artificial Weathering on Thermal Stability of Paper-Based Materials, Thermochemica acta 468 (2008) 27-34, DOI:10.1016/j.tca.2007.11.019, ScienceDirect, Elsevier
- Sivrikaya H. Ekinçi E. Can A. Tasdelen M. Gokmen K. 2015. Effect Of Heat Treatment On The Weathering And Hardness Properties Of Some Wood Species. 11th Meeting of the Northern European Network for Wood Science and Engineering (WSE). September 14-15, Poznan, Poland, Page 83-91.

TAPPI T519 om-02. 2002. Diffuse Opacity of
Paper (d/0 paper backing)

TAPPI T525 om-02. 2002. Diffuse Brightness
of Pulp (d/0)

The Combined Effects of Copper and Oil Treatment on Wood Chemical Properties

*Ahmet CAN¹, Hüseyin SİVRİKAYA¹

¹Bartın University, Faculty of Forestry, Bartın / TURKEY

*Corresponding Author: acan@bartin.edu.tr

Abstract

Copper are among the most commonly used substances in impregnating industry due to its high toxicity against fungi at last 50 years. The performance of CCA (copper-chrome-arsenic) approved by all over the World because of its superior performance against wood-inhabiting fungi and insects, New and environmentally friendly materials have developed due to this substance banned. Among of developed impregnation materials, copper-azole is the most widely used, because it is highly effective against fungi and insects. But most important problems leach away copper from the wood. Various factors are affected on the copper material leaching from wood. Fixation time is most important effect of this situation. In this study, wood samples impregnated with 2.4% copper azole, after 24 hours and 5 days fixation time samples secondly exposed to tall oil and linseed oil. Chemical analysis of samples was carried out after conditioning time. In addition, the remaining amount of copper in the wood samples was measured by leaching test. According to copper leaching and FTIR-ATR results, combination tall oil and copper was the most resistant against copper leaching, and at 1508 cm⁻¹ and 1720 cm⁻¹ peak variation was observed.

Keywords: Copper azole, Tall oil, linseed oil, FTIR-ATR

Bakır ve Yağ Kombinasyonunun Odunun Kimyasal Özelliklerine Etkisi

Özet

Bakır, mantarlara karşı sahip olduğu yüksek zehirlilik etkisi nedeniyle son 50 yıldır emprenye endüstrisinde en fazla kullanılan maddeler arasında yer almaktadır. Mantar ve böceklere karşı performansı tüm dünya tarafından kabul edilen CCA (bakır-krom-arsenik) maddesinin yasaklanması, bu maddeye alternatif yeni ve çevre dostu maddelerin gelişmesine neden olmuştur. Geliştirilen maddeler arasında yaygın olarak kullanılan bakır-azol; mantar ve böceklere karşı son derece etkilidir. Fakat bakırın yıkanarak odundan uzaklaşması en önemli problemlerindendir. Bakır maddesinin odundan yıkanması üzerine çeşitli etmenler etki etmektedir. Bu etkilerin en önemlilerinden bir tanesi fiksasyon süresidir. Bu çalışmada bakır azol ile emprenye edilen örnekler 24 saat ve 5 gün sonra tall oil ve keten yağı ile ikinci bir emprenye işlemine tabi tutulmuşlardır. Kondisyonlama süresi sonrası örneklerin kimyasal analizleri gerçekleştirilmiştir. Ayrıca yıkanma sonrası odun örneklerinde kalan bakır miktarı ölçülmüştür. Elde edilen yıkanma ve FTIR-ATR sonuçlarına göre; Yağ ve bakır kombinasyonu yıkanmaya karşı direnç göstermiş ve 1508 cm⁻¹, 1720 cm⁻¹ piklerinde değişiklikler gözlenmiştir.

Anahtar kelimeler; Bakır azol, Tall yağı, Keten yağı, FTIR-ATR

Introduction

Wood preservation by combined processes including wood preservative treatment and subsequent impregnation with an hydrophobic product reduces the leaching of copper in use. H When hydrophobic agents are using for impregnation wood humidity being 12-20% and wood surface hydrophobic in order to reduce water uptake and decrease leaching of wood preservatives (Treu et al. 2011).

In wood protection, there is a trend towards using new-generation materials and methods by utilizing the recyclable materials and by-products of other industries. In recent years, the interest in using the natural and synthetic oils increased. In wood protection, various commercial or being-developed oils are utilized. The most important ones of these are linseed oil, tall oil, orange oil, soybean oil, and nut oil (Ozgenç, 2013). Tall oil is the byproduct

emerging as a result of paper production from needle-leaved trees. It consists of resin acids (40-55%), fatty acids (40-60%) and unsaponifiable matters (5-10%). In some of the studies, the tall oil has been shown to decrease the water intake and to prevent the fungal development. The large amount of oil required and the tendency of the oil to exude out of the treated wood have prevented extensive utilization of tall oil (Hyvönen et al., 2006; Koski, 2008; Lahtela, 2014; Temiz, 2008).

Linseed oil is made from the pressing of the dried ripe seeds of the flax plant which gives flaxseed oil. This oil is then exposed to a solvent extraction process to produce linseed oil. Linseed oil has some advantages such as water left on the surface may penetrate given enough time and oil finishes continue to protect as the Wood expands and contract. Linseed oil is generally composed of some oil acids. For example: α -linolenic acid (51.9-55.2%), palmitic acid (about 7%) and stearic acid (3.4-4.6%), oleic acid (18.5-22.6%), linoleic acid (14.2-17%) (URL- 2; URL-3). It is remarked in the research that flax oil is water repellent and enduring against UV rays (Ozgenç, 2013).

In a study of decreasing the copper washing, it has been reported that the hot oil procedure significantly decreased the copper washing and declined the water intake of wood samples during the weathering duration. Moreover, it has been emphasized that an aesthetic view was obtained by adding pigments into oil and the color change on wood surfaces was decreased (Treu et al., 2011).

In this study, the effects of fixation duration, tall oil and linseed oil on copper washing were examined. The amount of copper residuals on wood samples exposed to washing process was measured. Moreover, the effects of executed procedures on the chemical properties of wood were examined.

Materials and Methods

Scots pine (*Pinus sylvestris* L.) logs obtained from Blacksea region from Turkey. 30 mm diameter samples were used for XRF analysis. As you can see pictures of the samples used in

figure 1. The moisture content of samples was around 12%.

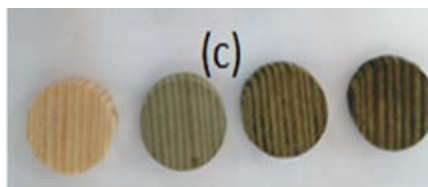

Figure 1. Photographs of treated samples (c) XRF samples

Copper-Azole was used as wood preservative at 2.4 % concentration alone as well as to the same ratio with water repellents. The major constituents of the copper azole are copper carbonate (20,5%), 2-aminoetanol (<20%), boric acid (<5%), tebuconazole (<0,5%), propiconazole (<0,5%), polyethyleneimine (<20%), organic acid (<5%), surfactant (<5%).

Linseed oil and tall oil was provided by the Izmir Altınyaz Company-Turkey and Çaycuma OYKA Paper Packing company-Turkey, respectively.

After the samples were prepared, they were conditioned for impregnation process for 2 weeks at 65% relative humidity and 25°C. The samples to be air-dried were impregnated at 30 minutes of 650 mmHg vacuum and 1 hour at 6bar pressure as predicted in ASTM D 1413-76 standard. The weights of samples before the impregnation ($M_{e\ddot{o}}$) were measured, and then their weights ($M_{e\ddot{s}}$) were measured by cleaning the solution residuals after the impregnation. The amounts of retention were determined by using the equation (1).

$$\text{Retention (kg m}^{-3}\text{)} = \frac{G \times C}{V} \times 10 \quad (1)$$

Where

G is amount of preservative solution absorbed by sample ($M_{e\ddot{s}} - M_{e\ddot{o}}$) (g), C is concentration of preservative solution (%) and V is sample volume (cm^3)

The weight percentage gain (WPG) which is indicative of net oil uptake was determined from the changes in the oven-dry weight after the treatment using equality 2.

$$WPG (\%) = \frac{W_a - W_b}{W_b} \times 100 \quad (2)$$

Where

W_b is the oven-dry weight of specimens before treatment (g), and W_a is the oven-dry weight of specimens after treatment (g).

Samples were divided into three test groups.

Test A; Examples in this group were impregnated with copper azole solution at 2.4% concentration.

Test B; The samples impregnated with copper azole solution were divided into 2 groups. First group of samples were kept at 50 °C for 25 hours for the completion of fixation process. Second group of samples, on the other hand, was kept for 5 days under room conditions (25°C and 65% relative humidity). After various fixation durations, the second impregnation procedures were executed with 50% tall oil (50TO) and linseed oil (50LO). Ethanol was used for preparing 50% tall oil and linseed oil.

Test C; Hot oil was used in this group. The samples impregnated with copper azole solution were kept at 50°C for 24 hours and 5 days under room conditions (25°C and %65 relative humidity) for completion of fixation process. At the ends of these durations, the samples were placed into oil heated to 80°C, and then kept for 4 hours. At the end of this period, after taking them out from the oil and cleaning the samples, they were weighed for determining the increase in weight (Equation 2).

In samples to be exposed to FTIR-ATR procedure, no washing was performed. Sample groups are included in the Table 1.

Fourier Transform Infrared Spectroscopy (FTIR-ATR) analysis has been used as a technique to obtain information about the structure of the wood constituents and chemical changes taking place in the wood impregnation process. FTIR spectra were obtained by a Shimadzu IRAffinity-1 equipped with a Single Reflection ATR pike MIRacle sampling accessory. Four accumulated spectra with a resolution of 4 cm⁻¹ were obtained for wavenumbers from 1100 cm⁻¹-1800 cm⁻¹ with 32 scans for each sample.

Tablo 1. Sample groups

Control	Non treated
Test A	Treated with copper azole
	CuA1d+50TO
Test B	CuA1d+50LO
	CuA5d+50TO
	CuA5d+50LO
	CuA1d+80TO
Test C	CuA1d+80LO
	CuA5d+80TO
	CuA5d+80LO

The measurements can be rapidly, sensitively, and reliably at low cost and without damaging the material via X-ray Fluorescence (XRF) technique. For this reason, it is widely used in scientific and technologic researches. The samples prepared were cut into 30 mm diameter and 5 mm thickness. These samples were kept in drying oven for 1 day at 60°C before starting the analyses and, in order to prevent any residual on the surface, they were air-dried with 1milibar air gun. In same day, the samples were analyzed using epsilon 5 model of XRF device and the device's own software. For each of the samples, the duration of total analysis was set at 25 minutes. Since the raw material was cellulosic material, H5C10O5 balance was selected and the amount of elements on surface was determined semi quantitatively. The measurements were executed under vacuum and He atmosphere conditions. Results were rapidly and reliably obtained at ppm-% concentration level without any damage.

Results and Discussion

Fourier Transform Infrared Spectroscopy (FTIR-ATR)

The FTIR spectra of treated and untreated samples are shown figure 2-3. Significant changes in the intensities of certain absorption bands are noticeable on the FTIR-ATR spectra between 1100 cm⁻¹ and 1800 cm⁻¹. The assignments of characteristic absorption IR bands of Wood samples in the fingerprint region given in table 4.

Table 4. Assignments of absorption IR spectral bands in Wood

Wavenumber (cm ⁻¹)	Functionality	Vibrating type
1740-1720	C=O in unconjugated ketones, aldehydes and carboxyl	C=O stretching ¹
1660-1645	C=O in para-OH substituted aryl ketones, quinines	C=C stretching ³
1600	C=O in aromatic ring in lignin	Aromatic skeletal vibrations ²
1515-1500	aromatic ring	Benzene ring stretching vibrations ¹
1420	aromatic ring and CH	Benzene skeletal combined with C-H deformations ¹
1330-1240	CO in lignin and hemicellulose, and OH	C-O stretching and bending OH, antisymmetric stretching vibration of the acetyl ester groups ^{1,2}
1162-1086	C-O-C in cellulose	Antisym, Bridge oxygen stretching ²
1128	S-Syringyl lignin and C-O	C-H deformations in S lignin and C-O stretching ¹
1025-1035	C-O-C	Deformation ¹
897	Anti-symmetric out-of phase stretching in pyranose ring	Stretching in pyranose ring ¹

¹Ozgenç et al. (2013), ²Esteves et al. (2013),
³Temiz (2005)

In Table 4, the peaks show deviations because of the translocations of rings. In other words, the absorption peak at 1510 cm^{-1} is seen within the range of $1500\text{-}1515\text{ cm}^{-1}$. The similar results were obtained in our study.

Given Figure 2 and 3, it can be seen that the treatment with copper and oil led to changes in chemical structure of the wood. The peak at 1159 cm^{-1} changed after the treatment with copper and oils. These changes led to decrease in copper and significant increase in linseed oil. This increase can be attributed to ester bonds in linseed oil (Ozgenç et al., 2013; Weerd et al., 2005).

The peak at 1261 cm^{-1} shows the CO and OH groups in hemi-cellulose and lignin. A decrease was observed in samples impregnated with CuA

solution. This decrease was minimized by using tall oil and linseed oil. The changes in absorption peaks at $1230\text{-}1267\text{ cm}^{-1}$ are directly related with lignin delignification and modification of aromatic rings. Temiz et al., (2007) said that absorption peaks at around 1261 cm^{-1} for linseed oil and tall oil treatments did not change significantly.

The peak at 1508 cm^{-1} shows the aromatic ring peaks. In some of the studies, it has been shown that the peak at 1508 cm^{-1} disappeared or significantly decreased after the impregnation procedure (Temiz et al., 2007; Temiz, 2005; Salla et al., 2012). But, in another study, the increase in peak at 1508 cm^{-1} has been emphasized (Ozgenç et al., 2013).

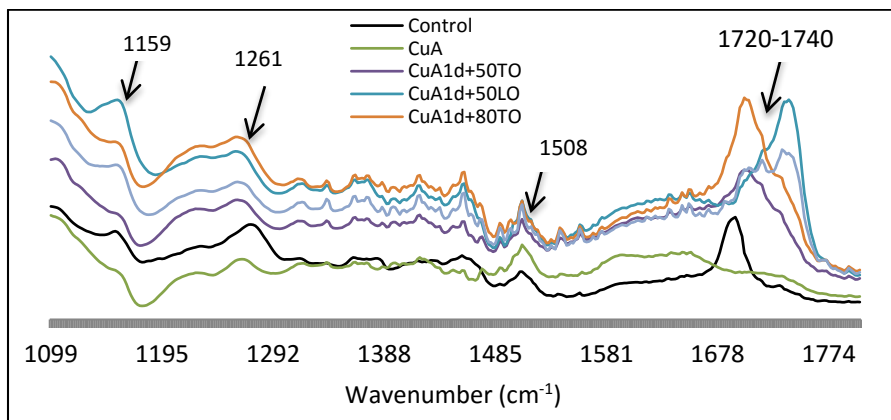

Figure 2. FTIR-ATR spectra of the control, CuA and 1 days fixation time test group

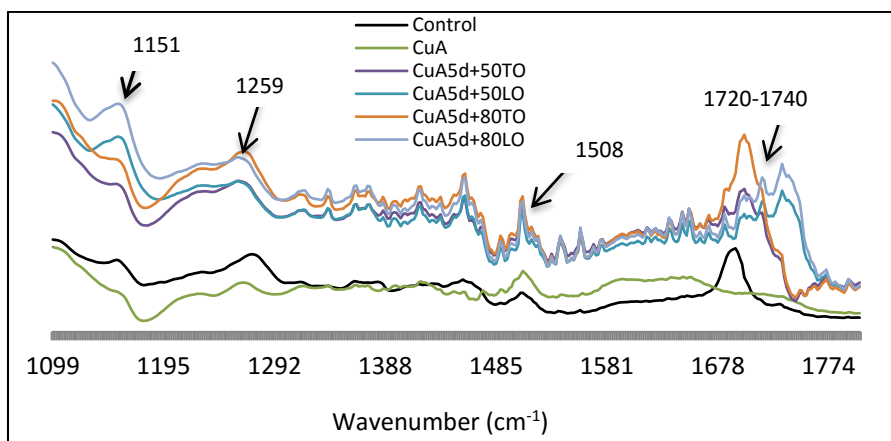

Figure 3. FTIR-ATR spectra of the control, CuA and 5 days fixation time test group

A decreased was found for the carbonyl absorption band at 1720-1740 cm^{-1} except for copper treatment. After the copper impregnation, this peak disappeared. Zhang and Kamdem (200a), in their study carried out by using copper ethanol amine, have reported that the peak at 1739 cm^{-1} decreased after the impregnation, and that this decrease was related with the anion of carboxyl acid. Moreover, it has been reported by Temiz (2005) that the fact that these peaks were not seen in the same region after the impregnation is caused from the effects of impregnation materials on translocation of aromatic rings and from the interaction between wood components and copper. But, an increase was observed in the samples exposed to secondary impregnation with linseed oil and tall oil. The increase in peak at 1720-1740 cm^{-1} during the treatment with oils shows similarities with literature (Temiz et al., 2007).

X-Işınları Floresans (XRF) Spektroskopisi
The lowest copper amount was determined from Cu5d+80TO treated wood. The highest copper amount was obtained from the samples treated with CuA. Significant level of washing (65%) was observed in Test A group samples. In their study, Kangsepp et al., (2011) have reported

that, after 14 days of washing, 23% copper washing occurred in samples impregnated with Tanalith-E.

The fixation duration is known to have effect on the wash of copper. In our study, except for CuA5d+50LO, the amount of copper washed decreased inversely proportional to the increase in duration. The oil treatment of samples kept in 80 °C for 5 days for fixation and the impregnation executed at 50% concentration in samples kept for 1 day for fixation produced effective results.

In both of 1 day of fixation and 5 days of fixation, the lowest WA values were observed in the samples impregnated with linseed oil. But, the level of copper washed is lower in samples treated with tall oil, except for CuA1d+50TO (1490 ppm). 65% washing was observed in Test A group samples. But, when the samples were treated with oil, the maximum washing was 50.76% (Table 4). In procedures, where the oils were used, the water intake of wood was decreased and the copper washing was declined.

Table 4. The percentage removed copper from CuA treated Wood samples

Variation	Retention (Kg m-3)	WPG (%)	Initial Cu amount (ppm)	Total Cu amount leached out (ppm)	Percentage of Cu leached out (%)
CuA	15.94	-	4860	1920	65.31
CuA1d+50TO	18.78	28.18	5260	1490	39.52
CuA1d+50LO	14.56	30.03	3490	570	19.52
CuA1d+80TO	14.47	16.30	3220	960	42.48
CuA1d+80LO	14.03	12.36	3750	1180	45.91
CuA5d+50TO	14.25	25.75	5040	600	13.51
CuA5d+50LO	16.28	35.28	5970	2010	50.76
CuA5d+80TO	14.38	16.88	5320	320	6.40
CuA5d+80LO	17.03	18.68	6310	700	12.48

In this study, after 24 hours and 5 days of fixation, the chemical analyses of the samples previously treated with tall oil flex oil were executed. The results obtained are summarized below.

1. According to FT-IR results, intensities of absorption band at 1508 cm⁻¹ (characteristic peak for lignin) were less increased by copper, linseed and tall oil treatments. A decreased was found for the carbonyl absorption band at 1720-1740 cm⁻¹ except for copper treatment. This peak disappeared after the copper impregnation. The increase in fixation duration caused alterations in chemical structure.

2. According to the study results, higher level of copper washing was observed when compared to copper azole impregnation. This rate decreased in parallel with the use of oils. The lowest level of copper washing was observed in Test C group.

3. Before using the samples impregnated with copper solutions, the completion of copper's fixation should be waited. In order to decrease the copper washing, the oiled heat-treatments are believed to be more efficient.

References

- AWPA 2000. E11-97. Standard method of determining the leachability of wood preservatives. American Wood Preservers' Association Standard.
- Basf S., 2009. Polyol formed from an epoxidized oil. Patent no: WO2009138411 A1. Dated 19 October 2009.
- Dizman E.T., Yıldız Ü.C., Can A. 2010. Treatment of Scots Pine Wood With Oil in Water and Water in Oil Emulsion Systems: Effects on Boron Leaching and Water Absorption. The International Research Group on Wood Protection. IRG/WP 10-30535
- European Standard EN 113, 1996. Wood preservatives – Test method for determining the protective effectiveness against wood destroying basidiomycetes – Determination of toxic values. European Committee for Standardization (CEN), Brussels, Belgium.
- Esteves B., Marques A.V., Domingos I. and Pereira H. 2013. Chemical Changes of Heat Treated Pine and Eucalypt Wood Monitored By FTIR. *Maderas Ciencia Y Tecnología* 15(2): 245-258, 2013
- Freeman M.H., Nicholas D.D., Schultz T.P. 2006. Non-Arsenical Wood Protection: Alternatives for CCA, Creosote, and Pentachlorophenol. In: *Environmental Impacts of Treated Wood*. Townsend, T.G., Solo-Gabriele, H. Taylor&Francis Group, CRC Press, 520 p.
- Freeman M.H., McIntyre C.R. 2008. A comprehensive review of copper-based wood preservatives-with a focus on new micronized or dispersed copper systems. *Forest product journal* 58 (11):6-27.
- Green III F., Schultz T.P. 2003. New Environmentally-Benign Concepts in Wood Protection: The Combination of Organic Biocides and Non-Biocidal Additives. In: *Wood Deterioration and Preservation Advances in Our Changing World*. Goodell B., Nicholas, D.D., Schultz, T.P. ACS symposium series 845, 482 p.
- Helsen L., Hardy A., Van Bael M.K., Mullens J 2007. Tanalith E 3494 impregnated wood: Characterisation and thermal behavior. *Journal of Analytical and Applied pyrolysis* 78, 133- 139.
- Humar M., Bucar B., Pohleven F. 2006. Brown rot decay of copper impregnated wood. *International Biodeterioration and Biodegradation*, 58, 9-14.
- Hyvönen A., Nelo M., Piltonen P., Niinimäki J. 2006. Using the emulsion technique and an iron catalyst to enhance the wood protection properties of tall oil. *Holz Roh Werkst* 65:247–249
- Kangsepp K., Larnoy E., Meier P. 2011. Leaching of commonly used impregnation agents affected by wood properties. In: *Proceedings of the 7th meeting of the Nordic-Baltic Network in Wood Material Science & Engineering (WSE)*. October 27-28, 2011, Oslo, Norway.
- Koski A. 2008. Applicability of crude tall oil for wood protection. Dissertation. University of Oulu
- Lahtela V., Karki T. 2014. Improving the UV and water-resistance properties of Scots pine (*Pinus sylvestris*) with impregnation modifiers. *Eur. J. Wood Prod.* 72:445–452
- Ozgenç Ö., Okan O.T., Yıldız Ü.C., Deniz, I. 2013. Wood surface protection against artificial weathering with vegetable seed oils. *BioResources* 8(4), 6242-6262.
- Panda H. 2008. Handbook on tall oil rosin production, processing and utilization. Asia pasific business press. 106-E, kamla Nagar, Delhi- 110-007.
- Salla J., Pandey K.K., Srinivas K. 2012. Improvement of UV resistance of Wood surface by using ZnO nanoparticles. *Polymer Degradation and Stability*, 97, 592-596
- Schultz T.P., Nicholas D.D., Shi J. 2007. Water repellency and dimensional stability of Wood treated with waterborne resin acids/TOR. *Proceedings IRG Annual Meeting, IRG/WP 07-40364*.

URL-1, 2013. hemel.com

URL-2. 2016 [http:// www.woodworkdetails.com](http://www.woodworkdetails.com)

URL-3. 2015 http://www.vias.org/church_paint

Yildiz S. 2007. Retention and penetration evaluation of some softwood species treated with copper azole, *Bulding and Environment* 42, 2305-2310

Temiz A., Yıldız U.C., Gezer E.D., Yıldız S., Dizman E. 2004. Interaction of Copper Based Preservatives With Wood. *Kafkas University, Artvin Faculty of Forestry Journal*, 3-4 (204-211)

Temiz A. 2005. The effect of simulated weathering on preservative treated wood. *Karadeniz Technical University, Science Institute, PhD thesis, Trabzon.*

Temiz A., Terziev N., Eikenes M., Hafren J. 2007. Effect of accelerated weathering on surface chemistry of modified wood. *Applied surface science*. 253, 5355-5362.

Temiz A., Alfredsen G., Eikenes M., Terziev N. 2008. Decay resistance of wood treated with boric acid and tall oil derivates. *Bioresour Technol* 99:2102–2106

Treu A. Larnøy E., Militz H. 2011. Process related copper leaching during a combined wood preservation process. *Eur. J. Wood Prod.* (2011) 69: 263–269

Yang V.W., Clausen C.A. 2008. Inhibitory effect of essential oils on decay fungi and mold growth on wood. *AWPA103*, 62–70.

Van der Weerd J., van Loon A., Boon J.J. 2005. FTIR studies of the effects of pigments on the aging of oil. *Studies in conservation*, 50(1), 3-22.

Chemical Modification of Cellulose for Use in Composites

*Nihat Sami ÇETİN¹, Nilgöl ÖZMEN¹

¹İzmir Katip Çelebi University, Faculty of Forestry, Çiğli/İzmir/TURKEY

*Corresponding Author: nihatcetin@yahoo.com

Abstract

Cellulose based composites have gained significant popularity in the last decade. The most conspicuous problem of using cellulose based materials as reinforcement in a thermoplastic matrices is the compatibility of the material with the matrices. Cellulosic materials are hydrophilic (abundance of OH functionality) and thermoplastic polymers are hydrophobic. As a result of this divergent behaviour, the adhesion between the cellulose and polymer is very poor. The bond between the reinforcing material and the matrix plays an important role in determining the mechanical properties of a composite material. To improve the compatibility between cellulose and the matrix, cellulose was modified with acetic anhydride (AA) and vinyl acetate (VA). Untreated, AA- or VA- modified cellulose were characterised by FTIR and ¹³C CP-MAS NMR spectroscopies. Degree of substitution and thermal properties of modified cellulose were also determined.

Keywords: Cellulose, Acetylation, Vinyl acetate, Acetic anhydride

Kompozit Üretimi için Selülozün Kimyasal Modifikasyonu

Özet

Selüloz kökenli kompozitler son yıllarda belirgin bir şekilde popülerite kazanmıştır. Selüloz kökenli malzemelerin takviye elemanı olarak termoplastik matrisler içerisinde kullanımını kısıtlayan en önemli sorun uyum problemidir. Selülozik materyal hidrofilik (OH grubunun yaygınlığı) ve termoplastik polimerler hidrofobik yapıdadır. Kompozitlerin mekanik özelliklerinin belirlenmesinde takviye elemanı ile matris arasında oluşan bağ önemli rol oynamaktadır. Matris ile selüloz arasındaki uyumun artırılması için selüloz asetik anhidrit (AA) ve vinil asetat(VA) ile modifiye edilmiştir. Kontrol, AA ve VA modifiye edilmiş selüloz FTIR ve ¹³C CP MAS NMR spektroskopileri ile karakterize edilmiştir. Modifiye edilmiş selülozların yer değiştirme derecelerinin yanında termal özellikleri de belirlenmiştir.

Anahtar Kelimeler: Selüloz, asetillendirme, Vinil asetat, Asetik anhidrit

Introduction

Composite material is defined as a material combined of two or more constituent materials to produce a material with possess better properties than the individual components. One of these components at least are solid phase. Composite materials are generally used various application such as buildings, aircraft, spacecraft, car bodies and bridges etc. Composites are generally preferred from many industries because they are stronger, lighter and less expensive than the traditional materials (Schuh and Gayer 1997). In the past, micro or macro size reinforced materials were mixed with some polymer matrix for production of composites.

Cellulose is the most abundant organic polymer on Earth and obtained from various natural sources such as wood, annual plants, some sea animals (tunicia) and some bacteria. Cellulose is a linear polymer which consists of

$\beta(1,4)$ -D-Glucose molecules linked together with glucosidic bonds. (Figure 1). Cellulose consists of crystalline and amorphous regions.

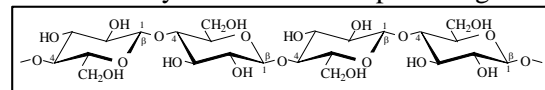

Figure 1. Partial structure of cellulose

Recently, cellulose based fibers have attracted attention as reinforcements for producing environmentally friendly composites due to many advantages such as annually renewable, sustainable, high specific strength, biodegradable and low cost(Eichorn et al. 2010). On the other hand, incompatibility between polar hydrophilic cellulose based reinforcement materials and hydrophobic thermoplastic matrices creates problems during the composites production. (Eichorn et al. 2010). As a result of this divergent behaviour, the adhesion between the

cellulose and polymer is very poor. The bond between the reinforcing material and the matrix plays an important role in determining the mechanical properties of a composite material.

Utilization of compatibilisers (silanes, isocyanates, maleic anhydride modified polyethylene) or surface modification of fibers may be employed to improve bond quality or compatibility of cellulose based materials with a hydrophobic matrix. In the literature, many researchers studied partial acetylation of crystal cellulose. They reported that surface acetylation was adequate for improving compatibility between hydrophobic thermoplastic and hydrophilic cellulose surface (Sassi and Chanzy 1995, Matsumura et al. 2000 a, b; Seavey and Glasser 2001).

In previous studies, it was reported that bacterial cellulose was modified with acetic anhydride for creating hydrophobic surfaces. After acetylation degree of substitution value was found as 0.17 by X-ray analysis and at this level of modification, crystal structure of cellulose was not affected (Nogi et al. 2006).

Grunert and Winter (2002) produced crystal cellulose by acid hydrolysis. They reported that utilization of crystal cellulose as a reinforcing material in thermoplastic matrices was limited due to incompatibility of cellulose and matrices. For overcoming this problem, cellulose was modified with trimethyl silane. Modified cellulose reinforced cellulose acetate butyrate composites showed better properties than unmodified reinforced one.

In another study, microcrystal cellulose was modified with vinyl acetate at 0.7 degree of substitution by transesterification reactions (Çetin et al. 2015). Cellulose reinforced high density polyethylene composites were produced. Modified cellulose reinforced high density polyethylene composites showed better tensile strength values and thermal stability than unmodified cellulose reinforced composites.

The purpose of this study was to modify the surface of cellulose with acetic anhydride and vinyl acetate in order to improve the compatibility of cellulose with thermoplastic matrices. Effect of reaction time on the degree of substitution was determined. Modified

cellulose with both acetylation methods were characterized by FTIR and ^{13}C CP-MAS NMR analysis. Thermal properties of modified cellulose were also determined.

Material and Methods

Acetylation of cellulose

Cellulose was transferred to a round bottom flask containing DMF solution with acetic anhydride (AA) or vinyl acetate. All reactions were performed at 100°C. For each reaction 10 g cellulose was used and each set of conditions were repeated at three times. At the end of the reaction, all modified samples were Soxhlet extracted with deionised water for 6 hours then with toluene:acetone:ethanol mixture (4/1/1, vol./vol.) for 6 hours. This was done to remove excess unreacted chemicals and by products. The Soxhlet thimble and contents were oven-dried overnight at 103°C transferred to a desiccator containing phosphorus pentoxide until cool, then degree of substitution were calculated.

Calculation of degree of substitution

About 0.2 g dry acetylated cellulose was weighed accurately, and put into 8 mL of 75% ethanol in a glass erlenmeyer. The erlenmeyer, loosely stoppered, was heated to 50–60°C for 30 min. Then 8 mL of 0.5 N NaOH solution was added to the sample and the mixture was heated to 50–60°C for 15 min. Then the erlenmeyer was stoppered tightly and allowed to stand at room temperature for about 72 h. The excess alkali was then titrated with 0.5 N HCl using phenolphthalein as an indicator (Luo and Sun 2006, Çetin et al. 2009).

Infrared spectroscopy

Infrared absorption spectra of acetylated and unmodified cellulose were obtained with the KBr (potassium bromide) technique, using a Shimadzu 8400s FT-IR spectrometer, at a resolution of 4 cm^{-1} (40 scans). In each case, 1% w/w of oven dry cellulose flour was dispersed in a matrix of KBr and pressed to form pellets.

^{13}C CP-MAS NMR analysis

NMR spectra of cellulose were performed at room temperature on a Bruker DPX-400

NMR spectrometer (Bruker), using MAS rates of 4 and 8 kHz, a frequency of 100.61 MHz for ^{13}C NMR.

Thermogravimetric (TGA) analysis

The thermogravimetric analyses of unmodified, VA modified and AA modified cellulose were performed by thermal gravimetric analyzer (Shimadzu TA60). The sample weight was 20 mg. The measurement were carried out at a heating rate of $10^\circ\text{C}/\text{min}$ in an inert nitrogen atmosphere with a flow rate of 20mm/min. Weight loss versus temperature were recorded.

Results and Discussion

The reaction mechanisms between cellulose hydroxyl groups and acetic anhydride (AA) or vinyl acetate (VA) are shown in Figure 2.

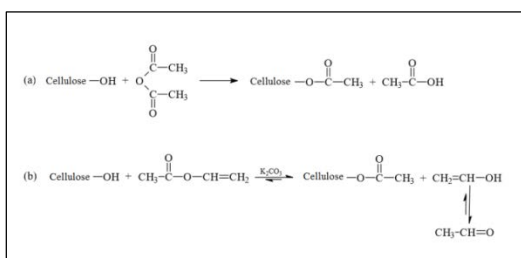

Figure 2. Reaction mechanisms between cellulose and acetic anhydride (a) or vinyl acetate (b)

As seen from Figure 3, cellulose was modified with AA or VA, degree of substitutions were found as 0.47, 0.65, 0.72, 0.9 and 0.97 for AA and 0.4, 0.61, 0.69, 0.86 and 0.91 for VA at for 1, 2, 3, 6 and 24 hours reaction times, respectively.

Figure 4 shows FTIR spectra of unmodified cellulose, acetic anhydride modified (AA) cellulose and vinyl acetate modified (VA) cellulose.

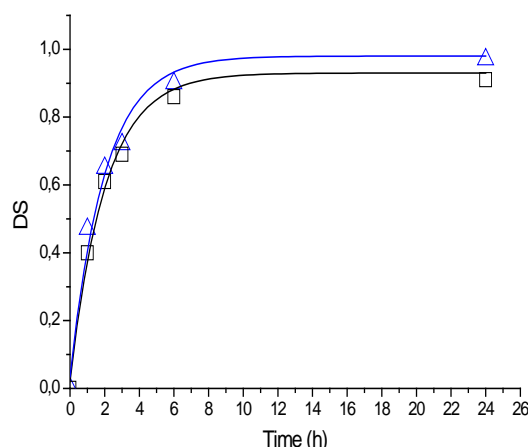

Figure 3. Effect of reaction times on Degree of Substitution (DS) of acetic anhydride modified cellulose (triangle) and vinyl acetate modified cellulose (square)

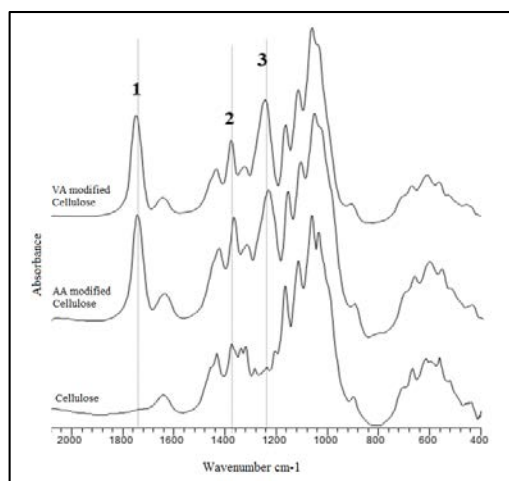

Figure 4. FTIR spectra of unmodified cellulose, AA modified cellulose (DS: 0.97) and VA modified cellulose (DS: 0.91)

As can be seen from Figure 4, some major changes were observed after acetylation. Acetylated cellulose was easily identified in the FTIR spectra, the emergence of a carbonyl (C=O) stretching vibration at 1745 cm^{-1} in the spectra confirmed the formation of ester bonds after reactions with AA and VA (Çetin et al. 2009). In addition to the C=O at 1750 cm^{-1} , the intensity of the band at 1241 cm^{-1} also increased and was associated to the C-O stretching vibration of the acetyl moieties. The intensity of the bands located at 1376 cm^{-1} was also enhanced after acetylation. This band was attributed to the C-H bending vibrations of the methyl groups introduced.

Acetic anhydride and vinyl acetate modified cellulose samples were also characterized with CP-MAS ^{13}C NMR spectra and results are shown in Figure 5.

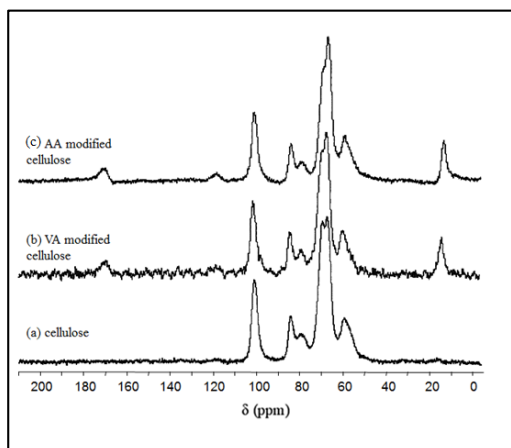

Figure 5. CP-MAS ^{13}C NMR spectra of (a) unmodified cellulose, (b) acetic anhydride modified cellulose (DS: 0.97) and (c) vinyl acetate modified cellulose (DS:0.91)

In Figure 5, the dominant pattern of the ^{13}C NMR spectra is that of the carbohydrates, namely C1 (107 ppm), C4 crystalline (91 ppm), C4 amorphous (86 ppm), C2 (77 ppm), C3/C5 (75 ppm), C6 crystalline (68 ppm), C6 amorphous (65 ppm) (Boonstra et al. 1996, Çetin et al. 2005). After acetylation of cellulose with acetic anhydride or vinyl acetate, the methyl band of the acetyl group at 21 ppm and the carboxylic group at 171 ppm show the acetyl groups on the cellulose. There was no difference between the VA or AA modified cellulose spectra.

The thermal degradation of the unmodified, vinyl acetate modified and acetic anhydride modified cellulose was investigated using the techniques of thermogravimetric analysis between room temperature and 600°C and results are shown in Figure 6. On pyrolysis of the cellulose, the active temperature of decomposition was determined as 360°C (Figure 6a). On the acetylated samples with VA (Figure 6b) or AA (Figure 6c), the main decomposition temperatures shifted to higher values 390 and 405 °C for VA and AA modified cellulose, respectively.

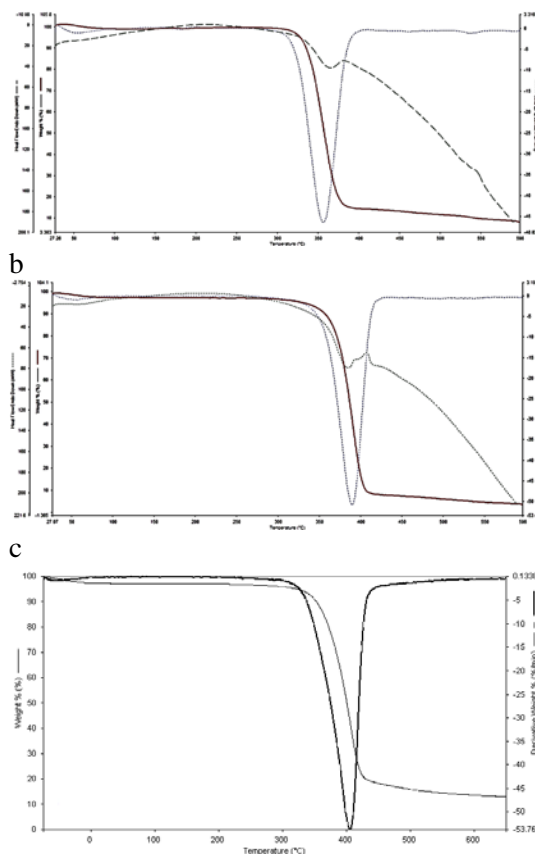

Figure 6. TGA curves of (a) unmodified cellulose, (b) VA modified cellulose (DS:0.91) (c) AA modified cellulose (DS:0.97)

Conclusion

Cellulose was successfully acetylated with acetic anhydride and vinyl acetate. Proof of the reaction was obtained with FTIR and NMR analysis. At the same reaction conditions, maximum degree of substitution values of acetic anhydride and vinyl acetate modified cellulose were found 0.97 and 0.91 for 24 hours reaction time, respectively. The AA or VA modification showed a significant effect upon thermal properties of cellulose, making cellulose thermally more stable. The main decomposition temperature of acetylated cellulose was higher than that of unmodified cellulose.

Acknowledgement

This study was carried out with financial support from TÜBİTAK (Project 110O138).

References

Boonstra, M. G., Pizzi, A., Tekely, P., Pendlebury, J. 1996. Chemical modification of Norway spruce and Scots pine. A ^{13}C NMR CP-MAS study of the reactivity and reactions of polymeric wood components with acetic anhydride. *Holzforschung*. 50(3), 215-220.

Çetin, N. S., Özmen, N., Tingaut, P., Sebe, G. 2005. New transesterification reaction between acetylated wood and tetrametoxysilane: A feasibility study. *Euro. Polym. J.* 41, 2704-2710.

Çetin, N.S., P. Tingaut, N. Özmen, N. Henry, D. Harper, M. Dadmun, G. Sèbe. 2009. The acetylation of cellulose nanowhiskers with vinyl acetate under moderate conditions. *Macromol. Biosci.* 9(10):997-1003.

Çetin, N:S., Özmen, N., Harper, D. 2015. Vinyl acetate-modified microcrystalline cellulose-reinforced HDPE composites prepared by twin-screw extrusion. *Turkish Journal of Agriculture and Forestry*. 39: 39-47.

Eichhorn SJ, Dufrense A, Aranguren M, Marcovich NE, Capadona JR, Rowan SJ. 2010 Review: Current international research into cellulose nanofibres and nanocomposites. *J Mater Sci* 35 : 201 - 207.

Grunert, M., Winter, W. T. 2002. Nanocomposites of cellulose acetate butyrate reinforced with cellulose nanocrystals. *Journal of Polymers and the Environments*. 10 (1/2). 27-30.

Luo, J., Sun, Y. 2006. Acetylation of cellulose using recyclable polymeric catalysts. *J Appl. Polymer Sci.* 100: 3288-3296.

Matsumura, H., Sugiyama, J., Glasser, W. G. 2000a. Cellulosic nanocomposites. I. Thermally deformable cellulose hexanoates from heterogeneous reaction. *J. Appl. Polymer Sci.* 78. 2242-2253.

Matsumura, H., Glasser, W. G. 2000b. Cellulosic nanocomposites.II. Studies by atomic force microscopy. *J. Appl. Polymer Sci.* 78. 2254-2261.

Nogi, M., Abe, K., Handa, K., Nakatsubo, F., Ifuku, S., Yano, H. 2006. Property enhancement of optically transparent bionanofiber composites by acetylation. *Applied Physics Letters*. 89. 233123-1-3.

Sassi, J. F., Chanzy H. 1995. Ultrastructural aspects of the acetylation of cellulose. *Cellulose*. 2(2). 111-127.

Schuh, T., Gayer, U. 1997. Automotive applications of natural fiber composites. de Sao Paulo and Universidade Estadual Paulista, pp 181-195.

Seavey, K. C., Glasser, W. G. 2001. Continuous cellulose fiber-reinforced cellulose ester composites. II. Fiber surface modification

and consolidation conditions. *Cellulose*.8. 161-169.

Decay Resistance Evaluation of Chemically Modified Wood Flour Filled Thermoplastic Composites

*Eylem DİZMAN TOMAK¹, Ayfer DÖNMEZ ÇAVDAR², Kadir KARAKUŞ³

¹Bursa Technical University, Faculty of Forestry, Bursa/TURKEY

²Karadeniz Technical University, Faculty of Architecture, Trabzon/TURKEY

³Kahramanmaraş Sütçü İmam University, Faculty of Forestry, Kahramanmaraş/TURKEY

*Corresponding Author: eylem.dizman@btu.edu.tr

Abstract

In this study, decay performance and dimensional stability of modified aspen wood flour with propionic, maleic and succinic anhydrides filled thermoplastic composites were evaluated. Water absorption and thickness swelling of composites were determined after 60 days of water immersion period. Decay test was carried out according to principles of EN 113 standard both for leached and un-leached composites. *Poria placenta* was used as a brown rot fungus and *Trametes versicolor* was used as a white rot fungus. Maleic and propionic anhydride modified composites showed better dimensional stability than other composites. The highest dimensional stability was found as 74% in maleic anhydride modified composites. All composites including controls demonstrated great biological resistance against decay fungi showing less than 1% weight loss while the wood samples showed more than 25% weight loss.

Keywords: Chemical modification, wood plastic composite, decay fungi, dimensional stability

Özet

Bu çalışmada, propiyonik, maleik ve süksinik anhidritler ile modifiye edilmiş kavak odunu dolgululu termoplastik kompozitlerin çürüklük performansı ve boyutsal kararlılıkları araştırılmıştır. Su alma ve kalınlığına şişme oranları 60 gün boyunca suda bırakılan örneklerde belirlenmiştir. Çürüklük testi yıkanmış ve yıkanmamış kompozit örnekleri için EN 113 standardı esaslarına göre gerçekleştirilmiştir. Esmer çürüklük mantarı olarak *Poria placenta* ve beyaz çürüklük mantarı olarak da *Trametes versicolor* kullanılmıştır. Çalışmada, maleik ve propiyonik anhidrit ile modifiye edilmiş kompozitler diğer gruplara göre daha iyi bir boyutsal kararlılık göstermişlerdir. En yüksek boyutsal kararlılık olan %74 maleik anhidrit ile modifiye edilmiş kompozitlerde bulunmuştur. Çürüklük testi sonrasında, odun örneklerinde %25'in üzerinde bir ağırlık kaybı gözlenirken, kontrol örnekleri dahil tüm kompozitlerde %1'den daha düşük bir ağırlık kaybı bulunmuş ve kompozitler çürüklük mantarlarına karşı iyi bir biyolojik dayanım göstermiştir.

Anahtar Kelimeler: Kimyasal Modifikasyon, odun plastik kompoziti, çürüklük mantarları, boyutsal kararlılık

Introduction

Nutrient source, moisture (generally greater than 20%), temperature and oxygen are highly needed for all biological agents. The agents feed on the organic layers in materials, and cause irreversible damages (Schirp et al., 2008). Wood being one of the organic and hygroscopic materials can be susceptible to decay by biological agents (Pendleton et al., 2002; Clausen, 2010). Wood plastic composites (WPCs) a new generation of composite materials (Hosseinhashemi et al., 2016) are made of wood or other natural fibers and thermoplastic(s). WPCs generally known as a biologically durable material can expose to decay under favorable conditions of moisture and temperature due to their wood component (Mankowski and Morrell, 2000;

Verhey et al., 2001; Ibach et al., 2003; Simonsen et al., 2004; Manning et al., 2006; Lu et al., 2008; Kartal et al., 2013; Tascioglu et al., 2013; Sun et al., 2016). Internal gaps, voids and wood content in the WPCs accelerated the moisture uptake and the risk of fungal decay (Müller et al., 2013). Durability of WPCs may be improved by following precautions (1) minimizing amount of nutrient source such as wood content below 50% by weight, (2) incorporating protective chemicals into polymer matrix (3) obstructing to access the nutrient source such as wood particles in WPC by encapsulating them with the plastic matrix (4) using naturally durable wood species (5) making wood hydrophobic (Schirp et al., 2008).

Compatibility between wood and polymer is very important in WPCs since it affects all properties of the composites. As mentioned precaution (5), hydrophilic nature of wood decrease when wood cell wall is chemically modified by forming covalent bond between a chemical reagent and wood substrate (Hill, 2006). Chemical modification enhances the compatibility between the components of WPCs, increase durability of WPCs and decrease moisture content (Raj and Kokta, 1991; Lyon et al., 2008). Therefore, it leads to improve decay resistance of WPCs. Reduced water uptake in WPCs was obtained by using methylated melamine-formaldehyde resin (Müller et al., 2012). Aminosilane, melamine and acetic anhydride reinforced WPCs showed high resistance to basidiomycetes, and with regard to the modifications used, aminosilane treated composites showed slightly less weight loss values compared to the controls (Müller et al., 2013). Hosseinihashemi et al. (2016) studied possibility of heat treated wood chips as a potential filler for WPC production, and found that the water absorption decreased with increasing severity of the heat treatment and water immersion time as compared to the control composites. Furthermore, the composites produced with wood heated at 180°C for 120 min demonstrated the least water absorption.

The recent studies have been focused on acetylation process with acetic anhydride (Tserki et al., 2006; Lisperguer et al., 2007; Mat Taib et al., 2010; Ozmen et al., 2013a) however, there are limited studies on other anhydrides such as maleic, succinic and propionic anhydrides in WPC production (Cavdar et al., 2014). In our previous study (Cavdar et al., 2014), effect of chemical modification with the aforementioned anhydrides on mechanical, thermal and fire properties of WPCs was studied. Based on the test results chemical modification enhanced the properties, and wood flour modified with the anhydrides suggested as filler in polymer matrix. To the best of our knowledge, the biological resistance and dimensional stability of WPCs with modified wood flour with these anhydrides is still unknown. Furthermore, there is not a substantial study dealing with the effect of long-term leaching on decay

performance of WPCs. Current standards for decay resistance need a modification of the test procedure such as pre-treatment to increase initial moisture content of WPC due to slow moisture uptake of WPC compared to solid wood (Van Acker, 2006; Segerholm, 2012). The aim of this study is to investigate the effect of chemical modification of wood flour with maleic, succinic and propionic anhydrides and their various concentrations on water absorption, thickness swelling and decay resistance of WPCs. In addition, long-term leaching procedure for 60 days prior to decay test was applied to ensure necessary moisture content that are required by decay fungi for end-use performance evaluations.

Material and Method

Material

Aspen (*Populus euroamericana*) wood flour (45 mesh size fiber) was used as lignocellulosic material. High density polyethylene (HDPE) (density = 0.965 g/cm³, melt flow index 190°C/2.16kg = 5.45g/10min) was supplied by Petkim Petrochemical Company in Izmir, Turkey. Anhydrides (maleic anhydride, propionic anhydride and succinic anhydride) and their solvents (xylene and acetone) were obtained from Merck Company.

Chemical modification of wood flour and WPC production

The modification process and WPC production have been explained in a study performed by Cavdar et al. (2014) which is the first part of this project. Ten different composites were produced depending on anhydride types and their concentrations. The modified wood flour and high density polyethylene (HDPE) were compounded using laboratory single-screw extruder and injection moulding machines. The wood flour and HDPE ratio in the composites was 40/60 by weight. The weight gain percentages of modified wood flour were found as 4.59-12.64%, 2.54-5.7% and 4.71-15.78% for maleic anhydride, propionic anhydride and succinic anhydride, respectively, depending on concentration (Cavdar et al., 2014).

Water absorption and thickness swelling

Oven dried WPCs with dimension of 20 x 10 x 5 mm were immersed in deionized water for 60 days. Ten replicates were used for each group. After 168h intervals, the water replaced with the fresh water. Relative water uptake (WA) and thickness swelling (TS) were calculated based on the initial oven dry weight and thickness, respectively. After water immersion test, the WPCs were exposed to decay test. These samples were labeled as leached WPCs in the study, and they were quickly subjected to decay test to prevent any loss in absorbed water since fungi need a specific amount of water in wood to start a decay process.

Decay test

Decay test was performed according to basis of EN 113 (1997). Five replicates for each composite type and reference wood

samples which are Beech (*Fagus orientalis* L.) and Scots pine (*Pinus sylvestris* L.) as for validity of decay test, were exposed to fungal attack. For this purpose, a brown-rot fungus *Poria placenta* and a white rot fungus *Trametes versicolor* were used. After incubation period of vaccinated petri dishes, two samples were placed on the growing mycelium in each petri dish. The petri dishes were then incubated at 20°C and 65% relative humidity for 40 days. End of the test, the surface of all WPCs and wood samples were cleaned from mycelium, and weighted for moisture content calculations. Afterwards, the decayed samples were dried to constant mass at 103±2°C, weighed, and the weight loss was calculated on the principle of oven dry weight before and after fungal attack. Table 1 shows the experimental design of this study.

Table 1. The experimental design of the study

Test fungus	White-rot, Brown-rot
Leaching proses (60 days)	Un-leached, Leached
Anhydride types	Control, propionic, maleic and succinic anhydrides
Ratio of reagent (wt.% of wood flour)	5% , 10% and 15%
Total variations	40

Statistical analysis

Differences in WA, TS and weight loss among all composite types were analyzed using analysis of variance (General Linear Model) test using with SPSS 22.0 program. The significance ($P < 0.05$) was compared with Duncan homogeneity groups.

Results and Discussion

Dimensional stability

The dimensional stability of WPCs was evaluated by water absorption and thickness swelling. Figs. 1 and 2 show water absorption (WA, %) and thickness swelling (TS, %) values of the WPCs, respectively.

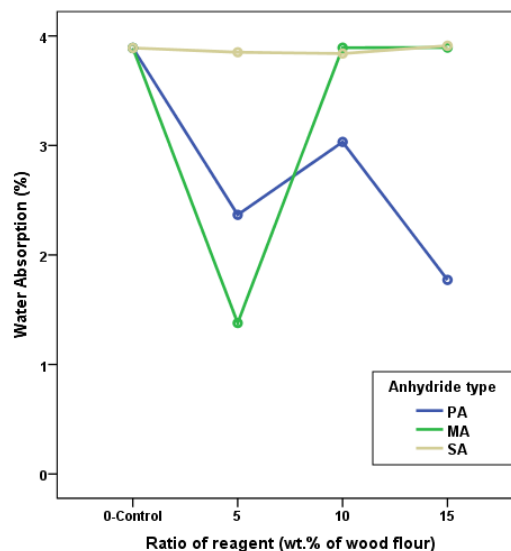

Figure 1. Water absorption of chemically modified WPCs (%)

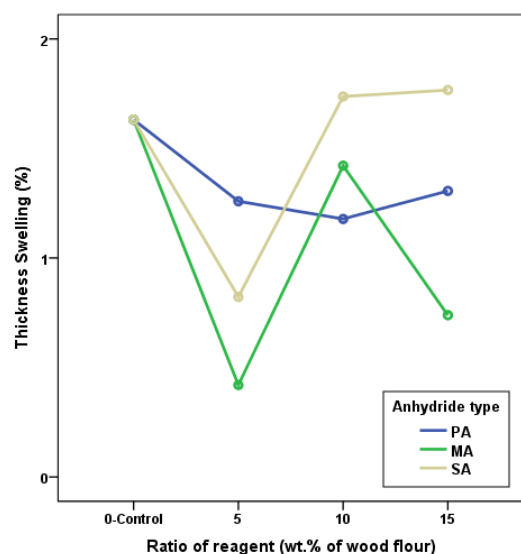

Figure 2. Thickness swelling of chemically modified WPCs (%)

Depending on anhydride type and concentration, modified WPCs had 1.37-3.91% water absorption and 0.42-1.77% thickness swelling while the control WPCs had 3.89% water absorption and 1.63% thickness swelling after water immersion for 60 days. In general, modified WPCs showed lower water absorption and thickness swelling than controls, indicated dimensional stable WPCs could be produced by modification process of wood flour. There were three possible reasons for the enhanced dimensional stability in WPCs. 1) Anhydride modification removed hydroxyl groups which are responsible for the water absorption into the composite structure. Covalent bond between a chemical reagent and wood substrate decreases water absorption and thickness swelling rate because hydrophobicity of wood flour is increased after chemical modification with the anhydrides (Schirp et al., 2008), 2) Reduced void content in composite. The fewer voids cause slow water penetration into the depth of the composites. In addition, the presence of fewer voids helps to make the WPC much less accessible for the moisture uptake due to decreasing of hydrogen bonds between hydroxyl groups of wood flour and water molecules (Hosseinihashemi et al., 2016), 3) Increased compatibility of wood flour and polymer matrix due to a reduction of polarity between them (Sundar, 2005; Tserki et al., 2006; Ozmen et al., 2013a, 2013b;

Cavdar et al., 2014; Hosseinihashemi et al., 2016) It is reported that there is a correlation between compatibility of WPC components and its dimensional stability, and the increase in wood hydrophobicity decreases moisture content, water uptake, and maximum thickness swelling of WPC (Chen et al., 2014; Ibach et al., 2014). In our previous study (Cavdar et al., 2014), scanning electron microscope (SEM) analysis clearly showed that controls had more voids and more crack formation between the wood flour and HDPE than modified WPCs due to a low interfacial binding force between them. The SEM images confirm the dimensional stability of modified WPCs.

The water absorption of WPCs was in the following order: 5% < 15% < 10% < Control, and propionic anhydride < maleic anhydride < succinic anhydride. Thickness swelling was found as 5% ≤ 10% ≤ 15% < Control, and maleic anhydride < propionic anhydride = succinic anhydride. The classification of the treatment groups was proven by statistical test. The WPCs produced from the wood flour modified with propionic and maleic anhydrides and 5% concentration exhibited the highest dimensional stability. Increase in anhydride concentration could cause less interaction between wood flour and polymer. Mat Taib et al. (2010) reported a reduction in composite properties at high acetylation levels due to the poor fiber-matrix interaction.

Decay resistance

The moisture content and weight loss (%) of WPCs is shown in Figs. 3 and 4 for *T. versicolor* and Figs. 5 and 6 for *P. placenta*. The weight loss was found to be 35.52% for beech wood exposed to *T. versicolor* and 29.76% for S. pine wood decayed by *P. placenta*. The weight loss of solid wood samples clearly verified that the test conditions were suitable for growth of the test fungi. The moisture content of WPCs was between 1.07-3.06% and 1.21-3.83% after *T. versicolor* and *P. placenta* attack, respectively. In the case of weight loss, these values were in a range of 0.13-0.93% for *T. versicolor* attack and 0.24-1.01% for *P. placenta* attack.

WPCs showed a slower decay rate than wood samples due to the limited moisture

content in WPCs despite the leaching procedure in water for 60 days, and had an excellent protection against both decay fungi. Less than 1% weight loss values were probably related with the low moisture contents in WPCs during the decay test which might not provide suitable conditions for fungal attack. Suitable moisture content for a proper fungal attack is about 20%, ideal 30%

(Lomeli Ramirez et al., 2009). Encapsulation of wood fiber in plastic matrix restricts the accessibility of fibers for the fungus and provides a physical barrier for fungal hyphae penetration into the composite, and at the same time reduces moisture uptake (Schirp and Wolcott, 2005; Karimi et al., 2007).

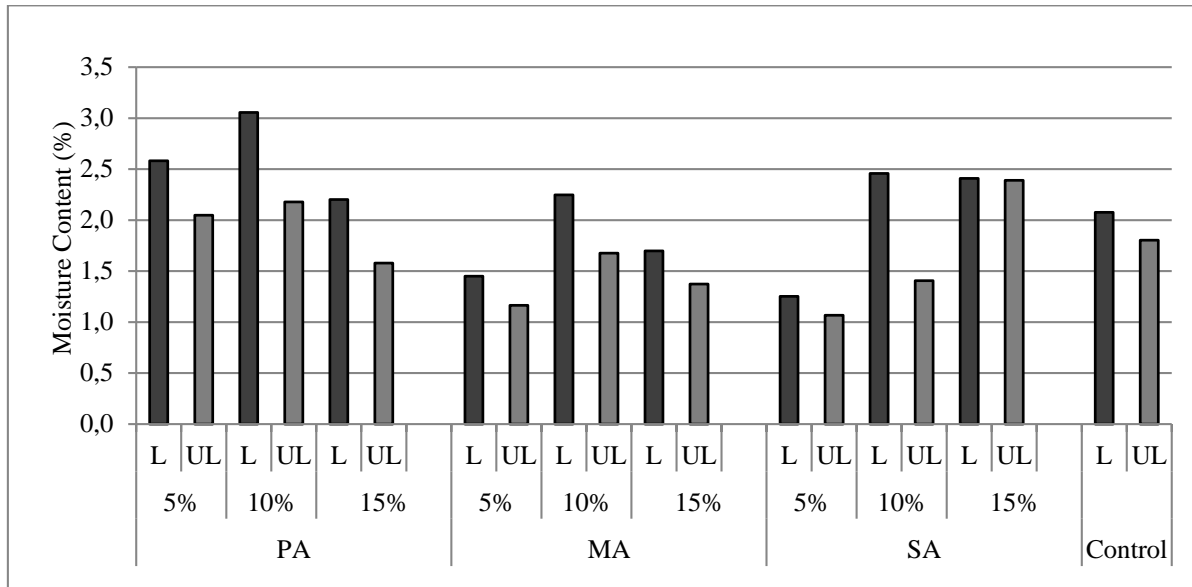

Figure 3. Moisture content of WPCs after *T. versicolor* attack

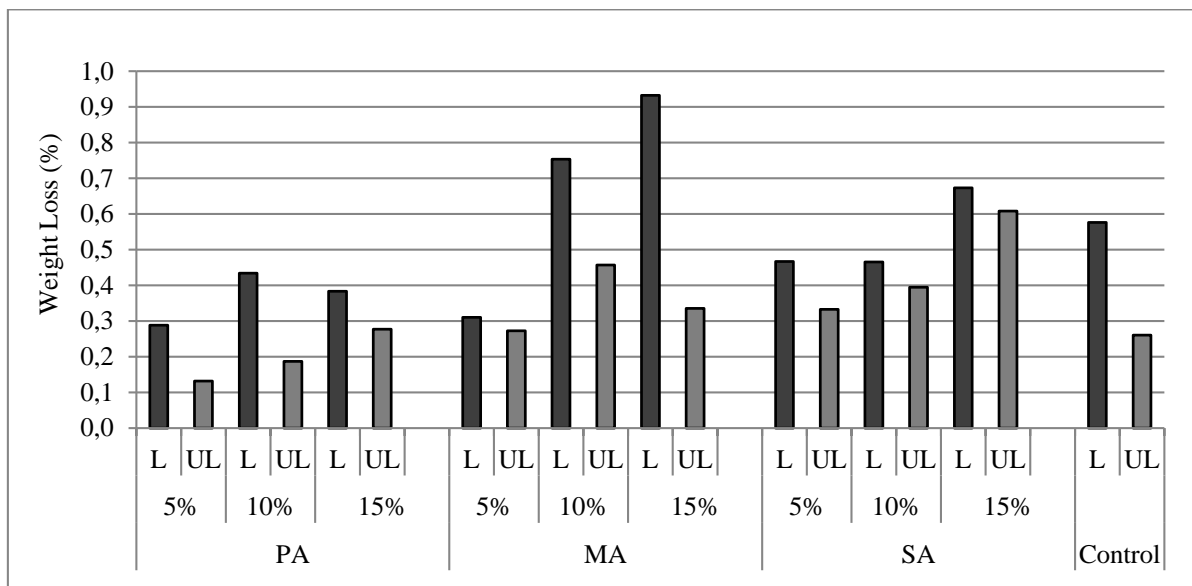

Figure 4. Weight loss of WPCs after *T. versicolor* attack

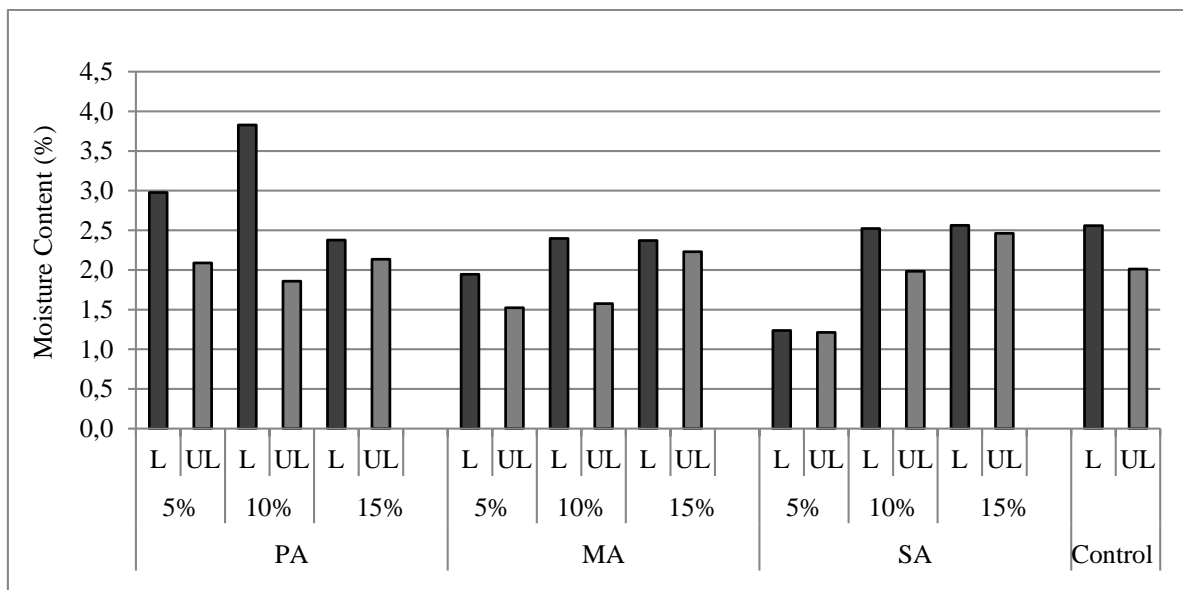

Figure 5. Moisture content of WPCs after *P. placenta* attack

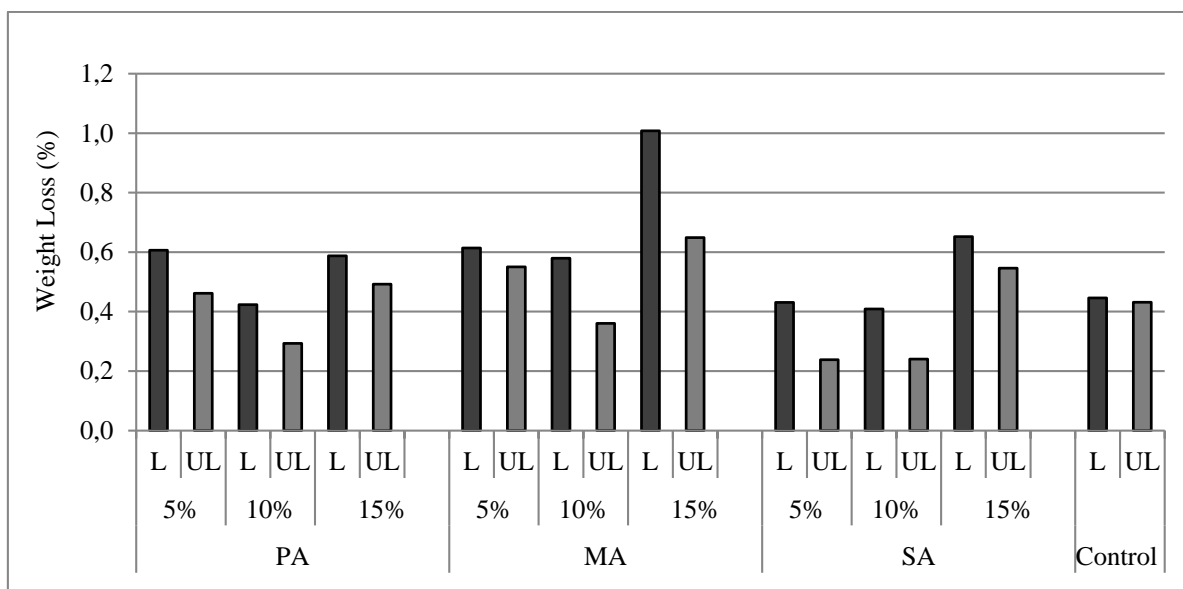

Figure 6. Weight loss of WPCs after *P. placenta* attack

Water immersion for 60 days increased weight loss and moisture content of WPCs. However, moisture content of WPCs including controls was not in a range of decay fungi needed to start decay process. Severe weathering, aging methods and longer water immersion tests are needed to increase moisture content and weight loss in WPCs before decay test as well as to evaluate long term durability of composites. Some studies reported that pre-treatments such as combined UV exposure and water soaking (Ibach et al., 2003), several cycles of water soaking-oven

drying or water boiling-oven drying (Ibach et al., 2002), water soaking or cyclic boiling-drying (Clemons and Ibach, 2004), immersion in hot water and 6 cycle (boiling, steaming, freezing drying, steaming and drying) aging process (Aysal, 2014) were resulted in an increase in moisture content and fungal attack.

The weight losses in WPCs showed statistically significant differences among the groups. The weight loss due to *T. versicolor* attack was in the following order: 5% ≤ Control = 10% < 15%, and propionic anhydride ≤ Control < succinic anhydride ≤

maleic anhydride. In the case of *P. placenta* attack, it was found as $10\% \leq \text{Control} \leq 5\% < 15\%$, and succinic anhydride $\leq \text{Control} \leq$ propionic anhydride $< \text{maleic anhydride}$.

In general, the decay test results revealed that weight losses were less in propionic and succinic anhydride modification and at the concentration of 5% and 10%. Better interfacial adhesion between wood flour and HDPE matrix at these parameters could be a reason for these findings. From the results, it can be generally concluded that there is no need to chemical modification process to have high resistance against decay fungi since all WPCs including controls exhibited quite low weight loss. However, the effectiveness of chemical modification on decay resistance was much clear for leached WPCs at the concentrations of 5% and 10% in comparison to control WPCs, indicating that modified WPCs had lower weight loss than controls after leaching. Effect of modified wood flour as potential filler in WPCs on decay resistance under the exposure of long term outdoor conditions is still needs to further research.

Conclusions

WPCs produced by chemically modified wood flour with propionic, maleic and succinic anhydrides exhibited less water absorption and thickness swelling than control WPCs, and therefore, they had an increased dimensional stability after water immersion for 60 days. Among the treatment groups, propionic and maleic anhydrides, and their 5% concentration showed the highest dimensional stability. All WPCs including the controls had a great biological resistance against decay fungi. The weight loss found less than 1% could be related with the low moisture content in WPCs which did not provide suitable conditions for fungal attack. Water immersion for 60 days in a room temperature did not provide enough moisture uptake to start decay process. Severe aging or outdoor weathering studies are needed to study the biological resistance of chemically modified WPCs contained higher fiber content for a proper end-use evaluation.

References

- Aysal, S. 2014. Odun Plastik Kompozit Malzemelerin Biyolojik Performanslarının İncelenmesi. İstanbul Üniversitesi, Yüksek Lisans Tezi, İÜ Fen Bilimleri Enstitüsü, 144 p. İstanbul.
- Cavdar, A.D., Mengeloglu, F., Karakus, K., Dizman Tomak, E. 2014. Effect of chemical modification with maleic, propionic, and succinic anhydrides on some properties of wood flour filled hdpe composites. *BioResources*, 9(4), 6490-6504.
- Chen, Y., Stark, N.M., Tshabalala, M.A., Gao, J., Fan, Y. 2014. Properties of wood-plastic composites reinforced with extracted and delignified wood flour. *Holzforschung*, 68 (8), 933-940.
- Clausen, C.A. 2010. Biodeterioration of Wood, chapter 14, (Editor: ROSS, R.J., *Wood Handbook: Wood as an engineering material*, Centennial edition) U.S. Department of Agriculture, Forest Service, Forest Products Laboratory, 14/1-16. Madison, WI.
- Clemons, C.M., Ibach, R.E. 2004. Effects of processing method and moisture history on laboratory fungal resistance of wood-HDPE composites. *Forest Products Journal*, 54(4), 50-57.
- EN 113, 1997. European Committee for Standardization (EN), *Wood Preservatives. Test method for determining the protective effectiveness against wood destroying Basidiomycetes determination of the toxic values*. Brussels, Belgium.
- Hill, C.A.S. 2006. *Wood Modification-Chemical, Thermal and Other Processes*, ISBN: 9780470021729, John Wiley & Sons Ltd, 239 p. England.
- Hosseinihashemi, S.K., Arwinfar, F., Najafi, A., Nemli, G., Ayrilmiş, N. 2016. Long-term water absorption behavior of thermoplastic composites produced with thermally treated wood. *Measurement*, 86, 202-208.
- Ibach, R.E., Rowell, R.M., Lange, S.E., Schumann, R.L. 2002. Effect of wet-dry cycling on the decay properties of aspen fiber high-density polypropylene composites. Sixth International Conference on Woodfiber-Plastic Composites (15-16 May 2001), 267-270, Madison, WI, USA.
- Ibach, R.E., Clemons, C.M., Stark, N.M. 2003. Combined ultraviolet and water exposure as a preconditioning method in laboratory fungal durability testing. Seventh International Conference on Woodfiber-Plastic Composites (and other natural fibers) (19-20 May 2003), 61-67, Madison, WI, USA.
- Ibach R.E., Chen Y., Stark, N.M., Tshabalala, M.A., Fan, Y., Gao, J. 2014. Decay resistance of wood-plastic composites reinforced with extracted or delignified wood flour. IRG 45th Annual

Conference (11-15 May 2014), IRG/WP 14-40655, Utah, USA.

Karimi, A.N., Tajvidi, M., Pourabbasi, S. 2007. Effect of compatibilizer on the natural durability of wood flour/high density polyethylene composites against rainbow fungus (*Coriolus versicolor*). *Polymer Composite*, 28(3), 273–277.

Kartal, S.N., Aysal, S., Terzi, E., Yilgör, N., Yoshimura, T., Tsunoda, K. 2013. Wood and bamboo-PP composites: Fungal and termite resistance, water absorption, and FT-IR analyses, *BioResources*, 8(1), 1222-1244.

Lisperguer, J., Droguett, C., Ruf, B., Nunez, M. 2007. The effect of wood acetylation on thermal behavior of wood-polystyrene composites. *Journal of the Chilean Chemical Society*, 52(1), 1073-1075.

Lomeli Ramirez, M.G., Ochoa Ruiz, H.G., Fuentes Talavera, F.J., García Enriquez, S., Cerpa Gallegos, M.A., Silva Guzmán, J.A. 2009. Evaluation of accelerated decay of wood plastic composites by *Xylophagus* fungi. *International Biodeterioration and Biodegradation*, 63, 1030-1035.

Lu, J.Z., Duan, X., Wu, Q., Lian, K. 2008. Chelating efficiency and thermal, mechanical and decay resistance performances of chitosan copper complex in wood-polymer composites. *Bioresource Technology*, 99(13), 5906-5914.

Lyon, F., Thevenon, M.F., Pizzi, A., Tondi, G., Despres, A., Gril, J., Rigolet, S. 2008. Wood preservation by a mixed anhydride treatment: Using simple models of polymeric wood compounds for a ¹³C NMR investigation. IRG 39th Annual Conference (25–29 May 2008), IRG/WP 08-30457, Istanbul, Turkey.

Mankowski, M., Morrell, J.J. 2000. Patterns of fungal attack in wood-plastic composites following exposure in a soil block test. *Wood and Fiber Science*. 32(3) 340-345.

Manning, M.J., Ascherl, F.M., Mankowski, M.E. 2006. Wood-plastic composites and the durability dilemma: Observations from the field. 37th IRG Annual Conference (18-22 June 2006), IRG/WP 06-40351, Tromsø, Norway.

Mat Taib, R., Ramarad, S., Mohd Ishak, Z.A., Rozman, H.D. 2010. Effect of acetylation and mape on the properties of steam-exploded acacia mangium fiber-HDPE composites. *Journal of Reinforced Plastics and Composites*, 29(3), 431-444.

Müller, M., Radovanovic, I., Grüneberg, T., Militz H., Krause, A. 2012. Influence of various wood modifications on the properties of polyvinyl chloride/wood flour composites. *Journal of Applied Polymer Science*, 125(1), 308-312.

Müller, M., Gellerich, A., Militz, H., Krause, A. 2013. Resistance of modified polyvinyl

chloride/wood flour composites to basidiomycetes. *European Journal of Wood and Wood Products*, 71,199-204.

Ozmen, N., Cetin, N.S., Mengeloğlu, F., Birinci, E., Karakuş, K., 2013a. Effect of wood acetylation with vinyl acetate and acetic anhydride on the properties of wood-plastic composites. *BioResources*, 8 (1), 753-767.

Ozmen, N., Cetin, N.S., Mengeloğlu, F., Birinci, E. 2013b. Vinyl acetate modified scots pine reinforced HDPE composites: influence of various levels of modification on mechanical and thermal properties, *BioResources* 8 (1), 1361-1373.

Pendleton, D.R., Hoffard, T.A., Adcock T., Woodward, B., Wolcott, M.P. 2002. Durability of an extruded HDPE/Wood Composite, *Forest Products Journal*, 52 (6), 21-27.

Raj, R.G., Kokta B.V. 1991. Improving the mechanical properties of HDPEwood fiber composites with additives/coupling agents. 49th Annual Technical Conference (5-9 May 1991), 1883-1885, Montreal, Canada.

Schirp, A., Ibach, R.E., Pendleton, D.E., and Wolcott, M.P. 2008. Biological degradation of wood-plastic composites (WPC) and strategies for improving the resistance of WPC against biological decay. Chapter 29 (Editor: SCHULTZ, T.P., Development of commercial wood preservatives), ACS Symposium Series 982, 480-507, Washington, DC, USA.

Schirp A., Wolcott, P.W. 2005. Influence of fungal decay and moisture absorption on mechanical properties of extruded wood-plastic composites, *Wood and Fiber Science*, 37(4), 643-652.

Segerholm, K. 2012. Characteristics of wood plastic composites based on modified wood - moisture properties, biological resistance and micromorphology. Doctoral Thesis, KTH Building Materials Technology, 66 p. Stockholm.

Simonsen, J., Freitag, C.M., Silva, A., Morrell, J.J. 2004. Wood/plastic ratio: Effect on performance of borate biocides against a brown rot fungus, *Holzforschung*, 58, 205-208.

Sun, G., Ibach, R.E., Faillace, M., Gnatowski, M., Glaeser, J.A., Haight, J. 2016. Laboratory and exterior decay of wood-plastic composite boards: voids analysis and computed tomography. *Wood Material Science & Engineering*, DOI: 10.1080/17480272.2016.1164755

Sundar, S.T. 2005. Chemical modification of wood fiber to enhance the interface between wood and polymer in wood plastic composites. Master's Thesis, University of Idaho, 87 p. Moscow ID, USA.

Tascioglu, C., Yoshimura, T., Tsunoda, K. 2013. Biological performance of wood-plastic

composites containing zinc borate: laboratory and 3-year field test results. *Composites Part B: Engineering*, 51, 185-190.

Tserki V., Matzinos, P., Panayiotou C. 2006. Novel biodegradable composites based on treated lignocellulosic waste flour as filler Part II. Development of biodegradable composites using treated and compatibilized waste flour. *Composites: Part A*, 37, 1231–1238.

Van Acker, J. 2006. Testing biological durability of wood-plastic composites. 37th IRG Annual Conference (18-22 June 2006), IRG/WP 06-20347, Tromsø, Norway.

Verhey, S.A., Laks, P.E., Richter, D. 2001. Laboratory decay resistance of wood fiber / thermoplastic composites. *Forest Products Journal*, 51 (9), 44-49.

Decay Resistance of Scots Pine Wood Impregnated by Organic Solvent and Tannin

*Mahmut Ali ERMEYDAN¹, Eylem DİZMAN TOMAK¹, Oktay GÖNÜLTAŞ¹

¹Bursa Technical University, Faculty of Forestry, Department of Forest Industrial Engineering, 16330, Bursa / Turkey

*Corresponding Author: mahmut.ermeydan@btu.edu.tr

Abstract

Wood is an excellent engineering material with its light weight and mechanical properties. However, it is susceptible to biodegradation due to its hygroscopic nature that limits outdoor usage. Tannins are wood extractives that have a potential as being eco-friendly wood preservatives. Wood impregnation of some types of tannins by using water as a solvent has already been studied. It is known that swelling of wood in some organic solvents is very high. Dimethyl formamide (DMF) is one of the solvents that swell wood about 25% more than water does. The aim of this study is to impregnate two types of tannins into already DMF swelled wood, thus more tannin will enter inside wood cell walls and decay resistance will improve. In the study, Scots pine samples were swelled in DMF solvent for further impregnation of chestnut and valonia tannins which were dissolved in water. Two concentrations of chestnut and valonia tannins were used (5% and 10%). Decay test was performed according to EN 113 standard using with a brown rot fungus *Poria placenta* for both leached and unleached samples. The results are compared to only DMF impregnated and untreated samples. Fungal resistance of the tannin impregnated samples was increased compared to references while leaching removed all of the tannins in wood.

Keywords: Dimethyl formamide, tannin, decay test, wood impregnation

Özet

Ahşap hafifliği ve mekanik özellikleriyle mükemmel bir mühendislik malzemesidir. Ancak, higroskopik yapısı sebebiyle biyolojik bozunmaya karşı dirençsizdir, bu da ahşabın dış ortamda kullanımı kısıtlar. Tanenler, çevre dostu ahşap koruma maddesi olabileme potansiyeline sahip odun ekstraktlarıdır. Literatürde tanenlerin sulu çözeltilerinin potansiyel bir ahşap empenye maddesi olarak araştırıldığı pek çok çalışma bulunmaktadır. Bazı organik çözücülerin ahşabı yüksek oranda şişirdiği bilinmektedir. Dimetil formamit (DMF) de ahşabı suya nazaran %25'den daha fazla şişiren bir organik çözücüdür. Bu çalışmanın amacı, DMF kullanılarak şişirilmiş ahşap ile iki çeşit taneni empenye etmek, böylece ahşabın içine daha çok tanen girmesini sağlamak ve mantar çürüklüğüne karşı dayanımı arttırmaktır. Çalışmada, sarıçam örnekleri DMF içinde şişirilmiş ve ardından suda çözünen kestane ve kabalak tanenleriyle empenye edilmiştir. İki konsantrasyonda kestane ve kabalak taneni kullanılmıştır (%5 ve %10). Mantar çürüklük deneyleri EN 113 standardına göre yıkanmış ve yıkanmamış örneklerde bir esmer çürüklük mantarı olan *Poria placenta* kullanılarak yapılmıştır. Sonuçlar sadece DMF ile empenye edilmiş örnekler ve empenyesiz kontrol örnekleriyle kıyaslanmıştır. Tanen empenye edilmiş örneklerin mantar çürüklük dayanımları kontrole kıyasla artmış ancak yıkama işleminin tanenleri odundan uzaklaştırdığı görülmüştür.

Anahtar Kelimeler: dimetil formamit, tanen, mantar çürüklük testi, empenye

Introduction

Wood utilized in the outdoors may be severely decomposed by enzymes of rot fungi (Fengel and Wegener, 1984; Yildiz, 2000). The critical factor for fungal decay is moisture content (Williams, 2005). Moisture content above 20%, sufficient amount of oxygen, and temperature between 15-45°C are suitable environmental conditions for fungal growth. Wood in the outdoors generally meets with those environmental conditions and consequently exposes to decay (Zabel and Morrell, 1992; Yildiz, 2000). Rot fungi in the convenient conditions may decompose the

whole wood in a couple of years (Williams, 2005). Brown rot fungi, white rot fungi and soft rot fungi may cause weight losses around 70%, 96-97%, and 3-60%, respectively (Zabel and Morrell, 1992) and decrease mechanical resistance of wood considerably. 75% of mechanical resistance decrease due to brown rot decay only caused by 5% weight loss (Zabel and Morrell, 1992). In addition, decay in wood negatively affects esthetic appearance of wood, reduce physical, technological and biological properties (Evans et al., 2005; Williams, 2005) and thus limits its service-life. There are some

conventional ways to increase service life of wood used in the outdoors. According to place of utilization, wood materials can be impregnated by chemicals to eliminate fungal decay, and thus they may stand several years under or above water levels (Bozkurt et al., 1993; Yildiz, 2005). However, due to growing environmental consciousness, use of toxic impregnation chemicals are started to be limited and banned recently, instead use and investigation of eco-friendly chemicals are encouraged.

From the beginning of 21st century, wood preservation industry has been interested on alternative methods. Worldwide creosote and CCA (copper/chrome/arsenic) are the most used impregnation materials, and full-cell method is the most common impregnation process (Yildiz, 2005). Since Dec 31st 2003 the US Environmental Protection Agency (EPA) and Canada Pest Management Regulatory Agency (PMRA) banned use of arsenic included CCA for wood preservation industry and limited recovery of CCA treated wood. This decision was also accepted by EU countries, West Europe and European Institute for Wood Preservation (WEI-IEO) (EPA, 2006). Today, for wood protection still copper/chrome based or boron compounds are used. Boron compounds are effective against decay, but can be easily washed out by rain which limits its outdoor usage. Chrome based impregnation materials are also problematic in terms of environment and there are a lot of debate for their use. That's why new methods of wood protection such as modification, surface coating/paints, or use of plant-based extractive chemicals for impregnation are arising methods for investigation (Ermeýdan et al., 2012).

Tannins are amorphous phenolic biopolymers which can be extracted from various parts of plants like wood, branch, leaf, bark, and fruit. Efficiency of natural tannins depend on several factors such as type of tannin, type of origin, chemical structure, growth place and climate. Tannins have a wide spectrum of colors from light brown to white and a special odor. Tannins may react with alcohols, gelatin or other proteins and precipitate (Khanbabaee and Ree, 2001). Griffiths (1991) reported that tannins can be divided two sub-section as hydrolyzed and

condensed tannins. Small production of hydrolyzed tannins limits the economic interest on it but condensed tannins production is larger (Pizzi, 1983). Hydrolyzed tannins consist of pyrogallol, gallic and ellagic acid units and especially can be extracted from chestnut, Terminalia, Phyllanthus, divi-divi (*Caesalpinia coriaria*), oak and sumac (Gonultas, 2013). Yearly product of tannins in the world is about 200.000 tons and 90% of the production is condensed tannins (Pizzi, 2006). Main chemical structure of condensed tannins consist catechins (flavan-3-ol) and leucoanthocyanidins (flavan-3,4-diol). Especially tannins of Acacia and Quebracho heartwood have been investigated several times (Gonultas, 2013).

Plant polyphenolics are traditional extracts that are used for several purposes. Today, the interest on plant polyphenolics is focused on anti-oxidant properties. Mimosa, quebracho, sumac, oak bark tannins and pine tannins are used in formulations of various paints. Especially, in textile industry due to the risks of carcinogenic paint additives, interest on tannins is emerging (Gonultas, 2013). For tanning industry in Turkey production of oak (*Quercus ithaburensis*), pine barks, sumac (*Rhus coriariae*) leaves have economic value. Natural tanning materials are used in Turkish tanning industry and also exported (Sen and Hafizoglu, 2008).

According to 2009 statistics, our country has 2.950.000 m³ wooden boards and ranked 4th producer in the world (Sakarya ve Canli, 2011). Consequence of this huge production, a large amount of bark is gathered which is a main source of tannins. Another waste source of tannins is barks from the log production by forest enterprises. During log production a large amount of barks become waste. These waste barks are valuable biomass to extract important materials from the barks which will be an important addition to the economy (Gonultas, 2013).

In plants, tannins are used as a defense agent against pathogens, and limit oxidation and UV degradation (Grigsby et al., 2015). Natural tannins those are affective against fungicide and insecticide in plants has eco-friendly properties (Sen and Hafizoglu, 2008). Anti-oxidant and UV absorbent properties of

tannins depend on the hydroxylation level (Grigsby et al., 2015). Condensed tannins are anti-fungal impregnation materials and can form complexes with fungi enzymes to limit degradation (Laks et al., 1988). Besides, tannins can also form complexes with metal salts (zink, copper, iron, aluminum etc.) which may be used to formulate un-leachable and durable impregnation materials (Lotz and Hollaway, 1988; Scalbert et al., 1998).

Research on effect of some tannin types against decay in wood composites has already been carried out. Amusant et al. (2009) produced eco-friendly oriented-strand boards by using lignin and tannin based resin which resist against termite attack. Quebracho tannin was added to the phenol-formaldehyde resin to give additional mechanical strength and decay resistance to

tannin should be at least 4% for the effectiveness (Dirol and Scalbert, 1991). Another research was reported that mimosa tannin, chemically modified tannin and tannin-copper complex were used as conservative material for wood. It was found that a mixture of tannin+CuCl₂ and ammonia solution in wood helped fixation of tannin-copper complex in wood and increased decay resistance (Yamaguchi and Okuda, 1998). Anttila et al. (2013) reported that 8 different tannin fraction extracted from spruce cone, spruce bark and pine cone inhibited the growth of 8 different brown rot, 3 white rot, and 4 soft-rot species. Sen (2001) reported that extracted tannins have antifungal and insecticide properties above 4% concentrations. Other researchers (Tascioglu et al., 2012) impregnated wood samples with

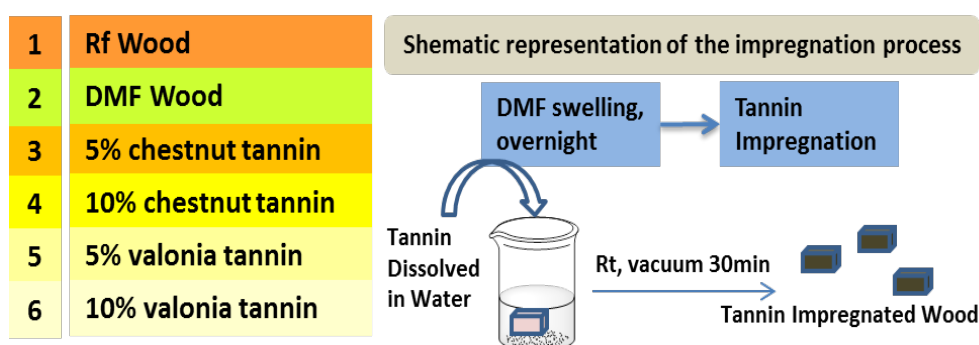

Figure 1. Left: 6 sets of samples were used during the study. Right: Schematic representation of the impregnation process

the plywood, and the formaldehyde emission was reduced (Charrier et al., 2010). Red pine bark extracts were used in boards and increased fungal resistance (Nemli et al., 2006).

In researches on tannin treated wood generally fungi and termite resistance of the product were investigated. Wood samples impregnated with Colatan IPG-F and Colatan PG-C materials which consists of Quebracho Colorado tannin were found to be resistant to white and brown rot fungi (Bernardis and Popoff, 2009). Water and sulfite extract of *Mimosa tenuiflora* was found to be as resistant as boric acid against termites (Calegari et al., 2014). It was found that white rot (*C. versicolor*) and brown rot (*G. trabeum*) resistance of wood impregnated with quebracho and chestnut tannin was increased, and it was reported that concentration of

6 and 12% concentration of mimosa, quebracho and red pine extract to investigate termite resistivity. They found that wood samples had the best termite resistance when they were treated with 12% of extract. In another research by Tascioglu et al. (2013), they used 4 different concentrations of mimosa, quebracho and red pine extract to observe brown-rot and white-rot resistance in impregnated wood. They found that 9 and 12% of mimosa and quebracho extract were effective against decay, while even 12% extract of red pine showed no resistance to decay.

It was mentioned that natural or synthetic tannin has no positive effect on dimensional stability of wood (Machado, 1992). In another research, oak, spruce, and chestnut tannins were investigated to find the shrinkage and decay (*A. Niger* and *P. placenta*) resistance,

and it was found that due to the hygroscopic nature of tannins, they leached out easily and did not get fixed into the wood (Militz and Homan, 1993).

In this paper, a new approach about impregnation of two types of tannins into already swelled wood by dimethyl formamide (DMF) was investigated. DMF is one of the polar solvents which swell wood 25% more than water (Mantanis et al., 1994). It was thought that more swelling of wood structure and in the swelled state, cell wall or lamella may be impregnated with more extractive materials, and thus decay resistance will be improved. In the study, wood preservation by different concentrations of chestnut and valonia tannins were investigated against brown rot fungus *P. placenta*, and the results were compared to reference (control) and only DMF treated wood samples. DMF treated samples were studied to observe if DMF itself may have any toxic effect against fungi. Leaching tests were carried out to investigate the possible fixation of tannins into wood structure by use of DMF. Brown rot fungi were chosen in the study because brown rot wood decay represents a major problem in the storage and preservation of wooden structures and causes a rapid destructive decay, which is the main reason of failure in wooden structures and buildings (Zabel and Morell, 1992). Brown rot fungi are the most prevalent to attack on softwoods such as pine, fir, spruce etc.

Chemicals: Chestnut and valonia tannins were supplied from Balaban Valeks Inc., Manisa, Turkey. Dimethyl formamide (DMF) were ordered from Merck and used as delivered. Malt extract-agar and sterile plastic petri dishes (90 mm diameter) were used for decay test. Distillated water was used for all necessary cases.

Impregnation Process: 6 sets (Figure 1) of wood samples were soaked in DMF over night to swell wood structure. This step was applied for better chemical uptake into the cell walls in the further step. DMF was poured out and later on, 5 and 10% of chestnut and valonia tannins dissolved in water were poured on already swelled wood samples. 45 minutes of vacuum at 650 mmHg were applied for impregnation, and samples were 1 hour more waited in solutions for diffusion. Retention (kg/m^3) of solutions in wood was calculated. Ten replicates were used for each set.

Leaching Test: Half of the samples including the controls were used for leaching. Leaching test was conducted to treated samples according to EN 84 standard in order to evaluate any loss in effectiveness in biological resistance. 6 sets of samples were leached for 14 days with 9 changes of the distilled water.

Decay Resistance Test: Decay test was performed according to principles of EN 113, with some modifications on sample dimensions, Kolle flasks, and total test period. Instead of Kolle flasks, plastic sterile petri



Figure 2. *Poria placenta* growth in petri dishes and decayed samples

Material and Method

Wood material: Scots pine (*Pinus sylvestris* L.) sapwood samples with dimensions of 5 mm (tangential) x 15 mm (radial) x 30 mm (longitudinal) were supplied from Osmanlı Mobilya, Bursa, Turkey.

dishes were used.

Malt extract agar of 4.8% concentration and samples were sterilized in an autoclave at pressure of about 0.1 MPa at 120 °C for 25 minutes.

A brown-rot fungus namely, *Poria placenta* was inoculated to sterile malt extract

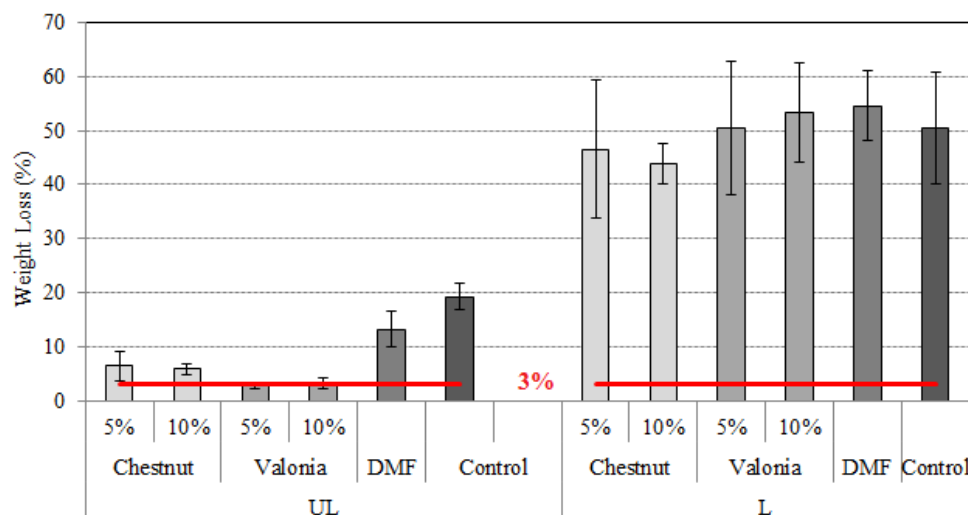

Figure 3. Weight loss of leached and unleached samples

agar medium in the petri dishes. 6 sets of samples (test and control) were placed on the growing mycelium in each petri dish, and then were incubated at 20 °C and 65% RH for 6 weeks. At the end of the test, samples were removed from the petri dishes, cleaned, and dried at a temperature of 103°C. Weight loss was calculated on the basis of oven-dry weight before and after decay test.

Statistical Analysis: Differences in weight loss values were analyzed by One Way Anova test using with SPSS 13.0 program. The significance ($P < 0.05$) was compared with Duncan homogeneity groups.

Results and Discussion

The retention (kg/m^3) of wood samples after impregnation is given in Table 1. The retentions increased as the solution concentration increased from 5 to 10%. Both tannin impregnations at the same concentration level showed similar retentions in wood samples.

P. placenta growth in petri dishes and decayed samples is shown in Figure 2. All samples were covered by mycelium during the decay test. After the test, small cubic cracks and a brown discoloration were seen on the control and leached samples. The weight loss (%) of leached and unleached wood samples due to *P. placenta* attack is given in Figure 3. Depending on the concentration, the weight loss of samples treated with tannin solutions was found to be 2.7-6.42% for unleached

samples, and 43.85-53.30% for leached samples.

Table 1. The retention of wood impregnated samples

Treatment groups	Retention (kg/m^3)
Chestnut 5%	30.15 (1.03)*
Tannin 10%	59.10 (2.83)
Valonia 5%	30.42 (1.54)
Tannin 10%	60.59 (2.58)

*Values in parenthesis are standard deviations.

Tannin impregnated samples demonstrated a slower decay rate than control samples. Protection effect of chestnut tannin at the 5 and 10% concentration was 67 and 69%, and the rates were 86 and 83% for 5 and 10% concentration of valonia tannin, respectively. DMF treatment had 31% biological resistance against *P. placenta* in comparison to controls. The mechanisms involved in tannin toxicity are explained by many authors. Plant extracts and tannins have highly fungicide and insecticide properties due to their phenolic structure (Sen and Hafizoglu, 2008). Their ability to form soluble or insoluble complexes with fungi proteins or polysaccharides has been discussed in relation to their toxicity. They might inactivate fungi enzymes or reduce the accessibility of wood cell-wall polysaccharides by fungi enzymes (Dirol and Scalbert, 1991). Another toxicity mechanism might involve complexation by tannin of the metal ions such as iron required by the fungi

(Dirol and Scalbert, 1991). Both tannins used in this study are mainly hydrolyzed tannins consist of pyrogallol, gallic and ellagic acid units (Gonultas, 2013). But valonia tannin consist of 5% of condensed tannin (Gonultas, 2013). Catechol, epicatechin and gallic acid are known with suppressing fungal activity (Tascioglu et al., 2013). According to EN 113 test, the average weight loss of treated samples should be less than 3% of their initial dry mass for a good biological resistance against decay fungi. Among the test groups, valonia tannin treated samples met this criterion and can be considered as an effective wood preservative against brown rot fungus, *P. placenta*. Chestnut tannin solutions resulted in weight losses 6.42 and 5.96% for 5 and 10% concentration, respectively. This indicates effectiveness of chestnut tannin was not high enough to prevent fungal activity of *P. placenta*. Different chemical composition of tannins could affect the biological activity differently. Valonia may be more effective due to having 5% of condensed tannins in its composition. In addition, particle size of tannins may affect the biological resistance. Particle size is believed to be responsible for penetration depth of solutions thus directly affecting durability of treated specimens (Tascioglu et al. 2013). Chestnut tannin particles were absorbed on surfaces due to their larger size leaving core sections vulnerable to fungal decay. Similar observations were also noted on pine bark extract by Tascioglu et al. (2013). The increased concentration levels did not significantly reduce weight losses for both tannin solutions. This was also proven by statistical test (Anova, $P < 0.05$). DMF treated samples exhibited a slightly lower weight loss than the controls, indicating the solvent treatment had no positive influence on biological resistance of wood.

Leaching procedure increased weight loss of impregnated samples. In some cases, tannin impregnated samples exhibited slightly higher weight losses when compared to the control samples. This finding clearly showed that all tannin in wood leached out from wood during leaching procedure. During the leaching period, dark leaching water was observed in spite of replacement of leached water with the fresh water for 9 times as reported in EN 84

standard. This indicated that tannin leaching continued to 14 days in water immersion. The weight losses in leached samples including the controls did not statistically differ to each other, indicating similar performance on decay resistance was obtained in impregnated and control samples against *P. placenta* attack. Militz and Homan (1993) also reported oak, spruce and chestnut tannins leached out easily and did not get fixed into the wood due to their hygroscopic nature. The decay test results of leached samples clearly showed that DMF did not provide more tannin absorption inside wood cell walls and a positive effect on decay resistance for chestnut and valonia tannins.

As an interesting result, the unleached control samples had lower weight loss (19.25%) than leached controls (50.45%). Two possible reasons may cause this observation. 1) Leaching of some extractives from wood during leaching procedure for 14 days, 2) Growth of fungi on leached control samples could differ from fungi growth on unleached samples. Mycelium growth and its spreading rate on unleached controls could be suppressed with the tannin in treated samples since unleached test samples were put with the unleached controls in the same petri dish.

According to EN 350-1 standard which shows durability classes based on the weight loss, Valonia tannin impregnated samples had durability class 1, meaning very durable, while chestnut tannin impregnated samples had durability class 2, durable, before leaching procedure. They all had durability class 5 which means not durable after leaching.

Conclusions

Chestnut and valonia tannins can be used as alternative environmental friendly wood preservatives against brown rot fungi used in this study. Valonia tannin had better fungicide properties than chestnut tannin. Concentrations of the tannin solutions did not have a significant effect on decay resistance. Biological resistance obtained by tannin toxicity in wood samples was lost after leaching procedure. This finding clearly showed that all tannin in wood leached out from wood during leaching for 14 days, and DMF did not provide more tannin absorption

inside wood cell walls and a positive effect on decay resistance. According to the results, the chestnut and valonia tannins can be recommended in indoor applications where usage of non-toxic chemicals is unacceptable. For better understanding the role of these tannins on decay resistance of wood, GS-MS and HPLC analysis are needed for the determination of the chemical components for fungal activity. SEM analysis could also helpful to determine the particle size and distribution of tannins inside wood.

References

- Antilla, A-K., Pirtillä, A.M., Häggman, H., Harju, A., Venäläinen, M., Happala, A., Holmbom, B., Julkunen-Tiitto, R., 2013. Condensed Conifer Tannins as Antifungal Agents in Liquid Culture, *Holzforschung*, DOI 10.1515/hf-2012-0154.
- Bernardis, A.C., Popoff, O., 2009. Durability of Pinus Elliotti Wood Impregnated with Quebracho Colorado (*Schinopsis Balansae*) Bio-Protectives Extracts and CCA, *Maderas. Ciencia y Tecnologia*, 11(2), 107-115.
- Bozkurt, A., Göker, Y., Erdin, N., 1993. Impregnation Technique, Istanbul: Istanbul University, Press No: 3779, Faculty Press No: 425 (In Turkish).
- Calegari, L., Lopes, P.J.G., Santana, G.M., Stangerlin, D.M., De Oliveira, E., Gatto, D.A., 2014. Eficiência de Extrato Tânico Combinado ou não com Ácido Bóronico na Proteção da Madeira de *Ceiba pentandra* Contra Cupim Xilófago, *Floresta*, 44, 43-52.
- Charrier, F., Moubarik., Allal, A., Pizzi, A., Charrier, B., 2010. Fungal Decay resistance and Mechanical Properties of Plywood Panels Made from Maritime Pine (*Pinus Pinaster*) and Bonded with Cornstrach-Quebracho Tannin-Phenol Formaldehyde Adhesive, 41st Annual Meeting, Biarritz, France, IRG/WP10-40490.
- Dirol, D., Scalbert, A., 1991. Improvement of Wood Decay Resistance by Tannin Impregnation, 22nd Annual Meeting, Kyoto, JAPAN, IRG/WP2380.
- EN 113:1980 Wood preservatives. Test method for determining the protective effectiveness against wood destroying basidiomycetes. Determination of the toxic values
- EN 84:1997 Wood preservatives. Accelerated ageing of treated wood prior to biological testing. Leaching procedure.
- EPA (2006) US EPA – Pesticides: Reregistration – Chromated Copper Arsenate (CCA).
<http://www.epa.gov/oppad001/reregistration/cca/>
- (January 25th 2010)
- Ermeýdan, M.A., Cabane, E., Masic, A., Koetz, J., Burgert, I., 2012. *Applied Materials and Interfaces*, 4, 5782-5789.
- Evans, P., Chowdhury, J.M., Mathews, B., Schmalzl, K., Ayer, S., Kiguchi, M., Kataoka, Y. 2005. 277-293. Weathering and surface protection of wood, *Handbook of environmental degradation of materials*. Editor: Kutz, M., New York: William Andrew Inc.
- Fengel, D., and Wegener, G., 1984. *Wood : chemistry, ultrastructure, reactions*, W. de Gruyter, Berlin ; New York.
- Gonultas, O., 2013, “Use of Bark Tannins of East Spruce (*Picea orientalis*) and Oak (*Quercus* spp.) for Production of Bio-glue”, Ph.D. Thesis, Istanbul University. Science Institute, Istanbul (In Turkish).
- Griffiths, D.W., 1991, *Toxic substances in crop plants*, ed. J. P. F. D’Mello, D. M. Duffus and J. H. Duffus, The Royal Society of Chemistry, Cambridge, p. 180.
- Grisby, W., Bridson, J.H., Schrade, C., 2014. “Modifying Biodegradable Plastics with Additives Based on Condensed Tannin Esters”, *Journal of Applied Polymer Science*, DOI:10.1002/app.41626.
- Khanbabae, K., Ree, T.V., 2001, Tannins: classification and definition, *Natural Product Reports*, 18, 641–649.
- Laks, P.E., McKaig, P.A., 1988. Flavonoid Biocides: Wood Preservatives Based on condensed Tannis, *Holzforschung*, 42, 299-306.
- Lotz, W.R., Hollaway, D.F., 1988. Wood Preservation, United States Patent, Patent number: 4,732,817.
- Machado, J.S., 1992. Impregnation of Timber Tannin as a Mean of Improvng its Dimensional Stability, International Research Group on Wood Preservation Harrogate, Unated Kingdom, IRG/WP/3695-92.
- Mantanis, G. I., Young, R. A., and Rowell, R. M., 1998. Swelling of Wood. Part II. Swelling in Organic Liquids, *Holzforschung*, 48(6), 480-490.
- Militz, H., Homan, W.J., 1993. The Use of Natural and Synthetical Tannis to Improve the Dimensional Stability and Durability of Beechwood (*Fagus Sylvatica*), International Research Group on Wood Preservation Orlando, USA, IRG/WP/93-30016.
- Nemli, G., Gezer, E.D., Yildiz, S., Temiz, A., Aydin, A., 2006. Evaluation of the Mechanical, Physical Properties and Decay Resistance of Particleboard Made from Particles Impregnated with Pinus Brutia Bark Extractives, *Bioresource Technology*, 97,2059–2064.
- Pizzi, A. 2006. Recent developments in eco-efficient bio-based adhesives for wood bonding:

opportunities and issues, *Journal of Adhesion Science and Technology*, 20(8), 829-846.

Pizzi, A., 1983, *Wood adhesives chemistry and technology*, Marcel Dekker: New York, vol. 1, 0-8247-1579-9.

Sakarya, S., Canli, S., 2011, *Board Industry Report*, Central Anatolia Wood and Forestry Products Exporters' Association Press, Ankara.

Scalbert, A., Cahill, D., Dirol, D., Navarrete, M.-A., De Troya, M.-T., Van Leemput, M., 1998. A tannin / copper preservation treatment for wood, *Holzforschung*, 52(2), 133-138.

Sen, S., 2001. *Determination of Wood Preservative Activities of Plant Phenolics*, Ph.D. Thesis, Zonguldak Karaelmas University, Graduate School of Natural and Applied Sciences, Department of Forestry Industrial Engineering, pp. 300, Bartin.

Sen, S., Hafizoglu, H., 2008. *Determination of Wood Preservative Effects of Some Plant Extracts Contacting with Soil*, *Duzce University Forestry Journal*, 4(1-2), 69-82 (In Turkish).

Tascioglu, C., Yalcin, M., De Troya, T., Sivrikaya, H., 2012. *Termiticidal Properties of Some Wood and Bark Extracts Uses as Wood Preservatives*, *Bioresources*, 7(3), 2960-2969.

Tascioglu, C., Yalcin, M., Sen, S., Akcay, C., 2013. *Antifungal Properties of Some Wood Plant Extracts Used as Wood Preservatives*, *International Biodeterioration & Biodegradation*, 85, 23-28.

Williams, R.S., 2005. *Weathering of wood*, (Editor: Rowell, R. *Handbook of wood chemistry and wood composites*.) CRC Press, 139-185, Florida.

Yamaguchi, H., Okuda, K.-I., 1998. *Chemically Modified Tannin and Tannin-Copper Complexes as Wood Preservatives*, *Holzforschung*, 52(6), 596-602.

Yildiz, Ü.C. 2000. *Odun Zararlıları Ders Notları (Basılmamış)*. Trabzon: KTÜ, Orman Fakültesi.

Yildiz, Ü.C. 2005. *Odun Koruma Ders Notları (Basılmamış)*. Trabzon: KTÜ, Orman Fakültesi.

Zabel, R.A., Morrell, J.J., 1992. *Wood microbiology: decay and its prevention*, UK: Academic Press. Inc.

The Comparison of Fibre Morphologies of Growing Some Tree Woods in Turkey Naturally

*Ekrem DURMAZ¹, Saim ATEŞ¹

¹Kastamonu University, Faculty of Forestry, Department of Forest Industrial Engineering,
Kastamonu/TURKEY

*Corresponding Author: edurmaz@kastamonu.edu.tr

Abstract

Alnus glutinosa, *Paulownia tomentosa*, *Quercus robur*, *Juniperus foetidissima*, *Citrus sinensis*, *Robinia Pseudoacacia Deca İsneana Hispida*, *Abies nordmanniana subsp. Bornmulleriana*, *Juglans regia*, *Buxus sempervirens*, *Acer platanoides*, *Castanea sativa*, *Pinus nigra*, *Malus domestica* and *Prunus avium* trees grow in many regions of Turkey naturally. It is possible that assessment of these trees in many of industries and in landscape design. Furthermore some of them are used for fruit growing. The maceration process is made to provide realizing of wood fiber analyses truer and easier. The samples which were cut from stated tree types were treated to maceration process with 37% formaldehyde solution and 50% nitric acid solution. With this process, the samples were softened and by providing disintegration of fibers easily, fiber dimensions were measured. In consequence of obtained results, felting ratio, elasticity modulus, rigidity modulus, muhlstep ratio, Runkel ratio and F factor were determined.

Keywords: Maceration, Fiber analysis, Formaldehyde, Nitric acid

Türkiye’de Doğal Olarak Yetişen Bazı Ağaç Odunlarının Lif Morfolojilerinin Karşılaştırılması

Özet

Kızılağaç (*Alnus glutinosa*), pavlonya (*Paulownia tomentosa*), meşe (*Quercus robur*), kokulu ardıç (*Juniperus foetidissima*), portakal (*Citrus sinensis*), pembe çiçekli akasya (*Robinia Pseudoacacia Deca İsneana Hispida*), uludağ göknarı (*Abies nordmanniana subsp. Bornmulleriana*), ceviz (*Juglans regia*), şimşir (*Buxus sempervirens*), çınar yapraklı akçaağaç (*Acer platanoides*), kestane (*Castanea sativa*), karaçam (*Pinus nigra*), elma (*Malus domestica*), kiraz (*Prunus avium*) ağaçları Türkiye’nin pek çok yöresinde doğal olarak yetişmektedir. Bu ağaçların pek çok sanayi kolunda ve peyzaj düzenlemesinde değerlendirilmesi mümkündür. Ayrıca bazıları meyve yetiştiriciliği için de kullanılmaktadır. Maserasyon işlemi odun lif analizlerinin daha doğru ve kolay bir şekilde gerçekleştirilmesini sağlamak için yapılmaktadır. Belirtilen ağaç türlerinden alınan örnekler %37’lik formaldehit çözeltisi ve %50’lik nitrik asit çözeltisi ile maserasyon işlemine tabi tutulmuştur. Bu işlem ile örnekler yumuşatılmış ve liflerinin kolay bir şekilde ayrışması sağlanarak lif boyutları ölçülmüştür. Elde edilen sonuçlar neticesinde keçeleşme oranı, elastiklik katsayısı, rijidite katsayısı, muhlstep oranı, Runkel oranı ve F faktörü belirlenmiştir.

Anahtar Kelimeler: Maserasyon, Lif analizi, Formaldehit, Nitrik asit

Introduction

Since ancient eras, wood products have attained a place in the industry as production of furniture, pulp and paper etc. Owing to high mechanical and physical properties of wood fibres, the products which are produced from wood also display advanced durability, tensile strength and flexibility characteristics. Especially in the paper industry, types of the used fibres in the pulp impress the quality of produced paper.

Pulp and paper industry is one of the most important industrial areas in the world. The more population growth rate increases, the more necessity for wood raw materials

increases, too and this become a significant issue day by day (Kırcı 2009).

The world forests include 31% coniferous tree and 69% deciduous tree (Bozkurt and Erdin 1989). It is thought that coniferous tree is the best option for the production of pulp. However due to decreasing in coniferous forests, deciduous trees prefer in the production of pulp yet (Rydholm 1965). Coniferous trees have long fibres and these fibres increase sheet strength in paper production. Deciduous trees have short and fine fibres and it can be produced papers with very homogeneous and smooth surface. Hence in the world for the production of pulp

coniferous and deciduous fibres are used with together by mixing (Kırcı 2009).

Pulp production contains mechanical or chemical treatment. In mechanical treatment wood is hewed, while in chemical treatment fibres can be separated with chemicals easily without crumbling. Moreover fibre dimensions are among the most substantial quality factors in pulp production as commercially (Hudson et al. 1995; Sandercock et al. 1995).

The maceration process provides to separate the fibres without damaging. In researches different maceration methods were tried. Nitric acid in combination with other chemicals was used in varied concentrations. The solution in different concentration of nitric acid and potassium chlorate is identified Schultze's method (Chamberlain 1915). In many research Schultze's method was modified. Jeffrey (1917) conducted maceration with by combining 8% and 10% nitric acid and chromic acid solutions in equal ratio. Schmid (1982) sonicated and modified Jeffrey's method. Franklin (1945) macerated wood fibres acetic acid and hydrogen peroxide. Spearin and Isenberg (1947) preferred acetic acid and sodium chlorite for maceration. However they noticed that the fibres damaged comparatively. Burkart (1966) used phenol sulfonic acid and triethylene glycol in maceration treatment. Hall et al. (1986) utilized from nitric acid and formaldehyde to macerate. Han et al. (1999) measured dimensions of macerated Kenaf fibres with digimizer and they investigated relationship between fibres dimensions and growth condition.

The importance of wood fibre dimensions and their derived values such as felting ratio, elasticity modulus, rigidity modulus, muhlstep ratio, Runkel ratio and F factor on pulp and paper mechanical strength was researched beforehand. Seth and Page (1988) stated that tearing resistance relates to fibre length influentially. Horn (1978) specified that increase in plant fibre length improves the tearing strength of hardwood pulps. Horn and Setterholm (1990) determined that the plurality of distinctness in burst and tensile strength in hardwood paper sheets would be considered for by fibre length and cell wall thickness. In addition to Kellogg and

Thykeson (1975) and Matolcsy (1975) stated the importance of fibre dimensions for determining pulp mechanical properties. Dinwoodie (1965) expressed the significance of the three formed values on pulp strength. Saikia et al. (1997) and Ogbonnaya et al. (1997) utilized from those derived values to evaluate the convenience of different non-wood fibres raw materials for pulp and paper manufacture. However, the dimensions of fibres are not only important factor in the production of pulp and paper. Besides, in terms of the mechanical properties of paper cellulose and lignin contents of wood types have importance. Particularly fibre mechanical strength and tensile strength associated with cellulose content. As for lignin is an unenviable component and it must be removed from the pulps (Madakadze et al. 1999; Ververis et al. 2004).

Nowadays, long-fibred and short-fibred pulp terms are uttered in the pulp and paper production. The relations between lengths of fibres of pulp and properties of pulp are very significant. To illustrate the increase in fibre length influences the strength properties of paper positively, whereas in the papers which were produced with very high long fibres structural defects occur. Additionally fibre wall thickness is effective in the durability of fibres. It was seen that tearing strength of produced papers with fibres with overfine wall was low. As for strength properties of fibres with very thick wall is low since they can't flatten sufficiently and they cause bulky papers (Kırcı 2009).

Material and Method

In this study, as wood samples *Alnus glutinosa*, *Paulownia tomentosa*, *Quercus robur*, *Juniperus foetidissima*, *Citrus sinensis*, *Robinia Pseudoacacia*, *Deca Isneana Hispida*, *Abies nordmanniana* subsp. *Bornmulleriana*, *Juglans regia*, *Buxus sempervirens*, *Acer platanoides*, *Castanea sativa*, *Pinus nigra*, *Malus domestica* and *Prunus avium* were used. The samples were gathered from different cities of Turkey. To separate the fibres, Mahesh et al. (2015)'s method was carried out. Wood samples were cut in the shape of matchstick. Gathered wood samples were sunk in 37% formaldehyde solution and it was waited during a night. Before the

maceration treatment, samples were washed with distilled water and filtered to inhibit more evaporation of formaldehyde solution fumes. The concentration of nitric acid was 50%. Wood samples were put in the beakers with nitric acid and submerged completely. The beakers were placed in a water bath at 70°C. Maceration treatment proceeded 5-6 hours until the samples bleached. The beakers were taken out water bath and were cooled at room temperature. After the beakers were refrigerated, acid solutions were drained and macerated samples were washed plenty of distilled water.

For microscopic investigations, the solutions were prepared with safranin. Safranin gives a red colour to solution and provides to appear the fibres more brilliantly. Then a little fibres solution was taken with a dropper and it was put on the glass slide.

The measurements of fibres were realized with a light microscope. For determination of fibre lengths, fibre widths and lumen widths 100 measurements were performed. With obtained fibre dimensions were measured felting ratio, elasticity modulus, rigidity modulus, Muhlstep ratio, Runkel ratio and F factor. In calculations, these formulas were used (Bozkurt, 1971; Göksel, 1986; Tank et al. 1990).

Felting Ratio = Fibre Length (L) /
Fibre Width (D)

Elasticity Modulus = Lumen Width (d) x
100 / Fibre Width (D)

Rigidity Modulus = Fibre Wall Width
(W) x 100 / Fibre Width (D)

Muhlstep Ratio = Fibre Wall Area
($D^2 - d^2$) x 100 / Fibre Cross-Sectional Area
(D^2)

Runkel Ratio = 2 x Fibre Wall
Thickness (W) / Lumen Width (d)

F Factor = Fibre Length (L) x
100 / Fibre Wall Thickness (W)

that in 60% acid solution the structures of fibres were damaged and splintered. Achieved results were demonstrated in Table 1 and Table 2. In Table 1 the results of fibre dimensions and in Table 2 the properties for paper production were specified.

Results and Discussion

In consequence of this study, it was seen that 50% nitric acid solution is appropriate for maceration of fibres. Mahesh et al. (2015) used this process. They tried three different nitric acid solutions as 40%, 50% and 60%. It is sighted that the fibres separated in 40% solution merely. Furthermore they noticed

Table 1. The average dimensions of fibres

Wood Types	Fibre Length (µm)	Fibre Width (µm)	Lumen Width (µm)	Fibre Wall Width (µm)
<i>Alnus glutinosa</i>	968,46	28,16	18,36	5,31
<i>Paulownia tomentosa</i>	1014,83	30,68	22,92	4,06
<i>Quercus robur</i>	514,55	16,57	8,13	4,17
<i>Juniperus foetidissima</i>	1013,89	22,09	14,89	3,98
<i>Citrus sinensis</i>	582,75	12,40	7,91	2,36
<i>Robinia Pseudoacacia Deca İsneana Hispida</i>	295,21	17,66	11,05	3,28
<i>Abies nordmanniana subsp. Bornmulleriana</i>	2075,20	39,23	24,86	7,65
<i>Juglans regia</i>	989,71	16,08	8,96	4,26
<i>Buxus sempervirens</i>	461,36	18,46	8,78	4,84
<i>Acer platanoides</i>	258,09	21,35	15,34	3,54
<i>Castanea sativa</i>	716,74	23,16	13,18	5,06
<i>Pinus nigra</i>	1220,35	22,84	12,25	5,42
<i>Malus domestica</i>	1116,43	20,44	16,72	1,98
<i>Prunus avium</i>	715,64	17,28	11,80	3,48

Table 2. The some mechanical and paper production properties of samples

Wood Types	Felting Ratio	Elasticity Module	Rigidity Index	Muhlstep Ratio	Runkel Ratio	F Factor
<i>Alnus Glutinosa</i>	34,39	65,19	18,85	57,49	0,57	18238,41
<i>Paulownia Tomentosa</i>	33,07	74,70	13,23	44,18	0,35	24995,81
<i>Quercus Robur</i>	31,05	49,06	25,16	75,92	1,02	12339,32
<i>Juniperus Foetidissima</i>	45,89	67,40	18,01	54,56	0,53	25474,62
<i>Citrus Sinensis</i>	46,99	63,79	19,03	59,31	0,60	24692,79
<i>Robinia Pseud. Deca İs. Hispida</i>	16,71	62,57	18,57	60,84	0,59	9000,30
<i>Abies Nord. Subsp. Bornm.</i>	52,89	63,36	19,50	40,15	0,61	27126,79
<i>Juglans Regia</i>	61,54	55,72	26,49	68,95	0,95	23232,62
<i>Buxus Sempervirens</i>	24,99	47,56	26,21	77,38	1,10	9532,23
<i>Acer Platanoides</i>	12,08	71,85	16,58	48,37	0,46	7290,67
<i>Castanea Sativa</i>	30,94	56,90	21,84	67,61	0,76	14164,82
<i>Pinus Nigra</i>	53,43	53,63	23,73	71,23	0,88	22515,68
<i>Malus Domestica</i>	54,61	81,80	9,68	33,08	0,23	56385,35
<i>Prunus avium</i>	41,42	68,28	20,13	53,36	0,58	20564,36

According to Table 1, the longest fibres were seen in *Abies nordmanniana* subsp. *Bornmulleriana* samples as 2075,20 µm. It is determined that in USA the fibres length of some wood types were as 1260 µm in *Betula populifolia* Marsh., 1350 µm in *Betula papyrifera* Marsh., 1520 µm in *Betula lenta* L., 1380 µm in *Betula alleghaniensis* Britton, 1330 µm in *Populus grandidentata* Michx., 1380 µm in *Populus trichocarpa* Torr.& Gray, and 1320 µm in *Populus tremuloides* Michx. (Panshin and Zeeuw 1970). The fibre lengths of *Populus canescens* L. and *Populus nigra* L. were measured as 1257 µm and 1208 µm respectively (Saribas, 1989). In the past it was thought that the fibre length is the most significant factor which affects paper characteristics. Afterwards conducted researches displayed that the ratio to fibre width of fibre length (felting ratio) is more substantial than only fibre length (Panshin and Zeeuw, 1970). Felting ratio gives any ideas about tearing strength (Göksel 1986; Bostancı 1987). Once Table 2 was examined, it is found that the highest felting ratio is 61,54 in *Juglans Regia* samples. Huang (1970) specified as 48,14 for I-214, 54,33 for 70 D and 56,19 for 64 D in three varied clone of *Populus euroamericana*. Felting ratio was found as 48.72 for *P. Canadensis* and 43,58 for *P. nigra* (Saribas, 1989).

Modulus of elasticity calculates by proportioning lumen width to fibre width. There is a positive relation between modulus of elasticity with tensile strength and when modulus of elasticity increases, tensile strength increases (Bozkurt 1971; Göksel 1986; Bostancı 1987). It was found that the highest elasticity module is in *Malus Domestica* with 81,80 in Table 2. These fibres are included to very flexible fibres groups which be modulus of elasticity greater than 75. The fibres in this group are very flexible. However tearing strength of produced papers from these fibres is low (Kırcı 2009).

Rigidity index is the opposite situation modulus of elasticity. In the even that the high rigidity index, the physical strength properties of paper are influenced negatively and in

fibres with high stiffness index the connection between fibres cannot be established sufficiently (Akkayan 1983; Göksel 1986). According to researches rigidity index affects tearing factor positively, whereas it affects bearing strength negatively (Bozkurt, 1971). The highest rigidity index was confirmed as 26,49 in *Juglans Regia*. It was found rigidity index in *Pinus maritima* as 16,60, in *Pinus radiata* as 18.80, in *Pinus brutia* as 19,08, in *Fagus orientalis* Lipsky as 37, in *Carpinus orientalis* Miller as 42 and in *Carpinus betulus* L. as 30 (Tank, 1968; Tank et al. 1990).

According to Runkel classification, in fibres with thick wall when Runkel ratio is bigger than 1, these fibres are determined as “minimum suitable fibres for paper production”. In case of this ratio is equal to 1, the fibres are suitable for paper production. When the ratio is under 1, these fibres are the optimum fibres for paper production since they are with thin wall (Bozkurt 1971; Akkayan 1983; Göksel 1986). In this case according to Table 2, *Quercus Robur* and *Buxus Sempervirens* were seen that they aren't suitable for paper production. It was thought that the other types are appropriate for papermaking.

Mühlstep ratio is a relation between relative area of fibre wall and paper quality. This ratio gives prior knowledge about weights of produced papers. As this ratio diminishes, the strength properties of paper increase positively (Bostancı 1987). When Table 2 was investigated, it was noticed that *Malus Domestica* has the lowest Mühlstep ratio with 33,08. Thus it can be said that *Malus Domestica* fibres have high strength properties. Tank et al. (1990) found as 61,78 and 61,17 Mühlstep ratios of *P. brutia* and *P. radiata*, respectively.

It is stated that flexibilities of papers which were obtained from fibres with high F factor are high (Bostancı 1987). According to Table 2, *Malus Domestica* samples have the maximum F factor, therefore, it is thought that the papers produced from these fibres have good flexibility properties.

Conclusion

It was seen that most of researched samples are suitable for paper production with regard to Elasticity Module and Runkel Ratio, however they aren't suitable in terms of Felting Ratio. These results gave us pre-understanding about paper production from these fibres. Nevertheless in order to understand exactly convenience of these fibres for paper production, it is necessary determination of cellulose, hemicellulose, lignin and extractives contents of them. Furthermore different maceration methods can be used to separate the fibres and to compare the fibre dimensions. But in the paper production usage of coniferous and deciduous tree woods with together gives excellent results by gathering positive aspects of them and in the world it is applied in this way.

References

- Akkayan S. C. 1983. Sarıçam (*P. sylvestris* L.), Kızılcım (*P. brutia* Ten) ile Doğu Kayını (*Fagus orientalis* Lipsky), Kavak (*P. euroamericana* c.v. I-214), Okalıptus (*E. camaldulensis* Dehnh.) odunlarından elde edilen selüloz karışımları, özellikleri ve kağıt üretiminde kullanılabilme olanakları üzerinde araştırmalar. İ.Ü. Orman Fakültesi Dergisi, Seri A, 33 (1), 104-132.
- Bostancı Ş. 1987. Kağıt hamuru üretimi ve ağartma teknolojisi. K.T.Ü Orman Fakültesi, 114 (13), Trabzon, 299.
- Bozkurt Y. 1971. Doğu Ladini (*Picea orientalis* Link. et Carr.) ile Toros Karaçamı (*Pinus nigra* var. *caramanica* (Loud.) Rehd.)'dan birer ağaçta lif morfolojisi üzerine denemeler. İ.Ü. Orman Fakültesi Dergisi Seri A, 21 (1), 70-93.
- Bozkurt A. Y., Erdin N. 1989. Odunsu lifler ve tanımı. Orman Fakültesi Dergisi, Seri B, 4, 1-16.
- Burkart L. F. 1966. New technique for maceration of woody tissue. Forest Products Journal, 16, 52.
- Chamberlain C. J. 1915. Plant cell physiology: Schultze's maceration method. In: Chamberlain C.J. (eds) Methods in Plant Histology. University of Chicago Press, Chicago.
- Dinwoodie J. M. 1965. The relationship between fiber morphology and paper properties: A review of literature. Tappi, 48 (8), 440-447.
- Franklin G. L. 1945. Preparation of thin sections of synthetic resins and woody resin composites and a new method for wood. Nature, 155, 3924-3951.
- Göksel E. 1986. Pamuk saplarının selüloz ve kağıt endüstrisinde kullanım olanakları üzerine araştırmalar, İstanbul Üniversitesi Orman Fakültesi Dergisi, Seri A, 36 (1), 38-54.
- Hall R., Patton B. D., Haas P. A. 1986. Reaction of formaldehyde and nitric acid in a remotely operated thermosiphon evaporator. In: Proceedings of Waste Management '86, Tucson, Arizona, USA.
- Han J. S., Mianowski T., Lin Y. 1999. Validity of plant fiber length measurement: A review of fiber length measurement based on kenaf as a model. Kenaf properties, processing and products. Mississippi State, Mississippi State University, Ag & Bio Engineering, 149-167.
- Horn R. A. 1978. Morphology of pulp fiber from hardwoods and influence on paper strength. USDA Forest Service. Research Paper FPL 312, Forest Products Laboratory, Madison, WI, USA.
- Horn R. A., Setterholm V. C. 1990. Fiber morphology and new crops. In: Janick, J., Simon, J.E. (Eds), Advances in New Crops. Timber Press, Portland, OR, 270-275.
- Huang M. Z. 1970. I-214, 70 D ve 64 H Melez Kavak klonlarında lif morfolojisi yönünden araştırmalar ve odunlarından yarı kimyasal metotla selüloz elde etme imkanları, Basılmamış Doktora Tezi.
- Hudson I. L., Wilson C., Sandercock C. F. Sands R. 1995. Within-ring variability of wood microstructure in *Eucalyptus nitens*. In: Potts BM, Borralho NMG, Reid JB, Cromer RN, Tibbits WN & Raymond CA (eds) Eucalypt plantations: Improving fibre yield and quality. CRC for Temperate Hardwood Forestry, Hobart, 110-115.
- Jeffrey E. C. 1917. The anatomy of woody plants. University of Chicago Press, Chicago, Illinois.
- Kellogg R. M., Thykeson E. 1975. Predicting kraft mill paper strength from fiber properties. Tappi, 58 (4), 131-135.
- Kırcı H. 2009. Kağıt hamuru endüstrisi ders notları, Karadeniz Teknik Üniversitesi, Orman Fakültesi, Trabzon.
- Madakadze I. C., Radiotis T., Li J., Goel K., Smith D. L. 1999. Kraft pulping characteristics and pulp properties of warm season grasses. Bioresources Technology, 69, 75-85.
- Mahesh S., Kumar P., Ansari S. A. 2015. A rapid and economical method for the maceration of wood fibers in *Boswellia serrata* Roxb., Tropical Plant Research, 2 (2), 108-111.
- Matolcsy G. A. 1975. Correlation of fiber dimensions and wood properties with the physical properties of kraft pulp of *Abies balsamea* L. (Mill.). Tappi, 58 (4), 136-141.
- Ogbonnaya C. I., Roy-Macauley H., Nwalozie M. C., Annerose D. J. M. 1997. Physical and histochemical properties of kenaf (*Hibiscus cannabinus* L.) grown under water deficit on a

sandy soil. *Industrial Crops and Products*, 7 (1), 9–18.

Panshin A.J., Zeeuw C. 1970. Textbook of wood technology, M. C. Graw-Hill Book Company, London.

Rydholm S. 1965. *Pulping Processes*, Interscience Publishers, New York-London-Sydney, 576-577, 610-616.

Saikia S. N., Goswami T., Ali F. 1997. Evaluation of pulp and paper making characteristics of certain fast growing plants. *Wood Science and Technology*, 31 (6), 467–475.

Sandercock C. F., Sands R., Ridoutt B. G., Wilson L. F., Hudson I. L. 1995. Factors determining wood microstructure in Eucalyptus. In: Potts BM, Borralho NMG, Reid JB, Cromer RN, Tibbits WN & Raymond CA (eds) *Eucalypt plantations: improving fibre yield and quality*. CRC for Temperate Hardwood Forestry, Hobart, pp. 5–9.

Sarıbas M. 1989. Türkiye'nin Euro-Siberien (Euxine) bölgesinde doğal olarak yetişen kavakların morfolojik (dış morfolojik, iç morfolojik ve palinolojik) özellikleri üzerine araştırmalar, *Kavak ve Hızlı Gelişen Tür Orman Ağaçları Araştırma Enstitüsü Teknik Bülteni*, 148, İzmit, 152 s.

Schmid R. 1982. Sonication and other improvements on Jeffrey's technique for macerating wood. *Stain Technology*, 57, 293–299.

Seth R. S., Page D. H., 1988. Fiber properties and tearing resistance. *Tappi Journal*, 71 (2), 103–107.

Spearin W. E., Isenberg I. H. 1947. The maceration of woody tissue with acetic acid and sodium chlorite. *Science*, 105, 214.

Tank T. 1968. Odun ve lif özelliğinin tespitinde küçük örneklerin değerlendirilmesi. *İstanbul Üniversitesi Orman Fakültesi Dergisi, Seri B*, 18 (1), 182-198.

Tank T., Göksel E., Cengiz M., Gürboy B. 1990. Hızlı gelişen bazı iğne yapraklı ağaç türlerinin lif ve kağıt teknolojisi yönünden incelenmesi, *İstanbul Üniversitesi Orman Fakültesi Dergisi, Seri A*, 40 (1), 40-50.

Ververis C., Georghiou K., Christodoulakis N., Santas P., Santas R. 2004. Fiber dimensions, lignin and cellulose content of various plant materials and their suitability for paper production. *Industrial Crops and Products*, 19, 245–254.

Mineral Oils in Recycled Food Packaging

Gülnur MERTOĞLU ELMAS

Istanbul University, Faculty of Forestry, Istanbul / TURKEY

mertoglug@istanbul.edu.tr

Abstract

The present study is a compilation investigating mineral oil amounts and sources in recycled paper cardboard packages. As in all around the world, recycled paper is a raw material with high economic added value in Turkey that facilitates protection of natural resources and also contributes in sustainability of the same. The secondary fibers include the recycled paper and contain waxes, printing inks and other chemicals in addition to their basic virgin fiber contents in their pre-process structure. During the paper surface treatment processes, printing processes and packaging product manufacturing processes cause loading of carcinogen mineral oils. Transfer of such mineral oils from paper cardboard food packaging to the food through direct or indirect migration creates a threat to public health. Generally, mineral oils with a carbon number between C₁₄-C₂₂ and also those with a carbon number larger than 28 carbons cause migration of paper cardboard packages. The mineral oils are classified according to their constituents as saturated hydrocarbons (MOSH) and aromatic hydrocarbons (MOAH). It is seen that the majority of the total mineral oil content of the recycled paper cardboard raw material sources derives from newspapers while corrugated cardboard constitutes the least and that the MOSH amount of total mineral oil in nearly all types of waste paper sources vary between %81-88 while this ratio reaches as high as %171 for magazines.

The proportion of mineral oils can be reduced by optimization of the waste paper and cardboard fed to the recycle process and by the printing method and selection of appropriate printing ink for newspapers. It is seen that selection of flexographic printing method instead of offset printing and also use of plant-based inks instead of petroleum based mineral oils will reduce the mineral oil content. It is further understood that use of a lamination in the form of an inner envelop to function as a barrier in paper cardboard food packaging is very effective in reducing mineral oil migration.

Keywords: Mineral oil, Recycling paper, Ink, Migration

Introduction

Use of paper and paper-composite packaging products deriving from waste paper ensures both economic efficiency as well as use of a sustainable raw material thus promoting a reduction in consumption of natural sources. However, recycled paper products contain many contaminating contents differing from virgin or primary pulp. Mineral oils constitute most of the unknown and undesirable components of recycled paper material used for manufacturing food packaging in recent years and they directly and indirectly threaten public health through migration from paper cardboard food packaging to food.

In practice, the structural components of paper and cardboard material and packaging are desired to be manufactured in a way that does not endanger human health, cause any unacceptable alterations in the structure of food and most importantly that does not

deteriorate organoleptic properties of the food contained (CEPI and CITPA, 2012). Use of paper and cardboard as well as its suitability to public health and optimum requirements for environmental protection are stipulated by national and international legislations such as EU directives.

The objective of present study is to serve as a compilation concerning determination of main sources as well as amounts of mineral oils in recycled paper and cardboard materials.

Mineral Oils

Mineral oils are classified into three major categories. These are: alkenes-based "alkenes", a colorless, odorless distillate of petroleum, cycloalkane-based "naphthalene" and aromatic hydrocarbon-based "aromatic oils" which differ in terms of general structure. According to World Health Organization, they are classified into two toxicological components groups. Raw or

lightly processed mineral oils are classified as 1st group carcinogenic components that directly affect human health while highly processed or refined mineral oils are classified as 3rd group toxicological components due to lack of sufficient information (URL 1).

Any food packaging contains a couple of hundreds of sub-components. In general, despite a distinct health risk arising from complexity of aromatic hydrocarbon as well as mono- and polycyclic-aromatic hydrocarbon (PAHs) structure of these compounds, there is limited data on their structural and toxicological properties and this fact itself begs questioning on its own merits. Up to date, the main focus has been pointed on the potential problem of carcinogenic properties (Plos One, 2006).

According to the JECFA (Joint FAO/WHO Expert Committee on Food Additives) criteria, it is accepted that the

long-term migration rate of a packaging without an effective barrier layer and containing mineral oil with a carbohydrate larger than 28 carbons, is more than half in ambient conditions. In a paper and cardboard food package with a food-package ratio between 1:5 to 1:25, and an average mass rate of 1:10, the mineral oil content with a carbon count larger than 28 is 28mg/kg while MOAH content constitutes approximately one quarter of the contents with 6,5mg/kg. Furthermore, contents of the printing inks which are widely used especially for decorative boxes generally exceed this concentration levels. On the other hand, it has been observed that paper inner envelopes in form of inner lining or PET (polyethylene terephthalate) layers remain ineffective in certain cases while they mostly prevent migration of mineral oils (Droz and Grob, 1997). Classification of mineral oils according to JECFA is given in Table 1 below.

Table 1. Acceptable daily intake (ADI) amounts of various mineral oils (Tiggelman, 2012).

	Carbon count at 5% distillation point >28	Average molecular mass (Da) >500	ADI (mg/kg bw) 0-20
High			
Viscosity oils			
Medium	>25	480-500	10
Low viscosity oils	>22 >17	400-480 300-400	0.01 0.01

Reduction of viscosity causes greater rate of reduction of acceptable daily intake (ADI) of mineral oils (Table 1).

Recycled paper

Recycled paper is a material with economic value which ensures high level of environmental protection as well as sustainability and rejuvenation of natural resources through recycling. The contents of the recycled paper pulp includes, secondary fibers deriving from waste paper and cardboards being recycled and printing ink contained therein as well as fillers, pigments, adhesives, polymers that improve the paper strength, sterilization agents. Some additives to help the paper making process are also included in this pulp. Some of these additives

are saturated and aromatic hydrocarbon based mineral oils.

According to a 2013 report prepared by the Pulp and Paper Industry Association a total amount of 2.191.865 tons of waste paper and cardboard was collected. The blend composition of for the pulp to be processed based on the waste paper and cardboard was added approximately % 36 cellulose (primary fibers). Secondary fibers obtained from waste paper provided a very high level of contribution with % 71. The usage rates of the waste paper are shown in the Figure 1 below (SKSV, 2013):

5.

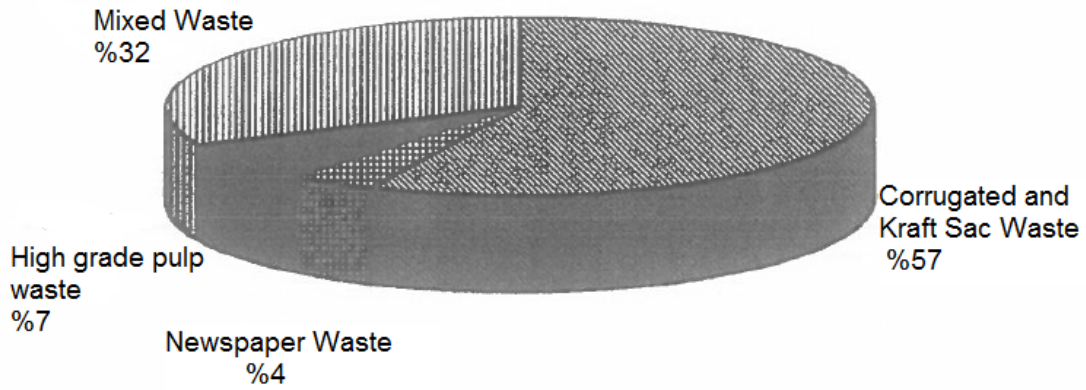

Figure 1. Usage rates of waste paper types (SKSV, 2013 report)

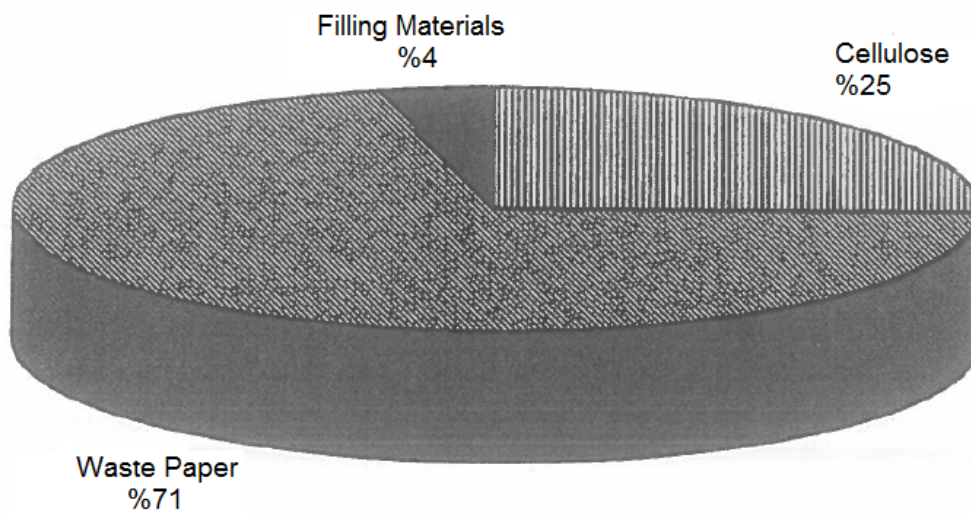

Figure 2. Proportion of the waste paper and cardboard contained in paper (SKSV, 2013 Report)

As in Europe, the waste paper collected in Turkey is recycled into paper products by addition of a certain degree of primary (virgin) cellulose depending on the quality of the waste paper collected.

In order to achieve a homogenous and clean waste paper pulp, the impurities must be removed during recycling process. It is practically impossible to completely purify

the waste paper pulp and obtain %100 homogeneity for the raw materials are obtained from many different sources. The production process involves three main stages. These are: braking down process (pulper), screening and cleaning process and dispersion process. Depending on the purpose of use, the de-inking process of the paper production takes place before and the

bleaching process takes place after the dispersion process (Harling *et al*, 2012).

Current recycling process of cardboard boxes does not involve any cleansing stage. Water cannot reduce the amount of mineral oil contained in the pulp suspension created during pulper stage. Previous studies determined that MOSH and MOAH have little impact (not significant) during de-inking and their impacts take effect during drying phase throughout the whole process (Harling *et al*, 2012)

Printing Inks

Basic components of the ink and their functions:

Pigments: They form the color and color-resistance properties and create optical characteristics of the inks.

Binders bind the color to the printing material and provide ink gloss and drying.

Solvents: Solvents adjust the ink viscosity and have certain impacts on ink preparation and drying processes and they also dissolve binder at the same time.

Most of the time the printing process applied for paper and cardboard printing procedures is offset printing method. Heat-set and cold-set offset inks contain different pigments, resins and mineral oil contents. Cold-set inks contain %60 mineral oil by weight while hot-set inks contain between %24-40 mineral oils (Pauck and Marsh, 2002).

A large portion of the mineral oils contained in recycled paper and cardboard derives from the newspapers used as raw material. Usually, cold-set inks are used to produce newspapers. Ink printing of newspapers involves evaporation through air which is a procedure that is based on absorption in the paper instead of drying by application of heat.

Flexo printing system aniline dye: this is an organic dye derived from coal ether. It is mainly used for flexo printing. Flexo printing

inks are water- or oil-based inks with medium and low viscosity which dry very rapidly. For a large proportion of flexo printing inks, mineral-free vegetable-based oils are used.

Typically, mineral oils from n-C 18 up to n-C 23 are used for printing inks of recycled papers and cardboard-based materials and acceptable daily intake per kg body weight (bw) limit of these oils is 0,01 mg/kg. On typical use, considering a person of 60 kg of body weight consumes food containing 1 kg contaminants, then 0,6 mg of refined (white) mineral oil is consumed per kg daily, which is well above specific migration limits. Even though the exact toxicity of MOAH is unknown it has been stated that reduction to minimum levels is a safe precaution (Dima *et al* 2011).

Conclusions and Discussion

The recycled paper contains mineral oils mainly because of the ink solvents used in off-set printing practices as well as use of waxes used to provide water-resistance to cardboards, adhesive components, solvents used as diluting agents in binding substances and offset printing inks used on cardboards for decoration purposes.

Typically the solvents of off-set printing inks usually contain %20-30 mineral oils (MOSH+MOAH). Recycled paper and cardboard contains 200-600 mg/kg of MOSH (Dima *et al* 2011).

It has also been determined that newspapers and similar printed material, which constitute the dominant mineral oil source for recycled cardboard boxes have a carbon number higher than 24. Table 1 below gives the percentages as well as difference between minimum and maximum amounts of MOSH (mg/kg) with carbon numbers higher than 24 contained in various types of paper and cardboard feedstock in recycling process according to Biedermann *et al* (2011).

Table 1. Mineral oils in papers and cardboards

	(MOSH/ MOSH+MOAH) C ₂₄ (mg/Kg)(%)	Change between min-max MOSH(times)	*Mineral (mg/Kg) MOSH+MOAH	Oil
Newspaper	82	5.2	3240	
Leaflets	83	5.4	2300	
Recycled Paperboard,	84	76	845	
Magazines	171	3.5	258	
Virgin paperboard	88	380	262	
Reports	83	289.50	218	
Corrugated board	81	7.3	156	
Books	85	57.5	94	
Office paper	88	2.8	40	

*Biedermann *et al* 2011

The table shows that the newspaper material contains the maximum amount of mineral oil with dominant average of <C₂₄ whereas the second place is taken by leaflets which in fact has a very wide area of usage. The last place is taken by imprinted cardboards which are most produced of recycled fibers the content of which is half derived from recycled fibers and the other half from off-set printing inks. Given that the amount of mineral oil with a carbon number larger than 24 contained in office paper and books is three folds of that of imprinted cardboards made of primary or virgin fibers, it is concluded that the difference is caused by the printing ink. Corrugated carton on the other hand is reported to contain less mineral oil (Table 1) (Biedermann *et al* 2011).

It is understood that total MOSH mineral oil content in nearly all types of papers that constitute sources of recycled paper and cardboard varies between % 81-88 with the exception of magazines which feature a content around %171 (Table 1). This significant difference of magazine papers originates from the fact that these papers have more colors and more intensive decorative printing and forms to achieve more attraction with heavy treatment with chemicals to improve the characteristics of the paper.

The highest % difference of maximum and minimum MOSH values among sources of paper occurs between reports and office paper (Table 1). It is concluded that the

reported difference is caused by structural and surface treatment of the paper and also that the type of the printing ink used on these papers cause significant changes in values. It is evaluated that the minimum change in office papers is a function of the fact that usually virgin fibers are used to create these papers which would not result in a significant change in the structure of base paper and the fact that the different types of printing inks used for these papers do not have significant differences.

Based on the findings of Harling *et al* (2012) it is seen that the newspapers have 8-fold higher amounts of mineral oil content compared to those of uncut, untreated and un-printed recycled food packaging boxes in terms of MOAH < n-C₂₄ rates. Furthermore, a very significant difference up to 13-times occurs between the papers with a MOSH carbon number (C₁₆-C₂₄) and <n-C₂₄.

According to risk assessment of a German Federal institution (BfR) the amounts of mineral oil contained in recycled cardboard food packaging are extremely high which must be urgently minimized (Vollmer *et al* 2011).

Recycling paper process management must be implemented to control the raw material sources concerning dilution of mineral oils; to adjust the furnish of pulp according to raw material source types and to implement cleaning procedures as steps of production processes and to conduct

chemical tests at different production steps so as to minimize the mineral oil content levels.

In Italy, use of flexographical printing (a process involving mineral oil-free inks) for newspapers significantly reduced the mineral oil content (10 times, to be specific) (Biedermann *et al* 2011) and in Japan the mineral oil content was also significantly reduced due to high vegetable oil content of them (6,3) (Biedermann *et al* 2011). These facts indicate that the solution for reducing the mineral oil contents lies within their main source, i.e. printing inks.

Conclusions

Direct contact of paper and cardboard packaging made of recycled fibers expose the food to migration of mineral oils. It is seen that total MOSH mineral oil content in nearly all types of papers that constitute sources of recycled paper and cardboard varies between % 81-88 with the exception of magazines which feature a content around %171. The amount of mineral oil contained recycled paper and cardboard can be reduced through optimization of waste papers and cardboards fed to the recycling process. Molecular mass distribution of the oils is close to MOSH accumulated in human body where as MOAH, which has been detected at unacceptable levels in foods, remains to be evaluated.

It has been determined that in the furnish of pulp of the recycled papers, the source with maximum amount of mineral oil is newspapers while the source with minimum amount of mineral oil content is corrugated cardboard. For this reason it is concluded that adjustment of the amount of newspapers in proportion to the corrugated cardboards fed to the recycled paper furnish would constitute a suitable solution.

It is clearly understood that the amounts of mineral oil contents highly depend on the printing methods and the printing ink types used for producing newspapers.

It has been further understood that use of flexographic printing instead of off-set printing would reduce the mineral oil contents in paper and cardboard packaging.

Given absence of any assessment or knowledge on MOAH, there is a need to

determine limit values for them which should be less than MOSH limits.

It has also been determined that use of vegetable-based oils instead of petroleum-based oils would significantly reduce the mineral oil content of inks.

Lastly, use of a functional barrier in the form of an inner sack would serve as a good way to prevent or to reduce migration of mineral oils from paper and cardboard food packaging.

References

- Biedermann M, Uematsu Y, Grob K. 2011. Mineral Oil Contents in Paper and Board Recycled to Paperboard for Food Packaging By Packaging Technology and Science (Packag Technol.Sci. :24:61-73. DOI:10.1002/pts.914
- CEPI and CITPA (2012). *Industry Guideline for the Compliance Paper and Board Materials and Articles for Food Contact* (Issue No. 2), Confederation of European Paper Industries, Brussels, Belgium.
- Dimaa G, Verzeraa A and K Grobb. 2011. Migration of mineral oil from party plates of recycled paperboard into foods: 1. Is recycled paperboard fit for the purpose? 2. Adequate testing procedure. *Food Additives and Contaminants* **28** (11): 1619–1628.
- Droz C. and Grob K. 1997. Determination of food contamination by mineral oil material from printed cardboard using on-line coupled LC-GC-FID. *Zeitschrift für lebensmitteluntersuchung und Forshung A* **205**(3): 239-241.
- Harling A, Altkofer W, Richter L, Simat T, Grote K, Rüdiger Helling, Is recycled board safe for use as food packaging material? 5. ILSI Europe 5th International Symposium on Food Packaging-Scientific Developments supporting Safety and Innovation, 14-16 Kasım 2012, Berlin, Germany.
- Pauck, W. J. and Marsh, W. 2002. The role of sodium silicate in the flotation deinking of newsprint at Mondi Merebank. *Tappsa J.*, 20–25.
- Pulp and Paper Industry Foundation (SKSV) (2013). *Turkish Paper-Board Industry 2013 Annual Report*, Istanbul, Turkey.
- Tarnow P, Hutzler C, Grabiger S, Schön K, Tralau T, Luch A. 2016. Estrogenic Activity of Mineral Oil Aromatic Hydrocarbons Used in Printing Inks. *PLOS ONE* | DOI:10.1371/journal.pone.0147239, 1-15
- Tiggelman, I. 2012. Migration of organic contaminants through paper and plastic packaging. Thesis Master of science Stellenbosch university).

URL 1
https://en.wikipedia.org/wiki/Mineral_oil,
14.07.2016).
Vollmer A, Biedermann M, Grundböck F,
Ingenhoff J.E, Bredermann-Brem S,
Altkofer, Koni Grob W. 2011. Migration of
mineral oil from printed paperboard into
dry: survey of the German market. Eur Food Res
Technol, 232:175-182.

A Research on Particle Board Factory by Utilization of Integer Linear Programming

Yunus ŞAHİN¹, *Hasan SERİN¹

¹Kahramanmaraş Sütcü Imam University, Faculty of Forestry, Kahramanmaraş/TURKEY

*Corresponding Author: hasanserin@ksu.edu.tr

Abstract

There are some factors which effect production of establishments for instance; quality, cost, time, capacity of production, raw material, market structure, and, customer variables. The establishments have to perform their productive activity in accordance with these variables for minimum cost or maximum profit. Therefore, it is necessary to make a production planning for doing something at correct time. While making the production planning, quantitative determine techniques are used for solving of complex problems. The linear programming which is the best among the quantitative techniques provides active and optimum production planning. The particle board factories have established at Turkey in 1950s. This sector is in relation with furniture, forest managements, glue, and chemistry industry, sawmills, joiner's workshops. At the present time this sector has problems which are lack of coordination, raw material, labour power. In this study, it was determined that particle board production quantity, particle board stock quantity for a year.

Keywords: Linear programming, Production planning, Cost, Forestry

Yonga Levha Fabrikasında Doğrusal Programlama Kullanımı Üzerine Bir Araştırma

Özet

İşletmelerin üretimini etkileyen faktörler; fiyat, kalite, zaman, üretim kapasitesi, hammadde, piyasa yapısı ve müşteri değişkenleridir. İşletmeler üretim faaliyetlerini bu değişkenler doğrultusunda minimum maliyet ya da maksimum kar amacına yönelik yürütmek durumundadırlar. Bu sebeple yukarıda sayılan faktörler bakımından nelerin, nerelerde, kimler tarafından, ne zaman ve nasıl yapılacağına ilişkin bir üretim planı yapılması gerekmektedir. Üretim planlanması yapılırken ortaya çıkabilecek karmaşık sorunların çözümünde kantitatif karar verme teknikleri kullanılır. Bu tekniklerin başında gelen doğrusal programlama metodu, yapılan üretim planının etkin ve optimum olmasını sağlar. Türkiye'de yonga levha fabrikaları 1950 yıllarında kurulmuştur. Bu sektör, mobilya, orman işletmeleri, tutkal ve kimya sanayi, kereste fabrikaları ve marangozlar ile ilişki içerisinde. Günümüzde bu levha sektörü koordinasyon eksiliği, hammadde sorunları, işgücü gibi sorunlarla karşı karşıyadır. Bu çalışmada, yıllık olarak yonga levha üretiminin miktarı ve yonga levha stok miktarı belirlenmiştir.

Anahtar Kelimeler: Doğrusal Programlama, Üretim Planlama, Maliyet, Ormancılık

Introduction

The production of board which has a wood-based homogeny structure has started in 1940s. Particleboard and fibreboard industries have established in Turkey, 1950s. Particularly, these industries have rapidly developed after the Second World War, because it has been in need of large scale materials for working on restructuring of cities. Particleboard, constitutes dried wood chips which are glued together with a resin which cures under the influence of high pressure and heat. Wood chips are derived from wood raw materials, such as round wood, sawdust, shavings, flakes, and recovered wood from various sources.

Particle board is used in furniture, forestry enterprises, glue industry, timber factories, paper sector, construction, decoration, energy sector, and other fields. Particle boards have many mechanical and physical characteristics (Akbulut, 2000);

- Smooth surface and it can be produced all thickness,
- Homogeny structure and it can be joined with nail, screw, and glue,
- It provides saving from labour because of it's produced large sizes,
- It can be applied top surface process,
- It can get new characteristics by treating with hydrophobic, protector, and fire-retardant materials,

- It can be handed easily and it has not defects such as knot, decay, and fibre curvature in solid wood panels also it is cheap.

Quantitative research is an approach for testing objective theories by examining the relationship among variables (Crotty, 1998). The objective of quantitative research is to develop and employ mathematical models, theories and hypotheses pertaining to phenomena. A mathematical model is a description of a system using mathematical concepts and language. Mathematical models are used in natural sciences (physics, biology, chemistry, etc.), social sciences (economics, sociology, political science, etc.), and engineering disciplines (computer science, artificial intelligence, etc.) (Wayne, 1994).

Mathematical models can take many forms, including linear programming, statistical models, game theoretic models, etc. Linear programming (LP) is a method to achieve the best outcome such as maximum profit or lower cost (Chase, et al 2001). This programme is a widely used field of optimization several reasons. Many practical problems in operation research can be expressed as linear programming. LP provided a basis for stochastic, non-linear programming, and so on (Morris, 1967).

Linear programming is heavily used in microeconomics and company management, such as planning, production, transportation, technology, and other issues. A research on Fortune 500, which is big company among the biggest companies in America, was determined that 85% of firms used linear programming at decision making process (Büyükkeklik, 2007).

Linear programming has 3 basic factors: objective function, constraints, and non-negative variables (Özsan, 2006). Objective function is generally established up suitable for maximum profit and/or minimum cost.

Objective function of maximum problems;

$$Z_{max} = \sum_{j=1}^N X_j c_j \quad (j = 1, 2, \dots, N)$$

Objective function of minimum problems;

$$Z_{min} = \sum_{j=1}^N X_j c_j \quad (j = 1, 2, \dots, N)$$

- Constraints, which use in linear programming, are demonstrated at below:

At maximum problems;

$$\sum_{i=1}^M \sum_{j=1}^N X_{j a i j} \leq b_i$$

(j = 1, 2, ..., N i = 1, 2, ..., M)

At minimum problems,

$$\sum_{i=1}^M \sum_{j=1}^N X_{j a i j} \geq b_i$$

(j = 1, 2, ..., N i = 1, 2, ..., M)

Decision variables must be positive (Non-negative condition, $X_j \geq 0$).

In this study, it was determined that particle board production quantity, particle board stock quantity for a year by using linear programming method at particle board factory.

Material and Method

In this research, particle board factory and it's production process were examined. It was intended that the production of firm was in optimal level. The employers work 26 days in a month so work power is 37440 minutes. The production quantity (m³) of particle board were determined in reference to months (Table 1).

Table 1. The production quantity of particle board material (m³) in reference to months

Months	Production		Number of Worked Day
	m ³	m ³ /Day	
January	-	-	31
February	9.148	326.71	28
March	8.506	274.38	31
April	2.932	97.73	30
May	5.245	169.19	31
June	5.355	178.50	30
July	5.258	169.61	31
August	4.615	148.87	31
September	9.681	322.7	30
October	3.569	115.12	31
November	10.735	357.83	30
December	10.464	337.54	31
TOTAL	75.508	206.87	365

As shown at Table 2 the machines and number of operators were determined on production process. Time is important factor

at production process. The time spent at production was determined at Table 3

Table 2. The machines and number of operators

Machine No	Machine	Machine Quantity	Number of Operator
1	Chipping	2	4
2	Dryer	1	2
3	Sifter	2	2
4	Layer	1	1
5	Press	1	2
6	Sanding	1	2
7	Melamine Covering	1	2
8	Packaging	1	2

Table 3. The time spent at production process

Machine No	Machine	Production Times	
		Particle (Uncovered)	Particle (Covered)
		Minute/Number	Minute/Number
1	Layer	3.5	3.5
2	Press	2.1	2.1
3	Sanding	2.4	2.4
4	Melamine Covering	-	3.1
5	Packaging	2.5	2.5

The linear programming method was run on LINGO 13.0 programme. Demands for particle board (covered and uncovered) were 7500 and 1000 number every month in a year, respectively. Beginning product quantity was zero for all products. In this production system, sanding and melamine covering machine were narrow pass. It was ignored that the machines stop in maintenance and failure situation. The developed model was determined according to data and constraints;

$$Z_{max} = TG - (SM + STM + EASM + EAKM)$$

Results and Discussion

The enterprise thought two products as uncovered particle board (Y) and covered particle (YL) board at production system. After using the LINGO package programme, outputs of the model were gained. These outputs were showed at tables.

Table 4. Number of particle board quantity (Uncovered-Y)

Machine No (j)	Months (t)											
	1	2	3	4	5	6	7	8	9	10	11	12
1	1325	1323	1009	0	996	1752	2100	2098	0	0	0	0
2	1325	1323	355	1001	996	1752	358	1513	1046	0	1831	0
3	1002	1001	1000	1001	996	1752	358	1000	1559	0	979	1200
4												
5	1000	1000	1000	1000	1000	1000	1000	1000	1000	1000	1000	1100

As given at Table 4, there was particle board (Y) production table. Particle board demand quantities were given at production line monthly in a year. The demand was covered completely. 1000 number demand at month.

production of particle board were covered with stock product by different production quantities in particular months. There were some 0 values at Table 4 because the firm covered the demand it's stock product at this

Table 5. Number of stock particle board (YSS)

Machine No (j)	Months (t)											
	1	2	3	4	5	6	7	8	9	10	11	12
1	0	0	651	0	0	0	1742	2277	1581	1581	100	100
2	323	645	0	0	0	0	0	513	0	0	850	0
3	2	3	3	4	0	752	110	110	669	19	0	100
4												
5	0	0	0	0	0	0	0	0	0	0	0	100

There were stocks between the production machines within production time of particle board in some months. It was seen that the stock quantities went back to acceptable stock level at last of year. As given at Table 5, there

was 100 number of stock at last of year and it provided stock constraint that was maximum 1000 number stock.

Table 6. Number of covered particle board quantity (YL)

Machine No (j)	Months (t)											
	1	2	3	4	5	6	7	8	9	10	11	12
1	7505	9842	0	6648	9	0	8151	0	8035	0	0	0
2	7500	8992	8855	6647	7	8	8150	9131	10004	0	0	0
3	7500	8992	8	9994	0	9	8150	6662	10004	9759	1542	0
4	7500	8992	8	7500	8993	7	7500	7500	7500	9759	1542	7500
5	7500	7500	7500	7500	7500	7500	7500	7500	7500	7500	7500	7600

Covered particle board demand quantities were given at production line monthly in a year (Table 6). There were some 0 values at Table 6 because the firm covered the demand

it's stock product at this month. Also successive 0 values showed that the firm produced 1000 number production monthly.

Table 7. Number of stock covered particle board (YLSS)

Machine No (j)	Months (t)											
	1	2	3	4	5	6	7	8	9	10	11	12
1	5	5855	0	0	2	0	1742	2277	1581	1581	100	100
2	0	0	8847	1	7	0	0	513	0	0	850	0
3	0	0	0	2494	0	752	110	110	669	19	0	100
4	0	1492	0	0	0	0	0	0	0	7500	0	0
5	0	0	0	0	0	0	0	0	0	0	0	100

It was determined that the stock quantities were occurred within a year plan during the production of covered particle board. As given at Table 7, there was 100 number of stock at last of year and it provided stock constraint that was maximum 1000 number stock. For instance; 1-2-3-5-11th months had 0 value at 3 number machine, 1-3-4-5-6-7-8-9-11-12th months had 0 value at 4 number machine because there was not stock requirement at these months.

Conclusion

Covered particle board and uncovered particle board covered demands and quantity

of uncovered demand (TKM) was zero (Table 4 and Table 6). Because these particle boards produced enough level and the firm had adequate stock quantity. The firm arranged stock cost to production rate after that the stock cost reduced.

As a result, the firm covered the demand of customer properly by working on suitable conditions. The firm will get over with using sources properly and customer satisfaction. After this done research, sustainability of the firm will increase by optimal approaches and it will provide competitive advantage. Development of the firms on this way will

lead to further in terms of economic of country and its development.

References

Akbulut, T., 2000. Yonga Levha Endüstrisi, Laminart Mobilya Dekorasyon Sanat Tasarım Dergisi, Nisan-Mayıs sayı 7 s.112-119.

Büyükkelik, M., 2007. "Üretim Planlama Problemlerinde Doğrusal Programlama Modelinin Kullanımı : "Bir Üretim İşletmesinde Uygulama", Yüksek Lisans Tezi, s.40.

Chase, R. B. ve Aqilano N. J. ve Jacobs F. R., 2001. Operations Management For Competitive Advantage, New York: The McGraw-Hill Companies.

Crotty, M. (1998) The foundations of social research: Meaning and perspective in the research process. Thousand Oaks, CA: Sage.

Morris, W., 1967. " On the Art oof Modeling." Management Science, Vol. 13, s. B707-B717.

Özsan, Ö., 2006. Mermer işletme tesislerinde ürün miktarının doğrusal programlama tekniği yardımı ile belirlenmesi. Yüksek Lisans Tezi İzmir, s.15.

Wayne, L. W., 1994. "Operations Research: Applications and Algorithms", International Thomson Publishing, s.151-153.

Economic Awareness and Knowledge Level of Managers: A Sample of Forest Products Industry

Hasan SERİN¹, *Muhammet DURGUN¹

¹Kahramanmaraş Sutcu Imam University, Faculty of Forestry, Kahramanmaraş / TURKEY

*Corresponding Author: muhammetdurgun@ksu.edu.tr

Abstract

Economic awareness and knowledge are important notions for each individual and firm in modern-day economy world. Development of economic awareness is dependent upon the development of the relevant cognitive capacities, social class, ideology, and social representations. Moreover, these notions are related to the practical handling of pocket money. Increasing awareness and knowledge about economics is connected highly with economic literacy. Identifying economic problems, alternatives, costs, and benefits; analyzing the incentives at work in economic situations; examining the consequences of changes in economic conditions and public policies; collecting and organizing economic evidence; and weighing costs against benefits are main abilities for economic literacy. Considering abovementioned explanations, in this study economic awareness and knowledge level of forest products industry managers is investigated. The sample of this research consists of 21 managers in Adana forest products industry. Face to face survey is used as method. Findings are shown as frequency tables. It is found that 95% of managers takes into consideration their income when making installment. Conversely, 18% of these managers states that they cannot make comments about the effect of currency changes on import and export.

Keywords: Economic awareness, Economic knowledge, Economic literacy, Forest products industry

Yöneticilerin Ekonomik Bilgi ve Farkındalık Seviyeleri: Orman Ürünleri Endüstrisi Örneği

Özet

Ekonomik farkındalık ve bilgi modern günümüz ekonomi dünyasında her bir firma ve birey için önemli kavramlardır. Ekonomik farkındalığın geliştirilmesi ilgili bilişsel kapasitenin, sosyal sınıfın, ideolojinin ve sosyal temsillerin geliştirilmesine bağlıdır. Dahası, bu kavrayışlar cep harçlığının pratik biçimde ele alınmasıyla ilişkilidir. Ekonomiyle ilgili bilginin ve farkındalığın artırılması sıkı bir biçimde ekonomi okuryazarlığına bağlıdır. Ekonomik problemleri, alternatifleri, maliyetleri ve faydaları tanımlama, ekonomik durumlarda çalışma hayatındaki teşvikleri analiz etme, kamu politikalarında ve ekonomik koşullarda yaşanan değişikliklerin sonuçlarını inceleme, ekonomik kanıtları toplayıp organize etme ve faydalar karşısında maliyetleri tartma ekonomi okuryazarlığı için başlıca yeteneklerdendir.

Yukarıda bahsedilen açıklamaları göz önüne alarak, bu çalışmada orman ürünleri endüstrisindeki yöneticilerin ekonomik farkındalık ve bilgi düzeyleri incelenmiştir. Bu araştırmanın örneğini Adana ilindeki orman ürünleri endüstrisindeki 21 yönetici oluşturmaktadır. Veri toplama metodu olarak yüz yüze görüşme ile anket kullanılmıştır ve elde edilen bulgular frekans tabloları şeklinde gösterilmiştir. Bazı sonuçlar olarak, yöneticilerin %95'i taksitlendirme yaparken gelirlerini dikkate aldıkları bulunmuştur. Diğer taraftan bu yöneticilerin %18'i döviz kurlarındaki değişimin ihracat ve ithalata etkisini yorumlamadıklarını ifade etmişlerdir.

Anahtar Kelimeler: Ekonomik farkındalık, Ekonomik bilgi, Ekonomi okuryazarlığı, Orman ürünleri endüstrisi

Introduction

People from households to concerning business have interacted with financial and economic institutions more than in the past. Therefore they have been exposed to higher financial risk by virtue of financial liberalization and policy reforms intended by promoting retirement savings through private

pension funds and individual retirement accounts.

The development of economic awareness is dependent upon the development of the relevant cognitive capacities (Lewis et al., 1995; Lunt & Furnham, 1996; Furnham & Argyle, 1998). On the contrary Emler and Dickinson (1985) have found that social

class, ideology and social representations are important independent notions for economic awareness. Sophisticating at economy is especially related to direct interaction with the market. For example, Jahoda (1983) has shown that African people acquire the concept of profit more rapidly than European people which switches the usual cognitive/developmental comparisons between first and third world countries. Ng (1983) has shown that Chinese children in Hong Kong are much more involved in business and have a much better understanding of how banks work compared to children in Scotland.

Moreover other things equal, differences in economic literacy create the potential for significant allocational outcomes of a financial crisis, because unsophisticated investors are more exposed to financial market fluctuations than investors that are able to manage and diversify risks (Jappelli, 2010).

Walsted and Larsen (1992) report that from US samples, 39% of the general public, 35% of high school seniors and 51% of college seniors can provide accurate answers to questions in a range of topics such as knowledge of unemployment rates, inflation and definitions of monetary policy.

Caroselli (1996) has shown that, in her article related to nurses, respondents answered slightly more than half of the economic knowledge questions correctly. Interestingly, economic awareness did not increase with age, experience, gender, marital status, education, or management experience but did increase with certification.

Williams et al., (1992) found no evidence regarding significant and consistent gender differences exist in college students' performances on economic exams in terms of economic knowledge.

Walstad (1997) has shown that economic knowledge about the national economy is affected by many factors-education, income, age, sex, and race-and is not determined by one variable. Political party affiliation has some effect on the development of economic knowledge, with Republicans showing more understanding than Democrats, but the difference is slight and it appears to be a minor influence. Economic knowledge has a

direct and significant effect on public opinion about many economic issues.

Economic literacy is important for three sides. First is the asset side because financial products have become extremely complex. Second is the debt side because credit cards and consumer credit have increased in almost all OECD countries. To evaluate the information available on different loan possibilities, choose among different credit instruments and identify predatory lending necessitate a minimum level of financial literacy and skills to distinguish between products. Third is the macro side because it contributes to the good workings of markets and policies (Jappelli, 2010).

Gleason and Van Scyoc (1995) in their report on the economic literacy of adults, have shown that both adults and high school students scored higher on the microeconomics and the fundamentals sections of the TEL (Test of Economic Literacy) than on the macroeconomics and international sections.

In this study, it is attempted to investigate economic awareness and knowledge level of managers at forest products industry. In next section, the material and methodology is explained. It then presents results and a number of conclusions are highlighted in the final section.

Materials and Methods

Forest products industry has an important place in national economy. This industry part is concerned with wide range of outputs such as timber, package, plywood, particle board, fiberboard, paper, parquet, joinery and furniture. With a share percent 1.6% in manufacturing industry, it is ranked 16th among subsectors and approximately employs 300 thousand personnel. Moreover its production value is about 4.3 billion dollars.

Our material is managers at forest products industry firms of Adana city, Turkey. This city's all industry percent in Turkey industry is 2% and 3141 industrial firms is registered by industrial certification. The industrial firm structure of this city consists of food products manufacture (17%), furniture manufacture (10%) and fabrication metal products manufacture except machine

and equipment (9%) as biggest 3 subsectors. Wood, wood products and mushroom products in this city take share form industry data as 3%. Therefore forest products industry used in this research has totally 13% of industrial firms (Sanayi Genel Müdürlüğü, 2014).

For obtaining data from managers of forest products industry, a questionnaire survey is prepared by considering scale developed by Gerek and Kurt (2011). This survey form consists of 2 parts. First part is related to demographic questions. Second school, 9.5% with secondary school, 28.6% with high school, 47.6% with undergraduate and 9.5% with master degree. 36-45 and 46-55 aged managers consist of each 40%. Other part (20%) is 26-35 aged managers. There is no big enterprise in this study sample. Micro, small and medium sized enterprises consist of 61.9%, 28.6% and 9.5%, respectively.

14.3% of enterprises is active at between 1-5 years, 33.3% of enterprises is active at between 6-9 years, 33.3% of enterprises is active at between 10-14 years and 19% of enterprises is active at above 14 year. 28.6% of enterprises has annual return under 1 million TL. 61.9%, 4.8% and 4.8% of

part consists of economic knowledge, economic rationality, social economic reflections and individual economic planning questions. Face to face method is used to 21 firms. To analyze obtained data, SPSS (Statistical Package for the Social Sciences) software is used with descriptive statistics and crosstabs.

Results

In this study, 85.7% of participants is male and other is female. Education situation of managers is 4.8% with primary enterprises have annual return between 1-4 million TL, 5-25 million TL and 50 million TL-above, respectively.

Table 1. shows economic knowledge results of managers at forest products industry. 66.7% of managers state with strongly agreement that they can understand the effect of interest rates on market. 57.1% of managers state that they cannot entirely understand the effect of international economic resources on market and the effect of national financial resources on economy. All of managers reply to surveys either with partly agreement or with strongly agreement that they can define what the change of inflation rates mean.

Table 1. Economic knowledge of managers

	Strongly Disagree	Partly Disagree	Undecided	Partly Agree	Strongly Agree
I can comment the effect of change at currency on export and import	-	-	9.5	38.1	52.4
I can discuss the effect of IMF policies on economy	-	-	4.8	38.1	57.1
I can understand the effect of developments at stock market on economy	-	-	9.5	42.9	47.6
I can understand the effect of international economic resources on market	-	-	4.8	57.1	38.1
I can understand the effect of national financial resources on economy	-	-	4.8	57.1	38.1
I can define what the change of inflation rates means	-	-	-	38.1	61.9
I can comment the reflections of external economic developments on national economy	-	-	-	52.4	47.6
I can understand the effect of interest rates on market	-	-	-	33.3	66.7
I can evaluate benefit and cost of economic policies	-	-	5.0	40.0	55.0

Table 1. (Continue)

I can understand the economic roles of small, medium and big sized enterprises	-	-	4.8	33.3	61.9
I can comment the causes of changes at currency and gold prices	-	-	9.5	38.1	52.4
I can define the economic roles of public, private, and nongovernmental organizations	-	-	-	50.0	50.0
I can understand the relationship of income distribution-economy	-	-	4.8	42.9	52.4

According to Table 2. which shows statement related to economic rationality, 75% of managers think with strongly agreement they can compare benefit and cost of their economic preferences. 65.0% of managers cannot completely perceive economic factors which effect the individual

behaviors. Moreover 61.9% of managers cannot entirely understand how demand and supply gap is reflected on prices. On the other hand, the statement of commenting the effect of increase and decrease at goods to market prices receive reply as undecided with 14.3%, partly agreement with 52.4% and strongly agreement with 33.3%.

Table 2. Economic rationality

	Strongly Disagree	Partly Disagree	Undecided	Partly Agree	Strongly Agree
I can compare benefit and cost of my economic preferences	-	-	-	25.0	75.0
I can make rational choices by evaluating my monetary resources	-	-	-	28.6	71.4
I can evaluate rendered services in terms of economic	-	-	-	38.1	61.9
I can understand the difference between profit and cost	-	-	-	47.6	52.4
I can organize general consumption expenditures in compliance my income	-	-	-	38.1	61.9
I can perceive economic factors which effect the individual behaviors	-	-	-	65.0	35.0
I can understand how interaction between producer and consumer is reflected on prices	-	-	4.8	28.6	66.7
I can comment the effect of increase and decrease at goods to market prices	-	-	14.3	52.4	33.3
I can understand how demand and supply gap is reflected on prices	-	-	-	61.9	38.1

Table 3. shows social economic reflections statements related to economic literacy of managers at forest products enterprises. According to these results, 90.5% of managers state with strongly agreement that they look the quality instead of brand while buying a product and others reply as partly agreement. Furthermore 81% of managers indicate that they buy lower one which has same benefit, if a product's price

increases. Conversely, the statement of taking into consideration need while making decision on product receive answer as undecided with 9.5%, partly agreement with 19% and strongly agreement with 71.4%.

Table 4. indicates results related to how managers make economic planning individually. All of managers state that they take into consideration their income while making an installment plan, either with

strongly agreement (80%) or with partly agreement (20%). Moreover 73.7% and 71.4% of executives remark that they spend

with respect to ability to pay while using credit card and provide income-outcome balance while using credit, respectively.

Table 3. Social economic reflections

	Strongly Disagree	Partly Disagree	Undecided	Partly Agree	Strongly Agree
I take into consideration price-benefit relationship while making decision on product	-	-	5.0	40.0	55.0
I can understand the economic consequences of competition	-	-	5.0	40.0	55.0
I can comment contributions of advertisement expenditures on economy	-	-	4.8	38.1	57.1
I take into consideration my need while making decision on product	-	-	9.5	19.0	71.4
I buy lower one which has same benefit, if a product's price increases	-	-	4.8	14.3	81.0
I look the quality instead of brand while buying a product	-	-	-	9.5	90.5
I can understand how transport process of products to consumers is reflected on prices	-	-	4.8	28.6	66.7
I can comment the effects of economic crisis on unemployment	-	-	5.0	30.0	65.0

Table 4. Individual economic planning

	Strongly Disagree	Partly Disagree	Undecided	Partly Agree	Strongly Agree
I provide income-outcome balance while using credit	-	-	4.8	23.8	71.4
I spend with respect to ability to pay while using credit card	-	-	5.3	21.1	73.7
I take into consideration my income while making an installment plan	-	-	-	20.0	80.0

Conclusions

Economic literacy is a clustered structuring. As such, it has many psychological premises. Some of these have to do with abilities; others may be attitudinal or based such structurings as interests, values, or personality.

As shown in results section, managers of forest products firms don't reply to questions neither with strongly disagree nor partly disagree. This means managers at this industry find adequate themselves. However, there are some topics that more than half of managers find themselves adequate, such as economic factors which effect the individual behaviors, demand and supply gap which is reflected on prices, effect of international economic resources on market, effect of

national financial resources on economy, reflections of external economic developments on national economy, effect of increase and decrease at goods to market prices and economic roles of public, private, and nongovernmental organizations. In addition Şahin et al., (2016) found that some industrial managers can't comment change at currency on export and import, can't discuss the effect of IMF policies on economy, and can't understand the effect of stock market on economy.

In Lewis and Scott's (2000) study, 80% of participants knew what an interest rate was and over 60% had some idea about the purposes of interest rates, although it should be stressed that only 10% mentioned interest

rates in relation to both borrowing and investing.

To conclude, with high economic awareness, knowledge and literacy, managers at forest products industry can behave more strategic. So competitive advantage come with this. Sustainable growth and profit over sector average will be other important outcomes.

References

- Caroselli, C. 1996. Economic awareness of nurses: Relationship to budgetary control. *Nursing Economics*, 14(5), 292-299.
- Emler, N. and Dickinson, J. 1985. Children's representation of economic inequalities: The effects of social class. *British Journal of Developmental Psychology* 13, 191-198.
- Furnham, A. and Argyle, M. 1998. *The Psychology of Money*. London: Routledge.
- Gerek, S. ve Kurt, A.A. (2011). Ekonomi Okuryazarlığı Ölçeğinin Geçerlik ve Güvenirlik Çalışması, *Uludağ Üniversitesi İktisadi ve İdari Bilimler Fakültesi Dergisi*, 30(1), 59-73.
- Gleason, J., & Van Scyoc, L. J. 1995. A report on the economic literacy of adults. *The Journal of Economic Education*, 26(3), 203-210.
- Jahoda, G. (1983). European lag' in the development of an economic concept: A study in Zimbabwe. *British Journal of Developmental Psychology* 1, 110-120.
- Jappelli, T. 2010. Economic literacy: An international comparison. *The Economic Journal*, 120(548), F429-F451.
- Lewis, A., Webley, P. and Furnham, A. 1995. *The New Economic Mind: The social psychology of economic behaviour*. London: Harvester Wheatsheaf.
- Lewis, A., & Scott, A. J. 2000. The economic awareness, knowledge and pocket money practices of a sample of UK adolescents: A study of economic socialisation and economic psychology. *Citizenship, Social and Economics Education*, 4(1), 34-46.
- Lunt, P. K. and Furnham, A. 1996 (eds.). *Economic Socialisation*. Cheltenham: Edward Elgar.
- Ng, S. 1983. Children's ideas about the bank and shop profit. *Journal of Economic Psychology* 4, 209-221.
- Sanayi Genel Müdürlüğü 2014. Türkiye 81 il sanayi durum raporu. Ankara: T.C. Bilim, Sanayi ve Teknoloji Bakanlığı.
- Şahin, Y., Durgun, M., and Serin, H. 2016. The Determination of Economic Literacy Level of Forest Products Industry Managers: A Sample of Kahramanmaraş City, Turkey. 14th International Scientific Conference on Economic and Social Development, Belgrade, Serbia, 13-14 May 2016.
- Walstad, W. B. 1997. The effect of economic knowledge on public opinion of economic issues. *The Journal of Economic Education*, 28(3), 195-205.
- Walstad, W. and Larsen, M. 1992. A National Survey of American Economic Literacy. Lincoln, Nebraska: Gallup.
- Williams, M. L., Waldauer, C., & Duggal, V. G. 1992. Gender differences in economic knowledge: An extension of the analysis. *The Journal of Economic Education*, 23(3), 219-231.

Factors Affecting Job Satisfaction and Performance of Forestry Workers in Turkey

*Kadri Cemil AKYÜZ¹, Aytaç AYDIN¹, Tarık GEDİK², İbrahim YILDIRIM¹,
İlker AKYÜZ¹

¹Karadeniz Technical University, Faculty of Forestry, Department of Forest Industrial Engineering, 61080, Trabzon, Turkey.

²Düzce University, Faculty of Forestry, Department of Forest Industrial Engineering, Düzce/ Turkey.

*Correspondent Author: akyuz@ktu.edu.tr

Abstract

In this study, the factors of job satisfaction and performance of forest workers, working on dangerous, hard and tiring conditions at the terrain in Turkey are investigated. The known 7 base factors and 60 sub factors, affecting the satisfaction; are measured with a questionnaire created according to quinary likert type scale. The questionnaire is consisted of two parts about demographical properties and the factors affecting job satisfaction. The results searched with factor, correlation and Hierarchical Regression analysis. Results show that managerial approach type, behaviours of manager to employee and the position of firm at the society are important on job satisfaction. In addition, based on the salary and social rights of forest workers, their satisfaction level is low, according to manager, the position of firm, communication, co workers, the job and working conditions; the satisfaction level of forest workers is high.

Keywords: Job Satisfaction, Performance, Forestry Workers, Factor Analysis

Introduction

Nowadays, one of the most important changes and developments at our society is to understand the importance of human factor. The production and usage of information is important at our time, every employee defines the customer satisfaction as the same goal and this forces the companies to change their framework (Akıncı, 2002).

Although, the job satisfaction; which is highly correlated with performance and happiness, has too many definitions, The concept of job satisfaction is defined the level of enjoyment of employee getting from the job (Locke, 1969), the whole relationship between person and his environmental factors (O'Reilly, Chatman and Caldwell, 1991) or the happiness or sadness of individual during working (Davis, 1988). Job satisfaction level affects workers' life highly because of taking most of the time of the employee's life. Positive effects of job satisfaction can be seen on their mental and physical health and family life as well as this increases the efficiency and performance of

employee in the organization (Keser, 2005; Örucü et. al., 2006).

If the companies use their man power at higher level this means the increase of whole performance and competitive power of company (Ostroff, 1992). If the employee works with low satisfaction level, he works with low attention, and this causes to absenteeism, decrease of efficiency and rasing labour force wages (Duffy et. al., 1998; Michael et.al, 2005).

There are hundreds of different studies about job satisfaction and performance were reported. On these studies; the main goal of researchers is finding some information for correlating the performance and satisfaction (Seo et. al, 2004). Most of the studies are about industrial and organizational psychology (Iaffaldano and Muchinsky, 1985; Judge et. al., 2001; Landy, 1989), also some of them are about labor and health industry (Lincoln and, Kalleberg, 1990; Bhagat and Mcquaid, 1982; Weisman and Nathanson, 1985; Tzeng and Ketefian, 2002; Leiter et. al., 1998).

The researches and theories show that; the satisfaction has relation with much other

organizational behaviour and is effective on absenteeism or similar results (Fisher and Locke, 1992). In the literature, at different studies; personal properties are also known as an important factor, affecting the job satisfaction and job performance (Strauss, 1968; Barrick et. al. 2001; Tzeng, 2002; Chen et. al., 2004; Bowling, 2007; House, 1981; Stewart, 2001; O'Toole, 2002; Tett et. al., 1991; Judge et. al., 2002; Hartline and Ferrell, 1996). Also in the literature; different studies proves a low correlation between job performance and job satisfaction (Brown and Peterson, 1993; Gardner and Pierce, 1998; Rich, 1997).

Forests; earthbound, renewable and biological being; are worked in natural conditions and open air. They face too many risk factors. In this area the workers generally work in rural places at open air. Because of this risky conditions and working duration the forestry works are in the group of most dangerous occupations (Michael et. al, 2005).

Liira and Leino (1999) studied the effective factors on forest workers job satisfaction and performance. They reported that the facilities of job environment and the amount of stress are found the effective factors on satisfaction.

It is found by Mirza et. al., (1997) that for increasing the performance and efficiency of forest workers; some factors like; job environment, life conditions, health, job security and staff policy should be investigated and improved.

Gagnon and Michael, (2004) underlined the support of administration for increasing the satisfaction and performance at forestry business and they defined that the closer relation between directors and employees improves the satisfaction highly.

Hoffman and Lewark, (1999) investigated the effects of marital status of forest workers on job satisfaction and performance. It was reported that social framework, working and family problems were important factors on satisfaction level and performance.

Yoshimuno and Acar (2004) investigated the states of Turkish forest workers health and security. They detected; the 24% of workers have industrial injuries. They underlined that the industrial injuries have

negative effect on the job satisfaction and performance also for increasing the job satisfaction, the job security should be increased, too.

The researches of Jelacic et. al. (2008) investigated the motivation factors of foresters and forest products industry workers and they determined the most important factors on job satisfaction level and performance as; social conditions, job security, the level of communication between employees and working duration.

Michael et. al. (2005) reported that the forest workers are working in more dangerous conditions than the other industries and this situation affects the satisfaction and performance negatively.

Eventhough the effects of working sector and working area on job satisfaction and performance are searched in many studies but there are not enough studies on forest workers and their job satisfaction and performance. In this study it was aimed to investigate the effective factors on the job satisfaction and performance of these forestry workers.

Research Metedology

In the study, the most active forestry business production areas of Turkey were selected and questionnaire method was used. During the preparing of questionnaire; in the literature; the past studies about job satisfaction, theories and reports were investigated.

The questionnaire is consisted of two parts about demographical properties and the factors affecting job satisfaction. At the first part, consisted of 14 questions, investigates some demographical properties like gender, age, marital status, education, working time at the company and health problems. Second part of questionnaire is about job satisfaction. Four major theories were used for evaluating in the second part of questionnaire. The first one of these is; Minessota Satisfaction Questionnaire (MSQ) created by Weiss, Davis and England (1967) and used generally for academical researches to measure the job satisfaction levels of employees. The second one is Porter's Need and Satisfaction Questionnaire which was created from Maslow's requirement hierarchy theory. The

third one is Kunin's measure, is created in 1955 (Kunin, 1955) and the last one; also accepted as the most analytic method is Job Descriptive Index (JDI) theory of Smith, Kendal and Hulin.

During the selection of questions about job satisfaction; the questions of present theories were tested on employees for an experimental research. At the end of experimental research, the most appropriate questions for the forest workers were defined. In this part; there are 9 base factors (pay, promotion, managers, additional facilities, rewards, working procedures, co workers, the job and communication) and 60 sub factors.

5 point likert scale was used in the study. The scale is like 1: Strongly Disagree, 2: Disagree, 3: Undecided, 4: Agree, 5: Strongly Agree.

247 workers, working at the regions of high forestry activities in Turkey answered the questionnaires but 112 of them are

appropriate for using in the study. The proportion of the return of questionnaires is calculated as 45%.

When we base the literature; it is shown that the proportion of returning is between 20% and 45% (Hum and Leow, 1996; Bal and Gundry, 1999). Hence, statistically; the amount of data in this study is accepted as suitable.

At this study reliability of the scale was detected by calculating the Cronbach Alpha Coefficient. The Cronbach Alpha Coefficient is calculated 0.96 by SPSS program. This result proves that the scale's reliability is high and the variables were measured reliably.

Findings

Workers demographical properties

Demographical datas of 112 workers in the research are shown in the Table 1.

Table 1. Workers' demographic features

Age	Frequency	Percent	Educational Status	Frequency	Percent
18-24	4	3.6	Primary School	29	25.9
25-34	58	51.8	Elementary School	23	20.5
35-44	27	24.1	High School	29	25.9
45-54	19	17.0	Associate Degree Program	15	13.4
55 and over	4	3.6	Undergraduate	14	12.5
Total	112	100	Graduate	2	1.8
Gender			Total	112	100
Male	107	95.5	Staff Status		
Female	5	4.5	657	59	52.7
Total	112	100	Permanent	42	37.5
Marital Status			Contracted	2	1.8
Married	92	82.1	Seasonal	9	8.0
Single	20	17.9	Total	112	100
Total	112	100	Working Time in Organization		
Does your partner work?			Up to 1	13	11.6
Yes	12	10.7	1-3	16	14.3
No	80	71.4	4-6	9	8.0
Total	92	82.1	7-9	6	5.4
			10 and over	68	60.7
			Total	112	100

The results of workers demographical datas show that half of the workers are between 25-34 years old, most of the workers are male and married, nearly all of the participants' partners are not employed, the primary education graduated workers are half of the all workers and over the half of workers have been working for 10 years or more.

Factor analysis

Defining the most appropriate model and the number of explaining factors are important problems at the past studies. An ideal model should contain accuracy, parsimony and generalizability properties but finding all of them in the same model is too hard. Defined fewer factors could be parsimonious but can not be generalized. Defined more factors able to be generalized but this situation causes to less parsimonious. Therefore factor analysis method was used to find the most appropriate factor numbers and solving. Factor analysis is helping to solve a problem, but once data is in hand factor structure can be assessed using latent root

(eigenvalue), scree test and percentage of variance explained (Mount and Bartlett, 2002).

The datas taken from the scale were factor analysed to define the factor framework of the job satisfaction in the study. Factor analysis can not be appropriate for all data forms. The suitability of datas searched with Kaiser-Meyer-Olkin (KMO) coefficient.

Bartlett's test of sphericity value and its significance investigate that variables correlate with each other or not. KMO being higher than 0.60 and Bartlett's test being significant show that data is appropriate for factor analysis (Sharma, 1996; Büyüköztürk, 2002). Bartlett's test of sphericity with a value of 5577.881; ($p < .001$) and the calculation of Kaiser-Mayer-Olkin statistics of .806 indicated that data seemed suitable for factor analysis.

The datas used for measuring the job satisfaction also calculated on exploratory factor analysis. Principal components and factor structure getting with varimax rotation method are show in Table 2.

Table 2. Factor loadings belonging to variables after varimax rotation

Items	Factor Loading	Eigen value	% Variance Explained	of F value	P
Managerial approach		10.184	37.718	74.171	0.001
Honest and fair management	83.9				
Tasks are in the competence to do	78.0				
Duties and responsibilities of management	79.2				
Problems in a comfortable way to communicate	77.5				
Employees evaluation method	76.8				
Agency and employee interests	70.5				
Thought to be given importance	70.6				
Management support	79.5				
Management's view of human	75.8				
Management's attitudes and behavior	83.9				
Business perception in community		2.492	9.231	39.730	0.001
My business environment is safe	.797				
My business relationship is a source of pride for the environment in the	.729				
My communication with the business environment is always positive	.737				

Table 2. (continued)

Pay		1.776	6.579	21.055	0.001
I'm getting a good salary	83.9				
I do not take the hardship of living	82.6				
Salary increase rate is sufficient	82.5				
I'm getting a regular salary every month	79.8				
I'm getting the right salary	79.5				
Business structure		1.598	5.919	22.646	0.001
Profession to work in	78.8				
Knowledge and skills to use	75.7				
Communication		1.298	4.806	12.545	0.001
I can make joint efforts with my friends	83.6				
I can easily share the problem	78.0				
Working conditions		1.202	4.451	28.517	0.001
I can use my permission when I asked	77.0				
The technology used is sufficient	73.1				
Security measures are sufficient	71.8				
Social facilities		1.083	4.013	23.978	0.001
Artistic and cultural activities will have	78.2				
Everyone has equal social rights	71.2				

One of the most important steps of factor analysis is defining the number of factors. Although there are different methods for defining the number of factors, generally Kaisers' criterion and Scree plot method is used. According to Kaisers' criterion, if the eigen value of factors is equal or bigger than 1.00, they will stay in the analysis (Howard and Tinsley, 1987). In this study, the eigen value of 7 factors is bigger than 1.00.

The results of factor analysis are presented in Table 2. Twenty seven items from the factor analysis resulted in five factor grouping and explained 72,716% of the total variance. All of the factor loadings were greater than 0.70 indicating a good correlation between the items and the factor grouping they present. As a result of factor analysis; the datas have factor weight less

than 0.70 were quit from the research. The first factor explains 37.717% of the sum of the explained variance.

The variables under the first factor are called "Management approach". The second factor is "Business perception in community", the third factor is "Pay" the forth factor is "Business Structure". The fifth factor is called as "Communication". The sixth factor is "Working conditions" and the seventh is "Social facilities".

Correlation analysis

The correlation analysis helps to understand the relation between independent job satisfaction variables. The means, standard deviations, correlations and Cronbach's alpha reliability estimates are presented in Table 3.

Table 3. Correlation matrix

	Mea n	S.D .	1	2	3	4	5	6	7	8
1 Business perception in community	3.55	1.07	(80.4)							
2 Business structure	3.59	1.21	.41**	(79.2)						
3 Pay	2.83	1.01	.30**	.14	(78.7)					
4 Social Facilities	2.60	1.09	.31**	.30**	.36**	(35.8)				
5 Working conditions	2.85	1.01	.39**	.35**	.39**	.54**	(49.8)			
6 Communication	3.61	1.06	.36**	.27**	.25**	.25**	.32**	(75.3)		
7 Managerial Approach	3.63	1.08	.59**	.45**	.39**	.41**	.41**	.39**	(95.7)	
8 Job Satisfaction	3.31	0.77	.71**	.56**	.63**	.59**	.64**	.53**	.90**	(92.6)

Values in parentheses are Cronbach's alphas.

**Correlations are significant at the .01 level

As seen at the Table 3, there is an important relation between job satisfaction and other factors. Especially management approach and Business perception in community are important factors on job satisfaction.

Hierarchical regression analysis

The hierarchical regression analysis was done to understand the effects of investigated factors on job satisfaction. This method is important to understand the most important independent factors on the dependent factor. So in this analysis job satisfaction is accepted as the dependent variable. At the first steps of analysis, the age, education levels and marital status of workers were used as the independent factors and the effects of them on the job satisfaction were investigated.

At the second step of analysis, the factor groups (gotten by as a result of factor analysis); management approach, working

conditions, pay, business perception in community, business structure, communication and social facilities were analysed as independent variables.

As the result of analysis; the beta values and R² values are shown in the Table 4. In the first stage, age ($\beta = 0.001$), education level ($\beta = 0.142$) and marital status ($\beta = -0.215$) explained a significant portion (5.0%) of the variation in the job satisfaction. In the second stage, it is seen that managerial approach ($\beta = 0.520$), pay ($\beta = 0.242$), business perception in community ($\beta = 0.153$) and working conditions ($\beta = 0.146$) are the factor having the best expressiveness by accruing the other factors in analysis. The other factors; business structure ($\beta = 0.117$), social facilities ($\beta = 0.104$) and communication ($\beta = 0.100$) were determined as factors having low importance. It is seen that all factors have 97.3% expressiveness level on job satisfaction of workers.

Table 4. Factors being effective in job satisfaction to the results of regression analysis

Factors	β	R ²
Demographical characteristics of workers		0.050*
Age	0.001	
Education Level	0.142	
Marital status	-0.215	
Factors		0.923**
Managerial approach	0.520**	
Working conditions	0.146**	
Pay	0.242**	
Business perception in community	0.153**	
Business structure	0.117*	
Communication	0.100*	
Social facilities	0.104*	
Total R ²		0.973**

Results and Discussion

Results from the survey show that most of the workers were married and 75.9% of them were between 25-44 years old. Even the number of temporary and seasonal workers is less (9.8%) the number of permanent workers is absolutely high (90.2%). When the educational status of forestry workers was investigated it was shown that most of them are well educated (53.6%). 60.7% of them have been working for 10 years or more.

At the beginning of the study; the questionnaire consisted of present theories questions about job satisfaction, 9 base and 60 sub factors (pay, promotion, managers, additional facilities, rewards, operational procedures, co workers, job and communication) turned to a new questionnaire, appropriate for forestry workers, consisted of 7 base and 27 sub factors (management approach, working conditions, pay, business perception in community, business structure, communication and social facilities) with the help of factor analysis.

Management approach and support of manager were defined as the most important factors (37.718) by the factor analysis. Manager is an important factor for employee's job satisfaction. Especially their behavior and fair and honest managing style increases the job satisfaction of the employee and this causes to high performance and efficiency. This result is similar to the other studies on the literature. In the past studies,

even one of the most important motivation factors, wage is not enough; because of the manager and his/her managing style the satisfaction level of employees can be high. The studies prove that managing style is a very important factor on satisfaction (Feldman and Hugh., 1986; Erdil et.al., 2004).

When the employees join the decisions and management, express their ideas, take the support of management and talk about their problems, this also increases the job satisfaction and these are the other sub factors affecting the job satisfaction. Because of this, managers should care this reality and use their energies on their job (Nicholsan, 2003).

The managers who does not care the employees' ideas, problems and does not know much about the job causes dissatisfaction. Hard working conditions also affects forest workers daily life. For example; overtime or long working hours steals the time from workers family life or social life. Short working hours causes to more times with family of friends or own selves (Luthans, 1973). If the workers do not trusting the management, there could be dissatisfaction even the good working conditions are. If the employees trust the management, although uncomfortable working conditions are, the complaints will be less. Therefore, if there are some problems about trusting to the management, for satisfaction; the working conditions are

not so important. The correlation analysis also proves this result.

The second important factor on the job satisfaction is the importance of job in the society and business perception in community. If the society cares the employee's job, this makes employee happy and pleased from the job. Workers believe that; socially and economically important jobs provide them prestige in the society. This feeling is an important factor on job satisfaction which is also found by correlation and hierarchical regression analysis (Oksay, 2005).

Another important factor on job satisfaction is pay. Pay, has an important correlation with job satisfaction, also affects job satisfaction and the motivation (Kim, 1990; Rhee, 1990; Bozkurt and Turgut, T. 1999). A systematic and enough pay and

References

Akinci, Z., 2002. Turizm Sektöründe İşgören İş Tatminini Etkileyen Faktörler: Beş Yıldızlı Konaklama İşletmelerinde Bir Uygulama, Akdeniz Üniversitesi, İktisadi ve İdari Bilimler Fakültesi Dergisi, 04/05.

Bakan, İ., Büyükbeşe, T., 2004. Örgütsel İletişim İle İş Tatmini Arasındaki İlişkiler: Akademik Örgütler İçin Bir Alan Araştırması, Akdeniz Üniversitesi İ.İ.B.F. Dergisi, 7, 1-30.

Bal, J., Gundry, J., 1999. Virtual Teaming in the Automotive Supply Chain Team Performance Management: An International Journal, 5, 6, 174-193.

Barrick, M.R., Mount, M.K., Judge, T. A., 2001. Personality and Performance at the beginning of the new millennium: What do we know and where do we go next?. International Journal of Selection and Assessment, 9, 9-30.

Bhagat, R.S., Mcquaid, S.J., 1982. Role of subjective culture in organizations: a review and directions for future research. Journal of Applied Psychology 67 (5), 653-685.

Bozkurt, T., Turgut, T. 1999. Çalışanların Toplam Kalite Yönetim Uygulamaları İle İlgili İş Tatminleri Ve Kültürel

Sayıtları Arasındaki İlişkiler. Marmara Üniversitesi Öneri Dergisi, Cilt 2, Haziran.

Bowling, A.B., 2007. Is the job satisfaction-job performance relationship spurious? A meta-analytic examination, Journal of Vocational Behavior, 71, 167-185.

Brown, S. P., Peterson, R. A., 1993. Antecedents and consequences of sales person job satisfaction: Meta-analysis and assessment of

economical happiness are very important on job satisfaction.

Working on the experienced job and using the talents also makes employee happy and increases the satisfaction. The communication between co workers makes the work easier and increases the efficiency of the job. If the employees are sure about safety, can socialize at the work and by working, having good working conditions without stress, these increase the job satisfaction (Edvardsson and Gustavsson, 2003).

The social facilities and the technological equipments using for the job are also important factors on satisfaction. Working hours, breaks, working conditions and equipments are also affecting the job satisfaction positively (Bozkurt and Turgut, 1999).

casual effects, Journal of Marketing Research, 30, 63-77.

Chen, G., Goddard, T.G., Casper, W. J., 2004. Examination of the relationships among general and work-specific self-evaluations, work-related control beliefs, and job attitudes, Applied psychology: An International Review, 53, 349-370.

Davis, K., 1988. Human behaviour at work: Organisational behaviour (5th Ed.). NY: McGraw-Hill.

Duffy, M.K., Ganster, D.C., Shaw, J. D., 1998, Positive Affectivity and negative Outcomes: The Role of Tenure of job satisfaction, Journal of Applied Psychology, 83, 950-959.

Edvardsson, B., Gustavsson, B.O. 2003. Quality İn The Work Environment: A Prerequisite For Success İn New Service Development. Managing Service Quality, Volume 13, Number 2, 148-163.

Erdil, O., Keskin, H., İmamoğlu, S.Z.,Erat, S. 2004. Yönetim tarzı ve çalışma koşulları, arkadaşlık ortamı ve takdir edilme duygusu ile iş tatmini arasındaki ilişkiler: tekstil sektöründe bir uygulama, Doğu Üniversitesi Dergisi, Cilt 5, Sayı.1, 17-26.

Feldman, D., Hugh, A. 1986. Managing individual and group behavior in organization. Auckland, McGraw-Hill International Book Company.

Fisher, C.D., Locke, E.A., 1992. The new look in job satisfaction research and theory. In: Channy, C.J., Smith, P.C., Stone, E.F., Job Satisfaction: How People Feel About Their Jobs

and How it affects Their Performance, Lexington Books, NY, pp. 165-194.

Gagnon, M.A., Michael, J.H., 2004. Outcomes of perceived supervisor support for wood production employees, *Forest Product Journal*, 54 (12), 172-177.

Gardner, D.G., Pierce, J.L., 1998. Self-esteem and self-efficacy within the organizational context, *Group and Organizational Management*, 23, 48-70.

Hartline, M., Ferrell, O.C., 1996. The management of customer-contact service employees: An empirical investigation, *Journal of Marketing*, 60, 52-71.

Hoffman, V., Lewark, S., (1999) Working conditions of female forest workers a study in German state forest enterprises, *Forstarchiv*, 70(5), 187-195.

House, J.S., 1981. *Work Stress and Social Support*, Addison Wesley Publishing Company, Reading, MA.

Howard, E.A., Tinsley, D., 1987. Uses of Factor Analysis in Counseling Psychology Research, *J. Counsel Psychol*, 34(4): 414-434.

Hum, S.H., Leow, L.H., 1996. Strategic Manufacturing Effectiveness; An Empirical Study Based on the Hayes-Wheelwright Framework, *International Journal of Operations and Production Managements*, 16, 4, 4-18.

Iaffaldano, M.T., Muchinsky, P. M., 1985. Job Satisfaction and Job Performance: A meta-analysis. *Psychological Bulletin*, 97, 251-273.

Jelacic, D., Grladinovic, T., Sujova, A., Galajdova, V., 2008. Motivation factors in wood processing and furniture manufacturing, *Drvna Industrija*, 59 (1), 11-21.

Judge, T. A., Thoresen, C.J., Bono, J. E., Patton, G.K., 2001. The job satisfaction-job performance relationship: A qualitative and quantitative review, *Psychology Bulletin*, 127, 376-407.

Judge, T.A., Heler, D., Mount, M. K., 2002. Five -factor model of personality and job satisfaction: A Meta-analysis, *Journal of Applied Psychology* 87, 530-541.

Keser, A., 2005. İş Doyumu ve Yaşam Doyumu İlişkisi. *Çalışma ve Toplum*, (7) 4.

Kunin, T., 1955. The Construction of a New Type of Attitude Measure. *Personnel Psychology*, 8, 65-67.

Kim, S.D., 1990. Determinants of jobsatisfaction of medical recorders. *Journal of Korean Hospital Association* 19 (5), 44-50 (in Korean).

Landy, F.J., 1989. *Psychology of work behavior*, Pacific Grove, CA: Brooks/Cole.

Leiter, M.P., Harvie, P., Frizzel, C., 1998. The Correspondence of Patient Satisfaction and Nurse Burnout, *Social Sciences in Medicine*, 47 (10), 1611-1617.

Liira, J., Leino, A.P., 1999. Predictors and consequences of unemployment in constructions and forest work during a 5-year follow-up, *Scandinavian Journal of work environment and Health*, 25 (1), 42-49.

Lincoln, J.R., Kalleberg, A.L., 1990. *Culture, Control, and Commitment: A Study of Work Organization and Work Attitudes in the United States and Japan*. Cambridge University press, New York.

Locke, E.A. 1969. What is job satisfaction? *Organizational Behavior and Human Performance*, 4. 309-336.

Luthans, F. 1973 *Organizational Behavior*. Sixth Edition, Mcgraw-Hill, New York.

Michael J.H., Evans D.D., Jansen, J.K., Haight, J.M., 2005. Management Commitment to safety as organizational support: Relationship with non-safety outcomes in wood manufacturing employees, *Journal of Safety Research*, 36, 171-179.

Mirza, S.S.S., Syed, A.W., Julary, H.A., 1997. Human resource management in forestry :employee's concerns, *Forest Research Institute Malaysia*, 70, 1-26.

Mount, D.J., Bartlett, A.L.B., 2002. Development of a Job Satisfaction Factor Model for the Lodging, *Journal of Human Resources in Hospitality and Tourism*, Vol. 1, 17-40.

Nicholsan, N., 2003. How to motivate your problem people. *Harvard Business Review*, January , 57-65.

Oksay, A., 2005. Çalışanlarda İş Tatmini: Sağlık Sektörü Üzerine Bir Araştırma, Yüksek Lisans Tezi, Süleyman Demirel Üniversitesi, Sosyal Bilimler Enstitüsü, Isparta.

O'Reilly, C.A., Chatman, C., Caldwell, D.F., 1991. People and Organizational Culture: A Profile Comparison approach to assessing person-organizational fit, *Academy of Management Journal* 34 (3), 487-516.

O'Toole, M., 2002, The relationship between employees perceptions of safety and organizational behavior, *Journal of Safety Research*, 33, 231-283.

Örücü, E., Yumuşak, S., Bozkır, Y., 2006. Kalite Yönetimi Çerçevesinde Bankalarda Çalışan Personelin İş Tatmini ve İş Tatminini Etkileyen Faktörlerin İncelenmesine Yönelik Bir Araştırma, *Celal Bayar Üniversitesi İ.İ.B.F. Yönetim ve Ekonomi Dergisi*, 13, 1, 39-51.

Ostroff, C., 1992, *The Relationship Between satisfaction, Attitudes, and Performance: An*

Organizational Level Analyses, *Journal of Applied Psychology*, 77, 963-974.

Rhee, U.H., 1990. Nurses' job satisfaction and horizontal mobility within a university hospital (In Korean). Master's Thesis, Kyung-Hee University, Seoul, Korea.

Rich, G. A., 1997. The sales manager as a role model: Effects on trust, job satisfaction, and performance of salespeople, *Journal of the Academy Marketing Science*, 25, 319-328.

Seo, Y., Ko, J., Price, J.L., 2004. The Determinants of job satisfaction among hospital nurses: a model estimation in Korea, *International Journal of Nursing Studies*, 41, 437-446.

Stewart, J., 2001. The Turnaround in Safety at the Kenora Pulp and Paper Mill. *Professional Safety, The Journal of American Society Engineers*, 46, 34-45.

Strauss, G., 1968. Human relations-1968 style, *Industrial Relations*, 7, 262-276.

Sun, H.Ö., 2002. İş Doyumu Üzerine Bir Araştırma: Türkiye Cumhuriyet Merkez Bankası Banknot Matbaası Genel Müdürlüğü, Uzmanlık Yeterlilik Tezi, Türkiye Cumhuriyet Merkez Bankası Banknot Matbaası Genel Müdürlüğü, Ankara, pp. 33.

Tett, R. P., Jackson, D.N., Rothstein, M. 1991. Personality measures as predictors of job performance: A meta-analytic review, *Personnel Psychology*, 44, 703-742.

Tutuncu O., Kozak, M., 2007. An investigation of factors affecting job satisfaction, *International Journal of Hospitality & Tourism Administration*, Vol. 8(1).

Tzeng, H.M., 2002, The Influence of Nurses Working motivation and job satisfaction on intention to quit: an empirical investigation in Taiwan, 39, 867-878.

Tzeng, H.M., Ketefian, S., 2002. The Relationship between nurses' job satisfaction and impatient satisfaction: an exploratory study in a Taiwan's teaching hospital, *Journal of Nursing Care Quality* 16(2), 50-60.

Weisman, C.S., Nathanson, C.A., 1985. Professional satisfaction and client outcomes: a comparative organizational analysis, *Medical Care*, 23, 11-79.

Weiss, D.J., Davis, R.V., England, G.W., 1967. *Manuel for the Minnesota Satisfaction Questionnaire*, University of Minnesota, Industrial Relations Center.

Yoshimuno, T., Acar, H.H., 2004. Occupational safety and health conditions of forestry workers in Turkey, *Journal of Forest Research*, 9(3), 225-232.

Research on Noise Level of Wood Processing Machine Groups

*Hasan SERİN¹, Semih DEMİR²

¹KSU, Faculty of Forestry, Kahramanmaraş / TURKEY

² KSU, Technical Sciences Vocational School of Higher Education,
Kahramanmaraş / TURKEY

*Corresponding Author: hasanserin@ksu.edu.tr

Abstract

Machines are commonly used at production and everywhere in daily life. The using of machines has been increased instead of hand-workmanship at forest products industry. Also wood processing machines show differences in reference to place and intended purpose. Every machine which works during the production and blank time causes noise pollution. In view of occupational health and safety rules don't apply enough at workplace or small enterprises, these machines will have more negative effect on workers.

This study has been performed at workplace and small forest products enterprises in Kahramanmaraş. Average noise levels of wood processing machines at these enterprises have been determined with group. The noise levels of commonly used 22 number machine types have been determined at 56 enterprises in Kahramanmaraş. 40% of the measured enterprises produce furniture and door; 60% of them produce furniture. While 48% of the measured machines was used for furniture, 52% of them was used for furniture and door production. According to classification of wood processing machine it was determined that the planning machine, the machine was loaded, had the highest noise level (average 95.17±4.5 dB(A)); top surface processing machine, the machine was empty, had the highest noise level (average 88.09±0.36 dB(A)).

Keywords: Wood processing machines, Noise, Furniture, Kahramanmaraş

Ahşap İşleme Makine Gruplarının Gürültü Düzeyinin Araştırılması

Özet

Günlük hayatın her yerinde ve üretimde makineler yaygın olarak kullanılmaktadır. Orman ürünleri sanayinde el işçiliği yerine makinelerin kullanılması da giderek artmaktadır. Ayrıca ahşap işleme makineleri de kullanım amaçları ve yerine göre farklılıklar göstermektedir. Üretimde ve boş durumda çalışan her makine ortamda gürültü kirliliğine sebep olmaktadır. Atölye veya küçük ölçekli işletmelerde iş sağlığı ve güvenliği kurallarının yeterince uygulanmadığı göz önüne alındığında bu makinelerin çalışanlar üzerinde olumsuz etkisi daha fazla olacaktır.

Bu çalışma, Kahramanmaraş il merkezinde faaliyet gösteren atölye ve küçük ölçekli orman ürünleri işletmelerinde yürütülmüştür. Bu işletmelerde yaygın olarak kullanılan ahşap işleme makineleri yaptıkları işlemlere göre gruplandırılarak ortalama gürültü düzeyleri belirlenmiştir. Kahramanmaraş ahşap malzeme işleyen 56 tesiste, yaygın olarak kullanılan 22 adet makine çeşidinin gürültü düzeyleri belirlenmiştir. Ölçümlerin yapıldığı işletmelerin %40'ı mobilya ve kapı üretimi, %60'ı mobilya üretimi yapmaktadır. Ölçüm yapılan makinelerin %48'i mobilya üretiminde kullanılır iken %52'si hem mobilya hem de kapı üretiminde kullanılmaktadır. Ağaç işleme makine sınıflandırılmasına göre makinenin dolu durumda çalışır iken en yüksek gürültü düzeyi renceleme makinelerinde ortalama 95.17±4.5 dB(A), makineler boş durumda çalışır iken üst yüzey işleme makinelerinde ortalama 88.09±0.36 dB(A) olarak belirlenmiştir.

Anahtar Kelimeler: Ahşap işleme makineleri, Gürültü, Mobilya

Introduction

At the present time, the people are exposed to noise at all kinds of hard work such as construction works, stone and marble quarries, road works, and heavy equipments (Yalçınkaya et al., 2007). In recent years; legal documents as regulation, notification, rule and so on, which determine the top

limits of noise levels at heavy equipments, have been determined with occupational health and environmental consciousness to prevent noise pollution.

The noise is unpleasant sounds and affects negatively on the people. The noise is unpleasant and undesirable mechanical vibrations that be formed with pressure

changes in solid, liquid, and gaseous state. The changes in the air pressure reach as waves to sense organs and after that it is heard as sound. A vibration as characteristic is stated with its frequency and volume (Akan, 2002). Particularly, the noise level in large cities exceeds measurements which determine from World Health Organization (WHO). At the top of the results, that increase city noise, is intense traffic, honk, and the noise from industry areas (Aydın and Ateş, 1997). In addition to these, there is a continuous exposure to the noise at some work fields.

There are 2 different classification from the noise: the frequency distribution and time-varying sound level. According to the frequency distribution; the noise goes into division as broadband noise and narrowband noise (Esen, 2010). On the other hand, in reference to time-varying sound level; the noise goes into division as stable and unstable (Ertürk, 2001; Anonymous, 2011).

There are some negative influences such as temporary or permanent hearing disorders, blood pressure increase, speeding at

respiration, change at heart beatings, sudden reflex, some behavior disorders, extreme irritation and stress, concentration disorder, slowing the movements because of the noise but it depends on the time of noise exposure and its volume (Güller and Çobanoğlu, 1994; Anonymous, 2012). In other words, the noise is an important factor which causes communication problem, unrest, damage on nervous system, decrease in working performance and hearing problems (Andrews, 1982; Feldman and Grimes, 1985). With these negative influences, it is possible that the various diseases or health problems originating from the noise occur depends on the time of noise exposure (Dalgıç, 1992).

After the results of researches, it is clearly that the noise affects differently from person to person. Interrupted and sudden noise may cause the heart beating increase, the blood pressure increase, sleeping disorders, losing attention. The sudden noise causes the heart beating increase, pupil constriction, quick temper, and anger (Güner, 2000).

Table 1. The decibel degrees of some noise types and its psychological effects (Anonymous, 2006)

Noise Type	dB(A)	Psychological effect
Space rocket	170	
Siren	150	Earache, nerve cells disorder
Ear endurance limit	140	
Machine drill	120	
Motorbike	110	Nervous and psychological disorders (3. Step)
Cabaret music	100	
Subway noise	90	
Danger zone	85	
Turning lathe	85	Psychological signs (2. Step)
Alarm clock	80	
Telephone bell	70	
Human voice	60	Psychological signs (1. Step)
Sleep noise	30	

As shown at Table 1, the noise has 4 influences in terms of psychological. While subway noise, alarm clock, and human voice are 1. and 2. step psychological signs, motorbike and cabaret music cause 3. step nervous and psychological disorders.

Relaxation time at work life may be two times of the maximum working time. For this

reason, temporary hearing losses on workers increase in time and ultimately they turn into permanent hearing losses. The hearing losses consisted over 90 dB(A) are permanent and they never get better. Researches show that the influences of noise (till 80 dB(A) level) on human health can be prevented. For this purpose in the workplace conditions, it has

been determined that the highest noise level is 80 dB(A) during the 8 hourly working hours. It is hard to protect workers health in a place

where has over the 90 dB(A) noise level even so the sound is liked (Haksal, 1997).

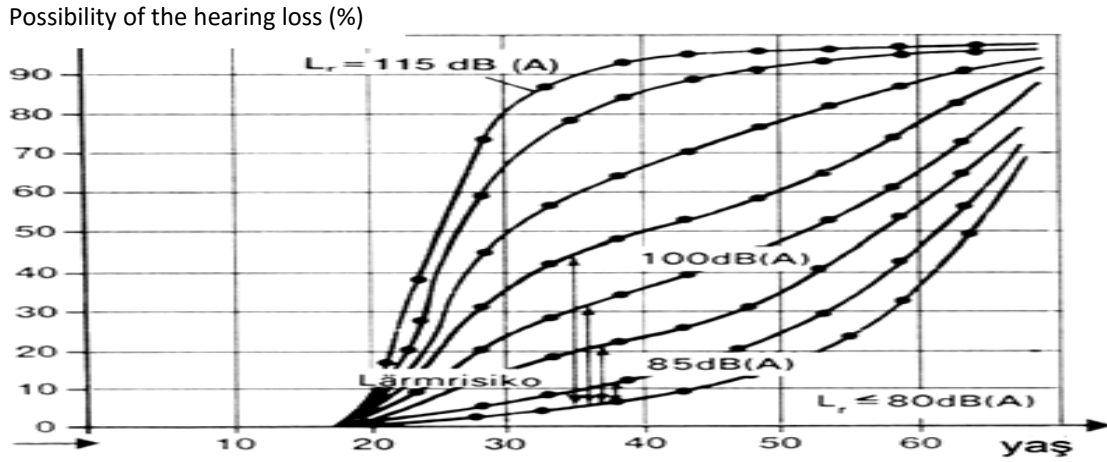

Figure 1. The possibility of hearing loss at noisy environment (Babalık, 2003)

The noise level as shown at Fifure 1 gives the hearing loss possibility depends on working age and working hours. It is seen that a worker who is 20 years old has 50%

and 65% the possibility of hearing loss respectively in case of working 30 and 40 years at 100 dB(A) noise level.

Working Hours (Hour/Day)

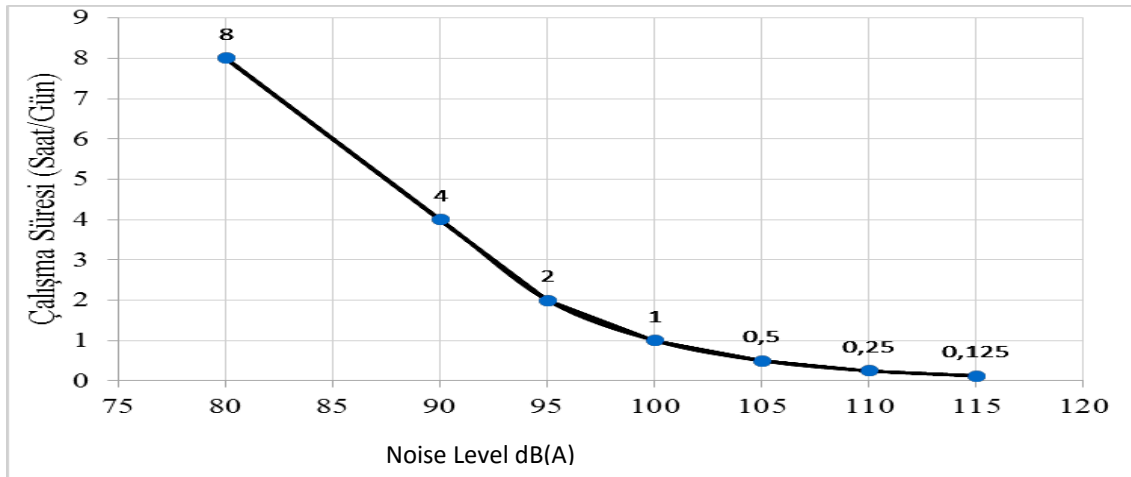

Figure 2. Noise levels and daily maximum working hours (OSHA, 1983).

As shown that at Figure 2, working hours have to be arranged according to the noise levels for the workers don't get the temporary and permanent hearing losses when the noise level increasing at working field. For instance; while a worker should be worked one hour maximum at 100 dB(A) noise level, the worker can do two hours maximum at 95 dB(A) noise level.

Wood processing machines

The machines, which they are used for cutting, drilling, planing, profile, top-surface process and changing shape of wooden material, are called as wood processing machines. İlhan et al., (1990) classified furniture industry machines as given the Table 2 with 10 groups.

Table 2. The Wood Processing Machines Types (İlhan et al., 1990)

	a) Circular saw	b) Band saw
1. Timber and board cutting dimensioning machines	<ul style="list-style-type: none"> • Pendulum length cutting machine • Length cutting machine by bottom saw • Radial length cutting machine • Two-sided length cutting machine • Length cutting and multiple perforation machine • Circular saw machine • Multiple circular saw machine • Board cutting machine 	<ul style="list-style-type: none"> • Band saw machine • Jigsaw machine
2. Planing machines	<ul style="list-style-type: none"> • Planer • Thickness machine 	<ul style="list-style-type: none"> • Thickness and multiple slicing machine
3. Profile and shaping machines	<ul style="list-style-type: none"> • Vertical milling machine • Horizontal milling machine • Quadripartite trimming machine 	<ul style="list-style-type: none"> • Template and copy shaping machines • Two-sided trimming machine
4. Corner joint machines	<ul style="list-style-type: none"> • Automatic routing machine • Finger joint machine • Screwing machine 	<ul style="list-style-type: none"> • Routing and one-sided trimming machine • Cross insertion machines
5. Boring machines	<ul style="list-style-type: none"> • Horizontal boring machine • Vertical boring machine • Multiple vertical boring machine • Oscillation vertical boring machine • Chained angular boring machine 	<ul style="list-style-type: none"> • Automatic multiple horizontal and vertical boring machines • Automatic knot patch machine • Horizontal length boring machine
6. Lining and pressing machines	<ul style="list-style-type: none"> • Lining preparation machines • Lining cutting machine • Lining adding machine • Flat lining presses • Montage presses 	<ul style="list-style-type: none"> • Glue preparation and spreading machines • Frame press • Box press • Twisting presses
7. Edging strip and lining machines	Edging strip machines	
	<ul style="list-style-type: none"> • One-side • Two-sides 	
	Edge lining machines	Folio lining machine
	<ul style="list-style-type: none"> • One-side • Two-sides 	<ul style="list-style-type: none"> • One-side • Two-sides • Quadripartite

Table 2.(Continue)

8. Sanding machines	<ul style="list-style-type: none"> • Band sanding machine • Two-sides edge sanding machine • Cylindrical part sanding machine 	<ul style="list-style-type: none"> • Oscillation vertical band sanding machine • Surface and edge profile sanding machine • Cylindrical sanding machine (Calibre)
	•	•
9. Top surface processing machines	<ul style="list-style-type: none"> • Pneumatic injection • Classic injection • Covering cast machine • Cylindrical varnishing machine • Drying plants • Car drier cells • Loop drier cabins 	<ul style="list-style-type: none"> • Based injection (gun) machine • Multiple gun automatic injection machine • Airless high pressure and electrostatic injection • Heat light drier cells • Pre-heat tunnels • Vertical drier channels
Auxiliary machines		

As given at Table 2; the furthest machines are in two groups which are top surface processing machines and timber-board cutting dimensioning machines.

Materials and Methods

This research has been done at furniture and door enterprises in Kahramanmaraş city. There are not big enterprises which they produce furniture and door in this city. For this reason, this research has been done at small scale and studio type enterprises.

The measurements were made with 3 minutes at 3 different points (material input

to machine, material output and the place where the worker be) according to machines were loadind and not. The measurements were saved every 5 seconds at 3 minutes and 30 items data ocured from all machines. From done literature review; while the measurements were made at least 15 min periods at unstable noise environment such as traffic (Atmaca and Peker, 1999), the measurements were mostly made 3 min periods at stable noise environment (Esen, 2010; Serin, 2012). DELTAOHM HD 2010 was used for noise measurements (Figure 3).



Figure 3. DELTAOHM HD 2010 noise measurement device

Device's batteries were checked, it was calibrated, the atmospheric features of environment were checked at working range of device and a plan of measurement place was made to make accurate the noise measurements. The measurement points, reflecting and absorber surfaces on the environment were marked over the plan. It was chosen accurate settings according to device's features and type of the noise (Serin at al., 2013).

Measured machines classified in reference to cutting theory on wood process and types of furniture industry machines (Table 2). As shown Table 2, timber and board cutting dimensioning machines are circular saw, band saw, drawer, mitre saw, length cutting, dimensioning, slicing, double mitre saw; planing machines are planing, thickness machine; profile and shaping machines are milling cutter, planing, and CNC (Computer Numerical Machine); boring machines are perforating, driller, and lock-out machine; lining and pressing machines are jumbo machine, frame press; sanding machines are

band sanding machine, and vibrant sanding machines; top surface processing machines are slicing machine, and drying plants; auxiliary machines are dust absorber machines, compressor, knife sharpener machine.

The measurement data from the research was determined by basic statistics on SPSS programme.

Findings and Discussions

In this research, the noise levels of 22 number machine types were determined at 56 number enterprises where they produce furniture and door in Kahramanmaraş city in reference to classification of wood processing machine. Measured machines were combined as 8 ranks according to the classification. 2730 number measurement data (average noise levels, standard deviation values, min-max noise values) of the machine without loading were given at Table 3 in reference to classification of wood processing machine.

Table 3. The noise level in reference to classification of wood processing machine when the machine without loading

Machine classification	N	Average dB(A)	Standard deviation	Min. dB(A)	Max. dB(A)
Timber and board cutting dimensioning machines	990	84.17	7.34	69.10	104.40
Planing machines	360	85.28	4.48	76.60	96.30
Profile and shaping machines	450	78.98	5.08	70.20	88.50
Boring machines	330	79.36	5.48	70.90	93.30
Lining and pressing machines	180	76.17	3.84	70.90	83.90
Sanding machines	240	79.54	5.41	73.60	89.90
Top surface processing machines	90	88.09	0.36	87.00	88.50
Auxiliary machines	90	83.66	5.53	77.60	95.40

As given at Table 3, the average noise level didn't mostly exceed the danger limit (85 dB(A)) when the machines were running without loading. On the other hand, planing and top surface process machine groups exceeded too little this limit. The maximum measurement (96.3 dB(A)) was saved at planing machines. It was determined that saved minimum measurements are acceptable noise levels in top surface processing machine groups.

The average noise level exceeded the danger limit (85 dB(A)) when the all machines were running with loading (Table 4). The noise levels, which cause serious hearing losses, were measured while looking maximum values of the machines. These maximum values were saved on timber-board cutting dimensioning machines and planing machines (107.7 dB(A)); the boring machines (106.50 dB(A)). It was determined that all machine groups except lining and pressing machine group exceeded 90 dB(A) and they endangered at serious noise level.

Table 4. The noise level in reference to classification of wood processing machine when the machine with loading

Machine classification	N	Average dB(A)	Standard deviation	Min. dB(A)	Max. dB(A)
Timber and board cutting dimensioning machines	990	90.61	6.32	77.50	107.70
Planing machines	360	95.17	4.50	85.40	107.70
Profile and shaping machines	450	88.85	4.35	78.50	97.80
Boring machines	330	93.79	8.51	79.30	106.50
Lining and pressing machines	180	81.18	2.89	75.90	86.60
Sanding machines	240	85.12	5.52	74.00	90.90
Top surface processing machines	90	91.66	0.69	90.00	92.30
Auxiliary machines	90	91.79	1.91	89.80	97.30

The average noise levels were shown at Figure 4. while the machine was running without loading. The maximum value at planing machines was measured as approximately 85 dB(A) while the machines without loading. The boring machine group had the minimum value as 73 dB(A) also the auxiliary machines had the maximum noise level as 85 dB(A) when the machines running without loading. In addition, it was seen that the least division was between

minimum and maximum values at auxiliary machines.

Planing, boring, auxiliary and top surface machine groups, which exceed 90 dB(A) noise level, should be running maximum 4 hours according to OSHA (1983) while the machines are running with loading. The working hours of workers should be determined in reference to Figure 3 for preventing temporary and permanent hearing losses.

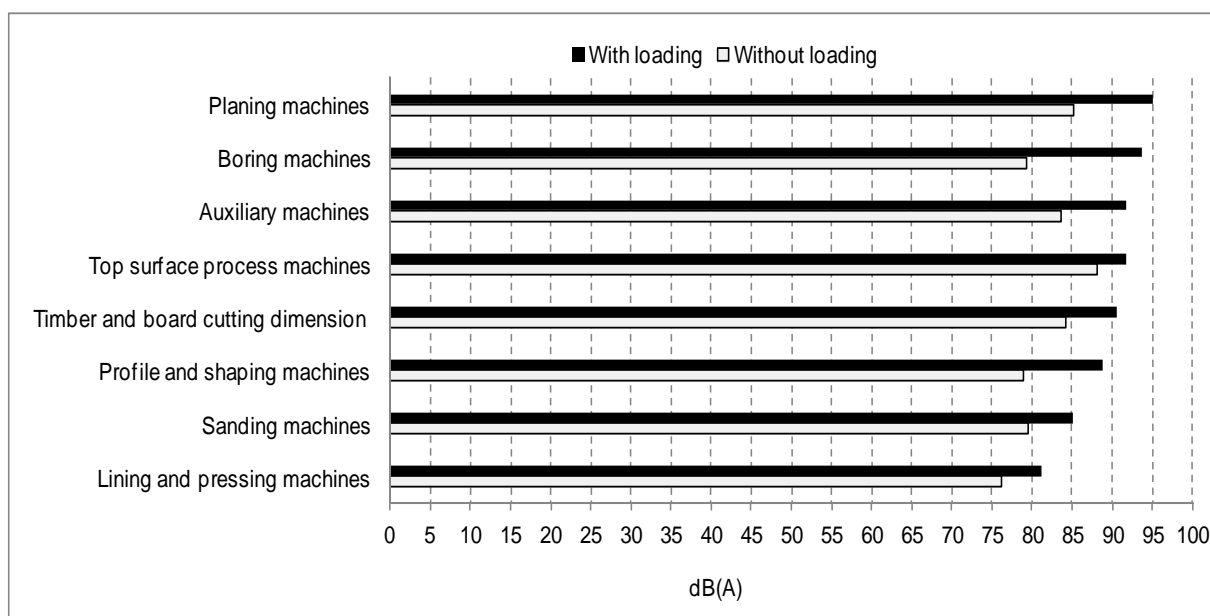

Figure 4. The average noise level on wood processing machine groups

Results

As a result it was seen that the noise levels of machine groups, which produce furniture, have influences to human health. The worker should keep away environment, that is a noisy place over than 90 dB(A),

1000 minutes for preventing temporary hearing loss 18-20 dB(A) on the worker who works 100 minutes at this environment (Sabuncu, 1998).

As shown at Figure 4, it should be taken precautions such as engineering precautions

on the machines, that exceed 85 dB (A) limit noise level (planing machines, timber and board cutting dimension machines, boring machines, profile and shaping machines, top surface processing machines and auxiliary machines), and also some precautions about lessen the noise influence on the workers. In addition, it should be given some knowledge to the workers about potential risks from the noise. Enough relaxing-working ranges should be arranged. The workers should go through physical tests and their health records should be made regularly.

References

- Akan, Z., 2002. Van hava alanında oluşan gürültü kirliliğinin çalışanlar üzerindeki etkileri. Yüzüncü yıl üniversitesi, Yüksek Lisans Tezi. Van, 86s.
- Andrews, G.J.A.B., 1982. Ergonomics fundamentals of senior pupils, Napier College, Collington Road; Edinburgh,
- Anonim, 2012. Gürültünün etkileri, T.C Milli Eğitim Bakanlığı, Aile ve Tüketici Hizmetleri, Ankara. 29s.
- Anonim, 2006. Gürültü ve gürültü kirliliği Orman ve Su İşleri Bakanlığı. Ankara. Gürültü düzeyleri çalışması. 75s.
- Anonim, 2011. Çevresel gürültü ölçüm ve değerlendirme kılavuzu, Çevre ve Orman Bakanlığı Çevre Yönetimi Genel Müdürlüğü Ankara - 2011
- Atmaca, E. ve Peker, İ., 1999. Sivas'ta trafik gürültüsü, Ekoloji Çevre Dergisi, Cilt 8, Sayı 30, s.3-8.
- Aydın, M. E., Ateş, N., 1997. Konya'da trafik gürültüsü ve bazı öneriler, Journal of Engineering Sciences, 3 (3) 447-456
- Babalık, F. 2003. İş yerinde gürültü ve sağırlık olasılığı. Mühendis ve Makine Dergisi, http://www.mmo.org.tr/resimler/dosya_ekler/b04d152845ec0a3_ek.pdf?dergi=50 (Erişim Tarihi:24.06.2016
- İlhan, R., Burdurlu, E., Baykan, İ.,1990. Ağaç İşlerinde Kesme Teorisi ve Mobilya Endüstri Makinaları, Bizim Büro Basımevi, S.361, Ankara.
- Esen, M. 2010. Üretim sahasında gürültü ve gürültü kontrol uygulaması. Yıldız Teknik Üniversitesi Fen Bilimleri Enstitüsü Yüksek Lisans Tezi. İstanbul. 107s
- Ertürk, B., 2001. Hidrolik gürültü ve azaltma yöntemleri, II. Ulusal Hidrolik Pnömatik Kongresi ve Sergisi, s 213-236, 8-11 Kasım 2001, İzmir.
- Feldman, A.S., Grimes, C.T., 1985. Hearing conservations in industry, Williams&Wilkins; London
- Güller, Ç., Çobanoğlu, Z., 1994. Gürültü, Sağlık Bakanlığı Çevre Sağlığı Temel Kaynak Dizisi 19, Ankara, 43s.
- Güner, C. 2000. Gürültünün Sağlık Üzerine Etkileri, Sürekli Tıp Eğitimi Dergisi, (9)7:251-253.
- Dalgıç, N. 1992. Gürültü ve sağlık, Sağlık ve Sosyal Yardım Vakfı Dergisi, 3:5-7.
- Haksal, V. 1997. Gürültü ile oluşan işitme kayıpları ve korunma yolları. Mühendis ve Makine TMMOB Makine Mühendisleri Odası Aylık Yayını, (451): 28-29.
- OSHA, 1983. Occupational noise exposure: Hearing conservation amendmend. Federal Register, Occupational Safety and Health Administration (OSHA) 48, 9738-9783.
- Sabuncu, H., 1998. Fiziksel etkilere bağlı meslek hastalıkları. İşyeri Hekimliği Ders Notları, Türk Tabipler Birliği Yayını. Ankara s.207-226.
- Serin, H. 2012. Analysis of noise levels in corrugated board factories, International Journal of Physical Sciences Vol. 7(11), pp. 1857 – 1861.
- Serin H., Şahin, Y., Durgun, M., (2013). Küçük ölçekli mobilya işletmelerinde gürültü analizi, Ormancılık Dergisi 9 (2) 1-8.
- Yalçınkaya, K. A., Arıkoğlu, T., ve Çalışkan, M., 2007. İş makinalarında gürültü kontrolü, Mühendis ve Makine Dergisi, 48 (571) 9-13.

Conservation of Heat-treated Black Pine Wood with Nano-Reinforced Acrylic Varnishes

*Soner AKSU¹, Orhan KELLEÇİ¹, Abdullah İSTEK², Deniz AYDEMİR²

¹Abant İzzet Baysal University, MudurnuSüreyya Astarci Vocational School, Bolu / TURKEY

²Bartın University, Faculty of Forestry, Bartın / TURKEY

*Corresponding Author: soneraksu0415@hotmail.com

Abstract

Wood is one of the most important building materials. It is a biodegradable material due to it is an organic building material which makes it superior according to other building materials when taken account of environmental concerns. Building materials such as Iron, steel, concrete, ceramics, polymer, and plastic composites have superior long lifetime and durability feature as compare with wood. Thus, many studies aim to extend the lifetime of wood materials. In this study, water based acrylic varnishes reinforced with nano TiO₂ and nano Al₂O₃ were used to preserve the heat-treated black pine (*Pinus nigra*) wood surface. Samples were dried at outdoor conditions after 70gr/m² varnish was applied on the surface of the samples. After the 48 hour drying time; curing test, abrasion test and scratch test were conducted on test samples. In the curing test, best result was found to sample with 4% TiO₂. Same results were taken in abrasion and scratch tests for %4 nano TiO₂. As a result; in the surface protection in the heat-treated black pine wood, nano- TiO₂ had better performance as compare with control samples and the samples with Al₂O₃.

Keywords: Termo-wood, nano varnish, conservation

Isıl İşlem Görmüş Kara Çam Odunlarının Nano Katkılı Akrilik Verniklerle Korunması

Özet

Ahşap malzeme önemli yapı malzemelerinden birisidir. Ahşap malzemenin organik bir yapı malzemesi olması ona biyobozunur malzeme özelliği kazandırmaktadır. Çevresel kaygılar dikkate alındığında bu özelliği onu diğer yapı malzemelerine göre üstün kılmaktadır. Demir-çelik, beton-seramik, plastik ve plastik kompozit gibi yapı malzemeleri ise dayanıklılığı ve kullanım ömürlerinin uzun olması ile ahşap yapı malzemelerine üstünlük sağlamaktadırlar. Bu sebepten dolayı ahşap yapı malzemelerinin kullanım ömürlerinin uzatılması amacıyla yapılan çalışmalar önem kazanmıştır. Yapılan çalışmada ısıl işlem görmüş karaçam (*Pinus nigra*) örnekleri üzerine nano TiO₂ ve nano Al₂O₃ takviyeli su bazlı akrilik vernik uygulaması yapılmıştır. Örneklerin üzerine 70gr/m² vernik uygulaması yapıldıktan sonra örnekler açık hava koşullarında kurumaya bırakılmıştır. 48 saatlik kuruma süresi sonunda örneklere kürlenme testi, aşınma testi ve çizilme testi yapılmıştır. Kürlenme testinde en iyi sonuç %4 nano TiO₂ katkılı test örneklerinden elde edilmiştir. Çizilme ve aşınma testlerinde yine en iyi sonuçların %4 nano TiO₂ ilaveli test örneklerde görülmüştür. Sonuç olarak; ısıl işlem görmüş karaçam odununun korunmasında nano TiO₂ takviyeli verniklerin koruma etsinin nano Al₂O₃ katkılı ve katkısız (kontrol) test örneklerine göre daha iyi olduğu tespit edilmiştir.

Anahtar Kelimeler: Termowood, Nano vernik, Ahşap koruma

Introduction

New materials can be obtained with progressions in the nanotechnology which have superior properties or their properties can be improved. In forest products, nano technological innovations can be used to preserve wood materials against to abiotic factors. The surface properties of various varnishes are developed with nano fillers. Thus, production of nano based-varnishes was started to produce specific areas from 2000 to today. Many factors such as

moisture, sunlight and ultraviolet can be caused the deterioration on wood material surface. To protect wood surface from this harmful effect, it have to use varnishes or surface stain (Özen and Sönmez, 1996). Ultraviolet (UV), visible light and infrared region of sun have the harmful effects on wood surface if their wavelength are lower from 290 nm. 5-7% of UV lights can be arrive the earth surface because of atmosphere block the its effect. UV lights can be differed to 3 categories which are UV-

A (315-400 nm), UV-B (280-315 nm) and UV-C (200-280 nm). UV-C is absorbed by the atmosphere, although it is most damaging wave length. UV-B is more harmful than UV-A (Koleske, 1995). If the wood is exposed to UV rays, lignin starts to dissolve within hours. When Extractives exposed to UV rays, they change their color. Color change cause the darker wood surface or lighter color formation (Williams, 2009). The wood left to atmospheric conditions can be exposed dimensional change and the shape change due to changes in air moisture content, thus defects occur to water intake. Coating of the entire surface with surface treatment to block the water intake is claimed to protect to wood against various atmospheric conditions (Bufkin and Wildman, 1980).

Heat treated wood surface tends to aging caused by weathering conditions and sunlight, rain and wind effect. This does not affect the wood's durability but after a certain period of time wood surfaces grayed out. This color change is more obvious than heat untreated wood. Tiny cracks form in the surface when heat-treated panels are exposed direct sunlight (ultraviolet radiation). Paints and lubricants which are without pigment and containing low-volatile organic compounds does not protect to untreated wood against external weather conditions. If wood panels are coated with low density volatile organic stains, they shows intense crack tendency. Heat treated wood materials must coat with coating materials; so that they prevent it from the harmful effect of weather. When wood materials are coated generally transparent stain preferred by expert. Unfortunately these stains have low performance value.

Surface of wood treated with heat can be paint for aesthetic appealing or against weathering. Penetration and adhesion of painting process are effected by heat treating. Heat treated wood need to more dry time than to un-treated wood because of it cannot well absorb the water due to its hydrophobic structure. Thus, one layer film is more effective than sole layer film for effective painting; for example, first film layer is 80 µm and second layer is 80 µm thicknesses.

Best coating stain for heat treated wood is topcoat oil paint and solvent-based alkid paint or water-based acrylic topcoat paint. Acid cured acrylic or water based acrylic paint has best performance on heat treated wood surface and exfoliation is generally not observed on surface (Boonstra, 2008). Heat treated wood has low wettability and due to this disadvantage, wood effects more by weathering condition and UV. Surface of a wood expose to high temperature can be expose inactivation. When bonding points on wood surface was pyrolysis, this action causes a real and inevitable initial inactivation (Sernek, 2002).

The aim of the study is to investigate the effect of nano particles filled varnishes on the surface properties of heat-treated wood.

Materials and Methods

Materials

In this study, water-based acrylic varnishes were used (VW260.30). Water-based varnishes were purchased from Kimertsan Chemical, which is a domestic chemistry firm in Turkey (Fig. 1). The varnishes have double component. Al₂O₃ and TiO₂ were used as fillers in the varnishes.

Table 1. Properties of purchased acrylic varnish.

Properties	Value
Solid mass % (weight)	36 - 38
Viscosity 25°C KU1	95 - 100
Density kg/liter	0.92 - 1.03
pH	7.8 - 9
Applied quantity gr/m ²	160 - 220
Dust dry minute	30
Touch dry minute	60
Flash off minute (20 °C)	15
Laminar air minute (30 °C)	90
Freeze minute(20 °C)	15

Nano Al₂O₃ and nano-TiO₂ was purchased from Grafen Inc., a domestic firm. Nano Al₂O₃ is 80% pure, 30nm, well separate (>95%) and transparent. While Al₂O₃ has used as reflector and abrasive paper. In this study, Al₂O₃ was used to increase the stretch durability of wood surface. Nano TiO₂ is

anatase: 99,9% pure, 5nm, transparency and well separate in water. Nano TiO₂ can block the UV light is down 400nm wavelength, when used in varnishes for coated wood surface (MV Cristea at all 2010). In this study, nano TiO₂ was used to hamper the color changes and increase durability against fading.

In the study, wood test samples are heat-treated black pine species purchased from Nova wood firm. Black pine samples were treated at 170°C for 6 hours. Heat treatment is a method used to increase to durability of wood against to outdoor condition (Aydemir and Gunduz, 2009).

Test sample preparation;

Heat-treated black pine samples were firstly cleaned, and oil or dust on them was removed from surface of them. The surfaces were sand by sand paper with 120 grids in preparation of the surfaces. 15 pieces of heat-treated black pine was prepared for varnish processing. 3 pieces of samples were used as control samples, which is water-based acrylic without nano particles. Coating process was conducted with brush according to firm advice. 12 pieces of test sample were treated with nano varnishes filled with 1% Al₂O₃ and TiO₂ nano particles, and then test samples were dried in air condition.

Three different solutions were prepared with TiO₂ and Al₂O₃ nano particles. 10% Al₂O₃ and TiO₂ water solution was prepared with mechanic blender for 5 min., and then ultrasonic blender for 10 min.

The solutions obtained were added to varnish as 1% wt. Varnishes with nano particles were mixed firstly by mechanical blender for 10 minute at 1500 rpm, then varnishes with nano particles were mixed by ultrasonic blender for 20 min. to obtain the homogenous varnish. This mixing process was conducted in water-cooled water bath to prevent degradation among molecules of polymer.

Determination of abrasive properties;

TABER test device was used to determination of abrasive properties of the prepared test samples. Before the test process, test samples were placed in a climate chamber for 24 hours at 18-22°C and 60-70% relative humidity. The sand paper with 200 grids was used on device roller. Samples were drilled on abrasive test device. Sand paper was rolled to the device wheels, and the papers were placed on surface of wood samples. Weights of abrasive wheels were 500 gr. Surfaces of the test samples were drilled to per 20 cycles with the device. After averages of testing cycle numbers were taken, and obtained value was evaluated according to related standards.

Determination of scratch stress;

Scratch stress was determined according to TS EN 14323 standard. Test samples were placed in the climate chamber at 18-22°C and 60-70% relative humidity for 24 hours. Test samples were drilled with the device, and then the surfaces of them were cleaned with cotton. The samples were placed to test device for scratch test. Horizontal plate of device was positioned under the scratch bar which has a diamond header. The samples were begun to spin with 360 degrees. At first, scratch effect was 0.5 N on the surface of test samples and scratch force was increased up to 360 degrees, and full scratch line was observed. Initial force was 0.5 N to the scratch, the surface force was increased from 0.5 N to 2.5 N. The results obtained were evaluated according to related standards (Aksu, 2009).

Determination of curing degree;

Curing is to convert a hardener film of a thermoset characteristic material due to polymerization reactions of surface plate on the surface of coating materials (Kara et al.,). Curing degree of solid layer on varnished surface was determined by curing test (acid test). Initially 30 mg rhodamine B is a colorant, and it was added to 1 litter HCL. Sample surface was cleaned, and they were cooled at +4 degree for 5 min. 35mm circle was drawn on samples with a pencil. Prepared solution was used as two drops with

pipet on samples surface. After 5 min., samples surface was cleaned with a cotton cloth. The surfaces of test samples were evaluated from 1 to 5 according to observations. The evaluation was made according to Table 2.

Table 2. Curing test (acid test) values

Observation	Degree	Evaluation
Non change on surface	5	Over curing
A little color change	4	enough
Middle level color change	3	Adequate
High color change	2	enough
Exceeding color change/surface degraded	1	Little curing

Result and Discussion

Abrasive test results;

According to Fig.1, abrasive test results of nano fillers-filled varnishes have more durable properties than control test results. Nano TiO₂ filled varnishes has better abrasive value than Al₂O₃ filled varnishes. Varnishes with 4% TiO₂ have best results for abrasive test. Abrasive value in Al₂O₃ filled varnishes exhibited lower for Ip values. It was determined that Al₂O₃ addition to varnishes increased abrasive values. In initial Point (Ip), the addition of TiO₂ to varnishes provided to 53% higher results as compare with Al₂O₃. In Final Point (Fp), any important difference cannot be determined to both TiO₂ and Al₂O₃. Fig. 1 shows the abrasive values of samples.

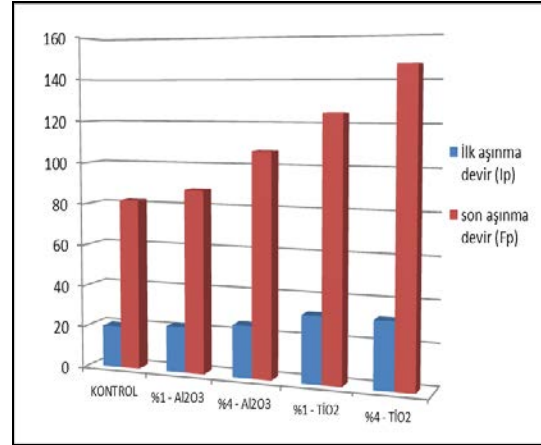

Figure 1. abrasive test results.

Scratch test results;

Nano TiO₂ added varnishes showed better properties than control and Al₂O₃ added varnishes test samples. The lowest scratch value was obtained control samples. In the Al₂O₃ added varnishes, when the nano particle loadings increased from 1% to 4%w/w, an increasing was determined in scratch value. Best result in the scratch test was obtained to 4% TiO₂ added varnishes. An increasing was determined in the scratch test when TiO₂ loading increased from 1% to 4%. Scratch results were figured in Fig. 2.

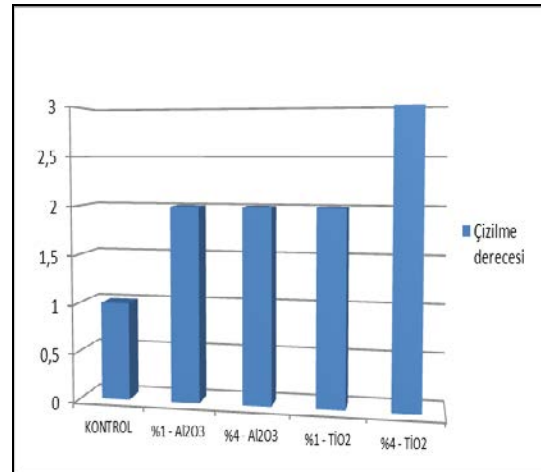

Figure 2 . scratch test results.

Curing test results;

In the curing test (acid test), the lowest results were determined to control samples. In the nano Al₂O₃ added varnish tests, an increasing was obtained on curing test result

when nano particle increased from 1% to 4%. The best result was taken in curing test from 4% nano TiO₂ added varnish. An increasing was determined when nano TiO₂ increased from 1% to 4%. It was determined that TiO₂ filled varnishes have better properties than Al₂O₃ in curing test. Acid test result was given in Fig. 3.

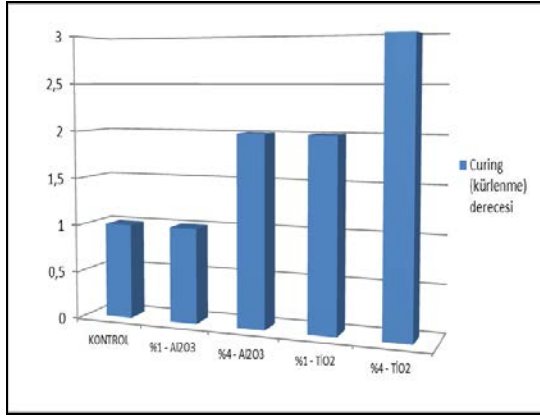

Figure 3. Result of curing test (acid test)

Conclusion

Nowadays, water-based acrylic varnishes advice because of environmental concerns. In this study, conservation of heat-treated black pine (*Pinus nigra*) wood surfaces coated with nano filled water-based acrylic varnishes. 1% and 4% nano-TiO₂ reinforced varnishes showed better results than the Al₂O₃ and control varnishes. The best abrasion, scratching and curing results were obtained from 4% TiO₂ reinforced nano varnishes. The best effective results were obtained from 4% nano filled TiO₂ varnish that can be recommended to industrial applications.

References

Aksu S., 2009. Dekor kâğıdı ve reçine tipinin yongalevhaların fiziksel – mekanik ve yüzey kalitesine etkisi, Yüksek Lisans Tezi, Bartın Üniversitesi, Fen Bilimleri Enstitüsü, 65 s. Bartın.

Aydemir D, Gündüz G 2009. Ahşabın fiziksel, kimyasal, mekanik ve biyolojik özellikleri üzerine ısıyla muamelenin etkisi, Bartın Orman Fakültesi Dergisi, 11(15): 71-81.

Boonstra MJ., 2008. A two-stage thermal modification of wood. Ph.D. dissertation Ghent University, 297 s. France.

Cristea M.V., Riedl B., Blancher P 2010. Enhancing the performance of exterior waterborne coating for wood by inorganic nano-sized UV absorbers, Prog. Org. Coat. 69(4): 432-441.

Kara, M.E., İstek, A., Esgin, E., The Effect Of Lamination Conditions On Surface Characteristics Of Particleboard, 3rd International Non-wood Forest Products Symposium 8-10 May 2014, Kahramanmaraş-Turkey s 1030-1037.

Koleske V.J., 1995. Paint and Coating Testing Manual, American Society for Testing and baterials, 53(2), 643-653.

Ncube E, & Meincken M 2010. Surface characteristics of coated soft-and hardwoods due to UV-B ageing. Applied Surface Science, 256 (24): 7504-7509.

Özen R, Sönmez A 1996. Ahşap Verniklerin Harici Etkilere Karşı Dayanıklılığına ilişkin Araştırmalar, Devlet Planlama Teskilatı Arastırma Projesi, Ankara.

Sivrikaya H, Hafızoglu H, Yasav A, Aydemir D 2009. Natural Weathering of Oak (*Quercus petrae*) and Chestnut (*Castanea sativa*) Coated with Various Finishes. Co. Res. A. 36 (1), 72-78.

URL 1, 2016 Wikipedia. “Aluminium oxide”.http://en.wikipedia.org/wiki/Aluminium_oxide #cite_ref-azom_6-1.

Williams S 2009. Finishing of Wood, General Technical Report, 190, 188-190

Combined Effect of Heat Treatment and Varnishes on Thermal Conductivity of Fir and Beech Wood

Hamiyet ŞAHİN KOL¹, Erkan Sami KÖKTEN¹, *Günay ÖZBAY²

¹Karabuk University, Faculty of Forestry, Karabuk / TURKEY

²Karabuk University, Faculty of Engineering, Karabuk / TURKEY

*Corresponding Author: gozbay@karabuk.edu.tr

Abstract

In this study, the thermal conductivity of wood specimens heat-treated with ThermoWood method and followed by the finished process was evaluated. Fir and beech specimens heat-modified at temperatures 170 °C, 180 °C, 190 °C and 212 °C for 2 h. were varnished with different varnishes (polyurethane, Hickson Decor, Polyester). The thermal conductivity of the specimens was then measured based on the ASTM C 1113-99 hotwire method and compared with those of unheated specimens. The results show that varnish type and heat treatment were important factors effecting thermal conductivity of wood.

Keywords: Thermal conductivity, Heat treatment, Varnish, Beech, Fir

Özet

Bu çalışmada, ThermoWood yöntemi ile ısıtım işlem uygulamasının ardından vernikleme işlemine tabi tutulmuş odun örneklerinin ısıtım iletkenlik değerleri araştırılmıştır. 170 °C, 180 °C, 190 °C, 200 °C ve 212 °C’de 2 saat süreyle ısıtım ile modifiye edilmiş göknar ve kayın örneklerine farklı vernikler (poliüretan, Hickson Decor, Polyester) uygulanmıştır. Vernik uygulamasının ardından örneklerin ısıtım iletkenlikleri ASTM C 1113-99 standardına göre hotwire metodu ile ölçülmüştür ve ısıtım işlem uygulanmamış örnekler ile kıyaslanmıştır.

Elde edilen sonuçlar vernik türünün ve ısıtım işlem sıcaklığının ısıtım iletkenlik üzerinde önemli bir etkiye sahip olduğunu göstermiştir.

Anahtar kelimeler: ısıtım iletkenlik, ısıtım işlem, Vernik, Kayın, Göknar

Introduction

Wood has many applications in areas that require good insulating properties. For example, the significant presence of wood and wood products in buildings, the energy design of wood frame buildings and the evaluation of their energy performance depend in part on the thermal properties of wood products (TenWolde et al., 1988). In addition, information on thermal conductivity of wood and its relationship to other wood properties is of interest from stand point wood thermal degradation and other processes in which wood is subject to a temperature change (Sanyal et al., 1991; Gu, 2001; Gu and Zink-Sharp, 2005).

Thermal conductivity is a measure of the rate of heat flow through the one-unit thickness of a material subjected to a temperature gradient (Simpson and TenWolde, 1999). The ability of a material to conduct heat as a result of transmitting molecular vibrations from one atom or molecule to another varies greatly depending upon the chemical nature of the material and its gross structure or texture (Gu and Hunt, 2007).

Wood is used in severe outdoor and indoor situations where special treatments and finishes are required for proper protection and best service. These situations involve the need for protection against decay (rot), insects, fire, and harsh exposures such as marine environments. A large proportion of the damage done to exterior woodwork (paint defects, deformations, decay, leakage, etc.) is a direct result of moisture changes in the wood and subsequent dimensional instability. The treatments can also be used as natural finishes for wood (Ozcifci and Ozpak, 2008).

Increasing environmental pressure appeared in the last years in many European countries leading to important changes in the field of wood preservation, particularly regarding biocide toxicity promoting the development of non-biocidal alternatives. Among these alternatives, wood heat treatment by mild pyrolysis has been intensively investigated leading to the development of several industrial processes in Europe (Militz, 2002; Inari et al., 2007).

Thermal modification at high temperatures (above 170° C) leads to

chemical changes in the wood constituents (polyoses, cellulose and lignin); this has been subject in numerous publications (Tjeerdsma and Militz, 2005; Windeisen et al., 2007; Nuopponen, 2005; Alen et al., 2002; Boonstra and Tjeerdsma, 2006). As a consequence of chemical changes in wood's structure, the physical properties of wood are also modified. Dimensional stability is improved (Viitaniemi, 1997a; Yıldız, 2002; Esteves et al., 2007), equilibrium moisture content is lowered (Jämsä and Viitaniemi, 2001; Esteves et al., 2007), colour darkens (Johansson and Moren, 2006; Gunduz and Aydemir, 2009) and biological durability is increased (Viitaniemi, 1997b; Boonstra et al., 2007; Kandem et al., 2002). The degree and intensity of the modifications during heat treatment depend on the process conditions applied: the process type, the duration and the temperature of the heat treatment, and the nature of the wood itself (Nuopponen, 2005). The higher the heat-treating temperature and the longer the time, the more significant are the changes.

Also, wood materials can finish with various surface processes before their usage. Among the various surface processes applied to wood, varnishes are used to show its beauty, color and the wood pattern resulting from its nature along a film layer. After the application of surface treatments performed according to industry standards the technical, aesthetical and economical value of wood increases (Uysal et al., 2008).

The thermal conductivities of solid wood and wood-based materials have been widely investigated. Previous studies reported that the thermal conductivity of wood varies with the direction of heat flow with respect to the grain, with specific gravity, with defects and with extractives. The thermal conductivity of wood increases with density moisture content and temperature (Rowley, 1933; Wangaard 1940; Suleiman et al., 1999; Gu and Zink-Sharp, 2005; Steinhagen, 1977; Tenwolde et al., 1988; Sahin Kol and Altun, 2009). Also, many early studies show that heat-treatment increases the thermal insulation of wood (Militz, 2002; Esteves et al., 2007; Kortelainen et al., 2006; Santos, 2000). However, research regarding thermal conductivity values of heat-treated and

finished wood and the changes in the property depending on the heat-treatment temperature has not been reported detail.

Fir and beech are the main wood species for industrial-scale heat treatment in Turkey. Heat-treated wood has a growing market in outdoor applications like exterior cladding, window and door joinery, garden furniture and decking. There are also many indoor applications for heat-treated wood such as flooring, paneling, kitchen furnishing and interiors of bathrooms and saunas (Viitaniemi, 2000).

The target in this research was to determine how finished materials affect the thermal conductivity of heat-treated fir and beech wood. The effect of heat treatment temperature was also examined. The thermal conductivity of heat-treated and varnished wood was measured and compared with those of the varnished wood. In this purpose, polyurethane, Hickson-decor and polyester varnishes were used as finished materials.

Material and Method

Wood species

Fir (*Abies bornmülleriana* Mattf.) and Oriental beech (*Fagus orientalis* L.) planks were purchased from a local supplier in Bolu, Turkey. A special emphasis was put on the selection of the wood material. Accordingly, sapwood region, non-deficient, whole, knotless, normally grown (without zone line, reaction wood, decay, insect or fungal infection) wood materials are selected. The planks were industrially kiln-dried approximately at a temperature of 70 °C to a moisture content of 11-15%.

Varnishes

Transparent varnish named as Hickson decor, polyurethane and polyester were used for finishing process of the samples and applied according to the manufacturer's instructions. Hickson décor varnish was provided from HEMEL; polyurethane and polyester varnish were provided from DY0. Technical specifications of the varnishes were given in Table 1.

Method

Heat-treatment

The 20 planks chosen for experiments from each wood species were sawn and

planed on four sides to form a cross section of 25×140 mm². Then these 4 m long planks were split from the middle and cut into five 80 cm long pieces. The other halves of these test planks were left as a reference material (later also called untreated control, which was only subject to varnishing process) and the other halves were heat-treated under steam at five different temperatures according to Fig. 1.

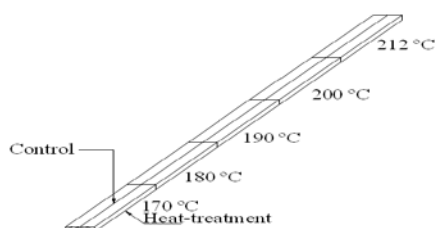

Figure 1. Descriptions of the wood materials used in the tests

Planks (25 mm thickness, 70 mm width and 800 mm long) were subject to heat-treatment using various schedules. Heat-treatment was carried out under accurate conditions under steam with a laboratory kiln from Nova ThermoWood in Gereede, Turkey. The heat treatment was applied according to the method described in the Finnish ThermoWood Handbook (Anon., 2003). At

first, the temperature of the kiln was raised near to 100 °C. When the temperature inside the wood had risen to near the same temperature, the raising of the kiln temperature was carefully continued to the actual treating temperature. The target temperatures were 170 °C, 180 °C, 190 °C, 200 °C and 212 °C. The time of thermal modification at the target temperature was 2 hours on every test run. After the heat-treatment phase, the temperature was lowered to 80 °C to 90 °C using water spray system. Conditioning was carried out to moisten the heat-treated wood and bring its moisture content to 4%–7%.

After heat treatment, only the planks that were free of defects were selected for further testing.

The samples with dimensions of 20x50x100 mm were cut from heat-treated and untreated planks. 20 samples were used in each variation. Then, treated and untreated samples were conditioned in a climate controlled room at 65% RH and 20 °C for 6 weeks.

Table 1. Technical specifications of the varnishes used

Type of Varnish	Density (g cm-3)	Viscosity (second/DIN CUP 4 mm/20°)	Nozzle gap (mm)	Amount applied (g m-2)	Air pressure (bar)	Drying type	Drying time (20°) h.	Solid Amounts (%)
Polyurethane (Filler)	0.98	16	1.8	120	2	Chemical	2-3	50
Polyurethane (Finishing)	0.99	16	1.8	120	2	Chemical	3-4	40
Hickson decor Varnish (Finishing)	0.94	18	-	110	-	Physical	2-4	55
Polyester (Filler)	1.03	18	1.8	150	3	Chemical	3-4	55
Polyester (Finishing)	1.03	18	1.7	150	3	Chemical	3-4	55

Varnishing

The heat-treated and untreated test samples were varnished according to ASTM D 3023 (Anon., 1981). The surfaces of the samples were sanded with abrasive papers to remove the fiber swellings and the resulting dust was cleaned off before varnishing. The manufacturer's instructions were followed for the composition of the solvent and hardener ratio and 1 or 2 finishing layers were applied after the filling layer. The polyurethane and polyester varnishes were applied to the surface of the test samples with spray. Spray nozzle distance and pressure were adjusted according to the manufacturer's instructions and moved in parallel to the sample surface at a distance of 20-30 cm. Hickson decor varnish was applied with a brush. Varnishing was done under 20 ± 2 °C and $65\% \pm 3$ relative humidity conditions. Dry film thicknesses of the varnish layers were measured with a comparator, which has a sensitivity of 5 µm.

After varnishing, the samples were conditioned in a climate controlled room at 65% RH and 20 °C for 3 weeks.

Thermal conductivity tests

Thermal conductivity measurements were made using QTM 500 device which is a product of Kyoto Electronics Manufacturing, Japan. The quick thermal conductivity meter based on ASTM C 1113-99 (Anon., 2004) hot-wire method was used. Variac (power supply) was used to supply constant electrical current to the resistance. PD-11 box probe sensor (constantan heater wire and chromel-alumel thermocouple) was used. Measurement range is 0.0116–6 W/m-K. Measurement precision is 5% of reading value per reference plate. Reproducibility is 3% of reading value per reference plate. Measurement temperature is -100 to 1000 °C (external bath or electric furnace for the temperature other than the room). The sample size required is 20 x 50 x 100 mm. Measuring time is standard 100–120 s.

The measurements were made at 20–24 °C room temperature. Each sample was checked on a table-top to assess flatness prior to testing; a factor that preliminary testing indicated was critical to consistent thermal conductivity values (Rice and Shepard,

2004). The flat samples were measured, weighed and then the measurements were carried out. Each sample was tested twice. After each test, each sample was reweighed and flipped 180 degrees and the thermal conductivity retested. Variations in values (>5%) in the readings between each side indicated that samples warped or defective and they are discarded.

The air dry densities of test samples were determined according to TS 2472 (Anon., 1976). The weights were measured with an analytic balance of ± 0.02 g sensitivity. Afterward, the dimensions were measured by the digital compass of ± 0.001 mm sensitivity and volumes were determined by the stereometric method. The air-dried densities (δ_r) of the samples were calculated with following equation:

$$\delta_r = M_r/V_r \quad (1)$$

Where; M_r is the air-dry mass (kg) and V_r is the volume (m³) at air-dry conditions.

Data analyses

By using two wood types, five heat-treatment temperature and control samples (untreated) and three different types of varnishes as factors, a total of 720 samples (2x6x3x20) were prepared using 20 samples for testing. Multi analyses of variance were used to determine the differences between the thermal conductivity of the prepared samples and Duncan's test was done to identify which groups were significantly different.

Results and Discussion

The mean values of thermal conductivity of the samples were given in Table 2. According to the Table 2, for both fir and beech wood, the highest thermal conductivity values were found in the case of untreated, finished with the polyester varnish of samples and the lowest values were found in the case of heat-treated at 212 °C, finished with hickson decor varnish of samples. The thermal conductivity of heat treated samples was reduced by 0-20% for fir and 5-31% for beech wood, when compared with untreated samples.

Table 2. The thermal conductivity of samples according to varnishes (W/m-K)

Varnish	Treatment	Fir			Beech		
		Specific gravity	Mean	Std. Deviation	Specific gravity	Mean	Std. Deviation
Polyurethane	Control	465.7	0.1198	0.0047	648.8	0.1704	0.0125
	170	450.3	0.1151	0.0074	646.7	0.1610	0.0106
	180	444.8	0.1082	0.0066	636.3	0.1424	0.0085
	190	442.4	0.1015	0.0063	633.2	0.1399	0.0069
	200	439.1	0.0971	0.0066	621.4	0.1347	0.0053
	212	438.3	0.0952	0.0069	609.6	0.1312	0.0043
Hickson Décor	Control	465.6	0.1154	0.0065	647.4	0.1608	0.0052
	170	449.4	0.1154	0.0054	645.8	0.1375	0.0052
	180	443.9	0.1073	0.0096	635.7	0.1402	0.0076
	190	441.7	0.1000	0.0085	632.9	0.1378	0.0058
	200	438.4	0.0961	0.0070	619.3	0.1321	0.0025
	212	437.8	0.0944	0.0085	608.8	0.1267	0.0065
Polyester	Control	466.5	0.1201	0.0062	650.7	0.1967	0.0247
	170	455.4	0.1152	0.0057	649.5	0.1683	0.0121
	180	446.7	0.1092	0.0080	637.6	0.1437	0.0086
	190	444.5	0.1036	0.0076	636.3	0.1420	0.0103
	200	441.2	0.0975	0.0049	623.8	0.1397	0.0052
	212	438.6	0.0956	0.0069	610.7	0.1348	0.0091

Duncan's multiple comparison tests were used to determine the differences between the experimental groups. The Duncan test results were given in Table 3 as letters. Statistical analysis showed that the thermal conductivity of beech wood was higher than that of fir wood.

While the highest thermal conductivity values were obtained in the samples finished with polyester varnish, the lowest thermal conductivity values were obtained in the samples finished with hickson décor varnish (Table 3).

As can be seen from the table 4, the heat treatment decreased the thermal conductivity of samples. Also, the effects of finishing were determined to be statistically significant ($P < 0.05$).

The effects of wood species, heat treatment process and finishing are statistically significant ($P < 0.05$).

Table 3. Homogeneity groups of results

Thermal Conductivity (W/mK)			
		Average	Homogeneity Group
Wood Species	Fir	0.1059	A
	Beech	0.1466	B
Temperature (°C)	Control	0.1471	E
	170	0.1354	D
	180	0.1251	C
	190	0.1207	BC
	200	0.1161	AB
	212	0.1129	A
Varnish Type	H. Decor	0.1219	A
	Polyurethane	0.1264	B
	Polyester	0.1305	C

Differences between average values with the same letter are not significant ($P < 0.05$).

The differences of thermal conductivity values found in this study are strongly related to the specific gravity of samples. The specific gravity of samples used in the tests were presented in Table 2. According to the

Table 2, the specific gravity of samples decreased by increasing heat treatment temperature.

While the highest specific gravity values (466.5 for fir and 650.7 for beech) were measured in the case of untreated, finished with polyester varnish of samples, the lowest specific gravities (437.8 for fir and 608.8 for beech) were measured in the case of heat-

treated at 212 °C, finished with Hickson Décor varnish of samples. Thermal conductivity increases as specific gravity increases. The influence of density on thermal conductivity has been proved by several authors (Rice and Shepard, 2004; Kurt et al., 2009; Şahin Kol and Altun, 2009; Şahin Kol et al., 2010).

Table 4. Multiple variance analysis for the effect of wood species, process and finishing on thermal conductivity

Source	Sum of squares	Degree of freedom	Mean square	F ratio	Significance
Wood Species	0.299	1	0.299	4185.656	0.00
Process	0.1	5	0.02	278.968	0.00
Varnish	0.009	2	0.004	61.493	0.00
Wood x Process	0.011	5	0.002	30.598	0.00
Wood x Varnish	0.005	2	0.002	35.005	0.00
Process x Varnish	0.006	10	0.001	8.554	0.00
Wood x Process x Varnish	0.006	10	0.001	8.801	0.00

Conclusion

The results indicate that the thermal conductivity of all heat-treated samples decreased compared with the control (untreated) samples. While the highest thermal conductivity values were obtained in the samples finished with polyester varnish, the lowest thermal conductivity values were obtained in the samples finished with hickson décor varnish. Because of its good thermal insulation, heat treated wood is pretty preferable material for applications where the insulation is required such as saunas, outer doors, cladding, and windows. The thermal conductivity decreases depending on heat treatment temperature and this is demonstrated that the treatment level could be determined to create a product where it is desired to use. The heat treated samples with finished hickson decor varnish is more preferable for applications where the insulation is required than the polyester and polyurethane varnishes.

Acknowledgement

The authors would like to thank Nova ThermoWood for using the Laboratory for this study.

References

- Alén R., Kotilainen R., Zaman A. 2002. Thermochemical Behavior of Norway Spruce (*Picea abies*) at 180-225 °C. Wood Science and Technology, 36, 163-171.
- Anonymous, 1976. TS 2472 1976. Wood-Determination of Density for Physical and Mechanical Tests, TSE, Ankara, Turkey.
- Anonymous, 1981. ASTM D 3023 1981. Determination of Resistance of Factory Applied Coating on Wood Products of Stain and Reagents, USA.
- Anonymous, 2003. ThermoWood Handbook, Finnish ThermoWood Association, Helsinki.
- Anonymous, 2004. ASTM C 1113-99 2004. Standard test method for thermal conductivity of refractories by hot wire (Platinum Resistance Thermometer Technique), West Conshohocken, USA.
- Boonstra M.J., Tjerdtsma B. 2006. Chemical analysis of heat treated softwoods. Holz als Roh- und Werkstoff, 64, 204-211.
- Boonstra M.J., Van Acker J., Kegel E., Stevens M. 2007. Optimisation of the two-stage heat treatment process: durability aspects. Wood Science and Technology, 41, 31-57.
- Esteves B.M., Domingos I.J., Pereira H.M. 2007. Pine wood modification by heat treatment in air. Bioreources, 3 (1), 142-154.
- Gu H.M., 2001. Structure Based, Two-dimensional Anisotropic, Transient Heat

Conduction Model for Wood. Ph.D. Thesis, Virginia Polytechnic Institute and State University, 214 pp. Blacksburg, Virginia.

Gu H.M., Hunt J.F. 2007. Two-dimensional finite element heat transfer model of softwood. Part III. Effect of moisture content on thermal conductivity. *Wood Fiber Sci.*, 39 (1),159-166.

Gu H.M., Zink-Sharp A. 2005. Geometric model for softwood transverse thermal conductivity. Part 1. *Wood and Fiber Sci.*, 37 (4), 699-711.

Gunduz G., Aydemir D. 2009. Some Physical properties of Heat-treated Hornbeam (*Carpinus betulus* L.) wood. *Drying Technology*, 27, 714-720.

Inari G., Petrisans M., Gerardin P. 2007. Chemical reactivity of heat-treated wood. *Wood Sci. Technol.*, 41, 157-168.

Jämsä S., Viitaniemi P. 2001. Heat treatment of wood. Better Durability without Chemicals. In: Proceedings of COST E22 Environmental optimisation of wood protection, 21-26, Antibes, France.

Johansson D., Morén T. 2006. The potential of colour measurement for strength prediction of thermally treated wood. *Holz Roh Werkst.*, 64, 104-110.

Kandem D.P., Pizzi A., Jermannaud A. 2002. Durability of heat-treated wood. *Holz als Roh- und Werkstoff*, 60, 1-6.

Kortelainen S.M., Antikainen T., Viitaniemi P. 2006. The water absorption of sapwood and heartwood of Scots pine and Norway spruce heat-treated at 170°C, 190°C, 210°C and 230°C. *Holz Roh Werkst.*, 64, 192-197.

Kurt Ş., Uysal B., Ozcan C. 2009. Thermal conductivity of oriental beech impregnated with fire retardant. *J. Coat. Technol. Res.*, 6 (4), 523-530.

Militz H. 2002. Thermal treatment of wood: European processes and their background. In: International Research Group on Wood Preservation, Document No: IRG/WP 02-40241.

Nuopponen M. 2005. FT-IR and UV Raman spectroscopic studies on thermal modification of scotch pine wood and its extractable compounds. Helsinki University of Technology, Espoo, Finland.

Ozcifci A., Ozbek A.S. 2008. Impacts of impregnation solutions on the adhesion strength of outer usage varnish coatings. *Construction and Building Materials*, 22, 513-520.

Rice R.W., Shepard R. 2004. The thermal conductivity of plantation grown white pine (*Pinus strobus*) and red pine (*Pinus resinosa*) at two moisture content levels. *Forest Prod. J.*, 54 (1), 92-94.

Rowley F.B. 1933. The heat conductivity of wood at climatic temperature differences. *Heat. Pip. Air Cond.*, 5, 313-323.

Sahin Kol H., Altun S. 2009. Effect of some Chemicals an Thermal conductivity of impregnated laminated veneer lumbers bonded with Poly(vinyl acetate) and Melamine-Formaldehyde Adhesives. *Drying Technology*, 27, 1010-1016.

Sahin Kol H., Uysal B., Kurt Ş., Ozcan C. 2010. Oak thermal conductivity. *BioResources*, 5 (2), 545-555.

Santos J.A. 2000. Mechanical behaviour of Eucalyptus wood modified by heat. *Wood Sci Technol.*, 34, 39-43.

Sanyal S.N., Jain V.K., Dubey Y.M., Verma P.C. 1991. A Preliminary note on relationship between dielectric properties and thermal conductivity of wood. *J. Ind. Acad. Wood Sci.*, 22 (2), 45-49.

Simpson W., TenWolde A. 1999. Physical properties and moisture relations of wood, Chapter 3, (In: *Wood Handbook-Wood as an Engineering Material*) GTR 113, Madison, WI., 3-23.

Steinhagen H.P. 1977. Thermal Conductive Properties of Wood Green or Dry from -40° to +100 °C: A Literature Review. General Technical Report FPL-9, USDA Forest Service, Madison, USA. 10 pp.

Suleiman B.M., Larfeldt J., Leckner B., Gustavsson M. 1999. Thermal conductivity and diffusivity of wood. *Wood Sci. Technol.*, 33 (6), 465-473.

Tenwolde A., McNatt J.D., Krahn L. 1988. Thermal properties of wood and wood panel products for use in buildings. INC. DOE/ USDA-21697/1, USDA Forest Service, Madison, USA.

Tjeerdsma B.F., Militz H. 2005. Chemical changes in hydrothermal treated wood: FTIR analysis of combined hydrothermal and dry heat-treated wood. *Holz als Roh- und Werkstoff*, 63, 102-111.

Uysal B., Kurt Ş., Seferoğlu D., Ozcan, C. 2008. Combustion Propeties of Scotch Pine of Finishing Processed. *Teknoloji*, 11 (4), 305-313.

Viitaniemi P. 1997b. Decay-resistant wood created in a heating process. *Industrial Horizons*, December 1997-23.

Viitaniemi P. 2000. New properties for thermally-treated wood. *Industrial Horizons*, March 2000-9.

Viitaniemi P. 1997a. ThermoWood-Modified wood for improved performance. In: Proceedings of wood the ecological material the 4th Euro-wood symposium (22-23 September 1997), 67-69, Stockholm, Sweden.

Wangaard F.F. 1940. Transverse heat conductivity of wood. Heat Pip. Air Cond., 12, 459-464.

Windeisen E., Strobel C., Wegener G. 2007. Chemical changes during the production of thermo-treated beech wood. Wood Sci. Technol., 41, 523-536.

Yıldız S. 2002. Effect of heat treatment on water repellence and anti-swelling efficiency of beech. In: International Research Group on Wood Preservation, Document No: IRG/WP 02-40222.

The Determination of the Surface Adhesion Resistance and Pendulum Hardness Values on Laminated Parquets of a UV System Varnish Applied Oak Wood Derived by Using Different Water-Based Paints

*Ümit AYATA¹, Levent GÜRLEYEN², Nevzat ÇAKICIER³

¹Forestry and Forest Products, Oltu Vocation School, Ataturk University, 25400, Erzurum, Turkey

²ÇPAL Atatürk Cad. No: 94, 81950, Yiğilca/Duzce, Turkey

³Department of Forest Industry Engineering, Duzce University, 81620, Duzce, Turkey

*Corresponding Author: umitayata@atauni.edu.tr

Abstract

Over the last years the UV system varnish applications have been improved and the water-based paint types have been seen to be used more frequently in the laminated parquet industry. In this study, the determination of the surface adhesion resistance and pendulum hardness values of the UV system varnished laminated parquets derived by using different water-based paints was aimed. To fulfill this aim; the UV varnishing system was applied on the natural form of oak (*Quercus petraea*) wood. Water-based paints of white, walnut and nut colors were applied on the remaining three experimental samples. Then, all of the samples underwent a UV system varnish application. The surface adhesion resistance and pendulum hardness resistance values on all of the derived materials with water-based paints and without paint were tried to be determined. As a consequence; the different paint applications before UV varnish application were determined to be having a dramatic effect on the pendulum hardness and surface adhesion resistance values. According to test results; the applications of water-based paint and filling of nut and walnut colors on the surface were determined to be creating a strong adhesion and increasing the pendulum hardness resistance with the drying effect of air and UV. The white color was detected to be negatively affecting the pendulum hardness resistance and surface adhesion resistance due to the pigment structure it has. The use of the paint of nut color is recommended on the surfaces of laminated parquets where a high adhesion resistance is desired whereas, the use of the paint of walnut color is recommended on the surfaces of the laminated parquets where a high pendulum hardness resistance is desired.

Keywords: Parquet; Adhesion; Pendulum hardness; Oak

Meşe Odunu Üzerinde Farklı Su Bazlı Boyalar Kullanılarak Elde Edilen UV Sistem Laminat Parkelerinde Yapışma Direnci ve Salınımsal Sertlik Değerlerinin Belirlenmesi

Özet

Son yıllarda laminat parke endüstrisinde UV sistem uygulamaları oldukça gelişmiştir ve bu alanda çeşitli su bazlı boya türleri kullanılmaktadır. Bu çalışmada, UV sistem uygulamasında farklı su bazlı boyalar kullanılarak elde edilen laminat parkelerde yüzeye yapışma ve salınımsal sertlik değerinin belirlenmesi amaçlanmıştır. Bu amaçla bu çalışmada, meşe (*Quercus petraea*) odunundan üretilen laminat parkeler üzerinde UV sistem uygulamasının yanında beyaz, ceviz ve fındık boya kullanılmıştır. Elde edilen su bazlı boyalı ve boyasız malzemeler üzerinde; yüzeye yapışma direnci ve salınımsal sertlik direnci belirlenmeye çalışılmıştır. Araştırma sonuçlarına göre; UV sistem vernik uygulamasından önce farklı boya uygulamalarının, pandüllü sertlik ve yüzeye yapışma direnci değerleri üzerinde bir etkiye sahip olduğu belirlenmiştir. Test sonuçlarına göre, ceviz ve fındık rengi su bazlı boya uygulamalarının yüzeylerinde, UV ve hava kurutmanın etkisiyle pandüllü sertlik direncinde artma ve güçlü bir yapışma oluştuğu belirlenmiştir. Beyaz boyanın pigment yapısı nedeniyle yüzey adezyon direnci ve pandülüm sertlik direncinin diğer boyalara göre düşük olduğu belirlenmiştir. Laminat parke üretiminde yüzey yapışma direncinin yüksek olması istenilen durumlarda fındık boyasının, salınımsal sertlik direncinin yüksek olması istenilen durumlarda ise ceviz boyasının kullanılması önerilmektedir.

Anahtar kelimeler: Parke, Adezyon, Pendulum sertlik, Meşe.

Introduction

Top surface on laminated parquet are generally dried covering with UV system on

5-7 layers with acrylic or poliuretane varnishes (Döngel, 2005).

When it comes to the drying operation to ensure the coating is fully cured, water-based coatings do require special consideration (Skinner 2003).

UV-cured coating systems are factory-friendly, as they emit no volatile organic compounds (VOCs) (PCI, 2008).

In coloring of furniture and decoration components are waterborne wood coatings to much used paint type. Solvent of these paints are water and they are known as water coatings. Waterborne wood coatings are applied as cold to surface. It is easy to prepare and costs are low (Sonmez, 2005).

Laminated parquets have some advantages and disadvantages for human life according to usage. Nowadays, a variety of tests are performed for all parquet species (color, glossiness, pendulum hardness, adhesion test, etc.). Water-based paints are very important for the parquet industry.

Aqueous coatings promote good adhesion to wood material (Decker et al. 2004).

UV-cured coatings present perfect chemical and heat resistance and waterborne coatings give better adhesion in particular on wood (Sow et al. 2010).

For wood coatings, waterborne UV-curable resins were offered excellent adhesion (Carson et al. 2014).

UV coatings are very different from conventional water-based liquid or solvent and paste coatings (Skinner 2003).

UV systems are applied to the surface, 5-20 m min⁻¹. UV lines running through the tape speed of light in 2x80 Watt dried in 1-3 seconds. UV system contains 100% solid. So applied paint and varnish remains 100% of the surface is not lost (Megep, 2011).

Table 1. Laminated parquet flooring production process

- Sanding & Calibrating Machines (80 - 120 - 220 grip sandpaper)
- Paint machine (wood water-based paint concentrate)
- Air drying (min 70°C)
- Roller UV parquet paste (white 25 g m ⁻²)
- UV lamp drying (80°C)
- Amount of UV Sealer Clear S to be applied (25 g m ⁻²) part 1
- UV lamp drying (80°C)
- Amount of UV Sealer Clear S to be applied (25 g m ⁻²) part 2
- UV lamp drying (400°C)
- 280 - 320 grip sandpaper
- Amount of UV Antiscratch Semi Matt W to be applied (7.5 g m ⁻²) part 1
- UV lamp drying (80°C)
- Amount of UV Antiscratch Semi Matt W to be applied (7.5 g m ⁻²) part 2
- UV lamp drying (400°C)

The objective of this study is to evaluate pendulum hardness and surface adhesion resistance properties of UV varnishing system laminated parquets used different types water-based paints.

Material and Method

UV varnishing system was applied on the natural form of oak wood (60 cm by 10 cm by 1.5 cm). Then, test samples were cut (10 cm by 10 cm by 1.5 cm).

Later, the test specimens were conditioned in a climate room (20°C and relative humidity of 65% until all test samples reach the equilibrium moisture content of 12%).

This UV varnishing system, three types of finishes were used. These paints were named walnut, white and nut dyes. Unfinished samples were used control specimens.

All finishes were commercially supplied in the form of paste and mixed with water before the application to the surface of the samples, using a roller at a rate of 25 g m⁻².

In the next step coated samples were kept in a conditioning room for several weeks before any tests were carried out (ISO 554, 1976).

Laminated parquet flooring production process are shown in Table 1.

Pendulum hardness measurement

König pendulum hardness measurements off UV system varnished laminated parquet samples were made according to ANS/ISO 1522 (1998) standard. A total of 30 measurements were taken from each type of sample. The pendulum hardness device are shown in Fig 1.



Figure 1. Pendulum hardness device

Adhesion strength measurement

In the study, the adhesion strength of all wood samples UV system applied on the natural form of oak (*Quercus petraea*) wood, ASTM D-4541 (1995) compliance with the principles set forth in ALSA- brand 1 ton (10 kN) was made in electromechanical universal testing machine. 404 brand adhesive plastic steel were used. ALSA brand adhesion test machine, test sample and cut tool for glue are given in Fig 2.

Adhesion test was calculated according to the formula given below.

$$X = 4F / \pi.d^2 \quad (1)$$

Where;

F = the rupture force (Newton)

d = the diameter of the experiment cylinder (mm)



Figure 2. Electromechanical universal test machine for adhesion test and cut tool for glue

Statistical analysis

Test results were obtained by using SPSS 17 statistical software. Pendulum hardness were noted by using thirty measurements from samples and an average value was reported. For adhesion resistance test, it were noted by using ten measurements from samples.

Results and Discussion

Pendulum hardness and adhesion resistance test

As reported in Table 2, the analysis of variance results and paint type comparison for pendulum hardness according to könig and adhesion resistance values.

According to pendulum hardness and adhesion test values results, for the paint types were found to be significant ($\alpha = 0.05$).

According to Table 2, the lowest pendulum hardness and adhesion test values were obtained with UV system varnished laminated parquet white paint applied samples.

Also, UV system varnished laminated parquet nut painted samples were obtained on highest adhesion test measures.

The adhesion test according to ASTM D-4541 (1995) standard for nut paint obtained between 1.97 MPa and 2.63 MPa.

The cationic reaction of an epoxy ring with hydroxyls on the cellulose in wood can increase a hybrid UV system's adhesion (Modjewski, 1999).

Highest könig pendulum hardness values were noted UV system varnished laminated parquet walnut paint applied samples.

In this study, the pendulum hardness according to König (ANS/ISO 1522, 1998) for walnut paint obtained between 72 and 92.

The formulation cured with the UV-mercury lamp presents a greater hardness (Landry et al. 2015).

High-quality finishes in terms of chemical resistance and surface hardness are achievable (PCI, 2001).

Paints, because they have different chemical, different test results were obtained. Between paints and oak wood, the adhesion strength was observed at different rates.

According to Carson et al. (2014) for wood coatings, waterborne UV-curable resins were exhibited perfect adhesion.

Using waterborne UV primers results in significantly enhanced adhesion (PCI, 2013).

According to test results, addition of water-based paints affected the hardness and adhesion of UV varnishing system.

Table 2. Pendulum hardness and adhesion test values results of the variance analysis and UV system applied paint type comparison

Test	Source	Type III	Sum of Squares	Df	Mean Square	F	Sig.
Pendulum hardness	Paint types		7062.033	3	2354.011	67.192	0.000*
	Error		4063.933	116	35.034		
	Total		615762.000	120			
	Corrected Total		11125.967	119			
	Paint type	N	Mean	HG	Std. Deviation	Min	Max
	Unpainted	30	68.17	B	5.36	60.00	79.00
	White painted	30	62.90	C	7.07	49.00	76.00
Walnuts painted	30	83.60	A*	4.64	72.00	92.00	
Nuts painted	30	69.27	B	6.32	52.00	80.00	
Adhesion test (MPa)	Source	Type III	Sum of Squares	Df	Mean Square	F	Sig.
	Paint types		14.659	3	4.886	165.655	0.000*
	Error		1.062	36	0.029		
	Total		92.561	40			
	Corrected Total		15.721	39			
	Paint type	N	Mean	HG	Std. Deviation	Min	Max
	Unpainted	10	1.24	B	0.18	1.06	1.54
White painted	10	0.64	C	0.06	0.54	0.76	
Walnuts painted	10	1.33	B	0.18	1.11	1.57	
Nuts painted	10	2.33	A*	0.22	1.97	2.63	

HG: Homogeneous Group, N: Number of measurements, Mean: Average, *: Maximum value

Conclusions

In this study, surface adhesion resistance (ASTM D 4541) and pendulum hardness (ANS/ISO 1522) values of UV system applied different dyes using (Unpainted (X), white paint (Y), walnuts paint (Z) and nuts paint (W)) used on oak (*Quercus petraea*) wood were investigated.

In this paper, statistical analysis results showed that after different UV system applied different dyes using (Unpainted = X, white paint = Y, walnuts paint = Z and nuts paint = W), on adhesion resistance (MPa) and pendulum hardness values were seriously changed.

To increase the strength of the adhesion of the UV system varnished laminated parquet nut painted samples, but the UV system varnished laminated parquet white painted was shown to reduce the resistance of the adhesive.

These paints results are very important for oak wood and laminated parquet industry.

As a result the addition of water-based paints affected the hardness and adhesion of UV varnishing system.

Acknowledgements

The authors would like to thanks Karabacak Laminated Parquet Flooring for laminated parquet flooring.

References

- ANS/ISO 1522, 1998. Paints and varnishes - Pendulum damping test approved as an american national standard by ASTM international.
- ASTM D 4541, 1995. Standard Test method for pull-off strength of coatings using portable adhesion testers, American Society for Testing and Materials, 12-15.
- Carson T., Morris L., and Folkman D., 2014. Innovative waterborne UV polyurethane, dispersions for wood coatings, Technical Paper, Radtech Report Issue 2.
- Decker C., Masson F., Schwalm R., 2004. How to speed up the UV curing of water-based acrylic coatings, J. Coat. Technol. Res., 1 (2), 127-136.
- Dongel N., 2005. Ahşap ve ahşap esaslı döşeme kaplama malzemelerinin (parke) teknik özellikleri, Doktora Tezi, Gazi Üniversitesi, Fen Bilimler Enstitüsü, Ankara.
- ISO 554 1976. Standard atmospheres for conditioning and/or testing - Specifications.
- Landry V., Blanchet P., Boivin G., Bouffard J.F., and Vlad M., 2015. UV-LED Curing Efficiency of Wood Coatings, Coatings 5, 1019-1033.

Megep, 2011. T.C., Millî Eğitim Bakanlığı, Kimya Teknolojisi, Ahşap Yüzeyleri Boyama, 524KI0072, Ankara.

Modjewski R.J., 1999. UV Curing for Wood Applications, Radtech Report, May/June, 45-48.

Paint Coatings Industry, 2001. UV-Curable powder coatings on wood benefits and performance, November 1.

Paint Coatings Industry, 2008. UV coatings: a cure for wood alternatives, April 8.

Paint Coatings Industry, 2013. Increasing adhesion of UV coatings on wood, February 1.

Skinner D., 2003. UV Curing in the Plastic Components Industry, July/August, Radtech Report 1, 19-23.

Sow C., Riedl B., Blanchet P., 2010. UV-waterborne polyurethane-acrylate nanocomposite coatings containing alumina and silica nanoparticles for wood: mechanical, optical, and thermal properties assessment, Journal of Coatings Technology and Research, 8 (2), 211–221.

Sonmez A., 2005. Ağaç İşlerinde Üst Yüzey İşlemleri-I Hazırlık ve Renklendirme, (Düzeltilmiş ve Genişletilmiş II. Baskı), Cem Web Ofset, Ankara, 7-66-68-74-75-80-83-84-88.

Effect of Heat-Treatment on Some Properties of Wood Plastic Composites

*Emre BİRİNCİ¹, Alperen KAYMAKCI², Türker DÜNDAR³, Nadir AYRILMIŞ³

¹Kastamonu University, Arac Rafet Vergili Vocational High School, Kastamonu

²Kastamonu University, Department of Forest Industrial Engineering, Faculty of Forestry, Kastamonu

³Istanbul University, Faculty of Forestry, Department of Forest Industrial Engineering, Istanbul

*Corresponding Author: ebirinci@kastamonu.edu.tr

Abstract

In this study, the effect of heat treatment on some properties of wood plastic composites (WPCs) produced from Uludag Fir (*Abies nordmanniana* subsp. *bornmülleriana* Mattf.) was investigated. Heat treated Uludag fir wood flour was compounded with polypropylene with and without coupling agent (MAPP, 3 wt%) in a twin screw co-rotating extruder. The test specimens were produced by injection molding process from the pellets dried to moisture content of 1%. Thickness swelling and water absorption of the WPCs samples decreased by increasing the treatment temperature and time. The mechanical properties of WPCs filled with heat treated wood was lower than WPCs samples filled with untreated samples. According to the results it was found that the heat-treatment significantly improved the dimensional stability of the WPCs.

Keywords: Heat Treatment, Wood Plastic Composite, Mechanical Properties, Water Absorption

Introduction

To decay wood resistance and improve its dimension stabilization, the heat treatment is one of the effective methods (Hill, 2008). Tiemann (1915), who was one of the first researchers to report on heat treatment of wood, heated air-dry wood in superheated steam at 150 °C for 4 hours. This treatment minimised the following moisture sorption by 10–25 %, with comparatively low reductions in strength found in most cases.

Heat treatment changes the chemical components of wood and it causes some changes on the physical, mechanical and biological properties of the wood. These changes are given as following (Hill, 2008);

- Increase in dimensional stability;
- Decrease in hygroscopicity;
- Increase resistance to microbiological harms;
- Frequently, a rise in modulus during the premier stages of heating, with a decrease in subsequent stages;
- Decrease in impact toughness, modulus of rupture and work to fracture;
- Decreased abrasion resistance;
- Tendency for fractures and splits to structure of wood, knots to come loose and so on;
- Darkening of the wood.

Composite materials combine two or more materials to obtain a new material. And this new material has different and better properties than former. The composites known as wood plastic composites (WPCs) are the result of combining wood (or other lignocellulosic materials) and plastics.(Clemons, 2002; Geng and Simonsen 2004).

Productive forests in many countries are being destroyed and most of their forest areas are being unproductive biomass can be utilized in wood plastic composite industry as filler such as sound wood, carpentry wastes, agricultural wastes and decayed wood. There have been a lot of works related the use of sound wood flour on the mechanical, physical, thermal and decay properties of WPC. However, there is no any work about the potential use of decayed wood in the manufacture of thermoplastic composites in the literature (Ayrilmis et al. 2011; Ayrilmis and Jarusombuti, 2011; Ayrilmis and Kaymakci, 2013).

One of the main problem of WPCs is that adhesion is not seen between the hydrophilic wood flour and the hydrophobic polymers and this make worse some of the mechanical properties of the wood filled polymer composites. The wood flour tends to aggregate which makes it difficult to disperse

in the polymer matrix. To solve this problem among wood modification methods, mostly acetylation and heat treatment methods are being used. These modification methods decrease the OH groups of the wood, therefore these processes lead to an increase in the coupling of hydrophilic wood and hydrophobic plastic polymers. The chemicals needed for acetylation process are expensive and difficult to obtain in terms of legal status (Cetin et al. 2011; Ozmen et al. 2013). Therefore, in the present study heat treatment was preferred to produce WPCs.

In this study, effect of heat treated / non-heat treated Uludag Fir wood on some properties of wood plastic composites manufactured via injection molding method.

Material and Methods

Material

The Uludag Fir wood (*Abies nordmanniana* subsp. *bornmülleriana* Mattf.) was obtained from Belgrad Forest in Istanbul. The Uludag Fir wood (UFW) was dried in an oven at 60°C for 10 h to moisture content of 20-30% based on the oven-dry solid weight. Following the drying, the UFW was then processed by a rotary grinder without adding additional water. Finally, the UFW flour passing through a U.S. 35-mesh screen and was retained by a U.S. 80-mesh screen. The UFW was dried in a laboratory oven at 100°C for 24 h to moisture content of 1-2%.

Heat treated Uludag Fir wood (*Abies nordmanniana* subsp. *bornmülleriana* Mattf.) was obtained from Novawood in Bolu. Heat treated Uludag Fir wood (HUFW) was processed by a rotary grinder without adding additional water. Finally, the HUFW flour passing through a U.S. 35-mesh screen and was retained by a U.S. 80-mesh screen. The UFW was dried in a laboratory oven at 100°C for 24 h to moisture content of 1-2%.

The polypropylene (PP) ($T_m = 160^\circ\text{C}$, $\rho = 0.9 \text{ g cm}^{-3}$, MFI 230°C 2.16 kg = 6.5 g 10-1 min) supplied by a Petkim Petrochemical Corporation in İzmir, was used as the polymeric material.

The MAPP (Optim-425, MFI 190-1 °C; 2,16 kg = 120 g 10-1 min, density: 0,91 g cm⁻¹) as coupling agent was supplied by Pluss Polymers Pvt. Ltd. in India.

Composite manufacturing

The UFW, HUFW and PP with MAPP granulates were processed in a 30mm co-rotating twin-screw extruder (Figure 1) with a length-to-diameter (L/D) ratio of 30:1. The barrel temperatures of the extruder were controlled at 170, 180, 190, and 190°C for zones 1, 2, 3, and 4, respectively.

The temperature of the extruder die was held at 200°C. The extruded strand passed through a water bath and was subsequently pelletized. These pellets were stored in a sealed container and then dried for about 3-4h before being injection molded (Figure 2).



Figure 1: Twin screw extruder



Figure 2: Injection molding machine

The temperature used for injection molded specimens was 170-190°C from feed zone to die zone. The specimens were injected at 5-6MPa with cooling time about 30s. Finally, the specimens were conditioned at a temperature of 23°C and relative

humidity of 50% according to ASTM D 618. The composite group consists of different amounts of PP, UFW, HUFW and MAPP. The formulations of the composites are given in Table 1.

Table 1: Formulations of the composites

Composite Code	PP (%)	Wood Flour (%)	Heat Treated Wood Flour (%)	MAPP (%)
A	60	40	-	0
B	60	40	-	3
C	60	-	40	0
D	60	-	40	3

Determination of physical and mechanical properties

The water absorption (WA) and thickness swelling (TS) tests were carried out according to ISO 62. The conditioned specimens were entirely immersed for 1 day, 7 days and 28 days in a container of water at 23±2°C. At the end of each immersion time, the specimens were taken out from the water and all surface water was removed with a clean paper towel. The specimens were weighed to the nearest 0.01g and measured to the nearest 0.001mm immediately. The flexural tests were conducted in accordance with ISO 178 using a Lloyd testing machine (Figure 3) at a rate of 1.3mm/min crosshead speed. The tensile tests were conducted according to the ISO 527. Seven specimens were tested for the tensile and flexural properties of each composite formulation.



Figure 3: Universal testing machine

Results and Discussion

WA values of WPCs strengthened with UFW and HUFW flour are given in Figure 4 and TS values are given in Figure 5. Values given in Figure 4 and Figure 5 show WA and

TS values of WPCs strengthened with HUFW flour are lower than control group at the end of the first day. The same trend is seen at the end of 7. and 28. days.

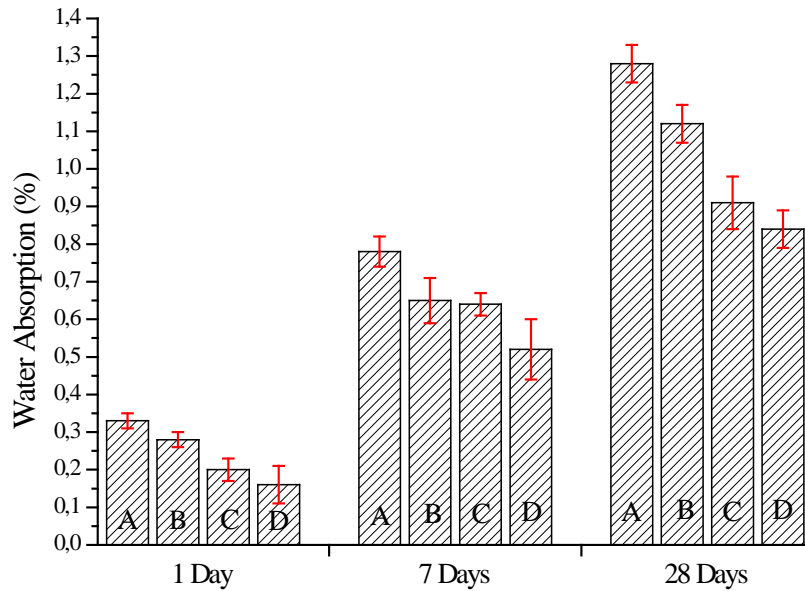

Figure 4: Water absorption values of WPCs (%).

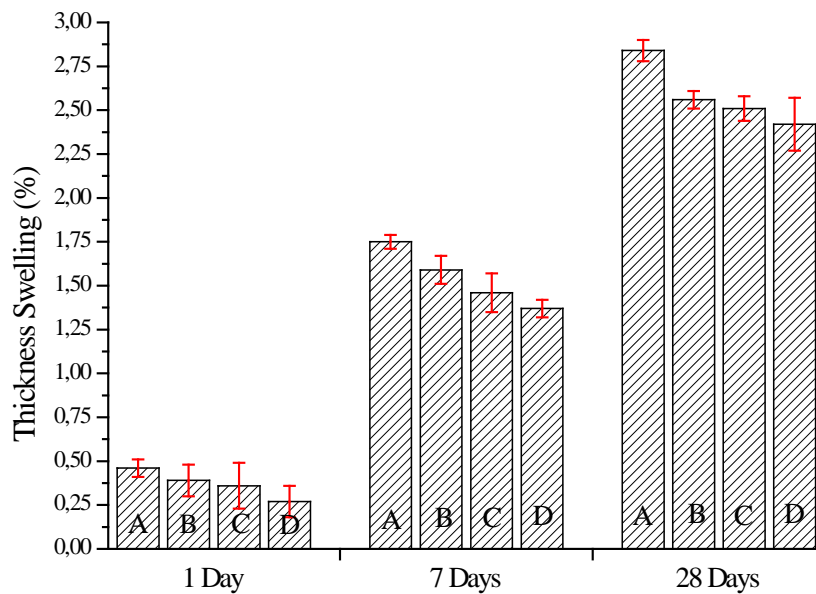

Figure 5: Thickness swelling values of WPCs (%).

Heat treatment is a physical process causing permanent changes in chemical composition of cell wall polymer compounds in wood material. In the wood components exposed to high temperature a number of physical and chemical changes take place.

Especially as a result of thermal decomposition of hemicellulose, reduction of the hydroxyl groups in wood holding water promotes the dimensional stability of the wood. Therefore, the percentage of WA and TS of the WPCs produced by HUFW flour is lower than control group.

Besides, it is seen from the Figure 4 and Figure 5 that WPCs produced by using MAPP show the results lower than control groups.

Increasing the bonding between the surfaces of plastic and wood flour is the main reason for the improvement of the WA and TS properties of WPCs by using MAPP. Generally, water molecules enter the WPCs by using the following ways; the space between the surface and the defects, micro-cracks occurred in matrix material during the production process, fine pores and connecting to the free hydroxyl groups in the lignocellulosic material with the enter of coupling agent into the system, mentioned defects are being tried to be solved by preventing poor bonding between the plastic and lignocellulosic material.

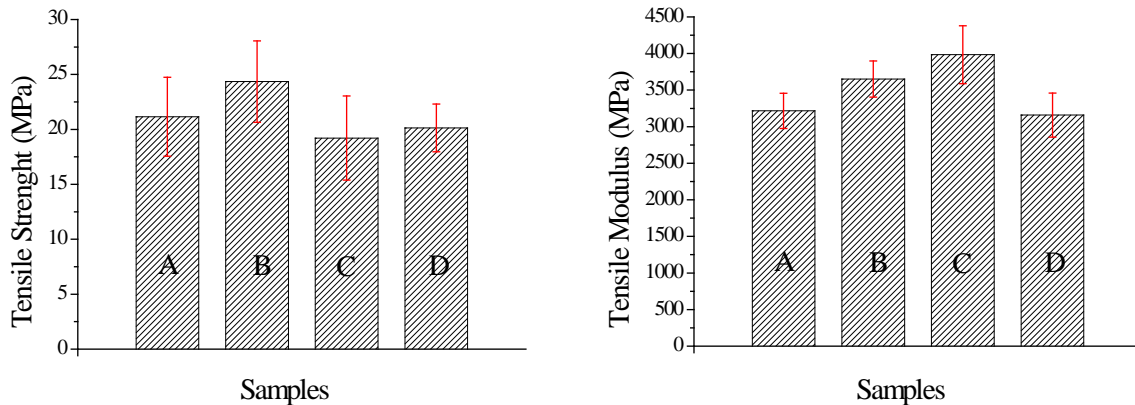

Figure 6: Tensile strength and tensile modulus values of WPCs (MPa).

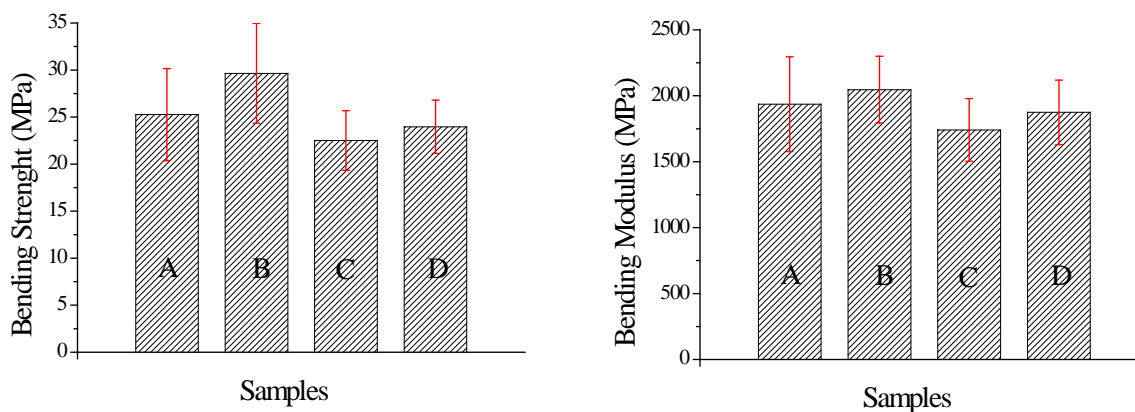

Figure 7: Bending strength and bending modulus values of WPCs (MPa).

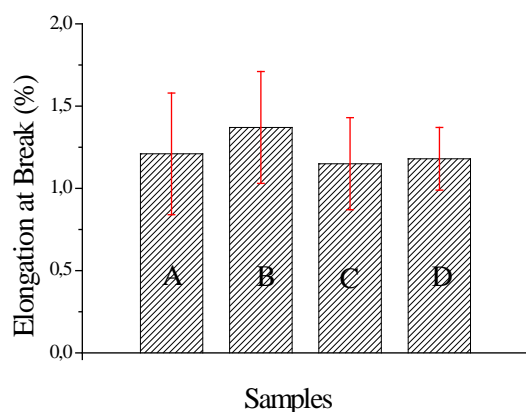

Figure-8: Elongation at break values of WPCs (%).

Mechanical properties of the WPCs obtained by applying heat treatment decrease compared to untreated WPCs. As a result of the heat treatment on the wood hemicellulose degrade and acidic chemicals occur such as acetic acid and formic acid. This situation may explain the loss of the mechanical properties of the WPCs (Garrote et al. 2001).

Mechanical properties of the WPCs obtained by adding MAPP increase more than WPCs obtained without adding MAPP. This condition is thought to become with that surface of the wood flour become compatible with plastic surface by the participation of the MAPP.

Conclusion

In this study, the effects of heat treatment on WPCs' some mechanical properties were investigated. The investigated properties were listed below:

- Physical properties such as WA and TS of WPCs
- Tensile strength
- Tensile modulus
- Bending strength
- Bending modulus
- Elongation at break

As a result of the research, it was determined that heat treatment decreases the percentage of WA and TS properties and ensures dimensional stability, while it leads to some loss of mechanical properties. The reason for this loss is that heat treatment leads to permanent changes in chemical

composition of the polymer compounds of cell wall.

As a conclusion, it was determined that polypropylene and HUFW flour has a potential to be used in WPCs production. However, this should be tested by different rations of wood flour and plastics in the mixtures, and additionally different physical and mechanical tests should be applied.

References

- Ayrimis N., Jarusombuti S., Fueangvivat V., Bauchongkol P. 2011. Effect of thermal-treatment of wood fibers on properties of flat-pressed wood plastic composites. *Polymer Degradation and Stability*, 9 (1), 818-822.
- Ayrimis, N., Kaymakci, A. 2013. Fast growing biomass as reinforcing filler in thermoplastic composites: *Paulownia elongata* wood. *Industrial Crops and Products*, 43, 457–464.
- Ayrimis, N., S. Jarusombuti. 2011. Flat-pressed wood plastic composite as an alternative to conventional wood based panels. *Journal of Composite Materials*, 45(1), 103–112.
- Cetin N.S., Ozmen N., Birinci E. 2011. Acetylation of wood with various catalysts. *Journal of Wood Chemistry and technology*, 31, 142-153.
- Clemons C. 2002. Wood-plastic composites in the United States: The interfacing of two industries. *Forest Production Journal*, 52, 10-18.
- Colak S., Colakoglu G., Aydin I., Kalaycioglu H. 2007. Effects of steaming process on some properties of eucalyptus particleboard bonded with UF and MUF adhesives. *Building and Environment*, 42 (1), 304-309.
- Garrote G., Dominiguez H., Parajo JC. 2001. Study on the deacetylation of hemicelluloses during the hydrothermal processing of *Eucalyptus* wood. *European Journal of Wood and Wood Products*, 59 (1), 53-59.
- Geng Y., Li K., Simonsen J. 2004. Effects of a new compatibilizer system on the flexural properties of wood-polyethylene composites, *Journal of Applied Polymer Science*, 91 (6), 3667-3672.
- Hill C.A.S. 2006. *Wood Modification: Chemical, Thermal and Other Processes*. ISBN: 0-470-02172-1, 99-100, John Wiley & Sons, Ltd., Bongor.
- Mengeloglu, F., Karakuş, K. 2008. Some Properties of *Eucalyptus* Wood Flour Filled Recycled High Density Polyethylene Polymer-Composites. *Turkish Journal of Agriculture and Forestry*, 32, 537-546.

Mengelöglu F., Kurt R., Gardner D.J., O'Neill S. 2007. Mechanical Properties of Extruded High Density Polyethylene and Polypropylene Wood Flour Decking Boards. *Iranian Polymer Journal*, 16 (7), 477-487.

Ozmen, N., Cetin, N.S., Mengelöglu, F., Birinci, E. 2013. Vinyl Acetate Modified Scots Pine Reinforced HDPE Composites: Influence of Various Levels of Modification on Mechanical and Heat Properties. *BioResources*, 8 (1), 1361-1373.

Ozmen, N., Cetin, N.S., Mengelöglu, F., Birinci, E., Karakus, K. 2013. Effect of Wood Acetylation with Vinyl Acetate and Acetic Anhydride on the Properties of Wood Plastic Composites. *BioResources*, 8 (1), 753-767.

Sanadi A.R., Young R.A., Clemons C., Rowell R.M. 1994. Recycled newspaper fibers as reinforcing fillers in thermoplastics: Part I. Analysis of tensile and impact properties of polypropylene, *Journal of Reinforced Plastics and Composites*, 13, 54-67.

Tiemann, H.D. 1915. The effect of different methods of drying on the strength of wood. *Lumber World Review*, 28(7), 19-20.

Tiemann, H.D. 1915. The effect of different methods of drying on the strength of wood. *Lumber World Review*, 28(7), 19-20.

The Determination of Visual Quality Assessment in Landscape in Urban Environment: “A Case Study of Kastamonu Castle Environment”

*Sevgi ÖZTÜRK¹, Elif AYAN¹

¹ Kastamonu University, Faculty of Engineering and Architecture, Department of Landscape Architecture, Kastamonu/TURKEY

*Corresponding Author: sevgiozturk37@gmail.com

Abstract

The cities which have historical pattern are getting decayed as a result of fast and uncontrolled improvements and they are not get into the process of urbanization. Thus, it can be seen that the physical environmental conditions are not good in the areas which have the intense of traditional architecture. Therefore, it needs to make the working of planning in terms of increasing qualities in order to protect areas especially including historical urban pattern. Kastamonu who have hosted many civilizations province is rich in historical pattern visual quality of these values is very important. In this study, the area of Kastamonu Castle environment which has historical pattern and consists of important historical and architectural values was chosen as an example and the target was determined by examining quality of existing historical urban pattern and the buildings which surround this area. In this context, this study it was used that visual quality assessment method in landscape. Survey questions were prepared for the assessment of visual quality using the pictures taken from the area. The data getting by this way was evaluated according to “*coherence, legibility, complexity, ephemera, imageability, stewardship, historicity, naturalness, visual scale and sense of place*” criterias. In the result, the current situation of visual quality in landscape was put forth in Kastamonu Castle area and there are some advises for treatment methods.

Keywords: Kastamonu Castle Environment, Visual Quality Assessment, Historical pattern

Kentsel Çevrede Görsel Peyzaj Kalite Değerlendirmesi: “Kastamonu Kale Çevresi Örneği”

Özet

Hızlı ve kontrolsüz gelişmeler sonucunda tarihi dokuya sahip kentsel alanlar yıpranmakta, kentleşme sürecine uyum sağlayamamaktadır. Bunun sonucunda, geleneksel mimarinin yoğun olduğu alanlarda fiziksel çevre kalitesinin çok iyi olmadığı gözlemlenmektedir. Bu yüzden, koruma amacının esas alındığı bu alanlarda kaliteyi artırıcı yönde planlama çalışmalarının yapılması gerekmektedir. Birçok uygarlığa ev sahipliği yapmış olan Kastamonu ili tarihi doku açısından oldukça zengin olup bu değerlerin görsel kalitesi oldukça önemlidir.

Bu çalışmada geleneksel mimari dokuya sahip, önemli tarihi ve mimari değerler içeren Kastamonu ili Kale çevresi örnek alan olarak seçilmiş, mevcut tarihi kent dokusunun ve onu çevreleyen yapıların görsel kalitesinin belirlenmesi amaçlanmıştır. Çalışmada, görsel kalite değerlendirme yöntemi kullanılmıştır. Örneklem alandan alınan fotoğraflar ile görsel kaliteyi değerlendirmek üzere anket soruları hazırlanmıştır. Bu yöntemle elde edilen veriler, “Tutarlılık, okunabilirlik, komplekslik, geçicilik, tasvir edilebilirlik, sahip çıkma, tarihsellik, doğallık, görsel ölçek ve mekan duygusu” kriterleri temel alınarak değerlendirilmiştir. Çalışma sonucunda, Kastamonu Kalesi ve çevresinin görsel peyzaj kalitesinin mevcut durumu ortaya konmuş ve iyileştirilmesine yönelik önerilerde bulunulmuştur.

Anahtar kelimeler: Kastamonu Kale çevresi, Görsel kalite değerlendirilmesi

Introduction

An urban area is described as a type of settlement that is in constant social development where societal requirements such as dwelling, accommodation, transportation, work, recreation and entertainment are met and less number of people engage in agricultural activities, and which consist of small scale but densely populated neighborhood units as compared to the rural settings (Keleş, 1998). The concept of urbanization has undergone some changes under the influence of various factors throughout the centuries. Today, the traces of the past are still abundantly evident in most of our cities. Contemporary urban areas are increasingly being subject to modern housing development schemes which result in disorganized urban landscapes. The cities that bear traces from the past see an increase in housing projects in proportion with the increasing population, which harms the historical feel of the landscape and undermines the perception of the historical locations.

In historical environments, the main focus of urban design -intended for preservation, renewal and improvement of urban environmental quality- is centered on the human being, as a result of which the harmonious and complementary nature of the relationships involving buildings, environment and natural landscape are mostly neglected (Tüfekçioğlu, 2008). However, historical buildings –as important cultural legacies from the past- are important milestones for our cities today. An urban environment can be likened to an organism consisting of structural and natural elements. The urban aestheticism reflects the visuality and perception represented by such organism as a whole. Urban environments consist of positive and negative elements, namely structures and outdoor locations. The relationships identified among such elements, spatial fluidity, well constructed spatial transitions and harmony are the factors that determine the quality of urban aesthetics (Erdoğan, 2010). The increasing growth of the urban population makes it necessary to take the issue of environmental quality more seriously due to the fact that human is the most important factor of the mentality of

quality. The primary purpose of the urban, architectural and landscape designs should be to improve the life quality of people and meet their requirements. The concept of quality in an urban environment should be sought and evaluated in every single element constituting the environment and in totality of such elements (Tüfekçioğlu, 2008).

The visual impact of an area has a direct influence in the perception of the environment as good or bad and the degree of satisfaction obtained from that area by users (Özgüç, 1999). According to Daniel (2001) the visual landscape quality is the sum of certain (salient) landscape characteristics in interaction with the psychological (perceptual, cognitive, emotional) processes depending on the observations of the person. A systematic visual landscape quality assessment was introduced and developed in the second half of the 20th century. It has assumed a significant role in the environmental management and policies and turned into a recognized field of scientific study that is supported by a considerable literary basis (Benliay et al., 2015). Visual quality assessment is the idealization of the visual information pertaining to a landscape and measurement of its congruity with the landscape by the observer. The method employed in quality measurement and assessment constitutes a basis for making associations among the qualities pertaining to the resource, classifying them, conducting an analysis of the area and determining landscape values based on such analysis, taking decisions and making suggestions regarding the use of the area (Kaptanoğlu, 2006). Assessment of the visual quality of environment can be defined as the examination of the perceptible physical qualities of the elements constituting the environment and their impact on the individual observing them (Kalm, 2004).

Kastamonu is an important Anatolian city that has been home to many civilizations in the past. It is possible to see various historical buildings in the city, representing the traces of many different societies. However, the city has remained highly inadequate in terms of perceptibility of its rich historical texture. One does not get the

sense of a holistic preservation effort in this city which has considerable number of historical houses. Kastamonu castle and its immediate vicinity is an important historical environment which saw the initial settlement in the area. However, the construction of buildings that are markedly different than the traditional local architecture and the neglect of the trio of residence-street-garden contribute to the erosion of the influence of the existing historical buildings.

In this respect, the purpose of this study is the evaluation of the visual landscape quality of the historical buildings situated in the Kastamonu Castle and its immediate vicinity from a holistic perspective.

Material and Method

The study area consists of the Kastamonu castle and its immediate vicinity that falls within a protected urban area located in Kastamonu province. Kastamonu is situated in Western Black Sea region between 41° 21' degrees north latitude and 33° 46' degrees east longitude. Altitude from the sea level is 775 m. It covers a surface area of 13.108,1 km² (URL1, 2016). The city center of Kastamonu is situated between two hills, in middle of which runs Karaçomak creek and a corridor that allows constant vehicular and pedestrian traffic on the either side of the creek. The vicinity of the hill where the Kastamonu Castle is situated has been subject to intensive housing development. It is possible to see historical and contemporary buildings erected next to one another. The boundaries of the study area is shown in Figure 1.



Figure 1. Boundaries of the study area

As part of the study method, photographs were taken in the area to determine its visual quality, based on which a likert scale type (I don't agree at all, I don't agree, I'm not sure, I agree, I fully agree) survey questions were prepared (Kaplan and Kaplan, 1989). The questionnaire thus prepared was applied to the locals living in Kastamonu and those who visited the area briefly, who were asked to evaluate their satisfaction with the area in terms of the following criteria: *Consistency, Readability, Complexity, Temporariness/Permanentness, Describability, Protection/Sense of Belonging, Historicity, Naturalness, Visual Scale, Sense of Location*. In assessing the questionnaire results, the views of Kastamonu residents and visitors were compared to each other. In field of photography shown Figure 2.



Figure 2. Study area of photography

Results and Discussion

In this study, conducted with the purpose of identifying the visual quality of the Kastamonu Castle and its immediate vicinity, a total of 80 persons filled out a questionnaire form. Demographic characteristics of the participants are presented in the Table 1 below. According to Table 1, a total of 80 people participated in the study, 40 from Kastamonu and 40 from various other cities. According to the demographics, 42.5% of the participants are male and 57.5% female. In terms of their educational status, 18,75% of the participants are post graduate students, while 62.5% undergraduate and 18,75% high school students.

Table 1. Demographic characteristics of the participants

		n	%
Gender	Female	46	57,5
	Male	34	42,5
Educational status	High school	15	18,75
	University	50	62,5
	Post graduate	15	18,75
Age group	15-25	48	60
	26-35	23	28,7
	35-	9	11,25

The concepts of Consistency, Readability, Complexity, Temporariness/ Permanentness, Describability, Protection/ Sense of Belonging, Historicity, Naturalness, Visual Scale, Sense of Location –presented in the questionnaire created for identifying the visual quality of the Kastamonu Castle and its immediate vicinity- were assessed by the locals and visitors, the results of which are presented in the Table 2 below.

According to the responses listed in the Table 2, Kastamonu residents agree, in terms of consistency (57.5%), that there is no relationship and harmony between the locations and that there is a balance in the area in the dimensional sense (42.5%) and they are in agreement with the question about different colors and shades in the area (50%). When reviewed in terms of readability, it is seen that that the participants responded to the readability aspect of the area on a fifty fifty basis and that suggested that no open guidance is available (40%) and no road hierarchy is available in terms of readability of the area (72.5%). According to the evaluation based on the photographs, they agreed to the presence of inanimate materials (45%) and the presence of different objects (52.5%) in terms of complexity. The area gives the impression of a natural environment (62.5%). It is found that the area is not suitable for utilization in different climate types (70%), it does not have the plants that offer seasonal varieties (57.5%) and insufficient in terms of temporariness/ permanentness. The area is found to be sufficient in terms of scenic spots (57.5%), as understood from the users' agreement to the question about the local landmarks question in the describability section (47.5%). The

participants appear to agree to the question that suggests that the area looks desolate in terms of sense of belonging (50%). When examined in terms of historicity, it is seen that the participants recognize the historical texture (70%) and agree that the historical time layers are clearly perceived (45%). When reviewed in terms of visual scale, it is established that the participants are divided in terms of their agreement regarding the presence of different objects in the area, and thought that the area failed to offer a sense of depth (52.5%). It is found that the current condition of the area offers a sense of identity (67.5%).

According to the results obtained from the questionnaires filled out by the visitors to the province of Kastamonu -as presented in the Table 2- the participants agree that there is no relationship and harmony between the locations in the area (55%) and that there is balance in the dimensional sense (40%) and that the area is not consistent in terms of colors and shades (50%). When reviewed in terms of readability, the participants appear to disagree that the area is clearly perceivable (40%) and there is a clear guidance (50%). Moreover, they believe that there is no road hierarchy in the area (72.5%). The visitors agree that the variety of inanimate materials is insufficient in the area (47.4%) and that there are different objects in terms of complexity criterion (42.5%). When reviewed in terms of total scores, the visitors agree with the question that suggests that the area looks natural (42.5%), it is insufficient in terms of climatic use (42.5%) and that it lacks the types of vegetation that vary in accordance with the seasons (57.5%). When reviewed in terms of describability, the visitors agree that the area offers scenic spots (65%) and that there are landmarks in the area (35%). It is found that 42.5% of the visitors agree with the question that suggests that the area looks desolated. When reviewed in terms of historicity, the visitors agree that the area offers a historical texture (67.5%) but they disagree regarding the chronological layers felt within that historical texture (37.5%). In terms of the quality of visual scale in the area, however, it is seen that 42.5% of the visitors felt that the area inspired no sense of depth and spaciousness

when asked whether different objects in the area blocked the view, while 45% of the visitors disagreed. According to 60% of the visitors the area has a local identity of its own with its current condition.

As a result of the survey conducted with different participants, Kastamonu residents and visitors have more or less similar views regarding the area in terms of the concepts of Consistency, Readability, Protection/ Sense of Belonging, Historicity, Naturalness, Visual Scale, Sense of Location, however

they appear to hold different views regarding the presence of inanimate materials in terms of complexity in that while 45% of Kastamonu residents find their presence sufficient, 47.5% of the visitors find their presence insufficient. According to the evaluation conducted based on photographs, it is seen that the visitors who has been to the area for a brief period of time and the residents who have been living in the area for a long time have similar views about the area.

Table 2. Visual Quality Evaluation of Kastamonu Castle and its Vicinity

		Local population								Visitors											
		n	%	n	%	n	%	n	%	n	%	n	%	n	%	n	%	n	%	n	%
Consistency	Relationship-harmony between location	5	12,5	18	30	-	-	14	35	3	7,5	10	25	12	30	3	7,5	14	35	1	2,5
	Balance in the dimensional sense	6	15	8	20	9	22,5	15	37,5	2	5	8	20	7	17,5	9	22,5	15	37,5	1	2,5
	Color harmony	5	12,5	11	27,5	4	10	17	42,5	3	7,5	7	17,5	13	32,5	5	12,5	14	35	1	2,5
Readability	Perceptibility	1	2,5	14	35	10	25	14	35	1	2,5	6	15	10	25	9	22,5	14	35	1	2,5
	Guidance	2	5	14	35	9	22,5	13	32,5	2	5	6	15	14	35	8	20	11	27,5	1	2,5
	Road hierarchy	9	22,5	20	50	6	15	2	5	3	7,5	14	35	15	37,5	4	10	5	12,5	2	5
Complexity	Variety of inanimate materials	3	7,5	7	17,5	12	30	16	40	2	5	7	17,5	12	30	8	20	12	30	1	2,5
	Presence of different objects	3	7,5	11	27,5	5	12,5	19	47,5	2	5	5	12,5	9	22,5	6	15	14	35	3	7,5
Naturalness	Natural scenic of the area (animate materials)	3	7,5	9	22,5	3	7,5	18	45	7	17,5	6	15	5	12,5	11	27,5	12	30	6	15
Temporariness/ Permanentness	Climatic usage	8	20	20	50	5	12,5	6	15	1	2,5	9	22,5	8	20	11	27,5	10	25	2	5
	Seasons changes	7	17,5	16	40	9	22,5	7	17,5	1	2,5	8	20	15	37,5	7	17,5	8	20	2	5
Describability	Scenic spots	3	7,5	8	20	6	15	17	42,5	6	15	8	20	4	10	2	5	18	45	8	20
	Landmarks	4	10	7	17,5	10	25	16	40	3	7,5	8	20	5	12,5	13	32,5	10	25	4	10
Protection/ sense of belonging	Maintenance desolateness	4	10	12	30	4	10	13	32,5	7	17,5	5	12,5	11	27,5	7	17,5	12	30	5	12,5
Historicity	Historical texture	2	5	3	7,5	7	17,5	20	50	8	20	6	15	3	7,5	4	10	18	45	9	22,5
	Historical time layers	5	12,5	10	25	7	17,5	15	37,5	3	7,5	7	17,5	8	20	11	27,5	9	22,5	5	12,5
Visual scale	Blocking of view by different objects	4	10	12	30	8	20	13	32,5	3	7,5	5	12,5	12	30	7	17,5	12	30	4	10
	Sense of depth and spaciousness	7	17,5	14	35	3	7,5	13	32,5	3	7,5	7	17,5	11	27,5	10	25	9	22,5	3	7,5
Sense of location	Exhibition of location identity	2	5	5	12,5	6	15	22	55	5	12,5	7	17,5	5	12,5	4	10	17	42,5	7	17,5

When the survey results are reviewed in general, it is seen that, according to the Table 2, the readability, temporariness and permanentness of the area is fairly inadequate while the visual quality of the area is considered to be high in terms of its historical identity, historicity and naturalness.

Conclusions

Today historical texture is even more important for urban areas. However, the cities see an increase in the number of residence units built in proportion with the population growth. Irresponsible and disorganized housing development harms the historical texture greatly and causes it to lose its perceptibility. The works to be conducted in such areas should primarily include preservation oriented utilization and renewal projects.

As a result of this study, conducted with the purpose of presenting the visual landscape quality of Kastamonu Castle and its immediate vicinity, the visual quality has been found to be insufficient by the Kastamonu residents and visitors to the area in terms of various concepts. Despite the fact that the presence of a good number of historical buildings lends the area its own identity, the area is nevertheless found to be insufficient in terms of sense of belonging. As a result of the assessments made based on photographs, the availability of scenic spots in the area can not be perceived. The presence of different objects interferes with the historical texture, and thus impairing the visual quality. In order to accentuate the historical texture, unplanned urbanization should be fixed in such a way as to be rendered compatible with the historical texture. Historical buildings should be restored and the neglected appearance of such buildings should be eliminated.

İsmail Bey Külliye in the area attracts a great deal of visitors in terms of spiritual tourism. However, there are very dilapidated buildings erected on the way to the said building. Street improvement studies should be conducted along the routes leading to such

historical locations. Despite having an intensive vegetation cover, the area offers a poor visual quality in terms of seasonal changes; in this respect, it is recommended that a vegetative arrangement be made and the types of plants that offer different varieties in terms of color, texture and form in different seasons be introduced to the area.

References

- Daniel, T.C., 2000. Whither Scenic Beauty? Visual Landscape Quality Assessment in the 21st century, *Landscape and Urban Planning*, 54, 267-281.
- Benliay, A., Soydan, O., Kayku, M. 2015. Aspendos- Sillyon- Perge Bisiklet Güzergahı Örneğinde Peyzaj Görsel Kalitesi ve Peyzaj Özelliklerinin Değerlendirilmesi. *Artium*. 3(1);48-64.
- Erdoğan E., Kuter N. 2010. Edirne Kenti Kültür Varlıklarının Kent Estetiği Açısından Değerlendirilmesi, *Tekirdağ Ziraat Fakültesi Dergisi*, 7(3).
- Özgüç, G. M., 1999, Tem Hadımköy - Kınalı Arası Peyzaj Planlaması Üzerine Görsel Araştırmalar, Doktora Tezi, G. Ü. Fen Bilimleri Enstitüsü
- Keleş, R. 1978. İdeolojiler, Kent Politikaları ve Üçüncü Dünya ŞBF derişi c:31,75
- Kalın, A. 2004. Çevre Tercih Ve Değerlendirmesinde Görsel Kalitenin Belirlenmesi ve Geliştirilmesi: Trabzon Sahil Bandı Örneği. Doktora Tezi. KTÜ. Fen Bilimleri Enstitüsü.
- Tüfekçioğlu, H.K. 2008. Tarihsel Çevrede Görsel Peyzaj Kalite Değerlendirmesi İstanbul Yedikule Örneği. Yüksel Lisans Tezi. İ.T.Ü. Fen Bilimleri Enstitüsü.
- Bulut, Z., Karahan, F., Sezen, I., 2010. Determining visual beauties of natural waterscapes: A case study for Tortum Valley (Erzurum/Turkey) *Scientific Research and Essay* 5 (2):170-182
- Daniel, T.C., Boster, R.S. 1976. Measuring Landscape Esthetics: The Scenic Beauty Estimation Method. USDA Forest Service Research Paper, RM-167, Rocky Mountain Forest and Range Experiment Station, Fort Collins, CO.
- Kaplan S, Kaplan R. 1989. The experience of nature: a psychological perspective. Cambridge: UnPress

Agroforestry Landscapes for Traditional Rural Settlement Characteristics

*Canan CENGİZ¹, Feride Kübra TAY²

¹Bartın University, Faculty of Forestry, Department of Landscape Architecture 74200 Bartın / TURKEY

²Bartın University, Graduate School of Natural and Applied Sciences, Department of Landscape Architecture 74200 Bartın/TURKEY

*Corresponding Author: canankapuci@yahoo.com

Abstract

Traditional rural landscapes are very important in terms of leaving sustainable environments for the next generations. One of the key components of traditional rural landscapes, agroforestry practices have ecological functions and production potentials and play an important role in adding symbolic value to landscapes. Also, agroforestry is an important practice that should be used more in land use patterns to improve the sustainability of traditional biodiversity.

Guzelcehisar, which was selected as a study area, is a traditional rural coastal settlement in Bartın, the Black Sea Region. This settlement has natural and cultural values and microclimatic characteristics that are very well protected. Thanks to its natural structure and climatic characteristics, Guzelcehisar draws attention with its biological riches and largely protected natural landscape. In this context, Guzelcehisar is an area that has high landscape values with multiple spatial characteristics. Plant groups and species of both Black Sea and European-Siberia plant geographies can be found in this area. Thanks to its microclimatic characteristic, Guzelcehisar is a rare area in Bartın where citrus fruits can be grown in Black Sea climates. Mandarin gardens, olive (*Olea* sp.), hazelnut (*Coryllus avellana*), walnut (*Juglans* sp.), linden (*Tilia* sp.), oak (*Quercus* sp.) and poplar (*Populus* sp.) populations are key agroforestry elements of Güzelcehisar. The literature review and land works determined the potential plant species that can be used in the agroforestry practices in Guzelcehisar. This study firstly defined the characteristics of these plants. In this context, this study revealed the functions of natural and cultivated plant species growing in the study area as well as the ecosystem services and the environmental benefits of agroforestry practices. As a result, this study developed management strategies in terms of not only biodiversity conservation and sustainability but also local and regional development.

Keywords: Güzelcehisar, agroforestry landscapes, traditional rural settlement

Geleneksel Kırsal Yerleşim Karakteristiğinde Tarımsal Ormancılık Peyzajları

Özet

Geleneksel kırsal peyzajlar gelecek kuşaklara sürdürülebilir çevreler bırakmak açısından büyük öneme sahiptir. Geleneksel kırsal karakterin önemli bileşenlerinden olan agroforestry (tarımsal ormancılık) uygulamaları; ekolojik fonksiyonları ve üretim potansiyellerinin yanısıra peyzajlara sembolik değer kazandıran kaynaklar olarak önem taşımaktadırlar. Aynı zamanda agroforestry, geleneksel biyoçeşitliliğin sürdürülebilirliği açısından da alan kullanım desenlerinde yaygınlaştırılması gereken önemli uygulamalardan biridir.

Çalışma alanı olarak seçilen Güzelcehisar, Batı Karadeniz Bölgesi'nde Bartın İli'ne bağlı önemli ölçüde korunmuş doğal ve kültürel değerler ile mikroklimatik özelliklere sahip geleneksel kırsal karakterli bir kırsal yerleşim alanıdır. Doğal yapısı ve iklimik özelliği sayesinde; biyolojik zenginlikleri ve büyük ölçüde korunmuş geleneksel dokusu ile dikkat çekmektedir. Bu kapsamda çok yönlü mekansal karakteristikler sergileyen yüksek peyzaj değerlerine sahip bir alandır. Bitki örtüsü bakımından hem Karadeniz hem de Avrupa-Sibirya bitki coğrafyasına ait bitki grupları ve türleri görülebilmektedir. Mikroklimatik özelliği ile Karadeniz iklimi içerisinde Bartın'da turuncgillerin yetiştiği ender alanlardan biridir. Mandalina bahçeleri, zeytin (*Olea* sp.), fındık (*Coryllus avellana*), ceviz (*Juglans* sp.), ıhlamur (*Tilia* sp.), meşe (*Quercus* sp.) ve kavak (*Populus* sp.) popülasyonlarının oluşturduğu arazi örtüsü tipleri (land cover types), key agroforestry elements of Güzelcehisar. Bu bildiriye, öncelikle Güzelcehisar'da Agroforestry uygulamalarında kullanılabilecek bitkilerin özellikleri tanımlanmıştır. Yapılan literatür taraması ve arazi çalışmaları kapsamında Güzelcehisar'da Agroforestry uygulamalarında kullanılabilecek potansiyel bitki türleri saptanmıştır. Bu kapsamda Agroforestry uygulamaları açısından araştırma alanında yetişen doğal ve kültüre alınmış bitki türlerinin işlevleri, ecosystem services and environmental benefits ortaya koyulmuştur. Sonuçta, gerek geleneksel biyoçeşitliliğin korunması ve sürdürülebilirliği, gerekse yerel/bölgesel kalkınmaya katkısı açısından yönetim stratejileri geliştirilmiştir.

Anahtar Kelimeler: Güzelcehisar, tarımsal ormancılık peyzajları, geleneksel kırsal yerleşim

Introduction

The term “agroforestry” first appeared in the 1970’s and now enjoys widespread use (Hsiung et al., 1995). As a system, it emerged as a topic of study in an era where research on rural systems had completely moved beyond an agronomic focus to embrace a more comprehensive view of social–ecological systems (Liu et al., 2007). In other words, the scope of this issue has expanded to include more than that of simply production and ecology. It identifies and explores examples of the intimate, interactive flow of influences between the human and environmental aspects in meeting local and regional economic needs (Smith and Mbow, 2014).

Traditional cultural landscapes (Antrop, 1997), defined as “landscapes with a long history, which evolved slowly, taking centuries to form a characteristic structure reflecting an harmonious integration of abiotic, biotic and cultural elements”, are culturally significant hotspots of biodiversity for urban ecosystems (Eichorn et al., 2006, Plieninger and Schaar, 2008). These landscapes hold major importance in their ability to leave sustainable environments for future generations. Agroforestry applications—important components of traditional rural characteristics—serve a special purpose in terms of their ecological functions and production potentials, as well as of possessing sources capable of imparting symbolic values to landscapes. Moreover, agroforestry—insofar as it relates to sustainability of traditional biodiversity—is a significant application for the necessary implementation of widely-applied land-use patterns. According to Jose (2009), agroforestry can be considered as the provision of ecosystem services, environmental benefits and economic commodities as part of a multifunctional working landscape.

According to Turna (2012), agroforestry systems can be defined under three different categories: Agrosilvicultural system (agriculture + forestry activities), Silvopastoral system (agriculture + animal breeding activities) and Agrosilvopastoral system (agriculture + forestry + animal breeding activities). Each system has various

application areas and can be implemented in binary and ternary combinations.

A forestry ecosystem includes trees, herbaceous plants, litter, humus, soil, stone, main rock, air, water, sunlight, microorganisms, fungi, insects and other macro organisms and is defined as an environment in which distinctive living conditions form in terms of climate and soil and whose main elements are interactive closure and tall trees (Kuter, 2008). Management of the forest community is based on the needs and habits of an owner, whose decisions, influenced by the agroforestry principal of sharing resources to obtain optimal yields, form various agroforestry patterns (Lestaria et al., 2013). Turkey—in addition to its economic, social and cultural diversity—has huge potential owing to its variety of plant species that are suitable for multiple land uses in terms of topography, settlement configuration and product diversity (Turna et al., 2014).

Smith and Mbow (2014), in their study, concentrated on Africa and investigated the topic of “agroforestry” under the sub-titles of “socio-ecological links”, “complex systems”, “appropriate practices”, “learning from the past”, “addressing future change”, “policy potential” and “research needs”. In a study by Jose (2009), an examination was conducted on four major ecosystem services and environmental benefits of agroforestry: (1) carbon sequestration, (2) biodiversity conservation, (3) soil enrichment and (4) air and water quality.

In this paper, the natural and cultivated plant species that are capable of being used in agroforestry applications were determined for the Güzelcehisar coast settlement, which was selected as the research land area. In this scope, the functions, ecosystem services and environmental benefits of the plant species grown on the Güzelcehisar coast settlement were identified in terms of their agroforestry applications. In conclusion, management strategies were developed to both protect and sustain traditional biodiversity as well as to contribute to local/regional improvement.

Materials and Method

The Güzelcehisar settlement, located in Bartın, served as the research land.

Güzelcehisar lies within the provincial borders of Bartın, situated between 41° 53' of north latitude and 32° 45' of east longitude in the Western Black Sea, and is 17 km west of the city center of Bartın (Anon. 2011).

Güzelcehisar features high priority lands, including coast lines, forest lands, lava pillars and first-degree natural protected and archeological areas (Figure 1).

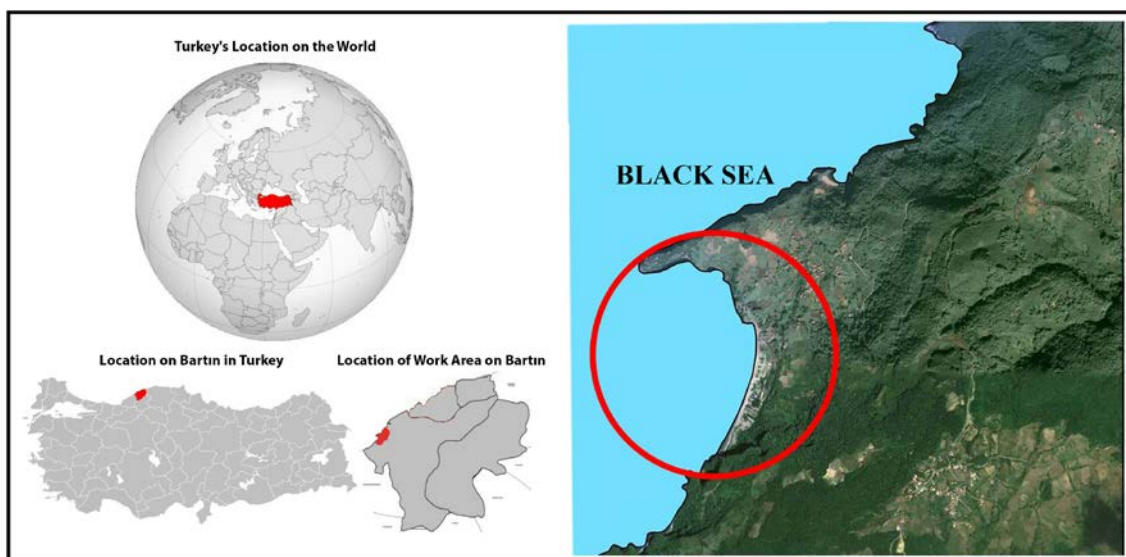

Figure 1. Geographical location of Güzelcehisar rural settlement

After the field observations and interviews with the local people, general uses of the plant species in the city of Güzelcehisar, land usage status in the region, and multi-purpose plant species were determined. As a research method, first the previous scientific studies were utilized in the determination of plant species in the city of Güzelcehisar. And features of the determined plant species in the determination of usage in Agroforestry some other studies were utilized.

Research Findings

Site description

The Güzelcehisar settlement, which has attracted interest on account of its floristic richness, traditional texture – largely preserved over the years – lava pillar formations, natural coasts and forest lands, is a coastal region with high landscape values.

The settlement has a rural character and lies next to a forest. Moreover, it is one of the rare areas in Bartın where citrus fruits can grow due to its micro-climatic characteristics.

Considering present land-use data on the area, the first-degree natural protected area of this settlement does not show any diversity in terms of field functions. The area dominated by trees, forest, settlements, agricultural lands, rocky terrain and coast are primary land-use types. According to the land determination studies conducted, the first-degree natural protected area has single- and two-story buildings. The first-degree archeologic area is surrounded by dense forests, rocky terrain and especially, large agriculture areas (Figure 2). A rough pathway through agricultural lands provides access to the first-degree archeologic area (Anon.2011).

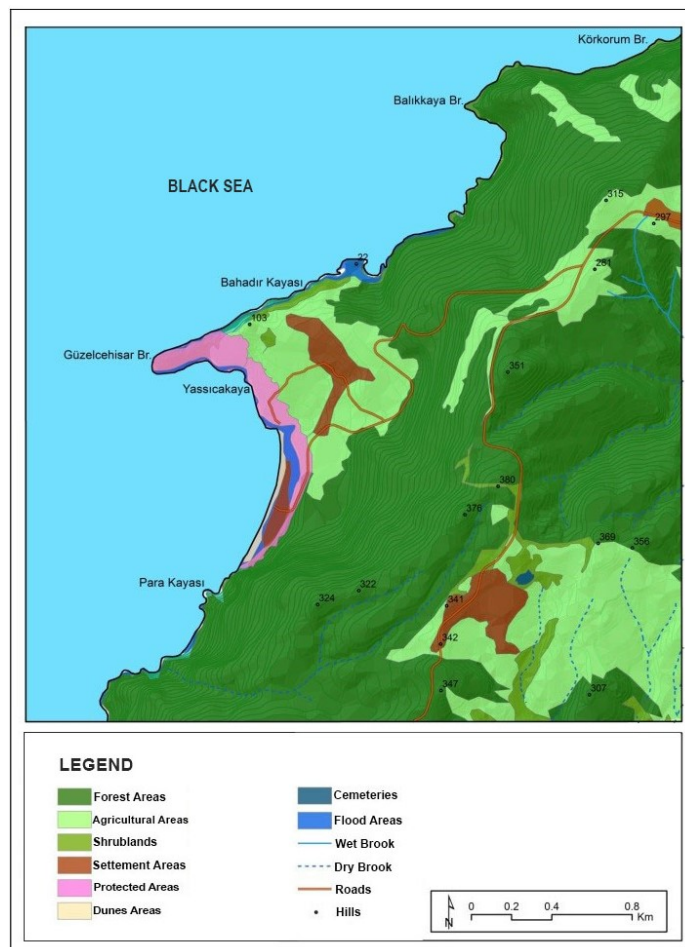

Figure 2. Present land use map of the research area (Cengiz et al., 2015)

Lava rocks in Güzelcehisar have caused vertical cliffs to form. The topographic structure of the area consists of steep slopes that rise from sea level and blend in naturally with the land of the Black Sea. The incline of these slopes is very high in the southern region and low in the north. The heights range between 0 and 30 m in the southern region and between 10 and 65 m in the northern region (Anon. 2011).

Güzelcehisar has a climate characteristic of the Black Sea. Because of its proximity to the sea and the fact that it runs parallel to the mountains along the coastline, there is very little temperature variation along the coastal line but large amounts of moisture, which forms as a result of the air mass coming out the Balkans (Anon. 2011). Regarding the soil type characteristics of the research area, gray

brown podzolic soils, which are among the medium and high magnitude erosion groups, are dominant.

Vegetation

In terms of vegetation cover, plant groups and species belonging to both the Black Sea and the Europe-Siberian regions are observed in the Black Sea region. The forest areas of Güzelcehisar are among the richest in Turkey with respect to its various plant and tree species, as well as to its wild animals. The forest is mainly composed of flat- and needle-leaved trees. The common trees are *Quercus* sp., *Carpinus* sp., *Populus* sp., *Fagus* sp., *Pinus* sp., *Juglans* sp., *Castanea* sp. and *Corylus* sp. species are observed (Figure 3 and Figure 4) (Cengiz et al. 2015).



Figure 3. Vegetation cover of research area



Figure 4. A view from research area coastline

Forest stand types of the research land, which were categorized under twenty-two groups,

are shown in Figure 5. Forest closure map of the research land is shown in Figure 6.

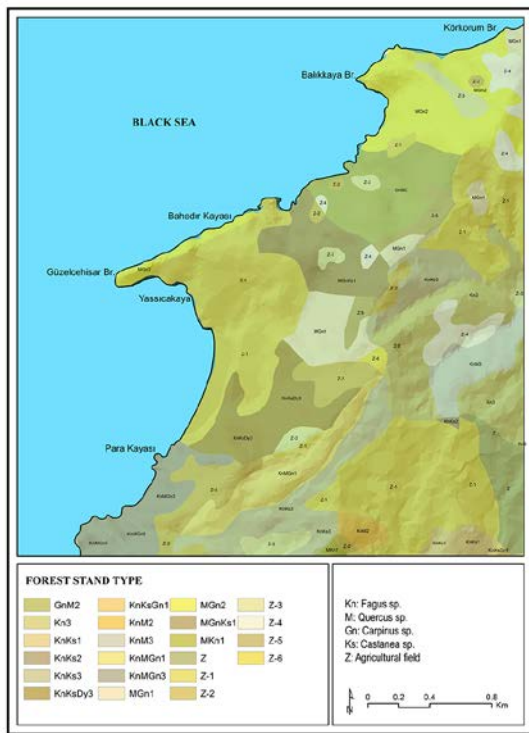

Figure 5. Forest stand map of the research land (Cengiz et al., 2015)

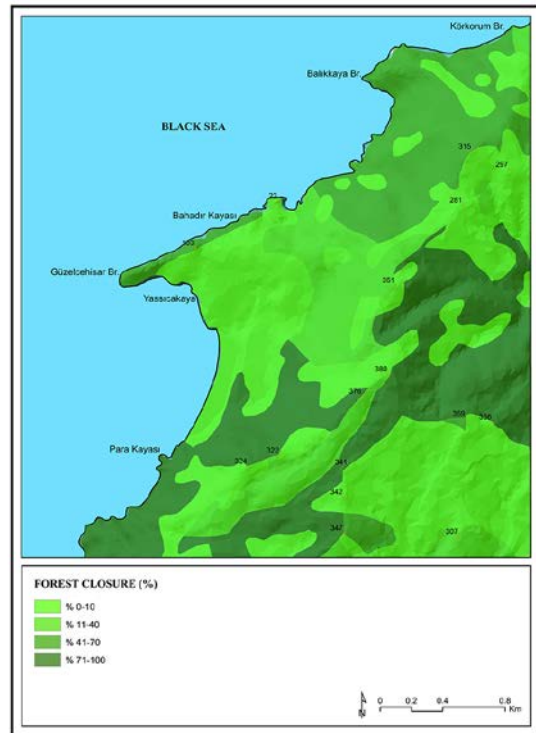

Figure 6. Forest closure map of the research land (Cengiz et al., 2015)

Potential species present in the research area in terms of agroforestry applications are of ecological and socio-economic importance. Collection, consumption and marketing of these species are means of livelihood for the rural population living

around forest areas and serve as part of their life-style. Moreover, species included in the components of the rural identity of the area are significant for their ecosystem services and environmental benefits.

Table 1. Usage features of the plant species determined in Güzelcehisar, in terms of Agroforestry practices. (developed by Turna and Acar, 2001; Turna and Acar 2002; Yilmaz and Yilmaz, 2010, Cengiz et al. 2014).

PLANT SPECIES	Firewood	Wooden Material	Animal feed	Food	Medical	Beekeeping	Live fence	Shading	Ability to sprout	Pruning ability	Soil protection	Water Protection	Reclamation of land	Adaptability	Ornamental feature	Shelter belt	Handicrafts
<i>Acer campestre</i>								X	X	X				X	X		
<i>Arbutus unedo</i>				X				X	X						X		
<i>Actinidia deliciosa</i>				X													
<i>Buxus sempervirens</i>					X		X		X	X	X		X	X	X	X	X
<i>Carpinus betulus</i>	X		X					X	X	X							X
<i>Castanea sativa</i>	X	X		X	X	X		X	X	X	X			X	X		X
<i>Citrus reticulata</i>				X											X		
<i>Cornus mas</i>				X	X				X		X				X		X
<i>Corylus avellana</i>				X	X				X	X					X		X
<i>Crataegus monogyna</i> subsp. <i>monogyna</i>				X	X						X		X	X	X		
<i>Erica arborea</i>					X	X	X		X	X	X				X		
<i>Fragaria vesca</i>				X	X						X						
<i>Hedera helix</i>					X						X				X		
<i>Ilex aquifolium</i>					X		X								X	X	
<i>Juglans regia</i>		X		X	X			X				X					X
<i>Laurus nobilis</i>				X	X						X				X	X	
<i>Morus alba</i>	X	X	X	X	X			X		X				X	X		
<i>Myrtus communis</i>					X		X				X					X	
<i>Ocimum basilicum</i>				X	X											X	
<i>Olea europea</i>			X	X	X			X	X						X		
<i>Pinus pinea</i>				X	X			X						X	X		
<i>Populus tremula</i>	X	X			X								X		X		
<i>Populus nigra</i>	X	X													X		
<i>Prunus ssp.</i>				X	X			X							X		X
<i>Pyracantha coccinea</i>					X		X				X				X		
<i>Quercus petraea</i>	X	X	X					X						X			X
<i>Rhamnus ssp.</i>					X												
<i>Rhododendron ponticum</i>	X				X	X					X			X	X		
<i>Rosa canina</i>					X						X				X		
<i>Rubus fruticosus</i>				X	X						X						
<i>Salix alba</i>					X			X	X		X	X		X	X		X
<i>Sorbus domestica</i>					X										X		
<i>Tilia tomentosum</i>	X	X	X		X			X	X					X	X		X
<i>Vaccinium myrtillus</i>				X	X										X		
<i>Vitis vinifera</i>			X	X	X			X	X					X	X		

Discussion and Conclusion

Turkey, aside from its economic, social and cultural diversity, possesses huge potential for the various plant species it has that are suitable for multiple land uses in terms of topography, settlement configuration and product diversity. However, uncontrolled and excessive uses, which have resulted in the disruption of the ecological balance, have caused many species to vanish and beneficiaries to move away from these areas. Therefore, regarding sustainability of the ecosystem, it is necessary to allow multi-purpose uses of species that will contribute to rural improvement, and to raise awareness in local residents about this issue (Turna et al., 2014).

According to Cengiz et al. (2014), agroforestry potential in Bartın is very high, and Bartın is a very rich geographical region in terms of the species available for multi-purpose uses. In this context, the Güzelcehisar coastal settlement of Bartın is an important area due to its agroforestry potential. Besides its agroforestry potential, Güzelcehisar can present various alternatives to visitors, with respect to its sea tourism, rich biological diversity, historical and archeologic values and lava pillars. It is among the few areas in the West Black Sea region where many resource assets are brought together in one place for visitors to enjoy. For the sake of the sustainability of resource assets and the provision of invaluable opportunities for the economic improvement of the local people, Güzelcehisar must be protected and its sustainability must be secured. In this scope, sustainable uses of the Güzelcehisar settlement should be investigated to derive optimum benefits from its lands. The evaluation of vegetation cover in the research area in terms of agroforestry applications is vital for the proper use of lands, for sustaining the rural identity and for contributing to rural development.

References

- Anonymous, 2011. Bartın Güzelcehisar I. Derece Arkeolojik Sit Alanı Koruma Amaçlı 1/5000 Ölçekli Nazım ve 1/1000 Ölçekli Uygulama İmar Planı Araştırması ve Plan Açıklama Raporu. Bartın İl Özel İdaresi, Türkiye.
- Antrop M., 1997. The concept of traditional landscapes as a base for landscape evaluation and planning: the example of Flanders region. *Landscape and Urban Planning* 38:105-117.
- Cengiz B., Cengiz C., Bekci B., 2014. Plant Species that can be used in Agroforestry Applications, in the Case of The City of Bartın, 3rd International Nonwood Forest Product Symposium. May 08-10, Kahramanmaraş, 842-847.
- Cengiz C., Cengiz B., Bekci B., Tekdamar D., 2015. Bartın Güzelcehisar Kıyı Yerleşiminin Ekolojik Planlaması, Bartın Üniversitesi Bilimsel Araştırma Projesi Sonuç Raporu (BAP-2011-2-26), Bartın.
- Eichhorn M. P., Paris F., Herzog L. D., Incoll F., Liagre K., Mantzanas M., Mayus G., Moreno V. P., Papanastasis D. J., Pilbeam A., Pisanelli C., Dupraz., 2006. Silvoarable systems in Europe: past, present and future prospects. *Agroforestry Systems* 67:29-50.
- Hsiung W., Yang S., Tao Q., 1995. Historical development of agroforestry in China. In *Agroforestry: Science, Policy and Practice* (pp. 277-287). Springer Netherlands.
- Jose S., 2009. Agroforestry for ecosystem services and environmental benefits: an overview. *Agroforest Syst* (2009) 76, pp. 1–10.
- Kuter N., 2008. Ilgaz Dağı Milli Parkı'nın Orman Peyzajı ve Estetiği Açısından Değerlendirilmesi. *Süleyman Demirel Üniversitesi Orman Fakültesi Dergisi Seri: Isparta. A, Sayı: 1, Yıl: 2008*, pp. 36-47.
- Lestaria P., Rahayub S., Widiyatnob, 2013. Dynamics of gall rust disease on sengon (*Falcataria moluccana*) in various agroforestry patterns. *Procedia Environmental Sciences*, 17, pp. 167 – 171.
- Liu J.G., Dietz T., Carpenter S.R., Alberti M., Folke C., Moran E., Pell A.N., Deadman P., Kratz T., Lubchenco J., 2007: Complexity of coupled human and natural systems. *Science* 2007, 317:1513-1516.
- Plieninger T., Schaar M., 2008. Modification of Land Cover in a Traditional Agroforestry System in Spain: Processes of Tree Expansion and Regression. *Ecology and Society* 13(2): 25.
- Smith M.S., Mbow C., 2014. Editorial overview: Sustainability challenges: Agroforestry from the past into the future. *Current Opinion in Environmental Sustainability*, (6), 134-137.

Turna İ., Acar C., 2001. Doğu Karadeniz Bölgesi Kırsal Ev Bahçelerinin Agroforestry Uygulamalarındaki Yeri ve Önemi. I. Ulusal Ormancılık Kongresi, Ankara. Kongre Serisi No: 1. 353-362.

Turna İ., Acar C., 2002. Doğu Karadeniz Bölgesi'nde agroforestry uygulamaları için çok amaçlı bitki türleri ve seçimi. II. Ulusal Karadeniz Ormancılık Kongresi, 15-18 Mayıs 2002, Trabzon, 280-288 s.

Turna İ., 2012. Akdeniz Bölgesi'nde agroforestry uygulamaları için çok amaçlı bitki türleri ve seçimi. I. Ulusal Akdeniz Orman ve Çevre Sempozyumu, 26-28 Ekim 2011, KSÜ Doğa Bil. Der., Özel Sayı. Kahramanmaraş. s. 219-225.

Turna İ., Güney D., Atar F., 2014 Odun Dışı Orman Ürünlerinin Agroforestry açısından değerlendirilmesi. 3rd Internatioal Non-wood Forest Products Symposium 8-10 May 2014, pp. 127-136, Kahramanmaraş-Turkey

Yılmaz H., Yılmaz H., 2010. Artvin ilinde agroforestry (tarımsal ormancılık) uygulamaları ve bu uygulamalarda kullanılan bitki türleri ve peyzaja katkıları. III. Ulusal Ormancılık Kongresi. 20-22 Mayıs 2010. Cilt: IV, s. 1606-1617.

Natural Children Playgrounds Which are Suitable for Kastamonu City's Identity

*Çiğdem SAKICI¹, Türkan Sultan YAŞAR ISMAIL¹, Elif AYAN¹

¹ Kastamonu University, Faculty of Engineering and Architecture, Department of Landscape
Architecture, Kastamonu/TURKEY

*Corresponding Author: csakici@kastamonu.edu.tr

Abstract

With the modern society understanding which has started in 20th century, many individuals were directed to spent more time in interior spaces such as concrete apartment buildings, offices etc. than outdoors. This modern urbanisation fact shows its effects globally and also in Kastamonu as well. Moreover, smart technologies in 21st century led individuals to loneliness day by day. Therefore, this generation's children found themselves in a world that has been isolated from the nature, people try to implement their existence in virtual world and contacting with very few people in daily life even though they have hundreds of friends or followers in social accounts. The child that grows in such a bell jar, started to be alien to the nature where he/she belongs originally and try to fill his/her playing needs with computer games, or directed to play in the interior areas like public building's playground and modular outdoor playgrounds with unnatural materials such as metal, plastic and rubber floor. However, the playing areas and activities which were mentioned above are not efficient to meet with children's all development needs and they start facing with many problems such as behaviour disorders, physical and psychological problems, obesity etc. Whereas, children can improve themselves physically, socially, cognitively with the correct play activities and playgrounds. Answering this issue, outdoor natural playground's benefits have been proved scientifically with positive effects on contributing children development. Within the scope of his study, firstly the existing playground areas will be determined in Kastamonu and then the children's level of satisfaction from these areas will be revealed. For making this implication, a comprehensive questionnaire was conducted to the pupil age between 9 to 12. With this questionnaire, children's play needs and the places for meeting this needs, also their choices of playing activities were determined. Afterwards, the pupils were asked to make a comparison in between unnatural modular playground activities and natural playground examples from abroad. Ultimately, it was revealed that children were bored of modular existing playgrounds and they choose to play in natural playground areas which are more creative and lead children to play using their abilities. With this study, it is determined that how a natural playground can be by considering children's needs and desires for children.

Keywords: Children Playgrounds in Kastamonu, Natural Playgrounds, Child and Play

Kastamonu Kimliğine Uygun Doğal Çocuk Oyun Alanları

Özet

20. Yüzyıl sonlarında başlayan yoğun modern toplum anlayışı ile birçok toplum bireyi yaşadığı şehirlerde betonarme apartman bloklarına, iç mekânlara hapsolmeye yönelmiştir. Bu yeni kentleşme olgusu, küresel olarak her yerde olduğu gibi Kastamonu'da da etkisini göstermektedir. Ayrıca 21. yüzyılla birlikte gelişen akıllı teknolojiler de, kişileri gün geçtikçe yalnızlığa sevk etmeye başlamıştır. Haliyle, bu neslin çocukları da kendilerini doğadan (hijyen, konfor gereksinimleri sonucu) izole edilmiş, kendi varoluşlarını sanal dünyada gerçekleştiren, sosyal hesaplarında yüzlerce arkadaş ya da takipçisi olmasına rağmen günlük hayatlarında çok az insanla temas halinde olan bireylerin dünyasında bulmuşlardır. Böyle bir cam fanusta büyüyen çocuk, ait olduğu yere, doğaya gittikçe yabancılaşmaya başlamış ve oyun ihtiyaçlarını çoğunlukla bilgisayar gibi teknolojik aletler üzerinden, alışveriş merkezleri gibi kamu alanlarında bulunan oyun bölümlerinde ya da dış mekânlarda bulunan, zemini çoğunlukla kauçuk kaplı, plastik ve metal gibi yapay malzemelerle oluşturulmuş modüler çocuk oyun alanlarında gerçekleştirmeye yönlendirilmişlerdir. Ancak bahsedilen bu oyun mekân ve aktiviteleri çocukların gelişimi ve ihtiyaçlarını yeterli düzeyde karşılayamamakta ve çocuklar davranış bozuklukları, fiziksel ve ruhsal sorunlar, obezite gibi birçok sorunla yüzleşmektedirler. Hâlbuki çocuklar doğru oyun aktiviteleri ve oyun alanları sayesinde fiziksel, sosyal, bilişsel, psikomotor gelişimlerini gerçekleştirebilmektedir. Bu noktada, dış mekân doğal çocuk oyun alanları da, çocuk gelişimi açısından bilimsel olarak faydaları kanıtlanmış bir kavram olarak karşımıza çıkmaktadır.

Çalışma kapsamında öncelikle doğal güzellikleri ile ön plana çıkan Kastamonu kentindeki mevcut oyun alanlarının durumu açıklanıp, çocukların bu oyun alanlarındaki memnuniyet düzeyleri ortaya konulacaktır. Bunun için, 9-12 yaş arasındaki çocuklara geniş kapsamlı bir anket uygulanmış ve çocukların oyun ihtiyaçları, bu ihtiyaçları nerede karşıladıkları ve oyun tercihleri belirlenmiştir. Sonrasında çocuklara kullandıkları mevcut modüler çocuk oyun alanlarının ve yurtdışındaki doğal malzemelerle oluşturulmuş oyun alanlarının görselleri gösterilmiş ve bunlar arasında karşılaştırma yapmaları istenmiştir. Çıkan sonuçlar doğrultusunda çocukların modüler oyun alanlarından sıkıldıkları, daha yaratıcı ve kendi yeteneklerini kullanabilmek için oynayabilecekleri doğal çocuk oyun alanlarını tercih ettikleri ortaya çıkmıştır.

Bu çalışma ile geleceğimizin mimarı olan çocukların istek ve ihtiyaçlarına uygun çocuk oyun alanlarının nasıl oluşturulması gerektiği ve nelere dikkat edilmesi gerektiği ortaya konulmuştur.

Anahtar Kelimeler: Kastamonu Çocuk Oyun Alanları, Doğal Çocuk Oyun Alanları, Çocuk ve Oyun

Introduction

With the modern society understanding which has started in 20th century, many individuals were directed to spent more time in interior spaces such as concrete apartment buildings, offices etc. than outdoors. This modern urbanisation fact shows its effects globally and also in Kastamonu as well. Moreover, smart technologies in 21st century led individuals to loneliness day by day. Therefore, this generation's children found themselves in a world that has been isolated from the nature, people try to implement their existence in virtual world and contacting with very few people in daily life even though they have hundreds of friends or followers in social accounts.

Because of increasing traffic density in cities, safety concerns, negative attitudes against young people, makes hard for children to play outdoors and they have less opportunity compare with older generations (Butler et al., 2008). According to a survey that which was made by Playday Organization in 2007, today's %71 percentage of British adults used to play outdoors, however, same survey indicates that only %21 percentage of today's British young generation play outdoors (Play England, 2007). Thus, children tend to spend their leisure times on computer or smart technologies. Even though digital games or social media have some positive effects on children, there are many psychological or biological negative effects as well (Setzer and Duckett, 1994; Hauge and Gentile, 2003; Chilu, Lee and Huang, 2004; Wan and Chiou, 2006).

The child that grows in such a bell jar, started to be alien to the nature where he/she belongs originally and try to fill his/her playing needs with computer games, or

directed to play in the interior areas like public building's playground and modular outdoor playgrounds with unnatural materials such as metal, plastic and rubber floor. Nevertheless, the playing areas and activities which were mentioned above are not efficient to meet with children's all development needs and they start facing with many problems such as behaviour disorders, physical and psychological problems, obesity etc. Whereas, children can improve themselves

physically, socially, cognitively with the correct play activities and playgrounds. Answering this issue, outdoor natural playground's benefits have been proved scientifically with positive effects on contributing children development.

Play is very important for children's development. It is determined that playing in playgrounds not only beneficial for children's and young people's physical improvement but also helps social and cognitive improvement as well (Butler et al., 2008). Tompowski et al. (2014) revealed that children's understanding can be improved with the help of games which includes physical activities.

According to the report of American Pediatrics Academy in 2007, during the last few decades children's leisure times has been decreasing while childhood and pubescence depression cases have been increasing. This report also indicated that the games that gives freedom to and allow them to direct the playing process, can prevent them to the negative effects of external pressure and stress (Ginsburg, 2007).

This work aims to discover how the pupils in Kastamonu city can benefit from their right to play which was determined with laws in Turkey in 1995 and how they meet with their playing needs in existing conditions. Kastamonu is a city that famous with natural beauties and %64 percentage of the area meter of the city is covered with forests. Kastamonu has incomparable geological and floristic formations such as canyons, caves, waterfalls, highlands, lakes, water resources and beaches. However, the children in Kastamonu city also having these global results of modern world and technology. According to the data from Turkish Statistical Institute in 2013, there are 20061 children living in Kastamonu ranging in age from 0 to 14. There is 36.747 square meter spared for playgrounds in Kastamonu's city development plan which is %16.31 of the all green areas in the city centre. According to these data, for each child 1.41 square meter of playground area is allocated. Thus, children in this city even have less places to play outdoors comparing with other developed countries. Regarding these issues, this research focuses on outdoor natural playgrounds in order to provide children a safer environment for growing up in Kastamonu, Turkey.

On top of this, the existing playground areas in Kastamonu, consists of modular playgrounds which are made of unnatural materials such as plastic, rubber materials etc. and all of them having same design, giving limited options for children to play. As a result of this, the children indicate that they are bored with current play grounds and do not want to go to those areas for playing. However, the recent studies shows that an ideal playground design should have some certain qualities such as being accessible for disabled children, including natural elements, allows children to experience risk and challenges, having a sustainable understanding, and lastly can evolve and change in the course of time (Butler, 2008).

Evaluating the natural environments as a playground area and thinking about the concept of playscape is an important way of thinking about playground designs in recent years. Fjortoft and Sageige (2000) reveals that natural landscape meets with children's play needs and also alert their senses with different variety of plants, animals, soil, natural elements with different patterns etc. Moreover, previous studies point outs that children find natural playgrounds more exciting than standard modular playgrounds (Titman, 1994). Nature is one of the best education environment for children in order to provide various opportunities for children to improve themselves in terms of cognitively, socially and physically (Kuo et al., 1998; Taylor et al., 1998; Wells, 2000).

Within the scope of this study, firstly the existing playground areas were determined in Kastamonu and then the children's level of satisfaction from these areas will be revealed. For making this implication, a comprehensive questionnaire was conducted to the pupils aged between 9 to 12. With this questionnaire, what is naturality concept means for children, children's play needs and the places for meeting this needs, also their choices of playing activities were determined. With the results from this questionnaire, this work aims to contribute the scholars and landscape designers to have a different perspective of designing and evaluating playgrounds in Kastamonu city which is famous with its natural values and wooden production. This study also aims to propose appropriate

playgrounds to children of Kastamonu which meets with their needs and desires.

Material and Method

Kastamonu is located the Northwest of Turkey and has an oceanic climate with cold winters and hot summers. Kastamonu is known with its unique natural values and history. Although Kastamonu have many potential qualities as a liveable city, playgrounds for children are not efficient and enough. In order to determine the expectation of the playground users in the city centre, a questionnaire was conducted in four different primary schools students in between the ages of 9 to 12 in Kastamonu. The primary schools are located in three main neighbourhoods which are Kuzeykent, Sali Pazarı and Aktekke Mahallesi. The number of participants is 105. The questionnaire process is consist of three main steps.



Figure 1. Kastamonu City.

The First Step: Determining the Knowledge of Participants about Natural Materials and Playgrounds

In order to evaluate the information from pupils clearly, firstly two main questions were asked them, which are:

- What is natural playground means; do you know a place like that?
- What are the natural materials? Write the ones that you remember

With these questions, pupil's knowledge and awareness about natural materials and playgrounds has been determined. For answering these two questions, participants were free to write or draw. After getting the answers from the children, a short explanation about natural materials and playgrounds were given via projected images in order to continue the second step.

The Second Step: Determining the Participant's Playing Habits

This stage of the work aims to inquiry following questions:

- Demographic Structure (age, gender, grade)
- Living in a house with garden or not
- Where they are meeting with their playing needs
- Why do they chose these places
- If they are having friends from their neighbourhood or not
- When they meet with their friends, what kind of activities they make
- If they have natural areas for playing near to their accommodations
- What kind of activities they want in a playgrounds
- What kind of design features they would like to see
- What kind of feelings and sensations they wish to have in a playgrounds
- If they are interested or not with computer games and what kind of games they play
- If they wish inside the computer games spatial formations to become reality or not.

With these set of questions, the issues such as children's point of view about the existing playgrounds in Kastamonu and the reason about opting these areas are determined. Moreover, children's technology usage habits and the effects of digital games on them are figured as well. Apart from these issues, participant's preferences about playground designs, usage of materials and lastly activities involved.

The Third Step: Comparisons between Natural Playgrounds Examples and The Existing Playgrounds in Kastamonu.

In the last step of the research participants were ask to make a selection in between two pictures according to 16 different physical and cognitive activities. The first pictures were from built example of natural playgrounds from abroad related with a particular activity and the second one was existing playground examples from Kastamonu. Participants made their choices for each activities (jumping, knowledge acquisition, getting different sensations, hiding, sliding, swinging etc.)

After the selection process, they were also asked to write what kind of activities they wish to make in playgrounds and if they like to play in a natural playground which were shown in examples or not.



Figure 2. Some Playground Examples of Kastamonu City Centre, 2016.

Results and Discussion

When the existing condition of Kastamonu considered, the adults or children who live in Kastamonu are not familiar with the concept of natural playgrounds. They are more likely to define this concept as a natural area. With the first phase of the questionnaire, participants were free to write their opinion about the questions which are "What is natural playground means; do you know a place like that?" It was determined that, most of the children who participate the survey, defines natural playgrounds as open green areas with a lot of trees and living creatures inside. As the spatial perception of natural playgrounds for the participants, the parks or forests are places that they can get fresh air and communicate with natural elements. The activities that the children think in a natural play area are swinging, climbing walls or playing in tree houses.

Moreover, there are considerable number of students that who consider existing modular playgrounds as a natural playgrounds. Some participants said that, even interior plastic playgrounds can be considered as natural play area. This indicates that most of the children are not aware of natural elements or areas because of lacking information. Also, some of the children define natural playgrounds as hygienic areas. Interestingly, the definition of hygiene was defined in different ways by the participants.

Some of them indicated that natural playgrounds are hygienic areas because they consist of earth, and some of them said that, natural playgrounds includes 'hygienic natural plastic materials'. Especially the second indication gives information about misconception of natural material understanding.

The second question of the first step of the survey was determining the knowledge of the participants about natural materials. It is observed that the most popular answer for this question was wood and wood based materials. There were also some other natural materials or elements answers were given such as; water, glass, brick or earth. However, the most of the answers to this question were unnatural materials like metal, plastic, cement. Accordingly, it can be said that the children do not aware what are natural materials.

After the first step, the children were informed about the concept of natural playgrounds, natural materials and elements in order to prevent the misconceptions for the second step of the survey. This stage consists of 22 questions in total with multiple answers.

%75 percentage of the 105 participants indicates that their residences have a garden nearby and most of children satisfy their playing needs in playgrounds, residence garden and streets. However, a considerable amount of the participants which is %59 (n= 62) percentage prefer to play computer games as well. The reason for choosing the spaces for playing which are mentioned above is security reasons with %72 (n= 76) percentage of the participants. In addition to these, the large part of the participants indicates that they have friends in their neighbourhoods.

When the children meet with their friends, %86 (n= 90) percentage of them they like to do physical activities, mainly ball games. Other than physical activities, they also like to do more passive activities as well such as socialising, playing some creative games. Besides that, %47 (n= 49) percentage of the participants also prefer playing online games together with their friends.

%50,5 (n= 53) percentage of the participants indicates that they do not have a natural area nearby for playing and most of the participants wish to live near to a natural area. Additionally, the children who go to

playgrounds everyday remain at % 21(n= 22) percentage, and the rest of the participants go playgrounds less frequently. When the participants go to playgrounds, %46 percentage of them like to play in modular units while %37 (n= 39) percentages of them playing with natural elements such as earth or pebble. Other than these, %39 (n= 41) percentage of the participants like to bring their personal toys to playgrounds and play with it.

After determining the current situation about the playing habits of the participants, they were also asked about if a playground is designed for them, what kind of elements or concept should be applicate. Correspondingly, the %69 (n= 72) percentage of the participants designates that playgrounds should be consist of only natural elements and materials. Also %35 (n= 37) percentage of them indicates that playground designs can include both natural and unnatural materials. According to this data, it can be said that children are not happy with the current material usage of the existing playgrounds in Kastamonu and they like to engage with more natural materials.

In addition to all of these, the participants are also asked about what kind of emotions they would like to feel in a playground. A significant percentage of the participants which %86 (n= 90), like to feel happiness and %83 (n= 87) percentage of them wish to feel excitement. Therefore, one can be said that, children are do not feel excited with the existing playgrounds in Kastamonu. The other prominent feelings are mystery with %74 (n= 78) percentage, %67 (n= 70) is percentage being surprised and %69 (n= 72) is percentage feeling creative. This data also indicates that playgrounds should involve some inscrutable spatial formations in order to keep users excited. Additionally, letting children to be creative is also desirable quality in playground design and it will help children's motor skills improvement.







Furthermore, this step of the survey determines that the participant's the amount of the usage of technological devices increases during holidays. The reason for playing online and computer games is with %59 (n= 62) percentage is 'feeling bored' and %49 is percentage 'there is nothing else to do.







The content of the online and computer games are mainly adventure themes. This data gives also crosscheck that children feel bored generally and the available playgrounds are not exiting for them. Thus, they tend to meet with their play needs with some computer games which gives the feeling of excitement, adventure and explore. Although these games are having the feeling which mentioned in previous sentence, the child who plays it sitting all the time and staring at screens. Interestingly, when the participants asked about ‘if the spatial formations and places in computer games could be built, instead of playing those games online, would you prefer to go outside and actively experience?’ %78 (n= 82) percentage of them agreed to stop playing computer games completely and go to the designed areas.

swinging, water games, tracing, climbing, being creative with organizing the playgrounds or plays inside them, racing and rolling. The high majority of the participants said that all the activities which mentioned above, should be in playgrounds. Accordingly, it can be said that most of the natural playground designs already have those activities and qualities because of consisting natural elements.

At the third and the last step of the survey, it was determined that the participants strongly prefer natural playground examples instead of the existing playground examples in Kastamonu. According to each activity, natural playground design examples were shown to the participants. Moreover, the participants asked about what kind of activities they would like to see in a playground design. The physical and cognitive activities were jumping, getting informed via play units or surroundings, balancing, getting different sensations while playing such as smelling, hearing, touching, throwing items, hiding, sliding, resting,

Table 1. The Step 3-Results for Natural Playground Activity Preferences

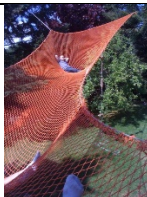
			
Jumping %82,9	Getting Informed %91,4	Balance %97,1	Collecting Materials %79,0
			

Different Senses %96,2	Hiding %95,2	Sliding %90,5	Sitting- Resitng %97,1
			
Swinging %96,2	Water Games %70,5	Tracing %95,2	Climbing %96,2
			
Creativity %89,5	Racing %77,1	Rolling %94,3	Bouncing %92,4

Conclusions

Children need to play in order to improve themselves physically, emotionally, cognitively and intellectually. Because games are the rehearsal of the real life experience. Keeping this in mind, playing outdoor games, spending time with nature is very important as well in order to grow healthy generations both mentally and physically. However, the recent research on 12.000 parents in 10 different countries including Turkey made by “dirt is good” campaign shows that children do not spend enough time outside (URL 1). The “dirt is good” campaign’s research indicates that one third of the children in England, the time that they spend playing outside is less than an average prisoner.

The aim of this research is to determine the existing outdoor playing condition for children and proposing some fresh ideas which fits with Kastamonu’s identity. Getting children’s opinions is also very important for determining the reasons why they do not prefer playing outside. The data which is given in the findings section confirms that most of the children in Kastamonu city also do not spend enough time outside. With this research, the reasons of why children do not play outside are also determined. The reasons are mainly not having exiting or different playground designs in the city, being busy with studies throughout the school term, security concerns, computer games keep children indoors. On top of these, the areas

spared for children and parks are also not enough in Kastamonu. Existing playground areas. The playgrounds which are not look alike and all same, are more exiting for children (Fjorft and Sageie, 2000). During 2015 and 2016, Kastamonu city council started to replace some relatively different modular playgrounds in few places in the city centre which have more variety of activity. Nevertheless, these new modular playgrounds are also made from unnatural materials including the ground. Also the level of excitement for children still not as much as natural playgrounds.

Kastamonu is one of the leading cities in Turkey when it comes to wood production. Also the city’s natural values and landscape is undeniable. Thus, natural playground designs and the concept of natural playscapes are more suitable with the city. The general discussion and suggestions about this issue are itemised below:

- ✓ Children in Kastamonu should engage more with nature.
- ✓ Playgrounds need to organise considering children’s needs and criticism.
- ✓ At the end of the survey, all of the participants declared that they wanted natural playgrounds in Kastamonu.
- ✓ Playground designs should include some spatial formations that allow children to do different activities.

✓ Playgrounds should be designed with the concepts that can offer adventure, mystery and excitement for children

✓ Playgrounds that does not indicate the user what to do in every step and allows them to be more creative are more attractive for children.

The participants also indicate that if they see more exiting playgrounds, they like to play outside more and play less computer games.

It is the duty of the scholars, professionals and governors to help the next generations to grow healthy both mentally and physically. Accordingly, this study aims to fill the gap in outdoor playground design field Kastamonu city. With the next step of this study, it is aimed to propose some natural playground design proposals for Kastamonu city centre.

References

Butler, C.W., (2008) *Talk and Social Interaction in the Playground*, Ashgate Publishing Company, Hampshire, England.

Chiu, S. I., Lee, J. Z., & Huang, D.H., (2004) Video Game addiction in children and teenagers in Taiwan, *Cyber Psychology & Behaviour*, 7(5), 571-581.

Fjorft I. , Sageie J. (2000) The natural environment as a playground for children Landscape description and analyses of a natural playscape, *Landscape and Urban Planning* 48 ,83-97

Ginsburg, K. (2007). The importance of play in promoting healthy childhood development and maintaining strong parent-child bonds. *Pediatrics*, 119, 182-191.

Hauge, Marny R., and Douglas A. Gentile (2003) "Video game addiction among adolescents: Associations with academic performance and aggression." *Society for Research in Child Development Conference*.

Setzer, V.W. & Duckett, D.E. (1994), *The Risks to Children Using Electronic Games*, Paper Presented at Asia Pacific Information Technology in Training and Education Conference and Exhibition , Brisbane, Australia.

Taylor, A.F.,Wiley, A.,Kuo,F. E.,& Sullivan,W. C. (1998). Growing up in the inner city: Green spaces as places to grow. *Environment and Behavior*, 30, 3-27.

Titman, W., (1994). *Special Places, Special People. The Hidden Curriculum of School Grounds*. WWF UK (World Wide Fund For Nature)/Learning Through Landscapes.

Tomporowski, P.D., McCullick , B.A., Pesce C. (2014). *Enhancing Children's Cognition with Physical Activity Games*, U.S.A. ,Sheridan Books.

URL1:<http://www.dirtisgood.com/uk/home.html>

Wan, C.S. ve Chiou, W.B. (2006) Why are Adolescents Addicted to Online Gaming? An Interview Study in Taiwan, *Cyberpsychology & Behaviour*, 9 (6), 762-766

Wells, Nancy M. (2000). At Home with Nature, Effects of "Greenness" on Children's Cognitive Functioning, *Environment and Behavior*, 32(6), 775-795

Investigating Landscape Value of Urban Forests in Gaziantep

Müge ÖZTÜRK

Kahramanmaraş Sutcu Imam University, Department of Landscape Architecture,
Kahramanmaraş/TURKEY
mugeozturk36@gmail.com

Abstract

One of the most rapidly developing cities in Turkey, Gaziantep, is faced with unprecedented urbanization and population growth during especially last decades. These developments resulted with transformation of land use / land cover types (LULC), and decrease of green areas. Within this study, the existence of forests and their effects on landscape types and urban structure have been analysed. LULC structure and landscape character types have been analysed to assess status of forest area in the city of Gaziantep. LULC information was generated from high resolution satellite image acquired in 2015, and the statistics were analysed by using geographic information systems technologies. Landscape values of the urban forests, and other open and green areas were assessed, and some proposals were also developed to protect and improve their values.

Keywords: Landscape value, Urban forest, Gaziantep

Gaziantep Kent Ormanlarının Peyzaj Değeri Açısından Araştırılması

Özet

Türkiye'nin en hızlı gelişen şehirlerinden olan Gaziantep hızlı bir kentsel büyüme ve nüfus artışı ile karşı karşıya kalmıştır. Bu gelişmeler alan kullanım / arazi örtüsü tiplerinde (AK/AÖ) dönüşüm ve yeşil alanlarda büyük ölçüde azalma ile sonuçlanmıştır. Bu çalışma kapsamında orman varlığının peyzaj tipleri ve kent yapısına etkileri analiz edilmiştir. Gaziantep'in orman alanlarının durumunu değerlendirmek için AK/AÖ yapısı ve peyzaj karakter tipleri analiz edilmiştir. AK/AÖ bilgileri 2015 tarihli yüksek çözünürlüklü uydu görüntüsünden elde edilmiş ve istatistikî değerler coğrafi bilgi sistemleri teknolojileri kullanılarak analiz edilmiştir. Kent ormanları ve diğer açık ve yeşil alanlar peyzaj değerleri bakımından araştırılmış ve değerlerini arttırmak ve korumak için bazı öneriler geliştirilmiştir.

Anahtar kelimeler: Peyzaj değeri, Kent ormanı, Gaziantep

Introduction

Migration from rural to urban areas in Turkey has caused increase of the population in the city center, so it has led to deterioration of natural and rural areas and their surroundings. Thus, rapid and irregular urbanization made urban people move away from their natural environment. Although the world's population in the last two centuries has increased 6 times, urban population has increased more than 100 times (Stalker, 2000). Destruction rate of agricultural and forest areas have increased in parallel. This ongoing urban growth has led to increase concerns, such as deterioration of ecological features and health of environment.

Urban forestry has emerged as a part of urban planning in early 1960's, so the development of the cities were attempted to be regular, planned and compatible with the natural environment (Grey/Deneke, 1986,

Atay, 1988). Urban forest was defined as, coppice forest dating from natural forests in the city and nearby city, artificial forests (including green belts), urban parks, trees on streets, roads, and residence (Atay, 1988).

Urban forests provide an array of local and global benefits (i.e. ecosystem services), including benefits to the environment, to public health and to communities. On the other hand, urban forests have declined in many cities in the last few decades and urban canopy cover in many cities is below recommendations or targets (Nowak & Greenfield, 2012; Watkins, 2015).

In the study area, in the city of Gaziantep, there was an unprecedented urbanization, and rapid population growth especially during past three decades. These developments have effected natural and cultural landscapes negatively, and the amount of green areas has

decreased gradually during urbanization process.

This study will describe how landscape character classification system can be used for landscape and green area assessment in Gaziantep. The specific objectives of the study were a) analysing land use / land cover types, b) analysing landscape character types by using natural and cultural data (geology, geomorphology, soil, vegetation), and c) assessment of LULC structure by using some landscape metrics. Following the study results, we have also discussed the theoretical and practical implications of the findings for future researches.

Material and Method

Study area

The study area is located in the Southeastern Anatolia Region of Turkey, in the province of Gaziantep which is one of Turkey's most important cities with its historical, industrial, trade and touristic potential. The population in the city of Gaziantep is 1,899,466, and in terms of population density it is the largest city in Southeastern Anatolia Region, and the 8th largest city of Turkey (Anon., 2016).

Gaziantep, with an area of 6887 km² constitutes approximately 1% of Turkey's land. Mountains cover 51.9%, lowlands cover 26.9%, plateau cover 19.0% and uplands cover 2.2% of the area (Anon., 2015).

Altitudes change between 744 and 1204 meters. Elevation has gradually increased from city center to the north, and it was observed that elevation is more intensive in the outer region.

Forests which belong to miocene period partly covered with eocene limestone. Gaziantep city and its surrounding, the large area of basalt and limestone mixed together where there are intensive reddish brown soils. In the region there are colluvial soils, especially along river valleys (Anon., 2015). The study area is characterized by reddish brown soil, red Mediterranean soil, basaltic and colluvial soils as well as soil class is determined I., II., III., IV., VI. and VII.

Only 14% of the soil is covered with forests in Gaziantep. These forests are

dominated by oak and pine species. All the oak forests are defective so they are under protection. Western and northern regions of Gaziantep are surrounded by forests, steppe and grassland. 60 per cent of land is suitable for agriculture and covered by olive, pistachio, fruit and vegetable (Özbadem et al., 2014).

The total forest area is 112922.6 ha in Gaziantep. These forests are situated on the Great Sof Hill. The high altitudes of the area are the ridge which constitutes the western boundary. Elevation of forests generally range from 800 to 1450 m. Plant and forest consist of pine, black pine, cedar, cypress, beech, poplar, oak, juniper, wild olive, sandalwood, shrub, rosaries, spruce, euphorbia, blackthorn, nettle is blackberry and meadow grasses. Artificial forests such as Dülükbaba (306 ha), Burç (192 ha), Yelligedik, Erikçe (214 ha), and Taşlıca have constituted of this area (Figure 1). Burç Forest also contains a picnic area and a zoo.



Figure 1. Location of the study area.

Method and Data

The study is based on the landscape character analysis by using geographical information systems (GIS) and high resolution remotely sensed image. For processing and storing spatial data ArcGIS, NetCAD and E-cognition softwares have been used. 1: 1000 scale development plans of the city were also used to obtain spatial data. Development plans with vector are included attribute information such as residential areas, industrial areas, road types, parks and gardens, sports facilities. All vector data are prepared using WGS 84 UTM zone 37 coordinates. Information on forest

structure was obtained from 1/25000 scale map produced by Kahramanmaraş Regional Directorate of Forestry.

This study was performed at the provincial level in the landscape character analysis. Some previous researches on landscape character analysis which are realised by Swanwick (2002), Turner (2005), Wascher (2005), and Kim and Pauleit (2007) have been considered to develop this study. The study has four main phases: (1) Producing LULC map (2) obtaining soil, stand, geology data (3) determination of landscape character types (4) analyzing LULC data by using landscape metrics.

LULC map was produced considering CORINE classification system. This map was also assessed by using “class area, patch number, mean patch measurement, mean patch rate, mean patch fractal size and edge density” metrics, and the deterioration process was taken as a base.

Within the evaluation process, “the over size and number of the patch, moving away from the circle with a patch form and increase in the curl of the patch edge, low density of the patch edge, over density of the patch edge, decrease in the inner life, low density in core areas, described as the biggest

circle area which can fit inside the patch, low inner habitat type” circumstances were accepted as the result of landscape deterioration (Forman and Godron, 1986; Forman, 1995; Uzun and Yılmaz, 2009; Uzun and Gültekin, 2011). Lower deterioration patch were accepted as a prior in protection and were characterized as the landscape habitat function.

Results

According to LULC analyses, agricultural areas class which surrounds the city has showed the largest coverage with 16190 ha. Urban area which consists of continuous and discontinuous urban fabric has the second largest area with 11753 ha of land (Figure 2) (Table 1). From the viewpoint of forests, coniferous forest areas had 2775 ha, while mixed forests have covered 320 ha. Forest areas surround the city of Gaziantep especially in the north and west sides.

Green urban areas consisted of urban parks, refuges, playgrounds, sport areas, and other public green areas cover 558 ha. The amount of open spaces with little or no vegetation had 653 ha of land. The areal coverage of bare rocks is 507 ha, while water bodies have occupied 33 ha.

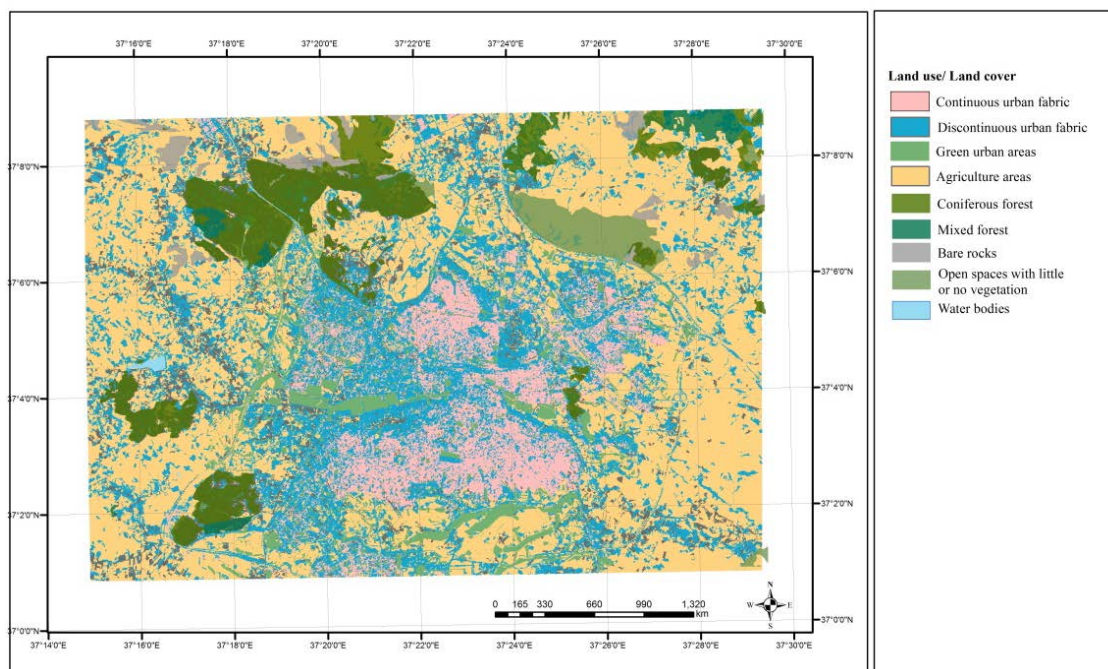

Figure 2. LULC maps

Table 1. Area of land cover classes

Land Cover	Area (ha)
Water bodies	33
Continuous urban fabric	3161
Discontinuous urban fabric	8592
Agriculture areas	16190
Open spaces with little or no vegetation	653
Coniferous forest	2775
Mixed forest	320
Bare rocks	507
Green urban areas	558

LULC data of the study area have been also analysed from the viewpoint of some landscape metrics. This study has been performed considering four LULC classes: coniferous forest, mixed forest, open spaces with little or no vegetation, and green urban areas (Table 2).

When evaluated as a percentage of mean patch number, least coniferous forests mixed forests consisting of the number of patch (0.9%), most mixed coniferous forest (7.4%) was determined to be the cover. In this case, it can be said that most of habitat functions belong to coniferous forests. Two criteria are important criteria for the Patch edge in landscape; ED (Edge density), MPE (Mean Patch Edge). However, the edge density of these indices, it is important to interpret. Coniferous forest (5.07%), mixed forest (1.02%) open spaces with little or no vegetation (0.71%) were found in edge density. The lower the density, the lower edges of the patch class have therefore said to include more domestic species habitats.

Patch number of mixed forest (31) than patch number of coniferous forest (348) least so it's considered to be more fragmentation.

When evaluating the patch forms on the patch class, small size of the mean patch fractal dimension close to 1 and mean perimeter area ratio assessments that, mixed forests (1.36%) considered as a priority for protection.

Landscape character analysis studies were realized by considering two levels. In the first level, geological, and soil data, and land cover data have been used. Land cover data was obtained from classification studies. Four main land cover types were considered: Artificial surfaces, Forest and semi natural areas, Agricultural areas, and Water bodies. In the second level, stand maps were added to these data. According to these results, forests of landscape character types were found 316 in Gaziantep (Figure 3).

Table 2. Patch-corridor-matrix model of the patch analysis results

	MSI	MPAR	MPFD (%)	ED (%)	MPE	MPS (ha)	MedPS (ha)	NumP
Open spaces with little or no vegetation	4.2	58.6	1.34	1.02	38215	652.69	652.69	74
Coniferous forest	10.2	68.7	1.42	5.07	190537	2774.86	2774.86	348
Mixed forest	4.2	83.0	1.36	0.71	26559	319.88	319.88	31
Green urban areas	106.2	911.4	1.71	41.4	1557211	1708.57	1708.57	572

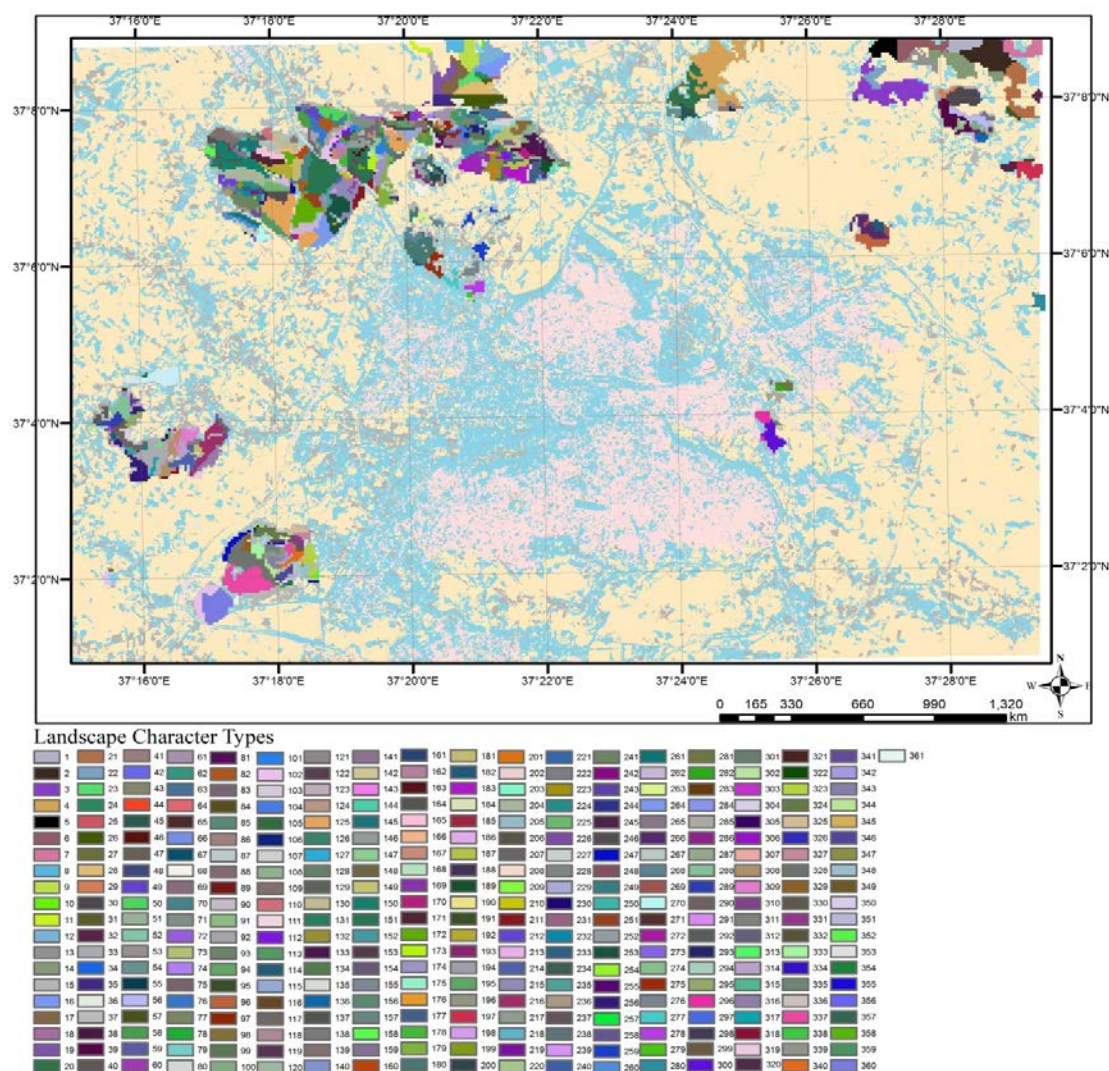

Figure 3. Landscape character types of urban forests

Conclusion

Within this study, the existence of forests and their effects on landscape types and urban structure have been analysed. LULC structure and landscape character types have been analysed to assess status of forest area in the city of Gaziantep. LULC information was generated from high resolution satellite image acquired in 2015, and the statistics were analysed by using geographic information systems technologies.

Habitat function of the study area, which involves the surrounding forests of the Gaziantep province, was evaluated with the help of landscape character types and metrics. Forest areas were evaluated in terms of landscape metrics with LULC map created

within the study and patch were subjected to class level analysis.

As a result of the study, 361 forest landscape character types were found and when evaluated in terms of habitat function, it was observed that coniferous forests have a high habitat function, while mixed forests were found to be put under protection due to high fragmentation.

With this study, it was observed that there is no sufficient urban forest for the rapidly growing Gaziantep province; also it is thought that, in terms of habitat function, natural tree types must be determined for enriching. Besides, according to the European Landscape Charter, it has to be a must for all accepted countries to determine

the landscape character and the scope of these types of studies must be extended. Forest and green areas that are studied with the landscape metrics reveal the landscape value of these areas. Enhancement and protection of the forests under the developing pressure of the city could be supported by this method.

Consciousness-raising studies about the protection and usage of these areas should be explained with various activities to the urban people, who are the ultimate users of the urban forest and park areas, and management plans should be constituted.

There has been considerable research in recent years to identify landscape values and assessment of landscape character using GIS methods. Landscape value research has been motivated by the need to development land use planning and environmental management. For example, typologies of landscape values have been developed and implemented to inform forest management, national parks and protected area management, urban park planning, residential and tourism development, coastal area management, rural development, and climate change risk (Brown, Brabyn, 2012).

References

Anonymus, 2015. Gaziantep ili 2014 yılı çevre durum raporu, Çed ve Çevre İzinleri Şube Müdürlüğü Gaziantep – 2015.

Anonymus, 2016. TÜİK, Türkiye İstatistik Kurumu, il ve ilçe nüfus göstergeleri http://www.tuik.gov.tr/yillik/Ist_gostergeler.pdf

Atay İ., 1988. Kent Ormancılığı, İstanbul Üniversitesi Orman Fakültesi Yayınları, İ.Ü. Yayın No:3512, O.F.Yayın No:393, İstanbul.

Brown G., Brabyn L., 2012. An analysis of the relationships between multiple values and physical landscapes at a regional scale using public participation GIS and landscape character classification. *Landsc. Urban Plan.* 107 (3), 317–331.

Forman, R. T. T. and M. Godron, 1986. *Landscape ecology*. Wiley and Sons, New York, USA. 618p.

Forman, R. T. T., 1995. *Land mosaics: the ecology of landscapes and regions*. Cambridge University Press, UK, 656p.

Grey, G. W., Deneke F.J., 1986. *Urban Forestry*. New York: John Wiley and Sons.

Kim K., Pauleit S., 2007. *Landscape Character, Biodiversity and Land Use Planning: The Case of Kwangju City Region, South Korea*. *Land Use Policy* 24(1), 264-274.

Nowak, D. J., Greenfield, E. J. 2012. Tree and impervious cover change in U.S. cities. *Urban Forestry & Urban Greening*, 11(1), 21–30.

Ozbadem S.A., Okkiran P., Gökçek B., Doygun H., 2014. Gaziantep ili doğal ve kültürel peyzaj potansiyeli için yönetim planı önerisi, Akdeniz ormanlarının geleceği: sürdürülebilir toplum ve çevre, 11. Ulusal Akdeniz orman ve çevre sempozyumu, (22-24 ekim 2014) , 232-240, Isparta, Turkey.

Stalker P., 2000. *Handbook of World*. Oxford University Press. New York

Swanwick, C. 2002. *Landscape Character Assessment*. Department of Landscape. UK, University of Sheffield.

Turner, S.C., 2005. *Devon Historic Landscape Characterisation*. Devon County Council Historic Environment Service/English Heritage, Exeter.

Uzun, O., Gültekin, P., 2012. Determination of Eco-tourism potential of Düzce Uğursuyu and Aksu Basins and Landscape Management. *African Journal of Business Management*, 10(29):3428-3437.

Uzun, O., Yılmaz, O., 2009. Düzce Asarsuyu Havzası Peyzaj Değerlendirmesi ve Yönetim Modelinin Gelistirilmesi, 15(1):79-81.

Wascher D.M.(ed), 2005 *European Landscape Character Areas- Typologies, Cartography And Indicators For The Assessment of Sustainable Landscapes*, Netherlands.

Watkins, S. L., 2015. *The Public Good Nature of the Urban Forest and Implications for Management*, 28 p.

Evaluation of the Recreational Potential of Kastamonu Urban Forest

*Hakan ŞEVİK¹, Mehmet ÇETİN²

¹Kastamonu University, Faculty of Engineering and Architecture, Department of Civil Engineering, Kastamonu/TURKEY

²Kastamonu University, Faculty of Engineering and Architecture, Department of Landscape Architecture, Kastamonu/TURKEY

*Corresponding Author: hakansevik@gmail.com

Abstract

The present conditions of urban forests are evaluated in response to the demands of city residents for recreational services, as well as aesthetic and health (clean air, abundant oxygen) purposes. Psychologically, forests have become necessary facilities for our cities because of their economic and ecological contributions. This study examines the status of urban forests and recreational areas and aims to determine the existing and potential recreational value of Kastamonu Urban Forest by the GIS method. The results indicate that it has high recreational potential of 82.3% in terms of areas where the most important landscape features and factors that provide conveniences have been identified. GIS modeling of mapped areas shows the recreational potential of the area. The urban forest will not only contribute to the recreational potential of Kastamonu but will also create an infrastructure for landscape planning studies in the coming years.

Keywords: Kastamonu, Landscape architecture, Recreational potential, Urban forest

Kastamonu Kent Ormanı Rekreyon Potansiyelinin Değerlendirilmesi

Özet

Kent ormanlarının mevcut koşulları, şehir halkının estetik ve sağlık (temiz hava, bol oksijen) gibi rekreasyonel hizmetlerine bağlı olarak değerlendirilir. Psikolojik olarak ormanlar, ekonomik ve ekolojik katkıları nedeniyle şehirler için gereklidir. Bu çalışmada, GIS yöntemi ile kentsel ormanlar ve rekreasyon alanlarının durumunu incelenerek, Kastamonu Kent Ormanı'nın mevcut ve potansiyel rekreasyon değerinin belirlenmesi amaçlanmıştır. Sonuçlar, çalışma alanının önemli peyzaj özellikleri ve tanımlanan özellikler bakımından %82,3 gibi yüksek düzeyde rekreasyon potansiyelinin olduğunu göstermektedir. Çalışmada alanın rekreasyon modeli GIS yöntemi kullanılarak haritalandırılmıştır. Kent ormanı yakın gelecekte sadece Kastamonu'nun rekreasyon potansiyeline katkı sağlamakla kalmayacak, aynı zamanda peyzaj planlama çalışmalarına da altlık teşkil edecektir.

Anahtar Kelimeler: Kastamonu, Peyzaj mimarlığı, Rekreyon potansiyeli, Kent ormanı

Introduction

Rapid urbanization and industrialization of countries in the development of natural and socio-economic structures that are differentiated according to environmental issues have been brought together. At present, great efforts are directed toward solving the problems arising from industry and transportation in economically developed countries. These countries need to be strengthened in the area of social care as well as balancing population growth, since the 1970s have led to the achievement of significant progress in the development of solutions to environmental problems and land use decisions. In Turkey, rapid expansion of

cities has produced intense environmental problems, such as the creation of slums and population flows from rural areas; on the other hand, it has also brought about the construction of large, multi-storey buildings and has effected significant changes, including wider roads and growth of industry. As a result of decreasing the natural areas in the cities that have ignored ecological relationships, climate and soil conditions have changed as well as housing, creating an artificial living environment with harmful substances resulting from industrial and vehicle pollution (Topay and Cinar 2008; Kaya et al., 2009; Attia and Herde 2009; Cetin et al., 2010, Bezlova ve Doncheva-Boneva

2011; Cetin 2013a; Bowler et al. 2010; Cetin 2015a; Cetin 2015b; Cetin and Sevik, 2016a;). People in the artificial city are looking for living conditions in the ecosystem and are longing for a cleaner environment (natural landscape, clean air, clean water, unpolluted soil, silence, natural freedom, etc.) that is free of overpopulation, air pollution, psycho noise and fatigue, and physiological imbalances. Currently, outdoor recreation facilities are widely used in rehabilitation and removal of imbalances.

Community recreational behavior was investigated for media people who were physically and mentally refreshed, and the changes are seen as an important function. However, changes in the environment to make cities more liveable are not affordable (Cetin 2015b; Cetin and Sevik, 2016b). Therefore, the environment changes people's desires and pushes them out of the cities. This response to urbanization is especially pronounced in regions of industrialization and causes rural recreation areas around the city to become unpopular and close. Because of the high number of available recreational activities and ample free time to relax and have fun in immediate surroundings that include water and dense plant life, people prefer to spend their leisure time nicely. In this context, various recreational activities at the waterfront (picnics, camping, sports, swimming, hiking, cruising, fishing, etc.) are recognizable and generally adorned with docks and green surroundings, which, in terms of recreation in this region, are the most desirable landscaping elements. It is set to the position. Inland waters, rivers, natural lakes, reservoirs and ponds, especially during holidays and on weekends during the summer months, are among the most sought-after rural recreation areas (Cetin 2015c; Cetin and Sevik, 2016c; Cetin 2016a)

Many water resources of the Black Sea (rivers, lakes, reservoirs and ponds) and its surroundings, despite having high recreational potential of the lower and upper structures, cannot be utilized due various deficiencies. In this study, we determine the recreational potential of the Kastamonu urban forest with respect to addressing damaged areas and increasing space for optimal processes and structures.

Materials and methods

Research areas comprise Kastamonu in a north-south direction, which includes a new urban forest corridor that showing Figure 1. The new urban forest corridor forms the heart of the city? Is it necessary to specify which cities are affected by the new corridor? Data analysis in research, synthesis and evaluation play basic base as of 2013 Tape 10 × 10 m spatial resolution satellite imagery, digital elevation models (DEMs) image of 1:25,000 scale topographic maps are used in the study to support the creation of the necessary methodological approach to the planning of a landscape-oriented recreation system. In this context, the research method used consisted of main phases:



Figure 1. Location of study area

Focus of the shooting and recreational weight to reveal the multi-criteria analysis (MCA) at this stage; (1). Determination of the areas to be the focus of shots, (2). To reveal the weight of the recreational potential of this focus, (3). consists of three sub-stages, according to the classification of focal potential recreational shooting weight.

Action to protect such areas should be intensive, and inaction naturally present in suitable areas to intensive recreation facilities. Focus shots in this area of research aims at MCA, determined by the method.

Benchmarks identified for use in the detection of MCA in the first phase will be the focus areas. These criteria are based on the work of, Salıcı and Altunkasa (2010) relevant to (1) current land use, (2) soil capability class, (3) slope, (4) maintenance and (5) the river corridor. The situation in the field of evaluation criteria has been converted to digital maps for use in the MCA method EIS (define) environment. In the second phase of the MCA, the assessment criteria are classified to conform to the formation of it in order to determine their relative values. In the assessment, post-classification is based on the features used by the recreational availability feature, and relative values ranging from -3 to +3 are assigned to each sub-criterion (Uslu et al., 2009). Thus, based on these values for each criterion, weighted maps were obtained. An increase in the relative value range comprising the negative identification seventh digit of the purpose of the positive (+) and negative (-) reveals the distinctions between factors (Table 1). In the third stage of the MCA, in order to reveal the extent of weight relative to each other criterion, weighting coefficients between 1 and 3 are assigned to each sub-criterion for each criterion (Table 2). Because the level of importance of each criterion for recreational availability is not the same, physical planning of the river corridor is important, according to this study, which is concerned with the river. Therefore, the weights of criteria are taken from river corridor 3. The topography usually needed is a flat or nearly flat slope inclines and declines of both the severity of the look accordingly (Figure 2) Therefore, these criteria are assigned weight coefficients of 2 and 1. In the weighting process at the third stage, each weighted evaluation criterion consists of multiplying and dividing the total weight coefficients by the weights assigned to them. This process results in conformity in the definition of the focus of attraction for the area, allowing the development of a green corridor research map. To reach the highest fitness value of each criterion according to this calculation, $(2 \times 3) + (3 \times 3) + (1 \times 3) + (2 \times 3) + (3 \times 3) = 33$ is calculated. Equality, the first number of the specified evaluation criteria weight coefficients in Table 2, respectively, while the second number

represents the largest relative value given in Table 1. In the study, the areas closer to showing that value were evaluated as focus shooting.

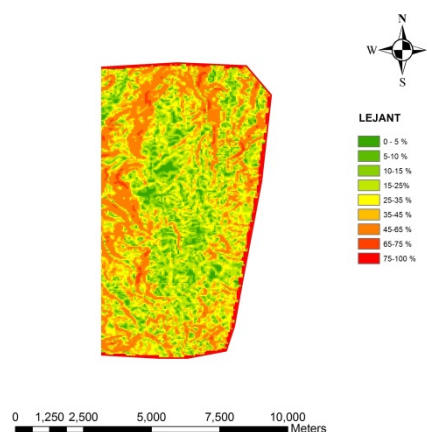

Figure 2. Slope analysis

Table 1.

Evaluation criteria	The properties are used in the evaluation	Values
Use of available area	Water surface	+3
	Horticultural	+3
	Forest areas	+2
	Residential areas	+2
	Nonfarm cultural vegetation	+1
	Garden	-2
	Agriculture	-2
Land capability classes	Field agriculture	-2
	Coastal dunes	-3
	Class I agricultural land	-3
	Class II agricultural land	-2
	Class III agricultural land	-1
View	Class IV agricultural land	+1
	Class V-VI agricultural land	+2
	Class VII-VIII agricultural land	+3
	North West	-1

Tablo 1. (continued)

	North	-2
	North east	-3
	South West	+3
	South	+2
	South east	+1
	East West	-1
Slope	%0-3	+3
	%3-9	+2
	%9-15	+1
	%15-23	-1
	%23-35	-2
	%35 <	-3
Distance of riverside	0-10 km	+3
	10-20	+2
	20-30	+1
	30-40	0
	50<	-1

Table 2.

Evaluation criteria	Weight coefficients
Use of available space	2
Land capability classes	3
View	1
Slope analysis	2
Distance to the river corridor	3

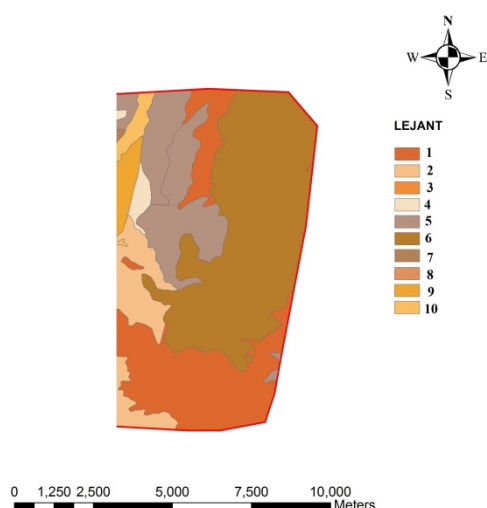

Figure 3. determining of recreational potential

The results indicate that it has high recreational potential of 82.3% in terms of areas where the most important landscape

features and factors that provide conveniences have been identified (Figure 3).

Discussions and conclusions

A link is provided between urban and rural areas, including cultural and natural values along the corridor and shores of rivers with high recreational potential, as agreed in the development of these and other features of the spine due to the corridor system. Because of the similar characteristics of the Kastamonu urban forest, transportation has been the backbone of the green corridor model envisaged for the field research for this study.

Remaining in the landscape plan and recreational plan of the Kastamonu urban forest, especially in urban areas, which is today the extent of multi-purpose facilities and recreation areas, is considered to be continuous. This makes possible the continuity of the potential green corridor. In this study, in the model proposed greenway, recreation will form the focal point recreation-oriented high corridor, and it is important to determine the potential of the area. Therefore, the corridor area is utilized by users from different sources, and the focus shots identify priority areas for recreational use in nature, which has created one of the main foci of the research method.

Determination of the photographic field was made before the focus was analyzed for general conformity. In conformity with the multi-criteria approach in the GIS analysis technique have used similar analyses for compliance purposes. However, analysis shows the differences in the underlying criteria. In this study, the forest recreation development in numerous shots focused on the Kastamonu urban forest is located along the adjacent areas. Shooting in recreational activity allows the use of different locations in the focus of research on different characteristics. The recreational-use nature of this focus, the size and make-up of the user resource vary depending on relations with the settlements. Therefore, in this study, the recreation potential weights were determined to capture focus.

-As the action in the development process of the city of Kastamonu in studies by many researchers busy and inertia intensive recreation possibility of creating open and green spaces in total and gradually decline in

terms of space per person, and Kastamonu region of fertile agricultural land. The study was opened to the zoning of sensitive areas, developing city open new for recreational use and public access in the landscape and in the provision of green space, and has agreed to increase the green space in urban areas and the organic relationship between natural rural areas and sources of sustainable use in terms of the Kastamonu urban forest and planned as close as the backbone of the greenway system of environmental requirements of the results.

-Considering all aspects of the system, it is not likely to be considered as a recreational area. In this context, this type of work in recreation shooting designated as the focus, as in this study of recreational use, using mainly protection, the separation of such land use class protection has been necessary for the viability of recreational activities to be recommended.

-In this study, the primary focus of recreation is located in the area between the town's inhabitants in the oppressive and monotonous life, which has distanced itself from time to time in the outdoors and nature closer requirements in terms of the costs in rural areas, often in neighborhoods and the Kastamonu urban forest corridor. The establishment of a connection with the existing green space in the city is of necessity in these areas in the context of continuous improvement of the system of urban ecosystems.

-This is focused on organizing recreational areas because they are not too far from the influence of dense settlements, which will reduce the intensity of use in the neighboring focus; as well, good neighborly relations with conservation priorities will prevent the conversion of the land use to a weak focus.

The highest among the recreational availability is as the attraction. Due to the greater number of users, the focus of environmental and spatial size of these settlements is understood to offer quality services to these users. Therefore, the focus of the picnic area, horse rides, fishing and boat rides, and planning the necessary facilities and equipment for recreational activities like canoeing may be more appropriately connected to water.

-Recreational focus depending on the availability of a low protection–usage balance in employment protection has been proposed as a weighted evaluation. The focus needs to be considered within the scope of protection.

It has been determined that the focus of the scope of my bodyguard is usually located in areas north of the Kastamonu urban forest. These areas today are still largely natural and close to the property. For this purpose, it would be because of the natural decay of the areas open to recreational use in this section that they are not considered in the proposal for recreational use. However, to be developed in connection with the Kastamonu urban forest green corridor system are a dam and fauna observation points in conjunction with other foci in order to make the northern and southern parts continuous. Bicycle paths and pedestrians will not harm the environment, and features such as walkways that provide a place for passive recreational activities will be of great benefit.

-In this study, recreational use in the field of research within the field of protection is located in both the northern and southern sections.

These areas are which focus on it. The difference between appropriate handling characteristics for the establishment of connections with each other in terms of recreational use of ensuring continuity in the forest and shot focal focus of this class, the recreational availability high. The focus on the continuation of activities and recreational activities is proposed.

References

- Attia, S., De Herde, A. (2009). Bioclimatic architecture: design strategies in Egypt. Aachen, Germany: Sustainable energy technologies.
- Bezlova, D., Doncheva-Boneva, M. (2011). Protected areas at the black sea coast as natural resources for development of ecotourism. *Journal of Environmental Protection and Ecology*, 12(3), 1179–1185.
- Bowler DE, Buyung-Ali L, Knight TM, Pullin AS. 2010. Urban greening to cool towns and cities: a systematic review of the empirical evidence. *Landsc Urban Plan.* 97:147–155.
- Cetin, M.; Topay, M.; Kaya, LG. & Yilmaz, B. (2010). Biyoiklimsel konforun peyzaj planlama sürecindeki etkinliği: Kütahya örneği. Süleyman

Demirel Üniversitesi Orman Fakültesi Dergisi 1: (1), 83–95.

Cetin, M. (2013a). Chapter 27: Landscape Engineering, Protecting Soil, and Runoff Storm Water. *Advances in Landscape Architecture*. InTech, Ed: Murat Özyavuz, 2013, p. 697-723. DOI: 10.5772/55812.

Cetin, M. (2015a). Using GIS analysis to assess urban green space in terms of accessibility: case study in Kutahya. *International Journal of Sustainable Development & World Ecology* 2015; 22 (5): 420-424. DOI: 10.1080/13504509.2015.1061066.

Cetin, M. (2015b). Evaluation of the sustainable tourism potential of a protected area for landscape planning: a case study of the ancient city of Pompeipolis in Kastamonu. *International Journal of Sustainable Development & World Ecology* 2015; 22 (6): 490-495. DOI: 10.1080/13504509.2015.1081651.

Cetin, M. (2015c). Determining the bioclimatic comfort in Kastamonu City. *Environmental Monitoring and Assessment*. 2015; 187 (10): 640. DOI: 10.1007/s10661-015-4861-3.

Cetin, M., Sevik, H. (2016a). Evaluating the recreation potential of Ilgaz Mountain National Park in Turkey. *Environmental Monitoring and Assessment* 2016; 188 (1): 52. DOI: 10.1007/s10661-015-5064-7.

Cetin, M., Sevik, H. (2016b) Chapter 5: Assessing Potential Areas of Ecotourism through a Case Study in Ilgaz Mountain National Park, *Tourism - From Empirical Research Towards Practical Application*. InTech, Eds:Leszek Butowski, pp.190, ISBN:978-953-51-2281-4, Chapter pp. 81-110.

Cetin, M., Sevik, H. (2016c). The change of air quality in Kastamonu city in terms of particulate matter and CO₂ amount. *Oxidation Communications* pp. 0–0. (In press)

Cetin, M. (2016a). A Change in the Amount of CO₂ at the Center of the Examination Halls: Case Study of Turkey. *Studies on Ethno-Medicine* 10: (2), 146–155.

Kaya L.G.; Cetin M., Doygun H. (2009). A holistic approach in analyzing the landscape potential: Porsuk Dam Lake and its environs, Turkey. *Fresenius Environmental Bulletin*. 2009; 18 (8), 1525-1533.

Salıcı A., Altunkasa MF (2010) Çatalan Baraj Gölü-Deli Burun Aksında Seyhan Nehrinin Yeşil Koridor Sistemi olarak kullanılabilirliğinin Araştırılması. *Ekoloji* 19(76), 36-49

Topay, M., Cinar, I. (2008). Determining of bioclimatic comfort structure of Suleyman Demirel University East Campuses situated in the back of Mediterranean region. *Geophysical*

Research Abstracts, 10(2008). EGU general assembly.

Uslu C, Altunkasa MF, Boyacigil O, Konaklı N (2009). Adana kuzeybatı üst kentsel gelişme alanında bisikletli bağlantı olanaklarının değerlendirilmesinde çözümlenmeli bir yaklaşım. *Ekoloji* 70, 57-60.

Effects of the Recreational Aspect of Urban Forests on Ecology

Ertan DÜZGÜNEŞ¹, *Elif BAYRAMOĞLU¹, Öner DEMİREL¹

¹Karadeniz Technical University, Department of Landscape Architecture, Trabzon/TURKEY

*Corresponding Author: elifsol@hotmail.com

Abstract

The quality and quantity of the open green spaces owned by urban areas in developed countries are in parallel with the quality of life attributed to that particular space. However, increasing public needs along with rapid population increase in cities cause these areas to shrink. In this respect, urban forests that are included in urban green space systems are actually green islands that play a crucial role in curtaining the hard-edged, concrete structure of cities and increasing the aesthetics in the city. In our present day, urban forests both offer various recreational services to townspeople and provide numerous ecological benefits such as balancing the city climate and air quality, reducing noise, preventing soil erosion, maintaining the water cycle and protecting the flora and fauna. Yet, recreational utilizations of these areas, which occupy an important place in the urban ecosystem, cause many negative impacts on ecological cycle. In the current study, starting off from the question how to set the balance between the city and ecology, we revealed the effects of recreational activities performed in urban forests in Turkey on the structure of soil, flora and fauna, water cycle and noise levels. Through the evaluations, suggestions were made for preventing negative impacts.

Keywords: Urban Forestry, Recreation, Ecology, Urban Ecosystem

Kent Ormanlarının Rekreatiyonel Boyutunun Ekoloji Üzerine Etkileri

Özet

Gelişmiş ülkelerde kentsel alanların sahip olduğu açık-yeşil alanların nicelik ve nitelikleri o alanın yaşam kalitesi ile paralellik göstermektedir. Ancak kentlerdeki hızlı nüfus artışına bağlı olarak kamusal ihtiyaçların artması bu alanların azalmasına neden olmaktadır. Bu anlamda kentsel yeşil alan sistemleri içerisinde yer alan kent ormanları, kentin keskin hatlı betonlaşmış yapısını perdelemeye ve kent estetiğini artırmada önemli bir rol üstlenen yeşil adalardır. Günümüzde kent ormanları bir yandan kent halkı için çeşitli rekreasyonel hizmetler sunarken diğer yandan da kent iklimini ve hava kalitesini dengeleme, gürültüyü azaltma, toprak erozyonunu önleme, su döngüsünü sağlama ve flora ve faunayı koruma gibi birçok ekolojik yararlar sunmaktadır. Ancak kent ekosistemi içerisinde önemli bir yeri olan bu alanların rekreasyonel etkinliklere dayalı kullanımlar sonucu ekolojik döngü üzerinde birçok olumsuz etkilere neden olmaktadır. Bu çalışmada kent ile ekoloji arasındaki dengenin nasıl kurulması gerektiğinden yola çıkarak Türkiye'deki kent ormanlarında gerçekleştirilen rekreasyonel faaliyetlerin toprak yapısı, flora ve fauna, su döngüsü ve gürültü üzerindeki etkileri ortaya konmuştur. Yapılan irdelemeler sonucunda olumsuz baskıları önlemeye yönelik önerilerde bulunulmuştur.

Anahtar Kelimeler: Kent ormanı, Rekreatiyon, Ekoloji, Kent ekosistemi

Introduction

Technological developments paralleled by rapid population increase ignited the emergence of densely populated settlements thanks to social and economic concerns. Urban spaces, which are composed of intensive structure systems that are isolated from nature, have had considerable negative impacts on the lives of human beings. This trend has also caused the open green spaces to shrink day by day (Uyanık and Küçükkaya, 1999; Gül, 2002). In order to reduce the mentioned impacts, urban people swarmed into the natural forest areas surrounding cities. The term “Urban

forestry” emerged as a solution proposal to the diminishing urban green spaces that fail to meet the needs of the increasing population in terms of both quality and quantity (Dirik and Ata, 2004; Gül and Gezer, 2004).

Urban forestry has been stressed more and more, especially in recent years as settlement areas continuously departed from the natural environment (Tilki et al., 2008). Urban forests are defined as areas that are located in or around urban spaces, marked off naturally or artificially, providing opportunities to urban people in terms of recreation, and that are easily accessible being located in a short

distance (Ayaşlıgil, 2007). According to Miller (1997), urban forests are not the outcome of reforestation endeavors performed inside the cities; rather they are spaces located within or around cities hosting naturally grown plant groups. According to Wolf (2003), on the other hand, it is the method of management of the forest resources in urbanized areas that belong to public. From another perspective, all vegetal areas located within the urban ecosystems are defined as urban forests (Yılmaz et al., 2004). The Communiqué on Recreation Areas of Turkey (2006) defines urban forests as areas which enable sports, aesthetic, health and cultural activities in a different way from the traditional picnicking, as well as being officially determined in order to publicize forestry endeavors and the peculiar flora & fauna (Sağlam and Özkan, 2011). Demirel et al. (2005) indicate that “urban forests are not mere parks” while Tilki et al. (2008) argue green belt afforestation and roadside planting are outside the scope of the notion of urban forests (Kurdoğlu and Düzgüneş, 2011). According to Konijnendik (2003), “urban forests are such woodlands that are planned within or around the city so as to meet the recreational needs of urban people”. When pondered on the definitions restated above, it can be inferred that urban forests emerged to supplement cities and people living in them with activities that will provide various benefits in social, cultural and ecological terms.

Starting off with roadside planting projects in the early 20th century, the scope of urban forests has expanded in an attempt to take the natural ecosystems into cities (Wolf, 2003). The phrase ‘urban forestry’ was first introduced in 1965 at Toronto University in the statement of “planning and management of urban forests” (Sertok, 2004). Afterwards, implementers started to use plants with differing functions to be able to change the congested and dull scenery of urban areas in the US, Canada, Australia and numerous parts of Europe. It was found out that urban forestry was initially evaluated as a means of landscape development and prosperity, while environmental impacts took primacy afterwards (Carter, 1995). Even if it was known to developed countries in the 1960,

discussions about the term ‘urban forestry’ started only after the 1980s in Turkey (Serin and Gül, 2006). As every country had its own definition of urban forestry, the development processes differed around the world. As a result of this, countries determined their own plans to set up urban forests and special rules for the continuation of such spaces (Yılmaz et al., 2004). Scrutinizing the implementations regarding urban forestry, we see that the Ministry of Environment and Forestry in Turkey initiated an urban forestry project in order to increase the social functions of forests, and creating an urban forest in every province was set as an ultimate goal. Because of the increasing demand for the forested areas surrounding the cities due to fast urbanization, the ministry focused on planning endeavors to meet the demand. In this scope, 63 urban forests were set up between the years 2003 and 2008 (Anonymous, 2007; Anonymous, 2008). In parallel with this trend, the fact that urban people came to recognize the presence of forests and realize their benefits, and ultimately started to establish the relationship between urban areas and urban forests played a crucial role in generating the infrastructure for urban forestry and determining the legal framework (Dirik and Ata, 2004; Kurdoğlu et al., 2011).

In the current study, we point out the importance and recreational benefits of urban forestry in our day. Further proposals are made by establishing the prominence of urban forestry. Apart from that, we discuss the negative impacts of recreational activities performed in urban forests on the structure of soil, flora and fauna, water cycle and noise levels.

Benefits of Urban Forests

The purpose of setting up urban forests is to make ecological, recreational, social, economic and psychological contributions to urban areas and urban people (Gül, 2002). Trees in urban forests, on the other hand, play quite a crucial role in sustainability of urban life (Dirik and Ata, 2004). Urban forests are essentially meant to regenerate climatic conditions, protect and rehabilitate such natural resources in and around cities as soil, water, vegetation and wildlife, prevent

hazards like noise, dust and gas from polluting the city, ensure ecological functions like naturally refining and cleaning the atmosphere of the city, and provide aesthetic, psychological, economic and recreational benefits for urban people (Dirik, 2001). Benefits that urban forests provide for urban life are stated below:

- **Social Benefits:** Urban forests enable many recreational activities by increasing the total quality of the environment people live in. They provide socio-cultural services to urban people through recreational activities in the green belts they create. Urban forests contribute to sanitation of the life spaces of people and have direct and indirect effects on the psychological and physical health of urban people. They also play a social role as they make positive contributions to the visual value of the city, raising environmental consciousness and meeting recreational needs of people (Tilki et al., 2008). They are quite suitable areas where urban people can meet their recreational needs in open green spaces, because urban forests are located by cities close enough to benefit from the urban opportunities, and distant enough to experience the naturalness. As a result of this, urban forests can meet the recreational needs of varying groups with proper arrangements (Dirik and Ata, 2004). Besides, urban forests portray aesthetically impressive sceneries by posing contrast within the solid and concrete urban structure, and soft lineaments through their vegetation texture (Aslanboğa, 1976). By emphasizing different spaces in different colors thanks to seasonal coloring designs of planting schemes in intra-urban areas, they positively affect the environment in visual terms (Öner et al., 2007). Urban forests provide people living in cities with innumerable social and psychological benefits through their visual features and aesthetic functions including lowered stress levels, opportunities of emotional and spiritual recreation, better relationship with neighbors, and decreasing number of aggressive behaviors and increasing capacity of coping with problems (Zhu and Zhang, 2008).

- **Economic benefits:** The larger is the area of urban forest areas within the city, the bigger is the benefit they provide people with. Urban forests can meet the firewood needs of people, especially in underdeveloped countries, by 25% up to 90% (Dirik and Ata, 2004). Presence of non-wood plants within urban forests increases the economic value of these places, as well as serving as a source for food. In most developing countries, fruit trees are frequently preferred in designs so as to be able to meet nutritional needs of the public (Cecil et al., 2005; Tilki et al., 2008). On the other hand, urban forests affect the energy consumption of buildings in urban areas, too. It was detected that the plant texture surrounding buildings make a contribution by 5-15% to heating and 5-50% to cooling (Nowak, 1994; Öner et al., 2007).

- **Ecological benefits:** Urban forests can change the ecological conditions of the city. They change the air of the city thanks to the natural cleaning function they serve with their trees producing oxygen through photosynthesis (Ürgeç, 1998). Clean and oxygenated air masses filtered through green belts surrounding cities replace heated and polluted air rising from the center of the city (Dirik and Ata, 2004). Moreover, cities are warmer than rural areas because of the huge masses of concrete buildings. Urban forests can change the climatic conditions of cities. Increasing the rate of humidity, urban forests create a cooling effect. They increase the moisture in the city through transpiration they generate along with other urban green spaces (Kuchelmeister, 1998). Decreasing wind velocity due to concrete masses results in lower cooling effect and psychological oxygen intake in urban areas. Trees, on the other hand, filter the air and prevent pollution (Barış, 2005). In their study, McPherson et al. (1995) revealed that considerable amount of energy could be saved by planting trees on the western sides of buildings in hot climate zones to maintain a shady area, and by creating wind barriers using trees in cooler places. Trees can also prevent the negative impacts of wind erosion in arid and semi-arid climate zones. They eliminate the negative effects of erosion and soil pollution by

preventing soil attrition and erosion (Öner et al., 2007). Urban forests have a noise reducing effect as they create noise barriers across the city. Especially broad-leaved forest trees play an essential role in reducing noise beginning from the ground level (Bariş, 2005). An urban forest is the only environment in the city where biological diversity can be maintained. These places are unique zones that embrace a vast biological diversity and a rich fauna that can adapt to the ecological balance. IUCN pointed out that urban forests serve to preserve and improve the biological diversity, and green belts and linear parks that surround the cities have turned into 'biological tracks' (Dirik and Ata, 2004; Öner et al., 2007).

Relationship of recreation – urban forest

Recreation, deriving from 'creating again', connotes recreating and recovering something (Sağcan, 1986). It is the combination of all the entertaining and relaxing activities one performs outside his/her daily routine (Kurdoğlu, 2005). Smith (1989), on the other hand, defines recreation as the combination of actions that are performed in a landscape designed in a special pattern or in a classified action system. Setting off from these definitions we can perceive recreation as the bunch of activities people get engaged in so as to pass their leisure time to relax and attain psychological satisfaction. In this respect, as part of the unspoiled nature, urban forests are places that provide people with opportunities in terms of their biological and psychological needs.

The desire to get away from boring and tiring life of the cities, and regenerate spiritually and physically has been the propelling force that directed people to rural areas. Especially forests are among the top destinations thanks to the natural, cultural and visual values they bear (Akten, 2003). In this sense, urban forests enable numerous recreational activities because of their proximity to city centers and ecological, aesthetic and functional spaces. However, some environmental impacts may emerge as the result of intensive utilization of these places. Especially utilizations that exceed

carrying capacity can cause irrevocable destructions on resource values.

Environmental impacts of the recreational activities conducted in urban forests can be investigated under four domains, namely the structure of soil, flora and fauna, water cycle and noise levels.

- **Structure of soil:** Urban forests, especially the ones set up on slopes where vegetation is weak, protect the soil against erosion and the risk of landslides. Moreover, they eliminate the negative impacts caused by wind erosion in cities located in arid and sub-arid regions (Dirik and Ata, 2004). Trees prevent the soil erosion by reducing the kinetic energy of raindrops with their leaves, branches and trunks in these areas where planting schemes suitable for the given region are implemented (Kırman, 2004). However, the desire to increase the recreational activities in these areas results in the formation of flat and relieved areas, in other words, causes erosion by destructing the form of topography. In addition to this, intensive recreational activities performed beyond carrying capacity cause soil compaction, and decrease soil permeability increasing the pressure on the ground.

- **Flora and Fauna:** Urban forests makes contributions to ecological balance thanks to their green texture, rich flora and fauna. Nevertheless, structures and other facilities (parking lots, walking tracks, urban furniture, architectural elements etc.) that are built in these areas without any systematical recreational planning induce the depletion of green texture, and decline or total disappearance of vital reserves in parallel with intensive use of the natural environment. Apart from those, preference of different species in formation of urban forests rather than using species suitable for the natural conditions of the given area causes unwanted changes on the local fauna.

- **Water Cycle:** Urban forests play an essential role in preventing water loss caused by surface runoff by holding up the water infiltrated into soil after rainfalls, thus securing the water supply for urban use. Besides, urban forests are the natural areas that enable an intact water cycle by filtering and refining the wastewaters (Atay, 1988).

However, wastewaters and poisonous chemicals like detergents deriving from structures like catering facilities and WCs that lack proper infrastructure and deficiency in regular controls can easily pollute water resources.

- **Noise pollution:** Noise pollution caused by recreational activities and large groups of users can pose negative impacts both on the fauna and other users of natural areas.

Urban Forests in Turkey

Our country has been familiar with the term 'urban forestry' thanks to planting projects conducted in numerous cities in this scope. It has been stressed even more in recent years thanks to positive contributions they make to urban spaces and urban people.

Urban forestry presented its first outstanding examples initially through the meadows created during the Ottoman Period, especially in Istanbul, and later with 'Atatürk Forest Farm' formed in Ankara in the early years of the Republic period. These examples were followed by Istanbul – Florya Atatürk Forest, Eskişehir – Kocakır Urban Forest, Balıkesir - Degirmenbogazı Urban Forest, and Kahramanmaraş – Ahırdağı Urban Forest (Dirik and Ata, 2004). Urban forestry was supported with botanical gardens, intra-city parks, roadside planting schemes and mass planting endeavors performed in many more provinces around the country. Ministry of Environment and Forestry is the institution primarily responsible for the formation and management of urban forests in Turkey. General Directorate of Afforestation and Erosion Control (*AGM*) and General Directorate of Nature Protection and National Parks (*DKMP*), both of which serve under the order of the Ministry, directly deal with urban forests (Öner et al., 2007).

Discussion and Conclusions

Changing and diversifying needs in parallel with population growth, and advancing global economic mobility as a result of this have resulted in disruption of ecological balance by deeply affecting the nature and lifestyles (Ozan, 1995). Increasing levels of stress, long working hours and monotonous lifestyles compelled people to

turn their faces to the nature. Urban forests are among such natural places. Urban forests are very important places that bridge between nature and human beings, enabling numerous recreational activities and maintaining the ecological balance. The most important reason why people are attracted to these places is quite obvious: they provide a suitable environment for resting, health and entertainment activities with the natural and cultural resource values they have. As a result of this, recreational plans should be prepared meticulously taking into consideration the natural life systems and forest ecosystems while making arrangements regarding recreational activities. Urban forests should be planned at a certain level of suitability in terms of distance, accessibility, size, composition of species and recreational facilities, and these plans should be implemented properly during zoning works (Kurdoğlu et al., 2011).

As excessive use of urban forests results in breaching the carrying capacity limits, destruction of the area of question equally increases. These areas, which have preserved their natural characteristics for a long period of time, are often irrevocably destroyed by user-oriented causes.

From this point of view, the following precautions that will minimize the impact of recreational activities on the natural structure should be taken:

- Plant species that are suitable with the local environment should be preferred in setting up urban forests.
- Special visitor management plans should be made for urban forests, and a holistic structure should be generated in accordance with these plans. In this manner, excessive utilizations can be prevented and soil compaction and deformations on the permeable structure can be evaded.
- Preferring smaller amounts of hard surfaces by protecting the green texture, and designing special fittings for the given area will minimize the destruction on the local flora and fauna.
- Various types of pollution (especially noise pollution) that are caused by utilization of urban forests can be eliminated through adequate and efficient information boards

and a strict control program. Placing adequate number of trashcans and containers can completely solve the solid waste problem.

- Pollution of the water resources can be prevented by creating wastewater systems that strictly comply with the standards.

In conclusion, urban forests should be formed according to such planning decisions that take into consideration the social, functional and aesthetic characteristics, as well as recreational utilization forms that are suitable for the natural structure, and in this way, potential hazards on the resources should be avoided.

References

Anonymous, 2007. Stratejik Plan Çalıştay. Çevre ve Orman Bakanlığı Orman Genel Müdürlüğü, pp. 9, Ankara.

Anonymous, 2008. İklim Değişikliği ve Yapılan Çalışmalar 2008. T.C. Çevre ve Orman Bakanlığı, 101.

Aslanboğa İ., 1976. Şehir çevresi ağaçlıkları (Translation), İstanbul Üniversitesi Orman Fakültesi Dergisi, B:XXVI:(2), 256-279, İstanbul.

Atay, 1988. Kent Ormanlığı, İstanbul Üniversitesi Orman Fakültesi Yayınları, .Ü. Yayın No: 3512, O.F. Publ. No: 393, İstanbul.

Akten M., 2003. Isparta İlindeki Bazı Rekreatyon Alanlarının Mevcut Potansiyellerinin Belirlenmesi. Süleyman Demirel Üniversitesi Orman Fakültesi Dergisi Vol: A, Issue: 2, ISSN: 1302-7085, pp.: 115- 132

Ayaşlıgil T., 2007. Kent Ormanlarının Rekreatyonele Amaçlı Kullanımı ve İstanbul İli Örneğinde İrdelenmesi. YTÜ Mim. Fak. E-Dergisi. 2(4): 213-236.

Barış M.E., 2005. Kent planlaması, kent ekosistemi ve ağaçlar. Planlama. TMMOB Şehir Plancıları Odası Yayını. 34:156-163.

Carter J., 1995. The Potential of Urban Forestry in Developing Countries. A Concept Paper, Roma, FAO.

Cecil C.C, Nilsson, K., Randrup, T.B. and Schipperijn, J. 2005. Urban Forests and Trees: A Reference Book. Springer-Verlag, pp. 516.

Dirik H., 2001. Kent Ormanlığı ve Yeşil Kuşak Tesisleri, Orman Mühendisliği Dergisi,38(5):16-23, Ankara.

Dirik H., Ata, C., 2004. Kent Ormanlığının Kapsamı, Yararları, Planlanması ve Teknik Esasları, I. Ulusal Kent Ormanlığı Kongresi Bildiriler Kitabı, 63-77, Ankara. D

Gül A., 2002, Orman Peyzajı ve Rekreatyonu Ders Notu. S.D.Ü. Orman Fakültesi Isparta (unpublished).

Gül A., Gezer A., 2004, Kentsel Alanda Kent Ormanı Yer Seçimi Model Önerisi ve Isparta Örneğinde İrdelenmesi, I. Ulusal Kent Ormanlığı Kongresi, 9-11 April 2004, Ankara, pp.: 365-382.

Kırıman S., 2004. Kent Ormanlarının Çevresel Etkileimi, I. Ulusal Kent Ormanlığı Kongresi Bildiriler Kitabı, 426-437, Ankara.

Kuchelmeister G. 1998. Urban green for local needs-improving quality of life through multipurpose urban forestry in developing countries. Proc. 1st international conf. on quality of life in cities. Vol 1. pp. 181-191. Singapore.

Kurdoğlu B. Ç., 2005. Trabzon – Gümüşhane Eski Devlet Karayolu'na Ait Hamsiköy – Zigana Köy Güzergahı'nın Yeşilyol Olarak Planlanması Üzerine Bir Araştırma, Doctoral Thesis, Karadeniz Teknik Üniversitesi, Fen Bilimleri Enstitüsü, Trabzon.

Kurdoğlu O. and Düzgüneş, E., 2011. Artvin Kent Ormanının Rekreatyon Olanakları ve Kullanıcı Tercihlerinin İrdelenmesi. Artvin Çoruh Üniversitesi Orman Fakültesi Dergisi, 12 (2):199-210

Kurdoğlu O., Düzgüneş, E. and Kurdoğlu, B.Ç. 2011. Kent ormanlarının kavramsal hukuksal ve çevresel boyutuyla değerlendirilmesi. Artvin Çoruh Üniversitesi Orman Fakültesi Dergisi, 12 (1): 72-85.

Mesire Yerleri Yönetmeliği, 2006. Çevre ve Orman Bakanlığı, Official Gazette Date: 30/10/2006, Issue : 26305.

Nowak D.J., 1993. Atmospheric Carbon Reduction by Urban Trees, Journal of Environmental Management, 3 (3): 207-217.

Ozan K., 1995. Çevrecilikte Yeni Bir Vizyon Arayışı, Türkiye'de Çevre, Türkiye'nin Sorunları Dizisi-13, Yeni Yüzyıl Dergisi, İstanbul.

Öner N., Ayan, S., Sıvacıoğlu, A. and İmal, B., 2007. Kent Ormanlığı ve Kent Ormanlarının Çevresel Etkileri. Kastamonu Üniversitesi, Orman Fakültesi Dergisi, 7(2): 190-203.

Saçcan M., 1986. Rekreatyon ve Turizm, Cumhuriyet Basım Evi, İzmir, pp. 280.

Sağlam S. and Özkan, U.Y., 2011. Kent Orman Kavramı ve Planlama Örnekleri. I. Ulusal Akdeniz Orman ve Çevre Sempozyumu. 26-28 October 2011, Kahramanmaraş. 555-568.

Serin N. and Gül A., 2006. Kent Ormanlığı Kavramı Ve Isparta Kent İçi Ölçeğinde İrdelenmesi. Süleyman Demirel Üniversitesi Orman Fakültesi Dergisi, 2: 97-115.

Sertok B.S. 2004. Kent ormanı kavramı çerçevesinde orman içi dinlenme yerlerinin

planlanması. I. Ulusal Kent Ormancılığı Kongresi Bildiriler Kitabı. pp. 78-95, Ankara.

Smith S., 1989, "Why a Botanical Garden", The Public Garden, American Associa Swathore, USA.

Tilki, F., Güner, S. and Tüfekçioğlu, A., 2008. Kent Ormancılığı Ve Artvin İli Kent Ormancılığı Uygulamaları. Artvin Çoruh Üniversitesi, Orman Fakültesi Dergisi, 9 (1-2): 92-100.

Uyanık, M., Küçükkaya, İ., 1999, Tarım ve Köy Dergisi. Issue:129, Eylül-Ekim, AGM Erozyon Kontrolü ve Mera Islahı Daire Başkanlığı, Ankara.

Ürgeç, S., 1998: Genel Plantasyon ve Ağaçlandırma Tekniği. İ.Ü. Orman Fakültesi Yayınları No: 3997/444, ISBN 975 - 404 - 443 - O. pp. 664, İstanbul

Wolf, K. L. 2003. Introduction to Urban and Community Forestry Programs in The United States. Landscape Planning and Horticulture, 4(3): 19-28.

Yılmaz H., Demircioğlu Yıldız, N. and Turgut, H., 2004. Kent Ormanı Kavramı; Erzurum Kenti Örneği. I. Ulusal Kent Ormancılığı Kongresi, Bildiriler Kitabı, 315-330.

Zhu, P. and Zhang, Y., 2008. Demand for urban forests in United States cities. Landscape and Urban Planning 84(3-4): 293-300.

Recreational Usage of Urban Forests: The Case of Trabzon City

*Makbulenur BEKAR¹, Müberra PULATKAN¹, Nilgün GÜNEROĞLU¹

¹Karadeniz Technical University, Faculty of Forestry, Dept. of Landscape Architecture,
Trabzon / TURKEY

*Corresponding Author: mnurbekar@gmail.com

Abstract

Industrialization and increasing population have triggered unplanned urban expansion which is characterized by deforestation, lose of green coverage and rising rates of impervious surfaces. However, green spaces are very effective landscape elements of the urban inhabitants as they provide necessary facilities for more comfortable and social life. The green urban texture is mainly formed by urban forests which are supporting and regulating climatological conditions, enhancing the population health by filtering the air, balancing the ecological cycles and meeting recreational demands of the urban populations.

The city of Trabzon is well-known for its green vegetation that is recently threatened by urbanization. Therefore the importance of the urban forests as potential recreational places is brought to forefront. In this study potential areas that can be used as urban forests were determined to decide about landscape potential by evaluating their landscape values.

Finally, alternative recreational activities were suggested for the urban forests with landscape potential. Moreover, alternative planting is proposed to promote the seasonal coloration of the urban forests considering their visual effects.

Keywords: Urban forest, Green coverage, Recreation, Trabzon

Kent Ormanlarının Rekreatif Kullanımları; Trabzon Kent Örneği

Özet

Endüstrileşme ve nüfus artışına bağlı olarak hızlı kentleşme yapısal elemanların artmasına ve yeşil dokuların gün geçtikçe azalmasına neden olmaktadır. Oysaki kentsel yeşil dokular kentlilerin kaliteli bir yaşam sürdürebilmeleri ve sosyalleşebilmelerinde etkili olan peyzaj elemanlarıdır. Yeşil dokuların kentlerdeki en önemli bölümlerinden birini kent ormanları oluşturmaktadır. Kent ormanları kent iklimini iyileştiren, kentin havasını temizleyerek kent halkının sağlığına katkı sağlayan, kent ekolojisini dengeleyen ve kent insanının rekreatif ihtiyaçlarını karşılayan ortamlardır.

Trabzon Doğu Karadeniz Bölgesinde yer alan yeşil bir kenttir. Fakat son yıllarda ortaya çıkan yapılaşmadan dolayı bu özelliğini kaybetme noktasına gelmiştir. Bunun nedenlerle Trabzon kent ormanları kentliler için rekreatif etkinlik alanları olarak ön plana çıkmıştır. Çalışmada Trabzon kent sınırları içerisinde bulunan kent ormanı niteliğindeki alanlar belirlenmiştir. Bu kent ormanlarının peyzaj potansiyelleri irdelenerek herbirinin sahip olduğu peyzaj değerleri tespit edilmiştir.

Sonuç olarak geliştirilmesi gereken kent ormanları için alternatif rekreatif etkinlikler önerilmiştir. Ayrıca kent ormanlarının görsel etkileri de göz önünde bulundurularak mevsimsel değişimlerini ön plana çıkartabilecek alternatif bitki önerileri sunulmuştur.

Keywords: Kent ormanı, Yeşil doku, Rekreatif, Trabzon

Introduction

Located in the urban and natural environment have been established near or artificial trees, tree groups and forest areas, public benefit in accordance with the planning, design, construction, performing operations such as forestry protection is a special system (Tyrväinen, et al., 2003, Kiper and Öztürk, 2011). Forest areas inside the city give citizens possibilities by using flora and fauna specialties. City forests play a

balanced direct role in inside the city (Dirik and Ata, 2005). With aesthetic and functional ways it is green texture that becomes one with the city. Not only regional forest life's, but also it is a part of rural landscape (Dirik and Ata, 2005). Landscaping architecture provides special human needs and provides recreative needs. In a whole it's a planning system that includes participatory approach.

Urban forests have got advantages that in the city and to the citizens that has lots of functions. These are ecologic, social, economic and aesthetic functions. These 4 are collected under the same title (TyrvaEinen and Vaananen, 1998; Yilmaz, et al., 2006; Öner et al., 2007; Tilki, et al., 2008).

Ecologic functions:

-Because of the climatic effects, city forests provides positive additives to city air and heals the air by oxygen oscillation.

-With the green texture it has, it creates shelter for the wild life.

-Inside the city because of the wind that has been created by climate it slows the speed of the wind. Making it work like a barrier.

-It provides balances hot and cold. While it's lowering the heat in summer, it also increases the heat in winter.

-It prevents radiation.

-It stops rains and streams from carrying the mud.

-It prevents natural disasters.

-By concentrating on water steam it makes it convert to rain.

-It reduces urban heat island effect.

Social functions:

-It provides recreation to the city citizens. (Walking, running, learning the nature, having an picnic, resting, feeling nature e.g)

-It provides the adults and children to be one with the nature.

-With its potential attributes, it becomes a tourist attracting point, and also it adds visual and aesthetic beauty to the city.

-While it services peoples entertainment, resting and eating, it also adds positive effects to peoples physical and mental health.

Economic functions:

-With being a rich raw material it provides work employment to many areas of the country.

-Drinking water being first, it provides the water which industry and agricultural needs and water which is being formed at underground.

-It makes a route for the tourists in the city with various recreational events.

-It is the raw material source for some medicines and this provides a huge

marketing opportunity to country economy.

-With natural beauty of the forests, having people walk in their free time, it is a field where they create their living. And this creates a big economic income for tourism.

Aesthetics funcions:

-It softens the stiff and sharp platform which is caused by city's construction.

-With urban's structure members, line, colour, form, it creates a contrast for texture and measurement and this helps it to create an efficient landscapes.

-It is used to close the unwanted view in urban areas.

-With the morphologic attributes hat plant material has, It presents different landscaping views depending on the weather.

-With the functions that the urban forests have, because of tourism perspective. Importance of this cannot be avoided.

Mass tourism acceptance which occurs in 1960's left its place to alternative tourism approachment which is more respectful and responsible to nature. Connected to this, A new tourist type have been nascent and they are more personally moving, nature friendly and wants to learn the cultures and traditions of the people that lives in that area (Güneş, 2001). Depending on this, areas in the forest has this potential making it more important. With urban forests being minimum distance to the citizens, is the biggest reason they are chosen. Because of these reasons, city forests should be considered as urban recreation by protection balance.

In this work, city forest in Trabzon are examined. These forests have natural and cultural richness. These chosen city forests were evaluated on their recreation potential and to improve citizens happiness. It is suggested to protect and present Trabzon's cultural and natural richness.

Materials and Methods

Materials

Our working are is based on 4 main routes (Figure 1). The taken 4 main axle is the most potentially closest to Trabzon City Center. The reason is that it is easy availability chosen as the study area.

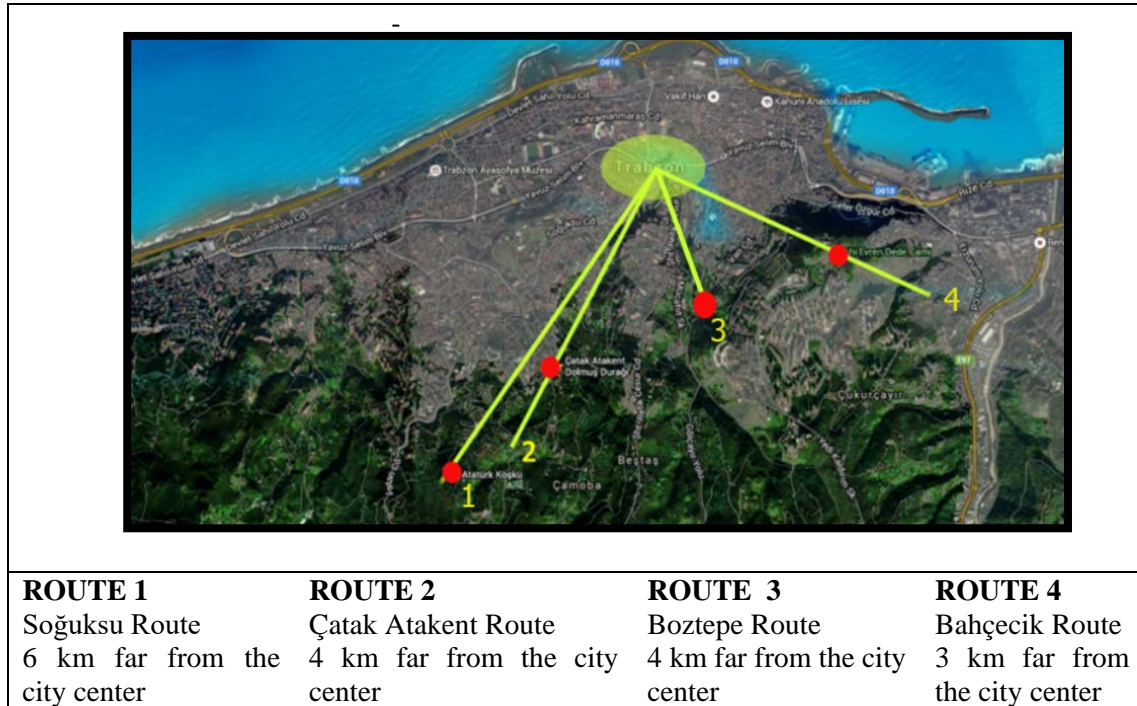

Figure 1. Study routes

Route 1: Soğuksu and Atatürk Pavillion

Soğuksu place is one of the best places of Trabzon Merkez and has got population of 8.989, and it is 6 km far from Trabzon City Center, it is one of the most chosen places because of its distance to historical Atatürk mansion's walking path.

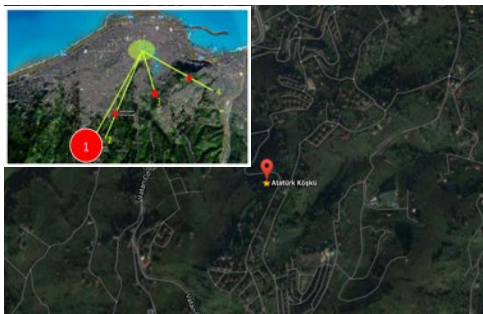

Figure 2. Route 1

Route 2: Çatak Atakent route

Çatak district has a rich forest returning path in Atatürk Mansion (Figure 3). City forest in this district creates a quiet place for the neighbours who live in there. It has a recreative potential of having a healthy life parkour and walking paths.



Figure 3. Route 2

Route 3: Boztepe route

Boztepe district, it's in a place where social facilities are most active. It has a population of 15.647 people (Figure 4). City forest captures a large area in this district. There are places which you can make different activity and take pictures from a point where it has full view on the city, also it is in a walking distance to the city center.



Figure 4. Route 3

Route 4: Bahçecik route

Bahçecik district is one of the oldest streets in Trabzon. It has a population of 10.395. Cephanelik restaurant and Gölçayır facilities are the most potential places in this district. There are forests around Cephanelik and Gölçayır that can give opportunity to peoples recreative requests (Figure 5).

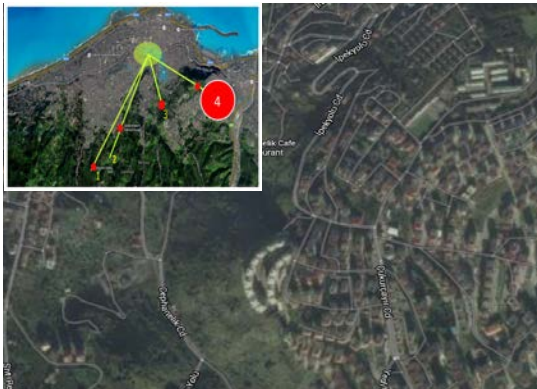

Figure 5. Route 4

Methods

In this work, observation on the spot, examination, analyzation and evaluation are used. First of all, these 4 routes in these area and working subjects are used to create literature scanning. After that by doing area working, the plants in the park have been pictured and the identification has been made. These areas have been analyzed to see how much potentiality it has to be a landscape. Existing potentials, which could provide opportunities were investigated. After these analyzations it is suggested that these recreative events needs to be upgraded.

Findings

According to some areas and literature studies, field studies on the facilities available in urban forests are compared considering the study area. In addition, each landscape values of the area were also analyzed separately. (Table 2) (Figure 11).

Table 2. Opportunities of study areas

Olanaklar	Study Areas			
	Soğuksu	Atakent	Boztepe	Bahçecik
Easy transportation	X	X	X	
Eating facilities	X		X	
Near the centre town	X	X	X	X
Having a picnic	X		X	
Opportunity to walk	X		X	
Being close historical places	X		X	X
Recreational values	X		X	
Kids play places			X	
City view option	X		X	
Nature view option	X	X	X	X
Culturel tourism opportunities	X		X	X
Nature tourism opportunities	X	X		X
Architectural texture feature				X

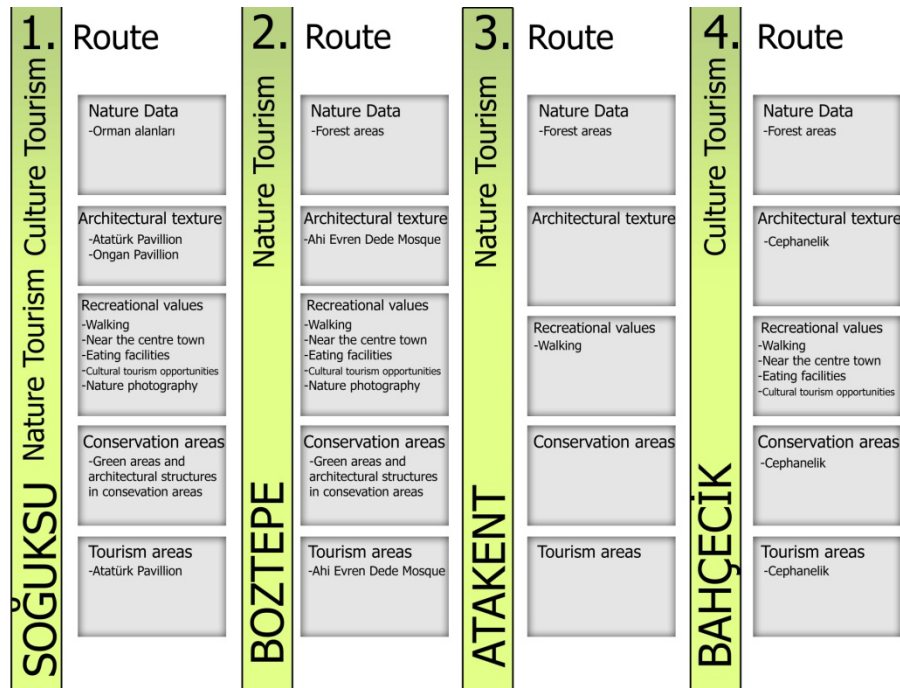

Figure 11. Landscape values of study areas

Soğuksu district has come to the fore with extensive spruce forests owned. The biggest advantage of this place is having Atatürk Mansion close to it. Walking areas, playgrounds, picnic can stroll and cultural, are the most important opportunities that provide the users of this district. City forest in Boztepe district is more recreational than other forests. Transportation to the center is within walking distance, to allow for different activities such as eating and drinking establishments and picnic areas indicate that more advantageous compared to other areas. The forests in Atakent district has shown that it has an advantage of having no structuring inside. However because of it not having any activities the place is not in use. Having hard transportation to urban forest in Bahçecik district, the lack of certain facilities such as playgrounds and picnic is from the missing features. Cephanelik structure near Bahçecik is one of the special places in City. It is an advantage to have this historical structure for Bahçecik district.

Conclusions

Boztepe, Soğuksu, Bahçecik and Atakent are important to Trabzon for having natural, cultural and historical resources. These areas

have forest textures and recreational possibilities for people. Also they are important to increase the number of green areas because of excessive construction in city. Other than increasing green areas they are important to create wild life. According to the survey, ensuring the improvement and protection of working areas have emphasized the need to use-protection balance. With the data, recommendations that can be done to increase the development and utilization of these forests have been created. These are;

- Creating spaces which have walking, picnic e.g. activities in urban forest.
- Creating locations to take pictures of special views.
- Introducing these areas inside the city.
- Having more space to city forests in the brochures.
- Equipments in the area, eating facilities to be fit to city identity.
- Parking problems in the area to be fixed.
- To encourage people to use alternative transportation.
- To have more bins in the area for enough rubbish to be thrown out.
- To have arrangements for areas floristic varieties and wild life. Based on these regulations, making several shows at certain

times, the creation of the collection yard.

-To exhibit traditional handicrafts and local products which belong to Trabzon and sell them

As a result these forest areas have been marked to have many opportunities. However it was clearly identified the fact that the efforts to conserve and to improve forest and urban areas were limited. On the other hand it was underlined that there was a great need for the keeping sustainability of the areas and the improving of their quality and quantity.

References

Dirik H., Ata C., 2005. Kent Ormancılığının Kapsamı, Yararları, Planlanması ve Teknik Esasları, Journal of the Faculty of Forestry Istanbul University, 55;1,1-14.

Kiper T., Öztürk A.G., 2011. Kent Ormanlarının Rekreasyonel Kullanımı ve Yerel Halkın Farkındalığı: Edirne Kent (İzzet Arseven) Ormanı Örneği, Tekirdağ Ziraat Fakültesi Dergisi, 8(2).

Öner N., Ayan S., Sıvacıoğlu A., İmal B., 2007. Kent Ormancılığı ve Kent Ormanlarının Çevresel Etkileri, Kastamonu Orman Fakültesi Dergisi, 7.,2, 190-203.

Tilki F., Güner S., Tüfekçioğlu A., 2008. Kent Ormancılığı ve Artvin İli Kent Ormancılığı Uygulamaları, Artvin Çoruh Üniversitesi Orman Fakültesi Dergisi, 9 (1-2): 92-100.

Tyrväinen L., Silvennoinen H., Kolehmainen O., 2003. Ecological and Aesthetic Values in Urban Forest Management, Urban Forestry, Urban Greening, 1, 135-149.

Tyrvaäinen L., Vaananen H., 1998. The Economic Value of Urban Forest Amenities: an Application of the Contingent Valuation Method, Landscape and Urban Planning 43, 105-118.

URL-1,
http://www.ortahisar.gov.tr/default_B0.aspx?content=1029

Yılmaz S., Bulut Z., Yeşil P., 2006. Kent Ormanlarının Kentsel Mekana Sağladığı Faydalar, Atatürk Üniversitesi Ziraat Fakültesi Dergisi, 37;1, 131-136.

The Visitor Satisfaction of Munzur Valley National Park

*Sevgi ÖZTÜRK¹, Korhan ENEZ²

¹Department of Landscape Architecture, Faculty of Engineering and Architecture, Kastamonu University, Kuzezykent Campus, 37 200 Kastamonu, Turkey

²Department of Engineering Forestry, Faculty of Forestry, Kastamonu University, Kuzezykent Campus, 37 200 Kastamonu, Turkey

*Corresponding Author: sozturk@kastamonu.edu.tr

Abstract

To conserve the nature which rapidly depletes and the natural sources, the human race has been improving several kinds of nature conversation. Especially, declaration of areas with scientific and aesthetic values as conserved zone one of the most effective implements. National Parks from the conserved areas protect both the nature and the natural sources also allow to people benefit from this areas in more efficient way. In this paper, Munzur Valley National Park which is between Tunceli and Ovacık to Munzur Valley with 42,000 ha area was discussed. The zone was announced as a national park in 1971. The region has a wealthy landscape value with biodiversity, crater lakes located in high summits, canyons and waterfalls. In the study, a survey research was done to 137 people to specify the visitor satisfaction in the national park with high guest potential. In the light of obtained data, required proposals have tried to reveal.

Keywords: Visitor satisfaction, National park, Ecotourism

Munzur Vadisi Milli Parkı Ziyaretçi Memnuniyeti

Özet

Hızla yok olan doğa ve doğal kaynakların korunması için insanoğlu çeşitli doğa koruma biçimleri geliştirmektedir. Özellikle bilimsel ve estetik değerlere sahip olan alanların korunan alan olarak ilan edilmesi en etkili araçlardandır. Korunan alanlardan milli parklar, hem doğa ve doğal kaynakları korumakta, hem de insanların bu alanlardan daha etkili bir şekilde yararlanabilmesine imkan vermektedir. Çalışmada, 1971 yılında milli park olarak ilan edilen Tunceli –Ovacık arasında Munzur Vadisi'nde uzanan 42.000 ha alana sahip Munzur Vadisi Milli Parkı ele alınmıştır. Alan, biyoçeşitliliği, yüksek zirvelerde bulunan krater gölleri, kanyon ve şelaleleri ile zengin peyzaj değerine sahiptir. Çalışmada, ziyaretçi potansiyeli yüksek olan milli parkta ziyaretçilerin memnuniyetini belirlemek için anket (137 kişi) çalışması yapılmıştır. Elde edilen veriler ışığında gerekli öneriler ortaya konmaya çalışılmıştır.

Anahtar Kelimeler: Ziyaretçi memnuniyeti, Milli Park, Ekoturizm

Introduction

The status of national parks constitutes one of the most significant means of nature conservation (IUCN, 1994). Such areas provide opportunities for preserving natural and cultural resources and biological diversity and bolstering the tourism-recreation industry and support rural development (Akten et al., 2012). In this respect, the government and local authorities in Turkey have been trying to exploit the tourism industry, especially, for their economic benefits in many rural areas since 1990's (Türker and Öztürk, 2013).

Preserving the existing status of national parks as much as possible is only possible with the existence of various binding legal and administrative laws. Such areas with a sensitive ecosystem should be preserved

so that their ecological balance is not disturbed any further.

The areas in question are open for visitors and ecotourism activities albeit on a limited scale. Within this complexity, determining the damage that the users cause in natural places and taking the necessary precautions are of great importance for the sustainability of the protected areas (Belkayalı and Kesimoğlu, 2015). Understanding the perceptions of visitors toward the protected areas is a critical factor in the efforts to enhance local management strategies and to guide national and global policies.

For this reason, allowing visitors to walk and take part in certain recreational activities within certain designated areas can only be achieved with maintaining the conservation and utilization balance of an area. In recent

years, this approach has been named as 'community-based conservation'. The objective of community-based conservation is to promote local residents' active participation in the management process and to improve their economic welfare (Belkayalı et al, 2015; Infield and Namara 2001; Berkes 2007; Cbc 2015). If the protected areas are to achieve their goals, protected area–people relationship has to be improved.

While the increasing number of visitors to national parks enhances their importance and requires an efficient management of such areas, it also brings about the necessity of developing a subscale visitor management plan. The present study aims to create a visitor profile for Munzur Valley National Park and study the degree of satisfaction of the visitors coming to the area. It is believed that the present study –conducted in the absence of any visitor management plan for the said national park- will be beneficial for such subscale plans that support the long term development plans.

Material and Method

The study area comprises the Munzur Valley National Park located within the borders of Tunceli province in the Eastern Anatolian Region of Turkey (Figure 1).

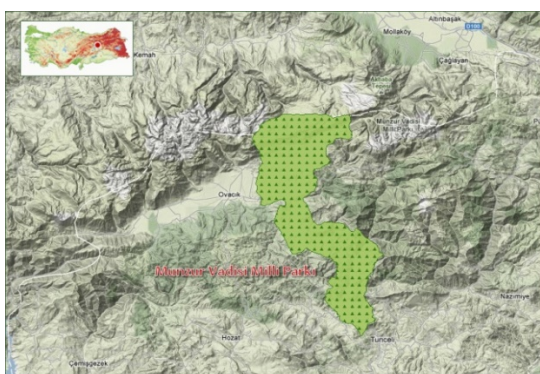

Figure 1. Geographical location of the area

Located in Munzur Valley, stretching on an area of 42.000 ha between Tunceli and Ovacık, Munzur Valley National Park was proclaimed a National Park in 1971. Possessing interesting orogenic characteristics in addition to its geological structure, the area is highly diverse in terms of its geomorphologic structure. The area is

characterized by valleys, ridges and peaks. While the highest peak of Mount Munzur is 3188 m., other high peaks include Mt. Köşek, Mt. Karadağ, Mt. Bayramdağ and Mt. Çataldağı. The main tributary of the area is Fırat river. Other tributaries of Munzur Valley National Park include Munzur Creek, Peri Creek, Pülümür Brook Mercan and Tahar Brooks. The significant areas that cater for the visitors' recreational requirements include Lake Karagöl, Lake Koçgözü, Lake Dilincik, Lake Çimli, Lakes Mercan, Lakes Katır and Lakes Buyer Baba and Keban Reservoir, Munzur (Ovacık) Springs, Halbori Springs, Zengin pınar (zagge) waterfall and resort, Dere ova waterfall, Kutudere resort area and other resort areas. The area is also home to Dedebağ (Bağın), Aşağı Doluca (Harik), Anafatma, Karaderbent Village Thermal Springs and Sütluce (Harçik) Fountain. While 1518 different plant species have been identified in Munzur Valley National Park, 43 of them are endemic to the Mount Munzur and 227 of them to Turkey. The animals living in the National Park include wolves, foxes, weasels, bears, lynxes, otters, badgers, squirrels, rabbits, wild boars and wild goats. The grizzly bears living in caves and rock holes are the significant major mammals of Munzur wildlife. The Munzur Creek is highly suitable for the growth of red spotted salmon trout variety (<http://www.milliparklar.gov.tr/>).

Dividing the National park into two parts, the Munzur Creek offers a potential for nature tourism with its 70 km. rafting route, while the areas close to the boundaries of the national park have the potential for winter and hunting tourism. The 3500 meter high Mount Munzur and the oak barren hills in the south of Ovacık and the Mount Bağırpaşa, in the north east of Tunceli province, in particular, offer good opportunities for the development of skiing and mountain climbing tourism.

The present study consists of 3 chapters. The first chapter covers the current status of the Munzur Valley National Park and the visitor data. The second chapter involves a field study and survey questions addressed to the visitors. The third chapter involves an analysis in which the questionnaires

answered by visitors and the data obtained from the area have been evaluated and various recommendations made based on the presentation of the visitors' satisfaction.

Results

The questionnaire questions have been mostly intended for the visitors to Ovacık and Pülümür counties. According to the questionnaire results, 39% of the participants were female while 61% of them male; 33% of them came from Istanbul, while the rest of them came from the following cities and countries to visit the area: Mersin (2%), Erzincan (4%), Elazığ(4%) , İzmir (10%), Ankara (4%), Diyarbakır (4%), Uşak (0.7%), Muğla (0.7%) , Germany (0.7%) , Gaziantep (1.4%) , Erzurum (0.7%), Tokat (1.4%), Balıkesir (0.7%), Muş (0.7%), Sivas (0.7%), Bingöl (0.7%), Aydın (0.7%) , Siirt (0.7%),

Antalya (1.4%), Ağrı (0.7%), Mardin (0.7%), Karabük (0.7%) , İzmit (0.7%), Batman (0.7%), Bartın (0.7%), Hatay (0.7%), Malatya (2%), Manisa (1%), Van (3%) , Kayseri (0.7%), Hakkari (1%), Bursa (2%), Adana (4%), Samsun (1%), Eskişehir (3%), France (1.4%), Syria (0.7%) and Georgia (0.7%). It has been found that the visitors to the area are mostly university graduates (60%), which are followed by high school graduates (31%) and primary school graduates (9%). The distribution of the age groups of visitors (18-28 (41%), 29-39 (37%), 40-50 (18%), 51-61 (4%)) suggests that the area is mostly favored by the young.

The results of the questionnaire regarding the visitors' visit to the area and their degree of satisfaction are presented in the following table (Table 1).

Table 1. Questions regarding visitor satisfaction

Visitor	Number of visitors (n)	Percentage (%)
<i>How they came to the area</i>		
By joining a tour	7	5.1
Through Individual Initiative	130	94.9
<i>With whom they came to the area</i>		
Alone	39	28.5
With their family	59	43.1
With their friends	38	27.7
Other	1	0.7
<i>How many times have they visited the area in the past</i>		
1	30	21.9
2	20	14.5
3	11	8.0
4	8	5.8
5	67	48.9
<i>Where did they stay during their visit</i>		
Hotel	23	16.08
Private Home / At a Friend's	80	58.4
Hostel / Dormitory / University Guest House	3	2.2
Other	31	22.6
<i>Where Did They Get the Necessary Information</i>		
I have come to the area before	41	29.9
Based on recommendation of family and friends	41	29.9
Through the Internet	15	10.9
Through a travel agency or tour operator	8	5.8
Through print media such as newspapers or magazines	11	8.0
Through visual media such TV	14	10.2
Other	7	5.1

Tablo 1. (continued)

<i>Particular Reason for Coming to the Area</i>		
Discovering nature	20	14.6
Observing the flora and fauna	8	5.8
Visiting relatives and friends	13	9.5
Visiting historical sites	12	8.8
Looking for adventure	10	7.3
Seeing sacred places	8	5.8
Trying something new	10	7.3
For health reasons	10	7.3
Getting away from the hustle & bustle of the city	17	12.4
Learning the traditions of the local population and spending time with them	15	10.9
Trying something new	7	5.1
Shopping	5	3.6
Other	2	1.5
<i>How Do You Describe Yourself</i>		
Occasional Nature Tourist	16	11.7
Normal Nature Tourist	70	51.1
Dedicated Nature Tourist	45	32.8
<i>Degree of Visitors' Satisfaction</i>		
Not Satisfied At All	2	1.5
Not Satisfied	3	2.2
Not Sure	5	3.6
Satisfied	39	28.5
Very Satisfied	82	59.9
<i>Visitors' Intention of Coming Back Again</i>		
Intending to Come Back Again	133	97.1
Not Intending to Come Back Again	2	1.5
<i>Visitors' Intention of Recommending the Place to Others</i>		
Will Recommend	133	97.1
Won't Recommend	3	2.2

*Percentages are calculated as per N=137.

According to the results, the visitors have mostly come to the area through individual initiative (95%) with their families (43%) and mostly preferred to stay at a private home/friend's place (58%) and those who have been to the area for the fifth time (48.9%) constitute the majority. When the reasons provided by visitors for preferring this area are viewed, it is established that they mostly wish to discover nature (14.6%), get away from the hustle & bustle of the city (12.45) and learn the traditions of the local population and spend time with them (10.9%). When asked how they acquired information about the area, the highest percentage of the answers informed that it was not their first visit to the area (29.9%), and based on the recommendation of family and friends (29.9%). The vast majority of the visitors have described themselves as a

normal nature tourist (51%). The fact that almost 88% of the visitors were satisfied with their visit –with nearly 60% of them stating that they were very satisfied and 28% saying they were satisfied- suggests that the area has lived up to the expectations of the visitors. The follow-up question “would you consider coming back to the area again?” has been answered affirmatively by 97% of those participating in the survey. Similarly, the same 97% has stated that they would recommend the area to others.

Conclusions

Activities conducted in a national park vary depending on the natural and cultural resources of the area in question as well as the profile and conditions of the visitors. The Munzur National Park has the natural and cultural resources that will allow the realization of a number of recreational

activities. Despite the presence of some infrastructural problems with respect to the realization of such recreational activities, the results of the survey suggest that the area lives up to the expectations of the visitors. The fact that the majority of the visitors are young and university graduates makes a positive contribution to the level of awareness of ecotourism. According to the survey results, a significant number of the visitors -97% of them- has stated that they would recommend the area to others. However, in addition to offering recreational opportunities for visitors, national parks provide significant scientific and educational opportunities as well. Such areas with a sensitive ecosystem are rich in terms of biodiversity and cultural resources. In this respect, an effective management structure that will maintain the conservation and utilization balance of the area and promote participation and an efficient implementation based management plan covering large scale implementations to action plans will be vitally important for the Munzur Valley National Park. In order to ensure effective short term conservation, determine the visitor capacity of the area and create a source of revenue for the area, it is recommended that entrance gates are built and a certain amount of fee is charged to the visitors. Removal of picnic areas –which have nothing to do with ecotourism- from the area and taking measures in that regard is important for the sustainability of the area and raising awareness of the visitors. It is recommended that professionals from various profession disciplines –such as landscape architects, biologists, ecologists, veterinarians etc.- be employed in addition to the forest engineers and that the number of guards be increased for the purpose of ensuring efficient management and planning works.

References

- Akten, S., Gül, A., Akten, M., 2012. Korunan doğal alanlarda kullanılabilecek ziyaretçi yönetim modelleri ve karşılaştırılması, SDÜ Orman Fakültesi Dergisi, 13: 57-65, Isparta.
- Belkayalı, N., Güloğlu Y., Şevik, H., 2015. What affects perceptions of local residents toward protected areas? A case study from Kure Mountains National Park, Turkey. International

Journal of Sustainable Development&World Ecology, 2015
<http://dx.doi.org/10.1080/13504509.2015.1098743>.

Belkayalı, N., Kesimoğlu, M.D., 2015. The stakeholders' point of view about the impact of recreational and tourism activities on natural protected area: a case study from Kure Mountains National Park, Turkey. *Biotechnology & Biotechnological Equipment*, 29(6), 10921103., Doi: 10.1080/13102818.2015.1072054.

Berkes, F., 2007. Community-based conservation in a globalized world. *Proc Natl Acad Sci*. 104:15188–15193.

Cbc (Community-based conservation), 2015. http://en.wikipedia.org/wiki/Community-based_conservation. (cited 2015 Jan 20).

<http://www.milliparklar.gov.tr/mp/munzurvadi/index.htm>

Infield, M., and A. Namara. 2001. Community attitudes and behaviour towards conservation: an assessment of a community conservation programme around Lake Mburo National Park, Uganda. *Oryx* 35:48-60. IUCN, 1994.

International Union for Conservation of Nature. 1994. Guidelines for protected area management categories. Gland (Switzerland): IUCN; p. 22.

Türker, N., Öztürk, S., 2013. Perceptions of Residents Towards The Impacts of Tourism in the Kure Mountains National Park. *International Journal of Business and Social Science*, 4(2), 45-56.

Sustainable Future of Bolu-Köroğlu Uplands in terms of Ecotourism

*Bülent CENGİZ¹, Başak ERTEM MUTLU²

¹Bartın University, Faculty of Forestry, Department of Landscape Architecture 74200 Bartın / TURKEY

²Bartın University, Graduate School of Natural and Applied Sciences, Department of Landscape Architecture 74200 Bartın/TURKEY

*Corresponding Author: bulent_cengiz@yahoo.com

Abstract

Ecotourism is a tourism type that provides people with socio-economic opportunities in touch with nature and aims at protecting and understanding the nature. Turkey-with its natural and cultural assets-has convenient geography for ecotourism. Forestry areas of Turkey are also very suitable for upland tourism-a branch of ecotourism. There are approximately 400 uplands in Bolu and some of them are leading uplands of Turkey. In very hot periods in summer, micro-climatic comfort of uplands increases the usefulness of Bolu uplands. Moreover, majority of these uplands are located near or inside forests. All these positive features make Bolu an important region that has a huge potential for upland tourism. Therefore, as the study area, total six uplands including the Deveören Uplands (Tembel and Ardalan Upland), Karadoğan Upland, Bölücekkaya Aladağ Upland, Sinnecik Upland and Örencik Upland located on the slopes of Köroğlu Mountain in Kıbrısçık county of Bolu. In the content of the study, opportunities provided by upland tourism for tourists and local people were determined in terms of ecotourism. In this regard, uplands selected for the study were analyzed in terms of ecological, socio-cultural, and psychological and esthetics. Strengths-Weaknesses-Opportunities-Threats (SWOT) analysis was constructed. As a result of evaluations, strategies were developed to improve Köroğlu uplands, based on protection-use balance of upland tourism.

Keywords: Ecotourism, Upland tourism, Sustainability, Bolu

Ekoturizm Açısından Bolu-Köroğlu Yaylalarının Sürdürülebilir Geleceği

Özet

Ekoturizm doğayla iç içe bir şekilde insanlara sosyo-ekonomik olanaklar sağlayan, doğayı korumayı ve anlamayı amaçlayan bir turizm dalıdır. Türkiye sahip olduğu doğal ve kültürel değerleri ile ekoturizme elverişli bir coğrafyaya sahiptir. Türkiye'nin ormanlık alanları ekoturizmin bir dalı olan yayla turizmi için de oldukça elverişlidir. Bolu ilinde yaklaşık olarak 400 yayla bulunmakla birlikte bu yaylalardan bazıları Türkiye'nin önde gelen yaylaları arasında yer almaktadır. Yaz aylarının sıcak dönemlerinde yaylaların mikroklimatik konforu sayesinde, Bolu yaylalarının kullanılabilirliğini artırmaktadır. Ayrıca, bu yaylaların çoğu orman kenarı veya orman içi konumda bulunmaktadır. Bütün bu olumlu özellikler, Bolu ilini yayla turizmi açısından önemli potansiyele sahip bir bölge yapmaktadır. Bu nedenle çalışma alanı olarak, Bolu ili Kıbrısçık ilçesindeki Köroğlu Dağı yamaçlarında bulunan Deveören Yaylaları (Tembel ve Ardalan Yaylası), Karadoğan Yaylası, Bölücekkaya Aladağ Yaylası, Sinnecik Yaylası ve Örencik Yaylası toplam altı adet yayla araştırma alanı olarak seçilmiştir. Çalışma kapsamında ekoturizm açısından yayla turizminin hem turistler hem de yerel halka sağladığı olanaklar saptanmıştır. Bu çerçevede seçilen yaylalar ekolojik, sosyo-kültürel, psikolojik, estetik vb. gibi birçok işlevleri yönünden analiz edilmiş ve SWOT analizi oluşturulmuştur. Yapılan değerlendirmeler sonucunda yayla turizminin koruma-kullanma dengesi esaslı Köroğlu yaylalarının gelişimine yönelik stratejiler geliştirilmiştir.

Anahtar Kelimeler: Ekoturizm, Yayla turizmi, Sürdürülebilirlik, Bolu

Introduction

The concept "ecotourism" emerged as in relation to sustainable tourism and has become very well-known and widespread term over the last years. Ecotourism-a type of sustainable improvement-is defined as "A

reliable tourism type done to natural regions that protects natural environment and resources and improves economic welfare of local people" by TIES (2015). Ecotourism includes upland, mountain, cave, agriculture and farm tourisms, trekking, bird watching,

wildlife watching, botany tourism, cycling, white water, and hunting tourism, camping and it is considered as an alternative to mass tourism (Baykal and Çimen, 2015).

Although the meaning of term “Ecotourism” is not completely understandable, Hetzer (1965)-one of the first people used that term-defined four basic principles of ecotourism (TODEG, 2010):

- Minimize environmental effects
- Respect culture of the host country
- Maximize benefits for local community
- Maximize satisfaction of tourists

Transhumance constituting life styles of migrant settler Turkic tribes in Central Asia basically emerged as a result of an economic life based on animal breeding. Upland and transhumance for the Turkish is not only a life style coming from Central Asia to nowadays, but also among the most important factors constituting and shaping milestones of Turkish culture. Hence, because of suitability of geographic characteristics of Anatolia, transhumance has become a significant element of Turkish rural culture by being continued in 26,000 uplands all over the country, primarily in Black Sea and Mediterranean regions. However, adaptation of migrant settler groups to a sedentary life-which started from the 18th century in Anatolian and continued in the Republic period-has become a milestone in the change of traditional transhumance based on animal breeding. In the following period, some reasons, such as increases in the general level of welfare, change of the socio-economic structure and urbanization prepared the ground for recreational or relaxation based transhumance (upland tourism). Therefore, it is possible to say that upland and transhumance activities in our country have been in a period of change, including aspects of purpose, settlement, function and use. Recreational based transhumance and upland tourism has developed mostly in uplands of Taurus Mountains and Black Sea. The reason for this is the necessity of cool places in Mediterranean coastal lines where summers are usually hot and depressing. Similarly, in addition to hot and depressing effects of coasts, uplands of Black Sea are preferred to

become cool, rest and do tourism activities in summer periods influenced by sub-tropical air masses (Çetin, 2012).

However, considering at an international level, susceptible ecosystems constituting very important functions and benefits, as well as essential elements of life systems were grouped in the scope of Agenda 21 and mountainous areas were determined as primary ecosystems among these. Principle decisions taken in the Agenda 21 for mountain ecosystems are of vital importance for sustainability of upland ecosystems in Turkey (Açıksöz et al., 2004).

Doğanay (1997) defined “uplands” as economic territories, which stay outside permanent living region of rural settlements, belong to their community properties or under secretariat for the treasury, depend on villages through social and economic bonds and are subsidiary of village economy (Doğanay, 1997; Tapur, 2009). In accordance with the pasture law no. 4342 published in the official gazette on February 28, 1998, upland was defined as “a place assigned for farmers to spend summer season with their animals, pasture them by utilizing grass or used for this purpose from time immemorial”. As stated by Doğanay (1994), there are approximately 26,000 uplands in Turkey. That number is very close to number of villages (35,700). The reason for this is due to the significance of economic function of transhumance. Thus, although tourism, recreational and agriculture activities are done in some uplands of Turkey, transhumance is mainly based on the economy of animal breeding (Doğanay, 1994; Tapur, 2009).

Transhumance based on economic purposes has been in a decline period over the last years as a result of the change in socio-cultural and economic structure in Turkey. However, an urbanized population spending money and time in uplands and working in non-earthbound jobs participated in a rural population that earns money from uplands. This process caused to form uplands and transhumance activities for recreational uses. Over the last years, uplands especially the ones on the south of Turkey have been started using as recreational activity areas to

rest and become cool (Özdemir and Çelikoğlu, 2014).

There are approximately 400 uplands in Bolu for upland tourism. At the beginning of summer, local people go to uplands to pasture their animals and do agricultural activities. Transhumance activities continue within the months between June and October. Over the last years, uplands have become important for tourism due to building of second houses and organizing traditional festivals (Özcan, 2005).

In this regard, uplands selected for the study were analyzed in terms of ecological, socio-cultural, and psychological and esthetics. Strengths-Weaknesses-Opportunities-Threats (SWOT) analysis was constructed. As a result of evaluations, strategies were developed to improve Koroğlu uplands, based on protection-use balance of upland tourism.

Materials and Method

The peak of Koroğlu Mountains-one of the highest mountains in Bolu-is 2,499 meters. Kıriscık Tableland formed by deep valleys due to volcanic formations and rainfalls is on the south of Koroğlu Mountains. It has high altitude and rich tree species with intense vegetation cover. Koroğlu Mountains are covered by very thick

Pinus sp. and *Carpinus* sp. trees. People living in the region earn their livelihoods from forest products. Slopes of Koroğlu Mountains are covered by high tablelands. Over Kıriscık county, mountainous and hilly lands are arrived by going from high tablelands to the north through Koroğlu Mountains. *Fagus* sp. is very intense on low forest lands damaged. At higher forest lands, *Pinus brutia* Ten. and *Pinus nigra* are present. *Pinus sylvestris* is observed at the lands higher than *Pinus nigra*. *Abies nordmanniana* and *Juniperus* sp. are present in the transition region from *Pinus nigra* to *Pinus sylvestris* (Anon. 2012).

Mountain meadowlands grown under moist conditions are present above the forest boundary of mountains. Annual average temperature is below 4 °C at the region. Average temperature is sometimes above 15 °C in summer while it is usually below 0 °C in winter (Anon. 2012).

Main material of the study area is uplands present on the slopes of the Koroğlu Mountain in Kıriscık county of Bolu. The study area consists of six uplands on the slopes of the Koroğlu Mountain: Devören Uplands (Tembel and Ardanan Upland), Karadoğan Upland, Bölücekaya Aladağ Upland, Sinneçik Upland and Örencik Upland (Figure 1).

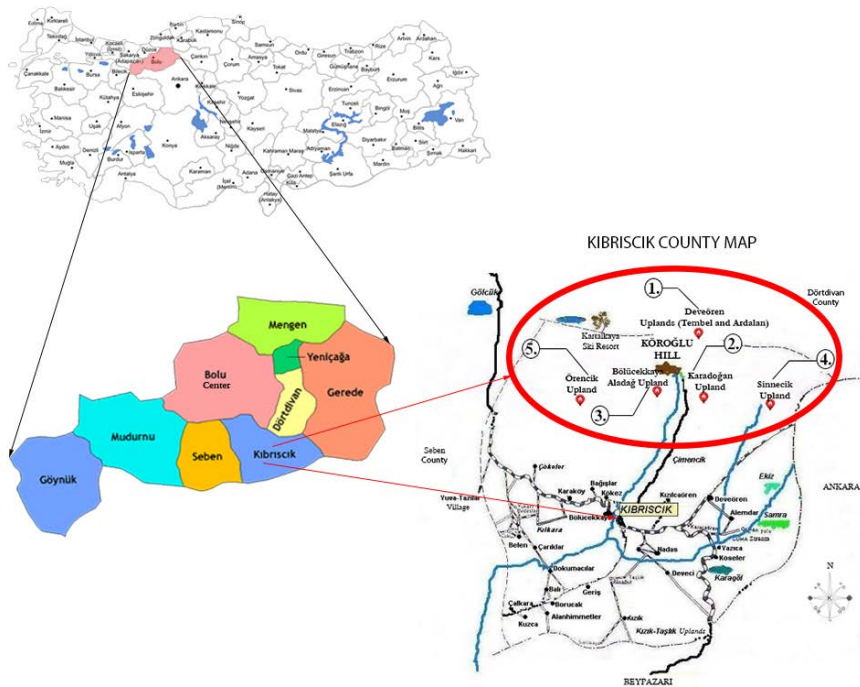

Figure 1. Location of Bolu in Turkey and position of the Koroğlu Mountain in the county
(developed from URL 1, 2016)

Regions on the south of the Koroğlu Mountain (Figure 2), that are densely populated, enable to do economic activities. These regions are permanent settlements at a height between 1,000 to 1,300 m on Uludere valleys. Uplands are present at heights

between 1,250 and 2,350. Animal breeding is the main livelihood in the regions dominated by uplands. Especially sheep & goat breeding is common. In addition to animal breeding, forestry is also one of livelihoods.



Figure 2. General views of the Koroğlu Mountain (Original, 2016)

In the study, firstly literature review was done about the study area. Photographs were taken related to the study area. Uplands on the slopes of the Koroğlu Mountain were investigated one by one and present situation was analyzed. Later, Strengths-Weaknesses-Opportunities-Threats (SWOT) analysis was performed for the study area and suggestions were made.

Research Findings

Koroğlu Mountain Uplands

Uplands and transhumance in Kıbrısçık date back to old times. Majority of Kıbrısçık uplands accumulate on the booms of the Koroğlu peak. In the past, the Turkmenia coming from Polatlı, Haymana, and Sivrihisar regions formed some of these settlements and later constituted villages in Kıbrısçık. Some of the uplands are still named as these regions (URL 1, 2016).

There are;

- Deveören Uplands (Tembel and Ardalan Upland) on the north,
- Bölücekkaya Aladağ Upland and Karadoğan Upland on the south,
- Sinnecik Upland on the south-east,
- Örencik Upland on the south-west of Koroğlu Mountain.

I. Deveören Uplands (Tembel and Ardalan Upland)

Uplands used by Deveören villagers are located on the north of Koroğlu Hill. They are affluent uplands with their water resources, green areas, forests and natural resources. On the one side Koroğlu Hill are while on the other side Kartalkaya is. Koroğlu Valley Project was considered in this area but could not be implemented.

Koroğlu Valley Project, including uplands located on the north slopes of Koroğlu Hill, was considered by a private company to service winter and summer seasons according to world standards in an area of 1,900,000 m² in 1998; however it could not be finalized. The purpose of the project was to form a wellness center in accordance with nature all year around by continuing winter and summer activities. It was planned that two-, three-, four- and five-star hotels, waterfalls, youth hotels and studios were to be built in the accommodation unit while shops, fast food restaurants, bars, cafes were considered in the commercial center (URL 1, 2016).

Natural common seabream is present in water resources around Deveören Uplands.

Transportation to the upland can be provided through the Ayman Bridge on Bolu-Kıbrısçık road after travelling 15 km. On the other hand, the upland is 20 km away from Kıbrısçık and transportation can be provided

by a forest road passing the Karadoğan Upland. The distance between two uplands is 5 km (URL 1, 2016) (Figure 3).



Figure 3. General view of Tembel Upland (left) and Ardalan Upland (right) (Original, 2016)

II. Karadoğan Upland

It is located on an area seeing frontally the Koroğlu Hill of the Arközü Valley (Figure 4). On the south forests are while on the

north wide pastures are. There is an accommodation opportunity in the upland by renting free houses.



Figure 4. General view of Karadoğan Upland (Original, 2016)

Bakacak Tower is present on the Bakacak Hill on the upper side of Karadoğan Upland to observe forest against probable fires. Forest watchman can inform the fire

department by monitoring any fire incidence, such as smoke occurring in the forest. The position and structure of the Bakacak Tower is shown in Figure 5.



Figure 5. Bakacak Tower and its position (Original, 2016)

III. Bölücekkaya Aladağ Upland

Uplands belonging to Bölücekkaya Village are located on the south slope of the Köroğlu Hill. On the slope of Köroğlu Hill, Karataş Valley is one of the regions where

cold water resources are very intense. Bölücekkaya Aladağ Upland is present on the south of the valley (Figure 6). Bölücekkaya Village can be arrived through a forest road of 15 km (URL 1, 2016).



Figure 6. General view of Bölücekkaya Aladağ Upland (Original, 2016)

IV. Sinneçik Uplands

These uplands belonging to Karacaören and Kızılcaören Villages were simultaneously constituted. Transportation can be provided through a forest road over

Serke Brook. It is 22 km away from Karacaören Village. It has green areas in the forest and cold water resources. Two uplands are neighbor (URL 1, 2016).



Figure 7. General view of Sinneçik Upland (Original, 2016)



Figure 8. Local upland houses in the Sinneçik Upland (Original, 2016)

Many endemic flower species are grown on the Koroğlu Mountain. Some of them are grown on the Sinneçik Upland. As shown in Figure 9, they are *Cyclamen coum* Mill.

subsp. *coum*, *Muscari neglectum*, *Helleborus niger*, *Helichrysum arenarium* subsp. *aucheri* species, respectively (Anon. 2012).



Figure 9. Endemic flowers grown on the Sinneçik Upland (Original, 2015)

V. Örencik Upland

It belongs to Kilkara Village. Upland region is located on the north of forest store, on the south-west of the Koroğlu Hill, near the Örencik Brook and around the buildings of Forestry Department. There are green areas in the forest and a small settlement. It is

a quite nice place to picnic in summer with salmons in the brook. Transportation to the upland is possible through a forest road of the Örencik Brook. It is 25 km away from Kilkara Village and 8 km away from Upland Region Forest Store (URL 1, 2016).



Figure 10. General view of the Örencik Upland (left) (URL 1, 2016) and Örencik Upland house (right) (Original, 2016)

Rehabilitation of Koroğlu Uplands

Continuity of the uplands is only possible by continuously preserving and renewing forests. Rehabilitating or rejuvenating forestry areas makes living areas in the forest more livable. Sustainability of the uplands in Koroğlu Mountains is achieved by continuous forest rehabilitation and rejuvenation areas. Serke Mountains are

among the areas being rehabilitated by works of Kıbrısçık Forest Sub-District Directorate (URL 1, 2016). In Figure 11, Serke Forests being rehabilitated-located on the road to Sinneçik Upland-are seen. The aim is to increase new sprouts by cutting down dead trees. Trees are planted on free areas, thereby rejuvenating forests and making them more long-lived.



Figure 11. Rejuvenated forestry areas Koroğlu-Serke Forests (Original, 2016)

SWOT Analysis

SWOT analysis was performed for the uplands present on the slopes of Koroğlu Hills (Table 1).

Table 1. SWOT analysis of Koroğlu Uplands

STRENGTHS (S)	WEAKNESSES (W)	OPPORTUNITIES (O)	THREATS (T)
<ul style="list-style-type: none"> - Possession of an undisrupted nature - Continuous rehabilitation for the continuity of forests - The proximity to Kartalkaya Ski Center - The proximity to big cities like Ankara and İstanbul - Advertisement by Koroğlu summit trekking coordinated every year - Possession of areas for activities, such as camping, ski, speleology, rafting and paragliding - Possession of rich potentials in terms of biodiversity, such as flora, fauna and endemic species 	<ul style="list-style-type: none"> - Uncared upland houses - Unrecognized uplands due to lacking of organizing tours - Insufficient transportation (neglected roads) to uplands - Potential of doing tourism not only in summer seasons but also through all the year, but lack of sufficient planning to do so 	<ul style="list-style-type: none"> - Presence of areas for people to camp, pitch or stay in a caravan - Sustainability for next generations by forest rehabilitation - Strong desires of people for going to uplands due to missing the nature 	<ul style="list-style-type: none"> - Disruption of areas as a result of forest fires - Declining in the number of people going to uplands every year - Declining in water resources due to global warming - Lacking of environmental consciousness for development of tourism and informed guides

Conclusion and Suggestion

Rising in structuring in cities increases missing of people to nature, making them escape from cities. Therefore, people now tend to forests, villages and uplands more than the past. Koroğlu uplands are the areas that mostly local people use and go to pasture their animals in summer seasons, and prepare wintery foods. Examining Koroğlu uplands, it is observed that they have water, wood and fruit resources, endemic plant species, high recreational potential, self-renewing rehabilitation and rejuvenated areas.

Considering global upland tourism, certain strategies should be developed to use its potentials. Strategies below should be developed for the development of Koroğlu uplands and implemented:

- Attention of people should be drawn to Koroğlu uplands by advertising and popularizing ecotourism.
- After planning the carrying capacity of Koroğlu uplands, certain areas should be constituted for people to do activities not only in summer seasons but also all the year round.

- Touristic activities to be done on uplands should be formed in a system based on sustainable tourism by protecting natural and cultural characteristics of the area.
- It should be provided that people earn money from sustainable tourism by preserving socio-cultural structure of local people. Handicrafts, organic products and regional foods of local people should be advertised, reaching the large masses. However, firstly local people must be given conscious education.
- Areas should be formed and protected for development of endemic plants specific to uplands.
- Problems of infrastructure and transportation to uplands should be solved, but avoiding anomalous structuring to nature. Moreover, accommodation facilities in accordance with nature should be built for travelers and tourists to stay in uplands, preserving the traditional structure of the region. For temporary accommodation, certain solutions compatible with nature should be found by pitching tents on clearings of uplands.
- The purpose of recreational activity is to popularize activities, such as trekking, camping, photography, nature-bird watching, orienteering and paintball, without damaging the nature. Touristic tours to uplands should be organized every year, and participation to tours should be encouraged by '*upland festivals*'. Tourist guides should be people who know the area very well and are well-educated.

References

- Açıksöz S., Topay M., Gökyer E., 2004. Bartın yaylalarının rekreasyon ve turizm kullanımları açısından irdelenmesi. Ankara Üniversitesi Ziraat Fakültesi Tarım Bilimleri Dergisi, 10(4), 359-365, Ankara.
- Anonymous, 2012. Tabiatın Kalbi Bolu. Bolu Belediyesi, Bolu Araştırmaları Merkezi Yayınları:12, Bolu.
- Baykal D., Çimen H., 2015. Sürdürülebilir turizm ve ekoturizm sertifikaları. Doğu Karadeniz

Bölgesi Sürdürülebilir Turizm Kongresi Bildiriler Kitabı, s: 10-21, 14-16 Mayıs 2015, Gümüşhane.

Çetin B., 2012. Alan yaylasında (Kırıkhan-Hatay) fonksiyonel değişimin coğrafi özellikleri. Doğu Coğrafya Dergisi, 17(27), 129-150.

Doğanay H., 1994. Türkiye Beşeri Coğrafyası. Ankara: Gazi Büro Kitabevi.

Doğanay H., 1997. Türkiye Beşeri Coğrafya. İstanbul: MEB Yayın No: 2928.

Hetzer W, 1965. Environment, tourism, culture. *Links*, July, 1-3.

Özcan E., 2005. Bolu ilinde turizmi etkileyen faktörler ile doğal, tarihi ve kültürel turizm değerleri. Gazi Eğitim Fakültesi Dergisi, 25(1), 55-75, Ankara.

Özdemir Ü., Çelikoğlu Ş., 2014. Batı Karadeniz'de rekreasyonel açıdan giderek önemi artan bir yaylacılık sahası: Uluyayla. Doğu Coğrafya Dergisi, 19(32), 79-100.

Tapur T., 2009. Abanoz Yaylası (Mersin). Selçuk Üniversitesi Sosyal Bilimler Enstitüsü Dergisi, Sayı: 21, 473-487, Konya.

TIES (The International Ecotourism Society), 2015. <http://www.ecotourism.org/>, Erişim Tarihi: 20.07.2016.

TODEG, 2010. (Türkiye Ormancılar Derneği Ekoturizm Grubu) Orman ekosistemlerinde ekoturizm çalıştay, ekoturizm ve doğa temelli turizmin geldikleri noktadaki kavramsal çerçeve, No:10, 42-52, Ankara.

URL1,2016.<http://www.kibriscik.gov.tr/yaylalar>.,Erişim Tarihi: 20.07.2016.

Visual Characteristics of Northern Anatolian Forest Roads in Turkey

*Engin EROĞLU¹, Habip EROĞLU²

¹ Düzce University, Faculty of Forestry, Department of Landscape Architecture, Konuralp Campus, 81620 Düzce/TURKEY

² Karadeniz Technical University, Faculty of Forestry, Department of Forest Engineering, 61080, Trabzon/TURKEY

*Corresponding Author: engineroglu@duzce.edu.tr

Abstract

Northern forests of Turkey have high visual resource value with their botanical variety. Northern forests which accommodate three different phytogeographical regions also include different visual resource values. Road and its close environment are important components for defining the landscape for visual evaluation. Within the scope of this study, the forest roads in euxin and colchic zones, two sub-zones of Euro-Siberian region, which constitute most of the Black Sea region, as well as forest roads which have the characteristics of Mediterranean phytogeographical zone, which also includes Marmara region, have been examined visually. The visual characteristics of these roads have been handled with such visual quality concepts as diversity, naturalness, visual attractiveness, continuity. As a result, potentials belonging to different visual resource values towards habitats of different nature such as deciduous forests, sandarac forests, pure stands, rocky habitats, and moist stream vegetation has been displayed.

Keywords: Northern forests, Forests roads, Different habitat types, Visual characteristics

Introduction

Nowadays, forest aesthetic and its visual characteristics have been an important issue aspect of sustainability of visual and ecological resources of the forests. Moreover these visual and ecological characteristics are attempts to integrate functional forest management plans. It is a major shortcoming that silvicultural and other forestry facilities and interventions should be reflected in the reserved area of the recreation potential and visual attributes to protect both the planning in forest landscapes in Turkey. Therefore it seems to take into account the necessity of

3708 of these species are widespread in the country. Moreover, with 171 mammal, 105 species of reptiles and 180 species of freshwater fish Turkey is considered as a natural resource rich country according to international standards. In addition to all this, Turkey is sitting on some important Flyway and is home to 454 bird species, including some very rare (Terzioğlu et al., 2009).

The forests are the climatic vegetation type northern Anatolia and enter into the whole Black Sea area, Istranca mountains of Thrace and in Marmara. Humid-temperate broadleaf (angiosperms) there are forests in

visual resource values in forestry (Acar et al., 2005)

Turkey has several unique ecosystems many kinds of life hosting. In addition to its unique geographical location, rich topographic features and climatic differences between the regions, Turkey has on the flora and fauna, to earn an impressive variety in terms him a respected place among the three continents. So that area covered with almost 30% of its total property with woods, Turkey has 11,000 species of plants, nearly the number of plant species of the entire continent of Europe as a whole. the northern exposures at low altitude, and humid / sub-humid and winter tolerating needle (gymnosperms) forests at higher elevations. These forests also show a unique distribution from east to west. Here included northeastern Blacksea forests similar vegetation types as in the low Caucasus, where rainfall and humidity is high and Oriental Spruce (*Picea orientalis*) dominate. Oriental spruce extends west to Ordu on, and further to the west, it is replaced by species such as Turkey or hairy oak (*Quercus cerris*) and Calabrian pine that require less moisture. Blacksea region as a whole has the largest

area covered with forests, accounts for 25% of total forest cover of the country. Underlying landforms in conjunction with the climatic conditions with high rainfall and warm temperatures that prevail in the region, which involves primarily this vegetation structure. Unique Blacksea climate is the main driving force that contributes to establishing the forest forms with different blends and properties in the region. The high number of tree species and much rich biodiversity constitute a further aspect of the values that have the North Anatolian forests. In addition to the unique genetic and faunal and floristic biodiversity these forests contain diversity of ecosystems in this region from east to west is also very impressive. Scotch pine extends in the Blacksea coasts in some places, for example, is one of the most important characteristics of these ecosystems (Terzioğlu et al., 2009).

Forestry services; silviculture and reforestation activities, transportation of wood raw material and by-products, intervention to fire people and the protection of forests against insects, forest management and cadastre activities consist of forest workers and material transport, etc. issues. These services are needed to perform a planned road network (Görmez and Kuyucu, 2014; Eker et al., 2010; Tunay and Melemez, 2004).

According to OGM 2014 report, the amount of forest roads planned has been revised to 282,000 km and 177,000 km of it is made for the realization of all kinds of forestry activities. Forest road passing through the village and the total path length highway that can be utilized in conjunction

Species diversity owned forest structure, forest presence of a number of concepts such as forestry and vegetation cover degree and

with forestry services has reached 243,000 km.

Natural and different corridor structures such as road, stream, and valley represent different situations of landscape. Although corridors are witnessed with natural structures, roads are essential corridor structures which lead the fragmentation of the landscape. Forests are the most important components of landscape. Forest roads are the most important components in perception and definition of forest landscapes. Forest road corridors contribute to the formation of a new habitat style as well as fragmentation of the habitat (Sayer and Maginnis, 2005).

In accordance with all this information the aim of the work is to determine visual characteristics and landscape aesthetics of the Northern Forest Roads in Turkey and to understand visual values of these landscapes.

Material and Methods

The main material of this study consists of forest roads owned forests in northern Turkey. This study was carried out in the two sub flora including the colchic (COL.) and euxin (EUX.) of the forest road (Figure 1). Some forest roads in these areas are subjected to visual evaluation.

In this study, the northern forest roads were grouped according to different visual and ecological characteristic they have. After this grouping, these forest roads were identified in terms of their visual attributes. When to determine this features visual assessment techniques were used (Eroğlu, 2012). These methods consist of the subjective methods such as visualization and by using visual parameters. type of the stand were the most important parameters in determining the visual characteristics.

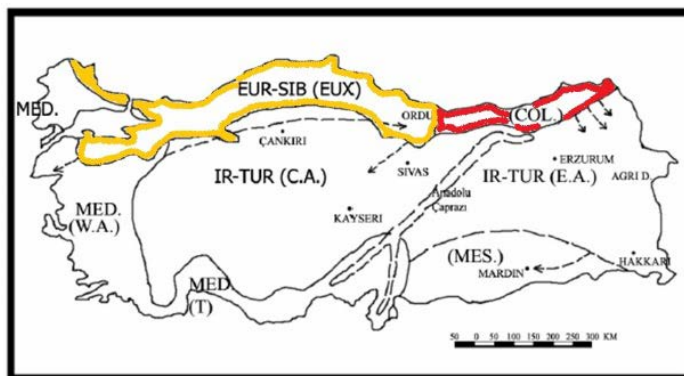

Figure 1. Phytogeographical zones of Turkey

Results

The findings obtained from this study are divided into two main categories.

Visual characteristics of Northern forest roads in colchic sub-region

The region embodies the land from Melet River in Ordu Province to the border of Georgia. This part is of a significant importance in the Blacksea Region phytogeographically, and is called colchic sector. This sector has remarkable similarities to Caucasus in term of the flora it contains. Northern Blacksea Region has a special importance for nature conservation because of the flora and fauna it possesses, and valleys, highlands and glacier lakes caught between the summits of the

mountains, and the streams like a cobweb flowing in deep valleys. Just as the natural old forests in the skirts of the Kaçkar Mountains in the region cast light on the past, Camili Biosphere Reserve Area, a nature museum, or common box (*Buxus sempervirens*) communities in tree form found in narrow strips in Fırtına Valley is there to teach the future generations what nature conservation is (Terzioğlu et al., 2009).

The main forest communities characterized the colchic region forests have started from 600m to 1900m. The region has include Trabzon, Artvin, Rize, Giresun and some part of the Ordu province.

The visual structure and characteristics of this region were collected in the table 1.

Table 1. Visual characteristics of colchic roads

Forest road types	Visual attributes
<i>Picea orientalis</i> forests	Dark green color, pyramidal forms, intense texture, high size vegetation cover include just trees, usually close canopy and there is no seasonal effect.
<i>Picea orientalis</i> - <i>Fagus orientalis</i> forests	Dark and light green color, pyramidal and dispersed form, high size vegetation cover include just trees, close canopy in spring, summer and autumn, semi open canopy in winter, there is a seasonal effect.
<i>Fagus orientalis</i> forests	Light green color, dispersed form, high size vegetation cover include just trees, close canopy in spring, summer and autumn, open canopy in winter, there is a seasonal effect.
Mixed deciduous forests	Light green color, dispersed form, high size vegetation cover include trees, small trees and shrubs close canopy in spring, summer and autumn, open canopy in winter, there is a seasonal effect.
Mixed conifer forests	Dark green color, pyramidal forms, intense texture, high size vegetation cover include just conifer trees, usually close canopy and there is no seasonal effect.
Mixed forests	Dark and light green color, pyramidal and dispersed form, high size vegetation cover include small trees and shrubs, close canopy in spring, summer and autumn, semi open canopy in winter, there is a seasonal effect.
Other types	There are some unique forest types such as hardy shade and stream habitat include <i>Alnus</i> spp. forests, rocky and plateau habitats have open vegetation. There are changeable seasonal effects such as monochrome and polychrome colors.

Visual characteristics of Northern forest roads in euxin sub-region

Thrace forests constitute an ecosystem range extending from Istranca Mountains on the slopes facing the Blacksea to Kocaeli peninsula with the southern border at Gelibolu (Gallipoli). Forests in this region are structurally composed of humid forests. Oriental beech forests in the region establish a zone along Bulgaria-İğneada line on the Istranca Mountains up to 1000 m on north and 500-600 m on south facing aspects. Bay oak (*Quercus petraea*) forming small groups accompany Oriental beech on the northern slopes of Istranca Mountains down to the coast. This region is of crucial importance in terms of biodiversity and in this regard attracts immediate attention with the oak (*Quercus petraea*, *Q. cerris*, *Q. frainetto*) and other tree species it has, and the existence of extremely unique İğneada complex of alluvial floodplain forest and Thracian Black Sea coastal wetlands and sand dune ecosystems. To the north and south of İğneada are also wetlands almost completely

surrounded by forest ecosystems. Western and Central Blacksea Region embraces the land area from Sakarya River to Ordu-Melet River. Forests occur on the slopes of North Anatolian Mountains facing the sea where a humid-temperate climate zone dominates. Oriental beech forms not only pure beech forests but also mixed forests with common hornbeam at low altitudes in this zone. As the elevation increases, mixed forests composed of oriental beech, Uludağ fir (*Abies nordmanniana* ssp. *bornmülleriana*) and Scotch pine become dominant (Terzioğlu et al., 2009).

The main forest communities characterized the euxin region forests have started from 300m to 1200m. The region has include Tekirdağ, Kırklareli, Çanakkale, Bursa, Kocaeli, İstanbul, Yalova, Sakarya, Düzce, Bolu, Sinop, Bartın, Kastamonu, Zongulda, Karabük, Samsun and some part of the Ordu province.

The visual structure and characteristics of this region were collected in the table 2.

Table 2. Visual characteristics of euxin roads

Forest road types	Visual attributes
Pseudo-mediterranean forests	The habitats have open vegetation covers including flowering plants. There are changeable seasonal effects such as monochrome and polychrome colors.
<i>Quercus</i> sp. forests	Light green color, dispersed form, low size vegetation cover include just small trees, semi-close canopy in spring, summer and autumn, open canopy in winter, there is a weak seasonal effect.
<i>Abies bornmülleriana</i> forests	Dark green color, pyramidal forms, intense texture, high size vegetation cover include just trees, usually close canopy and there is no seasonal effect.
<i>Fagus orientalis</i> forests	Light green color, dispersed form, high size vegetation cover include just trees, close canopy in spring, summer and autumn, open canopy in winter, there is a seasonal effect.
Mixed deciduous forests	Light green color, dispersed form, high size vegetation cover include trees, small trees and shrubs close canopy in spring, summer and autumn, open canopy in winter, there is a seasonal effect.
Mixed conifer forests	Dark green color, pyramidal forms, intense texture, high size vegetation cover include just conifer trees, usually close canopy and there is no seasonal effect.
Mixed forests	Dark and light green color, pyramidal and dispersed form, high size vegetation cover include small trees and shrubs, close canopy in spring, summer and autumn, semi open canopy in winter, there is a seasonal effect.

Conclusions

In recent years, with the emerging functional forestry, the concept of conservation has taken place in planning as well as to benefit from forest. Especially in this planning, forest roads and transportation play an important role aspect of integrity of the habitat. In this study shown that this integrity is not only ecological both also visual which include whole landscape such as forest and other habitats.

Consequently, in forest road planning and management, it is necessary that the concepts which are ecological, functional and aesthetical should be considered.

References

- Acar C., Acar H., Turna İ., Eroğlu E. 2005. Doğu Ladini Orman Ekosistemlerinde Görsel Kaynakların Değerlendirilmesi. Ladin Sempozyumu Trabzon 2005. Bildiriler Kitabı. Cilt:2 Sayfa: 1016-1024.
- Eker M., Acar H.H., Çoban H.O. 2010. Orman Yollarının Potansiyel Ekolojik Etkileri. Süleyman Demirel Üniversitesi Orman Fakültesi Dergisi Seri: A, Sayı: 1, Yıl: 2010, ISSN: 1302-7085, Sayfa: 109-125.
- Eroğlu E. 2012. Defining of Native Plant Compositions Determined Landscape Character in Mountainous Area Roadside Corridors; A Case Study Of Ataköy-Sultanmurat-Uzungöl Roadside Corridor. Karadeniz Technical University The Graduate School of Natural and Applied Sciences Landscape Architecture Graduate Program.
- Görmez Y., Kuyucu M. 2014. Orman Ekosistemine Etkisi Açısından Orman Yollarının Kritiği (Armutlu Orman İşletme Şefliği Plan örneği). II. Ulusal Akdeniz Orman ve Çevre Sempozyumu Bildiriler Kitabı. 268-280.
- Sayer J., Maginnis S. 2005. Forests in Landscapes. Ecosystem approaches to sustainability. ISBN: 1-84407-195-2 Typesetting by IUCN Publications Services Unit, Cambridge, UK.
- Terzioğlu S., Bilgili E., Karaköse M. 2009. Forest of Turkey. T.C. Çevre ve Orman Bakanlığı Yayını, ISBN 978-605-393-044-0. Gokce Ofset. Ankara.
- Tunay M., Melemez K. 2004. Zor arazi koşullarında çevreye duyarlı orman yolu inşaatı tekniğinin değerlendirilmesi. itüdergisi/d, mühendislik, Cilt:3, Sayı:2-3-4-5, 3-10.

Producing of Predatory Insect *Calosoma sycophanta* (L.) by Using Different Food Sources in Laboratory Conditions to Use in Biological Control of *Lymantria dispar* (L. 1758) (Lepidoptera:Lymantriidae)

*Yaşar AKSU¹, Cihangir DEDEAĞAOĞLU¹, Berna Ç. GÖKTÜRK¹

¹Regional Directorate of Forestry-Artvin/TURKEY

*Corresponding Author: y_aksu3@hotmail.com

Abstract

Calosoma sycophanta that fed with larvae of *L. dispar* in area has harmonized biology of *L. dispar* in nature so *Lymantria dispar* (L.) (Sponge weaver) that damaged in forests of *Quercus petraea* can reduced to the natural balance limit. Moreover, it feeds with caterpillars like *Euproctis chrysorrhoea*, *Tortrix viridana* that situated in area even if *L. dispar* occurs lately. Adults of *Calosoma sycophanta* are 30-40 mm length and live 3-4 years. When they feed very good, they spawn average 80 eggs in year. The eggs of them are 4-6 mm length, almost 1.5-2 mm width, elipsoidal shape and pale yellow. The eggs open in 4 days. Spawning period of a female can continue until 15 days according to the ambient conditions. The length of larvae can extend until 4-4.5 mm. Adults of *Calosoma sycophanta* were brought to laboratory by collecting from area where *Lymantria dispar* damaged intensely. They placed in laboratory that had 20x20x40cm plastic pots mixing with %80 topsoil and %20 river sand, 22-23°C, %60-65 moisture and 8:16 (day and night). The two each larvae of *Dendroctonus micans* and the two each caterpillars of *Lymantria dispar*, *Hyphantria cunea*, *Aglais urticae* were given to adults every day. One female and two male were placed in producing pots with account from adults mating in the pots. The larvae that hatching were fed with average 3.8 larvae of *D.micans* and two each caterpillars. The larvae of *C. sycophanta* that received trial ate average 49.4 larvae of *D.micans* in the last three periods and average 8.4 caterpillars until mature larva stage. The larvae of *D.micans* reduced maturation time of the larvae of *C. sycophanta*, because they are rich with regard to protein according to other foods. It was determined that adult of one *C. sycophanta* spawned average 49.7 eggs in laboratory.

Keywords: *Lymantria dispar*, *Calosoma sycophanta*, Biological control, *Euproctis chrysorrhoea*

Lymantria dispar (L. 1758) (Lepidoptera:Lymantriidae)'ın Biyolojik Kontrolünde Kullanmak için, Avcı Böcek *Calosoma sycophanta*(L.)'nın Laboratuvar Şartlarında Farklı Besin Kaynakları Kullanılarak Üretilmesi

Özet

Meşe (*Quercus petraea*) ormanlarında zarar yapan *Lymantria dispar* (L.) (Sünger örücüsü)'ü, doğal denge sınırına indirilmesi için sahada, *L. dispar* larvaları ile beslenen *Calosoma*'ın bir alt varyetesi olan *C.sycophanta*, doğada *L.dispar*'ın biyolojisine uyum sağlamıştır, *L.dispar* geç çıkarsa da sahada var olan *Euproctis chrysorrhoea*, *Tortrix viridana* gibi tırtıllarla beslenmektedir. *Calosoma sycophanta*, erginleri 30-40 mm boyunda olup ortalama 3-4 yıl yaşarlar, iyi beslendiklerinde yılda ortalama 80 yumurta bırakırlar. Yumurtaları 4-6 mm uzunlukta, yaklaşık 1.5-2 mm genişlikte, elipsoidal şekilli açık sarı renktedir. Yumurtalar 4 günde açılır, bir dişinin yumurtlama dönemi ortamın şartlarına göre, 15 güne kadar uzayabilir. Larvaların boyları 4-4.5 cm'ye kadar uzayabilir. *C.sycophanta* erginleri, *Lymantria dispar*'ın yoğun olarak zarar yaptığı sahalardan toplatılarak, laboratuvara getirildi. Erginler toplu halde, içinde %80 humuslu orman toprağı ile, %20 dere kumu ile karıştırılmış 20x20x40 cm ebadındaki plastik kapların bulunduğu ve sıcaklığı 22-23°C, nemin de %60-65 oranında ve 8:16 saat (gece:gündüz) olan laboratuvara konuldu. Erginlere her gün 2'şer adet *Dendroctonus micans* larvası ve 2'şer adet (*Lymantria dispar*, *Hyphantria cunea*, *Aglais urticae*) tırtıl verildi. Kap içinde çiftleşen erginlerden, 1 dişi 2 erkek hesabı ile üretim kaplarına alındı. Üretim kapları her gün kontrol edilerek, konan yumurtalar, yumurta kaplarına alındılar. Yumurtadan çıkan larvalar, her gün ortalama 3.7 adet *D.micans* larvası ve 2'şer adet tırtilla beslendiler. Denemeye alınan *C. sycophanta* larvaları olgun larva dönemine kadar, ortalama 49.4 adet son üç gömlekteki *D.micans* larvası ve ortalama 8.4 adet tırtıl tükettiler. *D.micans* larvalarının protein bakımından diğer besinlere göre zengin olması, *C. Sycophanta* larvalarının olgunlaşma süresini de kısaltmıştır. Laboratuvarında bir *C. Sycophanta* ergini ortalama 49.7 adet yumurta bıraktığı tespit edildi.

Anahtar Kelimeler: *Lymantria dispar*, *Calosoma sycophanta*, Biyolojik kontrol, *Euproctis chrysorrhoea*

Introduction

Forestry Regional Directorate of Artvin was built a production laboratory in Artvin in 2013 so as to produce *Calosoma sycophanta* L. 1758 (Coleoptera:Carabidae) in laboratory conditions and to biological control of *Lymantria dispar* L. 1758 (Lepidoptera:Lymantriidae) that damage on fruit trees in the agricultural areas next to forests, on deciduous trees in the forest and in the forests of *Quercus petraea*. It has been produced in laboratory conditions to biological control of *Thaumetopoea pityocampa* Denis and Schiffermüller. 1775 (Lepidoptera: Thaumetopoeidae) in West. *L. dispar* damages together *Euproctis chrysorrhoea* L. 1758 (Lepidoptera: Lymantriidae) and *Tortrix viridana* L. 1758 (Lepidoptera: Tortricidae) in the forests of oak. *Euproctis chrysorrhoea* has damaged by taking over the level of damage once in 5-10 year since 1982. It has been kept under control consistently. Although *L. dispar* has continued its existence in our areas within the limits of the national balance, it has damaged consistently since 2010. Therefore, it was decided to medicate with bacterial drug that is names of *Bacillus thuringiensis* var. *Kurstaki* against to *L. dispar* under microbial struggle so damage of *L. dispar* was reduce limit of the national balance in 2012. But, we started to produce *C. sycophanta* in laboratory conditions. Because, the villagers opposed with concern that damage to bees. The larvae of *Dendroctonus micans* and the caterpillars of *Lymantria dispar*, *Euproctis chrysorrhoea*, *Hyphantria cunea*, *Aglais urticae* (Linnaeus, 1758) were used as food in the production of *C. sycophanta* because *T. pityocampa* which feed *C. sycophanta* is not in East Blacksea. The adults of *C. sycophanta* that used as full-grown in the production were collected in the forests of oak in Forest Management Chieftaincy of Ardanuc and Forest Management Chieftaincy of Ogdem (Yusufeli) that *Lymantria dispar* proliferates in case of the mass. The larvae of *Dendroctonus micans* and the caterpillars of *Lymantria dispar*, *Aglais urticae* were collected in areas of Forest Management Directorate of Ardanuc. The caterpillars of *Hyphantria cunea* Drury. 1773 (Lepidoptera: Arctiidae) were collected in the areas of alder

in Forest Management Directorate of Arhavi. The production of *C. sycophanta* was made in air-conditioned laboratory that is 22-23°C and %60-65 moisture.

Material and Methods

This work was made in order to produce *C. sycophanta* that fed with *L. dispar* by using different foods in laboratory conditions so damage of *L. dispar* which damaged on forests of oak in Forestry Regional Directorate of Artvin was reduce limit of the national balance between 2010-2014. It was benefited from laboratories that were built to produce *Rhizophagus grandis* and *Thanasimus formicarius* in order to produce *C. sycophanta* in laboratory conditions. Production of *C. sycophanta* was made in air-conditioned laboratory that is 12 m², 22-23°C, %60-65 moisture, adjustable 8:16 hour (night: morning). The caterpillars of *L. dispar* and *H. cunea* were brought to laboratory by collecting in forests of oak and alder in 2012 to production of *C. sycophanta* in 2013. Moreover, they were provided to be pupae by feeding up to the last shirt. After the adults of *L. dispar* mated by getting out from pupae, they were provided to lay eggs in production containers that are 27x41x16 cm dimensions to pass on egg phase in winter. After the larvae of *H. cunea* came to the last shirt, they were provided to kip down pupae phase in the production container that are 27x41x16 cm dimensions in september to pass in winter. To production that was made in 2014, the larvae of *L. dispar* and *H. cunea* were brought to laboratory by collecting in areas and the wintering was made in laboratory in 2013. The larvae of *D. micans* were collected in forests of spruce in Forest Management Directorate of Ardanuc. The adults of *C. sycophanta* which were used to production were collected in areas of oak that *L. dispar* were intensely damaged. The plastic containers that are 20x20x40 cm dimensions, humic forest soil and river sand within them, the egg container that is 5.2 cm height and 2.7 cm diameter, the round larvae-feeding container that is 4 cm height and 5.5 cm diameter, the air-conditioner, the humidifying equipment, tea spoon and table spoon were used for the adults of *C. sycophanta* could lay egg.

Results and Discussion

The adults of *Calosoma sycophanta* L. are average 30-40 mm tall and they live average 3-4 years. They have two pairs wings. The front wings take shape of elytra by chitining, and the back wings are shape of integument. There are small hollownesses that concatenated longitudinally on the front wings. The front wings are greenish red colour and brilliant. Moreover, the legs and the abdomen are black colour. According to climatic conditions, the ground outlet of the adults of *Calosoma sycophanta* continues until to mid of march with mid of february. The time of ovulation continues 20-25 days and the eggs open in 6-13 days. The larvae are 7-8 mm tall and dirty yellow colour in first period. Moreover, they transform black colour after 1.5-2 hours. They kip down pupae phase in june and the pupae phase takes 9-16 days (Kanat et. al 2005.). The first larvae phase of hunting insect takes 7-11 days, the secand of it takes 8-12 days and the third of it takes 15-18 days (Kanat and Özbolat 2006.). To production of *C. sycophanta* in laboratory conditions, the mixture of grated and sterilised % 80 humic soil and % 20 river sand is put 3-4 cm depth into 20x20x40 cm dimensions of plastic containers. Therefore the adults keep to, the grill cover that made stainless steel wire is put on the mouth of containers. The adults of hunting insect which collected from nature were put into the large containers that had 2-3 cm depth sterilised soil and had the cover that made 5-10 holes. Moreover, they were brought to laboratory. The adults with the 2 males and 1 female account from the adults of *C. sycophanta* that copulated in container were put into spawning container. The sand was moistened with hand pump once or twice in week. To water demand of the adults, the wet cotton that impregnated water was put into container. The spawning containers were put into the laboratory that has 22-23⁰C, %60-65 moisture and adjustable 8:16 hour (night: morning). The larvae in the last shirt of *D.micans* and two each caterpillar of (*Lymantria dispar*, *Euproctis chrysorrhoea*, *Hyphantria cunea*, *Aglais urticae*) were given to the adults. The total 12 females and 24 male adults of *C. sycophanta* were put into the twelve production containers which received trial. Moreover, it was waited

to ovulation. They spawned, the containers were checked everyday and the eggs were taken gantly with tea spoon. The eggs were put into the egg containers that have 5-6 holes with specially prepared and slightly moistened, sterilised soil. The 10-12 eggs were put into every egg container. It was provided to not come in contact each other. After every egg was put into, the surface was covered with moist sand. It was determined that the twelve females which received trial put total 596 eggs. It was determined that a female put average 49.7 eggs, but It was determined that 421 (% 70.6) of eggs opened, 175 (%29.4) of them didn't open. Ceylan et. all (2012) is determined that time of ovulation continued 13-18 days in the production that made by giving larvae of *Spodoptera littoralis* Boisduval. 1833 (Lepidoptera: Noctuidae) to *C.sycophanta*, and the opening time of eggs was between 8 -11 days, the opening rate of egg was average %84. Kanat and Özbolat (2006) is determined that time of ovulation continued 20-25 days in the production that made by giving *T. pityocampa* as food in the their study and the opening time of eggs was between 6-13 days, the opening rate of egg was average %85. Serttaş and Çetin (2014) is of opinion that the amount of ovulation is positively affected to put 1 female in response to 3 males, or 1 female in response to 2 males and multiples in the ovulation containers in the laboratory that made the production of *C.sycophanta*.

The larvae of twelve *C. sycophanta* which received trial were fed total 9 caterpillars and daily the larvae in the last three shirts of 4 *D. micans* until the their last shirt. The larvae of twelve *C. sycophanta* were fed total 720 larvae of *D.micans* and 108 caterpillars until the their last shirt. It was determined that the larvae of *C. sycophanta* ate 593 (%82.4) of 720 larvae and 101 (%93.5) of 108 caterpillars. It was determined that the larvae of *C. sycophanta* which received trial ate average 49.4 larvae of *D.micans* in the last three shirts and average 8.4 caterpillars of *Lymantria dispar* and *Hyphantria cunea* until the mature larvae period. Weseloh specified that the larvae in the first and secand period of *C. sycophanta* preferred the pupaes and the small larvae of *L.dispar* in the his work (1988). Moreover, he specified that the larvae

in the third period of *C. sycophanta* preferred larvae and bigger larvae in his work (1988). Evans specified that *C. sycophanta* was brought from England to America at the beginning of the 20th century and *Lymantria dispar* with *Euproctis chrysorrhoea* were kept under control in America in his work (2009). The adults of *C. sycophanta* that collected from forests of oak in Forest Management Directorate of Canakkale were brought with bus to Artvin to use in the production in 2013. But, the adults which being stress didn't mate and didn't spawn. The adults that used in the production in 2013 were collected from the areas in Artvin. The adults that brought from Canakkale entered to soil in laboratory in order to hibernate until from august to 5 september. But, the adults of *Calosoma* that brought from Canakkale exited from soil by waking up hibernation in laboratory (7,1 C⁰ and %58 moisture) at 13.02.2014 and they were used in the production in 2014.

C. sycophanta lives naturally in Artvin. It feeds with the larvae of *E. chrysorrhoea* that passed on larvae phase in winter when its first exit, and it feeds with the larvae of *Lymantria dispar* and *Tortrix viridana* as from april. *C. sycophanta* is a polifac species, it benefits from every various alive food that it finds in nature for this reason. *C. sycophanta* has approached to the natural balance limit *E. Chrysorrhoea* for 15 years and *L.dispar* since 2015. The adults of *C. sycophanta* can withstand on hunger 30 days. The adults are collected after fifteenth day of april to production in laboratory. The adults of *Calosoma* exit from soil at the beginning of april, and they enter to soil in order to hibernate at the first week of september in conditions of Artvin. Moreover, The adults which entered to soil pass on diapause stage by preparing the place like pupae cradle. It was determined that the adults of *Calosoma* entered to soil since fifth day of september at 21-22⁰C in laboratory. The adults arrange their life cycle according to plenty, diversity and kind of food sources that they find. *Calosoma* significantly contributes to establish the natural balance by always keeping under control species in the its area.

Conclusion

The caterpillars of pine processionary moth are used as food in the production of *Calosoma sycophanta* in laboratory conditions. This butterfly causes to allergy on working staff, makes negative impact on attendant staff, and reduces the production efficiency.

The production was made by giving the larvae of *Spodoptera littoralis* as alternative hunt to the hunter insect *Calosoma sycophanta* in the works that made in seeking alternative food. It was determined that the adults and larvae of *Calosoma* ate the larvae of this Lepidopter species.

Giving the larvae of *Dendroctonus micans* besides the species that live in nature and the species that *Calosoma sycophanta* eats was contributed to uneventfully execution of the production study in the our work. *Lymantria dispar* and *Tortrix viridana* don't causes to allergy on working staff. *Euproctis chrysorrhoea* is in the food chain in the areas in the habitats of *C. sycophanta*. But, the larvae of this butterfly cause to allergy on working staff. The areas of *Hyphantria cunea* are outside of the domain of *Calosoma*, *H.cunea* is specially produced in laboratory conditions for this reason. The production of the larvae of *L.dispar* is more economic in laboratory conditions, because it isn't efficient that the larvae of it are collected from nature. It will positively affected both employees and productions that the adults and the larvae of *Calosoma* are fed with different butterfly and the larvae of bark beetle. It additionally needs to be investigated that *Calosoma sycophanta* that adapted to this species and produced to the biological control of *Thaumetopoea pityocampa* is produced by using the caterpillar of *L.dispar* and *H.cunea*.

It was determined that the amount of egg production was increased to put into spawning containers with account of 1 female 3 male, 1 female 2 male in a work. It was provided positive results from the production that made by putting 2 male 1 female into spawning containers in the our work.

References

Evans v. A, 2009 The Forest Caterpillar Hunter, *Calosoma sycophanta*, An Old World Species Confirmed as Part of the Virginia Betle

Fauna (Coleoptera: Carabidae). Banisteria Number 34, pages 33-37.

Ceylan, S., Argun, N., Cengiz, N. 2012, Determined that utilization facilities of *Spodoptera littoralis* in the production of *Calosoma sycophanta* (Coleoptera: Carabidae), Publications of Forestry Research Institute of Central Anatolia, Technical Bulletin No: 294.

Kanat, M., Toprak, Ö., Akbulut, S. 2005. Determination of Some Biological Characteristics of *Calosoma sycophanta* L. (Coleoptera: Carabidae). Turk. J. Zool. 29. 71-75.

Kanat, M ve Özbolat, M. 2006. Mass Production and release of *Calosoma sycophanta* L. (Coleoptera: Carabidae) Used against the Pine Processionary Moth, *Thaumetopoea pityocampa* (Schiff.) (Lepidoptera: Thaumetopoedidae), in Biological Control. Turk. J. Zool. 30. 181-185.

Serttaş, A., Çetin, H. 2014, Increasing of the amount of production of *Calosoma sycophanta* L. that used in biological struggle in laboratories. 11. National Mediterranean Forest and Environment Symposium, Isparta 444-448.

Weseloh, R. M., 1988. Prey Preferences of *Calosoma sycophanta* L. (Coleoptera: Carabidae) Larvae and Relationship of Prey Consumption to Pradator Size. Can. Ent. 120: 873-880.

Effects of the Global Climate Change on Resin Production in Forest Trees and Harmful Insect Outbreaks

Yalçın KONDUR¹, *Ceyhun GÖL¹

¹Çankırı Karatekin University, Faculty of Forestry, Çankırı/TURKEY

*Corresponding Author: drceyhungol@gmail.com

Abstract

Turkey is among the risky countries group in sense of aridity which is just one of the effects of the global climate change. The ecological degeneration as a result of aridity may cause disease and insect outbreaks in forest ecosystems. Also, aridity may adversely affect tree resistance by directly and/or indirectly. The water stress as a result of aridity will affect tree physiology and phenology, and also will change resin production mechanisms which are the most defense mechanism of trees. Resin is the most important defense mechanism in coniferous trees. Water directly affects the resin production amount. It is estimated by many researches that harmful insects in forest ecosystems may become epidemic and the insect biology-tree phenology relationships may collapse. Also, it is thought that the resin production will negatively be affected. Thus, the health of coniferous forests is directly bonded to tree resin production. Otherwise, insect (especially bark beetles) outbreaks may increase since the decreased resin production due to decreased water amount trees could take and also environmental stress factors.

Keywords: Global warming, Insect, Resin, Water stress

Küresel İklim Değişiminin Orman Ağaçlarında Reçine Üretimine ve Zararlı Böcek Salgınlarına Etkileri

Özet

Küresel iklim değişikliğinin etkilerinden sadece biri olan kuraklık bakımından Türkiye, risk grubu ülkeler arasındadır. Kuraklık sonucu ortaya çıkacak ekolojik bozulmaların orman ekosistemlerinde hastalık ve böcek salgınlarının artmasına neden olabilecektir. Ayrıca, kuraklık ağaç direnci üzerine doğrudan ve/veya dolaylı olarak olumsuz etki edebilecektir. Kuraklık sonucu oluşan su stresi, ağaçların fizyolojisi ile fenolojisini etkileyecek ve en önemli savunma mekanizması reçine üretimi değiştirecektir. Reçine özellikle iğne yapraklı ağaç türlerinin böceklerle karşı en önemli savunma mekanizmasıdır. Su, ise üretilecek reçine miktarını etkilemektedir. Küresel iklim değişikliği ile birlikte orman ekosistemlerinde zarar yapan böceklerin salgın yapabilecekleri ve biyoloji-fenoloji ilişkisinin bozulacağı tahmin edilmektedir. Aynı zamanda, kuraklıkla birlikte reçine üretiminin olumsuz etkileneceği düşünülmektedir. Dolayısıyla, ibreli ormanların sağlığı, ağaçların reçine üretimine doğrudan bağlıdır. Aksi halde küresel iklim değişikliği ve kuraklığa bağlı olarak, ağaçların topraktan alabileceği su miktarının azalması, çevresel diğer stres faktörlerinin de etkisiyle reçine üretiminde azalma meydana gelebileceğinden, özellikle kabuk böceği salgınlarının artması söz konusu olabilecektir.

Anahtar sözcükler: Küresel ısınma, Böcek, Reçine, Su stresi

Introduction

Global warming may be defined as increasing of temperature due to accumulation of greenhouse gases over the earth or certain atmosphere layers that near to earth. Turkey is one of the risky countries with regard to the effects of the global climate change. It is expected to have an increase insect and disease outbreaks due to ecological disruption due to aridity and desertification. Aridity and temperature may not only affect tree resistance and insect populations directly and/or indirectly but also may change

ecosystem functions and stand structure (Şimşek et al., 2010).

Aridity directly affects tree physiology and development. However, the secondary factors which are results of aridity (i.e., harmful insects, pathogens and fire), generally cause more tree death than aridity itself (Rouault et al., 2006).

Water stress and high summer temperature affects the distribution area and abundance of tree species since these factors directly affects tree physiology and phenology (Beniston and Innes, 1998; Greenbank, 1956).

Global climate change plant pests either directly or indirectly by affecting host plants. There are detailed studies regarding the possible effects of climate change on insect populations (Ungerer et al., 1999; Virtanen et al., 1996; Williams and Liebhold, 1995). Breshears et al (2005) showed that bark beetle damage and extreme droughts are the main factors on rapid forest composition change. Explanation of how climate extremes affects insect populations may help better estimation of the effects of climate change on forest ecosystems (Rouault et al., 2006).

Temperature increase causes longer summers and longer damage periods by insects, and also cause trees to go into water stress that adversely affects resin production. Temperature increase may also increase annual generation numbers of insects and disrupt insect biology-plant phenology relationships (Şimşek et al., 2010).

Healthy coniferous trees are capable of defending themselves against smaller bark beetles by secreting resin since a little number of insects can attack coniferous trees in a specific period of time. In such cases, insects may only kill diseased and weakened trees due to certain number of reasons. Since trees produce resin while consuming water, it is an important parameter showing drought and insect outbreak relationship (Şimşek et al., 2010).

Resin in Forest Trees

Certain matters that obtained from wood components and waste waters from factories but non-fiber matters are called silvi-chemicals. These matters generally are wood coal, lignin derivatives, vanillin, etheric oils, resins, yeast, alcoholics, tannins, gums, glues, ethanol, acetic acid, waxy matters etc. Naval stores are main one amongst all silvi-chemicals as volume and value (Hafizoglu, 1984). Naval stores are certain chemicals such as turpentine, oils, resins, tars, pitch and obtained by extracting or wounding coniferous tree woods (Anonymous, 1979).

The term “naval stores” were used only for wood tar in ship building in the ancient times. However, today this term is used for all kind of derivatives of oleoresin extracted from pines. All these chemical products are compatible with environment and do not cause any health issues in living organisms. There are two products harvested from oleoresin; the first one is composed of resin acids, rosin and the second one is a vaporizing oil, mostly mono-turpentine hydrocarbon, turpentine (Deniz, 2002).

Resin which is not used by the plant after secretion and many coniferous plants such as *Pinus*, *Larix*, *Pseudotsuga* and *Picea*, have normal resin channels. After wounds, new cells and traumatic resin channels form in these species. These cells that surround normal channels have thin walls however cells surrounding traumatic channels have thick walls. As the width of annual rings increase, the number of vertical resin channels increase in the wood.

Kibblewhite and Thomson (1973) reported as a result of anatomical studies in *Pinus ellioti* that traumatic channels had increased 10 times within sapwood rings in the year that bark had wounded. Normal or traumatic resin channels occur as a result of disappearing mid-lamels and also parenchyma cells differentiating and multiplying vertically and horizontally at inner side of cambium. Thin walled parenchyma cells covering channels divide and multiply then transform into epithelium cells where resin biosynthesis occur (Deniz, 2002).

Longitudinal and flat resin channels are connected. The amount of the resin produced is closely connected to the numbers and also diameters of longitudinal and flat resin channels. Channel number in heartwood is lesser than sapwood and channel length may be up to one meter. Transverse channels are shorter in length and have smaller radius but many in numbers (Deniz, 2002).

Table 1. Channel diameter, number of channels in per cm² and resin amounts (Deniz, 2002).

Pine Species	Channel Width (μ)	Channels in 1 cm ² *	Resin Amount (%)		
			Sapwood	Heartwood	Bole
<i>Pinus pinea</i>	126,0	33	3,47	14,16	7,75
<i>Pinus nigra</i>	124,0	59	3,21	10,25	4,68
<i>Pinus brutia</i>	100,0	50	2,74	18,96	7,32
<i>Pinus sylvestris</i>	93,3	-	4,19	9,17	6,81

* Mean numbers of channels in heartwood and sapwood.

Table 1 shows that *Pinus nigra* has the highest resin channel count and *P.brutia* has the highest resin amount in the heartwood. *P.pinea* and *P.brutia* have the richest resin content within bole. *P.pinea* is suitable for resin production within its distribution area however, resin production may cause seed decrease in cones. Thus *P.pinea* is thought to be utilized in pinon production (Şad, 1976). Since *P.nigra* is generally located at sea facing aspects and at higher altitudes with lower temperature, this species is not suitable for resin production. However, it may be possible to produce resin from *P.nigra* in northern countries such as Austria. *P.brutia* is suitable for resin production since its distribution area is generally favorable for temperature and altitude. Also, the distribution area of *P.brutia* mostly includes maquis sites. Afforestation of such sites will not only have economical contributions but also prevent erosion. *P.sylvestris* is mostly located at northern sides of high coastal mountains and northern slopes of mountains in the southern distribution areas. *P.sylvestris* is not suitable for resin production due to ecological reasons. However, in certain countries such as Russia and Poland, resin extraction is made from *P.sylvestris*.

Evaluation of pine species shows that *P.brutia* is suitable for resin production in all aspects. However, in case of resin exportation, it is possible to produce resin from *P.nigra* and *P.sylvestris* (Deniz, 2002).

Relationship Between Bark Beetles and Resin Production With Regard to Global Climate Change

Bark beetles are much more affected from the global climate change relatively than defoliators (Şimşek et al., 2008). Temperature increase causes longer summers and insect damage continue longer periods and also cause trees go into water stress and adversely

affect the amount of resin produced. Temperature increase may increase annual insect generations while disrupting the relationship between plant phenology and insect physiology (Şimşek et al., 2010).

It is long known that resin produced in resin channels is related to the resistance against bark beetles in many pine species (Webb, 1996). It is also known that oleoresin works as a trap and makes digging the bark difficult for bark beetles. Thus, sometimes dead bark beetles could be seen crystallized as trapped in resin produced from the resin channels. However, certain aggressive bark beetle species (i.e., *Dendroctonus brecomis*) have a significant resisting ability against toxic monoterpenes. Oleoresin may contribute to tree resistance importantly since it may be chemically toxic to bark beetles and microorganisms related to bark beetles (Hodges et al. 1985). Thus, oleoresin and monoterpenes may act as repellents against bark beetles especially when in high concentrations (Struble, 1957; Pitman et al., 1966). Drought and poor water balance probably decrease the coniferous tree resistance by decreasing Turgor in the cells in resin channels and weaken oleoresin pressure. There are certain studies supporting this argument (Vité, 1961; Wood and Vité, 1961; Wood, 1962; Brown et al., 1987).

Hodges et al. (1979) report that resin of pine species that is resistant to bark beetles, crystallizes more slowly than pine species that is not resistant, and Cook and Hain (1987) report that resin flow in the susceptible pine species is slower. However, Berryman (1972) could not find any significant difference between resin flow of resistant and susceptible Scots pine (*Pinus sylvestris*) against *Tomicus piniperda*. Furthermore, it is reported in *Larix occidentalis* that *Dendroctonus pseudotsugae* attacks are lesser when 3-carene concentration in resin is higher (Reed et al. 1986).

Another important factor is toxicity of the compounds in the resin. Smith (1961, 1965a) applied the resin vapors of host and non-host pines to *Dendroctonus* species and insect were found to be more tolerant to vapor of host trees. In that study, it was determined that the most toxic monoterpene as limonene and it is followed by (+)-3-carene, myrcene, (-)- β -pinene and α -pinene. Smith (1965b) reported that n-heptane had deterred *D. ponderosae* from feeding however this compound affected *D. jeffreyi* slightly.

Although verbenone deters attraction of bark beetles, this compound only produced in Hylesininae species in large quantities. Base structure of Ipsenol, ipsdienol, e-myrcenol looks similar to plant monoterpenes, myrcene; cis- and trans- verbenol look similar to α -pinene. These structural similarities support the idea of bark beetles using plant compounds as a sign for their own pheromones (Byers, 1995).

Conclusion

Global warming is increase of temperature due to accumulation of greenhouse gases over the earth or at certain atmosphere layers near to earth; global climate change is the change of climatic elements depending on the global warming.

The global changes observed show that temperature has increased 0.5°C and sea level has increased 20 cm, temperature at stratosphere has decreased, rainfall at mid altitudes has increased but rainfall at sub-tropical latitudes has decreased since the last century.

Population dynamics in forest ecosystems may change due to the global climate change and certain insect species which is not considered as pests today, may outbreak in the future. Bark beetles are the most affected insects from the global climate change (Şimşek et al., 2008).

There is a strong correlation between temperature increase and insect epidemics. Since temperature increase cause longer summers and insects harm plants and trees longer periods, increased temperature also affect trees as they go into water stress and adversely affect resin production. Water deficiency (poverty), is one of the main factors that trigger bark beetle damage and it

is thought to be a messenger of the global climate change.

Temperature increase also may increase annual generations of insects and disrupt the relationships between plant phenology and insect biology. Climatic changes will not only affect disease and insect pests in both agriculture and forest areas, but also cause changes in habitats of plants and animals. Increased temperatures

Resin is one of the most important defense mechanisms of coniferous trees as mentioned above. Secondary volatile compounds in resin have a repellent effect for certain insect species and have a great importance against some pests such as bark beetles in forest areas. Thus, keeping forest areas healthy and maintaining trees to produce enough amounts of resin will maintain trees strong for bark beetle attacks and cause bark beetles to die within resin. Otherwise, decrease of the water amount that trees could get from the soil and other environmental stress factors may cause a decrease in resin production with regard to the global climate change and thus outbreaks of bark beetles may increase.

References

- Anonymous, 1979. ASMT D-804-79. Standard definitions of terms relating to Naval stores and related products. 970-975
- Beniston M., Innes J., 1998. The impacts of climate variability on forests, Springer-Verlag, Berlin.
- Berryman, A. A., 1972. Resistance of conifers to invasion by bark beetle-fungi associations. *Bioscience*, 22, 598- 602
- Breshears, D.D., Cobb, N.S., Rich P.M., Price K.P., Allen C.D., Balice, R.G., Romme, W.H., Kastens, J.H., Floyd, M.L., Belnap, J., Anderson, J.J., Myers, O.B., Meyer, C.W., 2005. Regional vegetation dieoff in response to global-change type drought, *Proc. Natl. Acad. Sci. USA* 102: 15144–15148.
- Brown, M. W., Nebeker, T. E., Honea, C. R., 1987. Thinning increases loblolly pine vigor and resistance to bark beetles. *South. J. Appl. For.*, 11, 28-31.
- Byers, J.A., 1995. Host tree chemistry affecting colonization in bark beetles, in R.T., Cardé and W.J. Bells (eds.). *Chemical Ecology of Insects* 2. Chapman and Hall, New York, pp.154-213.
- Cook, S.P., Hain, F.P., 1987. Four parameters of the wound response of loblolly and shortleaf pines to inoculation with the blue-staining fungus

associated with the southern pine beetle. *Can. J. Bot.*, 65, 2403-9.

Deniz, İ., 2002. Dikili ağaçlarda reçinenin biyosentezi ve reçine üretimi. Kastamonu Eğitim Dergisi Cilt: 10, No.2, 375-386.

Greenbank, D., 1956. The role of climate and dispersal in the initiation of outbreaks of the spruce budworm in New Brunswick, *Can. Entomol.* 34: 453-476.

Hafizoğlu, H., 1984. Türk çam yağının özellikleri, K.Ü. Orman Fak. Dergisi, Cilt:7, Sayı :1 90-106.

Hodges, J.D., Elam, W.W., Watson, W.R., Nebeker, T.E., 1979. Oleoresin characteristics and susceptibility of four southern pines to southern pine beetle (Coleoptera: Scolytidae) attacks. *Can. Entomol.*, 111, 889-96.

Hodges, J.D., Nebeker, T.E., DeAngelis, J. D., Karr, B.L., Blanche, C.A., 1985. Host resistance and mortality: a hypothesis based on the southern pine beetle-microorganism-host interactions. *Bull. Entomol. Soc. Am.*, 31, 31-5.

Kibblewhite, R.P., Thompson, N.S., 1973. The ultrastructure of the middle lamella region in resin canal tissue isolated from slash pine holocellulose. *Wood Sci. And Tech.* 7: 112-116.

Pitman, G.B., Renwick, J.A.A., Vité, J.P., 1966. Studies on the pheromone of *Ips confusus* (LeConte). IV. Isolation of the attractive substance by gas-liquid chromatography. *Contrib. Boyce Thompson Inst.*, 23, 243-50.

Reed, A.N., Hanover, J.W., Furniss, M.M., 1986. Douglas-fir and western larch: chemical and physical properties in relation to Douglas-fir bark beetle attack. *Tree Physiol.*, 1, 277-88.

Rouault, G., Candau, J.N., Lieutier, F., Nageleisen, L.S., Martin, J.C., Warzée, N., 2006. Effects of drought and heat on forest insect population in relation to the 2003 drought in Western Europe. *Ann. For. Sci.* 63: 613-624.

Smith, R.H., 1961. The fumigant toxicity of three pine resins to *Dendroctonus brevicornis* and *D. jeffreyi*. *J. Econ. Entomol.*, 54, 365-9.

Smith, R.H., 1965a. Effect of monoterpene vapors on the western pine beetle. *J. Econ. Entomol.*, 58, 509-10.

Smith, R.H., 1965b. A physiological difference among beetles of *Dendroctonus ponderosae* (= *D. monticolae*) and *D. ponderosae* (= *D. jeffreyi*). *Ann. Entomol. Soc. Am.*, 58, 440-2.

Struble, G.R., 1957. The fir engraver, a serious enemy of western true firs. *U.S. Dep. Agric. Prod. Res. Rep.* II.

Şad, H.C., 1976. Türkiye’ de reçine üretimi yapılan ormanların amenejman esasları hakkında araştırmalar. İ.Ü. Orman Fak. No:24, 199s.

Şimşek, Z., Kondur, Y., Şimşek, M., 2008. Küresel İklim Değişikliğinin Zararlı Böcekler Üzerine Olası Etkileri. IV. Çankırı Kültürü ve Bilgi Şöleni 13-15 Kasım 2008

Şimşek, Z., Kondur, Y., Öner, N., Şimşek, M., 2010. Küresel İklim Değişikliği Dikkate Alınarak Kabukböceklerinin Yönetimi. Kastamonu Üniversitesi Orman Fakültesi Dergisi 10(1): 44-54.

Ungerer, M., Ayres, M., Lombardero, M., 1999. Climate and the northern distribution limits of *Dendroctonus frontalis* Zimmerman (Coleoptera: Scolytidae), *J. Biogeogr.* 26: 1133-1145.

Virtanen, T.S.N., Nikula, A., Varama, M., Niemela, P., 1996. Climate change and the risks of *Neodiprion sertifer* outbreaks on Scots pine, *Silva Fenn.* 30: 169-177.

Vité, J.P., 1961. The influence of water supply on oleoresin exudation pressure and resistance to bark beetle attack in *Pinus ponderosa*. *Contrib. Boyce Thompson Inst.*, 21, 37-66.

Webb, J.L., 1906. The western pine destroying bark beetle. *USDA Bur. Entomol. Bul.* 58 Pt. II., 30pp.

Williams, D., Liebhold, A., 1995. Forest defoliators and climatic change: potential changes in spatial distribution of outbreaks of western spruce budworm (Lepidoptera: Tortricidae) and gypsy moth (Lepidoptera: Lymantriidae), *Environ. Entomol.* 24: 1-9.

Wood, D. L. , Vité, J. P., 1961. Studies on the host selection behavior of *Ips confusus* (LeConte) (Coleoptera: Scolytidae) attacking *Pinus ponderosa*. *Contrib. Boyce Thompson Inst.*, 21, 79-96.

Wood, D.L., 1962. Experiments on the interrelationship between oleoresin exudation pressure in *Pinus ponderosa* and attack by *Ips confusus* (LeC.) (Coleoptera: Scolytidae). *Can. Entomol.*, 94, 473-7.

An Investigation on Decline of Scots Pine (*Pinus sylvestris* L.) in Kastamonu Kadıdađı Recreation Site

*Sabri ÜNAL¹, Mertcan KARADENİZ¹, Erol AKKUZU¹, Ömer KÜÇÜK¹,
Özkan EVCİN¹, Abdullah UĞIŞ¹

¹Kastamonu University, Faculty of Forestry, Kastamonu / TURKEY

*Corresponding Author: sabriunal@kastamonu.edu.tr

Abstract

Field studies was carried out at various dates since September 2014 to investigate the causes of decline of Scots pine (*Pinus slyvestris* L.) in Kastamonu Kadıdađı recreation site that occurred in 2013 and 2014. In field examinations, crown declining, weak canopy, resin flows on trunks on old trees and yellow discoloration of needles on young Scots pine was observed in the study area. Also resin flows were observed on stems. Samples taken from needles, trunk, and root was examined in the laboratory. Pests and disease agents that can cause decline in the area were studied to determine the results.

After determining the cause of the mortality is not about drought studies concentrated towards soil properties, climate conditions and pests and disease pathogens. Intensive use of the area, causing the degradation of soil compaction and soil infiltration capacity. The results of inability to penetrate into the soil of rain water and maximum water needs of trees in spring and summer could lead trees to weakening. Insect and fungal pathogens which are penetrated to weakened trees are determined. Blue stain fungus, are seen in trees which are weakened by *Phellinus pini* and *Armillaria* fungi. The increasing damage of seconder harmful insects such as bark beetle (Scolytidae), longhorn beetles (Cerambycidae) and wood wasps (Siricidae) draws attention under the influence of this fungus.

Keywords: Kadıdađı recreation site, *Pinus slyvestris*, Pest and diseases, Kastamonu.

Kastamonu Kadıdađı Mesire Alanında Kuruyan Sarıçamlar (*Pinus Sylvestris* L.) Üzerine Bir Araştırma

Özet

Arazi çalışmaları, Kastamonu Kadıdađı mesire alanında 2013 ve 2014 yıllarında meydana gelen sarıçam (*Pinus slyvestris* L.) kurumalarının nedenlerini araştırmak için Eylül 2014'ten bu yana çeşitli tarihlerde gerçekleştirilmiştir. Arazi çalışmalarında yaşlı ağaçlarda tepelerin kuruması tepe taçlarının zayıf olması ve gövdelerinde reçine akıntısı ayrıca genç sarıçamlarda ibrelerde sarı renk değişikliği görülmüştür. Ayrıca ağacın dip kısımlarında da reçine akıntısı görülmüştür. İbrelerden, gövdeden ve köklerden örnekler alınmış ve laboratuvarında incelenmiştir. Ağaçlarda kurumaya neden olan zararlılar ve hastalıklar sonuçlar için incelenmiştir.

Ağaçlardaki ölümlerinin nedeninin kuraklıktan kaynaklanmadığı tespit edildiğinde çalışmalar toprak özellikleri, iklim özellikleri ve zararlılar ve hastalıklar üzerine yoğunlaşmıştır. Alanın yoğun olarak kullanılması sonucu alandaki toprağın kompaktlaşmasına ve su geçirgenliğinin azalmasına sebep olmuştur. Yağmur sularının toprak altına geçmemesi ve yazın ve ilkbaharda ağaçların maksimum su ihtiyacına sahip olması onların zayıflamalarına neden olmuştur. Zayıflayan bu ağaçlara giren böcekler ve fungal patojenler tespit edilmiştir. Mavi renklenme mantarı, *Phellinus pini* ve *Arm.illaria* mantarları tarafından zayıflatılan ağaçlarda görülmektedir. Kabuk böcekleri (*Scolytidae*), Teke böcekleri (*Cerambycidae*) ve odun arıları (*Siricidae*) gibi ikincil zararlı böcekler bu mantarın zayıflatmış olduğu ağaçlarda daha çok görülmeye başlamaktadır.

Anahtar Kelimeler: Kadıdađı mesire alanı, *Pinus slyvestris*, Zararlılar ve hastalıklar, Kastamonu.

Introduction

People who are in efforts to meet the physical and mental needs, are turning to recreation areas in order to regain their energy and lose their leisure with their social, cultural, economic and physiological opportunities. Therefore, urban recreation

sites which ensure to meet the needs of city people, are gaining importance in this direction (Şimşek ve Korkut, 2009). Especially nature parks are seen as the most suitable places for outdoor recreation activities. Natural parks with different natural resources offers users many options. With

these features, nature parks provide positive contributions to people in both physically and psychologically (Çalık et al., 2013). These events are taking place in natural areas, can cause the deterioration of the natural environment, lead to contamination and damage in various ways (Karaküçük, 1995).

The trampling is one of the effects that seen where nature visits occur. While consequences of trampling disturbance vary by the type of environment; vegetation is a significant indicator representing the form and degree of human-nature relation including recreation use (Atik et al., 2009).

Kastamonu is one of the important city that need of protection because of its high biodiversity and cultural values (Şen and Buğday, 2015).

In recent years, Scots pines (*Pinus sylvestris* L.) were dead in Martyrs Şerife Bacı Natural Park where located in Kastamonu. Drought is not mentioned in Kastamonu, according to recent 10-year average weather. However Martyrs Şerife Bacı (Kadıdağı) Picnic site has an average of 2000 people a day for recreational activities, especially in summer. This situation can lead to negative consequences such as increased surface water flow and soil become compact so tree roots can't benefit from water. In this study, the causes of deaths of Scots pines in the area has been determined.

Materials and Methods

Field work was carried out on different dates since September 2015 to investigate the causes of mortality in *Pinus slyvestris* in Martyrs Şerife Bacı Natural Park. As required by nature conservation approach, first, mortality of trees was examined that it originates from drought or soil characteristics. In this situation providing dead trees left in place and they may be left to their natural development. However,

mortality of trees due to especially harmful nematodes, bacteria, viruses, or in case of fungal pathogens, dead trees must be removed from the area immediately in order to protect the healthy trees.

Materials

Martyrs Şerife Bacı Natural Park where field work carried out take place in Kadıdağı in Kastamonu province and size of area is 10 ha. Park was established on 11.07.2011 general geographic location, North: 4.571000, East: 566000 South: 4569000 and the West: it is 565000. It is near Kastamonu-Çankırı highway (12 km from Kastamonu Center) and approximately 700 m above from sea level (Figure 1).

Main plant species in the park are Scots pine (*Pinus sylvestris*) and pine (*Pinus nigra*). You can see mammals such as bear, wolf, rabbit, hedgehog, wild boar, marten, weasel, roe deer, foxes, squirrel, the birds such as woodcock, quail, falcon, owls, the crow, wood pigeon and reptiles like snakes, turtles and lizards. (Anonymous, 2016).

Methods

In this study, climatic characteristics were investigated, soil characteristics were examined and were evaluated in terms of pests and diseases in order to determine the cause of the mortality of trees. In order to investigate the climatic characteristics of Kastamonu last 10 years' average annual precipitation, annual mean temperature, annual average relative humidity values that taken from the meteorology directorate were compared with annual ring development of trees. Evaluations have been made about the physical condition and soil properties according to physical observation and results of the analysis obtained from soil samples in order to determine the soil characteristics. For the research in terms of pests and diseases, samples taken from needles, stems and roots are examined in the laboratory.

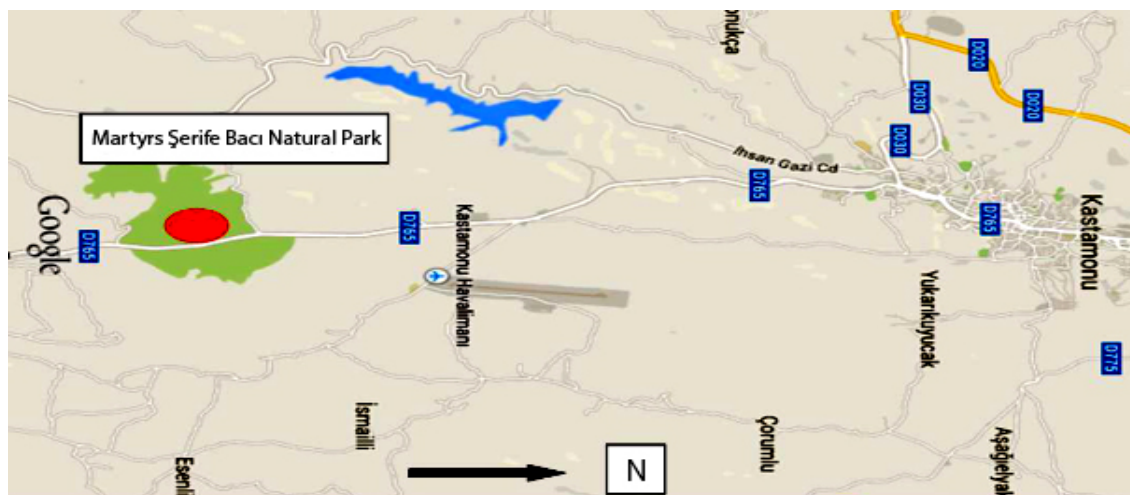

Figure 1. Martyrs Şerife Bacı Natural Park (Anonymous, 2016)

Results

Data obtained in terms of climate properties

According to recent 10-year average drought is not mentioned in Kastamonu drought, despite summer drought is seen at June, July, August and September in long years average (Table 1,2). Development annual growth rings measured with the help of in Digimizer program and according to that no abnormalities is seen. After counting the annual rings, ages of dead pine trees have

been identified that 70 and 100. After determining the cause of the mortality is not about drought studies concentrated towards soil properties, silvicultural intervention and pests and disease pathogens. Mortality occurred in Scots pines that have 20-40 cm breast-height diameter. It is determined that 32 of 112 dead trees, were standing dead trees in other words 28.5% of dead trees were standing dead trees.

Table 1. Kastamonu province last 10 years' average annual precipitation, annual mean temperature, annual average relative humidity values

	Ann. Precip.	Mean Temp.	Mean Hum.	Annual ring width (mmx100)
2003	31,65	18,23	65,14	34,8
2004	73,66	9,63	67,01	43,5
2005	80,62	10,2	66,86	76,4
2006	53,7	10,03	64,79	74
2007	39,23	13,38	60,48	70,9
2008	45,78	18,54	69,2	64,8
2009	109,65	10,01	73,4	108,4
2010	121,29	11,44	72,69	126,5
2011	88,38	9,32	72,18	70,8
2012	76,35	10,38	69,32	104,3

Table 2. Graphical representation of the relations between the development annual rings average rain, annual average temperature and annual average relative humidity

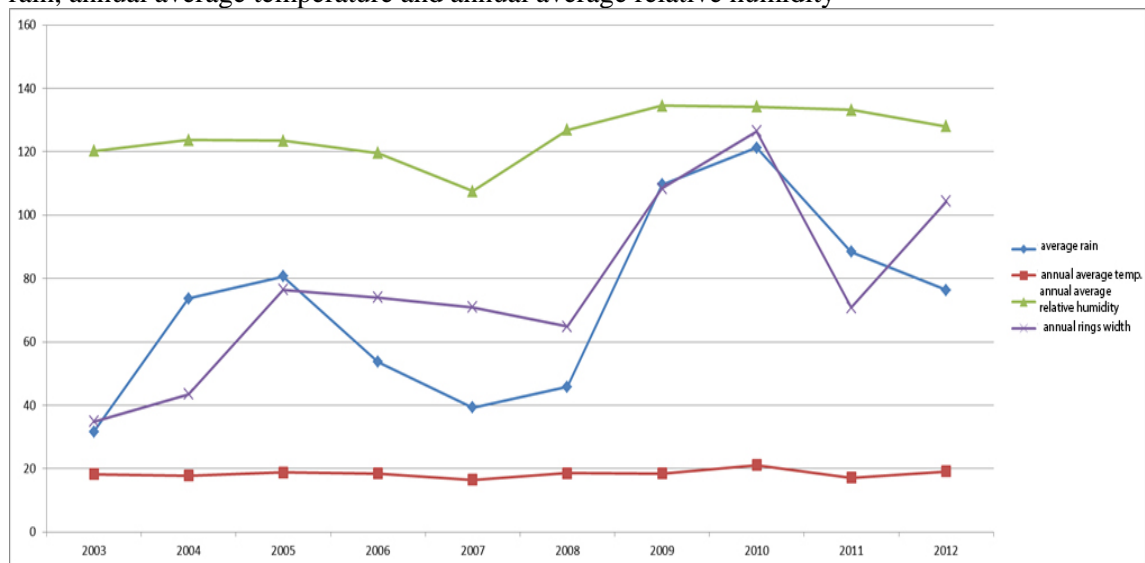

Data obtained in terms of soil properties

In the field, 4 soil samples were taken where mortality was seen and evaluated. In addition 2 soil samples were taken where away from dead trees and aimed compare the characteristics of the soil where trees were dead. Field was also examined by evaluating the soil in terms of soil compaction.

In the field; the soil usually have a high clay content, especially in the upper layers have fine-textured soil, sub layer has the coarse-textured soils. Especially it was determined that stone rate was increased when went down to the lower layer of soil profile.

In the examination of the soil profile and the field, the soil compaction has been very high due to the intensive use of land in the picnic area, but in non-used areas, no soil compaction has seen. In this case, it is considered to result from densely visit of the people especially in spring and summer. In the days of the visit human activities and use of vehicles have been identified that they may cause soil compaction in the picnic area.

Data obtained in terms of pests and diseases

Poor canopy, resin leaks at the bottom of the tree trunk was observed in the area where the studies performed. The yellow

discoloration on the needles of young Scots pine is noted. The resin leaks at the bottom of the tree and fluid formation was noted in this section. Samples taken from needles, stems and roots of dead trees are examined in the laboratory.

On the trunk wood wasp (*Xeris spectrum* (Linnaeus, 1758)), bark beetle holes, larvae and adults of long-horned beetle (*Rhagium inquisitor* (Linnaeus, 1758)), were determined.

Xeris spectrum is a conifer wood wasp species that damage trees in the forest. It distributes in Europe, Asia, Africa and North America. They are usually seen in dead or new fallen conifers (Fukuda and Hijji, 1997).

Rhagium inquisitor spreads in Europe, North Asia and North America and larvae do damage in the wood. It can cause harm on *Pinus*, *Picea*, *Abies*, *Larix* species (Friedman et. al, 2008).

In addition, fungi and nematodes are found in the bark in field and laboratory investigations. There are also symptoms of *Armillaria* sp., *Phytophthora* spp., *Ophiostoma* spp.. Fruiting body of *Phellinus pini* Bondartsev & Singer, (1941) on the trunk has been seen.

Armillaria species are located mostly in the roots and lower trunks of conifers and deciduous trees. This fungi, cause wood rot, the reduction of development and sudden death tree (Coetzee et. al., 2001).

Phytophthora species are pathogens that cause damage root of many woody and herbaceous plants in the world. Symptoms of this pathogen can be confused with high temperature and drought losses (Çanakçioğlu and Eliçin,1999).

Phellinus pini shows distribution in Europe and North America and do harm on *Pinus sylvestris*, *P. nigra*, *P. brutia*, *Abies cilicica*, *Cedrus libani* and *Picea orientalis* in our country. It can damage the wood and makes the tree vulnerable to winds (Çanakçioğlu and Eliçin,1999).

Ophiosto species are spread by insects and cause on blue stain on conifers (Nkuekam et al., 2011).

Conclusions and Suggestions

People that living in cities involved in rural recreational because of wishes to see different places and reasons of the lack of green spaces. Especially because of its owned natural, cultural and visual values, forest areas are one of the most preferred outdoor recreational resources (Atken, 2003). This recreational activities performed in nature brings with it a number of environmental problems as well. The effects of these activities in natural areas may be positive or negative depending on the significance of the changes caused by the activity and its size (Turton, 2005).

In this study, the causes of deaths of Scots pines in Kastamonu Martyrs Şerife Bacı Natural Park has been evaluated for climate, soil characteristics, diseases and pests.

According to recent 10-year average drought is not mentioned in Kastamonu drought, despite summer drought is seen at June, July, August and September in long years average. The investigated area also in the lower border of Scotts pine distribution. Distribution in such limits associated with climate change and summer droughts greatly affect populations and weakened populations can damage by other biotic and abiotic factors.

In the assessment made in terms of soil properties; high soil compaction has seen due to the high use in areas, consequently barred from water movement within the soil profile and rain waters can not penetrate into the soil because intense usage. Intensive use of the

area, causing the degradation of soil compaction and soil infiltration capacity. The results of inability to penetrate into the soil of rain water and maximum water needs of trees in spring and summer could lead trees to weakening.

Insect and fungal pathogens which are penetrated to weakened trees are determined. *Phellinus pini* that identified on Scots pine is one of a dangerous fungus that causes serious stem rot. In addition, blue stain fungus, are seen in trees which are weakened by *Phellinus pini* and *Armillaria* fungi. The increasing damage of seconder harmful insects such as bark beetle (Scolytidae), longhorn beetles (Cerambycidae) and wood wasps (Siricidae) draws attention under the influence of this fungus. So a chain damage effect on the trees in the area is observed.

In the field and laboratory investigations, intense mortality of trees is observed in the area, it is understood that the reason of mortality isn't due to the dry climate in other words that is not originate from drought, there can be a physiological drought and the primary damage made by fungi and nematodes, the secondary damage made by insects.

For this reason, in the first stage 32 standing dead trees are considered to remove from area in order to prevent spread of disease to healthy trees. Then plantation of seedlings of deciduous trees that suitable to the local climate will be made in the proper areas.

Acknowledgment: We wish to thank to Kastamonu Directorate of Meteorology, the manager of natural park Saim ATASOY, Kastamonu Forest Directorate - Central forest management, Nature Conservation and National Parks General Directorate of Kastamonu province branch management.

References

- Anonim,2016.(http://bolge10.ormansu.gov.tr/10bolge/AnaSayfa/Korunan_Alanlarimiz/tabiatparki/sehit-serifebaacitabiatparki.aspx?sflang=tr)
- Atik, M., Sayan, S., ve Karagüzel, O., (2009), „Impact of Recreational Trampling on the Natural Vegetation in Termessos National Park“, Antalya-Turkey, *Tarım Bilimleri Dergisi*, Cilt: 15, Sayı: 3, Sayfa: 249-258.

Atken, M., (2003), „Isparta İlindeki Bazı Rekreasyon Alanlarının Mevcut Potansiyellerinin Belirlenmesi“, *Süleyman Demirel Üniversitesi Orman Fakültesi Dergisi*, Seri: A, Sayı: 2, ISSN: 1302-7085, Sayfa: 115-132.

Coetzee, M.P.A., Wingfield, B.D., Harrington, T.C., Steimel, J., Coutinho, T.A. And Wingfield, M.J., 2001. Blackwell Science, Ltd The root rot fungus *Armillaria mellea* introduced into South Africa by early Dutch settlers. *Molecular Ecology* (2001) 10, 387–396

Çanakçıoğlu, H., Orman Entomolojisi Genel Bölüm. İstanbul Üniversitesi: Orman Fakültesi yayınları Rektörlük no: 3405, Fakülte no:382 İstanbul, 1989

Çanakçıoğlu, H. and Mol, T.. Orman Entomolojisi Genel Bölüm. İstanbul Üniversitesi: Orman Fakültesi yayınları Rektörlük no: 4155, Fakülte no:455 İstanbul, 1998

Çanakçıoğlu, H. and Eliçin, G.. Fitopatoloji Genel Bölüm. İstanbul Üniversitesi: Orman Fakültesi yayınları Rektörlük no: 4064, Fakülte no:452 İstanbul, 1999

Çalık, F., Başer, A., Ekinci, N.E. Ve Kara, T. Tabiat Parklarının Sportif Rekreasyon Potansiyeli Modellemesi (Ballıkayalar Tabiat Parkı Örneği). *Spor Yönetimi Ve Bilgi Teknolojileri Dergisi* ISSN: 1306-4371 CİLT:8 SAYI:2 2013 (ELEKTRONİK DERGİ).

Friedman, A.L.L., Rittner, O., Chikatunov, V.I., 2008. Five New Invasive Species of Longhorn Beetles (Coleoptera: Cerambycidae) in Israel. *Phytoparasitica* 36(3):242-246

Fukuda, H., Hijii, N., 1997. Reproductive strategy of a woodwasp with no fungal symbionts, *Xeris spectrum* (Hymenoptera: Siricidae). *Oecologia* (1997) 112: 551-556

İnan, M. and Hızal, E., 2011. Zararlı böceklerin dağılımlarının GIS destekli haritalanması: İstanbul Orman Bölge Müdürlüğü Bahçeköy İşletmesi Örneği. *Türkiye I. Orman Entomolojisi ve Patolojisi Sempozyumu 23-25 Kasım 2011, Antalya*, p.179-183

Karaküçük, S., (1999), „Rekreasyon Boş zamanları Değerlendirme“, Bağırhan Yayınları, 3. Baskı, Ankara.

Nkuekam, G.K., de Beer Z.W., Wingfield, M.J., Mohammed, C., Carnegie, A.J., Pegg, G.S., Roux, J., 2011. *Ophiostoma* species (Ophiostomatales, Ascomycota), including two new taxa on eucalypts in Australia. *Australian Journal of Botany*, 2011, 59, 283–297

Oskay, F., Lehtijarvi, A. And Doğmuş-Lehtijarvi, H.T., 2011. Göller Bölgesi Konifer Ağaç Türlerinin Yeşil Aksamlarında Görülen Fungal Etmenler. *Türkiye I. Orman Entomolojisi ve Patolojisi Sempozyumu 23-25 Kasım 2011, Antalya*, p.51-55

Selik, M.. Ormancılık Fitopatolojisi. İstanbul Üniversitesi: Orman Fakültesi yayınları Rektörlük no: 3400, Fakülte no:377 İstanbul, 1986

Şen, G. & Buğday, S.E. (2015). Kastamonu İlinde çeşitli statülerde koruma ve kullanma amaçlı belirlenmiş alanlar. *Kastamonu Üniversitesi Orman Fakültesi Dergisi*, 15(2), 218.

Şimşek D. S., ve Korkut A. B., (2009), „Kıyı Şeridi Rekreasyon Potansiyelinin Belirlenmesinde Bir Yöntem: Tekirdağ Merkez İlçe Örneği“, *Tekirdağ Ziraat Fakültesi Dergisi*, Cilt: 6, Sayı: 6, Sayfa: 316-327.

Turton, S.M., (2005), “Managing Environment Impacts of Recreation and Tourism in Rainforests of the Wet Tropics of Queensland World Heritage Area”, *Geographical Research*, Cilt: 43, Sayı: 2, Sayfa: 140 – 151

Ecological Features and Distribution Areas in Turkey of *Quercus robur* L.

*Fatmagül GEVEN¹, Ebru ÖZDENİZ¹, Kerim GÜNEY², Latif KURT¹

¹Ankara University, Faculty of Science, Ankara / TURKEY

²Kastamonu University, Faculty of Forestry, Kastamonu / TURKEY

*Corresponding Author: geven@science.ankara.edu.tr

Abstract

Quercus, which has about 450 species in the world, belongs to **Fagaceae** family and has 18 species in Turkey. Four oak species *Quercus aucheri*, *Quercus vulcanica* and *Quercus macranthera* subsp. *syspirensis*, *Quercus petraea* subsp. *pinnatiloba* are endemic for Turkey. Taxonomical classification, ecological characteristics and distribution areas of oak species in Turkey is not clear as desirable as. There is a big variation in their ecological and morphological characters and hybridization with each other. Oaks; The anatomical structure of the wood, the fruit ripening period, according to the leaves and bark characteristics, they are divided into 3 sections. This section are as follows; white oaks (Section: *Quercus*), red oaks (Section: *Cerris*) and Evergreen oaks (Section: *Ilex*). *Quercus robur* is a member of the white oak section. There is two subspecies of *Quercus robur* distributed in Türkiye. One of them is *Quercus robur* subsp. *robur* which exists in North-western Anatolia, Thrace, Marmara, Central Anatolia and Southern Anatolia; Second one is *Quercus robur* subsp. *pedunculiflora* that has less distribution area. It exists in Eastern and South-eastern Anatolia. This species naturally distributed from 100-1800 m altitude in Turkey. *Q. robur* is usually found on nutrient rich soils prone to temporary water-logging. *Q. robur* populations were located in semihumid to arid climate types. These populations form Turkey's pure and mixed forests. Oak forest consist the 22.4 % of general Turkish forest area. Turkey is one of the most important region of the world according to oak species number and variation. Oak genus is very important economically. They have been used for many purposes, such as wood, fuel wood, nonwood products, grazing, medicinal plant, edible nuts for humans, tannins mainly as an antiseptic, handicrafts and etc. In this study, Taxonomical classification, ecological characteristics and distribution areas of *Quercus robur* L. in Turkey will be discussed and some suggestions will be made.

Key Words: *Quercus robur*, Oak, Forests, Distribution area, Turkey

Özet

Quercus, dünyada 450 Türkiye'de 18 tür ile temsil edilmekte olup **Fagaceae** familyasına üyesidir. species *Quercus aucheri*, *Quercus vulcanica* and *Quercus macranthera* subsp. *syspirensis*, *Quercus petraea* subsp. *pinnatiloba* olmak üzere 4 meşe türü Türkiye için endemiktir. Türkiye'deki meşe türlerinin taksonomik sınıflandırması, ekolojik özellikleri ve yayılış alanları açıkça belirlenmemiştir. Birbirleri arasında ekolojik ve morfolojik karakterler açısından büyük varyasyon bulunmaktadır. Meşeler; odunun anatomik yapısı, meyve olgunlaşma dönemine, yapraklar ve ağaç kabuğu özelliklerine göre üç seksiyona ayrılır. Bu seksiyonlar beyaz meşeler (Seksiyon: *Quercus*), kırmızı meşeler (Seksiyon: *Cerris*) ve herdem yeşil meşelerdir (Seksiyon: *Ilex*). *Quercus robur* beyaz meşe seksiyonunun bir üyesidir. *Quercus robur*'un Türkiye'de dağılım gösteren iki alttürü bulunmaktadır. Bunlardan ilki *Quercus robur* subsp. *robur*, Kuzey-Batı Anadolu, Trakya, Marmara, İç Anadolu ve Güney Anadolu'da yayılış gösterirken; ikinci alttür olan *Quercus robur* subsp. *pedunculiflora*' un yayılışı daha dardır. *Q. robur* subsp. *pedunculiflora* Doğu ve Güneydoğu Anadolu'da yayılış gösterir. Bu türler Türkiye'de doğal olarak 100-1800 m yükseklikte dağılış gösterir. *Q. robur* genellikle tutma özelliğinde olan besin maddesi bakımından zengin topraklarda bulunur. *Q. robur* yarıkurak ve kurak iklimlerde bulunmaktadır. Bu populasyonlar Türkiye'nin saf ve karışık ormanlarını oluşturur. Meşe ormanı genel Türkiye orman alanının %22.4'ünü oluşturmaktadır. Türkiye, meşe türleri sayısı ve varyasyon bakımından dünyanın önemli bölgelerinden biridir. Meşe, ekonomik değeri çok önemli olan bir cinstir. Bunlar odun, yakacak odun, odun dışı ürünler, otlama, tıbbi bitki, insanlar için kuruyemiş, özellikle antiseptik tanenler olarak, el sanatları gibi birçok amaç için kullanılmaktadır. Bu çalışmada, *Quercus robur* L.'un Türkiye'de taksonomik sınıflandırması, ekolojik özellikleri ve yayılış alanlarını tartışılacak ve bazı önerilerde bulunulacaktır.

Anahtar kelimeler: *Quercus robur*, meşe, orman, yayılış alanı, Türkiye

Introduction

Quercus robur L. (Synonyms: *Quercus pedunculata*), commonly known as the pedunculate oak is a species of flowering plant in the beech and oak family Fagaceae, it is native most of Turkey (Yaltrık, 1984). *Quercus* L. is one of the most important woody genera due to its ecological and economic value and contains about 400 species in several sections distributed across five continents. For example, oaks are important for wood and paper production and are associated with a large diversity of insect and fungal communities (Yücedağ and Gailing, 2013). Turkey has 21 188 747 hectares of forested area. Classified by the species type and the area covered, oaks (*Quercus* sp.) takes the lead with many species and 6 476 277 hectares (URL₁, 2012). *Quercus robur* L. appears almost all over Europe, from the Atlantic Ocean to the Urals, from Norway to the Iberian Peninsula and Italy, with its southern border on Sicily (Rodriguez-Campos, 2010) and it appear in Turkey (Davis, 1965-1988; Hedge and Yaltrık, 1982). The best stands are on the B7, B8, B9, C8, C9, A1, A2, A4, A5, B3, B4, B5, B6, C4 and C5 and on Turkey large areas (Hedge and Yaltrık 1982).

In this study, Taxonomical classification, ecological characteristics and distribution areas of *Quercus robur* L. in Turkey will be discussed and some suggestions will be made.

Material and Methods

The materials of the study were collected from Turkey during excursions between 2013 and 2016. It has also benefited from various studies (Copolovici et al., 2014; Yücedağ and Gailing 2013; Khela, 2012; Rodriguez-Campos, 2010; Kavgacı et al., 2010; Mamikoğlu, 2012; Şöhretoğlu and Sakar 2004; Yaltrık, 1984; Davis, 1982; URL₁, 2012; URL₂, 2016; URL₃, 2016; URL₄, 2016). *Q. robur* around the world were given a map of the distribution area (URL₂, 2016), (Figure 1). The geographical distributions of Turkish oaks with *Q. robur* was analyzed using Grid system (Davis 1965-1988, Hedge and Yaltrık 1982), (Figure 2, Figure 3). In addition, photos were taken (Figure 4, Figure 5). *Q. robur*' s

Taxonomy, the common name, the Turkish name, cultivated samples, conservation status, ecological characteristics, usage areas, the role of biodiversity, Hazards, Diseases, Trade has been described. *Q. robur* was also the illustration (Figure 18).



Figure 1. Distribution map of *Quercus robur* L. in the world (URL₂, 2016)

Results and Discussion

Taxonomy

Class: Equisetopsida

Subclass: Magnoliidae

Superorder: Rosanae

Order: Fagales

Family: Fagaceae

Genus: *Quercus*: Genus *Quercus* can be deciduous or evergreen trees or shrubs, with entire, lobed or toothed leaves; flowers inconspicuous, followed by characteristic acorns; sometimes good autumn colour (Figure 4), (URL₂, 2016). Europe, Anatolia and the Caucasus, find common natural habitats. It is long-lived, live 1000 years (Figure 5, Figure 6), (Mamikoğlu, 2012). Ground water in the forest on the slopes in the foothills of the high plains found in the streams. located in small groups or individually. as pure forests can not make (Yaltrık, 1984). Across Europe, in Turkey and the Caucasus, there is a wide spread. There are two subspecies in Turkey.

Scientific name: *Quercus robur* L.

Description: Details *Q. robur* is a large deciduous tree developing a magnificent, broad crown, the leaves with shallow, rounded lobes, turning reddish-brown in autumn. (URL₂, 2016). Distinguishing Features - Leaves: alternate, 5 - 12 cm long with 6 to 14 shallow, rounded lobes; color, dark green, olive green or blue-green; leaf base is ear-shaped or auriculate; leaves

remain green late into autumn. Young leaves are light green in colour (Figure 8, Figure 9, Figure 10), Flowers: monoecious, male flowers are yellow-green catkins. Fruit: small elongated acorns 1 - 1.5 cm wide and 1.5 - 2.5 cm long, borne singly or in clusters up to five. (Figure 11), Seeds are collected or not collected on folding planted in the spring. Can invade below an upper tree seedlings (Figure 12). Bark: dark-brown to almost black, ridged and furrowed (Figure 7), There is a strong root condition. Deep in the root system develops. (Hedge and Yaltrık 1982).

Geographic analyses: *Quercus robur* is native to Asia Minor (an area corresponding to the western two-thirds of Turkey), North Africa, the Caucasus (a geopolitical region at the border of Europe and Asia) and Europe (URL3, 2016). Distribution of oaks was typically between 0 and 2000 m altitudes over Turkey. A few *Quercus* species show a distribution relevant to the phytogeography and the Anatolian Diagonal at subspecies level. *Quercus robur* subsp. *robur* scattered on the western side of the diagonal whereas subsp. *pedunculiflora* Menitsky found at the eastern side (Uslu and Bakış, 2012). *Quercus robur* L. (Pedunculate Oak) is two subspecies in Turkey; *Quercus robur* subsp. *pedunculiflora* (K. Koch) Menitsky and *Quercus robur* subsp. *robur* L.

Quercus robur subsp. *pedunculiflora*: Leaves 2 cm long stalked the sinuses very narrow, very thick and short fruit stalk is 2-6 cm in length. Eastern and Southeastern Anatolia (Tunceli, Erzincan, Bingöl, Muş, Bitlis, Van and Hakkari in the region) show the geographical distribution.

Quercus robur subsp. *robur*: Leaves almost sessile, sinuses are quite large, elongated fruit stalk is 4-10 cm in length. Northwest Anatolia, Thrace, Marmara, Central Anatolia, East Anatolia, has a wide distribution (Yaltrık, 1984).

Q. robur subsp. *pedunculiflora* and *Q. robur* subsp. *robur* and their distributions, according to Flora of Turkey (Davis, 1982), (Figure 2, Figure 3).

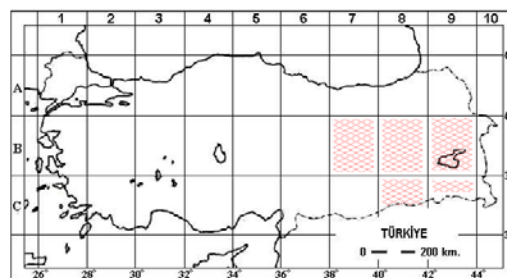

Figure 2. Distribution map of *Quercus robur* subsp. *pedunculiflora* (K. Koch) Menitsky

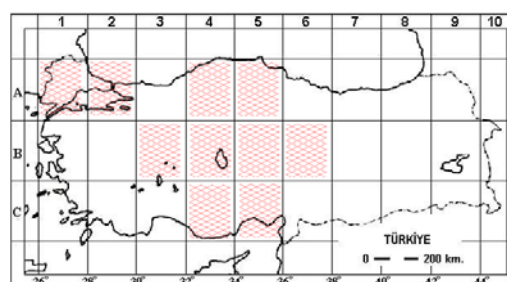

Figure 3. Distribution map of *Quercus robur* subsp. *robur* L.



Figure 4. *Quercus robur*

Common name: English oak, pedunculate oak, common oak, European oak, oak, oak tree, truffle oak.

Turkish name: Saplı meşe, yaz meşesi.



Figure 5. Large pedunculate oak (*Quercus robur*) in Turkey



Figure 8. Young branch with buds in leaf forks

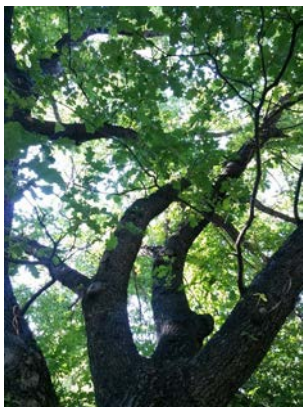

Figure 6. Habitat of old *Quercus robur*



Figure 9. Close-up of leaf undersides



Figure 7. Bark on main trunk



Figure 10. Young leaves are light green in colour



Figure 11. Young fruit beginning to develop

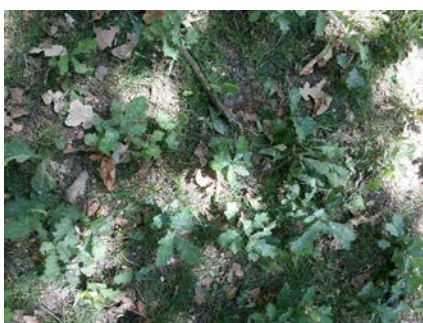

Figure 12. Infestation of seedlings under a parent tree

Cultivar: Important cultivars of *Q. robur* (cv) in European parks and gardens:

- *Q. r. cv. Atropurpurea*: Red oak leaves are stalked. Very slow-growing, young shoots and leaves are bright red.

- *Q. r. cv. Concordia*: Altuni oak. Slow growing trees is a small round tip. golden colored leaves in spring and summer.

- *Q. r. cv. Cristata*: The leaves are deeply lobed.

- *Q. r. cv. Fastigiata*: Cypress oak. Minor rose parallel are stuck to the body.

- *Q. r. cv. Fastigiata Purpurea*: The red oak leaf of Cypress. Redness will continue throughout the season.

- *Q. r. cv. Pendula*: Necklaces oak. It is a small tree branches that hang down.

- *Q. r. cv. Variegata*: The leaves are yellowish-white moon mottled (Yaltırık, 1984).

Conservation status: Least Concern (LC) according to IUCN Red List criteria (Figure 13).



Figure 13. Conservation status of *Q. robur* : Least Concern (IUCN 3.1)

Habitus: The Common Oak is a long-living species; some trees have been known to live over 1,000 years. Length-Width: 30-40. up sorting it makes 2 m in diameter. Oak, large, oval crown of a tree and looking messy. Crown of the oak tree are oval appearance, wide and scattered (Figure 14).

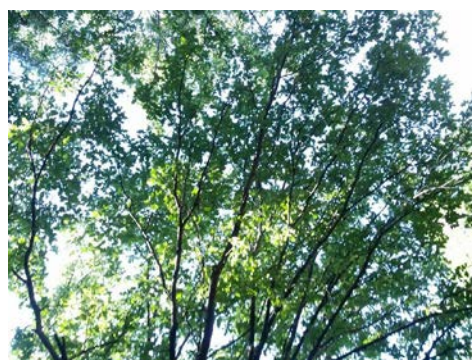

Figure 14. Habitat of *Quercus robur*

Habitat: Live in sunny places. and powdery mildew on the leaves in humid climates may fungus problems. Usually found in mixed forests; prefers basic, well-drained, fertile soils, including heavy soils; tolerant of city conditions. In the turkey, oaks are conspicuous members of the temperate deciduous forests (Figure 15), (Kavgacı et al., 2010).

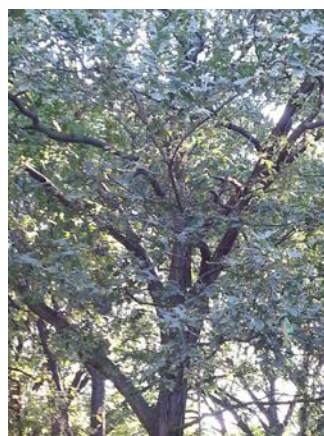

Figure 15. Habitat of *Quercus robur*

Ecology: Heavy soil (containing clay or silt loam soils), including pH 4.5 - 7.5 in the fertile land values. In general, the average rainfall is 350 mm above the high water-holding capacity, soil containing clay is usually enough. Groundwater levels are high places, prefer running water filling valleys and fields. not like ridges. It can be grown in wet and humid places. Older trees are quite resistant to flooding. It can be grown in dry and arid sandy soil. Deciduous forests are often seen alluvial fields, stepper, the creek edge.

Q. robur subsp. *pedunculiflora* and *Q. robur* subsp. *robur* are able to behave as pioneer trees, the acorns possessing large reserves and able to survive amongst grasses whilst developing sufficiently deep roots to allow rapid shoot growth. As these trees do not come into leaf until relatively late in the year (late April to early May), late frost damage is rarely a problem, unless the temperatures reach -3°C killing new foliage. Sustained temperatures below -6°C in winter can kill acorns, despite the epicotyl requiring some chilling to break its dormancy. Both oaks have a good re-sprouting aptitude, so they coppice and pollard easily. Their deep and penetrating taproots give them structural stability against windthrow and allow them to withstand moderate droughts by accessing deeper water. However, in conditions far from their optimum, they show ecological differences (Eaton et al., 2016).

Role in biodiversity: *Quercus robur* supports a wealth of organisms which benefit from the food, support and shelter it supplies. An abundance of insects live on the leaves, buds and bark, and even inside the acorns. The green oak moth feeds on oak leaves in its larval (caterpillar) form and then rolls itself up in a leaf to pupate into the adult. Gall wasps lay their eggs inside the oak leaves, where their larvae then secrete a chemical causing the leaf to mutate and form a gall (oak apple), providing them with protection and shelter – though not enough to prevent them from being parasitised by other species of ichneumon wasp. Birds such as great-spotted woodpeckers come to feed on insects in the bark. The decaying wood can host a vast array of fungi and the hollow

trunks provide roosting sites for owls and hibernation sites for bats (URL4, 2016).

Uses: Oak timber is of great importance for wood production and is strong, hard and extremely durable. It has many uses but is mostly used for its hardwood in construction, building ships, making furniture and as veneer and plywood (Khela, 2012).

Lift and learn how different parts of the English oak have been used throughout the ages. English oak leaves have been used as symbols of courage, strength, and honor in many cultures. The oak leaf wreath shown here came from a burial site in the Dardanelles (modern Turkey) from the 4th Century BC. Ink made from oak galls (round growths caused by insects) was the standard writing and drawing ink in England and the rest of Europe from about the 12th century to the 19th century, and remained in use well into the 20th century. English oak wood has been used to make wine barrels for centuries for its water-tight properties. Aging wine in oak barrels can affect its flavor, color and texture. The tannic acid found in oak bark was the original substance used to tan (preserve) leather, such as that used to make saddles (URL4, 2016).

Trade: The traditional herbal medicinal product is used for symptomatic treatment of mild diarrhoea and minor inflammation of the oral mucosa or skin. Herbal preparations are made from the comminuted herbal substance, decoction, infusion, dry extract and powdered herbal substance present in combination products and in food supplements. In the European Pharmacopoeia, it is described as the cut and dried bark of young branches and the lateral shoots which contain tannins. Its use is regulated in Belgium, France, Germany (Khela, 2012). *Q. robur* the aqueous extract of bark is reported to possess high antioxidant activity. containing polyphenols and tannins derived from the shells which could then be used in preparations used in hair and skin care compositions of the extracts (Şöhretoğlu and Sakar 2004).

Hazards: Tannic acid in the leaves is poisonous to horses if consumed in excess, damaging the kidneys. Acorns are poisonous to horses and cattle, though swine can

consume them safely in moderation (URL3, 2016).

Diseases: Pedunculate oak (*Quercus robur*) is the most susceptible species to infections of powdery mildew caused by *Erysiphe alphitoides*. In fact, powdery mildew caused by *E. alphitoides* is one of the major foliar diseases of *Quercus robur* in Europe that can significantly reduce tree growth and trigger tree decline. Although powdery mildew infection constitutes an important stress in *Q. robur*, physiological responses to powdery mildew infection have been studied only in a few cases. It has been demonstrated that *Erysiphe alphitoides* infection decreases net assimilation rates and stomatal conductance, and reduces the rate of isoprene emission (Copolovici et al., 2014), (Figure 16, Figure 17).



Figure 16. Oak (*Quercus robur*) leaves with an infection



Figure 17. Oak (*Quercus robur*) leaves with an infection



Figure 18. Illustration of Oak (*Quercus robur*)

Conclusion

The geographical distributions of *Q. robur* was analyzed using Grid system. Although this species suffers from habitat decline and diseases, it has a widespread Turkey distribution and is included in protected areas in parts of its range. It is therefore listed as Least Concern. These results clearly show that pedunculate oak does not have any risk.

Acknowledgments

We thank to Büşra Kalemci for illustration of *Quercus robur*.

References

- Copolovici L., Väärtnõu F, Estrada M.P, and Niinemets Ü. 2014 Oak powdery mildew (*Erysiphe alphitoides*) induced volatile emissions scale with the degree of infection in *Quercus robur*. *Tree Physiol.* 34(12): 1399–1410.
- Davis P. H. 1965–1988. *Flora of Turkey and the East Aegean Islands*, Vol: 1–10, Edinburgh University Press, Edinburgh.
- Eaton, E., Caudullo, G., Oliveira, S., de Rigo, D., 2016. *Quercus robur* and *Quercus petraea* in Europe: distribution, habitat, usage and threats. In: San-Miguel-Ayanz, J., de Rigo, D., Caudullo, G., Houston Durrant, T., Mauri, A. (Eds.), *European Atlas of Forest Tree Species*. Publ. Off. EU, Luxembourg, pp. 160-163.
- Hedge, I. C., Yaltrink, F., “*Quercus L.*” *Flora of Turkey and East Aegean Islands* Vol. 7, Davis, P. H. (Ed.), University Press, Edinburgh, Edinburgh pp. 659–683. (1982).
- URL₁, 2012. Orman Genel Md. <http://www.ogm.gov.tr>
- URL₂, 2016. <http://dx.doi.org/10.2305/IUCN.UK.2007.RLTS.T63532A12687478.en>

URL₃, 2016. <http://www.kew.org/science-conservation/plants-fungi/quercus-robur-english-oak>

URL₄, 2016. <http://arboretum.ucdavis.edu/documents/OakGroveExhibitsweb.pdf>

Uslu E, Bakış, Y. 2012. Geographic distribution of Turkish Oaks. *Dendrobiology* vol. 67, 41–48

Kavgacı A., Carni A., Tecimen B., Özalp G. 2010. Diversity and ecological differentiation of oak forests in NW Thrace (Turkey). *Archives of Biological Science Belgrade* 62: 705–718.

Khela, S. 2012. *Quercus robur*. The IUCN Red List of Threatened Species 2012: e.T63532A14719534. Downloaded on 23 July 2016.

Rodriguez-Campos A., I.J. Diaz-Maroto, E. Barcala-Perez, P. Vila-Lameiro. 2010. Comparison of the autoecology of *Quercus robur* L. and *Q. petraea* (Mattuschka) Liebl. stands in the Northwest of the Iberian Peninsula. *Ann. For. Res.* 53(1): 7-25,

Mamıkođlu, N.G. (2012). “Türkiye’nin Ağaçları ve Çalıları”. NTV Yayınları, İstanbul.

Şöhretođlu, D., Sakar, M.K. 2004. Polyphenolic Constituents and Biological Activities of *Quercus* Species. *J. Fac. Pharm, Ankara* 33 (3) 183 – 215.

Yaltrık, F., Türkiye Meşeleri Teşhis Kılavuzu, Yenilik Basımevi, İstanbul, 3-7, (1984).

Yücedađ, C., Gailıng, O. 2013. Morphological and genetic variation within and among four *Quercus petraea* and *Q. robur* natural populations *Turk J Bot* 37: 619-629.

Evaluation of Turkey and China INDC Documents in the Context of Climate Changes 21st Parties Conference

Gül TEKİNGÜNDÜZ

Abant İzzet Baysal University, Vocational High School, Bolu/Turkey

gulakbulut@ibu.edu.tr

Abstract

Of developed and developing countries in order to negotiate a global climate agreement on Climate Change in Paris 2015 21st United Nations Conference of the Parties (COP21) was conducted in the month of December. This meeting saw broad participation by the different masses, which is one of the most important problems of the 21st century climate change on countries' joint decisions intended to combat climate change and the creation of an agreement that includes the text of important steps have been taken. In this context, the picture they have created INDC countries (Intended Nationally Determined Contributions) sent to the Secretariat of the United Nations. Each of the countries INDC its own national priorities, prepared within the framework of conditions and capabilities, flexible and sanction non-targets.

In this study, we examined Turkey's and China's official INDCs, that were sent UN secretariat within the context of COP21, in a detailed way, and at the end of our examination we tried to make evaluations by finding out similarities and differences of these INDC documents.

Although Turkey and China have taken important steps on climate change, when the findings are evaluated, we observe that there are some important gaps and points that need to be revised in the process of creating aim and policy making.

Keywords: INDC, global climate change, Turkey, China, COP21

İklim Değişikliği 21. Taraflar Konferansı Kapsamında (COP21) Türkiye ve Çin'in INDC Belgelerinin Değerlendirilmesi

Özet

Küresel bir iklim anlaşması üzerinde uzlaşmak amacıyla gelişmiş ve gelişmekte olan ülkelerin bir araya geldiği Birleşmiş Milletler İklim Değişikliği 21. Taraflar Toplantısı (COP21), 2015 yılı aralık ayında Paris'te gerçekleştirilmiştir. Farklı kitleler tarafından geniş katılım gören bu toplantıda 21. yüzyılın en önemli sorunlarından biri olan iklim değişikliği konusunda ülkelerin ortak kararlarını içeren bir anlaşma metninin oluşturulması amaçlanmış ve iklim değişikliği ile mücadele de önemli adımlar atılmıştır. Bu kapsamda ülkeler hazırlamış oldukları resmi INDC'leri (Intended Nationally Determined Contribution – Niyet Edilen Ulusal Olarak Belirlenmiş Katkı) Birleşmiş Milletler sekreteryasına göndermişlerdir. INDC'ler her ülkenin kendi ulusal öncelikleri, koşulları ve yetenekleri çerçevesinde hazırladığı esnek ve yaptırımı olmayan hedefleri içermektedir.

Bu çalışmada Türkiye ve Çin'in COP21 kapsamında Birleşmiş Milletler sekreteryasına göndermiş oldukları resmi INDC'ler ayrıntılı olarak incelenmiş olup, bu incelemeler sonucunda INDC belgeleri arasındaki benzerlik ve farklılıklar ortaya çıkarılarak değerlendirmeler yapılmaya çalışılmıştır.

Bulgular değerlendirildiğinde Türkiye ve Çin'in iklim değişikliği konusunda önemli adımlar atmış olmalarına rağmen, hedef ve politika oluşturma sürecinde önemli boşlukların ve revize edilmesi gereken noktaların olduğu görülmektedir.

Anahtar Kelimeler: INDC, küresel iklim değişikliği, Türkiye, Çin, COP21

Introduction

The common name of the commitment of all countries in the fight against global climate change official documents in which the concept of our country "Intended Nationally Determined Contributions" is located in the form. Turkey, on the official INDC's the greenhouse gas reduction targets for emissions including 30 September 2015

United Nations Framework Convention on Climate Change (UNFCCC) has been submitted to the Secretariat. In this context, Climate Change 21. Meeting of Parties was held in Paris, and official INDC's (COP21) prepared by the parties are considered bases for Paris Agreement. INDC documents are basically considered as a mitigation and adaptation commitments. Turkey, stated to

reduce in 2030 to reduce greenhouse gas emissions to a maximum of 21% (UNFCCC, 2015). The United Nations Framework Convention on Climate Change Secretariat presented a total of 162 INDC document (UNFCCC, 2016). The global scale of climate change took place in the process of evaluating the active participation COP21 held in Paris.

This study aims to evaluate Turkey and China INDC's on a common ground by comparing their official INDCs. For that purpose, comparisons are made by taking several parameters in to account such as total greenhouse gas emissions, population, the growth rate, CO₂ emissions by sector, greenhouse gas production per capita, INDC objectives and INDC plans and policies to be applied. In this context, in order to evaluate the subject from the point of view of forestry, forestry topics were also emphasized elsewhere.

Material and Methods

This work was held in the city of Paris, France in December 2015 in United Nations climate change Conference of the parties (COP21) under common headings of documents which were prepared by Turkey and China, aiming to be evaluated under the INDC. Because it is the country that makes China, World's biggest CO₂ emitter therefore it was included in the research (Statista, 2016a; WorldBank, 2016a).

INDC document consists of flexible and non-penal sanction targets prepared in the frame of a country's own national priorities conditions and skills (WRI, 2016). In the context of COP21 INDCs of obtained from official websites of countries have been submitted to secretariat of the United Nations Framework Convention on Climate Change (UNFCCC) and most of them are focused on reduction of greenhouse gas emissions. INDC documents were reached via UNFCCC official website. Headlines focused in documents and comparative evaluations of INDCs of countries are discussed in detail in "Results" section.

In this research, "Scanning Model" is used and "Comparison Type" out of relational scanning, one of which is a general scanning model, was considered as a guide type. Scanning models are research approaches

aiming past and present conditions to describe as the way they are. In scanning model, a researcher compiles the data obtained with his own criticism (Karasar, 2014). INDC documents aimed to be assessed in the scanning model were first inspected from the point of view of the determined parameters, and then tried to be differentiated in terms of similarities and differences observed out of comparisons by common criteria. Finally, the results were interpreted and recommendations have been given.

Results

General information

In this part of the study, population and economic growth rates of Turkey and China will be discussed which were dealt within the scope of this study. By the year of 2015, Turkey has a population of 78 million increasing continuously (TÜİK, 2016). China on the other hand has a population of 1.3 billion making it the crowded country in the world (WorldBank, 2016a). Comparison of the growth rates of Turkey and China revealed 4% and 6.8% respectively (TÜİK 2015, Statista 2016b). In the long term evaluation, Turkey displayed an expansion in Gross Domestic Product (GDP) however China economic expansion rate had declined as lowest of last 25 years by 2015. According to the World Bank's annual reports (WorldBank, 2016b), both countries are regarded as upper-middle income countries.

Greenhouse gas emissions

In the documents data for greenhouse gas emissions were provided by the INDC, UNFCCC participating countries. Turkey's report consist of "Turkey 2012 Greenhouse Emission Inventory Report" data instead of recent or updated "Turkey 2013 Greenhouse Emission Inventory Report". Therefore in Turkey's INDC document greenhouse gas emission was reported as 439.9 Mt CO₂ instead of 459.1 Mt CO₂ (TÜİK, 2013) and CO₂ emission per capita was reputed as 5.9 tons capita instead of 6.04 tons capita (TÜİK, 2012). In this study values of "Turkey 2013 Greenhouse gas Emission Inventory Report" will be used for comparisons.

According to Turkey's 2013 greenhouse gas inventories, total emission is 459 billion

tons CO₂ equivalent (Table I), and for year 2013, total greenhouse gas was found to be elevated 110.4% in comparison with year 1990 (TÜİK, 2013). According to EDGAR, designated as European Commission's

Database for Atmospheric Research, in 2013 China's total greenhouse gas emission was 12.4 billion tons CO₂ equivalent which represents as 219.9% increase in comparison to 1990 (EDGAR, 2016).

Table I. Turkey and China's CO₂ emissions

<i>Total CO₂ emissions (million tons)</i>	<i>Changes compared to 1990</i>		
	1990	2013	(%)
Turkey	218.2*	459.1*	110.4*
China	3892.6**	12454.7**	219.9**

*TÜİK 2013 Greenhouse gas emissions inventory report

**EDGAR 2016 GHG emission time series 1990-2012 per region/country

In Turkey's 2013 report as shown in Figure I, sectors contributing most of the greenhouse gas emissions have been reported to be energy (67.8%), industrial processes (15.7%) followed by agricultural activities (10.8%) and waste (5.7%) (TÜİK, 2013).

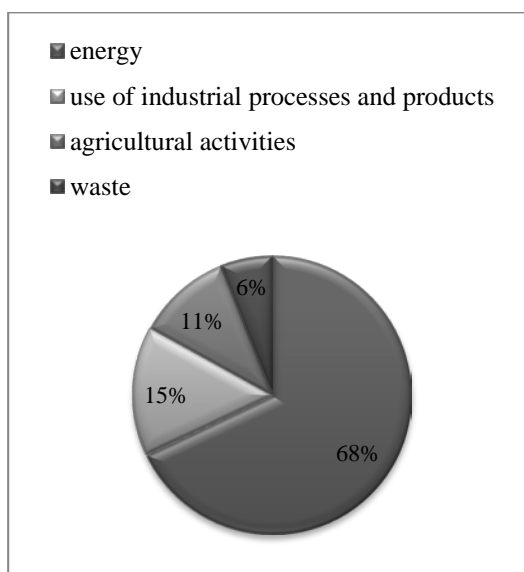

Figure I. Sector distribution of greenhouse gas emissions in Turkey

On the other hand as shown in Figure II, China's contribution was primarily due to use

of fossil fuels in industry (47%) followed by production (32%) (Liu, 2015).

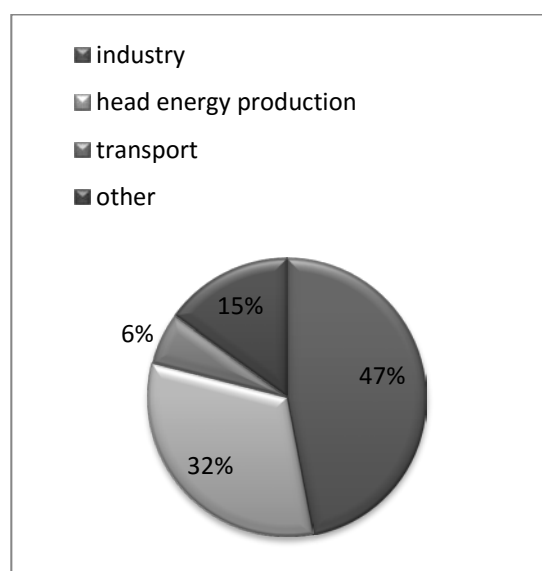

Figure II. Sector distribution of greenhouse gas emissions in China

INDC goals

In this section committed reduction rate in the INDCs of Turkey and China with in the scope of COP21 have been created, the fields that are included in the planning process to address the needs and financial targets have been given (UNFCCC, 2015).

Table II. INDC goals of Turkey and China

	Turkey	China
INDC (Contribution)	Up to 21 percent reduction in GHG emissions from the Business as Usual (BAU) level by 2030.	By 2030 as to lower carbon dioxide emissions per unit of GDP by 60% to 65% from the 2005 level.
Scope and Coverage	<ul style="list-style-type: none"> -Economy wide -Energy, -Industrial processes and products use, -Agriculture, -Land use -Land use change and forestry, -Waste sectors. 	<ul style="list-style-type: none"> -Energy -Industry -Building and transport -Sink area (forest and agricultural land) -Science and technology -Economics and politics -Statistics and accounting -Marketing
Planning Process	<ul style="list-style-type: none"> -10 th National Development Plan -National Strategy on Climate Change -National Climate Change Action Plan -National Strategy on Industry -Strategy on Energy Efficiency -National Strategy and Action Plan on Recycling -National Legislation on Monitoring, Reporting and Verification of GHG emissions -National Smart Transportation Systems Strategy Document (2014-2023) and its Action Plan (2014-2016) 	<ul style="list-style-type: none"> -National Program on Climate Change, -The Work Plan for Controlling Greenhouse Gas Emissions during the 12th Five-Year Plan Period -The Comprehensive Work Plan for Energy Conservation and Emission Reduction for the 12th Five Year Plan Period -The 12th Five Year Plan for Energy Conservation and Emission Reduction -The 2014-2015 Action Plan for Energy Conservation, -Emission Reduction and Low-Carbon Development, and the -National Plan on Climate Change (2014-2020)
Financial Needs	<ul style="list-style-type: none"> -Domestic sources -GCF (Green Climate Fund) -International financial, technological, technical and capacity building support 	<ul style="list-style-type: none"> -Public-private partnerships -Implement to optional tax policies -Develop innovation in pricing and taxation -The establishment of a carbon emissions trading market -Improve the green credit mechanisms -Encourage and guide financial institutions to operate energy-efficiency crediting business and to issue asset-securitized products for green credit assets -Improve disaster insurance policy against climate change -Provide support of finance, technology and capacity building to developing countries -Establish the Fund for South-South Cooperation on Climate Change -Strengthen the Green Climate Fund

Applicable plans and policies for INDC
Turkey and China determined plans and policies in their INDCs related with energy,

industry, transportation, buildings and urban transformation, agriculture, waste and forestry. However sectors such as energy,

agriculture and forestry will be given priority due to necessity required by the scope of the study. Therefore comparison in such fields will be performed accordingly.

Energy

The following table (Table III) includes energy plan and policies in the INDC's of Turkey and China.

Table III. Energy plans and policies

Turkey	China
<ul style="list-style-type: none"> -Increasing capacity of production of electricity from solar power to 10 GW until 2030. -Increasing capacity of production of electricity from wind power to 16 GW until 2030. -Tapping the full hydroelectric potential. -Commissioning of a nuclear power plant until 2030. -Reducing electricity transmission and distribution losses to 15 percent at 2030. -Rehabilitation of public electricity generation power plants. -Establishment of microgeneration, cogeneration systems and production on site at electricity production. 	<ul style="list-style-type: none"> -To increase the share of non-fossil fuels in primary energy consumption to around 20% until 2030. -To control total coal consumption. -To enhance the clean use of coal. -To expand the use of natural gas: by 2020, achieving more than 10% share of natural gas consumption in the primary energy consumption and making efforts to reach 30 billion cubic meters of coal-bed methane production. -To proactively promote the development of hydro power, on the premise of ecological and environmental protection and inhabitant resettlement. -To develop nuclear power in a safe and efficient manner. -To scale up the development of wind power. -To accelerate the development of solar power. -To proactively develop geothermal energy, bio-energy and maritime energy. -To achieve the installed capacity of wind power reaching 200 gigawatts, the installed capacity of solar power reaching around 100 gigawatts and the utilization of thermal energy reaching 50 million tons coal equivalent by 2020. -To scale up distributed energy and strengthen the construction of smart grid. -The elimination of outdated production capacity. -Strictly controlling the total expansion of industries with extensive energy consumption and emissions. -To promote low-carbon development of service industry, actively developing low-carbon business, tourism and food service and vigorously promoting service industries to conserve energy and reduce carbon emissions. -Increasing the recycling and utilization of renewable resources. -To implement preferential taxation policies for promoting the development of new energy.

Agriculture

The following table (Table IV) includes agriculture plan and policies in the INDC's of Turkey and China.

Table IV. Agriculture plan and policies

Turkey	China
<ul style="list-style-type: none"> -Fuel savings by land consolidation in agricultural areas. -Rehabilitation of grazing lands. -Controlling the use of fertilizers and implementing modern agricultural practices. -Supporting the minimum tillage methods. 	<ul style="list-style-type: none"> -To enhance the control of development intensity, to limit large-scale industrialization and urbanization, to strengthen the planning and construction of medium-and-small-sized towns, to encourage moderate concentration of population and to actively push forward the appropriate scale production and industrialization of agriculture in Major Agricultural Production Zones. -To promote the low-carbon development in agriculture, making efforts to achieve zero growth of fertilizer and pesticide utilization by 2020. -To control methane emissions from rice fields and nitrous oxide emissions from farmland. -To construct a recyclable agriculture system, promoting comprehensive utilization of straw, reutilization of agricultural and forestry wastes and comprehensive utilization of animal waste. -To continue to restore grassland from grazing land, to promote mechanism of maintaining the balance between grass stock and livestock, to prevent grassland degradation, to restore vegetation of grassland, to enhance grassland disaster prevention and farmland protection and to improve carbon storage of soil. -To improve the construction of water conservation facilities for farmlands, to vigorously develop water-saving agricultural irrigation and to cultivate heat-resistant and drought-resistant crops. -To properly develop and optimize the allocation of water resources, implementing the strictest water management regulation, building water saving society in all aspects and intensifying the development and utilization of unconventional water resources, including recycled water, desalinated sea water and rain and flood water.

Forestry

The following table (Table IX) includes forestry plan and policies in the INDC's of Turkey and China.

Table IX. Forestry plan and policies

Turkey	China
<p>-Increasing sink areas and preventing land degradation.</p> <p>-Implementing Action Plan on Forestry Rehabilitation and National Afforestation Campaign.</p>	<ul style="list-style-type: none"> - To increase the forest stock volume by around 4.5 billion cubic meters on the 2005 level. - To vigorously enhance afforestation, promoting voluntary tree planting by all citizens, continuing the implementation of key ecological programs, including protecting natural forests, restoring forest and grassland from farmland, planting shelter belt, controlling rocky desertification, conserving water and soil, strengthening forest tending and management and increasing the forest carbon sink. - To strengthen forest disaster prevention and forest resource protection and to reduce deforestation-related emissions. - Develop early warning and emergency response systems against the risks of climate change in sensitive areas (agricultural area, forests, water sources). - To strengthen the protection and restoration of wetlands and to increase carbon storage capacity of wetlands. - To track, monitor and assess the impact of climate change on biodiversity. - To strengthen the construction of forestry infrastructure.

Global responsibility and awareness

Turkey has been responsible from 0.7% global emissions since industrial revolution. Originating from possible scenarios, Turkey aims to reduce 21% by the year 2030 and foresee a limit of 2°C temperature increase. Therefore these goals can be regarded as concrete milestones in order for low carbon development. Besides direct aims in terms of responsibility and awareness are not mentioned in the official INDC of Turkey. INDC of the China for the some purpose is composed of the following aims:

-To enhance education for all citizens on low- carbon way of life and consumption, to advocate green, low- carbon, healthy and civilized way of life and consumption patterns and to promote low -carbon consumption throughout society.

-To strengthen laws and regulations on climate change.

-To encourage public institutes to take the lead to: advocate low carbon government buildings, campuses, hospitals, stadiums and military camps, advocate moderate consumption, encourage the use of low carbon products and curb extravagance and waste.

-To research on and establish carbon emission accreditation and low-carbon honor system, to carry out low-carbon certification pilots and promotion of selected products.

-To improve the technical supporting system for addressing climate change, to establish a mechanism that effectively integrates government, industries and academic and research institutes and to strengthen professional personel training for addressing climate change.

-To actively innovate the application of funds and explore new investment and financing mechanisms for low-carbon

development, such as public-private partnerships.

-To improve greenhouse gas emission statistics covering areas including energy activity, industrial process, agriculture, land-use change, forestry and waste treatment.

-To improve disaster insurance policy against climate change.

-To use platforms such as National Low Carbon Day to raise public awareness of low-carbon development throughout society.

-To encourage voluntary actions of the public to combat climate change.

-To let media play the role of supervision and guidance.

-To enhance related education and training and to fully utilize the function of schools, communities and civil organizations.

Conclusions

When evaluated as a function of INDC aims, foreseen or committed decrease rate of turkey will reduce by 21% by the year 2030, in the mean while china undertakes 2005 as baseline in which the rates were maximum. China started in its National Contribution Statement that it will peak until 2030 then start to decrease. In other words China mentions that it will reach to peak level by the year 2030 and then literally reduce. However Turkey aims to reduce out of an expanding situation. Turkey predicts 2030 however did not mention an explicit time and goal during this time span or period. Overall, both countries display reduction commitments, never the less they are not sufficient when the sensitivity of the issue about the climate change is taken into account.

Climate change is evaluated with "Adaptation" and "Mitigation" titles in official and scientific documents. Struggle with climate change necessitates more than developing policies for reduction or orientation with it. INDCs of both countries contains policies and aims for "Mitigation". However, for "Adaptation", china has some sort of attempts while turkey does not.

Although there are aims about the energy in INDCs, Turkey needs to take serious steps in terms of the use of the fossil fuels. In the struggle with climate change Turkey need to avoid using fossil fuels and develop alternative energy sources within the limits of

its infrastructure. World's number one charcoal consumer China, reflects on intention of charcoal consumption reduction, while Turkey's INDC does not mention anything about the reduction of leaving of the use of charcoal. So far our country, about the use of fossil fuels it can be said that there are not adequate attempts to satisfy the need of the fight against climate change. Besides, the inclination to nuclear energy of both countries contradicts to ecology, environmental protection and clean energy and it is thought that there is a need for revision for all of the policies mentioned. Therefore aims in the INDCs need to be concretization and determined realistically with numerical values for sectors.

China occupies the first rank in greenhouse gas emissions since it has a great part in industrial global market (WorldBank, 2016). When considered as a global contributor, Turkey just is responsible from the 0.94% of greenhouse emission in the world. Even though this value is below the world's average, it is expected to be maximum effort among countries since the problem being a global issue. However when the percent for global contribution is regarded, China does not seem to have intentions to take responsibility.

Turkey headed towards airports, high-speed railways and tunnels in order for fuel save and energy efficiency in transportation and achieved great lengths about it. However, projects should be performed with minimal harm to nature. Forests are very important structures in terms of fighting against climate change and preventing the landscape damage. So projects endangering the existence of forest should be prevented. It is obvious that studies trying to conserve the existence of forests are important. In that sense, Turkey INDC needs to provide more rational values in the aim by keeping the sustainable forest management as its priority. In addition to these, Turkey should include policies and objectives related to wetlands in the INDC document.

There is a necessity for Turkey to revise its INDC until 2018 in which COP22 conference will be taken place and during this time reachable aims need to be determined. Mitigation along with adaptation are two topics about which periodical surveillance

mechanisms would be beneficial. Besides participant attitude should be embraced by public institutes, university's, private sector representatives and collaboration among media and non-governmental organizations is important.

References

- EDGAR, 2016. Emission Database for Global Atmospheric Research. *GHG emission time series 1990-2012 per region/country*, <http://edgar.jrc.ec.europa.eu/index.php> [Ziyaret Tarihi: 20.01.2016].
- Karasar, N., 2014. *Bilimsel Araştırma Yöntemi. "Kavramlar-İlkeler-Teknikler"*. Nobel Yayıncılık. Ankara.
- Liu, Z., 2015. *China's Carbon Emission Report 2015*. Harvard Kennedy School, Belfer Center for Science and International Affairs. Cambridge, USA.
- Statista, 2016a. *The Statistics Portal. CO2 emissions*. <http://data.worldbank.org/indicator/EN.ATM.CO2E.PC> [Ziyaret Tarihi: 21.02.2016].
- Statista, 2016b. *The Statistics Portal*. <http://www.statista.com/statistics/271769/quarterly-gross-domestic-product-gdp-growth-rate-in-china/>, [Ziyaret Tarihi: 21.02.2016].
- TÜİK, 2012. Türkiye İstatistik Kurumu. *Sera Gazı Emisyon Envanteri, 2012*. Haber Bülteni. Sayı: 16174, [Ziyaret Tarihi: 25.01.2016].
- TÜİK, 2013. Türkiye İstatistik Kurumu. *Sera Gazı Emisyon Envanteri, 2013*. Haber Bülteni. Sayı: 18744, [Ziyaret Tarihi: 15.01.2016].
- TÜİK, 2015. Türkiye İstatistik Kurumu. *Gayri Safi Yurtiçi Hasıla, III. Çeyrek: Temmuz-Eylül, 2015*, Haber Bülteni. Sayı: 18730, [Ziyaret Tarihi: 15.02.2016].
- TÜİK, 2016. Türkiye İstatistik Kurumu. *Adrese Dayalı Nüfus Kayıt Sistemi Sonuçları 2015*. Haber Bülteni. Sayı: 21507, [Ziyaret Tarihi: 15.02.2016].
- UNFCCC, 2015. United Nations Framework Convention on Climate Change. *INDCs as a communicated by Parties*. (China / Turkey). <http://www4.unfccc.int/submissions/INDC/Submission%20Pages/submissions.aspx>, [Ziyaret Tarihi: 31.12.2015].
- WRI, 2016. World Resource Institute, *What is an INDC?* <http://www.wri.org/indc-definition>, [Ziyaret Tarihi: 17.02.2016].
- World Bank, 2016a. *The World Bank Data China 2014*, <http://data.worldbank.org/country/CN>, [Ziyaret Tarihi: 18.02.2016].
- World Bank, 2016b. *The World Bank Country Data Turkey-China*, <http://www.worldbank.org/en/country>, [Ziyaret Tarihi: 18.02.2016].

A Study on Job Satisfaction of Employees in the Düzce Forest District Directorates

*Derya SEVİM KORKUT¹, Gamze ÇINAR ŞAHİN²

¹Düzce University, Faculty of Forestry, Department of Forest Product Engineering, Düzce / TURKEY

²Forest Product Engineer, Bolu / TURKEY

*Corresponding Author: deriyasevimkorkut@duzce.edu.tr

Abstract

Job satisfaction comes from both the negative and positive feelings which a person experiences at the work. Working environment, working conditions and individual characteristics determine the degree of job satisfaction. Job satisfaction is quite important in terms of creating a productive working environment and keeping the employees happy. Thus, the existence of satisfied employees in a working environment will increase the success of the foundations and the degree of the competition between them. This study aims to find out the job satisfaction levels of employees in the Düzce Forest District Directorates which is a part of Bolu Regional Directorate of Forestry. Düzce Forest District Directorates which has 11 Forest Sub-District meets the needs of forest products in Düzce and its immediate environment. Survey method is used as the data collection method in this study. The survey forms prepared have been applied on 53 employees with 10% margin of error and 90% confidence interval. The survey form consists of two parts containing demographic characteristics of the employees and Minnesota job satisfaction scale consisting of 20 items that determine the general level of satisfaction take place. According to the results of the study, 49.1% of the employees state that they have been working at the same place for more than 10 years. In addition, it is found out that most of the employees claim that they are satisfied with their jobs with such statements as “being able to do things that don’t go against my conscience”, “the chance to be “somebody” in the community”, “the way my job provides for steady employment” and “the chance to do something that makes use of my abilities”.

Keywords: Job satisfaction, Employee, Survey, Düzce Forest District Directorates

Düzce Orman İşletme Müdürlüğü Çalışanlarının İş Tatminlerine İlişkin Bir Araştırma

Özet

İş tatmini, çalışan bireylerin yaptığı iş hakkında hissettiği olumlu ya da olumsuz duygulardır. Kişinin çalıştığı ortam, çalışma koşulları, bireysel özellikleri iş tatmininin derecesini belirler. İş tatmini çalışanların mutlu olması, verimli bir çalışma ortamının yaratılması açısından büyük bir öneme sahiptir. İş ortamında mutlu olan çalışanların varlığı ise işletmelerin başarısını ve rekabet düzeylerini artıracaktır. Bu çalışma ile Bolu Orman Bölge Müdürlüğü’ne bağlı Düzce Orman İşletme Müdürlüğü’nde çalışanların iş tatmin düzeylerinin belirlenmesi amaçlanmıştır. Düzce Orman İşletme Müdürlüğü Düzce ve çevresinin orman ürünleri ihtiyacını karşılamakta ve bünyesinde 11 adet Orman İşletme Şefliği bulunmaktadır. Çalışmada iki bölümden oluşan anket formu hazırlanmış ve anketler yüzyüze görüşme yöntemi ile çalışanlara uygulanmıştır. Anket formunun birinci bölümünde çalışanların demografik özellikleri, ikinci bölümünde genel tatmin düzeyini belirleyen 20 maddeden oluşan Minnesota iş tatmin ölçeği yer almıştır. Anket formları %90 güven aralığında %10 hata payı ile 53 çalışana uygulanmıştır. Çalışma sonucuna göre; katılımcıların %49.1’inin 10 yıldan fazla süredir aynı işyerinde çalıştıkları belirlenmiştir. Yapılan analizler sonucunda iş tatminiyle ilgili olarak en yüksek tatmin düzeyi “vicdanıma uygun şeyler yapabilme olanağının olması”, “toplumda saygın bir kişi olma şansını bana vermesi”, “bana sabit bir iş olanağı sağlaması ve “kendi yeteneklerimle bir şeyler yapabilme şansımın olması” ifadelerinden gelmiştir.

Anahtar Kelimeler: İş tatmini, Çalışan, Anket, Düzce Orman İşletme Müdürlüğü

Introduction

Job satisfaction is a hope for success that people have as a result of their efforts and it motivates them to work (Eren, 2001). In other words, job satisfaction is an evaluation

made by employees in terms of job conditions (the job itself, physical conditions, and manager’s attitude) and outcomes of the work (price, job security) (Çekmecelioğlu, 2006). Job satisfaction also means financial

gain, peace and happiness that result from cooperatively with co-workers (Aksungur, 2009).

Job satisfaction is one of the most important factors which affect people's behaviour at work. Basically, that a person likes his job or not depends on the difference between his expectations and the reality. Therefore, it is important to determine people's expectations and the facilities the job provides for them. In other words, it is important to determine the difference between satisfaction and dissatisfaction (Akin et al., 1998). Job satisfaction is crucial in terms of both individual and organizational. A job has a big role in an individual's life. People spend most of their times at work which makes them expect that the work environment should provide everything they need for them. Furthermore, it affects the employees' general life satisfaction and their emotional and physical health negatively (Serinkan and Bardakçı, 2009).

High job satisfaction level is desired by the managers in terms of providing positive working conditions (Bayrak Kök, 2006). If job satisfaction level is high it makes the employees' performance and productiveness higher. It also contributes to the institutions in terms of productivity growth, low employee turnover rate and having qualified employees. Job dissatisfaction results in unwilling to go to work, leaving work, feeling of inadequacy, lack of cooperation, mistakes at work and making inappropriate decisions (Sat, 2011). Managers should motivate employees to make them better, make sure that they don't leave work and make the working conditions desirable in order to be effective (Aksungur, 2009).

Minnesota Satisfaction Questionnaire (MSQ), Job Descriptive Index (JDI) and Porter Need Satisfaction Questionnaire are the most common and effective scales even though there are many scales used for job satisfaction level (Tarlan and Tütüncü, 2001). Minnesota Satisfaction Questionnaire is the most common one that is used for academic studies and it was developed by Weiss, Dawis, England and Lofquist in 1967 (Karataş and Güleş, 2010). It evaluates

productiveness gained by working

working conditions, opportunities for improvement and recognition by others. It also evaluates if the individuals can use their own judgement systems and good work is appreciated (Akin et al., 1998)

Material and Methods

It is aimed to find out job satisfaction levels of the employees in Forestry Department of Düzce with this study. Survey method is used to obtain data. Surveys have been prepared by using the sources (Yelboğa, 2007; Serinkan and Bardakçı, 2007; Kahraman et al., 2011; Karataş and Güleş, 2010; Sat, 2011; Köroğlu, 2012) which take place in the literature. The survey form consists of two sections. In the first section demographical features of the participants are given and Minnesota Satisfaction Questionnaire with 20 items that determine job satisfaction levels of the participant is used in the second section.

The first section consists of 15 questions which are about the gender, age, marital status, the number of the children, working condition of their partners, the place of birth, educational background, average monthly income, administrative functions and staffing pattern of the participants. Minnesota Satisfaction Scale used in the second section was developed by Weiss, Dawis, England & Lofquist in 1967 and was translated to Turkish by Baycan in 1985. It is a five point Likert scale that was controlled in terms of validity and dependability (Cronbach Alpha=0.77) and it consists of 20 questions (Kahraman et al., 2011). The template of "1: Very dissatisfied, 2: Dissatisfied, 3: Neither satisfied nor dissatisfied 4: Satisfied, 5: Very satisfied" is used for evaluation. Minnesota Satisfaction Scale consists of 20 items that determine satisfaction level in terms of intrinsic, extrinsic and general. No ambiguous question is used in the scale. Intrinsic satisfaction consists of the items of 1, 2, 3, 4, 7, 8, 9, 10, 11, 15, 16, 20. Extrinsic satisfaction consists of the items of 5, 6, 12, 13, 14, 17, 18, 19. General satisfaction consists of the items of 1, 2, 3, 4, 5, 6, 7, 8, 9, 10, 11, 12, 13, 14, 15, 16, 17, 18, 19, 20. (Sat, 2011). There are 181 employees in

Düzce Forest District Directorates (Anon. 2014). The sample size is 50 with 90% order to increase the dependability of the survey. Data obtained from the participants have been evaluated with SPSS (2003) by using statistical methods.

It is assumed that the participants answer the questions objectively by considering their own experiences and knowledge. The study is limited with the employees of Düzce Forest District Directorates. Data can be generalized with the employees that work in the similar working conditions.

Results and Discussion

Reliability Analysis

Reliability analysis is done in order to test the reliability of the job satisfaction scale (Cronbach Alpha). General reliability value is set as 0.87 in the study. Considering this result, it can be seen that the scale has a high degree of reliability. If alpha is lower than 0.40 it means that the scale is not reliable. If alpha is between 0.40-0.60 then it means it has a low reliability. In order to be considered as reliable, the alpha should be between 0.60-0.80. If alpha is between 0.80-1.0 it means that the scale has a high degree of reliability (Özdamar, 2002). While the value of reliability of intrinsic satisfaction is 0.81, the value for extrinsic one is 0.80.

Demographic features of the participants

18.9% of the participants are women and 81.1% of them are men (Table 1).

13.2% of the participants are between 25-34 years old, 35.9% of them are 35-44, 43.4% of them are 45-54 and 7.5% of them are 55-64. 90.6% of the participants are married, 7.5% of them are single and 1.9% of them are considered as others. 54.2% of the participants have partners who are currently not working. 43.4% of the participants have 2 children and 13.2% of them have no children (Table1).

64.1% of the participants were born in Duzce. Furthermore, 5.6% of them were born in Ankara; 5.6% Bolu; 3.8% Trabzon; 1.9% Sakarya; 1.9% Istanbul; 1.9% Balıkesir; 1.9% Batman; 1.9% Çorum; 1.9% Denizli;

confidence interval and 10% margin of error. The survey is applied on 53 employees in 1.9% Muğla; 1.9% Mardin; 1.9% Sivas; 1.9% Uşak and 1.9% Zonguldak.

Table 1. Demographic features of the participants (a)

Options	Frequency	Percent (%)	
Gender	Male	43	81.1
	Female	10	18.9
Age Group	25 to 34	7	13.2
	35 to 44	19	35.9
	45 to 54	23	43.4
	55 to 64	4	7.5
Marital status	Married	48	90.6
	Single	4	7.5
	Other	1	1.9
His wife's work status	Working	22	45.8
	Not working	26	54.2
	No children	7	13.2
Number of children	1	12	22.6
	2	23	43.4
	3	8	15.1
	4 and over	3	5.7

When the educational background of the participants are examined it is found out that 41.5% of them are high school graduates, 18.9% of them are associate graduates and 5.7% of them are master degree graduate (Table 2).

22.6% of the participants have worked for 21-25 years, 22.6% of them 26-30 years and 9.4% of them over 31 years. 7.5% of them have been working at the same institution less than a year. 26.4% of them have been working at the same institution for 1-3 years and 49.1% of them for more than 10 years. 49.1% of the participants have stated that they have worked at another institution before. 61.5% of them worked at public and 38.5% of them worked at private sector. Average monthly income of 62.3% of the participants is between 1001 and 2500 Turkish Liras (Table 2).

35.8% of the participants are officers, 22.6% of them are permanent employee, 20.8% of them are engineers, 15.1% of them are forest fire fighters and 5.7% of them are seasonal workers.

Table 2. Demographic features of the participants (b)

Options		Frequency	Percent (%)
Educational status	Primary school	6	11.3
	Secondary school	5	9.4
	High school	22	41.5
	Vocational school	10	18.9
	Undergraduate	7	13.2
	Graduate	3	5.7
Work experience	1 - 5 years	5	9.4
	6 -10 years	7	13.2
	11 - 15 years	5	9.4
	16 - 20 years	7	13.2
	21 - 25 years	12	22.6
	26 - 30 years	12	22.6
The time span of their working in the same institution	31 years and over	5	9.4
	Less than 1 year	4	7.5
	1-3 years	14	26.4
	4-6 years	5	9.4
	7-9 years	4	7.5
	10 years and over	26	49.1
Previously working status at a different institution	Yes	26	49.1
	No	27	50.9
Previously worked Institutions	Public	16	61.5
	Private sector	10	38.5
Average monthly income	1000 Turkish Liras and less	1	1.9
	Between 1001-2500 Turkish Liras	33	62.3
	Between 2501-4000 Turkish Liras	15	28.3
	4001 Turkish Liras and over	4	7.5
Administrative duties	Less than 1 years	3	5.7
	1-3 years	7	13.2
	4-6 years	5	9.4
	7-9 years	6	11.3
	10 years and over	32	60.4

When the administrative functions of the participants are examined it is found out that they work as warehouse officials, chief engineers, computer managers, document register, servants, administration, workers, chief managers, cadastre engineers, presidents of the commission, officers, accounting, pay clerks, engineers, forest fire fighters, operators, chief of staff, planning, non-wood forest products, drivers and technical staff. 5.7% of the participants have

administrative duties for less than a year and 60.4% of them have these duties for more than 10 years (Table 2).

Findings of Job Satisfaction Scale

Arithmetic mean and standard deviation values of the answers that are related with job satisfaction levels of the employees in Düzce Forest District Directorates are given in Table 3.

Table 3. Examination of job satisfaction degrees of the participants

Level of satisfaction	Item no	Items	Average*	Standard deviation
Intrinsic satisfaction	1	Being able to keep busy all the time.	3.3585	1.0758
	2	The chance to work alone on the job.	3.4151	1.0457
	3	The chance to do different things from time to time.	3.5094	0.9731
	4	The chance to be “somebody” in the community.	3.7736	0.8691
	7	Being able to do things that don’t go against my conscience.	3.8679	0.8329
	8	The way my job provides for steady employment.	3.7736	0.9535
	9	The chance to do things for other people.	3.7170	0.8633
	10	The chance to tell people what to do.	3.5660	0.9905
	11	The chance to do something that makes use of my abilities.	3.7736	0,9535
	15	The freedom to use my own judgment.	3.2075	1.0805
	16	The chance to try my own methods of doing the job.	3.3774	1.0602
	20	The feeling of accomplishment I get from the job.	3.7547	0.9178
Intrinsic satisfaction score			3.5911	0.9679
Extrinsic satisfaction	5	The way my boss handles his/her workers.	3.3396	1.0731
	6	The competence of my supervisor in making decisions.	3.3208	1.0335
	12	The way company policies are put into practice.	3.4151	0.9694
	13	My pay and the amount of work I do.	3.1698	1.0140
	14	The chances for advancement on this job.	3.0000	1.1435
	17	The working conditions.	3.4906	0.9731
	18	The way my co-workers get along with each other.	3.2642	1.0945
	19	The praise I get for doing a good job.	3.3019	1.1021
Extrinsic satisfaction score			3.2877	1.0504
GENERAL SATISFACTION SCORE			3.4698	1.0009

* 1: Very dissatisfied, 2: Dissatisfied, 3: Neither satisfied nor dissatisfied, 4: Satisfied, 5: Very satisfied

As is seen in Table 3 the mean of intrinsic satisfaction factors is higher (3.5911) than general mean (3.4698). It means that the employees are satisfied with intrinsic satisfaction factors. However, the mean of extrinsic satisfaction factors is lower (3.2877) than general mean (3.4698). The participants have stated that they are neutral about whether extrinsic factors affect their job satisfaction level or not.

Discussion and Conclusion

As a result of this study, it has been revealed that the employees of Düzce Forest

District Directorates are satisfied with intrinsic factors however they are neutral about extrinsic factors.

It has been observed that the employees cannot make decisions related to work on their own; they cannot find the opportunity to work alone; the work is monotonous and the employees cannot do their duties by using their talents. Satisfaction level of the participants related to these issues is lower than intrinsic satisfaction. It has been revealed that the employees are satisfied with the social role, status and opportunities that

the job provides for them. In general, high and they have positive attitudes towards work.

According to this study the participants are neutral about whether extrinsic satisfaction factors affect them or not. Accordingly, the employees are not satisfied with their income considering their efforts. The study conducted by Karataş and Güleş in 2010 also revealed that one of the most common reasons which affect job satisfaction negatively was the employees' salaries. Furthermore Bayrak Kök (2006) put emphasis on salaries in his study and he stated that this factor affected job satisfaction level negatively. Some studies also show that the employees are not satisfied with the fact that the job doesn't offer them the opportunity of promotion. Communication between co-workers is weak and administrators have poor decision making strategies. However it is found out that the employees of Düzce Forest District Directorates are satisfied with the management styles of their administrators. They are also pleased with the fact that they are appreciated by their administrators and co-workers. In general it can be said that the participants are neutral about extrinsic satisfaction factors.

In the light of all the facts mentioned above, it can be said that job satisfaction level can be increased in this institution by providing promotion opportunities, increasing salaries, making the employees take initiative by themselves and creating a socially positive atmosphere at work.

References

- Anonim 2014. Düzce Orman İşletme Müdürlüğü çalışan kayıt listesi.
- Akın B., Çetin C., Erol V. 1998. Toplam Kalite Yönetimi ve ISO 9000 Kalite Güvence Sistemi. s.166-168 İstanbul: Beta yayınları.
- Aksungur A., 2009. Zekai Tahir Burak kadın sağlığı eğitim ve araştırma hastanesinde çalışan ebe ve hemşirelerin iş doyumunu ve yaşam kalitesi düzeylerinin belirlenmesi. Yüksek Lisans Tezi, Hacettepe Üniversitesi Sağlık Bilimleri Enstitüsü, Ankara.
- Bayrak Kök S. 2006. İş tatmini ve örgütsel bağlılığın incelenmesine yönelik bir araştırma. Atatürk Üniversitesi İktisadi ve İdari Bilimler Dergisi, 20(1), 291-317.

intrinsic satisfaction level of the employees is

Çekmecelioğlu H., 2006. İş tatmini ve örgütsel bağlılık tutumlarının işten ayrılma niyeti ve verimlilik üzerindeki etkilerinin değerlendirilmesi: bir araştırma. "İş, Güç" Endüstri İlişkileri ve İnsan Kaynakları Dergisi, 8(2), 153-168.

Eren E. 2001. Yönetim ve Organizasyon (5.Basım), İstanbul: Beta Yayınevi.

Kahraman G., Engin E., Dülgerler Ş., Öztürk E. 2011. Yoğun bakım hemşirelerinin iş doyumları ve etkileyen faktörler. Dokuz Eylül Üniversitesi Hemşirelik Yüksekokulu Elektronik Dergisi, 4(1), 12-18.

Karataş S., Güleş H. 2010. İlköğretim okulu öğretmenlerinin iş tatmini ile örgütsel bağlılığı arasındaki ilişki. Uşak Üniversitesi Sosyal Bilimler Dergisi, 3(2),74-89.

Koroğlu Ö., 2012. İçsel ve dışsal iş doyum düzeyleri ile genel iş doyum düzeyi arasındaki ilişkinin belirlenmesi: turist rehberleri üzerinde bir araştırma. Doğu Üniversitesi Dergisi, 13(2), 275-289.

Özdamar, K. 2002. Paket Programlar ile İstatistiksel Veri Analizi, Kaan Kitabevi.

Sat S. 2011. Örgütsel ve bireysel özellikler açısından iş doyumunu ile tükenmişlik düzeyi arasındaki ilişki: Alanya'da banka çalışanları üzerinde bir çalışma. Yüksek Lisans Tezi, Çukurova Üniversitesi Sosyal Bilimler Enstitüsü.

Serinkan, C., Bardakçı A. 2007. Pamukkale üniversitesinde çalışan öğretim elemanlarının iş tatminlerine ilişkin bir araştırma. Selçuk Üniversitesi Karaman İ.İ.B.F. Dergisi, 12, 152-163.

Serinkan C., Bardakçı A. 2009. Pamukkale üniversitesindeki akademik personelin iş tatminleri ve tükenmişlik düzeylerine ilişkin bir araştırma. Sosyal Bilimler Dergisi, 21, 115-132.

SPSS, 2003. Institute Inc., SPSS Base 12.0 User's Guide, 703 p.

Tarlan, D., Tütüncü, Ö. 2001. Konaklama işletmelerinde başarımların değerlendirilmesi ve iş doyum analizi. Dokuz Eylül Üniversitesi Sosyal Bilimler Enstitüsü Dergisi, 3(2), 141-163.

Yelboğa A. 2007. Bireysel demografik değişkenlerin iş doyumunu ile ilişkisinin finans sektöründe incelenmesi. Sosyal Bilimler Dergisi, 4(2):1-18.

The Effects of The Demographic Development on Land Use Change in the Boğalı Catchment

*Ceyhun GÖL¹, Meltem YILMAZ²

¹Çankırı Karatekin University, Faculty of Forestry, Çankırı/TURKEY

²Middle Black Sea Development Agency, Samsun/TURKEY

*Corresponding Author: drceyhungol@gmail.com

Abstract

The effects of the demographic development have been analyzed on the Land Use Type/Land Cover Change (LUTLCC) in The Boğalı Catchment between 1935-2007 years. To show these effects, LUTLC maps and population have been investigated between 1935-2007 years. In addition a questionnaire has been performed on 166 people and land studies have been done to identify the social and economic structure of the public in 2009. According to this data, the forest, rangeland and cultivated areas have been changed respectively between 1935-2007 years. The forest land was 4914 hectare as (42%) in 1969 and 5126 hectares as (44%) in 2007. Over the years the decline of population has reduced the pressure over the natural resources. Moreover, in the survey it is seen that the population concentrated between the age 54-59 as 32% and also that the youth migrates for several circumstances. The main reasons for migration have been stated as low income, lack of social insurance, low employment opportunity and not having future reassurance.

Keywords: Social analysis, Land use, Rural, Migration, Turkey

Boğalı Havzasında Demografik Değişimin Arazi Kullanımına Etkileri

Özet

Amasya Boğalı Havzasında 1935–2007 yılları arasında demografik değişimin arazi kullanım türleri ve arazi örtüsündeki değişime etkileri incelenmiştir. Bu etkileri ortaya koyabilmek için 1935–2007 yılları arasındaki arazi kullanım haritaları ve nüfus yapıları incelenmiştir. Ayrıca 2009 yılında havza halkının sosyal ve ekonomik yapısını belirlemek için 166 kişi üzerinde anket çalışması ve arazi çalışmaları yürütülmüştür. 1935–2007 yılları arasında yapılan genel nüfus sayımları, havzaya ait kamu kurumlarından elde edilen bilgiler grafiksel olarak işlenmiş, anket çalışmaları sonucu elde edilen bilgiler işlenerek havza halkının doğal kaynaklara olan etkileri ve ilişkileri ortaya konmuştur. Elde edilen verilere göre 1935–2007 yılları arasında orman örtüsü, mera ve tarım alanları sırasıyla değişime uğramıştır. Orman arazileri 1969 yılında 4913 ha iken 2007 yılında 5125 ha olmuştur. Yıllar içinde nüfus sayısındaki azalma havza doğal kaynaklarına olan baskıyı azaltmıştır. Ayrıca anket çalışması sırasında nüfusun 54–59 yaş aralığında % 32 oranında yoğunlaştığı, gençlerin çeşitli sebeplerle göç ettiği ortaya çıkmıştır. Göçün temel nedeni olarak gelir düzeyinin düşüklüğü, sosyal güvencenin olmayışı, iş olanaklarının azlığı ve gelecek güvencesinin olmayışı ifade edilmiştir.

Anahtar Kelimeler: Sosyal analiz, Arazi kullanımı, Kırsal, Göç, Türkiye

Introduction

There had been five big waves of migration in the modern period of the history on the world. First of them continued from the 17th century with the Development of European Imperialist country establishment until the beginning of the first world war. The second wave of migration driven between the 17th and 18th centuries and the European free dealer moved from West Africa through South America for the transfer of contracted under labour workers and attendant.

The third wave of migration was between the End of the 1st World War with the

dispersion of Habsburg and Ottoman Empire new bordered urbanization had been established under ethnical base and Nations had been established. The fourth migration wave begun with the Second World War while the colonized countries gained their sovereignty. The fifth wave of migration developed in the same period with the fourth one between 1950 and 1960 in the West European, America and the petrol producing countries to full fill gap of the labour force (Korcun et al. 2006).

The same historical developments as huge migration waves had been developed in the

Ottoman Empire and Turkish Republic as the same of the rest of the World and Human History. The cultural, social and especially economical Development within the societies results in great population movements. There have been huge social and economical changes in rural life by the transfer of urban life in the Turkish Republic history. With the beginning of 1950s a fast social change developed in Turkey. Within industrialization a fast migration action begun. Industrialization was the main reason of migration. This is a general reason in every migration movement. Within industrialization the need of labour force increased in urban areas and the need was supported with the population in rural areas by migration. There had been a natural migration while the industrialization and mechanical modernization of agricultural machinery developed the need of human as a labour force in agriculture decreased (Korcun et al. 2006).

The increase in mechanical machinery in agriculture and population within 1950s lead to agricultural land increase. The result was a quick loss and decay of forest and pasture. However, between 1965-1980 and with the beginning of 1980s industrialization and the parallel increase of population, the rural population migrated to big cities and to other countries. As a result the rural population, has decreased relatively in the years of 2000 because of the population migration to bigger cities and to other countries and the pressure on the forest areas has been abolished slowly. The agricultural land in the mountainous area had been abandoned. And these lands had been turned into forest and degraded grasslands. The general population movement all around Turkey has been analyzed similarly in our studied catchment. In the studied catchment the migration from the towns to the cities and the effects of land use types and on the nature had been analyzed.

There are 7 302 towns inside forests, 13 128 towns next to forests totally 20 430 towns (Anon. 2005). The low suitable agricultural land area results to low income of the farmers in these towns. The average suitable agriculture in the forestry towns is about 25 decar per home. The general average for Turkey is 61 decar, and that of European countries is 118.5 decar (Anon. 2008a)

The economic impact of the house population number and the division of the family land because of this, in addition the industrialisation of the agricultural sector resulted migration from towns to cities. It has been shown that 43.5% of the house population had migrated because of family reasons. Approximately one of the third migrated by personal reasons, one of the fifth by economically reasons (Anon. 2006).

A similar study had been carried and developed in Trabzon and comprises 211 towns in the study area. In the study 68 forest towns from 211 towns in Trabzon, and with 848 people face to face socio-economical analysis had been made. The current state in these forest towns have been compared with the historical data (Alkan and Toksoy, 2008).

The management of the natural resources in a catchment, generally are planned by the catchment owners, therefore they have Networks with each other. For example, an agricultural farm is harvested by the decision of the owner. On the other hand, the issues which are processed in a catchment apart from each other effect the results in the catchment. Therefore, the management in a catchment, the ecology, economy, culture and sociological conformation should be taken into consideration all together with the natural resources of the catchment.

The properties of the Boğalı Catchment research area, especially the forest towns within the catchment were the priorities for the selection of the catchment. Especially the migration could have been easily seen with their reasons because of the land use and variety of land properties. There are 12 towns in the Boğalı Catchment. The population movement between 1935-2007 have been researched together with the land use.

In the research, the demographic properties of the catchment have been studied. Therefore an analysis have been performed and the population data have been used as well. Within this study the population motion, types of land use and the relationship between natural resources within the catchment have been studied. The effects of the farmers in the forest towns and next to the forest towns have been analyzed.

Material and Methods

Site description

The study area is located in Amasya province, the Boğalı Catchment (36°15' - 36°23" East longitude and the 40°44' - 40°35" North latitude). The area of the catchment is 11 673 ha. The elevation of the catchment is between 240-1956 meters in height. There are 12 forest villages within the catchment. The average slope of the catchment has been calculated 30% which is a high result. Catchment, the Black Sea Region with a humid climate and the Central Anatolia Region with a semi-arid climate are among the transition zone. The climatic conditions of the catchment, the Middle Black Sea coincides with the semi-humid climates with the climate. This property is equipped with a rich flora and fauna and is rich in forest resources and fresh water production (Anon. 2007a). The average annual temperature is 14.0 °C. The average annual precipitation is 520 mm.

Catchment forests essential types are oriental beech (*Fagus orientalis* Lipsky) and oak (*Quercus sp.*) is also very little black pine (*Pinus nigra* L.), scots pine (*Pinus sylvestris* L.), ponderosa (*Pinus brutia* Ten.). The region is rich in endemic plants include species and varieties (GDF; 2007). The local names are hazara rabies grass, maple flower, herb rolls, vetchling, pepper tree, ode, astragalus, false alkanet, hairy linen could be counted (anon. 2009). Most part of the natural forest has been fragmented and degraded by human activities such as clearance for agriculture, rangeland, and vegetable gardens.

Database development

Demographical data pertaining to the study area were obtained from the Turkish Statistical Institute. The questionnaire, socio-cultural and demographic characteristics of the people living in the catchment area of research involves determining total of 27 questions. The universe of this descriptive study, Boğalı Catchment constitutes of 12 forest villages. In the study, stratified random sampling method has been used (AAksaya et al. 2004). totally 166 person have been involved in the questionnaire.

The size of sample (n)

$$n = \frac{N \cdot p \cdot q \cdot Z \alpha''}{(N - 1) \cdot d^2} = \text{Eq. 1.}$$

Calculator (Eq. 1) has found the sample size $n=96$. Preliminary survey over 10 people living in the village before beginning the survey was conducted. The information obtained in the preliminary evaluation in the light information, the wrong and incomprehensible questions were put into corrected versions. For the collection of the data the methodology was carried out by face to face interviews. During the land survey over 166 questionnaires have been done and the questionnaire size was over the sample. The preliminary evaluation and the data and information taken by the questionnaire the missing parts have been completed. For the data collection face to face questionnaire methodology was performed. To each participant a summary of the study has been given. The participants who have been voluntary to participate in the questionnaire had been involved in this study.

After the questionnaires have been analyzed as correct the data have been transferred to the computer and the number of participants (f) and percentage (%) have been calculated. The questionnaire result has been calculated by the SPSS 15 and the other package programmes (we have no economical relationship with these institutions) and the percentage analysis have been evaluated.

The spatial database, developed as a part of this study, consisted of Land Use Type/Land Cover (LUTLC) type maps derived from forest stand maps (1969 ((GDF; 1969) and 2007 (GDF; 2007)) and field surveys during 2009. Forest stand maps were digitized and processed using a Geographic Information System (ArcGIS 9.0) with a maximum root mean square (RMS) error under 5m, the associated attribute data were entered to the computer and spatial database of the area was created. The basic categories of LUTLC were identified from forest stand map: cultivated area, forest, forest openings, settlement area and others.

Result and Discussion

Change of Land Use Type/Land Cover (LUTLC)

The land use type/land cover (LUTLC) maps for the years 1969 and 2007 are presented in Fig. 1. Percentage and quantity of each LUTLC types are given in Table 1. There is 5126 ha forest land, 1419 ha grassland and

5021 ha cultivated areas in the catchment (Fig. 1), (GDF, 1969-2007).

71% of the cultivated area in the catchment is dry agricultural land, 29% is watery land. Generally dry agricultural land which is non-productive and these lands are in higher altitude and highly sloped. Agricultural production is made in these non-productive areas.

Table 1. Boğalı Catchment 1969 (GDF; 1969) and 2007 (GDF, 2007) years of LUTLC

Land use/land cover	Areas				Change	
	1969		2007		ha	(%)
	ha	(%)	ha	(%)		
Forest	4914	42	5126	44	212	2
Grassland	1722	15	1419	12	-303	-3
Cultivated Area	4931	42	5021	43	90	1
Settlement	105	1	106	1	1	0
Others	1	0	1	0	0	0
Total	11673	100	11673	100	0	0

The forest cover and forest open area between 1969 and 2007 years have been compared and a positive development has been analyzed. The forestry area was 42% in the catchment in 1969; however in 2007 the forestry land has been increased to 44%. Normally, the forest cover decreases in highly densely populated rural areas. The increase in forest cover and agricultural land in the

catchment in general show an opposite with the decrease of grassland and open area in inside forest. The youth population is closely to distinction and generally the decrease in population in the catchment has prevented the wrong use of land and degradation in the catchment.

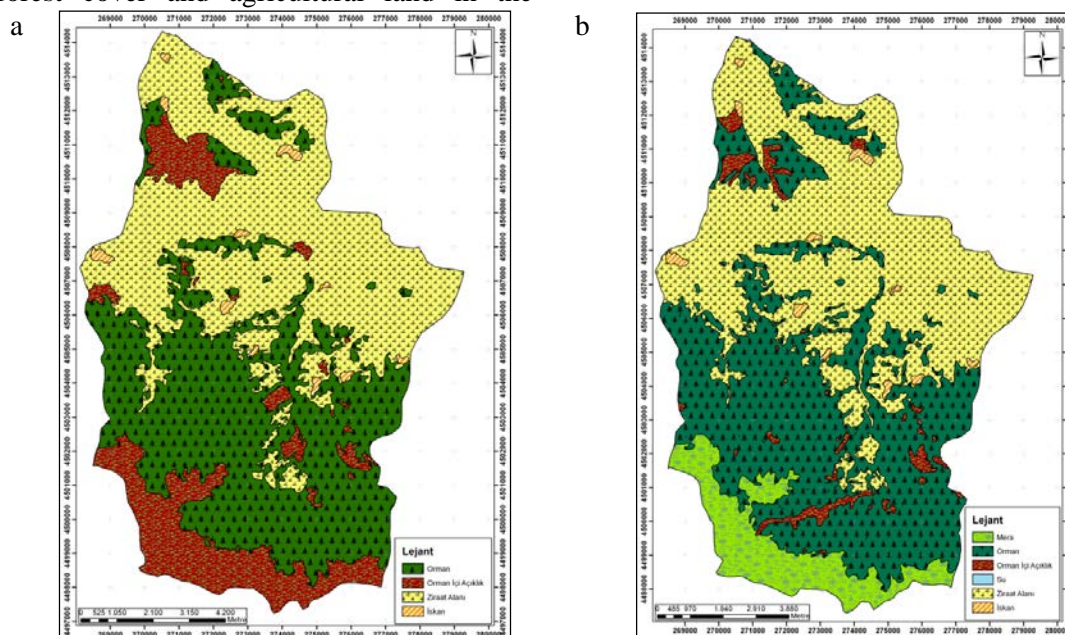

Figure 1. Boğalı Catchment a- 1969 year map of LUTLC (GDF; 1969) b- 2007 year map of LUTLC (GDF; 2007)

Population structure of catchment area

The land use type/land cover (LUTLC) maps for the years 1969 and 2007 are presented in Fig. 1. Percentage and quantity of each LUTLC types are given in Table 1. There is 5126 ha forest land, 1419 ha grassland and 5021 ha cultivated areas in the catchment (Fig. 1), (GDF, 1969-2007).

71% of the cultivated area in the catchment is dry agricultural land, 29% is watery land. Generally dry agricultural land which is non-productive and these lands are in higher altitude and highly sloped. Agricultural production is made in these non-productive areas.

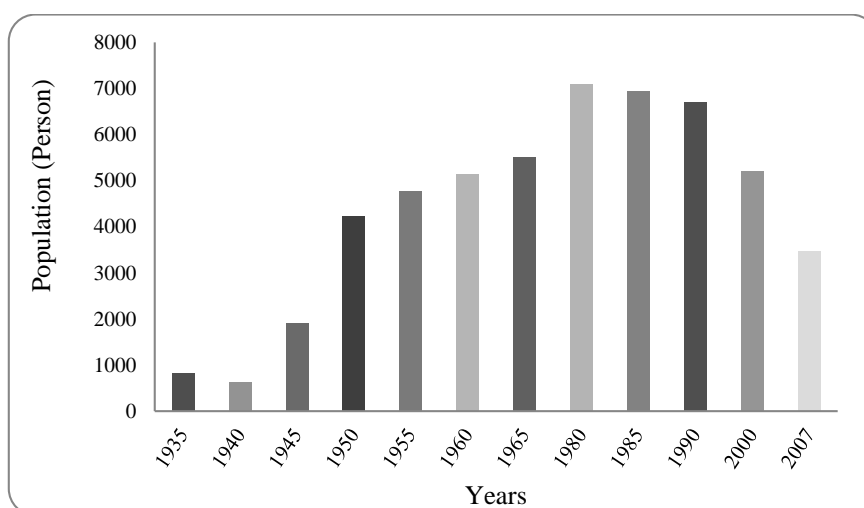

Figure 2. Boğalı catchment between 1935-2007 years difference in population (Anon. 2007b)

58% of the participants involved in the questionnaire were male and 42% were female. The average age of the participants was between 55-59 (32%) and in the age 65 (18%). When we have analyzed the level of education, 57% was primary school graduation, and 19% were illiterate. In Amasya the literate was 86% who lived in the catchment, which was under the city center average data.

The vocational division of the participants involving in the questionnaire was 58% farmers, and 1% forest worker. The rest 41% retired, unemployed and from different vocations. The forest workers are seasonal forest workers.

In the census 1985 shows that in whole the catchment the migration had begun. Between 1980-2007 the population in the Boğalı Catchment decreased 50% (Fig. 2) the catchment has the highest population in the 1980 census with a 7097 population rate. In 2007, 3635 number of decrease became the population 3435. The main reason of migration in the catchment was the unproductive agriculture land and the size of agricultural land which became less. The

other reason was the inefficient agricultural production which could not have been converted into economical income. The population which lived inside the catchment had to migrate to big cities or to foreign countries. The 43% was agricultural land of the catchment, which only 29% was watery and the rest was arid. 44% of the catchment was forest.

In 2001, the economic income Gross Domestic Product (GDP) of Amasya was 1439 USD which was under the average of Turkey (Anon. 2008). This shows a general overview of the economical income in the catchment. The pressure on the natural resources in the Boğalı catchment until 1980 was in the highest degree. After the migration this pressure was much more less (Anon. 2007c).

69% of the participants said that there was not enough medical services in the catchment. 59% of the participants said that they didn't have social insurance. These are important datas which are low to verify development in rural areas.

When we analyze the population motion between 1930 and 2007 the agricultural

income resources shows low levels and resulted into migration (Anon. 2007b).

Generally the population age was over middle age in the Boğalı catchment. And they were graduated from primary school. These led to different results. The preliminary studies showed that there was not a big obstacle in the field of education in the catchment. But despite this factor, due to the insufficient of the children and youth population in catchment showed the low level of education in the whole catchment. Therefore the number of primary school graduated population was high.

Nearly all of the participants were married. The number of having four children was high. 96% of the participating women said that they made additional support to the family budget. Most of the women worked on agricultural land, animal husbandry and add economical support. Women as in general of the rural country are in the working force. More than half of the men population helped their women in housework. This is not a common culture however but has been identified in this catchment. Who is the decision maker in the family was also a question and a classical answer was "man or husband". 90% of the 70 women participants said that they were happy about their life. 63% of the women said that they didn't want to live in another place apart from the catchment.

54% of the participants owned over 10 decar land. Because of the arid farmland, they obtain insufficient income. The most of the land ownership was because of heirship. This situation is important if in the last period the land from forestry and meadow was taken. The decrease in youth population, drought, the low economical income, alternative employment opportunities showed the decrease in being a farmer. All these effect the forest in the catchment to protect from opening agricultural land. When evaluation was made for natural resources it was a positive effect to the forest. New agricultural lands didn't be needed because the lands opened before for agriculture had been used for crop production for the support of the needs. Additionally, the old population and migration resulted into fewer land use in the catchment. In the catchment when we studied

on the land we could have analyzed many land parts which were left and turned into forest.

25% of the participants work on animal husbandry. Generally the farmers feeding own two cattle. The animal owners didn't own these animals for economic income they own them for daily milk needs for their family. The general sectoral income in the catchment was agriculture.

The animals were generally in the pasture feeded in the catchment. 63% of the participants said that they feed the animals sometimes inside the forestry. There was no scientific and technical knowledge about animal husbandry and feeding. There are forestry protection staff who are working on the protection forests from feeding animals which did not show any problem if they couldn't have been catch. On the other side, because most of the animals are cattle they couldn't have been damaged the forest. 65% of the participants use the firewood for heating their homes. And this amount is the highest in the aim of using concentration. Grazing in the forest is not a problem with the forest institution between the farmers. Most of the participants don't have any information about the damage caused by grazing in the forest. 88% of the participants think that the need to protect the forest and 94% believe that forest protects the their agricultural land. 54% of the participants emphasized that forest did not make any contribution to the family budget.

79% of the participants grow forage crop in the agriculture lands. The rest had no idea about this or stock farming. 68% didn't plan to migrate outside their village. The average age of the participant was over 55. This is a situation from that people didn't want to move from their hometown. In the face to face contacts people focused on that they didn't like urban life and they mentioned that they want to die and live in their hometown.

22% of the participants who wanted to migrate showed that economical determinism. Rural poverty and negative social life comfort were another reasons for migration. The main destination for migration was Istanbul. When we analyze the migration reasons, most of them were economic. Inefficient land, harsh climate conditions, low income, lack of socio-economic conditons and education

opportunity were the main migration reasons. Domestic and overseas migration has affected in this catchment. Many people emigrated for business opportunity.

Conclusion

Rural people in drylands often rely on a combination of rain-fed agriculture, livestock rearing, and other income generating activities that are extremely vulnerable to the climate change impacts anticipated under most models. Soil formation and water supply are already at unsustainable levels. Desertification and loss of biological potential will constrain drylands transforming into productive ecosystems.

The demographical development of Boğalı Catchment between 1935-2007 years could be analyzed in three periods. The first period is until 1935. In the population analysis in this time period there are some villages which haven't been constituted. These villages have been constituted in the 1950s. In the questionnaire study immigrants who had been migrated from East Black Sea and Thessaloniki were emphasized. In the second period, between 1950 and 1980s, the general population in the catchment was increasing. In the third period, between 1980 and 2007, the general population of the catchment was continuously decreasing. The migration period which was emphasized was first to the closest village and city center than the migration route became more far. Migration from higher altitudes in the catchment was more than that of the lower parts of the catchment. In 2009, there are only old and retired people left in the catchment. Rural poverty is coming out as the main pressure for migration. The degradation of natural resources are another result for migration. There hasn't been analyzed back to the catchment immigration. Only, people who became retired and missed their hometown returned back to their hometown so that the population became much more less. The population became old and the pressure on forest land decreased. Living the land for agriculture and pasture may have resulted into natural wild plantation. The population living in the catchment doesn't see the natural resources as an economical income anymore. Because of

these reasons crime rate may have dropped in the catchment.

With in the context of this study another important issue were the women title. The social title and the family economic status was evaluated as well for the women. In the women study all these subjects have been evaluated. Women were satisfied with the life within the catchment. However, the idea to live in another place became attractive. Women were unaware for their economic support to their home economy. Women were the mostly effected because of the social and economical insufficiencies. Women saw the decision maker as their husband or the men in the family. On the other hand, they emphasized that they may also took part in the decision.

In conclusion, the pressure on the natural resources is decreasing in rural lands because of the immigration to urban areas. Sustainable natural resource planning, in the size of catchment and the management with all the criterias should be managed. Catchment management should include all stakeholders by the way of catchment life cycle.

References

- Aksayan S., Bahar Z., Bayık A., Emiroğlu O.N., Erefe İ., Görak G., Karataş N., Kocaman G., Kubilay G., Seviğ Ü. 2004. Process and policy research methods in nursing, Nursing Research and Development Association (HEMARGE) Ankara.
(<http://www.turkhemsirelerdernegi.org.tr/menu/hemsirelik-yayinlari/kitap/26-kitap.aspx>).
- Alkan S., Toksoy D. 2008. The socio-economic structure of the forest villages: the case study in Trabzon, University of Kastamonu, Journal of Forest Faculty, 8 (1): 37-46.
- Anonymous. 2005. Implementation objectives of 2005. Ministry of Environment and Forests (Repealed), 29 p., Ankara.
- Anonymous. 2006. Migration and the displaced population survey in Turkey. University of Hacettepe, Institute of Population Studies. Ankara.
(www.hips.hacettepe.edu.tr/tgyona/TGYONA_rapor.pdf).
- Anonymous. 2007a. Meteorological climate bulletin of Taşova District (Amasya), 1987-2007, Amasya.
- Anonymous. 2007b. Population by years, age group and sex, census population, Ankara.

(<http://www.turkstat.gov.tr/UstMenu.do?metod=temelist>).

Anonymous. 2007c. Improvement project for Yesilirmak river basin within the framework of the regional improvement strategies. (<http://www.yesilirmak.org.tr/>).

Anonymous. 2008a. Our application note containing the information ministry in forest villages(www.cevreorman.gov.tr/orkoy/orkoy2008.doc).

Anonymous. 2008b. Turkey Statistical Institute regional indicators TR 83 Samsun, Tokat, Çorum, Amasya. (http://www.tuik.gov.tr/Kitap.do?metod=KitapDetay&KT_ID=0&KITAP_ID=175).

Anonymous, 2009. <http://www.amasya.gov.tr/http/index.asp?PageNo=186°er1=2>.

GDF. 1969. General Directorate of Forestry (GDF), Regional Directorate of Amasya, Forest District Directorate of Taşova, Management Plan of Forest Sub-district of Taşova.

GDF. 2007. 1996-2015, General Directorate of Forestry (GDF), Regional Directorate of Amasya, Forest District Directorate of Taşova, Management Plan of Forest Sub-district of Taşova.

Korcun C., Keçeli M., Şanlı G. 2006. Migration in Turkey, Southeastern and Eastern Anatolia Migration. p:1-4, İstanbul. (<http://mimoza.marmara.edu.tr/~mtekce/eco272/icgoc.pdf>).

Discussion of Objectives and Strategies of the Turkish Forestry Industry on Basis of Development Plans

Mustafa Fehmi TÜRKER¹, Canan YILMAZ¹, Emine Nur YEŞİLYURT¹, *Elif BERKER¹

¹Karadeniz Technical University, Faculty of Forestry, Trabzon/Turkey

*Corresponding Author: elifberker@ktu.edu.tr

Abstract

The objective is to be defined as the condition to be reached with the realization of certain activities; strategy means the path taken to reach the predetermined aims. While the most extensive aims towards all the economic activities that occur in one country are located in the national development plans; the objectives and the strategies of sectors that make up the economies of the countries should also be consistent with national development plans. Turkey, since the start of the 1963, arranged 10 development plans and objectives, policies and goals devoted to the forestry sector were also included in these plans. The purpose of the forestry sector in the first four development plans listed as: Protection of forests, expansion, operation, limitation, emphasis on forest and public relations. Along with these within the V-VIII. development plans objectives and policies like multi-purpose utilization, sustainability, ecosystem approach to forest resources are can be seen as taking the center of attention and high emphasis is given to production of raw wood materials. In the first eight development plans, even though the objectives, principles and policies for the forestry sector are determined; there are no clear explanations to with which tools or what strategies these determined objectives and policies are to be achieved. Realizing that this absence within the development plan is a major obstacle for achieving the objectives set for the forestry sector, a place had been given to strategic action planning within the IX. X. development plans. With this study, by determining the objectives and strategies by the 9. and the 10. FYDP, along with the relations between these periods of development plans; the problems faced in development of the purposes and particularly in the identification of strategies to be determined and suggestions for the solution of these problems to be made.

Keywords: Strategy, Objective, Forestry Sector and Development Plan

Introduction

As the most general expression, an objective could be defined as the personal or social values that guide current movements and reactions (Geray, 1986). According to another definition, objective expresses a future state that a business considers to achieve (Eren, 1986).

On the other hand; the most comprehensive objectives in a country are included in national development plans, industries are used as tools in achieving these objectives, while businesses are used as the tools to achieve the industrial objectives (DPT, 2001). Development plans, which bear objectives such as reducing inter-regional and cross-layer disparities in development and unemployment via improving income distribution, achieving a balanced growth rate, ensuring the structural changes and ensuring the efficient and rational use of the resources (Geray, 1998), plan the economy at the macro level. However, Turkey entered into the process of preparing development

plans, in which objectives, principles and policies towards the important industries that constitute country's economy are determined, since 1963 and prepared 10 development plans until currently.

On the other side, strategy could be defined as making a clear and comprehensive long-term business plan by using the best available resources in order to achieve the business' objectives (Türker, 2001). Similarly, strategy becomes the totality of actions that emerge due to the selection of the most convenient of the optional course of actions that could provide support in achieving the objectives in the light of the present structure, limited resources and tools, and ensuring the compatibility of these (Geray, 1986). Herein, the objectives and strategies of the industries that constitute the country's economy should present consistency with the objectives and strategies that are set out in the macro plans. Correspondingly, business objectives and strategies should not be in conflict with the

objectives and strategies of the industry they are in (Öztürk and Türker, 2002).

Objectives, principles and policies related to the forestry industry, which is one of the important industries of the Turkish economy, find different levels of expression in the development plans. In addition; especially if forestry industry does not appear in detail in the development plans, the objectives, policies and strategies appear in the Forestry Special Commission Reports that are prepared by the experts.

On the other hand, forest ecosystems, which are the main resource the forestry industry, are the assets that their preservation, expansion and development do not contradict with the macro objectives. However, the problem here lies in the decision-making and implementation of achieving these objectives via which technologies, through which priorities and with respect to which principles (Geray, 1998). In this study, each development plan would be examined in order to discuss the objectives and strategies identified for the Turkish forestry.

Material and Method

In determining the objectives and strategies of the Turkish forestry industry, 10 development plans prepared until today constitute the fundamental material of this study. In addition, various scientific research, which were conducted within this research area, were benefited as well. has been made on the subject also benefits from scientific studies. Besides, each development plan was considered independently and was scrutinized in line with the main aim of this study. by taking each individual development plan has been examined in accordance with the purpose of working. Hence, the problems faced in the identification of objectives and particularly strategies in forestry industry were detected and suggestions for the solution of problems were brought forward.

Results

Objectives and strategies of the forestry industry, which was considered within the agriculture industry in the development plans prepared from 1963 to today, were evaluated through the examination of each

development plan and presented in this section.

The objectives of the forestry industry in the 1st Five Year Development Plan (FYDP), spanning years between 1963 and 1967, were stated as; ensuring the preservation and sustainability of the forest, operating the degraded forest after reconstruction and rehabilitation, and acquiring new forest areas through afforestation (DPT, 1963). Including the objectives such as completion of the cadastral surveys of the forests, completion of the forest management plans and road construction in the same development plan demonstrates that wood raw material was especially considered as the forefront issue, and the objectives that serve this purpose were given the priority. On the other hand, in the period of this plan, low realizations such as 59% for afforestation and 12% for cadastral objectives (Öztürk and Türker, 2002) were met, and the plan remained below the objectives.

In the 2nd FYDP for years 1968 and 1972, principles such as preservation of forests, ensuring sustainability and increasing their contribution to the country's development through the most appropriate operation, establishing forests through reforestation, increasing the productivity of forests with the reconstruction and rehabilitation, regulation of forest-community relations in terms of preservation and operation of forests, re-detection of the forest borders depending on the forest presence and the ability to use land were stated (DPT, 1967). General Directorate of Forestry and Rural Affairs (GDFRA) was established in 1970 as a forestry organization dedicated to address the regulations of forest-community relations according to the objective stated in the development plan and concrete steps were taken in achieving the identified objectives. During this plan period, quantitative goals about activities such as reforestation, forest cadaster, road construction and increasing the amount of firewood were put forward, yet the realizations remained below the estimated values.

During the 3rd plan period between the years 1973 and 1977, regulation of forest-community relations, taking measures to decrease the wood raw material cost,

preservation and sustainability of forests and supplying the raw material demands of the forestry products industry (DPT, 1973) were included in terms of the principles and measures related to the forestry industry.

In the 4th FYDP for years 1979 and 1983, along with the principles and policies for the forestry industry determined by the previous three development plans, principles and policies such as multi-utilization of forestry resources, conducting afforestation activities with respect to ecological balance and suitability principles, encouraging domestic and international tourism for forest that have natural recreation potential (DPT, 1979) were established.

Similarly, during the 5th plan that spans the years 1985 and 1989, the objectives of the forestry sector was stated as the preservation and improvement of forests and the natural balance, planning, expansion and development of the forest with respect to the maximization of their contribution on the prosperity of the country (DPT, 1985). During this plan period, it is possible to state that the forestry industry, which is not scrutinized in detail, was focused on the preservation and sustainability of forests rather than the production of wood raw material.

The 6th FYDP for years 1990 and 1994 was determined to include principles and policies for the forestry industry such as meeting the continuous, balanced and versatile utilization principle for the demand of the society for forest products and services, expanding the forests, development of the forest peasants, endorsing the establishment of private forests and re-regulating the forestry organization, legislation, education and training by taking into consideration the entire functions of the forest resources (DPT,1990).

In addition, in the 7th FYDP for years 1996 and 2000, objectives, principles and policies for the forestry industry such as evaluation of forests within the framework of the ecosystem approach, regulation of forest management and silviculture plans considering various functions and business purposes such as wood and non-wood products and services, enabling the investigation of yet unknown benefits of

forests and expansion and dissemination of areas such as National Park, Nature Conservation Areas in order to protect the forests' natural and cultural values (DPT, 2001) were determined.

In the 8th FYDP for years 2002 and 2005 the principles of the forestry industry were listed as; operation, preservation and improvement of forests with respect to the ecosystem approach within principles such as continuity, multi-purpose utilization, participation, specialization; comprising issues such as land use, biodiversity, environmental functions in harmony with the global consciousness of forestry research units and studies; implementation of the method known as the "Green Certificate" in Turkey, which describes the production of forest products with environmental and social responsibility (DPT, 2000).

In the 9th development plan that spans the 2007 and 2013 period, no detailed information on the forestry industry was observed. However, once the report of the Special Commission of Forestry was analyzed, it was observed that the fundamental objectives of the forestry industry was stated as the preservation, development and utilization of the forests. Sub-objectives such as preservation of forest areas and borders, preservation of the biodiversity of forests, protection of forests against the biotic and abiotic damages were included within the scope of preservation of forests. On the other hand, in the Forestry Special Commission Reports, improving the existing forests and expansion of forest areas were designated as sub-objectives with respect to the objective of improving forests. In the same report, sub-objectives such as utilization of the forest products, benefiting from the social and cultural services of the forests, respect for local rights, contributing on the improving the living conditions of forest villagers and thereby reducing poverty were mentioned (DPT, 2007).

However, in the report; following the identification of the forestry industry, the policies and strategies in achieving these objectives were stated. In the report, the strategies to be followed were grouped under five headings; regulation of the legislations, institutional regulations, financial resources,

human resources and other measures. Hence, in order to ensure the provision of forestry services in accordance with the terms and requirements of the present day strategies were identified under the names of legislation regulations such as cooperation with village legal entity to combat forest fires and cooperation with related professional organizations. Along with these identifications, strategies such as increasing the attractiveness of working in rural areas in order to eliminate the staff deficit in the rural, under the heading of institutional arrangements (DPT, 2007).

The current 10th development plan covering the years 2014 and 2018 defines the objectives of the forestry industry similar to the previous plan; it is possible to list these objectives as the preservation of areas and borders, improvement of the forests and preserved areas, utilization of forest areas and preserved areas, and particular for this plan period, empowering the industrial capacity. In addition, in order to achieve the objective of preservation of areas and borders 17 policies were identified and the strategies to be used in achieving these objectives were mentioned. For instance, the policy that indicates combating forest fires and pest control concentrating on the biological methods was stated to achieve its objective via strategies such as development of the legislation regarding the forest and water resources relationship, improving the capacities of the forestry research units, and combating fire and increasing the number of ponds that have biodiversity.

On the other hand, eight policies were determined in order to achieve the objective of improvement of the forests and preserved areas. Of these eight policies one aims to ensure green belt afforestation and effective management and preservation of urban forests. It was observed that strategies such as secondary legislation on establishment, maintenance and management based on the laws no. 3234 and 6831 and cooperation with local administrations on green belt afforestation and improvement of urban forests were determined in achieving the stated objective and implementation of the identified policies. Besides, fourteen policies were determined for the objective of

utilization of forest areas and preserved areas and strategies in achieving the stated objective and policies were indicated as well. Of these fourteen policies one designated strategies such as fulfilling the needs for water procurement forests in scope of the Forest Law no. 6831 and development of the institutional capacity for the effective management of the forests assigned by the General Directorate of Forestry, in order to manage the contribution of forests to water procurement in a sustainable manner. On the other hand, in order to achieve the objective to strengthen the industrial capacity, five policies were identified. For the realization of this objective, strategies such as reflecting the international processes agreements, which are partied to, within the national legislations and increase the number of Turkish experts that could take part in international organizations were put forward (Kalkınma Bakanlığı, 2014).

Results and Discussion

Development plans, which are prepared in order to achieve economic, social and cultural objectives of a country, are instructive for the private industries and mandatory for the public industries, and as well constitute include objectives, policies and strategies at the macro level for the forestry industry, which is an important part of the national economy. Once the ten development plans prepared and implemented since 1963 until today are evaluated collectively, it could be observed that the forestry industry during the period of first three plans maintained a management approach based on the wood products and the main objective could be detected as increasing the production of wood raw material. As the objectives in the first three development plans were scrutinized, it was established that these objectives were towards increasing wood raw material production; yet, the achieved targets largely remained below expectations. On the other hand, during the 4th plan period, production of wood raw material, which was determined as the main objective, was partly abandoned, and along with it, it is possible to assert that the principle of multi-dimensional utilization of forest resources was adopted. In addition;

it attracts the attention that the concepts stated with similar expressions were named differently in the first four FYDPs. Hence, while increasing wood raw material was named as principle and policy in the first four development plans, after the fifth and latter FYDPs it was stated as an objective. In this regard, it is possible to assert that there is a "conceptual confusion" between the objective, principle and policy concepts for the development plans of the former periods. On the other hand, since the 5th FYDP, principles such as multi-dimensional utilization of forest resources, sustainability, participation came forward and it was aimed to manage and operate forest ecosystems via adopting these principles. Additionally; in the 8th plan period, these principles were extended and with every consequent plan period, broader objectives were determined. Although named differently, objectives of the forestry industry were included in the first eight development plans, and targets were indicated in order to achieve these objectives, yet it was observed that most targets remained below realization. Although forestry oriented objectives, principles and policies were included in the same development plan, the lack of mention for tools or strategies for achieving these objectives constitutes the main reason for such result. Due to the identification that failure to recognize the strategies in the forestry industry, a focus on the strategies that could be utilized in achieving the objectives was first noticed in the 10th Forestry Special Commission Report. Similarly, objectives set during the 10th plan period were supported by broader strategies; detailed observations for the preservation, improvement and utilization of forests within the objective-strategy-policy range emerged for the first time in this plan; responsible institutions, duration and location information were included on the realization of objectives and strategies. Including the objectives of the forestry industry and the strategies to achieve these objectives within the 9th and 10th development plans could be regarded as an indication that the Turkish forestry took steps towards contemporary forestry.

References

- DPT, 1963. I. Beş Yıllık Kalkınma Planı (1963-1967), TC Başbakanlık Devlet Planlama Teşkilatı, Ankara
- DPT, 1967. II. Beş Yıllık Kalkınma Planı(1967-1972), TC Başbakanlık Devlet Planlama Teşkilatı, Ankara
- DPT, 1973. III. Beş Yıllık Kalkınma Planı (1973-1977), TC Başbakanlık Devlet Planlama Teşkilatı, Ankara
- DPT, 1979. IV. Beş Yıllık Kalkınma Planı (1979-1983), TC Başbakanlık Devlet Planlama Teşkilatı, Ankara
- DPT, 1985a. V. Beş Yıllık Kalkınma Planı (1985-1989), TC Başbakanlık Devlet Planlama Teşkilatı, Ankara
- DPT, 1985b. V. Beş Yıllık Kalkınma Planı, Ormancılık Özel İhtisas Komisyon Raporu, YAYIN NO: DPT: 2872 - ÖİK: 310, Ankara
- DPT, 1990. VI. Beş Yıllık Kalkınma Planı (1990-1994), TC Başbakanlık Devlet Planlama Teşkilatı, Ankara
- DPT, 1996. VII. Beş Yıllık Kalkınma Planı (1996-2000), TC Başbakanlık Devlet Planlama Teşkilatı, Ankara
- DPT, 2000. VIII. Beş Yıllık Kalkınma Planı (2001-2005), TC Başbakanlık Devlet Planlama Teşkilatı, Ankara
- DPT, 2001 VIII. Beş Yıllık Kalkınma Planı Ormancılık Özel İhtisas Komisyon Raporu, Yayın No: DPT: 2531-ÖİK: 547, Ankara
- DPT, 2007a. IX. Kalkınma Planı (2007-2013), TC Başbakanlık Devlet Planlama Teşkilatı, Ankara
- DPT, 2007b. IX. Kalkınma Planı Ormancılık Özel İhtisas Komisyon Raporu, Yayın No: DPT: 2712-ÖİK: 665, Ankara
- Eren, E., 1986, Stratejik Yönetim, TC Anadolu Üniversitesi Yayın No: 967, 390 s., Eskişehir
- Geray, A. U., 1986, Planlama, İ.Ü. Fen Bilimleri Enstitüsü Orman Ekonomisi Yüksek Lisans Programı Ders Notları, 146 s., İstanbul
- Geray, A.U., 1998, Ulusal Çevre Eylem Planı-Orman Kaynakları Yönetimi, DPT Yayını, ISBN 975-19-1917-7, Ankara
- Öztürk A. ve Türker M.F., 2002, Ülkemiz Ormancılık Sektörü Amaç, Strateji Ve Politikalarının Makro Planlar Kapsamında İrdelenmesi, II.Ulusal Karadeniz Ormancılık Kongresi, ss. 25-39, Artvin
- TC Kalkınma Bakanlığı, 2014. Sürdürülebilir Orman Yönetimi, X. Kalkınma Planı Ormancılık Özel İhtisas Komisyon Raporu, Ankara

Türker M.F., 2001, Ormancılık Sektöründe Stratejik Yönetim Kavramının Sektörün Değişen Çevre Şartları Açısından İrdelenmesi , I. Ulusal Ormancılık Kongresi, ss.279-293, Ankara

Türker, M.F., 1999, Girdi-Çıktı Analizi Yardımıyla Ormancılık Sektörünün Ülke Ekonomisi İçindeki Öneminin Belirlenmesi, Tr.J.of Agriculture and Forestry, 23 (1999) Ek Sayı 1, ss. 229-237

Chestnut Flour; White Gold

Selim TOKMAK

İzmir Katip Çelebi University, Faculty of Forestry, İzmir / TURKEY
selintokmak@gmail.com

Abstract

The scientific name "castanea", which grows in all temperate regions of the Northern hemisphere and the globe fagaceae chestnut is from the family. Cultivation of chestnuts were cultured in the world according to various sources, it is estimated that begins before the year 6000. Production of fruit and chestnut wood with double production capacity, is a species of economic importance. The type of chesnut "Castenea sativa Mill." grows in the Mediterranean Basin and in our country.

The major countries that are mainly grown in China, Turkey, Italy and Korea. Turkey ranks second in the world with 60019 tons of chestnut production. However, it is ranked seventh in the world with exports 8647 tons. Be very limited range of processed chestnuts are to be effective in this ranking.

Chestnut flour is processed products and their too large uses in health-food industry sees a lot of demand in the domestic and foreign markets. Chestnut flour, it will be important in terms of opening new markets and creating value-added sector of the relevant stakeholders.

Keywords: Chestnut, Chestnut Flour, Fruit, Food industry, Celiac disease

Kestane Unu; Beyaz Altın

Özet

Bilimsel adı "*Castanea sativa* Mill." olan ve Kuzey Yarım Küre'nin tüm ılıman bölgelerinde yetişen kestane ağacı kayingiller familyasındandır. Çeşitli kaynaklara göre dünyada kültüre alınmış kestane yetiştiriciliğinin 1.000 yıl öncesinde başladığı tahmin edilmektedir. Kestane meyve ve odun üretimi ile çift üretim kapasitesine sahip, ekonomik önemi olan bir ağaç türüdür. Ülkemizin de olduğu Akdeniz Havzası içinde yer alan ülkelerde yetişen kestane türü *Castanea sativa* Mill'dir.

Dünya'da ağırlıklı olarak yetiştiği başlıca ülkeler Çin, Türkiye, İtalya ve Kore'dir. Türkiye yaklaşık 60 bin ton üretim ile ikinci sırada yer almaktadır. Fakat dünya ihracatında ise 8647 tonla yedinci sırada yer almaktadır. İşlenmiş kestanenin çok sınırlı olması bu sıralamanın düşük olmasında etkili olmaktadır.

İşlenmiş Kestane ürünleri geniş kullanım alanlarıyla sağlıklı ve güvenilir gıda endüstrisinde yurt içi ve yurt dışı pazarlarda çok ciddi talep görmektedir. Kestane unu, yeni pazarlar açma ve katma değer oluşturmasıyla ilgili sektör paydaşları açısından önemli olacaktır.

Anahtar Kelimeler: Kestane, Kestane Unu, Meyve, Gıda Endüstrisi, Çölyak Hastalığı

Introduction

The chestnut group is a genus (*Castanea sativa* Mill.) of deciduous trees and shrubs in the beech family Fagaceae. The culture of the chestnut in the Mediterranean Basin as well as our country is based on the pre-1000 years. Although distribution center is not known for this species there is a strong possibility that the homeland of Anatolia. From Anatolia to Greece, it was taken from here in Southern Italy and Spain.

Chestnut warm and temperate climates, relative humidity is grown in high places (Anonim, 2013)

90.5% of the world chestnut production in Asia, 6.6% is made in Europe and the Americas 2.9%. (Figure 1).

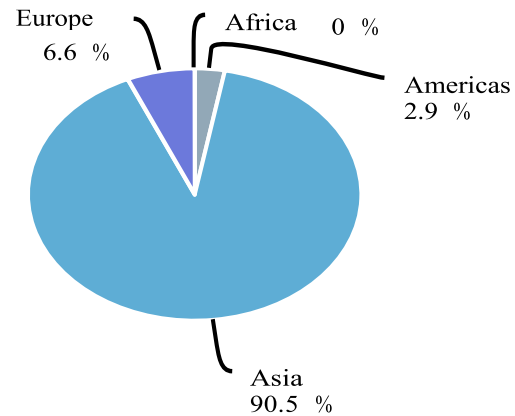

Figure 1. Chestnut production of the world (FAO, 2016).

The main countries that mainly grows in China, Korea, Turkey, Bolivia and Italy

(Table 1). According to FAO data for 2013, 305,000 hectares of production area in China and 87% of first place while world chestnut production with 1,650,000 tons of production meets China.

Table 1. The top five countries in the world producing Chestnut (FAO, 2016)

2013			
	Production (tons)	Production Area (ha)	
China	1.650.000	China	305.000
Korea	67.902	Bolivia	42.180
Turkey	60.019	Turkey	39.180
Bolivia	58.666	Portugal	35.200
Italy	49.459	Korea	33.073

In second place with 42.180 hectares and 67.902 tones of production in Korea, 39.180 hectares and 60.019 tones of production with Turkey it is in third place. In Turkey, in the humid forest areas in the Aegean, the Black Sea and the Marmara regions, (*Castanea sativa* Mill.) chestnut species is naturally grown. Turkey chestnut production has increased production to TUIK data (Table 2).

Table 2. Turkey chestnut production (TUIK, 2015)

Region	Production (tons)	Area (ha)
Aegean	36.803	9.402
West Marmara	2.195	90
East Marmara	3.905	1.195
West Blacksea	19.245	408.5
East Blacksea	1.462	12.6
Mediterranean	88	8
Middle East Anatolia	14	0.5
Istanbul	50	-
Total	63.762	11.116

Tannin-rich dark wood is very durable and shipbuilding, furniture and building industry, pier, boat, telephone poles, fences, piles of barrels and turning, also used in making baskets twigs. Production of fruit and wood chestnut with double production capacity, is a species of economic importance (Anonim, 2011).

Chestnut our country more fresh fruit, grilled chestnut is consumed in the form of candied chestnut. Chestnut flour is almost no

production in our country. Usage is not very common.

Chestnut trade in the world and Turkey

According to FAO data for 2013, the total amount of 125.094 tons in world export chestnuts (Table 3).

Table 3. World exports of chestnut (tons) from 2010 to 2013 (FAO, 2016).

Country	2010	2011	2012	2013
China	37.158	37.900	35.064	39.120
Portugal	6.842	7.356	13.821	16.153
Italy	18.936	17.120	14.345	14.148
Spain	6.776	7.346	9.047	13.690
Korea	12.584	10.190	10.793	12.285
Turkey	3.073	4.236	5.465	5.166
France	2.979	2.579	3.678	3.716
Japanese	1.747	514	1.010	1.314
EU	40.231	39.514	47.477	55.487
World	101.680	96.738	105.971	125.094

World exports of chestnut European Union (55.487 tonnes) are in first place. In European Union countries, Portugal (16.153 tonnes), Italy (14.148 tons), Spain (13.690 tonnes) and France (3.716 tonnes) is located in the first ranks. Chinese chestnut production of a large part of the performing, chestnut export 39.120 tonnes for the first rank, the second with 16.15 tons of Portugal, Turkey ranks sixth with 5.166 tons.

When we examine the world chestnut import figures it is seen very a different table (Table 4).

Table 4. World chestnuts imports (tons) from 2010 to 2013 (FAO, 2016).

Country	2010	2011	2012	2013
Italy	6.770	9.034	18.340	32.036
China	17.497	14.253	14.852	16.616
Japanese	12.625	11.690	11.269	10.483
France	7.978	8.352	4.302	7.609
Germany	3.470	3.469	3.845	4.315
Korea	1.337	2.054	2.110	2.197
Turkey	247	278	183	206
EU	35.105	36.352	43.518	62.333
World	99.798	97.130	103.408	124.397

According to the FAO 2013 data is the total amount of 124 397 tons of chestnuts that are subject to world imports. Approximately half of this figure (62.333 tones) realizes EU

countries. Italy ranks first in the world with 32.036 tones of imports, China with 16.616 tons a second, third Japanese 10.483 tons and Turkey ranks seventh with 206 tons of imports.

Chestnut and Chestnut flour consumption and their impact on human health

Chestnut since ancient times has occupied an important place in human nutrition. Researchers in the early time, the year of the people living in the Alpine region of 4 to 6 months that they are spent in mainly chestnut nutrition. This chestnut consumption per capita in the region is said to be around 150 kg per year. Therefore bread of poor people chestnut tree is defined as bread tree. Chestnut is grown under totally natural conditions in nature, in addition to the nutrients it contains, where the importance of long-standing in the diet remains today. The chestnut, in addition to being a lot of benefit to human health; chestnut meet with people in different flavors. At the head of sweet chestnut food made with Chestnut, chestnut cake, chestnut pudding, chocolate and sweet chestnut it comes from a similar flavor. A portion of the fresh consumption is very common chestnut is used in the confectionery industry. In some meat dishes as prepared turkey stuffed with chestnuts inside of Turkey is considered as a garnish. In addition, the European countries in chestnut flour and the dough is evaluated in a variety of fields of food industry. It can be eaten as fresh and boiled Chestnut can be eaten kebab made. Chestnut and unlike other nuts and seeds, contain relatively lower in calories and fat, but it contains vitamins and minerals which are extremely useful in terms of human health (Table 5).

Table 5: Raw nuts -100 g unpeeled - nutritional value (Anonymous, 2016a)

Nutrient	Unit	per 100 g
Water	g	48.65
Energy	kcal	213
Protein	g	2.42
Total lipid (fat)	g	2.26
Carbohydrate	g	45.54
Fiber, total dietary	g	8.1
Minerals		
Calcium, Ca	mg	27
Iron, Fe	mg	1.01
Magnesium, Mg	mg	32
Phosphorus, P	mg	93
Potassium, K	mg	518
Sodium, Na	mg	3
Zinc, Zn	mg	0.52
Vitamins		
Vitamin C, total ascorbic acid	mg	43.0
Thiamin	mg	0.238
Riboflavin	mg	0.168
Niacin	mg	1.179
Vitamin B-6	mg	0.376
Folate, DFA	µg	62
Vitamin B-12	µg	0.00
Vitamin A, RAE	µg	1
Vitamin A, IU	IU	0.0
Vitamin D (D2+D3)	µg	0
Vitamin D	IU	
Lipids		
Fatty acids, total saturated	g	0.425
Fatty acids, total monounsaturated	g	0.780
Fatty acids, total polyunsaturated	g	0.894
Cholesterol	mg	0

Chestnut and chestnut flour does not contain gluten, such as hazelnuts and almonds. Therefore one of the indispensable food prepared for consumption by celiac gluten-sensitive patients. Celiac disease (gluten enteropathy) is the most common nutritional disease in humans originated in the small intestine. The result of the interaction of genetic and environmental factors seen in susceptible individuals gluten (wheat, barley, rye and oats in a type of protein) which is resulting in a malabsorption syndrome that occurs shortly after the receipt of food. Therefore it is had to diet celiac patients with gluten-free food for life. The only treatment for celiac disease is diet. Celiac disease is a lifelong disease that people live together. Celiac is a genetic disease, at nowadays no specific treatment. Although it is estimated that 1% of people with celiac disease in

Turkey, many people do not even know he was sick. Carbohydrate level of the chestnut, about the same level as the content of wheat and rice grains. Chestnut vitamin B, vitamin A, vitamin C and a mineral (K, Mg, Fe, Mn, P, C) has a content. Similarly an important source of dietary fiber and essential amino acid. It also has high antioxidant content and low fat content. It increases the nutritional value do not contain cholesterol and increase the positive impact on human health (Table 6).

Table 6. Composition of the wheat and chestnut flour (Dokić, et al., 2014)

Components	Wheat flour (%)	Chestnut flour (%)
Moisture	12.29	5.71
Starch	73.75	45.28
Proteins	9.70	5.54
Reducing sugars	1.83	21.10
Fats	0.84	3.19
Ash	0.45	2.06

The chemical composition of chestnut flour; ash, fats, fibers and starch contents were similar in terms of corn flour, corn flour protein content contains protein at the level of care half. Dominant compound of chestnut flour is starch. Chestnut flour is similar to the protein content of rice protein content. The most characteristic feature of chestnut flour comprises protein with high content of essential amino acids and does not contain gluten. This feature provides a major contribution to the preparation of bakery products intended for consumption by celiac patients. Gluten-free raw products other B vitamins at a lower level compared with chestnut flour, iron, folic acid and contain dietary fiber. Therefore, when the nutritional value of such products is increasing chestnut flour is added (Dokić, et al., 2014). Chestnut flour is ideal for patients especially in infants and young age, food is more useful with their needs and priorities and developments. In Europe especially sweet chestnut flour, cake because of their high nutritional value and fragrant, baby food, gluten-free bread is used in large quantities in type. 1 kg chestnut flour price in the world, with 573.12 - 65.65 TL-kg ranged from (Table 7).

Table 7. The World market prices of chestnut flour (1 kg) (Anonymous, 2016b).

Country	Price (€)	Price (TL)
Amazon.com	52.95	158,06
Amazon.com Italian	55.00	164.13
Nuts.com	22.2	65.65
Goldenfields.co.nz	22.2	65.65
chestnuthilltreefarmm.com	191.9	573.12
Cheznuts victoria Victoria	55.9	167.05
N11.com (Naturelka)	33.2	101.6
https://cheznuts.com.au/product/chestnut-flour/	30	91,743
https://glutenfreeshop.com.au/cheznuts-	50	152,9

In our country, producers cannot take all the chestnuts market for their harvest. It called sub sieve and very little fruit, or finding buyers is considered very low price or as animal feed. To participate in the expansion of the food industry and the production of chestnut flour "sieve" called as fruit that can be used easily in flour production and added value can be sold at a higher price. In a project supported by Izmir Development Agency in 2012. "Beydağı to the chestnut flour is raining" chestnut flour production are given 1 kg flour can be produced from 3.5-4 kg of raw chestnuts. The producers except in extreme chestnut fruit prices in the hands of the Turkish lira's 3-8 -KG Given that production is to be understood that many of the more economically. Besides the high level of employment generated and the unit price will be breathing new life into the sector with new business opportunities.

Results

Turkey production with 60.019 tones of chestnut production in the world after China and South Korea are to take third place. However, when looking at export and import figures, we see that our country dropped to 6th and 7th row. Production in producing in quantities of less than Turkey Italy (49.459 tones), Portugal (24.700 tones), Japan 21.000 tones), Spain (17.200 tones) and France (9.209 tones) as countries they are more

involved in the world chestnut trade. These countries chestnut trade only in the food industry is not sold as raw fruits and fruit are produced with the participation of performing many different items. One of the most significant of these items are chestnut flour. Our country, its place in the world chestnut production, also wants to protect the chestnut trade; chestnut in the food industry must use various items

Chestnut flour to be one of the items that come to mind first.

Reference

Anonim, 2011. Kestane eylem planı 2012-2016. Bursa Orman Bölge Müdürlüğü. <http://bursaobm.ogm.gov.tr/Documents/Subeler/Silvikultur/KEP.pdf>

Anonim, 2013. 2013 yılı kestane raporu. Aydın Ticaret Borsası. <http://aydinticaretborsasi.org.tr/files/document/pdf/kestane-raporu.pdf>

FAO, 2016. Food and agriculture organization of The United Nations statistics division. <http://faostat3.fao.org/browse/Q/QC/E>

TUIK, 2015. Bitkisel üretim istatistikleri. <https://biruni.tuik.gov.tr/bitkiselapp/bitkisel.zul>

Anonymous, 2016a. United States Department of Agriculture Agricultural Research Service National Nutrient Database for Standard Reference Release 28. <https://ndb.nal.usda.gov/ndb/foods/show/3651?manu=&fgcd=>

Dokić L., Nikolić, I., Šoronja-Simović, D., Pajin B., Juul N. 2014. Sensory Characterization of Cookies with Chestnut Flour. World Academy of Science, Engineering and Technology International Journal of Biological, Biomolecular, Agricultural, Food and Biotechnological Engineering Vol:8, No:5.

Anonymous, 2016b. www.amazon.com, www.amazon.com (Italian), www.nuts.com, www.goldenfields.co.nz, www.chestnuthilltreefarm.com, <https://cheznuts.com.au/product/chestnut-flour/>, www.n11.com, <https://cheznuts.com.au/>, <https://glutenfreeshop.com.au>

The Economic Effects on Forest Villagers of ORKÖY's Beekeeping Investments (Case Study: Beekeeping Investments in Forest Villages in the Western Mediterranean Region)

*Ufuk COŞGUN¹, K. Hale GÜLER²

¹Karabuk University, Faculty of Forestry, Department of Forestry Engineering, Karabuk-
TURKEY

²South-West Anatolia Forest Research Institute, Department of Forest Economy, Antalya-
TURKEY

*Corresponding Author: ufukcosgun@karabuk.edu.tr

Abstract

The realisation of planned investments for Forest and Village Affairs (ORKÖY) district development projects remained at a low level. The realisation of "Professional Beekeeping" investments in Antalya was 11.62%, 8.44% in Burdur and 17.38% in Isparta in the scope of the District Rural Development Plans. A "Project monitoring, evaluation or economical analysis" mechanism for investments have not been fully established by ORKÖY. With the exception of monitoring the repayment of investments, there are no serious mechanism for "monitoring, evaluation and economical analysis". Therefore, the results, impact and, the economic analysis of the investments are not sufficiently able to be evaluated. This study takes a sample of enterprises from forest villages of the provinces Antalya, Burdur and Isparta with the aim of "identifying the problems and providing recommendations for solutions concerning the production, marketing and economical analysis of bee products by investigating the economics analysis of enterprises of forest villages of the Western Mediterranean region, which are conducting beekeeping and which taken beekeeping loans provided by ORKÖY". An annual average Gross Output Value of 11,189TRY as a level of income is a serious source of income. Such a level of income for forest villagers is important. When the economic factors and level of education are taken into account, beekeeping is a very good initiative for employment of the young population in rural areas. There needs to be colony support which shall be an economic resource for enterprises. In order to ensure this, the activities should be reorganised to provide support with 40-50 or 50-60 colony support. The support provided with 10-20 colonies are found to bring a low income by the enterprises. Thus, they do not see beekeeping as the main source of income generation. When the level of income is low for two years in a row, the enterprise tends to return to agricultural production or animal husbandry. A need for a significant allocation of time by the labour force of the enterprise for beekeeping is another negative aspect.

Keywords: Forest villagers, Economic analysis of ORKÖY's beekeeping investments, Gross profit analysis

ORKÖY Arıcılık Yatırımlarının Orman Köyleri Üzerindeki Ekonomik Etkileri Batı Akdeniz Bölgesi Örneği

Özet

Batı Akdeniz bölgesini oluşturan Antalya, Burdur ve Isparta illerinde de "Fenni Arıcılık" yatırımı 1970-1980-1990 ve 2010'li yıllarda uygulanmış bir destek türüdür. ORKÖY ilçe kalkınma projelerinde planlanan yatırımları gerçekleştirme oranı düşük düzeyde kalmıştır. Bunda en önemli etken kaynak sınırlılığı olmuştur. İlçe Kırsal Kalkınma planlarında Antalya ilinde "Fenni Arıcılık" yatırımları için gerçekleştirme oranı %11,62, Burdur ili için %8,44 ve Isparta ili için %17,38 olmuştur. Yatırımlarda çok önemli bir noktayı ise yapılan yatırımların üretim, pazarlama ve ekonomik analizler konusu oluşturmaktadır. ORKÖY yapılan yatırımlar için "proje izleme, değerlendirme ve ekonomik analiz" mekanizmasını tam olarak kurabilmiş değildir. Yapılan yatırımların geri ödemelerinin izlenmesi dışında ciddi bir "izleme, değerlendirme veya ekonomik analiz" mekanizması bulunmamaktadır. Bu nedenle de yapılan yatırımların sonuçlarını, etkilerini ve çok önemli bir nokta olarak sürdürülebilirliğini değerlendirememektedir. Bu çalışmada yöredeki arıcılık yatırımının sürdürülebilirliği de ortaya konulmuştur.

Çalışmada; "Batı Akdeniz bölgesi orman köylerinde ORKÖY tarafından arıcılık kredisi kullanan, arıcılık yapan işletmelerin ekonomik analizlerini inceleyerek, üretim ve pazarlamaya yönelik sorunların tespiti ve çözüm önerileri üretme." amacıyla Antalya, Burdur ve Isparta illeri orman köylerindeki işletmeler örneklenmiştir.

Çalışmada orman köylerinde ORKÖY arıcılık kredisinden yararlanan ve halen arıcılık yapan 64 işletmenin arıcılık kazancını belirlemeye yönelik ekonomik analizler yapılmıştır. İşletmelerin ekonomik analizlerinin yapılmasında brüt kâr analizi yöntemi kullanılmıştır. Arıcılık kredi uygulamasından yararlanan işletmelerin üretimi olan balın pazarlanmasına yönelik pazarlama karması unsurları ile ilgili pazarlama olanak ve kısıtları saptanmıştır. Yıllık Ortalama Gayrisafi Üretim Değeri olarak 11.189 TL. düzeyinde bir gelir aslında oldukça ciddi bir gelir unsurudur. Özellikle orman köyleri için bu düzeyde bir gelir çok önemlidir. Konunu ekonomik boyutları ve eğitim düzeyi dikkate alındığında arıcılık kırsal alanda genç nüfusun işlendirilebilmesi için çok uygun bir işletmecilik şeklidir. Elde edilen ürünlerin mutlaka yöredeki arıcılar birliği aracılığı ile ancak kar marjı düşürülmeden piyasaya sunulmasını sağlayacak pazarlama sistemlerinin yaşama geçirilmesi konusunda da ORKÖY'ün etkin görev alması gereklidir. İşletmeler için ekonomik bir kaynak olacak düzeyde bir koloni desteğinin olması gerekmektedir. Bunu için de destek için 40-50 veya 50-60 kolonilik bir destek ile çalışmaların reorganize edilmesi gerekmektedir. 10-20 kolonilik destekle işletmeler bu destekten sağlanan geliri düşük bulunmaktadır. Bu nedenle de arı yetiştiriciliğini temel geçim kaynağı olarak görmemektedirler. Gelirin bir iki yıl üst üste düşük olması durumunda işletmeci tarımsal üretime veya hayvancılığa dönebilmektedir. Arıcılık için işletme içi iş gücü konusunda ciddi bir zaman gereksinim duyulması da olumsuz bir nokta oluşturmaktadır. Gelirin düşük olduğu yılların da etkisiyle işletmeler temel geçim kaynağı olan tarım ve hayvancılıktan yeterince zaman ayıramamakta ve koloniler zaman içerisinde sönmemektedir.

Anahtar kelimeler; orman köyleri, ORKÖY arıcılık yatırımlarının ekonomik analizleri, brüt kar analizi

Introduction

ORKÖY. The ORKÖY Professional Beekeeping Loan practice was evaluated in two phases. The first phase is the sustainability of the ORKÖY beekeeping loan practice. The second phase is the impact of the ORKÖY Professional loan practice on the socio-economic structure of the forest villagers taking advantage of this loan. An evaluation study of the beekeeping loans of the ORKÖY General Directorate was discussed in the **Evaluation Report of the Questionnaire Administered regarding the Beekeeping Loans of the ORKÖY General Directorate** (Fıratlı, 2003). From this study, it is understood that, between the years 1991-2000, a total loan amount of 627.7 Billion TRY and 920.7 Thousand USD with a low interest rate was provided to 5,740 forest villagers in 60 provinces from the resources of the Fund Budget (FB), Rural Development Projects (KKP) and the Eastern Anatolian Water Basin Rehabilitation Project (DASHRP). No significant problem was experienced in the loan provision or repayment stages.

It is stated that the repayments are continuing without problem, and the remaining amount to be repaid in Turkish Lira is 317.8 billion and as of 2003, the loans provided in USD have not yet started to be repaid (Fıratlı, 2003). In the investigation conducted in this study, it was found that 2,176 producers had no bee hives following

the use of the loan and the notification that there were 63,451 empty hives was evaluated as these persons did not continue their beekeeping activities. As the number of empty hives existing before the utilisation of the loan is not known, it is not possible to measure the impact of the loans in this regard. It was seen that the questions and responses regarding production were not correct. Responses to the questionnaire item "Amount of annual honey production" were between 0-800kg; some beekeepers responded with colony yield and some with beekeeping yield. Due to the inconsistency of the responses, it was not possible to estimate the averages. Correct responses were not obtained concerning the location of wintering, whether they conducted travelling beekeeping, whether they developed swarms and neither to the questions regarding the size of the enterprise which received the loan or the practices and techniques of beekeeping which would incur costs (Fıratlı, 2003). The evaluation study conducted by ORKÖY staff found that there were some shortcomings in the national level findings, and it was stated that "...however, in some of the questionnaires, many of the questions on the 37 item questionnaire were left unanswered or had extreme or unrealistic responses or did not provide information and thus were not included in the evaluation." (Fıratlı, 2003).

Material and Method

This study takes a sample of enterprises from forest villages of the provinces Antalya, Burdur and Isparta with the aim of “identifying the problems and providing recommendations for solutions concerning the production, marketing and economical analysis of bee products by investigating the economics analysis of enterprises of forest villages of the Western Mediterranean region, which are conducting beekeeping and which taken beekeeping loans provided by ORKÖY”.

In the study, economic analysis was conducted with 64 enterprises in forest villages, which have received beekeeping loans and continue beekeeping, to identify income gained from beekeeping. The **gross profit analysis** method was used to conduct the economic analysis of enterprises. The marketing opportunities and limitations of the factors of mixed marketing was identified for the marketing of honey produced by enterprises that have benefitted from the beekeeping loans

Results and Discussion

An annual average Gross Output Value of 11,189TRY as a level of income is a serious source of income. Such a level of income for forest villagers is important. When the economic factors and level of education are taken into account, beekeeping is a very good initiative for employment of the young population in rural areas. ORKÖY must play an active role in ensuring marketing systems to ensure the marketing of products through beekeeper unions of the region without lowering the profit margin. The most

important aspect of the ORKÖY investments are the contribution of the investment to the enterprise and the sustained investment for the enterprise. The ORKÖY has not been able to completely establish its “project monitoring and evaluation” mechanism as yet. Currently there is not significant “monitoring and evaluation” mechanism besides the monitoring of the loan repayment activities. Thus, the results, impact and most importantly, the sustainability of the investments cannot be evaluated. At the level of the provinces in the regions, 1,191 enterprises have taken advantage of the loan opportunity. Of these, 31.32% were realised after 1990. Of the 373 enterprises which took the beekeeping support after 1990, only 32.44% have continued their beekeeping activities. To see that the production is continuing after nearly 20 years after the first investment is very significant. An evaluation of the region regarding the sustainability of the investment, it can be said that it is below the expectation. Only one out of three enterprises has continued their enterprise.

While the number of hives in the world were approximately 56 million in 1995, this number increased to 63 million in 2007, showing an increase of 13% from 1995 to 2007. With the period of review in question, the number of hives in Turkey increased from 4 million to 5 million (FAO, 2009). The number of bee hives in Turkey increased by 23% between 1995–2007. 7.59% of the total number of hives in the world are located in Turkey (Table 1).

Table 1: Distribution of Bee Colonies in the World and in Turkey

Years; Number of Bee Hives in the World and in Turkey	Worldwide	Index (1995=100)	Turkey	Index (1995=100)	Share in Turkey (%)
1995	56,295,226	100	3,916,038	100	6.96
1996	56,194,782	100	3,964,718	101	7.06
1997	56,276,843	100	4,002,000	102	7.11
1998	56,788,862	101	4,199,000	107	7.39
1999	58,250,947	103	4,322,000	110	7.42
2000	58,805,719	104	4,267,123	109	7.26
2001	59,656,104	106	4,115,353	105	6.90
2002	60,980,967	108	4,161,000	106	6.82
2003	61,034,082	108	4,288,853	110	7.03
2004	62,217,329	111	4,399,725	112	7.07
2005	62,354,852	111	4,590,013	117	7.36
2006	63,942,021	114	4,851,683	124	7.59
2007	63,540,145	113	4,825,596	123	7.59

Table 2: Distribution of Production of Honey in the World and in Turkey

Years; Production of Honey in the World and in Turkey (Tonnes)	Worldwide	Index (1995=100)	Turkey	Index (1995=100)	Share in Turkey (%)
1995	1,153,177	100	68,620	100	5.95
1996	1,103,638	96	62,950	92	5.70
1997	1,158,606	100	63,319	92	5.47
1998	1,191,330	103	67,490	98	5.67
1999	1,243,078	108	67,259	98	5.41
2000	1,255,185	109	61,091	89	4.87
2001	1,264,605	110	60,190	88	4.76
2002	1,283,709	111	74,555	109	5.81
2003	1,334,128	116	69,540	101	5.21
2004	1,369,636	119	73,929	108	5.40
2005	1,413,076	123	82,336	120	5.83
2006	1,446,043	125	83,842	122	5.80
2007	1,400,491	121	73,935	108	5.28

In the period of 1995-2007, the production of honey worldwide increased from 1.1 million tonne to 1.4 million tonnes. During this period, the worldwide honey production increased by 21%. In Turkey, the production of honey increased from 68 thousand tonnes in 1995 to 73 thousand tonnes in 2007. There was an 8% increase in the production of honey in Turkey from 1995 to 2007. Turkey produces 5.28% of the total honey produced worldwide (Table 2).

As at 2007, the most important honey producing countries are, respectively, China (21.65%), Africa (11.99%), Argentina (5.78%), Turkey (5.28%) and the Ukraine

(4.83%). Approximately 50% of the total honey produced worldwide is from these five countries (FAO, 2009). According to FAO data, Turkey has an important place in global honey production and is ranked 4th among the highest producers.

From 2007, the provinces of Turkey which have the highest number of beehives are Muğla (11.56%), Ordu (7.11%), Adana (5.34%) and Aydın (3.22%). In regards to honey production, the provinces to note are Ordu (13.28%), Adana (7.96%), Muğla (5.71%) and Mersin (4.15%). The Turkey average yield per hive is 15.3kg in Turkey. In regards to provinces regarding the yield is

Ordu is ranked highest with 28.6 kg, followed by Diyarbakır with 27.4kg, Bitlis with 23.9kg, Adana with 22.8kg and Mersin and Antalya with 20.2kg on average (TÜİK, 2009).

Conclusion

As to why the forest villagers do not sufficiently take advantage of the beekeeping support, the following reasons can be listed: i) forest villagers do not know enough about beekeeping, ii) experiencing a loss in product and hives due to mistakes in the implementation of support, iii) methods and means of production and variety of products and iv) not being fully informed about means of marketing (Kaftanoğlu et al., 1995; Coşgun et al., 2015).

The average yield per hive have been identified as 11.37kg for beekeeping families who have taken advantage of the ORKÖY beekeeping loan support in forest villages in the Western Mediterranean Region. Several other studies have also provided information regarding yield similar to the mentioned and it is also known that there are beekeepers who have a hive yield which is almost twice the amount (Seven & Akkılıç, 2005; Soysal & Gürcan, 2005; Kekeçoğlu et al., 2007; Fıratlı et al., 2000). The national average of yield per hive is 14.63kg. Thus, that the yields are close to the national average is a positive aspect to be considered (Saner et al., 2005; Solmaz, 2007; Gençdal, 2010; Parlakay & Esengün, 2005; Ören et al., 2010).

The Annual Average Gross Output Value for the beekeeping enterprises in forest villages of the Western Mediterranean Region is 11,189TRY. This level of income can in fact be considered as a significant income level; considering that the annual level of income of forest villagers is between 400-600 USD (Sakman, 1974). It is suggested that, to consider the following during the process of provision of loans for beekeeping for forest villagers will increase the level of sustainability beekeeping by enterprises: i) to select young entrepreneurs, ii) to provide practical training, iii) to increase the number of hives by providing the relevant loans and iv) to ensure the hives are provided in coordination with the beekeepers unions in the provinces where the loan support will be given.

Acknowledgements: This study was carried out under the project of Southwest Anatolia Forest Research Institute (Project No: 9.8205/2011-2014-2015).

References

- Coşgun, U., Güler, K., H., Vural, H., 2015; Arıcılık Yapanların İşletme Ekonomisi Açısından İncelenmesi (Batı Akdeniz Bölgesi Orman Köyleri Örneği), Proje Sonuç Raporu, (yayınlanmamış).
- Fıratlı, A., Ç., 2003; T.C. Orman Bakanlığı-Orman ve Köy İşleri Genel Müdürlüğü Tarafından Verilen Arıcılık Kredileri Hakkında Yapılmış Anket Çalışmasının Değerlendirme Raporu, Çevre ve Orman Bakanlığı, Ankara.
- Gençdal, F., 2010. İkizler Tarımsal Kalkınma Kooperatifine Ortak Olan ve Olmayan Süt Sığırcılığı İşletmelerinin Ekonomik Açısından Karşılaştırılması. Yüzüncü Yıl Üniversitesi, Fen Bilimleri Enstitüsü, Tarım Ekonomisi Anabilim Dalı, Yüksek Lisans Tezi, Van.
- Kaftanoğlu, O., U. Kumova, H. YeninaR ve D. Özkök, 1995. Türkiye’de Balarısı (*Apis mellifera* L.) Hastalıklarının Dağılımı, Koloniler Üzerine Etkileri ve Entegre Kontrol Yöntemlerinin Uygulanması. Türkiye Bilimsel ve Teknik Araştırma Kurumu Veterinerlik ve Hayvancılık Araştırma Grubu Proje No: VHAG-925, Kesin Sonuç Raporu, Ankara
- Kekeçoğlu, M., Gürcan, E.K., Sosyal, M.İ., 2007. Türkiye Arı Yetiştiriciliğinin Bal Üretimi Bakımından Durumu. Tekirdağ Ziraat Fakültesi Dergisi Sayı: 2007-4 (2), Tekirdağ. Seven, I., Akkılıç, M. E., 2005; The solution suggestions and determination of production and marketing problems of beekeeping enterprises in Elazığ Province. Lalahan Hayvancılık Arastirma Enstitusu Dergisi 45 (2) : 41-52
- Ören, N., Alemdar, T., Parlakay, O., Yılmaz, I., H., Seçer, A., Güngör, C., Gürer, B., 2010; Adana İlinde Arıcılık Faaliyetinin Ekonomik Analizi, Adana.
- Parlakay, O., Esengün, K., 2005. Tokat İli Merkez İlçede Arıcılık Faaliyetinin Ekonomik Analizi ve İşletmecilik Sorunları. Gaziosmanpaşa Üniv. Ziraat Fak. Dergisi, 2005, 22 (1), 21-30, Tokat.
- Sakman, E.; 1974. Orman Köy İlişkilerinin Düzenlenmesi, Türkiye Ziraat Odaları Birliği Yayın No: 99, Olgun Kardeşler Matbaacılık Sanayii, Ankara.
- Soysal, M., İ., Gürcan, E., K., 2005; Tekirdağ İli Arı Yetiştiriciliği Üzerine Bir Araştırma. Tekirdağ Ziraat Fakültesi Dergisi, Sayı: 2005-2, Sayfa: 160-165, Sayfa: 227-236 Tekirdağ.

Potential of Waste Paper Management Practices of Istanbul's Hotels in Sustainability of Forests

Gülnur MERTOĞLU ELMAS

Istanbul University, Faculty of Forestry, Istanbul / TURKEY

mertoglug@istanbul.edu.tr

Abstract

The products obtained from recycling practices provide significant contributions in sustainability of natural resources and in environmental protection. Source sorting of wastes is a waste collection principle which ensure efficient use of resources, improvement of those resources and ultimately protection of the environment. Source sorting of paper waste in hotels presents a significant potential for creating a raw-material source for recycling. The present study evaluates the contributions of lodging industry in sustainability and protection of natural resources and of the nature through waste paper management practices. Istanbul is a mega city which hosts 1717 lodging facilities and a room capacity of 75079 eighty percent of which are located in European Side while remaining twenty percent are in Anatolian side. By use of a simple paper waste management the city offers a significant recycling potential of approximately 750 tons of waste cardboard per year. This figure stands for preventing 22500 fully grown trees to be cutoff protecting the forests. Hence, compared to paper production out of wood, it can result in a reduction of air pollution, water pollution and water utilization needs respectively by %74-94, %35 and %45.

Keywords: Waste paper, Management, Sustainability, Environmentally-friendly, Istanbul's hotels

Introduction

The most basic element of sustainability is environmental sustainability identified with the green sustainability. The environmental sustainability ensures control over the waste management, greenhouse gas emissions, water consumption and climate change as well as improvement of the energy and resource efficiency, biodiversity, protection of ecosystem services and an improvement in employment and revenues (Kutluay Tutar, 2015).

Paper and cardboard waste is the most basic parameter for ensuring waste management control. Any paper and cardboard generated by user consumption as post-production wastage, intermediate or end products which may threaten environmental or human health if discharged to natural environment directly or indirectly is called waste material. The process to manufacture a secondary product created by use of waste paper and cardboard as raw material through physical or chemical procedures is called recycling.

Source-separation of waste enables re-introduction of products to the daily life which provide a significant contribution to sustainability of natural resources and

environmental protection. The process of source-separation of waste improves effective use of natural resources and their quality as well as ensures protection of human health as environmentally friendly raw materials. A significant part of source-separation of waste paper and cardboard is conducted within the hotels. The present study evaluates the source-separation practices of Istanbul's Hotels in the context of waste paper and cardboard management as well as their contribution to sustainability of natural resources and environmental protection.

Recycling of Waste Paper

The main objective of paper recycling is to convert the waste paper raw material, which constitutes a heterogeneous constitution due to impurity caused by different sources into a clean homogenous pulp. Differing from primary or virgin pulp, the secondary or waste paper pulp includes non-fiber substances such as filling material caused by the type and structure of the waste paper, starch, adhesives, paints or coating and printing ink. In order to obtain a homogenous and clean waste paper pulp the impurities must be removed through physical

and chemical processes. Nonetheless it is not entirely possible to obtain a %100 pure, homogenous pulp out of waste paper pulp. The quality and the efficiency of the recycled material directly depend on the mode of source-collection of the waste paper (Kırcı, 2003). Source-collection/-separation of the waste paper usually occurs in residences and workplaces, hotels and industrial premises.

Waste Paper Management of Hotels

The hotels potentially have a very significant contribution in waste management through separate collection of waste paper and cardboard on the source.

During 9 years of waste management process of Hyatt Regency Chicago, which has a total of 2009 rooms, approximately 2359 tons of waste paper and cardboard, including 1400 tons of boxes (cardboard), 630 tons of newspapers and 329 tons of magazines, was collected. An average of 190 tons of waste paper – cardboard packaging was separately collected on the source per year. As a result of this practice, %70 of the waste was recycled which saved approximately TRY 24 Million and landfills prevented saved approximately TRY 4Million (Enz and Siguaw, 1999).



Figure 1 Green Star Hotel Emblem (URL 1, 2015).

Hotels of İstanbul

The accommodation facilities are mostly located at European Side of İstanbul, which covers approximately %80 of the Province. Given the abundance touristic and business centers in this side, the accommodation facilities are located in Fatih, Beyoğlu, Şişli, Beşiktaş and Atatürk Airport districts. The overall combined capacity of these areas well exceeds %75 of the provincial capacity and

Usually, imprinted documents, brochures, menus, maps, magazines and newspapers constitute the waste paper contents in sections of the hotels such as reception area, guest rooms and restaurants. In a facility with 100 rooms, through waste paper management, 50 thousands of package boxes are recycled into 1 tons of waste paper annually (Banar, 2015).

The leading factors in establishment of a green industry includes such items like waste management, recovery of resources and renewable energy, demand for environmental products and services and similar (Türkiye Teknoloji Geliştirme Vakfı, 2014). In this regard, increase in the number of “Green Star Hotels”, hotels championing green sustainability, implies that their contributions in the waste paper and cardboard management practices.

The number of facilities and establishments that obtained an Environmental Sensibility (Green Star) Certification from the Ministry in Turkey increased to 194 facilities in first month of the year 2015 (Fig.1). İstanbul leads the list of distribution of Green Star Facilities in Turkey with 22 facilities which constitutes %11.3 of the overall figure. represents over 100.000 beds. Furthermore, new hotel investments in İstanbul represent approximately %25 of the total capacity with a bed capacity of 36.000. The largest part of these new investments lay in Şişli with a total bed capacity of 6.088. After Şişli, Beyoğlu, Zeytinburnu and Fatih districts attract the highest number of new investments (URL 1, 2015).

Only %20 of the total hotel capacity of İstanbul is located in Anatolian Side of the City. Of Anatolian Side Hotels, % 27 is located in Pendik, % 24 in Kadıköy, % 13 in Atasehir (URL 4, 2016). According the number of premises holding a Tourism Certificate by the Ministry of Culture and Tourism, İstanbul has a capacity of 40.676 rooms and 82.354 beds. When the irregular premises are added, the total accommodation capacity reaches 75.079 rooms and 152.441 beds (URL 3, 2016).

Conclusion and Discussion

The raw material of the paper and cardboard packaging is primary virgin or primary biomass. Approximately 1 tons of paper is produced out of 17 trees.

According to 2012 data by the Ministry of Environment and Urban Planning, a total amount of 1.176.088 tons of paper and cardboard packaging was marketed with a

recycling rate of % 112 (URL 3, 2016). This figure means that approximately 24-28 trees were obtained per 1 tons of recycled paper production. The amount of waste paper that can be recycled by management of waste paper and cardboards of hotels of Istanbul and the number of trees that can be potentially saved by this activity was calculated as shown in the Table 1 below.

Table 1. Istanbul Hotels' Capacity to Collect Waste Paper and Cardboard

	Area (%)*	Bed capacity*	Waste Amount (tons)	Number of Trees Saved
European Side				
Fatih	33	19812.94	198.13	5943.88
Beyoğlu	19	11407.45	114.08	3422.23
Şişli	14	8405.48	84.06	2521.65
Beşiktaş	9	5403.53	54.04	1621.06
Others	25	15009.80	150.10	4502.94
Anatolian Side				
Pendik	27	4052.65	40.53	1215.79
Kadıköy	14	2101.37	21.014	630.41
Ataşehir	13	1951.27	19.51	585.38
Üsküdar	9	1350.88	13.51	405.27
Others	37	5553.62	55.54	1666.08
Istanbul Total		75049	750.49	22514.7

* (URL 2, 2013)

Istanbul is a mega city which hosts a total number of 1717 hotel facilities with a total room capacity of 75079 (URL 2, 2013). Eighty percent of these hotels are located in European Side while twenty percent in Asian side. Potentially 750 tons of waste paper and cardboard can be collected in the hotels in Istanbul which will save 18.000 trees through production of recycled paper. When targeted %25 new investments are added, it was calculated that a total of 22.500 trees can be saved in each year.

1 ton of recycled paper prevents consumption of 4100 kwh of electricity, 32 tons of water and 1.750 L of fuel oil as well as preventing release of 27 kg of waste gas to the atmosphere (Yurtman ve Aydın, 2001). In the waste paper management process of hotels of Istanbul province 3.075.000 kwh of electricity, 19875 tons of water and 240 tons of fuel oil were saved and release of 20.250

kg of pollutant waste gas to atmosphere was prevented which in general means a significant contribution to environmental protection. At the same time, compared to the production of primary waste paper obtained from wood, the secondary paper obtained from recycling waste paper reduced the air pollution by %74-94 and water pollution by %35.

References

- URL1: www.skb.org.tr/otellerde-geridonusum-surdurulebilir-atik-yonetimi; Akdeniz Turistik Otelciler ve İşletmeciler Birliği (aktob). 2015. Mart Bülteni (13.05.2016).
- BANAR, Müfide. 2015. Anadolu Üniversitesi, Mühendislik Fakültesi Çevre Mühendisliği Bölümü Otellerde Gıda İri Dönüşüm Ve Sürdürülebilir Atık Yönetiminin Önemi (15 May 2016)
- Enz, C. A., & Siguaw, J. A. 1999. Best hotel environmental practices. *Cornell Hotel and*

Restaurant Administration Quarterly, 40(5), 72-77.

Kırcı, H. 2003. Kağıt Hamuru Endüstrisi. Ders Notları. Karadeniz Teknik Üniversitesi.Yayın No.72. Trabzon-Turkey

Kutluay Tutar, Filiz. 2015. Yeşil Ekonomi, Yeşil Turizm: Türkiyede Turizm Sektöründe Yeni Trend Yeşillenen Oteller Projesi, *Akademik Sosyal Araştırmalar* Dergisi, Yıl: 3, Sayı: 13, S. 328-352

Türkiye Teknoloji Geliştirme Vakfı. 2014. Ekoskop, İşkur Matbaacılık, 1. Baskı, Ankara.

URL2 :[http://www.tuyed.org.tr/turobtan-kapsamliistanbulun-konaklama-raporu/Otel-dergisinin-kasim-2013-2-nolu-raporu-\(13.05-2016\)..](http://www.tuyed.org.tr/turobtan-kapsamliistanbulun-konaklama-raporu/Otel-dergisinin-kasim-2013-2-nolu-raporu-(13.05-2016)..)

URL3: www.csb.gov.tr/turkce/index.php-Sehircilik-ve-Cevre-Bakanligi, (20.06.2016).

URL4:<http://www.turizmguzel.com/haber/istanbula-116-otel-ve-41-bin-yatak-daha-geliyor-h17373.html>, Turizm Güncel. (06 Mayıs 2016).

Yurtman A. ve Aydın, C. (2001). Atık Kağıt Geri Dönüşümü ve Değerlendirme Olanakları. İstanbul Ticaret Odası Yayını.

Economic Contribution of Waste Paper Recycling (Example of Istanbul's Hotels)

*Sultan BEKİROĞLU¹, Gülnur MERTOĞLU ELMAS²

¹Istanbul University, Faculty of Forestry, Forestry Economics Department, Istanbul-Turkey

²Istanbul University, Faculty of Forestry, Forest Products Chemistry and Technology
Department, Istanbul-Turkey

*Corresponding Author: sulbekir@istanbul.edu.tr

Abstract

Recycling of waste paper provides significant contributions to the sustainability of forestry resources, to energy saving efforts, to reduction of environmental pollution levels and to effective utilization of raw materials. Economic realization of this contribution can only be achieved through knowledge of the qualitative and quantitative properties of the recycled waste paper. On-source-separation can significantly improve the contributions of waste paper recycling in the economy. For this reason it becomes important to identify the sectors that consume relatively higher amount of paper as a final product, to raise their awareness and to provide solutions for on-source-separation practices in such sectors. It is widely known that the hotels consume higher amounts of paper products compared to other consumer units. Thanks to its historical, economic, political, cultural and scientific characteristics, Istanbul is one of the cities that receive the highest number of tourists not only in Turkey but in entire Europe. Hence Istanbul was chosen as the study area for the present study. The present study aims to provide monetary calculations of the waste paper collected by application of on-source-separation practices in Istanbul's hotels.

Keywords: Waste paper, Economic contribution, Waste management, Istanbul's hotels

Atık Kâğıt Geri Dönüşümünün Ekonomik Katkısı (İstanbul Otelleri Örneği)

Özet

Atık kâğıt atıklar geri dönüştürülerek, orman kaynaklarının sürdürülebilirliğine, enerji tasarrufuna, çevre kirliliği düzeyinin azaltılmasına ve hammadde tasarrufuna katkı sağlanmaktadır. Bu katkının ekonomik boyutu, ancak geri dönüştürülen atık kâğıtların nitelik ve niceliklerinin bilinmesi ile mümkündür. Atık kâğıtların geri dönüşümünün ekonomiyeye katkısı, kaynağında ayrı toplama işleminin uygulanması halinde çok daha fazla olabilir. Bu nedenle nihai ürün olarak kâğıdı fazla tüketen kesimlerin saptanması, atıkların geri dönüşümü konusunda bilinçlendirilmesi ve kaynağında ayrı toplama işlemiyle ilgili sorunların giderilmesi gerekir. Otellerde, diğer tüketici birimlere göre daha fazla kâğıt ürünü kullanıldığı bilinmektedir. Çalışma alanı İstanbul olarak kararlaştırılmıştır. Çünkü İstanbul sahip olduğu tarihi, ekonomik, siyasi, kültürel ve bilimsel özelliklerinden dolayı Türkiye'de ve Avrupa'da en fazla sayıda turist ağırlayan kentlerinden biridir. Bu çalışmada İstanbul otellerinde kaynağında ayrı toplama işlemi sonucunda elde edilen atık kâğıtların parasal değeri hesaplanmıştır.

Anahtar Kelimeler: Atık kâğıt, Ekonomik katkı, Atık yönetimi, İstanbul otelleri

Introduction

In conventional understanding of development, rapid industrialization would bring rapid economic growth. However, this simple rule brings many complications in practice such as increase in environmental disasters. For this reason, starting from early 1960s alternative development approaches have been explored especially in developed countries. Studies aimed at this objective have been conducted by the United Nations, the Organization for Economic Cooperation

and Development, World Bank, World Trade Organization, United Nations Environment Program, United Nations Commission on Sustainable Development, United Nations Conference on Trade and Development, World Wild Fund for Nature and World Business Council on Sustainable Development (TÜBİTAK, 2003; Doğaner Gönel, 2002).

At the end of 30 years of search for a solution, the concept of sustainable development was introduced as oppose to the conventional development approaches (Yıkılmaz, 2011). Differing from conventional development approach, the alternative development approaches focus on providing sustainability for three aspects of social welfare (i.e. economic, social and environmental aspects). However, targets of these three aspects may sometimes contravene. For instance, use/consumption of natural resources and generation of waste is required for economic sustainability while such activities expose environmental sustainability to the risks. Nonetheless, significant efforts have been made to solve the problems created by contradicting targets. One of such efforts involves “recovering recyclable wastes as secondary raw materials for economic use” as a means of preventing environmental pollution and excessive use of natural resources.

Mankind is the species that generates the highest amount of waste in the Earth. According to estimations, mankind generates an average of 1.15 trillion kg of waste per year. Previous practices of unsanitary disposal and incineration of such waste as it was accepted as mere garbage increased the environmental pollution. For this reason, waste management practices were started to be implemented so to prevent environmental pollution. These practices stipulates sanitary landfills, composting, re-use, recycled and recovery methods which ensure re-introduction of half of the wastes into the economy.

Given the advantages created by recovery of recyclable waste such as creation of job opportunities, effective use of natural resources, creation of economic added value and provision of environmental improvement the recycling sector has been a fruitful effort for mankind. In this sector there are many stages such as minimization of waste, source-separation of waste as well as storage, transportation, recovery, recycling and disposal of waste. As it can be understood from ongoing explanations, recycling is actually an important environmental protection policy. Thanks to this policy the waste shall no longer be categorized as an

environmental hazard and becomes an economic value which serves as basis for sustainable development. For this reason, the “National Recycling Strategy Document and Action Plan, 2014-2017” was prepared in Turkey to improve the efficiency of recycling sector in the country (T.R. Ministry of Science, Industry and Technology, 2014).

Mrayyan and Hamdi (2006), and Yılmaz and Bozkurt (2010) reports that while the developing countries still go on with the debates concerning disposal of the waste, the developed countries already move to advanced practices such as composting and recycling.

Paper is a material the consumption rate of which is acknowledged as an indicator for development. The base material of paper is cellulose. If the cellulose is obtained solely from raw fibers, plant sources, such as trees and other kinds of perennial and annual plants are consumed. For centuries forests, as well as other ecosystems wherein such plant sources are found have been exploited as sources for raw fibers to produce paper. Such exploitation, however, put the sustainability of natural resources in danger. Nonetheless, cellulose derived from waste paper can also be used for paper production which in fact was taken in practice thus turning the waste papers into a valuable raw material for national economies.

Consumption habits, population growth and lifestyles as well as standards of living affect the composition of solid waste generated by the population. Typically 20% of total weight and 50% of total volume of all solid waste is constituted by packaging waste and paper takes an important proportion of all packaging waste. In fact, source-separation of packaging waste essentially falls under the responsibility of municipalities. However, the costs of such efforts must be paid by the generators of such waste according to the principle of “polluter pays”. For this reason, the persons/organizations that use paper and thus generate waste must have increased awareness for recycling of waste paper (Armağan et al., 2006).

The objective of the present study is to calculate the monetary value of the source-separated waste papers generated by hotels in

Istanbul Province as the hotels are known to be areas where the paper and derivative products are consumed compared other consumer units. It is considered that once learning about the economic value of the waste paper, the operators of these hotels will have increased sensibility towards source-separation practices.

Benefits of recycling waste paper

Whole of the waste paper generated cannot be recycled for a certain part of it is collected in an inappropriate way and/or taken into recycling process after its decay time (between 3 months and 5 years) is expired. It is also known that the waste paper properly collected and introduced to recycling process in due time loss 25-20% of its fiber content during recycling processes. Nonetheless, despite certain losses during recycling of waste paper, around 80-85% can be regained.

Yorulmaz (2014) and Yıldızbaş (2007) refers to the "Paper Production Off Waste Paper, Industrial Profile, 2010 Report" prepared by the Ministry of Science, Technology and Industry and lists the benefits obtained through production of paper out of 1 ton of waste paper:

- 24-28 grown trees are saved (not cut-down)
- Dispersion of 36 tons of CO² to atmosphere is prevented

- 4100 kWh electric power is saved,
- Dispersion of 267 kg pollutant gases to atmosphere is prevented,
- 1750 liters of fuel oil is saved,
- 3 - 4 m³ of waste landfill area is saved,
- Destruction of 85 m² of forestry area is prevented,
- 38.8 tons of water is saved,
- Also, dependence on foreign sources is reduced given absence of need for paper import,
- On the other hand, collectors of waste paper generate revenues over scrap paper.

Description of study area

The study area is constituted by the hotels in Istanbul Province which is one of the most populated urban areas of Turkey and the World. These hotels have a total accommodation capacity of 40676 rooms and 82354 beds Certified by the Ministry of Culture and Tourism. When the uncertified facilities are considered, the total accommodation capacity increases to 75079 rooms and 152441 beds (Hatipoğlu et al., 2013).

80% of the hotels in Istanbul is located in European side of the city, especially in Fatih, Beyoğlu, Şişli, Beşiktaş and Atatürk Airport districts (Figure 1).

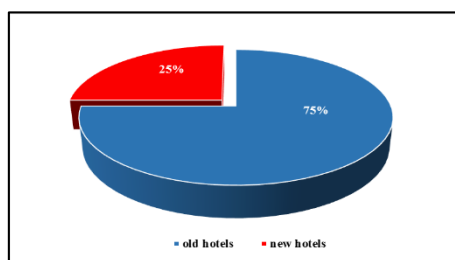

Figure 1. Distribution of old and new hotels in Istanbul province

Given the continuous growth of İstanbul, new hotel investments are planned. The total bed capacity of these new investments is

36000 corresponding 25% of current total bed capacity (Figure 2) (Association of Hoteliers and Operators AKTOB, 2013).

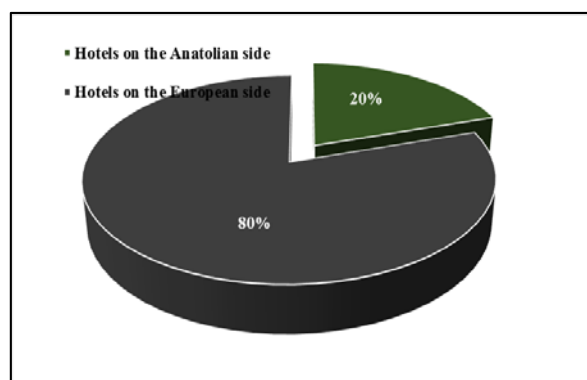

Figure 2. Distribution of Istanbul's hotels in European side and Asian side

Distribution of Istanbul's hotels' total bed capacity of 75079 by districts was calculated based Association of Hoteliers

and Operators AKTOB (2013) and shown in Table 1.

Table 1. Distribution of Istanbul's hotels' total bed capacity by districts

European side			Anatolian side		
District	%	Number of Rooms	District	%	Number of Rooms
Fatih	33	19820.9	Pendik	27	4054.3
Beyoğlu	19	11412.0	Kadıköy	24	3603.8
Şişli	14	8408.7	Ataşehir	13	1952.1
Beşiktaş	9	5405.7	Üsküdar	9	1351.5
Bakırköy	5	3003.2	Beykoz	7	1051.1
Others	20	12012.5	Maltepe	6	901.0
			Others	14	2102.2
Total	100	60063.0	Total	100	15016.0

Materials and Methods

The material used for the present study is domestic and foreign literature on waste paper recycling.

The present study was carried out as a case analysis to determine the economic contribution of recyclable waste paper generated by hotels in Istanbul in five steps: A) Benefits of recycling one ton of recyclable waste paper (Y_i) based on the information obtained from Yorulmaz (2014) and Öztürk (2013) and Yıldızbaş (2007):

Y_1 : Approximately 26 trees are kept in the nature,

Y_2 : 4100 Kwh of electric power is saved,

Y_3 : 38.8 tons of water is saved,

Y_4 : 1750 liters of fuel oil is saved,

Y_5 : Dispersion of 267 kg of waste gas to atmosphere is prevented,

Y_6 : Dispersion of 36 tons of CO₂ to atmosphere is prevented,

Y_7 : 4 m² of waste landfill area is saved,

Y_8 : Scrap paper is a source of revenue,

Y_9 : Destruction of 85 m² of forestry area will be prevented.

B) Monetary value (X_i) of 9 different types of benefits listed above was estimated or calculated as of the year 2013.

C) The amount of recyclable waste paper that can be collected from the hotels in Istanbul was estimated. The estimation was based on the information stated in a study by Banar (2015) that "A hotel with 100 rooms can collect up to 50 thousand packaging boxes thus contributing 1 tons of waste paper to the economy". Hence it was assumed that a hotel room can generate 0.01 tons of recyclable waste paper per year. Therefore the amount of waste paper

that can be generated by hotels in Istanbul was calculated by multiplication of the number of rooms with the value 0.01 ton/year.

D) The value of different types of benefits of recycling waste paper was calculated by multiplication of the amounts given in the first item for different types of benefits with the total amount of waste paper to be generated by hotels in Istanbul.

E) Total economic value (TEV) of the contributions by hotels in Istanbul in waste paper recycling is calculated by application of the following formula:

$$TEV = \sum_{i=1}^9 X_i \times Y_i$$

Whereas X_i : indicates the amount of the benefit i ., Y_i : indicates the unit economic value of the benefit i .

Results and Discussions

Unit values of the benefits created by recycling waste paper of hotels in Istanbul for the year 2013 have been determined as follows:

Y_1 : Average value of a coniferous pine tree that can be used for paper production is 147 Turkish Liras (TRY) (Ministry of Forests and Water Affairs, 2013).

Y_2 : Price of electricity is 0.29 TRY/kWh

(Turkish Electricity Distribution Corporation (TEDAS) 2013 electricity tariff) (TEDAS, 2016)

Y_3 : Price of water is 7.88 TRY/ton (Istanbul Water and Sewage Administration (ISKI), 2013).

Y_4 : Price of fuel oil is 2.08 TRY/liter (Energy World Magazine, 2016).

Y_5 : Cost of prevention of atmospheric dispersion of CO₂ is 153.6 TRY/ton (T.R. Ministry of Energy and Natural Resources, 2016; Central Bank of Turkey, 2016).

Y_6 : Cost of prevention of atmospheric dispersion of waste gases is 153.6 TRY/ton which is accepted equal to the cost of prevention of atmospheric dispersion of CO₂ (T.R. Ministry of Energy and Natural Resources, 2016).

Y_7 : Cost of waste landfill area is 11.69 TL/m³ (Güllü, 2006; Central Bank of Turkey, 2016).

Y_8 : Waste paper scrap value is 216 TL/ton (Ayhan Metal Recycling Industry Limited Company, 2013).

Y_9 : Annual gain of pine forests is 0.33 TL/m² (Bekiroğlu 2002).

Amounts of recyclable waste paper collected from hotels in Istanbul are shown in Table 2 below:

Table 2. Amounts of waste papers collected from hotels in Istanbul in the year 2013

European side			Anatolian side		
District	Room (number)	Waste paper (ton)	District	Room (number)	Waste paper (ton)
Fatih	19820.9	198.21	Pendik	4054.3	40.54
Beyoğlu	11412.0	114.12	Kadıköy	3603.8	36.04
Şişli	8408.7	84.09	Ataşehir	1952.1	19.52
Beşiktaş	5405.7	54.06	Üsküdar	1351.5	13.52
Bakırköy	3003.2	30.03	Beykoz	1051.1	10.51
Others	12012.5	120.13	Maltepe	901.0	9.01
			Others	2102.2	21.02
Total	60063.0	600.63	Total	15016.0	150.16

As it can be seen on the Table 2 above, for the year 2013, a total amount of 750.79 tons of waste paper can be obtained from the hotels in Istanbul. 80% of this figure is

generated by hotels in European Side of the City. Amounts of the benefits of recycling recyclable waste paper obtained from hotels in Istanbul are given in the Table 3.

Table 3. Amounts of the benefits of recycling recyclable waste paper obtained from hotels in Istanbul

	District	Tree (number)	Electricity (kwh)	Water (ton)	Fuel oil (liter)	Waste gases (ton)	CO2 (ton)	Landfill area (m ²)	Forestry area (m ²)
European side	Fatih	5153.5	812661	7690.5	346868	52.9	7135.6	792.8	16847.9
	Beyoğlu	2967.1	467892	4427.9	199710	30.5	4108.3	456.5	9700.2
	Şişli	2186.3	344769	3262.7	147158	22.5	3027.2	336.4	7147.7
	Beşiktaş	1405.6	221646	2097.5	94605	14.4	1946.2	216.2	4595.1
	Bakırköy	780.8	123123	1165.2	52553	8.0	1081.1	120.1	2552.6
	Others	3123.1	492492	4660.7	210210	32.1	4324.3	480.5	10210.2
	Total	15616.4	2462583	23304.4	1051103	160.4	21622.7	2402.5	51053.6
Anatolian side	Pendik	1054.0	166214	1573.0	70945	10.8	1459.4	162.2	3445.9
	Kadıköy	937.0	147764	1398.4	63070	9.6	1297.4	144.2	3063.4
	Ataşehir	507.5	80032	757.4	34160	5.2	702.7	78.1	1659.2
	Üsküdar	351.5	55432	524.6	23660	3.6	486.7	54.1	1149.2
	Beykoz	273.3	43091	407.8	18393	2.8	378.4	42.0	893.35
	Maltepe	234.3	36941	349.6	15768	2.4	324.4	36.0	765.85
	Others	546.5	86182	815.6	36785	5.6	756.7	84.1	1786.7
	Total	3904.2	615656	5826.2	262780	40.1	5405.7	600.6	12763.6
	Overall	19520.6	3078239	29130.6	1313883	200.5	27028.4	3003.2	63817.2

Economic values of the benefits of recycling waste papers from hotels in Istanbul are given in the Table 4.

Distribution of economic benefits of hotels by contributing to waste paper recycling by districts in Istanbul is given in the Table 5.

Table 4. Economic values of the benefits of recycling waste papers from hotels in Istanbul

	District	Trees (TRY)	Electricity (TRY)	Water (TRY)	Fuel oil (TRY)	Waste gases (TRY)	CO ₂ (TRY)	Landfill area (TRY)	Forestry area (TRY)	Scrap paper (TRY)
European side	Fatih	757558.6	235671.7	60601.5	721484.4	8128.8	1096022.0	9268.3	18532.6	42813.4
	Beyoğlu	436166.6	135688.7	34891.5	415396.8	4680.2	631038.0	5336.3	10670.2	24649.9
	Şişli	321392.0	99983.0	25710.0	306087.6	3448.6	464984.1	3932.0	7862.4	18163.4
	Beşiktaş	206617.3	64277.3	16528.5	196778.4	2217.1	298930.2	2527.8	5054.6	11677.0
	Bakırköy	114774.7	35705.7	9181.5	109309.2	1231.6	166053.9	1404.2	2807.8	6486.5
	Others	459098.6	142822.7	36726.0	437236.8	4926.3	664215.6	5616.8	11231.2	25945.9
	Total	2295607.9	714149.1	183639.0	2186293.2	24632.6	3321243.6	28085.5	56158.9	129736.1
Anatolian side	Pendik	154943.9	48202.1	12394.9	147565.6	1662.6	224170.0	1895.7	3790.5	8756.6
	Kadıköy	137744.9	42851.6	11019.0	131185.6	1478.0	199286.8	1685.2	3369.7	7784.6
	Ataşehir	74605.4	23209.3	5968.1	71052.8	800.5	107937.8	912.8	1825.1	4216.3
	Üsküdar	51673.4	16075.3	4133.7	49212.8	554.5	74760.2	632.2	1264.1	2920.3
	Beykoz	40169.2	12496.4	3213.4	38256.4	431.0	58116.1	491.4	982.7	2270.2
	Maltepe	34436.2	10712.9	2754.8	32796.4	369.5	49821.7	421.3	842.4	1946.2
	Others	80338.4	24992.8	6426.7	76512.8	862.1	116232.2	982.9	1965.4	4540.3
	Total	573911.5	178540.2	45910.5	546582.4	6158.2	830324.7	7021.5	14040.0	32434.6
	Overall	2869519.4	892689.3	229549.5	2732875.6	30790.8	4151568.4	35106.9	70198.9	162170.6

Table 5. Total economic value of the districts' contribution to waste paper recycling

European side			Anatolian side		
District	Waste paper (ton)	Benefits (TRY)	District	Waste paper (ton)	Benefits (TRY)
Fatih	198.21	2950081.4	Pendik	40.54	603381.8
Beyoğlu	114.12	1698518.2	Kadıkoy	36.04	536405.5
Şişli	84.09	1251563.2	Ataşehir	19.52	290528.2
Beşiktaş	54.06	804608.2	Üsküdar	13.52	201226.5
Bakırköy	30.03	446955.0	Beykoz	10.51	156426.8
Others	120.13	1787819.9	Maltepe	9.01	134101.4
			Others	21.02	312853.6
Total	600.63	8939545.8	Total	150.16	2234923.7

Table 5 shows that recycling one ton of waste paper provides economic benefits worth 14883.6 TRY (7711.7 USD). Table 5 also indicates that the European Side's contribution to this figure is 8939545.8 TRY (4631889.01 USD) while Anatolian Side contributes 2234923.7 TRY (1157991.5 USD) with a total amount of 11174469.5 TRY (5789880.5 USD) for overall Istanbul (1 USD=1.93TL). It should be noted that the present study did not consider the totality of economic benefits of recycling such as employment created in the recycling businesses or the market value of the products to be created through recycling. For this reason, it is safe to say that the above calculated benefits are just the tip of the iceberg.

The proportion of waste papers used in paper production is around 45% in Turkey for the year 2013. The rate of recycling is on an upwards trend and it is aimed to increase it up to 70% (Çevik, 2016). For this reason, once the waste papers generated by the hotels in Istanbul are introduced to the paper

production, an economic benefit worth of 17382508.04 TRY (9006480.85 US Dollars) will be obtained.

Recyclable paper waste can be re-introduced to economy 12 times over. For this reason, considering that the waste paper generate by the hotels in Istanbul can be submitted for recycling for minimum 5 times, the total sum of economic benefits of this practice can be calculated as 55872347.3 TRY (28949402.7 USD).

Çevik (2016) reports that Turkey recorded a total sum around 1.85 Billion USD for paper exports in the year 2013. Accordingly, with a 70% recycling rate, hotels of Istanbul can provide significant contributions to the national economy; to be specific, up to 3% of total paper exports of Turkey. On the other hand, given the problems concerning supply of raw material and inputs for paper production in Turkey, re-introduction of recyclable papers into the economy would serve as a good means to reduce foreign dependency and the environmental pollution and to support the sustainability of forests

References

Armağan B., Demir İ., Demir Ö., Gök N. 2006. Katı atıkların ekonomide değerlendirilmesi. Yayın No 2006-23 [Evaluation of solid waste in economy, Publication No: 2006-23 - in Turkish], Istanbul Association of Hoteliers and Operators AKTOB, 2013. İstanbul Konaklama Kapasitesi Raporu [Istanbul Accommodation Capacity Report-in Turkish]. http://www.turob.com/Resources/doc/20131213_2_konaklama.pdf (Accessed 16 July 2016).

Ayhan Metal Recycling Industry Limited Company, 2013. Hurda fiyatları [Scrap prices - in Turkish], <https://hurdametalfiyatları.wordpress.com/category/hurda-kagit-kilosu/> (Accessed 16 July 2016).

Banar M. 2015. Otellerde Geri Dönüşüm ve Sürdürülebilir Atık Yönetiminin Önemi [Importance of Recycling and Sustainable Waste Management in Hotels-in Turkish]. <http://www.skb.org.tr/otellerde-geri-donusum-surdurulebilir-atik-yonetiminin-onemi-s13482k/> (Accessed 16 July 2016).

Bassam Mrayyan, Hamdi, M.R. 2006. Management Approaches to Integrated Solid Waste in Industrialized Ones in Jordan: A Case of Zarqa City, *Waste Management*, 26 (2), 195-205.

Bekiroğlu S. 2002. Arazi ve orman değerinin saptanması konusunda araştırmaları (Ayvalık örneği). *İstanbul Üniversitesi Orman Fakültesi Dergisi*, Seri A, 52 (2), 96-123 [Investigations on the appraisal of land and forest, a case study: Ayvalık. Review of the Faculty of Forestry, University of Istanbul, Series A, 52 (2), 96-123 - in Turkish], Istanbul.

Central Bank of Turkey, 2016. Döviz kurları [Exchange rates-in Turkish], [http://evds.tcmb.gov.tr/cgi-bin/famecgi?cgi=\\$ozetweb&DIL=TR&ARAVE RIGRUP=bie_dkdovizgn.db](http://evds.tcmb.gov.tr/cgi-bin/famecgi?cgi=$ozetweb&DIL=TR&ARAVE RIGRUP=bie_dkdovizgn.db) (Accessed 13 March 2016).

Çevik B. 2016 Kağıt ve Kağıt Ürünleri Sektörü [Paper and Paper Products Industry-in Turkish], İktisadi Araştırmalar Bölümü İş Bankası Yayınları, https://ekonomi.isbank.com.tr/UserFiles/pdf/sr201607_kagitsektoru.pdf (Accessed 16 April 2016).

Doğaner Gönel F. 2002. Küreselleşen dünyada (nasıl bir) sürdürülebilir kalkınma. *Birikim. Neo-Liberalizm ve Ekonomi Siyaset*, (158) 72-80, [In a globalizing world (how) sustainable development-in Turkish], <http://www.birikimdergisi.com/birikim/2348/158> (Accessed 11 March 2016).

Energy World Magazine, 2016. Güncel yakıt fiyatlarını karşılaştırma tablosu [Comparison table of the current fuel price-in Turkish]. www.enerji-dunyasi.com/.../yakit/enerji-dunyasi-101-guncel-yakit-fiyatlari-karsilastir (Accessed 9 April 2016).

Güllü İ. 2006. Düzenli Depolama Alanlarının Maliyet Analizi [Cost Analysis of Sanitary Landfill Areas- in Turkish]. *Katı Atıkların Düzenli Bertarafı Eğitim Projesi*, ISBN 9944-60-073-3, 111 p, Istanbul.

Hatipoğlu B., Alvarez M.D., İnelmen K., Ünal D.2013. İstanbul Otellerinin 360° Değerlendirilmesi [Evaluating Every Aspect of Istanbul Hotels-in Turkish], <http://www.turob.com/bulten/360.html> (Accessed 16 July 2016).

Istanbul Water and Sewage Administration (ISKI), 2013. 2013 yılı birim su fiyatları. [Water tariff in 2013- in Turkish], http://www.iski.gov.tr/web/assets/SayfalarDocs/subirimfiyatları/2013_Su_Birim_Fiyatları.pdf (Accessed 16 July 2016).

Öztürk M. 2013. Çöp toplama maliyeti %50 düşürülebilir [Garbage collection cost can fall down from 50%-in Turkish]. [http://www.haberx.com/cop_toplama_maliyeti_50_dusurulebilir\(19,w,12908,959\).aspx](http://www.haberx.com/cop_toplama_maliyeti_50_dusurulebilir(19,w,12908,959).aspx) (Accessed 16 April 2016).

TEDAS 2016. 2013 Yılı Elektrik Tarifesi [Electricity tariff in 2013-in Turkish], <http://www.tedas.gov.tr/#!tedastarifeler> (Accessed 14 April 2016).

T.R. Ministry of Energy and Natural Resources, 2016. Karbon yakalama ve depolama nedir [What is the meaning of carbon capture and storage?-in Turkish], http://www.eie.gov.tr/teknoloji/ccs_nedir.aspx (Accessed 16 July 2016).

T.R. Ministry of Forests and Water Affairs, 2013. Orman İşletmeciliğinde Üretim Pazarlama Faaliyetleri [Operations of Production and Marketing in Forest Administration-in Turkish]. <http://docplayer.biz.tr/5573277-Orman-genel-mudurlugu-isletme-ve-pazarlama-daire-baskanligi.html>.

T.R. Ministry of Science, Industry and Technology, 2014. 2014. Ulusal Geri Dönüşüm Strateji Belgesi ve Eylem Planı 2014-2017. [National Recycling Strategy Document and Action Plan-in Turkish], <http://www.resmigazete.gov.tr/eskiler/2014/12/20141230M1-12-1.pdf> (Accessed 16 June 2016).

TUBİTAK 2003. Çevre ve Sürdürülebilir Kalkınma Tematik Paneli Raporu. Vizyon 2023: Bilim ve Teknoloji Stratejileri Teknoloji Öngörü Projesi, [Environment and Sustainable Development Thematic Panel Report. Vision 2023: Science and Technology Strategies for Technology Foresight Project-in Turkish], 64 p, Ankara.

Yıkılmaz R.F. 2011. Sürdürülebilir Kalkınmanın Ölçülmesi ve Türkiye İçin Yöntem Geliştirilmesi [Measurement of Sustainable Development and its Method Development for Turkey-in Turkish], Sosyal Sektörler ve Koordinasyon Genel Müdürlüğü Uzmanlık Tezi, Devlet Planlama Teşkilatı Yayın No: 2820, 224 p., Ankara.

Yıldızbaş F. 2007. Karaman İlinde Atık Geri Dönüşümü ve Ekonomik Faydaları [Waste Recycling and Economic Benefits in Karaman Province-in Turkish]. Selçuk Üniversitesi Karaman İ.İ.B.F. Dergisi Yerel Ekonomiler Özel Sayısı.

Yılmaz A., Bozkurt Y. 2010. Türkiye’de kentsel katı atık yönetimi uygulamaları ve Kütahya Katı Atık Birliği (KÜKAB) Örneği. Süleyman Demirel Üniversitesi İktisadi ve İdari Bilimler Fakültesi Dergisi Y.2010, C.15, S.1 s.11-28. [Urban solid waste management applications in Turkey and KUKAB Case-Suleyman Demirel University The Journal of Faculty of Economics and Administrative Sciences, 15, (1),11-28-in Turkish], Isparta.

Yorulmaz H. 2014, Doğu Marmara Bölgesi Atık Kağıt Raporu. Bölge Planı Yayınları Serisi 16 [East Marmara Region Waste Paper Report. Regional Plan Publications Series 16-in Turkish].

http://www.dogumarmarabolgeplani.gov.tr/pdfs/kagit_raporu.pdf (Accessed 16 June 2016).

Assessment of Natural and Artificial Regeneration in Burned Turkish Red Pine (*Pinus brutia* Ten.) Stand: Case Study of Adana Region

*Zafer YÜCESAN¹, Ali Ömer ÜÇLER¹, Ercan OKTAN¹, Öznur UÇAK¹,
Sena KARAPINAR¹

¹Karadeniz Technical University, Faculty of Forestry, Department of Forest Engineering,
61080, Trabzon/TURKEY

*Corresponding Author: yucesan@ktu.edu.tr

Abstract

In this study some morphological properties of natural and artificial seedlings were examined in burned Turkish Red Pine (*Pinus brutia* Ten.) stand. Sampled stand was burned in 2013 and artificial regeneration activities as full seeding were carried out in the same year. Sampled stand is located in Adana-Kadirli Forest Directorate Sumbas Forest Enterprise. Four sample plots were identified during the study and each sample plot was 400 m² in size. Morphological properties of the seedlings such as age, height, root collar diameter and unbranched stem height were measured in each sampling plot. Measurements were done on 415 natural and 150 artificial seedlings in total. Official seedling counting report which belongs to the local forest enterprise stated that average regeneration success was 90% in 2015. According to the data obtained, average unbranched stem height of natural seedlings was 3.3 cm (min.=1, max.=7) and 1.7 cm (min.= 1, max.=3) in artificial seedlings. Average height of natural seedlings was 37.7 cm (min.=8, max.=75) and 13.8 cm (min.=7, max.=22) in artificial seedlings. Average root collar diameter of natural seedlings was 9.4 mm (min.=1, max.=22) and 3.3 mm (min.=2, max.=6) in artificial seedlings. Average age of the natural seedlings was 2 (min.=1, max.=2) and all artificial seedlings were in 2 years old. Obtained results showed that local seeds can carry on their vitality at least 2 years in burned Turkish Red Pine stands. All morphological properties were significantly better in natural seedlings than artificial seedlings. Both seedling quality and seedling sturdiness were better in natural seedlings. Number of the natural seedlings was much more than artificial seedlings in sample plots. When local seed source is not sufficient for natural regeneration and full seeding is necessary for improving the success of regeneration in *Pinus brutia* stands, it is important to get seeds from suitable origins.

Keywords: Turkish red pine, Forest fire, Natural regeneration, Artificial regeneration, Seedling morphology

Yangın Görmüş Kızılçam (*Pinus brutia* Ten.) Meşceresinde Doğal ve Yapay Gençleştirilmenin Değerlendirilmesi: Adana Yöresi Örneği

Özet

Çalışma kapsamında Adana-Kadirli Orman İşletme Müdürlüğü Sumbas Orman İşletme Şefliği sınırları içerisinde yer alan, 2013 yılında yanmış ve aynı yıl suni gençleştirme çalışmaları gerçekleştirilmiş meşcerelerde, gençlikler üzerinde morfolojik incelemeler gerçekleştirilmiştir. Çalışma kapsamında 4 adet 400 m² büyüklüğünde örnek alan alınmış ve örnek alanlar içerisindeki doğal ve yapay gençlikler üzerinde yaş, boy, kök boğazı çapı ve dalsız gövde uzunluklarına ait veriler elde edilmiştir. Toplamda 415 adet doğal ve 150 adet yapay gençlik üzerinde ölçümler gerçekleştirilmiştir. Örnek alanların alındığı meşcerelere ait 2015 yılı çimlenmeleriyle ilgili olarak işletme şefliği tarafından hazırlanmış fidan sayım zabıtlarına göre başarı yüzdesi ortalama %90 olarak belirtilmiştir. Dalsız gövde uzunluğu doğal gençlikler için ortalama 3.3 cm (min.=1, max.=7), yapay gençlikler için 1.7 cm (min.= 1, max.=3), fidan boyu doğal gençliklerde 37.7 cm (min.=8, max.=75), yapay gençliklerde 13.8 cm (min.=7, max.=22), kök boğazı çapı doğal gençliklerde 9.4 mm (min.=1, max.=22), yapay gençliklerde 3.3 mm (min.=2, max.=6) ve fidan yaşı doğal gençliklerde ortalama 2 (min.=1, max.=2) olarak tespit edilmiştir. Örnek alanlardaki yapay gençliklerin tamamı 2 yaşındadır. Elde edilen sonuçlar değerlendirildiğinde kızılçam meşcerelerinde yangın görmüş sahalarda lokal tohumların hayatiyetlerini en az 2 yıl koruyabildikleri anlaşılmaktadır. Dalsız gövde uzunluğu, fidan boyu ve kök boğazı çapı açısından doğal gençliklerin yapay gençliklere nazaran oldukça önemli miktarda pozitif büyüme seyrine sahip olduklarını söylemek mümkündür. Gerek katlılık ve gerekse gürbüzlük indisi açısından doğal gençlikler yapay gençliklere üstünlük sağlamıştır. Dolayısıyla, lokal tohum kaynağının yeterli olmadığı kızılçam meşcerelerinde, tohum takviyesi gerekiyorsa mutlak suretle uygun orijinlerden tohum transferi yapılarak gençleştirme çalışmaları gerçekleştirilmelidir.

Anahtar Kelimeler: Kızılçam, Orman yangını, Doğal gençleşme, Yapay gençleştirme, Fidan morfolojisi

Introduction

In Turkey *Pinus brutia* is a natural tree species which has a large natural distribution area and covers 5.6 million ha (Anon. 2015). It is also the most characteristic tree species of the Mediterranean climate. In this context, it has a great silvicultural potential both in regeneration and afforestation workings. Deal with being fast growing tree species, it has a great power for elimination of the wood raw material deficit in Turkey. Boydak and Çalışkan (2014) emphasized that wood import amount which is still 17 million cubic meters in Turkey will increase 8 million cubic meters more in 2020. Therefore, forestry close to nature in *Pinus brutia* stands which is set forth by analysis and synthesis of silvicultural techniques suitable for its biology should be accepted as an extra obligation in Turkish Forestry.

Disturbances (e.g. fires, winds, hurricane, floods, erosion, siltation, landslides, glaciers, volcanic activities, ice storms, mammals, insect and diseases) have deep effects on forest development. The impact of the disturbance can change according to the stand and ecological conditions together with the magnitude of the disturbance (Boydak et al., 2006). Natural or human disturbances which occur in all forests also affect each other (Oliver and Larson, 1996).

The most effective disturbance of *Pinus brutia* forests is fire either natural or caused by human (Saatçioğlu, 1975). *Pinus brutia* is a fire adapted tree species. Already fire is a component of the *Pinus brutia* ecosystems. *Pinus brutia* seeds both inside cones and as bare seed show resistance to heat to certain degrees (up to 125 °C) and can survive (Boydak et al., 2006). On the other hand after fire seed dispersal reach maximum, seeds distribute homogenously by wind and germination barrier of seeds are substantially eliminated. Supplementary seeding after fire can be necessary if canopy seed bank or reliable soil seed bank is insufficient.

Material and Methods

Material

In this study some morphological properties of natural and artificial seedlings were examined in burned Turkish Red Pine (*Pinus brutia* Ten.) stand. Sampled stands were burned in 2013 and artificial regeneration activities as full seeding were carried out in the same year. Sampled stands are located in Adana-Kadirli Forest Directorate Sumbas Forest Enterprise (Figure 1). Both sampled stands were 250 meter high above the sea level. Both sampled stands were on sunny exposure.

Main rock in the study area is limestone and it is vertically cracked. Absolute soil depth is 40-50 cm and physiological soil depth is 100-120 cm in the study area. After fire maquis understory was burned and cleaning is not necessary for applying silvicultural treatments.

Methods

Four sample plots were identified in total during the study and each sample plot was 400 m² in size. Morphological properties of the seedlings such as age, height, root collar diameter and unbranched stem height were measured in each sampling plot. Measurements were done on 415 natural and 150 artificial seedlings in total.

Results and Discussion

Official seedling counting report which belongs to the local forest enterprise stated that average regeneration success was 90% in 2015. Regeneration success was obtained as 89% in the first sampled stand, 90% in the second sampled stand, 89% in the third sampled stand and 89% in the fourth sampled stand. Regeneration success should be at least 60% in *Pinus brutia* stands for a successful forest regeneration practice in Turkey.

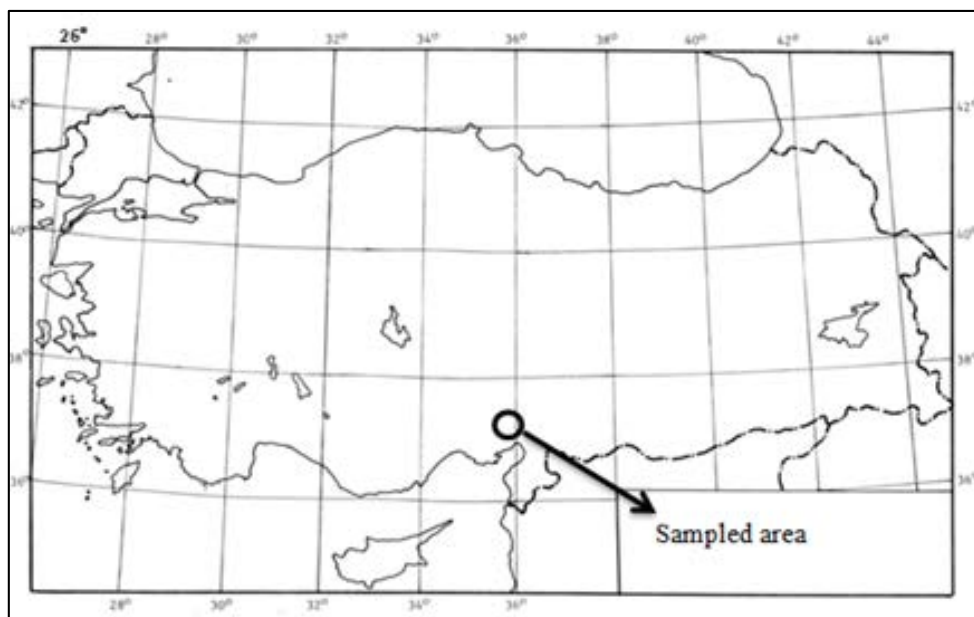

Figure 1. Location of the sampled *Pinus brutia* stands

According to the data obtained, average unbranched stem height of natural seedlings was 3.3 cm (min.=1, max.=7) and 1.7 cm (min.= 1, max.=3) in artificial seedlings (Figure 2).

Average height of natural seedlings was 37.7 cm (min.=8, max.=75) and 13.8 cm (min.=7, max.=22) in artificial seedlings (Figure 3). Average root collar diameter of natural seedlings was 9.4 mm (min.=1, max.=22) and 3.3 mm (min.=2, max.=6) in artificial seedlings (Figure 4).

Average age of the natural seedlings was 2 (min.=1, max.=2) and all artificial seedlings were in 2 years old (Figure 5). Obtained results showed that local seeds can carry on their vitality at least 2 years in burned Turkish Red Pine stands.

All morphological properties were significantly better in natural seedlings than artificial seedlings. Both seedling quality and seedling sturdiness were better in natural seedlings (Figure 6 and 7). Number of the natural seedlings was much more than artificial seedlings in every sample plot.

Mean number of *Pinus brutia* seedlings per hectare were 3531 in each sampled stand. 2593 of them were natural and 937 were artificial seedlings. During the thicket stage in *Pinus brutia* stands, early released cutting treatments have to be done when the tree saplings are more than 4 years old (Genç, 2007). After first release cutting treatment approximately 3500-4500 seedlings per hectare should take place in the stand (Genç, 2007). From this point of view it should be said that early release cutting treatments should be omitted in the sampled stands.

Besides its drought resistant character and its ability to grow on poor soil conditions, *Pinus brutia* was also a fire adapted tree species (Neyişçi, 1986 and 1987; Boydak, 1993 and 2004; Boydak and Özhan, 1996; Boydak et al., 2006).

Seed distribution occurs throughout the year, with maximum dispersal in August and the great majority of seeds dispersing between July and December (Ürgenç et al.,1989). Seeds on the ground persist at least one year (Boydak et al., 2006). However, obtained results showed that seeds can persist 2 years on the ground.

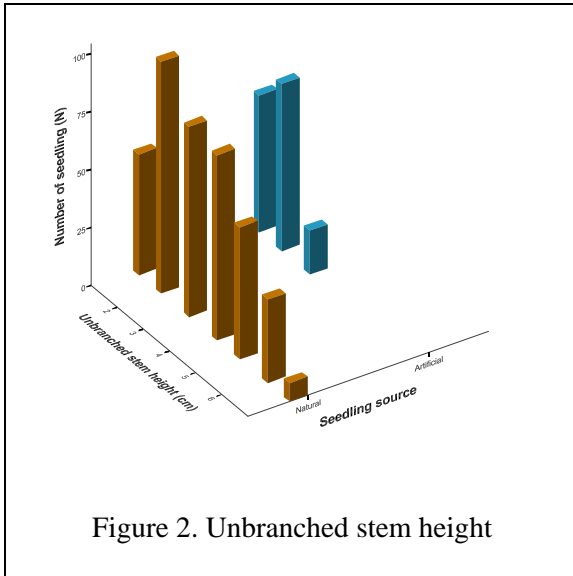

Figure 2. Unbranched stem height

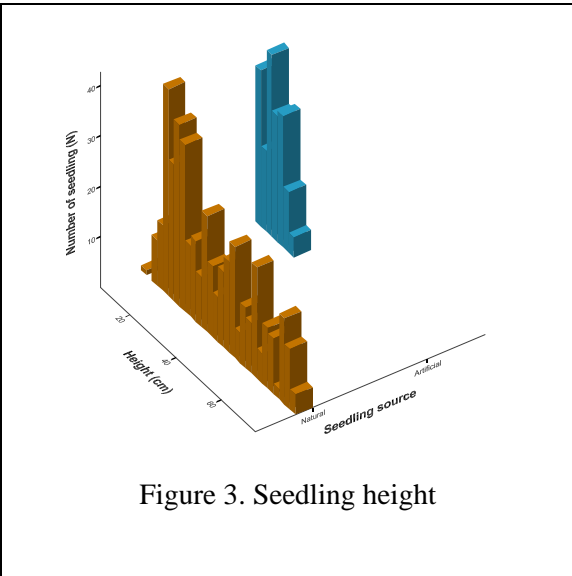

Figure 3. Seedling height

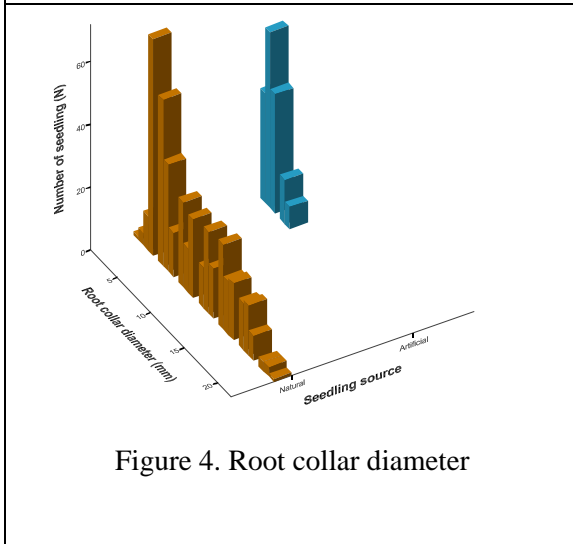

Figure 4. Root collar diameter

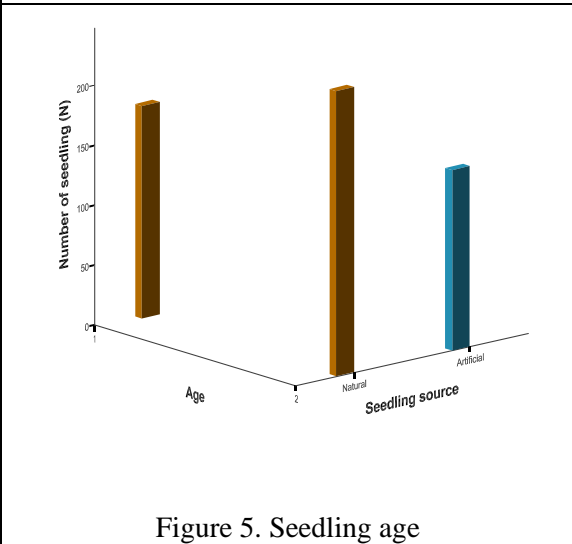

Figure 5. Seedling age



Figure 6. Natural seedlings



Figure 7. Artificial seedlings

Seed germination of *Pinus brutia* is very heterogeneous and this heterogeneity causes

an adaptive mechanism for seeding survival. Delayed germination in dry season will be

effective in wet season. 4-9 years old *Pinus brutia* closed cones can carry viable seeds inside. A certain fraction of pine seeds can survive the fire, protected by the scales of the closed, serotinous cones; moreover, as a result of heat, these cones open and disperse the enclosed seeds shortly after fire (Spanos et al., 2000). By the way natural regeneration can continue successfully after fire. However, effects of seed predators decrease after fire and fire provides suitable soil conditions and seed bed for germination and growth (Boydak et al. 2006). After seed dispersal, suitable soil conditions are required for seed germination and seedling development, which both represent crucial stages in the post fire recruitment process of pine population (Saracino et al., 1997).

Conclusion

As a result of this study, it can be said that *Pinus brutia* establishes its regeneration after fire. So, fire is the main natural disturbance in *Pinus brutia* ecosystems. If the canopy seed bank is sufficient for homogeneous seed dispersal after fire, artificial seeding is not necessary for regeneration. Growth abilities of natural seedlings are much more than artificial seedlings. If the canopy seed bank is in insufficient amount, artificial seeding can be necessary. However, suitable origins should be determined for artificial seeding in order to get better growth ability from artificial seedlings.

Acknowledgement

Special thanks to the Kadirli Forest Directorate Sumbas Forest Enterprise to provide data sharing for the study.

References

Anonymous, 2015. Türkiye Orman Varlığı 2015. T.C. Orman ve Su İşleri Bakanlığı Orman Genel Müdürlüğü (www.ogm.gov.tr).
Boydak, M., 1993. Kızılçamın silvikültürel özellikleri, uygulanabilecek gençleştirme yöntemleri ve uygulama esasları. Uluslararası Kızılçam Sempozyumu, 18-23 Ekim 1993-Marmaris, Orman Bakanlığı Yayını, s. 146-158.

Boydak, M., 2004. Silvicultural characteristics and natural regeneration of *Pinus brutia* Ten. A review. *Plant Ecol.*, 171:153-163.

Boydak, M., Çalışkan, S. 2014. Ağaçlandırma. OGEM-VAK Yayınları, CTA Tanıtım Rek. Hiz. Org. Basım yayın Bil. San. ve Tic. Ltd. Şti, İstanbul, 713p.

Boydak, M., Dirik, H., Çalikoğlu, M. 2006. Biology and silviculture of Turkish red Pine (*Pinus brutia* Ten.). OGEM-VAK Yayınları, Lazer Ofset Matbaa Tesisleri San. Tic. Ltd. Şti., Ankara, 253p.

Boydak, M., Özhan, S. 1996. Assessment of burned forest areas in term of watershed management and reforestation. *İ.Ü. Orman Fakültesi Dergisi*, A46(2):37-57.

Genç, M. 2007. Orman Bakımı. Süleyman Demirel Üniversitesi Orman Fakültesi Yayınları, Yayın No:14, Isparta, 237p.

Oliver, C.D. and Larson, B.C. 1996. Forest Stand Dynamics. John Wiley&Son, Inc. Update edition, New York, Chichester, Bribane, Toronto, Singapore, 519 p.

Saatçioğlu, F. 1975. Akdeniz Subtropikal Bölgede Orman Gençleştirilmesi Sorunları, *İ.Ü. Orman Fakültesi Dergisi*, A24(2): 84-127.

Saracino, A., Pacella, R., Leone, V., Borghetti, M. 1997. Seed dispersal and changing seed characteristics in a *Pinus halepensis* Mill. forest after fire. *Plant Ecology*, 130: 13-19.

Spanos, I.A., Evangelia, N.D., Costas, A.T. 2000. Postfire, natural regeneration of *Pinus brutia* forests in Thasos island, Greece. *Acta Oecologica*, 21 (1):13-20.

Ürgenç, S., Boydak, M., Özdemir, T., Ceylan, B., Eler, Ü. 1989. Investigation about the effects of thinnings on the grown development and seed crop in *Pinus brutia* stands. Ormançılık Araştırma Enstitüsü Yayınları, Teknik Bülten No.210, 69p.

Effect of Topography (Aspect and Slope Position) on Soil Properties and Soil Organic Carbon and Total Nitrogen Stock Capacity in Kastamonu Forest, Turkey

Temel SARIYILDIZ¹, Gamze SAVACI¹

¹Kastamonu University, Forestry Faculty, Department of Forest Engineering
37100 Kastamonu, Turkey,

Corresponding Author: gsavaci@kastamonu.edu.tr

Abstract

Topography has long been known as a factor potentially critical in creating contrasts in ecosystem characteristics. A few quantitative studies on the relationships of forest structure and species composition to environmental features, such as elevation, slope position, slope angle, and topographic aspect have revealed that the floristic composition, community structure, and distribution of vegetation species vary with slope position and aspect, which thusly bring about a few variations of soil properties. Topography impacts neighbourhood and provincial microclimates by changing the pattern of precipitation and temperature, sun based radiation, and relative humidity. Differing with height, atmosphere significantly impacts the pedogenic forms and soil properties by influencing types and rates of chemical, physical, and biological processes, and the type and composition of vegetation species. Climate straightforwardly impacts vegetation type and quality, weathering rates, and leaching intensity, which brings about inputs to soil properties, such as amount and quality of organic matter, clay and mineralogy, cation exchange capacity, base saturation. Although the effects of topographical land forms on microclimate and soils, as well as on plant species composition, community development, and site productivity have been extensively studied, very few studies have investigated their effect on soil organic carbon (SOC) and total nitrogen (TN) stock potential. In Turkey, not many studies are available on this topic. We have therefore set up a study to investigate the effects of topography (aspect and slope position) on soil properties and SOC and TN stock capacity using different tree species in Kastamonu region. Mineral soil samples were collected from north-facing site and south-facing site and at two slope positions (top and bottom) on each aspect. The soil samples were taken from 0-10 cm, 10-20 cm and 20- 30 cm soil depths, and analyzed for pH, soil texture, bulk density, SOC and TN. The SOC and TN stock capacity were then calculated by multiplying soil volume, soil bulk density, and the SOC or TN content. Analysis of variance (ANOVA) was applied for analyzing the effects of aspect and slope position on soil properties, and SOC and TN stock capacity for each species using the SPSS program. Results showed that soil properties and SOC and TN stock capacity can significant vary with tree species, and topography (aspects and slope positions). In general, SOC stock capacity was lowest under beech followed by Scots pine and fir, whereas TN stock capacity was highest under beech followed by fir and Scots pine. The north-facing sites and the top slope positions had higher SOC and TN stock capacity than the south-facing sites and at the bottom slope position for each tree species.

Keywords: Soil Properties, Carbon and Nitrogen Stock Capacity, Topography, Kastamonu

Kastamonu Yöresi Ormanlarının Toprak Özellikleri ve Toprak Organik Karbon ve Toplam Azot Depolama Kapasiteleri Üzerinde Topoğrafyanın (Bakı ve Yükselti) Etkisi

Özet

Topoğrafyanın ekosistem özelliklerinde farklılıklar oluşmasında potansiyel olarak önemli bir faktör olduğu uzun zamandır bilinmektedir. Orman yapıları ve tür çeşitliliğinin çevresel özelliklerle, örneğin yükselti, bakı ve eğim, olan ilişkilerini araştırmaya yönelik çalışmalar, tür çeşitliliği, topluluk yapısı ve bitki tür dağılımının bakı ve yükselti ile değiştiğini bu değişimin ise toprak özelliklerinde birkaç değişime sebep olduğunu tespit etmişlerdir. Topoğrafya düşen yağış miktarını, sıcaklığı, güneşe bağlı radyasyonu ve bağıl nemi değiştirerek, bulunduğu çevrenin ve yörenin mikro iklimini etkiler. Yüksekliği ile farklı, atmosfer; fiziksel, kimyasal ve biyolojik süreçlerin oranları ve tipleri yanında vejetasyon türlerinin tipi ve bileşimi de etkileyerek önemli ölçüde pedojenik formları ve toprak özellikleri değiştirir. İklim açıkça vejetasyon türünü ve kalitesini, parçalanma oranlarını ve yıkanma şiddetini etkiler ki bu etkilenme toprak özelliklerine girdilerini getirmektedir, örneğin organik maddenin miktarı ve kalitesi, kil ve mineraloji, katyon değişim kapasitesi, baz doygunluğu gibi. Topoğrafik arazi şekillerinin mikroiklim ve toprak özelliklerine etkileri yanında bitki tür çeşitliliği, topluluk gelişimi, yetişme ortamı verimliliği üzerinde birçok çalışma bulunmakla beraber topoğrafyanın bu farklı arazi şekillenmesinin toprak organik karbon (TOC) ve toplam azot (TN) depolama potansiyelleri üzerindeki çalışmalar oldukça azdır. Ülkemizde ise bu konuda yapılan çok az çalışma bulunmaktadır. Burada sunulan çalışmamız, Kastamonu Yöresinde yetişen farklı orman ağaçlarının toprak özellikleri ve organik karbon ve toplam azot depolama potansiyelleri üzerinde topoğrafyanın etkisini belirlemek amacıyla gerçekleştirilmiştir. Mineral toprak örnekleri kuzey ve güney bakı ile her bir bakımın iki farklı yükseltisinden alınmıştır. Toprak örnekleme 3 farklı toprak derinliğinden (0-10 cm, 10-20 cm and 20- 30 cm) yapılmış ve bu örneklerin pH, tekstür, hacim ağırlığı, TOC ve TN miktarları belirlenmiştir. Belirlenen TOC ve TN miktarları ile toprak hacim ağırlığı ve toprak hacmi kullanılarak TOC ve TN depolama kapasitesi hesaplanmıştır. Her bir türü için, Bakı ve yükseltinin toprak özellikleri ile TOC ve TN depolama kapasiteleri üzerinde önemli bir etkisinin olup olmadığı SPSS programı yardımıyla gerçekleştirilen tek yönlü varyans analizi (ANOVA) ile her bir tür için belirlenmiştir. Sonuçlar, Toprak özelliklerinin ve TOC ve TN depolama kapasitelerinin ağaç türlerine ve topoğrafyaya bağlı olarak önemli derecede değişiklik gösterdiğini göstermiştir. Genel olarak, TOC depolama kapasitesi kayın altı topraklarda en düşük iken bunu sarıçam ve göknar toprakları izlemiştir. TN depolama kapasitesinin en yüksek kayın altı topraklarda ve sırası ile göknar ve sarıçam topraklarında olduğu belirlenmiştir. Kuzey bakı ile üst rakımların ise her bir türde de daha fazla TOC ve TN depolama kapasitesine sahip olduğu tespit edilmiştir.

Anhtar Kelimeler: Toprak özellikleri, Karbon ve azot depolama kapasitesi, Topoğrafya, Kastamonu

Introduction

Atmospheric CO₂ concentration increased by about 9% between 1971 and 1990 and will probably have doubled by the end of the 21st century, mainly due to man-made emissions. This increase results in global climatic warming considered by the Rio summit in 1992 to be dangerous. The need for an accurate inventory of carbon stocks and the capacity of forest to accumulate carbon was emphasized at the Helsinki (1993) and Kyoto (1997) conferences. There are three main reservoirs regulating the carbon cycle on earth, namely the oceans, the atmosphere and the terrestrial systems. Forest ecosystems only cover 30% of the land areas, but contain 81% of the terrestrial carbon biomass (Dupouey et al., 1999). In addition, forests accumulate 20 to 100 times as much carbon per unit area as agricultural land and are 20 times more productive than grassland (Curtis et al., 2002). Globally, C sequestration in forests has been hypothesized to explain an “imbalance” in the anthropogenic C budget (Schimel et al., 1995) and has become a high priority research area. Many studies still exclude soil carbon (SOC) though forest soils sequester 69% of the global forest C (Dixon et al., 1994; Perruchoud et al., 2000), that is, more than the amount present in the atmosphere, and can respond rapidly and substantially under land-use changes (Davidson and Ackerman, 1993). Several studies have been carried out to estimate differences in soil carbon (SC) in relation to vegetation and soil properties, land uses and climate (Yimer et al., 2006; Lemenih and Karjalainen, 2007). Although the effects of topographical land forms (slope aspect and position) on microclimate and soils, as well as on plant species composition, community development, and site productivity have been studied extensively (Barnes et al., 1998; Sariyildiz et al., 2005; Sariyildiz, 2015), very few studies have investigated the role of aspect and slope position on SOC content globally. Topographical landforms (especially different aspects and slope positions) can create different environmental conditions which can retard or accelerate litter decomposition through negative or positive effects on the activity of organisms (Scowcroft et al., 2000; Sariyildiz et al., 2005; Sariyildiz, 2008). The slope position, slope

aspect, and its inclination can also affect soil depth, profile development, soil chemical characteristics, and the texture and structure of the soil surface (Boerner, 1984; Sariyildiz et al., 2005). Aspect and slope position also induces local variation in temperature and precipitation, which along with chemical and physical composition of the substrate, are the main regulators of decomposition rates of soil organic matter (Sariyildiz et al., 2005).

In this present paper, we present a study on the effect of tree species on soil properties and soil carbon stock in mineral topsoil situated on two aspects and at two slope positions on each aspect.

Material and Methods

Sampling site and litter collection

This study was carried out in Kastamonu province, northwest Turkey, (41° 23' 19" N, 33° 46' 57"E), a mountainous region with steep slopes (range from 30 to 65%) and high elevations (up to 2500 m.). Soil samples of Scots pine (*Pinus sylvestris* L.), Uludağ fir (*Abies nordmanniana* ssp. *bornmuelleriana*) and beech (*Fagus orientalis* Lipsky) were collected from two aspects (north and south) and two altitudes (800 m and 1500 m) on each aspect.

In each site, age of few mature and taller trees was measured for height, diameter (diameter at breast weight) and tree architecture was noted. Canopy cover was determined in the field by visually estimating the amount of cover in each site. The soil samples were taken randomly from 0-10cm, 10-20 cm and 20-30 cm soil depths by digging five soil pits at each slope. The samples were air-dried, ground and pass through 2 mm mesh-sized sieve. Two core samples from each soil pit were also taken and averaged to obtain representative bulk density. Soil pH was determined by a combination glass-electrode in H₂O (soil-solution ratio 1: 2.5). Soil texture was determined by Bouyoucos` Hydrometer Method. Soil organic matter (SOM) contents of the soils were determined according to wet digestion method described by Kalra and Maynard (1991) (Modified Walkley-Balck Method).

Percent of SOC for the soil depths was calculated for each soil pit, based on SOC (%) = 0.58 x SOM.

Total N was determined by Kjeldal digestion (Allen, 1989) followed by analysis of ammonium by the indophenols method using an auto-analyzer device for 2 days at 105 °C. The SC or nitrogen pool were calculated by multiplying soil volume, soil bulk density, and SC or nitrogen content and expressed as Mg ha⁻¹ (Lee et al., 2009). Soil mass was calculated as follows:

$$M_i = BD_i \cdot T_i \cdot 10^4$$

where M_i is dry soil mass (Mg ha⁻¹), BD_i is bulk density (Mg m⁻³), T_i is the thickness of the i -th soil layer (m), and 10^4 is the unit conversion factor (m² ha⁻¹). The fixed depth (FD) determination of areal C or (N) stock is calculated as follows:

$$C_{i\text{-fixed}} \text{ or } N_{i\text{-fixed}} = ([C_i] \text{ or } [N_i]) \cdot M_i$$

where $C_{i\text{-fixed}}$ is the C (or $N_{i\text{-fixed}}$ is the N) mass to a fixed depth (kg C or N ha⁻¹) and $[C_i]$ or $[N_i]$ is the C or N concentration (kg C or N Mg⁻¹).

Differences in soil properties and soil carbon stock rates between tree species, aspects and slope positions were tested for significance using ANOVA. Tukey's honest significance difference (HSD) test was used when statistically significant differences ($p < 0.05$) were observed.

Results

Mean soil pH, soil texture, soil organic carbon and total nitrogen, soil bulk density, and soil organic carbon and total nitrogen

Discussion

This study has shown that soil properties and SOC and TN stock capacity vary with respect to tree species, aspect and slope position. Mean SOC stock capacity were the lowest under beech and followed by Scots pine and Fir. However, TN stock capacity was highest under beech followed by fir and Scots pine. This could be attributed to the differences in canopy closure, nutrient contents and nutrient use efficiency in leaves, and also root and litter decomposition rates among three tree species (Sariyildiz, 2008; Sariyildiz and Kucuk, 2008; Sariyildiz, 2015)

stock capacity from three soil depths on two aspects at two slope positions are given Scots pine, fir and beech tree species in Table 1, Table 2 and Table 3 respectively.

Among three species, soil pH, soil sand, clay and silt contents did not show clear and significant differences between slope positions and aspects. Soil bulk density was highest under Scots pine, followed by Fir and beech (Table 1, Table 2 and Table 3).

In general, percent soil organic carbon and carbon stock capacity were lowest under beech followed by Scots pine and fir, whereas percent soil total nitrogen and nitrogen stock capacity were highest under beech followed by fir and Scots pine (Table 1, Table 2 and Table 3). However, these differences in soil properties and percent or stock capacity of soil organic carbon and nitrogen among tree species varied significantly with aspect and slope positions.

For all three tree species, soil pH, soil sand, clay and silt contents, percent soil organic carbon and total nitrogen, and soil organic carbon and total nitrogen stock capacity were higher at the bottom slope position than at the top slope position (Table 1, Table 2 and Table 3). Only, soil sand content was lower at the bottom slope position than at the top slope position.

For all three tree species, soil pH, sand content were lower on the north-facing site than on the south-facing sites, whereas percent soil organic carbon and total nitrogen, and soil organic carbon and total nitrogen stock capacity were higher at the north-facing site than on the south-facing sites (Table 1, Table 2 and Table 3).

and thus results in higher or lower SOC and TN stock capacity in the soil.

For each tree species, mean SOC and TN stock capacity were higher in the northern aspects and at the top slope positions than in the southern aspects and at the bottom slope positions in the upper 30 cm soil layer. This may be due to lower carbon turnover rate resulting from higher mean annual and lower temperature conditions favouring accumulation of considerably higher amounts of organic matter in these three tree species (Sariyildiz et al., 2005; Sariyildiz, 2015).

This finding was consistent with a number of researchers, such as Wang et al. (2004) and Yimer et al. (2006) who reported an increase in SOC levels with decreasing mean annual temperature (MAT). This is to be expected in the high mountain soils, where increasing altitude is associated with low MAT and higher orographic precipitation and high organic matter concentrations. Generally, the higher SOC stocks in the soils of the northern aspects and at the top slope positions, as compared to the southern aspects and at the bottom slope positions may be explained by the influence of (micro) climate on the biomass and litter production on the one hand, and the organic matter decomposing micro-organisms on the other (Sariyildiz et al., 2005).

Soil properties such as moisture and temperature regimes and pH affect litter decomposition rates by influencing the activity of decomposer (Vitousek et al., 1994). A field study of litter decomposition along elevational gradients in the Hawaiian Islands by Vitousek and others (1994) indicated that the rate of litter decomposition increased 4–11-fold for a 10 °C increase in air temperature, but they also stated that this increase in litter decomposition rate with increasing air temperature strongly depended on the site and substrate quality. In general, a number of studies showed for soil, air and under canopy that temperature was lower on the north-facing sites and at the top slope position compared to the south-facing sites and the bottom slope position. This could be the main factors which resulted in decreasing the activity of decomposers, and thus inhibited the decomposition of the major of the organic matter on the north-facing site and at the top slope positions.

It is previously reported by Sariyildiz and his colleagues (Sariyildiz et al., 2005) that the litters of beech, oak, fir and pine trees placed at top slope position decomposed lower rates than at the top slope position. However, the same litters placed on the north-facing site decomposed higher rates than on the south-facing sites. Those controversial results were due to the differences in biochemical variation in litters in relation to aspects and slope positions. In their study, they showed that litter quality parameters, especially lignin and

the combined concentrations of lignin and cellulose (ADF), and lignin:N and C:N ratios in beech, oak, fir and pine litters varied significantly within and between species in relation to aspects and the slope positions. In general, tree species growing on the south-facing sites and at the top slope position produce lower quality litters than those on the north-facing sites and at the bottom slope positions. Therefore, it can be concluded that in any topographical region one would expect the litter quality to be the

Table 1: Soil pH, texture, soil organic carbon, total nitrogen, bulk density, and soil organic C and total N stock capacity of Scots pine from three soil depths (a, b, c) on two aspects at two slope positions

Soil Properties	North		South	
	Top	Bottom	Top	Bottom
pH (H ₂ O)	5,64a	6,39b	6,10b	6,67c
Sand (%)	68b	59a	74b	69b
Clay (%)	16a	21a	18a	19a
Silt (%)	16a	20b	8a	12a
C (%)	4,28c	5,54d	2,72a	3,44b
N (%)	0,34b	0,48c	0,21a	0,37b
Bulk density (Mg m ⁻³)	1,11a	1,14a	1,18a	1,23a
Mean SOC stock capacity (Mg C h ⁻¹)	47,5c	63,2d	32,1a	42,3b
Mean STN stock capacity (Mg N h ⁻¹)	3,77b	5,47d	2,48a	4,55c

The Tukey's Honestly Significant Difference (HSD) test was used to determine significantly different means between the study stands. Means with the same letter are not significantly different by lines (n=5).

(b) Soil depth 10-20 cm

Soil Properties	North		South	
	Top	Bottom	Top	Bottom
pH (H ₂ O)	5,84a	6,59c	6,20b	6,97c
Sand (%)	65b	55a	66b	62b
Clay (%)	20a	25b	15a	18a
Silt (%)	15a	20b	19b	20b
C (%)	3,38b	4,04c	2,18a	3,04b
N (%)	0,29b	0,38b	0,18a	0,31b
Bulk density (Mg m ⁻³)	1,17a	1,21a	1,19a	1,27a
Mean SOC stock capacity (Mg C h ⁻¹)	39,5b	48,9c	25,9a	38,6b
Mean STN stock capacity (Mg N h ⁻¹)	3,39b	4,60d	2,14a	3,94c

(c) Soil depth 20-30 cm

Soil Properties	North		South	
	Top	Bottom	Top	Bottom
pH (H ₂ O)	5,96a	6,20a	6,19a	6,45b
Sand (%)	62b	50a	63b	69b
Clay (%)	20a	21a	17a	19a
Silt (%)	18b	19b	20b	12a
C (%)	2,28a	2,94b	2,08a	3,10b
N (%)	0,22a	0,35b	0,21a	0,27a
Bulk density (Mg m ⁻³)	1,23a	1,25a	1,28a	1,29a
Mean SOC stock capacity (Mg C h ⁻¹)	28,0a	36,8b	26,6a	40,0b
Mean STN stock capacity (Mg N h ⁻¹)	2,71a	4,38c	2,69a	3,48b

Table 2: Soil pH, texture, soil organic carbon, total nitrogen, bulk density, and soil organic C and total N stock capacity of Fir from three soil depths (a, b, c) on two aspects at two slope positions

(a) Soil depth 0-10 cm

Soil Properties	North		South	
	Top	Bottom	Top	Bottom
pH (H ₂ O)	5,94a	6,89b	6,40b	6,97b
Sand (%)	71b	60a	70b	62a
Clay (%)	15a	22b	17a	19a
Silt (%)	14a	18b	13a	19b
C (%)	3,98b	5,04c	3,18a	3,74b
N (%)	0,49b	0,55c	0,31a	0,47b
Bulk density (Mg m ⁻³)	1,24a	1,28b	1,31b	1,21a
Mean SOC stock capacity (Mg C h ⁻¹)	49,4c	64,5d	41,7a	45,3b
Mean STN stock capacity (Mg N h ⁻¹)	6,08b	7,04c	4,06a	5,69b

(b) Soil depth 10-20 cm

Soil Properties	North		South	
	Top	Bottom	Top	Bottom
pH (H ₂ O)	5,64a	6,19b	5,90a	6,17b
Sand (%)	68b	59a	70b	67b
Clay (%)	18a	19a	15a	17a
Silt (%)	14a	22b	15a	16a
C (%)	3,68c	3,94c	2,08a	2,84b
N (%)	0,32b	0,45c	0,21a	0,27a
Bulk density (Mg m ⁻³)	1,29a	1,32a	1,33a	1,29a
Mean SOC stock capacity (Mg C h ⁻¹)	47,5c	52,0d	27,7a	36,6b
Mean STN stock capacity (Mg N h ⁻¹)	4,13c	5,94d	2,79a	3,48b

(c) Soil depth 20-30 cm

Soil Properties	North		South	
	Top	Bottom	Top	Bottom
pH (H ₂ O)	5,84a	6,22b	5,85a	6,37b
Sand (%)	62b	54a	54a	57a
Clay (%)	18a	21a	23a	25a
Silt (%)	20a	25a	23a	18a
C (%)	2,58b	3,24c	1,78a	2,78b
N (%)	0,29b	0,45c	0,20a	0,42c
Bulk density (Mg m ⁻³)	1,32a	1,35a	1,37a	1,42a
Mean SOC stock capacity (Mg C h ⁻¹)	34,1b	43,7d	24,4a	39,4c
Mean STN stock capacity (Mg N h ⁻¹)	3,83b	6,08c	2,74a	5,96c

Table 3: Soil pH, texture, soil organic carbon, total nitrogen, bulk density, and soil organic C and total N stock capacity of Beech from three soil depths (a, b, c) on two aspects at two slope positions

(a) Soil depth 0-10 cm

Soil Properties	North		South	
	Top	Bottom	Top	Bottom
pH (H ₂ O)	5,55a	6,11b	6,33c	6,57c
Sand (%)	70b	60a	78b	65a
Clay (%)	16a	20b	12a	20a
Silt (%)	14a	20b	18b	15a
C (%)	3,38b	3,94c	2,18a	3,33b
N (%)	0,59a	0,75b	0,51a	0,67b
Bulk density (Mg m ⁻³)	1,33a	1,36a	1,36a	1,38a
Mean SOC stock capacity (Mg C h ⁻¹)	45,0b	53,6c	29,6a	46,0a
Mean STN stock capacity (Mg N h ⁻¹)	7,85a	10,2b	6,94a	9,25b

(b) Soil depth 10-20 cm

Soil Properties	North		South	
	Top	Bottom	Top	Bottom
pH (H ₂ O)	5,65a	6,33b	6,40b	6,68b
Sand (%)	68b	62a	73b	63a
Clay (%)	18b	20b	16b	17b
Silt (%)	14b	18b	11b	20b
C (%)	3,18b	3,44c	2,08a	3,04b
N (%)	0,36a	0,55b	0,40a	0,54b
Bulk density (Mg m ⁻³)	1,38a	1,39a	1,37a	1,36a
Mean SOC stock capacity (Mg C h ⁻¹)	43,9b	47,8c	28,5a	41,3b
Mean STN stock capacity (Mg N h ⁻¹)	4,97a	7,65b	5,48a	7,34b

(c) Soil depth 20-30 cm

Soil Properties	North		South	
	Top	Bottom	Top	Bottom
pH (H ₂ O)	5,44a	6,29b	5,66a	6,47b
Sand (%)	70b	59a	73b	65a
Clay (%)	20a	21a	17a	20a
Silt (%)	10a	20b	10a	15a
C (%)	2,58c	2,74d	1,78a	2,24b
N (%)	0,49a	0,65b	0,41a	0,47a
Bulk density (Mg m ⁻³)	1,41a	1,43a	1,40a	1,39a
Mean SOC stock capacity (Mg C h ⁻¹)	36,4c	39,2d	24,9a	31,1b
Mean STN stock capacity (Mg N h ⁻¹)	6,91b	9,30c	5,74a	6,53b

dominant decisive factor for the decomposition rate between aspects, and temperature between slope positions. Lower decomposition rates with lower litter quality and with temperature decreasing with altitude will influence the amount of carbon and nitrogen found in the profile, and in long-term perspective, soil C and N stocks will approach the ratio between litter input rate and litter decomposition rate (Yimer et al., 2006).

In conclusion, this present study illustrates that north-facing sites and top slope positions result in a higher amount of carbon and nitrogen stock in comparison with the south-facing sites and bottom slope positions. It also shows that aspect and slope position-induced differences in soil carbon and nitrogen stocks are highly variable between tree species. Differences in litter decomposition rates between tree species, aspects and slope positions due to differences in litter quality parameters, microclimatic factors such as the MAT (soil, air and under canopy temperature in this present study) and the activity of microorganisms (soil respiration rates) will control the rate and type of organic residue incorporated into the soil system.

References

- Allen S.E. 1989. *Chemical Analysis of Ecological Materials*. Blackwell Scientific Publications, Oxford.
- Barnes B.V., Zak, D.R., Denton S.R., Spurr S.H. 1998. *Forest ecology*, fourth ed. Wiley, New York.
- Boerner R.E. 1984. Nutrient fluxes in litterfall and decomposition in four forests along a gradient of soil fertility in southern Ohio. *Can. J. For. Res.* 14, 794–802.
- Curtis P.S., Hanson P.J., Bolstad P., Barford C., Randolph J.C., Schmid H.P., Wilson K.B. 2002. Biometric and eddy covariance based estimates of annual carbon storage in five eastern North American deciduous forests. *Agric For Meteorol* 113:3–19.
- Davidson E.A., Ackerman I.L. 1993. Changes in soil carbon inventories following cultivation of previously untilled soils. *Biogeochemistry* 20:161–93.
- Dixon R.K., Brown S., Houghton R.A., Solomon A.M., Trexler M.C., Wisniewski J. 1994. Carbon pools and flux of global forest ecosystems. *Science* 263:185–90.
- Dupouey J.L., Pignard G., Badeau V., Thimonier A., Dhôte J.F., Nepveu G., Bergès L., Augusto L., Belkacem S., Nys C. 1999. Stocks et flux de carbone dans les forêts françaises, *CR Acad. Agric. Fr.* 85:293–310.
- Kalra, Y.P., Maynard, D.G., 1991. *Methods manual for forest soil and plant analysis*. In: *For. Can., Northwest Reg, North. For. Cent., Edmonton, Alberta. Inf. Rep. NORX- 319*.
- Lee J., Hopmans J.W., Rolston D.E., Baer S.G., Six J. 2009. Determining soil carbon stock changes: simple bulk density corrections fail. *Agriculture Ecosystems and Environment* 134: 251-256.
- Lindner M., Karjalainen T. 2007. Carbon inventory methods and carbon mitigation potentials of forests in Europe: a short review of recent progress. *Eur J For Res* 126:149–156.
- Perruchoud D.O., Fischlin A. 1995. The response of the carbon cycle in undisturbed forest ecosystems to climate change: a review of plant-soil models. *J Biogeograph* 22:759–74.
- Sariyildiz T, Anderson JM, Kucuk M (2005) Effects of tree species and topography on soil chemistry, litter quality and decomposition in Northeast Turkey. *Soil Bio Biochem* 37 : 695-1706.
- Sariyildiz T. (2008). Effects of tree canopy on long-term litter decomposition rates of fir, spruce and pine species in northeast Turkey. *Scandinavian Journal of Forest Research*, 23 (4), 330-338.
- Sariyildiz T., Kucuk M. 2008. Litter Mass Loss Rates in Deciduous and Coniferous Trees in Artvin, Northeast Turkey: Relationships With Litter Quality, Microclimate and Soil Characteristics. *Turkish J Agri For* 32:547-559.
- Sariyildiz T. 2015. “Effects of tree species and topography on fine and small root decomposition rates of three common tree species (*Alnus glutinosa*, *Picea orientalis* and *Pinus sylvestris*) in Turkey”, *Forest Ecology and Management*, 335, 71-86.
- Schimel D., Alves D., Enting I., Heimann M., Joos F., Raynaud D., Wigley T., Prather M., Derwent R., Ehhalt D, et al. 1995. Radiative forcing of climate change. In: *Houghton J.T., Meira Filho L.G., Callander*

B.A., Harris N., Kattenberg A., Maskell K., editors. Climate change: the science of climate change. Cambridge: Cambridge University Press. p 69–131.

Scowcroft P.G., Turner, D.R., Vitousek, P.M., 2000. Decomposition of *Metrosideros polymorpha* leaf litter along elevational gradients in Hawaii. *Glob. Change Biol.* 6, 73–85.

Vitousek P.M., Turner, D.R., Parton, W.J., Sandford, R.L. 1994. Litter decomposition on the Mauna Loa environmental matrix, Hawaii:

patterns, mechanisms and models. *Ecology* 75, 418–429.

Wang, S., Huang, M., Shao, X., and Mickler, R. A. 2004. Vertical distribution of soil organic carbon in China, *Environ. Manage.*, 33, 200–209.

Yimer F., Ledin S., Abdelkadir A. 2006. Soil organic carbon and total nitrogen stocks as affected by topographic aspect and vegetation in the Bale Mountains, Ethiopia Original Research Article. *Geoderma* 135:335-344.

Fiber Morphology of Alder (*Alnus glutinosa* L. Gaertner) Wood Grown in Natural and Planted Stands

*Kamile TIRAK HIZAL¹, Nurgün ERDİN²

¹Duzce University, Faculty of Forestry, Duzce /TURKEY

²Istanbul University, Faculty of Forestry, Istanbul /TURKEY (retired)

*Corresponding Author: kamiletirak@duzce.edu.tr

Abstract

Industrial plantations of the fast growing tree species have increasingly becoming important for meeting demand. Plantation forestry is desirably due to rapid growth rates; however we don't know how affected wood properties. Alder (*Alnus glutinosa* L. Gaertner) is native species which is grown in Türkiye naturally. It has several usage area such as furniture, veneer, particle board, medium density fiber board (MDF), pulping, carving and turning. In this paper we investigated the fiber properties of alder wood which is planted and natural grown. Fiber properties of natural and planted alder wood was compared statistically. Three of planted trees were cut from Meryemana-Yeniköy, three of natural alder trees were cut from Maçka-Yüzüncüyıl in Trabzon. From the bottom, breast height and 3.3 m height of trees, discs was taken and determined the South and North side of them. Small cubes were taken from outer, middle and the inner of the 2 cm wide strips. Cubes were decided small pieces and then macerated according to Jeffrey. Fiber cell wall thickness, fiber length, fiber lumen diameter, and fiber diameter were measured. All the measurements were valued statistically by SPSS. As a result, there was significant difference between fiber length, fiber diameter, fiber lumen diameter, fiber cell wall thickness. Higher fiber length and fiber cell wall thickness values has been found in planted alder wood.

Keywords: Fast grown, Plantation, Common alder wood, *Alnus glutinosa*, Fiber

Doğal ve Plantasyon Meşcerelerde Yetişen Adi Kızılağaçların Lif Morfolojisi (*Alnus glutinosa* L. Gaertner)

Özet

Talebi karşılamak için hızlı büyüyen ağaç türlerinin endüstriyel plantasyonları artarak önem kazanmaktadır. Plantasyon ormancılığı hızlı büyüme oranları nedeni ile tercih edilmesine karşılık odun özelliklerini nasıl etkilediği konusunda bilginiz bulunmamaktadır. Kızılağaç (*Alnus glutinosa* L. Gaertner) Türkiye'de doğal olarak yetişen yerli bir türümüzdür. Mobilya, kaplama, lif levha, suntan, kağıtçılık, oymacılık gibi birçok alanda kullanım alanı bulunmaktadır. Bu çalışmada plantasyonda ve doğal büyüyen kızılğaç odununun lif özellikleri araştırılmıştır. Doğal ve plantasyonda yetişen kızılğaçların lif özellikleri istatistiksel olarak karşılaştırılmıştır. Çalışmada kullanılan ağaçların hepsi Trabzon ili içerisinde; plantasyonda yetişen ağaçların üç tanesi Meryemana-Yeniköy bölgesinden, doğal yetişenlerin üç tanesi Maçka-Yüzüncüyıl bölgesinden kesilmiştir. Ağaçların dip, göğüs yüksekliği ve 3.3 m yükseliğinden diskler alınmış ve kuzey ve güney yönleri belirlenmiştir. 2 cm genişliğindeki çitalardan dış, orta ve iç kısımdan küçük küpler alınmıştır. Lif çeper kalınlığı, lif uzunluğu, lif lumen genişliği ve lif çapı ölçülmüştür. Tüm değerler SPSS program ile istatistiksel olarak değerlendirilmiştir. Sonuç olarak; lif uzunluğu, lif çapı, lif lumen çapı ve lif çeper kalınlığı arasında anlamlı fark bulunmuştur. Plantasyonda yetişen kızılğaç odununda lif uzunluğu ve lif çeper kalınlığı daha yüksek değerlerde bulunmuştur.

Anahtar Kelimeler: Hızlı yetişen, Plantasyon, Adi kızılğaç, Lif, *Alnus glutinosa*

Introduction

Over millennia, most of the wood needs have come from the harvesting of natural forests, but the current and future wood demand of a growing human population cannot be covered by the natural forests of the world. Plantation forests play an

important role in the solution to this problem. To meet this deficit, wood production has to be increased in plantations by more growth per unit area with fast growing species. Introduction of fast growing species to Turkey was started in 1880's with *Pinus pinaster* and in 1939 with *Eucalyptus*

camuldensis as foreign species (Ayan and Sivacioğlu, 2006). About two decades ago, it was stated that the studies on fast growing species in Turkey should also be focused on native broadleaved species such as *Fraxinus*, *Alnus*, *Populus tremula*, *Ulmus* etc. (Çiçek and Yılmaz, 2002).

Because of the short rotations, there is a concern that fast-growing species would contain a large volume of juvenile wood bearing unstable properties. This concern is an obstacle for the use of fast-growing species for timber (Kojima et al., 2009). There is a little information on the timber properties of fast-growing species. Therefore, the use of these species has been limited to paper, pulp, and fuel woods, which are not so profitable for foresters (Cossalter and Pye-Smith, 2003).

Wood consists of matrix of fibre walls and air spaces (Rupert et al., 2002). The primary structural block of wood is the tracheids or fibre cells (Panshin and de Zeeuw, 1980). The variations in wood properties are attributable to the different distribution patterns of its micro structures, its arrangement, size and dimension of component cells. Fibres are the principal element that is responsible for the strength of the wood (Panshin and de Zeeuw, 1980; Desch and Dinwoodie, 1983), and fiber length is one of the quality parameters for pulpwood (Hudson et al., 1995; Sandercock et al., 1995; Jorge et al., 2000).

Common or black alder (*Alnus glutinosa* (L.) Gaertn.) belongs to the genus *Alnus* the family *Betulaceae* which comprises about 36 species is a broadleaved tree native to most of Europe. Alder can be found over most of Europe from Scandinavia to the Mediterranean countries and parts of North Africa (Houston et al., 2016)..

Alder is another native fast growing species in Turkey and it is distributed mainly in North-East Anatolian Region covering 148 296 ha and 144 795 ha are in the Eastern Black Sea Region (Anonymous, 2010). Yield study of Alder was carried out and an empirical yield table was constructed for its natural stands. It was found out that its mean annual increment (MAI) can reach 21,0 m³/ha/year at 20 years in good sites (Batu and Kapucu, 1995).

Alder wood is soft and diffuse porous, it has normally pale pinkish-brown colour, which darkens somewhat on exposure to light but durable if kept under water. Because of this property alder is used for jetties and underwater supports, bridge piles and small boats (parts of Venice were built on alder wood piles) (Knaggs and Xenopoulou, 2004; Housley et al., 2004; Klaassen and Creemers, 2012). Additionally it is used in sauna, benches and panels, turning and carving, plywood, flakeboard MDF (medium density fiberwood), pulp and in the packaging industry but also more and more in furniture and different kinds of interiors and decorations as well as in various special products (Erdin and Bozkurt, 2013; Akyüz, 1998). Alder is not generally strong enough for heavy construction uses but good quality wood is sought after in joinery and wood veneer. It yields high quality charcoal and can be coppiced and provides material suitable for biomass production (Savill, 2013).

Regarding the wood properties of a specific species, one usually compares differences between materials sourced from plantations and those from natural forests. Such differences may lead to different end-uses and market segments. These differences may be linked to the soil, growth conditions, age and genetics (Langbour et al., 2011). We investigated the fiber dimensions of planted common alder wood and compared them with natural common alder wood.

Materials and Methods

Common alder trees were felled from Eastern Blacksea Region of Turkey. Natural stand was belong to Maçka region in Trabzon (40°43'22" / 39°41'50"), and planted stand was belong to Meryemana region in Trabzon (40 °42'04" /39°44'12"). The location and details of the sites and sampled trees are given in Table 1. Sample tree was selected from each study site for destructive sampling, representing the average diameter class, and avoiding extreme cases such as excessively knotty and crooked trees. A total of 6 trees were identified and numbered and measured the breast height diameter before felling. Diameter at 1.3 m (DBH) was determined as the mean of two

cross diameter. Each tree was felled and the tree height was measured.

A 5 cm long disk was taken at breast height from the stems. From each disk 2 cm wide strip were cut from North side to South side. Transverse surfaces of each strip were polished with sandpaper. For fiber analysis,

annual ring was selected for measuring from inner (first 5. annual ring), middle and near the bark in North and South side of strip at three height level. We used totally 6 strips and 18 cubes (Figure 1).

Table 1. The location and details of the three sites and sampled trees

Trabzon	Plantation Stand			Natural Stand		
	T*1	T*2	T*3	T*4	T*5	T*6
Region name/No	Meryemana			Yüzüncü yıl/396		
Slope	Kuzey- batı			Kuzey- batı		
Aspect (%)	40			45		
Altitude (m)	1221			1214		
Coordination	40°42'04" /39°44'12"			40°43'22" / 39°41'50"		
Precipitation (mm yr ⁻¹)	971			902		
Mean temperature (°C)	12			8.4		
DBH diameter (cm)	21	20	19	32	24	25
Tree height (m)	13,9	14	12,5	16,3	15	11
Number of rings at DBH	28	28	28	88	68	38

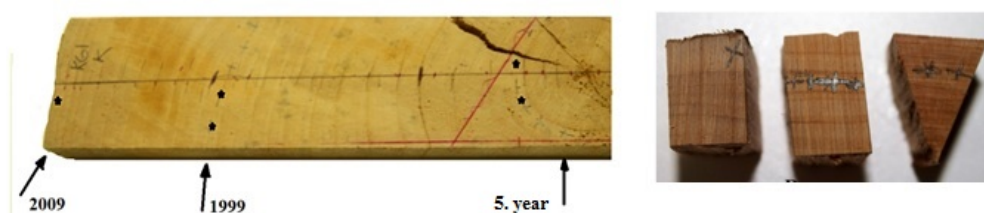

Figure 1. Selected annual rings and used wood cubes

All cubes were cut small wood chips about 1-2 cm long. Wood chips for fiber dimension measurements were macerated in %10 nitric acid and %10 chromic acid according to Jeffrey method for one day (Bozkurt and Erdin, 2011). Then rinsed in distilled water and placed in glycerin (Figure 2). 25 whole fibers per sample were measured at different magnification (4x, 10x, 100x). From the macerated samples, fiber length, fiber diameter and cell wall thickness were identified. Olympus BX 51 microscope connected to Olympus DP 71 camera was used to acquire images using the image analysis software ANALYSIS FIVE. All measurements were made according to *International Association of Wood Anatomists* (IAWA, 1989).

The overall means were calculated from the means of individual samples and an ANOVA procedure was formed using SPSS 17.0 software and for each sites were analyzed on the basis of the 95% confidence interval.

Result and Discussion

The descriptive statistics of fibre length, fiber diameter, fiber lumen diameter and fiber cell wall thickness were given Table 2. Fiber in tangential section of natural and plantation grown common alder wood are shown in Figure 1.

There is significant difference between natural and plantation trees for all fiber dimensions. FL was 1199.43 µm and FDCWT was 9.14 µm higher than natural trees, 1115.1 µm and 8.59 µm respectively.

FD was 27.27 μm and FLD was 18.68 μm higher than plantation trees, 26.46 μm and 17.32 μm respectively. Usta et al. (2014) was studied *Alnus glutinosa subsp. barbata* wood anatomy which were grown in different sites naturally. According to this study, FL was 1183.13 μm in Akçaabat, 1111.71 μm in Espiye, FD was 26.0 μm in Akçaabat, 23.5 μm in Espiye, FLW was 16.5 μm in Akçaabat, 14.4 μm in Espiye, FCWT was 4.75 μm in Akçaabat, 4.53 μm in Espiye. These results were similar to our naturally and plantation grown trees values.

The value of FL in plantation forest (1.45 mm) was found higher than in natural forests(1.34 mm), and the value of FD in plantation forest (28.91 μm) was found lower than that in natural forest (31.43 μm) by Kiaei et al. (2016), like our results.

FL was 1005 μm (Bostancı, 1985), 382-1676 μm (Merev, 1998), 507-1477 μm (Genç, 2010), 1.27 mm (Yaman 2009) and 0.58-1.09 mm (Robison et al., 1987). FD was 29.65 μm (Bostancı, 1985), 14-39 μm (Genç). FDCW was 4.08 μm (Yaman, 2009).

Table 2. Descriptive statistics of fiber dimensions

Properties	Natural grown				Plantation grown			
	Mean	S	Min.	Max.	Mean	S	Min.	Max.
FL (μm)	1115.1	227.97	468.71	1680.56	1199.43	189.82	640.54	1957.49
FD (μm)	27.27	4.49	16.77	44.48	26.46	4.47	11.62	44.48
FLD (μm)	18.68	3.83	10.05	34.25	17.32	4.24	4.27	30.15
FDCWT(μm)	8.59	2.09	4.31	20.56	9.14	2.57	3.55	21.20

S: Standard deviation, FL: fiber length, FD: fiber diameter, FLD: Fiber lumen diameter, FDCWT: fiber double cell wall thickness

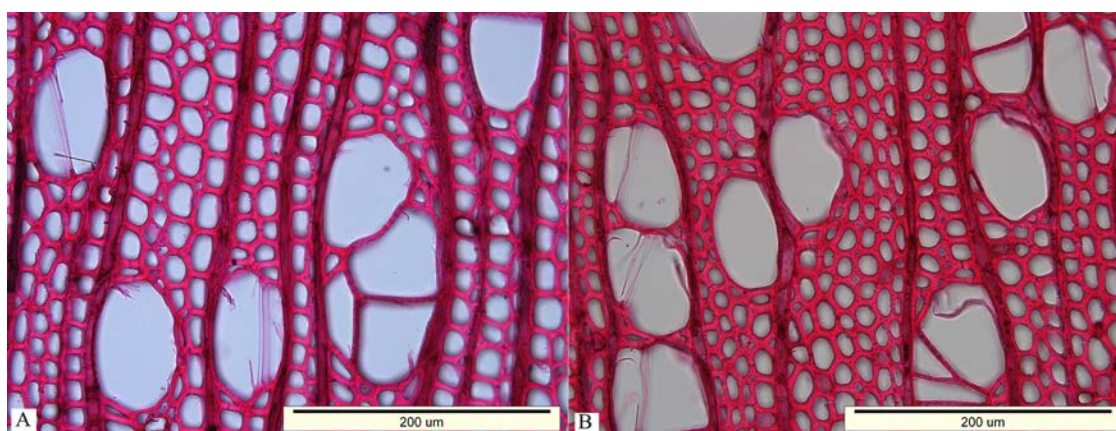

Figure 1. Fibers in tangential section; A-Plantation, B-Natural

Conclusion

Statistical analyses revealed significant differences between natural forest trees and plantation trees in FL, FD, FLD and FDCWT. The mean of FL and FDCWT in plantation stand trees was higher than the natural stand trees. FD and FLD values in plantation trees was lower than that of natural stands.

Acknowledge

This study was prepared by Kamile TIRAK HIZAL and a part of doctorate thesis which name is “Comparison of Structural Properties of Ash and Alder Wood Species Grown in Natural and Planted stands” in İstanbul University, Institute of Science, Forest Industry Engineering Department. Thank for İstanbul University and Forest Industry Engineering Department, Prof. Dr. Yılmaz BOZKURT Wood Anatomy Laboratory.

Reference

- Akyüz, M. 1998. Wood properties and applications of Black Alder (*Alnus glutinosa* subsp. *barbata* (C.A. Mey. Yalt)). Karadeniz Technical University Faculty of Forestry and General Directorate of Forestry, Symposium on Forest Ownership Issues Proceedings, 467-471.
- Anonymous, 2010. Turkey Forest Inventory General Directorate of Forestry (Unpublished).
- Ayan, S., Sivacıoğlu, A. 2006. Review of the Fast Growing Tree Species in Turkey. *Boletín del CIDEU*, Vol.2, 57-71.
- Batu, F., Kapucu F. 1995. Doğu Karadeniz Bölgesi kızılgağac mescerelerinde bonitet endeksi ve hasılat tablosunun düzenlenmesi. I. Ulusal Ormanlık Karadeniz Kongresi, s.348-363, Trabzon, Turkey.
- Bostancı, Ş. 1985. Adi kızılgağac (*Alnus glutinosa* L. Gaertn.) odunu kağıt endüstrisinde değerlendirme olanakları, TÜBİTAK, Tarım ve Ormanlık Araştırma Grubu, Orütar Ünitesi, Proje No.4.
- Cicek, E., Yılmaz, M. 2002. The importance of *Fraxinus angustifolia* subsp. *oxycarpa* as a fast growing tree for Turkey, In: Management of fast growing plantations. Proceedings of a meeting of IUFRO, p.192-200.
- Cossalter C., Pye-Smith C. 2003. Fast-wood Forestry: Myths and Realities. Center for International Forestry Research, Jakarta, Indonesia.
- Desch, H.E., Dinwoodie, J.M. 1983. Timber, Its structure, Properties and Utilization. 6th Edition. Published by Macmillan Education Limited. 410pp.
- Erdin, N., Bozkurt, Y. 2013. Odun anatomisi, İstanbul Üniversitesi, Orman Fakültesi, İ.Ü. Yayın No: 5145, O.F. Yayın No: 506, ISBN. 978-975-404-932-9, İstanbul.
- Genç, R. 2010. Camili'deki bazı odunsu *angiospermae* taksonlarının ekolojik odun anatomileri. Yüksek Lisans Tezi, K.T.Ü., Orman Mühendisliği Anabilim Dalı, Trabzon.
- Housley, R. A., Ammerman, A. J., McClennen C. E. 2004. That Sinking Feeling Wetland Investigations of the Origins of Venice. *Journal of Wetland Archaeology*, 4: 139-153.
- Houston Durrant, T., de Rigo, D., Caudullo, G. 2016. *Alnus glutinosa* in Europe: distribution, habitat, usage and threats, European Atlas of Forest Tree Species, ISBN 978-92-79-36740-3, Publication Office of the European Union, p.64-65, Belgium.
- IAWA Committee, 1989. IAWA list of microscopic features for hardwood identification., *IAWA Bull.* n.s. 10: 219-332.
- Kiaei M., Naji H. R., Abdul-Hamid H., Farsi M. 2016. Radial Variation of Fiber Dimensions, Annual Ring Width, and Wood Density from Natural and Plantation Trees of Alder (*Alnus glutinosa*) Wood. *Wood Research*, 61(1):55-64.
- Klaassen R. K. W. M., Creemers, J. G. M. 2012. Wooden foundation piles and its underestimated relevance for cultural heritage. *Journal of Cultural Heritage*, 13S, S123-S128.
- Knaggs G., Xenopoulou S. 2004. Guide to Irish Hardwoods, ISBN 1 902696 31 X, COFORD, Dublin.
- Kojima M., Yamamoto H., Yoshida M., Ojio Y., Okumura K. 2009. Maturation Property of Fast-Growing Hardwood Plantation Species: A Review of Fiber Length. *Forest Ecology and Management*, 257: 15-22.
- Langbour P., Gerard J., Roda J. M., Ahmad Fauzi P., Guibal D. 2011. Comparison of Wood Properties of Planted Big-leaf Mahogany (*Swietenia macrophylla*) in Martinique Island With Naturally Grown Mahogany from Brazil, Mexico and Peru. *Journal of Tropical Forest Science*, 23(3):252-259.
- Merev, N., 1998, *Doğu Karadeniz Bölgesindeki Doğal Angiospermae Taksonlarının Odun Anatomisi*, 1. Cilt, 621 s., Trabzon
- Panshin, A.J., de Zeeuw, C. 1980. Text book of Wood Technology, Structure, Identification, Properties and Uses of the commercial wood of the United States and Canada. McGraw Hill Book Company, New York. 722 pp.
- Robison, T. L., Mize, C. W. 1987. Specific gravity and fiber length variation in European black alder provenance study. *Wood and Fiber Science*, 19 (3), p. 225-232.
- Rupert W., Geoffrey M.D., Robert E. 2002. High-resolution analysis of radial growth and wood density in *Eucalyptus nitens* grown under different irrigation regimes. *Ann. For. Sci.* 59:519-524.
- Savill, P. S. 2013. The silviculture of trees used in British forestry, CABI, ISBN 9781780640266.
- Usta A., Yılmaz M., Malkoçoğlu S., Serdar B., Yılmaz S., Bozlar T. 2014. Effects of Environmental Factors on Wood Anatomy of Black Alder (*Alnus glutinosa* (L) Gaertner subsp. *barbata* (C.A. Meyer) Yalt) from Two Different Origins of Eastern Black Sea Region in Turkey. *Fresenius Environmental Bulletin*, 23(8):1778-1784.
- Yaman, B. 2009. Wood anatomy of ivy-hosting black alder (*Alnus glutinosa* Gaertn.), *Dendrobiology*, Vol:62, 41-45.

Determination of Glossiness and Color Values on Laminated UV System Varnish Applied Parquets That are Derived by Using Different Water-Based Paints on Oak Wood

Levent GÜRLEYEN¹, *Ümit AYATA², Nevzat ÇAKICIER³

¹ Forestry and Forest Products, Oltu Vocation School, Ataturk University, 25400, Erzurum, Turkey;

² ÇPAL Atatürk Cad. No: 94, 81950, Yığılca/Duzce, Turkey;

³ Department of Forest Industry Engineering, Duzce University, 81620, Duzce, Turkey;

*Corresponding Author: umitayata@atauni.edu.tr

Abstract

Water-based paints with different colors are generally used to change the color of the wooden materials on laminated UV System varnish applied parquets. In this study; it is aimed to determine the values of glossiness and color on laminated UV system varnish applied parquets that are derived by using different water-based paints. In accordance with this aim, a UV varnish system was applied directly on natural oak (*Quercus petraea*) wood. Then water-based paints of white, walnut and nut colors were applied on the remaining three sample groups. Later, the UV varnish system was applied on all of the four sample groups as well. The color and glossiness (The perpendicular and parallel to the surface) values were tried to be determined on the derived experimental samples with water-based paints and the ones without paint. As a consequence; the color of white was detected to be having the highest value of ΔE . The factors of water-based paints were detected to be significantly effective on the glossiness values of perpendicular-parallel to the surface and color. As compared to other applications, the white paint was detected to be increasing the lightness (L^*) and perpendicular-parallel to the surface values and decreasing the values of a^* and b^* .

Keywords: Parquet; Oak; Glossiness; Color

Meşe Odunu Üzerinde Farklı Su Bazlı Boyalar Kullanılarak Elde Edilen UV Sistem Laminat Parkelerde Renk ve Parlaklık Değerlerinin Belirlenmesi

Özet

UV sistem laminat parke uygulamalarında genelde ahşap malzemenin rengini değiştirmek için farklı su bazlı boya türleri kullanılmaktadır. Bu çalışmada, UV sistem uygulamasında farklı su bazlı boyalar kullanılarak elde edilen laminat parkelerde bazı yüzey özelliklerinin belirlenmesi amaçlanmıştır. Bu amaçla, bu çalışmada meşe (*Quercus petraea*) odunundan üretilen laminat parkeler üzerinde UV sistem uygulamasının yanında beyaz, ceviz ve fındık rengi boyalar kullanılmıştır. Elde edilen su bazlı boyalı ve boyasız malzemeler üzerinde; renk ve parlaklık (yüzeye dik ve paralel) değerleri belirlenmiştir. Araştırma sonuçlarına göre; en yüksek ΔE değeri beyaz boyada elde edilmiştir. Sonuç olarak, meşe odunu yüzeylerine uygulanan UV sistem laminat parke katmanlarının; renk, yüzeye dik ve paralel parlaklık değerleri üzerinde, su bazlı boya çeşidi (boyalı / boyasız) faktörünün önemli olduğu belirlenmiştir. Boya uygulanmamış örnekler, diğer su bazlı boya uygulanmış örneklere kıyasla beyaz boyanın ışıklılık (L^*), yüzeye dik ve paralel parlaklık değerlerinde artış olduğu, a^* ve b^* değerlerinde ise düşüş olduğu tespit edilmiştir.

Anahtar kelimeler: Parke, Renk, Parlaklık, Meşe.

Introduction

In recent years, during laminated parquet produce, there are used very type waterborne wood coatings. Purpose, laminated parquet are obtained to have different colors. These paint types are very important for furniture and decoration industry. Especially, solids content

and the chemical content of the paint is very important for UV curing. Water-based paints shows different color and glossiness properties for each tree species.

Development work continues to increase the range of UV curable coatings with new soft feel,

low matt and one-coat high gloss, pigmented systems coming into the market (Skinner, 2003).

Important of coloring are biggest on finishes (Delikan, 2001).

The industrial wood finisher has actually three options in types of UV curable coatings to water-reduced UV, use 100% UV and solvent reduced UV (Iseghem 2006).

Topcoats containing waterborne and solventborne acrylic polymers performed for gloss and color retention. Waterborne systems had good gloss compared to the solventborne systems (PCI, 2013).

The advantages of water-based UV-curable raw materials are presented in terms of low viscosity and the ability to be diluted with water (Arceneaux et al. 2011).

This study evaluated the glossiness and color of laminated parquets in UV varnish system and different water based paints applied on oak (*Quercus petraea*) wood, important for parquet industry.

Material And Methods

UV Varnishing System was applied on the natural form of oak (*Quercus petraea*) wood (60 cm by 10 cm by 1.5 cm). Then all samples were cut in dimensions of 10 cm x 10 cm x 1.5 cm.

The specimens were conditioned in a climate room having a temperature of 20°C and relative humidity of 65% until they reach the equilibrium moisture content of 12%.

In this study, three types of finishes, namely white, walnut and nut having different dyes in their content.

Control samples were also used as unfinished specimens.

All finishes application were commercially supplied in the form of paste and mixed with water before the application to the surface of the samples, using a roller at a rate of 25 g m⁻².

Later, coated specimens were kept in a conditioning room for several works before any tests were carried out.

Table 1. Laminated parquet flooring production process

- Sanding & Calibrating Machines (80 - 120 - 220 grip sandpaper)
- Paint machine (wood water-based paint concentrate)
- Air drying (min 70°C)
- Roller UV parquet paste (white 25 m ⁻²)
- UV lamp drying (80°C)
- Amount of UV Sealer Clear S to be applied (25 g m ⁻²) part 1
- UV lamp drying (80°C)
- Amount of UV Sealer Clear S to be applied (25 g m ⁻²) part 2
- UV lamp drying (400°C)
- 280 - 320 grip sandpaper
- Amount of UV Antiscratch Semi Matt W to be applied (7.5 g m ⁻²) part 1
- UV lamp drying (80°C)
- Amount of UV Antiscratch Semi Matt W to be applied (7.5 g m ⁻²) part 2
- UV lamp drying (400°C)

Color and glossiness measurement

The discoloration of the samples coated with white finish, walnut finish and nut finish were coded as Y, Z and W respectively.

Control specimens without having and finish on them were X. The color change of Oak (*Quercus petraea*) wood of different UV system applied different dyes using (Unpainted (X), White paint (Y), Walnuts paint (Z) and Nuts paint (W)) on laminated parquet flooring materials was analyzed by a The Datacolor 110 (Wavelength Resolution 10 nm, Measurement Geometry D/8°) with a D65 standard illuminant.

The CIELAB system is characterized by three parameters, L^* , a^* , and b^* . The L^* axis represents the lightness, $+a^*$ is the red, minus a^*

for green, $+b^*$ for yellow, minus b^* for blue, and L^* varies from 100 (white) to zero (black) (Zhang et al. 2009).

ΔL^* , Δa^* and Δb^* values were used and they were calculated for total color ΔE^* ;

$$\Delta L^* = L^*_{Y,Z,W} - L^*_X,$$

$$\Delta b^* = b^*_{Y,Z,W} - b^*_X,$$

$$\Delta a^* = a^*_{Y,Z,W} - a^*_X.$$

$$\Delta E = [(\Delta L^*)^2 + (\Delta a^*)^2 + (\Delta b^*)^2]^{1/2} \quad (1)$$

Surface brightness measurements in the UV system applied layers to ISO 2813 (1994) within the framework of the principles set forth in the brightness measurements meter (Gloss Meter Picogloss 562 MC) were made (perpendicular (\perp) and parallel ($//$) measurement 60°).

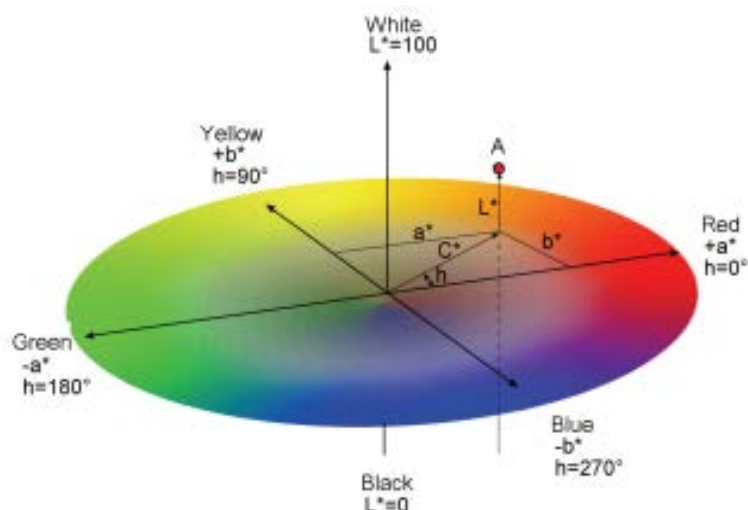

Figure 2. The three-dimensional CIE $L^*a^*b^*$ colour space (Johansson 2005).

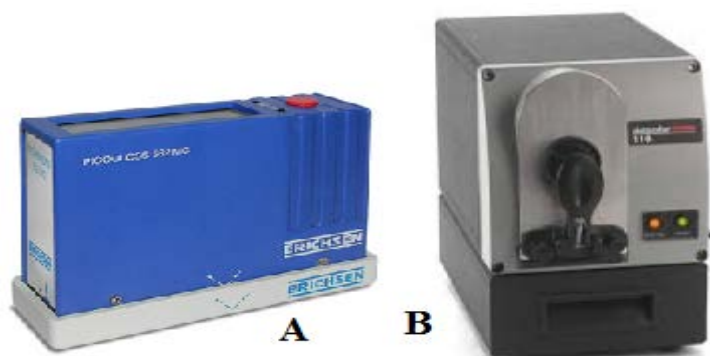

Figure 3. Gloss Meter (Picogloss 562 MC) (A) and Spectrophotometer (The Datacolor 110) (B)

Statistical Analysis

The total color, glossiness, red color tone, color lightness and yellow color tone values results of all tests were determined by using SPSS 17 software program.

Color lightness (L^*), red color (a^*) tone, yellow color (b^*) tone, glossiness parallel ($//$) and glossiness perpendicular (\perp) values were obtained using thirty replicates of each specimen and an average value was reported. The test results were evaluated.

Results And Discussion

Color and glossiness

Table 2 given the analysis of variance results and paint type comparison for red color (a^*) tone, yellow color (b^*) tone, glossiness paralel (\perp) and perpendicular (\perp) values results values.

According to color lightness, red color tone, yellow color tone, glossiness paralel and

perpendicular values results, the paint type were found to be significant ($\alpha = 0.05$).

According to Table 2, while the lowest red color (a^*) tone, yellow color tone (b^*) values were reported with values white applied paint samples, the highest color lightness (L^*), glossiness perpendicular (\perp) and paralel ($//$) values were determined white painted specimens.

On unpainted samples, when highest yellow color tone (b^*) values were obtained, lowest glossiness perpendicular (\perp) and paralel ($//$) values were noted.

Also, walnut painted samples were reported on highest red color tone values.

Table 2. Glossiness perpendicular (\perp), paralel (\parallel) (60°), color lightness (L^*), red color (a^*) tone and yellow color (b^*) tone test results of the variance analysis and UV system applied paint type comparison

Test	Source	Type III Sum of Squares	Df	Mean Square	F	Sig.	
Color lightness (L^*)	Paint types	32547.678	3	10849.226	6956.578	0.000*	
	Error	180.909	116	1.56			
	Total	430759.57	120				
	Corrected Total	32728.587	119				
	Paint type	N	Mean	HG	Std. Deviation	Min	Max
	Unpainted	30	61.01	B	1.27	58.94	63.73
	White painted	30	82.60	A*	0.82	81.41	84.24
	Walnuts painted	30	38.71	D	0.94	37.71	40.51
	Nuts painted	30	48.05	C	1.75	45.17	51.97
	Red color tone (a^*)	Source	Type III Sum of Squares	Df	Mean Square	F	Sig.
Paint types		1679.902	3	559.967	5094.515	0.000*	
Error		12.750	116	0.110			
Total		7190.840	120				
Corrected Total		1692.652	119				
Paint type		N	Mean	HG	Std. Deviation	Min	Max
Unpainted		30	8.71	B	0.46	8.22	10.03
White painted		30	0.85	D	0.30	0.31	1.39
Walnuts painted		30	6.60	C	0.17	6.40	6.97
Nuts painted		30	10.92	A*	0.34	10.00	11.48
Yellow color tone (b^*)	Source	Type III Sum of Squares	Df	Mean Square	F	Sig.	
	Paint types	5823.733	3	1941.244	4185.110	0.000*	
	Error	53.806	116	0.464			
	Total	39998.134	120				
	Corrected Total	5877.540	119				
	Paint type	N	Mean	HG	Std. Deviation	Min	Max
	Unpainted	30	24.62	A*	0.58	23.87	25.99
	White painted	30	5.87	D	0.42	5.20	6.77
	Walnuts painted	30	16.50	C	0.47	15.98	17.54
	Nuts painted	30	20.47	B	1.06	18.65	22.57
Glossiness perpendicular	Source	Type III Sum of Squares	Df	Mean Square	F	Sig.	
	Paint types	46.799	3	15.600	193.153	0.000*	
	Error	9.368	116	0.081			
	Total	25849.851	120				
	Corrected Total	56.167	119				
	Paint type	N	Mean	HG	Std. Deviation	Min	Max
	Unpainted	30	13.76	D	0.22	13.40	14.20
	White painted	30	15.51	A*	0.27	14.90	16.10
	Walnuts painted	30	14.55	C	0.27	13.90	15.00
	Nuts painted	30	14.82	B	0.36	14.20	15.50
Glossiness paralel	Source	Type III Sum of Squares	Df	Mean Square	F	Sig.	
	Paint types	129.565	3	43.188	113.525	0.000*	
	Error	44.130	116	0.380			
	Total	46415.301	120				
	Corrected Total	173.695	119				
	Paint type	N	Mean	HG	Std. Deviation	Min	Max
	Unpainted	30	18.39	C	0.47	17.40	19.40
	White painted	30	20.76	A*	0.48	19.60	21.60
	Walnuts painted	30	18.82	B	0.53	17.00	19.40
	Nuts painted	30	20.55	A	0.89	18.30	22.30

HG: Homogeneous Group, N: Number of measurements, Mean: Average, *: Maximum value

Total color values of the paint used in this study are given in Table 3.

According to formula 1, while the lowest nuts paint was obtained for total color (ΔE^*) values, highest white paint were noted.

For water based paints have different chemical; ΔL^* , Δa^* and Δb^* values had to different results.

For 100% UV-curable coatings, low-irradiance cure will result in lower gloss values and higher irradiance cure will result in higher gloss values (Iseghem 2006).

Table 3. Total color (ΔE^*) values of the paints

Types paint	Name	ΔL^*	Δa^*	Δb^*	ΔE^*
White paint	Y	21,59	-7,86	-18,75	29,66
Walnuts paint	Z	-22,30	-2,11	-8,12	23,83
Nuts paint	W	-12,96	2,21	-4,15	13,79

Conclusions

In this study, the color (a^* , b^* , L^* , ΔE , ΔL^* , Δa^* and Δb^*), glossiness parallel (//) and perpendicular (\perp) (60°) (ISO 2813), values of UV system applied different dyes using (Unpainted (X), White paint (Y), Walnuts paint (Z) and Nuts paint (W)) used on Oak (*Quercus petraea*) wood were obtained.

According to statistical analysis results, after different UV system applied different dyes using (Unpainted (X), White paint (Y), Walnuts paint (Z) and Nuts paint (W)), on color values lightness (L^*), red color tone (a^*) and yellow color tone (b^*), glossiness parallel (//) and perpendicular (\perp) (60°) values were changed.

These paints are very important for laminated parquet industry.

Test results have shown; the type of paint white paint has the highest luminance value. The highest red color value is obtained nut dye.

The paint has the highest total color difference values between the paint is white paint.

The highest value of the fiber obtained in parallel and perpendicular glossiness in white paint. As a result the addition of water-based paints affected color (a^* , b^* , L^* , ΔE , ΔL^* , Δa^* and Δb^*), glossiness parallel (//) and perpendicular (\perp) (60°) of UV varnishing system.

Acknowledgements

The authors would like to thanks ASD Laminat Factory in Duzce - Turkey for the all color (L^* , a^* and b^*) measurement and Karabacak Laminated Parquet Flooring for laminated parquet flooring.

References Cited

Arceneaux J., Smith J.C., Vanmeulder G., Smeets S., 2011. Water-Based, Field-Applied UV-Curable

Topcoats for Wood Flooring, Paint & Coatings Industry, 27 (7), 50.

Delikan A.B., 2001. Değişik ağaç türleri üzerinde farklı boyalar uygulayarak, hızlandırılmış solma deneyleri, Yüksek Lisans Tezi, Gazi Üniversitesi Fen Bilimleri Enstitüsü, Ankara.

ISO 554 1976. Standard atmospheres for conditioning and/or testing - Specifications.

ISO 2813 1994. Paints and varnishes - Determination of specular gloss of non-metallic paint films at 20 degrees, 60 degrees and 85 degrees, International Organization for Standardization.

Johansson D., 2005. Strenght and colour response of solid wood to heat treatment, Graduate Thesis, Luleå University of Technology, Department of Skelleftea Campus, Division of Wood Technology, Sweden, 93 (5), 1402-1757.

Iseghem L.C.V., 2006. Wood Finishing with UV-Curable Coatings, Radtech Report May/June.

Paint Coatings Industry, 2013. Self-crosslinking acrylic and acrylic/polyurethane resins for waterborne wood finishes, 1 May.

Skinner D., 2003. UV Curing in the Plastic Components Industry, July/August, Radtech Report 1, 19-23.

Zhang J., Kamdem D.P., and Temiz A., 2009. Weathering of copper-amine treated wood, Appl. Surf. Sci. 256 (3), 842-846.

The Effect of Using Siriono and Boric Acid on the Combustion Performance in Particleboard Production

*Abdullah İSTEK¹, İsmail ÖZLÜSOYLU¹

¹Bartın University, Faculty of Forestry, Bartın / TURKEY

*Corresponding Author: aistek@bartin.edu.tr

Abstract

In this study, the combustion performances of particleboards (PBs) produced using fire retardants (FRs) boric acid (BA) and Siriono 110 S1 (S110) were compared. BA and S110 were used in PBs production in ratios of 5%, 9% and 12%. Urea formaldehyde (UF) resin was used as a binder in the production of three-layer PBs in the ratios of 10% on surface layers, 8% in core layer. It was determined from the data that the combustion performance of PBs improved as the amount of both of the FRs increased. It was found out that using BA was more effective than S110. The minimum mass losses were observed as 21.58% when 12% BA was used and 28.3% when 12% S110 was used. In conclusion, it was discovered that using BA as FR was more effective than using S110 in PB production.

Keywords: Boric acid, Siriono 110 S1, fire retardant, particleboard, mass loss, combustion performance

Yongalevha Üretiminde Siriono ve Borik Asit Kullanımının Yanma Performansı Üzerine Etkisi

Özet

Bu çalışmada, yanmayı geciktirici borik asit ve ticari siriono 110 (S110) kimyasalları kullanılarak üretilen yonga levhaların yanma özellikleri karşılaştırılmıştır. Yanmayı geciktirici maddeler %5, %9 ve %12 oranlarında yonga levha üretiminde kullanılmıştır. Üç tabakalı yongalevha üretiminde yüzey tabakalarında %10, orta tabakada %8 oranında üre formaldehit tutkalı (UF) yapıştırıcı olarak kullanılmıştır. Yonga levha yanma özelliklerinin yanmayı geciktirici madde (FR) kullanım oranı arttıkça iyileştiği ve BA'nın S110'dan daha etkili olduğu belirlenmiştir. En düşük kütle kaybı %21.58 ile %12 BA kullanımında görülürken, %12 S110 kullanımında kütle kaybı %28.3 olmuştur. Bu sonuçlara göre yonga levha üretiminde yangın geciktirici olarak BA kullanımının S110 a göre daha etkili olabileceği anlaşılmıştır.

Anahtar kelimeler: Borik asit, yangın geciktirici, yonga levha, kütle kaybı, yanma performansı.

Introduction

Nowadays, the notion of decreasing the environmental pollution and the better-protection of human health increased the demand to biodegradable materials. Within this context, the use of wood composite boards constituted from wood and lignocellulosic materials gradually increases in proportion to alternative materials. Among the wood-composite boards, the highest production share belongs to the particleboards (Öztürk 2003). Even though wood-based materials have many advantages, their one of the main disadvantage is that they are combustible materials. For this reason, in order to retard the combustion of wood-based products, these products are treated with various fire retardant materials. In production of wood-composite boards,

generally the fire retardant materials, which are both cheap and effective and also are widely available, are preferred. From this aspect, the use of even various minerals as fire retardant is investigated. The factors playing role in using boron as fire retardant are their abundance in nature, cheapness, relatively environment- and human-friendly nature, no negative effects on resistance characteristics of the wood materials. The use of boron compounds is gradually becoming wider because of their useful effects of controlling the fungi and insects (Kartal and İmamura 2004).

For the usefulness of fire retardants, they need to improve the combustion characteristics of the materials without harming the products' characteristics. An efficient fire retardant should have low combustion rate, decrease the

severity of fire, create low level of smoke, and not be toxic. For certain purposes, also the appearance and characteristics should be acceptable, and they should not significantly affect the production costs (Aydın et al., 2016). Fire retardant boron compounds are environment-friendly because they release no toxic gas, and they have low volatility rate. Boron fire retardants delay fire by decreasing the contact with oxygen by creating glassy protection layer acting as barrier for polymer chain oxidation (Aydın et al., 2016).

The fire-retarding characteristic of boron has been examined in many studies. Among the special boron compounds, zinc borate and fluoro-borate are the most widely used ones having fire-retarding properties. These compounds are of the pigment characteristic being resistant to high temperature levels (Gürü et al., 2010). Uysal and Özçifçi (2004), Yalınkılıç et al. (1997) and Baysal (2002), in their studies, have reported that the boron compounds significantly decreased the flammability characteristic of wooden materials. In another study, the combustion performances of MDF boards, surfaces of which have been covered with calcic added with fire retardant boric acid, borax, and zinc borate, have been determined. It has been reported that, zinc borate, boric acid, and borax additives increased the combustion performance of glossy MDF boards, and that the highest performance was observed in boric acid, followed by borax, and zinc borate (İstek et al. 2012, 2013). Özdemir and Tutuş (2013) have examined the effects of fire retardants on combustion behaviors of high-density fiber (HDF) boards. Borax, boric acid, ammonium poly-phosphate, and commercial alpha-x materials have been used as fire retardant. As a result, it has been stated that the increasing concentration of fire retardant also increased the resistance to combustion and decreased the loss of weight. Moreover, while the best result in flame-caused combustion has been obtained from borax, the best result in self-combustion has been achieved from ammonium-phosphate.

Siriono is a commercial fire-retarder that is used for increasing the fire-resistance of wood-

based composites such as MDF, particleboard, OSB, and plywood. Siriono acts by decreasing the oxygen concentration in the air, and it also decreases the release of toxic gases besides decreasing the flame's rate of propagation (URL-1).

In this study, the effects of use of Siriono and Boric Acid (BA) fire retarders in production of particleboards on combustion performance were examined. By comparing the commercial uses of Siriono and BA, the differences between them were determined.

Materials and Methods

The wood chips and urea formaldehyde (UF) glue used in this study as materials were procured from Kastamonu Integrated Particleboard Industry. The wood chips consist of 55% softwood and 45% hardwood particles. Solid matter content of UF glue is 62%, and the proportion of ammonium sulfate ((NH₄)₂SO₄), which was used as hardener, to the weight of glue was 1%. As fire retarder material, various concentrations of Siriono 110 (S110) and boric acid (BA) that are commercially available were used. Both of the chemicals were procured from the market.

Experimental boards were produced in 400mmx400mm dimensions, 16 mm thickness, and 650kg m⁻³ density. Air-dried chips were prepared for gluing by drying to 1-3% moisture level in drying oven at 120°C. By using rotary drum gluing system, the middle and upper layer chips at appropriate moisture level were bonded with UF glue. In proportion to completely-dry chip weight, the weight of UF glue used in middle layer chips was 8% and that of chips used in surface layer was 10%. After the implementation of glues, 5%, 9% and 12% of fire retardant material (in proportion to completely dried wood chip weight) were applied in powder form. By using wood form mold with 400x400x300mm dimensions, the blank board was formed. The blank boards were produced by using 16mm-thick sticks and pressing under hot press (Cemil Usta SSP180, Turkey) at 180 °C, 160 bar for 4 minutes.

In order to determine the resultant boards' fire resistance, ASTM-E69 standard was used.

Burning tests were carried out in accordance with ASTM E-69 standard in Furniture and Decoration Department Laboratory of Karabük Technical University's Technical Education Faculty. According to this standard, the samples from experimental boards (in dimensions of 9.5x16x1016 mm) were weighed on a digital scale (in 0.01g increment) in order to determine the weight loss during the combustion. Along with the weight loss, the values of O₂, CO, NO, the maximum temperature, and chimney temperature were also determined. In flame-caused combustion, the butane gas was used in the way temperature reached at 1000 °C. After the start of combustion, the first 4 minutes were flame-caused combustion (FCC), while resting 6 minutes were self-combustion (SC). The measurements were automatically recorded in every 30 seconds.

Results and Discussion

The mean FCC and SC values obtained as a result of combustion experiment were evaluated separately. The mean values of weight loss, maximum temperature, chimney temperature, O₂, CO, and NO obtained as a result of FCC and SC are presented in Table 1. As seen in Table 1, the weight loss values varied depending on the type of fire retardant used and the amount of use. When the results of FCC and SC are examined together, it can be seen that, in use of both of Siriono 110 (S110) and boric acid (BA), the increasing concentration decreased the loss of weight. The highest level of weight loss was observed in control group with values of 22.4% in FCC and 44.7% in SC. The highest level of weight loss in presence of fire retardant (FR) was observed in 5% of S110 (17.4% in FCC) and in 5% BA (29.45% in SC). The lowest

levels of weight losses for FCC and SC (11.87% and 18.85%, respectively) were obtained in use of 12% BA. Given these weight loss results obtained from the experiments, it can be concluded that the weight losses are related with the structure of chemical materials and various factors play role in weight loss. Because of their structural properties, fire retardant chemicals alter the combustion mechanism by catalyzing the polymerization and dehydration reactions, decreasing the pyrolysis temperature, increasing the carbonization, and decreasing the level of combustible gases (Holmes 1974; Özdemir and Tutuş, 2012). Among the press conditions during the production of boards, the temperature and pressure affect the concentration of chemicals on board and the density of board. Depending on the increasing density, the carbonization increases and the penetration and propagation of flame decrease (White and Nordheim 1992; Özdemir and Tutuş, 2012).

As seen in Table 1, the highest maximum temperature level was observed in control samples (187.6 °C in FCC and 150.8 °C in SC). On the other hand, the lowest level of maximum temperature was observed in 12% BA concentration (161.5 °C in FCC and 121.3 °C in SC). These results indicated that, except of 5% concentration of BA in FCC, increasing concentration of fire retardant (FR) decreased the maximum temperature level. For SC, it was observed that increased concentration of S110 raised the maximum temperature values and BA decreased the maximum temperature levels. This may indicate that BA prevents the combustion better than S110 does.

Table 1. Results for mean weight loss, maximum temperature, chimney temperature, O₂, CO and NO levels obtained as a result of FCC and SC

Fire retardant materials	Rate	FFC			SC		
		5%	9%	12%	5%	9%	12%
Siriono 110 (S110)	Weight loss (%)	17.4	16.5	15.9	29.3	27.9	25.8
Borik acid (BA)		13.51	12.58	11.87	29.45	20.80	18.85
Control			22.4		44.7		
Siriono 110 (S110)	Maximum temperature (°C)	170.0	166.4	165.9	140.3	142.3	145.7
Borik acid (BA)		135.8	165.3	161.5	130.9	124.9	121.3
Control			187.6		150.8		
Siriono 110 (S110)	Chimney temperature(°C)	117.0	117.3	118.6	75.8	75.7	79.1
Borik acid (BA)		99.25	112.75	110.00	70.08	71.83	71.33
Control			134.7		93.9		
Siriono 110 (S110)	O ₂ (ppm)	20.4	20.2	20.2	19.8	19.7	19.6
Borik acid (BA)		19.80	20.12	20.11	20.23	19.68	19.76
Control			19.9		19.3		
Siriono 110 (S110)	CO (ppm)	52.3	55.6	56.9	101.8	126.8	132.3
Borik acid (BA)		85.3	58.6	60.3	289.8	147.4	124.2
Control			68.9		198.9		
Siriono 110 (S110)	NO (ppm)	22.0	26.5	28.5	36.1	38.6	41.3
Borik acid (BA)		33.0	21.8	21.3	25.2	30.8	29.1
Control			36.5		54.1		

Throughout the experiment, it was observed that the temperature of chimney decreased when the source of flame was closed. For FCC and SC, the highest levels of chimney temperature were observed in control sample as 134.7 °C and 93.9 °C, respectively, while the lowest values were found in 5% concentration of BA as 99.25 °C and 70.8 °C, respectively. Except for 12% concentration of BA, it was seen that increasing FR concentration caused slight increases in chimney temperature values.

Mean O₂ values obtained were at minimum in 5% BA concentration with 19.80 ppm, and maximum value was observed to be 20.40 ppm in 5% S110. In FCC, S110 was observed to be more effective than BA. On the other hand, for SC, the lowest value was found to be 19.3ppm in control sample, the maximum value was found to be 20.23ppm in 5% BA concentration. According to these results, it can be stated that,

while S110 is more effective in FCC in terms of O₂ level, BA is more effective in SC. Higher level of O₂ indicates that O₂ is consumed less and the combustion is more difficult.

Given the CO results, it can be seen that the highest values for FCC and SC were found to be 68.9 ppm and 198.9 ppm in control sample, while the lowest values were found to be 52.3ppm and 101.8 ppm in 5% S110 concentration. Increasing concentration of S110 use was observed to increase the CO amount, while the same doesn't apply to the use of BA. Furthermore, for both of FCC and SC, CO values of S110 were determined to be lower than those of BA. This is believed to be due to decreasing effect of S110 on toxic gases, besides its fire retarding effect.

The highest NO values as a result of FCC and SC were found to be 36.5 ppm and 54.1 ppm in control sample, while the lowest values were

determined to be 21.3 ppm in 12% of BA for FCC and 25.2ppm in 5% of BA for SC. On the contrary with CO results, these results indicate

that the use of BA is more effective from the aspect of NO.

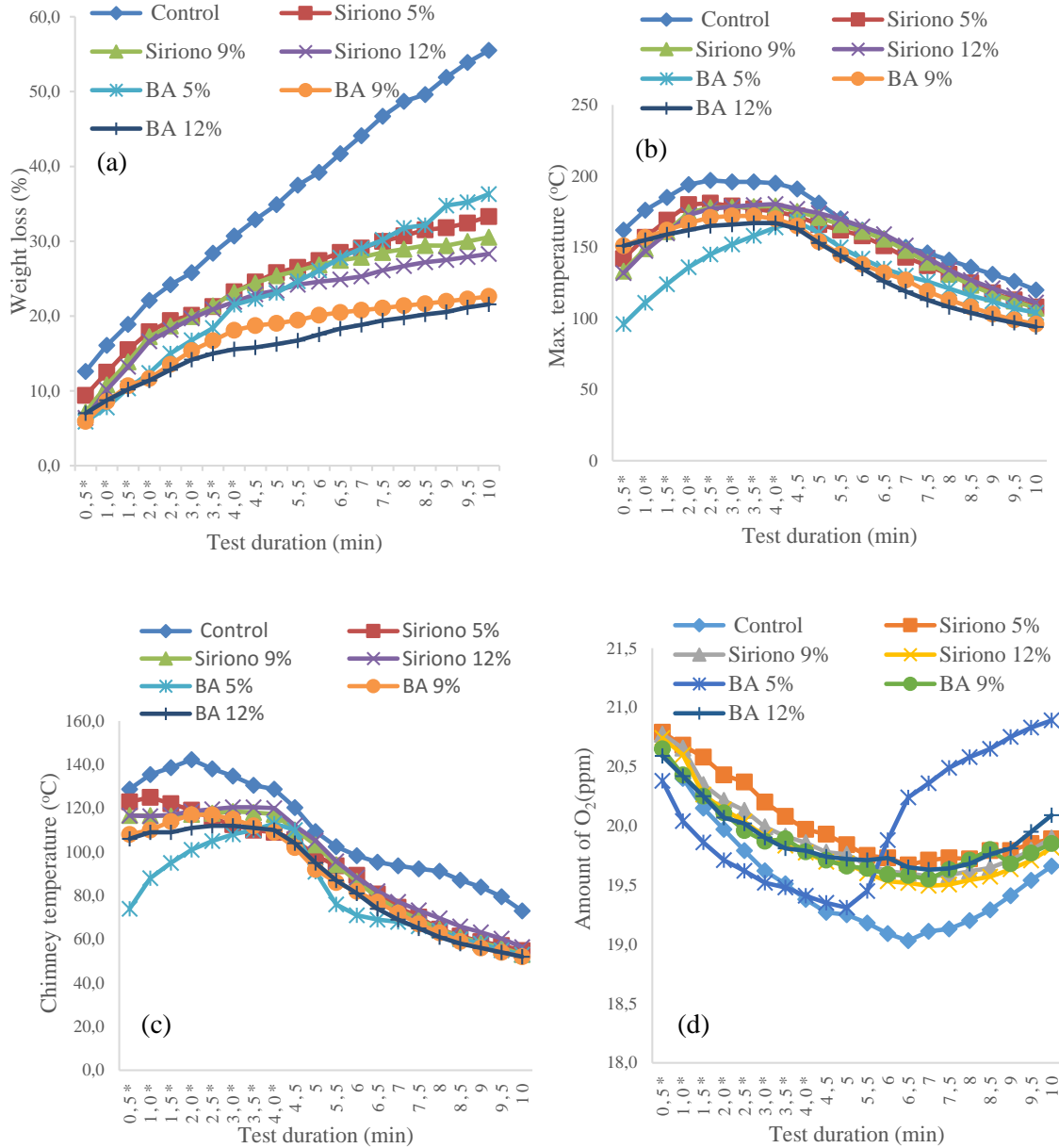

Figure 1. For S110- and BA-added boards and FR-free control boards, the weight loss (a), maximum temperature (b), chimney temperature (c) and O₂ (d) values (*: Flame-Caused Combustion)

For the boards added with various concentrations of S110 and BA and the FR-free control boards, the weight loss values, O₂

amounts, and maximum temperature and chimney temperature values obtained as a result of combustion experiments are presented in

Figure 1. As it can be seen in Figure 1, in FR-added board groups, decreases in mass loss were observed in similar with increasing concentration of FR (İstek et al., 2013; Ustaömer, 2008; Özdemir, 2012). Increasing concentration, also the amount of chemical penetrating into the fibrous matters increases. Consequently, the FR chemicals gathering on or near the surface constitute a protector layer, decrease the combustion speed of boards and increase the duration of resistance to combustion (Özdemir and Tutuş, 2011). The lowest level of weight loss was observed to be 21.58% in 12% BA concentration, while the highest level of weight loss reached at 55.5% in control group. At 9% and 12% concentrations, BA was observed to be more effective than S110.

In Figure 1b, when maximum temperature values are considered, it can be seen that the use of FR caused decreases in maximum temperature levels. The highest maximum temperature level was found to be 120 °C in control sample, while the lowest level was observed to be 94 °C in 12% BA concentration. Except for 12% S110 concentration, decreases were found in temperature values by means of increases in FR concentrations. Because of their properties of absorbing the temperature, preventing the inflammation, and cooling the

flames, chemicals are considered to cause decreases in temperature values (Özdemir, 2012). İstek et al.(2013) have examined the lowest level of temperature in use of BA among boron fire retardants, and reported that boron compounds decreased the temperature by retarding the combustion. In our study, when maximum temperature levels of BA and S110 are compared, it can be seen that BA better prevented the increase of temperature. This is believed to be caused from the boron compounds decreasing the pyrolysis temperature of wood and increasing the carbonization level (Özdemir and Tutuş, 2011; Ellis et al., 1987; Stevens 2006).

In Figure 1c, it can be seen that there were decreases in chimney temperature values with the use of FR. The highest chimney temperature value was found to be 73 °C in control board, while the lowest value was found to be 52 °C in 0% and 12% BA concentrations. From the aspect of chimney temperature values, it can be seen that the difference between BA and S110 was very low.

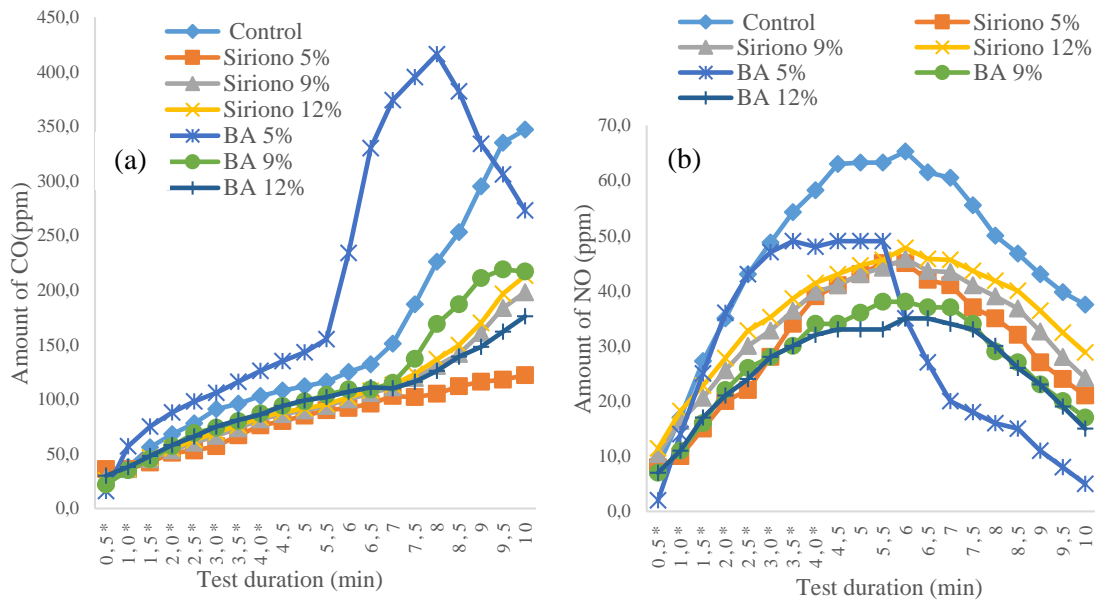

Figure 2. For S110- and BA-added boards and FR-free control boards, CO (a) and NO (b) levels (*: Flame-Caused Combustion)

In Figure 1d, it can be seen that O₂ levels increased with the use of FR. Higher levels of O₂ indicate lower consumption of O₂ in medium and less combustion. The lowest O₂ level was found to be 19.7ppm in control board, while the O₂ values obtained by using S110 and BA were found to be very close to each other.

In Figure 2, CO and NO values of S110- and BA-added boards and FR-free control boards are presented. Considering the CO values presented in Figure 2a, while the highest level of CO was found to be 34ppm in control sample, the lowest value was found to be 112ppm in 5% S110 concentration. When compared to BA, the use of S110 was observed to cause lower level of CO gas. Moreover, it can be seen that BA and S110 exhibited different characters in terms of CO gas. The level of CO is seen to increase with increasing concentration of S110, it is observed to decrease with increasing concentration of BA. İstek et al. (2013), in their study carried out with different FR materials, have found CO values to be 597ppm, 585ppm, and 410ppm at 1%, 2%, and 3% of BA, respectively.

In Figure 2c, the NO values obtained as a result of combustion experiment are presented. When compared to control sample, it can be

seen that the NO values of FR-added boards are lower. The highest NO value was found to be 37.5 ppm in control board, while the lowest value was found to be 5ppm in 5% BA concentration. When comparing BA and S110, the use of BA was found to be related with lower NO values.

Conclusions

Besides of the concentration, the production parameters, density, and the active anti-fire matter constituting FR material may also play role in efficiency of fire retardant materials. In our study, where we investigated the effects of using S110 and BA in particleboard production, the use of BA was seen to be more effective than using S110. Temperature values and O₂, CO and NO amounts were observed to vary depending on if flame source is on or off. With the increasing of FR concentrations, the weight losses were seen to decrease. From the aspect of weight loss, the most effective results were obtained from 12% of BA and S110 concentrations. When compared to control sample, 61.12% and 49.01% weight losses were observed in use of 12% BA and 12% S110. In similar with FR concentration, the level of O₂ consumption was seen to increase in proportion

to control sample. This indicates that the combustion slows and FRs used are effective.

References

ASTM E-69., 2007. Standart Test Method For Combustible Properties of Treated Wood by the Fire-Tube Apparatus.

Aydın, D. Y., Gürü, M., Ayar, B., Çakanyıldırım, Ç. 2016. Bor bileşiklerinin alev geciktirici ve yüksek sıcaklığa dayanıklı pigment olarak uygulanabilirliği, Journal of Boron, 1(1), 33-39.

Baysal, E. 2002. Determination of oxygen index levels and thermal analysis of scots pine impregnated melamine formaldehyde-boron combinations, Journal of Fire Sciences. 20(9), 373-389.

Ellis, D.W., Rowell, M.R. 1989. Flame retardent treatment of wood with a diisocyanate and an oligomer phosphonate. Wood and Fiber Science, 21(4), 367-375

Gürü M, Ayar B, Çakanyıldırım Ç, Özmen L, Alev ve yüksek sıcaklığa dayanıklı boya ve üretim yöntemi incelemeli Patent TR 2007 02470 B, 21.10.2010.

Holmes, C.A. 1974. The fire performance of wood and its provement by fire retardent treatments, american wood preserves; Association, 95-102.

İstek, A. Aydemir, D. Eroğlu, H. 2013. Combustion properties of medium density fiberboard coated by a mixture of calcite and various fire retardants. Turkish Journal Of Agriculture And Forestry, 37(5): 642-648.

İstek, A. Aydemir, D. Eroğlu, H. 2012. Surface properties of mdf coated with calcite/clay and effects of fire retardants on these properties. Maderas Ciencia Tecnología. 14(2), 135-144.

Kartal, S. N., Imamura, Y. 2004. The use of boron as wood preservative system for wood and wood-based composites, 2nd International Boron Symposium, (23-25 September 2004), 153 – 164, Eskişehir, Turkey

Özdemir, F., Tutuş, A. 2012. Investigation on increasing resistance of laminate flooring against combustion. KSU J. Engineering Sci., Special Issue, 83-89

Özdemir, F., Tutus, A. 2013. Effects of fire retardants on the combustion behavior of high-density fiberboard. BioResources, 8(2), 1665-1674.

Özdemir, F., 2012. Yanmayı geciktirici çeşitli kimyasal maddelerin laminat parkenin bazı özellikleri üzerine etkilerinin araştırılması, Doktora Tezi, K.S.Ü Fen Bilimleri Enstitüsü, 243 s. Kahramanmaraş.

Öztürk, O., 2003. Fiber levha kompozitlerinin fiziksel ve mekanik özelliklerinin polimerlerle iyileştirilmesi için alternatif yöntemler, Yüksek Lisans Tezi, Hacettepe Üniversitesi Fen Bilimleri Enstitüsü, 89 s. Ankara.

Stevens, R., Es, S.V.D., Bezemer, R., Krenanbarg, A. 2006. The structure-activity relationship of fire retardent phosphorus compounds in wood. Polymer Degredation and Stability, 78, 211-218

URL-1: <http://polychimique.com/product.html>

Ustaömer, D., 2008. Çeşitli yanmayı geciktirici kimyasal maddelerle muamele edilerek orta yoğunluklu lif levhaların (mdf) özelliklerindeki değişimlerin belirlenmesi, Doktora Tezi, KTÜ, Fen Bilimleri Enstitüsü, 244 s.Trabzon,

Uysal, B., Özçifçi, A. 2004. The effects of impregnation chemicals on combustion properties of laminated wood material. Combustion Science and Technology, 176(1), 117-133.

White, H.R., Nordheim, V.E. 1992. Charring rate of wood for astm E119 exposure, Fire Technology, 28(1), 5-24.

Yalınkılıç, M. K., Baysal, E., Demirci, Z. 1997. Fire resistance of calabrian pine (*Pinus brutia* (Ten.)) wood treated with some boron compounds and or water repellents. Turkish. Journal of Agriculture and Forestry, Vol 4: 423-431

The Effect of Moisture Content on the Screw Holding Capacity of Birch and Pine Plywood

Bekir Cihad BAL

Kahramanmaraş Sütçü İmam University, Faculty of Forestry,
Kahramanmaraş/TURKEY
bcbal@hotmail.com

Abstract

Plywood and OSB are used for wooden construction as covering materials. Solid lumber and structural composite lumbers, such as LVL, PSL, and OSL, are used as the main members. Different type of nails, screws, and bolts are used to assemble the members to each other in connection points of the wooden construction. There are many different factors that affect the durability of the connection points. For example, these factors include the species of the tree, the composition of the material, density of material, type of fasteners, and the thickness of the material. In previous studies, the effects of these factors on the fasteners' holding capacity were studied. Therefore, the effects of moisture content on the screw holding capacity of plywood were investigated at different moisture percentages, i.e., approximately 0, 10, 20, 30, and 40% and at the maximum moisture content. According to the data that were obtained, how the moisture content affects the screw holding capacity of birch and pine plywood were determined.

Keywords: Screw holding capacity, plywood, moisture content

Huş ve Çam Kontrplağın Vida Tutma Kapasitesi Üzerine Rutubet Miktarının Etkisi

Özet

Kontrplak ve OSB, ahşap yapılarda kapama malzemesi olarak kullanılmaktadır. Masif kereste, LVL, PSL ve OSL gibi yapısal kompozit keresteler de taşıyıcı eleman olarak ahşap yapılarda kullanılmaktadır. Farklı tiplerde çiviler, vidalar ve cıvatalar ahşap yapıların bağlantı noktalarında, parçaları birbirine tutturmak için kullanılmaktadır. Bağlantı noktalarının sağlamlığını etkileyen birçok farklı faktör bulunmaktadır. Bu faktörler ağaç türü, malzeme kombinasyonu, malzeme yoğunluğu, birleştirme gereci tipi, malzeme kalınlığı şeklindedir. Önceki çalışmalarda, bu faktörlerin birleştirme gerecinin tutma kapasitesi üzerine etkileri çalışılmıştır. Bu nedenle, kontrplağın vida tutma kapasitesi üzerine rutubet miktarının etkileri, %0, 10, 20, 30, 40 ve maksimum rutubet miktarı şeklindeki rutubet seviyelerinde araştırılmıştır. Elde edilen bulgulara göre, rutubet içeriğinin huş ve çam kontrplağın vida tutma kapasitesini nasıl etkilediği belirlenmiştir.

Anahtar Kelimeler: Vida tutma kapasitesi, kontrplak, rutubet miktarı

Introduction

Plywood is referred to as the original engineered wood product because it was one of the first wood-based panels to be made by bonding pieces of wood together (Anon, 2012). Plywood is manufactured using rotary-peeled veneer sheets from different species of trees. Generally, species with medium density wood are preferred. In Turkey, beech, poplar, pine, birch, and some exotic species imported from other countries are used for producing plywood. The properties of tree species used in the production of plywood affect the technological properties of the plywood. In addition, the moisture content and thickness of the veneer, the type of adhesive, the pressure and temperature of the press affect

the properties of plywood (Özen, 1981; Örs et al., 2002; Aydın and Çolakoğlu, 2008; Bal and Bektaş, 2013; Bal and Bektaş, 2014).

The appearance of the surface of the plywood is one of the major properties of plywood that is used in the production of furniture and as interior decoration. The mechanical performance of the plywood is a major property for plywood that is used in the construction of buildings, forming cement, and in some other heavy-duty usages. Fastener holding capacity of the plywood is one of the most important properties of plywood that is used in the construction of buildings, and many researchers have conducted studies to address this issue. For example, Erdil et al. (2002) determined the

screw holding capacity of hardwood and softwood plywood, and they reported that the screw holding capacity of plywood can be predicted as functions of the screw diameter, the depth of penetration, and the density of the panel. Herzog et al. (1999) determined nail-withdrawal and nail head-pull through strength for different conditions. But, there are limited studies about the effects of moisture content on the screw holding capacity of plywood. Therefore, in this study, we focused on how the moisture content affects the screw holding capacity of pine and birch plywood.

Material and Method

Birch and pine plywood panels were used to prepare test samples. The panels were bonded using phenol formaldehyde adhesive. The birch plywood was produced using 13-ply veneers, and the pine plywood was produced using 9-ply veneers. Some parts of three different plywood panels were used. Equal numbers of test samples were prepared from the same parts to set up homogeneous test groups. The dimensions of the test samples were 19 x 50 x 50 mm (thickness, width, and length). Six test samples, i.e., Groups A, B, C, D, E, and F, were prepared for different moisture percentages, i.e., approximately 0, 10, 20, 30, 40%, and the maximum moisture content, respectively. Twenty samples were prepared for screw withdrawal tests in both the birch and pine groups. After that, the test samples were dried in an oven at a temperature of 103 ± 3 °C until their moisture content was 0%. Then, they were weighed and measured.

Group A was immediately tested at 0% moisture content.

Group B was stored in a climatic chamber at a temperature of 20 °C and 65% relative humidity. Some test samples were weighed every day. When the moisture content reached 10%, the screw tests were conducted.

Group C was stored in a climatic chamber at a temperature of 20 °C and 90% relative humidity. Some test samples were weighed every day. When the moisture content reached 20%, the screw tests were conducted.

Group D was placed in distilled water at room conditions for one week. Afterwards, the test samples were stored in a climatic chamber at a temperature of 20 °C and 50% relative humidity. Some test samples were weighed every day. When the moisture content reached 30%, the screw tests were conducted.

Group E was placed in distilled water at room conditions for one week. Afterwards, the test samples were stored in a climatic chamber at a temperature of 20 °C and 50% relative humidity. Some test samples were weighed every day. When the moisture content reached 40%, the screw tests were conducted.

Group F was placed in distilled water at room conditions for two weeks. At the end of this period, the test samples were weighed. Then, the screw tests were conducted immediately.

The moisture content and density of the test samples were determined according to TS EN 322 and TS EN 323, respectively. Zinc screws were used in the screw tests. The dimensions of the flathead screws were 4 x 50 mm (shank diameter x length). The screw withdrawal tests were conducted according to TS EN 13 446.

The tests were conducted on Losenhhausen test machines (Fig. 1) using the Robutest program. The speed of the test was 4 mm/min. The data that were obtained were evaluated using the SPSS statistical software program. One-way ANOVA was used for the evaluations. Significant differences were determined by the Tukey comparison tests.

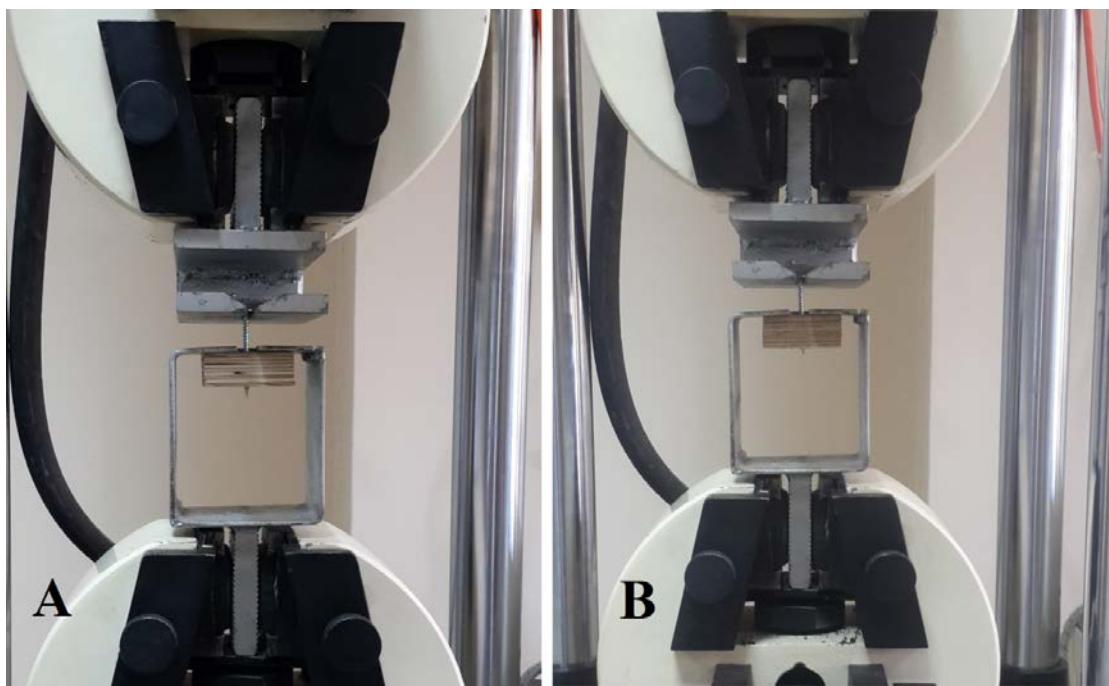

Figure 1. Screw holding capacity test: A) Pine plywood; B) Birch plywood

Result and Discussion

Table 1 provides the moisture content, density, and screw holding capacity of pine plywood and birch plywood. When the data in Table 1 were analyzed, it was observed that the moisture content of the test groups were very close to dedicated to moisture content of the groups. In addition, there was no significant difference between the moisture contents of the pine and birch plywood. But, there was a significant difference between the densities of the pine and birch plywood. This result was expected due to the difference in the density of wood from pine trees and birch trees. Concerning this issue, in previous studies, many researchers have reported that the density of plywood was greater than the density of the wood that was used to produce the plywood (Bal and Bektaş, 2014; Çolak et al., 2003; Örs et al., 2002; Özen, 1981). In addition, hardwood plywoods (except okume, poplar, and some other trees) have greater density than softwood plywoods (Bozkurt and Göker, 1986; Aydın and Çolakoğlu, 2008). Density is one of the many important factors that affect the technological properties of solid wood and wood-based panels. There are many factors that affect the density of trees, including the species (Bozkurt and

Erdirin, 1997; Bal, 2011), extractive contents (Bozkurt and Erdirin, 1997; Bal et al., 2012), moisture content (Kollmann and Cote, 1968; Bozkurt and Göker, 1996), juvenile wood (Githiomi and Kariuki, 2010; Bal and Bektaş, 2012), fiber morphology (Kojima et al., 2009; Bal, 2012). In general, as the densities of solid wood or wood-based panels increase, their mechanical properties also increase (Çolak et al., 2003; Kurt and Çil, 2012). Therefore, it was expected that the density of the birch plywood would be greater than that of the pine plywood.

Table 1. Moisture content, density, screw holding capacity of test samples, and Tukey results

Groups		Pine Plywood			Birch plywood		
		MC	D	SHC	MC	D	SHC
		%	g cm ⁻³	N mm ⁻²	%	g cm ⁻³	N mm ⁻²
A (0%)	x	0.34	0.511	31.7a	0.28	0.624	48.8a
	ss	0.15	0.028	4.3	0.12	0.018	4.0
B (10)	x	11.1	0.506	30.9ab	10.2	0.622	45.8b
	ss	0.2	0.034	5.6	0.2	0.017	3.4
C (20)	x	20.3	0.503	27.4bc	21.7	0.623	39.5c
	ss	0.7	0.041	3.2	1.2	0.014	2.6
D (30)	x	30.3	0.505	25.4cd	31.4	0.611	35.2d
	ss	1.7	0.027	3.5	2.9	0.018	3.0
E (40)	x	39.7	0.500	22.2d	39.4	0.613	30.0e
	ss	3.0	0.035	3.9	2.4	0.024	2.9
F (max)	x	65.6	0.504	22.5d	67.4	0.621	28.7e
	ss	4.6	0.036	2.4	1.8	0.020	2.0

MC: moisture content, D: density, SHC: screw holding capacity, x: arithmetic mean, ss: standard deviation, F (max) indicates the moisture content at the end of two weeks immersion.

The test results of the screw holding capacity of pine and birch plywood are given in Table 1. The results indicate that the screw holding capacity decreased as the moisture content increases, and the decrement was statistically significant ($p < 0.001$). The difference between groups A and F of pine plywood was approximately 30%. The differences for birch plywood were approximately 42%. So, it was apparent that the birch plywood was affected to a greater extent by increasing moisture content than the pine plywood. Groups A and B of pine plywood were close to each other. The same groups of birch plywood were quite different. The differences between groups E and F were insignificant for both pine and birch plywood. Thus, it can be said that the screw holding capacity of the plywood panels decreased as their moisture content increased. Similar results were obtained by Wu (1999) concerning this issue. He studied that effects of moisture content on screw withdrawal and reported that screw holding capacity decreased as the moisture content increased (from 7% to 20%). But, he also reported that there were no significant differences in screw holding capacity when the moistures contents were 21% and 62%. In addition, it has been demonstrated that other mechanical properties

of plywood panels, e.g., the modulus of elasticity, bending strength, and shear strength, were affected by changes in the moisture content below the fibre saturation point (Aydm et al., 2006).

Figs. 2 and 3 shows the relationship between screw holding capacity and moisture content in pine plywood and birch plywood, respectively, based on the data that were obtained in our tests.

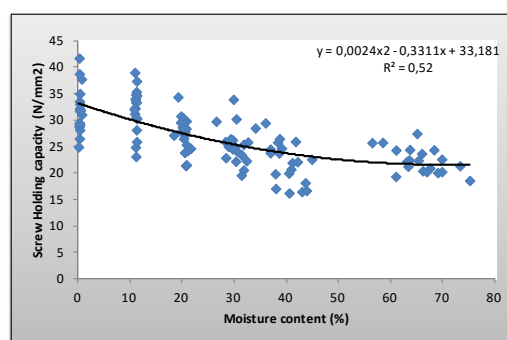

Figure 2. Relationship between screw holding capacity and moisture content in pine plywood

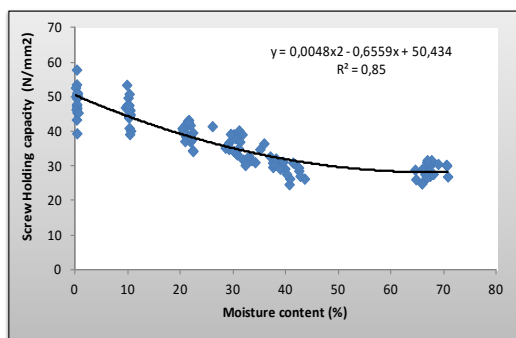

Figure 3. Relationship between screw holding capacity and moisture content in birch plywood

It was determined that the equations of these relationships were polynomials, as can be seen in Figs. 2 and 3. In addition, the coefficients of determination (R^2) for the relationship between screw holding capacity and moisture content were 0.52 and 0.85 for the pine plywood and birch plywood, respectively. According to these coefficients of determination, both relationships were significant. In addition, the coefficient of determination of the relationship for birch plywood was greater than that of pine plywood. Similar results were reported by Wu (1999). This difference probably is due to the density of the birch plywood. It is well known that the density of solid wood and wood-based panels affect their wood-water relationships (Özen, 1981; Kurt and Çil, 2012)

Conclusions

In this study, the effects of moisture content on the screw holding capacity of pine plywood and birch plywood were determined. According to data that were obtained, the following results can be inferred; the screw holding capacity of the plywood panels decreased as their moisture content increased, but there were no significant differences between groups E and F. The decrement of screw holding capacity of the birch plywood was more than that of the pine plywood. There are significant polynomial relationships between moisture content and screw holding capacity of pine plywood and birch plywood. In addition, the coefficient of determination of the relationship for birch plywood was greater than that for pine plywood due to the density of the birch plywood.

References

- Anonimous, 2012. Milestones in the History of Plywood, The Engineered Wood Association. APA, <http://www.apawood.org/>
- Aydin I., Colakoglu G., Colak S., Demirkir, C. 2006. Effects of moisture content on formaldehyde emission and mechanical properties of plywood. *Building and Environment*, 41(10), 1311-1316.
- Aydın İ., Çolakoğlu G. 2008. Variations in bending strength and modulus of elasticity of spruce and alder plywood after steaming and high temperature drying, *Mechanics of Advanced Materials and Structures*, 15 (5): 371 -374
- Bal BC., Bektaş i, Kaymakçı A., 2012. Toros Sedirinde Genç Odun ve Olgun Odunun Bazı Fiziksel ve Mekanik Özellikleri, KSÜ, *Journal of Engineering Sciences* 15 (2):17-27.
- Bal BC., Bektaş İ., 2012. The physical properties of heartwood and sapwood of *Eucalyptus grandis*, *Pro ligno*, 8 (4):35-43.
- Bal BC., 2012. Genç Odun ve Olgun Odunun Lif Morfolojisindeki Farklılıklar Üzerine Bir Araştırma, Düzce üniversitesi, orman fakültesi dergisi, 8(2): 29-36
- Bal BC., Bektaş İ., 2013. Okalıptüs, Kayın ve Kavak Kaplamalarından Üretilen Kontrplakların Eğilme Özellikleri, *Kastamonu Ün. Orman fak. dergisi*, 13 (2): (175-181).
- Bal BC., Bektaş İ., 2014. Some mechanical properties of plywood produced from eucalyptus, beech, and poplar veneer, *Maderas-Cienc y Tecnol* 16(1):99-108.
- Bozkurt Y., Göker Y., 1996. Fiziksel ve Mekanik Ağaç Teknolojisi, İÜ, Orman Fakültesi Yayınları, Üniversite Yayın No:3944, İstanbul.
- Bozkurt Y., Göker Y., 1986. Tabakalı Ağaç Malzeme Teknolojisi Ders Kitabı, İÜ, Orman Fakültesi Yayınları, Üniversite Yayın No: 3401, İstanbul.
- Bozkurt Y., Erdin N., 1997. Ağaç Teknolojisi Ders Kitabı, İ.Ü. Orman Fakültesi, Yayın no: 445, S: 1, İstanbul.
- Çolak S, Aydın İ, Çolakoğlu G, 2003. Okalıptüs (*E. camaldulensis*) ağacının farklı yüksekliklerinden alınan tomruklardan üretilmiş kontrplakların bazı mekanik özellikleri. *DOA dergisi*, 9, 95-111.
- Githiomi JK., Kariuki J.G., 2010. Wood basic density of *E. Grandis* from plantations in central rift valley, Kenya: variation with age, height level and between sapwood and heartwood, *J of Trop For Sci* 22(3): 281-286.
- Herzog B., Yeh B., Ph, D., 1999. Nail Withdrawal and Pull-Through Strength of Structural-Use Panels Nail Withdrawal Strength of Plywood and OSB. In *Proceedings of the 9 th World Conference on Timber Engineering* (pp. 6-10).

Kollmann FF., Cote Jr WA., (1968) Principles of wood science and technology. vol. I. Solid Wood. In Principles of Wood Science and Technology. Vol. I. Solid Wood. Springer-Verlag.

Kojima M., Yamamoto H., Yoshid M., Ojio Y., Okumura K., 2009. Maturation property of fast-growing hardwood plantation species: a view of fiber length, For Ecol and Manag 257 (2009) 15–22.

Kurt R., Cil M., 2012 Effects of press pressures on glue line thickness and properties of laminated veneer lumber glued with phenol formaldehyde adhesive. BioResources 7: 5346–5354.

Özen R., 1981. The investigations on the effects of various factors on physical and mechanical properties of plywood, Karadeniz Technical University, Faculty of Forestry publications, No. 9, Trabzon.

Örs Y., Çolakoğlu G., Aydın İ., Çolak S., 2002. Kayın, okume ve kavak soyma kaplamalarından farklı kombinasyonlarda üretilen kontrplakların bazı teknik özelliklerinin karşılaştırılması. Politeknik, 55(3), 257–265.

TS EN 322. 1999. Wood-based panels- Determination of moisture content, TSE, Ankara.

TS EN 323. 1999. Wood based panels- Determination of density. TSE, Ankara.

TS EN 13 446, 2005, Wood based panels- Determination of withdrawal capacity of fasteners, TSE, Ankara.

Wu Q., 1999. Screw-holding capacity of two furniture-grade plywoods, Forest products journal, 49(4): 56-59.

The Effect of the Type of Combination on the Screw and Nail Withdrawal Strength of Eucalyptus and Poplar LVL

Bekir Cihad BAL

Kahramanmaraş Sütçü İmam University, Faculty of Forestry,
Kahramanmaraş/TURKEY
bcbal@hotmail.com

Abstract

Structural composite lumbers, such as laminated veneer lumber (LVL), parallel strand lumber (PSL), and laminated strand lumber (LSL) are used for wooden constructions as building materials. These materials are produced from low- or medium-density wood species. Fast-growing wood species are preferred in many areas due to their low cost. In this study, LVL panels were produced from rotary-peeled veneers of eucalyptus and poplar trees using phenol formaldehyde adhesive. LVL panels were produced in four different combinations. Screw and nail withdrawal strength of LVL was determined according to TS EN 13446. The data that were obtained were analyzed statistically using the SPSS software program. Based on the results of the experiments, we determined the effects of the types of combinations of eucalyptus and poplar LVL on the screw and nail withdrawal strength.

Keywords: Screw withdrawal strength, Nail withdrawal strength, LVL

Okalıptüs ve Kavak TKK'nın Vida ve Çivi Tutma Direnci Üzerine Kombinasyon Tipinin Etkisi

Özet

Tabakalı Kaplama Kereste (TKK), Paralel Şerit Kereste (PŞK) ve Tabakalı Şerit Kereste (TŞK) gibi yapısal kompozit keresteler inşaat malzemesi olarak ahşap yapılarda kullanılmaktadır. Bu malzemeler, düşük ya da orta yoğunluktaki ağaç türlerinden üretilmektedir. Hızlı büyüyen ağaç türleri düşük maliyetlerinden dolayı birçok alanda değerlendirilmektedir. Bu çalışmada, TKK panelleri, fenol formaldehit tutkalı, okalıptüs ve kavak soyma kaplamaları kullanılarak üretilmiştir. TKK panelleri dört farklı kombinasyonda üretilmiştir. TKK panellerinin çivi ve vida tutma dirençleri TS EN 13446 standardına göre belirlenmiştir. Elde edilen bulgular SPSS yazılım programı kullanılarak istatistiksel olarak analiz edilmiştir. Test sonuçlarına dayanarak, okalıptüs ve kavak TKK'nın kombinasyon tipinin vida ve çivi tutma direnci üzerine etkisi belirlenmiştir.

Anahtar kelimeler: Vida tutma direnci, Çivi tutma direnci, TKK

Introduction

Naturally-grown forests are excessively decreasing due to the extensive use of wood and the rapid growth of the population (Anon., 2006). Fast-growing tree plantations are being established to overcome the wood shortage in many countries. The preferred fast-growing tree species are poplar, eucalyptus, some conifer trees, and some other species (Ayan and Sivacıoğlu, 2006). Fast-growing tree species have a shorter rotation than slow-growing trees. But, as a fast-growing tree, the eucalyptus species has some undesirable properties, such as juvenile wood, wide annual rings, and growth stresses (Malan, 1995). Poplar and some conifer species also have undesirable properties, including low

density, wide annual rings, and weak mechanical performance (Tunçtaner et al., 1994). Fast-growing trees are not used in valuable products, such as furniture, decorations, and construction materials, due to their undesirable properties. Instead, fast growing trees are used in wood-based composites, such as fiberboard, particleboard, plywood, and OSB.

LVL is the one of the structural composite lumbers, and it is used in many countries as a main component in constructing buildings. LVL is used for various building elements, such as beams, headers, joists, rafters, scaffold planks, and truss chords (Çolak et al., 2007). Structural composite lumbers, such as LVL, are the load-bearing materials. Plywood and

OSB also are used in constructing buildings. But, these panels are the covering materials. Plywood and OSB are fastened to the structural composite lumbers after the structural lumbers are formed. In constructing buildings, there are two types of fasteners, i.e., small-diameter fasteners (nails, spikes, and wood screws) and large diameter, dowel-type fasteners (bolts, lag screws, and drift pins) (Rammer, 2010). The durability of the construction depends on the fastening members in the connection points between the wooden main members and the covering members. In some cases, such as seismic activity and strong winds, failures can occur in the connection points even though the wooden members have very high mechanical performance (Herzog and Yeh, 2006).

There have been many previous studies about the physical properties (Ayata, 2008; Bal, 2012; Bal Bektaş, 2013) and mechanical properties (Bal et al., 2012; Bal Bektaş, 2014) of eucalyptus solid wood and eucalyptus LVL grown in the Tarsus-Karabucak region. In addition, some technological properties of combination LVL produced from poplar and eucalyptus veneer were investigated, and some positive results were reported (Bal, 2016). From this perspective, the screw withdrawal strength of LVL produced from eucalyptus and poplar veneers was investigated.

Material and Method

Eucalyptus logs were obtained from the Karabucak-Tarsus region in Turkey, and the poplar logs were obtained from Karabük region. Rotary-peeled veneers were obtained from the logs and dried in a plywood factory until the moisture content was $7\pm 1\%$. Phenol formaldehyde (PF) adhesive (Polifen 47) was obtained from Polisan A.Ş. to produce the LVL boards. No additives or fillers were used with the PF adhesive. A manual roller was used to apply the adhesive to the loose surfaces of the veneer in the amount of 200 g m^{-2} . After the adhesive was applied, the veneer sheets were pressed together parallel to each other, with seven veneer sheets with a nominal size of $600 \times 600 \times 3 \text{ mm}$ (length \times width \times thickness) for each LVL board. The LVL boards were pressed in a laboratory press for 24 min. Because poplar wood has a lower density than eucalyptus wood, the press pressures for groups A, B, C, and D were 7, 7, 7, and 12 kg cm^{-2} , respectively. Figure 1 shows the four different test groups. The first group contained only poplar veneers (Group A). The second group had two plies of eucalyptus veneers and five plies of poplar veneers (Group B). The third group contained four plies of eucalyptus and three plies of poplar veneers (Group C). The fourth group only contained eucalyptus veneers (Group D). Samples with the dimensions $20 \times 70 \times 70 \text{ mm}$ (thickness \times width \times length) were cut from the boards for use in the screw withdrawal tests.

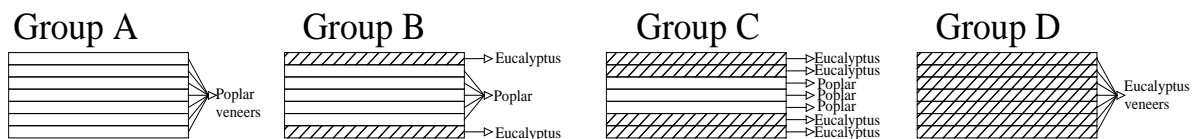

Figure 1. The type of the LVL groups

The test samples were stored in a climatic chamber at a temperature of $20\pm 2 \text{ }^\circ\text{C}$ and $65\pm 5\%$ relative humidity for three weeks. The air-dried density (D), moisture content (R), and screw withdrawal strength and nail withdrawal strength were determined according to TS EN 323 (1999); TS EN 322 (1999); and TS EN 13446 (2005),

respectively. Fifteen test samples were prepared for each group. The screws and nails were manually fixed to the test samples, and they protruded from the samples. The dimensions of the screws were $4 \times 50 \text{ mm}$. Ring nails were used for the tests, and their dimensions were $2.6 \times 60 \text{ mm}$.

Results and Discussion

Table 1 provides the data from the density, equilibrium moisture content, screw withdrawal strength, and nail withdrawal tests; the table also provides ANOVA and Duncan results. When the data related to density in Table 1 were analyzed, it was observed that the lowest density was in Group A, and the highest density was in Group D. The differences between the groups were significant ($p < 0.001$). These results were expected due to high density of the eucalyptus wood. It is well known that the density of wood species affects the density of wood-based composite products. Veneer-based composite products, such as plywood, LVL, and PSL produced from high-density wood species, have higher density than similar products produced from low-density wood

species (Çolak et al., 2003; Çolak et al., 2007; Kurt and Çil, 2012; Bal and Bektaş, 2013). The density of the product is one of the most important factors that affect the technological properties of the product. Many researchers have reported that the mechanical properties of the products increase as the their densities increase (Özen, 1981; Örs et al., 2002; Kurt and Çil, 2012; Bal and Bektaş, 2014; Gaff and Gašparík, 2015; Bal, 2016).

The moisture content of Group A at the end of three weeks was the highest and that of Group D was the lowest. The differences between Groups A and D were significant ($p < 0.01$). It is thought that the reason for this difference was the permeability of the species. Poplar wood is more permeable than eucalyptus wood, so the moisture content of group A was greater than that of Group D.

Table 1. Density, moisture content, screw and nail withdrawal, ANOVA and Duncan results

Groups		Density	Moisture content	Screw withdrawal strength	Nail withdrawal strength
		g cm^{-3}	%	N mm^{-2}	N mm^{-2}
Group A	x	0.416a	11.7a	21.3a	19.3a
	ss	0.015	0.2	2.0	1.6
Group B	x	0.502b	11.6ab	26.2b	23.0b
	ss	0.021	0.2	2.6	2.6
Group C	x	0.523c	11.5b	28.9c	24.5b
	ss	0.021	0.5	2.5	2.4
Group D	x	0.616d	11.3b	35.5d	27.6c
	ss	0.026	0.4	3.8	3.1
ANOVA		***	**	***	***

Screw and nail withdrawal strengths are given in Table 1. Also, the ANOVA and Duncan test results are provided in the table. According to the data that were obtained, Group D had the greatest screw and nail withdrawal strength, and Group A had the lowest screw and nail withdrawal strength. The differences between the groups were significant ($p > 0.001$). The screw withdrawal strengths of Groups A, B, C, and D were 21, 26, 28 and 35 N mm^{-2} , respectively. The screw

and nail withdrawal strength increased as the number of eucalyptus veneers increased in the LVL layers.

The relationships between withdrawal strength and density were determined for screw and nail tests using all of the test results. Figs. 1 and 2 show the scatter graphs, regression equations, and coefficients of determination (R^2) that were obtained. An analysis of the graphs indicated that the relationships between withdrawal strength

and density were positive and linear. According to coefficients of determination that were obtained, the relationships were very strong ($R^2 < 0.70$). In addition, the relationship between screw withdrawal and density was a little more than the relationship between nail withdrawal and density. It is thought that the difference originated from the form of the screw. The surface area of the screws that were embedded in the LVL was greater than that of the nails. Similar results were obtained in previous studies (Çelebi and Kılıç, 2007; Yapıcı et al., 2009).

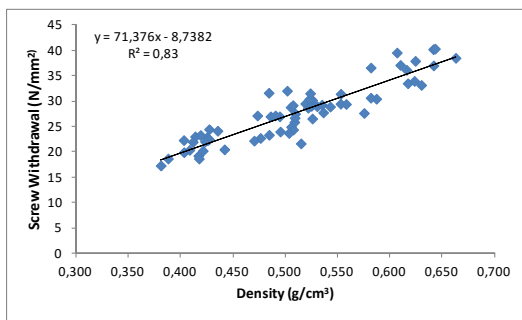

Figure 2. The relationship between screw withdrawal and density

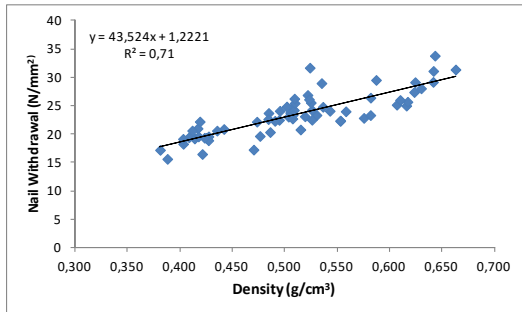

Figure 3. The relationship between nail withdrawal and density

Conclusion

In this study, screw and nail withdrawal strength of LVL produced from poplar and eucalyptus veneers in different combinations were determined. According to data that were obtained, the following results can be inferred; as fast-growing tree species, poplar and eucalyptus can be used in the production of LVL. Eucalyptus LVL has greater density, greater screw withdrawal strength, and greater nail withdrawal strength than poplar LVL. The screw and nail withdrawal strengths of Poplar LVL can be increased by using eucalyptus veneers on the top and bottom

surfaces of the LVL. The relationships between the screw and nail withdrawal strengths and the densities of the veneers were positive, linear, and strong. The coefficients of determination of both relationships were greater than 0.70.

Acknowledgment

Some of the expenses of this study was funded by TÜBİTAK (Project no: 215 O 899), and we thank TÜBİTAK for its support.

References

- Anonymous, 2006. Forestry Special Commission Report, 9th Development Plan, DPT, Ankara.
- Ayata Ü, 2008. Okalptüs (*Eucalyptus camaldulensis* ve *Eucalyptus grandis*)'ün odun özellikleri ve kağıt endüstrisinde kullanımının araştırılması. Kahramanmaraş Sütçü İmam Üniversitesi, Fen bilimleri Enstitüsü, Yüksek Lisans Tezi.
- Bal BC, 2012, Genç Odun ve Olgun Odunun Lif Morfolojisindeki Farklılıklar Üzerine Bir Araştırma, Düzce üniversitesi, orman fakültesi dergisi, 8(2): 29-36
- Bal BC., Bektaş İ., Özdemir F., 2012. Masif ve Lamine Ağaç Malzemelerin Isıl Genleşme Katsayıları Üzerine Karşılaştırmalı Bir Çalışma, Düzce Ün. Orman Fakültesi Dergisi, 8 (1): 77-83.
- Bal BC., Bektaş İ., 2013, Okalptüs, kayın ve kavak soyma kaplamaları ile üretilen tabakalı kaplama kerestelerin bazı fiziksel özellikleri, Artvin Çoruh Ün. Orman Fakültesi dergisi 14 (1):25-35.
- Bal BC., Bektaş İ., 2014. Some mechanical properties of plywood produced from eucalyptus, beech, and poplar veneer, *Maderas-Cienc y Tecnol* 16 (1):99-108.
- Bal BC, 2016. Some technological properties of laminated veneer lumber produced with fast-growing poplar and eucalyptus, *Maderas-Cienc y Technol* 18 (3): 413-424.
- Celebi G., Kilic M. 2007. Nail and screw withdrawal strength of laminated veneer lumber made up hardwood and softwood layers. *Construction and Building Materials*, 21(4), 894-900.
- Çolak S., Aydın İ., Çolakoğlu G., 2003. Okalptüs ağacının farklı yüksekliklerinden alınan tomruklardan üretilmiş kontrplakların bazı mekanik özellikleri, *DOA dergisi*, Sayı:9, 2003, Tarsus
- Çolak S, Çolakoğlu G, Aydın I, 2007. Effects of logs steaming, veneer drying and aging on the

mechanical properties of laminated veneer lumber (LVL), *Build and Environ.* 2007; 42 (1), 93-98.

Gaff M, Gaşparık M. 2015. Influence of densification on bending strength of laminated beech wood, *BioResources*, 10(1), 1506-1518.

Herzog B., Ye, B. 2006. Nail withdrawal and pull-through strength of structural-use panels. *Equilibrium*, 1100, 6-10.

Kurt R., Cil M., 2012. Effects of press pressures on glue line thickness and properties of laminated veneer lumber glued with phenol formaldehyde adhesive. *BioResources* 7: 5346–5354.

Malan S., 1995. Eucalyptus improvement for lumber production. *Seminario Internacional de Utilização da Madeira de Eucalipto, Para Serraria, Sao Paulo*, 15, 05-06.

Örs Y., Çolakoğlu G., Aydın İ, Çolak S., 2002. Kayın, okume ve kavak soyma kaplamalarından farklı kombinasyonlarda üretilen kontrplakların bazı teknik özelliklerinin karşılaştırılması, *Politeknik Dergisi*, 5 (3): 257-265.

Özen R., 1981. Çeşitli Faktörlerin Kontrplağın Fiziksel ve Mekanik Özelliklerine Yaptığı Etkilere İlişkin Araştırmalar, KTÜ, Orman Fakültesi Yayınları, Fakülte yayın No:120

Rammer DR., 2010. Fastenings, *Wood Handbook: Wood as an engineering Material*, USDA Forest Service, Forest Products Laboratory, General Technical Report FPL-GTR-190, Madison, WI (ss. 1–2).

Tunçtaner K., Tulukçu M., Toplu F., 1994. Bazı kavak klonlarının büyümeleri ve teknolojik özellikleri üzerine araştırmalar, kavak ve hızlı gelişen tür orman ağaçları araştırma enstitüsü, *Teknik Bülten* No: 170. İzmit.

TS EN 322, 1999. Wood based panels determination of moisture content, TSE, Ankara.

TS EN 323, 1999. Wood based panels determination of density, TSE, Ankara.

TS EN 13446, 2005. Wood based panels determination of withdrawal capacity of fasteners, TSE, Ankara.

Wang, X., Salenikovich, A., Mohammad, M. 2007. Localized density effects on fastener holding capacities in wood-based panels, *Forest products journal*, 57(1/2), 103.

Yapıcı, F., Gündüz, G., Özçifçi, A., Likos, E. 2009. Prediction of screw and nail withdrawal strength on OSB (oriented strand board) panels with fuzzy classifier. *Technology*, 12(3), 167-173.

The Investigation of Changes in Landscape Architecture on the Coastline of Doganyurt

Mehmet ÇETİN

Kastamonu University, Faculty of Architecture and Engineering, Department of Landscape Architecture, Kastamonu/TURKEY
mcetin@kastamonu.edu.tr

Abstract

Coastal zones, the atmosphere and the hydrosphere interact to create a unique environment. With their linear, dynamic nature, coastal zones are one of the most important features on earth. Nowadays, coastal zone changes indicate changes in environmental factors. In this context, the Doganyurt coastal zone, which is the longest coastline in a seaside town in Turkey, was analyzed for changes in the coastal zone using satellite images. According to its advantages and disadvantages, a procedure to determine changes in the Doganyurt coastline was developed. Using this method, the band ratio was based on the histogram thresholding technique. The working area of the project was the Doganyurt coast. To assess the accuracy of the results, they were compared with observations of the earth. The conclusion was that coastal zone accuracy was estimated to be 1.25 pixels (pixel size = 30 m). Based on the results, obtained in June 2008, the coast has been reduced about 985 m² as of June 2015. These results show 2.5 m of elevation change, which was confirmed by TOPEX/Poseidon satellite data.

Keywords: Band ratio, Coastline, Histogram thresholding

Doğanyurt Sahil Şeridinin Peyzaj Mimarlığında Değişikliklerin İncelenmesi

Özet

Kıyı bölgeleri, atmosfer ve hidrosferin birbirleri ile etkileşiminin en üst düzeyde olduğu, eşsiz bir çevredir. Kıyı bölgeleri, doğrusal ve dinamik yapısı ile dünyanın en önemli alanlarından. Günümüzde, kıyı alanları değişiklikleri, çevresel faktörlerdeki değişiklikleri gösterir. Bu bağlamda, Türkiye'de bir uzun bir kıyı şeridi olan Doğanyurt kıyı bölgesi, uydu görüntüleri kullanılarak, kıyı çizgisindeki değişikliklerin belirlenmesi için analiz edilmiştir. Avantajları ve dezavantajları göre, Doğanyurt sahil şeridindeki değişiklikleri belirlemek için bir prosedür geliştirilmiştir. Kullanılan yöntem, bant oranı histogram eşikleme tekniğine dayanmaktadır. Çalışma alanı olan Doğanyurt da, sonuçların doğruluğunu test etmek için yersel ölçümler yapılmıştır. Çalışma sonucunda elde edilen sonuçların kıyı bölgesi doğruluğu 1.25 piksel (1 piksel =30 m) olarak tahmin edilmiştir. Çalışma sonuçları, 2,5 m bir yükseklik değişimi gösteren TOPEX/Posidon uydu bilgileri vasıtasıyla doğrulanmış ve Haziran 2015 de kıyı alanının Haziran 2008'e göre 985 m² azaldığı belirlenmiştir.

Anahtar Kelimeler: Bant oranı, Kıyı şeridi, Histogram eşikleme

Introduction

Coastal zone, defined as the line of contact between land and a body of water, is a dynamic structure and therefore tends to change over time. Coastal zone monitoring is very important in terms of sustainable development and environmental protection. From 1807 to 1927, coastline maps were produced using ground measurements. Beginning in 1927, aerial photographs were used to improve the accuracy of the maps. Until 1980, aerial photographs of the coast were the only source used for mapping. In terms of number and scale, aerial photographs are quite suitable for this process (Chen, 2003;

De Jong et al., 2004; Alesheikh et al., 2003; Alesheikh et al., 2007; Cetin 2015a; Cetin 2015b; Cetin and Sevik 2016a).

However, in the mapping step, data acquisition, rectification, analysis and mapping information transmitted from photographs represent a costly and time-consuming process, besides which, the use of black and white photographs poses some other problems. The first of these problems, especially if the water is cloudy or the shore is muddy, is that photographs cannot fully distinguish the coastline or they make errors in interpreting the coastline (Alesheikh et al.,

2007; Cetin 2015a; Cetin 2015c; Cetin and Sevik 2016a; Cetin and Sevik 2016b).

Second, the images and the map data set are obtained in non-multiple digital formats. Labour-intensive digitization is required for this process of knowledge transfer, which brings additional costs and errors. Rim geometric complexity and fragmented patterns compound these problems. Because inexperienced staff is increasing, individual abilities also affect the accuracy and quality of a map, which at this stage must be personally reviewed for errors by technical staff (Alesheikh et al., 1999; Alesheikh et al., 2007; Cetin 2015c; Cetin and Sevik 2016b).

Furthermore, in addition to these problems, lack of timely coverage, lack of geometric accuracy, ortho-rectification process requirements, analytical equipment costs and the intense nature of the procedure are emerging as other sources of errors and constraints. This prevents the reduction of experienced and qualified technical personnel needed, which has led to increased costs. Prior to 1972, the limited availability of fairly expensive satellite imagery and mapping, described as the use of these images, was quite difficult. However, in 1972, Landsat remote sensing satellites and other ground-water interfaces were initiated to provide digital images of a well-defined infrared spectral band. These images were used to update coastal maps and permanently solved many of the problems afterwards (Miao and Clements 2002; Lillesand et al., 2004; Alesheikh et al., 2007).

Remote sensing is very economical compared to other methods. It provides important facilities for spatial data collection points. Optical images can be obtained in a simple, easy manner and can be interpreted. Furthermore, the infrared wavelength region, by using water-, vegetation- and soil-related data, can be obtained accurately, which means that such images are ideal for mapping data. Thus, using these images to create maps reduces the margin of error and yields much more accurate results than maps created using aerial photographs. The initial cost of obtaining satellite images may seem high compared to that of aerial photographs, but many processing costs are eliminated, which makes satellite images significantly more

economical in the long run (Winarso and Budhiman, 2001; Lillesand et al., 2004; Alesheikh et al., 2007). For these reasons, the satellite imagery mapping process has been used extensively in this study

Many types of satellite images used for the mapping are available. One type used for this purpose is TM (Thematic Mapper); another is ETM+ (Enhanced Thematic Mapper). In this study, TM and the map of the Doganyurt coast using ETM+ images were used. A new semi-automated approach to TM and ETM+ images of coastline has also been developed in this study.

Materials and Methods

In this study, phases of coastal change at Doganyurt were analyzed using satellite images. The district of Doganyurt constitutes the study area. The coast of Doganyurt, in the western Black Sea region of Kastamonu, is located within the city limits. Kastamonu is the province with the longest coastline. The district of Doganyurt in the Kastamonu Province is 121 km away from the centre and includes the coordinates of $42^{\circ} 00' 15.48''$ N (latitude) and $33^{\circ} 27' 37.72''$ E (longitude). The area of Doganyurt is 253 km².

The stages of change of the coastal town of Doganyurt were determined using digital satellite images: three Landsat 7 ETM+ images, three Landsat 5 TM images and four Landsat 3 TM images. Landsat 7 ETM+ Landsat 5 TM sensor was used for spectral and spatial properties. ENVI processing of the images, V 3.5, and ER Mapper software were used.

In this study, various methods for removal of the shoreline from the optical images have been developed. The reflective properties of the water in the infrared band are almost equal to zero, and the absolute majority of land covers is greater than of the water. Thus, the distinction was made clearer. Distinguishing land and water intersection points was the most difficult due to mixed pixels and the influence of the moisture regimes transition zone between land and water. Reflection values were sliced into two separate areas, classified as water (low values) and land (higher values).

The difficulty of this method is caused by the absence of any threshold value of land and

water separation in some areas. Another method is using; between the fifth and the second tape with water, also tape using tape ratio between the fourth and second detachable directly by the soil.

Rate B2/B5 in large areas of the coastal region and one for water allows for more comfortable separation. ER Mapper software TM and ETM+ images as an algorithm to separate land uses those water rates. Applying this method allows obtaining higher accuracy of the coastline. To obtain more precise results, two techniques are available to solve the problems. In the first technique, the colour composite strip can be used for the first embodiment. This technique is the best colour composite RGB 543 (red/green/blue) d, and colour shows a composite water–land interface. Also, low correlation coefficient bands and, therefore, other colour combinations give better results compared with (Moore, 2000; Alesheikh et al., 1999; DeWitt and Weiwen 2002; Alesheikh et al., 2007).

The 5 band histogram thresholding method was used to allocate land in the water. Threshold values are classified as water pixels. In this case, several water pixels, were classified as soil pixels, but this situation was corrected later. Therefore, the binary image was obtained to increase the accuracy of the study. This image was called “image No. 1”. Band image obtained ratio technique, also labeled as water, land zero pixels pixels. This second image was called “image No. 2”. Then the two images were superimposed. The final resulting binary image represents the correct coastline (Kelley at el., 1998; Alesheikh et al., 1999; Ghorbanali, 2004; Chen, 2003; Alesheikh et al., 2007)..

Results

In the study, the real base used to determine the shoreline, with panchromatic image ETM ETM+ band + band was determined by melting bands. Then, the coastline was extracted from the image by visual interpretation. To assess the validity of this approach, the images of the coast were issued with a map to compare actual ground with the extra beach (Jupp 1988; Alesheikh et al., 1999; Alesheikh et al., 2007).

Compared next two coastal data extracted from coast accuracy 1.25 pixels (pixel size = 30 m) was estimated. The image of the Doganyurt coast in 2008 is shown in Figure 1. The image in Figure 2 depicts the coast in 2015, and the map showing the change between 2008 and 2015 is given in Figure 3.

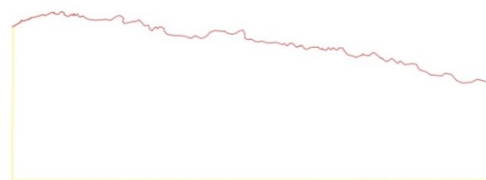

Figure 1. 2008 Image of Doganyurt Coastline



Figure 2. 2015 Image of Doganyurt Coastline



Figure 3. Doganyurt 2008 to 2015 Changes

Discussion and Conclusion

TOPEX/Poseidon images obtained from satellites were used to compare the map-level changes of the Doganyurt coast between 2008 and 2015. In this study, 6 TOPEX/Poseidon coast of relative elevation changes calculated from satellite data is used. The Doganyurt coastal level variation was compared to seasonal changes in the level between June 2008 and June 2015. The seasonal variation of Doganyurt coast pixels is calculated as 0.2 to 6 m. The effects of the tidal range on the Doganyurt coast can be described as insignificant. Therefore, coastal beach-level changes are not affected by changes in the tides. In fact, this change is due to the water balance of the Doganyurt coast. Various methods have been developed to detect coastline changes, including remote sensing,

which is the most accurate and also the most affordable.

A procedure based on the histogram thresholding and band ratio techniques has been developed during the study. Between the belt 5 and the second study, also tape 4 is separated from water and soil by using tape ratio between 2 and was determined coastline. To assess the accuracy of the results, the data obtained were compared with ground observations. It was determined that the area of the Doganyurt coast was 12,480 m² in 2008 and 11 495 m² in 2015 for a total reduction of 985 m² over the seven-year period.

References

- Alesheikh, A.A., Blais J.A.R., Chapman, M.A., Karimi, H., (1999). Rigorous geospatial data uncertainty models for GIS in spatial accuracy assessment: Land information uncertainty in natural resources, Chapter 24. Ann Arbor Press, Michigan, USA.
- Alesheikh, A.A., Sadeghi Naeeni F., Talebzade A., (2003). Improving classification accuracy using external knowledge, *GIM International*, 17 (8), 12-15.
- Alesheikh, A.A., Ghorbanali, A., Nouri, N., (2007). Coastline change detection using remote sensing. *Int. J. Environ. Sci. Tech.*, 4 (1), 61-66.
- Chen, C.H., (2003). *Frontiers of remote sensing information processing*. World scientific publishing Co. Singapur. 628.
- Cetin, M. (2015a). Using GIS analysis to assess urban green space in terms of accessibility: case study in Kutahya. *International Journal of Sustainable Development & World Ecology* 2015; 22 (5): 420-424. DOI: 10.1080/13504509.2015.1061066
- Cetin, M. (2015b). Evaluation of the sustainable tourism potential of a protected area for landscape planning: a case study of the ancient city of Pompeipolis in Kastamonu. *International Journal of Sustainable Development & World Ecology* 2015; 22 (6): 490-495. DOI: 10.1080/13504509.2015.1081651
- Cetin, M. (2015c). Determining the bioclimatic comfort in Kastamonu City. *Environmental Monitoring and Assessment*. 2015; 187 (10): 640. DOI: 10.1007/s10661-015-4861-3
- Cetin, M., Sevik, H. (2016a). Evaluating the recreation potential of Ilgaz Mountain National Park in Turkey. *Environmental Monitoring and Assessment* 2016; 188 (1): 52. DOI: 10.1007/s10661-015-5064-7
- Cetin, M., Sevik, H. (2016b). Chapter 5: Assessing Potential Areas of Ecotourism through a Case Study in Ilgaz Mountain National Park, Tourism - From Empirical Research Towards Practical Application. InTech, Eds: Leszek Butowski, pp.190, ISBN:978-953-51-2281-4, Chapter pp. 81-110
- De Jong, S.M., Freek, D., Van Der, M., (2004). *Remote sensing image analysis: Including the spatial domain*. Kluwer Academic Publishers. MA, USA. 359.
- DeWitt, H., Weiwen Feng, J.R., (2002). Semi-Automated construction of the Louisiana coastline digital land-water Boundary using landsat TM imagery, Louisiana's Oil Spill Research and Development Program, Louisiana State University, Baton Rouge, LA 70803.
- Ghorbanali, A., (2004). Coastline monitoring by remote sensing technology. MSc thesis. Department of GIS Engineering, Khaje Nasir Toosi University of Technology, Tehran, Iran.
- Jupp, D.L.B., (1988). Background and extensions to depth of penetration (DOP) mapping in shallow coastal water. *Proceeding of the symposium on remote sensing of coastal zone, Gold Coast, Queensland*, 1-19.
- Kelley, G.W., Hobgood, J.S., Bedford, K.W., Schwab D.J., (1998). Generation of three-dimensional lake model forecasts for Lake Erie. *J. Weat. For.*, 13, 305-315.
- Lillesand, T.M., Kiefer, R.W., Chipman, J.W., (2004). *Remote sensing and image interpretation.*, 15th. Ed., John Wiley and Son, USA.704.
- Miao, G.J., Clements, M.A., (2002). *Digital signal processing and statistical classification*. Artech House Inc. MA. USA., 414.
- Moore, L.J., (2000). Shoreline mapping techniques. *J. Coast. Res.*, 16 (1), 111-124.
- Winarso, G., Budhiman, S., (2001). The potential application of remote sensing data for coastal study, *Proc. 22nd. Asian Conference on Remote Sensing*, Singapore. Available on: <http://www.crisp.nus.edu.sg/~acrs2001>.

Assessment of the Sustainable Tourism Potential of a Natural Park for Landscape Planning: A Case Study of the Yesilyuva Nature Park

İlknur ZEREN¹, *Hatice AKARUSU¹, Hakan ŞEVİK², Mehmet ÇETİN³

¹Kastamonu University, Faculty of Forestry, Department of Forest Engineering, Kastamonu/TURKEY

²Kastamonu University, Faculty of Engineering and Agriculture, Department of Environmental Engineering, Kastamonu/TURKEY

³Kastamonu University, Faculty of Engineering and Agriculture, Department of Landscape Architecture, Kastamonu/TURKEY

*Corresponding Author: htce.akrsu@gmail.com

Abstract

Currently, the surface site of Yesilyuva Nature Park encompasses the region's natural, social, economic and cultural characteristics and has become a marker of natural and cultural heritage. This site should be passed on to future generations. To support the preservation of this site, promotional activities should be planned to use it in the best ways. In this study, because of tourism and related opinions of local residents and visitors alike in terms of their natural determination is an important cultural and historical feature aimed at evaluating the tourism potential of Yesilyuva Nature Park. This framework is designed to establish prospective tourism sustainability. As a result, Yesilyuva Nature Park in terms of natural and cultural properties has been identified as suitable for sustainable tourism activities that are determined using GIS (Geographic Information Systems). This protection in the field, balancing sustainability and landscape design, will provide for the development of tourism activities. In the SWOT (strengths, weakness, opportunities, threats) analysis and survey, local residents and visitors reported that the most important feature of the Yesilyuva Nature Park is its natural beauty. Visitors often come to observe the traditional and natural life and to engage in tourism activities. All data with showing maps derived from GIS represent landscape planning for sustainable tourism areas in Yesilyuva Nature Park.

Keywords: Landscape planning, Nature park, Protected area, Sustainability, Natural and cultural resources

Peyzaj Planlama İçin Bir Milli Parkın Sürdürülebilir Turizm Potansiyelinin Değerlendirilmesi: Yeşilyuva Tabiat Parkı Örneği

Özet

Yeşilyuva Tabiat Parkının yüzey alanı son zamanlarda, bölgesinin doğal, sosyal, ekonomik ve kültürel özelliklerini kapsayan, doğal ve kültürel mirasın bir belirleyicisi haline gelmiştir. Bu alan gelecek nesillere aktarılması gereken bir alandır. Bu alanın korunmasını desteklemek için, tanıtım faaliyetlerin en iyi şekilde planlanması gerekmektedir. Bu çalışmada, Yeşilyuva Tabiat Parkı'nın kültürel ve tarihi özellikleri dikkate alınarak, yerel halk ve ziyaretçilerin görüşleri değerlendirilerek turizm potansiyelinin belirlenmesi amaçlanmıştır. Bu değerlendirme, ileriye dönük sürdürülebilir turizm çerçevesinde gerçekleştirilmiştir. Çalışma sonucunda, GIS (Geographic Information Systems) yöntemi kullanılarak, Yeşilyuva Tabiat Parkı'nın doğal ve kültürel özellikleri bakımından sürdürülebilir turizm için uygun alanları belirlenmiştir. Çalışma, alandaki koruma, sürdürülebilirlik ve peyzaj tasarımının dengelenerek sürdürülebilir turizm aktivitelerinin geliştirilmesine katkı sağlayacaktır. SWOT (strengths, weakness, opportunities, threats) analizi ve sörvey çalışmaları, yerel halkın ve ziyaretçilerin, Yeşilyuva Tabiat Parkı'nın en önemli özelliğinin doğal güzelliği olduğunu düşündüklerini göstermektedir. Ziyaretçilerin genellikle geleneksel yaşamı ve doğal hayatı gözlemlemek ve turizm aktivitelerinde bulunmak amacıyla geldikleri belirlenmiştir. CBS ile üretilen tüm veriler, Yeşilyuva Tabiat Parkı'nda sürdürülebilir turizm alanları için peyzaj planlamasını göstermektedir.

Anahtar Kelimeler: Peyzaj mimarlığı, Tabiat parkı, Korunan alan, Sürdürülebilirlik, Doğal ve kültürel kaynaklar

Introduction

In Turkey, environmental problems associated with cities are rapidly increasing. Population flow from rural to urban areas has created slums and increased demand for large, multi-storey buildings, and cities are undergoing significant changes along with industrial organizations. In cities that have ignored ecological relationships, the reduction of natural areas results in changing climates and soil conditions, as well as an artificial living environment infused with harmful substances emanating from industrial and vehicle pollution. There is a complete harmony between people living in the artificial city who are looking for a niche within the ecosystem and those longing for a cleaner environment that cannot be achieved because of over population, air pollution, noise and fatigue, which has caused people to develop psycho-physiological imbalances. In this way, the environment changes people's desire to live in cities and pushes them out (Cetin et al., 2010; Cetin 2013a; Cetin 2013b; Cetin 2015a; Cetin 2015b; Cetin and Sevik 2016a, Cetin and Sevik 2016b).

The increase in demand for relaxation, fun and mental rebooting among city populations calls for the identification of and planning for suitable areas in the forest for recreational use (Cetin 2015b; Cetin 2015c; Cetin 2015d; Cetin 2015e; Cetin and Sevik 2016c). The Forestry and Water Affairs 10th Regional Directorate of the Kastamonu Province branch office is located within Kastamonu Province, is near the Abana district, in the Haciveli position. The Kastamonu Yeşilyuva Nature Park is located on Çatalzeytin Road, 101 km from the centre of Kastamonu, 3 km from the town of Abana, 20 km from the district of Çatalzeytin and 126 km away from Sinop (National Parks, 2016).

In 1966, Yeşilyuva Nature Park was registered as a "Type B Recreational Area". Of course, it carried the field, cultural values and recreational potential due to 2873 a statute on national parks in accordance with Article 3 of the law considered as appropriate to be declared a natural park by the Ministry of the office. On 7 November 2011, numbered 903, "Yeşilyuva Nature Park" was declared. The size of the area is 5 ha. The access control

module area door Access, Buffet, Tent Place and General Land Clearing Works management ended in December 2014, and the bidding process for the operation of the field continues (National Parks, 2016).

Yeşilyuva Nature Park consists of deciduous species of trees, such as Oriental beech (*Fagus orientalis*), hornbeam (*Carpinus betulus*), chestnut (*Castanea sativa*) and oak species (*Quercus* spp.), and conifers, such as Scots pine (*Pinus sylvestris*) and red pine (*Pinus brutia*), that largely constitute the green space and the sea area of Kastamonu Province, which has the potential to meet the requirements for recreational use of the environment by the local people of the province (National Parks, 2016).

Yeşilyuva Nature Park will provide an important take place the great landscape on the transport axis, and the sloping terrain of constitutes a significant response to the need for public recreation because it is suitable for picnics and prevents environmental pollution due to irregular use resulting from unauthorized picnic structures in the woods.

Materials and Methods

Yeşilyuva Nature Park is located in Kastamonu Province at an altitude of 22 m on the boundary of the Abana district. The Black Sea region is an area in bounded by the western Black Sea; Kastamonu is located in the border districts of the provinces of Abana which is 5 ha area. The size of 1:25,000 scale topographic map in Kastamonu, it is located in 36 parcels. The urban center nearest Yeşilyuva Nature Park on the Kastamonu Province scale is Sinop, while the nearest residential centre at the district scale of Abana and Çatalzeytin is İnebolu County. Its Surrounding Geographical Location is shown Figure 1.

Kastamonu is located in the western Black Sea region and is observed to partially share properties of the Black Sea climate. Kastamonu, features continental climate of the coast you enter contains outweigh. The Abana district is also located in the western Black Sea climate. The Black Sea coastline and the northern forests are maintenance and show all the characteristics of the marine climate. The effect is a quite humid and mild

climate. Although occurring during all seasons, rains influenced by the Black Sea climate are also evident in the drought period coinciding with July and August. In Kastamonu, the Black Sea climate produces considerably less rain than on the coast. July and August are the driest months. According to the monthly observation records of the Kastamonu İnebolu Meteorological Observation Station during the year, depending on the period measured, the seasonal average low temperatures in January and February are 3.2 °C and 2.6 °C, respectively, while the highest average temperatures in July and August are 27.3 °C and 27.6 °C, respectively. The average annual temperature in the planning area is 13.4 °C, and the average temperature in June, when the area is generally the most heavily used, the average temperature is for June and September the same. Yeşilyuva Nature Park does not have any water sources within its boundaries (Cetin 2016a; Cetin 2016b; National Parks, 2016, Meteorology 2016).



Figure 1. Yesilyuva Natural Park Districts and Surrounding Geographical Location

In general, the western Black Sea region is composed of brown forest soils around Kastamonu with colluvial soils in a small river valley. Some parts of Kastamonu have gray-brown podzolic soils. In the Abana district, of 3,322 ha, 1,743 are used for dry farming (52.5%), 2 for irrigated land, 199 for gardens and 58 for olive groves. In addition, of 1,092 ha (32.9%) of forest heather, 74 ha are used as

residential areas. Approximately 16.1% of the area under dry farming slopes moderately, while 83.9% has a steep slope; 1.8% of the soils are medium-deep, and the remaining soils are shallow or very shallow. Slope analysis is shown Figure 2. In the Abana district III more, although there are lands classes IV, V and VI, classes are also found on land. III. Class general characteristics of the land; grassland and forest land as can be also used as agricultural culture plants. The region of the Yeşilyuva Nature Park consists of limestone bedrock, mica schists and gneisses, with amphibolites occurring. The soil, which is sandy loam in character, varies from place to place with different proportions of sand and gravel.

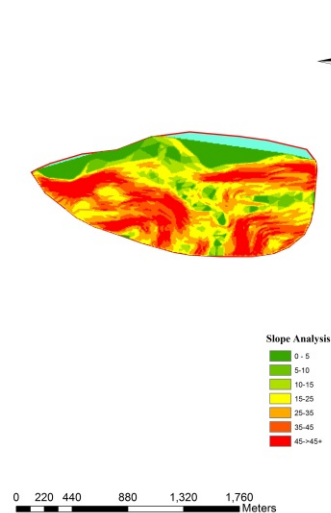

Figure 2. Slope Analysis of Yesil Yuva Natural Park Districts

To serve visitors, Yeşilyuva Nature Park has one wooden entrance door to the west of the planning area and an entrance-control unit, which continues into the south-eastern edge of the driveway entrance gate, is available. From the gate to the car park is 50 m further to the left of this point, where a children's playground, buffet and cafeteria facilities are situated. Fifty meters from the cafeteria area is a tent camping area, in addition to sanitary facilities and a paintball area next to plant when you go up 50 m further up next to the forest. The non-operational nature park entrance gate is 9 m from the site of the future septic tank on the left side and 40 m from the unused inputs and input-control unit that

regulates the water tank, which is located 10 m away. There is trailer parking on the left side, 70 m down the road from the unused entry-control point. There are also existing collective power lines in Yeşilyuva Nature Park.

The nature park is located at the boundary of the Abana district, with a wealth of plants and animals and activities such as summer camping, hiking and a day-long picnic event. To maintain the unspoiled natural structure of the forest landscape of the Yeşilyuva Nature Park, it is located at an easily accessible point in the Abana district; accommodating the flora and fauna is one of the area's most significant recreational potentialities. Nature parks are used for recreation by local people, especially in the summer. Electricity and sewage infrastructure are available in the area. In the plan area and nearby water, air and soil, pollution has been observed.

Results and Discussion

The most important resource value of the Yeşilyuva Nature Park is that it borders a natural forest and the sea. Today's planning area is strengthened by its forest ecology, landscape aesthetic and functional values, adding green space for the rest of the people and entertainment and sports facilities associated with daily and overnight stays (e.g. tent, trailer) that meet the regional requirements for nature-oriented recreational activities and attractions that are close enough to the Abana district to allow for ease of transportation. Five hectares of the nature park region, described as a small, protected area, are evaluated in terms of their location in the country and internationally. Yeşilyuva and other leafy nature parks have moved to the forefront of mixed forests in areas containing Scots pine and red pine, mainly due to ecosystems teeming with flora and fauna. Offering a nice view of the nature park and taking the necessary measures to ensure the protection of the rich bottom flora in the

forests is of great importance. Any structure in the area for visitors, despite being in an area of has been registered for a long time, and there has been no editing facility, which has led to the preservation of the natural structure of the area to this point.

Tourism in the district is much more advanced than in other sectors. It has failed to show improvement due to the lack of development in the industry and the lack of raw materials and market or town transportation. One of the sources of income in the district is fishing, but this amateurish industry is sustainable and can achieve small gains. It is possible for a family to continue fishing and make a living. There is not much progress in agriculture as there is almost no farmland. Commercial firms are unlikely to discuss agriculture. However, in recent years, kiwi cultivation has been carried out and has achieved efficiency and been successful in this regard.

There are several options for accommodations 98 km away in Abana, Kastamonu. In addition to camping at Yeşilyuva Nature Park, caravan parks in town center locations can also be utilized, along with existing accommodations, such as resorts, rental homes, hostels and affordably priced hotel-type facilities. Numerous trails in the area offer opportunities for trekking and mountain hiking, which have been favorite sports in recent years.

Kastamonu's Yeşilyuva Nature Park is an area of natural forests, allowing recreational and tourism activities because it is near the sea. This position and the value of its resources, with activities such as a picnic, scenic cruising, walking and jogging, paintball, flora and fauna monitoring, and so on, can be controlled within the nature park in an appropriate way. SWOT analysis of study areas is shown Table 1. Sustainable tourism suitability map is for Yesil Yuva Natural Park Districts shown Figure 3.

Table 1. SWOT analysis of Yesilyuva Nature Park

Topic	Threats–Weaknesses	Opportunities–Strengths
Accessibility and Location in the Region	<ul style="list-style-type: none"> • Intensive pressure in forest areas with the decline of rapid population growth 	<ul style="list-style-type: none"> • The lack of any agricultural or residential land in the area • Field of Kastamonu Çatalzeytin because that side of the highway lends itself to ease of transportation • The sea view • District is reachable and in proximity to the center
Soil Structure	<ul style="list-style-type: none"> • Visitors contribute to the deterioration of the soil structure and the potential for jams in the area 	<ul style="list-style-type: none"> • Uneven and sloping land that in some parts of the slope is exposed to human pressure • Having the forest intact raises ecosystem values • Area in settlement to be replaced
Natural, Cultural and Recreational Resources Values	<ul style="list-style-type: none"> • Nature parks with areas of insufficiencies or misrepresentations do not have enough accurate information about the value of the resources of the area 	<ul style="list-style-type: none"> • Higher potential for daily recreational activity areas • Having the unspoiled natural resource values • Joining the resources owned by the society to the values of protected areas with increasing environmental awareness and protection
Biology and Ecology Building	<ul style="list-style-type: none"> • Lack of scientific studies on All supplier • Insufficient; no effective maintenance work in the field 	<ul style="list-style-type: none"> • Intact and has not been exposed to human intervention in natural forest ecosystem structure and to have cultural values • Has a rich diversity flora and fauna • Areas absent of a dominant economic activity originating from agriculture and livestock • No settlement in area
Technical and Social Infrastructure	<ul style="list-style-type: none"> • To provide field service structure; lack of facilities and equipment • Lack of parking will give the service area • Lack of sewerage system 	<ul style="list-style-type: none"> • To provide field service warning publicity, the existence of o orientation and equipment information
Legal Framework		<ul style="list-style-type: none"> • The nature park has been declared to be a protected area • Lack of ownership issues

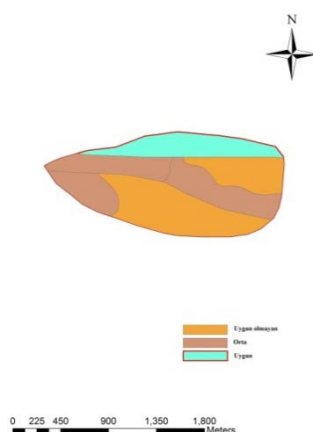

Figure 3. Sustainable Tourism Suitability Map for Yesil Yuva Natural Park Districts

Conclusions

A 1:10,000 scale objective of the development plan remains within the Abana, Kastamonu, District boundaries. A 5-ha Natural Park of the size of Yeşilyuva has biodiversity, geology and protection of natural and cultural landscape resource values to be developed and passed on to future generations in the long term. It takes the establishment of an organic link between the urban and natural areas owned by the planning area of natural, recreational opportunities and providing various recreational activities combined with visual resource values. Raising awareness of nature by the visitors and the sustainability of the mandatory regulatory protections and using the balance to meet basic needs demonstrates the decisions that need to be made.

The aim of Yeşilyuva Nature Park ecological development plans is the improvement of biological and environmental quality within the planning area by providing climatic benefits (linking the CO₂ and oxygen production, removing solid contaminants from the air via filtration, etc., to reduce the effects of poison gas), preserving soil and protecting water, improving water quality and preserving plant communities and wildlife to ensure the continuity of suitable habitat.

The recreational purposes of Yeşilyuva Nature Park development plans are to encourage different types of visitors to come to forest areas with natural charm so they can actively spend their leisure time having fun, as

well as being able to spend a day relaxing or engaging in recreational sporting activities in addition to being introduced to natural habitats.

To assuage the effects of industrialization and urbanization in the artificial environment of society by allowing individuals opportunities for physical and mental regeneration while serving emerging outdoor recreation needs, Yeşilyuva Nature Park provides access to unspoiled segments of nature, and the area has preserved its natural qualities, as preferred. This situation allows visitors to the nature park to engage in a variety of mental and physical activities in a specific forest ecosystem.

Yeşilyuva Nature Park's capacity building related to recreational facilities should be determined according to usage and demand intensity, and spatial solutions must comply with the standards. Yeşilyuva Nature Park properties to be determined include an appropriate visitor management model and public relations support to ensure that the work carried out in the public space is given to the appropriate workers. In this context, individual characteristics of visitors to the area—using relationships, factors that impact on the relationships and their use—are given to augment protection when visitors have an uncomfortable sense about people who should necessarily be investigated during certain periods.

Acknowledgment

The study has been supported by The Scientific and Technological Research Council of Turkey (TUBITAK) 2209-A-2015/2 period (University Students Domestic Research Projects Support Program) working on projects with 1919B011502715 number. Its title is “Determination of bioclimatic comfort in Kastamonu Nature Park” by researcher Ilknur Zeren. The one of the study areas in project is in showing in this article. We sincerely thank to TUBITAK 2209-A-2015/2.

T. C. Forestry and Water Affairs, National Parks and Nature Conservation, the General Directorate gave to information about Nature Park in Kastamonu. We sincerely thank to thank to T. C. Forestry and Water Affairs, National Parks and Nature Conservation, the General Directorate.

References

- Cetin, M.; Topay, M.; Kaya, LG. & Yilmaz, B. (2010). Biyoiklimsel konforun peyzaj planlama sürecindeki etkinliği: Kütahya örneği. Süleyman Demirel Üniversitesi Orman Fakültesi Dergisi 1: (1), 83–95.
- Cetin, M. (2013a). Chapter 27: Landscape Engineering, Protecting Soil, and Runoff Storm Water. *Advances in Landscape Architecture*. InTech, Ed: Murat Özyavuz, 2013, p. 697-723. DOI: 10.5772/55812
- Cetin, M. (2013b). Sert zemin tasarım ve uygulamalarında yeni bir yaklaşım plastiğinin kullanılması. *TMMOB Peyzaj Mimarları Odası Peyzaj Mimarlığı Dergisi* 2013: (1),65–72.
- Cetin, M. (2015a). Using GIS analysis to assess urban green space in terms of accessibility: case study in Kutahya. *International Journal of Sustainable Development & World Ecology* 2015; 22 (5): 420-424. DOI: 10.1080/13504509.2015.1061066
- Cetin, M. (2015b). Evaluation of the sustainable tourism potential of a protected area for landscape planning: a case study of the ancient city of Pompeipolis in Kastamonu. *International Journal of Sustainable Development & World Ecology* 2015; 22 (6): 490-495. DOI: 10.1080/13504509.2015.1081651
- Cetin, M. (2015c). Determining the bioclimatic comfort in Kastamonu City. *Environmental Monitoring and Assessment*. 2015; 187 (10): 640. DOI: 10.1007/s10661-015-4861-3
- Cetin, M. (2015d). Consideration of permeable pavement in landscape architecture. *Journal of Environmental Protection and Ecology* 16 (1),385–392.
- Cetin, M. (2015e). Chapter 55: Using Recycling Materials for Sustainable Landscape Planning. *Environment and Ecology at the Beginning of 21st Century*. Ed.: Prof. Dr. Recep Efe, Prof. Dr. Carmen Bizzarri, Prof. Dr. İsa Cürebal, Prof. Dr. Gulnara N. Nyusupova, ST. Kliment Ohridski University PRESS, Sofia; 2015. p. 783-788, ISBN: 978-954-07-3999-1.
- Cetin, M. & Sevik, H. (2016a). Evaluating the recreation potential of Ilgaz Mountain National Park in Turkey. *Environmental Monitoring and Assessment* 2016; 188 (1): 52. DOI: 10.1007/s10661-015-5064-7
- Cetin, M. & Sevik, H. (2016b). Chapter 5: Assessing Potential Areas of Ecotourism through a Case Study in Ilgaz Mountain National Park, Tourism - From Empirical Research Towards Practical Application. InTech, Eds:Leszek Butowski, pp.190, ISBN:978-953-51-2281-4, Chapter pp. 81-110
- Cetin, M. & Sevik, H. (2016c). Measuring the Impact of Selected Plants on Indoor CO₂ Concentrations. *Polish Journal of Environmental Studies* 25: (3), 973–979.
- Cetin, M. (2016a). A Change in the Amount of CO₂ at the Center of the Examination Halls: Case Study of Turkey. *Studies on Ethno-Medicine* 10: (2), 146–155.
- Cetin, M. (2016b). Peyzaj Çalışmalarında Kullanılan Bazı Bitkilerde Klorofil Miktarının Değişimi. *Kastamonu Üniversitesi Orman Fakültesi Dergisi* 16: (1), 239–245.
- Meteorology (2016). Turkish Meteorological stations Abana the data of 1985 to 2015 years.
- National Parks (2016) T. C. Forestry and Water Affairs, National Parks and Nature Conservation, the General Directorate, “The Information about Yesilyuva Nature Park”, Kastamonu, Turkey.

Assessment of the Area of Biocomfort for Kastamonu Forest

*İlknur ZEREN¹, Hatice AKARSU¹, Hakan ŞEVİK², Mehmet ÇETİN³

¹Kastamonu University, Faculty of Forestry, Department of Forest Engineering,
Kastamonu/TURKEY

²Kastamonu University, Faculty of Engineering and Agriculture, Department of Environmental
Engineering, Kastamonu/TURKEY

³Kastamonu University, Faculty of Engineering and Agriculture, Department of Landscape
Architecture, Kastamonu/TURKEY

*Corresponding Author: ukizeren@gmail.com

Abstract

Bioclimatic comfort is increasingly recognized along with changing climates and increasing heat stress in the forest area. Although forest areas create a cool effect during increasing heat, some of them are uncomfortable. In the biocomfort zone, people feel healthy and dynamic; otherwise, if the range in an area is not in the biocomfort zone, they do not want to stay there. In this study, the spatial and temporal aspects of the distribution of bioclimatic comfort in Kastamonu Forest were studied. Using thermal perception maps for determining thermal comfort areas is very important for landscape planning and offers a model for the physical planning process. To determine the biocomfort structure of Kastamonu Forest areas, climatic data, such as wind speed, precipitation and humidity values, were collected from meteorological stations, the RayMan 1.2 program was used to obtain the monthly temperatures, and the inverse distance weighted interpolation technique in geographic information system (GIS) software was used to produce monthly psychological equivalent temperature maps and a thermal perception map of the study area. As a result, the study shows that Kastamonu Forest has suitable ranges for bioclimatic comfort zones. The bioclimatic comfort value of Kastamonu Forest is 16.9 °C, which falls within the comfort range of 17 °C to 19 °C. Kastamonu Forest has suitable areas for bioclimatic comfort. Thus, the most comfortable months and regions for activities in Kastamonu Forest areas were detected using thermal maps based on psychological perceptions of equal temperatures.

Keywords: Kastamonu Forest, Biocomfort, Landscape planning

Kastamonu Ormanları için Biyokonfor Alanının Değerlendirilmesi

Özet

Biyoklimatik konfor, ormanlık alanlarda iklim değişikliği ve sıcaklığa bağlı olarak artan stres ile önemli artan bir konudur. Ormanlık alanlar, ısıyı azaltarak serin bir iklim oluşturmaya rağmen, bu durum bazen rahatsız edici olmaktadır. Biyokonfor bölgesinde insanlar kendilerini sağlıklı ve dinamik hissetmelidir, aksi takdirde insanlar bu alanda kalmak istemezler. Bu çalışmada, Kastamonu Ormanlık alanlarında biyoiklimsel konfor dağılımı mekansal ve zamansal açıdan incelenmiştir. Isıl konfor alanlarının belirlenmesinde termal algı haritalarının kullanımı peyzaj planlaması ve fiziksel planlama süreçlerinde çok önemlidir. Kastamonu orman alanlarının biyokonfor yapısının belirlenmesinde kullanılan, rüzgar hızı, yağış ve nem değerleri meteoroloji istasyonundan temin edilmiştir. Elde edilen veriler Rayman 1.2 Programı vasıtasıyla değerlendirilmiş ve coğrafi bilgi sistemi (CBS) yazılımları yardımıyla termal algı haritaları üretmek için kullanılmıştır. Çalışma sonucunda psikolojik eşit sıcaklık değerlerine göre, açık hava rekreasyon faaliyetleri için en uygun dönemler ve bölgeler termal algı haritaları vasıtasıyla tespit edilmiştir. Çalışma sonuçları Kastamonu ormanlık alanlarının biyoklimatik konfor bölgeleri için uygun aralıkta olduğunu göstermektedir. Kastamonu ormanlık alanların biyoklimatik konfor değerinin 16.9 °C olduğu ve 17 °C ile 19 °C arasındaki biyoklimatik konfor değer aralığı olduğundan Kastamonu ormanlarının biyoklimatik konfor aralığında olduğu belirlenmiştir. Çalışmada, Kastamonu ormanlık alanlarında faaliyetler için en uygun ay ve bölgeler ile psikolojik algılamalarına dayalı eşit sıcaklıklar, termik haritalar kullanılarak tespit edilmiştir.

Anahtar Kelimeler: Kastamonu, Orman, biyokonfor, Peyzaj planlama

Introduction

Ecological planning, on the one hand, involves the protection of natural assets and the environment. On the other hand, it is

necessary to meet the needs of the people living in this environment. Along with such planning, it is necessary to solve many problems. Indeed, an increased number of people have moved to work area in recent years. Especially in developing countries, urban development has been rapid and often unplanned. As a result, the cities have become crowded and dreary. These areas are affected by temperature and humidity, which affect human health and contribute to conditions producing bioclimatic stress factors that affect productivity". Studies indicate that air and surface temperatures are higher in urban areas than in rural areas, and this difference has been determined to be as much as 13 °C (Cetin vd., 2010; Topay, 2012; Cetin, 2015a; Cetin, 2015b; Cetin ve Zeren, 2016; Cetin and Sevik 2016a).

In many developing countries, in addition to rapid urbanization and unplanned urbanization ignoring ecological concerns, people are left to face dysfunctional and non-aesthetic cities. However, with ecological planning, these issues may be stopped from evolving into significant environmental problems. Ecological balance, a clean environment and comfortable conditions are very important factors to people when choosing where they will live together with others whose income levels are rising. Perhaps the most important of the components to be considered in ecological planning is the climate. Air quality and climate have a significant effect on a person's behavior and physiological state. Human performance and comfort can vary greatly based on climate change. Climatic conditions or thermal comfort for people's mood healthy and dynamic weather conditions, and thus refers to the human satisfaction (Topay and Cinar, 2008; Cetin et al., 2010; Topay, 2013; Cetin, 2015a; Cetin and Zeren, 2016; Cetin and Sevik 2016b; Cetin 2016).

In this study, detailed weather and climate analysis was used to evaluate the biocomfort conditions of the Kastamonu forest, and a landscape-planning and design-related

database was also planned for development. This planning and design database will incorporate other criteria, such as climate-balanced planning and bioclimatic design principles, in the evaluation process.

Materials and Methods

The study's aim was to produce a biocomfort map of Kastamonu forest and its environment, which constitutes the study area. The Kastamonu region in the western Black Sea region is located at 41° 22' 35" N latitude and 33° 46' 35" E longitude coordinates at 774 m above sea level. Kastamonu shares the typical Black Sea climate and four seasons, and the temperatures there are proportional to the humidity. Temperatures begin to rise in May and reach their maximum value in July. The winter minimum average temperature in February is -7.2 °C and 8 °C during summer. The average annual temperature is 18.7 °C (Meteorology, 2015).

In this study, climatic data of Kastamonu forest were obtained from meteorological stations, and equivalent temperatures according to the physiological index were prepared. The obtained data were evaluated by means of the RayMan 1.2 program (Matzarakis et al., 2007; Matzarakis et al., 2010), and a geographic information system (GIS) was used to produce a thermal perception map with the help of software. Results showed that the best biocomfort fields using ArcView software has been tried to be determined.

Annual temperatures, using data obtained from the annual average values, were converted into the RayMan 1.2 program. To view the map associated with it, humidity and wind speed maps were created. Given the theoretical basis of the study of climatic factors related to climate comfort in Kastamonu, it was evaluated in terms of the forest. This study provides the most accurate map of the climatic data obtained in the field. Ten ArcView software mappings of the study area climate were used with the Kriging interpolation method to create the appropriate fields. In the area of climate data, the universal linear extension system was used because it provides the most accurate distribution. Finally, Kastamonu climatic factors were identified, and bioclimatically suitable areas

in the province were evaluated in terms of comfort level.

Findings

The Kastamonu forest temperature study data were evaluated, and average annual temperature maps were prepared and presented in Figure 1.

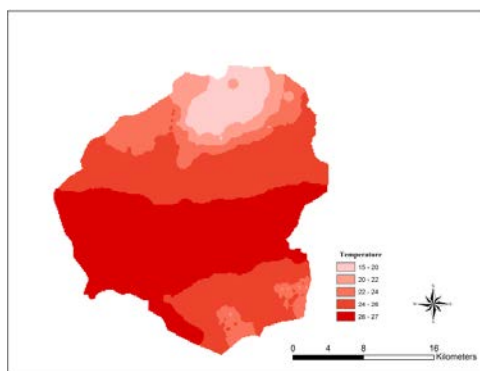

Figure 1. Average annual temperatures of Kastamonu forest

The average annual temperatures of the work area, as shown in Figure 1, vary between 18 °C and 19 °C, with higher temperatures in the north of the area and lower temperatures in the south. The average annual relative humidity values in the study area are shown in Figure 2.

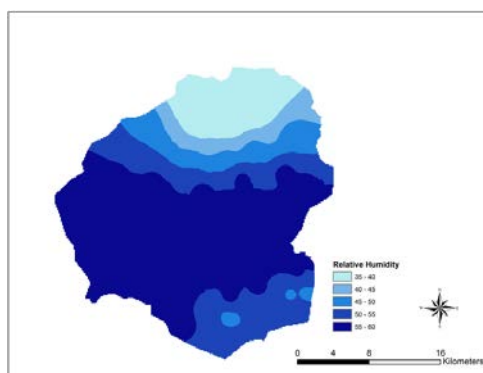

Figure 2. Average annual relative humidity values of Kastamonu forest

The average relative humidity ranges between 51% to 58% in the study area, with higher values in the north and lower values in the south in keeping with the temperature value of relative humidity. The average annual wind speed map is shown in Figure 3.

As shown in Figure 3, the majority of the region's average annual wind speed in the

work area was determined to fall between 2.6 and 2.9 m/s.

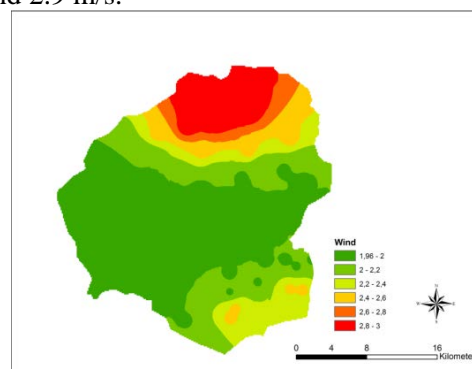

Figure 3. Average annual wind speed of Kastamonu forest

Bioclimatic comfort in Kastamonu province; temperature, humidity and wind speed data evaluated according to and marked on the maps created with GIS software. The values used for each element in the bioclimatic comfort zone climate were determined by the following ranges insert data. Overall, the bioclimatic map of Kastamonu forest was analyzed for areas suitable for bioclimatic comfort in terms of humidity and temperature from meteorological stations as shown in Figure 4.

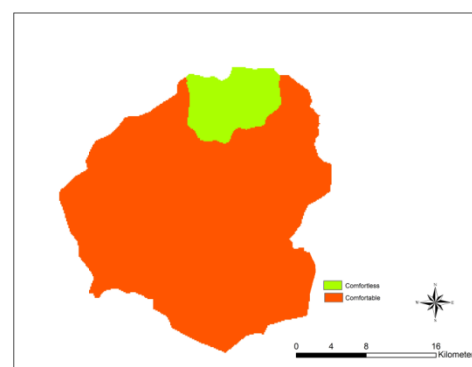

Figure 4. Suitable bioclimatic areas in Kastamonu forest

Results

Comfort the years produced maps for the study area is classified for each month. The average value for each field on the resulting bioclimatic comfort conditions, considering the 12-month map, allows us to obtain a map that coincides with the annual values of sensed temperatures. Classified program Twelve months were assessed using the ArcGIS raster data function. As a result,

average values were calculated for each 12-month span. Annual sensed temperature ranges in the maps were subjected to grading, and it was determined that all the data obtained are appropriate for biocomfort in most of the area that was evaluated.

Bioclimatic comfort conditions of the residential area have been determined that a further reduction. The average is optimally at 15 °C, which falls in the temperature range of 14 °C to 17 °C for bioclimatic comfort in Kastamonu forest. The comfort associated with moisture values varies. The results from the GIS map of Kastamonu generally show that it has appropriate space for bioclimatic comfort outside the forest area and in the cities.

The results also show that approximately 68% of the total area of the province of Kastamonu has been determined to be suitable for bioclimatic comfort. Areas with negative values are mostly in the northeastern and southern parts of the province. The reason for this is the absence of ideal values for relative humidity.

Landscape architecture and planning, improved comfort conditions for the application of bioclimatic principles and design criteria. Planning and design for bioclimatic comfort in the wrong environment can create extremely unfavorable conditions. In this study, the environment of Kastamonu forest was examined for bioclimatic comfort. Study results indicate that the majority of the areas assessed meet the requirements for bioclimatic comfort.

Acknowledgment

The study has been supported by The Scientific and Technological Research Council of Turkey (TUBITAK) 2209-A-2015/2 period (University Students Domestic Research Projects Support Program) working on projects with 1919B011502715 number. Its title is "Determination of bioclimatic comfort in Kastamonu Nature Park" by researcher Ilknur Zeren. The one of the study areas in project is in showing in this article. We sincerely thank to TUBITAK 2209-A-2015/2. T. C. Forestry and Water Affairs, National Parks and Nature Conservation, the General Directorate gave to information about Nature Park in Kastamonu. We sincerely

thank to thank to T. C. Forestry and Water Affairs, National Parks and Nature Conservation, the General Directorate.

References

Cetin M, Topay M, Kaya LG, Yilmaz B (2010), "Efficiency of bioclimatic comfort in landscape planning process: the case of Kutahya". Suleyman Demirel University. Journal of Faculty of Forestry, A(1), 83–95. Isparta.

Cetin M (2015a). "Determining the bioclimatic comfort in Kastamonu city", Environmental Monitoring & Assessment, 187(10), 640. doi:10.1007/s10661-015-4861-3.

Cetin, M (2015b). Evaluation of the sustainable tourism potential of a protected area for landscape planning: a case study of the ancient city of Pompeipolis in Kastamonu. International Journal of Sustainable Development & World Ecology 2015; 22 (6): 490-495.

Cetin M, & Zeren I (2016). "Evaluation of the value of biocomfort for Kastamonu-Inebolu". International Conference GREDIT'2016 – Green Development Infrastructure Technology, Poster section 4: Management of Urban and Industrial Waste, Climate Change – Biodiversity – Efficiency, ISBN 978-608-4624-21-9, 31.03 and 01.04 2016, p4–35, page: 310, Skopje, Macedonia.

Cetin, M. (2016). A Change in the Amount of CO₂ at the Center of the Examination Halls: Case Study of Turkey. Studies on Ethno-Medicine 10: (2), 146–155.

Cetin, M. & Sevik, H. (2016a). The change of air quality in Kastamonu city in terms of particulate matter and CO₂ amount. Oxidation Communications pp. 0–0. (In press)

Cetin, M. & Sevik, H. (2016b). Measuring the Impact of Selected Plants on Indoor CO₂ Concentrations. Polish Journal of Environmental Studies 25: (3), 973–979.

Matzarakis, A., Rutz, F., Mayer, H. (2007). Modelling Radiation fluxes in simple and complex environments – Application of the RayMan model. International Journal of Biometeorology 51, 323-334.

Matzarakis, A., Rutz, F., Mayer, H. (2010). Modelling radiation fluxes in simple and complex environments: basics of the RayMan model. International Journal of Biometeorology 54, 131-139.

Meteorology (2015). Turkish Metrological Data for Kastamonu Forest. Kastamonu.

Topay, M., Cinar, I. (2008). Determining of bioclimatic comfort structure of Suleyman Demirel University East Campuses situated in the back of Mediterranean region. Geophysical

Research Abstracts, 10(2008). EGU general assembly.

Topay, M. (2012). Importance of thermal comfort in the sustainable landscape planning. *Journal of Environmental Protection and Ecology*, 13(3), 1480–1487.

Topay, M. (2013). Mapping of thermal comfort for outdoor recreation planning using GIS: the case of Isparta Province (Turkey). *Turkish Journal of Agriculture and Forestry*, 37, 110–120.

Topay M., Parladir M.O. (2015). İsparta ili örneğinde CBS yardımıyla alternatif turizm etkinlikleri için uygunluk analizi. *Tar. Bil. Der.* 21 (2015): 300-309.

Anthropogenic Risks Encounter in Forestry Applications

*Seçil AYANOĞLU¹, Ebru GÜL², Melda DÖLARSLAN³, Sabit ERŞAHİN²

¹Çankırı Karatekin University, Yapraklı Vocational School, Worker's Health and Job Safety,
Çankırı/TURKEY

²Çankırı Karatekin University, Faculty of Forestry, Department of Soil Science and Ecology,
Çankırı/TURKEY

³Çankırı Karatekin University, Faculty of Science, Department of Biology, Çankırı/TURKEY

*Corresponding Author: secilayanoglu@karatekin.edu.tr

Abstract

Forestry activities include afforestation, protection from fires, combating pests, prevention of illegal wood cutting, forest production works (wood, timber supply, etc.), construction of forest roads, protection of forest areas and silvicultural interventions. In this context, while humans conducting forestry activities; they are adversely affect the ecosystem of forest areas with his interventions directly or indirectly. Those interventions made by people, is emerging extensively in the study such as forest production works, silvicultural interventions and the construction of forest roads (mechanization). Chemical wastes and noise emitted from transportation vehicle are used forest production and mechanization adversely affects the wildlife and polluting oil waste water resulting from the use of machinery. As well as it also has adverse effect on the soil characteristics and biological diversity, are important component of ecosystems.

Machinery production work increases suddenly soil bulk density, accelerates the runoff and soil erosion, moreover, removed from the pane by dragging the wood raw material leads to soil compaction and, soil nutrient loss causes a reduction in biological diversity. When all these factors are considered together, intensively forestry activities have anthropogenic effects caused the change of succession dynamics and life cycle in the forest ecosystem, and also stress, destruction and loss of productivity in this ecosystem. With this study, we determined the anthropogenic risks that may be encountered in forestry activities and investigated the effects of forest and ecosystem.

Key words: Forestry, Ecology, Anthropogenic Risks, Forestry Production

Ormançılık Uygulamalarında Karşılaşılan Antropojenik Riskler

Özet

Ormançılık faaliyetleri; ağaçlandırma çalışmaları, yangınlardan koruma, zararlı böceklerle savaşma, kaçak odun kesiminin önlenmesi, orman üretim işleri (odun, kereste temini vb.), orman yollarının yapımı, orman alanlarının korunması ve silvikültürel müdahalelerdir. Bu kapsamda insanoğlu, ormançılık faaliyetlerini yürütürken orman alanlarına doğrudan veya dolaylı yaptığı müdahaleler ile ekosistemi olumsuz yönde etkilemektedir. İnsanlar tarafından yapılan bu müdahaleler, daha çok orman üretim işleri, silvikültürel müdahaleler ve orman yollarının yapımı (mekanizasyon) çalışmalarında yoğunlukla ortaya çıkmaktadır. Orman üretim işleri ve mekanizasyon çalışmalarında kullanılan ulaşım araçlarından salınan kimyasal atıklar ve gürültü; yaban hayatını olumsuz yönde etkilemekte ve makine kullanımından kaynaklanan yağ atıkları su kaynaklarını kirletmektedir. Bunun yanısıra ekosistemin önemli bileşenlerinden olan toprak özellikleri ve biyolojik çeşitlilik üzerinde de olumsuz etkileri vardır. Makineli üretim çalışmaları toprak hacim ağırlığını ani olarak arttırmakta, yüzeysel akış ve toprak erozyonunu hızlandırmakta, odun hammaddesinin sürütülerek bölmeden çıkarılması toprak sıkışmasına neden olmakta ve toprak besin elementi kayıplarına yol açarak biyolojik çeşitliliğin azalmasına neden olmaktadır. Bütün bu unsurlar birlikte değerlendirildiğinde, antropojenik etkilerin yoğun olduğu ormançılık faaliyetleri orman ekosistemindeki yaşam döngüsünün ve süksesyon dinamiklerinin değişmesine, ekosistemde strese, yıkıma ve verim kaybına neden olmaktadır. Bu çalışma ile ormançılık uygulamalarında karşılaşılabilecek antropojenik riskler incelenerek, ormanlara ve doğaya ne derecede etkili olduğu irdelenerek çözüm yolları araştırılmıştır.

Key words: Ormançılık, Ekoloji, Antropojenik Risk, Ormançılık Üretimi

Introduction

As a result of the rapid population growth in the world, technological developments, the increase in the living standards of human

beings, the utilization form and intensity of forest has changed. As this intensity utilization is provided unplanned and disorganized, it causes a decrease in bio-

diversity, the loss of natural life and regional climate changes. Such kind of negative conditions affect the ecosystem as well (Yıldırım, 2014).

The forestry applications comprise planting works, fire protection, pest control, preventing illegal firewood cutting, forestry production works (wood and timber supply, etc.), forest road construction, protection of the forest lands and silvicultural interventions.

The forestry applications affect and change the environment. Some of these effects are realized deliberately. Beside them, the other effects also create unintended consequences in the environment. Most of these effects arise from the vehicles and moving materials in the forest. Thus, vegetation, soil and water are affected negatively. These effects should be considered in terms of permanency, amount, intensity and location in the area (Drosos, 2014). Within this scope, during the realization of the forestry applications, direct or indirect interventions by the human beings come into question. Especially, these interventions mainly take place during the forestry production works, silvicultural interventions and forest road construction (mechanization) efforts and affect the environment negatively. For that reason, in this study, the anthropogenic risks that could come up in the forestry applications were examined, to what extent they are effective to the forestry and the nature were addressed and the solutions were sought.

The Impact of Forestry Production Works to the Ecosystem in the Forestry Applications; The forestry production works are defined as tree cutting works, wood extraction (ground skidding) works, loading, transportation, stowage and conveying the final storage phase (Menemencioğlu, 2006). According to this definition, it is possible to examine the forestry production works in subprocesses such as tree cutting works and wood extraction (ground skidding) and transportation. The existence of anthropogenic effects is seen during the examination of these processes. The damages arising from the anthropogenic effects vary depending on the factors such as site conditions, the structure of the ground, the

seasons, the diameter and length of the product.

Tree cutting works are affecting the wildlife negatively as the tree cutting zones are the wildlife sheltering fields. Besides, as the forest villagers and workers which are uneducated and incompetent on tree cutting, cannot knock over the tree to the intended place so it causes damages on remaining trees, new growth and bugs and fungus. Moreover, when the tree cutting is not performed according to the land structure, it causes land ruptures and when it is performed in the zones close to the river and stream beds, it causes to the factors such as stuffed bed (Özçelik, 2013). On the other hand, there are also some environmental impacts arising from the usage of chainsaws in the tree cutting works. Fuel and oil spilled during the fueling and maintenance can damage the soil and water resources.

The wood extraction (ground skidding) works; The ground skidding works are performed by using the human, tractor (mechanic) and animal power in Turkey (Buğday, 2011). The round timbers which are trying to be extracted damage on the one hand the environment, on the other hand the workers, the round timbers themselves and working tools (Acar, 2013).

The ground skidding works performed by the tractor (mechanic vehicle) lead soil compaction, land slip and loss of soil nutritional elements due to the decay in the structure of the ground, thus, cause a decrease in the biodiversity.

All in all, as a result of wood extraction performed by human, tractor and animal power, some damages happen on the vegetation (planted trees and the new growth) ground and produced wood raw material. Besides, the noise pollution that arise during the ground skidding works affect the wildlife negatively as well.

Transportation works; Air pollution, dirt factors and suffusing fuel and mineral oil that arise during the transportation damage the soil and the plants and the wildlife is affected by the noise that arise from the trucks and soil compaction occurs as the transportation works are not performed according to the capacity of the forest roads (Özçelik, 2013).

The Impact of Silvicultural Interventions to the Ecosystem in the Forestry Applications;

Silviculture which means afforestation is defined as the studies to establish new forests planned and systematic, handling and renewing the naturally growth forests with these new ones, that enable prolongation of the functions expected from the forests. From this point of view, the silvicultural interventions can be examined under two major topics such as regeneration works (natural and artificial) and forestry handling works (cleaning, thinning, lightning, pruning, the new growth handling) (Anonymous, 2014).

If the silvicultural interventions are performed according to the species, age and mixture rate of the trees in the forest in due time and properly, they not only affect the forest positively but also protect the forest against the external factors. However, the silvicultural interventions which are not performed in due time and properly make the forests more unprotected against the external factors (Buğday, 2011). In this context, the existence of the direct effect of human come into question in the silvicultural interventions as it happens in the forestry production works.

In this context, the misuse of biocidal products (fungicide, herbicide, etc.) in and near the water resources in the forest during the forestry handling works cause an increase in the pesticide concentrations in the streams (Gülci et. al, 2015). As a result of the thinning works performed within the scope of maintenance and repair activities, despite the decrease in the risks of fire and disease due to the decrease of biomass in the unit area, significant damages occur on the soil surface and the quality of the soil is affected (Kezik and Altun, 2015). As a result of both production works and silvicultural interventions, the wildlife changes either positively or negatively and they have an influence on the population. For that reason, the activities of the specified works should be realized by knowing in what way they will affect the wildlife species (Oğurlu, 1988).

The Impact of Forest Road Construction Efforts (Mechanization) to the Ecosystem in the Forestry Applications; The forest roads are

affordable dirt roads which are constructed as single-lane in order to realize the forestry applications. At the same time, the forest roads provide transit and transport services and they are indispensable infrastructures for the forestry management. Even though the forest roads are basic infrastructures, they have negative effects in terms of ecology (Görmez and Kuyucu, 2014). As a result of the anthropogenic interventions which lead up to these negative effects, some changes have taken place in the forest lands physically.

Forest road construction efforts have an impact on habitat and its species, soil and water and atmosphere. *The impact on habitat and the species;* arise as the restriction of the right to live of wildlife as a result of pressure occurring with the road construction and transportation, the reduced productivity, distribution and shapes of the plants due to the decrease in habitat quality, the decrease in the biodiversity as a result of the noise due to the effect of the traffic. *The impact on soil and water;* results from the changes on the surface runoff due to the changed watercourses and the erosion steps up, the changes in the flow direction of the shallow groundwaters cause erosion on the rivers and step up the sedimentation flow. *The impact on the atmosphere;* the emissions (sera gas, nitrogen oxide, carbonmonoxyde hydrocarbons, particle matter) oscillated by the motor vehicles cause a decrease of biomass in the lands on the ecosystem, the climate, vegetation and affect the plant species richness and diversities of the land negatively (Eker et. al, 2010; Görmez and Kuyucu, 2014).

Conclusion

In conclusion, when the forestry production works, silvicultural interventions, forest road construction efforts in forestry applications are evaluated together, it is seen that the forestry activities with intensive anthropogenic effects cause a change in the life cycle of forest ecosystems and succession dynamics and stress, destruction and productivity loss in the ecosystem.

It is obvious that as a result of the anthropogenic effects in the forestry production works, the environment is

damaged. It seems impossible to perform applications without damaging the forests. However, it is important to work planned and systematically in terms of management to minimize the damage and make environment-friendly production activities with continuous audit, control and supervision in terms of field study.

In order to conclude the silvicultural studies successfully, it is very important to perform silvicultural interventions according to the species, age and mixture rate of the trees in the forest in due time and properly and extract the product obtained during the renewing and handling works from the forest so as to cause minimum damage to the environment. The ecosystem will have a minimum damage with the planned and relevant application of the roads in the road construction efforts. Moreover, while determining the forest road route, a careful and serious planning should be done as it is without recourse. In addition to this information, while conducting the forestry applications (forestry production works, silvicultural interventions and road construction efforts), the trash (plastic and paper waste, batteries, etc. and physical life finished machine parts) thrown away by the forest workers in the forest lands is threatening the environment. In this respect, it will be useful to train the workers for appropriate separation of the classes of the waste in terms of production and ecosystem. If these precautions are taken into consideration, it is thought that the stated damages will be minimized with the awareness of the society on these issues.

References

- Acar H.H., 2013. Eğimli arazide tomrukların traktörle kablo çekimlerinde tomruk çekme kaydırma başlığı (TÇKB) kullanımı. Kastamonu Üniversitesi, Orman Fakültesi Dergisi, 2013, 13 (1): 144-152.
- Anonymous, 2014. Silvikültürel uygulamaların teknik esasları, T.C. Orman ve Su İşleri Bakanlığı, Orman Genel Müdürlüğü, Silvikültür Dairesi Başkanlığı, Tebliğ No: 298, Ocak 2014.
- Buğday E. 2011. Ormancılık üretim çalışmalarının çevresel zararları. Yüksek Lisans Tezi, Çankırı Karatekin Üniversitesi, Fen Bilimleri Enstitüsü, 64 s. Çankırı.

Drosos V. C. 2014. Environmental effects of Forest operations on a suburban forest landscape – A Forest Engineering Approach. 7th International Symposium on Forestry Mechanisation: “Forest engineering: propelling the forest value chain”, September 23-26, 2014 in Gerardmer, France.

Eker M., Acar H. H., Çoban H. O. 2010. Orman yollarının potansiyel ekolojik etkileri. Süleyman Demirel Üniversitesi Orman Fakültesi Dergisi Seri: A, Sayı: 1, Yıl: 2010, ISSN: 1302-7085, Sayfa: 109-125.

Görmez Y., Kuyucu M. 2014. Orman ekosistemine etkisi açısından orman yollarının kritiği (Armutlu Orman İşletme Şefliği plan örneği) II. Ulusal Akdeniz Orman ve Çevre Sempozyumu, Akdeniz Ormanlarının Geleceği: Sürdürülebilir Toplum ve Çevre”. 22-24 Ekim 2014 – Isparta.

Gülci N., Erdaş O., Akay A. E. 2015. Üretim işlerinde hassas ormancılık yaklaşımı. Üretim İşlerinde Hassas Ormancılık Sempozyumu. (4-6 June 2015), 238-256, Ilgaz, Turkey.

Kezik U., Altun L. 2015. Üretim çalışmalarının toprak kalitesi ve ekosistem sağlığına olası etkileri. Üretim İşlerinde Hassas Ormancılık Yaklaşımı. Üretim İşlerinde Hassas Ormancılık Sempozyumu (4-6 June 2015), 285-299, Ilgaz, Turkey.

Menemencioglu K., 2006. Ormancılıkta üretim işlerinde çalışma koşulları ve iş kazaları üzerine bir araştırma. Süleyman Demirel Üniversitesi, Orman Fakültesi Dergisi Seri: A, Sayı: 2, Yıl: 2006, ISSN: 1302-7085, Sayfa: 1-12.

Özçelik K., 2013. Çevreye duyarlı ormancılık bağlamında üretim operasyonu karar süreçlerinin irdelenmesi. Yüksek Lisans Tezi. Süleyman Demirel Üniversitesi Fen Bilimleri Enstitüsü, 119 s. Isparta.

Oğurlu İ, 1988. İşletme ormanlarında yaban hayatı habitatlarının düzenlenmesi. İstanbul Üniversitesi, Orman Fakültesi Dergisi. Seri: B Cilt:38 Sayı:2.

Yıldırım V., 2014. Orman ekosistemlerinin yapı ve kuruluşunda meydana gelen konumsal ve zamansal değişimlerin CBS ve orman amenajman planları yardımıyla ortaya konulması. Yüksek Lisans Tezi, Kahramanmaraş Sütçü İmam Üniversitesi, Fen Bilimleri Enstitüsü, 77 s. Kahramanmaraş.

Evaluation of Çankırı Yapraklı Hazım Dağlı Natural Park in terms of Occupational Health and Safety

*Seçil AYANOĞLU¹, Melda DÖLARSLAN², Ebru GÜL³, Sabit ERŞAHİN³

¹Çankırı Karatekin University Yapraklı Vocational School, Occupational Health and Safety, Çankırı/TURKEY

²Çankırı Karatekin University, Faculty of Science, Department of Biology, Çankırı/TURKEY

³Çankırı Karatekin University, Faculty of Forestry, Department of Soil Science and Ecology, Çankırı/TURKEY

*Corresponding Author: secilayanoglu@karatekin.edu.tr

Abstract

Occupational health and safety concept, coverage of employees in the workplace as well as concerning human and environment relationships causing during the occurrence of any business or activity, includes the systematic and scientific studies for protection from conditions harmful to health. Therefore, it is possible to mention from occupational health and safety everywhere existed of people. Especially, it belongs to the public or private sector, regardless of the business shape, fields that are wholly or partially used for production or recreation purposes are within the important risk groups. In this context, featuring vegetation and wildlife, natural parks which is where people go for rest and recreation purpose, both avoided the deterioration of natural structure and visitors to the area must be protected from the risks that may occur in the field. In this study, hazards, risk that may be encountered in Çankırı Yapraklı Hazım Dağlı Natural Park and precautions that can be taken of evaluation in terms of occupational health and safety, has been identified with the necessary literature and field observations. Hazım Dağlı Natural Park, located in Çankırı in Central Anatolia Region is located within the boundaries of the district in the province of laminated. The size of the area is 126.03 hectares, has been declared as a natural park as of 2009 and is rented to the private sector for 29 years. Also there isn't any protection status such as protected area, international convention for the protection of wetlands, and special environment protection zone on the field. In this respect, the most important danger for visitors coming to the area for recreation; natural disasters (flood, fire, earthquake, lightning), sabotage-terrorism, sunstroke, attack of venomous animals, toxic and allergenic plants, nature-injury in sports activities and has been identified as a risk of choking wetlands. Hazards will be occurred by the visitors can be listed as; environmental pollution (exhaust fumes, waste), smoking, barbecue and fire, the damage to the soil and plant species, reduction of wildlife, noise pollution. As a result, the operating space must also be informed as well as those of people who come for visiting the area and that it can be reduced to a mutually acceptable level of threat determined by taking the necessary measures.

Keywords: Occupational Health and Safety, Çankırı Yapraklı Hazım Dağlı Natural Park, Hazards, Risk

Çankırı Hazım Dağlı Tabiat Parkının İş Sağlığı ve Güvenliği Açısından Değerlendirilmesi

Özet

İş sağlığı ve güvenliği kavramı, işyerinde çalışanları kapsamasının yanısıra insan ve çevre ilişkilerini ilgilendiren herhangi bir işin veya faaliyetin meydana gelmesi sırasında kaynaklanan, sağlığa zarar verecek koşullardan korunmak için yapılan sistemli ve bilimsel çalışmaları içerir. Bu sebeple insanın bulunduğu her yerde iş sağlığı ve güvenliğinden bahsetmek mümkündür. Özellikle, kamu veya özel sektöre ait olup, işletme şekli ne olursa olsun, tamamen veya kısmen üretim ve rekreasyon amaçlı kullanılan alanlar önemli risk grupları içerisinde bulunmaktadır. Bu kapsamda, bitki örtüsü ve yaban hayatı özelliğine sahip, insanların dinlenme ve eğlenme amaçlı gittikleri yerleri olan tabiat parklarının, hem doğal yapısının bozulmaması hem de alana gelen ziyaretçilerin alanda oluşabilecek risklerden korunması gerekmektedir. Bu çalışma ile Çankırı Yapraklı Hazım Dağlı Tabiat Parkında karşılaşılabilecek tehlikeler, riskler ve alınabilecek önlemlerin İş Sağlığı ve Güvenliği açısından değerlendirilmesi, gerekli literatür taramaları ve arazi gözlemleri ile tespit edilmiştir. Hazım Dağlı Tabiat Parkı, İç Anadolu Bölgesi'nde yer alan Çankırı iline bağlı Yapraklı ilçesi sınırları içinde bulunmaktadır. Alanın büyüklüğü 126,03 ha olup, 2009 yılı itibarıyla tabiat parkı olarak ilan edilmiş ve 29 yıllığına özel sektöre kiraya verilmiştir. Ayrıca alan üzerinde SIT, RAMSAR, ÖÇK gibi herhangi bir koruma statüsü bulunmamaktadır. Bu bağlamda, alana rekreasyonel amaçla gelen ziyaretçiler için en önemli tehlikeler; doğal afetler (sel, yangın, deprem, yıldırım düşmesi), sabotaj- terör, güneş çarpması, zehirli hayvanların saldırısı, zehirli ve alerjik bitkiler, doğa-sportif aktivitelerde yaralanma ve sulak alanda boğulma riski olarak belirlenmiştir. Ziyaretçiler tarafından meydana gelecek tehlikeler ise; çevre kirliliği (egzos dumanı, atıklar), sigara içimi, mangal ve ateş yakma, bitki türlerine ve toprağa verilen zarar, yaban hayatının azalması, gürültü kirliliği olarak sıralanabilir. Sonuç olarak, gerek alanı işletenlerin gerekse de alana ziyaret amaçlı gelen kişilerin bilgilendirilmesi ve karşılıklı olarak gerekli tedbirlerin alınması ile belirlenen tehlikelerin kabul edilebilir seviyeye ineceği düşünülmektedir.

Anahtar Kelimeler: İş Sağlığı ve Güvenliği, Çankırı Yapraklı Hazım Dağlı Tabiat Parkı, Tehlike, Risk

Introduction

The notion of occupational health and safety comprises both the employees and systematic and scientific studies performed to avoid from the conditions which are hazardous to health occurring in the course of performing any task or activity concerning human and environment relations. For that reason, it is possible to talk about occupational health and safety everywhere people exist. Especially, the areas belonging to public or private and whatever the enterprises are in line with fully or partly production or recreational are in the important risk groups.

Thus, the natural parks which are in the status of “protected area” are evaluated as the areas with recreational potential. The visitors going to the natural parks which are part of the nature should conduct their recreational activities by minding the protection-utilization balance. Frankly, beside taking precautions for danger and risks that the visitors can face in the area and taking into consideration the damages given by the visitors consciously or unconsciously is important. In this case, we confront the health and safety applications in all areas, particularly in natural parks which are the subject of this article, where human-environment relation exists. Within this scope, in our country, in order to execute the health and safety applications more systematic, the Occupational Health and Safety Law released on 30.06.2012 along with proactive (preventive) approach was adopted, it has been applied to all employees working in all enterprises belonging to public and private sector without looking at their areas of activity and has become an emphasis in parallel with these developments.

In this article, it is aimed to determine the dangers, risks and precautions to be taken in terms of Occupational Health and Safety that can be faced in the Çankırı Yapraklı Hazım Dağlı Natural Park in order to enable the incorruption of the natural structure of the natural parks which have vegetation and wildlife where people go with the aim of recreation and entertainment and protection for the visitors against the risks that can occur in the area.

Risks that may occur in the Natural Parks and Occupational Health and Safety

Natural parks, different from the national parks, are part of the nature which have recreational, protection and tourism areas with rarely found national and international merely natural resource values. According to another definition, it can be explained as an area which has vegetation, wildlife and will provide landscape integrity and suitable for recreation and entertainment for the people. Such kind of areas are not as wide and in national level as national parks, but have resource values such as natural resources, cultural resources, entertainment-recreation and tourism resources. (Kapucu Yeşil, 2010)

According to the data obtained from Nature Protection and National Parks General Directorate, while the number of natural parks was 5 in 1990, this number has increased to 203 in 2015 (URL 1, 2016). Thereby, as the natural parks which have increased over the years have different resource values, they are utilized in different ways by the people. Foremost among them are recreational activities (camping, picnic, trekking, photography, hunting, monitoring the wildlife, sports activities, etc.), coming together with nature and landscape, discovering the cultures, scientific trips. On the other hand, the natural parks have various benefits in local, regional and national level in terms of resource values that they have. These can be financial, social, cultural as well as protecting the environment and landscape and the balance of the nature. Thus, the natural parks are valuable treasures in terms of the contributions that they provide for the nature and the people.

In this study, the Hazım Dağlı Natural Park, which is located in Central Anatolia Region, Çankırı Province and Yapraklı Town was examined. The size of the area is 126, 03 ha and it was announced as a natural park in 2009 and rented to private sector for 29 years. Moreover, the area has no protected status, such as protected area, international convention for the protection of wetlands, and special environment protection. The area provides a suitable environment for trekking,

camping and nature sports activities due to its natural diversity and land structure. Besides, it will have the characteristics to respond the activities such as photography, bike tours and bird watching with the planned landscape arrangements in the area. The area allowed to construct cottages as it has glades due to its structure and mild slope of the hillsides. The cottages which had already been constructed but have not been put into service will provide accommodation facilities for the one-day tourists (Anonymous, 2010a). Generally, the Hazım Dağlı Natural Park is used as one-day recreation and picnic area. There is a kiosk, fountains, barbecues, sitting facilities, picnic tables, a water tank, toilets, wash-up areas, a rain shelter, a transformer, a parking area and a pond (2.5 ha) for recreational activities in the area. And also there is a hut which controls the entrance and the exit. The area is visited mostly in summer and about 1800 people visit the area annually (Anonymous, 2010b). Despite all these opportunities, it determined in the area that

1. The wire fences around the pond are not appropriate for protection and there can be a risk of drowning,

2. The picnic activities in the area are disorganized and uncontrolled, despite the barbecue places, the visitors prefer to use their own barbecues therefore there is a visual pollution and fire risk,

3. The plant diversity and soil characteristics are damaged as the visitors picnicers park their cars near the picnic tables rather than the car park,

4. The number of litter bins in the area is insufficient and affect the environment and visitors negatively,

5. The caution signs in the area were pulled out by the visitors and thrown away casually,

6. There is no water flowing from the fountains which were built for the visitors and picnicers,

7. The roads which provide transportation in the area is insufficient in terms of quality,

8. The sitting facilities and picnic tables in the area placed for the visitors and picnicers are blasted,

9. The visitors and the picnicers shoot casually, so it creates a danger for both caution signs in the area, people and the wildlife,

10. The toilets in the area built for the visitors and picnicers are not in good condition and the number of them is insufficient,

11. There is no equipment for immediate treatment related to first aid for the health problems (e.g. Sunstroke, injuries due to natural or sports activities, venomous animal attacks, etc.) of the visitors and picnicers,

12. There is a control hut in the area, but mostly no full time security officer in the control hut in the area, so this situation will increase the damage to the area and danger probabilities that will be faced.

Conclusion

The dangers and risks that can be faced in terms of Occupational Health and Safety are determined as natural disasters (flood, fire, earthquake, stroke of lightning), sabotage-terror, sunstroke, venomous animal attacks, toxic and allergic plants, injuries due to natural-sports activities, drowning in the wetlands. The dangers caused by the visitors can be aligned as environmental pollution (exhaust fumes, wastes), smoking, barbecue and lighting a fire, the damage given to the plant species and the soil, the decrease in the wildlife and noise pollution.

Despite the announcement of natural parks as “protected areas”, it is a very important issue in terms of saving the existence of ecosystems, showing sensitivity, and handing down the next generations continuously. The areas that cannot be protected by the people not only give harm to ecologic balance which means giving harm to plants, soil and wildlife, but also affect the people living around these areas negatively in terms of ergonomically, physically and psychologically.

In conclusion, the areas with the characteristics of Natural Park should have the eligibility to respond the needs of people in terms of health and safety. In order to provide it, both the keepers of the areas and the visitors of the areas should be informed within the occupational health and safety approach and the precautions should be taken

mutually. It is thought that the determined dangers will decrease to an acceptable level and provide the sustainability of the areas within this context with the help of all these applications.

References

Anonymous, 2010a. T.C. Çevre ve Orman Bakanlığı, Doğa Koruma ve Milli Parklar Genel Müdürlüğü, Hazım Dağlı Tabiat Parkı Uzun Devreli Gelişme Planı –Sentez Raporu.

Anonymous, 2010b. T.C. Çevre ve Orman Bakanlığı, Doğa Koruma ve Milli Parklar Genel Müdürlüğü, Hazım Dağlı Tabiat Parkı Uzun Devreli Gelişme Planı- Analitik Etüt Raporu

Kapucu Yeşil G., 2010. Tabiat Parkı: Türkiye ve Almanya karşılaştırması. Yüksek Lisans Tezi, İstanbul Teknik Üniversitesi, Fen Bilimleri Enstitüsü, 127s., İstanbul.

URL 1, 2016. Doğa Koruma ve Milli Parklar Genel Müdürlüğü, <http://www.milliparklar.gov.tr/korunanalanlar/tp.htm>.

Determination and Assessment of Some Heavy Metal Pollution Soils of Urban Parks in Bingöl Province

*Yasin DEMİR¹, Azize DOĞAN DEMİR¹, Alperen MERAL¹, Ezgi DOĞAN¹

¹Bingol University, Faculty of Agriculture, BİNGÖL/TURKEY

*Corresponding Author: ydemir@bingol.edu.tr

Abstract

The aim of this study the concentration of heavy metals was to determine in the soil in some city parks in Bingol province. For this purpose, the designated parks from taken were and analyzed in 12 soil samples. Cadmium lead, zinc, copper, chromium, iron, nickel and cobalt concentrations are determined in soil samples taken from the city parks. Usually, contents of all elements were determined in lower values. In all the parks wasn't determined Lead. In the city parks the lands the low concentration of heavy metal content shown as the reason for the lack of industrial activity and traffic in Bingol province.

Keywords: Heavy Metal, Soil pollution, Urban park soils

Özet

Bu çalışmanın amacı, Bingöl il merkezindeki bazı şehir parklarında toprakların ağır metal konsantrasyonlarını belirlemektir. Bu bağlamda belirlenen 12 parktan toprak örneği alınarak analiz edilmiştir. Şehir parklarından alınan toprak örneklerinde Kadmiyum, Kurşun, Çinko, Bakır, Krom, Demir, Nikel ve Kobalt elementlerinin konsantrasyonları belirlenmiştir. Genel olarak bütün elementlerin değerleri düşük bulunmuştur. Toprakların tümünde kurşun bulunmamıştır. Bingöl ilinde endüstriyel faaliyetler ve trafik yoğunluğunun az olması, şehir parklarındaki toprakların ağır metal içeriğinin düşük konsantrasyonlarda olmasının nedeni olarak gösterilebilir.

Anahtar Kelimeler: Ağır metal, Toprak kirliliği, Şehir park toprakları

Introduction

Soil pollution by heavy metals is a very important environmental problem worldwide (Alloway, 1995). Recently, with the development of the global economy, both type and content of heavy metals in the soil caused by human activities have by degrees increased, resulting in the degradation of the environment (Han et al., 2002; Sayyed and Sayadi, 2011; Jean-Philippe et al., 2012; Raju et al., 2013; Prajapati and Meravi, 2014).

Heavy metal pollution can be defined as an undesirable change in the physical, chemical or biological characteristics natural resources, that may or will harmfully affect animals and plants (Odum, 1971). Heavy metals have received the attention of researchers all over the world, mainly due to their harmful effects on plants. (Ekatarina and Jeliaskova 2001).

Heavy metals in urban soils may come from various human activities, such as industrial and energy production, construction, vehicle exhaust, waste disposal, as well as coal and fuel combustion (Komai, 1981; Ikeda and Yoda, 1982; Ritter and Rinefierd, 1983). Although there is occurs a industrial pollution in Bingol province, traffic pollution.

In previous studies, the amount of heavy metal content of the soil in the urban park was reported to be due to several factors These factors, was reported as the traffic conditions, human activity intensity distance and time to the city center. (Pfeiffer et al., 1991; Chen et al., 2005). In this study, is determined the some heavy metal content of the soil urban parks in Bingol.

Material and Methods

Bingol city, located in the east of Turkey. The annual average temperature at the Bingol is 12 °C, the annual evaporation 1202.5 mm and annual precipitation average is 936.0 mm (According to the National Meteorological Service, Bingol station, period 1959–2013). The population of the province is low but is intensive settlement in terms of people and traffic activity.

For this study, are determined 12 urban (Regression Area) parks (Table 1, Fig 1). Depending on the area of the parks, 3–6 sub-samples of the topsoil (0–5 cm) were collected in each park and mixed thoroughly to get a representative sample.

Table 1 Brief information of the parks investigated in Bingöl

Name of Parks	Area (ha)	History (years)	Distance of City (km)
R.A-1	0.77	5	1.36
R.A-2	0.72	6	2.66
R.A-3	0.95	6	2.44
R.A-4	3.42	25	0.45
R.A-5	1.25	12	2.35
R.A-6	0.65	7	2.89
R.A-7	1.15	12	2.34
R.A-8	1.55	16	2.75
R.A-9	0.45	14	3.08
R.A-10	1.45	6	2.58
R.A-11	0.87	12	3.11
R.A-12	0.79	10	2.78

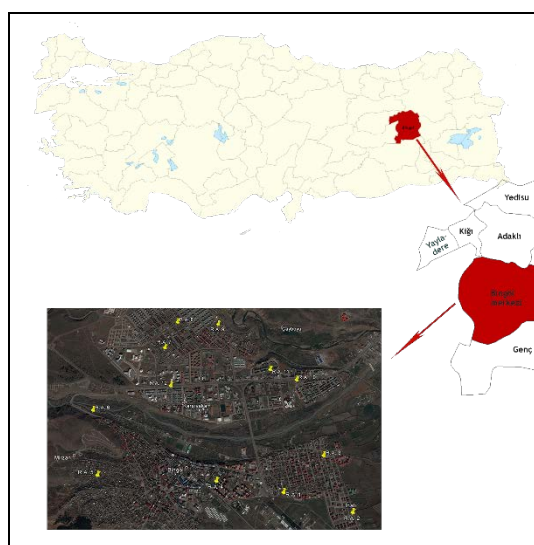

Figure 1. Map of Bingöl and the sampling parks

The soil samples were air-dried for approximately 24 h and sieved through a 2-mm sieve. The samples were analyzed for particle size distribution was determined by hydrometer (Richards, 1969). Soil organic matter was determined by the Walkley and Black method (Page et al., 1982). Calcium carbonate was measured volumetrically using the Scheibler apparatus and Hg-manometer. Electrical conductivity was determined in the saturation extract and pH in H₂O 1:2,5 (w/v) by electrode, following Jackson (1958). Fe,

Cu, Zn, Ni, Co, Pb and Cd concentrations were measured by atomic absorption spectrophotometry instrument.

Results and Discussion

Heavy metal pollution has an important role in environmental pollution. Today frequently used because of dangerous heavy metals are noteworthy features. Some heavy metals in the soil limit values shown in Table 2.

Table 2 Maximum permitted concentrations of heavy metals in soil (Anonymus 2016)

Heavy Metal	Concentration (mg.kg ⁻¹)	
	pH 5- 6	pH>6
Pb	50	300
Cd	1	3
Cr	100	100
Cu	50	140
Ni	30	75
Zn	150	300
Fe	-	-
Co	-	-

Basic soil properties of the research are presented in Table 3. According to these results, soil organic matter content is between %1.79 - %3.15, pH value between 7.03 and

8.11, EC value between 0.39 dS/m and 0.80 dS/m. in the same way soil CaCO₃ content is between % 0.28 and % 2.75. research soils are four generally that loamy structure. The

amount of organic matter has been found most R.A-4 and content of CaCO₃ most R.A-3.

Table 3 Basic soil properties of the research areas

Name of Parks	Texture	Organic Matter (%)	pH (1:2.5)	EC (dS/m)	CaCO ₃ (%)
R.A-1	SiC	2.88	8.11	0.63	1.01
R.A-2	L	2.14	7.95	0.77	1.83
R.A-3	L	1.79	7.93	0.39	2.75
R.A-4	C	3.15	7.61	0.54	2.48
R.A-5	CL	2.55	7.07	0.54	0.37
R.A-6	L	2.43	7.88	0.56	2.20
R.A-7	L	2.55	7.98	0.48	1.47
R.A-8	SiL	1.93	7.77	0.80	0.55
R.A-9	L	1.88	7.31	0.73	1.38
R.A-10	C	2.87	7.81	0.46	0.28
R.A-11	SiL	2.52	7.03	0.59	0.46
R.A-12	C	2.05	8.02	0.77	0.64

The concentrations of Pb, Cd, Ni, Co, Fe, Zn, Cu and Cr in urban park soils are given in Table 4. The heavy metal concentrations in the all park soils are generally low. The results obtained showed that heavy metal concentrations in the soils varied with different parks. Pb wasn't detected in all the park soils. There wasn't trace levels. Pb is usually caused by traffic and industrial gases. According to the results, the mean concentrations of Cd in R.A-11 were found higher than those in other area. Cadmium resources of our environment; dyes containing

cadmium, cigarette smoke, plastic additives are cadmium sulfide and zinc producing plant. Cadmium is known elements with more toxic effects of plant life (Jiang and Li, 1989). Similarly Ni concentration has been found most in R.A-11 were higher than those in other urban park soils. Pollution mainly results from effluent disposal from mining, smelting and electroplating industries, and from sewage sludge and compost (Karam et al., 1998). Ni²⁺ concentrations may reach 26 000 ppm in polluted soils (McGrath 1995).

Table 4 Heavy metal concentration (mg.kg⁻¹) in soil samples

Name of Parks	Heavy Metal (mg.kg ⁻¹)						
	Pb	Cd	Ni	Fe	Zn	Cu	Cr
R.A-1	0	0.07	0.60	2.08	12.35	3.1	2.73
R.A-2	0	0.06	0.55	2.54	3.85	2.0	3.15
R.A-3	0	0.11	0.98	5.98	25.25	3.3	4.41
R.A-4	0	0.10	0.88	4.94	18.6	3.7	5.73
R.A-5	0	0.11	0.37	5.58	3.8	2.0	4.66
R.A-6	0	0.16	1.08	3.69	10.45	3.0	3.05
R.A-7	0	0.17	1.03	5.08	20.15	3.1	2.39
R.A-8	0	0.20	1.08	4.58	10.35	3.9	1.36
R.A-9	0	0.23	1.34	5.16	5.1	6.0	0
R.A-10	0	0.26	1.53	1.44	2.8	3.0	1.55
R.A-11	0	0.34	2.46	10.35	7.0	6.2	0
R.A-12	0	0.33	2.15	3.89	5.8	5.4	0

Chromium has been made of with industrial oxidation of chromium-containing minerals and fossil fuels, the burning of wood and

paper products. The high chromium content (5.73 mg.kg⁻¹) is determined R.A-4 park soils. However, this value is not large enough to

cause toxic effects. Copper is an important metal for normal plant growth, although it is also potentially toxic (Yruela 2009). Copper, which is a material used in various fields, pollution caused by these elements, there are many sources. Cu concentration has (6.2 mg.kg^{-1}) been found most in R.A-11 were higher than other urban park soils. But it is below the limit value.

Iron is found in high levels in nature compared to other metals. Iron oxide is usually found as sulfate and carbonate compounds. Fe is an important metal for normal plant growth. According to results from analysis of soil samples, Fe content is determined in R.A-11 parks (10.35 mg.kg^{-1}) higher than other area. Concentration of iron in all the soil samples ranged between 1.44 to 10.35 mg.kg^{-1} . In all the soil samples concentration of iron was above the permissible limit. Zinc is one of the important trace elements that play a vital role in the physiological and metabolic process of many organisms (Nazir et al., 2015). Concentration of zinc in soil samples ranged between 2.8 to 25.25 mg.kg^{-1} . The highest values were found to R.A-3 parks. In the all soil samples concentration of zinc was recorded below the permissible limit.

Conclusions

The aim of this research work was to assess the concentration of some heavy metals and also some basic soils for urban parks, Bingöl province. According to the results, all values were below the limit values. Pb wasn't found all soil samples. R. A-11 park soils, in terms of some heavy elements (Ni, Cd, Cu and Fe) were found higher than the other parks.

References

Alloway B.J. 1995. Heavy metals in soils, 2nd ed. Blackie Academic and Professional, London
Anonymus. 2016. Ministry of Environment and Forestry, Turkey <http://www2.cevreorman.gov.tr/yasa/y/25831.doc>.
Chen T.B., Zheng Y.M., Lei M., Huang Z C., Wu H. T., Chen H., ... & Tian Q.Z. 2005. Assessment of heavy metal pollution in surface soils of urban parks in Beijing, China. *Chemosphere*, 60 (4), 542-551.
Ekatarina A., Jeliakova L.E. 2001. University of Massachusetts. Amherst, M.A, U.S.A, An internet review.

Han F.X., Banin A. 2002. Industrial age anthropogenic inputs of heavy metals into the pedosphere. *Naturwissenschaften*, 89 (11), 497-504.
Ikeda A., Yoda K. 1982. Soil pollution by heavy metals in Sakai City. *Japanese Journal of Ecology* 32, 241-249.
Jean-Philippe S.R., Labbé N., Franklin J.A. 2012. Detection of mercury and other metals in mercury contaminated soils using mid-infrared spectroscopy. *Proceedings of the International Academy of Ecology and Environmental Sciences*, 2 (3), 139-149.
Jiang W.Z., Li J.L. 1989. Effects of Cadmium on Photosynthetic Characteristics of Tobacco. *Plant Physiology Communications*, 6, 27-31.
Jackson M.L. 1958. *Soil Chemical Analysis*. Englewood Cliffs, New Jersey.
Karam N.S., Ereifej K.I., Shibli R.A., AbuKudais H., Alkofahi A., & Malkawi Y. 1998. Metal concentrations, growth, and yield of potato produced from In Vitro plantlets or microtubers and grown in municipal solid-waste-amended substrates. *Journal of plant nutrition*, 21 (4), 725-739.
Komai Y. 1981. Heavy metal contamination in urban soils: I. Zinc accumulation phenomenon in urban environments as clues of study. *Bulletin of the University of Osaka Prefecture*, 33, 7-15.
Nazir R., Khan M., Masab, M., Rehman H.U., Rauf N.U., Shahab S., ... & Shaheen Z. 2015. Accumulation of heavy metals (Ni, Cu, Cd, Cr, Pb, Zn, Fe) in the soil, water and plants and analysis of physico-chemical parameters of soil and water collected from Tanda Dam kohat. *Journal of Pharmaceutical Sciences and Research*, 7 (3), 89-97.
McGrath S.P. 1995. In heavy metals in soils (Ed: B. J. Alloway), 2nd ed., Blackie Academic and Professional, 152-174, London.
Odum E.P. 1971. *Fundamentals of ecology*, 3th ed: Saunders: Philadelphia, 574 p.
Raju K.V, Somashekar R.K, Prakash K.L. 2013. Spatio-temporal variation of heavy metals in Cauvery River basin. *Proceedings of the International Academy of Ecology and Environmental Sciences*, 3 (1), 59-75.
Richards L.A. 1969. *Diagnosis and improvement of saline and alkaline soils*. Agriculture Handbook vol. 60 U.S. Gov. Pr. Off., Washington.
Ritter C.J., Rinefield S.M. 1983. Natural background and pollution levels of some heavy metals in soils from the area of Dayton, OH. *Environmental Geology*, 5, 73-78.
Page A.L., Miller R.H., Keeney D.R. 1982. *Methods of soil analysis*, Part 2, 2nd edn. Agronomic Monograph, vol. 9. American Society

of Agronomy and Soil Science Society of America, Madison, WI. 1159 p.

Prajapati S.K., Meravi N. 2014. Heavy metal speciation of soil and *Calotropis procera* from thermal power plant area. Proceedings of the International Academy of Ecology and Environmental Sciences, 4 (2), 68-71.

Pfeiffer E.M., Freytag J., Scharpenseel H.W. 1991. Investigation of heavy metal and arsenic pollution of soils and plants in the urban area of Manila, Philippines. Mitteilungen der Deutschen Bodenkundlichen Gesellschaft, 66, 1169-1172.

Sayyed M.R.G., Sayadi M.H. 2011. Variations in the heavy metal accumulations within the surface soils from the Chitgar industrial area of Tehran. Proceedings of the International Academy of Ecology and Environmental Sciences, 1 (1), 36-46.

Yruela I. 2009. Copper in plants: acquisition, transport and interactions. Functional Plant Biology, 36 (5), 409-43

Antibiotic Resistance of *Bacillus* Species Isolated from Diesel Fuel Polluted Soil

*Belgin ERDEM¹, Alpaslan DAYANGAÇ¹, Merve GÜNAYDIN¹
¹Ahi Evran University, Faculty of Arts and Sciences, Kırşehir/TURKEY
*Corresponding Author: berdem@ahievran.edu.tr

Abstract

The present study, The resistance of antibiotics were examined in *Bacillus subtilis* and *Bacillus cereus* bacteria isolated from 50 samples of soils contaminated with diesel fuel. Six of these isolates as *B. cereus* and 18 of other isolates as *B. subtilis* were morphologically and biochemically characterized. A total of 24 bacterial strains were isolated and tested for their resistance against 10 antibiotics (cefuroxime, amoxicillin, cefazolin, cephalothin, vancomycin, ciprofloxacin, erythromycin, amikasin, gentamycin and tetracylin). The isolate was resistant to cefuroxime, amoxicillin, cefazolin, cephalothin and vancomycin. Also, it was sensitive to ciprofloxacin and intermediate sensitive to amikasin, erythromycin, gentamycin and tetracylin. Kirby-Bauer antibiotic sensitivity test using a basic disc agar diffusion procedure are used. Most of the isolates had have antibiotic resistance. Thus, These isolated strains are useful for enhancing the biotreatment of diesel fuel in soil. These strains isolated diesel fuel polluted soil are provide plant growth under stressful conditions. Bacterial strains are usable against forest pathogenic fungi as biological control agents and These bacteria protect the forest ecosystem. In addition to, These bacterial species can be used as biocontrol and bioremediation agents for health of forest, natural plant and tree ecosystems.

Keywords: *Bacillus* spp., Antibiotics, Resistance, Soil, Diesel fuel

Dizel Yakıtla Kirlenen Topraktan İzole Edilen *Bacillus* Türlerinin Antibiyotik Direnci

Özet

Bu çalışmada, dizel yakıtı ile kirlenmiş 50 toprak örneğinden izole edilen *Bacillus subtilis* ve *Bacillus cereus* bakterilerinde antibiyotik direnci incelendi. *B. cereus* olarak bu izolatların 6'sı ve *B. subtilis* olarak diğer izolatların 18'i morfolojik ve biyokimyasal olarak karakterize edildi. Toplam 24 bakteri suşu izole edildi ve 10 antibiyotiğe (sefuroksim, amoksisilin, sefazolin, sefalotin, vankomisin, siprofloksasin, eritromisin, amikasin, gentamisin ve tetrasiklin) karşı dirençlilikleri test edilmiştir. İzolatlar sefuroksim, amoksisilin, sefazolin, sefalotin ve vankomisine dirençli oldu. Ayrıca, siprofloksasine duyarlı ve amikasine, eritromisin, gentamisin ve tetrasiklin orta derecede duyarlıdır. Temel disk agar difüzyon prosedürü kullanılarak Kirby-Bauer antibiyotik duyarlılık testi kullanılmıştır. İzolatların çoğunda antibiyotik direnci vardı. Bu nedenle, Bu izole edilmiş suşlar topraktaki dizel yakıtların biyolojik arıtma işlemi geliştirmek için yararlıdır. Dizel yakıtla kirlenmiş topraklardan izole edilen bu suşlar stresli koşullar altında bitki gelişimini sağlar. Bakteri suşları biyolojik kontrol ajanları olarak orman patojenik mantarlara karşı kullanılabilir ve bu bakteriler orman ekosistemini korur. Buna ek olarak, Bu bakteri türleri orman, doğal bitki ve ağaç ekosistemlerinin sağlığı için biyolojik kontrol ve biyoremediasyon ajanları olarak kullanılabilir.

Anahtar kelimeler: *Bacillus* spp., Antibiyotiklere Direnç, Toprak, Dizel yakıt

Introduction

Soil contamination with petroleum products causes production and transportation of diesel fuel. Petroleum Pollution are causing a lot of damage to human and animal health (Xu and Lu, 2010). Disposal and accidental leakage of petroleum products (gasoline, kerosene, diesel fuel) creates hazard to the environment and human health.

Soils contaminated with hydrocarbons accumulation of pollutants in plant and animal tissue can cause death and mutations (Alvarez and Vogel, 1991).

The vast majority of antibiotic resistant genes (ARG) acquired by human pathogens could be epidemiologically significant (Knapp et al., 2011). Because heavy metals and antibiotic resistance genes are found on the same mobile genetic elements and metal pollution of environmental causes the

emergence of antibiotic resistance of organisms (Baker-Austin, et al., 2006; Ben Said, et al., 2008; Knapp et al., 2011).

Indigenous microorganisms or exogenous microorganisms to toxins or remove contaminants capabilities are degradation of many environmental pollutants problem including the products of petroleum industry (Medina-Bellver et al., 2005; Das and Chandran, 2011). Petroleum and hydrocarbon pollutants can be removed from the environment by hydrocarbonoclastic bacteria that might be suitable for bioremediation (Máthé et al., 2012; Hesnawi and Mogadami, 2013).

Petroleum spill remains a huge problem by contaminating land and water, thus propose to be major environmental pollutants. Discharges of petroleum hydrocarbon and petroleum waste streams have caused environmental pollution and human health effects (Ite et al., 2013; Zhou, 2015).

Antibiotic resistance appeared a result of use excessive and inappropriate use of antibiotics. It has been shown in studies in recent years that Soil bacteria exhibit to the increase in antibiotic resistance virtually every environment. Because Bacteria species become resistant, Many diseases have become difficult to treat. Antibiotic resistance occurs when bacteria change in the genetic and Thus, can occur genetic mutation or transfer of antibiotic resistance genes between bacteria in the environment. Microorganisms lead to the mutations that will allow them better to survive under the variable environmental conditions such as crude oil, hydrocarbon, diesel fuel, disinfectants, heavy metals and antibiotics (Baquero et al., 1998; Máthé et al., 2012; Zhou et al., 2015). Non-pathogenic organisms in environment serve as source of pathogens can acquire genes resistance by acquiring genes from pathogens into the environment (Krishna et al., 2014).

The purpose of this study was to isolation of *B. subtilis* and *B. cereus* bacteria from soil contaminated with diesel fuel, determine the antibiotic resistance.

Materials and Methods

Sample collection

Soil samples were collected from contaminated soil on diesel fuel spilled different 10 areas, Kırşehir, Turkey. Soil samples were collected at a depth of 15 to 20 cm from the surface after removing the top layer. Soil Samples were taken into sterilized plastic bags and transferred for microbial analysis the laboratory under aseptic conditions.

Isolation of bacteria

Isolation of bacteria were carried by standard serial dilutions of the samples were made up to 10^{-5} dilutions, spread on nutrient agar plates and incubated for 24 h at 37°C. In the current study, 24 bacterial strains were isolated from soil. The strains were identified as *B. subtilis* and *B. cereus* on the basis of morphological and biochemical characteristics, including endospore staining. Colonies were subcultured and maintained to obtain a pure culture on nutrient agar plates.

Antibiotic resistance analysis

Isolates (*B. subtilis* and *B. cereus*) were tested for resistance to antibiotics by means of a disc diffusion method. The bacteria were investigated using antibiotics disc containing cefuroxime (30 mcg/disc), amoxicillin (20 mcg/disc), cefazolin (30 mcg/disc), cephalothin (30 mcg/disc), erythromycin (15 mcg/disc), amikacin (30 mcg/disc), vancomycin (30 mcg/disc), tetracylin (30 mcg/disc), gentamycin (10 mcg/disc) and ciprofloxacin (5 mcg/disc). Isolates were grown in nutrient broth for 16-18 hours. Then, the grown cultures of *B. subtilis* and *B. cereus* isolates were spread surface Nutrient agar using sterile swabs. The plates were incubated at 37°C for 18-24 hrs. Kirby-Bauer testing measures sensitivity of bacteria to antibiotics by culturing bacteria and comparing the observed zone of inhibition's size to known values of antimicrobial drugs. Later, interpreted as sensitive, intermediate, or resistant, based on the size of the zone of inhibition (Ghaima et al., 2013).

Results

The diesel fuel contaminated soil samples were isolated total 24 isolates. These isolates were purified from the soil sample on the basis of colony morphology, texture, growth. The observation showed that 18 out of 24 isolates were *B. subtilis* remaining 6 were *B. cereus*.

Fifty Samples of soil contaminated with diesel fuel from 10 various places throughout were collected Kırşehir and 24 isolates identified as rod of spore former

(*Bacillus* spp.) by morphological and microscopic characteristics and according to their biochemical characteristics (Nwaogu et al., 2008). *B. subtilis* 18 of these isolates (BS1, BS2, BS3, BS4, BS5, BS6, BS7, BS8, BS9, BS10, BS11, BS12, BS13, BS14, BS15, BS16, BS17 and BS18) and *B. cereus* 6 of these isolates (BC1, BC2, BC3, BC4, BC5 and BC6) were identified in polluted soil with diesel fuel.

Table 1. Antibiotic resistance of *B. subtilis* and *B. cereus* isolated from soil sample contaminated with diesel fuel

Strains	CXM30	AMC30	CZ30	CF30	E15	AK30	VA30	TE30	GM10	CIP5
BS1	(R)	(R)	(R)	(R)	32(S)	24(S)	10(R)	10(R)	16(I)	30(S)
BS2	(R)	(R)	(R)	(R)	16(R)	12(R)	8(R)	(R)	10(R)	20(S)
BS3	(R)	(R)	(R)	(R)	20 (S)	20 (S)	(R)	8(R)	16(I)	30(S)
BS4	(R)	(R)	(R)	(R)	22(S)	28(S)	6(R)	(R)	10(R)	22(S)
BS5	(R)	(R)	(R)	(R)	22(S)	22(S)	6(R)	(R)	10(R)	22(S)
BS6	(R)	(R)	(R)	(R)	32(S)	20 (S)	16(I)	(R)	28 (S)	32(S)
BS7	(R)	(R)	(R)	(R)	30(S)	24(S)	(R)	8(R)	10(R)	26(S)
BS8	(R)	(R)	(R)	(R)	(R)	20(S)	12(R)	24 (S)	18(I)	22(S)
BS9	(R)	(R)	(R)	(R)	20(S)	14(R)	10(R)	20(S)	10(R)	20(S)
BS10	(R)	(R)	(R)	(R)	20(S)	16(I)	10(R)	22(S)	22 (S)	20(S)
BS11	(R)	(R)	(R)	(R)	20(S)	16(I)	8(R)	(R)	20(S)	20(S)
BS12	(R)	(R)	(R)	(R)	20(S)	(R)	6(R)	16(I)	10(R)	20(S)
BS13	(R)	(R)	(R)	(R)	(R)	20(S)	10(R)	22(S)	20(S)	28(S)
BS14	(R)	(R)	(R)	(R)	20(S)	22(S)	(R)	16(I)	16(I)	32(S)
BS15	(R)	(R)	(R)	(R)	20(S)	26(S)	(R)	4(R)	20(S)	20(S)
BS16	(R)	(R)	(R)	(R)	24(S)	26(S)	8(R)	(R)	16(I)	30 (S)
BS17	(R)	(R)	(R)	(R)	20(S)	16(I)	10(R)	(R)	16(I)	20(S)
BS18	(R)	(R)	(R)	(R)	20(S)	30(S)	(R)	(R)	16(I)	20(S)
BC1	(R)	(R)	(R)	(R)	20(S)	20(S)	16(I)	(R)	10(R)	20(S)
BC2	(R)	(R)	(R)	(R)	20(S)	16(I)	10(R)	20(S)	16(I)	30(S)
BC3	(R)	(R)	(R)	(R)	30(S)	20(S)	8(R)	10 (R)	16(I)	30(S)
BC4	(R)	(R)	(R)	(R)	(R)	16(I)	10(R)	26(S)	14(R)	32(S)
BC5	(R)	(R)	(R)	(R)	18(I)	30(S)	10(R)	(R)	10(R)	20(S)
BC6	(R)	(R)	(R)	(R)	20(S)	16(I)	(R)	(R)	16(I)	36(S)

The average diameter of the inhibition zones (mm)
S- susceptible; R- resistant; I- intermediate resistance.

Antibiotic-Resistance Assay

B.subtilis and *B.cereus* strains which showed multiple resistances against 5 antibiotics (CXM30, AMC30, CZ30, CF30 and VA30).

The highest susceptibility was observed in strains *B.subtilis* BS1, BS6 and BS7 and *B.cereus* BC3, BC4 and BC6 which were sensitivity against Ciprofloxacin(CIP5µg), Erythromycin (E15µg), Amikacin(AK30µg)

and respectively (Table 1). *B. subtilis* and *B. cereus* isolated from soil contaminated with diesel fuel exhibited resistance to most of the tested antibiotics (Table 1). Although the isolates were resistant to cefuroxime, amoxicillin, cefazolin, cephalothin and vancomycin, it was sensitive to ciprofloxacin and intermediate sensitive to amikasin, erythromycin, gentamycin and tetracylin.

Discussion

Gram-positive bacteria seems to be more resistant including hydrocarbons, antibiotic drugs, and heavy metals (Ghaima et al., 2013). In addition to, Gram negative bacteria has been reported to show high resistant hydrocarbons (Mittal and Singh, 2009; Das and Mukherjee, 2007). *Bacillus* can be used collective or utilize for survive in solvent rich petroleum contaminated soil (Edward et al., 2012).

B. subtilis and *B. cereus* isolated were studied resistance of antibiotics. It was found that the isolates exhibited resistance to most of the tested antibiotics. This may be arise the large number of antibiotic-resistant bacterial isolates from petroleum contaminated site in the presence of high concentration of heavy metals and toxic organic solvents (Nakahara et al., 1977; Holliger et al., 1997.). All the reports are consistent with our results and showed the correlation between organic solvent tolerance, heavy metals resistance and antibiotics resistance of our bacterial isolate. Antibiotic resistant and metal tolerant microorganisms which are ecologically important will adapt faster by the spread of R-factors. Thus, causing a rapid increase in their numbers (Bhattacharjee et al., 1988).

In our study, *B. subtilis* and *B. cereus* strains which showed multiple resistant; Cefuroxime, Amoxicillin, Cefazolin, Cephalothin and Vancomycin. On the other hand, All of these isolates were sensitive to the antibiotic Ciprofloxacin, and intermediate sensitive to amikasin, erythromycin, gentamycin, and tetracylin. Singh et al., (2010) stated that halotolerant *Bacillus cereus* SIU1 strain studied against antibiotic and heavy metal.

Ghaima et al., 2013 has reported that the isolate was resist to amoxillin, cloxacillin, cephalixin, ceftriaxone, cefoxitin and trimethoprim. Results of the present study in general consistent with those of other studies in which revealed high prevalence of multiple drug resistance (MDR) among the isolates. Krishna et al., (2014) revealed high prevalence of multiple antibiotic resistance (MAR) in soil microbes. This may be due to the metal induced indirect selection for antibiotic resistance.

Many investigators had been reported petroleum, diesel oil and different hydrocarbon-contaminated soil multiple drug-resistance (Kaszab et al., 2010, Kumari et al., 2013; Mathe et al., 2012).

Conclusions

Consequently, Our results revealed that isolates *B.subtilis* and *B.cereus* exhibited multiple resistance against antibiotics which could be potential agents for development of a soil inoculant applicable in bioaugmentation of heavy metal and hydrocarbon polluted industrial sites.

References

- Alvarez P. J. J., Vogel T.M. 1991. Substrate interactions of benzene, toluene, and para-xylene during microbial degradation by pure cultures and mixed culture aquifer slurries. *Applied and Environmental Microbiology*, 57 (10), 2981–2985.
- Baker-Austin C., Wright M.S., Stepanauskas R., McArthur JV. 2006. Co-selection of antibiotic and metal resistance. *Trends in Microbiology*, 14 (4), 176-182.
- Baquero, F., Negri M.C., Morosini M.I., Blazquez J. 1998. Antibiotic-selective environments. *Clinical Infectious Diseases*, 27 (Suppl 1), S5-S11.
- Ben Said O., Goñi-Urriza M.S., El Bour M., Dellali M., Aissa P., Duran R. 2008. Characterization of aerobic polycyclic aromatic hydrocarbon-degrading bacteria from Bizerte lagoon sediments, Tunisia. *Journal of Applied Microbiology*, 104 (4), 987-997.
- Bhattacharjee J.W., Pathak S.P. Gaur A. 1988. Antibiotic resistance and metal tolerance of coliform bacteria isolated from Gomti river water at Lucknow city. *The Journal of General and Applied Microbiology*, 34 (5), 391–399.
- Das K., Mukherjee A.K. 2007. Crude petroleum-oil biodegradation efficiency of *Bacillus subtilis* and *Pseudomonas aeruginosa* strains isolated from a petroleum-oil contaminated soil from North-East India. *Bioresource Technology*, 98 (7), 1339–1345.
- Das N., Chandran P. 2011. Microbial degradation of petroleum hydrocarbon contaminants: an overview. *Biotechnology Research International*, 2011, 1-13.
- Edward A., Melchias G., Kumar S.S. 2012. An investigation on organic solvents tolerance, heavy metals and antibiotics of *Bacillus oleronius* from petroleum contaminated soil. *Nature and Science*, 10 (10), 69-75.

- Enne V.I., Livermore D.M., Stephens P., Hall L.M. 2001. Persistence of sulphonamide resistance in *Escherichia coli* in the UK despite national prescribing restriction. *Lancet*, 357(9265), 1325-13280.
- Ghaima K.K., Al Draghi W.A., Lateef N.S. 2013. Study the heavy metals tolerance, biosorption and antibiotic resistance of *Bacillus cereus* isolated from diesel fuel polluted soil.” *International Journal of Biological & Pharmaceutical Research*, 4 (7), 502–506.
- Hesnawi R.M., Mogadami F. S. 2013. Bioremediation of Libyan crude oil contaminated soil under mesophilic and thermophilic condition. *APCBEE Procedia*, 5, 82-87.
- Holliger C., Gaspard S., Glod G., Heijman C., Schumacher W., Schwarzenbach R.P., Vazquez F. 1997. Contaminated environments in the subsurface and bioremediation: organic contaminants. *FEMS Microbiology Reviews*. 20 (3-4), 517–523.
- Ite A. E., Ibok U. J., Ite M.U., Petters S.W. 2013. Petroleum Exploration and Production: Past and Present Environmental Issues in the Nigeria’s Niger Delta. *American Journal of Environmental Protection*, 1(4), 78-90.
- Kaszab E., Kriszt B., Atzél B., Szabó G., Szabó I., Harkai P., Szoboszlai S. 2010. The occurrence of multidrug-resistant *Pseudomonas aeruginosa* on hydrocarbon-contaminated sites. *Microb. Ecol.* 59 (1), 37–45.
- Knapp C.W., McCluskey S.M., Singh B.K., Campbell C.D., Hudson G., Graham D.W. 2011. Antibiotic resistance gene abundances correlate with metal and geochemical conditions in archived Scottish soils. *PLoS ONE* 6(11), e27300.
- Krishna M. P., Varghese R., Thoma D. M., Mohamed Hatha A. A. 2014. Multiple antibiotic resistance of environmental bacteria isolated from heavy metal polluted industrial region. *Trakia Journal of Sciences*, 2, 109-113.
- Kumari N., Vashishtha, A., Saini P., Menghani E. 2013. Isolation identification and characterization of oil degrading bacterial isolate from the contaminated sites of Barmu, Rajasthan. *International journal of biotechnology and bioengineering research*, 4 (5), 429-436.
- Máthé I., Benedek T., Tánácsics A., Palatinszky M., Lányi S., Márialigeti K. 2012. Diversity, activity, antibiotic and heavy metal resistance of bacteria from petroleum hydrocarbon contaminated soils located in Harghita County (Romania). *Int. Biodeterior. Biodegrad.* 73, 41–49.
- Medina-Bellver J¹, Marín P, Delgado A, Rodríguez-Sánchez A, Reyes E, Ramos JL, Marqués S. 2005. Evidence for in situ crude oil biodegradation after the Prestige oil spill. *Environmental Microbiology*, 7 (6), 773–779.
- Mittal A., Singh P. 2009. Isolation of Hydrocarbon-Degrading Bacteria from Soils Contaminated with Crude Oil Spills. *Indian Journal of Experimental Biology*, 47(9), 760-765.
- Nakahara H., Ishikawa T., Sarai Y., Kondo I. 1977. Frequency of heavy-metal resistance in bacteria from inpatients in Japan. *Nature*. 266 (5598), 165-167.
- Nwaogu L.A., Onyeze G.O..C., Nuabueze R.N. 2008. Degradation of diesel oil in a polluted soil using *Bacillus subtilis*. *African Journal of Biotechnology*, 27 (12), 1939- 1943.
- Saul D.J., Aislabie J.M., Brown C.E., Harris L., Foght J.M. 2005. Hydrocarbon contamination changes the bacterial diversity of soil from around Scott Base, Antarctica. *FEMS Microbiology Ecology*. 53 (1), 141-155.
- Singh S.K., Tripathi V.R., Jain R.K., Vikram S., Garg S.K. 2010. An antibiotic, heavy metal resistant and halotolerant *Bacillus cereus* SIU1 and its thermoalkaline protease. *Microbial Cell Factories*, 9 (59), 1-7.
- Zhou Y., Xu Y.B., Xu J.X., Zhang X.H., Xu S.H., Du Q.P. 2015. Combined toxic effects of heavy metals and antibiotics on a *Pseudomonas fluorescens* strain zy2 isolated from swine wastewater. *International Journal of Molecular Sciences*, 16 (2), 2839–2850.
- Xu Y., Lu M. 2010. Bioremediation of crude oil-contaminated soil: comparison of different biostimulation and bioaugmentation treatments. *J Hazard Mater.*, 183(1-3):395-401.

