

Audio

THE AUTHORITATIVE MAGAZINE ABOUT HIGH FIDELITY

30th
Anniversary Issue

MAY 1977 \$1.00

47425



What You Don't Know,
HURTS!

Trends in Audio

How We Hear?

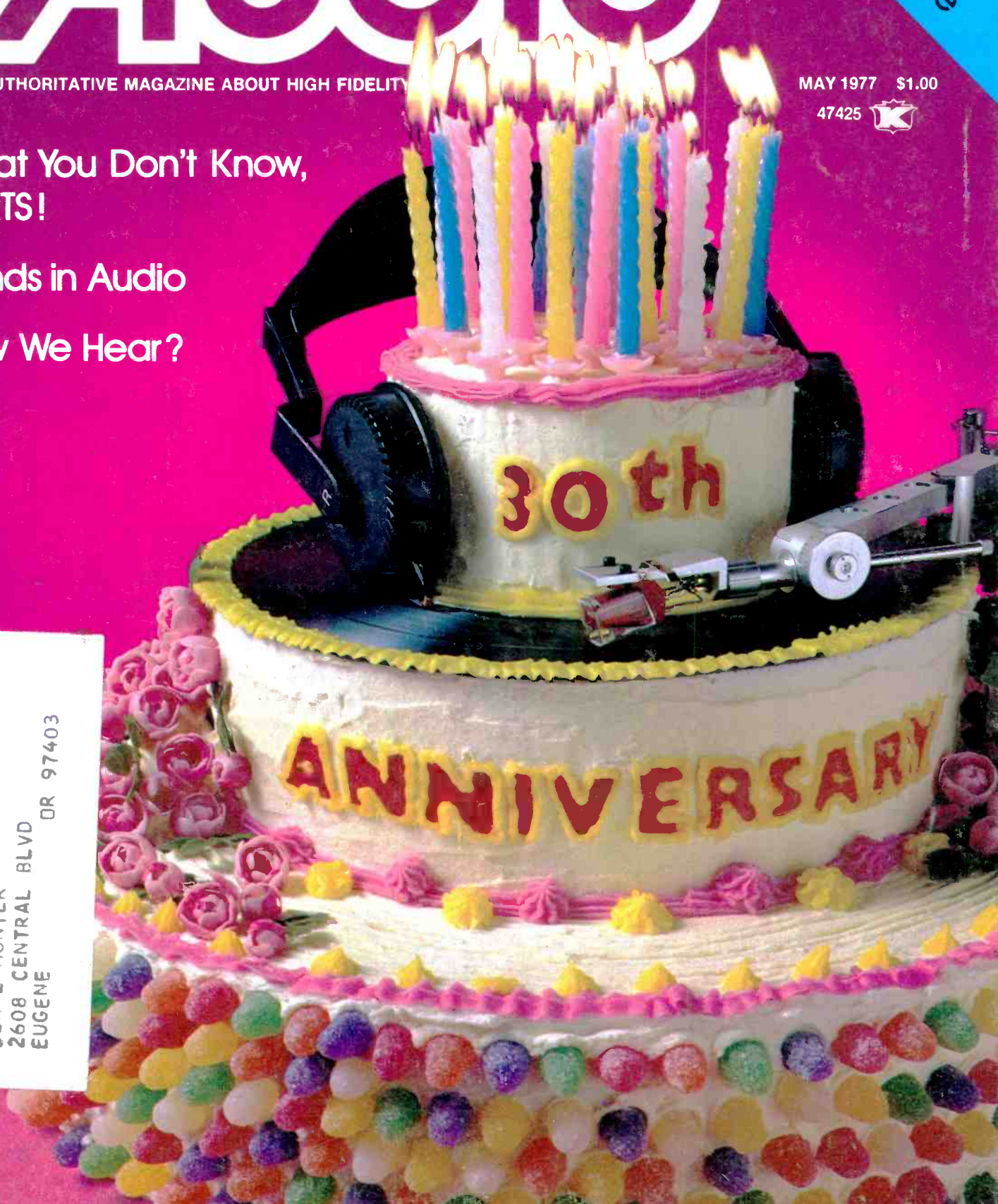

U0803760 0477 60616013P0201312
DON L HUNTER
2608 CENTRAL BLVD
EUGENE OR 97403

The high price.

For under \$200*, you can
now own the direct-drive PL-510.



*For informational purposes only. The actual resale prices will be set by the individual Pioneer dealer at his option.

Pioneer has
conquered the one
big problem of
high-priced
turntables.



The best way to judge the new Pioneer PL-510 turntable is to pretend it costs about \$100 more. Then see for yourself if it's worth that kind of money.

First, note the precision-machined look and feel of the PL-510.

The massive, die-cast, aluminum-alloy platter gives an immediate impression of quality. The strobe marks on the rim tell you that you don't have to worry about perfect accuracy of speed. The tone arm is made like a scientific instrument and seems to have practically no mass when you lift it off the arm rest. The controls are a sensuous delight to touch and are functionally grouped for one-handed operation.

But the most expensive feature of the PL-510 is hidden under the platter. Direct drive. With a brushless DC servo-controlled motor. The same as in the costliest turntables.

That's why the rumble level is down to -60 dB by the JIS standard. (This is considerably more stringent than the more commonly used DIN "B" standard, which would yield an even more impressive figure.) And that's why the wow and flutter remain below 0.03%. You can't get performance like that with idler

drive or even belt drive. The PL-510 is truly the inaudible component a turntable should be.

Vibrations due to external causes, such as heavy footsteps, are completely damped out by the PL-510's double-floating suspension. The base floats on rubber insulators inside the four feet. And the

turntable chassis floats on springs suspended from the top panel of the base. Stylus hopping and tone arm skittering become virtually impossible. (Even the turntable mat is made of a special vibration-absorbing material.)

But if all this won't persuade you to buy a high-priced turntable, even without the high price, Pioneer has three other new models for even less.

The PL-117D for under \$175* The PL-115D for under \$125* And the amazing PL-112D for under \$100*

None of these has a rumble level above -50 dB (JIS). None of them has more wow and flutter than 0.07%.

So it seems that Pioneer has also conquered the one big problem of low-priced turntables.

The low performance. U.S. Pioneer Electronics Corp., 75 Oxford Drive, Moonachie, New Jersey 07074.

Turntable:

- Direct drive
- Brushless DC servo-controlled motor
- 33½ and 45 RPM speeds
- Strobe light
- Strobe-calibrated platter rim
- ±2% fine adjustment of speeds
- Double-floating system of suspension
- Turntable mat of high-internal-loss rubber
- One-handed operation of controls

Tone arm:

- Lightweight S-shaped tubular design
- Static balance
- Ball-bearing pivot with angular contact
- Anti-skating device
- Lateral balancer
- Direct-readout counterweight
- Viscous-damped cueing
- Lightweight plug-in headshell

 **PIONEER®**

Anyone can hear the difference.

Enter No. 28 on Reader Service Card

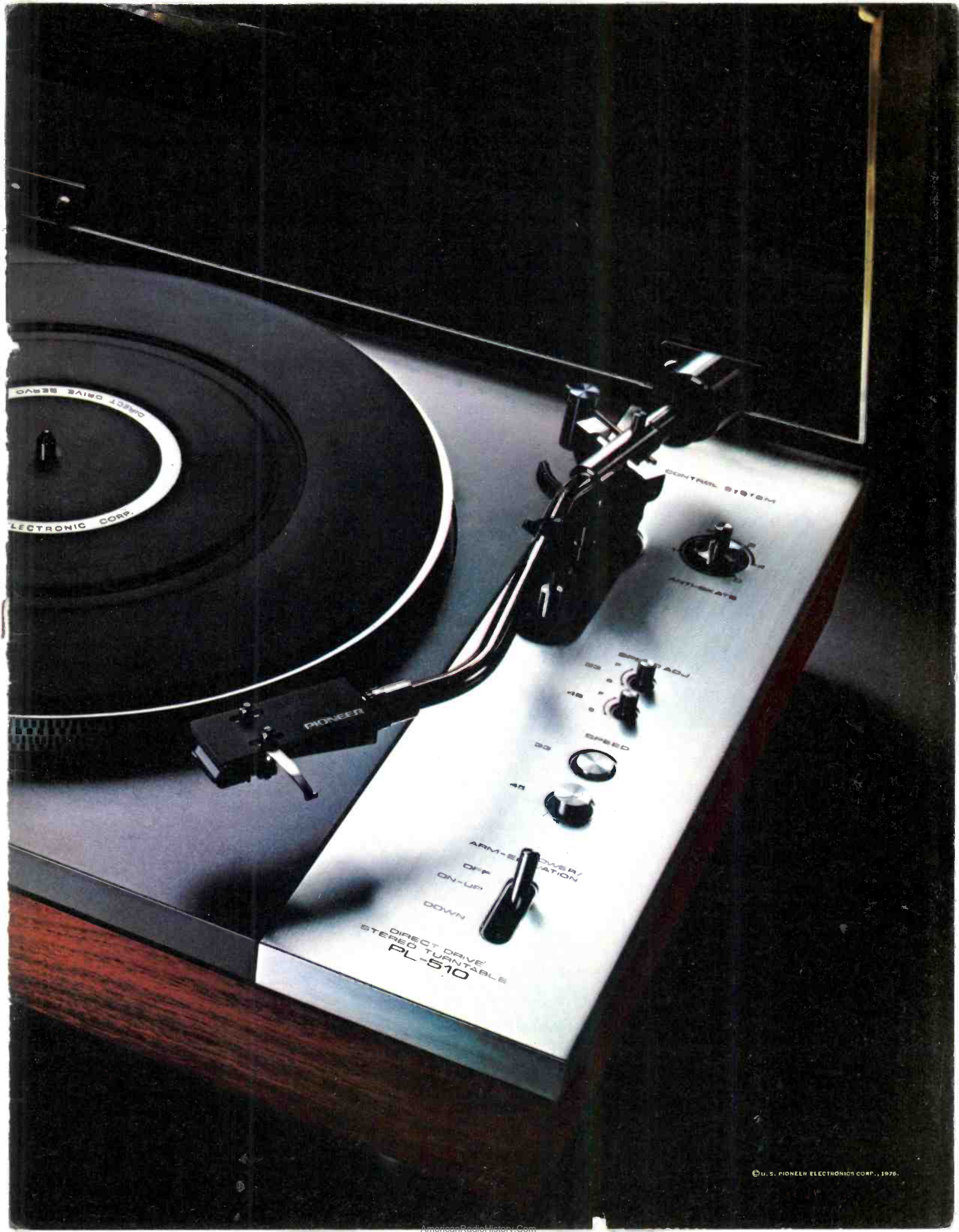

DIRECT DRIVE SERVO
PIONEER ELECTRONIC CORP.

CONTROL SYSTEM

BYPASS

SPEED ADJ.

SPEED

PUSH-TO-POWER/
STATION

OFF
ON-UP
DOWN

DIRECT DRIVE
STEREO TURNTABLE
PL-510

The Very First DIRECT-TO-DISC Of a Full Orchestral Production

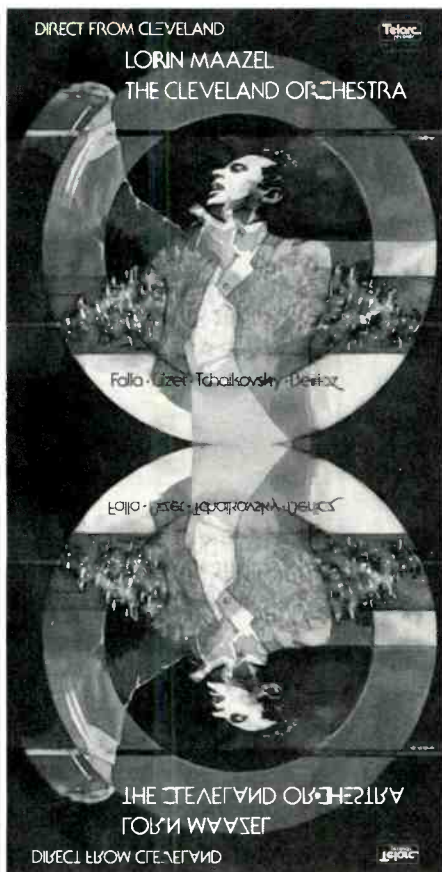

A record of incredible
fidelity from an incredible
performance of Berlioz,
Bizet, Falla and Tchaikovsky.

- \$16 (\$15 plus \$1 shipping handling) from TELAR RECORDS 4150 Mayfield Roc Cleveland, Ohio 44121.

- and at the world's finest record and audio stores.

Exclusively distributed worldwide
by the Discwasher Group.



1407 N. Providence Rd.
Columbia, MO 65201

Audio

May 1977

"Successor to **RADIO** Est. 1917"

Vol. 61, No. 5

Feature Articles	32	What You Don't Know, Hurts!/Jacob C. Turner
	38	Build A Low-Noise Preamp With Weighting Filters/M.J. Salvati
	48	Thirty Years Of Audio/Norman Eisenberg
	54	The Physiology Of Hearing/Dr. A. Joseph Ray, Jr. Ph.D.
	91	The Bookshelf: <i>Jazz People</i> by Dan Morgenstern & Ole Brask/John Lissner

Equipment Profiles	66	Pioneer TX-9500-II AM/FM Tuner/Leonard Feldman
	72	DB Systems DB-1 Preamplifier & DB-4 Moving Coil Pre-Preamp/George Pontis
	80	Technics RS-1500US Open-Reel Tape Recorder/Howard A. Roberson

Record Reviews	86	The Column/Michael Tearson & Jon Tiven
	92	Tape & Turntable/Bert Whyte
	94	Jazz & Blues
	98	Classical/Edward Tatnall Canby

Audio In General	4	Audioclinic/Joseph Giovanelli
	6	Dear Editor
	8	Audio ETC/Edward Tatnall Canby
	20	Tape Guide/Herman Burstein
	22	Behind The Scenes/Bert Whyte
	30	What's New In Audio
	103	Classified Advertising
	106	Advertising Index

Editor Eugene Pitts III

Associate Editors

Edward Tatnall Canby
Bert Whyte

Assistant Editor Eugene J. Garvin Jr.

Marketing Director Sanford L. Cahn

Design Frank Moore

Circulation Manager Jean Davis

Advertising Production Gloria Klaiman

Senior Editors

Richard C. Heyser
Bascom H. King
B.V. Pisha

Contributing Editors:

Tom Bingham, Herman Burstein,
Leonard Feldman, Joseph Giovanelli,
C.G. McProud, Dan Morgenstern,
Howard A. Roberson, Jon Sank,
Donald M. Spoto, Michael Tearson,
George W. Tillet, Jon Tiven.

Publisher Jay L. Butler

About the Cover: The cake is in celebration of *Audio Magazine's* 30th anniversary. Over the years we've recorded both the fads and phenoms; for a focus on a few, see Norm Eisenberg's article "Thirty Years of Audio" on page 48.

AUDIO (title registered U.S. Pat. Off.) is published monthly by North American Publishing Co., Irvin I. Borowsky, President, Frank Nemeyer and Jay L. Butler, Vice Presidents, Harry Feld, Treasurer, Joseph Florentine, Chief Financial Officer, Mary Clafey, Secretary & Circulation Director, R. Kenneth Baxter, Vice President/Manufacturing, Sanford L. Cahn, Marketing Director, Mary Anderson, Production Director, John Nolan, Corporate Art Director, Vic Brody, Promotion Director

Subscription Rates: United States only, 1 year for \$8.00, 2 years for \$14.00, 3 years for \$20.00, outside the U.S., 1 year for \$10.00, 2 years for \$18.00, 3 years for \$26.00. Printed in U.S.A. at Columbus, Ohio. All rights reserved. Entire contents copyrighted 1977 by North American Publishing Co. Second class postage paid at Philadelphia, PA and additional mailing office. Back issues, \$2.00 each. **World Library Congress Number:** ISSN 0004-752X

Dewey Decimal Number: 621.381 or 778.5

National Sales Office: Jay L. Butler, Publisher, 545 Madison Ave., New York, NY 10022 Telephone (212) 371-4100

West Coast Sales Office: Jay Martin, 2525 West 8th St., Los Angeles, CA 90057 Telephone (213) 385-2917

Continental European Representative: V.B. Sanders, International Publishers Advertising Service, Raadhuisstraat 24, P.O. Box 25, Graft-De Ryp, Holland Telephone, 02997-1303; telegams, Euradteam—Amsterdam



AUDIO Publishing, Editorial, and Advertising Production offices, North American Building, 401 No. Broad St., Philadelphia, PA 19108 Telephone (215) 574-9600 Postmaster Send Form 3579 to above address

EDITORIAL CONTRIBUTIONS are welcomed but should be accompanied by return postage. Submissions will be handled with reasonable care, but the publisher assumes no responsibility for return or safety of manuscripts, photographs, or artwork.



According to TRUTONE RECORDS..“The Stanton calibrated 681 series is our total point of reference in our Disc Mastering Operation”

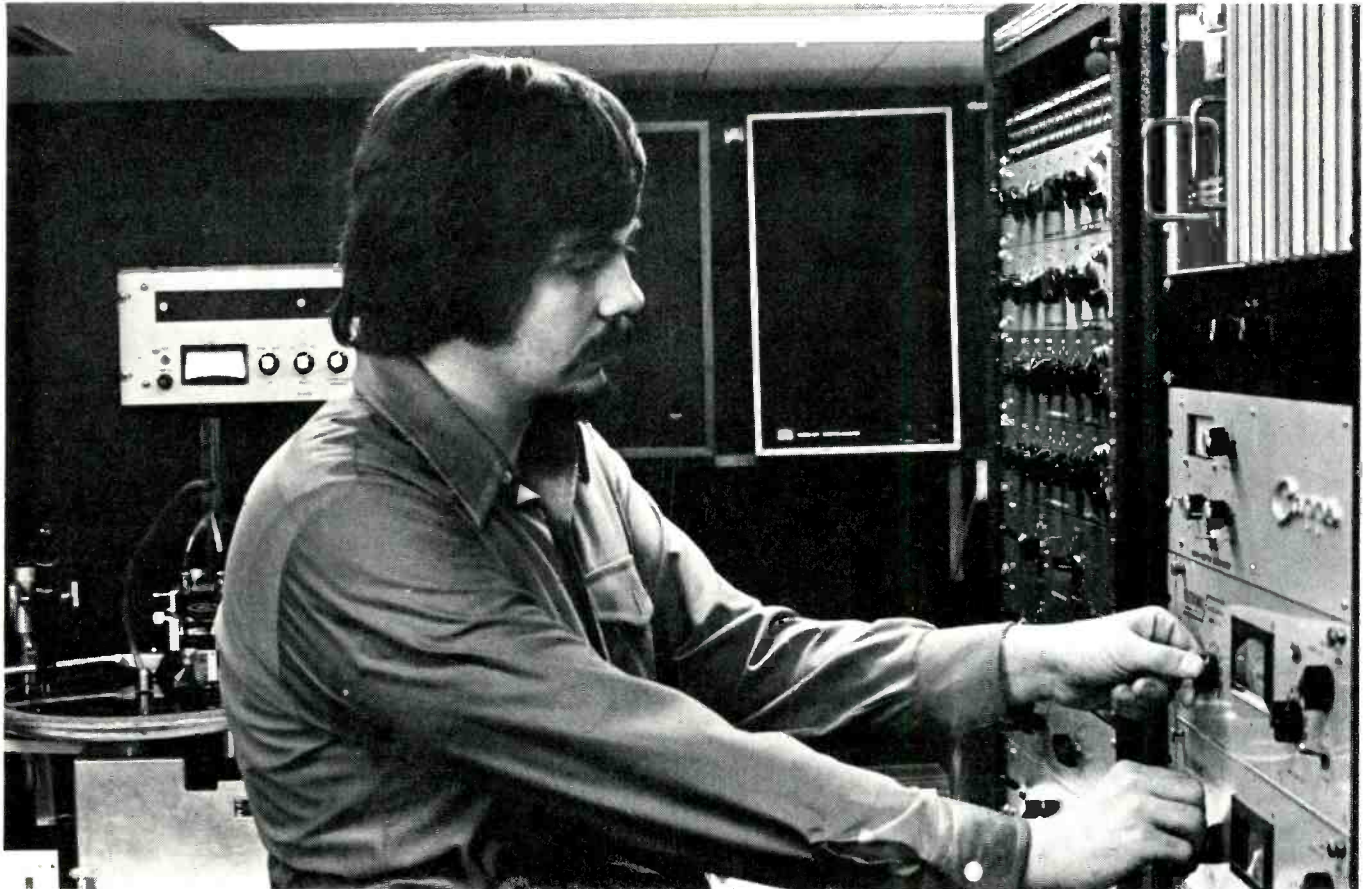

“Carl Rowatti, Chief Engineer, adjusting the Program limiters prior to cutting a master lacquer”.

Trutone can be described as a family enterprise . . . but what a family! Father Lou Rowatti is the President; Son Carl is Vice President and Chief Engineer; and daughter-in-law Adrienne handles the business end of the operation. They have great pride in their family, in their family's enterprise and in their products. That's why they insist on using the best — always.

Trutone Records in Northvale, New Jersey always uses the Calibrated Stanton Triple-E for A-B comparisons between tape and disc. They also use the Triple-E to check the frequency response of the cutter head (they'll record a 1,000 Hz tone and a 10 kHz tone twice a day to check the condition of the cutting stylus and the high end frequency response of the cutter head).

They make test cuts and play them back, using the Triple-E for reference, as high as 15 kHz all the way down to 30 Hz. Carl Rowatti says “We use the Stanton Calibrated 681 series as our total point of reference in our disc master-

ing operation. Everything in the studio is judged — and we think perfectly judged for quality—with this great cartridge”.

Professionals can't afford to take chances with quality. That's why they depend on Stanton in their operations.

Each Stanton 681 Triple-E is guaranteed to meet its specifications within exacting limits, and each one boasts the most meaningful warranty possible. An individually calibrated test result is packed with each unit.

Whether your usage involves recording, broadcasting, disco or home entertainment your choice should be the choice of the professionals . . . the Stanton 681 TRIPLE-E.



Write today for further information to:
Stanton Magnetics, Terminal Drive,
Plainview, New York 11803



Lou Rowatti inspects a master lacquer, Adrienne checks the lathe.



Carl Rowatti adjusts the pitch computer on the mastering lathe.



Carl installs the Stanton Calibrated 681 Triple-E on the playback table



Lou Rowatti (The Prez) adjusting the high frequency limiter in his cutting room.

Enter No. 39 on Reader Service Card

Empire's Blueprint For Better Listening

No matter what system you own, a new Empire phono cartridge is certain to improve its performance.

The advantages of Empire are threefold.

One, your records will last longer. Unlike other magnetic cartridges, Empire's moving iron design allows our diamond stylus to float free of its magnets and coils. This imposes much less weight on the record surface and insures longer record life.

Two, you get better separation. The small, hollow iron armature we use allows for a tighter fit in its positioning among the poles. So, even the most minute movement is accurately reproduced to give you the space and depth of the original recording.

Three, Empire uses 4 poles, 4 coils, and 3 magnets (more than any other cartridge) for better balance and hum rejection.

The end result is great listening. Audition one for yourself or write for our free brochure, "How To Get The Most Out Of Your Records." After you compare our performance specifications we think you'll agree that, for the money, you can't do better than Empire.



EMPIRE

Already your system sounds better.

Empire Scientific Corp.
Garden City, New York 11530

Enter No. 13 on Reader Service Card

Audioclinic

Joseph Giovanelli

Removing Record Scratches

Q. I have a large collection of 45-rpm records, and quite a few of them are so badly scratched the groove keeps repeating itself. Because some of these discs are treasured collector's items, I wonder if there is some process to remove the scratches from the records?—John Heiselman, Brooklyn, N.Y.

A. I do know of a method which is sometimes successful in keeping a repeating groove from repeating. It's a bit drastic so care must be used.

Use a cartridge with a conical stylus assembly and capable of an eight-gram tracking force. Set the tonearm on the disc at a point just after the scratch. Then slowly rotate the turntable backwards so the stylus approaches the scratch from the opposite direction. If you are lucky, the stylus will plow through that area and remove enough of the damaged groove so the disc will play once again without repeating. There will always be some noise at that spot, but the disc should play without repeating.

Improved Overload Characteristics

Q. A few years ago a phono overload figure of 100 mV was supposed to be excellent, but now some companies are advertising values in excess of 500 mV. Does one conclude that a figure of 100 mV is not high enough? What maximum output voltage is to be expected with a Shure M91ED, with a nominal output of 5 mV?—G.S., Honolulu, Hawaii.

A. A 100 mV overload figure is a good one, and I cannot imagine many instances where a cartridge having the voltage output you mention could reach this kind of signal level. The higher overload levels in today's equipment probably reflects the better transistors now available rather than a real need for the added headroom. As the cartridge output falls, because of the smaller moving mass,

there is even less requirement for this high overload capability. What does appear important is to have better and better signal-to-noise ratios in the early stages of equipment.

I cannot conceive of a cartridge with a nominal output of 5 mV putting out more than 30 to 40 mV on some hot discs. By nominal output I refer to that output produced by a cartridge when it plays back a signal recorded at a frequency of 1 kHz with a velocity of 5 cm/sec.

Speaker Synthesis

Q. I am a 17-year-old girl trying to understand the BIG technical world of audio. I am only a beginner and I hope you won't think my questions are too elementary. What is the difference between a woofer and a tweeter in a speaker system? How can a person tell which is which?—Soraya Cates, Tiptonville, Tenn.

A. You should not be concerned as to whether your questions are too elementary or not. All of us who work in the audio field had to start from the beginning, knowing nothing at all.

Both a woofer and a tweeter are loudspeakers which are combined to form a system. The woofer produces the lower tones, and the tweeter produces the higher ones. The tweeter is physically much smaller than the woofer since it has to move back and forth much faster, to produce the higher tones, as fast as 20,000 times per second. If it was larger, it couldn't move that rapidly.

The woofer is large and massive, compared to the tweeter. It requires a great deal of power to reproduce the low frequencies, and a large, rigid cone is needed to withstand that much power.

If you have a problem or question on audio, write to Mr. Joseph Giovanelli, at AUDIO, 401 North Broad Street, Philadelphia, Pa. 19108. All letters are answered. Please enclose a stamped, self-addressed envelope.

AUDIO • May 1977

Performance. Scott Stacks Up.

Every serious listener knows that separate tuners and amplifiers offer greater system versatility and flexibility than the all-in-one receiver. But Scott separates stack up where it really counts—performance.

Every one of Scott's complete line of tuners and amplifiers is engineered and designed to give you all the performance features you expect, at a price no higher than many receivers currently on the market.

Scott's T 526 AM/FM Stereo Tuner and A 436 Integrated Power Amplifier provide such important performance features as front panel Dolby de-emphasis switching, a phase locked loop multiplex section and linear motion calibrated controls.

And that's only part of the story. Compare these important performance features with any other medium-priced tuner and amplifier on the market today.

The Scott T 526 Tuner

IHF sensitivity rated at $1.9 \mu\text{V}$, S/N ratio 68 dB and a capture ratio of 1.5 dB.

Signal strength and center channel tuning meters.

Four gang tuning capacitor for better image rejection.

AM section designed around a tuned RF amplifier using J-FET for improved signal-to-noise ratio.

AM noise suppression circuitry.

The Scott A 436 Amplifier

42 watts RMS per channel, driven into 8 ohms from 20 Hz to 20 kHz with no more than 0.3% THD.

True logarithmic meter amplifier obviates the need for range switching. Individual channel power level meters calibrated in % of full power output capability eliminates confusing dB and VU readings.

Two completely independent tape monitors allow two tape recorders to be used simultaneously for direct tape-to-tape copying.

Instantaneous electronic protection circuit in the output stage.

IM distortion lower than 0.15% for a cleaner sound without listening fatigue.

High and Low filters, two auxiliary outlets and mic inputs.

And the Scott T 526 and A 436 come complete with professional rack-mount handles, and are backed by a three-year, parts and labor limited warranty.

For specifications on Scott's complete line of audio components, write or call H.H. Scott, Inc., 20 Commerce Way, Woburn, Mass. 01801. (617) 933-8800. In Canada: Paco Electronics, Ltd., Quebec, Canada. In Europe: Syma International S.A., 419 Avenue Louise, Brussels, Belgium.



 **SCOTT**
The Name to listen to.

Receivers/Tuners/Amplifiers/Turntables/Speakers

Enter No. 34 on Reader Service Card

Dear editor

Thanks for the Memories

Dear Sir:

I read with some surprise and delight your review of the MR-78 tuner which I designed (with the MR-77) while at the McIntosh Laboratory during the period from 1968 to 1974. The history of this tuner is a long and interesting story.

Things began back in the late 40s and early 50s when I lived under the shadow of Major Armstrong's old FM station in Alpine, N.J. I listened to it incessantly on an old Dumont TV set, and probably my love of music had its beginnings here.

After finishing high school and with my interest in FM strengthened by my interest in Armstrong's work, I began studies in Electrical Engineering at Manhattan College. By 1958 I began to become aware of the problems in FM reception and started to think about solutions.

FM tuner, a vacuum tube model which I still have.

Stereo IM distortion was the bane of all FM tuners at that time, and my discovery that most of this distortion came from the i.f. detector systems then in use was significant. Measurements on currently available tuners, using a two-tone close frequency method, disclosed values of stereo IM as high as 15 per cent, even though the same tuners had 1 kHz harmonic distortion of 1 per cent or less. No wonder FM sounded so fuzzy!

In 1966 I began post-master's research and study at N.J.I.T. where I took another Master's degree in Computing Science, and used this knowledge later at McIntosh to develop their computer-designed Rimo filters for the MR-77 and 78.

During 1968 I got the idea for that device that was later to become McIntosh's linear phase discriminator

During the winter of 68-69 I worked on the tuner model that was to become the MR-77, and we had a working model ready for demonstration by the following spring. It was clearly and easily better sounding than anything else in the lab. It measured less than 0.1 per cent IM distortion, and most of that in the final audio stage. This was exciting—as then the highly regarded Marantz 10B had about 1 per cent IM in the same test.

The MR-77 entered production in 1970, and I published a paper on it in the November 1970 IEEE BTR Transactions. This paper brought world-wide correspondence—I received letters from all five continents. We see today, in retrospect, the legacy of the MR-77-78 in the new crop of very fine Japanese tuners, such as the Sansui and Kenwood.

McIntosh had a favorite tuner test location at the home of Harold Colt in Farmington, Conn. Here, Mr. Colt had tried to receive WNYC 93.9, WQXR 96.3, and WNCN 104.3 from New York City, 90 miles away. All three of these stations are adjacent channel to three strong local stations. WTIC 96.5 is just across the highway. Colt owned a Marantz 10B which would just barely get WQXR, if you detuned it a little away from WTIC. It would not receive WNYC or WNCN well, as there were strong adjacent channel signals on both sides of the New York City stations.

Apparently all the FM engineers bring their best toys to Colt's, and he delights in showing them all how bad their tuners are. Almost all tuners degenerate into a mass of spurious signals and horrible distortion—as the helpless r.f. front end is pounded by the 10 or 15 quarter-volt signals from the Hartford transmitters surrounding Colt's home.

It is a great credit to Richard Sequerra's 10B that it worked at least tolerably well at Colt's. It was, and still is, a landmark design.

Well, into this mess I charged with my MR-77. It was a dismal failure. Spurious rejection was O.K. and it sounded great, but it would not pull in the distant signals Colt wanted at

Continued on page 14



Harold Colt (in red shirt) and Dirk Roos of McIntosh listening to WGXR, New York, on the MR-78 No. 3.

In graduate school I began to get some concrete ideas. Here the Rimo (phase linear) i.f. filter concept was born. Research work on this filter concept began during 1962-63, ending with a Master's thesis (The Rimo Filter) at the New Jersey Institute of Technology (then the Newark College of Engineering) in June, 1965. April, 1965 saw the world's first Rimo-filter

(U.S. Patent 3,646,461), and a crude working model was built at home during the summer of '68.

McIntosh knew about my work (I mailed them a resume in 1964), and Sid Corderman, their chief engineer, was so persistent in his appeals to get me to come and work there that I finally gave in and went there in the Fall of 1968 as a senior design engineer.

You may have noticed that few turntable manufacturers call your attention to the critical role of the tonearm in record playback. Dual is an exception.

Whatever the shape, materials, or mechanics of a tonearm, the goal is always the same: to maintain the cartridge in the correct geometric relationship to the groove, and to permit the stylus to follow the contours of the groove

Why we want you to know more about tonearms. And why others may not.

walls freely and accurately. Whenever the stylus cannot follow the groove undulations, it will gouge its own way. And as we have frequently reminded you, there is no way to repair a damaged record. Every tonearm designer should consider

geometry, mass, balance, resonance, bearing friction and the accuracy and stability of settings for stylus force and anti-skating. However, despite the simple fact that the shortest distance between two points is a straight line, some designers are more concerned with appearance. Hence, the curved tonearm, whose deviations between pivot and stylus simply add mass, reduce rigidity and increase the likelihood of resonance.

Dual engineers have always designed for optimum performance. The essential differences in approach and results are indicated below. You might keep all this in mind when you are considering your next turntable. Chances are you'll want it to be a Dual.

Dual

United Audio Products, 120 So. Columbus Ave., Mt. Vernon, N.Y. 10553
Exclusive U.S. Distribution Agency for Dual

The curved tonearm may appear longer than the Dual tonearm, but both actually have the identical effective length and horizontal tracking angle.

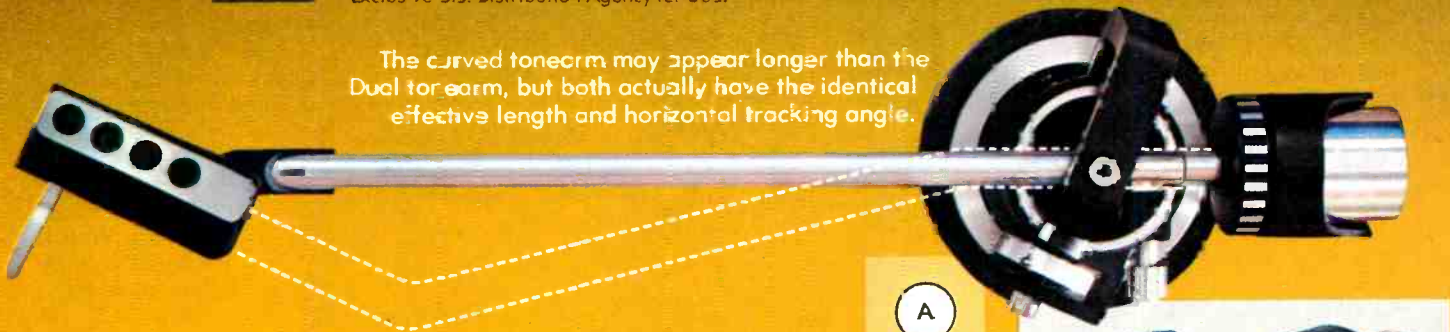

Actual size of Dual tube (A) and typical curved tonearm (B). For the same effective length, straight Dual tonearm has lower mass and resonance, yet greater rigidity.

Dual 1249. Single-play/multi-play. Belt-drive. Fully automatic start and stop, plus continuous repeat. Mode Selector parallels tonearm to record in single-play; 6% pitch control; illuminated strobe; two-control viscous-damped in both directions; multi-calibrated anti-skating. Less than \$280.

Dual 510. Similar except semi-automatic. Lead-in groove sensor. Tonearm lifts automatically at end of play and motor shuts off. Less than \$200.

Dual 502. Semi-automatic. Less sensor, strobe and pitch-control. Less than \$160.



Gimbal-mounted Dual tonearms pivot horizontally and vertically on identical sets of pivot points and high-precision low-friction bearings. Bearing friction: vertical, <math><0.007</math> gram; horizontal, <math><0.015</math> gram.

Stylus force, applied by long coiled spring around vertical pivot, remains perpendicular to record even if turntable is not level.

Specifications (DIN, B). Rumble, >66dB; Wow and flutter, <math><math>\pm 0.05\%

Enter No. 12 on Reader Service Card

Audio etc.

Edward Tatnall Canby

In case you've been too busy reading the Equipment Profiles to notice, this is our 30th Anniversary issue. We were born out of an earlier magazine, *Radio*, in May of 1947, just in time to catch the first big hi-fi boom.

This is also the precise 100th anniversary, by the time you receive this copy through the mail, of an idea that accounts for a very large part of our entire audio business—the conception of the phonograph, a machine to record and reproduce actual sound. The place of its first conception was Paris, France in April, 1877. And the man was Charles, not Thomas.

We still have a number of months to wait (and so I get a leg up on the competition) before the 100th of that audible moment when Edison's actual working phonograph croaked out something about *Mmrrryada wddle-wam* (its fleece was white as snow). There has long been disagreement on the precise date of that occurrence, not at all helped by Tom Edison's flair for after-the-fact time distortions. But Matthew Josephson in his 1959 biography of Edison indicates that "Mary had a little lamb" was probably played back some time on December 6, 1877. In any case, the machine was "finalized" on that date, and it talked out loud to most of the assembled staff of *Scientific American* magazine the very next day, December 7, which is an editorially established fact. The inevitable patent application went in a week later—the required working model was built back on December 6. Edison never wasted a moment get-

ting his patents off and with reason. Only months before this occasion, Elisha Gray had lost to Alexander Graham Bell on the telephone by no more than a couple of hours. Otherwise, we'd have a communications network nicknamed Ma Gray.

Involved in that famous telephone

conceived of a vocal "repeating telegraph," an idea that came straight out of his work with the storing up of telegraph code messages on punched paper tape, which could then be run through a high-speed sending machine whenever convenient. The theme of recording and playback was

already in his mind and had been, indeed, for many years in various forms. So the new repeating telegraph was first conceived as a voice recorder via wax coated paper.

At the Edison labs, summer 1877, they actually tried this out—Edison rigged up a diaphragm (very much on his mind at the time because of the Bell telephone of the year before and his own invention of the carbon transmitter) on which he mounted a crude stylus. For a first try, he stuck a piece of paraffin coated paper under the point (our paraffin, candle wax, not English paraffin, which is kerosene, or French paraffin, which is medicinal mineral oil!)—yelled a loud HALLOO! (testing, testing...) and simultaneously jerked the paper forward. Then he managed to retrace the paraffin track and was able to "hear a distinct sound, which a strong imagination might have translated into the original 'halloo'," as he himself put it. This was very nearly the phonograph. But not quite. A quick step on the way, though not towards a telegraph instrument.

Ideas from Observation

So typical! Edison was the arch-tinkerer, the pragmatist, and seldom a



dispute was something called a warning, in Latin a caveat, a formal declaration of intent to patent, that is, a conception before the workable fact. Curious! The U.S. Patent Office until 1910 recognized this sort of claim for priority of date, in anticipation of the full-fledged patent application and, of course, the required working model. Presumably, Edison could have filed such a warning on the phonograph as an idea in progress, but he would have gained only a week on the tin-foil machine; and some earlier experiments would have led to nothing, since they were put aside.

Still earlier on, sailing on a different tack but definitely on the right trail, if I may mix up my metaphors, he had

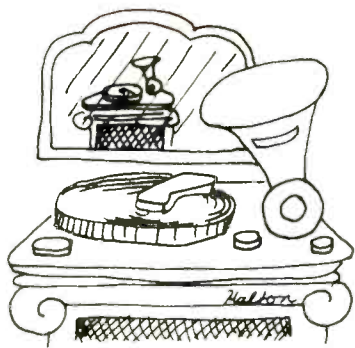

concept man. Not, at least, until after the fact. His ideas invariably grew out of direct observations and nine-tenths of them were technically accidental, i.e. not at all what he had been looking for nor in the direction he was supposedly going. Unlike more dogmatic minds, unlike those who today set up elaborate plans for research, get grants, follow straight down to the bottom line point by point, Edison was always ready for an instant change of course, depending. On the other hand, he was superbly prepared for these accidents via his immense background knowledge and an acute ability to notice and to stop, where others would merely move on. An accident with this sort of preparation—ready for anything—is really no accident at all.

And so the Edison phonograph began life as a telegraphic coded tape. It had even been a disc, before that, the same paraffin coated paper, on which a spiral of dots and dashes was embossed direct from the telegraph receiver. It could be "played back," not with sound but digitally, in code. (So, you see, digital recording came before analog. How's that for an idea!) The disc was put aside (symbolically, perhaps) in favor of coated paper tape, and it was then that Edison noticed a slight buzzing noise when the Morse code indentations whizzed past a restraining guide spring in the rapid play mode.

That was the actual beginning. Would you have given that sound a thought? To Edison, it seemed vaguely like a speaking voice. Words! He almost heard them.

He was then very heavily preoccupied with sound, of course, and knew the sonic basics as well as anyone alive. He also knew about the phonoautograph of 1857, 20 years before, invented by one Leon Scott. That device came within a hair of the phonograph—but stopped. Wrong brain. Scott's gadget recorded sound waves, ever so clearly, as a visible track on paper smoked with carbon

black, via diaphragm, stylus and all. Period. That is as far as he got. There they were, the actual traces of a sonic waveform, scarcely different from our own grooves on disc today. And yet for a couple of decades nobody thought to go a step further and do the physical mirror act, *play the grooves back*.

Nobody, that is, until in early 1877 an impecunious French poet, strictly an amateur at science but with some good connections, somehow got onto the whole bit, the exact same idea as Edison's, independently. With

him, it came as a concept, out of sheer mind, rather than via experiment and inspired observation. Charles Cros simply had an idea that he thought might work and felt he ought to do something about it.

But what? Unlike Edison, he had no laboratory full of ready assistants, nor the vast background of practical mechanics and physics which so deftly aided Edison in reaching a workable model. He floundered, and probably would have gotten nowhere. But this man had precisely the right idea, pure and simple, before Edison. Let

Soundcraftsmen THE PERFECT PRE-AMP

Here's how the PE2217 can solve your Patching and Equalization problems

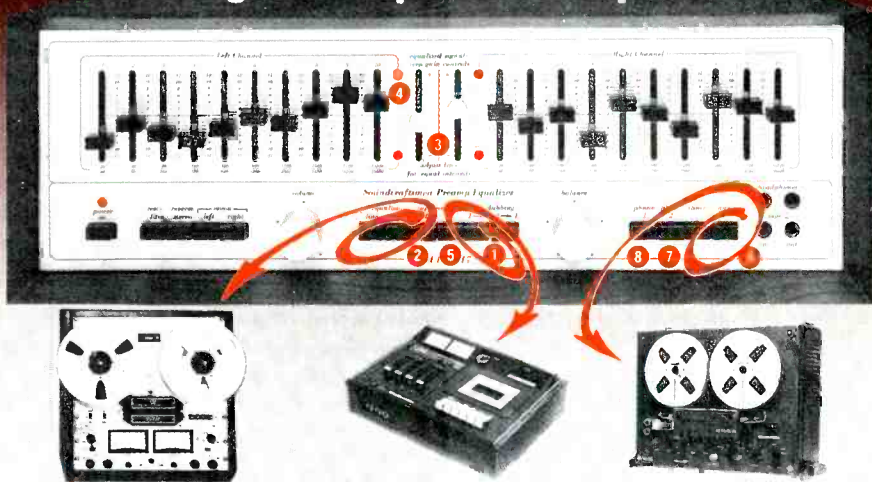

- 1 Four (4)-Way Tape Dub — Decks 1→2, 2→1, 1→2 & 3 or 3→1
- 2 Four (4)-Way Tape "EQ" — Decks 1→2, 2→1, 1→2 & 3 or 3→1
- 3 "Zero-Gain" for Clean/Undistorted Tape "EQ"
- 4 "L.E.D.'s" for Visual Tape & Line "EQ" Balancing
- 5 Three (3)-Way Tape Deck Monitoring Capability
- 6 Front Panel 2nd or 3rd Tape Deck Patching
- 7 Simultaneous Tape Dubbing and Third Source System Listening
- 8 A "Top-Rated" Phono Preamp Section for a Clean (—84db S/N) Natural Disc Source

New SG2205 Graphic Equalizer IMPROVES any fine stereo system

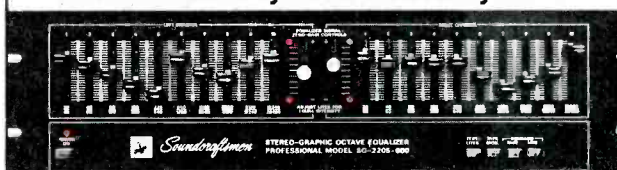

FREQUENCY RESPONSE: ± 0.5 dB 20-20,480Hz
 THD: Less than .1% @ 2 v., Typ: .05% @ 1v.
 S/N RATIO: Better than 106 dB @ full output.
 Better than 96 dB @ 2 v. RMS.
 FILTER TYPE: Toroidal and Ferrite-core.
 INDIVIDUAL OCTAVE-CONTROL RANGE: Minimum ± 12 dB (Typ. ± 14 dB), each octave centered at 30, 60, 120, 240, 480, 960, 1920, 3840, 7680, and 15,360Hz.

SUGGESTED PRICES

PE2217 (incl. Cabinet).....\$529.50
 SG2205 (rack panel).....\$370.00
 RP2212 (not shown).....\$369.50
 RP2204 (not shown).....\$329.50
 20-12A (not shown).....\$299.50

FREE!

THE "WHY'S AND HOW'S OF EQUALIZATION,"

an easy to understand explanation of the relationship of acoustics to your environment. This 6 page booklet also contains many unique ideas on "How the Soundcraftsmen Equalizer can measurably enhance your listening pleasures." "How typical room problems are eliminated by Equalization," and a 10-POINT "DO-IT-YOURSELF" EQ evaluation check list so you can FIND OUT FOR YOURSELF WHAT EQ CAN DO FOR YOU!

Does Your AM Tuner Sound Like Quality FM?



Our Dymek AM5 Does!

"Listening to a local classical-music station that carries the same programs on its AM and FM outlets, switching between the audio-output signals from an FM tuner (set to mono) and the AM 5, we found that the differences were very slight, actually comparable to those we have sometimes heard between different FM tuners. Much of the time no difference at all could be heard." . . . JULIAN HIRSCH

Reprinted with permission, *Stereo Review*, August 1976

Factory Direct. Money Back Guarantee. Rent/Own Plan. Call or write for complete specs and details on the remarkable AM 5, its companion piece the DA 5 antenna, and other Dymek Products. Call toll free:

Nationwide 800/854-7769
California 800/472-1783



McKay Dymek Company
675 N. Park Ave., P.O. Box 2100
Pomona, Calif. 91766

Enter No. 21 on Reader Service Card

12

THE SOLUTIONS

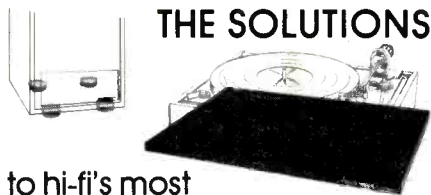

to hi-fi's most unrecognized problems

The Problems:
acoustic feedback and structure-born vibration

The Solutions:
Netronics Acousti-Mounts and Speaker-Pods

Feedback may be the mysterious reason why your sound is muddy, your turntable rumbles, and in severe cases, you can't turn up the bass or volume controls without speaker howl. Designed specifically to accommodate today's fine turntables, the Netronics turntable Acousti-Mount sub-base platform suppresses acoustic feedback by effectively decoupling the entire turntable assembly from structure-born vibration - up to 30dB of isolation.

The vibrating speaker cabinet, which causes much of the turntable feedback, also causes walls and other objects to vibrate producing spurious audible distortions as well as annoying the neighbors. These vibrations can now be isolated using "Speaker Pods" designed to isolate the speaker cabinet from the room. Simply inserted between the floor or shelf and the speaker they isolate vibration up to 40dB.

Julian Hirsch's test report: "We doubt that any other \$15 investment could make such an improvement in a record-playing system."

MONEY BACK IF NOT DELIGHTED

Patents Pending

Please Send:

___ 16x13½ turntable Acousti-Mount at \$15.00 ea

___ 19x13½ turntable Acousti-Mount at \$17.50 ea

___ Set of 4 "Speaker Pods" (spkrs. to 45 lbs.) at \$11.95 per speaker

For heavier speakers use 2 extra pods for every 15 lbs. over 45 lbs. A-577

Canadian residents add \$1.00 per item
Conn. res. add 7%.

NAME _____

ADDRESS _____

CITY _____ ZIP _____

Send information on direct drive turntable kits

NETRONICS R&D LTD., 333 Litchfield Road, New Milford, Connecticut 06776 or call (203) 354-9375

Enter No. 23 on Reader Service Card

me quote him from Roland Gelatt's "Fabulous Phonograph" (Lippincott 1954), as translated. The Cros process was to consist in "obtaining traces of the movements to and fro of a vibrating membrane and in using this tracing to reproduce the same vibrations, with their intrinsic relations of duration and intensity, either by means of the same membrane or some other one equally adapted to produce the sounds which result from this series of movements."

Poetic *deja vu*

That was written down on April 18, 1877, a full eight months before the Edison phonograph and, if I am right, well before the experiments with the repeating telegraph. Apparently, as Gelatt recounts it, the poet tried desperately to raise some cash to try his idea in practice and apply for a patent; failing that, he did the next best thing—deposited his paper, sealed, dated, at the Académie des Sciences in Paris. That was April 30.

Now just suppose Cros had filed that same document, or a similar one, in the form of an official dated warning at the U.S. Patent Office? Cros could not at this time have known of Edison's work, barely begun and in a different direction, and it seems doubtful that Edison could have known about Cros at least until late in the autumn of 1877, if then. Of course, Cros would have had to follow through, with the completed invention, you understand...but he would have had the priority.

More marvels. In October an article in a French magazine took up Cros, and the author actually called it *the phonograph*. Where did he find that name? It isn't clear. Edison could have seen the article by December but this is unlikely—it was in something called "The Clergy Week." Probably each man came independently to this name by analogy, following upon the telegraph and the telephone.

Towards late autumn, possibly, or probably, because of advance reports around November of Edison's experiments (he was famous for tossing out flamboyant advance hints of things to come), Cros got disturbed and demanded that his paper be unsealed and officially read at the Académie. It was. And believe it or no, that reading was on December 5, 1877, just one day before Edison's tinfoil machine was put into its final shape, so to speak, for publication.

So who *invented* the phonograph? If you mean, who made it work, there

can be no question and I suspect the U.S. Patent Office would go along. Edison, and Edison alone (with his colleagues), made it talk. But I keep worrying, myself, about that warning idea. True, a lot of warnings have been thrown out, including that by Elisha Gray. Very soon, one of Edison's own patents would be challenged, by none other than Emile Berliner, who later developed the flat disc (with acid-etched grooves); Berliner also thought of the loose-particle transmitter, or microphone, and his caveat was filed just two weeks before Edison's patent application. After 15 years, that one was settled in Edison's favor. (The specific use of carbon granules was his idea.)

Definitely, a warning does not have the status of a full patent application and leaves the inventor open to very serious questioning unless he in turn comes through with the complete works. It is highly doubtful that Cros could have competed with Edison on this basis.

Yet—it would have been a challenge, this clearly stated idea for a phonograph filed and on record before Edison's work! What might have happened?

Humane Protection

Not too much. Judging from Edison's numerous other involvements in patent wars, I suspect, having discovered the Cros prior caveat via the Patent Office (we are still assuming it was filed in the U.S.), he would immediately have sent an emissary to France to work out a deal—and most probably, to take M. Cros over, body and soul, as an Edison partner, of sorts. The more wily Edison operation, to invent some ingenious alternative gadget that could by-pass the opposing claims, wouldn't have been possible—Cros had the situation neatly covered in generalities. Edison, unlike the financial barons of his day, was not given to cruelty nor inhumanity, though he would go a long, long way to always protect his own interests, humanely.

So we might well have had in Paris, 1878, a new Cie. *Edison-Cros, fabricateurs de machines sonores*. And at least a modicum of glory for poor Charles. The co-conceiver of the phonograph. I think he deserved it. My research doesn't tell me whether this actually happened, nor does Mr. Gelatt help. Cros isn't even mentioned in the Edison biography. Next time I go to France I'll have to find what happened to him. *They'll know, most certainly.* A

the SAE Revolution

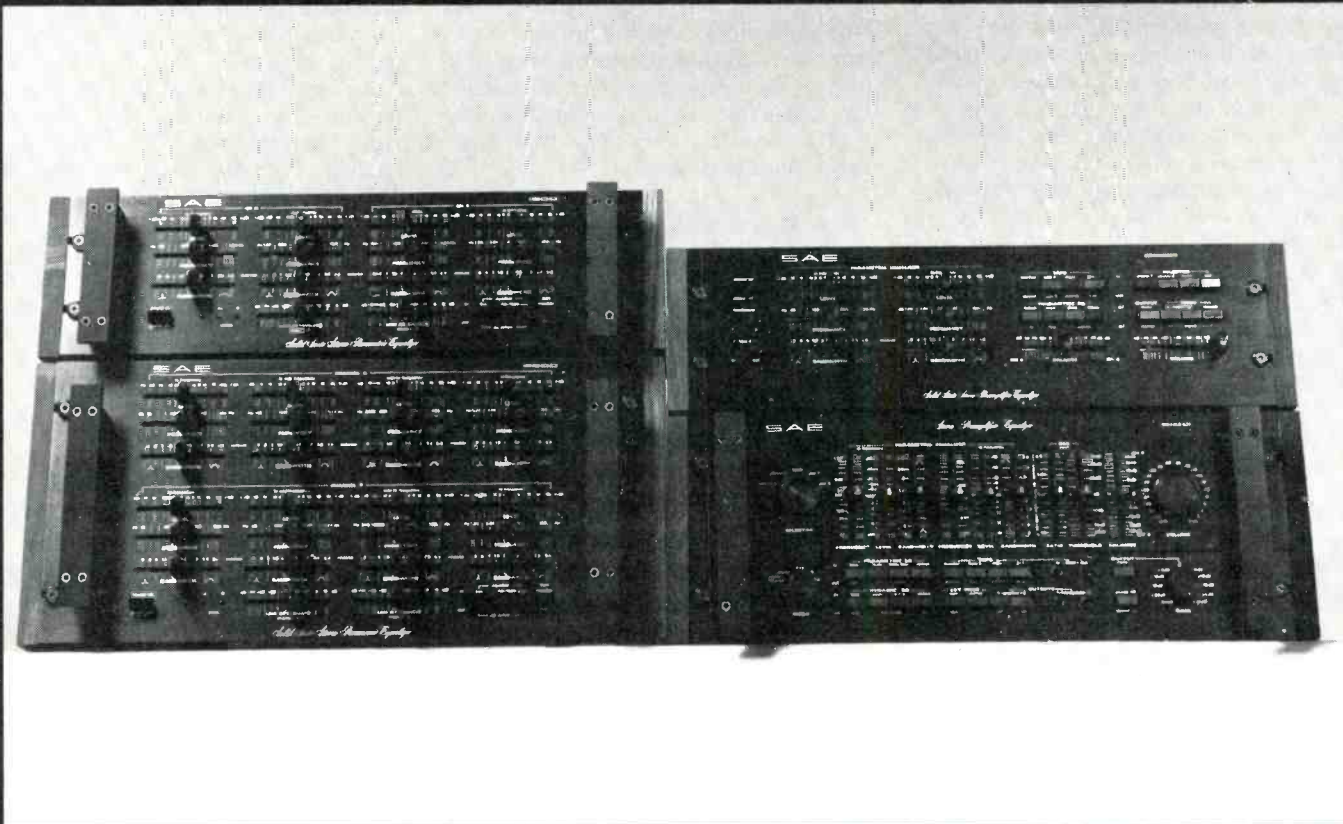

Suggested Price: 1800 — \$300.00 (Top Left), 2800 — \$550.00 (Bottom Left), 2900 — \$450.00 (Top Right), 2100 — \$300.00 (Bottom Right).
Cabinets shown optional at additional cost.

SAE has long been involved in the field of tone equalization. From our pioneering efforts in variable turnover tone controls to our more recent advancements in graphic equalizers, we have continually searched for and developed more flexible and responsive tone networks. From these efforts comes a revolution in tone equalization — the Parametric Equalizer.

Parametric Equalization, long a mainstay in the recording industry, is now available in SAE pre-amplifiers (2100, 2900) and as separate components (2800, 1800).

With the parametric, you can control not only cut and boost, as in the graphic, but also bandwidth and center-frequency. With this extra control flexibility, you can control precisely any problem or create any sonic effect you wish. Whether you need a .3 octave

notch filter because of room resonance, or a tailored bandwidth boost to bring out a hidden vocalist, the control flexibility of the parametric can fit these needs and many more. All of the products shown here offer the sonic performance and quality of construction that is typically SAE.

SAE

AM-5/77

SCIENTIFIC AUDIO ELECTRONICS, INC.
P. O. Box 60271, Terminal Annex
Los Angeles, Cal. 90060

Please send more information on the SAE Revolution

Name _____

Address _____

City _____ State _____ Zip _____

Enter No. 32 on Reader Service Card

Dear Editor|Continued from page 6

all. He threw me out and said, "Come back with something that works."

I'm not intimidated by failure. I was mad, but now bowed. On the long drive back to Binghamton I dreamed up the MR-78. I reported the failure to Sid Corderman and went into the lab to build the MR-78.

After a few months activity I finished the first model—the "Kluge." MR-78 number zero (like Bruckner I dared not give this thing a number) was a real bomb—two old MR-71s and an MR-77 all hooked in series.

I brought this mess to Colt's, and after he recovered from his laughing fit—imagine a pile of chrome chassis, tubes, wires, and transistor PC boards stuck out in all directions with loose cables dangling all over—we hooked it up. Picture his surprise, and mine too, when this contraption pulled in clear signals from WNYC, WQXR, and WNCN. We were dancing all over his listening room like excited kids. Nick Perfito of the Stereo Shop in Hartford was also present, looking and listening in utter disbelief. We all went out to dinner to celebrate, and then I went back to McIntosh to attempt to cram all of this stuff into one chassis.

During 1971 and 1972 I made many trips to Colt's refining prototype after prototype until the MR-78 worked as well as the laws of physics allowed.

Actually the MR-78 suffered a little due to the laws of commonsense economics. My prototype had 100 dB adjacent-channel selectivity instead of 55 dB, and much lower distortion in super-narrow, but the 100 dB filter was too expensive. It also had, in one version, a complex TTL discrete PLL stereo decoder which gave better separation—50 dB up to 15 kHz—and lower distortion—0.02 per cent—but it was too complex and expensive. It also had a dynamic stereo filter (patent pending) which operated on a noisy FM stereo signal in a manner similar to the operation of the Burwen noise reduction system on a noisy record. These ideas were incorporated into a later super digital tuner prototype not considered for production.

I left McIntosh at the end of 1973 when my tuner work was finished.

Richard Modafferi
Vestal, N.Y.

Audio Specs & Measurement

Dear Sir:

Although we were flattered and generally pleased at the treatment accorded our Technics SA-5760 stereo receiver in your January, 1977, issue of

Audio ("Battle of the Titans"), the report did leave us with some questions and reservations. Although our doubts may not be serious, they do involve problems that are of concern to your readers, as well as to us as manufacturers. For one thing, some oversights and misunderstandings in the review, however inadvertent, are subject to reader misinterpretation. For another thing, the report re-awakened certain long standing doubts concerning the entire matter of "specsmanship" and the approach to equipment evaluation, its philosophy, and the continuing problem of reaching subjective/objective conclusions of genuine value. Let's begin with one of the simpler points.

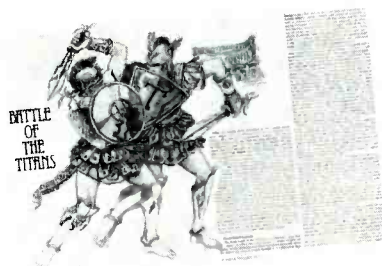

Audio, Jan. '77

Published vs. measured specifications: There is no industry-wide standard, official or unofficial, from which a manufacturer can determine his base point for publishing specifications. At one extreme, he could publish the very best figures optimized in the laboratory prototype but never actually achieved in any production sample. At the other extreme, he could follow the very conservative practice of publishing specifications below worst case production samples, thus guaranteeing that every purchaser will obtain performance better than he buys. Obviously the latter suffers a disadvantage in a direct comparison against the former.

Fortunately both manufacturers involved in your two receiver evaluations are reputable enough to frown upon bending the truth in the first mentioned manner. However, we think you would have served your readers better by printing *actually measured* readings in chart form as you did *published specifications*, which dominate the second spread of the article. The actual readings to which you refer do indeed appear scattered throughout the article, but they lose their perspective and impact when presented in this diffuse way.

Expanded vs. normal scaling: Here is another illustration of the fact that the style of data presentation can have

at least as much impact as the basic data itself. When relatively small differences are presented graphically, they tend to vanish altogether with normal scaling. There is thus a temptation to use expanded scaling to make the differences obvious. Unfortunately, this can have the converse effect of exaggerating their significance. In the case of two of the three distortion charts shown (Figs. 5 and 6), this has tended to work to the disadvantage of the SA-5760, whereas normal scaling was used in other graphs we would have preferred to see in expanded form! This may seem like nitpicking, but a simple solution could have avoided the problem. For resolving such dilemmas in the future, may we suggest that two graphs be shown, one with normal and one with expanded scaling? That should keep the matter in perspective. (Editor's Note: Figs. 5 and 6 presented measured performance of the two receiver's amplifier sections, while the other graph of distortion, Fig. 4, showed mono THD vs. frequency for the tuner sections. E.P.)

Specsmanship vs. realistic performance: In "New Tests for Pre-amplifiers" in your February issue, Tomlinson Holman has some very perceptive things to say about the what, why, and how of equipment testing that pertain broadly to all sound-reproducing equipment, not just preamplifiers. He speaks of "audible differences among designs that had nearly identical measurements on conventional tests" although he acknowledges a role for conventional electrical testing as the "...easiest to replicate and communicate since the hardware produces numbers.... Of course, such measurements form the basis of published specifications and test reports." But he reminds us that "ultimately the object of all measurement must be considered to be the assessment of the *subjective* quality of the device under test...the usual test signals employed do not adequately represent the demands of program material...."

His remarks are particularly relevant with respect to conventional approaches to FM circuit evaluation. Many of us put the cart before the horse, sanctifying certain specifications to the point that, in the hands of some engineers, *audible performance is actually sacrificed* for the sake of a handsome looking number. For example, such parameters as sensitivity, selectivity, and the rejection of unwanted signals can be numerically improved at the expense of bandwidth,

ARE YOU BLAMING YOUR TAPE RECORDER FOR PROBLEMS CAUSED BY YOUR TAPES?

Every day people all over the country go into hi fi dealers with complaints about their tape recorders.

When in reality what they should be complaining about is their tapes.

Because the fact is, a lot of the problems that plague tape recorders can be attributed to bad tape.

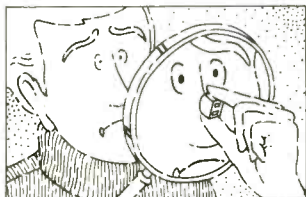

HEAD WEAR IS CAUSED BY YOUR RECORDER. OR IS IT?

If you have to clean your tape heads more than usual, for example, it could be your tape doesn't have a special nonabrasive head cleaner.

Maxell is the only tape that has one.

If your recorder jams, it can be any number of things. Maxell does something to prevent all of them.

We make our cassette shells of high impact polystyrene. And then so they won't crack

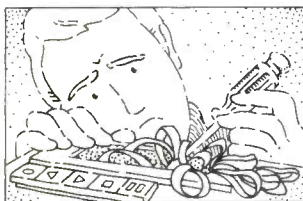

JAMMING IS CAUSED BY YOUR RECORDER. OR IS IT?

even after years of use, we finish them to tolerances as much as 60% higher than industry standards.

Inside, we use free rolling Delrin rollers so the tape doesn't stick.

And finally, we screw instead of weld everything together because screws make

for stronger cassettes.

If your recorder frequently suffers lapses in sound, it could be the tape is of inferior quality. And nobody's bothered testing the tape for dropouts before it leaves the factory.



DROPOUTS ARE CAUSED BY YOUR RECORDER. OR ARE THEY?

Maxell tape is made of only the finest polyesters. And every inch of



POOR TRACKING IS CAUSED BY YOUR RECORDER. OR IS IT?

it is checked for even the slightest inconsistencies.

So if you're having problems with your recorder, try a Maxell cassette, 8-track or reel-to-reel tape.

You might find there's really nothing wrong with your tape recorder, just with your tape.



MAXELL. THE TAPE THAT'S TOO GOOD FOR MOST EQUIPMENT.

Maxell Corporation of America, 130 West Commercial Ave., Moonachie, N.J. 07074

Enter No. 19 on Reader Service Card

The Sound Shaper. Because all rooms are not created equal.



You can own the finest component system and still be getting inferior sound.

Because unless you happen to have an acoustically perfect listening room, your system and space probably don't match. Hard walls, soft carpets, glass tables, even the size of a room can change sounds.

So ADC developed the new ADC 500 Sound Shaper Frequency Equalizer.

By adjusting the twelve frequency levels you can actually shape your sound to fit the shape of the room, and compensate for spaces and textures that interfere with sound. You can even tinker with the sound just for the fun of it: bring up a singer, lose a violin, actually re-mix your recording.

The new ADC 500 Sound Shaper can get your system into great shape.

ADC

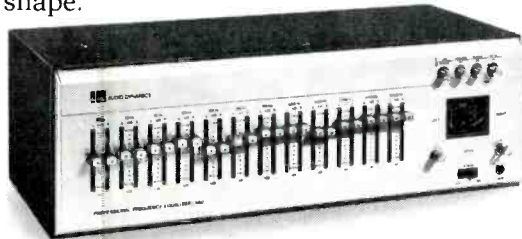

The Sound Shaper

ADC Professional Products Group. A division of BSR (USA) Ltd., Route 303, Blauvelt, N.Y. 10913

which will have effects that are audible though less than laudible. But what is high fidelity about, after all?

Most of our electrical tests use steady-state, single-frequency signals. This is true of THD testing, and even of swept response testing, in which a single frequency is applied at a time. The use of two frequencies at the same time in IM testing is about as bold as most evaluators get.

True musical waveforms are complex, constantly-changing clusters of many different frequencies occurring simultaneously, with intricate patterns based on their phase and amplitude relationships. Thus, we at Technics have chosen to use the square wave, which is, after all, a cluster of a large number of related but distinct frequencies with very specific amplitude and phase relationships, to depict overall *musical* performance of the FM section of the SA-5760. Offhand, we can remember no other FM receiver or separate tuner for which this stringent test is recommended. We invite it.

Another practical matter that is completely overwhelmed by conventional, uninspired "specsmanship" is that of overmodulation at the FM transmitter. It is a notorious fact that, at any given moment, a large percentage of FM broadcasters are modulating beyond the FCC-defined limits for the sake of putting out a "fatter" signal to a larger listening audience. On conventionally designed receiver and tuner circuits, nothing is done about this, and the result is distortion. But something *can* be done about it, like using a wideband detector to reproduce such overmodulated signals cleanly, as is the case of the SA-5760.

In the SA-5760, we make no apologies for the commendable performance levels we have achieved with respect to such *pro forma* specifications as those relating to sensitivity, selectivity or unwanted-signal rejection. But, rather than force the receiver to do electrically what a reasonably good antenna can do better without compromising waveform-reproduction integrity, we have opted for the best and purest sound we can get. Remember when that's what high fidelity was all about? Regrettably there is no room in the test procedures used by *Audio's* evaluators for acknowledging such meaningful achievements.

Sid Silver
Merchandising Coordinator
Technics by Panasonic
Secaucus, N.J.

AUDIO • May 1977

"..a pair of 66's may sound unspectacular, even disappointing.."

This is not the sort of quote that manufacturers usually select from equipment reviews. However, we did it for one reason: to get your attention. That's not an easy task, considering the hundreds of other speaker manufacturers clamoring for your ear and your dollar.

The complete excerpt (from *Canadian Stereo Guide*) reads: "To the untrained ear, a pair of 66's may sound unspectacular, even disappointing. There's no thump and sizzle which many equate with good frequency response. No spectacular effects, just the neutral sound of musical instruments playing with nothing added by the speakers. Purity of tone and cleanness of reproduction is particularly noticeable."

The Ditton 66 was in fact developed by Celestion to serve as an authentic monitor speaker, which means

that it was designed to neither add nor subtract anything from the original program material. Recording engineers aren't interested in "hi-fi effects"—they want to hear exactly what's on the master disc or tape with minimum sonic contribution by the speaker.

When the British publication, *Hi-Fi Answers* needed a concert monitor they found the Ditton 66's "...sufficient to cope with the loudest orchestral climaxes available (or even required) ... when we wanted to provide concert levels in a large hall, 110 feet x 55 feet with a 25-foot ceiling. A most impressive performance..."

Since most listening rooms are somewhat smaller, the shape of the Ditton 66 should be of special interest. Though its internal volume is three cubic feet, it needs only 1.2 square feet of floor space. It is 15" wide, 11" deep and 39½" high.

Another thoughtful aspect of the enclosure: the drivers are mounted on a finished baffle board. So those who like to operate their speakers with the grille off, for whatever reason, can do so happily.

Now, if you'll drop us a card, we'll send you a list of our carefully selected dealers by return mail. We believe you'll be impressed by the exceptionally "unspectacular" sound of the Ditton Monitor 66.



The
Ditton
66
by Celestion.
\$499.50

Celestion

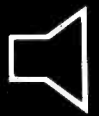

Loudspeakers for the perfectionist

Celestion Industries, Inc., Kuniholm Drive, Holliston, Mass. 01746

In Canada: ROCELCO INC., Montreal

The HF-2000 soft-dome tweeter operates from 5,000 to 20,000 Hz. Its exceptionally smooth extended response and wide dispersion achieve an open, airy quality and accurate stereo imaging.

The MD-500 2½" soft-dome mid-range operates from 500 to 5,000 Hz with very low distortion, wide dispersion and correct phase relationships. An extremely powerful magnetic assembly ensures critical damping and high power handling capability.

The FC-12 woofer has a heavy plasticized diaphragm that effectively suppresses resonances. The neoprene roll suspension permits considerable cone excursions without non-linear effects. A massive Ferro II magnet provides critical damping.

The Auxiliary Bass Radiator (ABR) is a highly effective proprietary Celestion device that operates in conjunction with the woofer/enclosure acoustic circuitry. The critically-damped moving system of the ABR has a carefully chosen mass and compliance, acoustically coupled to the woofer and enclosure to control the lower range of the woofer excursion. It takes over completely at the very lowest frequencies. Result: exceptionally smooth reproduction to well under 40 Hz.

Enter No. 6 on Reader Service Card

Automatic Distortion

Dear Sir:

In response to Mr. Bert Whyte's "Behind the Scenes" column in the January, 1977, issue of *Audio*, I would like to suggest some answers.

I must agree there are a lot of bad records being produced in this country. I believe we can attribute a great deal of this to automation. I am not saying automation cannot produce a good product, but its basic meaning is fast production which becomes some sort of a disease and does compromise quality.

As for the terminology "concrete," today our materials are much better than 15 or 20 years ago. Twenty years ago we had three basic materials, virgin vinyl, extended vinyl, and filled vinyl. To the best of my knowledge, the great majority of plants are now using only virgin vinyl materials.

With due respect to record company engineers who claim that shrink wrapping warps records, I wonder if they have overlooked the fact that many of the protective jackets are now being made of cheaper board, which has a tendency to bow when shrink-wrapped. When you combine this with the fact that many jackets are bowed or warped to start with, you have two strikes against getting a flat record.

I have never heard the terms "symphonic" or "pop" cycles used, nor have any of our customers. A rock record (so-called pop cycle) can be a 33-minute side and have just as many moulding problems as a classical record (so-called symphonic cycle) which has a 21-minute side.

Some food for thought. . . the Westminster Lab series played on today's sophisticated equipment might not prove to be the great listening experience one assumes.

In the so-called "good old days" we did not have groove guard which introduces a lot of problems. . . swishes, thumps, and worst of all skipping and skidding. One of the reasons for some of the quieter European pressings is the fact that many of their pressings are non-groove guard, eliminating stress at the lead-in and run-in of the record which is caused by the groove guard. A noisy beginning on any record will always leave a bad taste in anyone's ear.

Pressing plants are a part, but only a part of the problem. To make a well-pressed record requires good control of many complex procedures: cutting, plating, labels, sleeves, jackets,

vinyl, molding, wrapping, packing, and shipping.

Frank P. Gaudenzi
Plant Manager
Windsor Records, Inc.
Paterson, N.J.

Record Degradation

Dear Sir:

I am writing concerning Bert Whyte's "Behind the Scenes" in the January issue of *Audio* as he talks about the bad pieces of plastic on the shelves of record stores. I say, "Good article!!" Keep on mentioning the bad quality of records. From my own experience about eight out of ten records on the market are either warped, or snap, crackle, and pop when I play them. The money they want for these records is ridiculous. You can own a \$5,000 component system and it's not worth a dime if the disc is all warped and cracked up.

Why have good equipment? At times I'm tempted to sell my system for a good price. Maybe, someday there will be a turntable or device that will tone down the bad records so they don't sound like breakfast cereal. . . Snap! Crackle! and Pop!

Robert H. Lacher
Pittsburgh, Pa.

Sounds Remembered

Dear Sir:

After reading the March, 1977, issue of *Audio* I was greatly enthralled with the story by John Hilliard on "Movie Sound Reproduction." This was wonderful reading for me because during those very times I was involved in sound movies. First, it was the electrical reproduction of recordings, instead of the orchestra and piano player in the pit.

My home town of Schoharie, N.Y., had since 1916 put on free openair movies for 15 nights, one each week from Memorial Day to Labor Day. They were held on the Main Street in front of the courthouse, and thousands would come to town on these Thursday evenings, bring their own chairs, or if they had an "open-top" automobile. . . head that towards the curb facing the screen and sit in "luxury" to watch the silent movies. This continued each year and soon "talkies" came into being.

Was Schoharie's famous open-air drive-in theater now doomed? No, it wasn't! I am proud to have had the

opportunity to develop what has been classed as the world's first open-air talking picture theater. Right at the moment I cannot give you the exact dates, as several years ago I lost all my photos, newspaper stories, and accompanying dates in a fire. However, it was in the early 1930s. "Motion Picture Herald" carried a story on it as did their supplement, "Better Theatres." I purchased a sound head from Karl Weber, of the Weber Machine Corp. of Rochester, N.Y., and installed it on a Powers 6A projector, built an amplifier, and hooked up a couple of speakers. I had been in the sound business since 1927, so this was just up my alley. We had open-air talkies!

A few years later when "Motion Picture Herald" ran a story on the opening of the Camden, N.J., open-air theatre which they tried to claim was the first, a lot of fanfare was given to it. A letter to this trade publication reminded them of the previous article which they had published a few years earlier, and so we regained our fame as having the first open-air talkies.

I didn't mean to ramble on so, but Mr. Hilliard's story was so great that I couldn't help but write to you and express my appreciation for the story which brought back many fond memories of those days "when the screen began to talk."

And many thanks for a fine publication like *Audio Magazine*.

Edward Scribner
Schoharie, N.Y.

Microphone Test Addenda

Dear Sir:

I hasten to add credit where it is due to my article "The Compleat Microphone Evaluation" which appeared in the April, 1977, issue of *Audio*.

I wrote the description of the precision spherical sound source from memory. At that time I asked John Volkmann of RCA Laboratories for more information on the source. It took some time for him to locate this information and obtain company approval to send it to me. Alas, it arrived too late to stop the presses. I would like to thank him for his efforts.

I find that Volkmann, as department supervisor in 1948, worked with Witchey in the development of the source. This credit should be added to the article.

Jon Sank
Contributing Editor
Haddonfield, N.J.

THE ADC CARTRIDGE CAUSES NO PERCEIVABLE WEAR OVER THE LIFE OF YOUR RECORDS.

MKII is different, because our engineers found a way to detach the magnet and reposition it above the stylus, so the stylus applies less pressure against the groove.

Less pressure means less wear.

The fact is, of all the leading brands, ADC cartridges have the lowest mass moving system you can buy. That means better sound and superior performance.

The XLM frequency response is exceptionally flat, from 15Hz to 24KHz ± 1.5 dB. And for the ultimate in stereo reproduction, it has a minimum of 28dB of channel separation.

Think about it. In the long run you'll probably spend more on your record collection than you will on your whole stereo system. So it makes sense to buy a cartridge with proof that it makes your records sound better and live longer.

THE ADC LOW MASS CARTRIDGE.

IT HELPS YOUR RECORDS LIVE LONGER.

Unbelievable?
Believe it.
A series of tests
conducted by a leading

independent audio-testing laboratory prove it.
The tests show that the ADC XLM-MKII cartridge causes no perceivable wear until after 60 plays. Industry sources estimate the "life of a record" (the average number of times a record is played) to be 40 to 50 plays.

Other cartridge manufacturers may talk about less record wear, but ADC has proven *no wear over the life of your record!*

The reason for this is our unique patented design.

It's patent #3294405.

We call it the "induced magnet" cartridge.

Most cartridges are designed so that a heavy magnet is part of the moving system.

The ADC XLM-

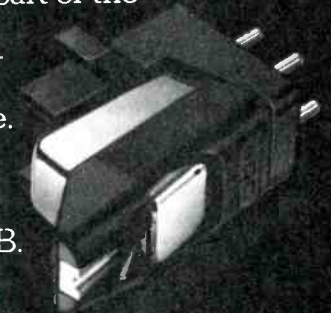

The ADC low mass cartridge.
Unbelievable.



A BSR COMPANY

ADC Phono Cartridges

A Division of

BSR Consumer Products Group
Rte. 303, Blauvelt, N. Y. 10913

THE PROOF:

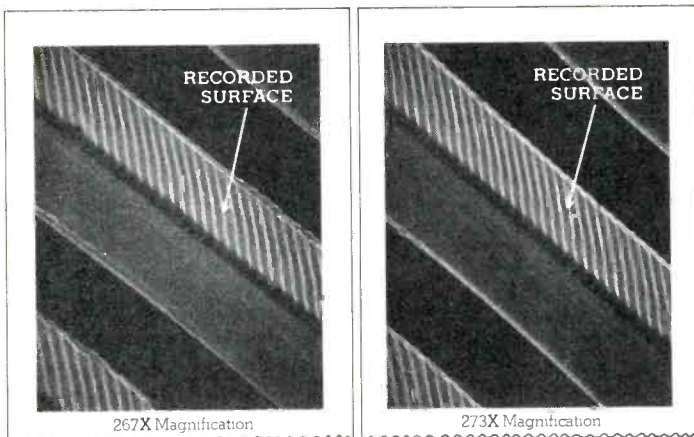

This is a photomicrograph of a 20kHz record groove that has never been played before.

This is a photomicrograph of a similar 20kHz record groove that has been played 75 times with an ADC XLM-MKII cartridge. As you can see there is no difference.

If you'd like your own personal copy of the test result, write to ADC at address shown above.

THE DIFFERENCE:

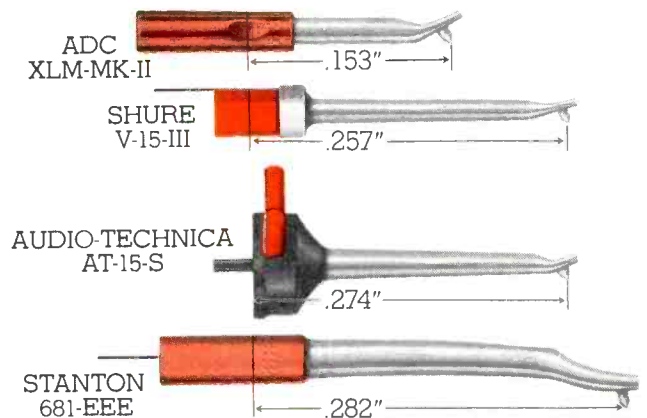

The way to get the most accurate reproduction of sound is to lower the total effective mass of the moving parts of the stylus. And that's exactly what

our engineers did. In fact, of all the leading brands, ADC cartridges have the lowest mass moving system you can buy.

INDUCED MAGNET

MAGNET

Tape guide

Herman Burstein

Bias Adjustment

Q. In using low-noise tape, can there be an improvement even though the bias is set for conventional tape? If the bias is set for low-noise tape, how does this affect the playback of tapes recorded with the bias for conventional tapes? Can a switch for changing bias from low-noise to conventional tapes be built into an older tape deck? Does the bias differ among various brands of low-noise tape?—Ronald Slakie, Tacoma, Wash.

A. There can be some improvement when using low-noise tape with conventional bias, but the best overall performance requires an increase in bias. Bias does not enter into playback, so properly recorded tapes will still play properly on a machine with the bias set for low-noise tape.

Yes, a switch for changing the bias from low-noise to conventional tape could be built into an older deck by a competent person. What such a switch does is to increase the bias for low-noise tape. This increase can be achieved by using different values of capacitors or resistors in the circuit from the bias oscillator to the record head. Bias for low-noise tape is about 15 per cent more than conventional tape which you can determine experimentally by varying the bias until you get the flattest possible treble response using low-noise tape.

While the optimum amount of bias differs among particular brands of tape, usually the differences are slight enough not to have a pronounced effect upon the recording. For one seeking the best possible performance, it is advisable to adjust the bias for the particular tape used.

Deck Dilemma

Q. I own a Sony 651 tape deck purchased overseas and have found that the only tape I can use is Sony. If I use another brand, I get distortion in the left channel during recording. How-

ever, I can play tapes recorded on other machines regardless of brand. I took the machine to an authorized Sony dealer; all he could tell me was that the unit is biased for Sony tape and I can't record on other tapes without having the deck rebiased. Since the Sony 651 isn't available in the U.S., I don't believe him because even less expensive units than this one can play all brands and record on them also. I've made inquiries at the regional Superscope center and they stated that they have no service information on this machine at all. Now I don't know where to turn and I trust that you may be able to find the answer to my problem.—Kenneth Kinney, East Detroit, Mich.

A. Yours is a strange problem made all the more peculiar by the fact that the distortion appears only on the left channel. If Sony tapes were much different than competitive tapes, and therefore required an appreciably different bias, then your difficulty would appear on both channels. Perhaps the left channel is somewhat under-biased. If this channel also sounds overbright in recording, this would confirm the possibility of under-biasing. It may also be that the VU meter is improperly calibrated for the left channel, so that you are over-recording and, hence, getting distortion on most tapes. It would be well to have the bias and VU meter calibration carefully checked by an authorized service station using whatever tape you customarily record on.

Recording Squeal

Q. I have a small recording business and have been using Scotch 175 tape. Recently some of these tapes have developed a high frequency chatter or squeal which is mechanical and can be stopped by rubbing the tape with a light coating of talcum powder. The squeal occurs only on the Scotch 175 tape even when used with several dif-

ferent brands of tape machine. Have you heard of anyone else having this problem with the Scotch 175 tape?—Robert Coe, Manchester, Conn.

A. Yes, I've heard other complaints about squeal, sometimes involving Scotch tape which is not surprising in view of 3M's large share of the market, but yours is the first complaint about the 175 tape. Another professional I know complained about a different Scotch tape and indicated that all the trouble lay in one particular batch. He returned the number of reels, got new ones in exchange, and hasn't had any problems since. You, too, may have been unlucky enough to have gotten a number of reels from a defective batch. You should contact a 3M dealer about your difficulty.

Discount Dilemma

Q. I have seen an ad in various audio magazines for a stereo tape transport. . . it says: "Stereo tape transport. Made for leading manufacturer, two-speed, pause control, seven-inch reel, 50-15,000 Hz, 0.25 per cent wow and flutter, with record/play and erase heads. Without case, \$19.50." Can this transport be used for copying tape from one deck to another? Can it be worthwhile for so low a price?—A.H. Raynor, Hillcrest Hts., Md.

A. Note that the item in the ad is only a transport, and you would have to supply the electronics for recording and/or playback. I am rather doubtful about the quality of anything selling for this advertised price as a good head alone costs more, and the wow-and-flutter specification is not very good.

If you have a problem or question on tape recording, write to Mr. Herman Burstein at AUDIO, 401 North Broad Street, Philadelphia, Pa. 19108. All letters are answered. Please enclose a stamped, self-addressed envelope.

Some \$5 blank cassettes have the nerve to tinker with Beethoven. We think it's outrageous.

Beethoven, even when he was deaf, knew exactly how a piccolo sounded in relation to the rest of the orchestra. Some cassette manufacturers would just as soon forget. Their cassettes give the piccolo and other high frequency sounds a distorted prominence. They appear to do this deliberately, regarding absolutely natural sound as raw material to be improved upon.

At BASF, we think this is an abomination. We're purists; we stake everything on total accuracy of sound reproduction. You will never encounter artificially enhanced high frequencies in our cassettes. We believe that if you care enough to buy an expensive audio system, the last thing you need is a cassette that imposes its own dubious tastes upon your sensitive ears.

Faithful reproduction entails more than miracle ingredients and fanciful initials on a cassette label. At BASF, we begin with the best quality ferric oxide. We mill it by a patented process to

achieve maximum packing density and uniformity of coating. We use an exclusive chemically cross-linked polymer binding which will never deteriorate and cause head-related frictional noise or wow and flutter.

We use a unique multi-stage polishing process, and our slitting technique results in an edge that's clean even when viewed under a microscope. Even our cassette case is different, incorporating our patented Special Mechanism, designed to assure smooth tape feed for years of dependable performance.

Is completely natural sound worth that kind of effort? To people who know the difference, it is.

At BASF, we're purists. We've been obsessed with total accuracy since we invented magnetic tape back in 1932. There are no shortcuts to perfection. But you knew that when you planned your own audio system. We'll give you no reason to compromise when you buy our cassettes.



 **BASF The Purist**

Our Promise: the purest, most accurate sound that tape can reproduce.

Behind the scenes

In March I began my report on the remarkable new Ampex ATR-100 tape recorder with an in-depth look at the inner workings of the transport mechanism and associated controls, and the head block assembly. This report will conclude with an examination of the sophisticated electronics of the ATR-100, and the results of test measurements on performance parameters.

As noted in my description of the electronics assembly, there is a plug-in main audio board for each channel (Ampex calls them PWA...Printed Wiring Assemblies) and a PADNET (Parameter Determining Network) plugs into the rear of the PWA. On each main audio board, there is a vertical array of screwdriver-adjustable potentiometers covering such functions as *Reproduce Gain*, *Sync Gain*, *Reproduce Equalization* for high speed (30/15 ips) with high and low frequency adjustments, *Reproduce Equalization* for low speed (7 1/2/3 3/4) with high and low frequency adjustments. Then there is *Record Gain* and *Record Equalization* for high and low speeds, and bias adjust. On the PADNET board are two jumper pins, for high and low speeds, and according to the way in which they are positioned, they make available any pairing of the four tape speeds...30, 15, 7 1/2, 3 3/4. ATR-100 units are normally shipped from the Ampex factory set for 15/7 1/2 ips operation, with a four-speed master bias. If a speed is selected via the switch on the transport control panel for which the recorder has not been properly set up, i.e. 30

ips instead of 7 1/2 or 15 ips, a red light will glow on the "lockout" indicator and the recorder will not operate in either the *Record* or *Playback* modes.

In addition to the main audio board PWA for each channel (in my case, four PWA, since I have a four-channel half-inch unit, with a stereo head assembly as well), there is an audio control PWA. This audio control board has a master crystal oscillator, which is a multi-function device in this recorder. There are separate divisions of this crystal to avoid interaction. First we have the erase circuit with a frequency of 144 kHz, and there is four-speed master bias at a frequency of 432 kHz. Other subdivisions of this crystal handle the transport servo control. On this audio control board are jumper pins which can be positioned to provide two-speed dual master bias operation or four-speed master bias operation. When in the four-speed mode, a single master bias level is provided for each speed. Whatever speed is selected on the transport control panel, master bias level is automatically switched for each speed. While it is true there are bias controls on each of the main audio boards, it is much easier to use the master bias level control to set bias on all four channels simultaneously, and ignore the individual controls. Getting back to the main audio PWA boards in the PADNET section, there is still another jumper pin which controls a function Ampex calls PURC...which stands for "pick-up recording capability." In *Record* mode, the erase and record heads are energized simultaneously,

and since there is a 1.46 inch gap between erase and record head, there is some over-recording on unerased tape and a loud click is heard on the recording. With PURC, separate erase and bias amplifier circuits are provided and, in essence, when *Record* mode is entered, the erase is energized first, then after a delay (97 milliseconds at 15 ips), the bias amplifier comes on. On cessation of recording, erase circuit shuts off first, then the delay and the bias amplifier goes off. Voila! No clicks!

Level Controls

The ATR-100 as normally used is fitted with input/output modules, the number of them depending on the track configuration. Each module has a meter which may be set to operate as a standard VU meter or with EBU ballistics for peak indication. There are record and reproduce level controls with a switch to set them in manual or pre-set modes. Red "confidence" lights glow when bias and erase signals are present at the heads. A record calibration control is used to set input monitoring level and meter indication for "off-tape" levels. A headphone jack permits monitoring with 600-ohm phones. All input and output connections are with standard XLR male and female connectors. Depending on how the connectors are wired, balanced or unbalanced line inputs and outputs can be set up. Balanced input impedance is 50 kilohms. Variable input level can produce a maximum of plus 40 dBm. Balanced

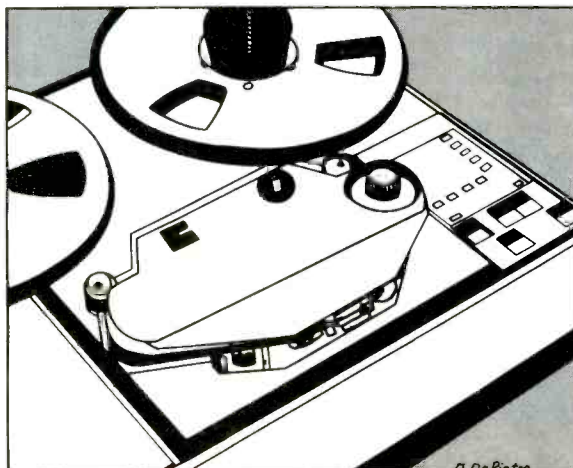

These new Dahlquist products will greatly improve the performance of your speaker system.

We are pleased to offer you four important new products and accessories that will add considerably to your listening enjoyment. Included are a remarkable subwoofer system and two crossover units, electronic and passive. Also available is an attractive stand for our popular Dahlquist DQ-10 loudspeaker, which will improve both performance and appearance. Ask for a demonstration at your Dahlquist dealer.

1 **DQ-1W LOW-BASS MODULE.** A superior subwoofer design. Adds an octave or more of extremely tight, well defined low response to most speakers. Propagates considerable acoustic output to 20 Hz and below. Its fast rise/decay times assure excellent coherence with high-definition speakers. Use with either the passive or active Dahlquist crossovers below. High quality 13" driver with heavy cast frame and 12,000 Gauss magnet. Oiled walnut finish with satin aluminum trim.

2 **DQ-MX1 PASSIVE CROSS-OVER.** For connecting any 8 ohm center-channel subwoofer without requiring another amplifier. Features: 3-position bass level switch; phase switch; frequency selector for 60 or 80 Hz crossover.

3 **DQ-LP1 ELECTRONIC LOW-PASS FILTER.** For optimum results as a no-compromise,

bi-amplified system. Features: continuously variable crossover settings from 40 to 400 Hz, @ 18dB/octave; bass level adjustments with up to 15dB gain; 0 to +5dB equalization at 20 Hz; bypass switches silence subwoofer and restore full-range response to main speakers; separate outputs for stereo and mixed-center-channel subwoofers; A unique combination of active low-pass and passive high-pass sections prevents any degradation of high frequency performance quality.

4 **ST-10 OPTIONAL STANDS.** For owners of our Dahlquist DQ-10 speakers. Improve radiation characteristics, especially noticeable in the lower-midrange/upper-bass regions. Packed two to a carton. Assembles with six screws.

DAHLQUIST

27 Hanse Ave., Freeport, N.Y. 11520

Enter No. 8 on Reader Service Card

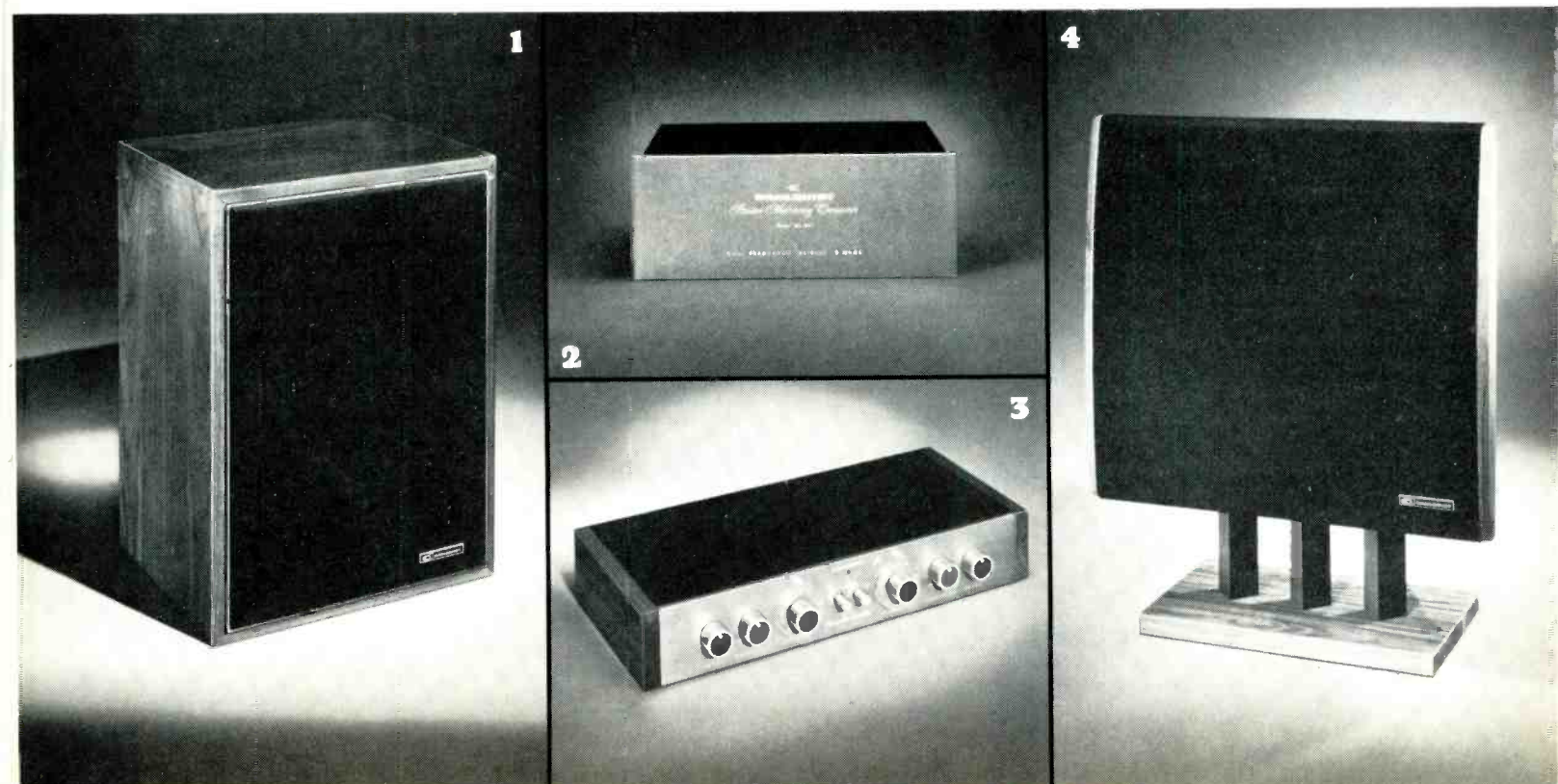

SYNCHRONIC TIME ARRAY: now, time/phase aligning at a popular price ...why should big spenders get all the breaks?

Call it phase linearity or linking. Time coherence or aligning. But what good is a new audio breakthrough, by any name, if only a privileged few can afford it?

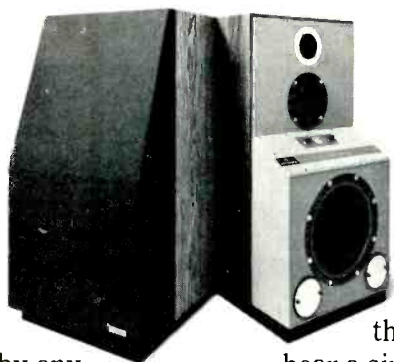

You wonder, for the umpteenth time, why high technology always starts out so expensive.

Frankly, we don't know why other famous brands run so high for speakers built to compensate time/phase differentials between drivers. But

we do know it can be done for less. Because Ultralinear, the up-front, coast-to-coast loudspeaker company, is doing it.

Our new *Synchronic Time Array*™ ST550 system can match—or exceed—their sophisticated performance, for the same bucks a conventional system costs.

Now it's plain you too can have it, why should you want it? Basically, time-sync techniques correct the split-second delay in getting sounds out of your speaker—in the same order they went in.

It's particularly critical when the same note's being reproduced

by more than one driver at the same time. In conventional systems, one driver is always fractionally closer to your ear than the others, so you don't hear a simultaneous attack.

Sure, it's a tiny distortion you wouldn't think matters. Until you hear the definition the Ultralinear ST550 system achieves through cross-over network refinements and driver re-positioning.

An ad can't do it justice. And since ads don't carry sound tracks, there's only one way to comprehend ST550's unique characteristics: direct comparison against any conventional speaker system you're familiar with (at any price).

To run your own one-on-one test, send for a list of Ultralinear dealers in your area, plus our brochure on the *Synchronic Time Array* ST550 system. Write to the up-front, coast-to-coast loudspeaker company:

Ultralinear, 3228 East 50th Street, Los Angeles, California 90058.

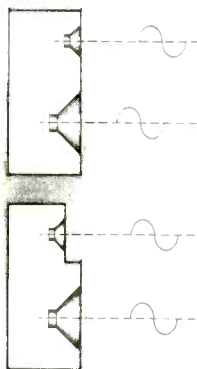

Ultralinear™

output can be 50 ohms or 600 ohms. At 600 ohms, the maximum output level can reach an astonishing +28 dBm! Operating level of the system is 370 nWb/m at 0 VU, which is used for Ampex Grand Master tape, and is 6 dB higher than the 185 nWb/m reference level of Ampex alignment tapes. As shipped, the pre-set mode switches are adjusted for +4 dBm input and output line levels.

In my initial description of the Ampex ATR-100, I pointed out that one of the units most interesting capabilities was that it could record square waves, and thus was essentially free from phase non-linearities. The question of the audibility and the importance of phase non-linearities notwithstanding, it would seem reasonable that if these anomalies could be corrected without inordinate complexity and expense, it would certainly be worth doing. Alastair M. Heaslett, Senior Staff Engineer for Ampex and one of the principal designers of the ATR-100, gave a most interesting paper at the 55th AES convention at the Waldorf, on "Phase Distortion in Audio Magnetic Recording." Mr. Heaslett points out that "anyone who has ever attempted to record square waves on an audio recorder will have seen the effect of the resulting phase non-linearity. The leading edges of the reproduced waveform have a large amount of overshoot. In addition, if the reproduce head resonance were not adequately controlled, the high frequency "ring" after the leading edges will be very evident." Mr. Heaslett goes on to note the importance of strict adherence to the equalization standards that have been established for magnetic recording, and then has this to say... "some attempts in the past have been made to provide corrections for phase non-linearities in audio recorders. However, the methods used for correction have principally been applied to the reproducing side of the system. When adjusted correctly, they certainly produce excellent square wave and transient response. This, however, is only true with the same type of tape, identically biased. In other words, this approach does not yield a recording implicitly compatible with the equalization standard. If such a recording were reproduced on our "ideal" reproducer, there would no longer be an accurate time domain representation of the recording." Mr. Heaslett then describes the special ATR-100 record equalizer which preserves the integrity of standard equalization from 3 3/4-to-30 ips, while essentially

Here's How Dolby FM Gives You: **More Signal** ↑ **Less Noise** ↓

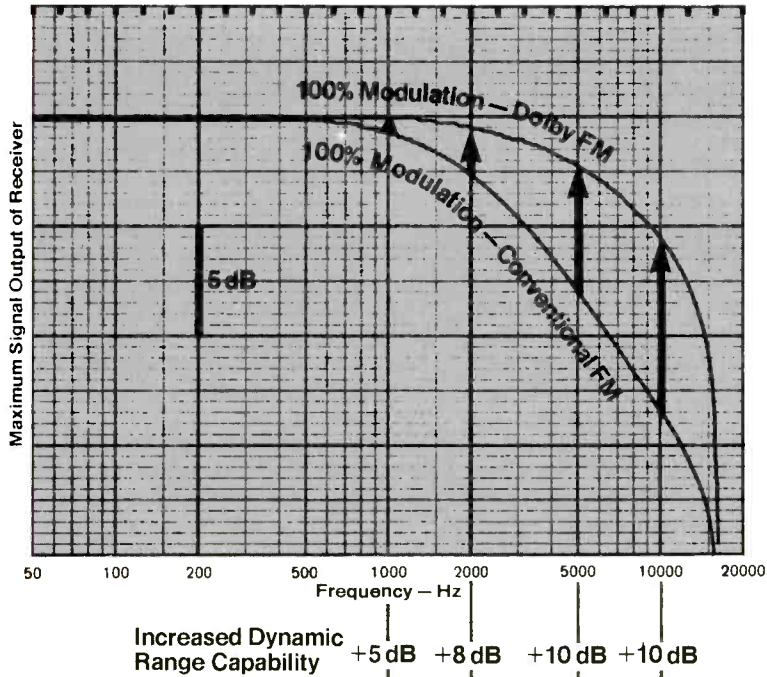

These curves show the improvement in maximum high-frequency output level with Dolby FM. Contemporary wide-range program material will not "fit" under the 100% modulation limit of the 75 microsecond conventional FM curve; the signal must be high-frequency limited (or reduced in overall level) enough to do so. Such program material *will*, however, fit under the 25 microsecond Dolby FM curve. (Note that these curves are maximum output curves; they are not frequency response curves in the normal sense. At low modulation levels both curves would be flat to 15 kHz.)

All curves were made on a typical new stereo receiver with full Dolby FM decoding capability. The receiver was driven from the rf output of a Sound Technology 1000A FM signal generator, operating at a frequency of 97 MHz. The rf level was set at 100 μ V at the 300 ohm antenna input terminals of the receiver.

For the maximum high-frequency output curves, the output of a B&K 1024 audio sweep oscillator was fed into the FM generator at a level giving 100% FM modulation at all frequencies (± 75 kHz deviation, including 19 kHz multiplex pilot). One stereo channel of the receiver (tape output) was fed directly into a B&K 2305 chart recorder. The Dolby FM/conventional FM switch on the receiver was then operated to give the two recordings shown.

For the noise level curves, the audio input to the FM generator was switched off. The receiver output was fed to a Radiometer FRA 3 wave analyzer which was coupled to the chart recorder and calibrated to give a flat chart recording with pink noise input. The Dolby FM/conventional FM switch on the receiver was then operated to produce the two noise spectrum recordings shown.

In all of the chart recordings note that there is a sharp drop in response above 15 kHz. This is normal for all FM receivers and is caused by the filters necessary for rejection of the 19 kHz and 38 kHz multiplex components.

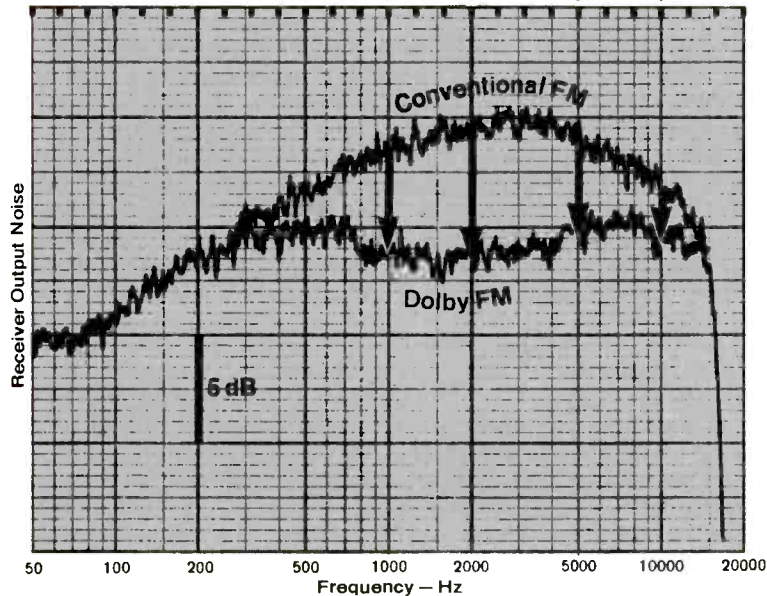

These chart recordings show the noise reduction effect of Dolby FM. The top curve is the noise spectrum of conventional 75 microsecond FM. The bottom curve shows the reduced noise level of Dolby FM.

These chart recordings show how the Dolby FM technique increases the available high frequency dynamic range of FM broadcasting.

The Dolby FM process works on both extremes of the dynamic range. The maximum permissible level of high frequency signals is increased, while low

level noise is reduced. The 10 dB action of the Dolby B system is split in an optimum way between these two equally important areas of operation. The net result is an FM system which can pass signals from transmitter input to receiver output with high integrity.

To find out more about this new development, please write to us for further

details. The following information is available:

1. Explanations and technical details on Dolby FM.
2. A list of stations with Dolby FM encoder units (160 stations).
3. A list of receivers with built-in Dolby FM circuits (45 models).

Dolby[®]
Dolby Laboratories
"Dolby" and the double-D symbol are trade marks of Dolby Laboratories

731 Sansome Street
San Francisco, CA 94111
Telephone (415) 392-0300
Telex 34409
Cable Dolbylabs

346 Clapham Road
London SW9
Telephone 01-720 1111
Telex 919109
Cable Dolbylabs London

Because music is mostly transients.



Our 282-e cartridge.

From the attack of an organ note to the bite of a plucked string, music is mostly transients: sudden bursts of sound at all frequencies. On a stereo record, transient signals define the characteristic attack and decay of musical sounds, differentiating one instrument from another.

Until Micro-Acoustics' direct-coupled design (U.S. Pat. No. 3952171), all high-fidelity cartridges concentrated on *tracking ability*, maintaining contact between stylus and groove at low forces, for minimum record/stylus wear. This reduces *transient ability*, because under-damped moving assemblies tend to remain in motion, impairing clarity and definition. On the other hand, earlier cartridges with stiffer stylus assemblies had better transient ability, but greater wear.

Unlike these single-pivot cartridges, which maximize one ability, Micro-Acoustics' 282-e has twin pivots optimized for *both* abilities. Resulting in superior transient and tracking performance from *one* cartridge on *all* records, including warped discs. Performance totally independent of tonearm cable capacity or preamp input impedance.

Visit your MA dealer and let your ears convince you. Or use our unique test record for evaluating and comparing cartridge tracking and transient ability. Just send \$3.95 for a postpaid copy, or write for free information. Micro-Acoustics Corporation, 8 Westchester Plaza, Elmsford, N.Y. 10523. In Canada, H. Roy Gray Ltd., Markham, Ont.

ma

Micro-Acoustics

"Because good tracking isn't enough."

© 1977, Micro-Acoustics Corporation.

maintaining phase linearity. The equalizer is far too complex to describe here, but the important thing is, in Mr. Heaslett's words, "it has the very real advantage that a recording made using it, will play back on any *conventionally* equalized audio recorder with the improved phase linearity."

Machine Measurements

Okay, we've poked our noses into all the nooks and crannies of the ATR-100, and now it is time to see what kind of performance such a sophisticated machine affords. . . . I must at this point gratefully acknowledge the assistance, both morally and technically, of good friend Frank Dickinson. Frank runs the "9 West Recording Studio" in Bloomfield, New Jersey, as well as an elaborate scientific machine shop and is considered a master in the care and feeding of Ampex and other professional tape machines. He grinds his own stainless steel spindles for his rebuilt motors, balances them with painstaking precision, and they are super smooth running and absolutely whisper-quiet. Frank loaned his fine dual-trace Tektronix scope to the cause. For distortion measurements, both total harmonic and intermodulation, we used the new Sound Technology 1700B analyzer. This is a great tool and makes measurements with an ease undreamed of a few years ago. I'm going to do a run-down on one of these units before long. Through the courtesy of Eli Passin of Gotham Audio in New York, wow and flutter measurements were made on the ultra-sensitive EMT 424 flutter meter. I should point out that Ampex quotes their distortion figures for *third* harmonic, while we were measuring THD with the 1700B. I should also note that all measurements on the ATR-100 were made using Ampex Grand Master tape. Frankly, the machine's high performance is built around this tape, although I should also mention that the ATR-100 has the erase and bias frequencies and drive capabilities, plus bountiful headroom, to cope with super tapes not yet formulated. This machine should have no problems with the iron-particle tapes now under development. Just as an aside, even the fine Ampex 406 tape couldn't quite match the performance figures of Grand Master, nor could three other brands of high quality tape.

All tests were performed at 15 ips, using the two-channel stereo head assembly. Ampex spec for the ATR-100 for *third* harmonic distortion was 0.1

per cent @ 1 kHz. We measured THD @ 0 VU, @ 1 kHz at 0.65 per cent; same conditions at 10 kHz, 0.85 per cent; at 30 kHz and minus 5 VU, the THD was 1.4 per cent. Three per cent THD was reached at +11 VU @ 1 kHz! Intermodulation distortion was measured using the SMPTE 4-to-1 ratio of 7 kHz and 400 Hz. Ampex spec is 1.0 per cent at 0 VU. We obtained 0.8 to 0.9 per cent at 0 VU. Three percent IM occurred at +6.5 VU. Frequency response was less than ± 2 dB from 20 Hz to 20 kHz (meets spec), was down 3 dB at 26 kHz, and down 5 dB at 30 kHz. Wow and flutter, ANSI/DIN weighted @ 3150 Hz, was an astonishing 0.015 to 0.02 per cent. Signal-to-noise ratio (measured at 9 dB above the operating level of 370 nWb/m) at 15 ips, NAB, unweighted, was -71 dB. These are obviously impressive figures that place the Ampex ATR-100 in a class by itself.

Overall Impressions

On an overall basis, the ATR-100 is the easiest tape machine I have ever used. Tape threading is actually simpler than many consumer machines, and once you master the little "jiggle" which locks in the reel servos, you're in business. The controls are quite explicit and a joy to use. Tape handling is the most positive ever, but very gentle at the same time. The exceptionally good tape motion and good head wrap result in almost non-existent modulation noise, and tape playback is smooth and ultra-clean. Needless to say, recordings made on the ATR-100 are virtually mirror images of the source. A nice plus is the very quiet operation of the machine, and although used for many long hours, it never became more than warm. The Ampex 440C was and is a fine recorder, but it was the end result of an evolutionary design. The ATR-100 is in many respects a revolutionary machine that has brought analog magnetic recording to a new peak of achievement. Several engineer friends have expressed two interesting thoughts. . . . One said that the ATR-100 was probably built and is so constructed that it should be easy to convert to digital use; the other said that after checking out the ATR-100, he doesn't see how they could carry the analog concept much further, and it might be quite likely that the ATR-100 is the last of the breed. Premature thinking? Who knows? All I know is that it is one helluva tape recorder, and I'm going to enjoy it for what it is, and leave the speculation to others! Δ

Because one good listening spot in a room isn't enough.

What's the most important characteristic of a high-fidelity loudspeaker?

If you answer "frequency response," you're only half-right. The other half is proper *high-frequency dispersion*. Without it, the optimum response of most high-quality loudspeakers is *confined only to a small area in your listening room* (see Figure 1). Outside this narrow listening area, the sound suffers from poor tonal balance. And degraded stereo imaging, since *the loss of high frequencies reduces the stereo effect*.

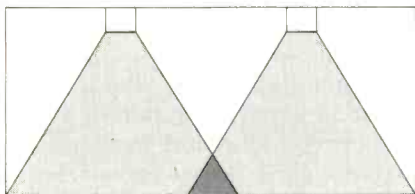

Figure 1. Typical listening-room dispersion with conventional speakers. Optimum stereo listening area where patterns overlap - barely room for one person.

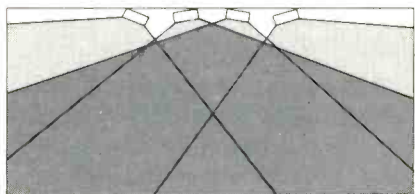

Figure 2. Control room dispersion diagram. Shaded area where two channels overlap covers virtually the entire room.

To counter the dispersion problem in recording-studio control booths, engineers resort to mounting loudspeakers in multiple-axis arrays, *literally aiming them at the ears of studio personnel!* While this approach provides optimum dispersion (see Figures 2 and 3), it is very costly.

Multi-Axial™ Arrays: recording-studio dispersion from a *single pair of loudspeakers*. Using mathematically-derived tweeter configurations, Micro-Acoustics engineers have obtained uniform high-frequency response *throughout any listening area*, from a single pair of loudspeakers. With the same performance as elaborate control-room arrays... at a fraction of the cost.

The FRM-1A's Penta-Axis Array. Features a unique arrangement of four tweeters and one super-tweeter, yielding a dispersion pattern of 180° vertically and horizontally.

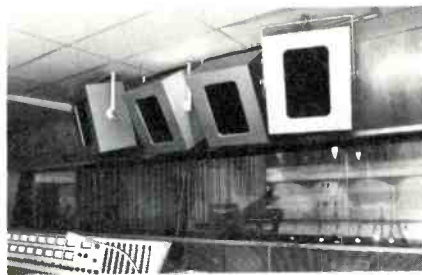

Figure 3. Multiple-axis speaker arrays in actual recording studio control room.

Incorporating a 10" woofer with 2½ lb. magnet assembly, the system's overall response is exceptionally smooth from 32-18,000 Hz. Two controls—dispersion and super-tweeter level—optimize playback in any environment. Suggested list, \$200 each, with full 10-year warranty.

The FRM-2A's Tri-Axis Array. Features three direct-radiating tweeters, with uniform dispersion through 160° vertically and horizontally. Single control adjusts all tweeters simultaneously. With its 10" acoustic-suspension woofer, response is smooth from 40-16,000 Hz, even when driven by moderately-powered amplifiers. Suggested list, \$159 each, with full 10-year warranty.

FRM-3's unique Vari-Axis Dispersion. Optimum dispersion in a *compact* loudspeaker. High-frequency driver is mounted on a rotating assembly. Five-position control optimizes 140° vertical and horizontal dispersion for speaker location and room environment. Using a long-throw 8" woofer operating into a twin-ducted port enclosure, response is smooth over 45-15,000 Hz, even

when driven by low-powered receivers. Suggested list, \$125 each* in matched pairs, with full 10-year warranty.

A simple, but meaningful test. At your audio dealer's, seat yourself midway between two conventional loudspeakers and listen. Try to distinguish the position of each instrument, as well as its individual sound. Then stand up and move around. Notice the distinct shift in tonal color, as well as instrumental position.

Now, try the same test with Multi-Axis Loudspeakers. *You'll hear little or no difference in sound, regardless of your position.*

For the name of your MA dealer, and our free 8-page brochure, return the coupon to Micro-Acoustics Corporation, 8 Westchester Plaza, Elmsford NY 10523. In Canada, H. Roy Gray Ltd., Markham, Ont.

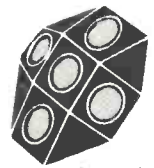

Figure 4. Penta-Axis Array of FRM-1A.



Figure 5. Tri-Axis Array of FRM-2A.



Figure 6. Vari-Axis Driver and Control of FRM-3.



"Quality worth a 10-year warranty."

Send me the name of my MA dealer and free 8-page Multi-Axis Speaker Brochure.

Name _____
 Address _____
 City _____
 State _____ Zip _____

A577

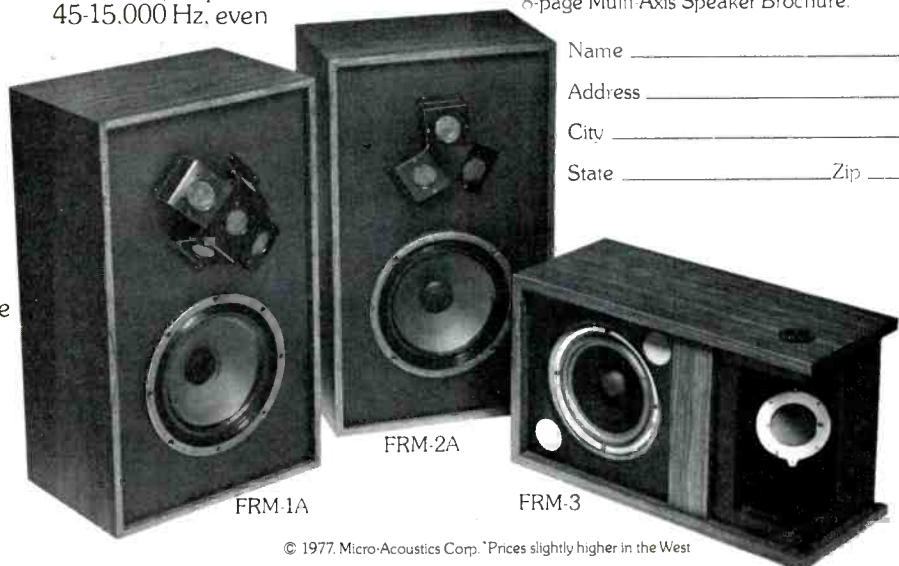

© 1977, Micro-Acoustics Corp. *Prices slightly higher in the West

Totally Nakamichi

The Nakamichi 600 Series components and the SYSTEM ONE rack bring a new approach to system high fidelity—a bold concept distinctly ahead of its time. Performance and quality are *totally* Nakamichi with standards of excellence not likely to be matched for years to come.

Unlike professional rack-mounted equipment, SYSTEM ONE is compact, slim, decidedly non-industrial in appearance, and fits comfortably into any decor. The specially designed rack features a multipurpose digital timer that augments the system's inherent versatility by providing several unattended automatic functions. Immediate rear access greatly simplifies intercomponent wiring, and thanks to four heavy-duty precision casters, the rack easily glides anywhere. Plug it into any AC outlet, hook up a pair of loudspeakers (and a turntable, if desired)—almost instantly, you've created a complete and incredibly impressive stereo system.

There are four superb components in the 600 Series: the 600 Cassette Console, the 610 Control Preamp, the 620 Power Amplifier and the newly introduced 630 FM Tuner Preamp.

SYSTEM ONE

Dolby[®] is a Trademark of Dolby Laboratories, Inc.

...any way you look at it.

The 630 is the unusual and versatile combination of a state-of-the-art preamplifier and a highly advanced FM tuner. The preamp section features outstanding phono circuitry, tone and variable contour controls, tape deck monitor and copy facilities and a high-output headphone amplifier. The FM section utilizes an elaborate hand-wired MOSFET front end, low phase shift IF filters, and an extremely stable phase-locked-loop multiplex demodulator. There are also switches for FM Dolby* and narrow/wide filter selection. Precise tuning indicator lamps and the large-scale, balanced vernier dial make station selection a breeze. The amazing thing is that the 630 is available at a price that you would normally expect to pay for such a fine tuner or preamp alone. It can be connected directly to the 620 Power Amplifier, or, if your needs so dictate, used in conjunction with the 610 Control Preamplifier.

Of course, you can get your Nakamichi act together without the SYSTEM ONE rack. Each of the 600 Series components is a study in human engineering: their gracefully sloped panels make them ideal for table or shelf placement.

Your particular system can be precisely the combination that best suits your needs. Start with the 600, 620, and 630—a formidable trio of no-compromise performers. A 610 can be added for increased programming flexibility, or a second 620 (with the optional Bridging Adapter) for greater power requirements.

So take your Nakamichis standing up or lying down. Either way, you have components that make a lot of sense by themselves, and even more together. Your Nakamichi dealer will be proud to give you a demonstration.

For complete information, write Nakamichi Research (USA) Inc. 220 Westbury Ave. Carle Place, N.Y. 11514.

Enter No. 22 on Reader Service Card



Nakamichi



What's new

Koss Headphones

The Model ESP/10 electrostatic stereophones were designed with special attention to the way the human ear hears reproduced sound and feature ultra wide frequency response and exceptional musical balance. The headphones plug into an electrostatic energizer which accommodates two sets of headphones, has semi-peak reading meters, an automatic overload device to prevent excessive input signals, and



can be operated from an amp with as little as 25 watts continuous power per channel. Price: \$300.00.
Enter No. 80 on Reader Service Card

Acoustic Research Loudspeaker

The Model AR-17 is a two-way speaker system with an 8-in. acoustic suspension woofer and an 1 1/4-in. magnetic fluid suspension tweeter. A two-position switch provides a means of altering the treble energy contour above the 2 kHz crossover frequency. With a nominal impedance of 8 ohms, the stated efficiency for one watt is 86 dB SPL at one meter on axis. Measuring 10 x 18 1/2 x 8 3/4 in., the unit weighs 17 lbs. Price: \$89.00.
Enter No. 81 on Reader Service Card

Heath Catalog

The new 96-page Heathkit Catalog illustrating nearly 400 electronic kits is now available. The kits include hi-fi components, a three-way bookshelf loudspeaker, test instruments, etc.

Enter No. 82 on Reader Service Card

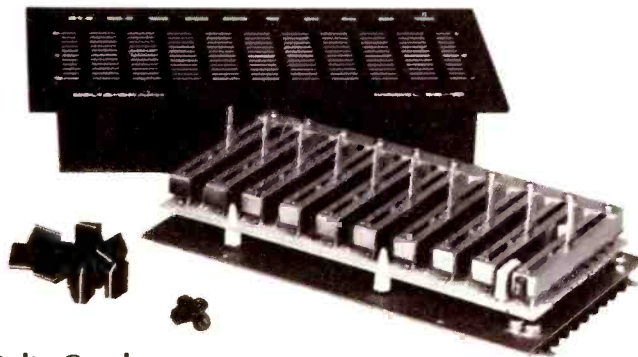

Delta-Graph Equalizers

The Model EQ-10 modular graphic equalization system consists of individual channel, 10-band octave equalization modules which can be used to form mono, stereo, quadrasonic, eight-

channel and multi-track systems. The boost and cut for each band is specced as 12 dB, minimum, with 0.05 per cent THD, and the frequency response is flat from 20 Hz to 20 kHz $\pm 1/4$ dB. Prices: from \$56.00.

Enter No. 83 on Reader Service Card



Thorens Turntable

The Model TD-126C Iso-track series turntable features a plug-in tonearm with the headshell and tonearm rod in a straight tubular design with a 7.5 gram effective mass, through elimination of the headshell and its collar connection. The unit, with speeds of 33-1/3, 45, and 78,

has a fine speed adjustment of ± 5 per cent, wow and flutter of 0.04 per cent, a -70 dB DIN weighted rumble figure, an illuminated stroboscope, a 16-pole synchronous motor, a Wein-Bridge oscillator for precise motor speed control, and an electronic tonearm lift-up/shutoff operation. Price: \$625.00.

Enter No. 84 on Reader Service Card

Fosgate Amplifier/Equalizer

The PowerPunch is an automotive amplifier/equalizer with a maximum power output of 20 W into 8 ohms @ 1 kHz, a frequency response at half-power of 20 Hz to 20 kHz ± 0.5 dB, and a claimed THD at 10 watts of 0.3 per cent. The active equalizer provides a maximum boost of +18 dB at 55 Hz and +12 dB at 20 kHz. Price: \$199.95.



Enter No. 85 on Reader Service Card

Phase Linear Tuner

The Model 5000 FM Tuner features a dynamic range expander specifically designed to improve the dynamic range up to 9 dB, and lesser amounts of expansion may be selected for those broadcasts which use smaller amounts of compression. There is also fully variable muting, fixed and variable outputs, signal strength and center tune meters which can be recalibrated, a 75/25 μ S de-emphasis switch, LED Multipath indicators, and a panel light dimmer. Price: \$499.00.
Enter No. 86 on Reader Service Card

White Speaker

The White Shot-Glass speaker system features four water-resistant "glasscone" speakers with a four-in. bass port and a 150° angle of dispersion. The waterproof urethane cabinet also contains a patented parabolic surround and six layer voice coils. Price: \$189.50.

Enter No. 87 on Reader Service Card

THE MACHINE

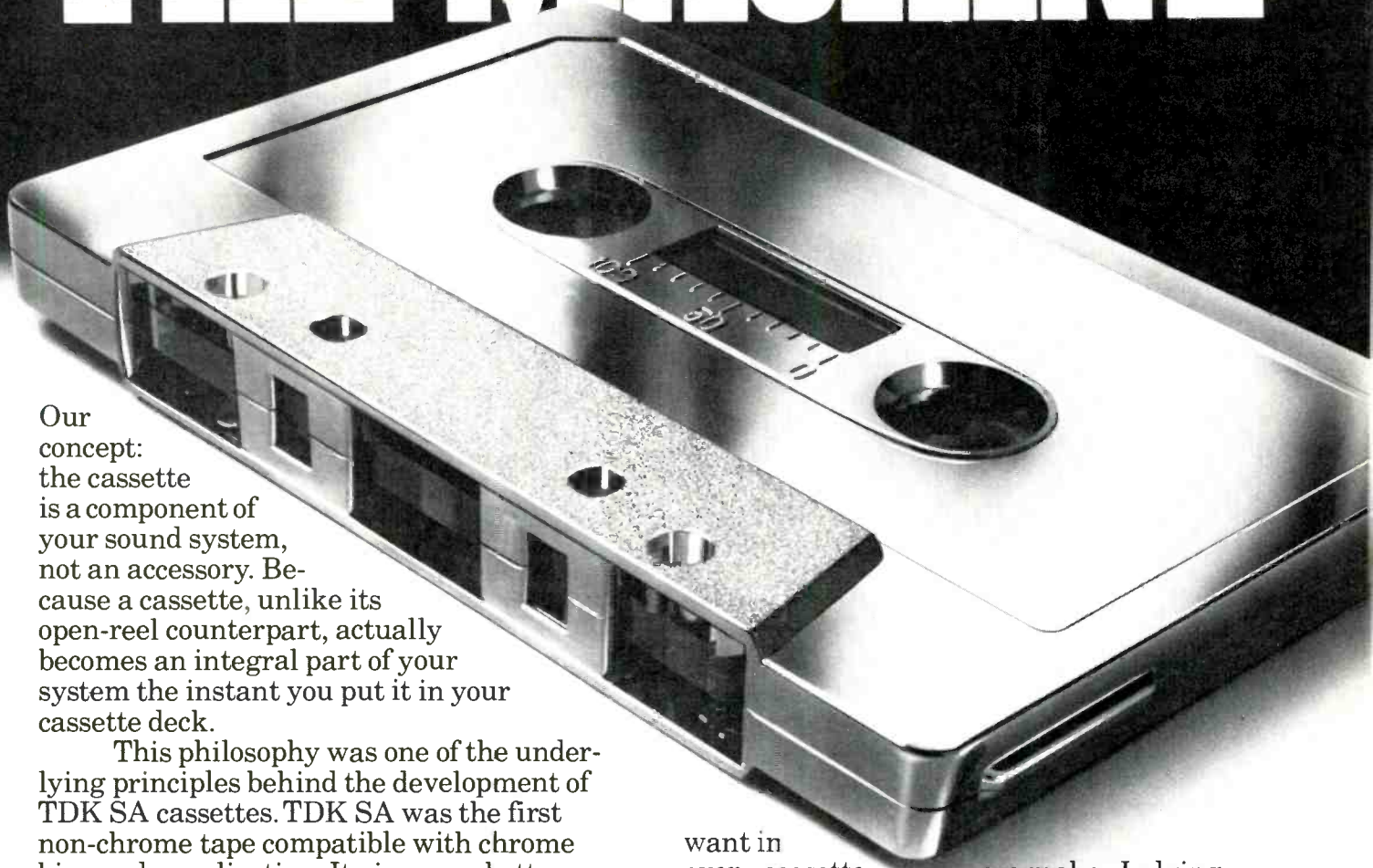

Our concept: the cassette is a component of your sound system, not an accessory. Because a cassette, unlike its open-reel counterpart, actually becomes an integral part of your system the instant you put it in your cassette deck.

This philosophy was one of the underlying principles behind the development of TDK SA cassettes. TDK SA was the first non-chrome tape compatible with chrome bias and equalization. It gives you better high-end performance than ferric-oxide-based tape, and unlike chrome tapes, it gives you greater dynamic range at low and mid-range frequencies, with far less distortion.

But our engineers put as much emphasis on the design and construction of the SA cassette housing as they did on the SA tape inside. Our cassette shell and tape carriage system are made to the same high standards as the tape they carry. So you get the kind of jam-proof, friction-free reliability you

want in every cassette we make. Judging from our sales and fan mail, you agree with our philosophy.

TDK SA cassettes offer both superior tape and precision mechanics. That's why quality tape deck manufacturers either use SA as their reference cassettes, or recommend it for their machines.* And why you'll get the best from your system by using our machine in your machine.

TDK Electronics Corp., 755 Eastgate Boulevard, Garden City, New York 11530.
In Canada, contact Superior Electronics Industries, Ltd.

for your machine.



*Questions about specific decks will be answered upon request



TDK®

Enter No. 41 on Reader Service Card

Being the trials and tribulations of a stereophone and loudspeaker designer during his quest for the ideal pair of stereo phones



What You Don't Know, HURTS!

Jacob C. Turner*

For longer than man has known about the spherical shape of the planet on which he lives, he has argued about the relationship between subjective and objective reality. Stereophone makers and users alike are presently stewing in that same juice. Let me attempt to bring this issue into perspective and show how it is acutely relevant both to the audio engineer and consumer.

This is no new conflict. Over 2300 years ago the Greek philosopher Democritus wrote: "Sweet and bitter, cold and warm, as well as all the colors; all these things exist but in opinion and not in reality." Many centuries after, the German mathematician Leibnitz wrote: "I am able to prove that not only light, color, heat and the like, but motion, shape, and extension too are mere apparent qualities."² Albert Einstein carried this train of logic further by showing that even space and time are forms of intuition, which can no more be divorced from consciousness than can our concepts of color, shape or size.

These seeming subtleties of philosophy have had a quite profound bearing on modern science. For along with the philosophers' reduction of objective reality to a shadow-world of perceptions, scientists later became alarmingly aware of the limitations of man's sensory ability and subsequently the equally limited scope of "objective" knowledge about our world, since it can only be perceived through this sensory veil.

In spite of our apparent sensory imprisonment, however, a curious order seems to run through our perceptions, as if indeed there might be an underlayer of objective reality which our senses are able to translate. Therein lies the dilemma.

The aim of science is to describe and explain objectively the world we live in. And yet, even the instruments and tools that the scientist creates and employs in his search for objective reality are, in fact, presuppositions of what that reality is. Ironically, the vast bulk of technology involved in modern electronic equipment (and in audio) is directly related to two natural phenomena which we are not yet able to explain, electricity and magnetism. We know how to use some of their effects but we don't know what they really are, or indeed if they are really "something." In other words, guided

by our perceptions of reality, we have amassed an enormous and constantly expanding body of knowledge and technology that we have learned to utilize in controlling and changing our lives.

It seems reasonable to conclude two points from the above. First, that man's primary understanding about the nature of his world is the result of sensory perception; second, that the discipline of modern scientific practice provides organization, integration and extension of all man's perceptions into a more manageable and consistent body of knowledge and technology which would otherwise be unthinkable. Viewed together, they create a highly synergistic combination of forces that is properly descriptive of modern man; viewed in isolation, each one individually is medieval and parochial.

Nowhere is this necessary relationship displayed more dramatically than in our own brain, where the objective scientist in all of us (left hemisphere) is joined together with the subjective intuitor/artist in all of us (right hemisphere) to form a complete functional mind.

Few areas of modern industrial society present greater opportunities for implementing this complete view of knowledge than is presented to to-

*Vice President-Engineering & Research, Koss Corporation

JVC Professionals. The only receivers that adjust sound to the acoustics in your room.



Listening to a demonstration of music systems at a dealer is an excellent way to make a buying decision. But it can be misleading. Because what you hear in the dealer's acoustically designed sound room may not be what you hear at home.

The reason is simple. Sound quality is determined by various factors, including the size of a room and its acoustic elements. Drapes. Carpet. Furniture. Windows. Ceiling height. Walls. They all play a role in the sound you hear.

To help you get the best sound from your music system—wherever you listen to it—JVC has built into its top three receivers (S600, S400, S300) their exclusive SEA graphic equalizer system. This unique 5-zone control lets you create 371,293 different tone adjustments. As a result, you can custom tailor the sound to compensate for any room size and acoustic surfaces. The graphic equalizer also enables you to overcome deficiencies in old or poor recordings and the placement of speakers. Nobody else has this built-in feature. Nobody. And the only

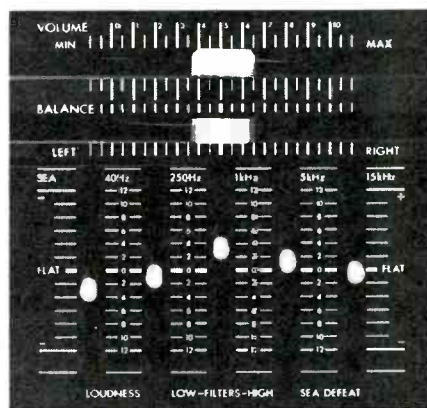

Exclusive 5-zone SEA graphic equalizer system for better performance from components and listening room.

way any other make of receiver can match the sonic versatility of these three JVC models is by your adding to it (at an additional cost of \$100 or more) a separate, outboard graphic equalizer.

When you consider that you get the built-in graphic equalizer plus JVC's

many other outstanding features for the price of a conventional receiver in their price ranges, you can understand why the JVC professionals are rapidly becoming the #1 receiver to own.

JVC also offers the less sophisticated, moderately priced S200 and S100 receivers with precision, linear slide controls for bass, treble and volume. Regardless what you plan to spend for a receiver—think like a professional and get the best. Think JVC.

Visit your local JVC dealer, or call toll-free (outside N.Y.) 800-221-7502 for his name.

JVC America, Inc., 58-75 Queens Midtown Expressway, Maspeth, N.Y. 11378 (212) 476-8300. Canada: JVC Electronics of Canada, Ltd., Scarborough, Ont.

JVC

Enter No. 16 on Reader Service Card

day's audio component designer, and particularly the stereophone engineer. Concerned primarily with equipment design and production, men in this area of the audio business are still very intimately involved with both the performing arts and the recording industry, that is the music business. And yet, unlike the performing musician, the audio designer is at once equally the artist and the scientist—the artist in that the designer's objective is musical pleasure and abstract communication; the scientist in that the designer's means to the foregoing objectives, of necessity, involve high technology.

Herein, however, lie several problems which hinder our ability to judge the accuracy of our efforts definitively.

Measuring With Music

To begin with, the entire structure of musical sounds and the manner in which they are produced are man-made and arbitrary, differing from culture to culture and from age to age. There are no fixed musical references in nature against which objective and subjective standards can be drawn, either for instrumental quality or musical interpretation.

As a result, the instruments which produce the musical sounds have such individual sonic personalities

cess itself if a record is to be made of a performance.

How, then, is the subjective intuition/artist portion of our stereophone designer to evaluate musical reproduction of his latest "baby?" Can he simply sit back and say, "Yes, this pair of phones makes this recording sound like Menuhin is truly playing in Boston Symphony Hall on Thursday, March 3?" But is it even possible for the designer to portray *the* true sonic reality of *that* Boston performance? What musical criteria are at all relevant? Which ones can be agreed upon by both designers and the buying public? Can any be agreed upon? Victor Campos (then of AR, Inc.) once claimed that in attempting to analyze how sound behaved in Boston's Symphony Hall that it took his computer from 12:00 noon until 4:15 in the afternoon just to plot all the reflections and delays from one quadrant in Symphony Hall.³

The generation of most musical sounds is a complexity of constantly changing variables, with no fixed standards of reference and low predictability both as to execution and reception. It is not presently possible, therefore, to electronically duplicate and analyze a reference violin sound, for example, with any reasonable degree of accuracy or meaningful correlation to the real world of violins.

The generation of most musical sounds is a complexity of constantly changing variables, with no fixed standards of reference and low predictability both as to execution and reception.

that there is, for example, no reference violin against which all other violins can be measured. In addition, no two persons produce the same sounds on *the* same instrument on any two successive playings of the same piece of music. Add to this dizzying scene the additional complication of the acoustic personality of the space in which a given instrument is being played and you end up with a very complex situation, ignoring for the moment the equally complex results of the inevitable recording pro-

Neither electronic engineers nor stereophone engineers have yet developed any definitive test or set of non-musical signals, such as white noise, pink noise, tone bursts, square waves, sine waves, warble tones, etc., that produces high correlation between measured performance and reproduced musical performance of audio products.

In the absence of such a definitive objective test, therefore, the final arbiter of truth in high accuracy stereophone reproduction is—of necessity—

subjective judgment. But is this a fault or a find?

Psychoacoustics And Subjectivity

Let us admit at the outset that the experience of listening to music is one of man's most personal activities and certainly involves communication of the most subtle feelings. Emotion, passion, sentiment, as well as thought, can be projected via that wave motion we call sound. To expect that such complex experiences can be reduced to physical formula is in some ways naive. The difficulty of high accuracy objective test correlation to reproduced musical performance is further enlightened by a cursory examination of some unique aspects of man's hearing characteristics.

To some degree, we hear what we expect to hear. Experts in psychoacoustics have confirmed this by playing the same passage of music coupled with loud white noise over and over to a group of stereophone listeners and gradually reducing the music level to zero until only the white noise remained. Almost all the subjects always continued to "hear" the music long after it had been turned off. The results of this and other similar experiments lead the honest, critical designer to conclude that he must keep a wary mind when performing subjective testing, lest he "hear" last week's concert instead of today's replay.

Many of the most striking phenomena of hearing have to do with the interaction of tones or sounds heard simultaneously. There is a law of acoustics called Ohm's Acoustical Law, which states that when we are exposed to two tones simultaneously we have the distinct sensations characteristic of hearing each tone separately.⁴ Although this is true for superimposed sinusoidal waves of 0° relative phase, it is not true in situations where we are listening to a complex sound made up of sinusoidal components of many frequencies in which the crests of the component sine waves have different relative phases.⁵ These two conditions would produce vastly different sounds^{6,7} contrary to Ohm's Law. The design of single-driver acoustic products, such as stereophones, is strongly affected by this consideration. Such complex wave forms covering the audio spectrum can be reproduced without measurable waveform deformation only when the driver utilizes either a flat diaphragm (such as the Koss Models ESP-9B and Auditor/ESP-10) or the

Advance- Meant...



To create a full featured cassette recorder at an affordable price. Well, our engineers out did themselves. To them, advance meant creating our Exclusive Biaset feature. A continuously adjustable recording bias control that lets you set the bias best suited for the formulation of any cassette tape. From normal to chrome and ferri-chrome tapes. As a matter of fact, Dokorder engineers built into this Biaset feature a setting for tapes that haven't even been produced yet!

The MK-630 also has 3-position Dolby Noise Reduction selector, a newly engineered DC servomotor system, mic/line mixing and more.

This is what advance meant to us. Investigate the Dokorder MK-630 Cassette Tape Deck... and it will mean the same to you.

SUGGESTED RETAIL PRICE
MK-630... \$379.95

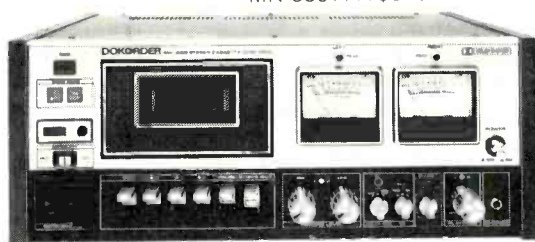

Telling it like it is.

DOKORDER

5430 Rosecrans Avenue, Lawndale, CA 90260 U.S.A.

Enter No. 11 on Reader Service Card

unique contouring of conventional moving-coil diaphragms (such as that used in the Koss Pro/4AA and Auditor/Dynamic 10).

In listening to two sounds close together in pitch, we are strongly aware of the phenomenon of beats. When we listen simultaneously to two sounds of comparable magnitudes but of slightly differing frequencies, the resultant sound appears to be a fluctuating sound of a single frequency. The frequency with which the amplitude fluctuates is the difference between the frequencies of the two beating sounds.

In the case of very faint sounds, this beating phenomenon disappears if the sounds are more than 20 to 30

what we hear on stereophones. Because of masking, we may be completely unable to detect some of the fainter frequency components of a complex sound, under certain conditions of playback level, and can also be influenced by outside sounds when using hear-through stereophones, more so than sealing stereophones. Knowledgeable audio buffs are correct in maintaining that high accuracy sound quality can be reproduced faithfully only if the original loudness for that particular recorded perspective of the musicians is accurately re-created. Surely the subjective appraiser of high quality musical reproduction must consider all the above and many more hearing

. . . .man's level of auditory expectation rises with his level of auditory achievement. In other words, the human "ear" never stops learning how to hear better. . .

Hertz apart in frequency. In loud sounds, however, we hear the beat as a separate, fainter sound of the difference frequency. (Now that would tend to confuse your listening session!)

Closely related to the phenomenon of beats is another hearing curiosity called masking, or the obscuring of one sound by another of a different frequency. The curious thing here is that if the masking sound is loud, it produces beats with other tones having its harmonic frequencies as well as with other tones of the same frequency. In addition, the relative ability of one sound to mask either a higher pitched or lower pitched sound changes with level. For example, in listening to a complex sound containing frequencies of 400, 300 and 2000 Hertz at respective levels of 50, 10, and 10 dB above threshold, the loudest sound would so mask the 300 Hz sound that the ear would hear only the 400 Hz and 2000 Hz sounds. If all the sounds are raised by 30 dB, however, then only the 400 Hz and 300 Hz sounds would be heard. Thus the quality of this complex sound would change markedly with loudness. (Now you hear it, now you don't.)

It should be apparent that masking is extremely important in considering

peculiarities in arriving at honest judgments, lest he fault the reproduction equipment for user indiscretion.

Let me emphasize that the phenomena of beats, masking, and loudness perception do not exist outside of the listener's head. In other words, these hearing peculiarities reflect non-linearities in the ear's response mechanisms to auditory stimulation and constitute built-in subjective distortion.

A further serious difficulty in developing objective and subjective standards of reference for musical reproduction lies in the fact that like his wealth, man's level of auditory expectation rises with his level of auditory achievement. In other words, the human "ear" never stops learning how to hear better, and even persists in hearing in some notables (e.g. Beethoven) long after the "microphones" have been unplugged.

The ear, apparently, like the other cerebral functions, operates on the basis of pattern recognition, that is patterns of sound. This may help to explain why most people find simple sounds such as sinusoidal waves to be very uninteresting, since the most interesting sounds to us are complex sounds and complex sequences of sounds.

Joining The Halves

With regular exposure, the human ear is capable of consistent and seemingly endless improvement in its ability to analyze complex sounds. At the same time, becoming ever more intolerant of minor aberrations in performance which would have been perfectly acceptable only weeks before. This characteristic makes it exceedingly difficult to establish any meaningful long term standards for analyzing state-of-the-art developments in musical reproduction.

The uncommonly complex demands placed both on recording technology and product design by the unrelenting pursuit of higher accuracy reproduction on the part of the audio enthusiast over the last ten years has spurred several major advancements in audio quality. As more and more information is generated concerning the intricacies of human hearing, the nature of three-dimensional musical space, the causes and effects of linear and non-linear distortion, etc., the need for meaning and consideration of long-term consumer benefit in the application of our expanding knowledge into worthwhile products will require a careful balance of our scientific and artistic best efforts. How else can we adequately serve an industry that demands excellence in both areas?

This author argues not for an anarchy of individual audio perceptions, nor for the tyranny of technical specifications, but rather the judicious and intelligent use of both in designing and evaluating high accuracy musical reproduction equipment. The final goal, of course, must be to provide the highest level of musical satisfaction possible under the circumstances. That is our business. 

References

- 1, 2 Lincoln Barnett, *The Universe and Dr. Einstein* (Bantam Books, Inc., New York, 1972).
- 3 "Great Quad Almighty!" *The Boston Phoenix*, Oct. 7, 1975, p. 30.
- 4 William A. Van Bergeijk, *Waves and the Ear* (Doubleday, 1960).
- 5 D. Preis, "Linear Distortion," *J. Audio Eng. Soc.*, vol. 24, pp. 346-367 (June, 1976).
- 6 V. Madsen and E.R. Madsen, "On Aural Phase Detection," *J. Audio Eng. Soc.*, vol. 22, pp. 10-14 (Jan.-Feb., 1974).
- 7 R.J. Matthys, "Telstar-Shaped Electrostatic Speaker—In Two Parts—Part 2," *Audio*, vol. 48, no. 6, p. 28, June, 1964.

U.S. PATENT 3,424,873

In 1969, the United States government issued a patent for a loudspeaker design that was as different from an ordinary loudspeaker as a laser is from an ordinary lightbulb.

It was a loudspeaker that could accurately reproduce the entire audio frequency range with a single dynamic driver operating as a wave transmission line. Because of this unique configuration, the loudspeaker would be free of the phase, time, and transient distortions common to all conventional multi-driver "piston-type" speaker systems. In other words, the first loudspeaker that wouldn't sound like a loudspeaker.

Today, U.S. Patent 3,424,873 is embodied in the Ohm F coherent sound loudspeaker. (Incidentally, a second U.S. patent, no. 3,935,402, has recently been issued for the voice coil used in the Ohm F).

To appreciate the magnitude of the accomplishment, you have to listen to music played through a pair of Ohm F's. There's nothing quite like it this side of Philharmonic Hall.

U.S. Patent 3,424,873. It means that no other company can make loudspeakers like the Ohm F, even if they knew how.

If you're interested in finding out what international hifi experts have to say about the Ohm F, please write to

us at the address below. Or visit your Ohm dealer. A 24-page full-line brochure is also available.

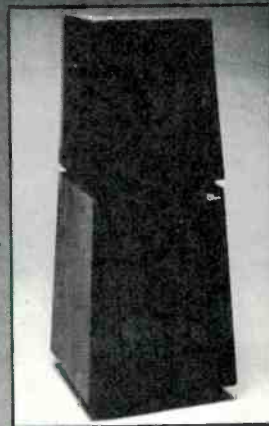

Ohm

Ohm Acoustics Corp.
241 Taaffe Place, Brooklyn, N.Y. 11205
(212) 783-1111

Enter No. 25 on Reader Service Card

Ohm holds the patent on great loudspeakers.

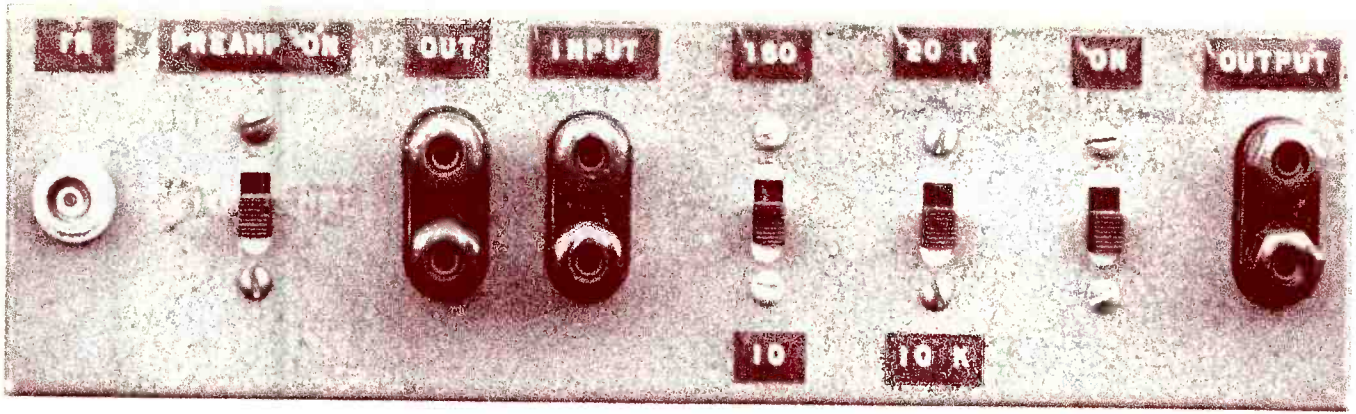

Build A Low-Noise Preamp With Weighting Filters

M.J. Salvati

38

The device shown in Fig. 1 and above is a measurement tool with which you can properly evaluate the signal-to-noise performance of your hi-fi preamplifiers, power amplifiers, integrated amplifiers, or any other signal-processing equipment that operates in the audio-frequency range.

Signal-to-noise ratio measurements are generally made by measuring the output voltage of an audio device with no input signal, and comparing this voltage to the output voltage normally present when the unit is properly driven. However, there are a few factors which complicate this simple technique. First, the noise output of modern hi-fi equipment is so low that it will not register on most a.c. voltmeters. Second, even sensitive a.c. voltmeters have input noise levels of their own that are high enough to obscure the measurement of extremely-good audio equipment. Third, S/N ratio specifications published by audio manufacturers are determined from weighted measurements, i.e., just the noise within a certain frequency range is measured. Therefore, what

you need (besides an a.c. voltmeter) is a preamplifier of known gain and extremely-low internal noise to boost the noise output of the audio equipment under test to a level readable on an ordinary voltmeter, and a filter network that will duplicate the weighting used by the manufacturer. The device described in this article does exactly this.

Theory Of Operation

The device consists of two main sections, a low-noise preamplifier and a filter. The preamplifier boosts the level of the signal (noise) being measured to a level high enough to provide a readable voltmeter indication and to negate the effects of filter and voltmeter internal noise. The filter passes only those noise components within specified, selectable passbands.

Preamplifier Capacitor C1 couples the input signal from jack J1 to transistor Q1. This transistor and transistor Q2 form a d.c.-coupled, negative-feedback complementary pair with an open-loop gain of about 4000. Feed-

back through pot R9 and resistor R5 sets the closed-loop gain at 40 dB (100X). The gain throwaway of 400 stabilizes the closed-loop gain and makes the gain essentially independent of transistor characteristics and battery voltage. Further d.c. stabilization is provided by deriving the bias voltage for transistor Q1 from the junction of resistors R10 and R11.

Pot R8 sets the d.c. output voltage of the preamp at zero. Pot R9 provides fine adjustment of the feedback so the preamp gain can be precisely adjusted to 100X. Diode D1 protects the input transistor from negative-going input spikes. Capacitor C2 adjusts the upper -3 dB point of the amplifier passband to 100 kHz, and provides high frequency stability (phase margin). Switch S1 allows the preamp to be energized independently of the filter section.

Filter Section The *Input* terminals of the filter section go directly to filter network #1. This network (whose exact configuration depends on the option you choose) forms various RC high-pass filters in conjunction with

Fig. 1—The measurement tool for evaluating the S/N performance of today's high fidelity signal processing equipment.

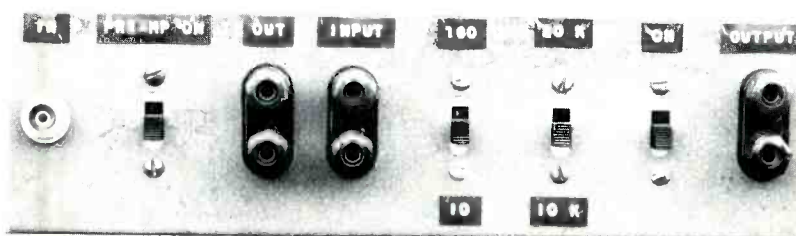



Ah So. Made in America Made in America!?

We'd have to be crazy to take on the big Shoguns and their top-of-the-line equipment if we weren't absolutely certain that inside of our new 203 preamp beats a heart of pure, solid-state dependability—which is how we made our reputation with the pros to begin with...solid.

Our numbers stick it to the honorable competition, and we're gonna get a slice of their market 'cause our stuff cuts it: like a classic samurai's sword.

You don't know us yet, but you will.
Go on in to your nearest BGW dealer and take a listen.

The BGW Model 50
Pre-Preamplifier



BGW Systems: 13130 S. Yukon Ave., Hawthorne, CA 90250 213/973-8090
In Canada: Omnimedia Corp., 10245 Cote de Liesse, Dorval, Quebec H9P1A3 514/636-9971

Enter No. 5 on Reader Service Card

We Bow To No One.



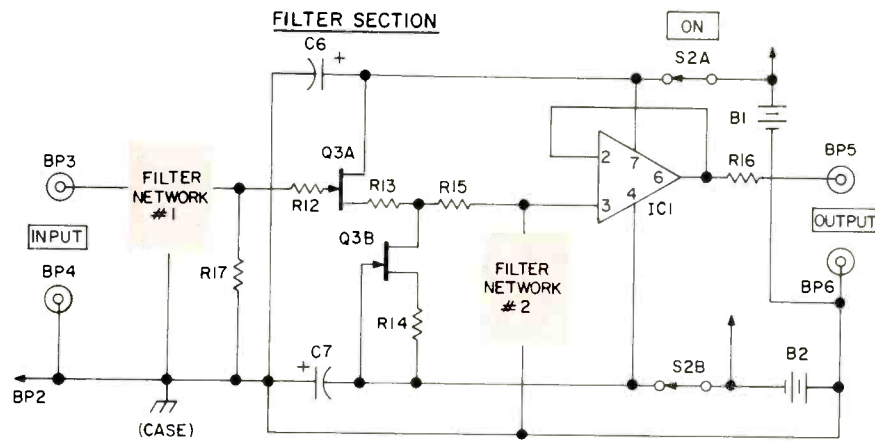
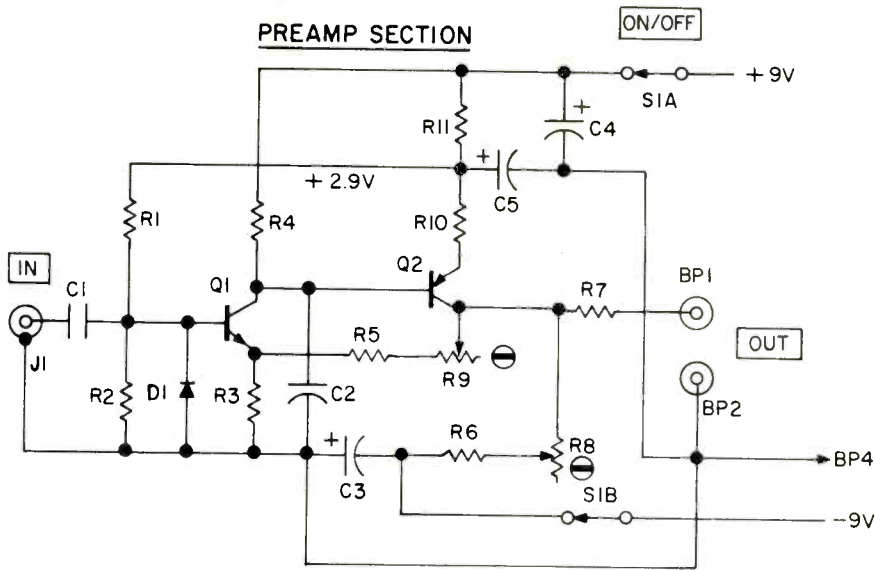
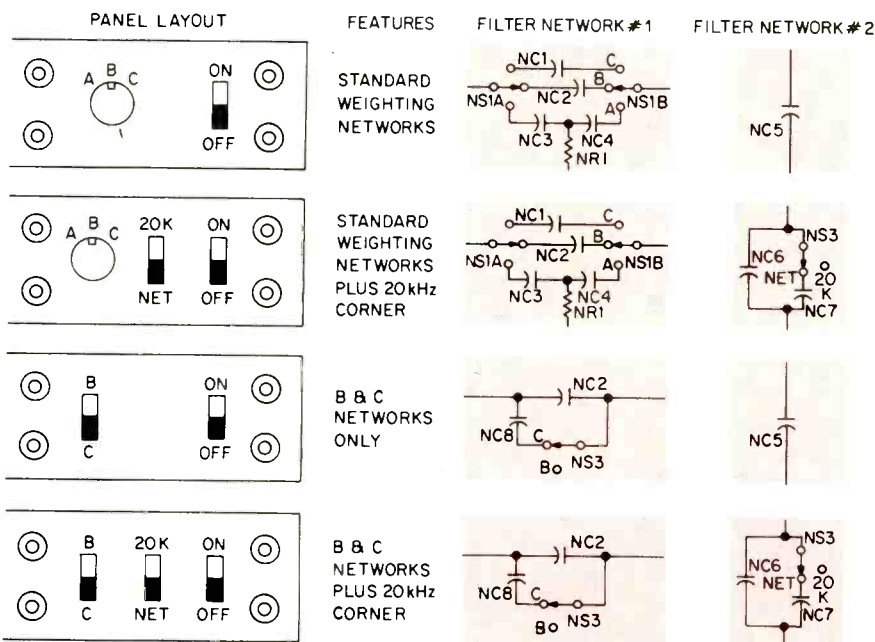

Fig. 2—Schematic diagram.

Fig. 3—Weighting network filter options.



resistor R17. These HP filters determine the lower -3 dB corner frequency of the filter-section passband. It is the lower corner frequency that constitutes the main difference between the A, B, and C weighting networks. The C network has a 20 Hz corner frequency and a 6 dB per octave rolloff rate. The B network has a 160 Hz corner frequency and also has a 6 dB per octave attenuation rate. The A network consists of two cascaded filters each having a 280 Hz -3 dB corner frequency. This provides an overall -3 dB point around 800 Hz and a 12-dB-per-octave rolloff rate, so the A network really wipes out low-frequency noise components.

Dual FET Q3 forms a high-impedance, unity-gain buffer to drive filter network #2. Transistor section Q3A is a source follower; section Q3B is a constant-current source for Q3A. By using matched source resistors (R13 and R14), the d.c. output voltage of the buffer is zero.

The capacitor(s) in filter network #2 forms an RC low-pass filter in conjunction with resistor R15 and the output impedance of the buffer. This LP filter establishes the 10 kHz upper -3 dB corner frequency characteristic of the A, B, and C weighting networks.

An operational amplifier connected as a unity-gain follower serves as the output stage so the filter can drive low-impedance loads when necessary. Switch S2 allows the filter section to be energized independently of the preamp.

Construction Notes

Options The first thing to do before buying parts is to decide what you would like in the way of combinations of filters and connectors. The left-hand side of Fig. 3 shows the physical layout of several possible filter sections; the right-hand side of Fig. 3 shows the corresponding schematic. When you decide which filter combinations you want, insert the schematic section of Fig. 3 into the corresponding spaces in the main schematic (Fig. 2) for a complete customized schematic.

The input connector must be a fully-shielded connector like an RCA phono jack (specified) or a BNC connector (as on author's version). The other connectors can be nearly anything you prefer; the author's version uses double 5-way posts for maximum convenience.

Parts Standard transistor radio batteries are adequate for hobby, service, and most lab applications. However, for critical lab applications where ex-

First the good news: some reviews and comments on the new Bose 901[®] Series III.

MODERN RECORDING

"The Bose 901 Series III seems to MR to be not only one of the very best-sounding speaker systems available, but also highly adaptable in terms of associated equipment and listening environment."

Dec./Jan., 1977



MODERN HI-FI & MUSIC

"The performance of the 901 Series III is superior to the 901 in that the bass is cleaner and tighter; it has a better frequency response; and it has a total sound that soars, with a brilliance that defies description."

Volume 1005

FM GUIDE

"It is difficult to refrain from using superlatives in describing the performance of this speaker system."

"All things considered, we would judge the Bose 901 Series III—if not the 'best' speaker system we have yet tested—to be certainly the equal of whatever could be called the 'best.'"

Jan. 1977

HIGH FIDELITY

"... its latest version of the Bose 901 system, on which the company's fame was founded, has taken it into materials and, particularly, technologies far beyond the purview of most speaker companies."

"Boston: Audio Hub City" by Michael Riggs
March 1977

Now better news: you won't have to wait so long to get a pair.

When we introduced our new Bose 901 Series III, we felt we had made a dramatic performance breakthrough (frankly, anything less would have been a disappointment for a speaker designed to replace the legendary Bose 901). Then some of the experts had a chance to evaluate the 901 III, and apparently they agreed, as you can see from the sampling of reviews and comments we've reprinted here.

More important, a lot of people who appreciate good music must have listened for themselves and decided

to buy 901 III's. Because it wasn't long before demand far outstripped our initial production capacity, and Bose dealers all over the world had to post the SOLD OUT signs. Since then, we've substantially increased our volume (without sacrificing our very demanding quality standards), and most dealers should be fully stocked very soon. So if you have 901 Series III's on order, just relax and wait for your dealer to call with the best news:

"Your 901 III's are in."

BOSE[®]

No advertisement can tell the full story of the performance of the Bose 901 Series III and the technology behind it. So we've put together a comprehensive literature package, including a very detailed, full-color brochure, a 20-page owner's manual, and a copy of Dr. Amar Bose's paper on "Sound Recording and Reproduction" reprinted from *Technology Review*. This material can be obtained by sending \$1.00 to Bose, Dept. AU5, The Mountain, Framingham, Mass. 01701.

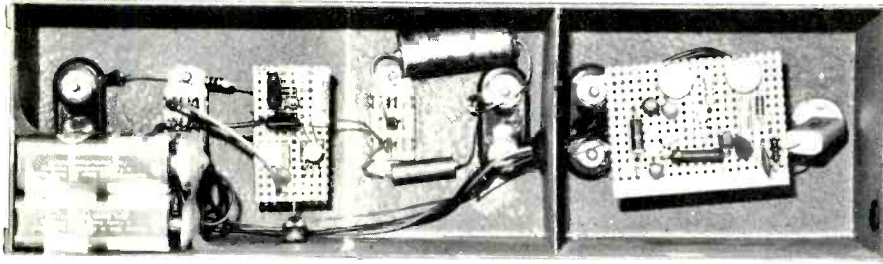

Fig. 4—Inside view with the protective metal cover removed.

treme a.c. & d.c. stability is important, use 8.4 volt mercury batteries.

Network capacitors NC1 and NC8 are not standard values. They are "made" by connecting in parallel the standard-value capacitors indicated in the Parts List.

For home use, or other applications where precision is not needed, wider-tolerance resistors (5%) and capacitors (10%) can be substituted for the precision parts specified in the Parts List.

Construction the size of the case depends on the amount of panel space needed to accommodate the switches and connectors used on the option you build. The actual circuitry occupies very little space, as you can see from Fig. 4. The largest thing inside the case is the pair of batteries. However, the case must be one that completely encloses the circuitry in metal; plastic cases or open-ended metal boxes are no good. (The author's unit shown in Fig. 4 has a metal cover that fits tightly over the open side.)

The labeling of the filter-section switches can be handled in either of two ways. In Fig. 3, the identification of switch positions is by network designation. This is preferable for audio

applications. In my unit (Fig. 1), the switch positions are identified by frequency. This is preferable when the unit is used for other applications besides audio work.

Parts Availability The Sony transistor types I used in my unit are available from Sony Parts Distributors throughout the nation. However, there are

as the 2N4058 or 2N5087. The 2N3957, 2N5087, and 2N5089 are available from Ancrona Corp., P.O. Box 2208, Culver City, Calif. 90230.

Adjustment & Calibration

The filter section requires no calibration or adjustment. For the pre-amp section, proceed as follows:

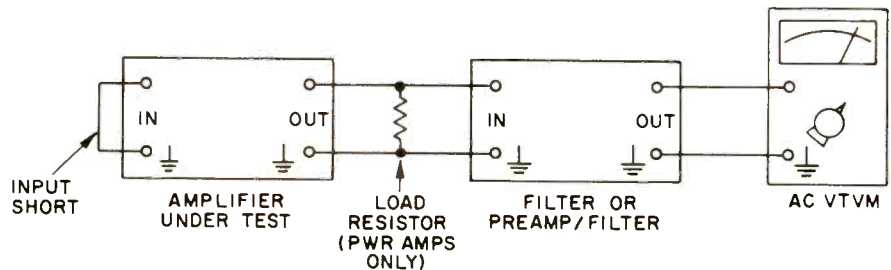

Fig. 5—Test setup for S/N ratio measurements.

several less expensive American-made transistors with suitable noise characteristics. The 2SC1632-xx48 can be replaced by the Motorola MPS-A18 and 2N5089. The first substitute is especially recommended since it has the lowest noise figure I've yet seen. The 2SA705 can be replaced by any good small-signal PNP transistor such

Adjustment Connect a d.c. voltmeter to the *Out* terminals of the pre-amp section. Two minutes after setting S1 to *On*, adjust pot R8 for a meter indication of 0 ± 0.1 volt.

Calibration Connect an audio oscillator to the *In* jack of the preamp section, and adjust the input level to 10 mV rms as indicated on an a.c. VTVM. Then connect the a.c. VTVM to the *Out* terminals of the preamp section and adjust pot R9 for a meter indication of 1 V rms.

Use

To measure S/N ratio with this device, assemble the test setup shown in Fig. 5. Energize all of the equipment and proceed as follows:

1. Set up the controls of the amplifier under test for the input you wish to test. Insert shorting plugs into that input.

2. Connect a short piece of wire between the red preamp *Out* and red filter *Input* terminals.

3. Set the filter network switches to the network (A, B, or C) specified in the manufacturer's literature for the input under test.

4. Adjust the voltmeter range switch for a near full-scale meter indication. If the reading is 1.0 volt or less, calcu-

Table of Specifications

Preamp Section	
Gain	: 40 dB (100X)
Frequency response	: 2 Hz - 100 kHz (-3 dB)
Input impedance	: 100 kilohms
Output impedance	: \approx 700 ohms
Max. input level	: 15 mV rms
THD @ max out	: 0.15 per cent
Noise rti (50-ohm source)	: 0.5 μ V over 20 Hz - 10 kHz bandwidth 0.65 μ V over 20 Hz - 20 kHz bandwidth 1.1 μ V over 10 Hz - 100 kHz bandwidth
Power required	: 1.1 mA @ 9 volts
Filter Section	
Gain	: 0 dB (1X)
Input impedance	: 100 k-ohms
Output impedance	: 50 ohms
Max. input/output level	: 5 V rms
THD @ 2.5 V out	: < 0.007 per cent
Noise rti	: 9 μ V over 157 kHz bandwidth
Power required	: \pm 2.5 mA @ 9 volts

If you can see a difference, imagine what you'll hear.



Magnified, you can see record vinyl wearing away.

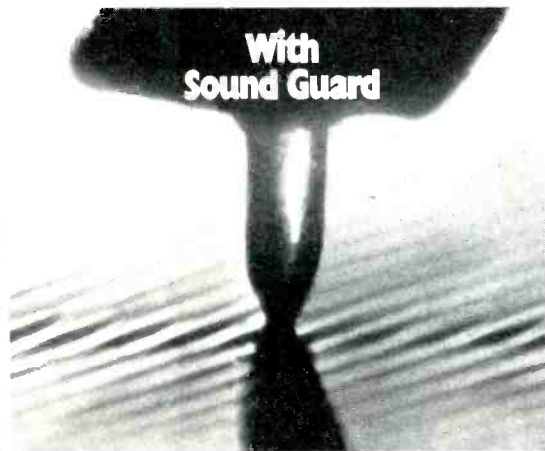

With same magnification, record vinyl shows no wear.

You're looking at the solution to one of the oldest problems in audio—how to protect records from wear, while at the same time preserving full fidelity.

It's called Sound Guard,* and it's remarkable.

Independent tests show that discs treated with Sound

distortion as "mint condition" discs played once.

A by-product of dry lubricants developed for aerospace applications, Sound Guard preservative is so smooth it reduces friction, yet so thin (less than 0.000003") it leaves even the most fragile groove modulations unaffected.

Len Feldman in Radio Electronics reports "At last!

The long awaited record-care product has arrived.

It preserves frequency response

in a kit complete with a non-aerosol pump sprayer and

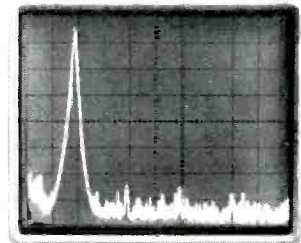

Test record played first time.

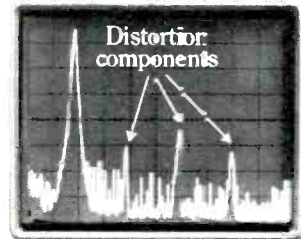

After 100 plays without Sound Guard.

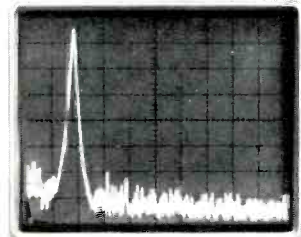

Identical test record after 100 plays with Sound Guard.



Guard preservative played 100 times display the same full amplitude at all frequencies and the same absence of surface noise and harmonic

while reducing distortion and surface noise." It's effective and safe for all discs, from precious old 78's to the newest LP's.

Sound Guard preservative,

velvet buffing pad, is available in audio and record outlets.

Sound Guard® keeps your good sounds sounding good.



*Sound Guard is Ball Corporation's registered trademark for its record preservative. Copyright ©Ball Corporation, 1976.

Decca Record Brush:



No Side Effects

Most record cleaners use liquids. They do the job. But not without side effects which reduce the life of your records.

To see why, imagine you are examining a record groove through a microscope while various liquid cleaners are tried. All the cleaners remove a lot of dust, but even the best ones leave some behind. Since liquid was applied, this soft dust dries into hard grit. While the stylus could have pushed a few soft dust particles out of its way, it must now track hard grit particles like they are part of your record. The result: distortion. Not to mention stylus wear caused by the new bumps and grinds it must now traverse.

Decca's research into these liquid side effects, resulted in their pioneering of a new, electrically conductive, carbon micro-fiber - the bristles of the Decca Record Brush. Each Decca Record Brush contains one million of these ultra-thin conductive bristles - 1000 enter each groove removing dust, dirt - and draining off static for lower surface noise and expanded dynamic range.

Decca Record Brush. No fluids, no side effects. Just keeps your records sounding like the first time.

Decca Record Brush available at quality dealers across the U.S. Sugg. list \$14.95

ROCELCO INC.

160 Ronald Dr.,
Montreal, Canada H4X 1M8
Phone (514) 489-6841

Enter No. 30 on Reader Service Card

late the S/N ratio as follows:

$$S/N \text{ ratio (dB)} = 20 \log \frac{100 \times \text{Rated output voltage}}{\text{Step 4 voltage}}$$

5. If the indication in Step 4 is over 1.0 volt, disconnect the wire jumper installed in Step 2 and move the cable at the preamp *In* jack to the filter *In*-put terminal.

6. Readjust the voltmeter range switch for a near full-scale meter indication. Calculate the S/N ratio as follows:

$$S/N \text{ ratio (dB)} = 20 \log \frac{\text{Rated output voltage}}{\text{Step 6 voltage}}$$

If you built one of the options with selectable upper corner frequency, you can also measure the S/N ratio over the traditional audio passband (20 Hz - 20 kHz) by setting the network switch "C" (to set the 20 Hz lower corner) and the 20K/NET switch to "20K" (to set the 20 kHz upper corner). A

PARTS LIST

Reference

Designation	Description
Q1	SONY 2SC1362-xx48 NPN transistor (see text)
Q2	SONY 2SA705 PNP transistor (see text)
Q3	2N3957 or 2N3958 dual FET
IC	741 integrated circuit, TO-5 or DIP-8 case
J1	RCA phono jack (Switchcraft 3501FR)
BP1,BP3,BP5	Red 5-way binding post
BP2,BP4,BP6	Black 5-way binding post
S1,S2	DPST slide switch
B1,B2	9-volt transistor radio battery
D1	High-frequency silicon diode (1N914, 1N4148, etc.)
R1	470 kilohm 1 per cent 1/4W metal-film resistor (Dale CMF-65)
R2	150 kilohm 1 per cent 1/4W metal-film resistor (Dale CMF-65)
R3	1000 ohm 5 per cent 1/4W carbon resistor
R4	68 kilohm 5 per cent 1/4W carbon resistor
R5	91 kilohm 5 per cent 1/4W carbon resistor
R6	8200 ohm 5 per cent 1/4W carbon resistor
R7,R16	51 ohm 5 per cent 1/4W carbon resistor
R8	2.2 kilohm trimmer pot
R9	22 kilohm trimmer pot
R10	100 ohm 10 per cent 1/4W carbon resistor
R11	6200 ohm 5 per cent 1/4W carbon resistor
R12	4700 ohm 10 per cent 1/4W carbon resistor
R13,R14	1000 ohm 1 per cent 1/4W metal-film resistor (Dale CMF-65)
R15	33 kilohm 1 per cent 1/4W metal-film resistor (Dale CMF-65)
R17	100 kilohm 1 per cent 1/4W metal-film resistor (Dale CMF-65)
C1	0.68 μF 100V mylar capacitor
C2	330 pF 5 per cent mica or ceramic capacitor
C3,C4,C6,C7	10 μF 16V electrolytic capacitor
C5	47 μF 6.3V electrolytic capacitor
—	12 x 2 1/2 x 2 1/4 aluminum case (see text)
—	9V battery connector (2 req.)

Network Parts List

(not all parts are required for each option)

Reference

Designation	Description
NS1	2-pole, 3-position rotary switch (Mallory 3123J)
NS2,NS3	SPST slide switch
NR1	Same as R17
NC1	0.08 μF 5 per cent 100V mylar capacitor (use .047 and .033 in parallel)
NC2	0.01 μF 5 per cent 100V mylar capacitor
NC3,NC4	5400 pF 1 per cent mica capacitor
NC5	430 pF 1 per cent mica capacitor
NC6,NC7	220 pF 1 per cent mica capacitor
NC8	0.07 μF 5 per cent 100V mylar capacitor (use 0.047 and 0.022 in parallel)

Who said you can't see the quality of a speaker? Look closely at the Sansui SP series.

5 speakers, 4-way L/C crossover
130 watt peak handling capacity
98 dB/W efficiency
16" woofer



SP-7500X

5 speakers, 4-way L/C crossover
120 watt peak handling capacity
98 dB/W efficiency
15" woofer



SP-5500X

5 speakers, 3-way L/C crossover
100 watt peak handling capacity
98 dB/W efficiency
12" woofer



SP-2500X

3 speakers, 3-way L/C crossover
70 watt peak handling capacity
93 dB/W efficiency
10" woofer



SP-1500X

The SP-7500X

In a great speaker, quality can be seen as well as heard. When you look at the Sansui SP series — you'll see what we mean.

Go to your Sansui franchised dealer and ask for the SP-7500X.

Let your salesman remove the handsome, hand-carved Kumiko grille. The size of the woofer is impressive — a massive 16" — for a rich and full bass. And for clean, transparent super-highs the SP-7500X speaker system features three tweeters — two 2" "super-tweeters" and an additional horn tweeter. Notice the unusually large 8" cone mid-range driver which adds a sense of presence and creates a smooth transition between the highs and lows. The four-way crossover network is built around a ferrite-core inductor with high-voltage capacitors to keep distortion way down over the entire audio range.

Now listen to the SP-7500X. Turn up the power. This speaker can handle lots of it. (130 watts peak). And always with unusually high efficiency.

The Sansui SP series is available in four models. One will certainly be ideal for your own budget and listening preferences.

All speakers simulated walnut grain enclosure.

A whole new world of beautiful sound

SANSUI ELECTRONICS CORP.

Woodside, New York 11377 • Gardena, California 90247 • SANSUI ELECTRIC CO., LTD., Tokyo, Japan
SANSUI AUDIO EUROPE S.A., Antwerp, Belgium • In Canada: Electronic Distributors

Enter No. 33 on Reader Service Card



10 sound reasons to buy our new receiver.

Plus its sound.



Sony's new, more powerful STR-6800SD receiver should get a warm reception. Because it not only looks different from other receivers, it is different.

It has some features found in more expensive separate components — and other features found nowhere else at all.

1. The most-used controls all in one place.

Electronically, it would have been convenient for us to scatter the level control, tuning knob and input and tape selectors all over our receiver. Instead we grouped them in the upper right-hand corner — so they're convenient for you.

2. A dial pointer that doubles in length when it's close to a station. Together with the signal strength meter and the center channel meter, this Sony innovation constitutes a system that helps you tune faster and more accurately.

3. A muting switch — great if the phone rings. Flick it down and volume drops. Flick it back up and volume goes back up to where it was. And this muting switch is right where it should be — right next to the level control.

4. A stepped level control to keep both channels equal. It guarantees unprecedented accuracy — to within $\frac{1}{2}$ db instead of 1 db. And it guarantees it over the whole volume range instead of just in mid-volume.

5. MOS FET front end electronics unitized tuning. The 4-gang tuning section and all its associated electronic parts are mounted on one sub-assembly. So

temperature differences don't affect these circuits — the receiver tunes the same whether it's cold or warmed up. And, with MOS FET, the receiver has a very wide dynamic range.

6. Dolby noise reduction system. As more and more stations broadcast in Dolby, you can really use a Dolby system. And ours has a definite advantage: Instead of being an optional extra, it's built in — operated from the front panel.

7. Phase locked loop. It gives you greater stereo separation and less distortion.



8. LEC (low emitter concentration) transistor. This piece of advanced design in the preamp phono stage assures you tight RIAA equalization plus low noise, low distortion and a wide dynamic range. It's a Sony exclusive.

9. An acoustic compensator for easy control of highs, lows and middles. A conventional loudness control only lets you boost bass. Our acoustic compensator has three positions: For true

loudness compensation, for bass boost and for mid-range presence.

10. Sony's most powerful receiver. It delivers 80 watts minimum RMS continuous power per channel at 8 ohms from 20 Hz to 20,000 Hz with no more than 0.15% total harmonic distortion. It has a direct-coupled power amplifier with true complementary symmetry output stages.

And more. To these specifications (remember, we state them conservatively), add Sony's proven reliability. And you get a receiver that produces a sound that'll make you understand why you have ears.

That's the STR-6800SD at \$600. Or, for less power and a few less features—but no loss of fidelity—the STR-5800SD at \$500 and the STR-4800SD at \$400 (all suggested retail prices).

A sound investment.



SONY

Enter No. 36 on Reader Service Card

30 YEARS OF AUDIO

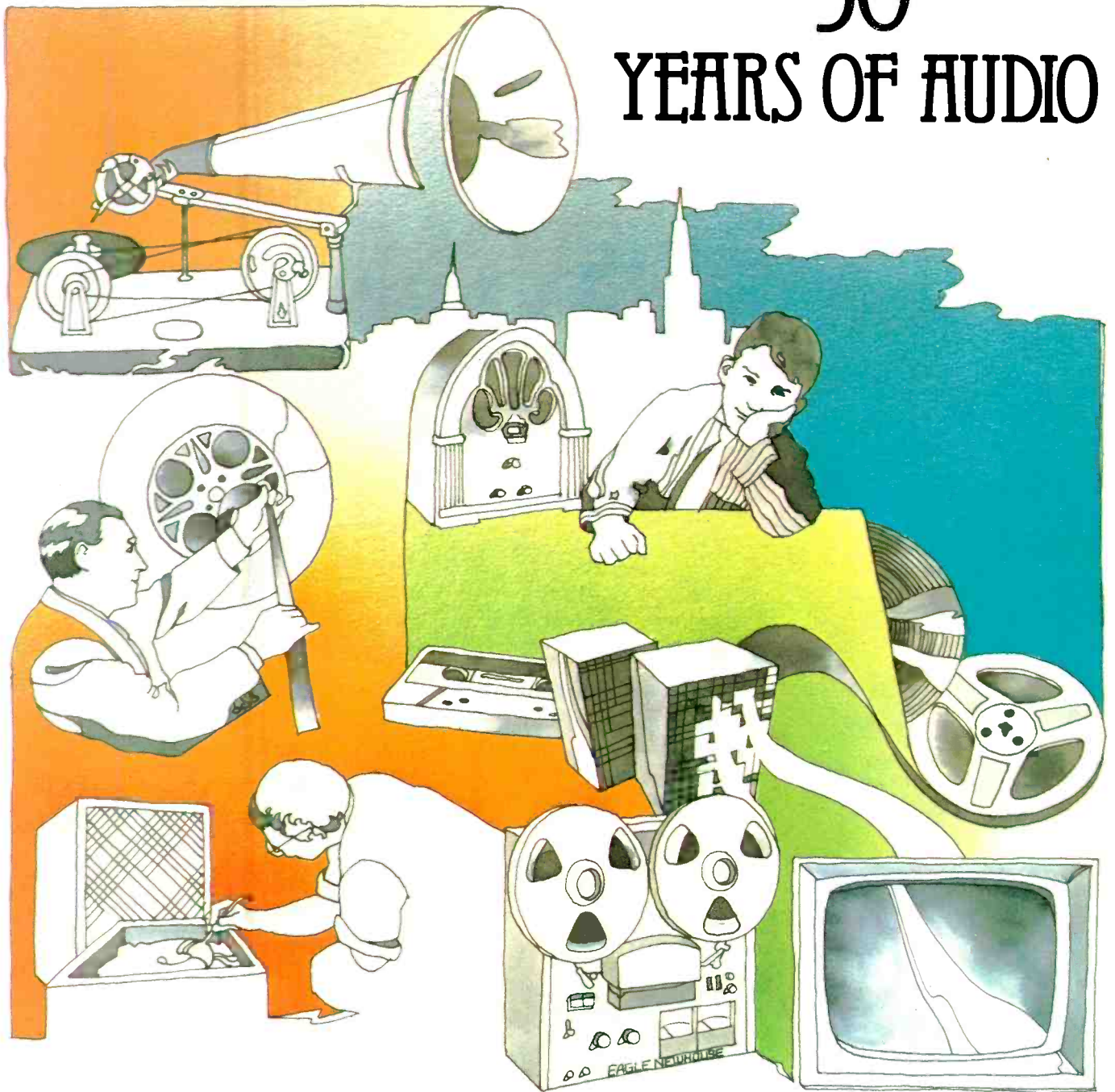

48

Norman Eisenberg

My first exposure to the term "high fidelity" came in a phrase used in a broadcast station break picked up on an old AM radio I owned as a kid in pre-World War II days. It went, I think: "This is WNYC, the high fidelity voice of New York City." In that time of pre-FM, pre-tape, pre-LP, pre-pushpull amplifiers, pre-everything

innocence, the word "fidelity" had vague connotations relating to insurance companies or marital commitment. As for *high* fidelity, I fantasized some arcane goings-on high up amid the towers of lower Manhattan, perhaps having to do with poking futuristic structures into the clouds and heavens in pursuit of ethereal vir-

tues into which I had not the least technical insight but which I assumed had something to do with a devotion to good music and good sound. Later I learned, at G.I. radio school, that "fidelity"—together with selectivity and sensitivity—was one of the general hallmarks by which radio performance was judged. But high fidelity, as

related to audio reproduction of music, was a term not widely heard in the 1940s. It had not yet become anything like the major sweep that rolled over us in the 1950s, although interestingly enough Harold A. Hartley, the British audio designer and author, claims to have used the term "high fidelity" in 1927 to describe a speaker he (and the late P. K. Turner) had developed. In any event, the term remained relatively unknown until its first surfacing in advertising copy in 1934 when the best-made recording had perhaps a top frequency of 8,000 Hz and most phonographs of that day had a high-end response that went no better than perhaps half-an-octave below that.

Actually, the durability of the concept and its being firmly rooted in musical values is perhaps best suggested by the story of Giuseppe Verdi's encounter in 1889 with an early gramophone being delivered for demonstration before the *Academie Française*. Verdi was persuaded to play the piano and sing his *Ave Maria* into the device. When the results were played back, Verdi exclaimed: "My God! What fidelity."

If we analogize software and hardware as egg and chicken respectively, the debate can go on ad infinitum as to which came first, which was responsible for the other. Without a doubt, both have interacted endlessly but my reading of the major trends in hi-fi (to use the abridged phrase that Hartley once termed "pure, unadulterated Americanese") gives a slight edge to software, or at least to the promptings and thrusts from program-oriented sources, as the prime motivator. Be that as it may (and I allow that many audio-minded will feel it may not), a good deal was going on during the 1930s and 40s that came to bear on hi-fi sound. To detail all that here would be impossible, but some of the highlights included the growing sophistication of sound for the film industry, the invention by Edwin Howard Armstrong of FM radio, the experiments in stereo—from Dr. Harvey Fletcher's 1933 demonstration of Bell Laboratories' new telephone lines which he used to pipe a three-channel transmission of the Philadelphia Orchestra into Constitution Hall in Washington, D.C., to the multi-channel setup used in 1940 for the film "Fantasia" which finally evolved in 1947 to Altec's seven-channel sound setup that was the forerunner of

sound for Cinerama, not to mention stereo and surround-sound generally.

The 1940s also saw a lot of experimenting and getting acquainted with electronics and audio gear, much of it under GI auspices as unprecedented numbers of young Americans were exposed for the first time to high-class communications gear. This ferment, continuing in the post-war years, was given more specific direction and a strong consumer interest base by the ascendancy of FM in broadcasting, the development of the long-playing microgroove disc, and the introduction onto the audio scene of magnetic tape recording. It remained only for a feasible and viable marketing pattern to evolve—and it did, based on the gradual conversion of "radio parts outlet shops" to "audio salons" or "high fidelity dealers"—to change a quasi-professional, hobbyist, near-elitist activity into a broader-based consumer-oriented industry that somehow sensed the time had come to revise its equipment-design concepts from "sound-system parts" to "home music-system products." And so it was that in the late 1940s and early 50s hi-fi sound made a quantum leap from its various origins and sources into the American living room.

In terms of the three program sources—FM, disc, and tape—it is obvious now, with the benefit of hindsight, that the sources themselves were, in the earliest days, far more "hi fi" than most of the equipment used for playing them. Thus, one of the major trends that permeated the entire hi-fi field in those days was an effort to upgrade, refine, and improve consumer audio products so that their playback capabilities would do justice to the newly developed software sources, and—in addition to that tremendous engineering task—to convince the buying public beyond the hard-core audiophile in-group that such equipment was worth buying, learning about, and living with. The present state of the hi-fi field is a direct measure of that dual efforts' success which took many forms: publications; audio shows (interestingly enough the first of these, developed by Harry N. Reizes, was called an "Audio Fair" rather than a high-fidelity show); new concepts in product styling and in control labeling (e.g., "brilliance" for high frequencies; "presence" for midrange); and of course

new product distribution patterns that involved sales reps and retail shops in a way perhaps more intensely and uniquely than in any previous industry. Encouraging traditional music critics to pay more attention to the sonic aspects of the recordings they wrote about, and involving some of the "brown goods" brains around the country to design and produce suitable cabinetry for the new-fangled audio machinery—and the game was under way full tilt. The age of hi-fi had arrived.

Microgroove Recording

Its most telling single event probably was the introduction in June 1948 of the Columbia microgroove disc which not only multiplied the playing time of a single side but improved its audio response, and spurred the development of high-quality magnetic pickups. These in turn required improved tone arms wedded to quieter-running and more sophisticated turntables. The output of the new pickups needed, of course, equalization and pre-amplification—enter the new breed of low-noise, high-gain pre-amp-control units.

FM, which had been around before the LP disc, began to come into its own as a logical adjunct to a typical home hi-fi system.

Tape, which also got started in the U.S. before the LP disc (the famous Ampex demonstration for Bing Crosby took place one year before the introduction of the LP), similarly caught the fancy of many hi-fi enthusiasts but remained for many years behind both discs and FM as a home-sound medium.

During the 1950s refinements in all these areas continued together with a lively hobbyist trend having to do with putting together one's own speaker system, an activity that extended in varying complexity on the part of many enthusiasts, from winding their own coils for crossover networks, to building their own enclosures.

Enter Stereo Sound

Stereophonic sound, which actually was older than many of us realized at the time, remained largely a specialized pursuit. Its first availability outside the cinema as a consumer item came on tape in the mid-1950s and my first mind-blowing experience of that was a demonstration by Ampex in the

old Ziff-Davis offices on Madison Avenue of—guess what—Strauss' *Also sprach Zarathustra*. To me those opening bars with their bold brass and percussion symbolized the dawn of a new era no less effectively at that time than the same music did years later in the futuristic film "2001."

Between the time stereo left the movie houses and Strauss got into them, of course, the next major thing had happened to hi-fi—stereo on discs, to be followed in a few years by stereo via FM. The retooling, restyling, and re-education that ensued during the 1960s were all vastly broader and deeper than the original hi-fi thrust a decade earlier. Stereo not only broadened the sound perspective in the home, it broadened the audience and it shook up the industry at all levels.

In no small way a contributing factor to stereo's commercial success was the development of the acoustic-suspension speaker which enabled the installation of two reproducers for stereo's two channels without preempting inordinate amounts of living space and with providing good clean sound at the same time. The a-speaker in turn prompted the design, manufacture, and marketing of high-powered amplifiers, hitherto thought to be relevant only for studio or professional applications. Once this trend caught on, it spawned another "sub-trend"—the so-called wattage race among amplifier manufacturers which, despite its often ludicrous side-effects, is still with us. Another, more salutary, trend related to the rise of stereo was the discovery by vast numbers of the attractions of listening via headphones which, improved over earlier types, and vigorously promoted (notably by Koss), became a staple item in many home music systems.

Tape Trends

As stereo discs gained wider public acceptance, home tape went into decline. It began to come back with the introduction of the four-track idea but it really took off in the late 1960s with the development of the high-quality cassette format, and in this area the single most telling influence probably has been the use of the Dolby-B noise-reduction system. Saying



this however runs the risk of oversimplifying and of not crediting several other contributions to the cassette that have combined (and indeed still are at work) to upgrade this prodigious format to the point where many insiders have begun to speculate that it may eventually rival or even displace discs as the dominant form of home audio. Among these contributions are the improvements in cassette motors and transports, and the improved tapes themselves with the attendant facility provided in cassette decks for optimizing performance for different tape formulations.

In a way, the rise of cassette tape as a home medium has combined with another cultural trend to influence what has happened in open-reel tape. Actually the whole tape field from the late 1960s to date has become a complex techno/cultural matrix and to understand it fully we must take cognizance of yet another trend (or perhaps "non trend") that right now seems more important for its spinoff effects than for its original avowed purpose. That trend, of course, is quadrasonic sound.

Again hindsight tells us that four-channel sound in essence is at least as old as the 1940 film "Fantasia." And all during the rise of stereo, many enthusiasts experimented with setups that used more than the two speaker systems nominally required for two-channel sound. The literature is full of material about center- or phantom-channel speakers, flanking speakers, rear speakers, out-of-phase speakers, and so on—all of which were intended to broaden, to make more convincing, to lend an added ambience, to the two-channel stereo presentation. Significantly, most of the source material considered better-than-fair game for such investigations during the 1960s was on tape, with its superior channel separation, its inherently "discrete" capability for separate sound-tracks. Readers may

recall, for instance, an early form of tape cartridge developed jointly by CBS and Wollensak in 1959. Explaining it to a press group, Peter Goldmark—then head of CBS Laboratories—pointed out that although the tape was two-channel stereo it had room for a third track. "Why a third track?" came the inevitable question. "To record the hall and its ambience," was the answer, "which could be reproduced over a third loudspeaker placed conveniently in the listening room." Almost simultaneously, Philips in Europe was developing an electroacoustic technique for enhancing sound which they chose to call "ambiphony."

Ambience & Quadraphonics

It took about another ten years for the message to get through as quadrasonic sound. I first heard it on tape recorded by Acoustic Research during a performance of a student orchestra. Later AR sponsored four-channel broadcasts of the Boston Symphony transmitted over two stereo FM stations in that area—WGBH and WCRB. But like stereo before it, quadrasonic sound did not make much headway until it appeared on discs, first as a matrix-encoded signal and then as the CD-4 type. At that, the headway has not been very auspicious and today quadrasonic sound languishes, its future uncertain. But its "natural affinity" for tape influenced a wave of four-channel open-reel designs which began coming onto the market a few years ago. What apparently has happened, however, to these machines is less a matter of their being used for quadrasonic sound than for their coincidental options of overdubbing synchronously, and otherwise creating special sonic effects for a relatively new segment of the audio population—created out of the rock-culture of the 1960s and bolstered by the technical advances in open-reel tape equipment—the so-called "semi pro" sound activists. Taken as a whole, these enthusiasts make up an alert, informed, dedicated group who have entered the hi-fi world by—so to speak—a side door, but they are in it and will influence it and be influenced by it in coming years.

A related spinoff of the environ-

The great impostor.



If you love beautiful music, but haven't been able to find any speaker system that could reproduce it the way you think it should sound, Koss has a special treat for you. Because Koss engineers have created a unique

3-way electrostatic and dynamic speaker system that will defy even the expert's vision of electrostatic perfection. Indeed, if the Koss Model One was perfect, the Koss Model Two is the world's greatest impostor.

But then, imagine a smaller, more compact version of the Koss Model One offering a room full of electrostatic sound unmatched by any other hybrid speaker system. You'll hear an electrostatic array of bass and mid-range panels that respond precisely to the deep, rich power of a pipe organ and to the brilliant charge of the brass section. And for delivering the crystal clear notes of a piccolo, Model Two's dynamic tweeter features a vertical and horizontal dispersion through 12kHz to cover an included angle of 120°.

But most important of all is the way Koss engineers

developed a revolutionary new crossover system that brought the unique Model Two system together. A system so unique that it successfully combines dynamic element performance

with the finely tuned precision of electrostatic panels to produce the smoothest crossover network ever. And that means musical reproduction that's virtually distortion-free, with a close-up, transparent sound like no other speaker of its kind. A speaker that's clean and sharp, with bass and mid-range tones that resound with power and highs that are unquestionably brilliant.

So if you want to hear a speaker system that sounds almost as good as the one that came before it, ask your Audio Specialist for a live demonstration of the new Sound of Koss. Or write for a free full color brochure on the Koss Model One and Model Two Speakers, c/o Fred Forbes. After all, when you've kept the electrostatic promise anything else must be an impostor. Even if it's Model Two.

© Koss Corporation

from the people who kept the electrostatic promise

 **KOSS**® Model Two Electrostatic speakers

KOSS CORPORATION, 4129 N. Port Washington Ave., Milwaukee, Wisconsin 53212 • Koss International/London, Milan, Dublin, Paris, Frankfurt • Amsterdam • Koss Limited/Burlington, Ontario

Enter No. 18 on Reader Service Card



Amati, Batista, Bechstein ...

52

... SME: a worthy companion for the world's great instrument-makers. The best reproduction of music, either by electronic or acoustic means, requires a combination of sensitivity and strength: sensitivity to the delicate vibrations which make up the sound, but strength enough to ensure that only the *right* vibrations are heard.

The SME arm achieves this delicate balance by precision engineering, setting a standard that others have tried to equal. Now with improved lift, the SME arm remains the essential component for a complete sound system.

For complete specifications and independent reports, write to:

Dept 1439, SME Limited
Steving, Sussex, England. BN4 3GY

Exclusive distributors for the U.S.:

Shure Brothers Incorporated
222 Hartrey Avenue
Evanston, Illinois 60204

and in Canada:

A. C. Simmonds and Sons Ltd
975 Dillingham Road
Pickering, Ontario, L1W 3B2

SME

The best pick-up arm in the world

Enter No. 35 on Reader Service Card

mental-conditioning and acoustic implications of quadraphonic sound has been the recent wave of various kind of "sound processors"—ancillary devices offered for patching into sound systems to improve them, or the source material, or the listening room itself. These include noise-reduction units, dynamic range expanders, ambience enhancers, and graphic equalizers. Whether this development turns out to be a major trend or a passing fad, I cannot tell. I will stick my neck out though and say that of all these devices and systems the one that seems to be the most valid and most viable for the future would be the graphic equalizers. I think they are demonstrably the most convincing class of "extra" device for most home music systems.

Future Phonics

As for future trends, the most obvious right now would seem to be home video recording and digital recording. But, again with my neck way out, it may be that the next major trend in hi-fi will be one that is not so obvious although in one way or another it has been discussed sporadically over the years. I am referring to psychoacoustics which can be

thought of ultimately as the personalization of the listening experience. Our prevailing audio concepts today—specific differences of detail notwithstanding—are based largely on generalities which are necessary in any science or discipline. But audio is also an art. Years ago the generations-old "rules" about recording were broken when bold souls at London Records and Columbia and some others decided that the way to make a successful recording was not simply to "eavesdrop with a microphone" but to deliberately treat the whole thing as a new art-form, as a creative "production" specifically designed for reproducing on home audio systems. A closer tailoring of the reproducing system itself to that end, based on listener reaction, may be the next logical move. This obviously would help in the long effort by conscientious sound people to relate instrument measurements to listening experiences. Equally obviously, it's going to take a major commitment to some serious and extended research, which of course means funding. But it may well be that the "bottom line" of such a project could become the starting line of a new chapter in home audio that will make all that has happened before seem like a prelude. A

SORTING IT ALL OUT

Pondering the first 30 years of hi-fi, I've come up with four general categories for the many things that have happened and still are going on. **Lasting Contributions** denotes major contributions of lasting importance. **Major Trends** include wide-reaching developments of more than passing durability. Under **Fads** are listed what obviously are less important developments of shorter duration or limited appeal or both (the term "fad" is used here in its transient sense, not disparagingly). Finally there are the **Possibles** whose future remains, at this writing, still undetermined.

LASTING CONTRIBUTIONS

FM
Tape — open reel and cassette
Microgroove discs
Magnetic pickups
Stereo
Headphones
Solid-state circuitry and related techniques
Recording productions
Noise-reduction techniques

MAJOR TRENDS

High quality automatic turntables
High-powered amplifiers
A/S speaker systems
Receivers (tuner/amp combinations)

Kits
Multi-directional speaker systems
Graphic equalizers

FADS

Ping-pong records
Compact modular systems
Cartridge tape
Reverb systems
Volume expanders
Color/light displays
"Rock" sound speakers

STILL TO BE DECIDED

Home video recording
Digital recording
Elcaset
Multi-channel or surround sound
Psychoacoustics

You've heard about Infinity's landmark Quantum Line Source, of course. Musically accurate—the critics agree—beyond any speakers ever made before.

They cost \$1200* Each. Ouch.

The Quantum 3 pictured here costs less than \$500*. It uses all the same advanced Infinity technology:

Same Infinity-Watkins Dual-Drive Woofer** with a combination of cleanliness and power throughout its astonishingly wide bass range.

Quantum 3 also uses the same Electromagnetic Induction Tweeter (EMIT) stacked in multiples. They deliver smooth and utterly natural

highs with excellent dispersion. Same high-definition ventilated dome midrange drivers, too.

Slightly fewer of them, that's all.

And the same meticulously-phased midbass coupler.

What is the difference, then?

Come see. For one thing, the Quantum Line Source stands a towering 5½ feet high; Quantum 3, a more companionable 3½ feet.

More important, *hear* the difference. If you can.

Infinity's QLS delivers every musical nuance from 18 through 32,000 Hz ± 2 dB.

Compare the Quantum 3 range:

28 to 32,000 Hz ± 3 dB.

And price.

Quantum Line Source is certainly the finest. Quantum 3, very probably the finest *value*. Choose.

In fact, bring a stash of favorite records in to your Infinity dealer. Introduce them and yourself to the whole Quantum Series of speakers by Infinity.

Whether your taste runs to chamber-style delicacy or sledgehammer impact, they will reveal more of it—and more depth and spatial imagery—than you ever knew were in those familiar grooves.

We promise you quite a turn-on.

This is Quantum 3

Your ears may not know the difference between it and our Quantum Line Source. Until you hear the price.



 Infinity

We get you back to what it's all about. Music.

©1977 by Infinity Systems, Inc., 7930 Deering Avenue, Canoga Park, CA 91304. (213) 883-4800. TWX (910) 494-4919.

*Manufacturer's suggested retail price, optional with dealer. **Manufactured by Infinity Systems, Inc., under license from Watkins Engineering.

Enter No. 14 on Reader Service Card



Antique Hearing Aid Courtesy of A. P. Mynders, Inc.

The audio enthusiast, like nearly every other human being, takes most, if not all, his physiological and psychological processes for granted. Indeed, most of us are typically unaware of those internal events which enable us to live our lives and experience our environment. Only now and then tingling fingers, ringing ears, a grumbling stomach or painful joints remind us indirectly of the specific sensory systems which gather the sensations and information the brain requires.

Of our 10 or possibly 11 individual sensory systems (each of which has unique, specialized receptors that respond to different kinds of stimuli), we tend to think of vision first. Indeed, since the great majority of research into sensory mechanisms has concerned itself with vision, we have more information about the visual sense modality than about any of the others. Nevertheless, hearing is extremely important in the lives of humans and not merely because we enjoy music. It has been long observed, for example, that deafness typically has a more disastrous effect on the psychological development of an individual than does blindness; not being able to communicate aurally, vocally and by the uttered word isolates us in a way blindness does not. An audiophile, of course, has a strong interest in the adequate functioning of his or her auditory system. Knowledge about it, while of intrinsic interest, can also enhance many listening experiences, as well as provide a

broader basis for the rational selection and evaluation of various stereo components. Information about auditory mechanisms also will enable one to more adequately care for this vital and largely irreplaceable link in the high-fidelity chain. We will first consider the auditory system from an anatomical basis, then we will discuss several physiological mechanisms involved in the processes of hearing. To more fully appreciate the anatomy and manner of functioning of our hearing system, let's first briefly discuss the biological origins and embryological development of the auditory system.

Origin and Development

In the evolutionary or phylogenetic sense, the auditory system is a derivative of a receptor system originally concerned with balance and equilibrium, not hearing. This sense modality, which we now call the vestibular sense, responds to rotation, our orientation in space, balance, acceleration, deceleration, and similar forces acting on the body. Wild amusement park rides strongly stimulate the receptors for this sense, which are located in the three-semi-circular canals shown in Figs. 1 and 2. Vertigo and car-, air- and boat-sickness are all products of vestibular system functioning. Among animals with backbones, the vestibular systems of fishes, amphibia (frogs, salamanders), reptiles (snakes, turtles), birds and mam-

HOW WE HEAR

Dr. A. Joseph Ray, Jr., Ph.D.*

*Professor of Psychology,
East Stroudsburg State College,
East Stroudsburg, Penna. 18301

SONY FRONT-LOAD CASSETTE DECKS

All the recording features you want.

Dolby® Noise Reduction System virtually eliminates high frequency tape hiss. Signal/noise ratio zips up as much as 10 dB at 5 kHz and over with Dolby in. That's impressive. There's a 25 μ s de-emphasis switch and rear-panel calibration controls for recording Dolby FM broadcasts.

Ferrite and Ferrite Head lasts up to 200 times longer than standard permalloy. Provides wide, flat frequency response. And—the high density of the ferrite and ferrite material and Sony precision craftsmanship of the head gap make possible a feature we call **Symphase Recording**. Here, you can record a 4-channel source (SQ** or FM matrix) for playback through a comparable 4-channel decoder-equipped sound system without phase shift. This means that

all signals will be positioned in the same area of the 4-channel spectrum during playback as they were in the initial recording.

Solenoid Operated Transport Controls mean feather-light operation. **Jam-proof Feature** lets you go directly from one mode to another—bypassing stop—without damaging either mechanism or tape. (Available on the 209SD only.)

Separate 3-position EQ and 3-position Bias Select Switches adjust for optimum performance of standard, chromium dioxide or Sony Ferri-Chrome cassette tapes. And **FeCr Equalization**, when used with the new Ferri-Chrome tape, provides significantly improved dynamic range and signal/noise ratio, and optimum frequency response.

Servocontrol Motor automatically compensates for voltage fluctuations, tape drag, other speed altering factors. Result: constant tape speed, minimum wow and flutter.

Level Measurement includes 2 VU Meters plus a Peak Limiter. Together, they eliminate sudden transient high level input signals that can cause distortion and tape saturation—without compromising dynamic range.

Front Load convenience allows you to stack with other components.

Mic/Line Mixing lets you blend signals from various sources for master quality recordings. (Available only on 204SD, 209SD.)

They're incredibly versatile. Ultra-reliable. And the sound is magnificent. They're the Sony front-load cassette decks. Hear them now at your Superscope dealer. He's in the Yellow Pages.

Brought to you by

SUPERSCOPE®

Listen to us.

**SONY®
TC-186 SD**

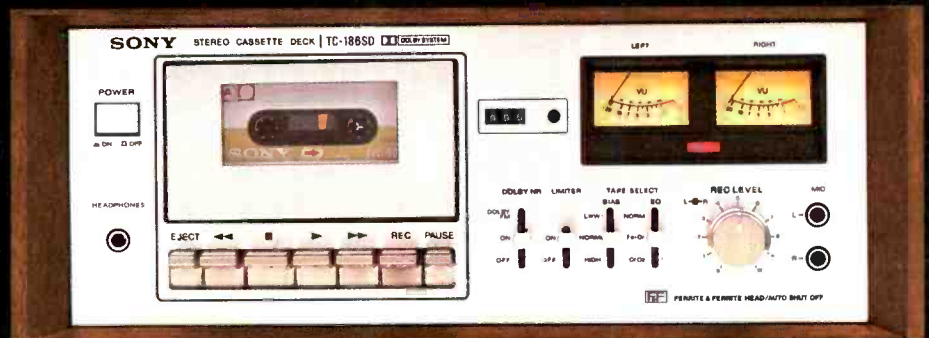

**SONY®
TC-209 SD**

**SONY®
TC-204 SD**

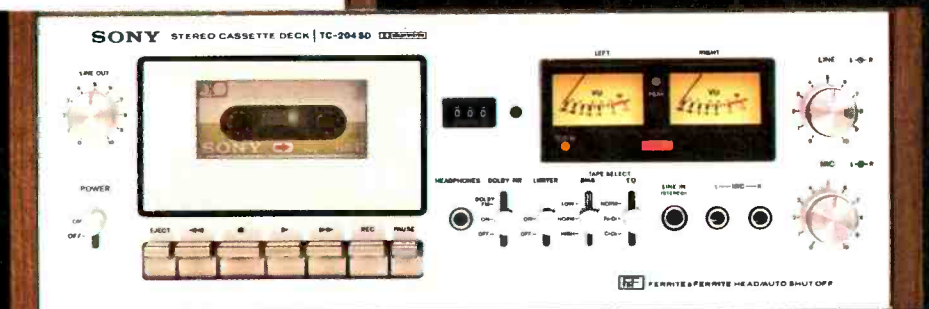

mals are remarkably similar and differ mostly in details and the degree of refinement. The similarity between the fishes' vestibular apparatus and our own is apparent in Figs. 1 and 2.

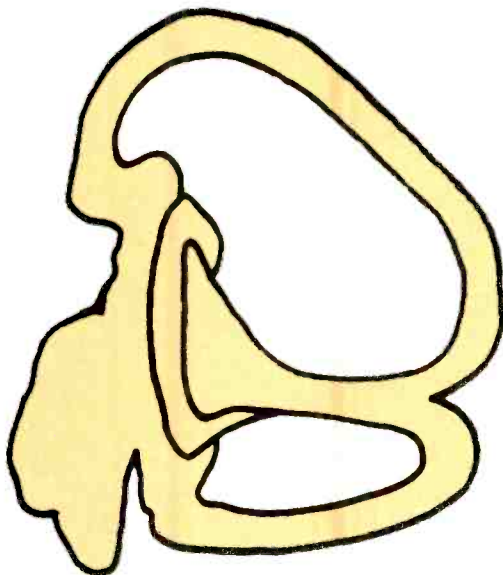

Fig. 1—Vestibular apparatus of a fish.

The vestibular system of the fish derives from the same group of cells that form the fishes' lateral line "organ." This lateral line system of receptors is readily seen on tropical fish and on many edible varieties at the grocers as a thin line midway down the side of the fish, which extends from just behind the gillplate to the base of the fishes' tail. The receptors of this lateral line system of fish are tiny hair cells, called neuromasts. These hair cells are themselves very similar to and appear to function much like the hair cells of our inner ear which are the actual receptors for hearing. References to Fig. 4 will give some idea of these hair cells in the human inner ear. Thus, the ultimate origin of our hearing receptors appears to have been a sensory system in the fish, the lateral line system, with its many hair cells situated in a lengthwise line down the fishes' side. Our auditory system appears to be a modification of the vestibular apparatus to accommodate the hair cells of the lateral line system.

Not surprisingly, in view of their relationship, the vestibular and auditory apparatus in the human develop nearly on a par with one another during gestation. Of the 12 cranial nerves which directly enter the lower part of the brain, the eighth cranial nerve is concerned with both hearing and equilibrium. We call this eighth cranial nerve the statoacoustic nerve to acknowledge its important equi-

ilibrium, vestibular and auditory functions. This nerve carries neural impulses from the vestibular receptors of the inner ear to the appropriate regions in the brain many months before the infant is born. In fact, study of human fetuses indicates that the vestibular receptors respond to stimuli and the statoacoustic nerve transmits neural impulses generated by these receptors to the brain by the 12th week of gestation.

The auditory portions of this system develop more slowly. After 24 to 25 weeks of growth, the human fetus appears to have an auditory system that is complete in most details. If not complete, it is, nevertheless, functional at this point in time. Analyses have

drum). The vestibular and auditory stimuli that impinge on the fetus and to which it can respond before birth contribute greatly to the development of both its vestibular and auditory sensory systems. At birth, then, these sensory systems are totally or highly matured. The receptors and neural transmission "lines" are complete and sufficiently well-developed to begin functioning in the outside world at a comparatively sophisticated level. Numerous studies have shown, for example, that newborn infants, less than two hours old, respond to a variety of sounds. More recently it has been shown that an infant is capable of discriminating familiar from unfamiliar voices within days after birth.

Fig. 2—Left vestibular apparatus and cochlea of human being. Letters identifying the following: a.) semi-circular canal; b.) cochlea; c.) organ of Corti.

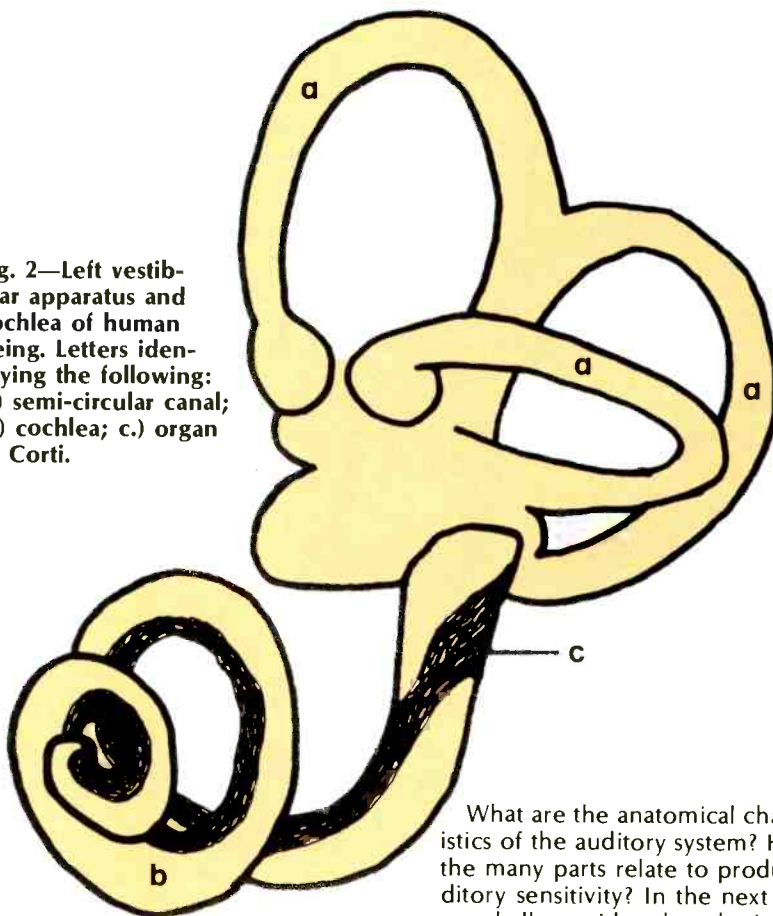

What are the anatomical characteristics of the auditory system? How do the many parts relate to produce auditory sensitivity? In the next section we shall consider the physical attributes of our hearing mechanism and the manner in which the vibrations in air eventually become the auditory experiences that so enrich our lives.

General Anatomy

Invariably when we think of the ear and of hearing, what first comes to mind is the accessory structure attached to each side of our heads, the cartilaginous pinna or auricle which aids in selecting and focusing vibrations at our ear drum. Some may think

DRAWINGS, PAUL KRUPA

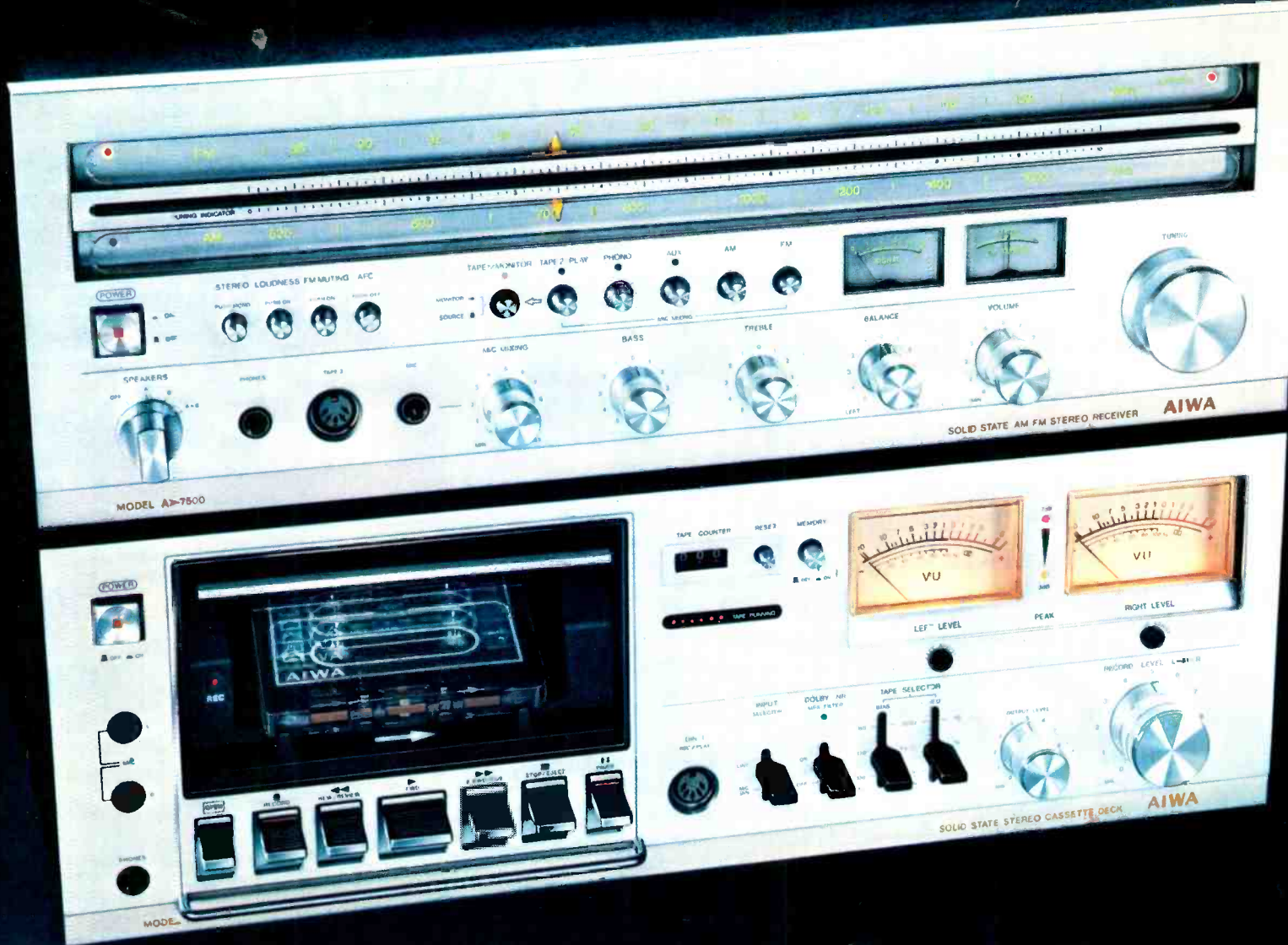

Meant for each other.

From the beginning it was a love match, each bringing out the best in the other. The AIWA AD-6500 cassette deck and the powerful AIWA AX-7500 receiver.

The AD-6500 cassette deck with its exclusive automatic front loading has been the belle of the ball since coming out. The separate transport system automatically loads the cassette into place. Added to this exclusive feature are those famous AIWA specs that impress even the most discriminating audiophile. The built-in Dolby* N. R. allows the S/N ratio of 62dB (Fe-Cr tape); the wow and flutter is kept to 0.07% (WRMS); the frequency response from 30 to 17,000Hz; the 2 step peak level indicator (+3dB, +7dB); the quick

cue and review; the Ferrite guard head and the 3 step bias and equalizer tape selector insures that the AD-6500 will always be out front.

The AX-7500 is a high powered, low distortion AM/FM stereo receiver that can hold its own with the best. Even the toughest engineers have nodded their approval. It boasts 30 watts per channel minimum RMS at 8 ohms from 20 to 20,000Hz with no more than 0.2% total harmonic distortion. The advanced 3-stage direct coupled OCL and differential amplifier circuitry equalizer assures stability and excellent transient response.

The AIWA AD-6500 and the AIWA AX-7500. The perfect sound relationship.

AIWA®

*Dolby is a Trademark of Dolby Laboratories, Inc.

Distributed in the U.S. by: MERITON ELECTRONICS, INC., 35 Oxford Drive, Moonachie, N.J. 07074
 Distributed in Canada by: SHIRO (CANADA) LTD., Montreal 256, P.Q. Canada

Enter No. 2 on Reader Service Card

It's time for everybody else to

From the very beginning, Yamaha receivers have set new laboratory standards. Our achievements in low distortion engineering, superb signal-to-noise, as well as high sensitivity and selectivity throughout the line have yet to be duplicated by any other manufacturer.

Now we've raised our standards even higher, beyond the laboratory and into the home. The result is the CR-2020: the pinnacle of a new line of advanced performance Yamaha receivers, rated to meet the more critical demands of real life.

Real Life Rated!™ While traditional laboratory measurements provide a good relative indication of receiver performance, they simply don't tell you how a receiver will sound in your living room in actual operation.

For example, in the lab, each receiver component is tested separately. At home, you hear them together as a single unit.

In the lab, distortion is measured at full-rated amplifier output. At home, you rarely, if ever, use the amplifier's full-rated power.

In the lab, power and distortion measurements are made with the volume control at maximum. At home, maximum volume would be painfully loud to listen to.

In the lab, noise and distortion are measured separately. At home, you hear them together.

Clearly a new standard is needed for evaluating overall receiver performance under real life conditions. Yamaha's new standard is called **Noise-Distortion Clearance Range (NDCR)**. No other manufacturer specifies anything like it, because no other manufacturer can measure up to it.

We connect our test equipment to the phono input and speaker output terminals, so we can measure the performance of the entire receiver. We set the volume control at -20dB, a level you're more likely to listen to than full volume. We measure noise and distortion together, the way you hear them.

On each of our new receivers, Yamaha's Noise-Distortion Clearance Range assures no more than a mere 0.1% combined noise and distortion from 20Hz to 20kHz at any power output from 1/10th watt to full-rated power.

Component-by-Component Excellence. By all conventional laboratory standards, as well as Yamaha's more stringent standards, the CR-2020 offers a new level of receiver performance.

At full-rated output, the 100 watt-per-channel power amplifier reduces total harmonic and intermodulation distortion to a new absolute low—a mere .05% from 20Hz to 20kHz into 8 ohms.

The CR-2020's exceptionally fine preamplifier is largely responsible for an incredible -95dB signal-to-noise ratio, from moving magnet phono input to speaker output.

The CR-2020's tuner makes FM reception up to 18kHz possible for the first time with unique negative feedback and pilot signal cancellation circuits (patents pending).

What's more, Yamaha's patented use of special ceramic and LC filters (developed for our revolutionary CT-7000 tuner) provide the highest selectivity and lowest distortion available.

Built-In Moving Coil Head Amp. Today, more and more people are discovering the superior performance of the moving coil phono cartridge. While

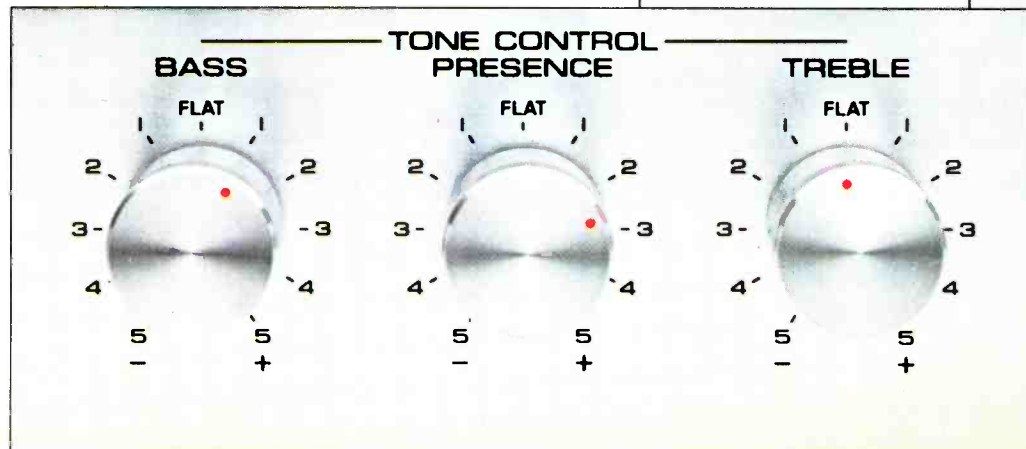
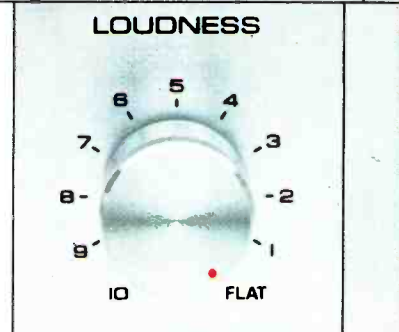
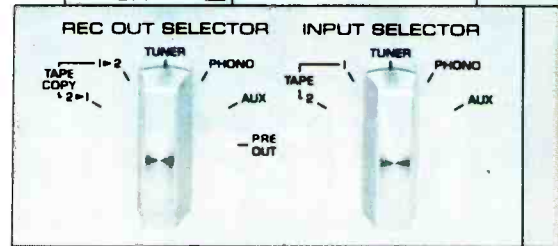
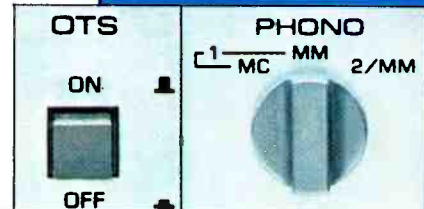

start playing catch-up. Again.

other receivers require an expensive preamplifier or step-up transformer, which can compromise sound quality, the CR-2020 already provides for it—the same solid-state device first developed for our superlative C-2 preamplifier.

Input/Rec Output/Pre Out Selectors. Here's extra convenience for tape recording enthusiasts. Record any source while listening to another. For example, copy a tape or disc at the same time you're enjoying an FM program. When you're in the mood to play recording engineer, you can use all the tone controls and filters to compensate for poor quality sound sources.

Fast Rise, Slow Decay Power Meters. The CR-2020's large, accurately calibrated power meters, with fast rise, slow decay characteristics, make accurate readings possible from 1/10th watt to 200 watt peaks without switching ranges.

Multi-Function Signal Quality Meter. When tuning, the right channel power meter automatically converts to a signal quality/strength meter. Needle oscillation indicates the degree of multipath present, while the meter calibrations indicate the strength of the signal. After tuning, the needle automatically reverts to power reading.

Optimum Tuning System. Yamaha takes the problem of inaccurate tuning out of human hands. After you manually locate the desired station, OTS automatically fine tunes it to the single point that gives maximum stereo separation and minimum distortion. A defeat switch is provided for special applications.

Built-In Equalizer. Think of the CR-2020's tone control circuitry as a small multi-band equalizer. Feedback bass and treble controls have selectable turnover frequencies. A midrange presence control adds more flexibility. Two-position low and high filters have 12dB/octave slopes. For the purist, a defeat switch removes the effect of the tone control circuitry entirely.

The Best Is Yet To Come. Now that you know about Real Life Rated, you'll want to hear a real life performance. At your Yamaha Audio Specialty Dealer, you'll find uncommon dedication to faithful music reproduction and genuine customer service.

If your Yamaha Audio Specialty Dealer is not listed in the local Yellow Pages, just drop us a line. Along with his name, you'll get complete details about this unprecedented receiver.

© 1977 YAMAHA INTERNATIONAL CORP



YAMAHA

Audio Division, P.O. Box 6600, Buena Park, CA 90622

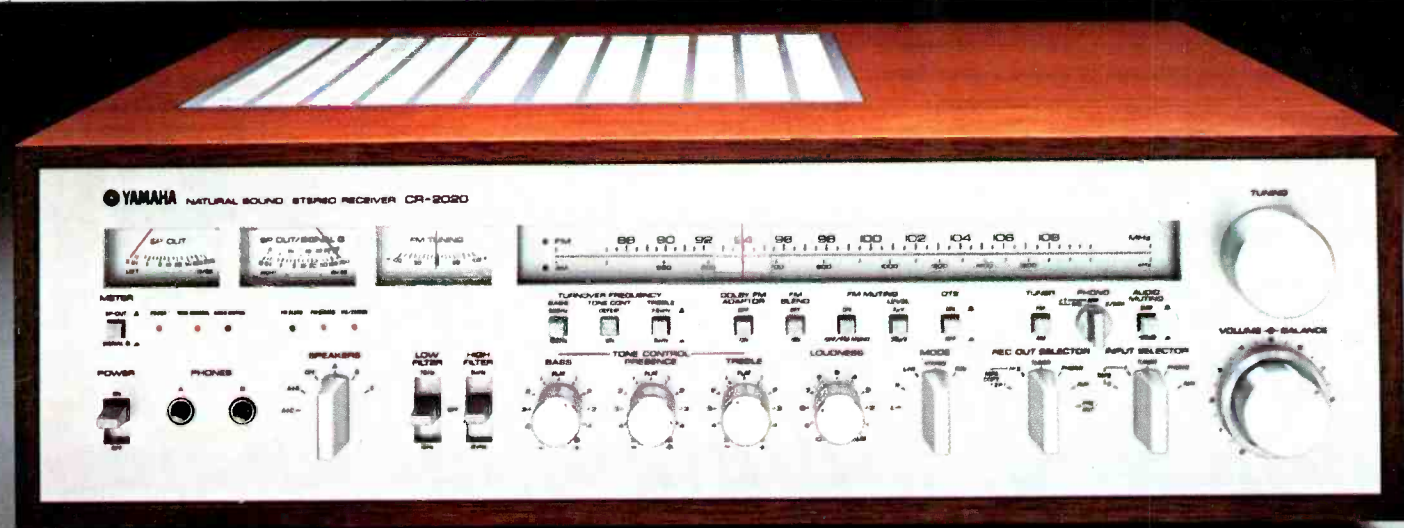
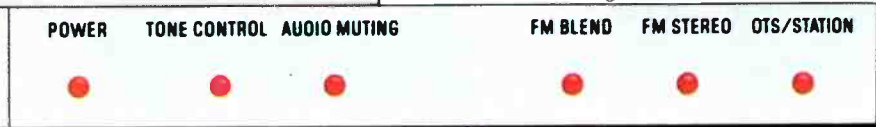
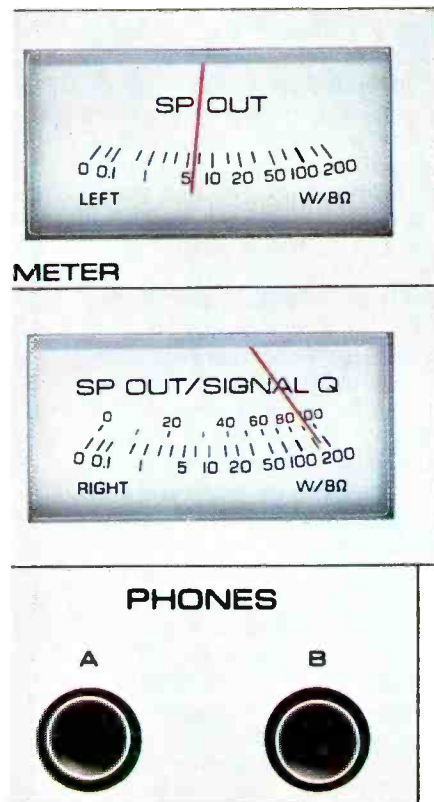

also of the tiny bones of the middle ear which transmit the vibrations of the eardrum to more internally situated structures. However, even these bones, called ossicles, are accessories—items convenient for but not essential to hearing in vertebrates. In a sense, the pinna and ossicles perform a preamp function—equalization and

Fig. 3—Diagram of mammalian auditory apparatus. Letters identify the following: a.) auditory meatus; b.) eardrum; c.) ossicles; d.) oval window; e.) round window; f.) uncoiled cochlea; g.) basilar membrane; h.) tympanic chamber; i.) vestibular chamber; j.) middle chamber; k.) eustachian tube.

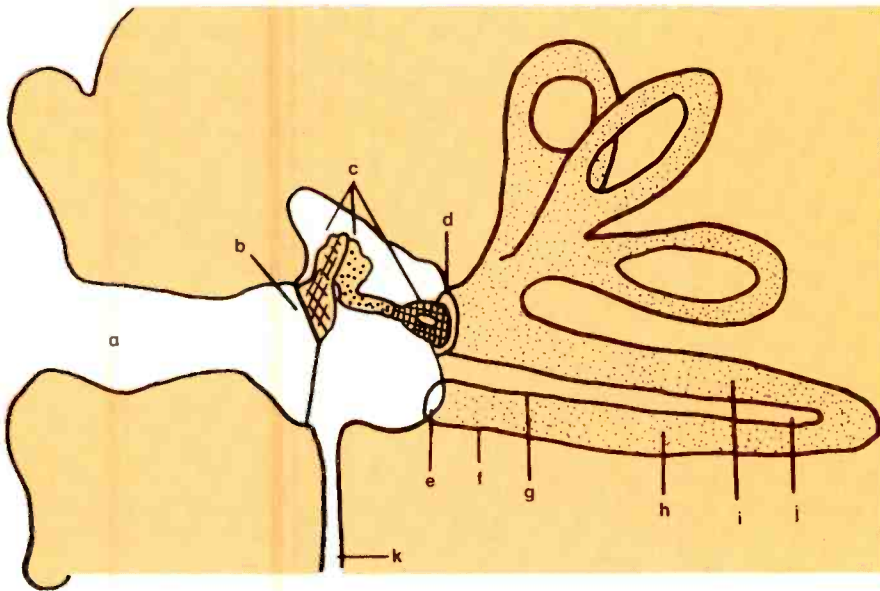

60

first-stage amplification. The real "ear" is the internal or inner ear, a coiled structure situated in an appropriately coiled canal within the temporal bone of the head. This coiled structure, called the cochlea, is shown in Fig. 2. In humans, the cochlea and its canal are coiled $2\frac{3}{4}$ times. The auditory sense receptors, the microscopic hair cells of Fig. 4, are situated here within part of the cochlea from one end of the spiral to the other. Thus, the pinna, auditory canal, eardrum, and ossicles *enhance* our ability to hear, but they are not the auditory receptors. To be sure, rupture of the eardrum and disruption of the three ossicles would result in a catastrophe from the audio enthusiast's point of view—a hearing deficit of from 30-to-50 decibels magnitude, but not complete deafness.

Outer and Middle Ear

The relatively simple anatomy of the outer and middle ear doesn't show the complexity of problems their evolutionary development has solved. Reference to Fig. 3 will make clear the fact that the pinna and external auditory meatus are a funnel. The human meatus is about one inch long with a natural vibration frequency of just less than 4000 Hz. The large

amplitude sound pressure waves in air are funneled to the eardrum or tympanic membrane. The eardrum, remarkably, manages to reflect back very little incident energy and to transmit most of it. Frequencies up to 2000 Hz cause the eardrum to vibrate as a whole, like a disc, with maximum oscillation at the bottom of the drum. As the frequency increases, the mode of vibration becomes increasingly complex with the drumhead no longer vibrating as a whole. The three ossicles, attached to flexible membranes at both input and output, transform the high amplitude, low pressure input movements of the eardrum into low amplitude, high pressure movements at the output point of the ossicles, the footplate of the stirrup (see Fig. 3); they function as a transformer. Pressure at the eardrum (where it begins) is approximately five per cent of the output pressure transmitted from the stirrup footplate to the oval window of the cochlea, the other flexible membrane (Fig. 3). As you might imagine, such a mechanical advantage could cause damage. To avert this, the two smallest striated muscles in the entire body are attached to two ossicles, respectively. These two muscles protect the hair cells from most overly loud noises and the huge oscillations derived from them by increasing the

internal friction of the system, thus reducing the ease of sound transmission. However, some intense noises (usually man-made) may have such an abrupt wavefront as to reach the hair cells unattenuated because these small muscles require between 60-150 milliseconds to contract. Permanent damage to hair cells is the result in this case; they are simply sheared off. The behavioral effect is a frequency region where one does not hear any sounds at all. Fortunately, most sounds are frequency composites or many of us would have more difficulty than we do.

The fantastic sensitivity of the ear can be attributed to nature's use of several transformers—each of which largely ameliorates the energy losses at the several "interfaces" in the auditory receptive system. The first transformer between the air and the cochlear fluid is a hydraulic piston transformer. It includes the eardrum, the ossicles, the oval window, and the inner ear fluid. Calculations by Dr. Georg von Békésy (1961 Nobel Prize winner for his audition research) indicate that the middle ear anatomy does, in fact, minimize energy loss in passing vibrations to the cochlea. Measurement in a variety of mammals has shown, also, that absolute auditory thresholds (minimal required pressure sensitivity to produce a neuroelectric response) are nearly equal. That is, little more energy can be conserved for transmission by further modifications to this already highly efficient system. This highly evolved capacity to transmit rather than to reflect incident energy is the special attribute of the outer and middle ear. The very small inertia of the ossicles provides one basis for this capacity.

Of course, high signal sensitivity implies high sensitivity to noise as well. Fortunately, the ear does establish and maintain an adequate signal-to-noise ratio. The effects of the many internal sources of noise (e.g. vocalization, chewing, breathing, muscular contraction, circulation of blood, and neural discharge) appear to have been minimized by judicious placement of sensitive components. External sources of noises must, of course, be handled differently. It is known presently, for example, that the S/N ratio is improved at several levels of the auditory nervous chain. A primary mechanism involved here is the inhibition of that nervous discharge which is largely random (as opposed to periodic) as is the frequency of most noise, a common-mode rejection of sorts.

You've got to be serious.

If you're interested in Phase Linear, you've got to be serious. Serious about music. Serious about enjoying the most realistic sound possible from a home stereo system. Serious about acquiring quality state-of-the-art components built to deliver a lifetime of top performance.

The three components featured here represent the very finest technical achievements of the Phase Linear Corporation:

The Phase Linear

5000 FM Tuner: An advanced tuner with a Dynamic Range Expander that restores FM broadcast signals to rival your records and tapes.

The Phase Linear 4000 Preamplifier: An incredibly sophisticated preamp and control center that actually compensates for limitations inherent in the recording and playback process through noise reduction and dynamic range expansion.

The Phase Linear 700B Power Amplifier: The most powerful, most dependable stereo amplifier you can buy, at any price.

Phase Linear manufactures a complete line of amplifiers and preamplifiers, a noise reduction unit, and a speaker system. Ask your dealer for an audition. If you're serious.

Enter No. 27 on Reader Service Card

Phase Linear
The Powerful Difference

Manufactured in the USA. Distributed in Canada by H. Roy Gray, LTD.

Once the energy has reached the inner ear, a second transformer comes into play. This transformer utilizes vertical pressure on a flexible membrane, the basilar membrane, to create a longitudinal stress in a second, inflexible membrane, the tectorial membrane (Fig. 4). The actual receptors, the hair cells, being situated somewhat obliquely between these two membranes, as shown, have their

which rests against another membrane, the oval window. Since these chambers are completely filled with watery perilymph fluid, the fluid pushes out on all the boundary surfaces. One of these surfaces is the flexible, basilar membrane. The basilar membrane is so termed because it forms part of the floor of the cochlear duct, thereby differentiating the middle and lower chambers. This

By comparison with the processes involved merely in pitch discrimination, things are simple indeed. A concluding fact or two may provide an adequate perspective.

The human eardrum has an area of about 70 sq. mm. The area of the oval window to which vibrations are finally transmitted is only about 3 sq. mm. Despite this small area, the approximate minimal energy level of a 1000 Hz tone that we can sense is 0.0002 dyn/cm² (dyne=energy to accelerate 1 gm at 1 cm/sec²). Were our hearing any more sensitive, we would be distracted continuously by molecular bombardment of our eardrums. In a manner of speaking, then, we could hear differences in temperature.

The prodigious accomplishment already described is, however, only a fraction of the story. For we can discriminate identical and different tones of subtly different sound intensities, perhaps 250 distinct intensity levels. We are able to make numerous pitch discriminations—about 1,000 of them within the range of 20 to 16,000 Hz. Moreover, we are sensitive to the “mass” or “volume” of sound as distinct from loudness; and finally, some of us can make pitch discriminations of such accuracy that these persons have been said to have perfect (!) pitch. These phenomena, observed and studied in the psychophysics of audition, deserve our attention. Yet, we have one more step to consider first—the generation of neural impulses and transmission of these to the appropriate regions of the brain.

The Inner Ear

Properly speaking, the hair cells are transducers, not transformers. Up until this point in the sequence, the energy has been mechanical. Once the hair cells respond, however, we are no longer dealing with mechanical energy. The hair cells have generated an electrical potential which neurally represents the mechanical energy transmitted to them. This potential, often called a generator potential, is one of several potentials that can be recorded from the inner ear. The actual mechanisms for the transduction process are not yet known. Despite that, our knowledge concerning auditory mechanisms has been advanced, and we can profitably consider the cochlear mechanisms for loudness discrimination and pitch discrimination. The organ of Corti concerns itself with other auditory dimensions in addition to these. Perusal of these two processes will demonstrate the

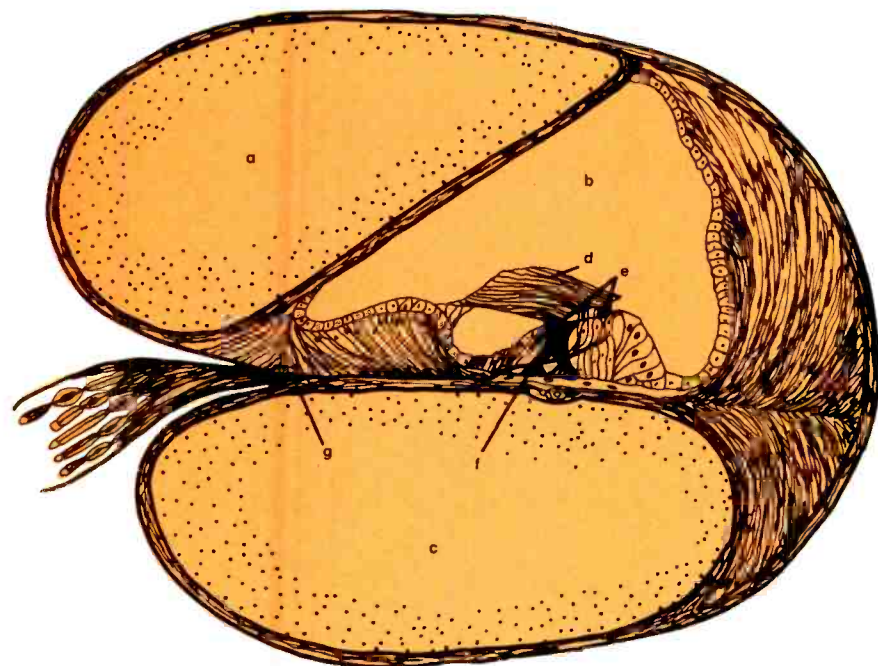

Fig. 4—Cross section through human cochlea. Letters identify: a.) vestibular chamber; b.) middle chamber; c.) tympanic membrane; g.) nerve fibers.

hairs bent over at the point where they contact the stiff, tectorial membrane by the shearing force thus generated. This second transformer has been called a shearing transformer. Let us look more closely at the elements of this mechanism and their interrelations.

About 12,000 hair cells (that's all) are situated within the spiral cochlea (Figs. 2 and 3). The cochlea is divided by two membranes into three chambers, two of which communicate with one another at the tip of the cochlea, through the helicotrema. These two chambers, the “upper” or scala tympani and the “lower” or scala vestibuli, are filled with a fluid, perilymph (Fig. 3), which is nearly identical to the watery fluid that bathes the central nervous system, called cerebrospinal fluid. The third, noncommunicating chamber, often called the cochlear duct, is between the other two chambers. Fluid fills this chamber also. This fluid, termed endolymph, is more viscous than the perilymph of the two other connecting chambers. The ossicular vibrations are transmitted to the fluid of the upper- and lower-connecting chambers by the stirrup

membrane, which von Békésy discovered is under no tension whatever, is displaced up and down by the forces exerted on it from beneath. As mentioned earlier, this displacement ultimately causes a shearing force to be exerted on the hair cell receptors which are situated in the cochlear duct between the basilar membrane and the rigid tectorial membrane above them. As can be seen from Figs. 2 and 4, this “receptor structure” occupies only a small part of the middle cochlear chamber. Endolymph fills the rest performing a vibration-isolating function. The basilar membrane, tectorial membrane, and receptor cells in between, which form the receptor structure, are usually called the organ of Corti. All this may appear to be an unusually complex system to transfer vibrations to cells which can respond to them, but in fact, it's elegant simplicity becomes increasingly apparent as one learns more about it.

Remember the plug-in-shell?

Thorens Isotrack Series Turntables proudly introduce the Plug-In Arm.

Thorens introduces an exciting new tonearm design to complement its highly sophisticated, new manual turntable series. Thorens has eliminated the headshell and its collar connection by incorporating the headshell and tonearm rod in a straight tubular design only 7.5 grams in effective tonearm mass. This reduction in mass (up to 50% that of other tonearms) reduces the inertial forces that affect stylus pressure. Tracking is improved, distortion lowered and stylus and record life are extended. Thorens Isotrack tonearm assures optimum performance with the newest, light weight, high-compliance pick-up cartridges.

The accent is on quality

—The high-speed stability and silent opera-

tion of the belt-driven 16-pole synchronous motor is a tribute to Thorens traditionally advanced engineering. The natural elasticity of the belt filters motor vibrations from reaching the platter, and therefore, the pick-up stylus. In more than twenty years of continuous development, and the manufacture of nearly one-million Thorens turntables, Thorens has brought its belt-drive design to a level of technical perfection not approached by *any other drive system known today.*

Thorens Isotrack turntables featuring the "mini-mass" tonearm—now at your Thorens Isotrack series Dealer, or for further details write:



ELPA MARKETING
INDUSTRIES, INC.

East: Thorens Bldg.,
New Hyde Park, N.Y. 11040
West: 7301 East Evans Road,
Scottsdale, Ariz. 85260

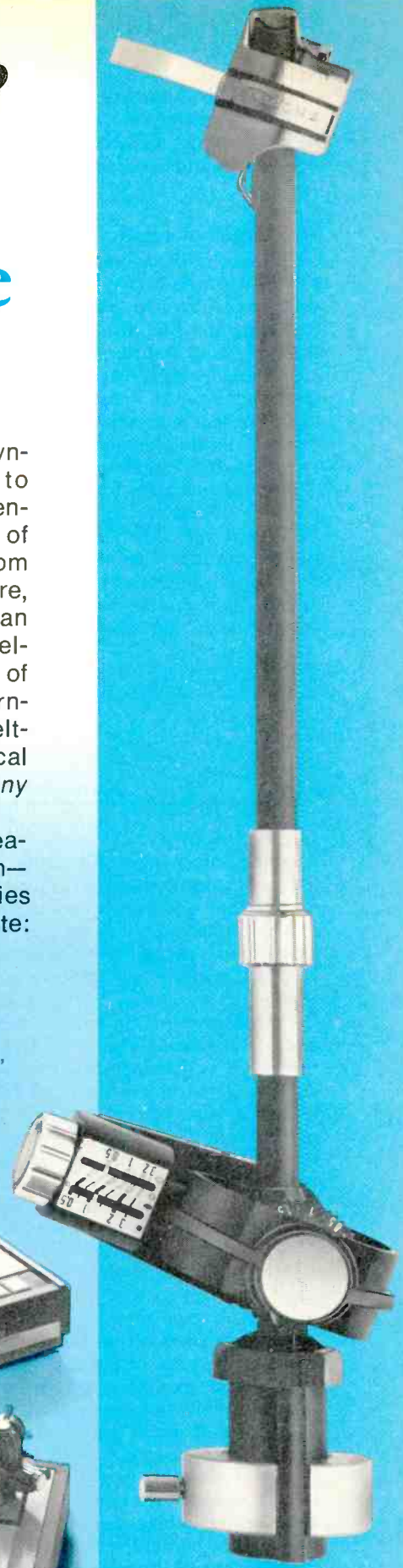

Pictured Above: Top Right—TD-126C • Lower Right—TD-145C
Lower Left—TD-166C • Top Left—TD-160C

ingenious evolutionary solutions that enable us to perceive extraordinarily subtle auditory differences in loudness, pitch and a combination of the two.

The Organ of Corti

The greater the vibratory motion of the basilar membrane, the more hair cells it stimulates to "fire." The more hair cells that fire, the louder will be the perceived sound. As is often the case, this straight-forward relation oversimplifies the actual state of affairs. Suffice it to say that the outermost column of hair cells (which are arrayed in four columns as seen in Fig. 4) is more receptive to vibration amplitude differences than any of the other columns. They derive this enhanced sensitivity to amplitude from their physical position and unique neural connections. These hair cells appear to provide us with most of our

basilar membrane are not standing waves from one side of the membrane to the other (piano string vibration), as had been theorized a century ago by Hermann von Helmholtz. Dr. von Bekesy has shown that, because the basilar membrane is not under tension, it vibrates similar to a rope, tied at one end and waved up and down at the other. This kind of vibratory motion is a travelling wave. The envelope of a travelling wave will show maximum vibration amplitude at various regions along an unstretched membrane as a function of the frequency of vibration and the physical qualities of the membrane. This characteristic is shown in Fig. 5. While the upper limit of this "tonotopic" organization and the frequency discrimination deriving from it is not known, it is clear that this static mechanism contributes greatly to our abilities to discriminate pitch.

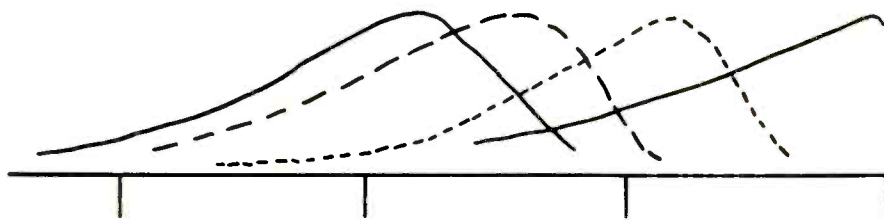

Fig. 5—Travelling waves of different frequencies on the basilar membrane (after von Bekesy).

loudness information. Obviously, the loudness information is *in addition* to though not necessarily independent of pitch information. In fact, as many know, these two dimensions of auditory experience are closely inter-related.

Pitch discrimination is partly a static and partly a dynamic process. The un-tensioned basilar membrane is wider at the apex of the cochlear coil than it is at the base where the coil originates. From Fig. 2, we might expect the opposite, that the basilar membrane narrows as the coil it's in narrows. Since the mass of the basilar membrane is least at the base (where it's narrowest), it's natural vibration frequency is higher there and it is most sensitive to high frequency vibrations in that region. Conversely, the greater mass of the basilar membrane at the apex of the cochlear coil renders that area more sensitive to vibrations of low frequency. Clearly the anatomical shape of the basilar membrane predisposes it to vibrate maximally at different regions along its length because, as it goes from base to apex, it gets wider and wider. Additionally, the higher the frequency, the more localized the area of vibration; very low frequencies (below 50 Hz) induce the entire membrane to vibrate as a whole. The waves set up in the

The second pitch discrimination mechanism that operates in the organ of Corti is a dynamic, neural one. In recent experiments, electrodes about a millionth of a meter in diameter (microelectrodes) have been placed in individual cells of the auditory nerve or at other auditory central nervous system locations. Research with these "microelectrodes" has shown that special nerve fibers to (not from) the organ of Corti inhibit the response of hair cells immediately above and below the region of maximum basilar membrane movement. That is, these special fibers make it more difficult for hair cells situated to either side of the maximally stimulated hair cells to respond. The effect is to increase or "sharpen" the discriminability of one frequency from another. Of additional importance here is the anatomical fact that all inner hair cells (Fig. 4), which are known to be primarily involved in pitch discrimination, are connected to their own individual neural fiber going to the central nervous system. Thus, precise, detailed information regarding pitch is transmitted to the higher neural centers.

Not surprisingly, much more happens to the neural signals that traverse these 25,000 or so fibers once they enter the central nervous system, for elegant though the preceding mechanisms are, they are not sufficient to account for the incredible pitch discrimination many people show. One of the mechanisms which occurs inside the central nervous system that is known to increase our pitch discrimination is the following.

Neurophysiological research with microelectrodes has established that frequency discrimination takes place at various levels of the neural circuitry as the impulses proceed to the portions of the brain that ultimately process and analyze the auditory impulses. Inside the brain, but not at the highest (cortical) level, neural inhibitory mechanisms appear to reduce further the neural response to random (aperiodic) input and to further accentuate a specific response. All this occurs in a system which ordinarily does not "follow" or keep track with stimulus frequencies beyond 200 Hz.

This account is necessarily brief. Nevertheless, it is hoped that some idea of auditory system origin, development, and functioning has been derived from it. The elegance of this system is surely obvious. What should also be apparent is that a great deal of signal processing has taken place even before the signal reaches its ultimate destination, the auditory regions of the cortex of the brain. A discussion of the processes occurring in the several brain areas concerned with audition would provide further insight into the psychology of audition. That enterprise, connecting the physiology and psychology of hearing, transcends the present topic in complexity and requires a separate treatment. ▽

References

1. Green, D.M. Audition. *Annual Review of Psychology*, 20: 105-128, 1969.
2. Milner, P.M. *Physiological Psychology*. New York: Holt, Rinehart and Winston, 1970.
3. Minkowski, A. (ed.) *Regional Development of the Brain in Early Life*. Philadelphia, 1967.
4. Ochs, S. *Elements of Neurophysiology*. New York: John Wiley & Sons, 1965.
5. Peele, T.L. *Neuroanatomic Basis for Clinical Neurology*. New York: J. Wiley and Sons, 1957.
6. Peiper, A. *Cerebral Function in Infancy and Childhood*. New York: Consultants Bureau, 1963.
7. Romer, A.S. *The Vertebrate Body*. New York: W.B. Saunders, 1956.
8. Stevens, S.S. (ed.) *Handbook of Experimental Psychology*. New York: Wiley and Sons, 1957.
9. von Bekesy, G. Traveling waves as frequency analyzers in the cochlea. *Nature*, 225: 1207-1209, 1970.
10. Zemlin W.R. *Speech and Hearing Science*. Englewood Cliffs: Prentice-Hall, 1968.



PARDON US WHILE WE ACT LIKE A PROUD FATHER.

We don't mean to brag, but our new Audio Purist Group is nothing short of sensational.

It's our engineers' brainchild. And it represents the culmination of exhaustive research and development.

Integrated DC amplifiers, our famous tuners, the concrete-base turntable, and esoteric speakers. They're what you'd expect from us. And what you should expect for yourself, given your highly critical listening demands.

Only a limited number of each model are being made, though, and will be available only through select Kenwood audio specialists.

For full information, specifications and location of the audio specialist nearest you, write Kenwood Electronics, 15777 South Broadway, Gardena, Ca. 90248; or 72-02 Fifty-First Ave., Woodside, NY 11377.



The 600 Amplifier, 600 Tuner, 500 Amplifier, Model 7 Speakers, KD-300 and KD-550 Turntables.



KENWOOD

Enter No. 17 on Reader Service Card

Equipment profiles

Pioneer TX-9500-II AM/FM Stereo Tuner



66

MANUFACTURER'S SPECIFICATIONS

FM Tuner Section

Usable Sensitivity, Mono: 8.8 dBf, 1.5 μ V.

50-dB Quieting Sensitivity: Mono, 13.2 dBf, 2.5 μ V; Stereo, 36.1 dBf, 35 μ V.

S/N: Mono, 82 dB; Stereo, 77 dB.

Frequency Response: 20 Hz to 15 kHz, +0.2, -0.5 dB.

AM Suppression: 65 dB.

Image Rejection: 120 dB.

I.F. Rejection: 105 dB.

Spurious Rejection: 110 dB.

Muting Threshold: 19.2 dBf (5 μ V)/34.1 dBf (28 μ V).

Subcarrier Rejection: 77 dB.

SCA Rejection: 62 dB.

THD in Wide I.F. Position: Mono, 0.07 per cent @ 100 Hz, 0.05 per cent @ 1 kHz, 0.07 per cent @ 10 kHz; Stereo, 0.1 per cent @ 100 Hz, 0.07 per cent @ 1 kHz, 0.2 per cent @ 10 kHz.

THD in Narrow I.F. Position: Mono, 0.07 per cent @ 100 Hz, 0.07 per cent @ 1 kHz, 0.1 per cent @ 10 kHz; Stereo, 0.3 per cent @ 100 Hz, 0.25 per cent @ 1 kHz, 0.5 per cent @ 10 kHz.

Capture Ratio: Wide, 0.8 dB; Narrow, 2.0 dB.

Selectivity: Wide, 35 dB; Narrow, 85 dB.

Stereo Separation: Wide, 35 dB @ 100 & 10,000 Hz, 50 dB @ 1 kHz; Narrow, 30 dB @ 100 & 10,000 Hz, 45 dB @ 1 kHz.

AM Tuner Section

Sensitivity: Ext. Ant., 15 μ V.

Selectivity: 30 dB.

S/N: 55 dB.

Image Rejection: 70 dB.

I.F. Rejection: 65 dB.

General Specifications

Audio Output Level: FM, 100 per cent modulation, 650 mV fixed or 50 mV to 1.3 V variable; AM, 30 per cent modulation, 200 mV fixed or 15 mV to 400 mV variable.

Power Requirements: 120 V, 60 Hz, 25 watts.

Dimensions: 16 9/16 in. (42 cm) W x 5 7/8 in. (15 cm) H x 15 9/16 in. (39.5 cm) D.

Weight: 20 lbs. 15 oz. (9.5 kg).

Price: \$400.00.

U.S. Pioneer Electronics has now joined that distinguished group of FM tuner designers who realize that the world (and, in particular, the world of FM) is full of compromises. If one wants super selectivity in an FM tuner, one must sacrifice super-low distortion and super-high stereo separation. But not everyone wants or needs such high levels of selectivity (some areas of the country have few FM stations spread across the band from 88 to 108 MHz, while others, though crowded over certain portions of the dial, have "open frequency space" at other portions of the dial).

To provide the "best of both worlds," Pioneer has now come up with selectable i.f. bandwidth—a feature which has been available on such high-end tuners as those made by Yamaha, Sansui, and, of course, McIntosh for some years now. But, when one takes a look at the price of this tuner, the accomplishment is all the more remarkable.

The front panel of the TX-9500-II follows the styling adopted by Pioneer in all its recent components. It is all gold-colored, including the highly visible dial area which slopes back for easy viewing. Signal-strength and center-of-channel meters are prominently positioned at mid-scale, above the linearly calibrated FM frequency and AM frequency dial scales. A rectangle of light to the right of the meters tells us when a stereo signal is received, while two rectangles at the left denote the *wide* or *narrow* settings of the i.f. bandwidth switch located at the lower left of the panel. Four movable "markers" or "sliders" glide along the lower edge of the dial opening and can be manually positioned for designating most often tuned-to frequencies. Pioneer calls this added feature its "memory markers."

Controls along the lower section of the panel include a toggle-type power switch, the aforementioned wide narrow i.f. switch, a three-position switch which provides an audible check of multipath distortion (one listens for a *minimum* of sound while orienting the antenna when the switch is set for multipath checking), as well as a 440-Hz calibrating tone corresponding to 50 per cent of full modulation and useful for pre-setting record level controls when recording an FM program. A rotary output-level control and a three-position muting control (*Off* and two threshold levels) come next, followed by the large diameter tuning knob, and a function selector switch with positions for AM, FM, FM with noise-filtering, and FM-mono. The "noise filter"

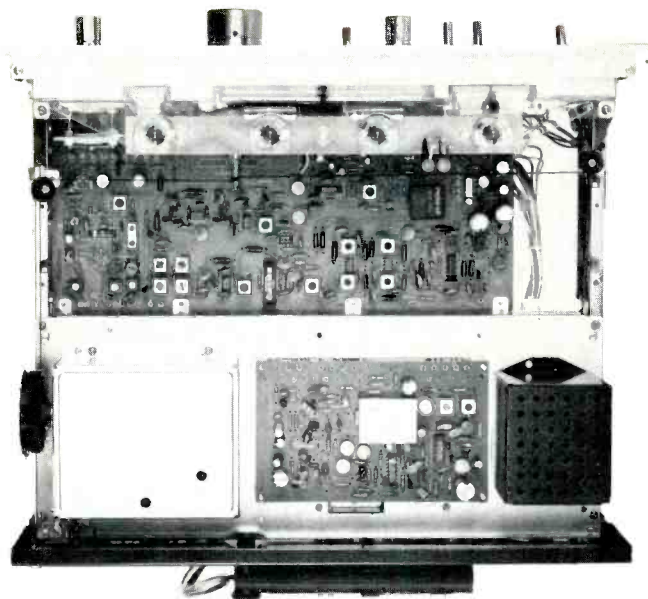

position is intended for use with weak-signal stereo stations and reduces high frequency stereo separation but does not alter overall frequency response.

The rear panel of the TX-9500-II is equipped with the usual external AM, ground, 300- and 75-ohm antenna terminals. A suitable clamp arrangement retains the coaxial cable in place if that type of lead-in transmission line is used. A slide switch, permanently "locked" in its 75 microsecond position, may be moved to the alternate 25-microsecond de-emphasis position by removing a retaining bracket if a Dolby decoder is to be used in conjunction with the tuner for proper reception of Dolby FM programs. Horizontal and vertical output jacks for connection to an oscilloscope for visual multipath observation are located near the center of the rear panel, the former also useful as an FM detector output jack for future discrete four-channel adaptor connection. Pairs of fixed level and variable output jacks come next, along with a single unswitched a.c. convenience receptacle. A pivotable ferrite bar which swings away from the rear panel serves as the built-in AM antenna.

67



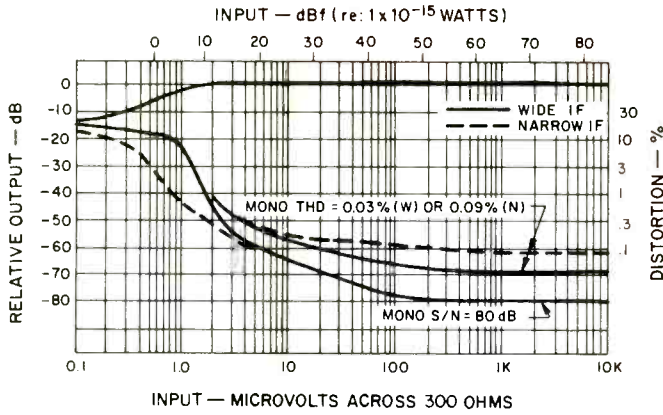

Fig. 1—FM quieting and distortion characteristics in mono.

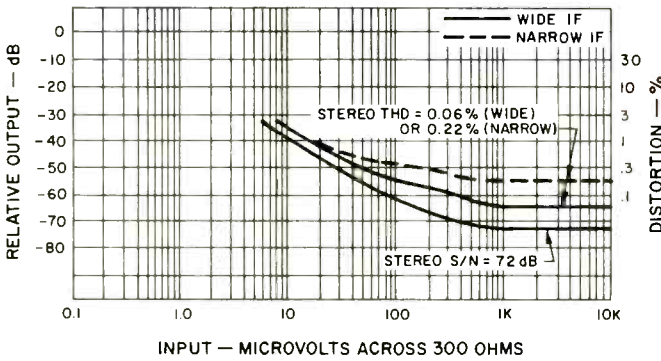

Fig. 2—FM quieting and distortion characteristics in stereo.

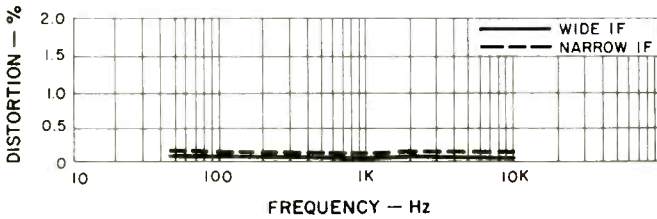

Fig. 3—Distortion vs. frequency for the Pioneer TX-9500-II in mono operation.

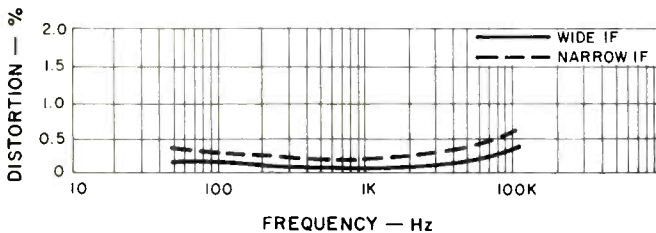

Fig. 4—Distortion vs. frequency in stereo.

Circuit Description

The front end of the TX-9500-II includes a five-gang tuning capacitor, two dual-gate MOS-FETs as r.f. amplifiers, a third MOS-FET for the mixer stage, and a buffer stage following the local oscillator. A three-gang tuning capacitor is used in conjunction with a multi-purpose IC for AM reception. There are actually two complete i.f. systems in the tuner, one a wide-band i.f. system which utilizes, among other things, a newly developed "surface acoustic wave" filter plus a four-pole phase-linear filter; the other for narrow-band reception which utilizes a 10-element ceramic filter to obtain the desired high level of alternate channel selectivity. When switching from one mode to the other, completely different i.f. signal chains are activated, unlike other designs having selectable bandwidth in which one or two circuit elements are switched to achieve the various bandwidth modes.

A new phase-lock-loop multiplex circuit includes an automatic pilot-carrier-cancelling circuit which permits extended flat frequency response in stereo FM without having to settle for a high level of carrier leakage at the output. A separate audio and MPX muting assembly contains three special purpose ICs, one of which takes care of the required audio amplification and isolation and employs full negative feedback in a differential direct-coupled audio frequency circuit. Total semi-conductor complement of this tuner consists of five FETs, 15 ICs, 12 transistors, and 19 diodes. The power-supply circuit board delivers two fully regulated voltages for operation of critical FM and AM circuits.

FM Laboratory Measurements

Measuring the FM performance of the TX-9500-II was like measuring two separate tuners, for each of the many measurements taken had to be repeated for the wide and narrow bandwidth settings. Figure 1 is a plot of signal-to-noise and distortion characteristics in both modes, with the tuner in the mono mode. While ultimate signal-to-noise ratio for strong (65 dBf) signals was the same for both bandwidth modes (80 dB—probably the limit of our test equipment), at very low input signal levels, the narrow mode offers somewhat steeper quieting, reaching the 50-dB quieting point with an input signal level of $2.0 \mu\text{V}$ (11.2 dBf) as opposed to $2.2 \mu\text{V}$ (12.0 dBf) in the wide mode. Differences in distortion are also apparent, with best readings of 0.03 per cent (yes, we said 0.03 per cent!) in the wide mode and perfectly acceptable levels of 0.06 per cent for the narrow mode. On the basis of these mono results, one might be tempted to ask why Pioneer bothered with the wide mode at all here (since good selectivity, measured at 86 dB for the narrow mode, as against 35 dB for the wide position, is never a fault if it can be had without sacrificing low distortion and good S/N ratios)—until one examines stereo performance relative to these same parameters, as plotted in Fig. 2. Here we see that while the wide position still yields amazingly good, low distortion of 0.06 per cent at 1 kHz (about the lowest we have ever read for any tuner operating in stereo), when it becomes necessary to switch to the narrow position for improved selectivity, distortion in stereo increases to around 0.22 per cent under the same test conditions. In mono operation, distortion at other frequencies (plotted in Fig. 3) is almost identical regardless of the i.f. bandwidth mode selected but, in stereo (see Fig. 4), the differences are once again fairly significant.

In stereo operation, usable sensitivity measured $6.0 \mu\text{V}$ (20.8 dBf) regardless of the bandwidth mode chosen (it measured exactly $1.5 \mu\text{V}$, or 8.7 dBf, for mono), and there was only a slight difference in the 50-dB quieting sensitivity (32

We're the other fine response, high performance microphone. The one that costs less!

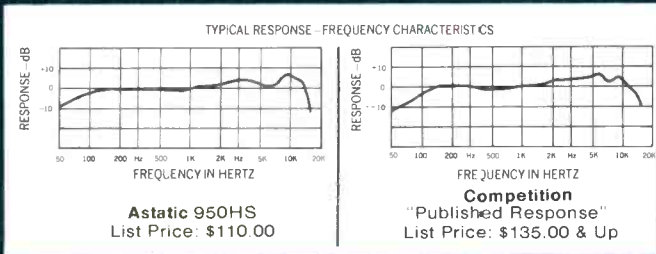

Now there is another fine response, high performance microphone you can buy at a lower cost! Astatic's Music Mike. . . Professional aesthetics and acoustic characteristics for the most demanding performer. Attractive design with brushed satin chrome finish.

The Music Mike comes in two basic models. One has a contoured response for the discreet listener, providing crisp sound that every artist will appreciate. A second model offers a flat response for the independent entertainer who prefers natural sound. Both cardioid mikes come with high and low impedance versions, each complete with switch and easy-on swivel stand adaptor. Packaging includes a modern plastic carrying case.

Astatic's Music Mike. Why buy any other microphone when quality and style are available now at a lower cost.

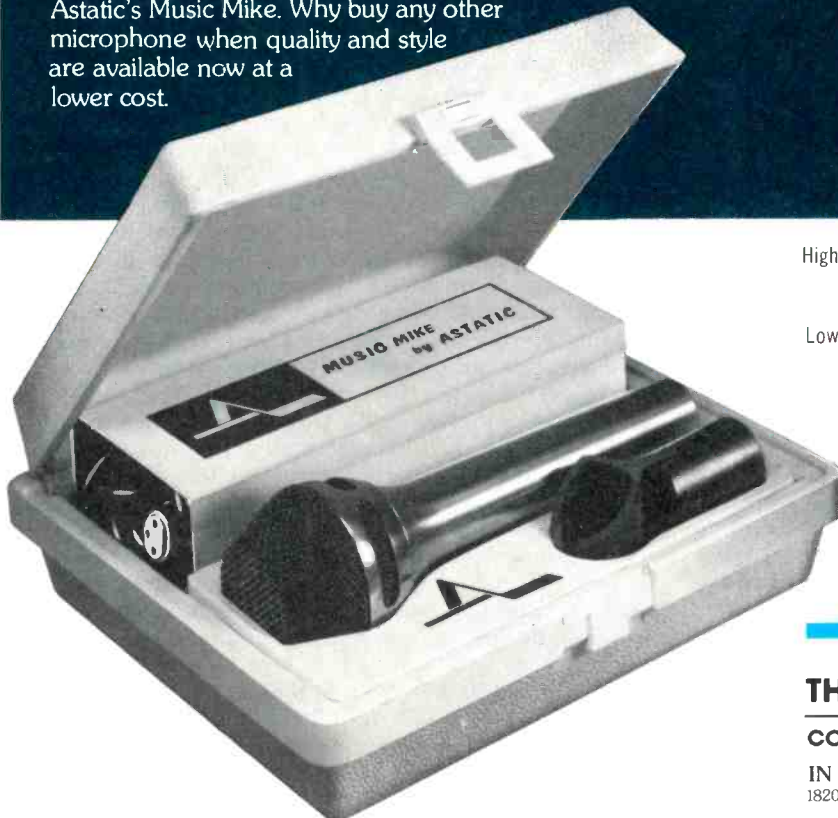

- High impedance models **950HS** (Contoured response)
952HS (Flat response)
List Price \$110.00
- Low impedance models **950LS** (Contoured response)
952LS (Flat response)
List Price \$100.00

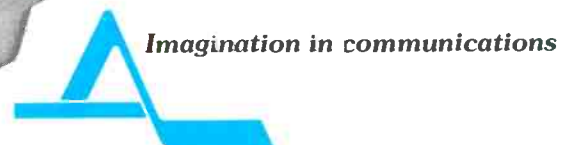

Imagination in communications

THE ASTATIC CORPORATION

CONNEAUT, OHIO 44030 (216) 593-1111

IN CANADA:

1820 Ellesmere Road, Scarborough, Ontario M1H 2V5. (416) 438-6384

Enter No. 4 on Reader Service Card

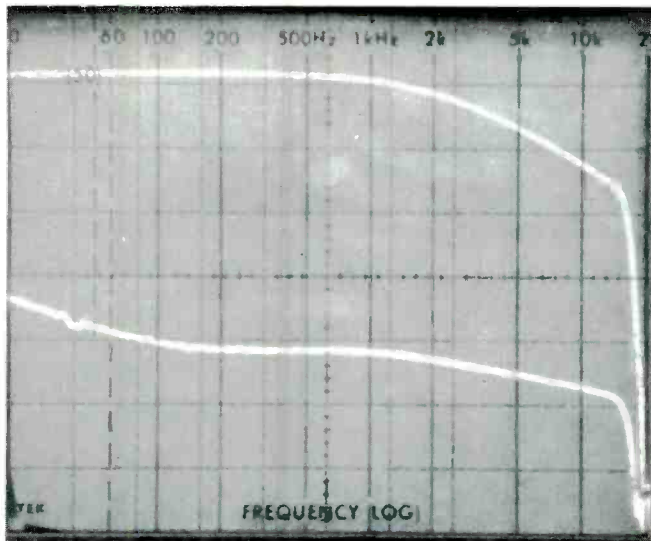

Fig. 5—Stereo separation for the Pioneer TX-9500-II in the wide i.f. setting.

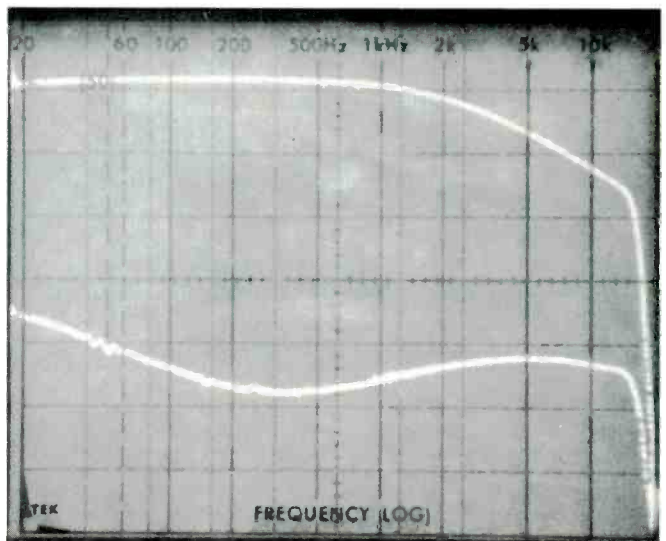

Fig. 6—Stereo separation in the narrow i.f. setting.

70

μ V or 35.3 dBf for the wide mode, slightly better at 30 μ V or 34.7 dBf in the narrow mode).

Differences showed up in stereo separation capabilities between the two modes of operation as well. We have devised a real-time method of plotting separation on our spectrum analyzer which will be used in this and all future test reports and which, we feel, accomplishes more than just a graphic display of separation capabilities. With the tuner set to the "wide" mode, the upper trace of Fig. 5 depicts the desired channel output of the tuner while the lower trace shows output from the opposite channel. The plot extends logarithmically from 20 Hz to 20 kHz. The decreasing output above about 500 Hz clearly shows the de-emphasis characteristic, which is down the requisite 13.6 dB at 10 kHz (each vertical division equals 10 dB in this display), and, in addition, we can clearly see the extremely effective 19 kHz cancellation circuit action as the output takes a steep dip at that undesired frequency. Actual metered measurements showed a maximum separation of nearly 50 dB at mid frequencies, decreasing to 40 dB at 50 Hz, and to 38 dB at 10 kHz.

Spectrum analyzer plots were repeated with the switch set to the narrow position, and results are shown in the scope photo of Fig. 6. The somewhat "degrading" effect of the narrower i.f. bandwidth shows up clearly as a diminution of high-frequency stereo separation which measured 32 dB at 10 kHz. Separation at mid-frequencies was still a superb 45 dB, while at 50 Hz, separation now read 38 dB, a slight decrease over that observed in the "wide" position.

Various rejection capabilities measured in excess of 100 dB (the limits of our test equipment), while capture ratio in the wide position measured a shade under 1.0 dB and increased to 2.0 dB for the narrow setting. AM suppression measured 65 dB as claimed, while sub-carrier rejection was so good as to be buried below the noise threshold. Frequency response was better than claimed, within 0.4 dB of the prescribed de-emphasis curve at 15 kHz in the wide mode, but down 1.0 dB in the narrow mode. Muting threshold was measured at 4.0 μ V (17.2 dBf) or 30 μ V (34.7 dBf), depending upon the setting of the dual-position front-panel muting switch, while stereo threshold or switching occurred at 6.0 μ V (20.8 dBf). We did note that, based upon our measurements, the 440-Hz calibration tone corresponded more

nearly to 100 per cent modulation than to 50 per cent modulation.

As for the AM section, it is a cut above most AM tuners supplied on high fidelity components these days. Sensitivity measured 15 μ V as claimed, while signal-to-noise ratio (for a 1 mV input) reached 56 dB. Distortion, for 30 per cent modulation, was 0.7 per cent, and selectivity measured 32 dB. Other listed specifications were confirmed exactly. Calibration, for both AM and FM, was very precise from one end of the dial to the other, and center-of-channel meter indications corresponded very closely with minimum-distortion tuning points in FM.

Summary—Listening and Use Tests

Fortunately, we now have at least two high-quality FM signals in our New York area, and this gave us an opportunity to compare results using both bandwidth positions of this tuner. Yes, we could certainly detect a difference, with reception noticeably cleaner and crisper (in stereo) when using the wide setting. Sure enough, though, when we cruised through the frequency range from around 97.0 MHz to 100 MHz (where our dial is swarming with signals), we found it necessary to switch to the "narrow" position to avoid adjacent channel interference problems. It was as though this feature had been specifically included for our listening area and situation. Listeners in less crowded areas will, no doubt, favor the wide position for most of their listening.

If you do audition this tuner and find that you can't tell the difference between the two settings, chances are the quality of reception is being limited by the broadcaster rather than by the tuner. In short, while we feel that the "wide" position could have been made just a little less wide so that it could be used by more people more of the time (after all, a THD of 0.04 per cent or 0.05 per cent for all practical purposes would have been "just as good" as the fantastic 0.03 per cent we measured), we *certainly* agree that this is the way a top quality tuner should be designed. It does, indeed, offer the "best of all possible" FM worlds, regardless of your particular area and signal conditions. At its relatively low price, it is bound to prove a favorite with those who take their FM listening seriously.

Leonard Feldman

Enter No. 90 on Reader Service Card

The discovery of the lost chords.

They're missing. The bombardment of brass. Pulsating percussion. Surging crescendos. And strings that caress your innermost senses. The live experience. Lost once the concert ends.

Now, for the first time, you can recapture that live experience with the exciting, new 3BX Expander. Now you can breathe new life into your audio system. Life that adds up to 50% more dynamic range to your records, tapes and FM broadcasts, while dramatically reducing noise.

But your discovery is not just the sounds you'll hear, but the music you'll see. Visual music that you can control. Divided into 3 separate frequency bands, the unique 30 LED display feature allows you to visualize expansion within each frequency range.

Come hear, and see, the exciting new 3BX perform. Discover the lost chords in your music.

Visit the dbxpert at your dealer or write: dbx, Inc., 296 Newton St., Waltham, MA 02154; (617) 899-8090.

dbx

71

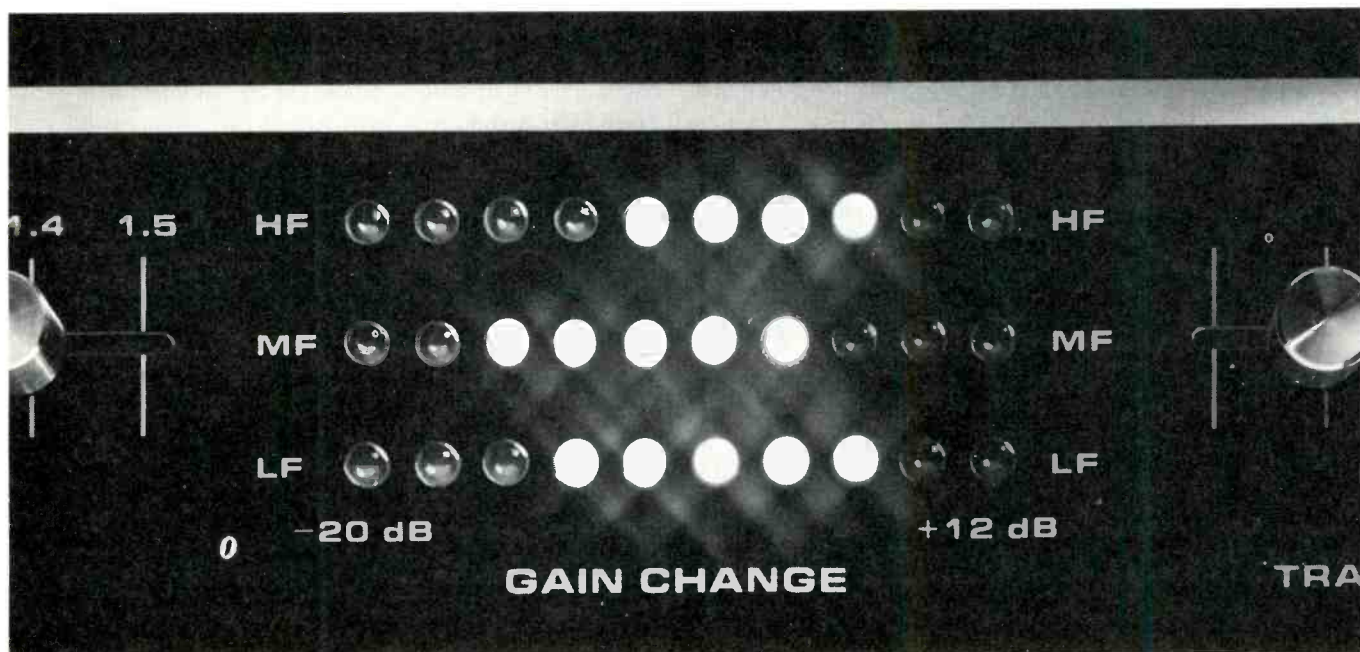

Enter No. 9 on Reader Service Card

DB Systems DB-1 Preamplifier & DB-4 Moving Coil Cartridge Pre-Preamplifier

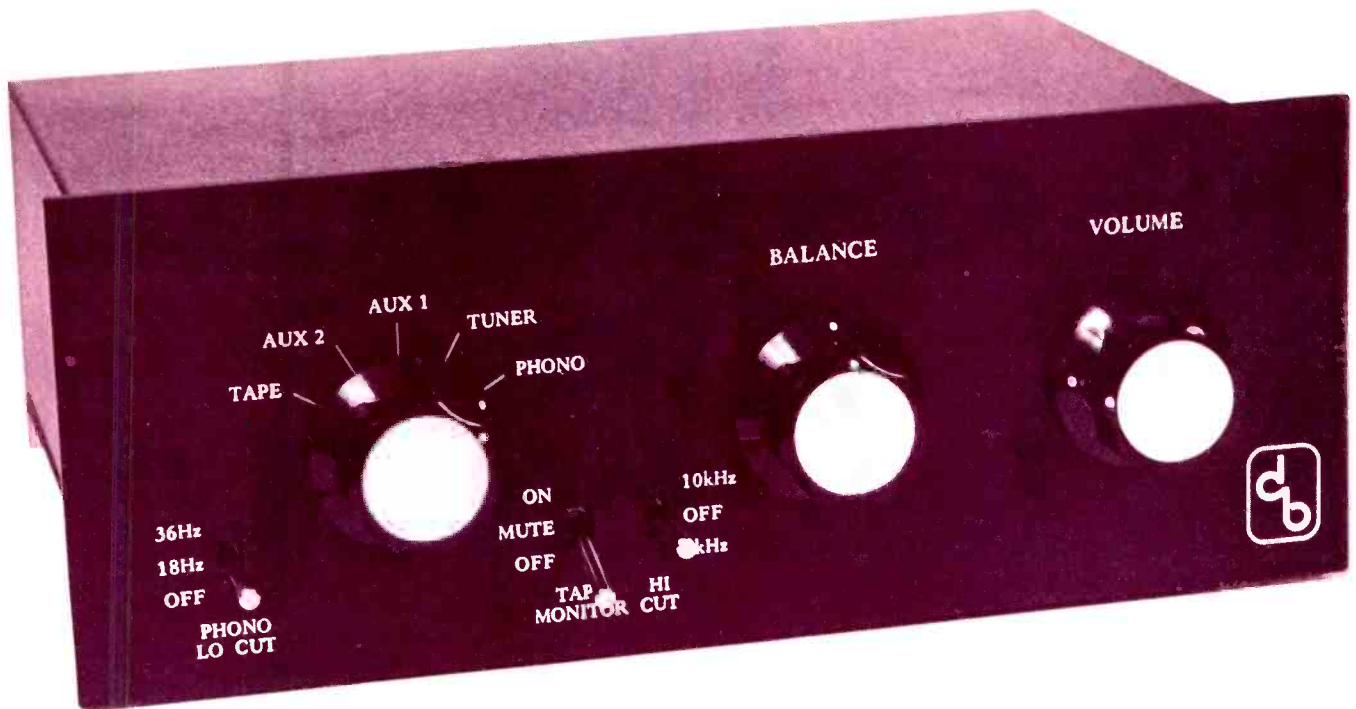

MANUFACTURER'S SPECIFICATIONS

DB-1 Preamplifier

THD: Less than 0.0008 per cent, 20 Hz to 20 kHz, excluding hum and noise.

Noise: Phono, -89 dB, A weighted with 10 mV input; high level, -90 dB, A weighted with 1 volt input.

Frequency Response: Phono, ± 0.25 dB 5 Hz to 20 kHz RIAA extrapolated; high level, +0 -1 dB, 2 Hz to 50 kHz, +0 -0.25, 10 Hz to 20 kHz.

Filters & Positions: Low cut, flat, 18 Hz, 36 Hz, 6 dB/octave (phono only); High cut, flat, 5 kHz, 10 kHz, 6 dB/octave.

Output Impedance: 1000 ohms.

Maximum Output Voltage: 6 volts into 10 kilohms.

Maximum Load for Rated Distortion: 10 kilohms and 3000 pF.

Input Sensitivity (For 1 Volt Output): Phono, 2.0 mV into 50 kilohms and 100 pF; High Level, 120 mV into 50 kilohms.

Phono Overload: 150 mV @ 1 kHz, 1.5 V @ 20 kHz, 16 mV @ 20 Hz.

Dimensions: 8.5 in. (21.6 cm) x 3.2 in. (8.1 cm) x 7 in. (17.8 cm).

Weight: 2.6 lbs. (1.2 kg).

Price: DB-1 preamp, \$397.00; DB-2 power supply, \$78.00; wood cabinet, \$34.95.

DB-4 Moving Coil Cartridge Pre-Preamplifier

THD: Less than 0.0008 per cent 20 Hz to 20 kHz, 1 V output, Medium gain setting.

Noise: -83 dB ref. 1 mV, shorted input, RIAA, A weighted.

Frequency Response: +0, -0.1 dB, 10 Hz to 100 kHz.

Input Impedance: 9 kilohms and 2000 pF.

Output Impedance: 220 ohms.

Maximum Load for Rated Distortion: 10 kilohms and 3000 pF.

Gain/Overload: High gain, 30 dB gain, 73 mV input overload; Medium gain, 24 dB gain, 122 mV input overload; Low gain, 18 dB gain, 130 mV input overload.

Channel Balance: Within 0.2 dB.

Dimensions: 6.2 in. (15.7 cm) x 4.5 in. (11.4 cm) x 2.2 in. (5.6 cm).

Price: \$150.00; power supply, \$78.00. Supply not needed when used with DB-1 preamp.

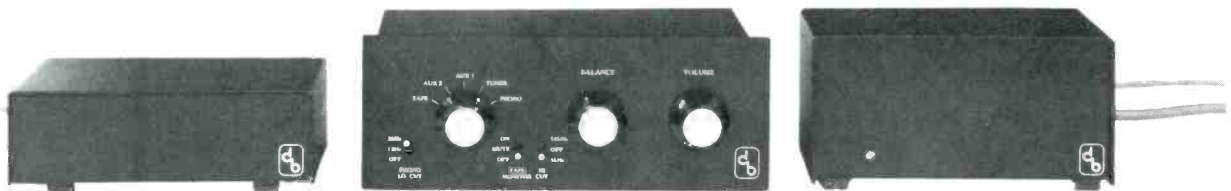

The DB-1 preamp and its companion DB-2 power supply is a fairly new, no frills, basic preamplifier of high quality currently selling for \$475.00. Used in conjunction with the DB-4 pre-preamp, \$150.00, it is capable of processing low level (moving coil) cartridge inputs in addition to the standard moving magnet cartridges.

The pre-preamplifier, if used, preamplifier, and power

supply are separate units. The power supply has a 5-prong DIN connector through which its regulated 33 volts is delivered to the preamp's rear panel power socket. Another 5-prong DIN socket is provided on the rear of the preamp which allows the DB-4 pre-preamp to share power from the same power supply. Since this socket also has high level audio connections, the accessory DB-3 crossover (not tested)

ANNOUNCING...
The all-new
1977
EQUIPMENT
PROFILES

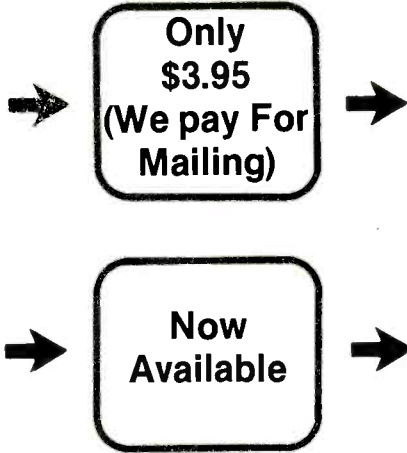

Just Published
by
AUDIO
Magazine

Dear Perfect Sound Lover:

The all-new, 1977 handbook of EQUIPMENT PROFILES has just been published by AUDIO magazine.

It is number 4 in our series of fact-packed handbooks.

With it, you can improve your sound system.

And, as an AUDIO reader you get a special bonus. It is... you can order a copy for \$3.95. (We will pay the mailing and postage costs.)

When you order, you receive a large (8½"x11") illustrated book... packed with equipment profiles, schematics, and including our unique equipment directory.

There are over 50 pages of equipment specifications and nearly 100 pages of test reports. Speakers, amplifiers, tuners... most equipment you would consider buying is listed in this handbook. There are specs and prices for over 2200 audio products.

There are graphs and schematics, in addition to comprehensive measurements. You can find out how a

piece of equipment really performs by studying this handbook.

We believe so strongly that anyone who buys audio equipment can get the best system (at the most economical cost) by using this directory, we even guarantee it.

30-Day Trial

Use this fact-packed handbook for 30 days. If after the 30-day trial you are not completely satisfied—for any reason—just return the book to me. (In good condition, of course.) I will send you a full refund, no questions asked.

As you can see, you take no chance by ordering. (you take a chance by not ordering. The supply is limited.) Just fill out the form below and send it—with your \$3.95 check or money order—to: AUDIO, 401 N. Broad St. Philadelphia, PA 19108.

If using credit cards, complete card information on form

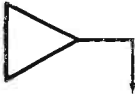

Jean Davis

73

CLIP AND MAIL

Send to: **AUDIO**
 North American Building
 401 N. Broad St., Philadelphia, PA 19108

Send me the 1977 **EQUIPMENT PROFILES** (1977 edition, published by **AUDIO** magazine). My check or money order for \$3.95 is enclosed, or I have completed credit card information.

Name _____

Address _____

City/State _____ Zip _____

Charge to: American Express
 Credit Card No. _____ Diners Club
 Master Charge

Card expires _____ Bank No. _____

Signature _____

GUARANTEE:
 I understand I can use this handbook for 30 days and receive a full refund if I am not completely satisfied.

FOR OFFICE USE



North American Building, 401 North Broad Street, Philadelphia, PA 19108



will have the power and audio connections made simultaneously, eliminating the need for an extra pair of audio cables.

Construction of the DB-2 power supply and DB-4 pre-pre-amp each consists of a simple two-piece metal box into which the respective circuit boards are mounted and connected. The DB-1 preamplifier is a more complicated structure which is composed of one PC board for all electronics, another for the rear panel to which the various sockets are soldered, a bottom cover, a black anodized aluminum front panel, and, finally, the one-piece top and sides cover. The rear panel P.C. board and the bottom cover are securely fastened with several sheet metal screws. The front panel is bolted to the three rotary controls and attached to the case with a bead of black RTV compound. Although there is quite a bit of electronic hardware in each package, the circuit board layouts are sufficiently well planned to allow dense component placement and compact packaging, as the dimensions indicate.

There can be no doubt that the simple packaging and lack of frills on these DB Systems units have helped make it possible to price them modestly. There are other components in this price range that, to this reviewer, have more attractive exterior designs and also sport more features, such as tone controls, multiple outlets, and headphone drivers, however, the electronics of the other units are all too often of low grade and cheaply mass produced. Definitely not so in the DB units we tested.

Looking inside the DB-1 preamp, one finds a clear, solder-plated, epoxy-glass PC board filled with components of unusually high quality. For example, all the electrolytic capacitors in the audio chain are the superior tantalum type. All feedback components are 1 per cent types, the resistors being high stability metal film types, the capacitors propylene.

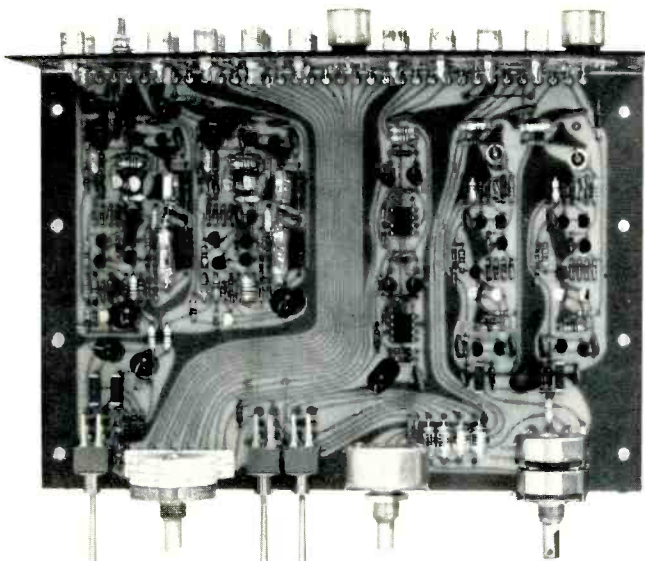

It is apparent to those engaged in high level audio design that great attention was devoted to the choice of *passive* components and their effect on the sonic and electronic performance of the system.

For those who can enjoy the fine points of electronic design, the schematic diagrams (Fig. 1) of the circuits used in DB's products are gold-mines of original thinking and solid engineering. A look at the schematic for the phono preamp shows DB's low level amplifier design. Although component and feedback values are different, both the DB-1 and the DB-4 utilize similar circuits. The input stage is bipolar-FET

Table 1

Volume Control Tracking Output Noise, 10K Source

ATTENUATION	ERROR	20-20kHz	400-20kHz
0 dB	0		
-5	-0.3	13.5	12.9
		at 0 dB	at 0 dB
-10	-0.5	24.5	24.0
-15	-1.2		
-20	-1.2	16.8	16.3
-25	-0.8		
-30	-0.8	11.5	10.8
-35	-1.0		
-40	-1.1	9.25	8.69
-45	-1.7		
-50	-1.3	8.69	7.77
-55	+0.8		
-60	-5.0	8.32	7.58

Table 1—Volume control tracking and output noise vs. volume control attenuation.

cascode (Q_1 & Q_2), which offers good low noise possibilities and very good output-to-input rejection—an important point often overlooked when driving phono inputs from high impedance type cartridges. Following is a Darlington common-emitter amplifier (Q_3 & Q_4), set up to achieve a stable operating point and to provide very high load impedance to the first stage for high gain. This second stage drives the common base amplifier Q_5 , which is loaded with the current source Q_7 and emitter follower Q_8 . Q_{10} is used as an integrator in the bias network and is not in the signal path. These two or three stages of voltage amplification provide a low frequency, open loop gain between 10 and 20 million, or 140 to 146 dB! This means that before compensation, there is 105 dB or more negative feedback available at mid-band frequencies and approximately 85 at low frequencies with RIAA equalization.

A discussion with Walt Morrey, partner at DB Systems, revealed that the compensation applied, in the form of three RC stops, tends to follow the RIAA equalization somewhat, thereby giving a fairly constant distortion reading over the audible range.

Although DB's five-year warranty, like others, does not cover electrical abuse, the circuit is definitely well protected from any likely accidental misuse. All inputs have diode clamps to protect against input transistor base-emitter avalanche, which can quickly and often subtly degrade a transistor's current gain and noise characteristics. All outputs also appear to be protected from abnormally low impedance loads by resistive padding. Another benefit of this resistive padding is that external loads are sufficiently isolated

THE OPTIMUM.



The first cassette deck that can find selections automatically.

Now there's a cassette deck that plays it your way.

The Optonica RT-3535. It's the world's only cassette deck with APLD, the Automatic Program Locating Device that lets you select the songs you want to hear automatically, instead of manually searching for each cut.

But that's not all.

This Optonica cassette deck also has the kind of specifications that will impress the most dedicated audiophile.

The high quality tape transport features a 2-motor drive system, and a precision polished capstan shaft. Which results in a wow and flutter of

an amazingly low 0.04%. Compare that figure with other top of the line cassette decks and you'll see why Optonica can honestly call the RT-3535, The Optimum.

A built-in Dolby® System means you won't have to worry about hiss and noise ruining the performance of your tapes. And the ultra-hard Permalloy head means you'll have greatly improved frequency response, especially in the high range.

We invite you to test the Optimum cassette deck at one of the select audio dealers now carrying the full line of Optonica high fidelity compo-

nents. We'd also like to give you a free copy of our complete catalog. For the name and address of your nearest showroom, write Optonica, Dept. C5B, 10 Keystone Place, Paramus, New Jersey 07652.

From our cassette deck that finds selections automatically to our unique turntable built on granite, find out why throughout Europe and Japan, Optonica is one of the fastest selling lines of stereo components on the market today.

OPTONICA THE OPTIMUM.

*Dolby® and the "Double-D" symbol are trademarks of Dolby Laboratories Inc.

Enter No. 45 on Reader Service Card

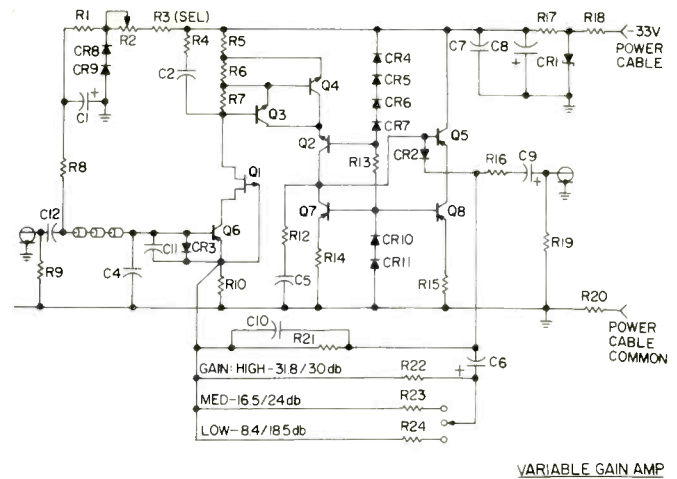
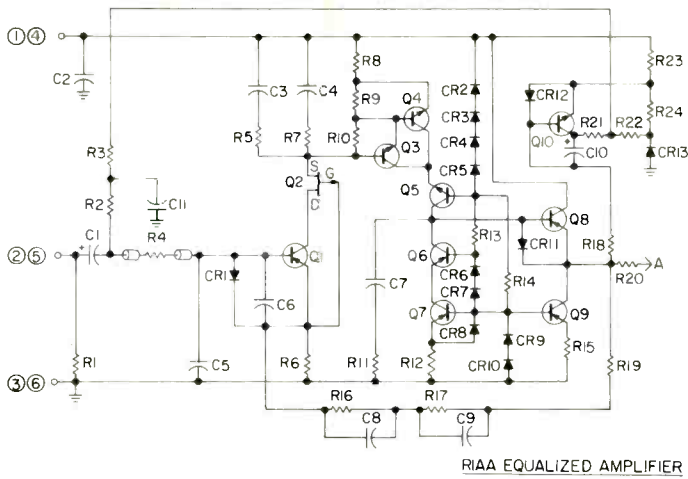
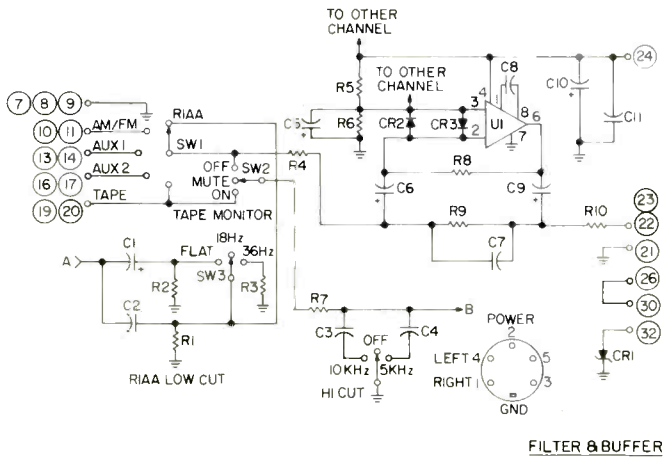

Fig. 1—Schematic diagrams of DB Systems phono section, filter and buffer, amplifier stage, power supply, and variable gain amp.



from the preamp's electronics to insure that the preamp's distortion will not noticeably rise with non-linear loads.

A not uncommon problem with many preamplifiers arises when operating in the *Phono* mode, with a tape machine connected to the *tape output* jacks. Low impedance tape inputs, or complicated nonlinear loads on this output caused by a tape machine's electronics being turned off, can seriously degrade the performance of the phono preamp stage. DB has chosen to eliminate this problem with an inverting buffer using a high slew rate operational amplifier fed back to unity gain.

Unique to the DB-1 and DB-4 is the amount of r.f. suppression provided on low level inputs. Both are extensively filtered with ferrite beads and disc ceramic bypass capacitors. DB Systems claims some 50-dB rejection at citizen band frequencies (27 mHz) in the DB-4 pre-preamp. Those living near large r.f. fields may find these products ease or eliminate their r.f. interference problems.

Measurements

As one would expect from a preamplification system design of this sort, the distortion products in the DB-4 and the DB-1 are vanishingly low at any output voltage below clipping. They are so low, in fact, that normal distortion measurements are impossible and the residuals were found to be below those generated in the finest commercially available test oscillators. DB Systems has specially constructed single frequency oscillators and filter sets, which in conjunction with a finely tuned spectrum analyzer, are used to measure distortion at three frequencies in every single unit produced.

It is this reviewer's opinion that such small quantities of THD and IM are not directly related to the sonic performance of either pre-amplifiers, preamplifiers, or power amplifiers, and therefore no attempt was made to verify DB's claims. Let it be said, however, that both THD or IM distortion under normal conditions is below, and perhaps considerably below, 0.001 per cent for both the DB-1 and the DB-4. The manufacturer's specifications do show distortion figures, provided by DB Systems, to satisfy the reader's curiosity.

Frequency responses are shown in Fig. 2. The upper curve here shows the RIAA equalization error of the phono section of the DB-1 as measured with a non-inductive 50-ohm signal

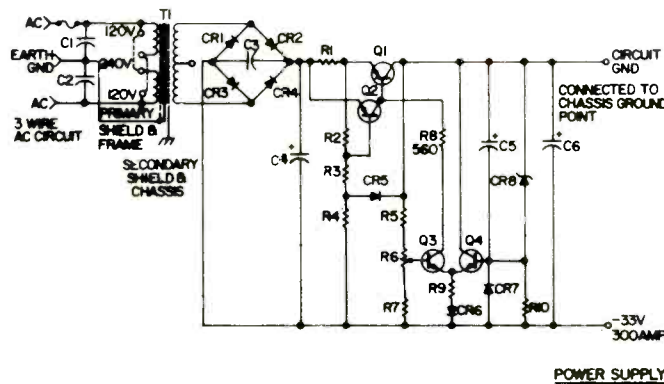
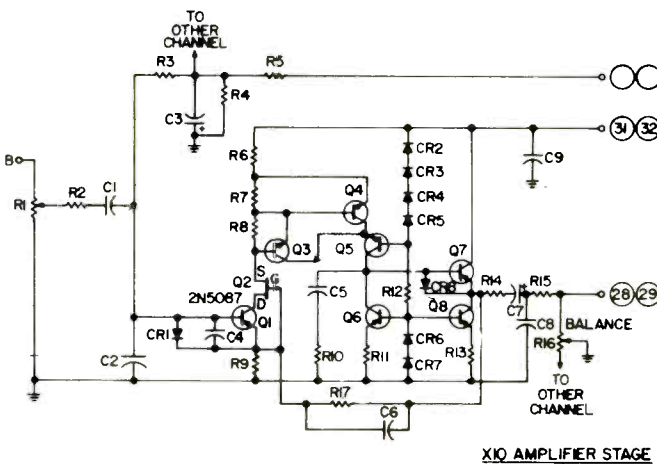

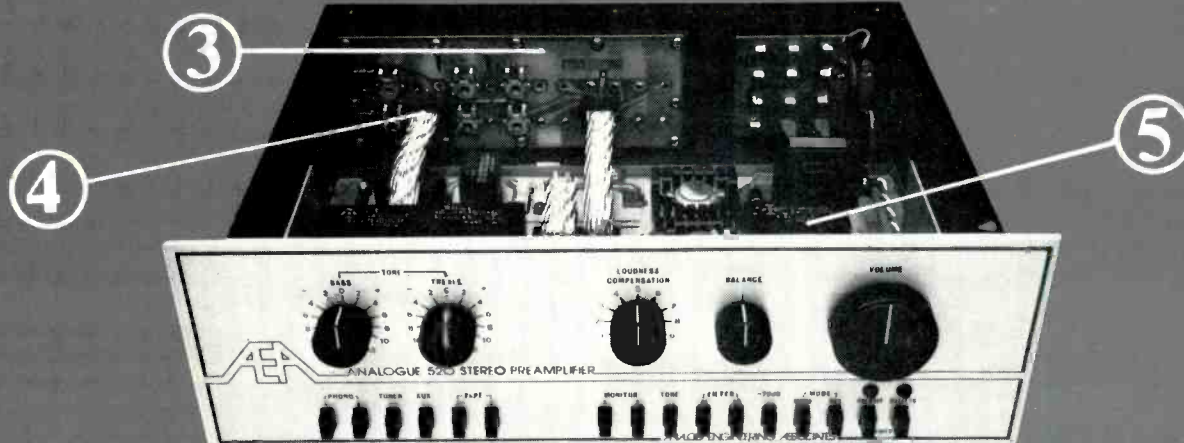

If you're buying components, and you want performance,

- ① All original circuit design. Pure Class A/Multi-path loop with lowest S/N ever 84 dB unweighted (92 dB A weighted).
- ② 95% of all circuit components are hermetically encapsulated in 6 Epoxy plug-in modules for the ultimate in facility of service and stabilized component protection.
- ③ Integral Back-plane interface system allows true integral jack to board wiring for constant impedance

- and consequent elimination of losses.
- ④ NASA and Mil. Spec. throughout — with all highest grade parts available/24k. gold-plated cable connectors. 36 pin/24k. gold-plated phono jacks/silver plated and 24k. gold-plated mode switch contacts.
- ⑤ Continuously variable loudness compensator uses precise *Summation Filter* design for infinite combination of room/amp/speakers.

"on the cutting edge of technology — where nothing matters but the music"



ANALOG ENGINEERING ASSOCIATES

520 PARK AVENUE SOUTH, WINTER PARK, FLORIDA U.S.A. 32789

For more information on A.E.A. and their products, write or call 305-628-1665.

Copyright and all rights reserved Analog Engineering Associates, Inc., 1977

Enter No. 3 on Reader Service Card

source. From 20 Hz to 10 kHz, it can be seen that the error is less than 0.1 dB — very good equalization here. Above 10 kHz, the output shows a slowly rising response because of the 50-kHz break in the equalization caused by R19. The oscilloscope photograph in Fig. 3 shows a pre-equalized 20-kHz square wave test of the preamp. Overshoot on the output is also due to the 50 kHz break in preamp equal-

ization network due to R19 (see Fig. 1). The bottom trace in Fig. 3 is the unequalized generator output waveform, and the top trace is the same waveform with inverse RIAA equalization, as applied to the preamp input. Notice the high amplitudes applied to and processed by the phono stage. Figure 4 shows perfect reproduction of tone-bursts of triangle waves near 20 kHz, a feat which requires large high frequen-

TABLE 2

DB-1	GAIN	20-20K	400-20K
L, High Level	8.71, 18.8 dB		See Table 3
R, High Level	8.71, 18.8 dB		
L, Phono	59.2, 35.44 dB	487 nV* -86.4 dB	223 nV* -93 dB
R, Phono	60.3, 35.61 dB	487 nV* -86.4 dB	225 nV* -93 dB

*Shorted Inputs, referred to 10mV for decibels.

DB-4	GAIN	20-20K	400-20K
L Low	8.38, 18.47 dB		
Med	16.62, 24.21	127 nV, -77.9 dB*	125 nV -78.1 dB
High	31.87, 30.07		

R Low	GAIN	20-20K	400-20K
Med	16.53, 24.37	135 nV -77.4*	129 nV -77.8*
High	31.68, 30.00		

*Shorted inputs, referred to 1mV for decibels

Table 2—Gain vs. phono preamp noise and pre-preamp noise.

Fig. 2—RIAA equalization error, frequency response of the output amplifier, and response of the DB-4 pre-preamp. (Note break in scale at 10 Hz/100 kHz for the bottom curve.)

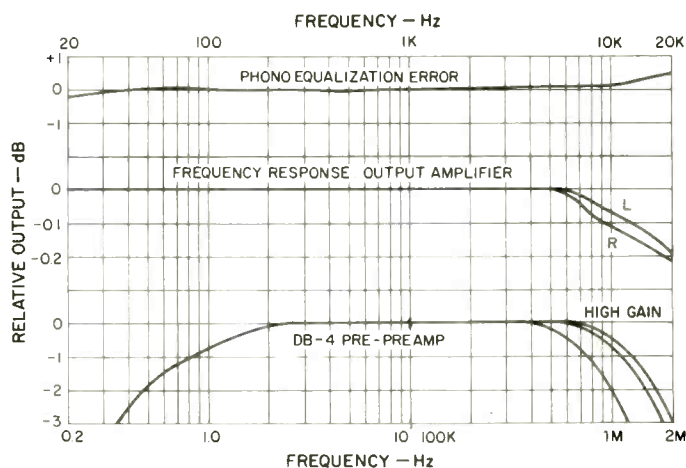



look into the Analogue 520 with ANA-MOD engineering exclusives.

- ⑥ All interconnections, all controls, all circuitry, all input/output jacks are mounted directly on printed circuit Blue-Boards.
- ⑦ Aerospace parts throughout, all resistors are 1%/capacitors, mica, metalized polycarbonate or solid tantalum for unvarying specs.
- ⑧ Integrated Equalizer tone control circuit with psychoacoustically computed slopes and non-ringing hi-cut filter.

- **⑨ Low transient error rating/below 0.001% under actual dynamic conditions (while using music as a test signal) TTE Method using proprietary A.E.A. Inc. Transient Error Detection System in Q.C. and circuit design.
- ⑩ 1000% overratec. ultra-regulated power supply with high thermal stability.

**Tech paper on total Transient Error detection techniques is available on request from the factory.

"on the cutting edge of technology—where nothing matters but the music"



ANALOG ENGINEERING ASSOCIATES

520 PARK AVENUE SOUTH, WINTER PARK, FLORIDA U.S.A. 32789

For more information on A.E.A. and their products, write or call 305-628-1665.

Copyright and all rights reserved Analog Engineering Associates, Inc. 1977

Enter No. 3 on Reader Service Card

cy level acceptance and very accurate RIAA equalization in the mid and high frequency range.

Figure 5 shows square wave response in the moving coil cartridge pre-preamplifier at 20 Hz and 20 kHz, medium gain setting. The bottom curve in Fig. 2 shows, on a greatly expanded frequency scale, the measured response for the DB-4 at the three gain settings.

The high level/output amplifier has similarly wide bandwidth, being down 1 dB around 2 Hz and 50 kHz as DB claims. The middle curve in Fig. 2 shows the 20 Hz to 20 kHz response on a 0.1 dB per division scale.

One possible minor problem with the DB system is the relatively low gain in the DB-1 (see Table 2). Moderate to low output moving magnet cartridges, when used with the DB's 35 + dB gain, may not provide a sufficiently high level on the tape outputs to drive some tape decks to 0 dB, so possible users of the DB-1 should make sure that their systems have enough gain to record properly. Gain in the output amplifier (near 19 dB) is a good choice, as were the settings available in the DB-4. Gains were quite well matched from channel to channel in each stage due to the type of circuitry employed and the precision feedback components.

Fig. 3—Response of the DB-1 to pre-equalized square waves. Top trace is input (1 V/div.), and lower trace is preamp output (5 V/div.) Time scale is 10 μ S/div.

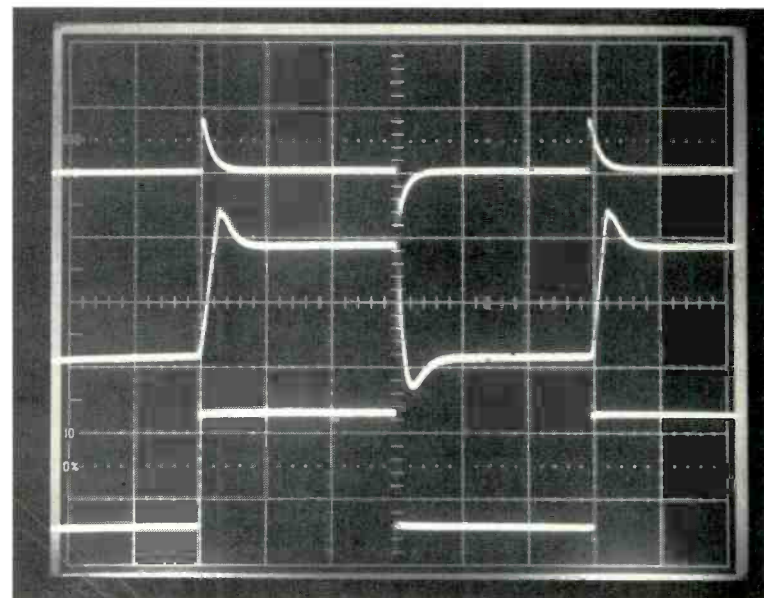

The noise in the DB-1 phono preamp was sufficiently low to provide good signal-to-noise ratios even with low output cartridges, as shown in Table 2. Noise performance of the output amplifier was also quite low—with the volume control off the stops, it is fairly well dominated by thermal noise in the 10k resistive source used and the 100k volume pot.

The DB-4 did not do as well in the noise department. Equivalent input noise voltage for a shorted input was over 120 nanovolts in the 400 Hz to 20 kHz region. Those using very low output moving coil cartridges, such as the Ortofon SL-15E MK II, may find it objectionable on recordings with a wide dynamic range. Although more difficult to achieve, 75 nV would be a better number here.

Listening Results

The DB-1 was first driven with a standard pre-preamp which made preamp A-B comparisons fairly easy to implement. Then, a number of high quality preamps, of both tube and transistor design, were alternately compared to the DB with several experienced listeners. Overall sound quality was reported to be rather good, though the DB-1 does have a sonic thumbprint as does every other piece of electronics yet encountered by this reviewer.

Some initial criticism centered on the preamp's bass response, which appeared to be weak in comparison with some other units. In subsequent tests using a network which permitted straight wire vs. pre-equalized phono preamp comparisons, the DB seemed to reproduce low frequency material quite accurately, yielding both solid and deep reproduction upon demand! So, the other preamps were compared on the same basis with special attention to their bass response. We then realized that two of the reference preamps appeared to slightly reinforce bass, perhaps with low order harmonic distortion! It should be noted here that RIAA equalization was quite accurate in each unit, so the sonic differences were felt to be circuit qualities rather than frequency response differences.)

Fig. 4—Response of the DB-1 to tone-bursts of triangle waves near 20 kHz. Lower trace is input, and top trace is output at Tape (2 V/div.). Time scale for both is 50 μ S/div.

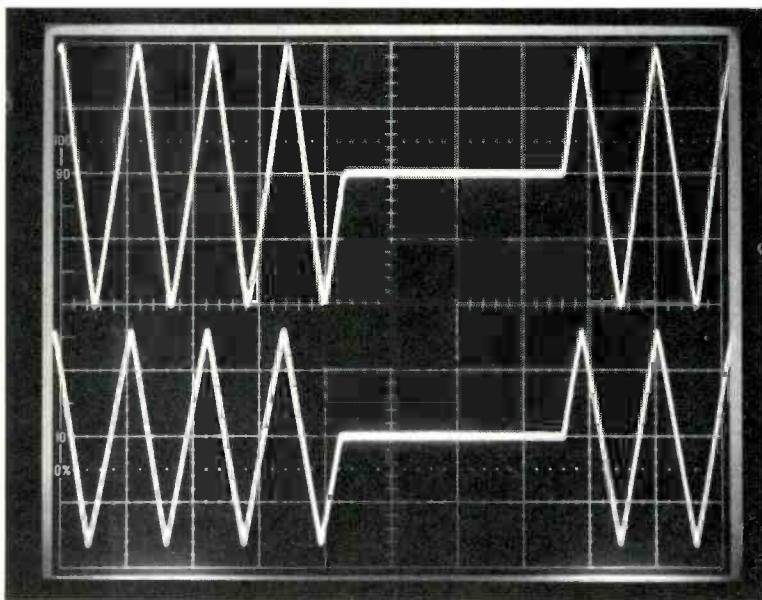

TABLE 3

	IN	OUT
20 Hz	17.7 mV	10V
100	37.9	10.4V
1k	172	10.4V
5k	438	10.5V
10k	842	10.4V
20k	1.56V	10.3V

Table 3—Phono preamp overload levels.

Midrange and high frequency material seemed to be reproduced in the DB-1 with some, but comparatively little edge and grit, being at least as good as the other excellent transistor circuits. However, the DB-1 was not judged to have quite the spaciousness and "freedom" of our best reference preamps, and the most complicated passages lost some of the nuances so important to accurate three-dimensional reproduction.

The DB-4, not surprisingly, had a sonic character much like the DB-1. Bass response solid and well defined, midrange and high end fairly smooth and extended, but accompanied by a slight loss of definition and space.

Readers should be reminded that criticism of high level audio electronics often revolves around very fine points of difference, and the DB Systems units have, in turn, their advantages over their competition, not the least of which is that these products offer long term stability and consistency from unit to unit thanks to the design techniques employed. Further, the DB-1 and DB-4 sound good in comparison with units at any price, but at \$475.00 and \$150.00, they probably offer the best performance per dollar. *George Pontis*

Enter No. 91 on Reader Service Card

Fig. 5—Response of DB-4 pre-preamp to 20-Hz and 20-kHz square waves, medium gain setting, 50 ohm source. Inputs (5 mV/div.) are superimposed over outputs (50 mV/div.). Time scales: top traces, 10 μ S/div.; bottom traces, 10 mS/div.

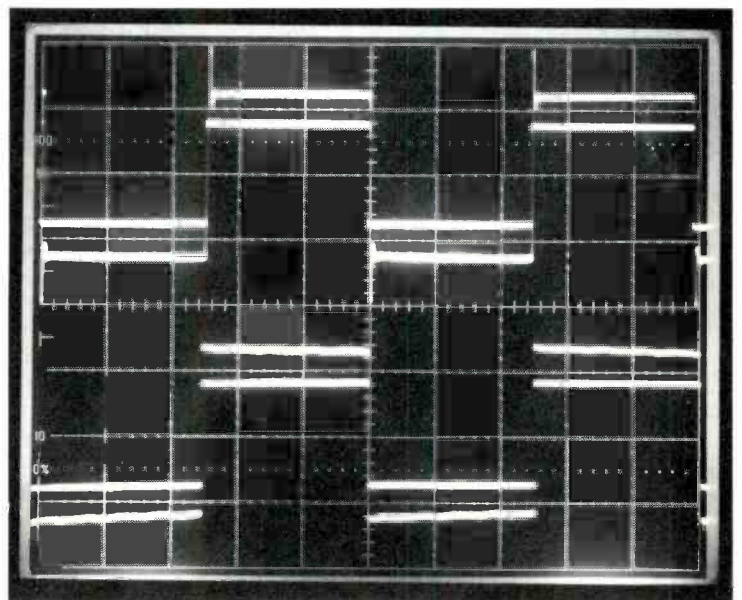

Technics Model RS-1500US Stereo Open-Reel Tape Recorder

MANUFACTURER'S SPECIFICATIONS

Frequency Response: 30 Hz to 30 kHz @ 15 ips, 30 Hz to 25 kHz @ 7 ½ ips.

Harmonic Distortion: 0.8 per cent.

S/N Ratio: 60 dB.

Separation: 50 dB.

Input Sensitivity: Mike, 0.25 mV; Line, 60 mV at 150 kilohms.

Output Level: Line, 420 mV; head-phone, 60 mV @ 8 ohms.

Wow and Flutter: 0.018 per cent W rms at 15 ips; 0.03 per cent W rms at 7 ½ ips.

Speed: Accuracy ±0.1 per cent; fluctuation, 0.05 per cent max.

Fast Forward & Rewind: 150 seconds for 2500 feet.

Dimensions: 18 in. (45.7 cm) W x 17 ½ in. (44.5 cm) H x 10 1/8 in. (25.7 cm) D.

Weight: 51 lbs. (23.1 kg).

Price: \$1500.00.

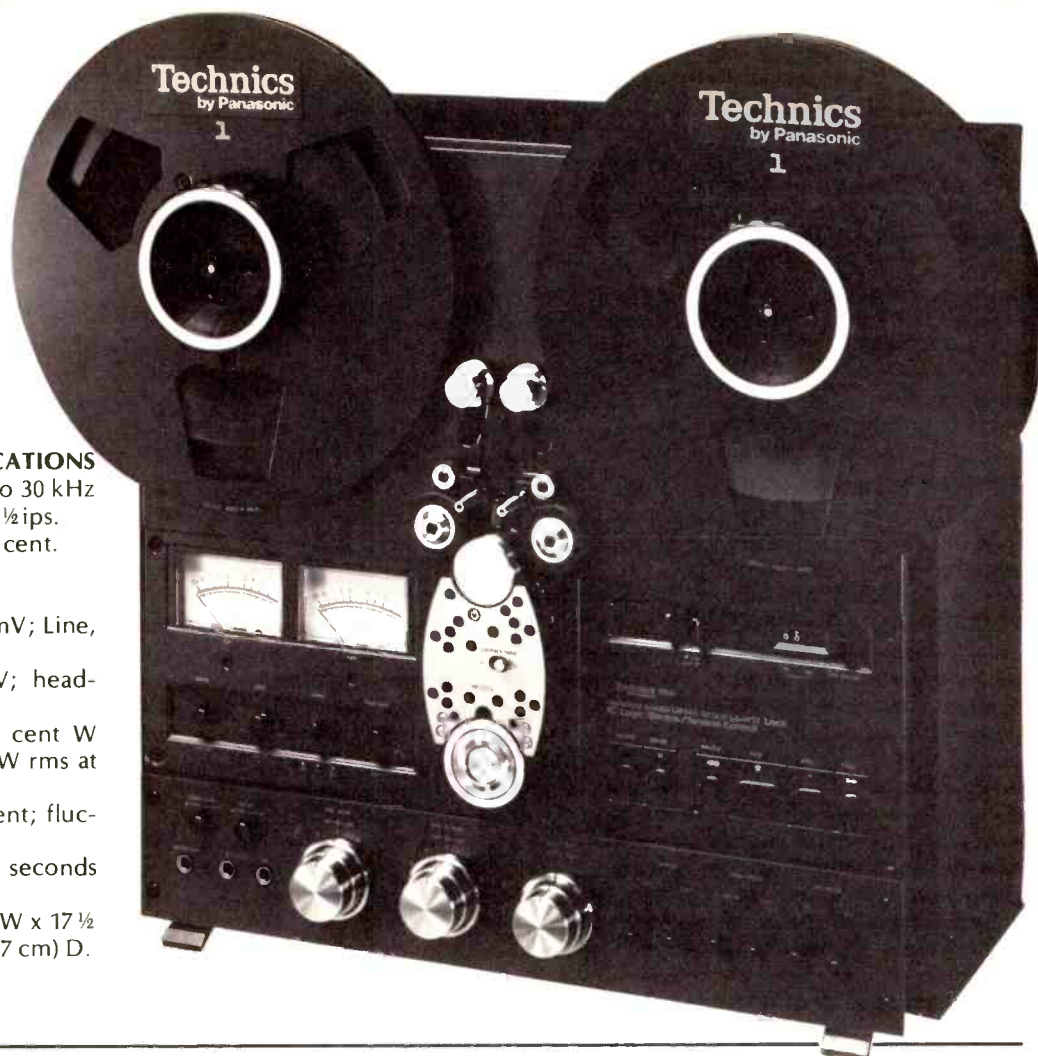

80

The Technics RS-1500US open-reel tape deck provides features and a level of performance that should be of interest to serious audiophiles and budding professionals. The front panel of the deck, which can be operated either vertically or horizontally, is dark brown with gold lettering. The unit can handle up to 10 ½-inch reels and operates at 3 ¾, 7 ½ and 15 ips. At the top of the closed-loop drive system are the two air-damped tension rollers. Immediately below are the tape-position markers, and then two tape guides. Of particular interest is the single, large-diameter, 1.3 inch (33 mm), capstan with pinch rollers on each side. This direct-drive capstan rotates at a very low rate, just 3.6 revolutions per second for 15 ips tape speed. The capstan motor and its speed-dependent frequency generator are part of a phase-locked servo loop. The basic time/speed reference is a quartz crystal operating at about 4 MHz, which is divided down for the capstan speed reference. The phase locking provides tight, responsive control, and the crystal ensures accurate speed. With the tape being metered in and out of the head assembly by the single capstan, there is substantially complete isolation from external tape motion effects. The tape first passes over the ¼-track playback head and then the ½-track erase head. The turn-around idler at the bottom incorporates helpful editing marks and an inner movable reference to facilitate moving the tape from the center of either playback head exactly to the nearest tape-position marker. After the idler, the tape passes the ½-track record and playback heads before being fed out by the capstan. A switch on the face of the head assembly selects ¼- or ½-track playback. The open construction permits very easy cleaning and demagnetization when needed. To the right is

the cue control which can be used for editing or monitoring during high-speed winding, and the real-time minute-second counter, which is scaled for 15 ips.

Below are the tape-motion switches, featuring a light touch, and LED indicators for *Play*, *Record* and *Pause*. The IC logic control permits switching between any desired functions with the exception that the unit will not go into *Record* from *FFWD* or *RWD* unless *Record* and *Play* are held down as the tape comes to a stop. *Pause* will stop the tape in *Play*, but sensibly its status light will not go on unless the pause is made in *Record*. In that case, recording will resume simply by pushing *Play*. Flying-start recording is easily accomplished by holding in *Play* and pushing *Record*. Below the good-sized VU meters on the left are the power switch, the pitch control which is pulled out to operate, the speed selector, and the timer-start switch. In the bottommost section to the left is a meter scale to select either ±3 (normal) or +6 VU for the maximum reading. The meters have the +6 VU scale in smaller print below the regular markings. Just to the right is the mike attenuator switch which can insert a very useful 20 dB reduction of the output from high-level mikes. The phone jack mike inputs are below next to the head-phone jack, which has its level controlled by the output pot.

From left to right are the mike, line input and line output dual-section pots which are friction clutched to permit channel level adjustments individually or simultaneously as desired, a worthwhile feature. The mike and line inputs, which can be mixed, have helpful settable marker rings. The output level control has a reference marker dot for a zero VU indication for a tape flux density of .185 n Wb/m (nanoWebers per meter). Lever switches to the right provide

source or tape monitor selection for each channel, three settings each of record equalizations and bias, and record mode preset for each channel.

End pieces attached to the metal frame are made of particle board and the back is hardboard. Line input and output connections are made with phono jacks, all nicely paralleled. Also on the back are an a.c. convenience outlet and sockets for a remote control and for 24 V d.c. power, permitting operation from storage batteries, which could be very handy at a remote location. A lock plate prevents switching between power modes accidentally. Removal of the back cover revealed the large-diameter construction of the low-speed direct-drive capstan motor. Circuit cards had components neatly identified, and board soldering was excellent. Access to adjustments appeared to be somewhat difficult, but further disassembly was not attempted to verify this assessment.

Performance

Playback responses at both 7½ and 15 ips were within 1.5 dB with slightly greater deviation at the lowest frequencies. The meter indications to the specified 185 nWb/m flux level were within 0.2 VU for both channels with the output pots set to the marker dot, within possible errors in the test tape itself. A pink-noise source and a third-octave real-time analyzer were used to check the machine's basic performance with a number of tapes. While observing the playback, the EQ (equalization) and bias switches were operated to find the best combination for all three tape speeds. Record/playback responses were excellent for all tapes tried, and Scotch 206, TDK Audua, Memorex Quantum, Ampex 456 Grand Master, and Maxell UD were used for more detailed testing. At 15 ips, the response was within 3 dB from 28 Hz to 45 kHz or wider for both Scotch 206 and Memorex Quantum at levels up to 0 VU! Response with the Scotch 206 at +10 VU extended from 30 Hz to 24 kHz, a good demonstration of the excellent headroom (Fig. 1). Responses were plotted with the Scotch tape with the three EQ settings and with the Memorex tape with the three bias positions. Responses were also taken at 7½ and 3¾ ips with the Scotch 206 tape (Figs. 2 & 3). At 0 VU, results were 18 Hz to 17 kHz and 16 Hz to 9 kHz, respectively. At -20 VU, the high-frequency end shifted out notably to 35 kHz for 7½ and to 19 kHz for 3¾ ips.

Measurements of the third harmonic distortion generated in the record/playback process used a 1-kHz signal with a record level from -10 to +10 VU for 15 and 7½ ips with Scotch 206, TDK Audua and Maxell UD (Fig. 5). At 15 ips, the distortion was 0.18 per cent or less at 0 VU, and 0.8 per cent (the specification limit) or less at +6 VU. The distortion level was less than 2.2 per cent at +10 VU, and was down to 0.025 per cent or less at -8 VU. At 7½ and 3¾ ips the distortion figures were, respectively, 1.4 and 2.8 times the 15 ips results at most record levels. The 3¾ ips data was obtained for Scotch 206 only. Distortion was also measured with test frequencies from 20 Hz to 15 kHz at record levels of 0 and -10 VU. As the distortion levels were too low at -10 VU to obtain valid data at all frequencies and test speeds, the data reported here is from 0-VU tests only. Because of the unit's very wide frequency response, it was possible to measure third harmonics with test frequencies as high as 15 kHz for 15 and 7½ ips and 12 kHz for 3¾ ips (See Fig. 6). In all of the distortion tests made, there was very little evidence of other harmonics in the output.

The A-weighted signal-to-noise ratio for two tapes and 7½ and 15 ips ranged from 63.2 to 66.4 dBA with the manufacturer's specified 185 nWb/m +6 reference. Even at 3¾ ips the figure obtained with Scotch 206 was 2.7 dBA above

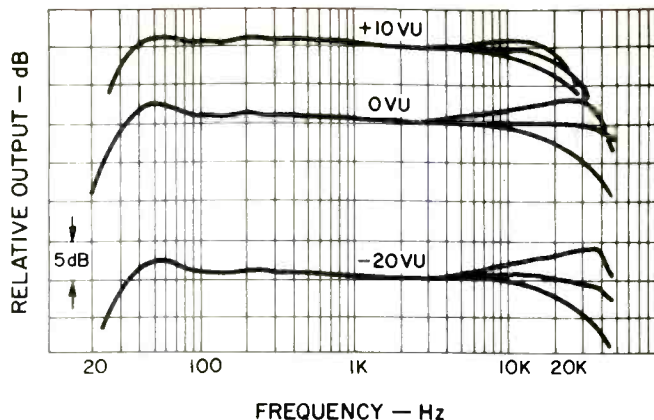

Fig. 1—Record/playback response @ 15 ips with minimum bias and three equalization settings.

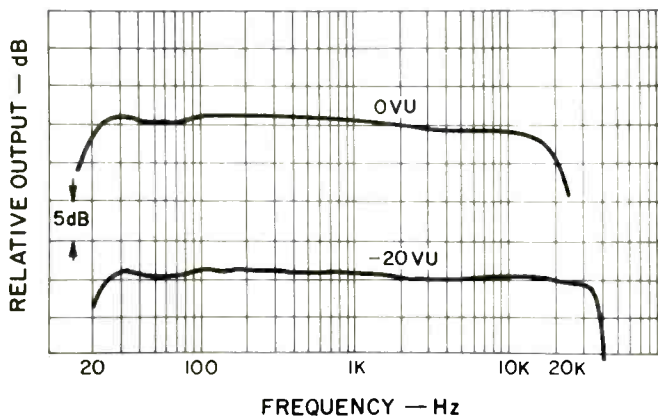

Fig. 2—Record/playback response @ 7½ ips with minimum bias and minimum equalization boost.

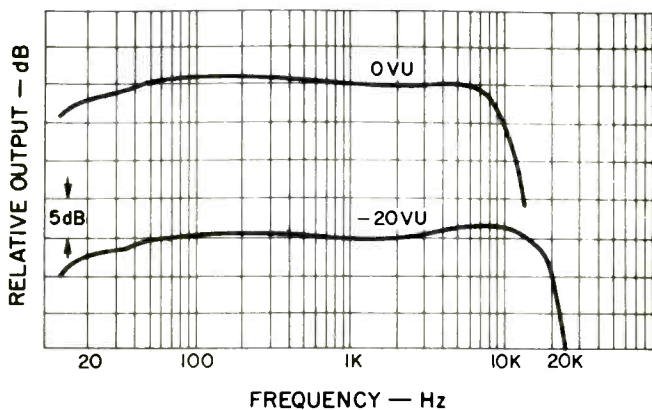

Fig. 3—Record/playback response @ 3¾ ips with minimum bias and medium equalization boost.



the specified 60 dBA. A two per cent distortion level seems proper for the VU meters used, which would provide ratios of 66.8 to 70.0 dBA for 15 and 7 ½ ips, and 62.0 dBA for 3 ¾ ips. Separation between tracks was at least 58 dB with a +6 VU test signal, easily better than the specified 50 dB. Erasure of the same signal was 63 to 67 dB down, depending on tape speed. Input sensitivities were 0.23 mV for mike and 59 mV for line, both slightly better than the specifications.

Playback of 0 VU record was exactly to spec on the right channel, 0.8 dB low on the left channel. Maximum output levels were 690 mV (L) and 735 mV (R) for the same record level. The headphone drive across 8 ohms was 67 mV, greater than specified. The meter response to a 300-millisecond burst was to VU standards, and the frequency response was down 3 dB at 27 Hz and 56 kHz. Meter scale readings were within 0.2 dB at all levels, and tracking of the channel pots was excellent.

To get a good collection of data on various speed characteristics of this excellent deck, a very stable 3160 Hz tone was recorded the length of reels of Scotch 206 and Ampex 456. The reels were then flipped and played back in opposite direction to maximize any possible errors caused by varying tape tension. The meter terminals of the flutter and drift meter were fed to a calibrated strip-chart recorder. At 15 ips the flutter was nominally 0.025 per cent DIN weighted peak throughout the entire tape run, with values as low as 0.005 per cent and occasional maximums of 0.04 per cent. At 7 ½ ips, typical figures were 0.04 per cent Wtd peak, with lows of 0.01 per cent and occasional maximums around 0.05 per cent. The manufacturer's figures of 0.018 per cent Wrms for 15 ips and 0.03 per cent Wrms for 7 ½ appear to be completely justified. Two other open-reel machines were measured for flutter at 7 ½ ips for comparison. One had demonstrated superior low-flutter performance in the past, but it did not

The Measurement of Tape Recorder Distortion

A plot of percentage distortion vs. output level for a typical amplifier can be flat over a considerable range with perhaps some rise at the lowest levels, and at maximum output the distortion figures increase sharply. Many plots of tape recorder distortion in the past have looked generally similar, but were in error at lowest levels because of noise effects. The fundamental-rejection type of harmonic distortion meter needs and has a wide bandwidth to measure the energy from all harmonics. This approach works well with amplifiers which have low noise. Tape recorders, relatively speaking, have high noise, and the result is that the measured "distortion" at lower levels is determined by the noise, not the harmonics.

To get accurate distortion figures in such a case, it is necessary to reduce the effect of the noise so that the discretely stand out. It might be noted here that your ears are regularly detecting signals below the overall, broadband sound level. Since April, 1975, *Audio* has been reporting recorder distortion figures that have been obtained with a spectrum analyzer. By settings its i.f. bandwidth to 10 Hz and scanning slowly, it is possible to display harmonics at levels considerably below 0 VU. Many had come to believe that recorders had distortion that was a minimum of perhaps 0.5 to 1.5

per cent. The experience of making such tests for two years has shown that the distortion can be as low as 0.1 per cent for recording at 0 VU, and possibly less than 0.01 percent at -10 VU. Actually, the distortion level is more directly related to the resultant flux level on the tape, but these figures give an idea of what might be expected from a high-performance recorder/tape combination.

The distortion products of the magnetic record/playback process normally consist almost exclusively of third harmonics. Any second harmonic is probably the result of some sort of maintenance problem: a magnetized head, a leaky coupling capacitor, or other defect. Higher odd harmonics, particularly fifth, may show up at higher record levels, but are usually of low amplitude compared to that of third. For the majority of operating conditions, the level of the third harmonic is essentially equivalent to the total harmonic distortion level. If the percentage distortion figures are plotted on a logarithmic scale against a linear scale for record (or flux) level in VU (or relative dB), the resultant curve is a straight line. The percentage distortion usually changes about ten to one, or 20 dB, for each 10 dB change in record level. This two-to-one relationship holds all the way from the noise limit at the lower end to perhaps 10 dB or more above 0 VU. Deviations from the nominal two-to-one slope can be caused by the contributions from lower-level fifth-order distortion products.

In the accompanying figure of a possible recorder/tape characteristic, the third harmonic distortion is about 0.5 per cent at 0 VU and reaches 3 per cent at +8 VU. At -10 VU, distortion is down to 0.05 per cent, just one-tenth that at 0 VU. Probable figures for distortion at levels below -10 VU can be obtained by extending the straight line and filling in the grid. To date all of the evidence indicates that the function remains straight down to the lowest levels. There is less data on very high levels, due to a general reluctance to burn out meters. It can be stated, however, that the measurements at least suggest that the straight-line character is maintained at least part way into saturation and self erasure. The evidence to date also supports a tentative conclusion that the slope determined for a test frequency such as 1.0 kHz applies to other frequencies for the same recorder/tape combination. In other words, the distortion figures for another frequency such as 200 Hz can be determined over a range of levels by applying the slope from the 1.0 kHz level data to the distortion level shown for 200 Hz on the distortion vs. frequency plot.

Howard A. Roberson

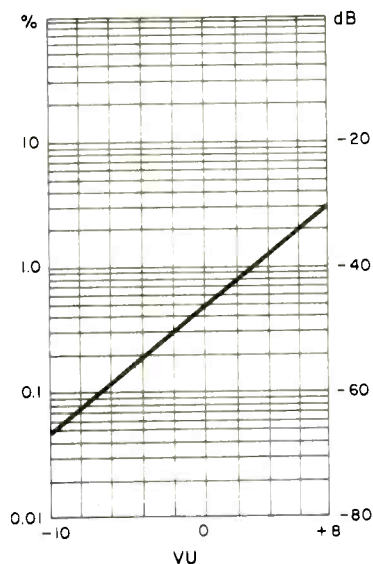

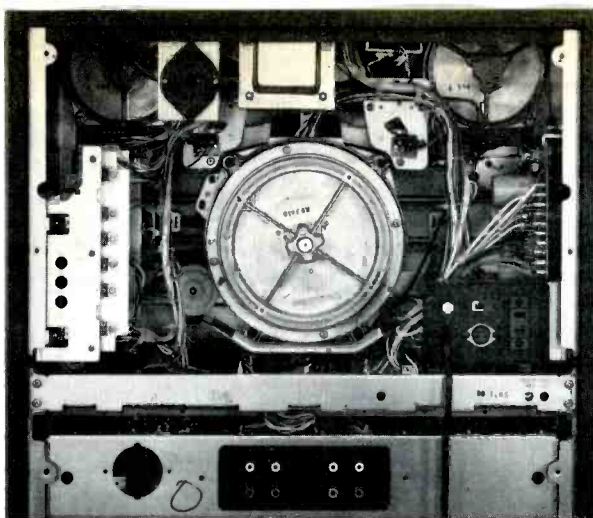

quite match the Technics deck. The second unit was obviously inferior in this comparison, although its specifications would usually be given a very high rating. To check modulation noise, a 1.0 kHz signal was recorded at 0 VU, and the narrow-band spectrum of the playback was plotted from 500 to 1500 Hz (Fig. 7). There was an evident reduction of sideband levels with Scotch 206 as tape speed was increased. On the low-flutter "other" machine, the modulation noise was generally comparable. Then, Ampex 456 was used with the Technics at 7 1/2 ips (See Fig. 8), and the reduction in modulation noise with this mastering tape was quite obvious.

Speed fluctuations were measured by playing the 3160-Hz tapes and feeding the strip-chart recorder as described above. The counter reading on playback was exactly 3160 Hz throughout the entire length of tape, and the plotted drift showed minute variations around a constant speed (frequency). The conclusion was drawn that the unit was exhibiting outstanding tape tension control and speed stability. At

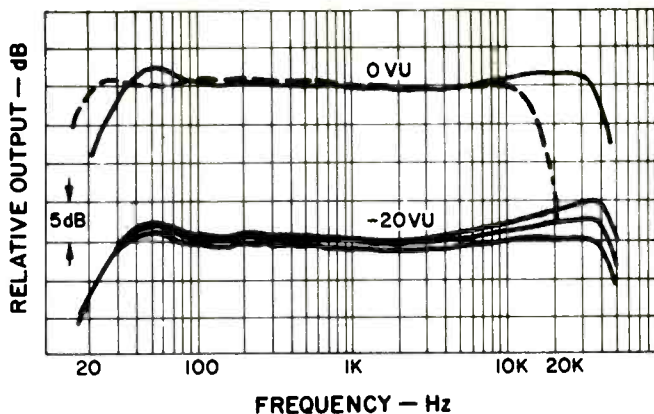
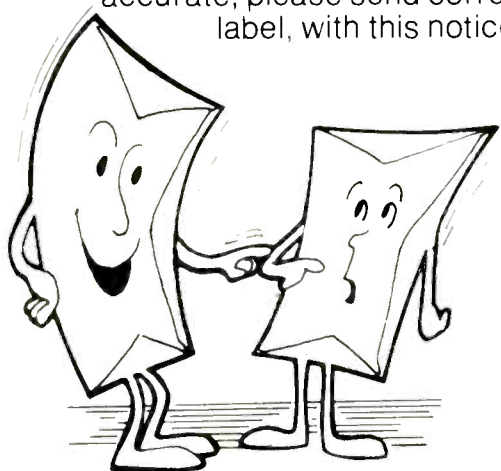

Fig. 4—Record/playback response with Memorex Quantum tape with the three bias settings at -20 VU @ 15 ips; upper trace @ 7 1/2 at 0 VU at the medium bias setting.

both 15 and 7 1/2 ips, the speed variations were within 0.05 per cent of a nominal reference, with 15 ips slightly better (Fig. 9). There was no measurable variation in tape speed with line power changes from 90 to 130 V. There was no external method refined enough to prove the exact tape speed, but according to the built-in strobe lamp and the marks on the edge of the turn-around idler, the tape was running a miniscule 0.015 per cent fast. With the variable pitch control pulled out, all three tape speeds could be varied from 6.1 per cent slow to 7.3 per cent fast. Recorder starts were tested by using the drift circuit as a speed detector, with its output fed to an X-Y recorder. Overshoot in the drift circuit itself

Is your name and address correct?

Please check the address label on this issue of Audio. If not accurate, please send corrected label, with this notice, to:



**Circulation Department
Audio**
North American Building
401 N. Broad St., Philadelphia, PA 19108

AUDIO • May 1977

ROTH/SINDELL STRIKE AGAIN!

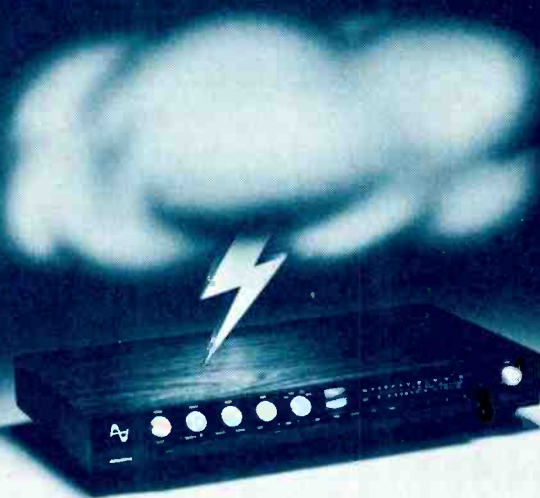

If you haven't heard the Armstrong receiver, you may end up with a component stereo system. Too bad.

This message has been brought to you as a public service by Roth/Sindell, importers of Armstrong and other high-end stereo equipment: Telephone (213) 478-3515.

Enter No. 31 on Reader Service Card

from the suddenly applied signal obscured the earlier conditions, but the plots for 15 and 7 1/2 showed the relatively short time required to obtain very steady tape motion. Improved instrumentation would be required to secure more complete verification of the recorder's excellent speed characteristics. Rewind for a 2500-foot 10 1/2-inch reel was 116 seconds, well within the specification. Readings taken of the counter at timed intervals during fast wind proved that with either 7- or 10 1/2-inch reels the tape speed was constant, showing excellent control of winding tension. The noise levels from the machine measured at one foot were 31 dBA at 15 ips, 28 dBA at 7 1/2 ips and 25 dBA at 3 3/4 ips. At a few feet in a reasonably dead room, all readings would be less than 20 dBA; excellent low-noise operation.

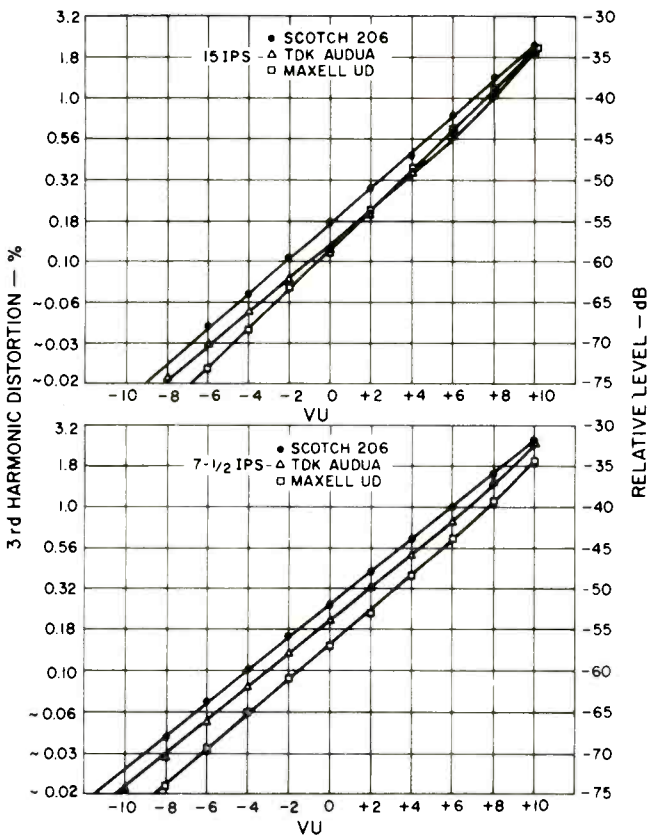

Fig. 5—Third harmonic distortion vs. record level @ 15 ips (top) and 7 1/2 ips (lower) with Scotch 206, TDK Audua, and Maxell UD tapes.

Fig. 6—Third harmonic distortion vs. frequency at 0 VU with Scotch tape @ 3 3/4, 7 1/2, and 15 ips.

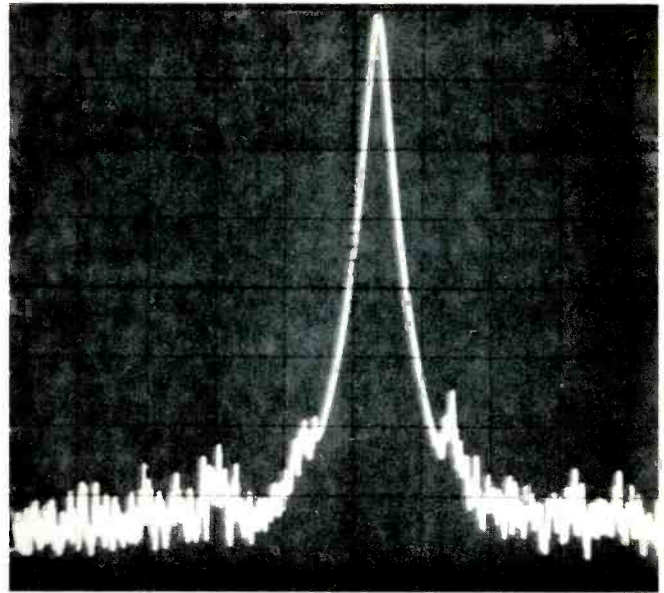
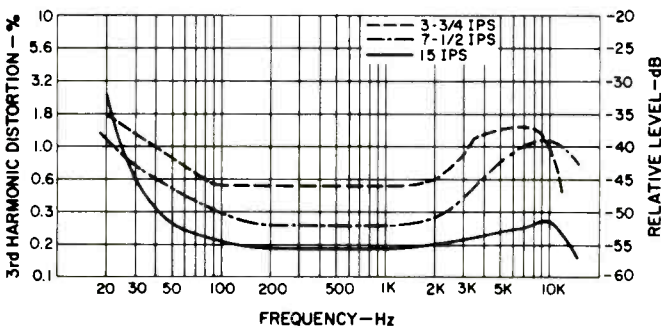

Fig. 7—Modulation noise with the Scotch 206 tape @ 15 ips on a 1 kHz signal recorded at 0 VU. The scope settings are: horizontal, 100 Hz per division to 1 kHz; vertical, 10 dB per division to 80 dB.

In-Use Tests

Threading the machine was much easier than might be judged looking at the collection of rollers and idlers, as the tape loop falls naturally around the head assembly. The feather-touch tape motion switches and the associated logic performed without error, and a thrown loop or stretched tape was never achieved in many attempts. Longer spindles on the reel turntables would aid putting on reels, particularly when the machine is vertical. The 10 1/2-inch-reel adapters caused a bit of fumbling as they fit into the outside of the reels, and then this assembly had to be placed on the spindle. All of the pot knobs are of good size and have an attractive appearance. The friction clutching worked very well in keeping sections together or slipping when desired, and the marker rings would benefit from a little more knurling. The meters have good visibility, and it was easy to set levels on both channels. Although the unit has excellent headroom, particularly at 15 ips, some form of peak indication would have been helpful. The machine was operated for many hours at all three speeds, switching back and forth from source to tape monitoring. Minor modifications to the sound could be detected only at 3 3/4 ips. Superior speed characteristics, especially the low flutter, and the extended response at higher levels were judged to be major factors in providing the excellent sonic results. Switching between source and tape did not generate clicks in the recording that could be detected. Record on/off clicks could be heard by listening carefully, but the actual level was down to that of tape noise. A brief check was made of the operation of the 1/4-track playback head.

The EQ switch provided maximum boost when it was down in position 1, minimum boost when it was up in position 3. The bias switch provided minimum bias when it was down, maximum bias when it was up. It seems that it would be more logical to most operators if lifting the levers up would cause the high frequency response to go up, the reverse of what happens with the present scheme. Comments cannot be made on the instruction book coverage in this or other areas, as it is still in process. The unit operated well in timer start, in Record if the record preset switches were on.

The performance of the Technics RS-1500US deck leaves

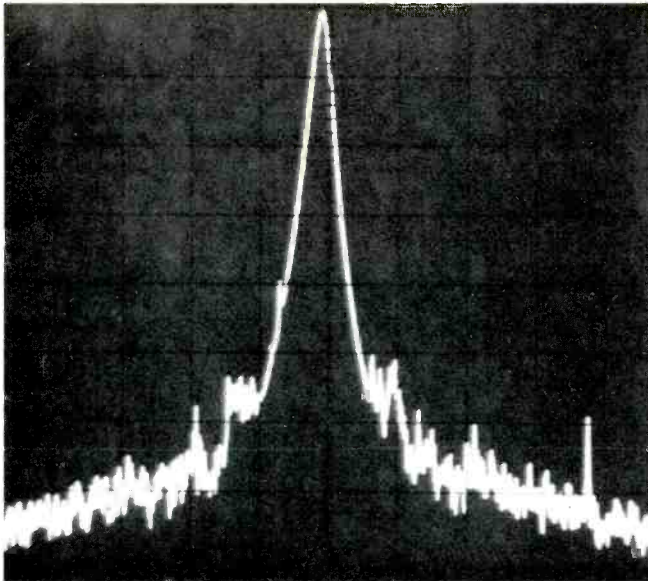

Fig. 8—Modulation noise with the Ampex 456 tape @ 7 1/2 ips on a 1 kHz signal recorded at 0 VU, with horizontal readings to 1 kHz in 100 Hz per division; vertical to 80 dB at 10 dB per division.

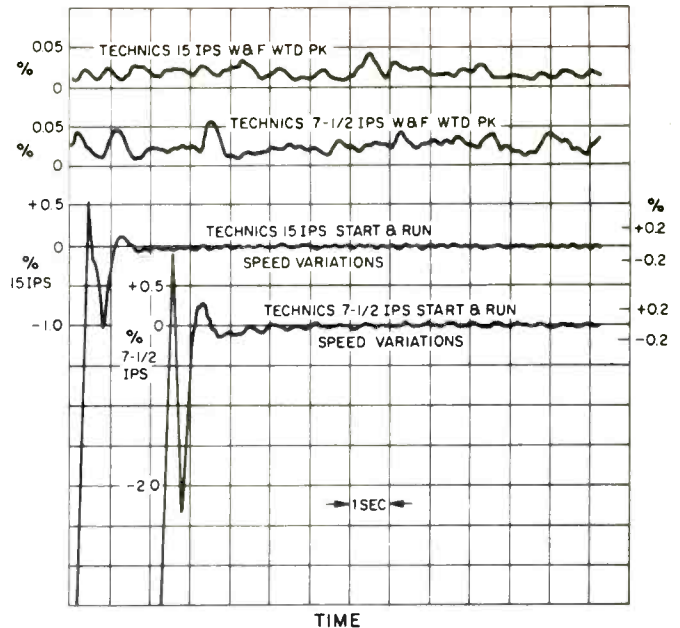

Fig. 9—Speed variations and wow & flutter at 7 1/2 and 15 ips with the Technics RS-1500US reel to reel tape deck.

substantially nothing to be desired by serious audiophiles. The unit is even capable of recording the carrier channel of CD-4 systems right out to 45 kHz. It must be noted that the excellent signal-to-noise ratios are achieved without Dolby circuitry. For the professional, the major limitations would actually be in the area of input/output interfacing.

Balanced line in/out could be added at relatively small expense, however, so budding professionals should consider this recorder quite competitive to other somewhat more expensive machines. Hopefully, Technics will add peak indicators to the benefit of all users. *H. A. Roberson*

Enter No. 92 on Reader Service Card

Announcing...

The all-new, 1977 **EQUIPMENT PROFILES** Just Published by **AUDIO** magazine

The newly-published **AUDIO** magazine **EQUIPMENT PROFILES** is now available. And you can order it for \$3.95. (Because you read **AUDIO** we will pick up the mailing and postage costs.)

When you order, you receive a large (8 1/2" x 11") illustrated book... packed with equipment test reports including schematics, and our unique equipment directory.

There are over 50 pages of equipment specifications and nearly 100 pages of test reports. Speakers, tuners, amplifiers... most equipment you would consider buying is listed in this handbook... 2200 products in all.

Remember, we are the most critical and thorough testers you'll find in print. As one reader wrote: "When you test equipment and report on it, I can believe what you say."

Of course, the handbook includes complete and detailed lists of audio equipment—including turntables, cartridges, reel-to-reel tape recorders, tape decks, speakers, almost every type of Audio equipment available. There are graphs and schematics, in addition to complete measurements. You can find out how a piece of equipment really performs.

We believe so strongly that anyone who buys audio equipment can get the best system (at the most economical cost) by using this directory, we guarantee it. Here is our ironclad guarantee: Use this fact-packed handbook for 30 days. If after the 30-day trial you are not completely satisfied, just return the book in good condition and receive a full refund, no questions asked.

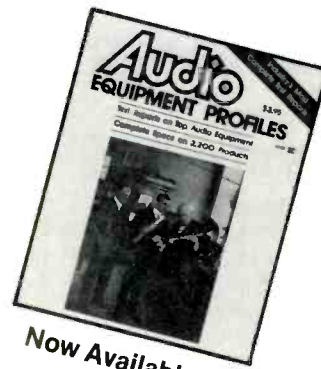

Send to: **Audio**
North American Building
401 N. Broad St., Philadelphia, PA 19108

Name _____

Address _____

City/State _____ Zip _____

As you can see, you take no chance by ordering. (You take a chance by not ordering. The supply is limited.) Just fill out the form below and send it—with your check for \$3.95—to: **AUDIO**, 401 N. Broad Street, Philadelphia, PA 19108.

Send me the 1977 EQUIPMENT PROFILES (published by **AUDIO** magazine). My check for \$3.95 is enclosed. I understand I can use this handbook for 30 days, and return it for a full refund if not completely satisfied.

The column

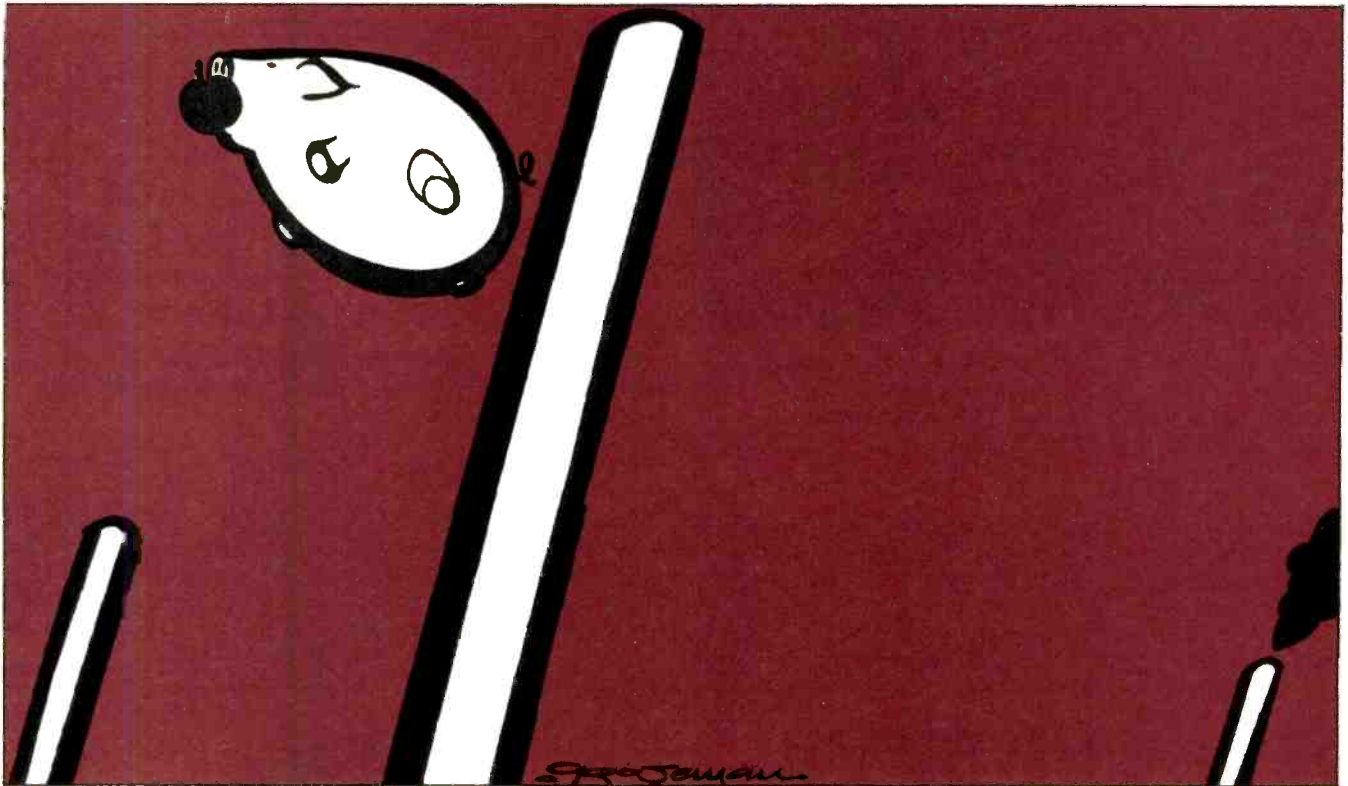

86

Animals: Pink Floyd
Columbia JC 34474, stereo, \$7.98.

Pink Floyd started, of course, as the spaciest of the spaceborne 60s bands. Instead of dying on the vine like so much Ultimate Spinach, they prospered. And as they prospered, they drifted from the abstruse and odd to a lofty, grand music that is still "cosmic" yet often rooted in the mundane. Things like the cave creatures of **Ummagumma** or the cows on **Atom Heart Mother's** cover, or that album's song recorded with breakfast sounds.

Animals also uses that juxtaposition of ordinary and ethereal. Side one's understated introduction *Pigs on the Wing (Part One)* leads to the rambling *Dogs* which appears to chronicle the thoughts of a street dog or an Aqualung-esque human statement. It is hard to be very sure.

The second side is more focused musically though it may sound familiar in spots. *Pigs (Three Different Ones)* throbs like *Welcome to the Machine*. The killer guitar riff of *Sheep* is nearly a lift from *Echoes of Meddle*. Yet all this doesn't detract

from the side. Quite the contrary, *Pigs* is very lively Floyd with single possibilities if edited. And *Sheep* is quite witty including a deadly parody of the Lord's Prayer—"He converteth me to lamb cutlets/For lo, he hath great power and great hunger." The song's story of sheep rising up to defy their masters, the dogs, is seriously unsettling. The brief finale *Pigs on the Wing (Part Two)* from the dogs' view looks at the pigs as villains, a distorted and ironic mirror image of *Part One* at the other end of the album.

Pink Floyd has grown comfortably into a big part of the rock terrain so long vacated by the Moody Blues. They sound as heady as any long-time band around, yet still, at least partly, rooted to earth. Technically, their records, especially side two of **Animals**, continue to have a beautiful shimmering quality with full use of stereo and exquisite sonic effects. The music of **Animals** may not break new frontiers, but it has a drive and an enthusiasm that makes it, again especially side two, one of Pink Floyd's more entertaining albums.

I must note that my review copy was defective with a bubble in the vinyl. Fortunately I got a good one in order to hear it properly. You'd hope (against all hope) that when they go to that higher \$7.98 list price that you'd get quality control. M.T.

Sound: A — Performance: A —

Animals: Pink Floyd
Columbia JC 34474, stereo, \$7.98.

When you're selling millions of records, it's easy to live inside your fantasies. It's hard to figure how 1973 allowed Pink Floyd the opportunity to not worry about any kind of financial consideration in either their lifestyle or their art—perhaps the afterburn of the so-called drug age created their audience—but nevertheless their ability to sell records is quite phenomenal in an age when record companies are hesitant to sign any new artist who isn't slightly more conservative than Barry Manilow. Pink Floyd does their best to tread the edges of the left wing of popular mu-

sic, and in each record they rebel against just about every convention put in front of them. And dammit, they make good records because of/in spite of it.

I mean, you wouldn't call any of them real virtuosos on their instruments. Rick Wright and Nick Mason have only really learned mastery of their instruments within the past three years, which may seem all right but the Floyd have been together for over three times that length of time. David Gilmour has yet to play a real lead guitar part rather than a guitar effect; only Roger Waters, the author of most of the group's music, has a sound of his own which might work outside of the Pink Floyd concept—of course bass guitar is the instrument which comes easiest with consistent practice, so it's natural that he should be the outstanding musician in the group.

Yet it all works. It's all so appealing, so mammoth this sound, but the songs never really follow any progression. They linger on chords endlessly, droning away on guitars and synthesizers as if it's the only note they know. What is the secret to their mystery?

The answer is quite interesting, actually, and it hangs on the background of the group. They were at first a rhythm & blues outfit made up of art students, primarily architecture majors, led by a brilliant songwriter named Syd Barrett who virtually dominated their debut album and first few tours in a tyrannically mad fashion. Eventually he drove himself to the brink (with the aid of several chemical substances) and was unable to function as the leader of the group. Gradually Roger Waters edged him out, replacing him with Dave Gilmour, and the group was left with an identity (spaced-out music), a cult audience, but no real point of focus. Waters, with thought processes still steeped in architecture, became the leader of the group, but his songs did not possess form in terms of the bridge, chorus, verse, etc. type of construction. He was attuned to spatial construction, and used to working with different textures on different levels; and so Pink Floyd's music exists not so much for its ability to move from note to note but to move within the note. Get it?

If not, check out **Animals** to see what I mean. It's very good for headphone listening, or through a terrific system (which I'm sure most of you Audiophiles have). Ta. J.T.

Sound: A Performance: A

AUDIO • May 1977



**Before
you buy
stereo
headphones,
get
some
good
advice.**

Theirs:

87

Julian S. Martin

HI-FI STEREO BUYERS' GUIDE, March-April, 1976

"Superb from every viewpoint. An outstanding achievement in headphone design. One of the most comfortable."

The Len Feldman Lab Report

TAPE DECK QUARTERLY, Winter, 1975

"Response of these phones extends uniformly from 20 Hz to over 22,000 Hz with no more than ± 2 dB variation over this entire range...this is nothing short of incredible."

New Equipment Reports

HIGH FIDELITY, January, 1976

"The sound quality the AT-706 presents [to you] is exceptional: very wide range and smooth...Within this excellent operating range the sound is exceedingly clean and open...an extremely fine stereo headset."

If you asked the critics they'd tell you to listen critically to a variety of products before you buy. We agree. Because the more carefully you listen, the more you'll be impressed by the sound of Audio-Technica.

AT-706

Electret Condenser

Stereo Headset \$129.95

Our finest Personal Transducer



audio-technica®

® INNOVATION □ PRECISION □ INTEGRITY

AUDIO-TECHNICA U.S., INC., Dept. 57A, 33 Shiloh Ave., Fairlawn, Ohio 44313
Available in Canada from Superior Electronics, Inc.



THE TRUTH ABOUT HEADPHONE TESTING

Write for a total reprint of the reference paper of headphone testing (AudioScene, August 1976).

STAX EARSPEAKERS

for those who seek truth



**American
Audioport, Inc.**

1407 N. Providence Rd.
Columbia, Missouri 65201

See What You've
Been Missing...
Read Audio's Classified

88

FREE McIntosh CATALOG and FM DIRECTORY

Get all the newest and latest information on the new McIntosh Solid State equipment in the McIntosh catalog. In addition you will receive an FM station directory that covers all of North America.



MX 113

FM/FM STEREO - AM TUNER AND PREAMPLIFIER

**SEND
TODAY!**

McIntosh Laboratory, Inc.
East Side Station P.O. Box 96
Binghamton, N.Y. 13904
Dept. 1

NAME _____
ADDRESS _____
CITY _____ STATE _____ ZIP _____

If you are in a hurry for your catalog please send the coupon to McIntosh.
For non rush service send the *Reader Service Card* to the magazine.

Enter No. 20 on Reader Service Card

Octoberon: Barclay James Harvest
MCA 2234, stereo, \$6.98.

When first emerging, BJH was an exciting new band that produced one of the all-time classic obscure British Rock Songs, *Taking Some Time On*, which was ahead of its time and better than most everything that was around back then. Years have gone by, Barclay James Harvest has gone through more than their share of record labels, and still no hit. And I must say that the time has come to put a stop to this. Their albums have taken a drastic turn downward quality-wise of late, and in recent times they've sounded more laid-back and occasionally resemble Pink Floyd, but never quite as good. All four members of the group write, but not a one of them can come up with a particularly decent song, although none of them is devoid of talent. It's just that this group doesn't have a sound, an image, or a reason to continue.

Octoberon is their very worst album, absolutely lackluster and not even particularly British. I would suggest they pack it in and either join established outfits or form their separate entities, because Barclay James Harvest is going nowhere either musically or commercially and the record market is glutted enough without this contribution.

J.T.

Sound: C Performance: D+

Songs from the Wood: Jethro Tull
Chrysalis CHR 1132, stereo, \$6.98.

Jethro Tull has always been most appealing to me when they have played songs instead of novels. **Songs from the Woods** is loaded with sprightly songs, the brightest, happiest Tull since **Benefit**.

Images of medieval England, replete with hints of even earlier pagan times, unite the album. But don't mistake **Songs** for an exercise in nostalgia. *Ring Out, Solstice Bells* is what you might call a pre-Christmas carol, a song for the winter solstice which invokes Druids and *Mistle-toe by the Holy Oak*. *Cup of Wonder* celebrates the annual rebirth of the world into a green place—"Pass the cup of ancient wisdom" it bids. *Hunting Girl* is a new telling of the ancient story of the low-born in love with the high. *Velvet Green* and *Jack-in-the-Green* invoke the strength of the tradition of the village green, now slowly disappearing. The album's very intent is clear from the opening lines of the first song, the title tune—"Let me bring you songs

AUDIO • May 1977



from the wood/To make you feel much better than you could know." Ian Anderson has not been so explicit since the opening of **Thick As a Brick**—"Really don't mind if you sit this one out."

Besides the change in attitude, there are several other departures for the Tull of **Songs from the Wood**. It is the first album that includes David Palmer as a full-time group member, and as an additional keyboardist he adds stature and depth to the sound (he has orchestrated part of nearly every prior Tull album but never was an official part of the band). It is John Glascock's second Tull album, and he has fully adapted to the built-in quirks of Anderson's composition. Further, his enthusiasm is obvious. It is also the first Tull album to extensively use other voices than Anderson's. The resulting tapestries cleverly enhance the album musically and thematically.

Unquestionably, Jethro Tull as a band and Ian Anderson personally were up against the wall after the relative failure of the last album, **Too Old to Rock 'n' Roll, Too Young to Die**, the first Tull album since their debut **This Was** not to achieve gold status (500,000). **Songs from the Wood** bounces back off that wall into Tull's greatest strengths. It reaffirms Ian Anderson's songsmithing powers and returns to Anderson's preoccupation with the English village. It is a triumphant record. M.T.

Sound: A- Performance: A+

Miracle Row: Janis Ian
Columbia PC 34440, stereo, \$6.98.

With **Miracle Row** Janis Ian is no longer the "poor, sad dear" her many fans perceived. Even the cover shots this time radiate confidence (front cover) and fun (back cover), and they are matched by her performance from the very first note. Immediately the album has a fuller, richer,

more muscular sound than she has ever achieved on record. In addition, her supporting band, which has played together for over two years now, has coalesced into a strong unit, with Claire Bay's harmony vocal work particularly noteworthy.

Janis' writing has grown as well. It is not so self-centered. The remaining traces of what has evidently been self-pity and self-righteousness are turning quickly into maturity. Songs such as *Take to the Sky* and the building *Candlelight* reflect this growth. The

grand finale of the intertwined stories *Miracle Row/Maria* is as impressive a piece as she has ever put together.

Credit coproducer/arranger Ron Frangipane as the outside ear that helped put strength into the arrangements. He had worked with Ian extensively on the **Stars** and **Between the Lines** albums but very little on **Aftertones**, and as a result it suffered.

Most of all **Miracle Row** is a solid team effort. Take several giant steps forward. M.T.

Sound: A Performance: A

About damping, bi-amping and the Crown DC-300A

Because of inertia, speaker transducers over-react to amplifier signals. This can be minimized by speaker design, but it can't be eliminated entirely. In the process, the transducers feed spurious signals back into the signal processing units.

A good amplifier is designed to control excessive transducer excursions by reducing — and absorbing — the unwanted signals generated by such excursions. It's part of a process audio engineers call damping. The Crown DC-300A power amplifier, in addition to its other well-known specifications, has a damping factor of 700, which means it should easily control speaker excursions. (A rating of 400 is considered good.)

But in a standard hi-fi stereo system, the DC-300A can't do all the damping it was designed for. The sound is a little muddier than it should be.

Why? Because the speaker crossovers — with their own impedance — get in the way. The amp is not directly

hooked up to the transducers.

Solution? Move the crossovers back between amp and pre-amp. Add another DC-300A and bi-amp the speakers.

The DC-300A now damps excessive transducer excursions efficiently. Which can mean crisper, cleaner sound.

Each transducer now has 155 watts of power available to drive it, and is limited only by its own characteristics. Which can mean more sound pressure.

There can also be less distortion, since harmonics of low-frequency distortion cannot feed to high-frequency transducers through the crossover.

Are you interested in how to use all the power and performance of a Crown DC-300A amplifier? Write. We'll send you information about the Crown VFX-2A a two-channel variable-frequency crossover that makes bi-amping easy. Plus reprints of some articles that may help you decide if bi-amping is for you.

Crown VFX-2A



crown

Box 1000, Elkhart IN 46514

Enter No. 7 on Reader Service Card

Marquee Moon: Television Elektra E-1098, stereo, \$6.98.

Here's the first long-playing disc by the most talked about band in New York, the group that's been in the public eye for three years with only one single (*Little Johnny Jewel*, available from Ork Records, P.O. Box 159, Cooper Station, N.Y.C. 10003) to communicate what they're all about to non-gothamites. A little history: Television began when rock's Henry Kissinger, Terry Ork, put together the collective energies of Tom Verlaine (lead

singer/poet/guitar), Richard Lloyd (Fender guitar), Billy Ficca (drums) and Richard Hell (bass). The emphasis was upon songs and persona; musicianship in the traditional sense began much later, and when some personalities became too strong (as in Hell's case), they left the fold (replaced by Fred Smith). And so with several record labels, numerous management firms, and a few producers courting the group, they finally settled upon a plan to unleash TV to the masses.

And so we find **Marquee Moon**, an

album with enough merits to eclipse their pre-publicity and New York punk/art-rock stigma. Granted that their appeal includes punks, art nouveau addicts, rockwriters, and other trash—Television is a rock group that's moderately daring, stylistically without peer, and successful at what they try to do at least half of the time. For a new group with no track record, that's entirely laudable.

I can't say the album is without faults, but in its flaws Television is justified—in trying to go over the edge they sometimes go too far. The title track and *Torn Curtain* are too long, but both contain some fine bits; *Elevation* has an implausible chorus, and Verlaine's guitar playing is overplayed throughout the album and some of the mystique is lost. But Tom's songwriting (especially his lyric abilities) and Lloyd's guitarwork break much new ground and manage to viscerally and intellectually grab the listener. *Venus* is an engrossing tale with originality to spare; *Friction* and *Prove It* are startlingly aggressive; I have no quarrels with the pleasant *Guiding Light* and the lyrically evocative *See No Evil*. Verlaine's voice doesn't work all the time, and one wishes that the production could have beefed up the lead vocal sound, and the need for more of a production sound is evident on a few tracks. Still, these gripes are minor ones compared to the overall merits of **Marquee Moon**, which may or may not be acceptable to the public at large. There's been some talk that the group is a little too distant from mainstream rock to break through, but I feel that very soon Television will be able to find their proper audience. In any case, you should hear them out—they make a good case for themselves. J.T.

Sound: B Performance: A

Night After Night: Bill Quateman RCA APL1-2027, stereo, \$6.98.

Bill Quateman's first album four years ago showed off a Midwestern singer/writer of considerable promise. Sadly, his second effort fulfills little of that promise.

The problem lies not with Quateman, but in the album's thin sound and less than exemplary production which feature overblown arrangements obscuring instead of clarifying the material.

The promise is still intact. It shouldn't take Bill Quateman four years for another shot. M.T.

Sound: C— Performance: C—

AUDIO • May 1977

90



\$1100

SUGGESTED RETAIL PRICE

SUPER RACK STACK

Perhaps the finest professional put-together of sound equipment ever assembled. Spectro Acoustics has engineered a system priced to be economical without being cheap. The Model 217R Straightline Preamplifier, Model 210R Graphic Equalizer and Model 202C Power Amplifier with 100 watts per channel. The Super Rack Stack is assembled in a rugged all-metal professional rack mount cabinet.

MODEL 217R has front panel accessible phono stage cartridge loading, gain selector and subsonic filter. Completely flexible source selector with two phonos, tuner, auxiliary and two tape circuits with by-directional bypass copying possible.

Distortion less than 0.05% THD
Phono S/N Ratio better than 85 db.
Frequency Response 10 Hz-100kHz \pm 0.25 db

MODEL 210R has ten bands of octave equalization per channel with \pm 15 db boost or cut per octave. "Gyrator" synthesized inductors eliminate distortion and noise. Line or tape equalization with tape monitor and equalizer defeat are provided for complete flexibility. IC construction provides increased S/N ratio of 90 db with no phase shift.

Distortion less than 0.1% any level of equalization.
S/N Ratio better than 90 db any level of equalization.
Dynamic Range better than 100 db at full output

MODEL 202C provides Scamp modular construction for rugged reliability and ease of repair in the event of breakdown. Class AB design with \pm 70v Power supply for 200 watt per channel peaks at clipping on program material.

FTC No less than 100w RMS continuous per channel both channels driven into 8 ohm any frequency 20 Hz to 20kHz and no more than 0.25 THD.

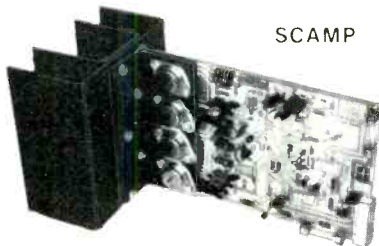

SCAMP

SPECTRO ACOUSTICS, INC.

3200 Geo. Wash Way (509) 946-9608
RICHLAND, WASHINGTON 99352

Enter No. 38 on Reader Service Card

The bookshelf



Jazz People: Text by Dan Morgenstern. Photographs by Ole Brask. Harry N. Abrams, Inc., \$25.00.

I am giving this splendid book as a graduation present to my 21-year-old nephew, a rock fan, who through his college years, has expanded his musical horizons and developed an interest in jazz.

Jazz People is both a pictorial delight and a concise yet comprehensive history of the idiom. Dan Morgenstern has put together a book that introduces the novice to the special ambience of the music, and, at the same time, stimulates and informs the long time aficionado.

Ole Brask's vivid black and white photos, buttressed by classic black and white prints borrowed from various jazz archives, have tremendous visual impact. The pictures are what makes **Jazz People** a unique volume. They dig into the soul of the music, conveying the special kind of brio, and the intense, uncompromising qualities that surround jazz and its important artists.

Pictures and text interact beautifully as Morgenstern, one of the most scholarly of jazz writers (Dan's catho-

lic tastes are, refreshingly, almost uniquely, non-partisan), presents broad, colorful chapters on Armstrong, Ellington, and Eddie Condon. He offers many profiles and anecdotes on jazz greats and near greats.

Morgenstern also demolishes such myths as the one about Bix Beiderbecke being frustrated by playing with Paul Whiteman's big band. Actually Bix regarded his employment with Whiteman as a glorious opportunity, and was extremely proud of the records he made with Whiteman. He was treated royally by the roly poly "King of Jazz." However, it was Beiderbecke's growing alcoholism that eventually eroded his position with the Whiteman orchestra.

Morgenstern also says another favorite portrait drawn by some jazz journalists (including this writer) of the bebop innovators as surly rebels disdaining and even insulting their audiences is "poppycock." (Surely, Morgenstern won't deny that the uncompromising and undanceable aspects of bop and progressive jazz alienated a large part of the mainstream audience which had savored Swing.)

In **Jazz People**, Dan Morgenstern and Ole Brask have collaborated to produce a visually striking and all-encompassing jazz book for a wide audience. **Jazz People** offers a wealth of information along with special insights that will be appreciated by both the neophyte and those who are already aware.

John Lissner

Congratulations to Contributing Editor Dan Morgenstern for winning the 1977 Grammy Award for album notes on the disc **The Changing Face of Harlem, The Savoy Sessions: Savoy SJL-2208**, 2 discs, \$7.98.



MUSIC SYNTHESIZER KIT
When you combine all of the modules that are part of this package and then throw in keyboard, 12 event sequencer and a four input stereo mixer, it's almost like having two synthesizers in a single package. Wrap them all in sturdy road cases and you have an instrument that goes anywhere and does any job. Module complement includes: Road keyboard with Glide, Two Road module cases, two Balanced Modulator/VCA's, Stereo Mixer, Reverb, three 4720 VCO's, 4730 VCF, two Envelope Generators, three Watt Blocks, Control Oscillator/Noise Source and 12-Event Sequencer.
No. 4700/S Synthesizer Kit \$499.00 *40 lbs.

FREE CATALOG

RAIA ELECTRONICS
DEPT. 5-A
1020 WEST WILSHIRE BLVD
OKLAHOMA CITY, OK 73116

Enter No. 26 on Reader Service Card

91

DIXIE HI-FI SAVE ON
Brand Name Audio Components
BY MAIL

Write Today for Our **FREE Audio Catalog**

DIXIE is one of the oldest and largest stereo mail order houses in the country. Our lower prices on brand name components can save you real money. Call us today for a price quote, toll free (800)446-7825, in Virginia call (804) 257-4241. Everything shipped in factory sealed cartons with manufacturer's warranty.

Major Charge Cards Honored on Mail Orders		KOSS
		SHURE
PIONEER	VENTURI	
	DUAL	TECHNICS

DIXIE HI-FI AM-S
P.O. Box 6496
Richmond, Va. 23230

Please rush me your **FREE** Audio Catalog and complete information. I understand there is no obligation.

Name _____
Address _____
City _____ State _____ Zip _____
Phone (____) _____ - _____
A.C.

Enter No. 10 on Reader Service Card

Tape & turntable

Bert Whyte

The King James Version—Harry James and his Big Band **Sheffield Lab 3**, 33 1/3, Direct disc, \$12.00. P.O. Box 5332, Santa Barbara, Cal. 93108

Rough Trade—Live!—Umbrella UMB-DD1, 33 1/3, direct disc, \$12.95, at Audio-technica phono/cartridge dealers.

First in Line—Randy Sharp & Orchestra, **Nautilus NR1**, 33 1/3, direct disc, \$8.50, P.O. Box 23, Pismo Beach, Cal. 93449.

Ever since Sheffield Labs created a sonic shock-wave with their direct disc recordings of **Lincoln Mayorga and Friends** and **The Missing Linc**, it was a foregone conclusion that other people would try to produce recordings in this difficult medium. "Difficult" is indeed apropos, since the sheer logistics of setting up a direct disc session, plus the expertise required to make a successful recording are a formidable challenge, even to top engineers with broad experience. There are a multitude of things that can go wrong in any recording session, but tape is a forgiving medium and mistakes can be rectified. On a direct disc session, there is no margin for error...any blooper, technical or musical...and it's back to square one—and put a new lacquer on the lathe!

Here we have three direct-to-disc recordings...one from the old pros at Sheffield, and two from newcomers in the field. When I heard that Harry James and his orchestra were going to make a Sheffield recording, I remember thinking what a wildly volatile combination this would be, and was looking forward to hearing some great sonic pyrotechnics. Well...this

King James Version is certainly the best of this group of direct disc recordings, but at the same time, it is somewhat disappointing. Perhaps it is because Sheffield used a different technique in recording Harry than they used in their previous recordings. Instead of a multi-mike studio job, Harry was recorded in a nearby Presbyterian chapel, with a single AKG C-24 "M/S" stereo mike for overall pick up, with an accent mike on piano and drums. A 600-foot line connected the output of a portable console to the input of the lathes in the Mastering Lab studio. The sound is pristine clean...certainly on a par with Sheffield's earlier recordings. But it lacks the sparkle and punch, the sheer dynamism and visceral excitement we were overwhelmed with in **The Missing Linc**, for example. In spite of the chapel as a recording locale, the acoustic perspective was not very spacious, and there was a lack of air around the instruments. The orchestral balance seemed to lack cohesion. When Harry was near the mike and blowing hard, *then* I heard the bright, punchy sound, with great presence, that is so characteristic of Sheffield sound. I would have thought that a snare drum, with more definition and projection, was more suitable to the acoustic locale than the rather dull sounding instrument I hear on this disc. Part of the problem may lie in the choice of repertoire. Perhaps there was a conscious effort to avoid too much nostalgia, but I for one would have liked to hear such James staples as *Two O'clock Jump*, *Ciri-biri-bin*, etc. Played at loud volume levels, the recording is still very impressive for its clean sound. I guess Sheffield's great sound on their pre-

vious albums has conditioned us to expect the best. This was a bit of a let-down.

The Umbrella direct disc recordings are made in Canada, and being imported and distributed in the United States by Audio-Technica of arm and phono cartridge renown. This first effort, by a rock group known as "Rough Trade," has some exceptionally clean sound, but the music just turns me off. In spite of my antipathy to the music, the record has fine transient response and a really socko gut-thumping Fender bass and kick drum sound.

The Nautilus recording of **First In Line** is a puzzle. I read all the glowing adjectives about this direct disc recording before I played it...and was expecting a real zinger. What a let-down! Randy Sharp is a good guitarist with a light pleasant voice, and he is backed with a bunch of good side men. Perhaps the songs, composed by Sharp, are good...and they may appeal to many, but they are unknown and obscure. Here I have to say that in the main audiophiles don't want vocal material on direct disc; they want excitement...big sounds...stunning sound, and such qualities are singularly lacking here. The sound is clean enough, the transient response is good...but it's all quite innocuous and the juices don't flow. A good tape would have served as well, without all the fuss.

The first 1,000 pressings of each Nautilus disc will be individually numbered and signed by the artist himself on the record. These limited edition discs will be available for \$25.00 each.

According to the manufacturer, all records will be packaged in a specially designed, patented polystyrene

cover to eliminate the inherent problems of conventional packaging. Also included is a 16 page, full color booklet describing the direct-to-disc process, along with lyrics and photographs of the session.

Robert Baker, Organist

Sonar OR10160, quadraphonic open-reel, 7 1/2 ips, \$34.95, P.O. Box 455 Kings Bridge Sta., Bronx, N.Y. 10463.

You don't get many four-channel, open reel tapes these days, and especially ones that are as good as this recording. Sonar is the company that has picked up where Ambiphon left off, and they maintain the old Ambiphon tapes in their inventory, as well as recording new material. This tape is unique, because, quite incredibly, it is duped on a one-to-one basis from the master. The process is reflected in the quality. The two organs used here are recorded with the proper acoustic perspective of churches, but without losing the essential sonic detail and definition. The sound is bright and clean, very wide in frequency response and dynamic range. There are plenty of huge sonorous pedal notes

that reproduce beautifully if you've got the right kind of speaker system. Dr. Baker is professor of organ at Yale, and while he may not challenge such luminaries as Biggs and Chorzewa, he has a good feel for these instruments. His performances of works by Brahms, Bach, and Franck, among others, are more than serviceable. The price may seem a bit steep to some...but on the other hand, one-to-one copies of masters are very hard to come by.

Liszt-Piano Concertos 1 and 2

Lazar Berman, piano; Carlo Maria Giulini conducting the Vienna Symphony Orchestra
Deutsche Grammophon 3300 770, Dolby B cassette, \$6.95.

Lazar Berman is just now becoming a "big" name in America, and on the strength of these performances, all the praise heaped on him is totally justified. These are pianistic tours de force, playing in the grand bravura fashion. His technique is impeccable, his power simply enormous. As a plus, Giulini affords a splendidly balanced accompaniment, completely in keeping with Berman's approach. The

sound of the piano is exemplary, very clean with fine transient response. Dynamic range is especially wide for a cassette. Tape processing is good, with little hiss, and only a trace of modulation noise. This cassette is a real winner.

Bartok - Concerto For Orchestra - Hungarian Pictures Zubin Mehta cond. the Israel Philharmonic Orch.
London CS 6949, Dolby B cassette, \$6.95.

Mehta and the Israel Philharmonic have established a fine rapport, and their performance here is one of the best currently available. Indulging in few eccentricities, Mehta manages a taut, wiry performance, characterized by lovely balances. If the Philharmonic is not quite the virtuoso ensemble of some of the more glamorous orchestras, they do very well indeed, and Mehta elicits some exceptional work from them. The sound is first rate, clean and wide in dynamics, with notable string tone. Processing is up to the standards we now take for granted from London/Decca...low hiss levels, and hardly a smidgin of modulation noise. You can't miss on this cassette.

"Something wonderful* happens when $Z_1 Z_3 = Z_2 Z_4$ "

Not a win on the pools, a trip to a Pacific paradise, or a reduction in income tax, but distortionless "current dumping"

Z's 1 to 4 are the four passive components which interconnect the current dumpers. (the output transistors which supply the power), to the small high quality amplifier which provides the error signal, so that when the above condition is met the current in the load, the loud-speaker, is independent of the current in the dumpers and hence distortion is solely dependent on the quality of the error amplifier, which because it is small can be very good.

Wonderful indeed.

For further details on current dumping and other Quad products write to Dept. A

The Acoustical Manufacturing Co. Ltd., Huntingdon, Cambs., PE18 7DB England

* Elektor Electronics Magazine No. 8 Dec. 1975

QUAD

for the closest approach to the original sound

QUAD is a Registered Trade Mark

Enter No. 1 on Reader Service Card

JAZZ & blues

EROSZEMAN



Hard Again: Muddy Waters
Blue Sky PZ 34449, stereo, \$6.98.
King Size: B. B. King
ABC AB-977, stereo, \$6.98.

Been quite a while between LPs for both of these blues greats. Their new albums illustrate very clearly the differences between their own distinctive styles.

Muddy Waters has never strayed far from the rough edges of his roots, and the grittier he sounds the better. For **Hard Again** Muddy is joined by harpist James Cotton and guitarist Johnny Winter, who also produced this disc. Aided by members of Muddy's traveling band, especially Pine Top Perkins on piano, they have gone for a sound as tough as Muddy's best work in the 50s. In fact, they cover three songs Muddy did back then, *I Can't Be Satisfied*, Willie Dixon's *I Want to Be Loved*, and Muddy's *Mannish Boy* which reworked Bo Diddley's *I'm a Man* and which cooks unmercifully this time around. They jam hard and free-spirited all through in what must

be Muddy's best session for a long while. Cotton, Winter, and the others know just how to set Muddy Waters up right and give him the room he needs.

B. B. King, on the other hand, has gotten slicker and slicker while ever more stylish and gracious since he crossed over to playing the Las Vegas lounges. . . his records have seemed low on substance and purpose for some time now. **King Size**, using former Chess records producer Esmond Edwards, is fun but very glossy and, thus, not too satisfying for blues fans. Oddly enough the best moment is Muddy's theme *Got My Mojo Working*. King's version of *I Just Want to Make Love to You* is less than exciting, especially when tagged with the disco chant *Your Lovin' Turns Me On*. *Mother Fover*, one of B.B.'s perennial live favorites, works just fine.

Overall **King Size** falls flat as an album. The huge band behind King doesn't really showcase the man. And most distressing is that King's legen-

dary guitar work which is all but absent, and that has always been his big attraction. I can't help wondering how much a tight, cooking little band would push B.B. King.

Michael Tearson

Muddy:

Sound: B Performance: A

B.B.:

Sound: B- Performance: C-

Dick Wellstood at the Cookery: Dick Wellstood

Chiaroscuro CR-139, stereo, \$6.98.

This, one of the finest solo jazz albums in years, may be doomed to be lost in the glut of last year's jazz piano releases. Seek it out and add it to your library. Wellstood is a youngish, two-fisted piano player who has been on the New York scene for well over a decade, and who revels in old time jazz piano styles—ragtime, stride and blues. This Chiaroscuro collection, ex-

tremely well-recorded on location by engineer/classic jazzbuff Hank O'Neal, presents Wellstood in an eclectic program—original tunes, Cole Porter (*I Concentrate on You* which he plays straight for the first chorus, then surges into some joyous, striding breaks), Jelly Roll Morton, Rachmaninoff's *Rhapsody on a Theme of Paganini*, McCoy Tyner's *Search for Peace*, and Edgar Sampson's *If Dreams Come True*.

Wellstood ranges far and wide in the tempo and mood of these selections. He is pensive on the Paganini theme, then breaks into buoyant stride. He is strutting and positively liling on the strutting Morton piece, *If You Knew*. *If Dreams Come True* starts at moderate tempo and then breaks into fast, filigree stride. *Lemming* is a rollicking original blues that swings exuberantly. Wellstood is a charming anachronism, a remarkable throwback to Fats Waller and James P. Johnson. On Roy Bargey's ragtime piece, *Jim Jams*, Wellstood's fingers appear to be flying off the keyboard. *Night Song for a White Rabbitt*, is another fine, rocking blues. This album is a delight from start to finish.

John Lissner

Sound: A+ Performance: A+

Love and Sunshine: Monty Alexander **Musicians:** Alexander, piano; Ernest Ranglin, guitar; Eberhard Weber, bass; Kenny Clare, drums.

Songs: *S.K.G.*, *Summer of '42*, *Now is The Time*, *You Are the Sunshine of My Life*, *Feel Like Makin' Love*, *On a Clear Day*.

MPS BASF G-22620, stereo, \$6.98.

What happens on **Love and Sunshine**? Everything that is warm and bright, and deep, dark, and sensual. That's how all-encompassing a quartet date this is. This album includes everything from be-bop to a touch of light rock—and everything is done with conviction. The work is, in a sense, a history of the jazz piano, which is evident in the many ways Alexander quotes the ideas, chord voicings, and captures the moods of the greatest jazz pianists. For example, on Milt Jackson's bluesy *S.K.G.*, Alexander hones in on the solid, on-the-beat cooking of Wynton Kelly, the melodic blocks and octaves of Red Garland, the overpowering force and lightening speed of Tatum and Oscar Peterson, and many others.

Now's the Time, a blues in F, is somewhat more up-tempo than

S.K.G., but our ears are rewarded with more of Alexander's eclecticism. Alexander receives just the right amount of support from the sidemen, and things move along without interruption or distraction. Dig Eberhard Weber's deep, resonant, grinding bass sound—the sound so many bassists would give their eye-teeth for—as he powers the group through 45 odd minutes of music. Note too how Weber does everything on acoustic bass, from the samba-like *Sunshine* to the light rock *Feel Like Makin' Love*.

No stone has been left unturned in making this album a success. MPS wanted to record Alexander on the magnificent Steinway grand in their studios, while not losing the chemistry produced in a live recording. So they brought the audience to the studio. The result? Listen to it. The piano reproduces with crystal clarity, and the balance is fine. My copy of the LP has none of those annoying ticks and pops even after many plays. This is quality control. If you have an appetite for jazz piano, quartet setting, here's the record for you. *Eric Henry*

If you missed the first two issues, it's still not too late.

We've reprinted Volume 1, Number 1 of *The Audio Critic* and have printed enough of Number 2 to keep up with the ever-increasing demand. Our phenomenal growth seems to indicate that noncommercial, consumer-oriented audio journalism has come of age.

One subscriber writes that *The Audio Critic* is as good as the four best-known "underground" audiophile reviews combined. Another calls it the new Bible of high fidelity. Even if you ascribe such reactions to fanaticism, the fact remains that *The Audio Critic* is unlike any other publication or service.

Six times a year, by subscription only, *The Audio Critic* tells you in print what has so far been only spoken of in private among a few enlightened professionals. What's the best. What isn't. What's smart. What's dumb. And why.

Since *The Audio Critic* accepts no commercial advertising, not even by retail stores, and since it has no connections with the audio industry, it has nothing to gain from being kind to unscrupulous or incompetent manufacturers. It names names, calls bluffs, praises and criticizes without restraint.

What's more, *The Audio Critic* doesn't just blithely inform you that the highs are "grainy" or the midrange is "liquid." It makes a serious effort to correlate its listening tests with measurements taken in its own, superbly equipped laboratory.

One year's subscription to *The Audio Critic* (six issues) costs \$28, first-class mail only. For overseas

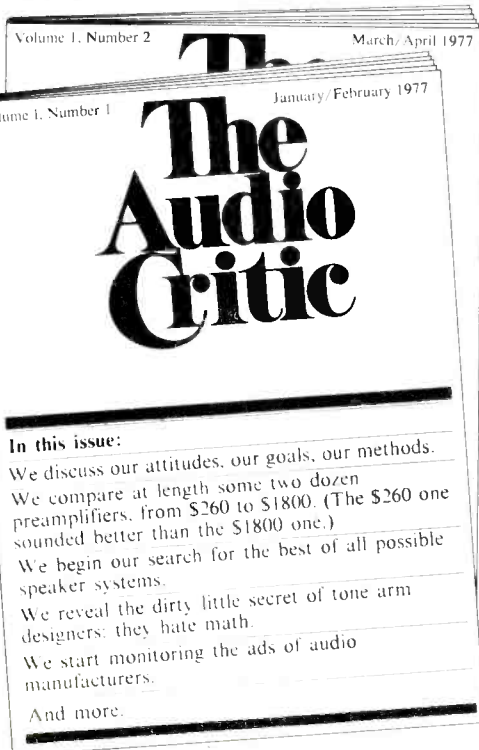

airmail, add \$5. No single copies are sold for any reason whatsoever, but the unused portion of canceled subscriptions is refundable on request.

The first two issues cover close to thirty preamplifiers, as well as power amps, speakers, subwoofers, tone arms and other subjects. The third issue (May/June) is devoted mainly to speaker systems with state-of-the-art pretensions. We strongly suggest that you begin your subscription with Volume 1, Number 1, in order to own a complete set and be thoroughly familiar with our approach.

Send your \$28 for the first six issues today to *The Audio Critic*, Box 392, Bronxville, New York 10708.

Albert: Albert King
Utopia BUL1-1731, stereo, \$6.98.

It's becoming increasingly difficult to remember that blues—now virtually the exclusive domain of collectors, specialists, and academic types—was as recently as the middle 60s a hot commodity among urban-black record buyers. The few bluesmen who have managed to maintain a modicum of mass popularity in the intervening years (B.B. King, Bobby Bland, Muddy Waters, Howlin' Wolf, Albert King, Little Milton, and to a lesser extent Little Johnny Taylor) have all had to make concessions to changing tastes. If the blues, as a dis-

represents a compromise, but one which allows King to remain as true to himself as the current market can realistically bear.

Contrasting with these tracks are three blues standards done in a tougher, purer urban-blues fashion, ranking with the finest performances of King's career. His singing is noticeably at-home with the stomping Chicago-flavored *I'm Ready* and *My Babe*, while his tautly bent, economical guitar lines on the masterful *Ain't Nothing You Can Do* soar and wail with fervent assurance. Two new songs, *Rub My Back* and *(Ain't It) A Real Good Sign*, are also excellent

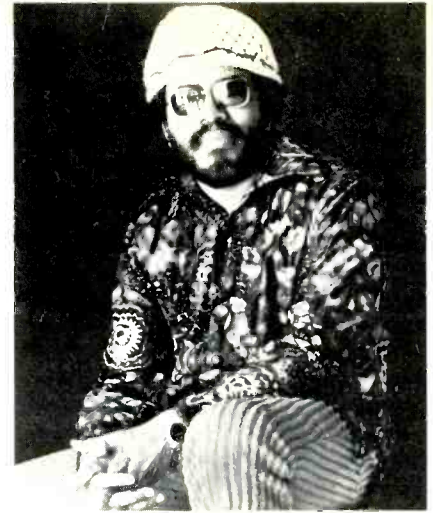

Renaissance: Lonnie Liston Smith & the Cosmic Echoes
RCA APL1-1822; stereo, \$6.98.

Having diluted his original electric-jazz concepts into a commercially successful "avant-muzak," Lonnie Liston Smith now reverts to a more substantial musical base.

Smith's last album, **Reflections of a Golden Dream**, ran the fluff gamut, from disco fluff to pretty fluff to spacey fluff. Contrast **Reflections** with **Renaissance**—from the opening moments of *Space Lady*, with its slowly twisting funk rhythm and subtle soloing by Donald Smith on flute and Lonnie on wahed electric piano, until the cooing vocal-group fade-out of the equally languorous album-ending title tune, all concerned seem involved with the music, an impression one never got with **Reflections**.

Not there's anything all that intricate, complex, or heavy on **Renaissance**. The compositions, such as the samba romp *Mardi Gras (Carnival)* and the sunny *A Song of Love*, are light and tuneful, the rhythms catchy and foot-tappable, and the overall feeling is one of mellow relaxation. Only David Hubbard's soprano solo on his Afro-modal *Mongotee* so much as hints at raucousness. Still, there's a lot of expert and inventive melodic playing by Lonnie and the Echoes and effective singing by Donald Smith (a welcome change from Lonnie's anti-vocals on **Reflections**), not to mention the orchestral overlays by Horace Ott which actually enhance Lonnie's electricity-filled basic tracks, rather than merely sweeten.

It should be noted that Lonnie is credited with acoustic piano and "electronic colorations," Ken Bichel with Moog, and Leon Pendarvis with clavinet. This leaves an awful lot of keyboard work—electric piano, mostly—unaccounted for. There's enough evidence of Lonnie's trademark echotic textures and lightweight structures



tinct artform, is to stave off a complete and final disappearance from the commercial marketplace, it will somehow have to be brought up-to-date in a manner that retains the music's identity in an altered form.

Albert presents a plausible solution to the blues' blues. Producer Bert de Coteaux, who earlier revitalized Ben E. King's dormant career, has fashioned a blues-oriented soul sound perfectly in keeping with Albert King's established style. Several tracks, most notably *Guitar Man* and *Running Out of Steam*, have contemporary funk arrangements, with disco-influenced backing vocals and bumping rhythm tracks, yet King's biting guitar solos and lazily tight vocals are as much "authentic" Albert King as was, say, *Born Under A Bad Sign*. Thus, **Albert**

hard-blues, though an unnecessary string section tends to blunt the impact of the former.

The rhythm section drives the music with a tenacious precision too often lacking from modern blues sessions. De Coteaux's arrangements for a six-man horn section are full and brassy, resulting in a forceful big-band sound not unlike Bobby Bland's mid-60s Duke classics. The vocal group grates on the ultra-commercial *I Don't Care What My Baby Do* and *Change of Pace*, but is otherwise acceptable.

The recording is very good, if unspectacular; perhaps a little cluttered on the busier funk tracks, but not so as to unduly distress anyone.

Tom Bingham

Sound: B Performance: A-

to credit him with the electric piano work, but why the omission? It's worth mentioning, though, that his most carefully conceived and most verbose solo on the album is on the acoustic instrument (on *Mardi Gras*).

The mixing could have better defined the overall group sound. The accompanying electric keyboard lines tend to clutter up the rhythm section sonically, though not musically. Also, I wouldn't be surprised if Ott intended the string section to be a bit lush than it sounds here. Surface noise plagues the fade-outs and quiet intros. Despite these flaws, the overall audio impression is quite favorable.

Tom Bingham

Sound: B Performance: A-

Gary Lawrence and his Sizzling Syncopators

Blue Goose 2020: stereo, \$6.95.

Now that nostalgia-mongers have gotten tired of ragtime and shifted their allegiance to the 20s and early 30s, there's been a small flood of jazz and dance-band recreations with old charts originally played by McKinney's Cotton Pickers, Paul Whiteman, and a variety of British bands revived intact. Gary Lawrence has taken the next logical step, creating his own, newly-written arrangements of 70s songs in the 20s style.

Lawrence's debut album gets off to a shaky start, as he attempts to reinforce the point that these are indeed *new* arrangements by trying to accouter Barry White's *You're The First, The Last, My Everything* with 20s trappings. The result has as much relevance to the "Jazz Age" as Tony Orlando's so-called "ragtime rock" had to ragtime (or rock, for that matter). He's much more successful with Van McCoy's *The Hustle* which, when divorced from its bumping disco rhythm, emerges as a likeably perky, syncopated dance melody.

The rest of the album is thankfully devoted to more judiciously chosen period material. Lawrence's repertoire ranges from early big-band-jazz classics (Ellington's *The Mooche*, with bluesy solo breaks and Dukish reed voicings; and Henderson's *Sugarfoot Stomp*, the only untouched period chart on the album) to vo-do-deo-do lunacy (*Crazy Words*, *Crazy Tune*, and *Doin' The Raccoon*). However, the majority of the tunes—including such evocative dance-band favorites as *Clementine* (From *New Orleans*), *The Breakaway*, and *Thinking Of You*—establish a

middle ground which might be called "tasteful 20s commercialism."

The Sizzling Syncopators' execution of Lawrence's scores is admirable, evincing both sensitive restraint and a lighthearted good-times spirit. In other words, they're serious enough to play with precision, aplomb, and a commendable lack of hokum, yet they're not so serious they forget to have fun. The soloing, especially by the reeds, is ingeniously in keeping with Lawrence's intentions. (Incidentally, a highly creditable trombonist had his name left off the credits.) The rhythm section—banjoist John

Gill and drummer Hap Gormley are especially fine—kicks it all along with an authenticity and spontaneity too often missing from more self-conscious re-creations.

Producer Nick Perls has fashioned a very natural sound which captures much of what I imagine the old dance bands must have sounded like in person—biting brass, an airy reed blend, and a rhythm section balanced so that it adds bounce without over shadowing the rest of the band.

Tom Bingham

Sound: B+ Performance: B+

career training in multitrack studio recording

Institute of Audio Research offers a complete program of courses in modern audio recording technology.

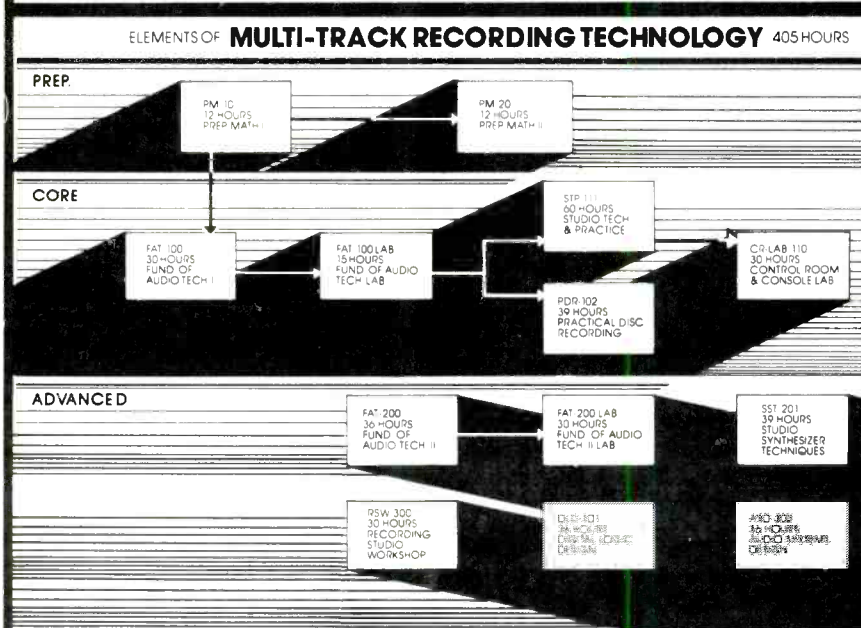

Accelerated Summer Term

In the 7 week summer term a beginning student may complete over 200 hours of this 405 hour program in Multitrack Recording Technology.



Write for information:
institute of audio research
64 University Place New York, N.Y. 10003
212 677-7580

LICENSED BY NEW YORK STATE EDUCATION DEPT.

Classical reviews

Edward Tatnall Canby

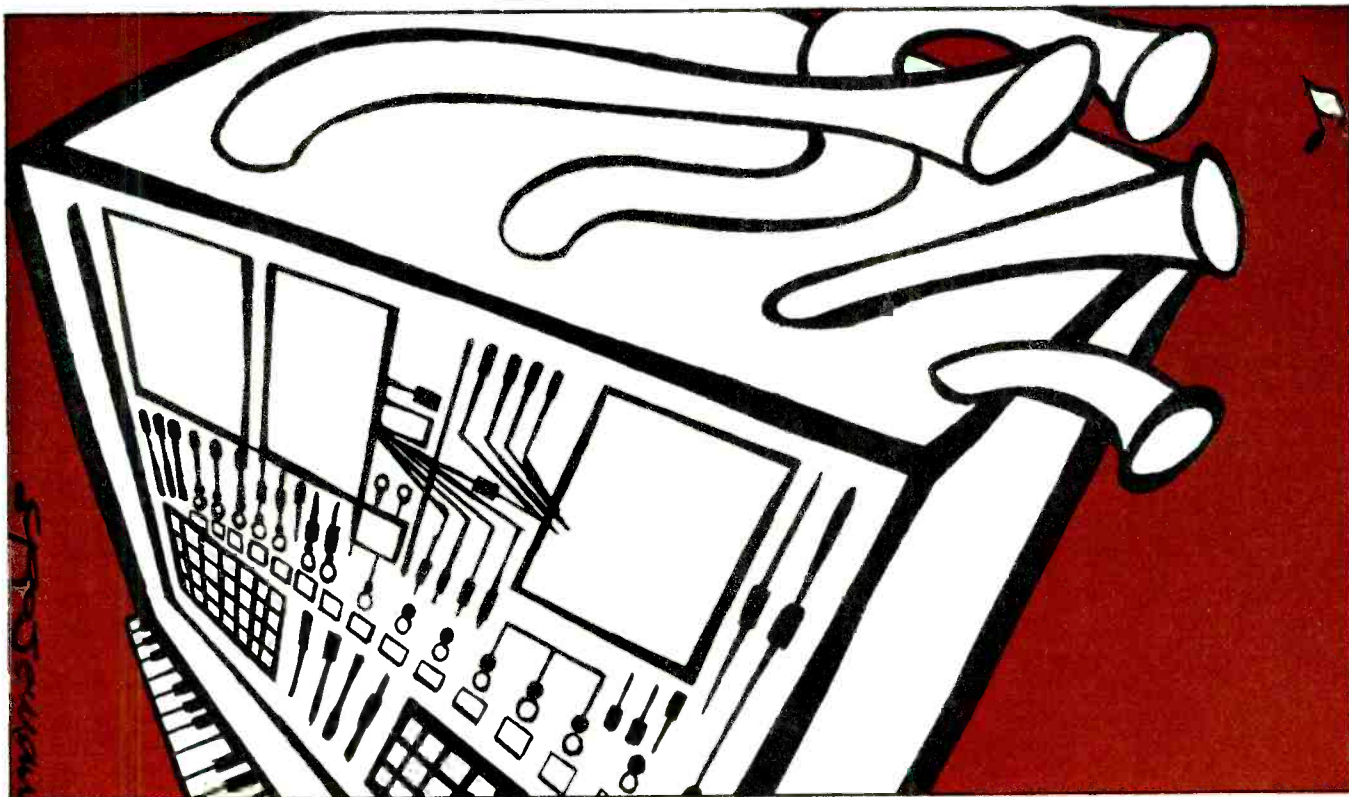

98

Subotnick: Until Spring (Created on the Electric Music Box)
Odyssey Y-34158, stereo, \$3.98.

Morton Subotnick is maybe the ultimate electronic composer. A big man, he writes big music, at least in length—two whole sides to this piece. But he is also fiendishly fond of silences, or long passages of nearly subliminal music, like the faint scratchings of mice in the attic or a heartbeat unamplified. This makes for problems in recording, to put it very mildly. A nightmare for the man at the tape machine and even worse for the guy who has to cut these mousy sounds into lacquer. And think of the pressing!

I'll have to admit that Columbia has, right here, the quietest disc I have ever heard, anywhere, and the mousiest tiny sounds I could ever imagine as workable via disc playback. No ticks, extremely little noticeable hiss, and no rumble. For minutes on end, while Subotnick's little mice stir about here and there, the sound of this disc is so smooth there is absolutely no trace of the familiar 33 1/3

rhythm which normally obtrudes itself in such places. Remarkable! You'd think somebody had turned off the machine, except for those mice in the speakers.

It's not all soft, of course. There are plenty of loud parts, and the electronic sounds are the very advanced type that have clean, sharp, complex transients and color, like live sound. Mostly, here, the sound is as of multiple tom-toms in complicated overlapping rhythms. Subotnick may go on and on, but his material is terse and economical in design—a rare thing in electronic work!

It doesn't say which brand of machine the "Electric Music Box" may be, but you can see a good piece of it in the cover photo, in case you are curious.

Krzysztof Penderecki, Roger Sessions, J. S. Bach. Roy Christensen, cello.
Gasparo GS-102, stereo, \$6.95, (P.O. Box 90574, Nashville, TN 37209).

Solo cello, all by itself. I suggest you skip side 1, Bach, in favor of a much

more lively side 2, the unpronounceable Krzysztof and the uncompromising Roger, both the very music of today. They come over.

The young classical guitarists play like Segovia, the ultimate old master, and cellists play like Casals, the same. Mr. Christensen's Bach Sonata No. 1, then, is Casals in manner, very old fashioned, all slow Romantic hesitations, lacking strong rhythm and in the end a bit flat. But turn the platter over and it's another story. Six short pieces by Roger Sessions, dean of older American modernists, all squeaks and jumps and stutters but the sound is full of life! After all, Mr. Christensen is contemporary too. It's his world. As for Penderecki of Poland, he goes even a few steps further into today—his *Capriccio* is full of weird thumps and bumps and scratches and taxi horns and a barnyard-full of other exotics, all put forth imperturbably by this excellent player. Not bad listening at all.

Very good and clear recording, too, if also somewhat old fashioned in that

the bottom tones of the instrument are prominent, making it sound bigger and fatter than it actually is. No great problem and maybe an asset if you are addicted to strong, clear bass reproduction.

Louis Moreau Gottschalk: Music for Piano Four Hands and Two Pianos. Eugene List, with Cary Lewis and Joseph Werner.

Vanguard VSD 71218, stereo, \$6.98.

For some years, Eugene List has made rather a specialty of the music of Gottschalk, that outstanding middle nineteenth century American composer from New Orleans, who trained in Europe among the great and whose catchy and tuneful piano music has been coming back on a wave of Americana. Good! Gottschalk, unlike most of the minor composers of that time, is really worth it. And you won't find better Gottschalk playing than on this excellent recording, decked out with a pair of performers for every piece and a lovely, full sound.

The three players alternate, if that is the word, between the top and bottom parts, *primo* and *secundo*, sometimes one, sometimes another on the lead—but so perfect is the teamwork that you will not be able to tell one from another. You may be sure, however, that the over-all sense of gracious, easy, light-fingered communication stems from the leader, List himself. Not a note is forced, never is a piece pushed too hard, and yet—such warmth and lift! Perfect pianism, especially for the recorded medium.

Gottschalk writes a very florid piano, in the manner of his time, after that great showman, Franz Liszt, but the music is much less weighty than Liszt, full of dance tunes and quite without fancy pretention—it ranks as the high-level pop music of its day, along with such as Offenbach and the Strauss waltz kings.

A special "extra" is the ever-present Latin-American slant, thanks to Gottschalk's infatuation with that area after an 1857 visit to the West Indies. In fact, he died, in Rio. Add to all this the excellent duo-piano recording by Vanguard and you really have a disc to play and play again.

Tippett: Symphony No. 1; Suite for the Birthday of Prince Charles: London Symphony Orch., Davis.

Philips 9500 107, stereo, \$7.95.

I like old Tippett! He is such an affable, extrovert of a big composer, so

AUDIO • May 1977

NUMBER ONE

The new Grace G707
is the largest selling tonearm in America
for a reason.

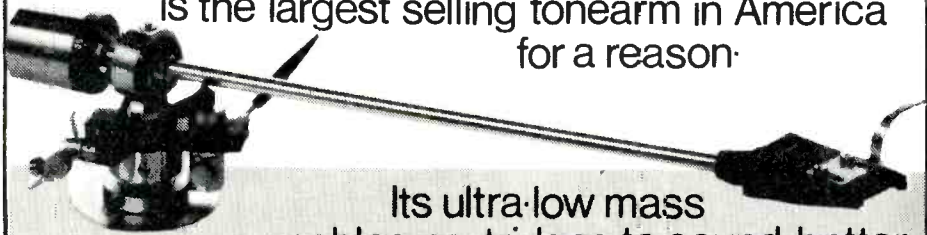

Its ultra-low mass
enables cartridges to sound better.

The name is Grace.

The tonearm: The G-707

It establishes new standards of cartridge performance and craftsmanship excellence. Critics and audio experts worldwide enthusiastically agree. About \$130 at the prestige audio specialist nearest you.

Contact: Sumiko, Inc., P.O. Box 5046, Berkeley, Ca 94705

Even our own!



Enter No. 40 on Reader Service Card

See What You've Been Missing... Read Audio's Classified

99

IN CHICAGO STAY AT THE

*Lake Shore
Drive Hotel*

THE BEST LOCATION
IN TOWN . . .



99 STEPS EAST OF MICHIGAN AVE.

Lake Michigan and the Park at your front door • Adjacent to business district and Michigan Ave. shops • Spacious Rooms and Suites (some with Kitchen & Bar) • Complimentary continental breakfast • Complete hotel service • Meeting and Banquet facilities up to 300 persons.

DINING AT
Sage's
EAST / WRITE TODAY
FOR BROCHURE
& TARIFF
DONALD O. CRONIN,
Gen. Mgr.

181 EAST LAKE SHORE DR.
CHICAGO, ILL. 60611
(312) 787-8500

PS AUDIO



... offers a first in Hi Fidelity. Now, for the price of a decent phono cartridge, you can buy sophisticated phono circuitry in an add on package. We guarantee that this unique device will LIFT A SONIC VEIL from your stereo, or we'll refund your entire purchase price.

While the **PS** AUDIO PHONO PREAMPLIFIER was designed to improve receivers and integrated amplifiers, separate preamps can benefit too. Write for details or circle the reader service card.

\$59.95*

*introductory offer expires June 30th

PS AUDIO

2734 Industrial Way,
Santa Maria Calif. 93454

Enter No. 29 on Reader Service Card

utterly at ease and so competent at orchestral writing, that you are somehow carried along by his music in spite of yourself, like a big smile. And this is so rare among British composers! Tippett was born in 1905, but you can put him into the wide generation that includes Walton and Britten, in a rough manner of speaking—that is, he is strictly pre-electronic, pre-old instruments, pre-chance music (aleatoric), a writer for the old-style big orchestra in its most marvelously advanced form.

This *Symphony No. 1* is WWII vintage and sheer neo-classic, mixed, to be sure, with a bit of British romance in the middle movement. The big beat, like middle Stravinsky, but less dry and altogether more genial. Really lovely clean musical sounds. (His later music is far more dissonant but never less than outgoing and, still friendly.) Gorgeous recording, too, and a performance that is sheer love and respect.

As for *Prince Charles*, this was his birth-day, his zeroeth birthday, and the music is just a big, floppy occasion piece, setting various folksy songs to a rousing prom-type big-orchestra treatment—*Pomp and Circumstance* but a lot leaner and stronger. Altogether a lovely record.

Hans Werner Henze: Kammermusik I-XII; In Memoriam: Die Weisse Rose. Philip Langridge, tenor, Timothy Walker, guitar, London Sinfonietta, Henze.

L'Oiseau-Lyre DSL 5, stereo, \$6.98.

For a long time, I've figured that Henze is one of the real German composers of the middle-older generation, if a modern/conservative. Like so much recent German music, his tends to be thick, complex, big, and long, and enormously skillful in technique, perhaps a residue of Wagnerian times. But unlike Orff, this does not, in Henze, cover up a lot of sheer superficiality, brilliant styling at the expense of real content. If you can stick out Henze, which isn't easy, you will begin to hear the real voice of music.

I was stunned by this **Kammermusik**, 12 pieces for small orchestra and tenor. It is overpowering. Moreover, not looking at the jacket, it struck me as, in this British performance, having an extraordinarily Benjamin Britten-like sound—and the tenor! Like Britten's ever-present Peter Pears. Well lo, I was right; the music is dedicated to Britten, and the first performance was done by no less than Peter Pears

himself. A continuing German-British coalition here, for Henze has also set words of W.H. Auden.

The music is post-Alban Berg, blended with Britten. Spare, slow, almost otherworldly, straight out of the late Austrian serial school, the "12-tone" composers who followed Schoenberg, it is a sort of ultimate version of this now long-since accepted style as it developed in the 1920s and 30s—the best known realizations perhaps being Berg's operas **Wozzeck** and **Lulu**. No matter—what counts is the superb performance by this dedicated group of instruments, the guitar solo, and above all Philip Langridge, who sings in the Peter Pears manner but better, I think, than Pears himself. An absolutely memorable recording.

The *Weisse Rose* is a short tailpiece at the end, similar in style, but more outspoken and faster. In memory of an anti-Hitler group, all of whom were executed.

A Guide to Gregorian Chant ... Including a Dictionary of Chant Terminology. Schola Antiqua, R. John Blackley.

Vanguard VSD 71217, stereo, \$6.98.

This, I must admit, is a very strange and confusing disc for me, who has had a nodding acquaintance with the age-old chant of the Catholic church ever since my student days—after all, it is the very foundation of European music. This chant was painstakingly and laboriously "restored" in the late 19th century, mainly by the Solesmes monks in France, who have been recording their music ever since the early electrical days—I had Solemnes 78 albums in the 1930s. And yet—here, with no fanfare, but a vast dose of scholarly terminology, comes a totally different sound, as unlike the familiar and accepted Solemnes-style way of Gregorian singing as, say, a cello is unlike a saxophone. Astonishing.

Don't ask me! The burden of the recording is to demonstrate three different traditions of Gregorian performance, the proportional, equalist, and metrical rhythmic approaches; yes, I hear the differences, more or less. But, I have to say again, all three of them are totally unlike any Gregorian I have ever heard before. Very dramatic and operatic, for one thing, which defies that monkish restraint which has supposedly been the right way for such a chant. Also with strange voice productions and tone colors, remote from all experience as we know it. Frankly, I am bewildered and also amazed that there is not a

word, in the complicated "dictionary" pages that serve as notes, which could help others as confused as myself. What gives, Vanguard??

Meranatha Choir of Christian Life Church, Baltimore

Richardson Recording RRS-4, stereo, \$6.95.

This handsome blue robed choir, posing outdoors near the sailing ship U.S. Constellation, is made up of Baltimoreans who have been born again in Christ and want to sing about it. Though the choir is mainly black, the minister, also the minister of music, is white and so are some of the singers. The Choir is well known on radio and now takes to records. But, alas, with the same thoughtless omissions as other groups—no address given, in case somebody wants to buy a copy, no record label (on top of the round label is where it belongs) for any sort of listing. I say this because—all you people out there—if you plan to distribute your special discs to a general public, and send them out to reviewers, you *must* provide these simple aids. Please do. So easy! (And don't expect your pet project *must be reviewed, not to mention favorably*—Editor.)

Anyhow, this is not quite what most of us think of, musically, as a gospel-type choir. The differences are in the voices, a great many of which sound trained and big, and in the content as well. The big chorus numbers, full of gusty, hand-clapping enthusiasm, are one thing. But some of the intervening solo items smack all too much of would-be TV and show biz, but minus the required professionalism. Some of it is barely even in tune. I can only say, stick to what you do best, people, and don't let Hollywood spoil your unique art.

(Editor's Note: Twenty minutes worth of phone calls enabled us to turn up the address where copies of the record may be obtained. Write: Christian Life Church, P.O. Box 7607, Baltimore, MD 21207.)

Liszt: The Complete Works for Violin & Piano. Endre Granet, vl., Francoise Regnat, pf.

Orion ORS 76210, stereo, \$6.98.

Violin and piano—something new in the way of Liszt, who is much better known for vast amounts of solo piano music plus numerous big works for orchestra. The small collection of this rare kind of Liszt makes good listening and very Lisztian, too. Each side fea-

tures one big early showpiece, scintillating variations on a theme with all the trimmings for both instruments. Each side, symmetrically, begins with two shorter and later works, as much as 40 years later, out of Liszt's increasingly significant old age when he was intensely experimenting with what amounts to sheer atonality. It is in Liszt, not Wagner, that we can find the roots of Schoenberg and the modern "12-tone" or serial school. Note especially *Elegy No. 1* on side 1, almost entirely a tortured chromatic melody, in half steps set to strange, shifting, never-resolved harmonies.

Good playing by both artists, the Granat violin richly guttural in the late-Romantic style though not as crisply articulated as it might be, the Regnat piano forceful and full of enthusiasm. Not a very good recorded balance, though the sound is clean enough. The violin is loud and very close-up, no matter where you listen, whereas the piano is just as irrevocably some distance away in a fair liveness. One wants to back away from the fiddle, move towards the piano.

Bloch: America, an Epic Rhapsody (1927). Symphony of the Air, Stokowski. **Vanguard Everyman SRV 545 SD**, stereo, \$3.98.

The title of this by-now slightly embarrassing piece tells all—it is epic, all right, and rhapsodic in an 1880 sort of way, a vast, sincere, and mealy expanse of Whitmanesque testimony to waving fields of grain, noble Indians, Pilgrims, the Soil, Abraham Lincoln, and everything else imaginable, by a very European immigrant who, unfortunately, really meant it; that's the trouble! Bloch was a great teacher and a fine man but, even so, this dreamy tone poem approach, the lengthy "program," the Chippewa Indian tunes that sound like Wagner or late MacDowell (*Indian Suite*), the negro spirituals, Dvorák but not as good, the pasty heroics and spread-out hymnings—the whole is just not for our present ears, however noble the inspiration. (One brief part I loved—*The Present*, corny 1926 jazz!) A Vanguard reissue, timed for the 200th. Try at your own risk.

Tchaikovsky Symphony #1 "Winter Dreams", Riccardo Muti cond. the New Philharmonic Orch. **HMV (EMI) ASD 3213**, SQ disc.

I can't recommend this recording too highly; it is a stunning achievement, both sonically and musically.

AUDIO • May 1977

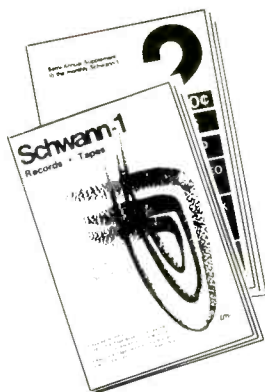

Enjoy Music More

If the recorded music you purchase and listen to is important in the way you enjoy life . . . you ought to know about a goldmine of helpful information for every record collector.

Schwann Record & Tape Guide

is a compilation of information about records and tapes of many classifications. This wonderfully useful catalog uncovers titles you didn't know were available, helps you select versions by conductors and artists whose work you prefer . . . shows you money-saving reprints on budget labels . . . and much, much more.

More than 65,000 records and 8-track and cassette tapes are listed in the monthly *Schwann-1* and its semi-annual companion, *Schwann-2*. All are available through your record dealer if you ask for them by Schwann title and number. Schwann opens up rich rewards in your record collecting hobby. See your record dealer for latest copies.

Schwann-1 Monthly. Lists the month's new releases in every category. Also nearly 45,000 available recordings on 702 record labels, 231 tape labels, 82 quadraphonic labels, in classical, recent popular, rock, jazz, musical shows, country, opera, ballet, electronic, etc. \$1.00 at your dealer's.

Schwann-2 The semi-annual companion catalog for specialized categories: pop more than two years old, classic jazz, classical classics of the pre-stereo era, also the great re-issue catalogs; international pop & folk on domestic labels, spoken, educational, religious, etc. 95c at your dealer's.

SPECIAL PRICE SAMPLE OFFER

If your favorite store doesn't carry Schwann, order samples by mail, but please try your dealer first. Prices include postage and handling.

- Latest Schwann-1 (monthly)..... \$1.60
- Latest Schwann-2 (semi-annual)..... \$1.40
- Combination Offer: latest Schwann-1 (monthly) and latest Schwann-2 (semi-annual)..... \$2.75
- Basic Record Library booklet.
Lists 1,000 suggestions in classical music by musical periods for your enjoyment.
Send 50c for cost of handling and postage.

I enclose \$ for the items checked above.

Name _____

Address _____

City _____ State _____ Zip _____

Dealer's Name & Address _____

Schwann Record & Tape Guide

137 Newbury Street, Boston, Mass. 02116

AU

Muti gives this rarely performed work a reading which is exemplary in every respect. He respects tempi, plays no games with phrasing, and in general gives a most musical and unmannered performance. He is aided by the splendid "ambient style" SQ recording. Great orchestral power here, with a wide dynamic range, ultra-clean sound of incisive clarity. Superb balance between the orchestral choirs, and a fine sense of spaciousness in the hall acoustics. The sonority of the

brass and low percussion in some of the great fortissimos have to be heard to be believed. Surfaces were quite good, with only a smattering of "ticks and pops." This is what symphonic recording is all about. Played in stereo, it is perfectly fine, but with the addition of hall ambience in the rear channels, there is no denying the increased awareness of the acoustic perspective and the enhancement of the musical experience. Don't miss this one!

The world's largest stone cathedral—and for most audio people the Christmas aspect of this recording will be subordinate to the sound itself—for, as I remember, the over-all decay time in the vast interior space is around *eight* seconds. There's plenty here, too, for those who want the works in terms of Episcopal church service on a solemn occasion. And a lot of music, strictly mixed-bag.

Some years back, my own small chorus tried out St. John's, singing in various locations, in the side chapels, out in the center of the vast nave, and so on. Wow! The side chapels are fine, being merely the size of a small church. But out in the middle! In most of our music, the singers could hear coming back at them the last four harmonies they had sung, in a glorious mixture of total non-sense. We refused to give a formal concert when we found we would have to sing out in the nave.

Well, life is strange. St. John's is a veritable hive of music, day in and day out, from Rock and Soul Music to Midnight Mass—and for most of the audiences, except those really close-to, it's all a splendid mish-mash. Live audiences, that is.

Enter Vanguard's mikes, manned by Marc Aubort, and you have something else, the power and the glory of recording technique at its most advantageous. What the living sound cannot do, the recorded product brings you with ease. True, if you listen closely you may be aware of that vast reverb, in the extreme background. But via good recording strategy and careful mixing the music comes to you without confusion and indeed, optimally for a "cathedral" sound. Any listener can hear it, too, not just those sitting close to the loudspeakers.

As for the music itself, to this jaundiced ear, it is professional church stuff, some excellent, some routine Sunday-type fare. What else? But you do get to hear the grand processions, from the distance to close-up, a large choir that's very pro and New Yorky, the Boys' Choir, almost angelic, anthems, motets, hymns, descants, carols, vast organ transitions (ugh)...the works. Good show.

Almost forgot. Down at the bottom of the back cover, if you look very closely, you'll find a note that "This SQ disc may be played..." etc. The only mention that this is a cathedral in surround sound. On the disc itself, not a sign of SQ. The front cover says stereo. Has somebody decided that SQ coding is poison (unless you don't know about it)? Life is strange!

New York University offers a new program combining music and technology.

Bachelor of Science with specialization in Music and Technology or Music and Business

A joint program of NYU's School of Education, Health, Nursing, and Arts Professions and College of Business and Public Administration in cooperation with the **Institute of Audio Research.**

For further information, write or call:

New York University
Ms. Rose Horowitz
Department of Music and Music Education
School of Education, Health, Nursing, and Arts Professions
777 Education Building
Washington Square
New York, N.Y. 10003
(212) 598-3491

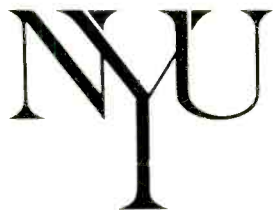

SCHOOL OF EDUCATION, HEALTH, NURSING, AND ARTS PROFESSIONS

New York University is an affirmative action/equal opportunity institution.

Sibelius: Four Legends from the Kalevala, Op. 22; In Memoriam, Op. 59: Hungarian State Symphony Orch., Jussi Jalas. **London ffr CS 6955**, stereo, \$6.98.

A splendid record, the real sound of Sibelius for orchestra! It isn't always that way, today, among conductors who no longer find his music easy to understand. These are five of the individual "tone poem" works, mostly based on Finnish legends about the hero with the cross-eyed name, Lemminkäinen, and only one of them is familiar Sibelius fare, the well-known *Swan of Tuonela* with its famed solo for English horn. As so often has happened, that work has been removed from a related series, supposed to go together. I find it invariably interesting to hear such a familiar piece at last put back into its original musical framework.

Listening to this excellent and, indeed, ardent interpretation of the Sibelius idiom, I had to remember that the Finns and Hungarians are close relatives, their two languages unique in larger Europe, out of the same roots. I would suppose this has at least something to do with the unusually fine understanding of the Finnish music shown by this all-Hungarian ensemble. Definitely worth a try, and you may forget the more famous orchestras and their jet-star conductors.

For hi-fi people, want to risk your hair standing on end? Mine did. Put on side 2 at the beginning, lowish in level, ominous. Stay with it through the first big climax, mostly strings; then a dramatic pause and climax #2 comes with a blast of dissonant brass that could sell you on old Sibelius for quite some time...Well, if it doesn't, what more can I say?

Christmas Eve at the Cathedral of St. John the Divine: Richard Westenburg, Conductor in Residence, David Pizarro, organist and Master of the Choristers, Cathedral Choir, Boys' Choir. **Vanguard VSD 71212**, SQ/stereo, \$6.98.

Classified

FOR SALE

THE SPEAKER STORE features the full line of VMPS Minimum Phase Response Loudspeakers, which in objective A-B comparisons outperform the most renowned and costly competitors. Seven VMPS models from \$72 to \$899 each, mail-orders accepted. Also, we demonstrate the Sound Concepts Digital Delay system and Trevor Lees' marvelous tube preamp. **THE SPEAKER STORE**, 4168 Piedmont Ave Oakland Ca 94611 (415) 658-6889.

DON'T PAY THE HIGH MAIL ORDER PRICES.

THIEVES WAREHOUSE OF HIALEAH, 6741 WEST 4TH AVENUE, HIALEAH, FLORIDA 33012

RECORDING TAPE - Money saving values! Maxell, TDK, Scotch, Cassettes, 8 tracks, reels. Free price list. Northhill Sales, Box 98014-A, Des Moines, Wa. 98188.

REMEMBER MY NAME!

By air parcel post in a short time you'll be able to get at a lower price, audio components and cords, kits of digital frequency display and multi-tester, etc. **K. SOEDA**, No. 5-9-503 Toshima 5-chome, Kita-ku, Tokyo 114, Japan

STEREO SAVINGS!!

Most popular and esoteric brands.
WILLNER, 223-B #4 Thayer, Providence, RI 02906.

LOWEST DISCOUNT PRICES ANYWHERE on audio equipment. All major brands discounted. Write for quotes, **K&L Sound Services**, 75 N. Beacon St., Watertown, Mass. 02172.

DIAMOND NEEDLES and Stereo Cartridges at Discount prices for Shure, Pickering, Stanton, Empire, Grado and ADC. Send for free catalog. **LYLE CARTRIDGES**, Dept. A, Box 69, Kensington Station, Brooklyn, New York 11218.

MODIFICATION MANUAL FOR VACUUM TUBE AUDIO EQUIPMENT 190+ pages of audio philosophy, design criteria, general instructions for all tubed equipment, and step-by-step procedures for optimizing performance of many components. "Proprietary" modifications detailed. If you can build a kit, this will enable you to upgrade hardware once doomed to garage sales. Latest printing includes new information, including a construction project for a **QUIET** Nuvistor sub-preamplifier...and more! Includes free consultation service - \$25.00. California residents add \$1.50. **AUDIO DIMENSIONS**, 8898 Clairemont Mesa, San Diego, Cal. 92123.

DON'T PAY THE HIGH MAIL ORDER PRICES. **THIEVES WAREHOUSE OF MIAMI**, 1756 S.W. 8th STREET. # 201, MIAMI, FLORIDA 33135.

CAMPUS REPS! CONSUMERS! DEALERS! Most medium and many high end lines available at lowest wholesale. Make 10%/40% Repping/Demonstrating high quality loudspeaker line. Prices, info. \$1 (refundable w/order) + SASE (812) 332-4252 **AUDIO 1010** S. Dunn, Bloomington, Indiana 47401.

ELECTRONIC CROSSOVERS—ALL TYPES. Updated definitive booklet describes applications, how to improve speaker systems, \$5.00 postpaid, credited to first purchase. **Huntington Electronics**, Box 2009A, Huntington, Conn. 06484.

ATTENTION DYNACO PAT 5 OWNERS! Our Pat 5 phono board update kit provides better definition, cleaner highs, tighter bass. Parts list and instructions-\$5.00. Complete Kit \$55.00 postpaid. **Musical Sound Lab**, Box 5503, Preston King Station, Arlington, Virginia 22205

FOR SALE

THE REAL TRUE BASS.

We believe that using a box resonance to obtain a clean uncolored bass cannot be the solution - That's why 3A has been created. 3A is the inventor of the Acoustic Pressure Feedback Principle (Don't get confused by other feedback systems).

We have been quoted flat to 30Hz - with 0.7% distortion at 30Hz - 1 Watt -

More information? Write for our explanatory color brochure to:

3A
172 Madison Avenue, Suite 602,
New York, New York 10016
U.S.A.

PALO ALTO CALIFORNIA

Dedicated to the proposition that audible differences between hi-fidelity components must form the ultimate basis for choosing among them.

Threshold	Rogers BBC
DB Systems	Dahlquist
Audionics	Linn Sondek
Ariston	Sonex
Connoisseur	Grace
Goldring	Onkyo
SupeX	J.H. Formula 4
A.E.A.	Dunlap Clarke
Koss Model Two	Stax
Decca Brush	Discwasher
Decca Cleaner	Denon

THE AUDIBLE DIFFERENCE

435 Tasso
Palo Alto, Ca. 94301
(415) 328-1081

SUPEX — ORTOFON — DENON — OTHER MOVING COIL CARTRIDGE OWNERS: Send for free literature on our Micro Preamp Superb performance at \$99.95. **Huntington Electronics**, Box 2009A, Huntington, Conn. 06484

ANTI-SKATING for AR TURNTABLES!! Proven counterweight design of nickel steel & aluminum construction. Install yourself in minutes. \$7.00 postpaid. (Dealer inquiries invited.) **AUDIO INNOVATIONAL PRODUCTS**, P.O. Box 1607, Portsmouth, N.H. 03801.

NO COMPROMISE ENGINEERING IN THE TIME ALIGN™ drivers gives the **SONEX TWO** speaker system detail and focus comparable to the finest electrostatics, with the dispersion necessary for enjoyment throughout the room. Impeccably linear down to very deep percussive bass. The **SONEX TWO** will delight even the jaded audio fanatic! **Absolute Audio**, 305 E. 17th, Santa Ana, CA 92706.

SOUND ADVICE MAGAZINE - THE FOURTH ISSUE REVIEWS THE NEW SOLID STATE ELECTRONICS FROM AUDIO RESEARCH: THE SP-4 PREAMP, D-100 AMPLIFIER AND UPDATED TYMPANI I-D SPEAKERS. THE REMARKABLE NEW VERION TRANSFORMER IS COMPARED TO OTHER TOP MOVING COIL PREAMPS: DB SYSTEMS, DENON TRANSFORMER AND MAS-1. WE'LL LOOK AT SOME NEW CARTRIDGES: GRADO SIGNATURE ONE, GOLDRING 900, MICROACOUSTICS 2002E, ORTOFON MC-20 AND GRACE F9L. PARAGON HAS IMPROVED THEIR TUBE PREAMP NOW CALLED THE 12 AND ADDED A SIMPLIFIED NEW MODEL FOR UNDER \$500. THERE'S MUCH MORE INCLUDING RECORD REVIEWS AND A COMPREHENSIVE SURVEY OF LOUD SPEAKERS. FOUR ISSUES FOR \$12. \$15 FIRST CLASS AND \$18 FOREIGN (SENT AIRMAIL). **SOUND ADVICE**, 225 KEARNY STREET, SAN FRANCISCO, CALIFORNIA 94108.

FOR SALE

ENGLISH HI-FI

B&W, Celestion, Decca, Tannoy, Garrard, Radford, SME, KEF, and very famous Transmission Line speakers for sale. Also, AEL Mini Monitors at £ 110.00 pair; Zeepa Anti-Static Gun at £ 6.50 & p/p £ 2.50, Zeppa Record Dust-Lifter at £ 4.00 & p/p £ 2.00, Linn Sondek, Saec arms. All from stock. Write for immediate airmail reply on all prices. **Mrs. Ling, Southern Audio Services Ltd.**, 43 High Street, Kingston, Surrey, UK. Tel: 01-549-3194. Telex 929679 AEL G.

PRESCRIPTION FOR AN AILING SYSTEM:

● Buy one Promethean Phase II custom cartridge - install after arrival and listen to as many times as desired.

Tired of cartridges that pass for "State-of-the Art" but sound metallic, thin, bright, pinched, hard, mushy, dead?

The **PROMETHEAN PHASE II** custom cartridge is a custom built, superior moving magnet cartridge with incredibly solid bass, clear, detailed, open, focused, alive, 3-dimensional sound without the problems found in other cartridges!

This remarkable cartridge is only \$135, requires no expensive cartridge preamp, and works in any tonearm with any cables. If you want to hear your piano recording sound like a real piano, order a cartridge (no literature) now!

Send \$135 check or money order to:

AUDIO EXCELLENCE
BOX 10253
PITTSBURGH, PA. 15232

CROWN DC 300A POWER AMP. MINT. \$650.00 203 288-4544.

CLASSIFIED ADVERTISING RATES

BUSINESS ADS - For Sale, Help Wanted, Services, Business Opportunities, Shortwave, Tape Recordings, etc. etc. 60c per word (minimum charge for eight words per line, \$4.80 per line). First line set in bold face type at no extra charge. Extra lines set in bold face type: \$1.20 per word (minimum charge for eight words per line, \$9.60 per line). One point ruled box, extra charge \$8.00. **Full payment must accompany order.**

NON BUSINESS ADS - Situations Wanted, used equipment for sale by private individuals: 35c per word (minimum charge for eight words per line, \$2.80 per line). First line set in bold face type at no extra charge. Extra lines set in bold face type: 70c per word (minimum charge for eight words per line, \$5.60 per line). **Full payment must accompany order.**

FREQUENCY DISCOUNT - 3 times, less 10%; 6 times, less 15%; 12 times, less 20%

BLIND ADS - Box numbers may be used at \$2.00 extra for handling and postage.

DISPLAY CLASSIFIED RATE

1 col x 1"	\$85
1 col x 2"	\$125
1 col x 3"	\$175
2 col x 1"	\$125
2 col x 2"	\$225

Advertiser must supply complete film negative ready for printing for mail order and display ads.

AUDIO Magazine
401 North Broad Street
Philadelphia, Penna 19108

HOW TO ANSWER BOX NUMBER ADS

When replying to an Audio Box Number Ad, please use this address: Box No. c/o Audio, 401 No. Broad Street, Philadelphia, Pa 19108.

FOR SALE

STEREO TV



The TE 200 TELEADAPTER EASILY CONNECTS TO ANY TV & STEREO SYSTEM. Using our coupling and matrix circuit, teledapter takes a low impedance output from the television and delivers two HIGH IMPEDANCE CHANNELS OF SIMULATED STEREO to drive any amplifier. Frequency response is maintained so you can hear the tinkle of bells or booming bass sounds as it happens on TV. With service warranty and hookup instructions \$19.95 ppd. Guaranteed to make your TV 100% more enjoyable.

OUR NEW TE 300 VHF UHF TELEVISION High Fidelity AUDIO TUNER is now available. Completely solid-state Recording and amp output jacks. Anodized Aluminum front panel and simulated Walnut Cabinet. 110 volt operation. \$169.95 ppd.

SEND CHECK, M.O. MASTERCHARGE or BANKAMERICARD NO and Expiration date TO RHOADES NATIONAL CORP DEPT NO 5C BOX 817, HENDERSONVILLE, TENNESSEE 37075.

NAME _____
ADDRESS _____
CITY _____ STATE _____ ZIP _____

SEND COMPLETE CATALOG

DON'T PAY THE HIGH MAIL ORDER PRICES. THIEVES WAREHOUSE OF HOLLYWOOD, 5719 HOLLYWOOD BOULEVARD, HOLLYWOOD, FLORIDA 33021.

TOURING SOUND SYSTEMS, 2, 4, and 8 Track Studios, Disco Sound, Cerwin Vega BGW, Altec, Shure, AKG, Tapco, Dyna, Revox, EV, Beyer, Cetec, etc K & L Sound Service, 75 North Beacon At, Watertown, Mass. 02172. (617) 787-4072-Att: Ken Berger.

PERFECTIONISTS PREFER DYNAKITS

Before Purchase You Owe Yourself Our Quote Mainline 11a 971 Fronheiser Johnstown, PA 15902

ATTENTION DYNA OWNERS: Our Dyna Double 400 modification with 16 output transistors, front end bypass, and 80,000 mfd power supply is twice as fast and twice as strong as a stock ST-400. Our Super PAT-5 has lightning fast ICs and improved high gain phono section. With a Denon DL103S straight in, these Super Dynakits show you just how great our Fulton Js and Magneplanars will play. **JENSENS STEREO SHOP,** where State of the Art is affordable. 2202 River Hills Drive, Burnsville, Minnesota, 55337. 612-890-3517

SEATTLE, WASHINGTON

—Seriously Pursuing The State of the Art—

Audio Research
G.A.S./Ampzilla
Quatre
Mark Levinson
Bravura
Dynaco (MODIFIED)
Connoisseur
Linn Sondek
Formula 4
Denon

Magneplanar
Fulton/FMI
Quad ESL
Beveridge
Yamaha
Nakamichi
AKG
ERA Mk6
Grace
Shure III

DEFINITIVE AUDIO

3414 NE 55th
Seattle, Washington
(206) 524-6633
Tuesday-Saturday

INFINITY SERVO-STATICS 1's \$1100; Levinson JC-2 \$850; Marantz 7C, 8B and 10B make offer. Paul, Rt. 4 Box 431-B, Chapel Hill, N.C. 27514; 919-929-6250.

MCINTOSH 275 amplifier. Excellent condition, \$355; McIntosh 110 FM tuner-preamp \$120. Call 614-837-3868 evenings.

DON'T PAY THE HIGH MAIL ORDER PRICES

THIEVES WAREHOUSE OF FT. WALTON BEACH
652-D BEAL PKWY, N.W., FT. WALTON BEACH, FL 32548

MAKING HIS MOVE — Mel Schilling, formerly of Willow Grove, Pa. has taken his knowledge of music and sound to California, where he will continue to serve a select nationwide clientele devoted to ultra state-of-the-art stereo. All shipments prepaid and insured. Write or call — 20929 Ventura Blvd., Woodland Hills, Calif. (213) 348-4600.

FOR SALE

WESTCHESTER, FAIRFIELD COUNTY

THE LISTENING ROOM INC.

590 Central Park Avenue
Scarsdale, N.Y. 10583
(914) 472-4558

Cordially invites you to audition our fine line of equipment. AMPZILLA II * SON OF AMPZILLA * AUDIO ANALYST * B & O * DAHLQUIST * DAYTON WRIGHT E.L.S. * DENON * DUNLAP CLARKE * GRACE * JANIS * KEF * LUXMAN * M & K * NAKAMICHI * PARAGON 12 * RAPPOPORT PRE-1 * S A E C * SEQUARRA * STAX * TANDBERG * THAEDRA * THOEBE * QUAD E.L.S. * YAMAHA

AUDIO PULSE DIGITAL DELAY SYSTEM

HAVE YOU HEARD THE DB SYSTEMS Crossover that you specify to match your system? It comes in bi- or tri-amped versions (with either stereo or common bass) at any crossover frequencies you order. It has the same low distortion — less than eight parts per million — that you've come to expect from a DB Systems product. 12 dB rolloff standard, 18 dB optional on bass and treble channels. For more information, contact your local DB Systems dealer, or write direct. DB Systems, P.O. Box 187, Jaffrey Center, NH 03454.

LEVINSON JC-1 CARTRIDGE PREAMP, \$100.00. Marantz 15 power amp, \$189.00, Supex SD-900-E cartridge, \$89.00. Ortofon SL-15, \$69.00, Shure V-15 type 2, \$45.00; B&O SP-12, \$59.00. All perfect. Phone 203-929-5255 or write Box 2009, Huntington, Conn. 06484.

SONY MODEL TC-880-2 tape deck new—save \$500. Now \$1995.

THE STEREO SHOPPE

3771 N. Michigan
Saginaw, MI 48604

REVOX A77 MK4 sealed box \$700; Revox A700 mint \$1500; Revox A720 mint \$1400; Revox A722 good \$250; Thorens TD126 sealed box \$400; McIntosh MR77 good \$500; Phase 4000 excellent \$450; Phase 400 excellent \$375; Marantz 500 \$700; Marantz 120B \$300; Klipsch Cornwall Walnut \$800; Yamaha NS1000 \$750; Yamaha TC800g1 \$200; Onkyo T4055 \$125; Sony TTS3000A SME3012 \$225; Kenwood KT 7000 \$130; Advent Dolby 100 cased \$175; Original Rectilinear 3's \$250; Technics SP10 Transcripitor \$400; Crown IC150 cased \$175; Dual 1019 \$85; Audiophile SA500 never used \$250; Presto 800 recorder make offer; Michael Wolf c/o Forex Travel, Statler Office Building, Park Square, Boston, Mass. 02116; phone 617-267-3765

AMPEX STUDIO RECORDER—Model 300, excellent condition, 10 1/2 inch reels, 7 1/2—15ips, 1/4 inch tape, 1/2 track stereo (\$850), will ship, (505) 299-9075

DYNAMIC VOLUME EXPANDER. Puts the "live" back into your program material. See Hirsch review of our product in Popular Electronics, Nov. '75. Immediate delivery for \$197.50 direct from manufacturer. Dealer inquiries invited. B-Cubed Eng. Inc. P.O. Box 95102, Schaumburg, Ill. 60196

IN ILLINOIS, OB SYSTEMS. Ariston, Grace, Micro-Acoustics, Allison, and much more: affordable excellence at Audio Ltd., 115 N. Walnut, Champaign 61820. 217-359-3774.

SONY TC-770-2, \$550. 213-457-2888

SOUND AND VIDEO recording, *WITHOUT* motors and moving parts? Diagram and investment opportunities \$3.28 to cover expenses. Send to: Gene R. Martin, 600 MacArthur Ave., San Pedro, Ca. 90731

DECCAPHILES—DECCA TONEARM, spare head shell, Deccalift \$75, Decca "London" cartridges, one new, one used briefly \$90 each. 805-466-4738 (7:30-8:30 AM)

MARK LEVINSON JC-2 preamp. Superb condition. \$670. 509-946-5200

FREE SAMPLE! World's first and only FREE AD Audio Newsletter. AUDIOMART, Box 821, Stratford, Connecticut 06497.

FOR SALE

DON'T PAY THE HIGH MAIL ORDER PRICES. THIEVES WAREHOUSE OF FT. LAUDERDALE, 3347 NORTH FEDERAL HIGHWAY, FT. LAUDERDALE, FLORIDA 33306.

DYNA STEREO 70 MOD KIT. Tighter bass, improved transient response, higher definition. Complete instructions, schematics, parts list. \$5.00. With parts kit, including all new tubes, \$58.00 all postpaid. Audio Designers, Box 122, Led yard, Conn. 06339

DON'T PAY THE HIGH MAIL ORDER PRICES. THIEVES WAREHOUSE OF WESTMINSTER, 2969 WEST 72ND AVENUE, WESTMINSTER, COLORADO 80030.

DON'T PAY THE HIGH MAIL ORDER PRICES. THIEVES WAREHOUSE OF MACON, 1564 EISENHOWER PARKWAY, MACON, GEORGIA 31206.

OUR TA-1 TONEARM IMPROVES RECORD SOUND with low effective mass (<2.5 grams with most cartridges) and pivot friction (all pivots jeweled), optimum silicone damping, vertical pivots at record level, anti-skate bias, damped cueing, and low capacitance cables. Money-back guarantee \$149.00 postpaid. JML Company, 39,000 Highway 128, Cloverdale, CA 95425

AUDIO PULSE DIGITAL DELAY SYSTEM: quantum step closer to the live experience. **AUDICOM,** Old Greenwich, Ct. 06870. (203) 637-3621

SONEX TWO SPEAKER SYSTEM. The Tin Ear Stereo Center has on demonstration the remarkable SONEX TWO speaker system. This TIME ALIGNED™ design provides exceptional clarity and definition with a sense of dimension and depth that is truly outstanding. The Tin Ear Stereo Center, 704 Symons, Richland, Wash. 99352; (509) 946-4459.

Garland Audio, Inc. cordially invites you to audition the SONEX TWO TIME ALIGNED™ speaker designed by E.M. Long. Openness, depth, detail, imaging, and musical transparency, in short, best describe the SONEX TWO.

Garland Audio, Inc.
3101 Telegraph Ave.
Berkeley, Cal. 94705
(415) 841-1591

Garland Audio, Inc.
2960 Stevens Creek Blvd. # D
San Jose, Cal. 95128
(408) 244-6724

CROWN 4 CHANNEL CX800 record playback with track sync and remote. 2 channel SX700 1/2 track record with 4 channel playback head. Asking \$2500. (516) 354-3737

RARE, QUAD TUBE AMPS two mono sets, new tubes, beautiful sound, innovative features, best offer over \$250; also Marantz 22 tuner \$150. (413) 584-8205

COLLECTOR'S ITEM—Thorens Turntable/Changer CD-43-N, Direct-drive, Stacks up to 12 records (any size or speed). Will pause up to 13 minutes between records. Variable speed control, repeat and reject, manual or automatic. Perfect condition \$150 with base. Also Supex SD-900-E \$75. Supex SOT-180 Variable Transformer \$90. Never used, both \$150. Vestigal Arm, never connected \$60. (206) 282-0155

INFINITY QUANTUM TWS \$900 Black Widow \$160, Paoli Amplifiers \$425. Mint. (415) 851-1202

MAGNECDRD 748-4 tape deck, 1/2 & 1/4 track. New heads, \$500 or best offer. Dave Shoaf, 305 Montague St., Ayden, N.C. 1-919-746-4898

DYNACO MARK III, 60 watts factory wired, perfect, \$125. Fonseca (615) 622-6182

FOR SALE, BEST OFFER, all equipment in excellent condition. 1-set 8 track heads, for 3M model M-79 recorder. 1-AKG BX-20E reverberation unit. 1-Quantum QM-12A, 12IN-4 out with additional factory installed options. Unit never installed. 1-Omnipressor model 2826. Contact Frank Tarsia (215) 561-3660

L.A. AND NEVADA DEALER for the new Promethean Phase II. An extremely clean smooth state of the art phono cartridge \$135. Also, a distortionless 100hz passive electronic crossover for bi-amp and sub-woofer application \$80. Serendipity Sound Specialties, Las Vegas, Nevada (702) 732-3933

FOR SALE

DON'T PAY THE HIGH MAIL ORDER PRICES. THIEVES WAREHOUSE OF RIDGEWOOD, 25 GOODWIN AVENUE, RIDGEWOOD, NEW JERSEY 07450.

WISCONSIN AND THE MIDWEST

AUDIOPHILE'S SOUND STUDIO IS AN ESTABLISHED DEALER IN SOPHISTICATED COMPONENTS FOR THE SERIOUS MUSIC LISTENER. WE OFFER FIVE INDEPENDENT AND FULLY-EQUIPPED LISTENING ROOMS, AND A TECHNICALLY COMPETENT STAFF WHO ARE WILLING TO APPRAISE HONESTLY ANY AND ALL EQUIPMENT. ALL OUR PRODUCTS ARE BACKED BY OUR SUPERB, PROFESSIONALLY EQUIPPED, AND STAFFED, SERVICE DEPARTMENT.

We are exclusive Wisconsin Dealers for Mark Levinson * Great American Sound Co. * Bower & Wilkins * Dayton Wright * Quad

Our carefully selected product lines also include: Denon * I.M. Fried * Fulton * Lux Audio * B&O * Dahlquist * Magnepan * and many more outstanding products.

ALL OUR EQUIPMENT IS PRETESTED AND GUARANTEED TO MEET SPECIFICATIONS. WE ALSO SHIP PREPAID AND INSURED WITHIN THE CONTINENTAL U.S.

AUDIOPHILE'S SOUND STUDIO

7459 Elmwood Avenue
Middleton, Wisconsin 53562
Phone 608-836-3807

CHARLESTON, SOUTH CAROLINA: SUNLOFT AUDIO has Fulton J Modular and E Modular, Luxman, G.A.S., Nakamichi, Infinity, Epicure, Stax, B&O, Fidelity Research, Technics, Otari, dbx, Nexus Bravura, etc. SUNLOFT AUDIO, 825 Savannah Highway, Charleston, SC 29407 803-556-8623

STEREO REPRESENTATIVES NEEDED!!! Sell 100 brands!! Lowest Possible Prices!! Krasco 623 Campbell Ave West Haven, Connecticut 06516

MINNESOTA—GREAT AMERICAN SOUND, FMI, Bravura, Electro Research, Sequerra, Janis woofer, DB Systems, Paoli, Grace, Linn-Sondek, Shreve Rabco, more. AUDIO PERFECTION, 822 Regent Drive, Apple Valley, MN 55124; (612) 432-3222.

CONNOISSEUR SYSTEM - Phase Linear 400 amp and Soundcraftsmen 2217 preamp \$700; Pioneer TX-9100 Tuner \$225. Will sell entire one year old system for \$900. Robert Cook, P.O. Box 8282, Denver, Colorado 80201.

MINT: YAMAHA CA-1000, CT-800, SAE IICM, SME Tonearm (detach.), NEW: Luxman P-121 turntable. (518) 783-6890, Albany, N.Y.

THE NEW PARAGON SYSTEM—E PREAMP. Startling musical reproduction at the right price. Also the highly acclaimed Paragon Model 12 preamp. Both at Paragon of Sound. Call 301-229-2676 after 6:30 p.m. for an appointment to hear the difference.

JANSZEN Z412HP \$350 pr. Ampzilla \$500; Audio Research EC-4 \$200; Sony TTS-3000 \$150; 912-746-0037 after 6pm EST.

QUICK AIRMAIL SERVICE FROM TOKYO. All brands of Cartridges and Tone-Arms. Great money-saving. Write us today!! JAPAN AUDIO TRADING CO., Saikaen Bldg., 4-33-21, Kamimeguro, Meguro-ku, Tokyo.

ELECTRO-VOICE Patrician speaker. Make offer. Call 614-837-3868 evenings.

MARANTZ 7C, PAIR MODEL 2 AMPS., Revox A-700 new, Tympanii IC speakers, passive Xover. Best offers. Audio Box A75-1

MCINTOSH C-22 PREAMP, MC-240 amp, MR-71 tuner. Excellent condition. Recent clinic certified No. 590. Norton (512) 884-1961, 852-3707, 3421 Floyd, Corpus Christi, Texas 78411.

TDK SUPER AVILYN C-90 CASSETTES \$3.19 ea. 10 or more \$3.06 ea. SHIPPING & HANDLING 10% under \$20.00 7% over \$20.00. Free Catalog. SAXTONE TAPE SALES, 1776 Columbia Rd., N.W., Dept. A, Washington, DC 20009

FOR SALE

~ SAN FRANCISCO BAY AREA ~
 ~ DYNAMIC SPECIALTIES ~ AUDIOPHILE ITEMS DIV. ~
 PARAGON, ANALOG ENG, LEES, AUDIONICS, SOUNDCRAFTSMEN,
 FUTTERMAN, DYNACO, DAHLQUIST, FMI, M&K, RTR, HARTLEY,
 ERA, FR, GRACE, SUPEX, PROMETHEAN, SHURE, ALSO QUALITY
 USED EQUIPMENT VINTAGE & CURRENT: MARANTZ, QUAD,
 AUDIO RESEARCH, CITATION, MCINTOSH ETC. VACUUM TUBES:
 TELEFUNKEN, AMPEREX, MULLARD, VALVO, SIEMENS, GENELEX ETC.
 BANKAMERICARD ~ BUY ~ SELL ~ TRADE ~ MASTERCHARGE
 2261 SPRING ST, REDWOOD CITY, CA 94063
 415 - 364-6634 364-2494

5% OVER COST - Any new AKAI; DYNACO; MARANTZ; SANSUI stereo components. Free Catalogs: Audio Discount World, P.O. Box 99147, San Francisco, California 94109

CONNECTICUT: ADC-Accutrac, Advent, Audio Pulse, B&O, B.I.C., Citation, Epicure, Harman/Kardon, J.B.L., McIntosh, Nakamichi, Ortofon, Phase Linear, Sony, Stax, Tandberg, Yamaha. Will ship prepaid. Sounds Incredible, 226 White St., Danbury, Conn., 06810. (203) 748-3889 - phone quotes only.

SAVE UP TO 69% ON OVER 100 TOP BRAND AUDIO COMPONENTS FROM CARSTON STUDIOS. NEW ENGLAND'S AUDIO SUPERMARKET ONE OF THE OLDEST MAIL ORDER FIRMS (EST. 1952) AND CERTAINLY ONE OF THE MOST RELIABLE. ALL ORDERS SHIPPED FROM STOCKED WAREHOUSE. SEND FOR PRICE QUOTE AND PRICE LIST CARSTON STUDIOS, OLD BROOKFIELD ROAD, DANBURY, CONN. 06810

STEREO ONE FAIRFIELD, CONN.

For the exceptional listener who demands purity and fidelity of sound, we have carefully evaluated and offer:

MARK LEVINSON	STEREOTECH
MCINTOSH	ROTEL
BOZAK	DAHLQUIST
NAKAMICHI	LINN SONDEK
ADS/BRAUN	AKG
YAMAHA	STAX
BANG & OLUFSEN	TDK
DENON	MAXELL
SUPEX-GRACE	DISCWASHER
DRTOFON	M-K BOTTOM END
AGI	AUDIO PULSE
ARISTON	AMPEX-TAPE
REVOX	HARTLEY
	WATTS

We pay freight.

STEREO ONE INC.

1229 POST RD. FAIRFIELD, CONN. 06430
PHONE 203-255-5939

STAX SRA-12S preamp with two pair SRX mKIII headsets. Perfect condition. \$400 ppd. (919) 967-6087.

RECTILINEAR RESEARCH CORP. would appreciate comments from interested parties on the feasibility of offering our highly rated Models 5a and 7a fully assembled, wired and tested, LESS CABINET, at very substantial savings. Freight prepaid within UPS zone. Detailed drawings for enclosure included. Franchised and non-franchised dealers can participate. To assist in this survey, write: Kit Division/A Rectilinear—207 Bruckner Boulevard, Bronx, N.Y. 10454, 212-585-9400.

ESS AMT 1A Monitors mint condition with 2241-AM Crossover \$950. B. Hodges Route 2, Box 74-B30, Ohatchee, Alabama 36271. (205) 442-2524

RAW SPEAKERS, High Quality, Low Prices. Free informative catalog. Please include information about types of speakers needed. Speaker Warehouse, Dept. Albert 23316 Locust Way, Bethell, Washington 98011

ACOUSTAT-X (full-range electrostatic with integral amps), latest model, beautiful teakwood & off-white linen grill. Mint as new. Call 919-449-4132 (days only). Also Audio Research Oual 76A, Grace 707.

UHER TAPE RECORDERS Parts, accessories & service. We have moved to larger facilities. Write for a free Catalogue:

MARTEL Electronics
970-A E. Orangethorpe Avenue
Anaheim, CA 92801

FOR SALE

MARK LEVINSON	DAYTON WRIGHT
KEITH MONKS	LINN SONDEK
DAHLQUIST	MAGNEPAN
AMPZILLA	THAEDRA
POLK	STAX
FR	MK

ABSOLUTE SOUND ABSOLUTE SOUND ABSOLUTE SOUND

SAE	ESS
AVIO	GALE
RABCO	GRACE
DENON	REVOX
LUXMAN	LESICON
TANDBERG	KOSS ESL
DUNLAP CLARK	SONY V-FET
HARMAN KARDON	SOUNDCRAFTSMAN

ABSOLUTE SOUND - HIGH ACCURACY AUDIO COMPONENTS

(313) 527-2244 12400 Morang Detroit, Mich 48224
 (313) 549-7550 4354 N Woodward Rd Mich 48072
 (313) 662-2026 312 S State St Ann Arbor 48104

FULTON J MODULARS Current "SH" Type. Shipped Prepaid \$1,850. Randy (206) 525-7593 or (206) 524-6633.

AMPZILLA-THAEDRA SON OF AMPZILLA

Sound Advice, 536 State Road, Emmaus, Pa. 18049. Hours Mon., Tues., Thur., Fr., 12-9:30, Wed. 6-9:30, Sat. 10-6. (215) 967-4418.

DON'T PAY THE HIGH MAIL ORDER PRICES. THIEVES WAREHOUSE OF GAINESVILLE, 434 N.W. 13th STREET, GAINESVILLE, FLORIDA 32601.

DON'T PAY THE HIGH MAIL ORDER PRICES. THIEVES WAREHOUSE OF DUMONT, 78 WASHINGTON AVENUE, DUMONT, NEW JERSEY 07628.

STEREOPUS—Perhaps you haven't heard of us by now. With all the new equipment review quarterlies, you ought to know that only two others now in existence predate *Stereopus*. Our first volume of four issues is now complete. In it we reviewed several dozen components, from modestly priced but quality equipment to full fledged state-of-the-art. We don't believe in slighting any class of components—the high end is necessary to give a reference standard, less expensive components help us retain a sense of perspective.

Don't you think it is about time you checked out *Stereopus*? Volume Two has begun. It will consist of three newsletters and two larger issues. Our first newsletter, out now, has over a dozen product reviews, including a first impression of the new Full Range Heil loudspeaker system! Reviews upcoming include the B&W DM-6, Audioanalyst Anthem Array, Fried Model H, IMF Electronics TLS 50II, Sonex Two, and Koss Model Two loudspeakers, Jensen Double Stereo 400, Ampzilla II, and Audio Research D-100 power amps, Infinity FET, DB systems, Jensen FET-5, Audionics, and Audio Research SP-4 preamps, and much more. \$10.00/year (\$12.50 first class), \$12.50 Canada and foreign, (\$16.00 foreign air). Limited copies of Volume One still available at the same price. P.O. Box 509, Shalimar, Florida 32579.

RARE CHANCE AT THE ULTIMATE. Experienced audio connoisseurs agree the old tube-type STAX SRA-3S operating the Stax SRX headphone to be absolutely the audio ultimate. I have one of those very rare units. Perfect, seldom used condition. Originally \$185. Mine for \$175. (Do not confuse with later transistor model SRA-125) R. Weir, RR 1, Box 18, South Holland, IL 60473

FOR SALE

**BUILD YOUR OWN SPEAKERS
AND SAVE UP TO 50%.**

Send for our free, fact-packed 40 page catalog manual and learn how to assemble your own multi-element stereo speakers from scratch or from kits. Our catalog includes chapters on design, construction, drivers, enclosures, midranges, woofers, tweeters and horns. Write us today.

SPEAKERLAB
Dept. AD-A, 5500 35th N.E.
Seattle, Washington 98105



DON'T PAY THE HIGH MAIL ORDER PRICES. THIEVES WAREHOUSE OF JACKSONVILLE, 6078 QLO ST. AUGUSTINE ROAD, JACKSONVILLE, FLORIDA 32217.

DON'T PAY THE HIGH MAIL ORDER PRICES. THIEVES WAREHOUSE OF KNOXVILLE, 5710 KINGSTON PIKE, KNOXVILLE, TN 37919

NEW GENERATION Crown Amplifiers. Cleanest, Smoothest sound ever produced - Crown D1200/HP1200, on demo only at Barclay Recordings, 233 E Lancaster Ave., Wynedwood, PA 19096; (215) 667-3048.

SIEMENS, TELEFUNKEN AND AMPEREX and other top quality audio tubes available at very competitive prices. Contact Jim Wallace at 201 McMasters Drive, Monroeville, Penna. 15146 or (412) 373-2602.

**JOSEPH GRADO
ATTENTION!!**

**READERS OF AUDIO REVIEW PUBLICATIONS
(STEREOPHILE, SOUND ADVICE, ABSOLUTE
SOUND, ETC.) AND AUDIOPHILES.**

Joseph Grado of Grado Laboratories, Inc. is contemplating an educational audio newsletter for the sole benefit of the audiophile.

During recent lecture tours it became obvious that important audio information was badly needed by the Audiophile. Lecturing simply does not reach enough people, so a new method is being planned.

This newsletter will be non commercial and will deal primarily with the problems of setting up, listening to and evaluating what you hear through your high fidelity system.

It will further explain such things as why different tone arms "sound" different. What makes a turntable perform? How to evaluate a turntable properly. Why do phono pickups sound different even though they all measure flat? What to look for in loudspeakers.

It will also act as a communicator between Audiophiles. The publication will be sent free upon request and will be issued monthly.

Send now and list the publications to which you already subscribe.

Joseph Grado
4614 7th Avenue
Brooklyn, N.Y. 11220

FUTTERMAN CAPACITOR COUPLED output transformerless tube amplifiers. Reports contrariwise **GOLDEN EAR** owns Futterman patent not Dalquist. For information about the incomparable Futterman contact Golden Ear. We also manufacture the Reference Loudspeaker System. Rare find C/M Labs CC-2A preamp, simple, no frills, extremely quiet preamp, only \$250. C/M Labs RR805 professional rack-mount stereo receiver \$600. Rare Brociner mono tubed amp. Futterman updated, \$150. Latest Sheffield and other recordings. Request used/demo/one-of-a-kind list. **WANTED:** Used Marantz-McIntosh, Audio Research D-150 tubed equipment. **GOLDEN EAR**, Box 2189, Riverview, Michigan 48192. (313) 479-1234.

THRESHOLD 800A class A amp \$1675. J. Fong. 1238 Green St., San Francisco, CA 94109.

MCINTOSH 2300 power amplifier, perfect \$1200. (503) 344-9858.

Advertising Index

ADVERTISER	PAGE	ADVERTISER	PAGE
Ace Audio.....	114	Designatron.....	112
Hi-Fi Components		Audio Store	
Write Direct to Advertiser		Write Direct to Advertiser	
Acoustical Mfg.....	93	Discount Music.....	111
Current Dumpers		Record Club	
Enter No. 1 on Reader Service Card		Write Direct to Advertiser	
ADC.....	19	Discwasher.....	2, 88
Phono Cartridge		Direct to Disc Recording	
Write Direct to Advertiser		Write Direct to Advertiser	
AIWA.....	57	Dixie Hi-Fi.....	91
Cassette Deck, Receiver		Loudspeaker Systems	
Enter No. 2 on Reader Service Card		Enter No. 10 on Reader Service Card	
Analog Eng. Assoc.....	77, 78	Dokorder.....	35
Preamplifier		Cassette Recorder	
Enter No. 3 on Reader Service Card		Enter No. 11 on Reader Service Card	
Astatic Corp.....	69	Dolby.....	25
Microphones		FM	
Enter No. 4 on Reader Service Card		Write Direct to Advertiser	
The Audio Critic.....	95	Dual (United Audio).....	7
Publication		Tonearm	
Write Direct to Advertiser		Enter No. 12 on Reader Service Card	
Audio-technica.....	87	Dynamic Specialties.....	105
Headphones		Audio Store	
Write Direct to Advertiser		Write Direct to Advertiser	
Ball Corp.....	43	Elpa.....	63
Record Preservation Kit		Turntables	
Write Direct to Advertiser		Write Direct to Advertiser	
BASF.....	21	Empire.....	4
Cassette Tape		Phono Cartridge	
Write Direct to Advertiser		Enter No. 13 on Reader Service Card	
BGW.....	39	Fantasy Sound.....	115
Hi-Fi Components		Audio Store	
Enter No. 5 on Reader Service Card		Write Direct to Advertiser	
Bose.....	41	Garland Audio.....	114
Loudspeakers		Audio Store	
Write Direct to Advertiser		Write Direct to Advertiser	
BSR.....	16	Infinity Systems.....	53
Equalizer		Loudspeaker Systems	
Write Direct to Advertiser		Enter No. 14 on Reader Service Card	
Celestion.....	17	Institute of Audio Research.....	97
Loudspeaker Systems		Audio School	
Enter No. 6 on Reader Service Card		Enter No. 15 on Reader Service Card	
Crown International.....	89	JVC.....	33
Amplifier		Hi-Fi Components	
Enter No. 7 on Reader Service Card		Enter No. 16 on Reader Service Card	
Custom Stereo.....	113	Kenwood.....	65
Audio Store		Hi-Fi Components	
Write Direct to Advertiser		Enter No. 17 on Reader Service Card	
Dalquist.....	23	Koss.....	51
Loudspeaker Systems		Loudspeaker Systems	
Enter No. 8 on Reader Service Card		Enter No. 18 on Reader Service Card	
DBX, Inc.....	71		
Expander			
Enter No. 9 on Reader Service Card			

Advertising Index

ADVERTISER	PAGE	ADVERTISER	PAGE
Lake Shore Drive Hotel..... Hotel Write Direct to Advertiser	99	SAE..... Hi-Fi Components Enter No. 32 on Reader Service Card	13
Marantz..... Turntables Write Direct to Advertiser	118, Cov. III	Sansui..... Loudspeaker Systems Enter No. 33 on Reader Service Card	45
Maxell..... Magnetic Tape Enter No. 19 on Reader Service Card	15	Schwann..... Catalog Write Direct to Advertiser	101
McIntosh..... Catalog Enter No. 20 on Reader Service Card	88	H.H. Scott..... Tuner, Amplifier Enter No. 34 on Reader Service Card	5
McKay Dymek..... Tuner Enter No. 21 on Reader Service Card	12	Sharp Electronics..... Hi-Fi Components Enter No. 45 on Reader Service Card	75
Micro-Acoustics..... Hi-Fi Components Write Direct to Advertiser	26, 27	SME..... Tonearm Enter No. 35 on Reader Service Card	52
Nakamichi..... Hi-Fi Components Enter No. 22 on Reader Service Card	28, 29	Sony Corp..... Receiver Enter No. 36 on Reader Service Card	46, 47
Netricons..... Hi-Fi Components Enter No. 23 on Reader Service Card	12	Sony/Superscope..... Cassette Decks Write Direct to Advertiser	55
New York University..... Audio Course Enter No. 24 on Reader Service Card	102	Soundcraftsmen..... Hi-Fi Components Enter No. 37 on Reader Service Card	11
Ohm..... Loudspeaker Systems Enter No. 25 on Reader Service Card	37	Speakerlab..... Speaker Kits Write Direct to Advertiser	106
PAIA..... Synthesizer Kit Enter No. 26 on Reader Service Card	91	Spectro Acoustics..... Hi-Fi Components Enter No. 38 on Reader Service Card	90
Phase Linear..... Hi-Fi Components Enter No. 27 on Reader Service Card	61	Stanton..... Hi-Fi Components Enter No. 39 on Reader Service Card	3
Pioneer..... Turntables Enter No. 28 on Reader Service Card	Cov. II, Pg. 1	Sumiko..... Tonearm Enter No. 40 on Reader Service Card	99
PS Audio..... Preamplifier Enter No. 29 on Reader Service Card	99	TDK..... Cassettes Enter No. 41 on Reader Service Card	31
Rhoades..... Teledapter T.V. Sound Tuner Write Direct to Advertiser	104	Teac..... Hi-Fi Components Write Direct to Advertiser	Cov. IV
Rocelco..... Decca Record Brush Enter No. 30 on Reader Service Card	44	Ultralinear..... Loudspeaker Systems Write Direct to Advertiser	24
Roth/Sindell..... Receiver Enter No. 31 on Reader Service Card	83	Yamaha..... Loudspeaker Systems Write Direct to Advertiser	58, 59

FOR SALE

FREE details A DIFFERENT KIND OF RECORD CLUB

Discounts up to 73%, no "agree-to-purchase" obligations. All labels, Schwann catalog of thousands of titles; classical, pop, jazz, country, etc. Discount dividend certificates. Newsletter, accessories; quick service. 100% iron-clad guarantees. Write for free details.

dmc DISCOUNT MUSIC CLUB, INC. DEPT. 14-0577
650 Main Street, New Rochelle, N.Y. 10801

SHDP AROUND — Listen to every speaker available — then come to Cyberacoustic Laboratory and hear RTR's New Direct Drive Electrostatic DR-1 speaker system at Philadelphia's exclusive distributor — by appointment — 233 E. Lancaster Ave., Wynewood, PA 19096; (215) 667-3048.

The objective: **THE BEST SOUND FOR YOUR DOLLARS** "State of the Art" systems: \$895 to \$3449. **AUDIO HOUSE**, 5232 Sagamore Dr., Swartz Creek, Mich. 48473

SP4 — SP4 — SP4

New analog module preamp from Audio Research with their new D100 amp, more need not be said! Barclay Rec. & Electronics, 233 E. Lancaster Ave., Wynewood, Pa. 215-677-3048

CABINETS FOR DYNACO preamps, tuners. Quadaptor, Stereo 120, Literature, Geometrix, Box 612, Mexico, MO 65265

AMBIENCE DECODER FOR REAR CHANNELS, \$149.95. Free literature. Huntington Electronics, Box 2009-A, Huntington, Conn. 06484.

SAE IB \$475, Pioneer TX9100 \$200; V15TIII \$35, Dyna 6t80 \$90. 404-241-2519

NATURAL SOUND

invites you to hear the Sleeping Beauty, a new moving coil cartridge from Great American Sound, the amazing Rogers mini-monitors with the M & K Bottom End, the new classical and jazz Audio Lab recordings brought to you by A TRAIN LTD. Hear Thaedra and the new Ampzilla II... the world's finest amplifier.

Hear some of the world's finest equipment: Fulton, KEF, Quad, Acoustat, Lentek, Magnepan, Rogers, and Visonik speakers, M & K subwoofers, Great American Sound, Mark Levinson, Naim and DB Systems Electronics, Bravura, Paragon, and Rappaport preamps and the Paoli 60M tube amplifiers. Hear the Linn Sondek, Ariston and Connoisseur turntables with Grace, KMAL, and Formula 4 arms and Shure V15III-G, Satin, Denon and Fidelity Research Cartridges, Teac Esoteric and Otari tape decks.

If you are interested in THE state-of-the-art system, call or write us for details about the soon to be released Fulton Musical System. If you are interested in state-of-the-art recordings, Audio Lab, Levinson, Fulton, M & K, European Imports... write for a copy of our newsletter and catalog of audiophile records. **NATURAL SOUND**, 315 South 11th Street, Lincoln, Nebraska 68508. (402) 475-3325.

DON'T PAY THE HIGH MAIL ORDER PRICES THIEVES WAREHOUSE OF BOCA RATON, 499 NE 20th STREET, BOCA RATON FLORIDA 33431

We Deliver!

This magazine was mailed on

APR 4 1977

and, hopefully, delivered five to seven days later.

FOR SALE

J N.Y. — Long Island
DESIGNATRON
is your franchised dealer for:
 ADC * Advent * Allison * Audio/Pulse
 * AKG * Bose * Cizek * Dahlquist *
 dbx * Harman/Kardon * JBL * Luxman
 * McIntosh * Ortofon * Revox * SME *
 Soundcraftsmen * Tandberg * Technics
 * Thorens . . . and more *
 Stereo Components for the
 quality-conscious buyer. Talk to our
 friendly, knowledgeable staff.
 Compare components in our spacious,
 professionally designed showrooms.
 Have your music system tested and
 aligned in our \$20,000 *Quality Control*
 and *Precision Tuning Laboratory*.

DESIGNATRON'S
STEREO STORES INC.

Hicksville: 260 Old Country Rd.
 (Zip 11801) (516) 822-5277
 Setauket: 748 Route 25A
 (Zip 11733) (516) 751-0253

DON'T PAY THE HIGH MAIL ORDER PRICES
 THIEVES WAREHOUSE OF SARASOTA
 6564 GATEWAY AVENUE, SARASOTA, FLORIDA 33581

DON'T PAY THE HIGH MAIL ORDER PRICES. THIEVES
 WAREHOUSE OF FT. MEYERS, 3081 CLEVELAND AVENUE,
 FT. MEYERS, FLORIDA 33901.

POLK AUDIO MONITOR SERIES

AUDIO BREAKTHROUGHS now has on demonstration the
 remarkable new Polk loudspeakers. Compare them to the
 finest loudspeakers in the world. Both the Seven (\$129.95
 ea.) and the Ten (\$199.95 ea.) utilize high definition polymer
 laminate bass-midrange drivers, wide dispersion soft dome
 tweeters and fluid coupled sub-bass radiators. They are ca-
 pable of reproducing a highly defined phase accurate three
 dimensional sonic image which rivals the thousand dollar su-
 per speakers. They sound great with a small receiver, yet re-
 veal the fine subtleties of state of the art electronics like Le-
 vinson and G.A.S. Shipped free in U.S. Send for free bro-
 chures on Polk or our other fine lines. **AUDIO BREAK-**
THROUGHS, 1681 Northern Blvd., Manhasset L.I., N.Y.
 11030 516-627-7333

POLK AUDIO and AUDIO DEN

The Audio Den is proud to have on display and demonstra-
 tion the amazing Polk Audio Monitor Series. Our customers
 say, "Fantastic! Compares with the finest loudspeakers I
 have heard. Probably the best value in the history of au-
 dio!!!" Audiogram™, from the Audio Advisor said, "We were
 so impressed that we could not believe the prices. . . Other
 \$200 speakers simply do not come close to the standards
 set by the Model 10. . . And at their price, they are simply a
 steal." Come in for an audition or write us for information on
 Polk or our other state-of-the-art products. Polk is shipped
 free in the continental U.S. Monitor 10^s - 199.95 ea. Moni-
 tor 7^s 129.95 ea. and the incredible Mini Monitor 79.95 ea.
 Audio Den Ltd. 1320-34 Stony Brook Rd., Stony Brook L.I.,
 N.Y. 11790, 516-751-3350.

MCINTOSH MX114 tuner preamp excellent condition
 \$400, pair Klipsch Cornwall II speakers \$650, Crown IC150
 preamp w/case and warranty \$360—Don Levy (603) 431-
 8162

SP-10 OWNERS—Custom Hardwood Bases for MKII, MKI,
 now available in your choice of hardwoods; mountings avail-
 able for one, two or three tonearms; Dustcovers available.
 Prices start at \$195.00. Write or call for more information,
 photos. (SP-10 MKII in stock)

Only at
 Paul Heath Audio
 2036 N. Clark
 Chicago, Ill. 60614
 312-549-8100

FOR SALE

PROTECT YOUR LPs. Poly sleeves for jackets 8c round bot-
 tom inner sleeves 7c Poly lined paper sleeves 15c White
 jackets 35c Postage \$1.50 House of Records, Hillburn, New
 York 10931

DON'T PAY THE HIGH MAIL ORDER PRICES. THIEVES
 WAREHOUSE OF BIRMINGHAM #3, 203 South 18th
 Street, BIRMINGHAM, ALABAMA 35233

Professional Hi-Fi Home Study Course—Instructors in-
 clude Len Feldman, Julian Hirsch, Larry Klein and Larry Zide.
 Send \$2.00 for full color AUDIO PRIMER and information on
 joining (SAC) Society Audio Consultants, Dept. A, NY, NY
 10016

CONN. AND WESTERN MASS.'S LARGEST STEREO DEALER

● Accuphase ● Audio Technica ● Epicure ● Dahlquist
 ● B&W ● dB Systems ● Crown ● Quatre ● Phase
 Linear ● SAE ● ESS ● Soundcraftsmen ● Magneplan
 ● Magneplanar ● Mayware ● Grace ● Tandberg ●
 Technics ● SME ● Ortofon ● Revox ● TEAC ● DBX
 ● Beyer ● Stax ● AKG ● Nakamichi ● Sequerra ●
 Hartley Woofers ● Harman-Kardon ● Rabco ● Avid and
 more.

FRED LOCKE STEREO

Avon	East Hartford	New Haven
203-678-1797	203-289-3231	203-787-3469
Newington	Waterbury	Orange
203-666-0555	203-757-9296	203-795-5757
Springfield, MA.	Professional Products Division	
413-782-7111	203-828-1124	

DON'T PAY THE HIGH MAIL ORDER PRICES.
 THIEVES WAREHOUSE OF BIRMINGHAM,
 123 ROEBUCK PLAZA DR., BIRMINGHAM, ALA 35206

NORTHWEST AUDIOPHILES

The finest in Audio Components - Audio Research, Beveridge,
 Celestion, db systems, Dahlquist, Dayton Wright, Decca, Den-
 non, Dunlap Clarke, Dynaco, ERA, Fidelity Research, Fulton,
 Formula 4, Grace, Hartley, Linn Sondek, Luxman, Magneplan,
 Mark Levinson, Nakamichi, Quad, Quatre, Sonex, Sound-
 craftsmen, Shure, Spendor, Stax, Supex, Tandberg, Technics,
 Yamaha and more.

THE TIN EAR STEREO CENTER

704 Symons
 Richland, Wa. 99352
 (509) 946-4459

THE ABSOLUTE SOUND™, in its ninth issue, is reviewing
 Audio Research's solid-state electronics (the SP-4 and
 D-100); the Infinity Black Widow tone arm and FET pre-am-
 plifier; the Grado Signature cartridge; Ampzilla II; the (Van
 Alstine) Double Dyna 400; the Yamaha pre-amplifiers. Con-
 siderations include the Fulton J. Modular; the Kenwood KD-500
 turntable; the Yamaha B-2; Hegeman's Input Probe; the new
 Dahlquist sub-woofer and electronic low-pass filter. There
 will also be an extended discussion of the Acoustat-X. Other
 reviews include: the AGI 511 pre-amp; the Fidelity Research
 Mk III; the Celestion UL-6 speaker; the Stax tone arm; the
 Goldring 900 SE cartridge; and the Luxman PD-121 turn-
 table. There's more than that. A record manufacturer tells
 the truth about American recordings. We tell you how to stalk
 the foreign imported discs. The record review section has
 been greatly expanded to assist you in your search for the
 best recorded sound. Our technocrats will tell you how to put
 a 24-inch Hartley woofer in your living room floor; how to
 isolate your turntable from acoustic feedback (with the help
 of a few new devices) and how to come to grips with
 Heath's new super-amp, the AA-1640. It's all yours for \$12
 (four issues), or \$13 (Canada), or \$16 (outside North Ameri-
 ca). Include an extra two bucks if you want the magazine
 mailed first class. (Back issues: \$3). The Absolute Sound,
 Box 5 ab, Northport, New York, 11768.

BOB HEENAN SELLS QUALITY USED EQUIPMENT
ONLY. Almost anything available, from KLH compacts to
 Quad ESL's Everything unconditionally guaranteed. Send \$1
 for newsletter, handwritten. Sound Advice, 1908 Beacon
 Street, Brookline, Mass. 02148 or Tel. 617-734-2727.

KLIPSCH CORNWALLS \$850 pair, SAE 2400 \$650, B&O
 4002 \$625. (305) 857-0279

FOR SALE

10 1/2" Recorder Specialists: Fresh Scotch L/N 3600 ft. on
 new 1/4" NAB metal reels five for \$35.00. New low noise,
 high output Ampex tape on 10 1/2" metal reel, six for
 \$35.00. Reconditioned NAB metal 10 1/2" reels, \$24.00 per
 dozen. 10% on above for postage. Other tapes also on spe-
 cial, write for catalog: Sound, POB 88338, Atlanta, GA
 30338.

THOUSANDS OF LIKE NEW LP's and prerecorded tapes.
 Catalogue - \$1.50. House of Records, Hillburn, New York
 10931.

AUDIO'S HI-FI HANDBOOK

Complete reference guide to over 1,000 components in-
 cluding prices and specs. All arranged in tabular form for
 easy comparison. Plus over 30 outstanding articles on audio
 topics, trends and advances. State-of-the-art reading for audi-
 ophiles. Only a limited quantity available. Over 200 pages.
 Send \$4.50 (including shipping and handling) to: Jean Davis,
 Audio Hi-Fi Handbook, 401 N. Broad St., Phila., Pa. 19108.

NAME BRAND RECORDING TAPE, custom loaded. Avail-
 able in cassettes, reels, and cartridges. Huge savings direct
 from manufacturer. New catalogue now available, MJS, 516
 Brooks, San Jose, Calif. 95125 (408) 998-2693.

HI-FI ENTHUSIASTS WANTED!! Earn more than just spare
 money in your spare time. We need campus representatives
 to sell name brand stereo components at discount prices in
 your area. High commission, no investment required. Serious
 inquiries only, please Contact Alan Weisberg, K&L Sound
 Services Co. 75 N. Beacon St., Watertown, Mass. 02172

AMPEX TAPES

Ampex Audio Studio Mastering Tapes. 631-641, 406-407,
 and "GRAND MASTER" in stock for immediate shipment 1/4",
 1/2", 1" & 2" Factory fresh. Best Prices. TECHNARTS, 8555
 Fenton St., Silver Spring, MD 20910 (301) 585-1118.

DON'T PAY THE HIGH MAIL ORDER PRICES

THIEVES WAREHOUSE OF PENSACOLA
 3731 NAVY BOULEVARD, PENSACOLA, FLORIDA 32507

DON'T PAY THE HIGH MAIL ORDER PRICES

THIEVES WAREHOUSE OF ORLANDO,
 1915 EAST COLONIAL DRIVE, ORLANDO, FL 32803

CANADIANS: Best Hi-Fi discounts on over 96 leading Hi-Fi
 brands. Many exclusive factory closeout and special deals.
 Quotations via return mail. Nationwide mailorder service.
 FREE catalogs jam packed with bargains in Hi-Fi equipment,
 tape and recording accessories, calculators, telephones and
 accessories, kits, parts, etc. Hundreds of factory and govern-
 ment surplus specials too! American inquiries welcome. Rush
 free catalog request to ETCO, Dept. AUA, Box 741, Montreal
 H3C 2V2.

SMALL RECORDING STUDIO Crown 800 & 700 series
 tape decks, Tascam Model 10 Board Master Room Rever-
 beration unit AKG Mikes one year old. Bob Swan — 704-
 982-4726, Albemarle, N.C.

MXR's 10 Band equalizer, Discwasher Systems, Maxell Tape.
 Discounted. N.A.B. Audio, Box 7 Ottawa, IL 61350

SERVICE EQUIPMENT: B-K 1431 oscilloscope, B-K 280
 DVM. (919) 967-4781.

AUDIO RESEARCH D-76 amplifier and SP-3a-4 pre-amp
 (latest update by AR), under warranty, orig. cartons, excellent
 condition, both \$1250. Will sell separately. (212) 376-
 4842.

TANNOY SPEAKERS all models, Quad 405 amplifier, 33
 pre-amplifier. Write to Nat, 423 South Sixth Ave., Mount
 Vernon, NY 10550.

RICHMOND, VIRGINIA

Beveridge, Connoisseur, Dahlquist, Polk, Acoustat, SAE, Fons,
 Quatre, Transient Research, Fulton, Grace, Audio Research,
 Revox, Magneplan, Supex, Stax. Service by Electrical Engineer
 BSEE. AUDIO ART, 2215 E. Broad St., (804) 644-8903

FOR SALE

DON'T PAY THE HIGH MAIL ORDER PRICES
THIEVES WAREHOUSE OF PENSACOLA # 2, 3820 NORTH
9TH AVENUE, PENSACOLA, FLORIDA 32503.

AUDIO RESEARCH EC-4a electronic crossover. SP-3a-4
preamp; Dual 76a, Dual 75a amplifiers. (919) 967-4781 af-
ter 9:00 PM EST.

DON'T PAY THE HIGH MAIL ORDER PRICES
THIEVES WAREHOUSE OF ATLANTA, 4162 JONESBORO
RD., ZAYRE CENTER, FOREST PARK, GA 30050

COLORADO'S AUDIO ALTERNATIVE — Boulder Sound
Gallery, Ltd. — Purveyors of unusually fine audio systems
and service to meet the needs of all serious music lovers. Our
product selection includes the Acoustat X ESL, Allison, B & O,
B & W, Dahlquist, dbx, Dynavector, Fidelity Research, Fons,
Luxman, Magneplanar, Mark Levinson, M & K Sound,
Quad Acoustical, Quatre, RAM Sound Concepts, Stax,
Supex/Sumiko, Yamaha, and Ultraphase, Demo Lux M-6000
amp with new warranty available.
1200 Pearl, Boulder, Colorado 80302; 1-303-444-2626

EVERYTHING ON OPEN REEL! Classical. Popular. Dolby.
Quadraphonic. Latest releases. For "Reel News," send \$1.00
Barclay-Crocker, Room 857 A, 11 Broadway, New York
10004.

DON'T PAY THE HIGH MAIL ORDER PRICES. THIEVES
WAREHOUSE OF NORTH TAMPA, 1441 EAST FLETCHER AV-
ENUE, TAMPA, FLORIDA 33612

DECOURSEY ACTIVE ELECTRONIC CROSSOVERS
Model 110 dividing network, complete with regulated power
supply, for bi-amp, tri-amp, or quad-amp. Custom assembled
to meet your specifications. Monoaural, stereo or with derived
third channel. Plug-in Butterworth (maximally flat) filters, 6,
12, or 18 db. per octave at any desired audio frequency. OP-
TIONS: Summer for single woofer systems, VLF hi-pass fil-
ters for elimination of subsonic noise, derived third channel.
FOR OEM OR HOME ASSEMBLERS: Model 500 or 600 dual
filters. Regulated power supplies. Write for new brochure.
DECOURSEY ENGINEERING LABORATORY, 11828 Jef-
ferson Blvd., Culver City, CA 90230. Ph. (213) 397-9668

DON'T PAY THE HIGH MAIL ORDER PRICES
THIEVES WAREHOUSE OF ATLANTA
3164 PEACHTREE RD., N.E., ATLANTA, GEORGIA 30303

DON'T PAY THE HIGH MAIL ORDER PRICES
THIEVES WAREHOUSE OF ATLANTA
2769 LAKEWOOD AVE., S.W., ATLANTA, GEORGIA 30315

DON'T PAY THE HIGH MAIL ORDER PRICES
THIEVES WAREHOUSE OF ATLANTA
4166 BUFORD HIGHWAY, N.E., ATLANTA, GEORGIA 30345

* Looking for the finest new & used audio components?
* Want the inside info on the latest stereo projects?
* Got a gripe, an idea, or something important to say?
* Want audiophile opinion from across the country?

THE AUDIO FORUM

is for YOU! In our first issue:

* The nation's finest audio dealers select: "The Worlds Best
(Upgradeable) \$1000 Music System"!

* David Fletcher (Grace, Supex) on: "Tonearm-Cartridge
Compatibility".

* John Iverson (Electro-Research) on: "The Force Field Loud-
speaker". (With NO moving parts!)

* E. M. Long (Sonex) on: "Time Alignment Techniques".

* Mark Deneen (Paragon) on: "Wide Band Tube Design".

* John Curl (Levinson) on "Ultra low noise design".

* Plus: "Reviewing the Reviewers"; The "Womens View-
point"; Reader reviews; Free subscriber classified ads; and
much, much more! Send \$15 for six bimonthly issues to:
**AUDIO FORUM, BOX 578, Fairfax CA 94930 415-453-
9530**

FOR SALE

DON'T PAY THE HIGH MAIL ORDER PRICES
THIEVES WAREHOUSE OF ST. PETERSBURG
9151 Park Boulevard, North Largo, Florida

AUDIO RESEARCH D-100s \$850 each; EC-4A, \$275; III-A
TM, \$600; Janis-styled subwoofers, \$250 each; Rabco SL-
8E, \$100; Dave, 614-474-6697 after 10 pm.

IN CONNECTICUT AUDIO RESEARCH is available at FRED
LOCKE STEREO Hear the *incomparable new* D 100, SP 4 and
Tympani I-D in acoustically designed rooms! FRED LOCKE
STEREO, 216 W. Main St., Avon (203-678-1797), and 1533
State St., New Haven (203-787-3469)

AUDIO DEN LTD

After careful auditioning we are proud to add to our already
fine line of audio products,
the BRAVURA & DB preamp
RAPPORT preamp
INFINITY (including BLACK WIDDW tonearm)
ROGERS MONITOR loudspeakers
YAMAHA and CM
NAKAMICHI
We also carry Fulton (60, 80, 100 in stock), Dahlquist, RTR,
Polk, Avid, Magneplanar, Quad (ESL and electronics), Lux,
Onkyo, B&O, Revox, Crown, Sonus, Grado Signature, Denon,
Grace Formula Four and Sheffield Labs.
FREE INSTALLATIONS IN N.Y. AREA. NO CHARGE FOR SHIP-
PING.

AUDIO DEN LTD
1320-34 Stony Brook Road
Stony Brook, New York 11790
516-751-3350

INFINITY SERVO Statik I with Dyna Stereo 70 \$1100
404-241-2519

DON'T PAY THE HIGH MAIL ORDER PRICES
THIEVES WAREHOUSE OF ATLANTA
1030-3 CHEROKEE ROAD, SMYRNA, GEORGIA 30080

VARIETY USED RECORDERS amplifiers, microphones,
speakers, bargain prices call 215-947-6217, write S. Spiel-
man 2440 Walton Rd. Huntingdon Valley Pa. 19006

Avant-garde
14583 Big Basin Way
Suite 2B, Saratoga, CA 95070
(408) 867-6677

TYPE YOUR SLIDES! Sizes 3 1/4 x 4 \$2.35 per 50 and 2 x 2
\$2.85 per 100 plus postage. Radio Mat Slide Co., 444 N.
Peninsula Drive, Daytona Beach, Fla. 32018

"RAW LOUDSPEAKERS"—We specialize in supplying the
industry with quality high wattage loudspeakers. If your cur-
rent supplier cannot deliver fast enough call us. We stock
what we build, sales geared for low or high volume users.
LTL Electronics, 525 N. Central St., Kent, WA 98031 (206)
852-3671.

DYNAVECTOR

at
THE LISTENING ROOM INC.
5900 Central Park Avenue
Scarsdale, N.Y. 10583
Tel. (914) 472-4558

LOW NOISE RESISTORS—1/4W, 5% from 1 to 4M7 ohms
for 3 1/2c ea. 50 per value \$.85 Postage & handling \$1. Send
25c for catalog, sample & specs. Components Center, Box
134A, NY, NY 10038

INNOVATIVE AUDIO

Audio Instruments & Service for the music lover & audi-
ophile. Crop in to experience us. You will experience a home-
like atmosphere as much as you need honest & concise infor-
mation, unmatched service, superb facilities & a good time.
Mark Levinson, Sequerra, Dunlap Clark, IMF Intl, Innotech,
Audio, Acoustat, Quatre, Spondor, AGI, DB Systems, Yamaha,
SAE, Accuphase, Stax, BGW, DBX, Klipsch, ADS, OHM, Micro-
seiki, Linn Sondek, Teac, Revox, Ortofon, Denon, Supex, Gale.
INNOVATIVE AUDIO
129 Degraw Street, Brooklyn, NY
(212) 596-0888

FOR SALE

CENTRAL OHIO Audiophile Art Headquarters

GAS • AUDIO RESEARCH
SAE • LINN SONDEK • FONS
TASCAM • MAGNEPAN
MAGNEPLANAR • KLIPSCH
GRACE • KIETH MONKS
SUPEX • FIDELITY RESEARCH
STAX • ROGERS • LUXMAN
AUDIO PULSE

CUSTOM STEREO

1391 S. Hamilton Rd., Columbus, OH 43227
235-7575

DON'T PAY THE HIGH MAIL ORDER PRICES. THIEVES
WAREHOUSE OF BETHESDA, P.O. Box 34251, WEST BETH-
ESDA, MD 20034.

AMPEX TAPE—NEW 1800' on 7" reel 12 for \$18 POST-
PAID, 1200' 12 for \$13 POSTPAID—free list—WIDE RE-
SPONSE, 6114A, SANTA MONICA BLVD., HOLLYWOOD, CA
90038.

DON'T PAY THE HIGH MAIL ORDER PRICES.
THIEVES WAREHOUSE OF TALLAHASSEE, 1119 APALACHEE
PARKWAY, PARKWAY SHOPPING CENTER, TALLAHASSEE,
FLORIDA 32301.

DON'T PAY THE HIGH MAIL ORDER PRICES. THIEVES
WAREHOUSE OF DAYTONA, 1769 SOUTH RIDGEWOOD,
SOUTH DAYTONA, FLORIDA 32019.

NORTHWEST AUDIOPHILES

THE TIN EAR presents high definition audio components for
the discriminating music lover

AUDIO RESEARCH	NAKAMICHI	MARK LEVINSON
BEVERIDGE	MAGNEPLANAR	TREVOR LEE
YAMAHA	FULTON	AUDIOANALYST
ROGERS	AKG	TECHNICS
LUXMAN	GRACE	DAHLQUIST
SUPEX	LINN SONDEK	QUAD
FORMULA 4	QUATRE	SONEX

Also: Audio Lab, Levinson, Pathi Marconi, Sheffield record-
ings.

THE TIN EAR STEREO CENTER
704 SYMONS, RICHLAND, WA. 99352
(509) 946-4459 Tues.-Sat.

DON'T PAY THE HIGH MAIL ORDER PRICES. THIEVES
WAREHOUSE OF AURORA, 10218 EAST COLEFAX, AURORA,
COLORADO 80010.

DON'T PAY THE HIGH MAIL ORDER PRICES. THIEVES
WAREHOUSE OF PENSACOLA #3, TOWN & COUNTRY
PLAZA, PENSACOLA, FLORIDA 32505.

DON'T PAY THE HIGH MAIL ORDER PRICES. THIEVES
WAREHOUSE OF MOBILE/VILLAGE SQUARE, 301 SOUTH
CRAFT HIGHWAY, MOBILE, ALABAMA.

OPAMP POWER SUPPLY

For Opamp filters, amplifiers, etc. Delivers +15 volts at 50
ma, regulated. Compact; suitable for PC board mounting. Each
\$27.50. DeCoursey Engineering Laboratory, 11828 Jefferson
Blvd., Culver City, CA 90230. Ph. (213) 397-9668.

THORENS TD-126C W/ADC XLM, purchased new
1/26/76. Absolutely perfect. \$375. Dynaco ST-400, mint,
\$425. Willner 223-B Thayer No. 4, Providence, R.I. 02906.
(401) 521-2072 after 6 pm.

CORNER HORN SPEAKER ENCLOSURE KITS Send for
free brochure. Kneller Audio Cabinets Dept "A", 6428 W.
27th Pl. Berwyn, Illinois 60402

WANTED—MARANTZ MONO PRE-AMPS and Model 6
Stereo Adaptors and Model 3 Electronic Crossovers. Also
want Lowther Speakers. C. Hawthorne 3675 38th Avenue,
Oakland, Calif. 94619. 415-531-7665.

FOR SALE

DON'T BE PUZZLED

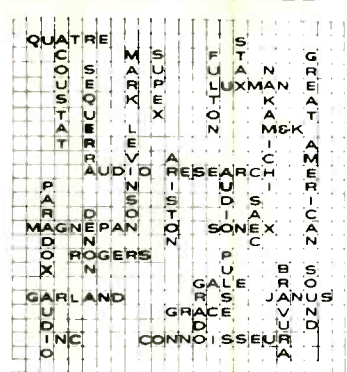

WE'LL FIT THE PIECES



GARLAND AUDIO, INC.
BERKELEY SAN JOSE
 3101 TELEGRAPH 2960 STEVENS CRK
 (415) 841-1591 (408) 244-6724
 TUES-FRI 11-6 SAT 10-5 CLOSED-SUN-MON

DON'T PAY THE HIGH MAIL ORDER PRICES. THIEVES WAREHOUSE OF BILOXI, 441 PORTER AVENUE, BILOXI, MISSISSIPPI 39530

DON'T PAY THE HIGH MAIL ORDER PRICES. THIEVES WAREHOUSE OF CLEARWATER, 1502A GULF TO BAY BOULEVARD, CLEARWATER, FLORIDA 33515

DON'T PAY THE HIGH MAIL ORDER PRICES. THIEVES WAREHOUSE OF BIRMINGHAM #2, 203 SOUTH 18TH STREET, BIRMINGHAM, ALABAMA 35233

CONTROL 1 - Signal Activated automatic power shut-off for Component Systems. \$49.95 Electromedia Design, Inc. Box 26, Livingston, N.J. 07039

DON'T PAY THE HIGH MAIL ORDER PRICES. THIEVES WAREHOUSE OF JACKSONVILLE NO. 3, CEDAR HILLS SHOPPING CENTER, 3716 BLANDING BLVD., JACKSONVILLE, FLORIDA 32210.

ONE STOP for all your professional audio requirements. Bottom line oriented. F.T.C. Brewer Company, P.O. Box 8057, Pensacola, Florida 32505

DON'T PAY THE HIGH MAIL ORDER PRICES THIEVES WAREHOUSE OF MOBILE 1770 BELTLINE HIGHWAY, MOBILE, ALABAMA 36609

DON'T PAY THE HIGH MAIL ORDER PRICES THIEVES WAREHOUSE OF ATLANTA #6 BELVEDERE PLAZA SHOPPING CENTER 1203 COLUMBIA DRIVE, DECATUR, GA. 30032

CYBERACOUSTIC LABORATORY is a research and development center combined with the most scientifically advanced audio acoustics lab. Exciting new product lines for 76-77 including: Audio Pulse Home Digital Delay Line, Acoustat Direct Tube Drive Electrostatic Spkr., Crown's New High Definition Series of Amps and Preamps, Fulton Systems, Infinity's New Quantum Spkr Series, Luxman Ultra-High Fidelity Solid State & Tubes, IMF International Spkrs., RTR Point Source Direct Drive Electrostatic Spkrs., IM Fried Models H, M, D, R II, L, Q & S Spkrs., Denon Blk & Wht Carts., Stax Electrostatic Spkrs., Nakamichi's Recording Director Series of Electronics, Source Engineering's New Noise Reduction System, EMT Moving Coil Cartridges, Transcriptors TT, Sonus Carts., Otari Decks, KEF Spkrs., Spondor Spkrs., Formula 4 Tonearms, Polk Spkrs., Fons TT **AND MUCH MORE!!!!** 233 E. Lancaster Ave., Wynewood, PA 19096; 215-667-3048.

FOR SALE

DYNAKITS, DYNASPEAKERS, SHURE, SME—lowest prices. **FRIED LOUDSPEAKERS** (not discounted). Perfectionist modifications. Underground HiFi Sales, 324c Broadwater Road, Arnold, Md 21012 (301) 647-0919.

**CHICAGO
 CHICAGO
 CHICAGO**

State-Of-The-Art has finally come to the windy city. Stereo Emporium of Buffalo, N.Y. and Paul Heath Audio of Rochester, N.Y., have joined together to form

PAUL HEATH AUDIO, LTD.

One of the most complete audio salons in the country. Acoustically designed demonstration facilities, instant A-B comparisons, experienced personnel, and honest money back policies all combine to make this **THE** place to audition the finest in audio.

WE HAVE, ON DEMONSTRATION: SPEAKERS

Magneplanar T IIIA, tri amp'd
 Magneplanar T-IC (BI or single amp'd)
 Dahlquist DD-10
 Magnepans-single and double
 Acoustat X
 Dayton Wright XG8III series II
 Beveridge cylindrical
 IMF Monitor IV, TLS80, TLS50
 Fried Model "H", R"
 Rogers BBC
 Koss Model 2
 B&O M-70
 Gale 401A
 Spondor BC1
 Quad ESL
 M&K subwoofer-single and double-(set up to be bi-amped with Magnepans, (1 or 2 pair); Dahlquists, Dayton Wrights, Quads, or Magneplanar T-IIIa-TM)

PRE-AMPS
 Mark Levinson LNP-2, JC-2
 Audio Research
 Thaedra
 Thoebe
 Dayton Wright
 DB Systems
 Quatre
 Quad
 Stax
TURNTABLES
 Linn Sondex
 Technics
 Lux
 Bank & Olufsen
 Connesieur
 Fons

CARTRIDGES
 EMT
 Grado Signature
 Denon
 Fidelity Research
 Sonus
 Satin
 ADC
 B&O

TAPE DECKS
 Revox
 Bang & Olufsen

RECEIVERS
 Onkyo
 Yamaha
 Bang & Olufsen

AMPLIFIERS
 Audio Research
 Ampzilla
 Son of Ampzilla
 Dunlap Clarke
 Mark Levinson
 Dayton Wright
 Quatre
 Quad
 Yamaha
ARMS
 Formula Four
 Grace
 Stax
 SME
 KMAL

TUNERS
 Sequerra
 Yamaha
 Onkyo
 Quad
 Dynaco

WE OFFER A FULL 5 YEARS PARTS AND LABDR WARRANTY ON EVERYTHING WE SELL. A 30 DAY REFUND POLICY, AND PRE-PAID FREIGHT IN THE CONTINENTAL U.S. PLEASE CALL OR WRITE FOR MORE INFORMATION.

PAUL HEATH AUDIO, LTD.
 2036 N. Clark
 Chicago, Ill. 60614

SAVE ON SACRED COWS-Bose, SAE, JBL, Thorens, Philips. Over 50 top brands. Write for quotes. **SOUTHBOUND SOUND**, P.O. Box 52508, Atlanta, Georgia 30355.

IMF SPEAKERS: Model R/II, perfect condition. Call after 2 pm. 216-792-2161 Ohio

FOR SALE

J. E. SUGDEN A48 integrated stereo amplifier \$360. P51 mono/stereo power amplifier \$300. C51 control unit \$225. In factory sealed cartons, complete array of printed boards and spares for Quad 33 & 303. R. Benavides, 630 Sun Valley Ct., Indianapolis, Indiana 46217.

IN PURSUIT OF EXCELLENCE WE OFFER: Luxman, Dayton-Wright, Nakamichi, I.M. Fried, ADS, Stax, BGW, Revox, Philips, Drtofom, SAE Beyer, DBX, McIntosh, JBL, Klipsch, Harman Kardon, Decca, SME, Dahlquist, Yamaha, Soundcraftsmen, Teac and more... Also custom room equalization, individually damped Altec and JBL Monitors and an ongoing equipment evaluation program. **THE HOUSE OF SOUND**, 821 Kent Avenue, Baltimore, Maryland, 21228, Tel: 301-747-5260

THE SENSIBLE SOUND: ONLY audio equipment testing publication with a "best sound for the money" philosophy. Subscribe \$10, \$11 Canada, \$16 Foreign. 403 Darwin, Snyder, NY 14226

THE WAREHOUSE — LOWEST PRICES ON TYPEWRITERS, MANUAL AND ELECTRIC. All brand new, factory sealed, and fully warranted. Free catalog and prices. **YOU CAN'T BUY IT ANYWHERE FOR LESS!** Fast service. **THE WAREHOUSE**, Dept 18, 187 North Main Street, Milltown, New Jersey 08850

CLASSICAL recordings old/current bi-monthly list. ARS Musica, 13 Dante St., Larchmont, N.Y. 10538.

DON'T PAY THE HIGH MAIL ORDER PRICES. THIEVES WAREHOUSE OF MOBILE #2, 301 SOUTH CRAFT HIGHWAY, CHICKASAW, ALABAMA 36105

MILWAUKEE & WISCONSIN'S ONLY TRUE AUDIOPHILE DEALER

Specialists in components by Audio Research, Dahlquist, Transcriptors, SAE, Nakamichi, Bozak, SME, DBX, Revox, Infinity, RTR, Phase-Linear, Tandberg, G.A.S., London-Decca, Stax, Sonus and over 50 others. Wisconsin's ONLY Audio Research dealer with their new product line on demonstration. Plus one of the truly largest displays of tape decks & accessories in the entire country. Over 130 machines on display. **WACK ELECTRONICS, INC. 5722 W. NORTH AVE. MILWAUKEE, WI. 53208**

DON'T PAY THE HIGH MAIL ORDER PRICES THIEVES WAREHOUSE OF ATLANTA ND 7, 215 COPELAND ROAD, ATLANTA, GEDRGIA 30342

KLH MODEL SCX-3A speaker mint condition, \$625.00. Call 1 (301) 742-5939

BACK ISSUE MAGAZINES. Over 200 titles. 1890 to 1977. Send Stamped Envelope. Free List. Everybody's Bookshop, Dept. AU, 317 West 6th, Los Angeles, Calif. 90014

—NDRTHERN OHIO AUDIOPHILES—

Akron's **GOLDEN GRAMOPHONE** (owned by audio systems)—Audio Research, Nakamichi, Magnepan, Great American Sound, Linn Sondex, ADS, Advent, SAE, Grace, Denon, Stax, Sonus, Grado Signature I, Vestigal, and many other fine audio components. 2858 W. Market St., Akron, Ohio 44313, 216-864-4411.

BUY DIRECT from England's Hi-Fi mail order specialists! Save on B&O Celestion, Tandberg, Revox, Transcriptors, Jordan-Watts, Lowther, KEF, Rogers, SME, Ariston, HPD, Sugden, Radford, Neal, Technics, Sony, Alwa, Yamaha, Pioneer, etc. Shipping list free or send \$3 bills to include literature. Goodwins, 7 The Broadway, WoodGreen, London N22. Phone 868 0077. Visitors welcome.

CANADIANS — DYNACO COMPONENTS AT TREMENDOUS DISCOUNTS. Write En-Jay Sales, Hornepayne, Ontario

FOR SALE

DON'T PAY THE HIGH MAIL ORDER PRICES
THIEVES WAREHOUSE OF TAMPA
1531 SOUTH DALE MABRY, TAMPA, FLORIDA 33609

DON'T PAY THE HIGH MAIL ORDER PRICES.
THIEVES WAREHOUSE OF PLANTATION, 231 SOUTH STATE
ROAD 7, PLANTATION, FLORIDA 33317

BIGGEST DISCOUNTS on audio - high-end components.
Over 125 brands. Audio Unlimited, 3386 Golf Dr., San
Jose, Ca. 95127; 408/737-0828 evenings.

DON'T PAY THE HIGH MAIL ORDER PRICES THIEVES
WAREHOUSE OF FAIR LAWN, 34-09 BROADWAY, FAIR
LAWN, NEW JERSEY 07410

SOUND GUARD \$5.75. Refills two for \$7.35. All postpaid
USA. Coastal Cinema, 1428 San Marco, Blvd., Jacksonville,
FL 32207

HEATHKIT/BELL & HOWELL tuner AJ15, brand new with
walnut cabinet. Both mint condition \$185. Heathkit/Bell &
Howell AAD 210 4 channel amp. 35 RMS per channel. Can
be used A52 independent stereos \$250; AR-XB91 \$75;
Sherwood 7100 A \$125; 4 large Advent speakers still in box
never opened \$125 each; Koss Phase 2 \$35. Eric Wertz, 411
Nobron Ln. #2716, Honolulu, Hawaii 96815

BLOMOAHL-ANIARA Columbia M25-902 (814) 238-6057

Discounts on most high-end lines. Free shipping.

AUDIOBROKERS
909 W. 77th Street, So. Drive.
Indianapolis, Indiana 46260

AKG, AMPZILLA, ARISTON, BEYER, CIZEK, CROWN,
Dahlquist, DB Systems, Denon Electronics, Entre, Fons, Grace,
Grado Signature, Infinity, Nakamichi, Ortofon, PHASE LIN-
EAR, PMI, REVOX, SAE, SAEC, Sennheiser, Sequerra, Sony,
Stanton, Stax, Supex, TASCAM, Technics, Thorens, etc.

HI-FI HAVEN
28 Easton Ave.
New Brunswick, N.J. 08901
201-249-5130

AN AUDIO SALON for discriminating music lovers and audi-
ophiles. Yamaha V. FET - McIntosh, Mitsubishi, Tandberg,
B&O, Hermary's, 386 El Camino Real, San Carlos, Ca. 415-
591-7194

ESOTERIC PRODUCTS - New and used. Audio Research,
Nakamichi, Ampzilla, Luxman, B&O, Dahlquist, Quatre. Write
for list. STEREO SHOP, 107 Third Ave SE, Cedar Rapids,
Iowa 52401

IN ILLINOIS, Quatre, DB Systems, Ariston, Allison, Grace,
Micro-Acoustics, & more: Affordable excellence at Audio Ltd.,
115 N. Walnut, Champaign, 217-359-3774.

FOR SALE: 6 Switchcraft Quadraswitchers (2 630-4A Pro-
gram Selectors, 2 631-4 Amp. Selectors, 2 632-4 spkr. se-
lectors), \$99, \$189 & \$149 resp. or best offer. Call (203)
637-9824.

IMF S SUBWOOFER DUAL 12' Transmission Line. Unfinish-
ed Chipboard Enclosure. KEF B139 Drivers. 314/449-2235,
104 E. Stewart Rd. #10, Columbia, MO. 65201

TUBE LOVERS, H.H. SCOTT 310E Tuner, needs its relays
cleaned and love, Leo Lutchanisky, Box 55, Dillingham, Alaska
99576

LEVINSON JC-2, 'A' and 'D' boards. (518) 783-6890, eves.
(Albany, N.Y.)

ATTENTION MUSICIANS! Low prices on instruments, spe-
cial effects devices, accessories. Free catalogue. Guaranteed.
C&D Music Co., Box 5128, Dept. B, Willowick, Ohio 44094

FOR SALE

M&K BOTTOM END SUB-WOOFERS POWERFUL, DETAILED, TIGHT, LOW BASS FOR THE BOTTOM TWO OCTAVES 80-20Hz.

If you have an ear for detailed sounds in bass, and a dislike
for "tubby" sound, we invite you to listen to the new BE-1A,
BE-1V and the DBE-1A. We believe they are the finest avail-
able sub-woofers.

A speaker for long sustained organ notes is easy to make and
the M&K BOTTOM ENDS are excellent in this regard; but, for
the discriminating audiophile, the BOTTOM ENDS also have:

- Superb detail on drum skin sounds and the ability to dis-
tinguish between various bass instruments.

- Solid feel of floor shock on Flamenco
- Exceptionally smooth transition to Quads ESL's, Acous-
tats, Magneplanars including T/M panels, Magnepan MG-II's,
Dahlquists, Dayton-Wrights, KLH-9's, and other fine audi-
ophile speakers.

- The lowest mid-bass & mid-range coloration of any sub-
woofer we have heard.

- New M&K universal matrixing & non-matrixing crossover
networks allow the use of one or two woofers, no bi-amping
necessary, your present stereo amp does it all.

- Extended frequency response, superb tone burst & pulse
response, high power handling capacity.

- The new DOUBLE BOTTOM END DBE-1A, our finest audi-
ophile super sub-woofer produces extremely high level deep
bass wavefronts with thrilling detail & definition.

- New M&K BASS RAMP to allow BOTTOM ENDS to be
used with high efficiency speakers such as Altec, JBL,
Klipsch, Tannoy, etc. The ramp is passive, works out of your
pre-amp tape in - tape out, and allows the full power of your
amplifier to be available. Front knob adjustable up to 20 db.
of correction.

NEW BASS & TRANSIENT MUSICAL TEST RECORD VOLUME II

- The new Bass & Transient Test Record, Volume II, con-
tains a brilliant array of musical sounds in classical, jazz,
marching bands, organ and opera passages.

- Each one is specifically designed to show and test im-
provements you can make to your system, as well as being
enjoyable on their own. A description of each of the twenty
bands tells what to listen for and its significance to audi-
ophile equipment.

- A few critical passages are excerpted and repeated sev-
eral times to avoid needle lifting and plastic deformation dis-
tortion in A-B comparisons or component evaluation.

- It is having an exceptional order rate from high-end audio
dealers and manufacturers. Really demonstrates tubby vs.
tight bass, very low frequencies and extremely high transient
peaks in high frequency crescendos. Available at your M&K
Dealer or by direct mail. (\$7.50-mail orders add \$1.00 for
postage.)

- Includes: 1812 Overture Finale with live cannons; Pipe
Organ and Orchestra; Bells; Flamenco Dancers; Xylophone;
Harp; Steam Locomotive

BE-1V "DAVID AND GOLIATH" - THE ALMOST INVISIBLE SYSTEM THAT SOUNDS LIKE A HUGE SPEAKER SYSTEM

- The BE-1V is a super sub-woofer with an internally in-
tegrated matrixing crossover network designed to work with
the new generation of small super speakers such as the "Vis-
ionic "David" 50's & 60's, B&W DM 5's, Roger's LS3/5A,
Jim Rogers JR-149, Polk's, ADS', KEF's, etc.

- The above mentioned small super speakers permit ex-
cellent decorator effects & when used in conjunction with
the BE-1V yield dynamic range, imaging, low distortion, defi-
nition and frequency response hard to distinguish from large
audiophile systems.

- Write for full descriptive literature on specifications and
principles involved. Of course, we don't expect you to believe
until you hear one of these systems at your M&K dealer.
Please come in and hear it. We have been enjoying watching
that expression of disbelief disappear.

Send for literature and dealer list.

MILLER AND KREISEL SOUND CORPORATION
8719 Wilshire Boulevard
Beverly Hills, California 90211
213-552-8318

DON'T PAY THE HIGH MAIL ORDER PRICES
THIEVES WAREHOUSE OF NORTH MIAMI BEACH, 1807 N.E.
164th STREET, MIAMI BEACH, FLORIDA 33162.

FOR SALE

BIC Turntables & Speakers at Wholesale Prices

DIRECT TO PUBLIC!
Factory Sealed - Full Manufacturer's Warranty

TURNABLES		LIST YOUR COST		SPEAKERS		LIST YOUR COST	
1000	\$280	\$166	FORMULA 1	\$ 75	\$ 47		
980	\$200	\$119	FORMULA 2	\$120	\$ 75		
960	\$160	\$ 95	FORMULA 4	\$160	\$100		
940	\$110	\$ 65	FORMULA 5	\$220	\$138		
920	\$ 80	\$ 48	FORMULA 6	\$300	\$185		
(Std. Base & Cover add \$15)			FORMULA 7	\$445	\$280		
(w. wd base add \$20)							

Send check or money order. No. C.O.D.'s

N. J. Residents add 5% ST

FREE CATALOG of Our Equally Amazing
Money Saving Stereo Equipment

the warehouse

187 N. Main St., Milltown, N.J. 08850

DON'T PAY THE HIGH MAIL ORDER PRICES
THIEVES WAREHOUSE OF PANAMA CITY, 5220 W HWY.
98, SUITE D. PANAMA CITY, FLA 32401

DON'T PAY THE HIGH MAIL ORDER PRICES
THIEVES WAREHOUSE OF MONTGOMERY
3386 NORMAN BRIDGE RD., MONTGOMERY, ALA 36105

FORMULA 4 model PLS4/D the best sounding universal
tone arm available at U.S. audio dealers. Literature \$1 bill.
Mayware Ltd. 15 Heather Walk, Edgware, Middlesex, HA8
9TS England.

TANBERG TR 2075, mint used, \$700; Son of Ampzilla,
mint used, \$350; 2 Tannoy Devon, new with warranty, \$450,
2 Dahlquist DQ-10, new with warranty, \$650. All prices
negotiable. C. Allen Durham, (703) 552-5568 Evenings.

TYMPANI Is, Gold fabric, \$650/offer. Vic 919/638-4463

AUDIO RESEARCH D-150 best offer over \$2000; ESS 504
amp with FAN \$520; Jensen stereo Dyna preamp FET-5
MKII \$325; Radford 20-22 preamp \$375; EMT XSD-15 cart.
only used a few hours \$200; Formula 4 arm \$85; Rabco
SL8-E \$150; Audio Craft AC300C arm \$110; Grado Signa-
ture One cartridge \$150; McIntosh MC240 power amp
\$250; McIntosh MC-75 mono power amp \$175; Thorens
TD-125 turntable no arm \$100; 4 ea. Electrovoice RE20 mi-
crophones \$140 ea.; 2 ea. Shure SM53 microphones
\$150 ea.; Shibaden video tape recorder model SV700VC
\$500; Panasonic strain gauge cartridge Model EPC 450C-II
\$60 ea.; custom demodulator power supply for strain gauge
cartridge, plugs in to preamp aux input \$100 ea.; J.P. Sam-
mut. P.O. Box 186, San Bruno, Ca. 94066

CANADIANS: ASSEMBLED DYNACO components, hardly
used, mint condition. Stereo 400, \$615; PAT-5, \$300; AF-6,
\$340. Will cover shipping C.O.D. within Ontario, Quebec and
Maritimes. Shipped fully insured. P.D., 1262 Lemoine, Sillery,
P.O. G1S 1A2

19 YEARS AUDIO \$25. Collins amps, preamp, power supply
\$35. Ampex tuning fork, heads etc. \$50. John Kozel, 101
Woods Ave., Rockville Centre, N.Y. 11570.

BRAND NEW QUAD 405 Dumping amps (2) \$315. Trevor
Lee preamp w/telefunks, T.L. Faceplate, Professionally
wired, \$285. More (408) 625-2433

HEATHKIT DOLBY Cassette, AD-1530, perfect condition
\$150. 616-982-3557

Accuphase T-100 Supertuner \$450 firm. Call 1-608-365-
5900 after 5 PM.

LOUDSPEAKER DESIGN COOKBOOK - Specific design in-
formation for air suspension, reflex, resistive and distributed
port, passive radiator, and T.L.'s. 9 graphs, 34 illustrations,
and 33 references make this one of the most comprehensive
references available. Price includes no-charge woofer analy-
sis (Q, impedance curve, cone mass, compliance etc.) (One
pair per customer, you pay postage). Excellent source book
for both the enthusiast and professional, \$6.50. To: Speaker
Research Associates, 3959 S.E. Hawthorne, Portland, ORE.
97214.

kit

● zero-distortion
on preamps

● equalizer

● power amp
lifiers

● electronic
x-over

● new "Pancake"
Preamp

free catalog:

ACE AUDIO CO.,
#532 5th Street,
East Northport,
New York 11731

TECHNIARTS

Professional Audio Equipment Showroom, Ampex, AKG, DBX, Crown International, Malatchi, Urban Parasound, Sescam on display and in stock for immediate delivery. 8555 Fenton Street, Silver Spring, MD 20910; 301-585-1118.

MICHIGAN AREA AUDIOPHILES: Perfectionist Stereo now on display at the **EQUINOX STUDIO**. Fulton FMI, Magnephanar, Magnephan, Rogers Monitors, Great American Sound GAS, Ampzilla, Paoli, DB Systems, Linn Sondek, KMAL, Grace, Win Labs, Denon, Fidelity Research, Promethean and more. 2763B, 44th St. S.E., Wyoming, Mi. 49508; 616-531-4530, 313-482-4801.

DAYTON WRIGHT XG-8-Mk3 loudspeaker \$1700. Ampzilla \$500. DB preamp \$340. ERA Mk6 (c) turntable \$135. Contact Larry Beiter, 719 Copeland, Pgh., Pa. 15232. (412) 683-9550.

SHOPPERS' GUIDE TO AUDIO MAIL ORDER DISTRIBUTORS—\$3.95 Hundreds of audio distributors worldwide surveyed! Box 94-A, Colmar, PA 18915.

SPEAKERS

B&W

Now the incomparable quality of B&W Loudspeakers from England is available in the Western U.S. Send name and address for information and the name of your nearest dealer.

CORINTHIAN MARKETING
P.O. Box 5948
Incline Village, NV 89450
(702) 831-3174

HIGH FIDELITY SPEAKERS REPAIRED
AMPRITE SPEAKERS SERVICE
655 Sixth Avenue, New York, N.Y. 10010
212-CH3-4812

PLANS & KITS

FM-3 FANS: Phase locked loop multiplex demodulator meter kit soon to be available. Send for free info. VSM Audio, P.O. Box 114, Maspeth, NY 11378.

LINEAR AMPLIFIER, 2—30 MHz, 140 watt mobile. Construction plans, \$3.00. IGOR, Box 5516-N5, Walnut Creek, CA 94596

SERVICES

CUSTOM RECORDING SERVICE, Tapes, discs, and cassettes. Stereo and mono. Live and copies. Editing. Masters and pressings. High quality at reasonable rates. Joseph Giovannelli, Audio-Tech Laboratories, 2819 Newkirk Ave., Brooklyn, N.Y. IN9-7134.

TAPE RECORDER HEADS re-lapped \$15.00 ea. Removed from machine or stack. One day service. E. Maher, 5 Evans Place, Orinda, Calif. 94563.

STEREO AND GUITAR SPEAKERS REBUILT Fast economical service. Dealer discounts. SRS 2409½ Colo. Ave., Colorado Springs, Co. 80904.

COLLECTORS' CONTACT GUIDE, \$4; Sound Search \$7; Unauthorized Duplication of Sound Recordings, \$6. Searches and referrals \$10 minimum prepaid. P. Jackson, Recorded Sound Research, 1506 W. Barker, Peoria, IL 61606.

STEREO SOUND LABS

Factory specs or better by 10% on all repairs on major brands. Warranty 90 days parts and labor. Ship us your gear properly packed and insured. 4419 John Marr Drive, Annandale, Virginia 22003 (703) 941-5707.

CROWN INTERNATIONAL

Complete repair, overhaul, and rebuilding service for current and early model Crown tape recorders and amplifiers. New Crown recorders in stock for immediate delivery. Excellent selection of reconditioned Crown recorders for sale. Used Crown recorders purchased and accepted for trade in. TECHNARTS 8555 Fenton Street, Silver Spring, MD 20910 301-585-1118.

TAPE DUPLICATION, 8 track & cassette. Rates write: Custom Audio, 4226 Robert St., Red Wing, Minn. 55066.

STEREO MASTERS, RECORDS AND ALBUMS. Check our prices. Newest type high level cutting equipment featuring: Neumann VMS 70 Computer control lathe. Parametric Equalization, Dolby, DBX, and the new SX74 Cutting System by Neumann. Special package prices on pure vinyl album and single record production. 1000 45 RPM stereo singles \$199.00 including mastering. 100 LP albums \$325.00 including printed jackets. Write or call for brochure. A & R Record Manufacturing Corp., 902 N. Industrial Blvd., Dallas, Texas 75207. Toll Free 1-800-527-3260.

NASHVILLE RECORD PRODUCTIONS WILL PRESS HIGH QUALITY PURE VINYL RECORDS FROM YOUR TAPES. SEND FOR SAMPLE RECORD AND PRICE LIST. ALSO FINEST DISC MASTERING. 469 Chestnut St., NASHVILLE TENNESSEE 37203.

POLK AUDIO PIONEER, DYNA SALES - Expert service - The Stereo Shop, 3907 Washington Rd., Martinez, GA. 30907 (404) 863-9143

WANTED TO BUY OR TRADE

OPEN REEL, pre-recorded tapes. Rock, folk, jazz, classical. Ray, 2282 Woodward, Lakewood, Ohio 44107.

REMOTE CONTROL for series "900" Heathkit television. 301 Pine Hill La., York, Pa. 17403 717-845-4003

RECORDING TAPE SPECIALIST OFFERS LOW PRICES, FAST SERVICE, WIDE VARIETY OF BRANDS, UNUSUAL CATALOG. SAXITONE TAPE SHOP, 1776 COLUMBIA ROAD, N.W. WASHINGTON, D.C. 20009.

WANTED: Harman-Kardon Citation II (tube-type) Power Amp. Any Condition. William Rankin, 128 Commonwealth Ave., Merrick, NY 11566.

RABCD SL-8E need not be in working condition. Dean Slindee Box 55, Lansing, Iowa 52151

QUAD electrostatic speakers (any condition), electronics (including Model II). Mention lowest price. DMS, 1360 Lake Shore, No. 2202, Chicago, IL 60610.

WANTED TO BUY OR TRADE

3 PIONEER OSCILLATOR scopes Model SD-1100, either 2-channel or 4-channel version. Please call or write with best price and condition. David Beatty Stereo, 1616 W. 43rd, Kansas City, Mo. 816-531-3109.

WANTED - RARE, OUT OF PRINT LPs with organ music popular and semi classic. Played by George Wright, Leon Berry, Don Baker, Al Melgrade and Buddy Cole. First order will be worth \$100 to supplier. Mr. C.M. Walton, Jr., 317 E. 67th St., N.Y., N.Y. 10021

CASH FOR your unwanted LPs & reel to reel tapes. Records. Box 323, Hillburn, New York 10931

WANTED: 4 CHANNEL open reel deck and pre-recorded quad tapes. Robert Guerin, 7125 Gail Way, Fair Oaks, CA 95628.

WANTED: Pre-1924 radio equipment and tubes. August J. Link, Surcom Associates, 305 Wisconsin Ave., Oceanside, Ca. 92054, (714) 722-6162.

WANTED SONY 850-2 & 650-4 Head Assy. Call Collect 904-476-6816

BOWERS & WILKINS Ionic Monitors, Fane Ionic Tweeters, Fane, Decca, Kelley Ribbon Tweeters. C.R. Cail, 2902 Santa Monica Dr., Decatur, Ga. 30032.

WANTED: One (1) Acoustic Research LST-2. Call Keith (618) 994-2935 mornings.

MARANTZ 7C, Z, 9, J, Fong, 1238 Green St., San Francisco, CA 94109.

WANTED - DIAPHRAM ASSEMBLIES for Pioneer PT-100 tweeters & PM-100 Midrange speakers. Jorgensen, 2241 Woodlawn, Erie, PA. 16510.

SITUATION WANTED

SOCIETY AUDIO CONSULTANTS member and dedicated audiophile wishes purchase of, or active partnership in, small to medium sized audio store. Audio Box A74-2.

DUTCH IMPORTER SEEKS TO REPRESENT High quality Audio equipment and accessories for starting on the Dutch market. Write Farlake Audio Postbox 6672 Rotterdam-Holland.

SALES REP. wants to buy stereo equipment from major brand distributors worldwide. Send catalogs and price quotes: L.W. David, World Ent., 729 Pinecrest Circle, New Albany, Miss. 38652. Member Int. Traders.

MUSICAL INSTRUMENTS

"LUDWIG" 14" BRASS SYMBOL set on foot pedal stand. \$60. T. McClure, Rt-2, Princeton, Kentucky 42445.

TAPE & TAPE RECORDERS

MAXELL, AMPEX, CAPITOL, Columbia Tape Bulk & Custom Loaded reels, cassettes. Reels, boxes, leader, splicers. For complete catalog write Omega Audio, Box 39253-B, Redford, MI 48239

T.V. CAMERAS FOR SALE (new) \$200. each. Also all accessories. Master Antenna Systems, Box 248, Branford, Conn. 06405

TDK, MAXELL, MEMOREX, BASF, cassettes, reels 8-tracks. Lowest prices. New. Guaranteed. FREE CATALOG S & S Audio, P.O. Box 56039, Harwood Hts. IL 60656

CUSTOMIZED TAPES. Jazz, Big Band. Select standard tracks or available artists. Free catalog 80 minute reel cassette or 8-track \$8.00. Tapes Unlimited, Box 163, Portsmouth, RI 02871

TAPE & TAPE RECORDERS

SCOTCH RECORDING TAPE. lowest prices TAPE CENTER Box 4305B, Washington, D.C. 20012

EVERYTHING ON OPEN REEL! Classical, Popular, Dolby, Quadraphonic. Latest releases. For "Reel News," send \$1.00. Barclay-Crocker, Room 857 A, 11 Broadway, New York 10004

RECORDING TAPE—OUTSTANDING VALUES
Write to: MAGNE HOUSE, 2271 Union # 4, San Francisco, CA 94123

CASSETTES, 8-TRK & REEL TAPES, lowest prices, name brands and custom loaded w/BASF or SCOTCH. Super mastering computer cassettes loaded with LAB SERIES TAPE. Prepaid shipment. FREE catalog STANFORD INTERNATIONAL, Box 809A, San Carlos, CA 94070

WE WILL BEAT any price sheet in America. Featuring TDK, MAXELL, and others. Tape World International, 220 Spring St., Butler, PA 16001.

SAVE! SCOTCH CUSTOM DOZEN 8 TRACKS - 45 min. \$15.75 Dozen. 90 min. \$19.50 Dozen - Postpaid. Custom Audio 4226 Robert St. Red Wing, Minn. 55066

BLANK RECORDING TAPE - Scotch, TDK, others. Don't buy another tape until you've checked our prices! M.R., P.O. Box 22635, San Francisco, Calif. 94122.

SONAR'S OPEN REEL TAPES Duped one to one from the master. All formats. Highest quality available anywhere! Send \$1.00 for catalog and stereo sampler 1/4 track, 7 1/2 ips tape. Sonar, P.O. Box 455A, Kingsbridge Station, Bronx, NY 10463

RECORDS

SOUNDTRACK RECORD ALBUMS—Mail Auction—Free List Whalon, 2321A Hill, Redondo Beach, Calif 90278

CATALOGS. Broadcasts, soundtracks Personalities of Thirties, Forties Box 225, New York, N.Y. 10028

WHILE YOU WERE LOOKING for out-of-print records, you should've been looking for us. DISContinued, 444 S. Victory Blvd., Burbank, Ca. 91502

QUASI-RATIONAL PRODUCTS has everything in record protection. Liners- covers- Discwasher- Watts. Also Maxell, TDK tape - Pioneer auto stereo - Jensen car speakers - Royce CB's, etcetera Reasonable, Swift, Reliable. Free catalog. QUASI-RATIONAL PRODUCTS, P.O. Box 171, Prospect Heights, Ill. 60070.

QUADRAPHONIC RECORDS AND TAPES - World's largest selection - all labels, over 1000 titles - at discount prices! For your free illustrated quad catalog, write: SOUND CONCEPTS, Box 654-C, Peoria, Illinois 61652

DISCOUNTS ON LP's, Tapes, Cutouts, Imports. Huge Catalogs. One Dollar. Record Finder Services NERT, Box 268, Lawrence, Mass. 01842

SOUNDTRACKS, CASTS, personalities! Free newsletter! RTSA, 3700 Plaza, F211, Santa Ana, Calif 92704

SOUNDTRACKS—JAZZ—POP. Vincent, Box 5202, Long Island City, N.Y. 11105.

78 RPM RECORD LISTS. (1) Popular & Jazz, (2) Americana, (3) Classical, (4) Country-Western. State category. AUCTION ONLY. Write, S.A. Langkammerer, RECORD LISTS, 3238 Stoddard, San Bernardino, Ca. 92405

SHOW ALBUMS—Rare. Out of Print LP's. 52 page list 50c. ROBBER BRIDEGRROOM 7" STEREO, 33-1/3, & songs - Jerry Orbach; Virginia Vestoff \$3.95 Broadway/Hollywood Recordings, Georgetown, Conn. 06829

BOOKS

BUY BOOKS BY MAIL AND SAVE. Send your check with order. We pay postage and handling.

No 1 - Sound System Engineering, By Davis. A comprehensive book covering the whole audio system \$19.95

No 2 - Microphones: Design and Application, By Burroughs. The practical use of microphones covering techniques, loading, sensitivity, proximity effect, temperature effect, maintenance, etc. \$20.00.

No 3 - The Recording Studio Handbook, by Woram. Everything to know about the recording studio from microphone to recording, to phasing and flanging to studio techniques. \$35.00

No 4 - From Tin Foil to Stereo, By Reed and Welch. A historical review of the evolution of the phonograph. \$19.95

Send your check with order to AUDIO Books, 401 North Broad Street, Philadelphia, Pa 19108

MISCELLANEOUS

TWO PIN SET—write—perfume guaranteed. \$4.95. Famous Jewelry Company, 12608 Rawsonville Rd., Belleville, Michigan 48111.

HOME AND INDUSTRY ENERGY SAVINGS

Rain in 6 days any area. Arrangements require for transportation and continued maintenance so you will be drought free thereafter. Crop Improvement Institute Inc., 1117 Washington Ave., Golden, Colorado 80401. Phone 303-279-0424. References available. Results or no fee.

TAPE SOUND COMPETITIONS Match your taped performance(s) with others! Participants evaluate. Details: MTS Box 13278 Sacramento, California 95813

TAPE RECORDINGS

OLDIES TAPES ON OPEN REEL TAPE. Rock n' Roll songs by their year of release. Over 100 songs per year. Free brochure. Rock N' Reel Rental, Dept. C, 4 Prescott Ave., Dix Hills, NY 11746

PHOTOGRAPHY

TAPE-SLIDE SYNCHRONIZER, lap-dissolve plans, \$5.50. With mixer, compressor, preamp schematics, \$8.50. The Millers, 1896 Maywood, S. Euclid, OH 44121.

AUTO ACCESSORIES

FUZZBUSTER POLICE RADAR DETECTORS. Latest Model, big discount. Hughes Electronics, 45 Dunn Street, Asheville, N.C. 28806

GOVT. SURPLUS

JEEPS, TRUCKS, Typically from \$52.40 ... Automobiles, Boats, Motorcycles, Airplanes, Cameras, Tools, Clothing, Sports, Camping, Photographic, Electronics Equipment ... 200,000 Bid Bargains Direct from Government Nationwide ... Low as 2c on Dollar! Surplus Catalog and Sales Directory \$1.00 (refundable). National Surplus Center, 240 Eastcass-AUD, Joliet, Ill. 60432.

MANUALS For Gov't. Surplus Electronics Equipment. List 50c. Books, 7218 Roanne Drive, Washington, DC 20021.

INSTRUCTION & EDUCATION

DEGREES, experience/credits. EMI, Inc. Box 4277, Inglewood, CA 90309

GET INTO BROADCASTING! Become a DJ, earn big money! Start your own station! Free details. Broadcasting, Box 5516-N5, Walnut Creek, CA 94596

PERSONALS

RECORDING STUDIO ENGINEER CAREER? Degree Unnecessary. Send two 13c stamps to Attainment Research, Box 45333AU, Dallas, Tex. 75245.

LEGAL FORMS, BIRTH, MARRIAGE, HIGH SCHOOL, College. Many others. Sold Blank. Free Brochure. Bristol House, 175 Fifth Ave., New York, NY 10010

EQUIPMENT WANTED

QUAD RECORDS WANTED: Mystic moods or sound effects on Warners label: G. Thilgen, 11390 Dorothy S.E. Lowell, Mich. 49331

HIGH FIDELITY

PINK NOISE TAPES. Measure loudspeaker response accurately with a microphone and voltmeter. 1/3 octave bands +1dB 31.5Hz to 16KHz. 15 ips-\$28 ppd 7 1/2 ips-\$23 ppd. Both 1/4" halftrack. Cassette available. Instructions included for stereo system or P.A. application. AUDIOLECTRO Audio Division, Box 5334-A, San Antonio, Texas 78201. QUALITY PRODUCTS SINCE 1929.

BUSINESS OPPORTUNITIES

OWNER'S HEALTH FORCES SALE!!

Well-established California audiophile store, five year national reputation, top lines, superb opportunity for diversified eccentric audiophile, priced for immediate bargain sale, terms negotiable, for details write: P.O. Box 637, San Carlos, CA 94070

HOMEWORKERS! BIG MONEY addressing, mailing envelopes. Valuable offer 10c. Linco, Dept. ADD, 3636 Peterson, Chicago 60659.

OUR PORTABLE DISCO SYSTEMS could make you rich. Earn \$150 night and more, playing records for parties, bars, weddings. Get in on one of the fastest growing best paying jobs. Free information. American Audio, 103 Ohio Ave, Fremont, Ohio 43420, 419-334-3326

RADIO PROGRAMS

OLD RADIO ON TAPE AND CASSETTES THOUSANDS AVAILABLE. 6 HOURS \$8.00 Immediate Service Catalogue 50c. Nostalgic Radio, Box 29K, Peoria, IL 61601

VINTAGE RADIO: Lowest rates, post free, traders welcome; shows for comics, etc. signals. Box 5063, Station E, Edmonton, Alta., Canada

1930-1962 RADIO PROGRAMS, Reels, \$1.00 hour! Cassettes, \$1.00 show! Mammoth catalog \$1.25. AM TREASURES, Box 192 AU, Babylon, New York 11702

GOLDEN AGE RADIO - your best source for radio tapes. Box 25215-D, Portland, Oregon 97225

YESTERDAY'S RADIO PROGRAMS ON TAPE. Reels, Cassettes. Fast-Reliable Service Catalog \$1.00 - refundable with first order. ADVENTURES, Box 4822-A, Inglewood, California 90302

RENT RADIO SHOWS Make your own copies or just listen. Great way to build your collection reasonably. Catalog \$1 refundable. OTR Rental, Box 1146, Livermore, Ca 94550

HELP WANTED

RECORDISTS interested in a high paying career. No experience necessary. No traveling. Modest investment required. Send resume to DGI, 551 NW 42nd Ave., Suite 304, Ft. Lauderdale, Fla. 33317.

THE MARANTZ

FOR THE BUDGET-MINDED PERFECTIONIST. THE 6100.

High on performance, the belt-drive 6100 features a super-dependable AC synchronous motor. The convenience of auto return and shut off. Plus full protection of your valuable records with a precision S-shaped tone arm, gentle-action viscous-damped cueing and anti-skate.

FOR THE BUTTON-PUSHER. THE TOTALLY AUTOMATIC 6200.

It's auto-everything. Auto start. Auto return and shut off. Auto repeat. Operates manually, as well. A servo motor, coupled

with belt drive, assures optimum speed accuracy. Stroboscopic pitch control "fine-tunes" speed to compensate for off-pitch records or for playing along with a musical instrument. The 6200 cares for your records, too, with a precision S-shaped tone arm, gentle-action viscous-damped cueing and anti-skate.



Model 6100/\$129.95*



Model 6200/\$199.95*

*Suggested 1st prices. Actual selling prices at dealer's discretion. All models come complete with anti-static turntable mat, plastic hinged dust cover, base enclosure, and low capacitance phono cables that assure 4-channel capability whenever you need it. The base enclosure for the 6300 is constructed of plywood, finished in genuine walnut veneer. The enclosures for the 6200 and 6100 are finished in walnut grain vinyl veneer.

TURNTABLES

FOR THE TOP-OF-THE-LINER. THE DIRECT DRIVE, OPTO-COUPLED AUTO LIFT 6300.

Features and technological excellence galore. Starting with **absolute speed accuracy** assured by a combination of **direct drive** design and **DC servo motor** that automatically compensates for voltage/speed fluctuations. Of course, there's **auto lift** and **shut off**, but on the 6300 it's **opto-coupled** — a significant Marantz exclusive. It means **no tracking distortion** caused by mechanical linkage between auto mechanism and tone arm. The secret: a tiny beam from a light-emitting diode maintains constant contact with a photo transistor during play.

At record's end, a sliding blade cuts contact, activating a circuit that lifts the tone arm and shuts off the motor. There's more. **Stroboscopic pitch control** "fine-tunes" speed to your personal preference. And **viscous damped cueing** gently, smoothly lowers the precision **S-shaped tone arm** onto the sensitive disk surface. **Vertical/lateral counterbalancing** and **anti-skate** result in lowest distortion and tracking error.

marantz®
We sound better.



Model 6300/S269.95

© 1976 Marantz Co., Inc., a subsidiary of Superscope, Inc., 20525 Nordhoff St., Chatsworth, CA 91311. Prices and models subject to change without notice. Consult the Yellow Pages for your nearest Marantz dealer.

THE TOP-RATED PERFORMER THAT JUST GOT A FACE LIFT.

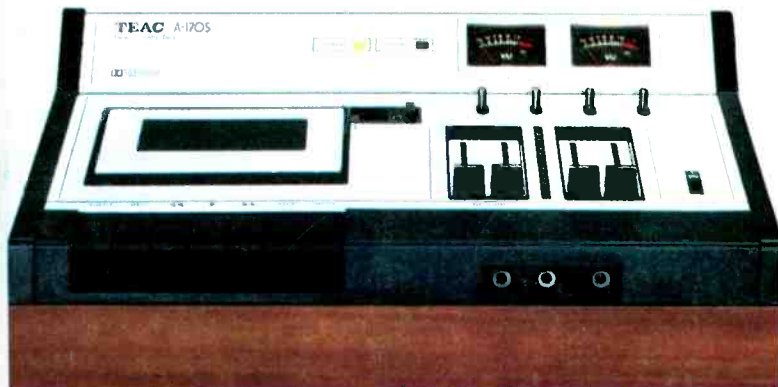

Last year the Teac A-170, our star cassette deck, lived up to its top billing with flawless performance and exceptional value. Now it's back for a command performance as the A-170S with an all new look. It has all the great features that made the A-170 the star of the show.

The A-170S transport system utilizes design innovations and many precision parts from more expensive

Teac decks. Features include extremely hard, high-density heads for distortion-free playback and recording. Built in Dolby noise reduction system. Separate bias and equalization switches, auto-stop, variable slide controls, expanded range level meters and convenient front access jacks.

So here it is with a face lift. The A-170S cassette, an ageless performer.

TEAC®

The Leader. Always has been.

Teac Corporation of America
7733 Telegraph Road, Montebello, California 90640

© TEAC 1977

*"Dolby" is a trademark of
Dolby Laboratories, Inc.