

Audio

FEBRUARY 1990 • US \$2.75 • UK £2.00 • CAN \$2.95

EXCLUSIVE REPORT
DIGITAL RADIO

**BOULDER 500AE AMP
AND ULTIMATE PREAMP**
OPEN AND ALIVE
SUPERIOR SOUND QUALITY

STATISTICS IN A/B TESTING

**REVIEWED
HAFLER IRIS TUNER**
GETS EVERY STATION

BBE SONIC MAXIMIZER
CLEANER RECORDINGS



330 TURNPIKE STREET, CANTON MASSACHUSETTS 02021 USA TEL: 617 8212300. HYDE, CHESHIRE SK14 1DY ENGLAND.

The Spirit Captured



In the AR tradition, another milestone.

*AR's designers and engineers achieve the ideal:
European Elegance... Exquisite Sound... Affordable
Prices. The quintessence of both sight and sound.
Premiered in Europe - now available in America.*



TIMELESS INNOVATION
TELEDYNE ACOUSTIC RESEARCH

Enter No. 1 on Reader Service Card

It stands to reason that the cassette decks built most like studio tape recorders will produce the highest quality home recordings.



Denon Studio A:
All our components
reflect lessons learned
in the recording studio.

The benefits of building home cassette decks with recording studio technology are even greater when the technology is your own.



Since 1910, Denon has been involved in every step of sound reproduction: recording music, making records and CDs, building studio tape recorders and producing open reel and cassette tape. In fact, Denon built the world's first digital studio tape recorder.

Denon builds this expertise into every cassette deck. Denon's proprietary clutchless Non-Slip Reel Drive produces constant tape tension, reduces distortion, wow and flutter and maintains superior performance over time. SF combination heads, in concert with Dolby B, C and HX Pro,[®] extract the most from today's digital sources by extending headroom and eliminating noise.

Lest you fear that Denon reserves this technology for its esoteric models, *all* these features are found for under \$400 on the three-head DRM-700, the DRW-750 Dual Cassette and the DRR-680 Auto-Reversing Cassette Decks.*

Why do Denon cassette decks sound better? Perhaps, it's because Denon has been making only one thing for over 80 years.
Music.

DENON
DESIGN INTEGRITY

*DRM-700 shown with the optional side panels available for most Denon models. Prices quoted are manufacturer's suggested retail prices and may vary.

Audio

FEBRUARY 1990

VOL. 74, NO. 2



Boulder Amplifier and Preamplifier, page 54

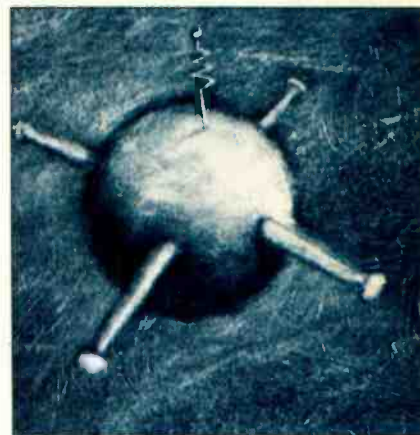

Digital Broadcasts, page 51

FEATURES

| | | |
|-----------------------------------|-----------------|----|
| THE AUDIO INTERVIEW: | | |
| DOC POMUS | Danny McCue | 36 |
| STATISTICS IN A/B TESTING: | | |
| BY THE NUMBERS | Herman Burstein | 42 |
| SOUND FROM SPACE: | | |
| DIGITAL BROADCASTS, | | |
| DIGITAL COMPONENTS | Robert Angus | 51 |

EQUIPMENT PROFILES

| | | |
|------------------------------------|--------------------|----|
| BOULDER 500AE AMPLIFIER AND | | |
| ULTIMATE PREAMPLIFIER | Bascom H. King | 54 |
| MITSUBISHI M-AV1 | | |
| AUDIO/VIDEO RECEIVER | Leonard Feldman | 72 |
| HAFLER IRIS FM TUNER | Leonard Feldman | 84 |
| AURICLE: BBE SOUND 1002 | | |
| SONIC MAXIMIZER | Hector G. La Torre | 90 |

MUSIC REVIEWS

| | |
|-----------------------------|-----|
| ROCK/POP RECORDINGS | 96 |
| CLASSICAL RECORDINGS | 100 |
| JAZZ & BLUES | 106 |

DEPARTMENTS

| | | |
|------------------------------|----------------------|----|
| SIGNALS & NOISE | 6 | |
| WHAT'S NEW | 8 | |
| AUDIOCLINIC | Joseph Giovanelli | 10 |
| TAPE GUIDE | Herman Burstein | 13 |
| BEHIND THE SCENES | Bert Whyte | 18 |
| SPECTRUM | Ivan Berger | 24 |
| CODA: DEANE E. JENSEN | Ivan Berger | 25 |
| AUDIO ETC | Edward Tatnall Canby | 28 |



Statistics in A/B Tests, page 42

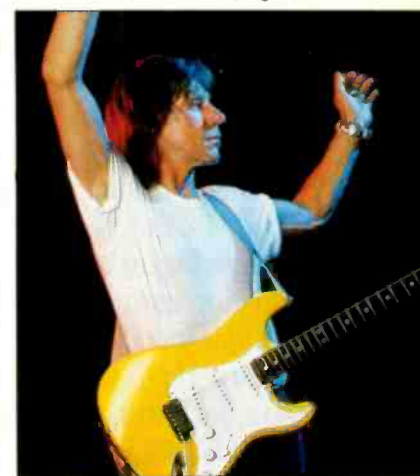

Jeff Beck, page 96

The Cover Equipment: Boulder 500AE amplifier and Ultimate preamplifier.
The Cover Photographer: Dan Wagner.

Audio Publishing, Editorial, and Advertising Offices,
1633 Broadway, New York, N.Y. 10019.

Subscription Inquiries, (800) 274-8808;
in Canada or other foreign countries, (303) 447-9330.



GET ON WITH IT.



The Proceed CD. An original expression of how technology can fulfill your desire for musical fidelity. Two years of research into the sonic possibilities of the compact disc medium have resulted in a component worth waiting for.

The Proceed CD. The world's most well understood CD player.

 **PROCEED**

Proceed[®] products are designed and manufactured by **MADRIGAL AUDIO LABORATORIES**
P.O. Box 781, Middletown, CT 06457 ITT TLX 4942158

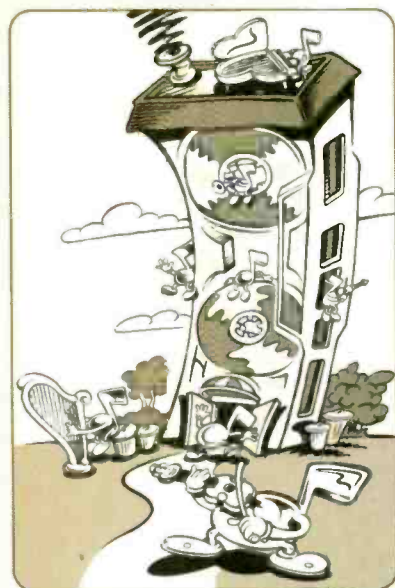

IS YOUR CLASSICAL MUSIC SUFFERING FROM POOR HOUSING CONDITIONS?



High resonance housing will put any tape in a nasty mood. Especially when pests, such as modulation noise, gnaw on the purity of digitally sourced music.

At TDK, we believe the formula for perfect reproduction includes not only technologically superior tape, but housing that enhances its performance.

Our incredible new SA-X, for example, features an ultra low resonance SP-ARII mechanism. By utilizing our unique co-molding technique, the unified two-layer shell realizes maximum total rigidity to improve reliability. Which drastically reduces modulation noise—an enemy of clear, pure sound that even noise reduction systems are powerless against.

This undesired "noise" is also attacked by SA-X's revolutionary magnetic characteristics and smooth, flat tape surface. First, there are the densely packed and uniformly distributed ultra fine Super Avilyn magnetic particles. Then, there is the advanced dual coating technology.

Together, the result is an unbelievably quiet tape with an exceptionally low bias noise of -61.0 dB. Plus, low and high frequency MOLS of $+5.0$ dB and -6.5 dB respectively.

And SA-X, which provides transparent reproduction of the most powerful digital sources, is available in convenient lengths of 46, 60, 90 and 100 minutes.

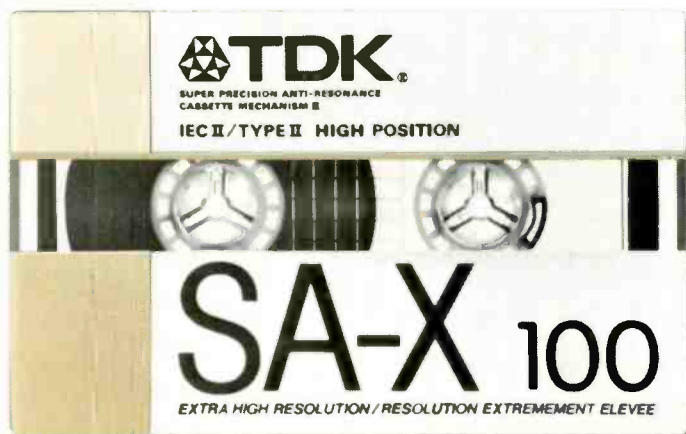

Editor: Eugene Pitts III

Art Director: Cathy Cacchione

Technical Editor: Ivan Berger
 Managing Editor: Kay Blumenthal
 Associate Managing Editor: Tony Scherman
 Copy Chief: Marita Begley
 Associate Art Director: Linda Zerella
 Editorial Assistant: Michael Bieber

Associate Editors:
 Edward Tatnall Canby, Bert Whyte, B. V. Pisha
 Senior Editors:
 Leonard Feldman, Howard A. Roberson
 Senior Editor/Loudspeakers: D. B. Keele, Jr.
 Senior Editor/Music Features: Ted Fox
 Editor-At-Large: David Lander

Contributing Editors/Artist:
 Michael Aldred, Susan Borey, Herman Burstein,
 David L. Clark, Anthony H. Cordesman, Ted Costa,
 John Diliberto, Frank Driggs, John M. Eargle,
 Joseph Giovannelli, Bascom H. King, Hector G. La Torre,
 Edward M. Long, Frank Lovece, Jon W. Poses,
 Jon R. Sank, Donald Spoto, Michael Tearson,
 Jon & Sally Tiven, Paulette Weiss, Michael Wright

Business Services Director: Greg Ropert
 Circulation Director: Leon Rosenfield
 Production Director: Patti Burns
 Production Manager: Nancy Potts
 Research Director: Vicki Blimblich
 Special Projects Coordinator: Phyllis K. Brady
 Ad Coordinator: Sylvia Corea
 Sales Secretary: Liz Dedivanovic

V.P./Publisher: Stephen Goldberg

ADVERTISING

Associate Publisher: Stephen W. Witholt
 (212) 767-6335
 Account Managers: R. Scott Constantine
 (212) 767-6346
 Barry Singer
 (212) 767-6291
 Carol A. Berman
 (212) 767-6292
 Western Manager: Bob Meth
 Regional Manager: Paula Mayeri
 (213) 739-5130
 Automotive Manager: James Main
 (313) 643-8800

DCI EXECUTIVE STAFF

President and CEO: Peter G. Diamandis
 Executive V.P.: Robert F. Spillane
 Sr. V.P., Finance, and CFO: Arthur Sukul
 Sr. V.P., Mfg. & Distribution: Murray M. Romer
 Sr. V.P., Operations: Robert J. Granata
 V.P., Controller: David Pecker
 V.P., General Counsel: Catherine Flickinger

AUDIO, February 1990, Volume 74, Number 2. **AUDIO** (ISSN 0004-752X, Dewey Decimal Number 621.381 or 778.5) is published monthly by DCI, a wholly owned subsidiary of Hachette Publications, Inc., at 1633 Broadway, New York, N.Y. 10019. Printed in U.S.A. at Dyersburg, Tenn. Distributed by Warner Publisher Services Inc. Second class postage paid at New York, N.Y. 10001 and additional mailing offices. Subscriptions in the U.S., \$21.94 for one year, \$39.94 for two years, \$53.94 for three years; other countries, add \$6.00 per year. **AUDIO*** is a registered trademark of DCI. ©1990, Diamandis Communications Inc. All rights reserved. **Editorial contributions** should include return postage. Submissions will be handled with reasonable care, but the Editor assumes no responsibility for safety or return of manuscripts, photographs, or artwork. The Publisher, in his sole discretion, reserves the right to reject any ad copy he deems inappropriate. **Subscription Service:** Forms 3579 and all subscription correspondence must be addressed to **AUDIO**, P.O. Box 52548, Boulder, Colo. 80321-2548. Please allow at least eight weeks for the change of address to become effective. Include both your old and your new address and enclose, if possible, an address label from a recent issue. If you have a subscription problem, please write to the above address or call (800) 274-8808; in Canada or other foreign countries, (303) 447-9330.

Fasten your seat belts



Buckle up and get ready to experience the sonic energy and pure power of Pyle PRO woofers.

Pyle engineers have reinvented the heart and soul of loudspeakers — our new woven fiber IronCloth voice coils make Pyle PRO woofers virtually indestructible. When combined with polymer laminate cones, vented pole pieces, massive motor structures and heavy duty housings, you get the most durable speakers available at any price.

Now you can dive to the deepest lows and accelerate to the highest peaks with new found confidence. You'll feel the power as your skin tingles, see the force as your car moves to the beat and hear sounds you've never heard before.

Break the sound barrier with Pyle car stereo speakers and electronics.



Powerful Enough To Be Pyle!

Dollar for dollar, the most dynamic speakers you can buy. Perfectly Pyle!

PYLE

For the name of the Pyle dealer nearest you write:
Pyle Industries, Inc. • Huntington, IN 46750

H A Harman International Company

Abolish Schoenberg?

Dear Editor:

It saddens me to read letters like the one from John Ona ("Signals & Noise," August 1989) because they exhibit the narrow-mindedness of someone who claims to know music. I grew up learning to play "classical" music, yet I thoroughly enjoy rock and pop. But in keeping with the spirit of Ona's letter, let me add to his list of inappropriate music to review. First, get rid of Italian opera. Who wants to hear a fat lady screeching a single syllable for countless bars? Second, abolish all violin pieces; they sound so strident and whiny. Next, to be more specific, banish Ravel's "Bolero." Talk about redundancy—I've heard some heavy-metal bands with more chord changes!

Of course, such suggestions are ludicrous, as are those Mr. Ona made in his letter.

Please continue to use rock and pop—and refer to them with the term "music"—when reviewing speakers, as I'm sure many of your readers do.

Erik Tracy
San Diego, Cal.

Fifth Debris

Dear Editor:

I am writing in response to John Ona's letter, in which he states that rock and pop composers "don't know a diminished seventh from an empty fifth." It seems obvious to me that Mr. Ona has been emptying a few fifths himself. His sweeping generalizations make it painfully apparent that he has never taken the time to find out anything about the subject. Yes, John, some rock and pop is loud and crummy, but some rock and pop is soft and melodic. Some rock composers are not very talented, but some are. Some lyrics don't rhyme, but some do. (Some classic poetry doesn't rhyme either, I might add.) Lumping all rock and pop together under a label of ear-piercing, three-chord screamers is a lot like putting down the classics because "it's all fat women wearing horns and yodeling." If Mr. Ona would pay more attention to the real music and stop being blinded by his preconceptions, he might find some pretty good music waiting to be heard.

Jon Jerome
Buffalo Grove, Ill.

A Great Cook

Dear Editor:

Thank you for the interview with Emory Cook (September 1989). I'm still enjoying the many records manufactured by his company, Cook Laboratories, most of which I purchased in the late 1950s.

I have the earthquake recording, with the music of the ionosphere—alas, somewhat damaged by poor arms and styli. The ionosphere sounds can be reproduced with a battery-operated amplifier and a speaker system with a long wire antenna connected to the output (see *Exploring Light, Radio and Sound Energy*, by Calvin B. Graf, TAB Books). I also have the 10-inch train record and a lot of others. Besides the wonderful Lizzie Miles recording, my absolute favorite is *Blow-out at the Mardi Gras*, a fine New Orleans jazz recording. (Did you know that Cook also released recordings of Carlos Montoya, the guitarist?)

I have only two problems with the Cook recordings when I play them: Saving them (are they to be put onto CD?) and obtaining the correct equalization, which I believe was AES -12 dB at 10 kHz. It does make the high end sound crisp when played RIAA. Thank you, Emory, for a job well done!

Ed Defreitas
Farmington, Conn.

Double Take

Dear Editor:

Thanks for the interview with Emory Cook. It sent me scurrying to the "old stuff" on my record shelves, where I found *Out of the Storm*, *Voices of the Sky*, and *Marimba Band*—all Cook Laboratories releases. The last was dubbed, after the title on the jacket, "Otherwise known as . . . To Hell with High Fidelity." The cover also noted: "A high-fidelity recording of a low-fidelity subject." Interesting stuff, even at this date, and an interesting man.

Harold Yeglin
Des Moines, Iowa

For Love, Not Money

Dear Editor:

I was pleased to learn from Edward Tatnall Canby's column, "Spinning Webs and Reels" (September 1989), that some audio amateurs, or "volunteers," are still alive and well. It was to

these amateurs that *Audio* magazine was directed in its early years. I had supposed that most of us had blown our rectifier tubes and that current no longer surged through our hand-soldered connections.

While a junior-high student, I got my first crystal set to function in 1925, built my first short-wave receiver a couple of years later, and was hooked on audio before I reached college. As a college student, I joined the IRE (now the IEEE) and later the Audio Engineering Society. I spent hundreds of hours in hands-on audio activities. Along with many failures, a few useful pieces of audio hardware resulted. Some were the subject of articles published in *Audio* during the '50s and '60s.

Most of my early efforts were directed toward noise reduction. More recent activities include restoration and preservation of material from old 78-rpm discs. The 78s (mainly old jazz and vocal music) are first recorded on reel-to-reel tape using appropriate noise reduction. After editing, the material is dubbed onto cassettes which are presented to the discs' owners. I keep the edited "masters" for my own library. Everybody profits, and no money changes hands. Like other "volunteers," I am occasionally asked to do live recording and to help with sound reinforcement. Where possible, I now try to leave these projects to younger "experts."

Contrasting audio "volunteers" with today's professionals, Canby notes that "the greatest pleasure in most people's lives rests in the activities that can be managed without pay, beyond money. Some people catch onto this early, and their lives are the happier for it, whether for pure pleasure or for a worthy cause." I certainly agree. Of course, *Audio* magazine can't revert to the format of the '50s and '60s, when its editor, C. G. McProud, did so much to encourage volunteerism. But there may be enough of us to warrant more editorial consideration in the form of articles, or perhaps a department, devoted to problems we face within a limited but lively domain.

Many of us older audio people don't die—but possibly our feedback loops become less stable.

Wayne B. Denny
Grinnell, Iowa

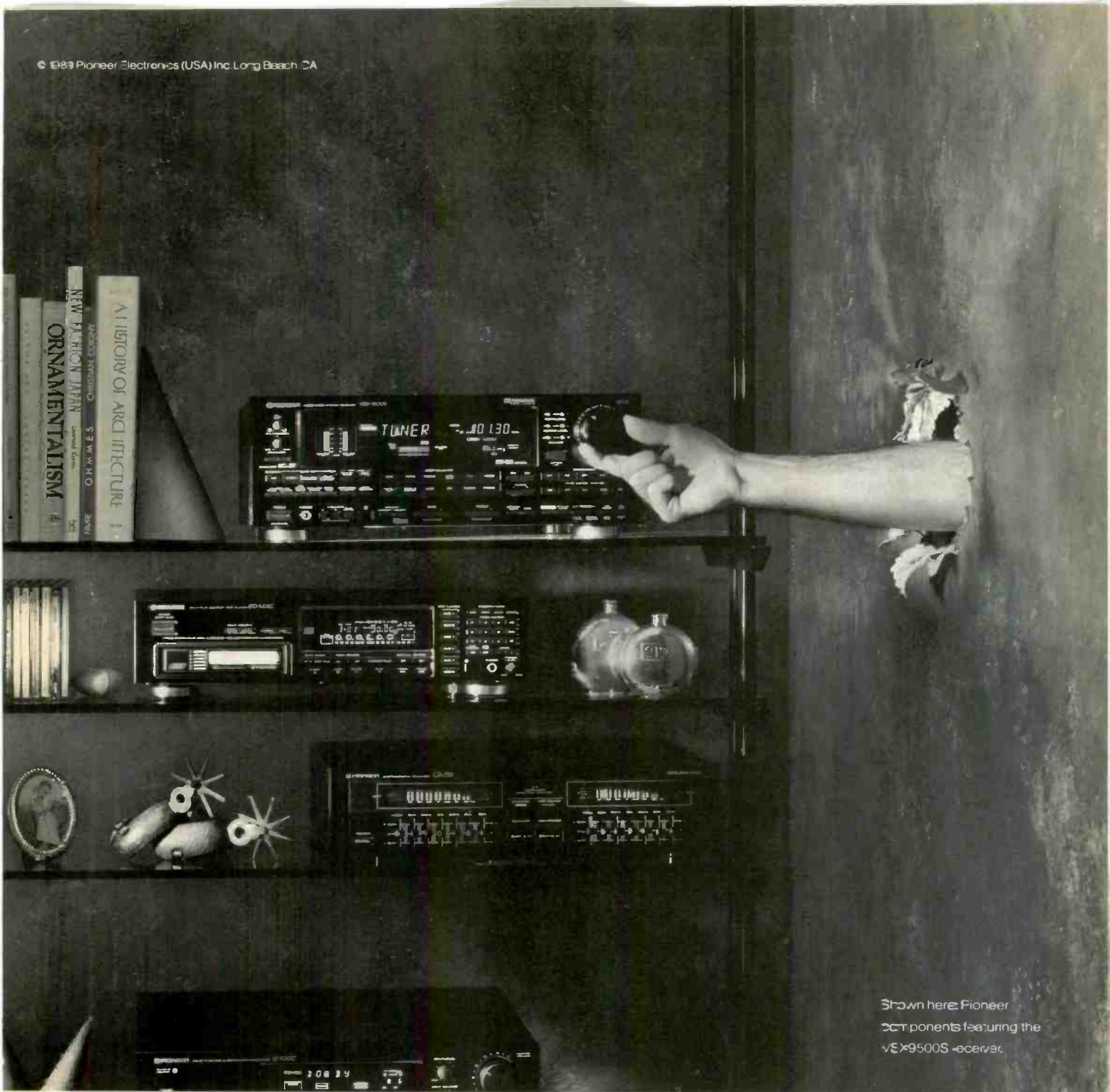

Shown here: Pioneer
components featuring the
VE-9500S receiver.

Now you can change a track,
adjust the volume, or other-
wise control your system from
beyond a wall, beyond two
walls—in fact, from any room
with remote speakers.

At the heart of the sys-
tem is your Pioneer receiver
with Multi-Room Remote and

**HOW THE PIONEER
MULTI-ROOM
REMOTE WORKS.
SORT OF.**

For more information call 1-(800) 421-1404
Enter No. 24 on Reader Service Card

Dolby ProLogic. Add a tiny
sensor with a Pioneer Smart
Remote and you're in control.
It's that simple.



PIONEER®
WE BRING THE REVOLUTION HOME.™

Geometric Speaker Stands

The Mantis speaker stands are available in three sizes to match a wide range of speakers, all at the same price. Standard finish is matte black, but custom finishes are available at extra cost. Matching TV/VCR stands are also available. Price: \$199 per pair.

For literature, circle No. 100

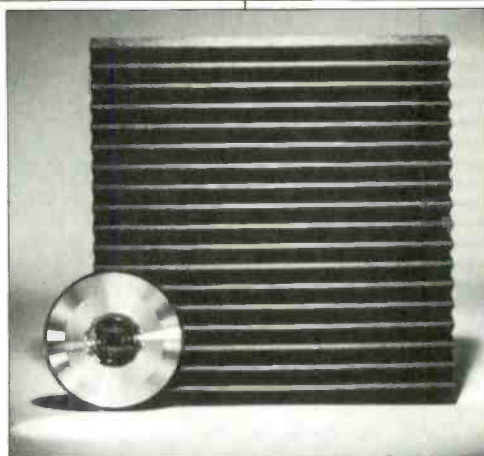
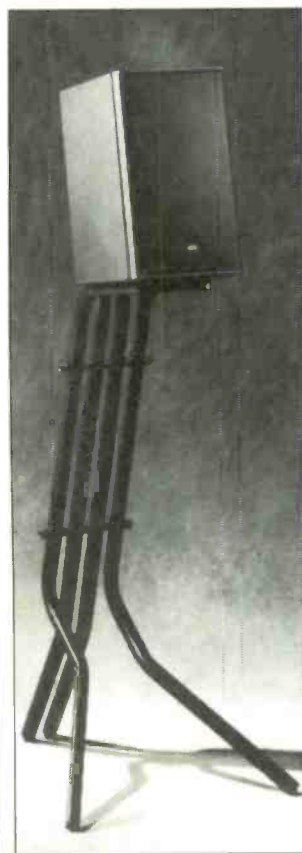

Cutting Wedge Acoustical Tile

Acoustical foam tile reduces transient noise, some standing waves, and ambient noise level. Cutting Wedge acoustical tiles are constructed from flame-retardant, flexible, open-cell polyurethane and are said to absorb audio frequencies more uniformly than other tiles. Wedges run the entire width of the tile to avoid a "busy" look. The foam is supplied by a

single manufacturer, assuring consistency in color and performance. The Cutting Wedge is available in 1- and 2-inch thicknesses for a choice of bass-absorption characteristics and is sold in foot-square tiles. Price: \$2 to \$2.25 per tile, shipping included. For literature, circle No. 101

Fisher Receiver

As the panel design implies, the RS-Z1 is full of features. Its tuner section has dual antenna inputs, switchable bandwidth, and 24 station memories which

store bandwidth and antenna selection along with frequency. Its preamp section has both MM and MC phono inputs, plus direct coaxial and fiber-optic digital inputs, including a coaxial jack on the front panel. The D/A converters are 18 bit, with eight-times oversampling. There's also a sleep timer, which can be set for 30 or 60 minutes. Output power is 150 watts, at 0.007% THD, into either 8 or 4 ohms. Price: \$1,400. For literature, circle No. 102



TDL Electronics Loudspeaker

TDL Electronics' Studio 1 is a transmission-line loudspeaker system employing a 25-mm ELAC metal dome tweeter and a 16.5-cm bass/midrange unit, with a crossover frequency of 3 kHz. The overall frequency range is 28 Hz to 20 kHz. Bi-wiring and biamping are possible. The speaker has a rated efficiency of 86 dB SPL, and a nominal load of 6 to 80 ohms, comfortably driven by 30 watts or more. The bass driver uses a polyolefin-type cone, with vented poles used with the magnets. Internal damping is via modern polyurethane materials. The Studio 1 is available with a walnut or black finish. Prices: \$1,635 per pair with stands, \$1,445 without. For literature, circle No. 103



We're making a big deal out of practically nothing.

The most difficult job for a compact disc player is to reproduce low amplitude signals. Fortunately, Yamaha has created a remarkable CD player that rises to the occasion.

The CDX-1120 reproduces those low amplitude signals that until now, have been distorted or lost in the noise generated by the digital-to-analog conversion process in most CD players.

Allowing you to distinguish the subtle variations between, say, both an oboe and clarinet softly playing middle C.

As well as enjoy improved ambience, revealing the acoustic characteristics where the performance took place.

And superior imaging, clarifying the placement of each instrument in an orchestra.

All worthy reasons to take a good, soft listen to our remarkable new CDX-1120. Only then, can you truly appreciate Yamaha's Super Hi-Bit Technology.

Yamaha's exclusive Super Hi-Bit System utilizes the additional information generated by our 20-bit digital filter to more accurately

reproduce the low amplitude signals coming from the disc.

To achieve this superior sound definition, Yamaha uses four 18-bit D/A converters, each with an exclusive 4-bit Floating System to boost linearity to 22-bits.

Delivering four times greater resolution of low amplitude signals than even fixed 20-bit D/A converter systems.

What's more, Yamaha's exclusive Super Hi-Bit DAC Direct Output provides phase accuracy so close to the original recording, it's unprecedented in the industry.

The CDX-1120 also features Digital DeEmphasis and Digital Volume Control to give the best possible signal output - - uncompromised by analog components.

To fully appreciate the phenomenal CDX-1120, pay a visit to your local Yamaha dealer.

Once you hear it for yourself, the advantages will come across loud - and soft - and clear.



A full-function remote lets you control everything. With 24-track random access programming, 5-way repeat play and more.

YAMAHA®



CDs and "Emphasis"

Q. My CD changer has an indicator which lights up with the word "Emphasis" when certain Compact Discs are played. I have noticed an audible decrease in high-frequency response when I listen to these recordings. I would appreciate your comments on this.—Colin C. Hall, Merrimack, N.H.

A. All else being equal, there should be no difference in sound quality between a CD marked "Emphasis" and one which is not so marked. CDs marked "Emphasis" are recorded with a bit of equalization in order to obtain about 6 dB better S/N ratio than would otherwise be possible. The player must sense the presence of such a disc and roll off frequencies to compensate for the rise during recording, thereby maintaining a flat frequency response. This is an automatic action, just as is true of the display you have described. It may be that your player is overcompensating for this frequency pre-emphasis when it attempts to play these Compact Discs.

Distortion at Low Volume

Q. I have a baffling problem with my audio system. I first noticed this problem after getting new loudspeakers. When I listen to FM programs at a low volume and the DJ comes on, the voice is distorted. Female voices tend to bring out more of this distortion than male voices do. When I raise the volume, the distortion disappears. Music generally comes through clear at all volume levels. However, both on FM and when playing LPs, I hear this same distortion with guitar music or with acoustic piano; most electric music is not affected. I notice no distortion when playing tape recordings, and I never hear it when listening through headphones, regardless of volume level.—Steven R. Sanchez, Mt. Clemens, Mich.

A. I appreciate your having given me lots of detail because it really gives me more to go on. I always prefer having too much information over too little.

I believe that the distortion you describe is present most of the time, regardless of volume, but is masked by the music. Although you mention that playing tapes does not produce this distortion, I think that if you were to record one of the DJs, the subsequent

playback of this tape would again bring out the distortion.

The clue as to the true nature of your problem lies in the fact that you never hear the distortion when listening to headphones. Because everything else in the audio chain remains the same, the loudspeaker must be responsible for the distortion. The voice-coil of at least one of the drivers is rubbing against its pole-piece. This, in turn, restricts the free movement of the cone. Not only that, but the mechanical friction produced by this rubbing is transmitted to the cone and is reproduced as a "buzz."

When I manufactured loudspeakers some time ago, I made a special test recording whose main content was acoustic guitar and acoustic piano. For me, these two music sources made this sort of distortion very apparent and provided a quick method by which I could determine if my completed loudspeakers were free from this defect.

Overdriven Audio System

Q. During the playing of certain symphonic passages, we hear clipping. Can we stop the clipping by adding another power amplifier to be used as part of a biamplified system? How about adding a powered subwoofer?—Allan and Alice Walter, Chatsworth, Cal.

A. Because the bass consumes most of the power required by your sound system, using a separately powered subwoofer should solve your problem. Of course, you could also do what you had suggested: Use a second amplifier to drive the woofer as part of a biamped setup. You may run into difficulties similar to those you already have. Your woofer needs a given amount of power, so if the second amplifier cannot provide more power than your present amplifier can, the second one may also clip.

Another thought comes to mind: Some listeners have said they heard amplifier clipping when they actually heard a "pop" caused by the voice-coil hitting the bottom of its pole-piece assembly when forced to carry more bass than it was designed to handle. If this is what you heard, you would certainly need a different woofer as part of a biamped setup—a condition which is met by using a powered subwoofer or a pair of them.

Amp and Speaker Concerns

Q. I am considering buying a receiver that has a rated power bandwidth of 5 Hz to 60 kHz. The speakers I intend to buy have a rated frequency response of between 20 Hz and 20 kHz. The speakers can handle about twice the amount of power which can be supplied by the power amplifier. Will this arrangement damage the loudspeakers? If the receiver is able to produce frequencies above and below what the speaker can deal with, will this damage the tweeters and woofers when I play the system at high volume levels?

Also, I have heard that amplifier clipping can damage tweeters. What is amplifier clipping, and how does it ruin the tweeters?—Richard Cramotte, Jr., Knoxville, Tenn.

A. In order for me to give you an answer as to whether or not this equipment can work together without destroying the loudspeakers, I need to know just a bit more. When you listen to your system as loud as you are likely to, is the amplifier working somewhere near its maximum rating? If not, then you can use the system without problems. If you are likely to drive the amp to its maximum, damage to the tweeters can result because of amplifier clipping.

Clipping occurs when the amplifier is forced to perform beyond its capabilities. The amp generates spurious audio frequencies (frequencies other than those intended by the nature of the program). These frequencies are quite high and, hence, will damage the tweeters rather than the other drivers.

The fact that the amplifier has a wider bandwidth than the speakers is of no consequence. Even though your amp is capable of producing frequencies above or below those which can be reproduced by the speakers, it is unlikely that these frequency extremes will be found in most program sources you will encounter. Regardless of frequency, if the power fed into the loudspeakers is less than they can handle, all is well. A

If you have a problem or question about audio, write to Mr. Joseph Giovanelli at AUDIO Magazine, 1633 Broadway, New York, N.Y. 10019. All letters are answered. Please enclose a stamped, self-addressed envelope.



Any way you look at it,
Hafler advances the
state of the art while it reduces
the price of admission.



Any way you look at it, Hafler advances the state of the art while it reduces the price of admission.

New Hafler SE Series. The SE Series embodies the basic Hafler design philosophy: Innovative circuitry, high reliability and, above all, sonic excellence. The result is pure, unimpeded sound at an affordable price.

SE100 J-FET Preamplifier. Based upon the critically acclaimed reference standard DH 110 circuitry. The SE 100's all J-FET line stage offers "tube-like" sound while maintaining ultra-low noise and distortion.

SE130 AM/FM Tuner. Features Delco Electronics receiver circuitry. This American-built tuner incorporates sophisticated stereo blending and superior interference immunity.

SE150 CD Player. Dual 16-bit digital to analog converters and quadruple oversampling capture all the dynamics and low-level resolution you expect from the latest in CD technology. A full-function remote control is provided to allow easy access to all of your favorite music.

SE120 MOSFET Amplifier. Featuring 60 watts per channel of MOSFET output power. This conservatively rated power amplifier is based upon the heralded DH 120 circuitry. Utilizing a novel drive circuit which is extraordinarily linear, it achieves ultra-low distortion without the use of high negative feedback. The result is: Ruggedness. Linearity. High speed. And the "tube-like" characteristics of smoother sound with less distortion.

The Hafler SE line of products, hand built in America, represents the affordable high end in separates.

Hafler

A DIVISION OF ROCKFORD-CORPORATION

"The Affordable High-End"



Info on Dolby NR

Q. I have the following questions about the various Dolby noise-reduction systems: How many different systems are there, and what are the advantages of each? Can you record with one system and play back with another? When you purchase a commercial cassette, how do you determine which system it has been recorded with? Can the various Dolby NR systems be used with all types of tapes? My equipment has both Dolby B and C NR; why do I need both?—Jack Speakman, Shawnee Mission, Kans.

A. For home audio equipment, there are two Dolby noise-reduction systems: Dolby B and Dolby C NR. There are also two Dolby systems for professional use: Dolby A NR and Dolby Spectral Recording; these provide greater noise reduction and other advantages. Dolby B NR was the first noise-reduction system for home equipment introduced by Dolby Labs. It offers about 8 to 10 dB of noise reduction. Dolby C NR came along more recently and offers about twice as much noise reduction. In addition, it has a special equalization curve in the upper treble range that reduces the chance of tape saturation, and of consequent distortion and treble loss, at high recording levels.

If a commercial prerecorded cassette has the Dolby double-D logo but fails to clearly indicate which Dolby NR system has been used in its recording, it almost certainly has Dolby B NR; commercial recordings using Dolby C NR are, in any case, comparatively rare. If you buy one, you can experimentally determine whether it sounds better in the Dolby B or C mode. Depending on the nature of the mismatch, the sound will be either shrill or dull if you use the wrong NR system in playback. No harm will befall the tape if you use the wrong one.

The various Dolby systems can be used with all types of tape, namely Type I (normally ferric oxide), Type II (usually chrome or ferricobalt), and Type IV (almost always metal particle).

Although Dolby C NR is superior, most decks that include it also have Dolby B NR, in order to be compatible with decks that provide only Dolby B NR and to properly play commercially prerecorded cassettes that use it.

Desirability of Level Controls

Q. I plan to buy my first cassette deck, and I wonder what difference it will make if I buy a deck without record and playback levels controls.—Jesse Morales, San Antonio, Tex.

A. If a deck has no level control for recording, the deck employs automatic level control (ALC). While some ALC circuits do a better job than others, the consensus is that for high-fidelity results, the record level should be set manually by the user—not automatically—to avoid the risk of compression and/or distortion. If you plan to do only "utility" recording of such things as background music, conversation, etc., you should find ALC satisfactory.

For playback, a level control is less important but is nevertheless desirable. A level control enables you to make the level of tape playback comparable with that of other sources—such as tuner, CD, etc.—and lets you compare the signal going to the tape deck with the signal coming from it.

Overheated Equipment

Q. I recently bought a cassette deck which works well, considering its low price. However, I'm concerned about the heat it develops after some three hours of continuous use. Not only is the deck hot, but so are the cassette tape and shell. Will this weaken, destroy, or otherwise affect my tapes? The unit is a double cassette deck, and I'm wondering if I should buy a more expensive one.—Fred McCullers, New York, N.Y.

A. Tape decks are designed to withstand considerable heat, and so are cassettes. If the deck stabilizes—in the sense that it and the cassette do not become very hot—there is probably nothing to fear. But if the deck becomes hot enough to burn your finger if you touch it more than momentarily, and/or if the cassette shell becomes so hot that it warps, either you have to confine yourself to shorter periods of use or buy a new deck. Repair is probably inadvisable for a low-priced deck because of the high cost of the repairs relative to the deck's value.

Precautionary Fast-Winding

Q. I have read that when recording a brand-new cassette tape for the first time, it is beneficial to fast-wind the

tape from end to end before recording. What is the reason for this? Also, should this be done with open-reel tapes?—Darren Hovsepian, West Bloomfield, Mich.

A. The advice you cited is usually given for tapes that have been recorded on a home deck and stored for a period. Fast-winding, if not perfectly even (it is more likely to be even with a professional-grade deck than a home deck), tends to stress the tape, and the tape may acquire a set during long storage. Also, print-through tends to develop during storage of a recorded tape. Fast-winding the tape before use tends to relieve the stresses and to diminish print-through.

I haven't previously encountered this advice in connection with virgin tape, but there's no harm in winding such tape just before initial use, in case the tape has been exposed to stresses. This also applies to open-reel tape.

Type I vs. Type II Tape

Q. I have read that a good-quality Type I tape (ferric oxide) is better than a Type II tape (chromium dioxide or ferricobalt) for sound quality. But is there a trade-off with respect to tape durability or deterioration of the sound?—Greg Shettler, Winnipeg, Man., Canada

A. Some Type I tapes are better overall than some Type II tapes. Typically, Type I tapes have less distortion than Type II as far as measurements go, but it is open to question whether the difference is audible. Type II tapes usually have somewhat more extended treble response because of the characteristics of their magnetic coatings. Also, Type II tapes usually have a somewhat higher S/N ratio by virtue of the fact that Type II calls for a playback equalization which reduces the treble more than does Type I equalization; the greater reduction in treble also brings down the noise more. But if you play at a moderate level and use Dolby C or dbx NR, the difference in S/N may be inaudible or audible only during very quiet passages. Summing up, on

If you have a problem or question on tape recording, write to Mr. Herman Burstein at AUDIO, 1633 Broadway, New York, N.Y. 10019. All letters are answered. Please enclose a stamped, self-addressed envelope.

Cassette decks with mixing facilities for mike and line have become a rarity, but you can add a mixer.

average Type II tends to produce performance that is a bit better than that of Type I, but there are individual Type I tapes that outperform some of the Type IIs. To my knowledge, there is no important difference with respect to durability and preservation of sound.

Mixing Facility

Q. Several years ago I acquired a cassette deck which had microphone inputs and allowed one to mix these with the line inputs. This was very useful; for example, it allowed me to record short stories with background music. I have recently upgraded, but at the expense of losing the mixing capability. My current deck's line inputs are cut off when one inserts mike plugs into the mike jacks. Are you aware of any cassette decks that permit mike and line mixing? I suspect deck manufacturers are more interested in providing dubbing facilities than in supporting creative home recording.—John W. Robbins, Annapolis, Md.

A. Cassette decks with mike and line mixing facilities are a rarity. Refer to the Annual Equipment Directory in the October issue of *Audio* to learn which decks have mike inputs, and then contact their manufacturers to ask if any of these models provide mixing facilities. Your best bet, probably, is to buy a mixer. Check with your local audio dealers on what they have. Several readers report that they have had satisfactory results with Radio Shack mixers.

Options for Boosting Treble

Q. If I wish to accentuate the high frequencies moderately, perhaps 3 to 5 dB, which of the following methods would give the least distortion and which would give the most: Reducing bias current by means of the bias control on my deck; using an equalizer in recording; using an equalizer in playback only, and increasing my speaker's tweeter output by means of the tweeter control on the back?—Anthony Hudaverdi, Santa Monica, Cal.

A. In theory, reducing bias is least desirable, because this causes an increase in distortion. However, if you are aiming at only a moderate elevation of the treble, no more than about 3 dB, the increase in distortion might be inaudible, depending on the individual listener.

If you are going to use an equalizer, it is far more preferable to do so in playback than in recording. If you accentuate treble in recording, you may overload the tape at high frequencies, with consequent distortion and treble loss, particularly at high recording levels. Boosting treble in playback will increase noise but will avoid distortion.

I am dubious about increasing tweeter output because you may be elevating a broader range of treble frequencies than you really wish to. If you play at very high levels, you may put your tweeter in physical jeopardy by elevating its output as much as 5 dB.

The best way to go, in my opinion, is to use an equalizer in playback. **A**

ACOUSTAT

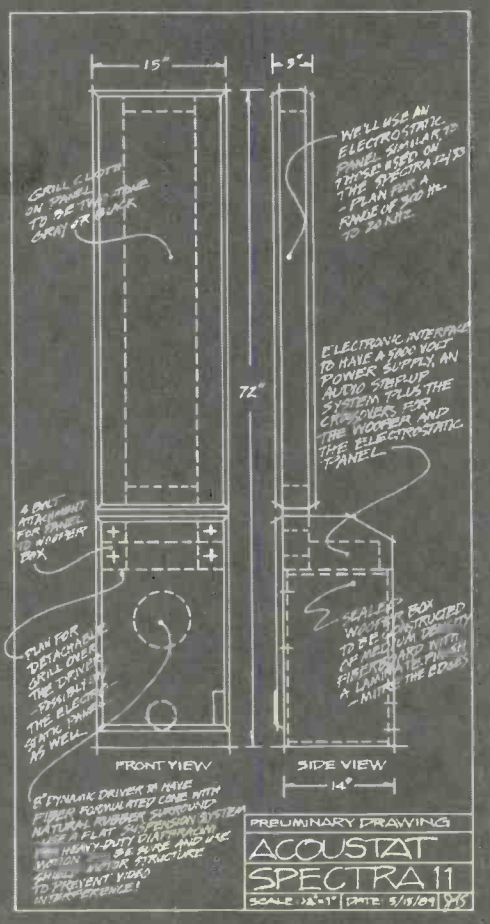

SPECTRA 11

A unique
sonic signature
from Acoustat.
Remarkable sound,
but then so is
the price.
For under \$1000
your listening
pleasure can
begin this fall.

For the Acoustat
dealer nearest you
call 1-800-366-1619

ACOUSTAT
A division of
Rockford Corporation



Enter No. 14 on Reader Service Card

Let Aragon save you from Digital Hell. The D2A will Convert you.

All digital IC's are computer socket mounted for easy upgradability

Digital processor board fully separated and isolated from analog circuit board

Zinc chromated EMI shield prevents digital noise and RF radiation from entering analog section

Each D/A chip has its own independent power supply

Face plate and knob machined from a solid billet of aluminum

Both optical and coaxial inputs

Dual D/A converter chips are hand selected and trimmed for most significant bit

Digital output for digital recording

Highest quality gold plated chassis mount connectors

Three digital inputs accept any combination of digital sources, i.e., CD, DAT, Video Disc and Satellite down link

Remote digital domain absolute phase invert switch

Digital circuitry co-designed by Theta Digital Corp. Includes proprietary reclocking of digital information

11 separate regulated DC power supplies

Reed relays with rhodium plated contacts, hermetically sealed in an inert gas atmosphere

LED information display of sampling rate, absolute phase and de-emphasis circuitry activation

Swiss made gold plated connector for external power supply

All components and circuit connections are soldered to military specifications

All discrete technology in analog section - no IO's used

Highest quality metallized polypropylene capacitors

All analog circuitry is fully dual mono with separate DC power supplies for each channel

Digital over-sampling filter, co-designed by Texas Instruments, found in CD players costing \$4,000+

Aragon 24k class A phono circuit topology utilized for current to voltage conversion

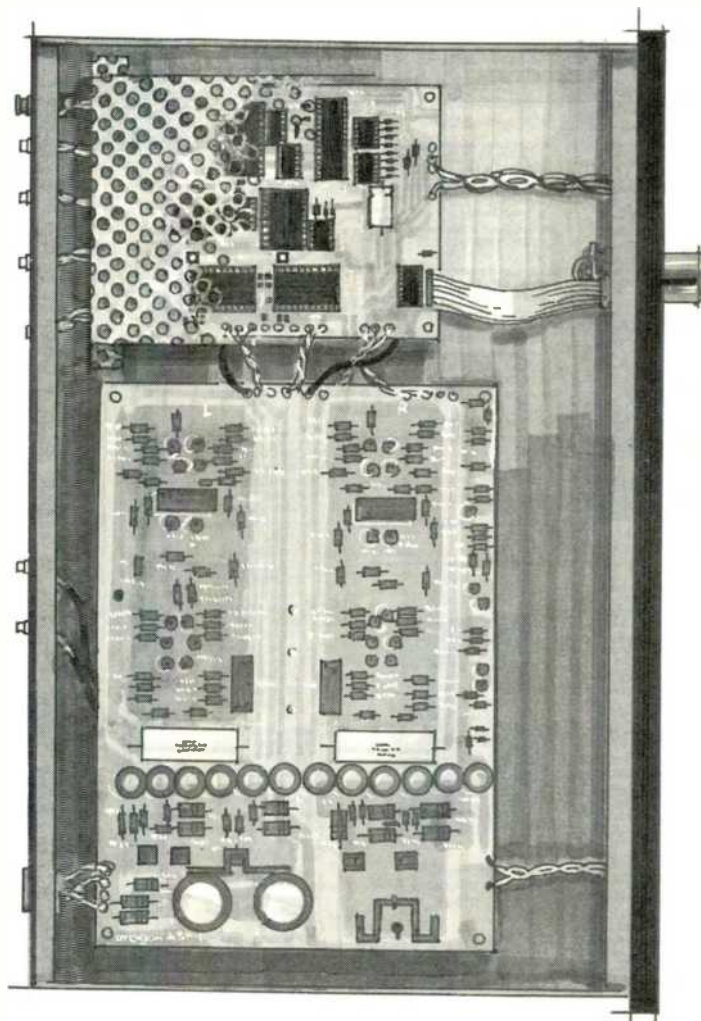

Aragon's D2A converter will deliver state of the art sound quality from any CD player with a digital output.

MONDIAL DESIGNS LIMITED
Two Elm Street, Ardsley, New York 10502 • (914) 693-8008

Enter No. 22 on Reader Service Card



Janet Jackson's
Rhythm Nation • 1814
72386



Tears For Fears:
The Seeds Of Love
33653



Mötley Crüe:
Dr. Feelgood
33928



Tracy Chapman:
Crossroads
42496



Reba McEntire:
Reba Live
44602

| | | | | | | | | | | | | | | | | | | | | | | | | | | | | | | | | | | | | | | |
|---|--|------------------------------------|--|---|--|---------------------------------------|---|--|---|--------------------------------------|---|--------------------------------------|---|--|--|--|---|--|--|--|---|----------------------------------|--|---|-------------------------------------|------------------|------------------------|---|--|------------------------------|--------------------------------------|--|---|--|----------------------------------|--|------------------------------------|---|
| Happy Anniversary Charlie Brown (GRP Artists) 5 4278* | DON HENLEY The End Of The Innocence 0 1064 | KISS Hot In The Shade 5 3475 | KEITH WHITLEY I Wonder Do You Think Of Me 3 3768 | TINA TURNER Foreign Affair 3 2900 | THE JEFF HEALY BAND See The Light 0 0810 | PRINCE Batman Soundtrack 6 0344 | OLIVIA NEWTON-JOHN Warm And Tender 2 1993 | OAK RIDGE BOYS Greatest Hits, Vol.3 7 3609 | HERB ALPERT My Abstract Heart 6 4339* | GENESIS Invisible Touch 5 3740 | PHIL COLLINS Buster/Soundtrack 0 0517 | GUNS N' ROSES GN'R Lies 0 0805 | 10,000 MANIACS Blind Man's Zoo 3 0236 | STEVIE NICKS Other Side Of The Mirror 7 0946 | FLEETWOOD MAC Greatest Hits 0 0796 | CINDERELLA Long Cold Winter 1 4780 | BIG DADDY KANE It's A Big Daddy Thing 3 4675* | RESTLESS HEART Big Dreams In A Small Town 2 4777 | The Duke Ellington Orch. Digital Duke 6 3356 | EDIE BRICKELL Shooting Rubberbands... 0 0789 | ANNE MURRAY Greatest Hits, Vol.2 3 3332 | GREAT WHITE Two Shy 0 1100 | JERRY LEE LEWIS Great Ball Of Fire/Soundtrack 5 4320 | BEST OF ERIC CLAPTON Time Pieces 2 3385 | DAVE GRUSIN Collection 0 0929 | MAX Q 5 3542* | INXS Kick 5 3606 | WAYLON JENNINGS New Classic Waylon 3 3805 | Great Love Songs Of The '50s & '60s 2 0768 | VAN HALEN OU812 5 0913 | EARL KLUGH Solo Guitar 6 3942* | KATHY MATTEA Willow In The Wind 6 0075 | Classic Old & Gold, Vol. 1: 20 Original Hits 3 4627 | LED ZEPPELIN Houses Of The Holy 3 4321 | JIMMY PAGE Outrider 2 3721 | ELVIS PRESLEY Essential Elvis (23 Classics) 6 4039 | BILLY IDOL Vital Idol 5 4038 | STEVE STEVENS Atomic Playboys 8 4166* |
|---|--|------------------------------------|--|---|--|---------------------------------------|---|--|---|--------------------------------------|---|--------------------------------------|---|--|--|--|---|--|--|--|---|----------------------------------|--|---|-------------------------------------|------------------|------------------------|---|--|------------------------------|--------------------------------------|--|---|--|----------------------------------|--|------------------------------------|---|

| | | | | | | | | | |
|--|---|-------------------------------------|--|---|--|------------------------------------|--------------------------------|---|---|
| PAULA ABDUL Forever Your Girl 0 0933 | THE DOOBIE BROTHERS Cycles 7 3187 | PAT BENATAR Best Shots 4 4319 | BELINDA CARLISLE Runaway Horses 7 3667 | DWIGHT YOAKAM Just Lookin' For A Hit 7 4052 | MELISSA MANCHESTER Tribute 7 0403* | THE CULT Sonic Temple 0 1015 | FINE YOUNG CANNIBALS 4 3927 | MELISSA ETHERIDGE Brave And Crazy 1 0503* | ANITA BAKER Giving You The Best... 0 0586 |
|--|---|-------------------------------------|--|---|--|------------------------------------|--------------------------------|---|---|

| | | | | | | | | | | | | | | | | |
|---|----------------------------------|--------------------------------------|--------------------------------|--------------------------------|---|-----------------------------|---|---|--|---|---|--|--|---|------------------------|---------------------------------------|
| RANDY TRAVIS No Holdin' Back 3 4766 | BON JOVI New Jersey 0 0516 | JETHRO TULL Rock Island 7 3901 | THE JETS Believe 5 4453* | RAFFI In Concert 5 4361* | D.A.D.: No Fuel Left For The Pilgrims 3 4663* | MTV POWER PLAYERS 0 0737 | Jim Newsom/Patsy Cline GREATEST HITS 6 0136 | LOUDNESS Soldier Of Fortune 4 4306* | STEVE WINWOOD Chronicles (Gt. Hits) 3 4501 | IRVING BERLIN 100th Anniversary Collection 0 0807 | J.R. Baker Rhapsody In Electric Blue 3 4647 | DOLLY PARTON Greatest Hits 1 4090* | TESLA The Great Radio Controversy 0 0839 | LIONEL RICHIE The Composer 2 4700 | RICHARD MARX 3 4073 | AIR SUPPLY GREATEST HITS 3 4424 |
|---|----------------------------------|--------------------------------------|--------------------------------|--------------------------------|---|-----------------------------|---|---|--|---|---|--|--|---|------------------------|---------------------------------------|

| | | | | |
|------------------------------------|--|----------------------------------|--|---|
| MADONNA Like A Prayer 0 1029 | DR. JOHN In A Sentimental Mood 4 2500* | WHITE LION Big Game 3 0143 | STARSHIP Love Among The Cannibals 4 4888 | GEORGE STRAIT Beyond The Blue Moon 0 1025 |
|------------------------------------|--|----------------------------------|--|---|

| | | | | | | | | | | | | |
|--|--|--|--|--|---------------------------------------|---|---|--|--|-------------------------------|-------------------------------------|-------------------------|
| Fine Young Cannibals The Raw And The Cooked 0 1068 | BILLY OCEAN Greatest Hits 2 4510 | DIRTY DANCING Original Soundtrack 8 2522 | TOM PETTY Full Moon Fever 3 3911 | TRAVELING WILBURYS Volume One 0 0711 | ROY ORBISON Mystery Girl 0 0842 | JIVE PRESENTS Yo! MTV Raps 6 4407 | PATSY CLINE 12 Greatest Hits 5 3849 | NEIL DIAMOND The Jazz Singer Soundtrack 3 2877 | HEIFETZ The Decca Masters 0 0604 | DION Yo! Frankie 0 0825 | THE CARS Greatest Hits 5 3702 | BABYLON A.D. 6 4170* |
|--|--|--|--|--|---------------------------------------|---|---|--|--|-------------------------------|-------------------------------------|-------------------------|

| | | | | | | | | | | | | |
|----------------------------------|-----------------------------------|------------------------------------|--|-----------------------|--|---------------------------|--|---|--|---|---|--|
| CHER Heart Of Stone 4 2874 | DEF LEPPARD Hysteria 0 0927 | ALABAMA Southern Star 0 0914 | POINTER SISTERS Greatest Hits 5 3912 | BLUE MURDER 0 1050 | JOHN WILLIAMS POPS IN SPACE 0 5392 | R.E.M. Green 0 0715 | KINGDOM COME In Your Face 0 1093 | CARLY SIMON Greatest Hits Live 5 4537 | HOLLY DUNN The Blue Rose Of Texas 1 0461 | CHERYL LYNN Whatever It Takes 3 3666* | BLACK SABBATH Headless Cross 5 0234 | MOODY BLUES DAYS OF FUTURE PASSES 4 4245 |
|----------------------------------|-----------------------------------|------------------------------------|--|-----------------------|--|---------------------------|--|---|--|---|---|--|



Aerosmith:
Pump
63678



Clint Black:
Kitlin' Time
01112



Mitti Vanilli:
Girl You Know It's True
01048

| | | | | | | | | | | | | | | | | | | | | |
|--|------------------------------------|-------------------------|--|--|-----------------------------|--|--------------------------------|--|--------------------------------|-------------------------------------|---------------------------------------|--|--------------------------------|--|--|------------------------------|-----------------------|--------------------------------------|--|-----------------------|
| TAYLOR DAYNE Can't Fight Fate 0 1114 | K.T. OSLIN This Woman 0 0579 | D'ATRA HICKS 6 4179* | SUGARCUBES Here Today Tomorrow Next Week 7 3922* | KEITH WHITLEY Don't Close Your Eyes 4 4246 | SOUEZEE Frank 2 4200* | Best Of The VELVET UNDERGROUND 6 2303* | LOU REED New York 0 1058 | STRESSBUSTERS VOL.1 Classics To Relax By 1 3406* | DAN SEALS Rage On 0 0041 | Best Of JOHNNY RIVERS 3 4650* | CAROLE KING City Streets 0 1099 | BARRY MANILWO Greatest Hits, Vol. 1 7 2863 | KIX Blow My Fuse 0 1011* | SANDI PATTI The Friendship Company 0 1022* | LEE GREENWOOD Greatest Hits, Vol. 2 0 0861 | MELISSA ETHERIDGE 6 0352* | BULLETTYOYS 0 0831 | EAGLES Hotel California 3 0330 | REBA MCENTIRE Greatest Hits 8 2110 | VAN HALEN 1 1 4620 |
|--|------------------------------------|-------------------------|--|--|-----------------------------|--|--------------------------------|--|--------------------------------|-------------------------------------|---------------------------------------|--|--------------------------------|--|--|------------------------------|-----------------------|--------------------------------------|--|-----------------------|

| | |
|---|--|
| GLENN MILLER ORCH. In The Digital Mood 4 3293 | Best Of The Doobie Brothers 4 3738 |
|---|--|

| | | | | | | | | | | | | | |
|--------------------------------------|---|-------------------------------|--------------------------------------|--|---|-----------------------------------|---|--|---|--|--|------------------------------------|-----------------------------|
| THE CURE Disintegration 0 1109 | DEBBIE GIBSON Electric Youth 0 0627 | R.E.M. Eponymous 0 0701 | LITTLE FEAT Lei II Roll 0 0497 | RANDY TRAVIS Storms Of Life 7 0446 | KITARO The Light Of The Spirit 6 4228 | ELVIS COSTELLO Spike 0 0841 | GALWAY & MANCINI IN THE PINK 5 1758 | THE BOYS Messages From The Boys 0 0926 | Bird The Orig. Recordings Of Charlie Parker 0 1044* | ARETHA FRANKLIN Through The Storm 0 1097 | MICHAEL MONROE Not Fakin' It 6 0017* | LEE RITENOUR Festival 0 0729 | ALABAMA "LIVE" 6 0027 |
|--------------------------------------|---|-------------------------------|--------------------------------------|--|---|-----------------------------------|---|--|---|--|--|------------------------------------|-----------------------------|

Introducing a big music offer!

Start with 4 compact discs, cassettes or records plus shipping & handling with membership. Buy just 1 smash hit in one year's time. Then get 1 album of your choice.

Enjoy 6 albums for the price of one.

PLUS 2 FREE CDs SEE DETAILS

Nothing more to buy...EVER!

| | | | | | |
|---|-----------------------------------|--|--------------------------------------|---|---|
| EXPOSE What You Don't Know 0 0937 | RANDY TRAVIS Old Hat 0 0008 | GHOSTBUSTERS II Original Soundtrack 5 1964 | GEORGE BENSON Tenderly 1 0762* | Ralph Emery & Shotgun Red Sing Songs For Children 1 3333* | TONY-LOC Luc Ed After Dark 0 1033 |
|---|-----------------------------------|--|--------------------------------------|---|---|

| | | | | | |
|-----------------------------------|--|--|---|----------------------|---|
| ROXETTE Look Sharp! 0 1106* | M.C. HAMMER Let's Get It Started 0 1143* | Best Of The Mighty Gritty Dirt Band, Vol. 2 0 0818 | PAVARTOTTI Live At Carnegie Hall 1 5311 | WHITESNAKE 6 3629 | WILLIE NELSON All-Time Greatest Hits 0 0705 |
|-----------------------------------|--|--|---|----------------------|---|

HERE'S HOW YOU SAVE!

Start Now With 4 Hits. Yes, start with any 4 compact discs, cassettes or records now! You agree to buy just 1 more hit at regular CD prices (usually \$8.98-\$9.98 for tapes or records, \$14.98-\$15.98 for compact discs)...and take up to one full year to do it. Then you can choose another hit FREE! And if you've selected CDs, you choose an additional 2 CDs FREE. That's 6 tapes or records or 8 CDs for the price of one and there's nothing more to buy ever!

No Further Obligation Whatsoever! You buy what you want...when you want it. It's all up to you!

Exciting "Members-Only" Benefits! You'll receive the Club's exclusive magazine about every three weeks. It will feature the Main Selection in your favorite music category, plus hundreds of other hits—many at special bargain prices. In all, you'll have 19 convenient, shop-at-home opportunities a year. And as a member in good standing, you need not send money when you order...we'll bill you later. (A shipping/handling charge is added to each shipment.)

It's Easy To Get Your Favorite Hits! If you want the Main Selection, do nothing. It will be sent to you automatically. If you want other hits, or none at all, just say so on the card always provided...and mail it back to us by the date specified. You'll always have at least 10 days to decide, but if you don't, you may return your Main Selection at our expense. Cancel your membership by writing to us whenever you wish upon completing your enrollment agreement. Or remain a member and take advantage of future money-saving bargains.

FREE 10-Day Trial! Listen to your 4 introductory hits for a full 10 days. If not satisfied, return them with no further obligation. You risk nothing! So don't delay. Pick your hits, write their numbers on the coupon, and mail it today!

Selections not available on Records are marked (*).

MS385A BMG Music Service 6550 E. 30th St. Indianapolis, IN 46219-1194. TRADEMARKS USED IN THE ADVT ARE THE PROPERTY OF VARIOUS TRADEMARK OWNERS.



BERT WHYTE

LIVE REBORN



Over the years, many recordings of pop and rock music concerts have been made, while recordings of live classical music are comparatively rare, restricted mostly to special concert events or music festivals like Bayreuth or Glyndebourne. However, a number of people have commented on the fact that quite a few live recordings of classical music are now appearing on CD. Deutsche Grammophon appears to have issued most of them, with some from Philips, London/Decca, and a few other labels. Although the people I've spoken to seem to be divided on the positive and negative aspects of live classical music recordings, I think I can detect a slight but unmistakable bias against live recordings, as opposed to those made in conventional, dedicated recording sessions.

There are some fascinating philosophical arguments on the subject of music appreciation, whether pop or classical. Few would argue that the ultimate enjoyment of music lies in attending a live concert. However, it is at such an event that the divergent natures of live pop and classical music are most apparent. One of the most emotional aspects of the live concert experience, for example, is the sense of participation. Although there is the

aura of uplifting excitement shared by the audience, it must be conceded that the pop audience is more immediately involved. The sense of occasion is greater, the audience's emotional response more unbridled and uninhibited. In addition to purely musical aspects, audiences become involved at pop concerts because of the stimulus of visual elements—flashing strobe and laser displays, multi-colored smoke, and the antics and gyrations of the performers.

It must be noted that between the pop music audience and the musicians onstage is a huge "wall" of audio electronics. Banks of brute-force amplifiers, stacked arrays of high-output loudspeakers, and an elaborate control console to provide equalization and a myriad of special effects all result in music that is totally electronically enhanced. In marked contrast, the audience attending a concert of classical music hears the natural acoustic output of the orchestral instruments and their interaction with the concert hall, period. In certain halls, microphones may be used on vocal soloists or choral groups, but it is usually quite minimal and discreet.

In a sense, devotees of pop music are pre-conditioned to electronic manipulation of their music, whether at a

concert or on a recording. The classical music lover, on the other hand, even one equipped with the most elaborate and expensive audio system and state-of-the-art recordings, is acutely aware that what he hears cannot equal the concert hall listening experience.

Which brings us back to the issue of live recordings of classical music concerts. Some feel that concert recordings capture more of the essence of a musical performance. They make the claim of more spontaneity, a more cohesive performance. There certainly is an element of truth in this. But what about the sonic problems which inevitably intrude during live concert recordings? Audience noises—especially coughs—can be irritating, particularly in pianissimo passages. Poor intonation, bad ensemble playing, and the occasional clam from a French horn can all disturb.

On the very first playback, these various problems are of minor import and, in fact, lend an atmosphere of reality. However, on subsequent listening, the loud cough at the beginning of a slow movement will become an anticipatory cue in your brain and turn into quite an annoyance. (Incidentally, my experience has been that in live concert recordings, European concert audiences are quieter and less prone to coughing than their American counterparts).

Considering the present spate of live concert recordings, a closer look is in order. Are the labels producing these releases because they are less expensive than standard recording sessions? To a degree, yes. A symphony of 50 minutes' duration will be recorded in that time span at a concert. In general, this same 50-minute work would require three recording sessions of three hours each. Add transportation to the recording hall (if the orchestra's own hall is not suitable), hall rental fees, sundry charges for recording-equipment transport and recording crew, and, finally, the expense of editing the session tapes.

To be fair, the cost difference between live concert and standard recording sessions is usually not the reason why a label decides to make a live recording. Often, the decision is made because one of the label's top conductors is performing with an orchestra which he rarely conducts, or because

Photograph: David Hamsley



Krell Digital Software Based Processing



- 64 Times Oversampling
- Proprietary—Updatable Processing Software
- Usable with the Digital Output from any CD/DAT
- Supports Industry Standard Fiber Optic Input and Coaxial Input Via RCA Connectors
- Class A—High Bias—Discrete Analog Output Circuit
- Three Independent—Fully Regulated Power Supplies
- Completely Modular Circuit Board Construction

For more information, contact your nearest Krell Digital dealer.

For More Information



Call 1-800-553-4355

KRELL DIGITAL INC. ■ 20 No. Plains Industrial Rd., Suite 12 ■ Wallingford, CT 06492
 Phone: 203-294-1213 ■ Fax: 203-294-1235
 Enter No. 17 on Reader Service Card



I must say, a number of the live classical recordings I've heard lately are quite good. Even the audiences have been blissfully quiet!

the music involved is rarely performed, or because the conductor is closely identified with some music he wants to record with a particular orchestra.

Concert recordings of operas are of particular interest to record companies because of problems in scheduling the various stars: Since most of these art-

ists are engaged in performances around the world, arranging for the desired artists to be at a recording session—say, in Vienna in July—can be a logistical nightmare.

Making a concert recording is an undertaking fraught with problems. If the engineers favor multi-mike record-

ing, the forest of microphones usually upsets the orchestra management, who fear this will irritate the audience. Hanging the mikes would be a good alternative, but it is usually impossible or, at best, quite difficult. The final mike setup will undoubtedly be somewhat less than what the engineers would consider optimal.

Naturally, the problems of hall acoustics must be addressed. It is common knowledge that though certain concert halls provide a superior listening experience for an audience, when empty they are less than suitable for recording. A case in point is Boston Symphony Hall, which gives an audience glorious sound at a reverberation period of 1.8 to 1.9 S. When empty, the hall has a reverb period of 2.3 to 2.4 S and can be a bit tricky in recording. On the other hand, consider Orchestra Hall in Chicago. After its modification in 1965, the hall became very dry acoustically. In recent years, record companies have expediently covered the seats with plywood panels and vinyl sheeting to bring the reverb period up to a usable 1.4 S. Obviously, this technique cannot be used when the hall is filled with people. Since the audience absorbs sound and makes the hall fairly dry, engineers would have to add digital reverb to a concert recorded there, in order to provide ambience and spaciousness.

I must say that quite a few of the live classical recordings I have heard lately are really quite good. Considering the difficulties, the recording engineers have coped very well. Even the audiences have been blissfully quiet!

It is worth remembering that the superior musical and sonic aspects of recordings made in the dedicated session tradition are due to the miracle of tape editing. If the players don't start a passage together, if intonation is poor, if there are various clinkers, or if someone drops a mallet or a mute, all this can be neatly excised electronically.

When I was music director at RCA Victor Red Seal, I was sitting in a studio with the late Artur Rubinstein, listening to the playback of some edited tapes of Chopin mazurkas that the great pianist had recorded. Rubinstein turned to me and quipped, "You know, I wish I could play as well as that fellow." That says it all. 

HPC
HELICAL PLANAR COPPER
CPC
CO-PLANAR COPPER

Over two years ago the staff at Madrigal Audio Laboratories began accumulating convincing evidence that solid conductors of rectangular cross-section would do a better job of carrying musical signals. Years of listening and engineering tests making use of ribbons of specially processed, high-purity copper with teflon insulation and the highest quality terminations, have resulted in the new Madrigal HPC and CPC cables.

Visit your Madrigal dealer and hear what these original designs can do to improve your music system.

HPC and CPC cables are designed by, and manufactured exclusively for Madrigal Audio Laboratories, P.O. Box 781, Middletown, CT 06457 ITT TLX 4942158

CYRUS

"In our personal judgement, the Cyrus 781 is one of the best-sounding speakers in its price range."

Julian Hirsch
Stereo Review
October 1989



From its Cyrus line of audiophile products, Mission Electronics brings you its latest triumph: The Cyrus 781 loudspeaker.

As with all Cyrus products, the 781 is attuned to the demands of the purist. As Julian Hirsch found in his recent test report, the 781 yields clear, extended bass, rapid transient recovery, and broad dynamic range. As you'll find when you listen, it produces music with astounding clarity and depth, and most importantly, total fidelity to the original recording.

The Cyrus 781 is a new and uniquely designed speaker, capable of producing expansive sound from a relatively small enclosure. At the same time, it has evolved from speaker technologies pioneered by Mission like mineral-loaded polypropylene woofers and plastiflexed fabric dome tweeters. It features our "inverted drive unit geometry" — placing the woofer above the tweeter — which ensures phase linearity at cross-over frequencies.

Of course, the most astounding part about the 781 is its price: \$599 per pair. Or as Julian Hirsch put it, "It is always a pleasant surprise to find a modestly priced product... that manages to outperform its competition."

In USA: MISSION ELECTRONICS USA INC., 13305 8th AVENUE SOUTH, SEATTLE, WA 98148, USA.
PHONE (604) 432 7727

In Canada: PACO ELECTRONICS LTD., 20 STEELCASE RD WEST, UNIT 10, MARKHAM, ONTARIO, L3F 1B2, CANADA
PHONE (416) 475 0740.

For More Information



Call 1-800-553-4355

“Cambridge SoundWorks May Have The Best Value In The World. A Winner.”

David Clark—Audio Magazine Sept. '89

Cambridge SoundWorks has created Ensemble, a speaker system that can provide the sound once reserved for the best speakers under laboratory conditions. It virtually disappears in your room. And because we market it directly, Ensemble costs hundreds less than it would in stores.



Henry Kloss, creator of the dominant speaker models of the '50s (Acoustic Research), '60s (KLH) and '70s (Advent), brings you Cambridge SoundWorks, a genuinely new kind of speaker company for the '90s.

The best sound comes in four small packages.

Ensemble consists of four speaker units. Two compact low-frequency speakers reproduce the deep bass, while two small satellite units reproduce the rest of the music, making it possible to reproduce just the right amount of energy in each part of the musical range without turning your listening room into a stereo showroom.

No matter how well a speaker performs, at home the listening room takes over. Room acoustics emphasize and de-emphasize various parts of the musical range, depending on

where the speaker is placed in the room. If you put a conventional speaker where the room can help the low bass, it may hinder the upper ranges, or vice-versa.

Your listening room works with Ensemble, not against it.

Ensemble, on the other hand, takes advantage of your room's acoustics. The ear can't tell where bass comes from, which is why Ensemble's bass units can be tucked out of the way—on the floor, atop bookshelves, or under furniture. The satellites can be hung directly on the wall, or placed on windowsills or shelves. No bulky speaker boxes dominate your living space, yet Ensemble reproduces the deep bass that *no* mini speakers can.

Unlike seemingly similar satellite systems which use a single large subwoofer, Ensemble uses two separate, compact bass units. They fit more gracefully into your living environment, and help minimize the effects of the listening room's standing waves.

“Very much in the Henry Kloss tradition... another hi-fi milestone.”

 Review



™Ensemble & Ambiance are trademarks of Cambridge SoundWorks, Inc.

Not all the differences are as obvious as our two subwoofers.

Unlike seemingly similar three-piece systems, Ensemble uses premium quality components for maximum power handling, individual crossovers that allow several wiring options and cabinets ruggedly constructed for proper acoustical performance. We even gold-plate all connectors to prevent corrosion. An even bigger difference is how we sell it.

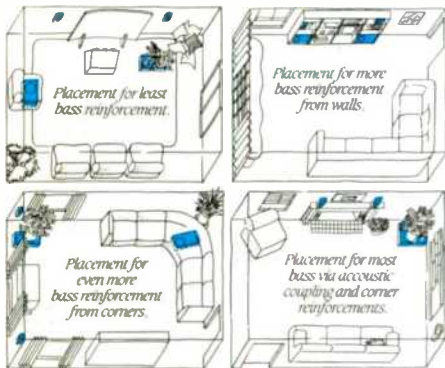

You can put Ensemble's low-frequency units exactly where they should go for superb bass. You can't do this with conventional speakers because you have to be concerned about the upper frequencies coming from the same enclosures as the low ones.

Thousands agree: the best showroom is your living room.

Choosing a loudspeaker after a brief listen at a dealer's showroom is like deciding on a car after one quick trip around the block. So we make it possible to audition Ensemble the *right* way—in your own home. In fact, Ensemble is sold *only* by Cambridge SoundWorks directly from the factory.

"They were designed to play music—and make it sound like music. This they do very well, in a most unobtrusive way, at a bargain price... it's hard to imagine going wrong with Ensemble."
Stereo Review

You get to listen for hours without a salesman hovering nearby. If after 30 days you're not happy, return Ensemble for a full refund (we'll even reimburse the original UPS shipping charges in the continental U.S.).

At only \$499—complete with all hardware and 100' of speaker cable—Ensemble is *the* value on today's speaker market.

"You get a month to play with the speakers before you have to either return them or keep them. But you'll keep them."

Esquire



Introducing Ambiance by Henry Kloss.

Ambiance™ is an ultra-compact speaker that proves high performance, small size and low cost need not be mutually exclusive. Ambiance is ideal for bedrooms, dens, dorm rooms...or for use as an extension speaker or in surround-sound systems. While *no* speaker of its size can provide the same low bass and total volume as our Ensemble system, Ambiance has more output in the 40Hz region than any "mini speaker" we've encountered. Indeed we know of *no* compact speaker that outperforms Ambiance, including those costing hundreds more. Ambiance is only \$109 per speaker in Nextel or primed for painting; \$129 in solid oak,* and comes with our 30 day money-back guarantee.

Enter No. 9 on Reader Service Card

"A listening test left no doubt that this system ranks with the best in its price range."

The New York Times

**Try them risk-free for 30 days.
Call 1-800-AKA-HIFI®
(1-800-252-4434)**

Our toll-free number connects you to a Cambridge SoundWorks audio expert. He or she will answer all your questions, take your order (you can use Visa, MasterCard or American Express) and arrange surface shipment via UPS. Your Cambridge SoundWorks audio expert will continue as your personal contact with us. We think you'll like this new way of doing business.

*In Canada, call 1-800-525-4434. Audio experts are on duty 9 AM to Midnight, Eastern Time, seven days a week. Fax #: 617-332-9229.

CAMBRIDGE SOUNDWORKS

Suite 104F 154 California St., Newton, MA 02158

- Send more information and test reports.
 - Send Ensemble risk-free for 30 days, for \$499.*
 - Send ___ (qty.) Ambiance (Nextel), for \$109 ea.*
 - Send ___ (qty.) Ambiance (Primed), for \$109 ea.*
 - Send ___ (qty.) Ambiance (Oak), for \$129 ea.*
- I'm paying by Check MC Visa AmEx

Acct. Number _____ Exp. _____
 Signature _____
 Name _____
 Address _____
 City _____ State _____ Zip _____
 Phone (Area Code) _____ Number _____

FOR IMMEDIATE SERVICE: 1-800-AKA-HIFI
 MA residents add 5% sales tax.
 *Plus freight (Ensemble \$7-\$25, Ambiance \$2-\$12)
 Delivery time usually 2-7 days.

REDIRECT

Direct to Disc—and from It

From the '50s on, most recordings have been made on tape and transferred to disc. Before then, all recordings were made direct to disc (or, still earlier, to cylinder). In the '70s, some audiophile labels began recording directly onto disc again, to regain the edge of clarity lost by the intermediary stage of analog tape. Now Reference Recordings has made a record direct to CD—and Nimbus has a series of recordings made direct from disc.

In the case of Nimbus' Prima Voce series, the discs are 78-rpm collectors' items, made by such operatic artists as Luisa Tetrazzini, Lawrence Tibbett, Conchita Supervia, Beniamino Gigli, Amelita Galli-Curci, Claudia Muzio, Lotte Lehmann, Giovanni Martinelli, Rosa Ponselle, and the inevitable Enrico Caruso. Transferring historic recordings like these to CD is nothing new, but Nimbus' Natural Ambisonic Transfer system is. Instead of playing the disc with a modern cartridge, Nimbus used an acoustic gramophone pickup, complete with thorn needle and brass horn, attached to a modern turntable (more accurate in speed and more convenient than the wind-up original). This setup was placed in Nimbus' small concert hall and recorded with an Ambisonic microphone.

According to Nimbus, this system naturally filters out the hisses, crackles, and pops normally heard when old discs are played on modern phonographs. "What emerges has the power to make old things new ...



The microphone system and player used in Nimbus' Natural Ambisonic Transfer system.

and, still more vital, to bring the old out into the light of day where it may be appreciated by the young," wrote John Steane, in *Gramophone*, of the discs' introduction.

If Nimbus' process is surprisingly direct, the process used to make Reference Recordings' first direct CD was fairly roundabout. First, Dick Hyman played music by Fats Waller on a Bösendorfer SE computerized reproducing piano in New York. The piano recorded his keystrokes and expression onto a floppy disk, which was then used to re-create his performance on another SE in a California studio. The signal picked

up by the studio's microphones was then converted to a digital bit stream and transmitted by microwave to the CD mastering facility at Disctronics Manufacturing, where it was then put on disc.

Producer J. Tamblyn Henderson says, "Most manufacturers of Compact Discs will admit that their finished product does not sound the same as the original master. In this case, the finished product is identical to the master."

Dick Hyman Plays Fats Waller (RR-33DCD) was engineered by Keith O. Johnson, and the mastering was supervised by Robert Harley. It will initially be issued in a deluxe limited edition for \$30, after which it will come out on regular CDs, LPs, and cassettes.

dBmystery

The dBm is an old familiar electrical unit that stands for decibels referred to 1 milliwatt. For a 600-ohm line, this would be equivalent to 0.775 V.

But there seems to be a new unit, with the same abbreviation, used for optical connections on CD players. It cropped up in the specifications for Sony's CDP-X7ESD and Philips' LHH1000, reviewed in the November 1989 and January 1990 issues. What's dBm stand for? Search me—we've yet to find anyone at Sony or Philips who can explain it!

Spinning, but Not in Their Graves

The turntable is dead, right? Wrong. According to Kevin Byrne of Ortofon, figures from the Electronics Industries Association show that more than 180,000 turntables were sold by major companies in the first five months of 1989. That's nearly 50% more than the total of all preamps, power amps, integrated amps, and tuners these companies sold in that period. Sales of CD players during those same months, however, totalled about 1,205,000. The turntable is still spinning, but CD is winning.

Moving to a New Ohm

The volt and the ohm are not what they used to be. As of January 1, 1990, the National Institute of Standards and Technology established new values for them (based on new, state-of-the-art measurement techniques) to bring them in line with international standards. As a result, the standard volt will increase by about 9.26 parts per million, and the standard ohm by about 1.69 ppm. These small changes won't affect audio measurements or specs.

A SOUND INVESTMENT! 8 CDs FOR 1¢

AND A CHANCE TO GET ONE MORE FREE!

plus shipping/handling, with membership. Details on other side.



Aerosmith—Pump. *Love In An Elevator*; *Janie's Got A Gun*; etc. (Geffen) 388-009
Bob Dylan—*Oh Mercy*, *Everything's Broken*; more. (Columbia) 389-262

Tracy Chapman—*Crossroads*. Title cut plus *Material World*; more. (Elektra) 387-951
Billy Joel—*Storm Front*, *We Didn't Start The Fire*, *Shameless*; etc. (Columbia) 387-902

Rolling Stones—*Steel Wheels*. *Mixed Emotions*; etc. (Rolling Stones Rec.) 387-738
Grateful Dead—*Built To Last*, *Foolish Heart*; plus more. (Arista) 388-025

Ziggy Marley & The Melody Makers—*One Bright Day*. (Virgin) 386-987
Tom Petty—*Full Moon Fever*, *I Won't Back Down*, *Free Fallin'*; etc. (MCA) 382-184

Belinda Carlisle—*Runaway Horses* (RCA) 400-788

Yo-Yo Ma—*Great Cello Concertos* (CBS Master) 401-604

Ars—*Truth In A Structured Form* (Imagine) 401-539

Joan Baez—*Speaking Of Dreams* (Gold Castle) 401-216

Bruce Willis—*It It Don't Kill You, It Just Makes You Stronger* (Motown) 401-182

Do The Right Thing—Original Sound Track Featuring: Branford Marsalis (Columbia) 401-117

Bros—*The Time* (Epic) 400-895



Nadja Salerno-Sonnenberg—*Violin Concerto*; *Bruch: Concerto No. 1*; *Edo De Waart and Minnesota Orch.* (Angel) 400-135

Joe Satriani—*Flying In A Blue Dream* (Relativity) 400-655

Best Of The Grateful Dead (Warner Bros.) 291-633

Best Of The Doobie Bros. (Warner Bros.) 291-278

The Very Best of Poco (Epic) 367-623

Pat Benatar—*Best Shots* (Chrysalis) 401-646

Paul Simon—*Negotiations And Love Songs* (Warner Bros.) 400-721

Eagles—*Live* (Elektra) 400-713

Yo-Yo Ma/Stephane Grapelli—*Anything Goes. Mostly Cole Porter Tunes* (CBS) 387-845

George Clinton—*The Cinderella Theory* (Paisley Park) 387-134

Lee Ritenour—*Color Rit* (GRP) 400-051

Dave Grusin—*Migration* (GRP) 400-044

Molly Hatchet—*Lightning Strikes Twice* (Capitol) 389-346

The Best Of Tim Curry (A&M) 388-926

Barry White—*The Man Is Back!* (A&M) 388-843

Liszt: Piano Sonata; *3 Petrarca Sonnets*; more. **Vladimir Feltsman**, Piano (CBS Master) 388-538

Jethro Tull—*Rock Island* (Chrysalis) 388-157

The Best Of The Dregs—*Divided We Stand* (Arista) 386-979

Paul Shaffer—*Coast To Coast* (Capitol) 386-276

Boogie Down Productions—*Ghetto Music: Blue Print Of Hip Hop* (Jive/RCA) 386-193

Babyface—*Tender Love* (Epic) 386-177



Janet Jackson—*Rhythm Nation 1814* (A&M) 388-918

The Best Of Luther Vandross—*The Best Of Love* (Epic) 400-473/390-476

Michel Camilo—*On Fire* (Epic) 389-999

Marshall Crenshaw—*Good Evening* (Warner Bros.) 386-110

Steve Stevens Atomic Playboys (Warner Bros.) 386-086

Jefferson Airplane (Epic) 385-906

Rippingtons—*Tourist In Paradise* (GRP) 385-658

Reba McEntire—*Live* (MCA) 400-739

N.R.B.Q.—*Wild Weekend* (Virgin) 389-882

Linda Ronstadt—*Cry Like A Rainstorm, Howl Like The Wind* (Elektra) 389-874

Yousou N' Dour—*The Lion* (Virgin) 384-362

Anderson, Bruford, Wakeman, Howe (Arista) 384-115

Tin Machine (EMI) 383-976

Billy Squier—*Hear And Now* (Capitol) 383-760

Loverboy—*Big Ones* (Columbia) 401-661

Terence Trent D'Arby—*Neither Fish Nor Flesh* (Columbia) 389-726

Gold & Platinum Volume Six (Realms) 388-355

Spyro Gyra—*Point Of View* (MCA) 383-737

Queen—*The Miracle* (Capitol) 383-547

Jean Luc Ponty—*In The Fast Lane* (Columbia) 383-521

Bonham—*The Disregard Of Timekeeping* (WTG) 383-497

Foreigner—*Records* (Atlantic) 318-055

Rickie Lee Jones—*Flying Cowboys* (Geffen) 388-199

Yellowjackets—*The Spin* (MCA) 388-173

Mozart: Flute Concertos; *Adante*; *Rondo*. **Jean-Pierre Rampal** And **Zubin Mehta**, Israel Phil. (CBS Master) 383-364

Haydn: Piano Sonatas 33, 38, 58, 60. **Emanuel Ax** (CBS Master) 383-331

Berlioz: Symphonie Fantastique. **Norrinton**, London Classical Players (Angel) 382-747

Taylor Dayne—*Can't Fight Fate* (Arista) 388-017



BUSINESS REPLY MAIL
FIRST CLASS PERMIT NO. 660 TERRE HAUTE, IN

NO POSTAGE
NECESSARY
IF MAILED
IN THE
UNITED STATES

POSTAGE WILL BE PAID BY ADDRESSEE

CBS/Columbia House

1400 NORTH FRUITRIDGE AVENUE
TERRE HAUTE, IN 47812-9202





ANY 8 CDs FOR A PENNY AND A CHANCE TO GET ONE MORE CD—FREE!

plus shipping/handling, with membership.

Elton John—Sleeping With The Past (MCA) 387-993

Rachmaninoff: Piano Concerto No. 3, Rhapsody On Theme Of Paganini, Vladimir Feltsman; Zubin Mehta, Israel Philharmonic (CBS Master) 383-315

Liza Minnelli—Results (Epic) 382-333

L.L. Cool J—Walking With A Panther (Def Jam / Columbia) 381-988

Don Henley—The End Of The Innocence (Geffen) 383-802

Branford Marsalis—Trio Jeepy (Columbia) 381-830

Todd Rundgren—Nearly Human (Warner Bros.) 381-780

Miles Davis—Amandla (Warner Bros.) 381-756

k.d. lang And The Reclines—Absolute Torch & Twang (Sire) 381-624

Placido Domingo—The Unknown Puccini (CBS Master) 387-829

Squeeze—Frank (A&M) 388-058

Jonathan Richman (Rounder) 400-861

Jane Siberry—Bound By The Beauty (Reprise) 400-804

The Psychedelic Furs—Book Of Days (Columbia) 400-689

The Alarm—Change (I R S) 400-465

Indigo Girls—Strange Fire (Epic) 400-333

Sugarcubes—Here Today, Tomorrow, Next Week (Elektra) 388-900

Max Q (Atlantic) 400-077

The Residents—The King And Eye (Enigma) 400-036

Kate Bush—The Sensual World (Columbia) 401-232

Camouflage—Methods Of Silence (Atlantic) 400-929

Canadian Brass—The Best Of The Canadian Brass (CBS Masterworks) 401-596

Joe Cocker—One Night Of Sin (Capitol) 387-084

Best Of Cher (EMI) 381-509

Jody Watley—Larger Than Life (MCA) 381-061

Steve Reich: Different Trains - Kronos Quartet / Electric Counterpoint - Pat Metheny (Nonesuch) 380-071

The Chick Corea Akoustic Band (GRP) 379-891

Bo Diddley Is A Gunslinger (Chess) 379-677

Warrant—Dirty Rotten Filthy Stinking Rich (Columbia) 379-644

Skid Row (Atlantic) 379-602

Madonna—Like A Prayer (Sire) 379-594

Soul II Soul—Keep On Movin' (Virgin) 386-037

Joe Strummer—Earthquake Weather (Epic) 400-010

Nick Lowe—Basher: The Best Of Nick Lowe (Columbia) 400-002

Vitamin Z—Sharp Stone Rain (Geffen) 389-601

David Byrne—Rei Momo (Sire) 389-494

Red Hot Chili Peppers—Mother's Milk (EMI) 389-205

Debbie Harry—Def, Dumb & Blonde (Sire/Reprise) 389-130

Thompson Twins—Big Trash (Warner Bros.) 389-114

Pete Townshend—The Iron Man (Atlantic) 385-724

Creedence Clearwater Revival—20 Greatest Hits (Fantasy) 308-049

Hooters—Zig-Zag (Columbia) 379-396

Enrico Caruso—Opera Arias and Songs, Milan 1902-1904 (Angel) 379-255

Crosby, Stills, Nash and Young—So Far (Atlantic) 378-745

Portrait Of Vladimir Horowitz—Mozart, Beethoven, Chopin, etc. (CBS Master) 378-604

Roy Orbison—The All-Time Hits, Vols. 1 & 2 (Columbia Special Prod.) 377-945

Cyndi Lauper—A Night To Remember (Epic) 377-887

Debbie Gibson—Electric Youth (Atlantic) 377-275

Dr. John—In A Sentimental Mood (Warner Bros.) 384-040

Big Audio Dynamite—Megalop Phoenix (Columbia) 388-215

John Hiatt—Y'all Caught (Geffen) 388-116

Camper Van Beethoven—Key Lime Pie (Virgin) 388-074

Syd Straw—Surprise (Virgin) 386-995

Chris Isaak—Heart Shaped World (Reprise) 386-144

Paul Kelly And The Messengers—So Much Water So Close To Home (A&M) 384-321

Bryan Ferry / Roxy Music—Street Life (Reprise) 384-230

Batman—Original Soundtrack (Warner Bros.) 383-885

The Best Of Emerson, Lake & Palmer (Atlantic) 306-969

The Who—Who's Better, Who's Best (MCA) 376-657

Guns N' Roses—GN'R Lies (Geffen) 376-087

Journey's Greatest Hits (Columbia) 375-279

.38 Special—Rock & Roll Strategy (A&M) 375-139

U2—Rattle And Hum (Island) 374-017

Luciano Pavarotti—Pavarotti in Concert (CBS Master) 373-548

Living Colour—Vivid (Epic) 370-833

Van Halen—OU812 (Warner Bros.) 369-371

REO Speedwagon—Greatest Hits (Epic) 367-672

Beastie Boys—Paul's Boutique (Capitol) 383-786

Bodeans—Home (Reprise/Slash) 384-206

The Call—Let The Day Begin (MCA) 384-156

The B-52's—Cosmic Thing (Reprise) 383-877

Peter Gabriel—Passion (Geffen) 383-810

Lloyd Cole & The Commotions—1984-1989 (Capitol) 383-778

Pixies—Doolittle (Elektra) 382-887

The Cure—Disintegration (Elektra) 382-093

10,000 Maniacs—Blind Man's Zoo (Elektra) 382-077

Indigo Girls (Epic) 381-269

R.E.M.—Green (Warner Bros.) 375-162

Gloria Estefan—Cuts Both Ways (Epic) 382-341

Billy Ocean—Greatest Hits (Jive/RCA) 400-879

The Beach Boys—Still Cruising (Capitol) 387-092

Joni Mitchell—Court and Spark (Asylum) 367-102

Traffic—John Barleycorn Must Die (Island) 364-935

The Babys—The Babys Anthology (Chrysalis) 312-256

Van Morrison—Saint Dominic's Preview (Warner Bros.) 364-927

Little Feat—Dixie Chicken (Warner Bros.) 363-515

Pretenders—The Singles (Sire) 362-541

Best Of The Doors (Elektra) 357-616/397-612

Rolling Stones—Exile On Main Street (Rolling Stones Rec.) 350-652

Mili Vanilli—Girl You Know It's True (Arista) 379-610

Fine Young Cannibals—The Raw And The Cooked (I R S) 379-214

Rolling Stones—Sticky Fingers (Rolling Stones Rec.) 350-645

The Police—Every Breath You Take... The Singles (A&M) 348-318

Jethro Tull—Aqualung (Chrysalis) 345-157

Paula Abdul—Forever Your Girl (Virgin) 374-637

Best Of Procol Harum (A&M) 344-457

Kiri Te Kanawa—Verdi & Puccini Arias (CBS Master) 343-269

Mötley Crüe—Dr. Feelgood (Elektra) 387-944

The Byrds—Greatest Hits (Columbia) 342-501

Bad Company—10 From 6 (Atlantic) 341-313

A Decade Of Steely Dan (MCA) 341-073

The Cars—Greatest Hits (Elektra) 339-903

Best Of Kansas (CBS Assoc.) 327-742

Joe Cocker—Greatest Hits (A&M) 320-911

Elton John—Greatest Hits (MCA) 319-541

© 1990 CBS Records Inc.

SEND NO MONEY—JUST MAIL POSTPAID CARD

CBS/Columbia House, 1400 N. Fruitridge Ave. P.O. Box 1129, Terre Haute, IN 47811-1129

Please accept my membership application under the terms outlined in this advertisement. Send my 8 Compact Discs and bill me only 1¢, plus shipping and handling. I agree to buy six selections at regular Club prices in the coming three years—and may cancel membership at any time after doing so.

My main musical interest is (check one): (But I may always choose from any category)

- | | | | |
|---|---|--|---|
| <input type="checkbox"/> Hard Rock | <input type="checkbox"/> Soft Rock | <input type="checkbox"/> Modern Rock | <input type="checkbox"/> Pop |
| <input type="checkbox"/> Rolling Stones, Aerosmith | <input type="checkbox"/> Tina Turner, Gloria Estefan | <input type="checkbox"/> Sugarcubes, Big Audio Dynamite | <input type="checkbox"/> Barbra Streisand, Barry Manilow |
| <input type="checkbox"/> Heavy Metal | <input type="checkbox"/> Black Music | <input type="checkbox"/> Easy Listening | <input type="checkbox"/> Country |
| <input type="checkbox"/> Mötley Crüe, Skid Row | <input type="checkbox"/> Babyface, Soul II Soul | <input type="checkbox"/> Johnny Mathis, Ray Conniff | <input type="checkbox"/> Jazz |
| | | <input type="checkbox"/> Classical* | |

Mr. _____
Mrs. _____
Miss _____

Print First Name Initial Last Name

Address _____ Apt. _____

City _____

State _____ Zip _____

Do you have a VCR? (04) Yes No **175/90**

Do you have a credit card? (03) Yes No

Note: We reserve the right to reject any application or cancel any membership. These offers not available in APO, FPO, Alaska, Hawaii, Puerto Rico; write for details of alternative offer. Canadian residents serviced from Toronto. Applicable sales tax added to all orders. *Classical members serviced by the CBS Classical Club.

Send these 8 CDs for 1¢

| |
|--|
| |
| |
| |
| |
| |
| |
| |
| |

Extra Bonus Offer: also send one more CD right now, for which I will be billed only \$6.95

| |
|--|
| |
|--|

...and I'm entitled to get this extra CD FREE!

| |
|--|
| |
|--|

WS2/F6 WS3/59

Anytime you can get 8 CDs for a penny—that's a sound investment! That's right—as your introduction to the Club, you can choose any 8 CDs listed in this ad—all 8 are yours for only 1¢, plus shipping and handling. And in exchange, you simply agree to buy 6 more CDs (at regular Club prices) in the next 3 years—and you may cancel your membership anytime after doing so.

How the Club works: About every four weeks (13 times a year) you'll receive the Club's music magazine, which describes the Selection of the Month—plus many exciting alternates, new hits and old favorites from every field of music. In addition, up to six times a year, you may receive offers of Special Selections, usually at a discount off regular Club prices, for a total of up to 19 buying opportunities.

If you wish to receive the Selection of the Month, you need do nothing—it will be shipped automatically. If you prefer an alternate selection, or none at all, fill in the response card always provided and mail it by the date specified. You will always have at least 10 days in which to make your decision. If you ever receive any Selection without having 10 days to decide, you may return it at our expense.

The CDs you order during your membership will be billed at regular Club prices, which currently are \$12.98 to \$15.98—plus shipping and handling. (Multiple-unit sets may be somewhat higher.) After completing your enrollment agreement you may cancel membership at any time; if you decide to continue as a member, you'll be eligible for our bonus plan. It lets you buy one CD at half price for each CD you buy at regular Club prices.

10-Day Free Trial: We'll send details of the Club's operation with your introductory shipment. If you are not satisfied for any reason, return everything within 10 days and you will have no further obligation.

Extra Bonus Offer: As a special offer to new members, take one additional CD right now for only \$6.95. This discount purchase entitles you to choose an extra CD as a bonus FREE. And you'll receive your discounted CD and your bonus CD with your 8 introductory selections—that's 10 CDs in all! Send no money now—just mail the postpaid card.

Selections with two numbers contain 2 CDs and count as 2—so write in both numbers.

CBS/COLUMBIA HOUSE: Terre Haute, IN 47811

Arkansas Tweaker Steps Down, Keeps Fiddling

One of audio's grand old lions, Paul W. Klipsch, has sold his speaker firm, Klipsch & Associates, to his cousin, businessman Fred S. Klipsch of Indianapolis. Founded in 1946 and based in Hope, Arkansas, Klipsch & Associates builds speakers for home, professional, and theater use. Fred Klipsch replaces his cousin as chairman of the board; 85-year-old Paul remains as a technical and marketing adviser.

The elder Klipsch, long known as a free-spoken audio maverick, has been known to circulate buttons at audio conventions emblazoned with his favorite eight-letter expletive. Fond of collecting quotes, he expressed his feelings about his new job at Klipsch & Associates by referring to Leslie Ayre's *The Wit of Music*: "When in his 80s, Pierre Monteux signed a 25-year contract as principal conductor of the London Symphony Orchestra, on the strict condition that he could have an option for another 25 years." Two (perhaps contrasting) sayings Klipsch also likes to repeat are Dr. Irving Gardner's "You can't make what you can't measure because you don't know when you've got it made" and this, from L. L. Beranek's book, *Acoustics*: "If one selects his own components, builds his own enclosure, and is convinced he has made a wise choice of design, then his own loudspeaker sounds better to him than anyone else's loudspeaker. In this case, the frequency response of the loudspeaker seems only to play a minor part in forming a person's opinion." *Tony Scherman*



Koss and Effect

Promotional T-shirts usually show just company logos, plus an occasional product or two. Koss' are a bit more creative. The most straightforward of their shirts, adorned with "Support Your Right to Privacy," shows a headphone-wearing listener next to a nonlistener. Another shirt shows a slightly glum, James Dean-ish figure labelled "Rebel Without A Koss"; the back of the shirt shows the same figure, wearing headphones and smiling—"Rebel With A Koss," naturally. And then, of course, there's the quasi-cubist headphone wearer by "Pikosso," modelled above.

Coda: Deane E. Jensen

Deane Ellsworth Jensen passed away suddenly in the North Hollywood laboratory of Jensen Transformers, on the weekend of October 21, 1989. Though he was only 47 at his death, Jensen had already become well known as a designer and manufacturer of low-distortion audio transformers. He also developed the COMTRAN circuit analysis program for use in computer-aided design and had published many articles on high-frequency phase response and its audible effects. Born in Annapolis, Maryland in 1942, Jensen attended the University of Pennsylvania, where he worked with WXPN, the student-operated radio station. He founded Jensen Transformers in 1972. His family requests that any memorial contributions be sent to the Richard C. Heyser Memorial Scholarship Fund, in care of the Audio Engineering Society, 60 East 42nd St., New York, N.Y. 10165.

Quibbles and Bits

Brace yourself for a semantic squall over the term "oversampling."

In playback of digital recordings, as all agree, it means using a higher sampling rate than that of the original recording. This is done so that the sampling frequency can be removed from the output more by digital than by analog filters.

In recording, the same idea can be applied to the anti-aliasing filter used at the input to an A/D converter. These filters prevent aliasing distortion by removing from the input signal all frequencies higher than the Nyquist limit (half the sampling rate). An oversampling input filter uses a much higher sampling rate than that of the eventual recording, so little or no analog filtration is required. At the 128-times oversampling rate now used by Chesky Records, for example, the audio input need only be cut off above 2.8224 MHz, where there's probably no signal anyway. After that, all frequencies above 20 or 22 kHz (the Nyquist limit for Compact Discs) can be filtered out in the digital domain, with no phase problems or other filter side effects.

Another way around the anti-aliasing filter problem is to actually record at higher sampling rates—and I'm told that professional decks with 88.2-MHz recording are in the offing. Some recording engineers feel that the term "oversampling" should be reserved for such machines.

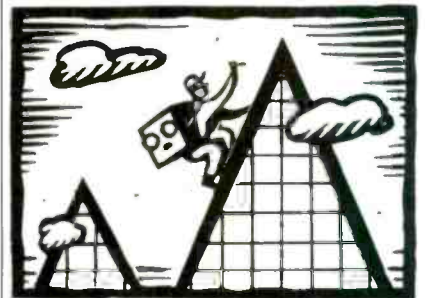

Until this gets wrangled into a consensus, it will pay to be specific when we use the term. I favor applying it to input or output filters, or to A/D or D/A converters. As to recording at a higher rate, let's call it just that—as we do already when we talk about DAT recording at 44.1 or 48 kHz.

The SRS Series



SRS 2.3 II

"The sound is superbly balanced and totally effortless." Stereo Review Magazine

“Matthew Polk’s SRS Speakers Bring You the Ultimate Listening Experience”

“Spectacular...it is quite an experience.” Stereo Review Magazine

The Joy of Owning the Ultimate Dream Speakers

Music lovers who are privileged to own a pair of SRS’s will share in Matthew Polk’s dream every time they sit down and enjoy the spine-tingling excitement of listening to their favorite music. Demonstrating them to admiring friends ultimately increases their pride-of-ownership. “Awesome” is the word most often used to describe the sound of an SRS system. They are capable of playing at live concert levels for long periods of time, with a surprising lack of effort and without producing ear-fatigue.

The bass response can literally move your body any time the music requires it, yet they perfectly reproduce all of the subtle nuances of a string quartet and are just as enjoyable at a low volume level as when played loud. Music and ambience surround the listener in an almost 360-degree panorama of sonic splendor that is, in the words of High Fidelity magazine, “Mind-boggling...Astounding...Flabbergasting.” But words alone cannot possibly describe the experience of listening to these ultimate speaker systems, you simply must hear them.

SRS 1.2 tl

Two time Audio Video Grand Prix Winner

The ultimate expression of Polk technology, this limited production flagship model sets the industry standards for imaging, detail, dynamic range, and bass reproduction.

SRS 2.3 tl

Audio Video Grand Prix Winner

This scaled-down version of the SRS 1.2 tl incorporates all of flagship’s design innovations without significantly compromising its awesome performance.

polkaudio

The Speaker Specialists®
5601 Metro Drive
Baltimore, Maryland 21215

**Where to buy Polk Speakers?
For your nearest dealer, see page 34**

Polk Audio’s SRS: The Quest for Perfection

The goal of Matthew Polk’s Signature Reference System (SRS) speakers is to bring an unparalleled level of life-like musical reproduction to your home. Perfect musical reproduction, long the dream of every speaker designer, is approached so closely by Matthew Polk’s SRS’s that it will seem as if the musicians are performing right in your listening room. This stunning achievement combines technology and creative insight to bring you a listening experience that you will never forget.

1. Patented SDA True Stereo Technology — The first and only speaker systems to maintain full stereo separation all the way from the source to your ears. (see pg. 9 for a more complete description). SRS speakers seem to disappear as musical images fill your listening room and seem to immerse you in a fully three-dimensional soundfield of startling realism.

2. Multiple Driver Arrays — The use of multiple drivers allows each separate element to work less hard and lowers distortion even at live concert levels. Power handling is increased to 1,000 watts per channel, providing a seemingly limitless dynamic range.

3. Time-Compensated Driver Alignment — Time-coherent driver placement insures that the entire spectrum of sounds reaches your ears at the same time. The sound is better focused, balanced and less fatiguing.

4. Wavelength Optimized Line-Source — Vertical driver arrays focus the sound waves into the room in a way which greatly reduces floor and ceiling reflections. Progressive reduction of the acoustical length of the arrays maintains constant vertical dispersion and eliminates “comb” filtering effects that limit other multiple driver systems. The result is extraordinary clarity and detail, great flexibility in room placement and precise stereo imaging from virtually any place in the room.

5. Planar 15” subwoofer — SRS bass performance is breathtaking. The use of small active drivers (eight in the SRS 1.2 tl, six in the SRS 2.3 tl) coupled to a huge sub-bass radiator achieves a bass response that is extraordinarily tight, fast (no boominess), deep and distortion free. In fact, the distortion at 25 Hz is lower than that of many audiophile-quality tube amplifiers.

6. Bi-amp Capability — The optional use of separate amplifiers for the high and low frequencies further improves clarity, lowers distortion and increases dynamic range.

7. Hand-Crafted Limited Production — The one-at-a-time attention that goes into the production of every Polk SRS speaker system means that your pair will sound and look as good as Matthew Polk’s own.



Matthew Polk with the ultimate expressions of loudspeaker technology: The SRS 1.2 tl and SRS 2.3 tl

CLASSIC PATTERNS



The more I live onward in audio, the more I wonder about the nature of music and about audio's immense effect upon it in these last few years. Often with pride! We have done so much. Occasionally, doggedly, it is a matter of fear. Because audio is now altering the very base of music's nature, as by some sort of unheard-of recombinant biology, and this at an ever faster pace. How long can music as we once knew it exist? What is music? Not so much the sound itself as its meaning, how we "read" it.

These questions, I think, go way beyond the usual talk of Preserving Great Art and the Importance of Culture, useful thoughts on which to base all sorts of worthy projects—not excluding, say, Avery Fisher Hall in New York City, rebuilt directly with cash from an audio success. Splendid that the profits of a lifetime in our area should lead Mr. Fisher to such a project—as well as others in his prolific musical giving—rather than, maybe, a baseball team or a stake in Atlantic City.

Yes, we can find ways to keep music alive in the flesh, the old pre-audio sort along with plenty that is new. But while Fisher Hall books its vast space week after week and month after month for live music, audio on a much larger scale goes onward with its own musi-

cal activities. In terms of fundamental musical impact, these can be devastating, a question of life and death for a whole art.

I'll have to say it bluntly. In far-reaching ways, audio is killing off the very sense of the older music on which it thrives—a kind of benevolent boa constrictor squeeze, slowly destroying our knowledge of what these sounds were once intended to convey.

No—not viciously, not intentionally. Our main audio work is to reproduce those sounds ever more perfectly, not to fuss with meanings. But . . .

I'm the first to delight in the things audio can do, and have long been the first. It's my specialty. Our music is *not* a mere reproduction, I've said. It is a new art in itself, based on an old one; it has its own principles, parallel and equal to the live music "original." Even so, I am still scared because there is so much meaning to lose, and it is being lost.

Here we have miraculously managed to preserve and keep alive a sonic art that took centuries to evolve. Here we are in fact expanding it on a vast scale, with more music going on right now than ever before—*audible* music, music in actual practice, not on paper. And yet the sense of so much of it is eroding away, inexorably.

The sales of CDs and cassettes (and even an LP or two now and then), the listenership for FM radio, represent the heartening best of our still-continuing wish to sense the "message" of music in its original pre-audio meanings. Impressive, as always! On the other hand, the commercial world reflects the opposite, the dangerous erosion. Unfortunately, commercial music is all too forward-looking. It shows up what is going on.

People are learning, it says, *not* to listen to music of the past in its original sense. Commercials treat this art outrageously from a musical viewpoint and, invariably, get away with it. Not even a passing notice on our part. Just a commercial. Nevertheless, we show how our listening goes for *all* music, don't we?

Commercials, maybe. But how about the well-informed, the educated people? They are no different, if in a gentler way. Their reactions to music's meaning are much the same, if polite. I've been into this before. Beethoven would be shocked to hear his epoch-making "Eroica" Symphony discreetly hidden behind a barrage of polite conversation at a party, but that's where it gets played all too often. A thousand other composers suffer the same and would be as deeply shocked—even Mozart, who could write real background music and often did. But it was right for the occasion—lightweight, easy, pleasant, inconsequential.

Clearly, a very large part of the original sense of such music is simply ignored when we reproduce it in this fashion—not only at home, but in the car, in restaurants, shopping malls, banks. Do you stop to listen when you hear Schubert, or even Stravinsky? Do your ears perk up when the restaurant puts on a piece you do not know: "What can it be?" Or do you just go right on eating and talking, oblivious. Most of us do just that. It is an audio way of life.

If the original meaning and sense are not getting across, *what is?*

Wallpaper music. What I call the Background Syndrome. We like it, or it would not be there. But we do not listen—not in the old, forward, conscious way. We have a new meaning for music. I think, perhaps, the proof of it is in what is called "beautiful mu-

Anyway you look at it, or listen to it.

Proton's 600 Series Stands Apart.

Sculpted for dramatic impact, and designed for ease of use, Proton's 600 Series components fit elegantly into any environment. Seldom used controls are concealed, yet revealed at the touch of a button. Cables, hidden by rear panel covers, disappear into the pedestal of this sleek, free-standing unit.

And naturally, the sound is pure Proton. With high performance technologies like Dynamic Power on Demand™ (DPD), the new Schotz II tuner circuitry and the exclusive Aphex® Aural Exciter™, 600 Series components provide absolute clarity and realistic reproduction for incomparable listening pleasure.

The series includes the AM-656 Integrated Amplifier, the AT-670 Tuner, the AV-646 AM/FM Receiver, the AD-630 Auto Reverse Cassette Deck, the AC-620 Compact Disc Player and the matching AB-600 pedestal. Each component can be controlled with the versatile AH-681 remote, which also controls select Proton video products.

Proton's new 600 Series. A rewarding investment for the discerning listener. From every point of view.



For a free brochure and the Proton retailer nearest you, call (800) 772-0172. In California, (800) 428-1006. Or write to 5630 Cerritos Ave., Cypress, CA 90630.

PROTON[®]
CLEARLY THE BEST

Enter No. 26 on Reader Service Card

Aphex and Aural Exciter are trademarks of Aphex Systems Ltd.
600 Series industrial design—Reinhold Weiss Design, Inc., Chicago.

U.S. DEALER LIST

| | |
|---|---|
| AUDITION <i>Birmingham, AL</i> | CLASSIC STEREO <i>Kalamazoo, MI</i> |
| CAMPBELL'S <i>Huntsville, AL</i> | CLASSIC STEREO <i>Grand Rapids, MI</i> |
| AUDIBLE DIFFERENCE <i>Palo Alto, CA</i> | AUDIO PERFECTION <i>Minneapolis, MN</i> |
| AUDIO EXCELLENCE <i>San Francisco, CA</i> | SOUNDING BOARD <i>Ridgewood, NJ</i> |
| CHRISTOPHER HANSEN LTD. <i>Los Angeles, CA</i> | WOODBRIIDGE STEREO <i>Woodbridge, NJ 07095</i> |
| KEITH YATES AUDIO <i>Sacramento, CA</i> | WOODBRIIDGE STEREO <i>W. Long Branch, NJ</i> |
| LISTEN UP AUDIO <i>Denver, CO</i> | WOODBRIIDGE STEREO <i>Princeton, NJ</i> |
| LISTEN UP AUDIO <i>Boulder, CO</i> | AUDIO VISIONS <i>West Babylon, NY</i> |
| LISTEN UP AUDIO <i>Colorado Springs, CO</i> | LYRIC HI FI <i>New York, NY</i> |
| TAKE FIVE AUDIO <i>New Haven, CT</i> | LYRIC HI FI <i>New York, NY</i> |
| SOUND COMPONENTS <i>Coral Gables, FL</i> | LYRIC HI FI <i>White Plains, NY</i> |
| LEE KRAMER'S HI FI SSS <i>Atlanta, GA</i> | AUDIO ADVICE <i>Raleigh, NC</i> |
| AUDIO CONSULTANTS <i>Evanston, IL</i> | HOFFMAN'S STEREO <i>Warrensville Hts, OH</i> |
| AUDIO CONSULTANTS <i>Libertyville, IL</i> | AUDIBLE ELEGANCE <i>Cincinnati, OH</i> |
| AUDIO CONSULTANTS <i>Hinsdale, IL</i> | AUDIO ENCOUNTERS <i>Dublin, OH</i> |
| PAUL HEATH AUDIO <i>Chicago, IL</i> | DAVID MANN AUDIO <i>Philadelphia, PA</i> |
| SOUND PRO <i>Carmel, Ind.</i> | SUMMIT AUDIO/VIDEO <i>Kingston, PA</i> |
| SOUND PRO <i>Iowa City, IA</i> | ON TOP AUDIO <i>Rio Pedras, PR</i> |
| WILSON AUDIO <i>New Orleans, LA</i> | SOUNDINGS <i>Middletown, RI</i> |
| HI FI EXCHANGE <i>Falmouth, ME</i> | AUDIO INSIGHT <i>Dallas, TX</i> |
| GOODWIN'S <i>Boston, MA</i> | SOUND DIRECTIONS <i>Rutland, VT</i> |
| MUSIC BOX <i>Wellesley, MA</i> | DEFINITIVE AUDIO <i>Seattle, WA</i> |
| WALTHAM STEREO <i>Waltham, MA</i> | SPECIALIZED SOUND <i>Madison, WI</i> |

Audio is killing the very sense of the older music on which it thrives—a kind of boa constrictor squeeze just destroys the music's intent.

sic"—which says that the stuff you are hearing sounds a lot like the older music, the classics, but without the meaning. It says nothing much. It is just "beautiful." Is this a good sort of progress for any music listening?

You see, we do this not so much with live music as with recorded—music v a audio. Music in the flesh still puts a lot of people to sleep at concerts, but at such events, at least, the old proprieties are kept up—you do not talk. You try not to snore. Those who want to listen *can* listen. In all truth, we are oddly more rigorous today in this respect than in the classical past! Total silence before music is a recent invention, believe it or not. But even minus silence, in older times people were in touch with the music's message, or a good part of it.

Live music is not often murdered in the manner of the music in commercials on radio and TV. But it can happen, usually through a misunderstanding. I remember one classic occasion, years ago, when the Dessoff Choirs of New York, including yours truly, sang for a benefit event at, I think, the Waldorf Astoria. It was on behalf of a Swiss charitable foundation—our director was Swiss born, and the connection seemed auspicious. We would be the entertainment for a fund-raiser, and it was a big one—the equivalent of \$1,000 a plate today. Lotsa money for a good cause. Good music, too.

And so a vast fleet of well-dressed gents and ladies in their evening finest duly showed up in the Grand Ballroom—a magnificent sight, if common enough at such a posh hotel. We showed up too, but we were parked outside the ballroom, on a hard marble staircase, for lack of a better spot. And there we sat, and sat, for hours, while the dinner went on. Then, at last—with the dessert—our signal came and we lined up for our grand entrance. Great music—was it Palestrina?—for a great occasion.

Now, our Swiss conductor had been in the U.S. for a long time, but he was a European musician of the old school. We would sing our elevated and beautifully prepared music as we always sang it to any audience, in proper concert format. For our director, music was music and an audience was an audience, wherever or however. So we

singers filed down the stairs in two lines, across a corridor, and into the Grand Ballroom. Suddenly, we were among hundreds of tables. No passageway to anywhere. How were we to sing and where? A small central space had been set aside, more or less, surrounded by tables, and toward that space our two formal lines of singers moved—or rather, snaked—between projecting arms and legs, barely able to get past. Later, some of the female singers said they had been discreetly pinched, presumably by the dignified gentlemen, not their ladies.

When we were assembled, tightly, there was a slight diminution in the roar of talk as the director appeared and, ever the formal musician and in the usual tails, swept through the tables—where? There was no room for him! The singers, including myself, performed an undignified compression and made a small space in which the director could operate, almost immersed in our front row. He arrived and started his bow, as a conductor is supposed to do at a concert. There wasn't room for a bow. So he nodded a dignified head, and waited for silence.

There was no silence. The audience continued to chat among itself, amiably enough. The director continued to wait. Impasse! Was this a concert, or a nightclub act?

Obviously, it was the latter, a thing unknown to our excellent leader. He stood, and stood, his face growing purple. He was far beyond outrage—this was the most horrendous INSULT of his life. Finally, he turned to us like a martinet and proceeded to conduct the entire program (not too long) like an overheated automaton, an absolutely furious face all the way through, without the slightest musical expression. We sang, the audience talked. Needless to say, after about 30 seconds, the talk was as loud as ever, and nobody paid us further attention. At the end, nightclub fashion, there was a slight patter of applause, and that was it. We got out as best we could. It was a shaking experience.

Who was wrong, who was right? Neither side. It was a case of hideous cultural misunderstanding, with music as its cause. But mind you, this was live music in actual performance. I have seen (and heard) other such

● BRYSTON'S INTERNATIONAL ACCLAIM

Bryston for over a quarter century has dedicated itself to the recreation of the musical performance. Here is what a few of our critics have to say about Bryston products:

"The way in which orchestral peaks were handled indicated that the Bryston .5B/2B combination's control over dynamics and attack was very impressive indeed."

Paul Miller
The New Hi-Fi Sound, Britain



Bryston 12B preamplifier

"Overall tonal balance of the system was beyond reproach, and I was particularly pleased with the clean, smooth reproduction of high frequencies using the Bryston .5B preamplifier."

Leonard Feldman
Audio Magazine, U.S.A.

"I would say that the LP playback qualities of the 12B with either moving coil or moving magnet cartridges are state of the art. I have not heard better from other more expensive amplifiers."

Andrew Marshall
Audio Ideas Guide, Canada



Bryston 2BLP power amplifier

"Simply put the Bryston 2B is a giant killer, one of the finest amplifiers on the market."

Gerard Rejskind
Hi-Fi Sound, Canada

"The recreation of ambiance is superbly spacious and gives an impression of pushing back the walls of the listening room. Symphonies and large orchestras are reproduced with extreme realism thanks to the wide stereophonic effect."

Revue De Son
France

For More Information Call 1-800-553-4355



BRYSTON

57 Westmore Dr., Rexdale, Ontario, Canada M9V 3Y6 Telephone: (416) 746-1800 Telex: 06-989548 Fax: (416) 746-0308
Brystonvermont, RFD#4 Berlin, Montpelier, Vermont 05602 Telephone: (802) 223-6159

Enter No. 8 on Reader Service Card

the *Soundcraftsmen* STORY



SECTION OF PRODUCTION AREA IN MAIN PLANT



One hundred percent quality control is seen on EVERY unit manufactured. EVERY completed unit is electronically tested for specification accuracy and then EVERY unit is connected to a high fidelity system and listened to—just like you would at home. If your unit meets or exceeds the critical standards set forth on these tests, it is then packaged for shipment.

INDIVIDUAL CERTIFICATE OF PERFORMANCE WITH EVERY AMPLIFIER



Soundcraftsmen celebrates its 20th year of manufacturing audio components for the discriminating audiophile.

Soundcraftsmen engineers are highly respected in audio design circles as being very forward thinking, yet practical, when engineering new products, by using proven design principles from the past with tomorrow's technology.

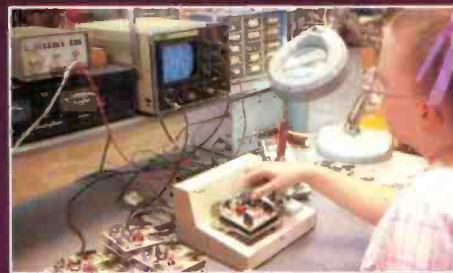

From the finest equalizers, the most accurate analyzers, to the unique preamps, to the revolutionary Class H and Power MOSFET amplifiers, you cannot purchase finer audio components.

The next few pages will answer many of your questions. If you have more, our customer service department will be pleased to assist you by telephone or letter. We invite your questions and appreciate your interest.



1990 BUYER'S GUIDE

TO PRO-QUALITY 19" RACK-PANEL ADD-ON SEPARATES

(For complete specs, prices & color photos of all 26 models, circle reader card number)

PREAMPLIFIERS



Len Feldman, in Audio Magazine, says: "...another example of Soundcraftsmen's superb engineering and dedication to user convenience and product flexibility. It serves as a true control center without adding complications for the user. My chief delight was with the versatile switching logic. What a joy not to hear any noise or clicks!"

The new PRO-CONTROL preamplifiers from Soundcraftsmen provide C-MOS digital-control electronic switching for noise-free and distortion-free recording and listening enjoyment. All signal routing is accomplished with Soundcraftsmen's new MOS-TROL high-performance electronic circuitry. This method allows all Signal Paths to be optimized, which measurably lowers noise and cross-talk. The integration of buffered inputs with C-MOS and proprietary circuitry completely eliminates the distortion and degradation caused by other presently available, but now outmoded, electronic switching techniques. Model 422 includes all these superb features plus Dual 10-band Octave EQUALIZER.

SPECIFICATIONS: FREQ. RESPONSE: High Level—5Hz-100kHz, ± 0.25 dB. THD: Less than 0.005%...S/N RATIO: Phono—97dB, High Level—116dB.

PREAMPLIFIERS\$329 to \$849

PRE-CEIVERS



The new REMOTE-CONTROL/Preamplifier/Tuner combines the outstanding performance and features of our separate tuner and preamplifiers. The PRE-CEIVER® offers the sensible alternative to the "all-in-one" receiver, by allowing the freedom to choose a separate power amplifier to match the needs of the speaker systems. To provide the lowest possible noise and distortion, FET transistors are utilized in critical circuits. Our unique SPECTRAL GRADIENT circuit provides the necessary filtering to eliminate the harsh characteristics associated with analog-digital Compact Discs.

DIRECT/TONE DEFEAT patches input directly to the line amplifier. DIFFERENTIAL MPX HI-BLEND circuit provides maximum stereo separation, while reducing noise and distortion when listening to distant FM broadcasts.

PREAMP SPECIFICATIONS: THD: 0.008%. FREQ. RESPONSE: 20Hz-100kHz ± 0.5 dB. S/N RATIO: Phono: 80dB, High Level: 100dB.

TUNER SPECIFICATIONS: IHF SENSITIVITY: 10.3dBf. SIGNAL STRENGTH for 50dB quieting: Mono: 12.5dBf, Stereo: 36dBf.

PRECEIVERS ©\$449 to \$599

POWER AMPLIFIERS

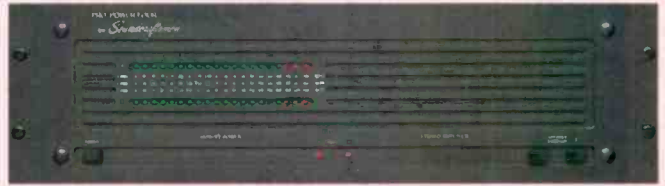

"...it brought out the best in all of the loud speaker systems with which I tried it. I sensed an effortless about the musical crescendos reproduced from some of my CD spectaculars..." "In my view, you can spend five times as much as what this amp costs, but you won't get a better, more reliable, or more musical unit!"

The New PRO-POWER amplifiers are especially designed for the extended Dynamic Range requirements of today's Compact Disc players and Hi Fi VCRs. The ULTRA HIGH CURRENT design offers you incredibly high power without sacrificing distortion-free performance and superb reliability. These new amplifiers operate flawlessly under all operating conditions. MOSFET amplification stages provide the utmost in sonic purity, rivaling that of vacuum tube amplifiers.

The Pro-Power Form features precision-calibrated LED power meters (0-400 watts at 8 ohms).. Speaker switching for two pair of stereo speakers...

SPECIFICATIONS: CONTINUOUS RMS POWER: 205 watts per channel @ 8 ohms, 20Hz-20kHz, 300 watts per channel @ 4 ohms, 20Hz-20kHz, 450 watts per channel @ 2 ohms, 1kHz...THD—less than 0.05%.

AMPLIFIERS, 205-600 w/p/c ...\$499 to \$1599

EQUALIZERS



All Soundcraftsmen Equalizers feature our exclusive 0.1dB Differential Comparator Unity-Gain circuitry, combined with dual balancing LED's, to make balancing of input to output voltage fast and exceptionally accurate to within 0.1dB. The Pro-EQ 44, above, is a two-channel Graphic Equalizer, designed especially for advanced applications in the field of music reproduction. The channels are divided in one-third octave center frequencies from 40Hz through 1kHz. Above 1kHz through 16kHz, center frequencies are at two-thirds octave intervals.

SPECIFICATIONS PRO-EQ 44: THD: .01 @ 2V RMS...S/N RATIO: 114dB-10V RMS output, -100dB-2V RMS output. ISO CENTER FREQUENCIES (Hz): 40, 50, 63, 80, 100, 125, 160, 200, 250, 315, 400, 500, 630, 800, 1K, 1.6K, 4K, 6.3K, 10K, 16K...BOOST/CUT INDIVIDUAL CONTROLS: ± 22 dB (all other controls at max): ± 15 dB (all other controls set at zero).

1/3-2/3 & 1-OCTAVE EQ's\$349 to \$549

FREE System/Analysis Test Recording,
Now available on 5" COMPACT DISC!

Soundcraftsmen

FREE!

\$19.95 SYSTEM EVALUATION KIT, includes your choice of 5" Instructional Test/Analysis COMPACT DISC, or 12" LP, plus 2-sets of Computone Charts, 1-Connector Cable for comparison test, 1-Instruction folder. WRITE TO US FOR FAST ACTION, OR CIRCLE READER CARD, and we'll send you FREE SPECIAL OFFER DETAILS, and 16-page COLOR BROCHURE. Enter No. 30 on Reader Service Card

2200 So. Ritchey, Santa Ana, California 92705, U.S.A./ Telephone (714) 556-6191 FAX: (714) 662-0753 • International Telex: 910 595 2524



Beethoven would be shocked to hear his epoch-making "Eroica" discreetly hidden behind a barrage of polite conversation at a party.

events. There was an outdoor wedding of a young musician who had a cellist friend play Bach while the guests assembled. The groom, too, was furious when the guests ignored the cello, right in their midst, for the usual prenuptial conversations. What else? His wife-to-be (not being on the scene yet)

must have been surprised at the awful scowl she met as the two were joined together! Why should we ever treat Bach like that?

Well, it's because audio has taught us to. Don't forget that Bach composed a Wedding Cantata and other such pleasantries. They did *not* sound like a

cello solo playing heavy music. That wedding music was suited to its occasion as a matter of course.

Now to the big point. How many times have I listened to recorded music in what amounts to exactly the same situation! Happens 100 times a day, all with the best of intentions. The most enlightened souls among us, college grads and all, think nothing of using high-class (classical) music as though it were fancy tonal wallpaper. Very discreetly, of course. Never loud and intrusive—though the music is often *supposed* to be loud, and to grab your full attention. We are, most of us, guilty here. We are almost as guilty, I'd say, if we play jazz, rock, even assorted pop ballads as background—though much of this music was made for informal enjoyment and isn't too harmed, nor misunderstood, in social conditions. It is our generation's, after all, and intended for us.

I am too well trained in the old way. I cannot ignore any music that gets through to my ear, even in fragments. Guess I'm often impolite. I forget what we are talking about, my mind wandering to the sound. I try. I fail. I have to listen. It's a real social liability.

A lady I know paid a visit just after I had discovered a marvelous new Berlioz CD, two works I had never before heard. The second was a huge piece for military band from 1840, composed for the 10th anniversary of the French "bourgeois revolution" that put Louis Philippe on the French throne. (He was tossed off eight years later.) *Two hundred* band members played this music as they paraded all over Paris with Berlioz at their head. What a scene! And wow—is this a good recording. Not only good sound: Somehow—imaginatively, not literally—you can visualize the gigantic spectacle, those hundreds of marching instruments putting forth a music which, I would say, was pretty strange, if exciting, for the thousands of Frenchmen lining the streets.

Impulsively, I put on this CD for my lady friend—loud, just the way you would. But she is very well conditioned in the new social uses of classical audio. "Please turn the music down!!" said she, horrified. And so I did, as another chip fell off the great edifice of past Musical Sense.

Where to buy Polk Speakers

AUTHORIZED HOME DEALERS

CANADA Call Evolution Technology, Toronto for nearest dealer 1-416-847-8888

AK Anchorage: Magnum Electronics • **Fairbanks:** Holt's

AL Birmingham: Audition • **Dothan:** International Audio • **Huntsville:** Sound Distributors • **Mobile:** Hi Fi Zone • **Montgomery:** The Record Shop

Tuscaloosa: Kincaid Stereo & TV

AR Fayetteville: Ft. Smith: Stereo One • **Little Rock:** Leisure Electronics • **Shary: Softart**

AZ Phoenix: Mesa: Hi Fi Sales • **Tucson:** Audio Emporium • **Yuma:** Warehouse Stereo

CA Bakersfield: Casa Moore • **Campbell:** Sound Goods • **Canoga Park:** Shelley's • **Carpinteria:** Creative Stereo • **Chico:** Sounds By Dave • **Corona**

Del Mar: Pacific Coast Audio Video • **Escodido:** Sound Company • **Eureka:** Eureka Audio Video • **Lancaster:** California Soundworks • **Long Beach:** Audio Concepts • **Mountain View:** Sound Goods

Napa: Futurvision • **Orange:** Absolute Audio

Penn Grove: California Stereo • **Redondo:** Systems Design • **Riverside:** Sacramental • **Sacramento:** Good Guys • **San Diego:** Sound Company

San Francisco & Suburbs: Good Guys • **San Gabriel:** Audio Concepts • **San Jose:** Good Guys

San Luis Obispo: Audio Ecstasy • **Santa Barbara:** Creative Stereo • **Santa Cruz:** Santa Barbara

Santa Maria: Creative Stereo • **Santa Monica:** Shelley's Stereo • **Stockton:** Gluskin's • **Thousand Oaks:** Creative Stereo • **Upland:** Audio Haven

Ventura: Creative Stereo • **Victorville:** Incredible Sounds • **Visalia:** Metro Stereo • **Westminster:** Videotek Stereo

CO Boulder: Soundtrack • **Colorado Springs:** Sunshine Audio • **Denver & Suburbs:** Soundtrack

Greenwood Spring: Stereo Unlimited • **Grand Junction:** Sound Company • **Wiltshire:** Custom Audio Video • **Pueblo:** Sunshine Audio

CT Avon: Hi Fi Stereo House • **Danbury:** Carlson's • **Fairfield:** Audio Design • **Greenwich:** Al Franklin's • **Hartford:** Al Franklin's • **New Haven:** Audio Etc. • **Newington:** Hi Fi Stereo House • **New London:** Robert's • **Norwalk:** Audiotronics • **Waterbury:** Zino Music

DE Wilmington: Blyn Maw Stereo

FL Daytona Beach: Stereotypes • **FT. Myers:** Stereo Garage • **FT. Lauderdale:** Sound Advice • **FT. Pierce:** Sound Shack • **FT. Walton Beach:** Audio International • **Steno:** Unlimited

GA Jacksonville: Audio Tech • **Spectrum Home Theater • Key West:** Audio International • **Lakeland:** Sound Factory • **Mary Esther:** Palm Audio Video • **Merritt Island:** Southern Audio • **Miami:** Electronic Equipment Co. • **Sound Advice • Naples:** Stereo Garage • **Panama City:** WaltSound Stereo • **Pensacola:** All Pro Sound • **Sunrise:** Sound Advice • **St. Petersburg:** Cooper for Stereo • **Sound Advice • Tallahassee:** Stereo Store • **Tampa:** Sound Advice • **W. Palm Beach:** Electronic Connection • **Sound Advice**

GA Athens: Hi Fi Buys • **Atlanta & Suburbs:** Hi Fi Buys • **Augusta:** Stereo City • **Branswick:** Hi-Fi Stereo Store • **Columbus:** Went TV • **Gainesville:** Audio Dimensions • **Milacani:** Georgia Music • **Savannah:** Audio Warehouse • **Valdosta:** Stereo Connection

HI Honolulu: Honolulu Audio Video

IL Okauchop: Grog's Music • **Des Moines:** Audio Labs • **Dodge City:** Sound World • **Oubuque:** Reners Iowa City • **Hawkeye Audio • Mason City:** Sound World • **Sioux City:** Audio Visions • **Waterloo:** Team

ID Boise: Stereo Shoppe • **Moscow:** Stereo Shoppe • **Sandpoint:** Electracraft • **Twin Falls:** Audio Warehouse

IL Alton: Reliable Stereo • **Aurora:** Stereo Systems • **Carbondale:** Southern Stereo • **Champaign:** Good Vibes • **Chicago & Suburbs:** United Audio • **Ocauchop:** Team Electronics • **Highland Park:** Columbia • **Joliet:** Stereo Systems • **Kankakee:** Barrett's Entertainment • **Lansing:** Uni-Tek Electronics • **Naperville:** Stereo Systems • **Normal:** Sundown One • **Peoria:** Team Electronics • **Rockford:** Columbia • **Springfield:** Sundown One • **Spring Valley:** Audio Labs • **Stirling:** Sterling Electronics • **Ill Bloomington:** Campus Audio • **Bloomington:** Eley TV & Appliances • **Evansville:** Rosley • **FT. Wayne:** Classic Stereo • **Indianapolis:** Ovalton • **Lafayette:** Good Vibes • **Marion:** Classic Stereo •

Michigan City: Audio Connection • **Muncie:** Classic Stereo • **South Bend:** Classic Stereo • **Terre Haute:** Stereo Crafters

KS Junction City: Audio Junction • **Kansas City:** Brands Mart • **Overland Park:** Audio Electronics • **Brands Mart • Wichita:** Audio Visions • **Topeka:** Nelson's

KY Bowling Green: Audio Center • **Lexington:** Ovalton Audio • **Louisville:** Audio Video Buy

Design • Owensboro, Paducah: Ruseley's • **Pikeville:** Mayo Inc.

LA Alexandria: Simpson Electronics • **Lafayette:** Sound Electronics • **Metairie & New Orleans:** Altman Audio

MA Boston: Goodwinds • **Waltham:** Camera & Stereo • **Fitchburg:** Filchburg Music • **N. Dartmouth:** Sound II • **Pittsfield:** H B S Stereo • **Worcester:** D Coins

ME Bangor: Sound Source • **Camden:** Harbor Audio • **Portland:** New England Music

MD Baltimore: Soundscape • **Gaithersburg:** Audio Buys

MA Worcester: Hi Fi Buys • **Birmingham:** Almas • **H. F. Dearborn:** Almas • **H. F. Farmington Hills:** Almas • **H. F. Flint:** Stereo Center • **Grand Rapids:** Classic Stereo • **Iron Mountain:** Sound North • **Kalamazoo:** Classic Stereo • **Lansing/Midland:** Hi Fi Buys • **Petoskey:** Kurtz Music • **Saginaw:** Court St. Listening Room • **Traverse City:** Kurtz Music

MN Alexandria: Sound Shop • **Outluth:** Mel's TV & Audio • **Grand Rapids:** Audio Files of Grand Rapids • **Mankato:** Audio King • **Minneapolis & Suburbs:** Audio King • **Rochester:** Audio King • **St. Paul:** Audio King

MO Cape Girardeau: Stereo One • **Columbia:** Johnson Audio • **Kansas City:** Brands Mart • **Springfield:** Harvey's Stereo • **St. Louis:** Sound Central

MS Hattisburg: McLelland TV • **Jackson:** Hopper's • **Pascagoula:** Empress

MT Billings: Video Sall & Sound Bozeman • **Thirsty Ear • Great Falls:** Rocky Mountain Hi-Fi • **Kallispell:** Audio Visions • **Missoula:** Aspen Sound

NC Boone: Holfons • **Chapel Hill:** Stereo Sound • **Charlotte:** Audio Video Systems • **Conover • Tri City • Greensboro:** Stereo Sound • **Hendersonville:** Hi-Fi • **Kinston:** Stereo Concepts • **Mooreshead City:** Anderson Audio • **New Bern:** Anderson Audio • **Raleigh:** Audio Buys • **Stereo Sound • Rocky Mount:** Microwave Audio • **Wilson:** Sound • **Atlantic Audio • Wilson:** Modern Stereo • **Winston-Salem:** Stereo Sound

ND Bismarck: Pacific Sound • **Fargo:** Today Electronics

NE Kearney: Midwest Audio • **Lincoln:** Stereo West • **Omaha:** Stereo West • **York:** Midwest Audio

NH Concord: Audio of New England • **Laconia:** Lakeside Stereo • **North Hampton:** The New Audiophile • **Salem:** Cuomo's

NJ Paterson: Atlantic Stereo • **Maple Shade:** Blyn Maw Stereo • **Montclair:** Perdue Radio • **Paramus:** Harvey Electronics • **Raritan:** AC Audio • **Ridgewood:** Sounding Board • **Shrewsbury:** Monmouth Stereo • **Toms River:** Brands Camera • **Wall Twp.:** Monmouth Stereo • **West Caldwell:** Perdue Radio

NM Alamogordo: D&E Electronics • **Albuquerque:** Sound • **West Coast Sound • Carlisle:** Beason's • **Clovis:** Towne Crier • **Santa Fe:** West Coast Sound • **Team**

NV Elko: Eiko Audio • **Las Vegas:** Upper Ear • **Reno:** Good Guys • **South Shore Lake Tahoe:** Audio Video Den

NY Albany: Clark Music • **Amherst:** Speaker Shop • **Batavia:** Unicom Audio • **Buffalo:** Speaker Shop • **Cornia:** Chemung • **Elmira:** Chemung • **Forest Hills:** Continental Sound • **Fredonia:** Studio One • **Glens Falls:** Audio Genesis • **Goshen:** Longplayer's Stereo • **Ithaca:** Chemung • **Sound Image • Jamestown:** Studio One • **Massena:** Hi Fi Shop • **Newburgh:** Audio Expressions • **New Hartford:** Adronack Music • **New York City:** Electronic Workshop • **Haley Electronics • Pittsfield:** Radio Alpha Stereo • **Rochester:** JB Sound • **Scarades:** Listening Room • **Syracuse:** Clark Music • **Vestal:** Hart Electronics • **White Plains:** Harvey Electronics

OH Akron: Audio Craft • **Canton:** Belden Audio • **Cleveland & Suburbs:** Audio Craft • **Cincinnati:** Stereo Lab • **Columbus:** Stereo Lab • **Dayton:** Stereo Showcase • **Findlay:** Audio Craft • **Lima:** Classic Stereo • **Toledo:** Audio Craft

OK Lawton: Hi Fi Shop • **Oklahoma City:** Audio Dimensions • **Shawnee:** Rave Sounds • **Stillwater:** Nelson's

CA Eugene: University Hi-Fi • **Grants Pass:** Sheehan's • **Medford:** Sheehan's • **Salem:** Kelly's Home Center

PA Allentown: Blyn Maw Stereo • **Blakey:** Hart Electronics • **Bryn Maw:** Blyn Maw Stereo • **Camp Hill:** Blyn Maw Stereo • **Chambersburg:** Sunrise Electronics • **Erie:** Studio One • **Harrisburg:** Blyn Maw Stereo • **Johnstown:** Gary's Entertainment • **Kingston:** Hart Electronics • **Lancaster:** G'n T Stereo • **Longhorne:** Blyn Maw • **Montgomeryville:** Blyn Maw Stereo • **Natrons Heights:** Stereo Land • **Philadelphia & Suburbs:** Blyn Maw Stereo • **Pittsburgh:** Audio Junction • **Quakertown:** Blyn Maw Stereo • **Reading:** G'n T Stereo • **Selinsgrove:** Stereo Shoppe • **State College:** Paul & Tony's Stereo • **Stroudsburg:** Main St. Audio Video • **Waxford:** Audio Insight • **Williamsport:** Robert M. Sides

PUERTO RICO Rio Piedras: Precision Audio • **RI Middletown:** Flint Audio • **N. Providence:** East-em Audio

SC Anderson: Music Machine • **Charleston:** Audio Warehouse • **Columbia:** Music Machine • **Greenville:** Music Machine • **Greenwood:** Stereo Shop • **Spartanburg:** Stereo Shop

SD Aberdeen: Engel Music • **Rapid City:** Team Electronics • **Siox Falls:** Audio King

TN Chattanooga: RSR TV • **Cookeville:** Lindsey Ward • **Johnson:** New Wave Electronics • **Kingsport:** Audition • **Knoxville:** Lindsey Ward • **McMinnville:** Lindsey Ward • **Memphis:** New Wave Electronics • **Nashville:** Hi Fi Buys

TX Amarillo: Sound Systems Ltd. • **Arlington:** Texas Audio • **Austin:** Marcus Electronics • **College Station:** Audio Video • **Corpus Christi:** Tape Town • **Dallas:** Americal • **El Paso:** Soundquest • **FT. Worth:** Sound Idea • **Houston:** Sheffield Audio • **Hurst:** Sound Idea • **Laredo:** Metek International • **Longview:** Audio Techniques • **Lubbock:** Electronics Supercenter • **McAllen:** Metek • **San Antonio:** Mobile Hi-Fi • **San Marcos:** Discovery Audio Video • **Sherman:** Worldwide Stereo • **Tampani:** Audio Tech • **Texasarkana:** Sound Town • **Victoria:** Dyer Electronics • **Waco:** Audio Tech

UT Logan: Stokes Brothers • **Salt Lake City:** Broadway Music • **St. George:** Boulevard Home Furnishings

VA Bristol: Audition • **Charlottesville:** Holdens • **Falls Church/Manassas:** Audio Buys • **Harrisonburg:** Ace Music • **N. Electronics • Richmond:** Gary's Stereo • **Roanoke:** Holdens • **Virginia Beach:** Digital Sound

VT Brattleboro: Scientific Stereo • **Essex Junction:** Creative Sound • **Rutland:** Mountain Music

WA Bellingham: OC Stereo • **Chelan:** Music Store • **Oak Harbor:** OC Stereo Center • **Seattle Bellevue/Lynnwood:** Magnolia • **Spokane:** Electracraft (Heli's) • **Tacoma:** Magnolia

WI Appleton: Sound World • **Eau Claire:** EME Audio Systems • **Fond Du Lac:** Audio Plus • **Green Bay:** Sound World • **Lacrosse:** Sound World • **Madison:** Happy Medium • **Marinette:** Sound Seler • **Milwaukee:** Audio Emporium • **Oshkosh:** Audio Plus • **Ripon:** Audio Plus • **Wausau:** Sound World

WV Barboursville, Beckley, Charleston: Pied Piper • **Clarksburg:** Audio Visual Concepts • **Huntington:** Pied Piper • **Piedmont:** Sound Gallery • **Wheeling:** Stereo Lab

WY Cheyenne: Electronics Unlimited • **Gillette:** Sheridan's • **Siar Video Library**



Now that the digital Compact Disc is a musical triumph, Sony presents the encore.



Introducing the world's first Digital Signal Processing Receiver.

Sony has news for the millions of music lovers who hailed our invention of the Compact Disc. That was merely our first act in digital audio. Now comes the world premiere of Act II: Sony AM/FM Stereo Receivers with DSP.

DSP stands for Digital Signal Processing, a Sony revolution that gives you note-by-note control over every aspect of your music. Yet with all this control, DSP actually maintains the Compact Disc's sound quality throughout your high fidelity system. This is technology no analog component can equal, resulting in sonic purity no analog component can match.

On Sony's STR-D2010 Receiver, DSP replaces conventional tone controls with the pinpoint precision of a digital parametric equalizer. We've equipped our Dolby® Surround circuitry with digital delay and digital noise reduction for eye-opening playback of movie soundtracks. And DSP places your music into a choice of Hall, Stadium and Live soundfields. Direct digital inputs for your Compact Disc player, digital dynamic suppression, and 130 watts per channel (front) plus 15 watts per channel (rear) combine to reserve a place in hi-fi history for the D2010.*

To audition the STR-D2010 with DSP and the entire line of Sony Receivers, visit your Sony high fidelity dealer. And be prepared to applaud.

For More Information  Call 1-800-553-4355

SONY
THE LEADER IN DIGITAL AUDIO™

© Copyright 1989 Sony Corporation of America. All Rights Reserved. Sony and The Leader in Digital Audio are trademarks of Sony. Dolby is a trademark of Dolby Laboratories Licensing Corp. *For those who read footnotes, the D2010 also has audio/video switching, programmable remote control, Sony's low-noise Direct Comparator FM tuning, discrete output transistors and front power output of 130 watts per ch., cont. RMS, both ch. driven into 8 ohms, 20-20,000 Hz, 0.008% THD; rear power output of 15 watts per ch., cont. RMS, both ch. driven into 8 ohms, 20-20,000 Hz, 0.08% THD.



PHOTOGRAPH: DAVID GAHR

DANNY McCUE

Doc Pomus

★ Born Jerome S. Felder in the Williamsburg section of Brooklyn in 1925, Doc Pomus began his career while still in his teens, singing the blues in neighborhood clubs. In fact, it was the proximity of these clubs to his home that prompted him to change his name in an attempt to hide his doings from disapproving parents. ★ In 1955, after a brief recording career that produced one minor hit—"Heartlessly," on Dawn Records—Pomus began a songwriting partnership with a young family friend, Mort Shuman. Together, they became one of the preeminent rock 'n' roll songwriting teams of the '50s and early '60s. Among their successes: "Marie's the Name (Of His Latest Flame)," "Little Sister," "Viva Las Vegas," and "Surrender," all penned for Elvis Presley, though the last-named song is actually an English translation of the 1911 Italian number "Torna a Sorrento"; The Drifters' "Save the Last Dance for Me," "This Magic Moment," and "Sweets for My Sweet"; The Coasters' "Young Blood," co-written by Pomus, Jerry Leiber, and Mike Stoller; Dion and The Belmonts' "Teenager in Love," and a host of other songs recorded by such lesser known talents as The Mystics ("Hushabye") and Terry Stafford ("Suspicion," a song originally written for Elvis).

★ When collaborator Shuman moved to Paris in 1965, Pomus left songwriting for more than a decade. He then reemerged in the early '80s with a group of romantic urban vignettes penned for Willy DeVille's critically acclaimed album *Le Chat Bleu* and a continuing collaboration with another great talent, Mac Rebennack (Dr. John). Pomus won a songwriting Grammy for his work on B. B. King's 1981 LP, *There Must Be a Better World Somewhere*.

The National Academy of Blues voted Pomus "Songwriter of the Year" in 1980 and '81, and in 1985, he was elected to the Board of Governors, New York Chapter, National Academy of Recording Arts and Sciences. ★ In recent years, Pomus has been collaborating with Los Angeles-based songwriter Kenny Hirsch. Together, they penned the Easter Seals theme song "One More Time" (Pomus himself is a polio survivor); the song was recorded by Ray Charles. ★ The interview that follows took place in Pomus' recording-filled apartment on Manhattan's Upper West Side.

D.McC.



©David Gahr

the Doctor is in

I'd like to ask you about something that's been rumored for years. Did Phil Spector help produce "Save the Last Dance for Me"?

I don't think so. I know he played on one of the big Drifters hits like "Up on the Roof" or "Under the Boardwalk," but I don't know which one.

What did he play?

Great guitar player. He used to play on a lot of demos for me. He was a fine guitar player; in fact, that's what he was doing last night when he was here. Usually when he comes to New York, he'll rent a piano for my apartment, believe it or not. Recently the neighbors complained, so this time he brought a guitar.

Years ago, there's a great songwriter, Don Robinson, who was mostly a country songwriter. He was famous for being the originator of a certain kind of country piano that Floyd Kramer got all the credit for, but it was really Don Robinson's style of playing. He's still around, but he lives reclusively in California. Anyway, back when we were all involved in writing material for Presley,

Robinson would come to town, and Spector was the first guy we'd mention to play rhythm guitar on the demos. He was a fine rhythm guitar player.

Most of the stuff he produced, he was the one who sketched a lot of those arrangements because he truly is an accomplished musician. I don't know why Spector's never gotten that kind of credit.

Which part of the songs would you generally write?

What I would call myself primarily is a lyricist. Originally, I was both singer and songwriter, and I always had a record out, but I never made much money. You see, I was a white person singing the blues in black clubs, and at the time, I didn't realize this was a rarity. I figured that in every major city there must be somebody doing the same thing I was doing. So all along, the main way I

Ray Charles

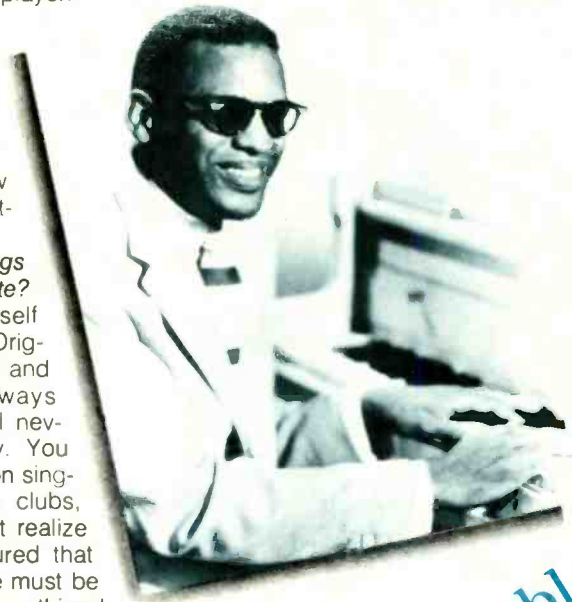

I'm somebody who's able to

supported myself was by writing songs for people like Joe Turner, Ray Charles, LaVern Baker, Ruth Brown—not that I made a lot of money this way, but I made more money as a songwriter than I did as a singer. Then, about 33, 34 years ago, I decided I'd had it with singing because I just couldn't make enough money to live comfortably. By that I mean, so I wouldn't have to live in a hotel room sharing a bathroom with somebody. I just got tired of that way of living. So I thought the best way to live the way I wanted was to concentrate on writing songs. Then I figured the only way to really make money writing songs was to write a lot of them, and I realized the only way to do that was to have a partner.

So I met this young kid. He was hanging around with a cousin of mine, and he was the fellow who would always play the piano at parties—a very, very talented guy. So what I did was I locked him in a room with me for two years, and every song I wrote while he was in that room, I'd give him a piece of. As time progressed, I gave him

Ruth Brown

Photographs: Frank Driggs Collection



LaVern Baker



What we would do is, we'd sit down and usually what we'd have was an idea for a song. It was always an idea that a grown-up could relate to—even with a song like "Teenager in Love." We both felt young people had just as many problems in love as older people, so a lot of the songs—for instance, "Save the Last Dance for Me"—might have language specifically geared toward 14-year-old kids, but the idea is one that adults could always relate to as well—you know, "as long as you're there at the end." I think that accounts for it; that is why people who grew up with that kind of music still relate to it a lot. Also, you've got to remember that I began as a songwriter for black artists, which in those days meant you wrote

Joe Turner



sit down and, if I have to, write lyrics on demand.

more and more of the song and he became more and more involved, so I made him a full partner. This was Mort Shuman. Before I wrote with Shuman, I had written a lot of rhythm and blues hits, but we had this enormous streak together. Until we became full partners, I was probably more a composer than a lyricist; then it switched around. I would say that now, with very few exceptions, I have very little to do with the melody on any song I write.

Do you see yourself as writing primarily for the audience or for the artist?

See, I think of myself as a songwriter functioning in an era of records. Years ago, people used to write songs for sheet music. But from the time I seriously started being a songwriter, what I would do is write a song that a particular artist coming up for a session could record. But always, in the back of my mind, I would try to write it, not according to the person's last record, but to the way the person could sing. That's why a lot of those songs keep getting rerecorded today. I was very involved in making records, as were most of my contemporaries, and I did this with Shuman for 10 or 12 years.

How was it that you older guys could write songs that, say, a 16-year-old girl could relate to?

for an adult black audience. When writing for Joe Turner and Ray Charles, you weren't writing for 14-year-olds buying records, you were writing for adults in the nightclubs.

How about writing novelty songs like "Sweets for My Sweet," as opposed to straight songs?

Well, I'll tell you, what happens very often, at least to my kind of songwriter, is this: I'll have an idea for a song, and the idea might be the language of it rather than a story line. When I write a song with a Latin feel, I always try to figure out what my English lyrics would sound like if they were a translation. In "Save the Last Dance for Me," there's a line that goes, "and in her arms I'm going to be." Now, that's not the way somebody talks. "Sweets for my sweet, sugar for my honey"—again, it's almost like a translation into English from another language. Some ideas are symbolic, some are literal, and some are novelties. I had a big hit with a song I wrote with Leiber and Stoller called "Young Blood." Now, that's an

expression that was used by a character who lived in my neighborhood. We called him Devil. I don't remember what his real name was, but he used to call all the younger guys youngbloods, and it just knocked me out. I had never heard it before, so I wrote a song around it.

Do the lyrics simply come to you out of thin air?

You know, that's very interesting. I once spent a day with Bob Dylan, and he told me he had always felt he was like an antenna. He doesn't even know where his words come from; it's like they were just floating around. In my case, I've always felt I have a tape recorder inside, and all of my song ideas are in there already. I don't even know how they got there, but they're in there. As a result, I'm one of those people who, when they have to, can sit down and write lyrics on demand. Any time I sit down with a paper and pencil,

The Coasters



me years ago during one of his college breaks. We went next door to get some coffee, and as we were leaving, I put my answering machine on and said, "Watch, I'm going to miss a million-dollar call." When we come back, there's a message on my machine saying, "Bob Dylan wants you to call him at such and such a hotel," blah, blah, blah. And I thought Spector, who's a great practical joker, was having some fun with me. So I call up the hotel, go through the instructions left on the machine, and although I'd never met Dylan, when he answered the phone, I recognized his voice. It really was Dylan. He said he'd like to get together with me soon, and I couldn't figure out why, but he did seem to know all my songs.

He said, "I know you wrote this song . . . and this song . . . and this song." He came over the next afternoon, and my lasting impression of him was that he was so painfully shy. To make a long story short, he told me of certain experiences, and we talked about things, but the bottom line was that he said he was having a little trouble coming up with a set of lyrics. So here was the poet of the 20th century, and he wants me to write lyrics to some melodies he wrote—what a strange fucking experience, you know? But what happened was, I think he came up with some things he was happy with on his own, and the idea of our writing together kind of fell apart. But what an interesting day I spent—an interesting day with Bob Dylan.

Although this is probably a pretty theoretical question, when you were writing during the late 1950s, were you con-

Photographs: Frank Driggs Collection

I can come up with ideas that just seem to flow. I have no idea why.

A song will just flow, line by line?

If it's only a line, it'll lead to other things. Sometimes it might be like eight bars of a lyric. Sometimes there's a dummy melody to go with it. It's so weird with songs.

Do you find yourself having to do a lot of editing?

Very seldom. Lots of people torture themselves over a song, but I've found that my initial instincts are as good as anything I might come up with later. I give a lot of songwriting workshops, and what I've found is there are really two kinds of songs—what I call "internal" and "external." There are great, great songwriters who write externally: They're craftsmen who go over each section a hundred times and torture these songs. And then there are other guys who have some lyrics that are almost throwaways, and I really respect those people more and I'll tell you why: Because their work is much more real. I really admire a lot of the songs of Kris Kristofferson because I assure you—though I've never discussed it technically with him—that that's where he's at. There's nothing superficial about lines like, "Freedom's just another word for nothing left to lose" or "I'm wearing my cleanest dirty shirt." These are unbelievably great lyrics, some of the best ever written, but I guarantee you, some of those were just throwaways for him.

You mentioned spending a day with Dylan. How did that come about?

My life is filled with strange experiences. I have a son who was visiting

Ray Charles and Elvis could add

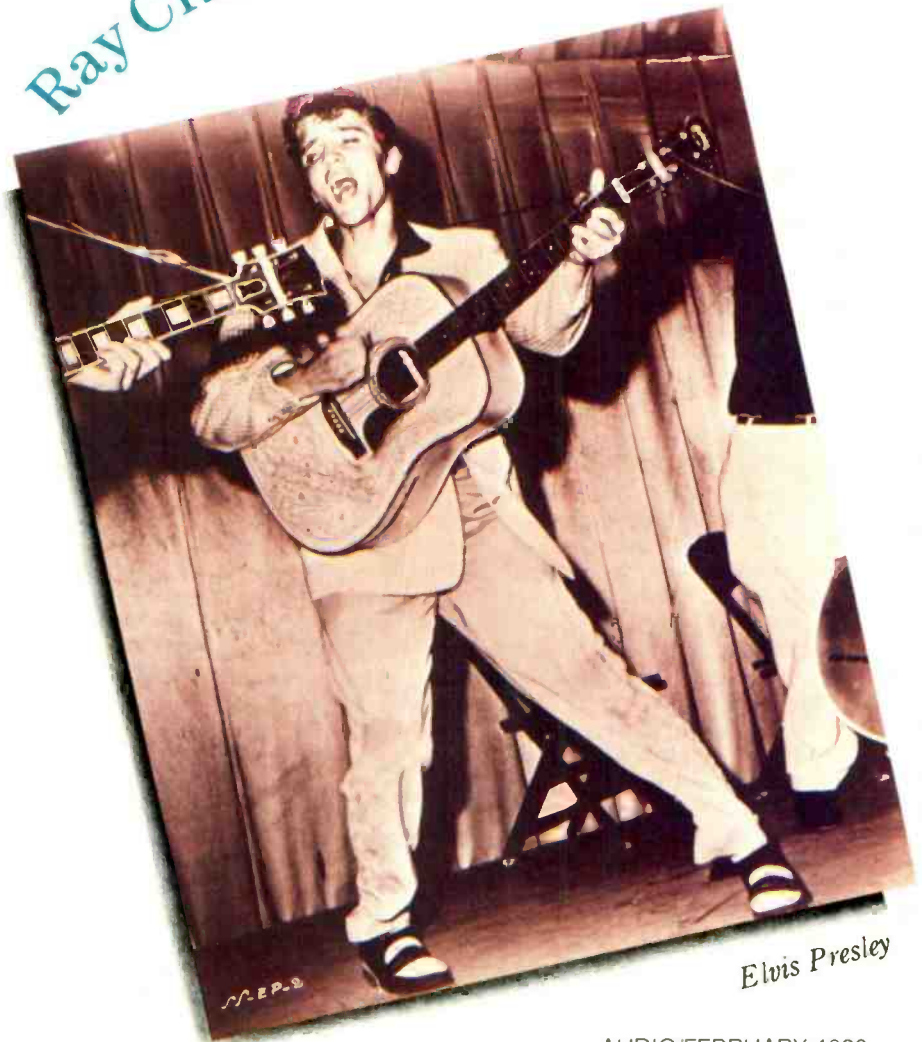

Elvis Presley

Dion & The Belmonts



The Drifters



Bob Dylan

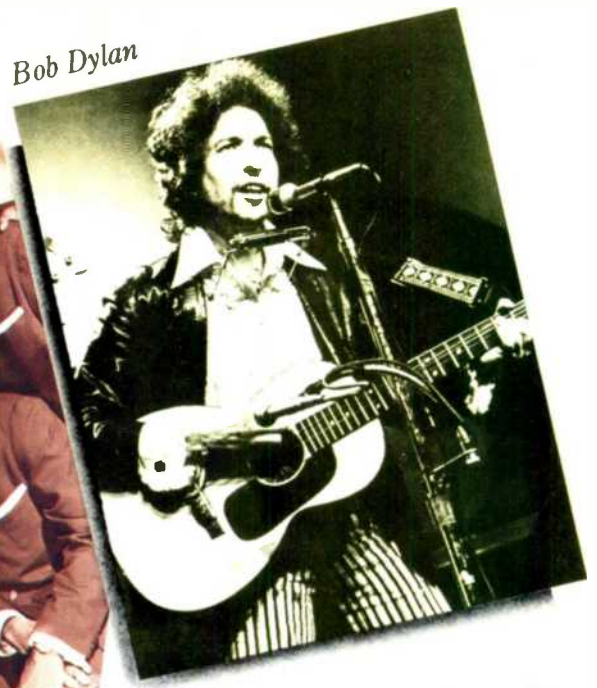

something to a song I didn't see when I wrote it.

scious of trying to write not just a hit song, but a classic?

When you're under contract and the publisher is paying you money, they expect a hit. But now, I think in terms of writing good songs, and if it's commercially viable, that, to me, is a bonus. I don't sit down and try to write hits because I don't have that kind of drive for recognition.

Would you say you've been heavily influenced by other songwriters?

Let me put it this way. I always surrounded myself with people I felt were masters of their craft. Now, I'm not saying I did this consciously, but that's the way it turned out. I think my craft grew because writing rock 'n' roll tunes, to me, was only one kind of songwriting. I was known in that field because that's where I had the hits, but I think I'm a much better writer of a certain kind of blues song. I'm not Chuck Berry, and yet I can write a certain kind of song as good as you can write it. I don't want to sound egomaniacal, 'cause I really don't mean it that way at all. I think what you have to do in this world is understand your limitations. Once you figure that out, you can really do a lot. There are certain kinds of songs I just can't write. But what I can write, I write pretty well.

And I'm going to tell you something about Mort Shuman. What we used to do was, he used to go to Mexico quite

often and come back with very complicated Mexican rhythms—he was a rhythmical genius—and it would be up to me to make them compatible with the American market. This process contributed to my growth considerably, and one of the songs that came about in that way was Elvis Presley's "Surrender."

Did you ever meet Elvis?

No, I never did. I was supposed to go to a session one time, but my brother got married unexpectedly, and that ended that. The closest I ever came was seeing him at a press conference. I was supposed to meet him, but the Colonel, who I had met a few times, wouldn't let me. I went to lunch afterwards and was very upset. I thought, "Here was my chance, and it's gone." Vernon Presley was at the next table, and we told him what happened. He tried to get hold of his son, but by then, Elvis had left—either for the place he was working or the airport. A year later, this guy calls me, a promoter or something, and says that Presley is coming to town and that he's arranged a meeting for us and I should write some material for him. So I sat down with this kid I was writing with at the time, and we started to write. After a couple of hours, we decided to take a break. I put the television on just as they were breaking into the regular programming to announce Presley had died.

Who would you say were the greatest interpreters of a Doc Pomus tune?

Ray Charles and Elvis Presley always added something to a song that I didn't see at the time I was writing it. And Leiber and Stoller productions—very often they'd put great things in, like on The Drifters' records.

We've been talking about the more successful instances in your career, but there must have been another side to the coin. Can you remember times when your songs were rejected by an artist?

Oh, many of the songs that Mort Shuman and I wrote were rejected a lot of times—Bobby Darin had rejected both "Marie's the Name (Of His Latest Flame)" and "Little Sister" before we brought them to Presley's attention.

What's your definition of a songwriter?

Mort and I, we considered ourselves songwriters because we put out many different kinds of songs. Today, I think the nature of being a songwriter has changed, because you don't have great singers anymore. There just aren't people like Sam Cooke, and I think that's because record companies want people who are disposable, who can easily be replaced. If Sam Cooke were around today, I think he'd have a hard time getting a record deal—if he had a couple of hit records and then one bombed, who's gonna replace him? **A**

S T A T I S T I C S I N

ILLUSTRATION: BART STABLER

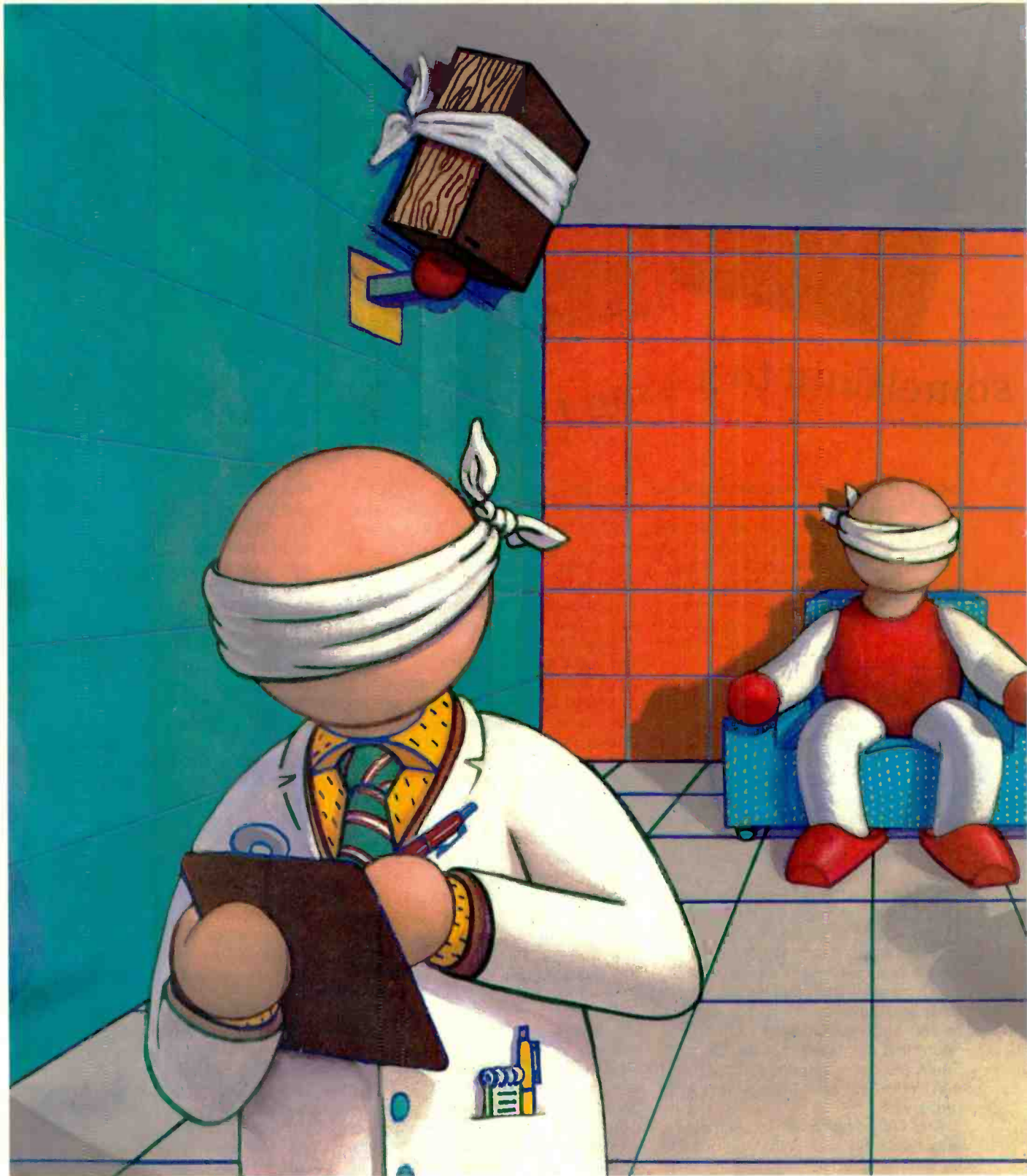

BY THE NUMBERS

The A/B tests reported in *Audio* and elsewhere try to discover whether, and to what extent, audible differences exist between two similar components such as preamps, power amps, CD players, etc. Very often, a unique device, such as the ABX comparator, is employed to indicate whether a test subject can distinguish between components A and B—say, two power amps. In a number of trials, typically 16, the comparator randomly selects A or B as component X, and the subject must decide whether he is hearing A or B. By pushing designated buttons, the subject can listen to A, B, or X (which is A or B), in any sequence and as often as desired, in order to decide whether X is A or B. Once the decision is made and noted, the subject proceeds to the next trial. The number of trials and the number of correct identifications are tabulated, yielding a score—for example, 12/16, which signifies 12 correct identifications in 16 trials. Studies with the comparator ordinarily employ several subjects, tested one at a time, and they may involve several pairings, such as four amplifiers compared two at a time in all possible combinations. (While it is possible to make such tests by switching the interconnects between the devices under test, such a plug-pulling technique requires the help of a trained and unbiased assistant, introduces hum or r.f.i./e.m.i. problems in many cases, and very often interjects an unacceptably long delay between presentations, making comparison difficult.)

The results of these and other A/B tests are usually subject to statistical analysis, and it is the purpose of this article to clarify what such analysis can do. First, however, it should be made equally clear what statistics *cannot* do. Statistical analysis cannot improve the quality of a study, although it may seem to impart a cloak of respectability—"blinding with science," as they say. Sta-

HERMAN BURSTEIN





statistics can add information to good research, but it adds nothing to poor research. The issue here is the *validity* of a test, which has nothing to do with statistics. So we'll first discuss validity and then turn to the useful role statistics can play in evaluating the results of valid A/B tests.

Validity and Reliability

Here, the issue is: Does the test *really* measure what it purports to measure? To illustrate, assume a subject is asked to distinguish between two power amps. The test design must ensure that only *audible* differences permit him to do so. If this is the case, the test has validity, but if an extraneous factor enables him to distinguish between components, the test lacks validity. Some examples of extraneous factors are visual or aural clues consciously or subconsciously provided by a researcher who knows which amp is playing (this can't happen if a good comparator is employed), an inadvertent (we hope) but slight difference in level between amps, a significant difference in cables, a click that precedes switching to one amp but not the other, operation at a level exceeding the low-distortion capability of one of the amps, a flaw that develops in

one amp during the test, etc. There is no overemphasizing the great care required to achieve validity—to prevent all but the audible differences from clueing the subject as to which amp is which. If a test lacks validity, it cannot be salvaged by statistics.

Associated and sometimes confused with validity is reliability. The issue of reliability is: Are the test results consistent? If a subject distinguishes between components one day but not the next, or if some subjects hear differences and others don't, reliability is poor. Further, reliability is a prerequisite for validity but does not ensure it. For example, if subjects can consistently distinguish between two amps because of a flaw in one—such as a leaky capacitor that causes audible distortion—we have reliability but not validity. On the other hand, if reliability is poor, validity is suspect.

When a test is considered to have reliability *and* validity, statistics can help us evaluate the results. There are two mathematically related approaches, and the researcher may use either or both. One approach tests the hypothesis that audible differences between two components truly exist; the other estimates how often a subject (or subjects) hears these differences.

Testing a Hypothesis

We deal here with the *significance* of test results. The issue is: Are the results due to audible differences or to chance? If we call the results significant, we attribute them to audible differences, not to chance.

In an A/B test, we expect that even a subject who hears no differences and merely guesses which component is playing will, on average, guess correctly half the time; for example, he will make eight correct identifications in 16 trials, for a score of 8/16. If his score is higher—say, 12/16—it *seems* he hears differences. Nevertheless, a score exceeding 8/16 can be due to chance, just as a coin flipped 16 times can come up heads more than half the time (there is a 40% probability that heads

will come up more than eight times in 16 tosses).

Thus, we have a dilemma. In our example, is a score as high as 12/16 due to chance or to audible differences? We can resolve this dilemma by using statistics or, more correctly, statistics *plus judgment*. This is not to deny the role of common sense in some cases. For example, if a subject makes 30 correct identifications in 32 trials, and if we have no question about validity, it would be difficult to gainsay the common-sense conclusion that audible differences very much exist. Still, it is nice to know that the statistical odds against this happening by chance are about 8 million to 1.

To return to the dilemma of whether a score as high as 12/16 is the result of chance or audible differences, we must first restate the problem in statistical terms. This requires choosing between a null hypothesis (H_0), which holds that a score as high as 12/16 is due to chance, and an alternative hypothesis (H_1), which holds that a score as high as 12/16 is due to audible differences.

Statistics provides no direct way of indicating whether H_1 is true. It can only directly inform us about H_0 . Whatever it indicates about H_0 leads to an opposite *inference* about H_1 . This is a seesaw proposition. If H_0 is supported, H_1 is discredited; if H_0 is discredited, H_1 is supported. Further, statistics cannot *prove* H_0 to be true or false (and, conversely, H_1 to be false or true). As long as we deal with a sample, we deal with the probability, not the certainty, of H_0 being correct. Certainty can be obtained only by testing an entire population, not just a sample of it—and then there is no need for statistics, which is concerned with probability, not certainty!

In the case of an A/B test, testing the population is impossible, even for one subject, because the population consists of an infinite number of trials. Therefore, we rely on samples and their attendant probabilities concerning H_0 . But small samples can deviate

appreciably from the "truth" about H_0 . The larger the sample, the closer it tends to come to the "truth."

Statistics supplies the probability of getting a score higher than chance alone would produce: In our example, a score as high as 12/16 instead of 8/16. This probability is termed the significance level, labelled α (alpha); α is the probability associated with H_0 being true. If α is sufficiently low, we reject H_0 and infer that H_1 is true: In our example, we would infer that audible differences, not chance, account for a score as high as 12/16. If α is not sufficiently low, we accept H_0 and infer that H_1 is false.

It is of critical importance, prior to conducting an A/B test, to define what is meant by a value of α that is sufficiently low to justify rejection of H_0 . This value is called the criterion of significance and is labelled α' (alpha prime). It is critical because it directs us whether to accept or reject H_0 , and thereby whether to reject or accept H_1 .

If α is greater than α' (the significance level exceeds the criterion of significance), we accept H_0 and thereby reject H_1 . In our example, this would signify that we lack a sufficiently low probability of getting a score of 12/16 by chance; rather, we believe that chance alone could reasonably account for this score.

But if α is less than or equal to α' , we reject H_0 and therefore accept H_1 ; we believe that the probability of a 12/16 score being due to chance is sufficiently low to reject H_0 and to make H_1 credible; we believe that audible differences exist.

Where does the value of α' come from? Not from statistics. It comes from our judgment. A widely used convention is to employ a probability of 0.05 as a suitable value of α' , although other values are also used. To illustrate, assume that, prior to A/B testing, we went along with the crowd by choosing 0.05 as α' ; let's also assume that a subject's score is 12/16. We find from the binomial distribution that, for this score, the significance level α is 0.038;

that is, if only chance is at work and not audible differences, the probability of getting a score as high as 12/16 is only 0.038. Inasmuch as α is less than α' —i.e., 0.038 is less than 0.05—we call our finding significant; we attribute the score to audible differences.

Suppose α is greater than α' ; we would then call our finding not significant and would attribute the score to chance. To illustrate, if a subject's score is 11/16, α equals 0.105, and if we use α' equals 0.05, then we accept H_0 because α is greater than α' —i.e., 0.105 is greater than 0.05. Therefore, we reject H_1 and disclaim audible differences.

Note importantly that our conclusion as to the significance of test results is not based simply on the objective laws of probability. It is also based on a subjective factor, our choice of α' . Although validated by common usage, nowhere is it written that α' *must* be 0.05. Other values, such as 0.10 and 0.01, are often used.

Suppose we choose to employ α' equals 0.01. We would then call a score of 12/16 not significant because α is greater than α' —i.e., 0.038 is greater than 0.01. We would accept H_0 , thereby rejecting H_1 and attributing the score to chance rather than to audible differences.

Contrariwise, suppose a subject's score is 14/16, and we retain α' equals 0.01. For 14/16, α equals 0.002. Since α is less than α' , we judge that our findings are significant, that audible differences exist.

A Matter of Form

There is an issue of good form in stating the significance of findings. Researchers in some fields only state whether the significance level satisfies their chosen criterion of significance—say, 0.05. Thus, their findings are reported either as "significant at the 0.05 level" or "not significant at the 0.05 level." However, this omits vital information: The actual significance level. If, say, the significance level is 0.002, this is important to know. Or, if the

In A/B comparisons, the test must be designed to ensure that only audible differences allow the listeners to distinguish between the components.

researcher's criterion is 0.05 and the actual significance level is, say, 0.055, this information is more helpful than simply being told the findings are not significant at the 0.05 level. The reader might be satisfied with a higher criterion of significance, such as 0.10, and so the results would appear significant. Thus, it's good practice to state the actual significance level.

Error Risk

We have stressed that a sample cannot prove anything about audible differences but can only lead to inferences about their existence. When we call findings significant, we are stating a belief that such differences exist. But, like it or not, we must recognize that judgment has played a critical role in our conclusion, which is based on subjective selection of the criterion of significance, α' .

Accordingly, we must further recognize that sampling entails the risk of error in accepting or rejecting the alternative hypothesis, H_1 . There are two kinds of error risk; both are important, although some researchers may be more concerned with one kind than with the other:

Type 1 error risk is called α' (yes, the same symbol as for the criterion of



significance). This is the risk of rejecting H_0 when it is actually true. Conversely stated, Type 1 risk is that of considering H_1 true when it is actually false, when a subject hears no audible differences.

Type 1 risk is determined by the value we have chosen as the criterion of significance and therefore bears the same symbol as this criterion. To illustrate, if we choose α' equals 0.05, and if only chance (guessing) is at work, then 5% of the time we will erroneously conclude that we have significant results.

The smaller the value chosen for α' , the smaller is Type 1 risk—namely, the probability of concluding that audible differences exist when in truth they don't. As one reduces α' , one reduces the probability of concluding that audible differences exist.

Type 2 error risk is called β (beta). This is the risk of accepting H_0 when in fact it is false. Conversely, it is the risk of considering H_1 false when it is actually true. The magnitude of β depends on four factors:

- Sample size, n . As n increases, β decreases.
- Value chosen for α' . As α' decreases, β increases. Because a reduced α' makes it more difficult to ac-

cept H_1 , rejection of H_1 becomes more likely.

- The score that chance tends to produce—in the case of A/B tests, 50%. The smaller this score, the smaller β is.

- Effect size, which we may label p^* . This is the smallest score that we consider interesting or meaningful. For example, we are not impressed if a subject can score about 52%—barely greater than what pure chance permits—but we begin to be impressed by, say, a score of 70%. In this instance, effect size is 70%. The larger the value chosen as p^* , the smaller is the value of β .

So long as we are sampling, we cannot know whether we have committed Type 1 error by accepting $H_{1,i}$ or Type 2 error by rejecting H_1 . We can only know the risk of each. Prior to sampling, these risks should be adjusted by judicious decisions as to the criterion of significance, sample size, and effect size.

Sample Size

Based on statistical probabilities (on the binomial distribution or on the normal distribution as an approximation of the binomial), one can calculate a sample size to meet all requirements. To illustrate, assume that a researcher planning an A/B test specifies Type 1 risk of about 0.05, Type 2 risk of about 0.10, and effect size of 70%. (We specify error risks of *about* 0.05 and 0.10 because sample size and number of correct identifications must be integers, so that the specifications for α' and β cannot be met exactly.) The required sample size is 50 trials.

After an A/B test has been conducted, one can evaluate the results in terms of error risk. To illustrate, again assume a score of 12/16, with a significance level of 0.038. If we previously chose α' equals 0.05, we consider a score of 12/16 significant and conclude that audible differences exist. Type 1 error risk is now the same as α —namely, 0.038. The risk of being wrong in accepting H_1 is 3.8%; the

chance, so to speak, that the subject was always guessing and never heard differences is 3.8%.

Still with a score of 12/16, now assume that we previously chose α' equals 0.01, leading us to reject H_1 and conclude that audible differences do not exist. Further assume an effect size of 70%. In this situation, Type 2 error risk is 0.75. If a subject can make correct identifications 70% of the time in the long run, we run a 75% risk of being wrong in rejecting H_1 .

An error risk of 0.75 is, of course, outlandish in a search for the truth about audible differences. More attention should have been paid to the design of the A/B test with respect to specifications of error risk, effect size, and resultant sample size. To illustrate, assume that the researcher had specified Type 1 and Type 2 error risks as 0.05 and 0.10 respectively, and effect size as 70%, and had thereby arrived at a sample size of 50. Assume the test produces a score of 32/50. The significance level is 0.032. Inasmuch as he selected α' equals 0.05, the findings are judged significant. Type 1 error risk is 0.032, not far from the specified 0.05. Now assume a score of 31/50, with a significance level of 0.059, leading to rejection of H_1 . Then the risk of Type 2 error is 0.08, also not far from the specified 0.10. If a score higher than 32/50 were achieved—for instance, 36/50—the significance level would be 0.0013; Type 1 risk of 0.0013 is much better than specified. If a score lower than 31/50 were achieved—say, 27/50—Type 2 risk, for an effect size of 70%, is reduced to only 0.012, much better than specified.

In terms of time and money, A/B testing is costly. Moreover, extensive testing of a single subject within a brief period may bring on fatigue, clouding the results. For these and other reasons—such as availability of personnel—large sample sizes, desirable as they may be, often have to give way to smaller ones, with concomitant increases in Type 1 and/or Type 2 error risks.

A researcher limited to a small sample, with its inevitably high error risks, may keep one risk moderately low by allowing the other to become immoderately high, but both the researcher and the reader should be aware of this. To illustrate, assume that a researcher limited to a sample of 32 trials seeks to challenge the hypothesis that audible differences exist. Further assume that he employs the conventional α' equals 0.05 to avoid reproach for using too rigorous a criterion of significance (such as 0.01), and that he reasonably specifies effect size as 70%. A score of 22/32 is needed to achieve significance; anything lower will produce a significance level higher than the 0.05 criterion. A score of 21 or less will fail to achieve significance and will allow the researcher to disclaim audible differences, but Type 2 error risk here is 0.36. For this test, a denial of audible differences would rest on weak statistical ground.

It is outside the scope of this article to explain the computation of significance level, error risk, and sample size. For these, the reader is referred to my 1988 article [1].

Point and Interval Estimates

A different approach to evaluating the results of A/B tests, either as an alternative or as a supplement to the test of a hypothesis, is the interval estimate, also called a confidence statement. It is often, but not necessarily, accompanied by a point estimate. These estimates seek to inform us how frequently a subject (or subjects) can identify which component is which. Clearly, an identification rate of, say, 80% is more interesting than a rate of, say, 60%, even if both of these rates are judged significant.

We may designate p_c as the proportion of the time that a subject could correctly distinguish between two components in an infinite number of trials. Based on a sample of trials, the point estimate is a single figure that estimates p_c ; we may call this estimate \hat{p}_c . The interval estimate consists of

two figures that delimit a range within which we believe p_c lies. Statistical probabilities (in this case, derived from the binomial distribution) are required for an interval estimate but not for the point estimate.

The Point Estimate

Let n be the number of trials in an A/B test, and c the number of correct identifications. The estimate of p_c is simply:

$$\hat{p}_c = \frac{c}{n} \quad (1)$$

For example, if a subject scores 12/16, we obtain \hat{p}_c equals 12 divided by 16, which equals 0.75.

However, this is not the point estimate we really want, because we know that some correct identifications are apt to result from guesswork. If a subject always guesses, on average his score will be 50%, or 0.50. Let p_k be the population proportion of correct identifications based solely on knowledge and not on guesswork. Let \hat{p}_k be the estimate of p_k . Then:

$$\hat{p}_k = \begin{cases} 2\hat{p}_c - 1 & \text{for } \hat{p}_c \geq 0.5 \\ 0 & \text{otherwise} \end{cases} \quad (2)$$

In the example where a subject scores 12/16 and \hat{p}_c is, therefore, 0.75:

$$\hat{p}_k = (2 \times 0.75) - 1 = 0.50$$

Thus, we estimate that the subject can *truly* distinguish between components, based solely on audible differences, half the time, not three-quarters of the time.

The Interval Estimate

As with the point estimate, we will first deal with an estimate of p_c and then with converting this into an estimate of p_k .

We have noted that, due to chance, a sample proportion may differ appreciably from the population proportion,

Interval estimates need two essential components to be complete—confidence limits and confidence level—and will be meaningless with only one of them.

especially for small samples. Thus, \hat{p}_c may deviate appreciably from p_c , but the point estimate gives no indication of how much. An interval estimate does indicate how close to the mark we may be by stating a range within which we *believe* p_c lies. This range includes the point estimate. The narrower the interval, the closer we think we are to p_c .

An interval estimate, or confidence statement, has the following two essential components:

- Confidence limits, called p_c and \bar{p}_c (p sub-bar and p bar), are, respectively, the lower and upper bounds of the interval within which it is estimated that p_c lies.

- Confidence level, called γ (gamma), expresses our degree of belief that p_c lies between p_c and \bar{p}_c . The value of γ is chosen arbitrarily, the most common choice being 95%, although other choices, such as 90% or 99%, are often made.

One of these components without the other is meaningless.

As in determining significance, human judgment plays an essential role in obtaining confidence limits. The higher the value chosen for γ , the farther apart are the confidence limits and the wider is the interval estimate. If we choose an extremely high value of γ —



say, 99.9%—the interval estimate tends to become meaninglessly wide, particularly for small samples. To narrow the interval, we must increase sample size and/or adopt a lower value of γ . Seldom is this value lower than 80%. Anything lower—say, 60%—excessively erodes confidence in the stated interval. All in all, we must choose γ wisely, understanding that there is a trade-off between γ and the width of the interval. While a high γ is desirable, this entails a wider interval, which is undesirable. If we want both a high γ and a narrow interval, sample size must be adequately increased.

Loosely, γ is sometimes described as the "probability" that p_c lies within the calculated interval. Correctly, γ means the following, using γ equals 95% for illustration: If we were to take a vast number of samples from a population, and each time follow a statistical procedure that employs γ equals 95%, p_c would be within the calculated interval 95% of the time and outside the interval 5% of the time. Inverting this relationship, we associate 95% confidence with any one interval estimate.

If, instead, we employ a statistical procedure based on γ equals 90%, the interval estimate would be narrower, but p_c would lie within the interval 90%

of the time and outside it 10% of the time.

To illustrate all this, again assume a score of 12/16. At γ equals 95%, then we obtain p_c equals 0.476 and \bar{p}_c equals 0.927. In words, we are 95% confident (please don't say "sure"—sampling never permits us to be sure) that p_c is between 0.476 and 0.927. Recall that our point estimate is 0.75, illustrating that the interval estimate brackets the point estimate.

An interval estimate of 0.476 to 0.927 may be too wide to be meaningful. As already indicated, one way to narrow it is by choosing a lower value of γ —say, 80%. At γ equals 80%, we obtain p_c equals 0.561 and \bar{p}_c equals 0.886. If this interval is still too wide, the only suitable step (assuming we want both p_c and \bar{p}_c) is to increase the sample size. Let's try n equals 64, with the score remaining 75%—i.e., 48/64. Now we obtain p_c equals 0.667 and \bar{p}_c equals 0.820 at γ equals 80%.

Suppose we want both a high confidence level—say, γ equals 95%—and a really narrow interval—say, about 4 or 5 percentage points wide. Then the sample size would have to be on the order of 1,000. If n equals 1,000 and the score is still 75% (750/1,000), then p_c equals 0.726 and \bar{p}_c equals 0.772 at γ equals 95%. The interval has been reduced to a width of 4.6 percentage points at the cost of a tremendous increase in sample size.

Sometimes only one limit is of interest—say, the lower limit. This raises the lower limit somewhat. (If we were interested only in the upper limit, this would lower that limit somewhat.) Returning to our example where we have a score of 12/16 and γ equals 80%, we can say that p_c equals 0.615—provided we say nothing about \bar{p}_c . In words, we are 80% confident that the subject can make correct identifications at least 61.5% of the time. This compares with p_c equals 0.561 when we make a statement about both the lower and upper limits at γ equals 80%.

We now turn our attention to p_k instead of p_c —namely, to the proportion

of correct responses based solely on audible differences. In a manner parallel to equation 2, we may estimate confidence limits p_k and \bar{p}_k as follows, retaining the confidence level employed for p_c and \bar{p}_c :

$$p_k = \begin{cases} 2p_c - 1 & \text{for } p_c \geq 0.5 \\ 0 & \text{otherwise} \end{cases} \quad (3)$$

$$\bar{p}_k = \begin{cases} 2\bar{p}_c - 1 & \text{for } \bar{p}_c \geq 0.5 \\ 0 & \text{otherwise} \end{cases} \quad (4)$$

To illustrate, assume we have a score of 12/16, with γ equals 80%, p_c equals 0.561, and \bar{p}_c equals 0.886. Then, at γ equals 80%,

$$p_k = (2 \times 0.561) - 1 = 0.122$$

and

$$\bar{p}_k = (2 \times 0.886) - 1 = 0.772$$

In words, the interval estimate of p_k ranges from 0.122 to 0.772 at the 80% confidence level.

Equations 3 and 4 enable the reader to convert binomial confidence limits for p_c into confidence limits for p_k . The reader interested in obtaining binomial confidence limits p_c and \bar{p}_c , and in determining sample size for an interval estimate, is referred to [2] and [3].

I guess it's time to take a nice deep breath. A

References

1. Burstein, H., "Approximation Formulas for Error Risk and Sample Size in ABX Testing," *Journal of the Audio Engineering Society*, Vol. 36, No. 11, November 1988.
2. Burstein, H., "Transformed Binomial Confidence Limits for Listening Tests," *JAES*, Vol. 37, No. 5, May 1989.
3. Burstein, H., *Attribute Sampling: Tables and Explanations*, McGraw-Hill, New York, 1971.

“Why all Boston Acoustics speakers sound alike. More or less.”

—Andy Petite, chief designer, Boston Acoustics



At Boston Acoustics, we design each of our speakers to be musically accurate based on a live music reference stan-

dard. In other words, instruments and voices played through our speakers have all the qualities of real live music.

Which is why all of our systems have a remarkable sonic resemblance.

To achieve that “live standard,” we design accurate octave-to-octave tonal balance and wide dispersion into our speakers – from our popular A40 Series II bookshelf to our

impressive T1000 tower.

We even go a few steps further by using the highest quality materials in all of our speakers, by manufacturing each one to a rigid tolerance, and by testing every single system before it leaves the factory.

But if each of our speakers has the same tonal qualities, why offer different models? Because not all listening conditions and personal preferences are the same.

In larger rooms, at higher listening levels, the superiority of our more expensive systems is obvious. They play louder without strain, reproduce deeper bass and offer exceptional sonic imaging. Our smaller speakers match that musicality, accuracy and

tonal balance. The only difference is that they’re designed to reproduce a wide musical range in smaller rooms at lower volumes.

So no matter which Boston Acoustics system you choose – one of four bookshelf models, three tower systems or our latest subwoofer/satellite model, the SubSat Six – you can be sure of one thing: what you hear will be as close to the original music as today’s technology allows.

Testing this is simple. Visit your Boston Acoustics dealer and listen to any Boston speaker. The differences from one speaker to another will become readily apparent. And so will the similarities.

The A40 Series II. \$180 a pair.
“... attains an aura of spaciousness surpassed only by some of the far more expensive multi-directional speakers.”
— *The New York Times*



The T830. \$500 a pair.
“... we were enormously impressed... superb sound, practical size and proportions, and affordable price.”
— Julian Hirsch, *StereoReview*

BostonAcoustics

70 Broadway, Lynnfield, MA 01940 (617) 592-9000

Prices are suggested retail price.

PARTICIPATING LOCATIONS

ARIZONA
HI FI SALES, MESA

ARKANSAS
AUDIO WORLD, LITTLE ROCK NO LITTLE ROCK

CALIFORNIA
BOOTS CAMERA, FRESNO CREATIVE STEREO, SANTA BARBARA SANTA MARIA THOUSAND OAKS VENTURA
DAVID RUTLEGE AUDIO, PALM SPRINGS DB AUDIO,
BERKELEY DOW STEREO, EL CAJON ESCROW
CHULLA VISTA VISTA SAN DIEGO EBER ELECTRONICS,
MENLO PARK SAN FRANCISCO EUREKA AUDIO,
EUREKA THE GOLDEN EAR, CHICO MARCONI RADIO,
GLENDALE PARIS AUDIO, WEST LOS ANGELES
WOODLAND HILLS ROGERS SOUND LABS, CANOGA PARK
EL TORO PASADENA SANTA MONICA TORRANCE
WESTMINSTER VAN NUYS SHERMAN OAKS CAMERA &
STEREO, SHERMAN OAKS SOUND GOODS, CAMPBELL
MOUNTAIN VIEW TURNTABLES UNLIMITED,
SACRAMENTO WATER STREET STEREO, SANTA
CRUZ WILSHIRE TV, LOS ANGELES

COLORADO
LISTEN UP, BOULDER DENVER SOUND SHOP, COLORADO
SPRINGS

CONNECTICUT
AUDIO ETC, NEW HAVEN

DELAWARE
HI FI HOUSE OF DELAWARE, WILMINGTON

FLORIDA
THE CONSUMER CENTER, TAMPA ELECTRONIC
CREATIONS, ALTAMONTE SPRINGS HOYT HI FI,
JACKSONVILLE SALON OF MUSIC, WEST PALM
BEACH SOUND ADVICE, ALTAMONTE SPRINGS BOCA
RATON CLEARWATER CORAL GABLES FT LAUDERDALE
HIALEAH HOLLYWOOD MIAMI NO MIAMI BEACH
ORLANDO SARASOTA ST PETERSBURG SUNRISE TAMPA
WEST PALM BEACH TVC, TEQUESTA
TV & MUSIC CENTER, ST PETERSBURG

GEORGIA
AUDIO WAREHOUSE, SAVANNAH HI FI BUYS, ATHENS
ATLANTA DULUTH KENNESHAW MORROW NORCROSS
RIVERDALE TUCKER

ILLINOIS
GOOD VIBES, CHAMPAIGN MILLS RECORDING,
CHICAGO STEREO SYSTEMS, AURORA JOLIET
NAPERVILLE UNITED AUDIO CENTERS, AURORA
CHICAGO DEERFIELD NILES SCHAMBURG VERNON HILLS

INDIANA
GOOD VIBES, LAFAYETTE HJS SOUND, NEW HAVEN

KANSAS
RED BARON, WICHITA

LOUISIANA
ALTERMAN AUDIO, METAIRIE NEW ORLEANS

MAINE
NEW ENGLAND MUSIC, SCARBOROUGH

MARYLAND
AUDIO BUYS, GAITHERSBURG THE GRAMOPHONE LTD.,
ELLCOTT CITY LUTHERVILLE

MASSACHUSETTS
MUSIC BOX, WELLESLEY Q AUDIO, CAMBRIDGE SOUND
& MUSIC, NORTHAMPTON

MICHIGAN
AUDIOVISION, WEST BLOOMFIELD POINTE
ELECTRONICS, GROSSE POINTE WOODS THE STEREO
SHOPPE, ANN ARBOR EAST LANSING LANSING SAGINAW
TRAVERSE CITY

MINNESOTA
AUDIO KING, BROOKLYN CENTER BURNSVILLE EDINA
MANKATO MINNEAPOLIS MINNETONKA ROCHESTER
ROSEVILLE ST CLOUD ST PAUL

MISSISSIPPI
MELLEND TV, HATTISBURG

MISSOURI
SOUND ENTERPRISES, KANSAS CITY STEREO ONE, CAPE
GIRARDEAU

NEBRASKA
STEREO WEST, LINCOLN OMAHA

NEW JERSEY
HARVEY ELECTRONICS, PARAMUS MONMOUTH STEREO,
SHREWSBURY RECORD SHOP, CHERRY HILL ROUTE
ELECTRONICS, PARAMUS TOTOWA

NEW MEXICO
HUDSON'S AUDIO CENTER, ALBUQUERQUE

NEW YORK
GRAND CENTRAL RADIO, MANHATTAN HARVEY
ELECTRONICS, MANHATTAN WHITE PLAINS LISTENING
ROOM, SCARSDALE LYRIC HI FI, MANHATTAN WHITE
PLAINS RABSONS AUDIO/VIDEO, MANHATTAN GARDEN
CITY SQUARE DEAL, PATCHOGUE STEREO CHAMBER,
ORCHARD PARK THE NEW STEREO EXCHANGE,
MANHATTAN

NORTH CAROLINA
AUDIO BUYS, RALEIGH SOUNDHAUS, DURHAM

OHIO
ALAMO ELECTRONICS, CINCINNATI B&B, EUCLID
MIDDLEBURG HEIGHTS GOLDEN GRAMOPHONE,
AKRON JAMESON'S, TOLEDO STEREO LAB,
CINCINNATI COLUMBUS

OREGON
BRADFORD'S HIGH FIDELITY, EUGENE FRED'S SOUND
OF MUSIC, GRESHAM PORTLAND

PENNSYLVANIA
AUDIO INSIGHT, WEXFORD STEREO BARN, EPHRATA
LANCASTER

RHODE ISLAND
STEREO DISCOUNT CENTER, PROVIDENCE

SOUTH CAROLINA
READ BROTHERS, CHARLESTON STEREO VIDEO,
GREENVILLE

SOUTH DAKOTA
AUDIO KING, SIOUX FALLS

TENNESSEE
HI FI BUYS, MURFREESBORO NASHVILLE

TEXAS
BJORN'S AUDIO/VIDEO, SAN ANTONIO DIGITAL CENTER,
DALLAS GROOVE AUDIO VIDEO, HOUSTON HAROLD'S
ELECTRONICS, MIDLAND ODESSA METEX
INTERNATIONAL, LAREDO McALLEN OMNI SOUND,
DALLAS SOUTHWEST RECORD & TAPE,
HOUSTON STEREO VIDEO CENTER, TYLER

UTAH
STANDARD AUDIO, SALT LAKE CITY

VIRGINIA
AUDIO ART, RICHMOND AUDIO BUYS, BAILEY S
CROSSROADS MANASSAS THE AUDIO CENTER,
ROANOKE DIGITAL SOUND, VIRGINIA BEACH

WASHINGTON
ADVANCED AUDIO, TACOMA DEFINITIVE AUDIO,
SEATTLE HUPPINS HI FI, SPOKANE MAGNOLIA HI FI &
VIDEO, BELLEVUE LYNNWOOD SEATTLE TACOMA

WISCONSIN
HI FI HEAVEN, GREEN BAY SOUND STAGE, MILWAUKEE

Announcing!

TECHNOLOGY UPDATE #8

BACK BY POPULAR DEMAND!

Why and How Digital Signal Processing is a Major Breakthrough in Audio

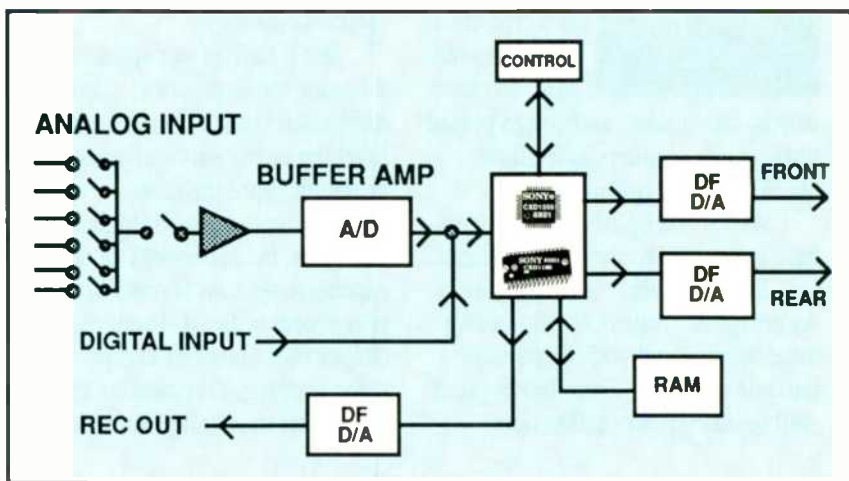

The Sony DSP Circuit incorporates two ICs which digitally process all signals for equalization, filtering, surround sound and dynamic range compression and expansion.

The latest Technology Update (now at your select audio specialty dealer), is a repeat command performance! Update #6 (on Digital Signal Processing) brought an astonishing response and requests for more information.

Audio Information Magazine (AIM) is glad to comply. Technology Update #8 offers the latest on how audio signals can be digitally processed for equalization, compression, expansion and sound field effects (including surround sound).

And all this while maintaining the integrity of the original signal.

Free AIM literature is yours through this cooperative effort of Audio Magazine, Sony® and select audio specialty dealers.

FREE!

The story of Digital Signal Processing.



UPDATE: DIGITAL SIGNAL PROCESSING

- ▶ Why it's a breakthrough
- ▶ What it does for you
- ▶ How it works

Audio

ES SONY
THE LEADER IN DIGITAL AUDIO

SOUND FROM SPACE

Digital Broadcasts, Digital Components

ROBERT ANGUS

Now that we've got the digital Compact Disc and Digital Audio Tape is clearly on the horizon, we need only one more program source—digital radio—to complete the transition from 100 years of analog. And that source may be nearer at hand than you think.

At the 1989 International Funkausstellung, an audio/video festival held biennially in Berlin, the big news was digital audio from satellite, with tuners from such companies as Philips, Telefunken, Thomson, and Grundig to receive it. Not only did these manufacturers show state-of-the-art tuners, but most had digital components and rack systems to accompany them.

In the United States, digital radio may be no farther away than your cable box, and may arrive not much later than the first quarter of this year. No fewer than three companies—the Jerrold Division of General Instrument, Digital Radio Labs, and International Cablecasting Technologies—are trying to convince cable operators to add digital music to their lineups. One company has already talked Marantz into signing on to provide the necessary reception equipment.

The trouble is, the three American digital formats are incompatible with one another and with the European format. None is suitable for over-the-air transmission, even assuming that some FM license-holder could be persuaded to give up profitable air time to try it.

Even more of a problem, from the American audiophile's point of view, is that the decision about which system he'll be able to get will be made neither

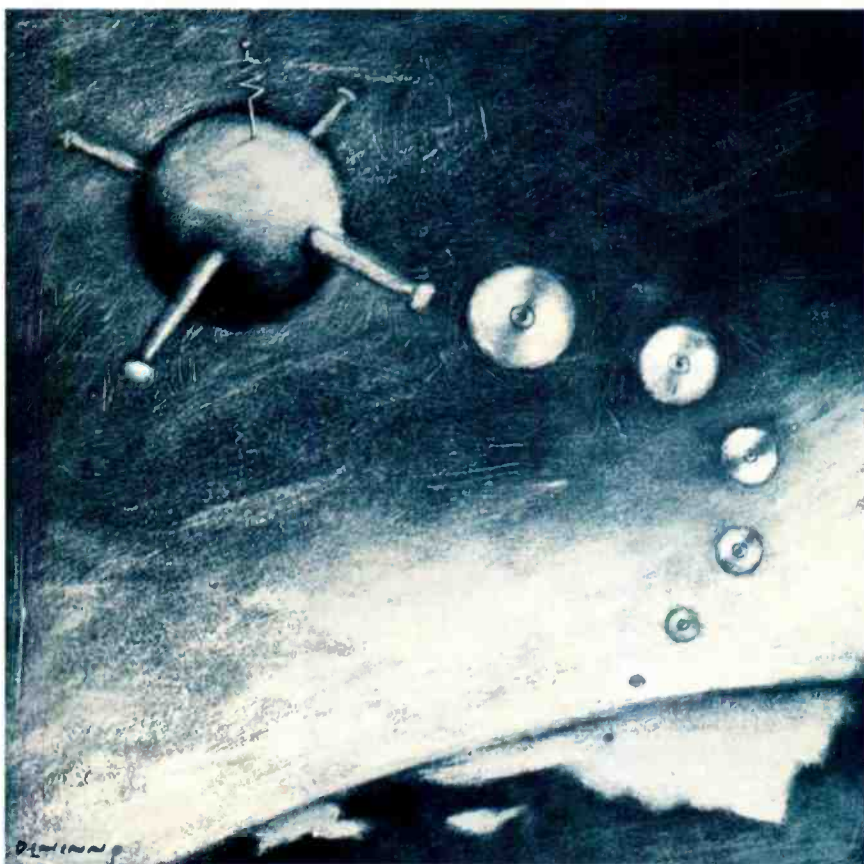
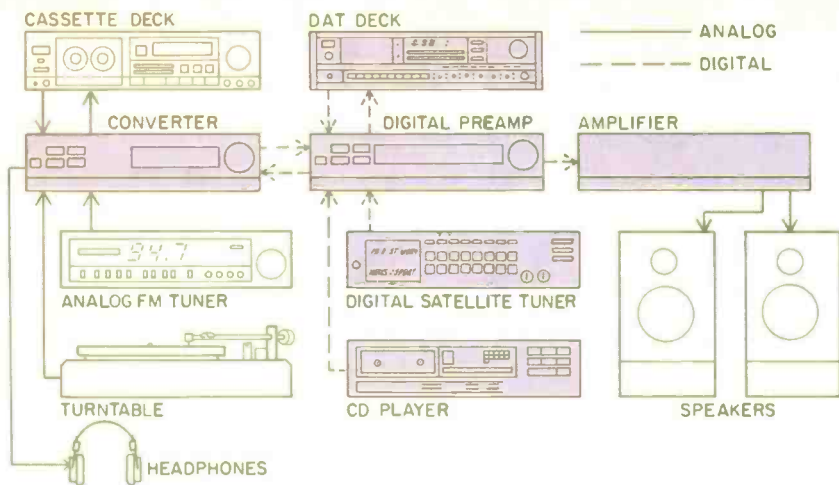

ILLUSTRATION: STEVE DINNINO

by the Federal Communications Commission nor the nation's FM broadcasters, but by local cable operators. And the decision is much more likely to be based on economic considerations than on technical merits.

What made digital audio practical in Europe was the launch in 1989 of the Kopernikus satellite, which carries 16

stereo programs or 32 mono signals—each with the sound quality of a Compact Disc. The tuners all feature 16 pushbuttons, one for each stereo pair. Programming is provided by independent broadcasters who, like their North American counterparts, generally concentrate on a particular music format. For example, available channels offer



Digital and analog interconnections of the Digital Line.



Thomson's DT 1000 DSR tuner, for Europe's new digital audio satellite service.



The three top components of Thomson's Digital Line: Analog Digital Converter, Full Digital Processed PreAmplifier, and Digital Controlled Power Amplifier.

news and talk, easy listening, classical music, Top 40, and so on. Instead of displaying frequency, a front-panel LCD readout shows which format has been selected. If a user selects "News," for example, and none can be received, the tuner will wait silently until a news program becomes available, then turn itself on and switch to the appropriate channel.

Typical of the new units is Thomson's DT 1000 DSR, for which the manufacturer claims a transmission range of 10 Hz to 15 kHz, a dynamic range of 92 dB, stereo channel separation in excess of 80 dB, and signal-to-noise ratio (A-weighted) of 110 dB. Designed for European cable formats, it receives a signal transmitted via satellite at 118 MHz, using "4 PSK" (four-phase shift

keying) modulation. The audio signals are reproduced with 16-bit dynamic range, and sampling frequency is 32 kHz. Oversampling, digital filtering, and two digital/analog converters recover the audio signals.

Accompanying this tuner—and similar units from Philips, from Grundig, and from Telefunken—are packages of all-digital units ranging from DAT decks and CD players to a digital-line A/D converter, preamp, and power amp, all connected either by fiber-optic cable or conventional coaxial cable. While some of these packages consist of individual components, others are rack systems designed to operate with a single infrared remote control.

Thomson's Digital Line takes this trend even further, with components interconnected only via digital fiber optics. At the top of this line is a three-piece amplification system consisting of an Analog Digital Converter, a Full Digital Processed PreAmplifier, and a Digital Controlled Power Amplifier. All analog components are connected to the converter unit, which has seven analog input pairs, a 16-bit A/D converter with input oversampling, and a 16-bit D/A converter with eight-bit oversampling to feed the unit's analog tape output and headphone jacks. A multi-function knob can be used for headphone volume and to independently select signals to be recorded, passed on to the preamp and amp for listening, and sent to the headphone jacks. The knob's current function (selected by a keypad) and that function's status are shown on an alphanumeric display.

Input and output fiber cables connect the converter to the preamp. Digital components such as the DT 1000 DSR, a CD player, and a DAT deck also connect directly to this component, which has optical inputs for seven digital sources. The preamp's controls, like those of the converter, consist of a multi-function knob and four selector buttons, but its functions are more complex. They include digital loudness compensation, programmable echo, digital control of balance and volume, and equalization. The built-in, 10-band digital graphic equalizer is adjustable by ± 10 dB in 0.1-dB steps and includes a matrix to compensate for response errors caused by "band superposition" (presumably, overlap between bands). The signals fed to the digital record output, the amp, and the monitor D/A in the converter box are all independently selectable.

The preamp is also responsible for controlling all the functions of the am-

plifier through digital control signals sent via the same optical link as the audio signal. For example, the pre-amp's volume control does not affect the audio portion of the digital signal but, instead, adds volume-command subcodes that control the amp's output level. The manufacturer claims that the amp delivers 200 watts per channel into 4 ohms and has a "nonlinear distortion factor" of 0.0039 into 8 ohms and an unweighted S/N of 100 dB.

Thomson's Digital Line also provides for simpler setups. Most of the above converter and preamp functions are also available in a Digital Active Box Controller which has six analog inputs, three optical digital inputs, plus outputs for one digital and two analog recorders and a headphone. With more functions, it has a more complex display that can be set for English, German, or French. This unit is designed to be used with up to four active speakers, each of which contains its own D/A converter and digitally controlled 145-watt amp. The same functions and facilities are also available in an integrated amp rated at 200 watts per channel into 4 ohms.

All this might be of academic interest to American audiophiles but for the fact that the Thomson Consumer Electronics Group's Chairman, Pierre Garcin, sought out reporters in Berlin to tell them he's serious about putting RCA, Thomson's major North American brand, into the audio business, including the offering of components in sound specialty shops. In making this announcement, however, Garcin did not say whether the digital components would be among the first to become available.

Meanwhile, it's possible that by the end of this year as many as 4 million of the U.S. homes served by TeleCommunications Inc. (TCI) cable companies could have access to the digital programming provided by International Cablecasting Technologies (ICT), with as many as another million able to subscribe to a rival system offered by General Instrument's Jerrold Division. The latter's technical specifications resemble those of a digital audio service now being provided to subscribers of Tokyo Cable in Japan.

TCI says it's going to start off cautiously, using carefully selected cable systems in urban, suburban, and rural areas to determine how many subscribers will be willing to pay about \$7.95 a month for a package of 18 digital formats—plus another \$2 a month to rent a digital tuner, or \$200 to \$250 to buy one outright. TCI, a cable

giant, has a heavy investment in ICT: It owns 3.18 million shares in the programmer. For years, it's been a truism in the cable industry that "you can't get money for a cable channel people can't see." Jerrold, ICT, and Digital Radio Labs (DRL) hope that rule doesn't apply to digital audio, where, in the words of Jerrold spokesman Paul Cleff, "We can offer the subscriber something demonstrably better than he can get off the air or from audio tape."

Europe's new digital radio tuners will seek out the kind of program a listener requests. If it's not on the air, the tuner will await it silently, and then turn on.

All three programmers plan to deliver their signals via satellite, which theoretically means they would be available to the 2.1 million U.S. homes equipped with satellite dishes. In fact, only ICT has plans to provide programming for the dish market, and then only in areas not served by cable companies carrying its signals. According to Mike Davis, ICT's National Operations Chief, dish owners would need a different type of tuner to pick up the programs, a dilemma which is likely to frighten away equipment suppliers who would like to manufacture (and sell) a single unit. Cable-delivered digital audio would arrive on an unused mid or high cable band, whereas dish owners would receive theirs via a baseband output on the satellite receiver. "The [ICT] chip has to know how to find and descramble the signal," Davis says.

DRL's Digital Radio Channel comprises 20 channels of commercial-free CD music in multiple formats, plus six channels reserved for full-time simulcasting of premium movie services and basic music video services. Chief Executive Officer Doug Talley is understandably vague about just how his system works, but he claims the sound quality is superior to that of its rivals; these systems, he says, add some low-

level noise and slight high-level congestion not found in DRC's programming. Talley says that his company's service places digital radio signals in otherwise unusable portions of the cable spectrum, where the carrier-to-noise ratio and channel flatness cannot support video or FM radio service. It's not necessary, therefore, to displace any existing programming to make room for digital audio.

While cable operators are likely to rent dedicated tuners capable of nothing beyond delivery, decoding, and selection of a digital program, ICT's Davis says his company has patents on a chip which could be built into virtually any digital audio component or into a conventional AM/FM tuner or receiver. "The cost of the chip is low enough that a manufacturer could offer it as an extra feature on a medium-priced CD player or portable," he says. So far, no component manufacturer has committed to marketing any product containing this chip, although Marantz has built a prototype and has expressed interest in obtaining a non-exclusive license to manufacture equipment. Like Jerrold, ICT plans to have cable-rental tuners manufactured in Japan on a private-label basis.

In addition to the receiver, ICT is considering marketing an accessory LED readout display to provide information on the recording being played—a substitute for voice announcements. "In addition to telling you the name of the selection and artist, it'll show the record label and catalog number for any listener who's interested in buying," reports Davis. "Our research suggests that people want to hear music uninterrupted, not only by commercials"—there won't be any on programs from ICT, Jerrold, or DRL—"but by DJs, even for a simple listing of [program] contents. For those people who want the information, the LED display can provide it for the duration of each selection, and it can provide more information than a voice announcement. We think the record companies will love it."

Jerrold's system, which uses Dolby 85 signal compression, claims a dynamic range of 85 dB and a frequency response of 20 Hz to 15 kHz on up to 28 stereo programs. By comparison, Davis says ICT's service, CD/18, delivers a response of 5 Hz to 20 kHz, a dynamic range of 96 dB, and a THD figure of less than 0.05% on its 18 available audio channels. Davis concludes, "When it comes to specs, ours are exactly the same as those for the Compact Disc."

1

BOULDER 500AE AMPLIFIER AND ULTIMATE PREAMPLIFIER

Manufacturer's Specifications Preamplifier

Frequency Response: 20 Hz to 20 kHz, +0.00, -0.1 dB; 0.015 Hz to 200 kHz, +0, -3 dB.

THD: 0.0015% from 20 Hz to 2 kHz, 0.0025% at 20 kHz, for 2 V out.

Maximum Output Level: 12 V rms.

Maximum Voltage Gain: Phono, 68 dB; line, 11 dB.

Input Impedance: Phono, 47 kilohms (high) or 100 ohms (low); line, 200 kilohms.

Output Impedance: Unbalanced, 50 ohms; balanced, 100 ohms.

Power Requirements: 65 watts, 50/60 Hz; voltage selectable (100/120/220/240 V a.c.).

Dimensions: Single-module frame, 5 in. W x 3¾ in. H x 15½ in. D (12.7 cm x 9.5 cm x 39.4 cm); dual-module frame, 9 in. W (22.9 cm).

Weight: 23 lbs. (10.5 kg).

Price: \$4,795, including modules for power supply, phono preamp, selector switch, and output controller plus one dual-module and two single-module frames; \$3,095 without phono preamp module.

Amplifier

Continuous Power: Stereo, 150 watts into 8 ohms, 250 watts into 4 ohms; bridged mono, 500 watts into 8 ohms.

Peak Power: Stereo, 300 watts into 4 ohms; mono, 600 watts into 8 ohms, 1,200 watts into 4 ohms.

THD at Rated Power: 0.0015% from 20 Hz to 2 kHz, 0.005% at 20 kHz.

Frequency Response: 20 Hz to 20 kHz, +0.00, -0.04 dB; 0.015 Hz to 200 kHz, +0, -3 dB.

Slew Rate: Stereo, 35 V/μS; mono, 70 V/μS.

Voltage Gain: Stereo, 26 dB (20×); mono, 32 dB (40×).

Peak Current: 50 amperes.

Damping Factor: 800 at or below 1 kHz, 100 at 20 kHz.

Minimum Input Impedance: Unbalanced, 30 kilohms; balanced, 10 kilohms.

Common-Mode Rejection: 80 dB at 60 Hz, 70 dB at 10 kHz.

Power Requirements: 1,000 watts, 120 V a.c., 60 Hz; export version with selectable voltage and frequency available.

Dimensions: 17 in. W x 5¼ in. H x 15½ in. D (43.2 cm x 13.3 cm x 39.4 cm).

Weight: 51 lbs. (23.2 kg).

Price: \$2,995; multi-voltage international version, \$3,295.

Company Address: 4850 Sterling Dr., Boulder, Colo. 80301.

For literature, circle No. 90

The Ultimate is Boulder's best foot forward in the preamp department, and the 500AE is their largest, latest amplifier.

The 500AE is basically intended for use as a mono bridged amp. However, it is equally at home as a stereo amp, albeit at lower power, and that is how it was reviewed. An earlier model, the 500, is said to be the same as the 500AE but with a fancier front panel that included input level controls and various indicators. A smaller model, the 250AE, rounds out Boulder's current line of power amplifiers.

The preamp is modular, consisting of four pieces: The MS01 power supply, MS11 phono preamp with MC capability, MS21 selector switch, and the MS32 output controller with balanced output. A step below the Ultimate in Boulder's hierarchy is the Complete preamp, whose four modules, tied together in a single case, are similar but do not include MC facilities or balanced outputs. If memory serves me correctly, Boulder was one of the first companies to offer preamps in this modular form.

Physically, the Ultimate has its selector switch and output modules tied together in a dual frame, with the phono preamp and power supply separate. This enables the power supply to be placed away from the phono preamp section and permits the phono section to be placed next to or near the turntable.

Actual construction of the modules is fairly straightforward, although I haven't seen very many pieces of hi-fi gear

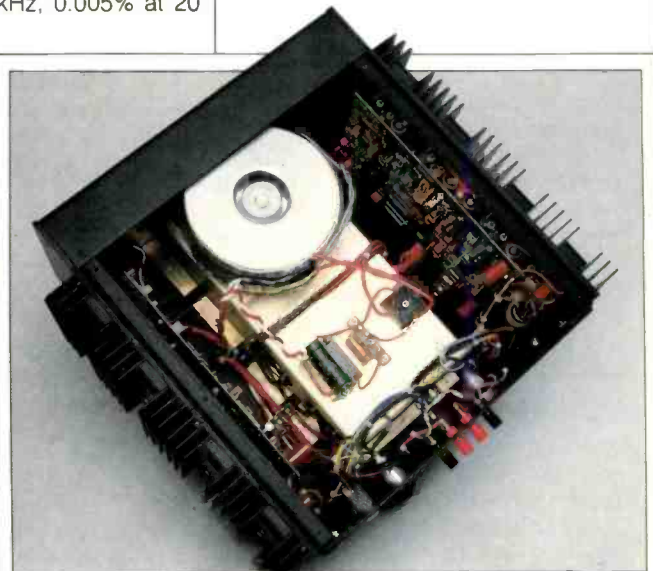

made this way. The chassis of the basic module is composed of two sides, rear and front panels, and top and bottom covers. Small pieces, ¼ inch square, are riveted to the sides; these pieces have threaded holes to accept the attachment screws which hold the front and rear panels in place. The internal p.c. boards are also attached to the side



pieces in this manner. Dress side panels cover the exposed outside of each module. Where two or more modules are tied together as a unit, the adjacent internal sides don't use these dress panels. Finally, each module has top and bottom covers that serve as the means to couple them together. Very nice mechanics indeed.

Internally, the selector switch module is the simplest, having no active circuitry inside. Signal input and output connectors are Tiffany phono jacks, linked by Teflon-insulated wire to a p.c. board at the rear of the module. This board has two rotary switches mounted on it, and long shafts from the front panel couple to the switches. The unit has two selector switches, one for the signal to be listened to and the other for what is to be fed to a tape recorder or external processing loop. The record selector switch has a couple of extra switch poles that prevent input-to-output feedback of connected tape recorders or signal processors. This works by grounding the feed to tape out of the selected tape input; i.e., if the signal at the tape 1 monitor input is selected as the recording source, the tape 1 record output is grounded.

The phono preamp and output controller modules are of roughly equal internal complexity, both using six (three per channel) of the special discrete operational-amplifier circuits which are the basis for all of Boulder's signal amplifying circuitry. Each of these modules has a motherboard running fore and aft, oriented parallel to the top and bottom

surfaces. The op-amp modules plug into the motherboards and are also mechanically fastened to the motherboard at each end of the module. There are *lots* of high-quality parts in these units. Resistors are all metal-film types, and capacitors are all plastic-encased film types or "audio-grade" electrolytics. The main volume control in the output controller is a Penny and Giles unit—one of the very finest.

The controls on the MS11 phono module's front panel are a pushbutton switch that takes the low-cut filter in and out of the circuit, a three-position frequency selector for the filter, and two screwdriver-adjustable pots for phono gain. A two-position toggle switch on the rear panel selects MM or MC gain. On the front panel of the MS32 output controller are rotary volume and balance controls plus pushbutton switches for muting, normal and reverse stereo, mono/stereo, and each channel's output polarity. The rear panel of the output controller has two pairs of Tiffany RCA connectors for unbalanced input and output plus a pair of XLR connectors for balanced output connection.

When the entire Ultimate preamp is connected, a short pair of signal leads with phono connectors couples the output of the selector switch module to the input of the output controller. Similarly, the output of the phono module is connected to the phono input of the selector module. Two additional cables are used to connect the power supply to the phono and output controller modules.

The modular construction of the Ultimate preamp lets one place the phono preamp near the turntable and the power supply far away.

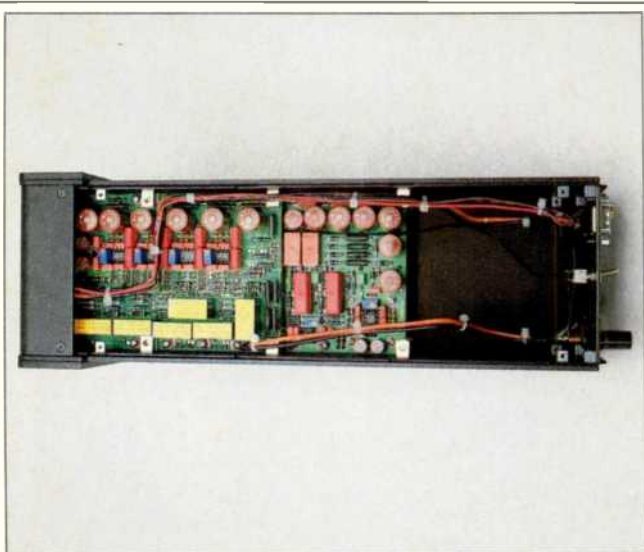

The MS01 power supply feeds about ± 25 V d.c. to the active modules. A large, shielded toroidal power transformer of approximately 100 VA is located at the front of the supply module, and the rest of the interior area is occupied by a p.c. board containing the regulator circuitry. Series-pass regulating transistors are mounted on two heat-sinks that protrude from the rear of the supply. Four multi-pin connectors on the rear of the supply imply that four Boulder preamp modules can be powered from one supply.

Turning our attention to the 500AE power amplifier, we find a rather solid, businesslike unit of deceptive simplicity. An uncomplicated front panel sports a power switch and an LED indicator. Looking at the rear panel, one sees a pair of XLR connectors and might ask: Where are the RCA signal input connectors? Boulder, by not including RCA signal connectors, apparently is encouraging people to use balanced-line interconnects from one's preamp. As an increasing number of components—including the Ultimate preamp—now have balanced outputs, this is a reasonable approach. For those who use unbalanced interconnects, all is not lost; Boulder supplies a short adaptor cable with a female RCA connector on one end and the appropriate XLR connector on the other.

Completing the subject of what's on the 500AE's rear panel, we find the usual pair of five-way binding posts for speaker connection. These are arranged with their red (or hot) terminals adjacent to each other, making speaker connections easier in the bridged output mode. Below the speaker connectors is a pushbutton mode switch for selecting stereo or bridged mono operation.

Another pushbutton switch controls whether or not clipping is to be shown on the front-panel power indicator. A word about this indicator: When the amp is first powered up, the indicator is red for a few seconds and then turns green when the amp is ready to operate. When the rear-panel switch is set to show overload, the power-on indicator flashes red whenever this occurs.

A resettable circuit breaker takes the place of the usual replaceable power-line fuse. A two-terminal barrier strip

allows the choice of whether or not the chassis is connected to the a.c. third-wire ground.

Looking inside the unit, one's attention is drawn to the way the central fore and aft space is utilized. A subchassis, 6 in. W \times 3 in. H \times 12 in. D, is mounted in the fore-and-aft direction to the bottom of the amplifier. The four main filter capacitors are mounted side by side under this subchassis, with the terminals of the front two facing to the left and those of the rear two facing to the right (as seen from the front). A large toroidal power transformer is mounted on the top of the subchassis, toward the front of the amp. Mounted on the rear top surface of the subchassis are the main power-supply rectifier bridge, a power resistor and relay, and a terminal strip containing several components to control the relay.

The actual amplifier circuitry is contained on four large p.c. boards, two per channel. In each channel, one board is mounted right next to the inside surface of the heat-sinks; the other is mounted parallel to the first and spaced about an inch away with four standoffs. These outer boards have one of the Boulder discrete op-amps mounted perpendicular to their main surfaces. I have not seen very many power amps that have as many parts as the 500AE, although I'm told by the manufacturer that many of these parts are for the sophisticated protection circuitry and for the extra gain stages in this two-stage design.

Physically, the 500AE's metalwork is simple and straightforward. One piece forms the bottom and sides. The sides of this piece are mostly cut out so the p.c. board assembly that is captive to each channel's heat-sinks can pass through when bolted together. Ledges are bent up on the top and rear of this main chassis piece to serve as mounting surfaces for the top cover and rear panel pieces. The front panel, like all the preamp's front-panel pieces, is formed into a "U," with the bottom of the "U" being the front surface and the sides of the "U" extending back about 2 inches along the bottom and top surfaces of the amplifier.

Circuit Description

One basic circuit is used for most of the signal amplifying blocks in Boulder electronics. Figure 1 shows the original version of this circuit, a general-purpose op-amp designed by the late Deane Jensen of Jensen Transformers to provide low noise, wide bandwidth, low distortion, and stability under many feedback conditions.

Although the topology of this circuit (which Jensen referred to as the JE-990) is nothing special from today's vantage point, and a number of audio preamps and power amps have been built and marketed with similar circuitry, a couple of things are neat and worth mentioning. The use of inductors across the emitter resistors in the first stage is clever. In the audio band, where one wants the emitter resistors to be shorted out for lowest noise, this is accomplished by the low reactance of the inductors. At higher frequencies, where one wants the emitter resistance in for stability of loop gain, the high reactance of the inductors allows this too. Diode CR4 prevents saturation of Q6, thus keeping the circuit's speed up when the amplifier is clipped. Great American Sound and other companies have used this technique in fully complementary circuits. The use of an

The McIntosh XRT 22 Loudspeaker System delivers

The McIntosh XRT 22 is the purest expression of the loudspeakers scientist's endeavors. It is the one *right combination* of component parts that has eluded the diligent searcher for the loudspeaker bridge to the dominion of reproduced musical reality. The high-frequency radiator column is an illustration of the *right combination*. The 23 tweeter elements can reproduce 300 watts sine wave input power at 20 kHz, with the lowest measured intermodulation distortion. Because each tweeter mechanism handles a small quantity of the total power, extremely low quantities of distortion are developed. The total column radiates the energy in a half cylindrical time co-ordinated sound field. The low distortion, transparency of sound, coherence of sound images, definition of musical instruments, and musical balance is simply a revelation that you must experience.

Extra Realism
Extra Depth
Extra Spaciousness
Extra Smoothness



Enter No. 19 on Reader Service Card

For information on the McIntosh XRT 22 SPEAKERS and other McIntosh products write:

MCINTOSH LABORATORY INC.
P.O. Box 96 EAST SIDE STATION, DEPT. 290A
BINGHAMTON, NY 13904-0096

**Handcrafted with pride in the United States
by dedicated, highly trained craftspeople.**

The circuit used for most of Boulder's signal gain blocks was designed for low noise, wide bandwidth, low distortion, and stability.

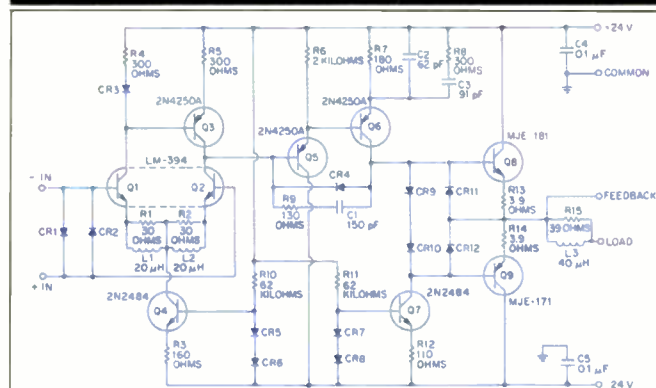

Fig. 1—Deane Jensen's JE-990 op-amp, the basis for Boulder's gain blocks.

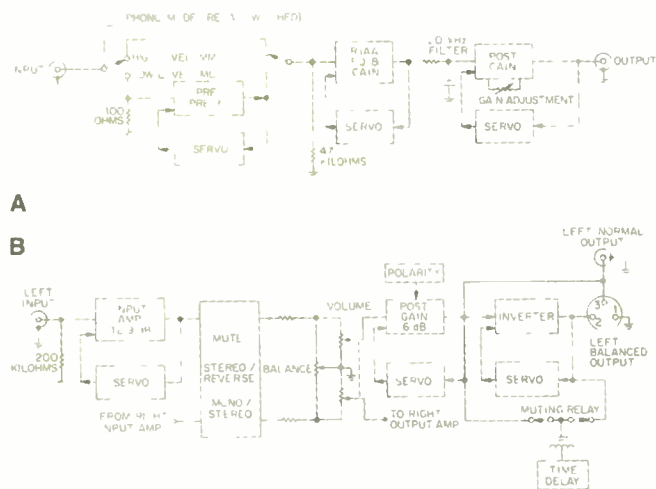

Fig. 2—Block diagrams of the Ultimate preamp's phono module (A) and output controller module (B).

output-buffering RL network in the circuit is a good idea that is seldom used outside of power amplifiers. Diodes CR11 and CR12 cause current limiting to take place at about 180 mA of output current. Diodes CR1 and CR2 prevent output latch-up with input signals faster than the response time of the circuit.

The actual circuit modules used as Boulder's gain stages are more complicated than the circuit just described, and they use about twice as many semiconductors. (This allows Boulder to use d.c. coupling between audio stages, thus eliminating coupling capacitors in the signal path.) One can

see on examination that ferrite-bead inductors are used for the input-stage emitters, and that many small-signal transistors are thermally coupled together with epoxy and copper clips in pairs and, in one instance, a triplet.

A block diagram of the phono and output controller modules used in the Ultimate preamp is shown in Fig. 2. Starting with the phono module in Fig. 2A, one can see that most of the RIAA equalization is done in the second gain block by frequency-selective negative feedback. The closed-loop gain of this block, at 1 kHz, is on the order of 26 dB, and since the circuit is noninverting, the high-frequency roll-off stops at about 30 kHz by bumping into unity closed-loop gain. Any frequency-selective feedback network connected as a series feedback element in a noninverting op-amp configuration can only reduce gain to unity. The inverting topology can reduce gain below unity. Hence the need for the interstage RC low-pass filter to continue this integration or roll-off beyond 30 kHz and on out to several hundred kilohertz. An extra 20 dB or so of flat gain is provided by the third phono gain block ("Post Gain" in Fig. 2A). By varying the amount of negative feedback in this stage, overall MM gain is variable from about 29 to 47 dB at 1 kHz.

The first block in the diagram of the phono module is a straight pre-preamp, with 20 dB of gain, that is switched in or out as indicated. The actual switching is done by a relay controlled by the rear-panel SPST toggle switch. This gain block is different from all the rest in the Ultimate preamp; the quiescent current in its input transistors is a lot higher, in order to get lower noise levels with the typical low source impedance of MC cartridges. Further, the power-supply voltage to these blocks is reduced to ± 8 V d.c. by regulators in the phono module. As can be seen in the block diagram, the input terminating resistor for the MC mode has a value of 100 ohms. Those who want to change this resistor for cartridges of other impedances or to fine-tune the load can only do so by finding the resistor, unsoldering it from the p.c. board, and replacing it with another.

All of the gain blocks in the phono module are direct-coupled to each other. Servo circuits around each block keep d.c. offset low enough to permit direct coupling.

In the output controller (Fig. 2B), the first gain block serves the dual functions of presenting a constant and high input impedance to the selected source and of providing the bulk of the necessary gain for the overall line amplifier function. Since there is considerable insertion loss (about 10 dB) in the balance and volume control circuit, the combined gain of the first and second ("Post Gain") blocks must be about 10 dB higher than the desired overall line gain, which comes out to about 8.6 dB. One result of this topology is that the first stage overloads before the output block does, at any volume setting, and does so at about 3.5 V in. The design also allows the volume control to be of unusually low impedance—in this case, 1 kilohm. This prevents a loss of high-frequency bandwidth as a function of volume control setting—or, rather, it puts that loss at frequencies beyond the bandwidth the preamp is designed to handle. A final result of this topology is that two gain blocks are in series instead of the usual single-block line amp, which might offend those of the "fewer devices in the signal path must sound better" school of thought. (They may prefer Boulder's

Real power has always been in the hands of the few.

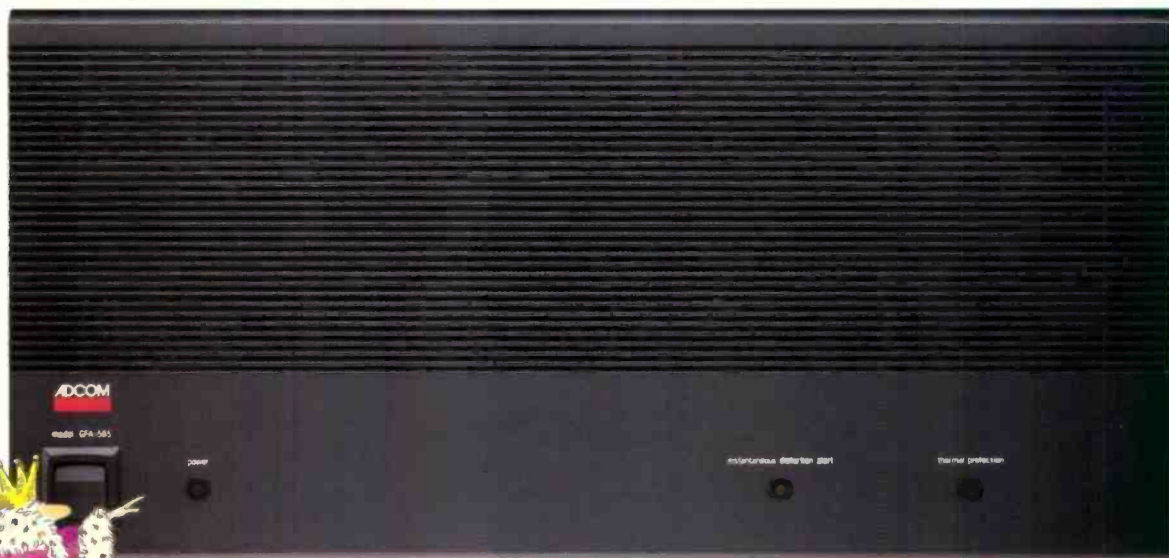

Adcom stereo components have a loyal and devoted following, having earned a reputation among audiophiles, engineers and musicians for extraordinary performance at affordable prices. Now Adcom introduces its newest amplifier, the no compromise GFA-565, for those in pursuit of absolute power and sonic perfection, but who prefer not paying a king's ransom.

The Evolution of Adcom's GFA-565

Adcom's new mono GFA-565 evolves from the design of the critically acclaimed GFA-555, greatly extending its capabilities. Representing brute strength, it delivers 300 watts at 8 ohms, 450 watts at 4 ohms and an awesome 850 watts at 2 ohms* Most significantly, it will accurately drive even esoteric loudspeakers which present loads as low as 1 ohm.

Inspired by the GFA-555, the new GFA-565's well-regulated, high-current power supply has an enormous reserve capacity to meet tremendous dynamic demands, resulting in distortion-free reproduction on a continuous basis.

Why Use Two Mono Amplifiers?

The ability to deliver very high power into complex loads is a prerequisite for superior sound reproduction. Power supplies capable of delivering the energy necessary for high power, high-current amplifiers are massive. But there are practical limits to the size and weight of stereo amplifiers designed for home use, as well as heat dissipation and reliability constraints. Consequently, the use of two Adcom GFA-565 mono amplifiers offers optimum sound definition, detail and dynamics, satisfying even the most demanding perfectionist.

More Sound, Less Money

Like the GFA-555, the new Adcom GFA-565 sounds superior to amplifiers costing two and three times as much. It is so powerful and pure that it may be the last amplifier you ever buy, even if you upgrade your loudspeakers several times over the years. And that makes the GFA-565 an extraordinary bargain considering its exceptional performance.

ADCOM[®]
details you can hear

**Continuous power output, 20 Hz-20 kHz < 0.02% THD, measured in accordance with FTC specifications.*

11 Elkins Road, East Brunswick, NJ 08816 U.S.A. (201) 390-1130 Distributed in Canada by PRO ACOUSTICS INC. Pointe Claire, Quebec H9R 4X5
Enter No. 2 on Reader Service Card

Boulder feels that using multiple amp stages, each optimized for its task, yields superior stability and lower distortion.

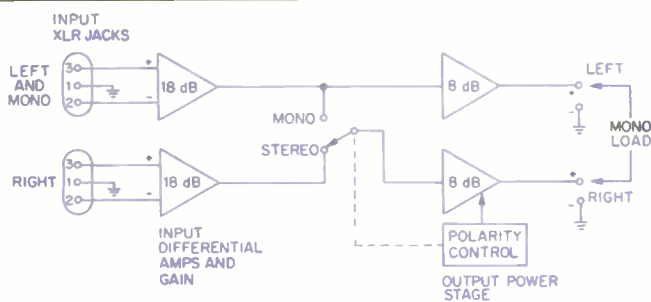

Fig. 3—Block diagram of the 500AE amplifier.

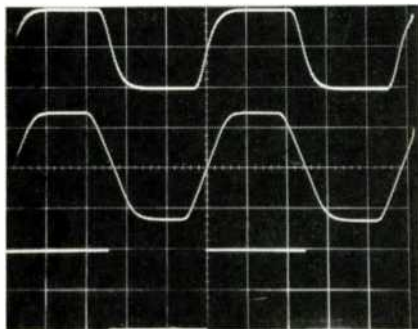

Fig. 4—Response to square waves through Ultimate preamp's output controller module for (top to bottom): 100 kHz at ± 5 V out, 100 kHz at ± 12.5 V, and 20 Hz at ± 5 V. Waveshapes were the same for IHF and instrument loads. (Scales: Vertical, 5 V/div. for 5-V curves, 10 V/div. for 12.5 V; horizontal, 2 μ S/div. for 100 kHz, 10 mS/div. for 20 Hz.)

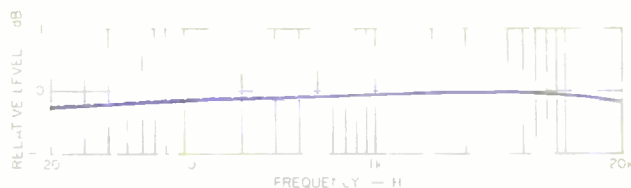

Fig. 5—RIAA equalization accuracy for left channel (solid curve) and right channel (dashed curve).

Complete preamplifier, which is of similar design but has only one stage of gain—"for those who want less," says the manufacturer.)

The second gain block has a proprietary method of changing the block's overall polarity from noninverting to inverting. Each channel has a switch to do this. If only one such switch is engaged, a red LED warns that the channels are in opposite polarity. If both switches are engaged, the absolute polarity of the input signal is inverted for both channels and a yellow LED indicator comes on.

A time-delay circuit in the output controller opens the normally closed contacts of the output muting relay a few seconds after power turn-on. Interestingly, instead of immediately muting after power turn-off, the circuit waits about the same time as the turn-on delay before muting.

As in the phono module, all of the circuits are d.c. coupled, and servo circuits are used for each gain block to keep d.c. offset low at the output of each block.

A block diagram of the 500AE power amplifier is shown in Fig. 3. The basic philosophy is to use the JE-990 type op-amp circuitry in two gain blocks per channel. One is a low-level front-end with a closed-loop gain of about 18 dB. The second block is another operational amplifier of similar topology but with higher power devices (obviously multiple power transistors) in the output stage; this block has a closed-loop gain of about 8 dB. Boulder feels that the use of multiple stages, each optimized for its particular use, yields an overall circuit of superior stability and ultra-low distortion, both static and dynamic. A servo circuit that controls overall d.c. offset maintains the low-frequency 3-dB down point at a very low 0.015 Hz, for outstandingly flat group delay from 20 Hz to 20 kHz.

As can be seen in Fig. 3, the input circuit is fully balanced. Unbalanced operation is possible by feeding either the positive or negative input, for noninverting and inverting polarity respectively, and ground. Boulder supplies an adaptor for this. It consists of a Tiffany female phono jack connected by a short piece of single-conductor shielded cable to a male XLR plug with gold-plated pins. The cable's shield is tied to pins 1 and 2 of this plug, corresponding to the amp's input ground and negative input, and the cable's hot conductor is tied to pin 3 (the amp's positive input). If one wants unbalanced operation with inverting polarity, the adaptor cable can be rewired so that the shield still goes to pin 1, but pin 1 is strapped to pin 3 and the hot conductor goes to pin 2.

When the mono/stereo switch is set to mono or bridged operation, the right output circuit is connected to the output of the left input circuit. Also, the polarity of the right output circuit is inverted in a manner similar to that used in the line controller's output stage.

A very sophisticated protection circuit in this amplifier creates an analog of the voltage across the output transistors and multiplies it by the current flowing in the load. This accurately assesses power dissipation in the output stage, regardless of the phase of the load current. The measured dissipation is weighted by measured heat-sink temperature and an analog of output-device chip temperature. Thus, a realistic assessment of output-stage capability is available to limit output when it really is needed.

*“If the PS•3 speakers were sold like magic elixirs, I would have bought a case!”**



Introducing the unique new PS•3 speaker system.

With every two-piece stereo speaker system you must resolve two quandaries: 1) where will it sound best, and 2) where will it fit? Often these are different and conflicting places in your listening room. Even worse, the best place for bass response is rarely ideal for stereo imaging.

“The PS•3 satellites sound smooth and natural.”

The new Design Acoustics PS•3 Micro-Monitor™ three-piece design offers a versatile answer to these dilemmas. Simply place the two tiny Point Source™ oak veneer satellites exactly where they create the best stereo image. Small and handsome, they fit almost anywhere without compromise.

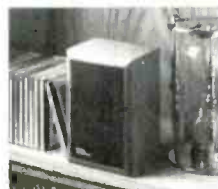

“The woofer continues the smooth work...”

Then locate the bass module wherever it creates the smoothest, deepest bass... even out of sight. Again, without sonic compromise. The result is far better imaging and wider, flatter response than you can hear from any comparable two-enclosure system. And the PS•3 looks and sounds great no matter the shape or size of your room.

“...you can tune the bass... without affecting the midrange or treble balance.”

The new PS•3 has many more advantages that make it the ideal system for your home. Don't choose any speaker system without first hearing and seeing the new PS•3. Visit a Design Acoustics dealer near you. Write for brochure and dealer list today.

*All quotes by noted audio critic Rich Warren, Chicago Tribune, May 12, 1989

**DA DESIGN®
ACOUSTICS**
An Audio-Technica Company
1225 Commerce Drive, Stow, OH 44224 • (216) 686-2600

The amp protection circuit monitors the output stage's true dissipation capacity, limiting power only when it really has to.

Table IA—Gain (in dB) for Boulder Ultimate preamp, with IHF and instrument loads, for high (MM) and low (MC) modes at low and high gain settings.

| | Left Channel | | Right Channel | |
|-------------------|--------------|-------------|---------------|-------------|
| | IHF Load | Instr. Load | IHF Load | Instr. Load |
| Phono to Tape Out | | | | |
| MM, Low Gain | 28.9 | 29.0 | 28.9 | 29.0 |
| MM, High Gain | 46.7 | 46.8 | 46.7 | 46.8 |
| MC, Low Gain | 49.4 | 49.5 | 49.5 | 49.5 |
| MC, High Gain | 67.1 | 67.2 | 67.2 | 67.3 |
| Phono to Main Out | | | | |
| MM, Low Gain | 37.6 | 37.6 | 37.6 | 37.6 |
| MM, High Gain | 55.4 | 55.4 | 55.4 | 55.4 |
| MC, Low Gain | 59.0 | 59.1 | 58.1 | 58.2 |
| MC, High Gain | 75.8 | 75.8 | 76.0 | 76.0 |
| AUX to Tape Out | 0 | 0 | 0 | 0 |
| AUX to Main Out | 8.6 | 8.6 | 8.6 | 8.6 |

Table IB—IHF sensitivity of Boulder Ultimate preamp (in mV) for high (MM) and low (MC) modes at low and high gain settings.

| | Left Channel | Right Channel |
|-------------------|--------------|---------------|
| Phono to Tape Out | | |
| MM, Low Gain | 17.9 | 17.9 |
| MM, High Gain | 2.29 | 2.29 |
| MC, Low Gain | 1.69 | 1.68 |
| MC, High Gain | 0.22 | 0.217 |
| Phono to Main Out | | |
| MM, Low Gain | 6.6 | 6.6 |
| MM, High Gain | 0.85 | 0.85 |
| MC, Low Gain | 0.62 | 0.615 |
| MC, High Gain | 0.081 | 0.079 |
| AUX to Tape Out | 500 | 500 |
| AUX to Main Out | 189 | 189 |

Table II—Noise of output controller module (in μV), referred to input, for 1-kilohm source impedance. The IHF signal-to-noise ratio was 107 dB for either channel.

| Bandwidth | Left Channel | Right Channel |
|------------------|--------------|---------------|
| Wideband | 3.3 | 3.2 |
| 20 Hz to 20 kHz | 1.65 | 1.62 |
| 400 Hz to 20 kHz | 1.25 | 1.2 |
| A-Weighted | 1.18 | 1.13 |

The power-supply setup in this amp is a little different than usual. One transformer winding feeds a full-wave bridge rectifier that is connected in turn to two sets of filter capacitors electrically in parallel but physically oriented toward the channel they supply. This way, the wires from the filter capacitors to their amplifier channels have the same length in each channel. There are four filter capacitors, each 36,000- μF , 75-V types.

On the p.c. boards next to the heat-sinks are eight 470- μF , 100-V capacitors that apparently bypass the supply lines at the site of every pair of same-polarity output transistors. Not only does this keep the local site of each output transistor well bypassed, it also adds about 4,000 μF more capacitance to the power supply.

To prevent excessive a.c. in-rush current when the amp is turned on, a 10-ohm power resistor is placed in series with the primary of the power transformer for several seconds, after which it is shorted out by relay contacts. The relay coil is fed from a half-wave rectifier that rectifies the power transformer's full secondary-winding voltage to produce about 120 V d.c. A 22- μF , 250-V filter capacitor smooths this supply to keep the relay from chattering. The delay in turning on the relay is the delay in charging the main filter capacitors with the 10-ohm resistor in the primary circuit. When the secondary is, in effect, "unshorted" by the charging up of the main filter capacitors, the relay's power-supply circuit comes up and turns the relay on. This is a clever idea for generating time delay for such a function, and it has been used in a number of other power amplifiers.

Preamp Measurements

Looking at the Ultimate preamp first, gain and sensitivity figures for the phono and output controller modules are presented in Table I. The gain values shown are for the controller module's unbalanced main output, and would be 6 dB higher if measured at its differential balanced output.

Concentrating on the output controller, its input resistance was found to be 200 kilohms, and its output resistance was 50 ohms. Rise- and fall-times at an output amplitude of ± 5 V were 1 μs for either my instrument load or the IHF load. Further, when the volume control was turned down 6 dB from maximum, which usually slows down most preamps, the rise- and fall-times stayed the same. With input amplitude increased so as to drive the output level up to ± 12.5 V, the exponential-edged waveshape that was exhibited at lower amplitudes became straight-sided, a sign that slewing was occurring. Specifically, it looks like a slew rate of about 20 V in 1.6 μs or about 12.5 V/ μs . Oscilloscope traces of square-wave performance that illustrate the preceding are shown in Fig. 4. The top trace is for 100 kHz at ± 5 V amplitude, the middle trace for 100 kHz at ± 12.5 V, and the bottom trace for 20 Hz at ± 5 V. The traces look the same for instrument or IHF loading. This line section can drive really tough loads!

Volume control tracking was checked and found to be within 0.5 dB down to -55 dB, worsening to 2.5 dB at -60 dB and to 3.6 dB at -65 dB, then becoming 0.3 dB with the control fully counterclockwise, at its maximum attenuation of 72 dB. There was excellent correlation between the scale on the front panel and the actual attenuation of the control.

Measuring interchannel crosstalk of the MS32 output controller without the selector switch connected was a surprise. Instead of the usual crosstalk pattern—very low at low frequencies and increasing as frequency goes up—this device exhibited a more or less constant -53 dB of crosstalk with frequency and was about the same in both directions. When the selector switch was hooked up ahead of the output controller, the behavior was essentially the same.

WE'RE ABOUT
TO TURN
THE AUDIO
INDUSTRY
ON ITS
EAR.



Introducing the
Sonic Enhancement
Series from Allsop.

Designed to insure
maximum sonic performance
from your audio components.

The CD Plus Protective
Stabilizer reduces disc vibration.
For greater laser reading
accuracy. And truer, clearer, more
natural sounding music.

The NAVCOM™ Audio Isolators
separate your components from
unwanted vibration. Purifying the
process of audio signals. For less
distortion, tighter bass and optimum
sound quality.

Find them wherever digital audio software
and hardware is sold.

ALLSOP 

1-800-426-4303

© 1989, 1990 Allsop Inc.

The capacitors that keep the output transistors bypassed also add to the capacitance of the 500AE's power supply. Clever.

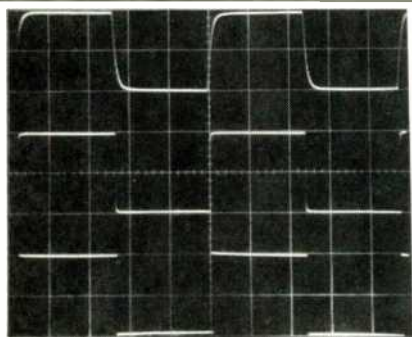

Fig. 6—Response through phono module to pre-equalized square waves for (top to bottom): 10 kHz, 1 kHz, and 40 Hz. (Scales: Vertical, 1 V/div.; horizontal, 20 μ S/div. for 10 kHz, 200 μ S/div. for 1 kHz, and 5 mS/div. for 40 Hz.)

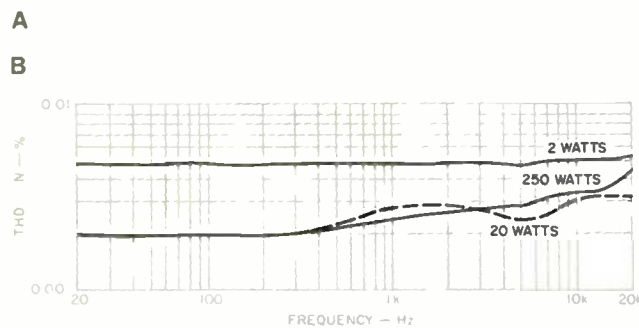
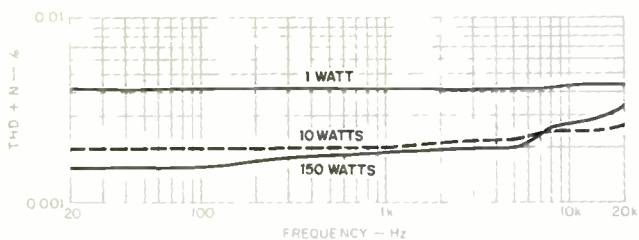

Fig. 7—Boulder 500AE amplifier's THD + N vs. frequency for 8-ohm loads (A) and 4-ohm (B), at various power levels.

With the output controller's volume set at -20 dB, crosstalk was about -51 dB and flat with frequency. Crosstalk was in phase. This flat crosstalk with frequency is something I haven't seen before; thus far, I have no explanation for the phenomenon.

Output noise for different bandwidths is presented in Table II. The excellent IHF signal-to-noise ratio comes about because of the two-stage topology of this unit. When the volume control is turned down to get unity gain in the line section—i.e., 500 mV out for 500 mV in—there is still 500 mV going into the first, highest gain section of the output controller. Consequently, the S/N of the input stage is terrific, and the overall S/N is degraded only a little by the noise added by the second gain block. In contrast, the usual line stage, a single gain block with about 20 dB of gain following the volume control, will have at least 20 dB less signal present at its input when the volume is turned down to the overall unity-gain point. As a result, its S/N is degraded by at least 20 dB—usually more, as the source impedance that the input stage actually sees is higher than the 1-kilohm line input terminating resistor used in the test.

Total harmonic distortion plus noise for the output controller was outstandingly low. Since it has only 8.6 dB of gain, the maximum 3 V output of my Soundtech distortion analyzer only drove the output controller to about 8 V rms. At this level and driving a 600-ohm load, THD + N was less than 0.01% from 20 Hz to 20 kHz.

A few miscellaneous comments before talking about the measurements of the phono section: The mute function on the output controller lowered the gain by about 21 dB. The a.c. line draw of the Ultimate preamp was about 0.44 ampere. Regulation of the power-supply output voltages held up until the a.c. line voltage was lowered to 90 V.

Turning now to the MS11 phono preamp, its measured gain and sensitivity figures are shown in Table I, as mentioned previously. Output impedance at the output of the MS11 itself was about 50 ohms. When going through the MS21 selector switch module, as one would when using the whole Ultimate setup, output resistance for phono at tape out was about 100 ohms, as there are 50-ohm buffering resistors in the selector switch module's tape out paths.

RIAA equalization error is plotted in Fig. 5. The data shown is for the high-level (MM) mode, set for maximum gain. However, the data looked the same for high-level mode with minimum gain and for low-level (MC) mode at either gain setting. Further, the equalization error curve looked essentially the same with instrument or IHF loading. It's nice to know that the phono equalization is going to be the same, regardless of mode, gain, or loading of the output. This is decidedly not the case with a number of other phono preamps!

Related to the frequency response error of the phono equalization is the accuracy of reproducing pre-equalized square waves. As can be seen in Fig. 6, waveform shape and amplitude were essentially the same with instrument or IHF loading. The equalization accuracy of the MS11 is outstanding.

When increasing the drive level to see how the circuit overloads, I found that it symmetrically compressed the high frequencies, starting at an output level of about twice that shown in Fig. 6. When the front-panel gain adjustment was turned down to minimum, the output level attainable for the same degree of compression reduced accordingly; this simply means the overload is taking place in the first gain block, where the bulk of the gain and equalization occurs.

We Spoil Audiophiles.

Magnavox CD Players

- CD8610 Player w/remote **199.95
- CD8683 CD Changer **279.95
- CD8630 Player w/digital out **329.95



AudioQuest CD FEET

- ### Energy-absorbing sorbothane
- CD Feet (4) 21.95
 - Large Feet (4) 34.95



Monster Sound Rings

- IMPROVE CD SOUND!**
- 12 Rings 14.95
 - 25 Rings 24.95
 - 50 Rings 49.95



VPI Brick

Reduces Vibration, Improves Sound. 39.95

Audioquest Moving Coil Phono Cartridge Demagnetizer



Only \$79.95
Batteries Included!

Stylus Cleaner

AQ Electronic Stylus Cleaner

Reg 39.95
SALE 19.95

DB Protrac Shure Gauge

Cartridge Alignment Gauge

..... 24.95

Stylus Force Gauge

Only 14.95

AUDIOPHILE HEADPHONES



- ### Beyer Dynamic
- BDT 990 Pro 229.95
 - BDT990 189.95
 - BDT880 149.95
 - BDT550 129.95
 - Rpicmt ear cushions 22.95
- ### STAX
- SR-34 Special 149.95
 - SR-34 Pro 179.95
 - SR-84 Pro 269.95
 - SRE-15N 5m extension cable 39.95
 - SRE-16 5m Pro cable 95.00
 - SRE-17 5m Sig cable 189.95
 - Rpicmt ear pads 34&84 19.95
- ### AKG
- K240DF 119.95
 - K240M 95.00
 - K141 79.95
 - K2 35.00

GRADO Cartridges

- ZTE-1 19.95
- Signature 8mz MC2 TLZ Call
- XTZ 89.95
- 8mz stylus 89.95
- MC2 stylus 135.00

TRT Wonder Solder

- ### SILVER SOLDER
- 1 lb. 34.95
 - 1 lb. 34.95

LAST Record Care

- #1 Power Cleaner 19.95
- #2 Preservative 19.95
- #3 Reg. Cleaner 14.95
- #4 Stylus Cleaner 12.95
- #5 Stylast 21.95



Monster X-Terminator

- pair 24.95
-

Niles Audio

- ### Speaker Switching Boxes
- Call
-

ASC Tube Traps

- TX6 Set \$724
-

SONEX JRs

- 2"x2"x2" SHEETS
4 colors
Box of (4) \$49.95
-

FM Antennas

- Terak Pi Special 49.95
Terak Pi 79.95
-

Sumiko Tweek

- Only 14.95
-

Minimum order: 2 LPs or CDs

Audiophile LPs/CDs

- ### Chevy NEW Jazz CDs
- J01 Johnny Frigo (cd) 14.98
 - J02 Clark Terry (cd) 14.98
 - J03 Phil Woods (cd) 14.98
 - J028 Caram. Rio After Dark (cd) 14.98
 - J029 Bontis. Nonstop to Brazil (cd) 14.98
 - CD32 Earl WK. Gerschwin (cd) 14.98
 - J033 David Chesky. Club de Sol (cd) 14.98
 - J034 Paquito D'Rivera. Teof Ticali (cd) 14.98
- ### Reference Recordings LPs or CDs
- Wilson Audio Center Stage (lp/cd) 15.98
 - Grace Cathedral Choir (lp/cd) 15.98
 - Beethoven/Escorial Sonatas (lp/cd) 15.98
 - S. Wonderful Jazz (lp/cd) 15.98
 - Debussy & Brahms Sonatas (lp/cd) 15.98
 - Winds of War and Peace (lp/cd) 15.98

- ### East Wind Jazz CDs
- LA Four Going Home (cd) 18.95
 - Pavane Four Line (cd) 18.95
 - Hank Jones. Hanky Panky (cd) 18.95
- ### Harmonia Mundi Recordings:
- HMC379 G. Panagua (lp) 12.95
 - HMC1050 La Folia Spagna (lp) 12.95
 - HMC7010 Handel Water Music (lp) 12.95
- ### Shelville Audio
- Shelville Audio Drums (lp/cd) 14.99
 - Moscow Singsons set (lp/cd) 39.95
 - Shelville Track Record (lp/cd) 14.99
- ### Proprios
- CantateDomino (cd/tp) 17.95
 - Jazz at Pawnshop (lps) 34.95 (cd) 16.95
 - Three Blind Mice Jazz (cd) 17.95
 - Atmosphere Blues Jazz (cd) 17.95
 - Opus 3 (lp) 16.95 (cd) 23.95

INTERCONNECT CABLES

Audi. Cards, Ditech, Audioquest, MIT, Monster, Vanderhal Call

Custom length interconnects Call

SPEAKER CABLES

As One. Cards, Audioquest, Monster, Tara Labs Space & Time Call

DELUXE POWERCORDS

- Cards "Non-resonant" powercord 89.95
 - Cards Powercord II 225.00
 - Ditech Powerbridge II 169.95
 - AudioQuest Red power cord, 8ft 95.00
 - Tara Labs AC Affinity power cord, 8ft 175.00
-

VIDEO CABLES

- Monster Video (1m) 19.95
 - Vanderhal Video (1m) 24.95
 - Audioquest Video "B" (1m) 34.95
 - Audioquest Video "Z" (1m) 69.95
 - (20 ft) 49.95
 - (2m) 30.95
 - (2m) 39.95
 - (2m) 89.95
-

Target Racks and Stands

RACKS

| # | Shivs | Ht. | Price |
|------|-------|-----|--------|
| TT2 | 2 | 20" | 149.00 |
| TT3 | 3 | 33" | 219.95 |
| PS3 | 3 | 33" | 275.00 |
| TT7 | 4 | 33" | 259.00 |
| TT5 | 5 | 33" | 275.00 |
| TT5T | 5 | 40" | 299.00 |

HS STANOS

Target HJ 149.95

- HJ20/2T 210.00
- HJ24/2T 235.00

POWER STRIPS

ISOBAR NOW IN 220V!

Clean up your power! Protection and better sound.

- Triplete "ISOBAR" Line Filters
- ISOBAR-4 220 4 outlet, 220/240v 79.95
- ISOBAR-6 6 outlet, 3-stage filtering 89.95
- ISOBAR-8 8 outlet, 4-stage filtering 99.95

Triplete Power Regulators

- LR-1200 220 4 outlet, 2 stage, 1200 watt output 120v 219.95
- LR-1200 220 4 outlet, 2 stage, 1200 watt output 120v 219.95
- LR-1800 6 outlet, 3 stage, for audio and video, 1800 watt output 299.00

Clean isn't clean until it's vacuum-cleaned.

NITTY GRITTY Record Cleaning Machines

- NG CD-1, CD cleaner 159.95
 - NG 1.5ft 399.95
 - NG 2.5ft 449.95
 - Mini-Pro 569.95
 - Hybrid 1 549.95
-

RECORD DOCTOR Vacuum-powered record-cleaning machine

The Record Doctor cleans records just like the expensive machines with liquid application and vacuum suck-up but costs only \$169.95! Made by Nitty Gritty USA. Comes with cleaning fluid and applicator brush. 220V-240V version for Europe and Asian countries, \$189.95

VPI Record Cleaning Machines

- VPI HW-16 5 369.95
 - VPI HW-16 5 220v 399.95
 - VPI HW-17 Call
 - VPI HW-17f fan model Call
 - VPI HW-16/17 suction tubes 49.95
-

Record Cleaning Solutions

- Tonalnet Em-7HX (16 oz) 14.95
 - Super Cleaner (32 oz) 16.95 (1 gal) 24.95
 - Nitty Gritty "First" Record Cleaner (6 oz) 14.95
 - (16 oz) 24.95
 - Nitty Gritty Purifier #2 (16 oz) 11.95
 - (1gal) 39.95
-

Specially Stands

- ARCIC Stands 399.95
 - B&M801M 175.00
 - ESL63 175.00
 - Old ESL 175.00
- ### Sound Anchors Stands
- Vandersteen IIc 249.95
 - MagIIIa 299.95
 - B&W801M 449.95
-



RAM Vacuum Tubes

- Last longer & sound better than original tubes. Complete sets.
- Audible M2 65.95
 - CJ PV2 85.00
 - CJ PV5 125.00
 - CJ Amps Call
 - CP SA3 or 7 65.00
 - CP SA-5 175.00
 - CP SA-12 75.00
 - CP SA-20 129.95
 - Dyna PAS 3K 55.00
 - NYAL Supert 45.95
 - NYAL Minut 59.95
 - ARC SP6 144.95
 - ARC SP9 15.00
 - Moscode 150/300 65.00
 - Moscode 600 149.95
 - Quaker Monos 269.95
 - ARC SP11 119.95
 - Tube Dampers 2.50

Target Wall Shelves

- TT-1 109.95
 - TT-1L 149.95
-

Lead Balloon

Turntable Stand

329.95

TIPTOES II

- Short 4.50
 - Medium (w/ screw) 7.50
 - Larger (w/screw) 14.95
-

Audiophile Books

- The VTL Tube Book Manley 12.95
 - Good Sound, Laura Dearborn 12.95
 - The Good CD Guide '89 17.95
 - The Wood Effect, RC Johnson 7.95
-

Shipping Charges

- Shipping Charges (UPS, Insured, 48 States) 4.95
 - Accessories: One Item 4.95
 - Extra Items 1.25
 - *Turntables/Stands 12.95
 - **Electronics 8.95
- Business Hours:
Mon-Fri 9:00-7:00 EST — Sat 10:00-3:00
Prices subject to change. Add 3% for Amex

CHARGE IT! 1-800-942-0220

Mastercard / Discover / Visa / Amex



225 Oakes SW, Grand Rapids, MI 49503 FAX 616-451-0709 Service 616-451-3668

The phono section's THD + N was less than 0.01% at 10 V out, from 20 Hz to 20 kHz. That's impressive.

Table III—Phono overload vs. frequency for high (MM) mode at high gain setting. Left and right channels were virtually identical, and there was negligible difference between results with instrument and IHF loads. For phono overload in low (MC) mode and at other settings, see text.

| Frequency, Hz | Input, mV | Output, V |
|---------------|-----------|-----------|
| 20 | 7.6 | 15.3 |
| 50 | 10.0 | 15.3 |
| 100 | 15.5 | 15.3 |
| 300 | 36.0 | 15.3 |
| 1k | 69.0 | 15.3 |
| 3k | 119.0 | 15.3 |
| 5k | 178.0 | 15.3 |
| 7k | 242.0 | 15.3 |
| 10k | 340.0 | 15.3 |
| 15k | 510.0 | 15.3 |
| 20k | 680.0 | 15.3 |

Table IV—Noise of phono section, referred to input, and IHF S/N ratios, vs. mode and source impedance. The high gain setting was used; in low gain settings, noise was about 10% higher in both MM and MC modes.

| Bandwidth | Source Impedance, Ohms | Referred Input Noise, μ V | |
|--------------------------|------------------------|-------------------------------|----------|
| | | Left | Right |
| MM Mode | | | |
| Wideband | 0 | 0.48 | 0.48 |
| 20 Hz to 20 kHz | 0 | 0.38 | 0.38 |
| 400 Hz to 20 kHz | 0 | 0.21 | 0.21 |
| A-Weighted | 0 | 0.22 | 0.22 |
| Wideband | 1k | 0.6 | 0.6 |
| 20 Hz to 20 kHz | 1k | 0.52 | 0.52 |
| 400 Hz to 20 kHz | 1k | 0.29 | 0.29 |
| A-Weighted | 1k | 0.3 | 0.3 |
| A-Weighted | IHF MM | 1.1 | 1.0 |
| MC Mode | | | |
| Wideband | 0 | 0.2-0.25 | 0.2-0.25 |
| 20 Hz to 20 kHz | 0 | 0.16 | 0.18 |
| 400 Hz to 20 kHz | 0 | 0.065 | 0.068 |
| A-Weighted | 0 | 0.069 | 0.074 |
| Wideband | 100 | 0.25-0.3 | 0.25-0.3 |
| 20 Hz to 20 kHz | 100 | 0.18 | 0.18 |
| 400 Hz to 20 kHz | 100 | 0.078 | 0.082 |
| A-Weighted | 100 | 0.082 | 0.085 |
| IHF S/N Ratio, dB | | | |
| MM Mode | 1k | 84.4 | 84.4 |
| MM Mode | IHF MM | 73.2 | 74.0 |
| MC Mode | 100 | 75.7 | 75.4 |

Phono overload as a function of frequency is depicted in Table III. Data shown is for high (MM) level and maximum gain. This circuit behaves ideally, in that its output overload point is absolutely constant with frequency; the input acceptance is a perfect mirror of the RIAA curve. Results with instrument or IHF loading were about the same. Rather than

show all the data for the three other mode and gain combinations in Table III, the well-behaved properties of this unit permit me to mention here just the 1-kHz input overload levels for these other mode and gain conditions. (The input voltages for output overload at other frequencies track the inverse RIAA curve virtually perfectly.) With the gain reduced to minimum in the high-level mode, input acceptance at 1 kHz was a whopping 535 mV. With the unit in the low-level mode, the input acceptance for high and low gains was 6.5 and 69 mV, respectively. What is not obvious is that the input acceptance is entirely related to the relative gain of the various mode and gain combinations.

Harmonic distortion plus noise with a 600-ohm load in the high-level, high-gain mode was less than 0.01% at 10 V output from 20 Hz to 20 kHz. Impressive.

Referred input noise for the phono module is shown in Table IV for a variety of conditions. The difference in the MM and MC noise figures for the gain blocks' two modes of operation is very apparent in the measurements. (Recall that the phono equalizer first-stage gain block uses the JE-990 op-amp in the normal form, whereas the MC block uses a modified form of the JE-990 for lower noise with low source impedances.) All noise levels are satisfactorily low, although not state-of-the-art low.

The phono module's interchannel crosstalk versus frequency was checked for different modes, gain settings, and source impedances. The lowest crosstalk numbers were obtained in the MM high-gain mode, with a 0-ohm terminating resistor for the undriven measured channel. Crosstalk was asymmetrical, being lower in the right-to-left direction. With a more realistic 1-kilohm terminating resistance, crosstalk in the worse direction (left to right) was better than -90 dB from 20 to 300 Hz, decreasing to -80 dB at 1 kHz, to -63 dB at 5 kHz, and to -52.5 dB at 20 kHz. Using the dummy IHF MM source, crosstalk maxed out at -35 dB at 10 kHz in the left-to-right direction. Reducing gain in the high-level mode equalized the difference between crosstalk directions, and it reduced crosstalk in either direction by about 8 dB from the figures quoted above. In the low-level mode, crosstalk was again better in the right-to-left direction, and with a 100-ohm terminating resistor, in general it was about the same as in the high-level mode. All crosstalk in the phono module was in phase.

Amp Measurements

The 500AE power amplifier was run at one-third rated power, or 50 watts per channel into 8-ohm loads, for one hour. As usual, the heat-sinks got very hot, but otherwise the hour passed without mishap.

I used two Boulder phono-to-XLR adaptors to connect to the signal inputs, and voltage gain in the unbalanced mode was 20.4 x, or 26.2 dB, for both channels. (This adaptor is wired to feed the unbalanced hot signal to pin 3, which is the noninverting input.) Sensitivity for 1 watt output was 140 mV. Voltage gain in the balanced mode was the same as in the unbalanced mode, provided the same magnitude of input signal was applied between the positive and negative inputs.

Total harmonic distortion plus noise is shown in Fig. 7 as a function of power output, frequency, and load. The right

ZAPCHORD

From **MIT**

The Fruit Doesn't Fall Far From The Tree

After nearly a decade of groundbreaking research and development, Music Interface Technologies now has neutral, noise-free audio cable that is easy for the picking.

Within reach of any audio budget, MIT's new ZAPchord Speaker Cable and Interconnect "ZAP" the noise and leave the music with special "ZAPline" networks and patented termination techniques. Because ZAPchord cables remove the noise, audio components sound more powerful, dynamic, defined, and detailed than ever before.

Unlock the vibrancy of the music on your favorite records, tapes, and CDs with ZAPchord from Music Interface Technologies.

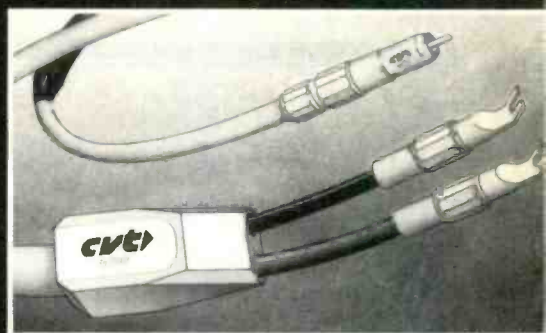

Constant Velocity Transmission™ Series • Selected from the top of the tree, CVT™ is MIT's "cost-no-object" and newest technology. The CVT Coupler™ in every cable is calibrated to eliminate delay distortion and phase noise.

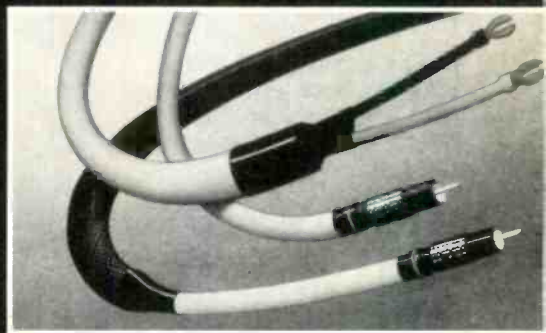

MIT and Shotgun Series • Plucked from the upper branches, these established MIT cable products are the audio industry's standard for neutrality, clarity, and precise focus because of their minimal delay distortion and phase noise.

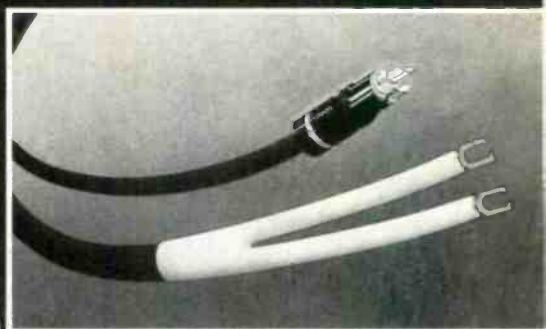

PC Squared • Ripe and ready to improve your system. MIT's new mid-priced line uses UNIFIELD™ and VARIFLEX™ construction, our patented computer modeled techniques that insure total neutrality and phase correctness.

HOME AUDITION PLAN
Visit Your Authorized MIT Dealer

Music Interface Technologies **MIT**

Distributed by Transparent Audio Marketing · Rt 202, Box 117 · Hollis, ME 04042 · (207) 929-4553
Enter No. 23 on Reader Service Card

I don't recall ever testing an amp whose distortion was as low as that exhibited by the Boulder 500AE.

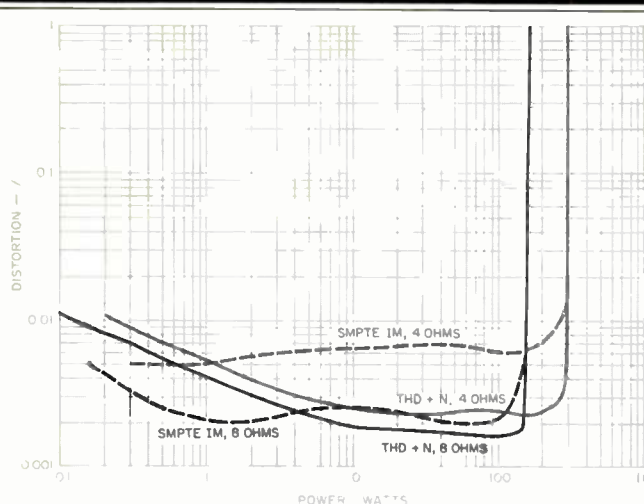

Fig. 8—SMPTE IM and THD + N vs. power for 8- and 4-ohm loads. THD + N is for 1-kHz test signal.

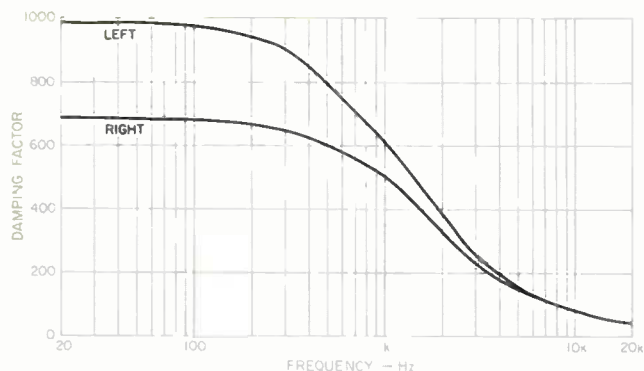

Fig. 9—Damping factor vs. frequency.

Table V—Boulder 500AE output noise (in μV), and IHF signal-to-noise ratio (in dB), with inputs terminated by 1 kilohm. Data is shown for signal grounds separated and tied together; see text.

| Bandwidth | Left | | Right | |
|------------------|----------|------|----------|------|
| | Separate | Tied | Separate | Tied |
| Wideband | 118 | 120 | 153 | 143 |
| 20 Hz to 20 kHz | 47.5 | 53 | 80 | 63 |
| 400 Hz to 20 kHz | 46 | 48 | 64 | 54 |
| A-Weighted | 43 | 45 | 62 | 51 |
| IHF S/N | 96.4 | 96.0 | 93.4 | 94.5 |

channel was slightly higher in distortion, and its results are plotted in the Figure. One thing quickly apparent in this data is the very low amount of distortion this amplifier exhibits; I don't recall ever testing a power amp that measured this low in distortion. Also of note is that the distortion does not rise very much in the high frequencies compared to its levels in the low and middle frequencies. To measure 0.005% or less at full power at 20 kHz into 4 ohms is not my everyday experience here at BHK Labs.

Figure 8 shows THD + N at 1 kHz and SMPTE-IM distortion as functions of power output and load. When this amp is driven into clipping, the positive half-cycle clips first; symmetrical clipping is technically more desirable.

Output noise, with inputs terminated by 1 kilohm, is shown in Table V for various bandwidths and with and without the input signal grounds tied together. Sometimes it makes a difference. In this case, when the grounds were tied together, which is what would happen when the 500AE is connected to a preamp, the output noise of the two channels became more nearly the same. The differences lie in the amount of line hum and its harmonics in each channel's output rather than in differences in random noise.

Interchannel crosstalk, like output noise, was found to be dependent on whether or not the input grounds were tied together. Crosstalk in this amp, as in most others, is also load-dependent; when the load is disconnected, crosstalk reduces dramatically. With the input grounds tied and the outputs loaded by 8 ohms, the worst (right-to-left) direction was better than -90 dB at frequencies up to 300 Hz, decreasing to -88 dB at 1 kHz, -76 dB at 5 kHz, and staying at about 75 dB up to 50 kHz. This property of the crosstalk levelling off above a certain frequency is unusual in my experience.

Damping factor as a function of frequency is shown in Fig. 9 for both channels of the 500AE. Damping factor at low frequencies is very high but is reduced at high frequencies, as is usual in amp designs that use an output RL buffering network.

Small-signal frequency response was flat from 10 Hz to above 20 kHz and was down 1.3 and 1.6 dB with 8- and 4-ohm loads at 100 kHz. Rise- and fall-times at ± 5 V were 1.8 μs with 8-ohm loads. Behavior was similar up to about ± 20 or ± 25 V, above which slewing started to set in, first for the negative-going direction and then for the positive-going direction. Approximate slew rates were then -30 V/ μs and $+40$ V/ μs . Oscilloscope traces of square-wave responses can be seen in Fig. 10. The top trace is for 10 kHz into 8 ohms; in the middle trace, 2 μF has been paralleled across the 8 ohms, and the bottom trace is for 40 Hz into 8 ohms.

Common-mode rejection was checked for both channels. The method used was to drive the amp to a reference 10 V output in the unbalanced input mode. A special connection to the XLR input jacks was then made, tying pins 2 and 3 together for signal high and with pin 1 signal low as usual. This drives both the positive and negative inputs with the same signal. If the common-mode rejection of the input gain block were perfect, no output from the amplifier would result. Output was measured as a function of frequency, referenced to the aforementioned 10 V. In the left channel, which was slightly the worse, common-mode rejection was

EXPLORE NEW MUSICAL TERRAIN.

Most people tire quickly of flat-sounding, one-dimensional music. But then, that's all most "stereos" have to offer.

And that's a shame. Because great sound offers immense diversity. You should get lost in it. Explore its natural beauty. Be awed by its power. And surprised by its exquisite detail.

Which is just what the Counterpoint SA-11 audio control center will do for you. It's a dual/mono, line-level-only amplifier with full wireless remote control of the listening parameters.

With a "price is no object" approach, the SA-11 stands alone in combining the convenience of mainstream audio components with the sonic benefits of tube technology.



Every Counterpoint separate, from our \$835 SA-1000 Preamp to our ultimate SA-11 offers consummate musicality. Call 800-266-9090 to find the Counterpoint dealer nearest you. Then go in and listen. We promise you a musical journey through entirely new terrain.



SA-11 with remote

COUNTERPOINT

Nothing Between the Music and You

2610 Commerce Drive, Vista, CA 92083

Enter No. 11 on Reader Service Card

With my new MC cartridge, the sound of the Boulder gear was superior to my reference setup in openness, space, air, and resolution.

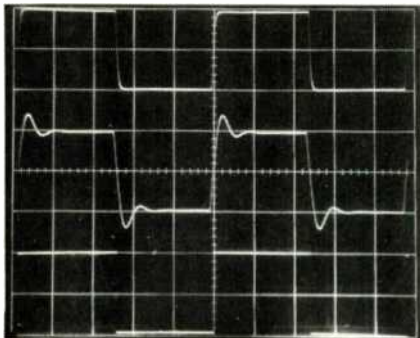

Fig. 10—Amplifier square-wave response. Top trace is 10 kHz with 8-ohm load; middle trace is 10 kHz with 2- μ F capacitance across the 8-ohm load; bottom trace is 40 Hz into 8 ohms. (Scales: Vertical, 5 V/div.; horizontal, 20 μ S/div. for 10 kHz, 5 mS/div. for 40 Hz.)

better than 90 dB from 20 to 100 Hz, worsening to 83 dB at 1 kHz, 69 dB at 5 kHz, and 57 dB at 20 kHz.

Finally, dynamic and clipping headroom were assessed. Results for dynamic headroom were 1 dB at 189 watts into 8 ohms and 1.6 dB at 364 watts into 4 ohms. Clipping headroom was 0.54 dB at 170 watts into 8 ohms and 1.1 dB at 320 watts into 4 ohms. Peak current into a 1-ohm load, with one channel driven and using the same tone-burst signal as in the tests for dynamic headroom, yielded an impressive ± 48 amperes.

Use and Listening Tests

Ancillary equipment used in evaluating the Boulder 500AE amp and Ultimate preamp included an Oracle turntable fitted with a Well Tempered arm and Koetsu Black Goldline cartridge (replaced later in the tests with a Spectral Audio MCR Select), a Nakamichi 250 cassette deck, a Technics 1500 open-reel recorder, a California Audio Labs Tempest CD player, a Vendetta Research SCP-2A preamp, and a Cook-King tube phono preamp. Power amplifiers on hand for comparison included a pair of 100-watt mono tube units from EAR and a Sonographe SA120. Listening was done through Siefert Research Magnum III speakers.

I have to be honest and state from the outset that I had a predisposition that these Boulder components might not sound as good as other leading solid-state gear because of all the devices in their signal paths—i.e., those multiple gain blocks in every major functional block.

Listening evaluations were made in a number of sessions spread out over a number of weeks in quite a lot of different ways. First, the phono module alone was listened to through my Cook-King tube phono preamp's selector switch and stepped output attenuators—my usual reference signal path. The Vendetta Research pre-preamp was also listened to in this way. Under these conditions, the Boulder MS11 phono module was set for MC gain to obtain enough listen-

ing level. Although I felt the Vendetta Research produced the better sound in terms of resolution, space, air, and detail, the MS11 gave a very good account of itself, producing a softer sound that was quite listenable and enjoyable.

Next, I listened to the combination of the selector switch and output controller, using CDs and other high-level sources. The sound, primarily using familiar CDs, was a bit brighter than my reference setup's. This is most likely because of the Boulder's low output impedance driving the long interconnect cables I use, compared to the higher driving impedance in the reference path. Other preamp line sections have driven this line without necessarily sounding brighter, though. I then fed the output from my CD player into my reference system's attenuator in two alternate ways, first through Boulder's MS21 selector and MS32 output controller set at unity gain, and then directly into another of my attenuator's high-level inputs. This allowed me to compare the sound of the inserted devices with the direct feed from the source. With my reference controller's attenuators at the settings I normally use when listening to CDs and using my standard cables between this reference controller and the amps, the reference system with the Boulders sounded much more like the reference system alone. However, I still preferred my normal path, not going through the MS21/MS32. I used EAR 519 tube amps in this test.

Now we come to the subject of the 500AE power amplifier. Boulder had also sent one of their Model 500 amps, which I had for a considerable while before the 500AE and Ultimate units arrived. I had listened a number of times to the 500 and found it somewhat disappointing. Upon the arrival of the 500AE, I set about to decide if the two amps sounded the same. Much to my delight, the 500AE sounded noticeably more open and alive.

I then started listening to the entire Boulder equipment chain with LP and CD sources. I listened for several days to this gear and found myself saying that it sounded pretty good—not as good as my reference, but quite listenable and musical. I was able to get into the music. I installed my new Spectral Audio MCR Select moving-coil cartridge, got it roughly tweaked in, began to listen, and experienced quite a shock of realization. The sound of my system using this new cartridge through the Boulder gear was so superior in terms of openness, space, air, and resolution that I haven't gotten around to listening to my other reference equipment yet! I preferred the sound of the system using the phono module in MM mode even though the S/N ratio was obviously better in MC mode. I briefly tried a pair of Boulder's CB-35 balanced interconnects, which are 35 feet long and allow balanced operation between the preamp and power amp inputs. Sonically, I didn't think this sounded any better and actually preferred unbalanced operation with the interconnect cable I had been using.

No particular operational glitches were found in using the gear, with one exception: The low-cut filter in the phono module would produce a mild surge in the woofers if it was engaged when system gain was up. The Penny and Giles volume control was a constant pleasure to turn and use. I enjoyed experiencing the Boulder gear and would recommend prospective purchasers give it a serious listen.

Bascom H. King



Only Sony could add this principle to a portable CD player.

Introducing the first CD player with Digital Signal Processing.

The next movement of the digital audio revolution is upon us. It's called Digital Signal Processing (DSP). Simply put, DSP is the biggest breakthrough since the digital Compact Disc itself. So who else but Sony, the inventor of the Compact Disc, could bring it to you first. In the new D-555 Discman® portable CD player.

DSP is such an important step forward because it allows you to digitally enhance CD sound reproduction by utilizing several different functions, without adding undesirable noise, distortion or phase shift.

Just contemplate the possibilities. Add digital bass boost below 80 Hz, for optimizing headphone bass

response. Adjust digital dynamic range compression, for listening to CD's in the high ambient noise environment of the car. There's also digital surround and digital graphic equalization at five frequency positions.

The D-555 is also accompanied by an 8X oversampling filter with noise shaping, plus dual D/A converters, for the finest music reproduction available from a portable CD player today.

And for the finale, the D-555 even features an optical output port, for direct interface with other digital components of the future.

The Sony D-555 Discman. It's the only digital CD player that lets you fine tune your music...digitally.



SONY

THE LEADER IN DIGITAL AUDIO™

2

MITSUBISHI M-AV1 AUDIO/VIDEO RECEIVER

Manufacturer's Specifications

FM Tuner Section

Usable Sensitivity: Mono, 10.8 dBf.

50-dB Quieting Sensitivity: Mono, 16.2 dBf; stereo, 37.2 dBf; blend, 33.2 dBf.

Frequency Response: 30 Hz to 15 kHz, ± 1.0 dB.

S/N: Mono, 80 dB; stereo, 75 dB; blend, 77 dB.

THD: Mono, 0.06%; stereo, 0.2%; blend, 0.15%.

Selectivity: 60 dB.

AM Rejection: 50 dB.

Capture Ratio: 1.0 dB.

Image Rejection: 50 dB.

I.f. Rejection: 80 dB.

Spurious-Response Rejection: 70 dB.

Separation: 50 dB at 1 kHz, 40 dB at 10 kHz.

AM Tuner Section

Usable Sensitivity: 300 μ V/m.

Selectivity: 35 dB.

S/N: 50 dB.

Image Rejection: 30 dB.

I.f. Rejection: 40 dB.

THD: 0.8%.

Amplifier Section

Power Output: Front channels, 125 watts per channel, 8 ohms, 20 Hz to 20 kHz; rear channels, 25 watts per channel, 8 ohms, 50 Hz to 10 kHz.

THD: Front channels, 0.05%; rear channels, 0.5%.

Frequency Response: Phono, 20 Hz to 20 kHz, ± 0.5 dB; high level, 20 Hz to 20 kHz, ± 0.3 dB.

Input Sensitivity: Phono, 2.5 mV; high level, 150 mV.

S/N: Phono, 72 dB; high level, 95 dB.

Tone Control Range: Bass, ± 10 dB at 100 Hz; treble, ± 10 dB at 10 kHz.

Subsonic Filter: 18 Hz, -6 dB per octave.

High-Cut Filter: 7 kHz, -6 dB per octave.

Video Section

Input Sensitivity and Output Level: 1 V peak to peak, 75 ohms, unbalanced.

Frequency Response: 5 Hz to 6 MHz, $+0$, -3.0 dB.

General Specifications

Power Requirements: 120 V a.c., 60 Hz, 250 watts.

Dimensions: 16 $\frac{1}{4}$ in. W \times 6 $\frac{1}{4}$ in. H \times 15 $\frac{1}{2}$ in. D (42.5 cm \times 15.8 cm \times 39.3 cm).

Weight: 26 $\frac{1}{2}$ lbs. (12 kg).

Price: \$999, including remote control.

Company Address: 5757 Plaza Dr., Cypress, Cal. 90630.

For literature, circle No. 91



In one of their four-color brochures, Mitsubishi states, "A concept as big as Home Theater called for a new look at the heart of the system." They must have meant it, because their top-of-the-line M-AV1 audio/video receiver looks like no other stereo receiver (whether A/V or just plain "A") I have ever seen. The color is a pleasant charcoal gray, as opposed to the monotonous black that has dominated the scene for some years now. Instead of controls cluttering the front panel, a multi-colored display tells you just about everything you want to know about the status of your system. And, of course, there's a dedicated remote that can handle other Mitsubishi audio and video components connected to this receiver. The M-AV1 has four stereo A/V inputs as well as two switchable S-video Y/C connectors and a video monitor output. So in terms of flexibility and switching characteristics, the M-AV1 certainly merits being called an audio/video receiver. Indeed, when I unpacked this unit, my first reaction was to praise Mitsubishi for having come up with a truly well-designed, easy-to-use receiver which could serve as the master control for even the most elaborate home A/V setup. After all, in addition to its input flexibility, it incorporates an extra pair of rear-channel amplifiers and a choice of true Dolby Surround decoding or the simpler matrix surround decoding that will work, more or less, even with nonencoded A/V program material.

Reading the published specifications, you might conclude, as I did, that the M-AV1 is the closest thing to a "perfect" A/V receiver—all this and on-screen menus, not to mention a truly well-thought-out, dedicated remote control. My enthusiasm remained high; I even thought of purchasing an M-AV1 for my "to be constructed" home theater in the cellar. The bubble burst when I measured the performance of this receiver in my lab, but we'll get to that presently.

In a technical paper supplied with my sample, Mitsubishi detailed some of the circuit approaches that went into this unit and several of their lower powered receivers. The set employs a dynamic companding circuit as part of its Dolby Surround delay, so as to maintain wide dynamic range for the rear channels. (They claim 95 dB using this approach, but I wonder how a 25-watt amplifier—the power rating of the M-AV1's rear channels—can take advantage of so much dynamic range.)

An elaborate network employing C-MOS ICs is used in the video switching circuitry in order to maintain full amplitude

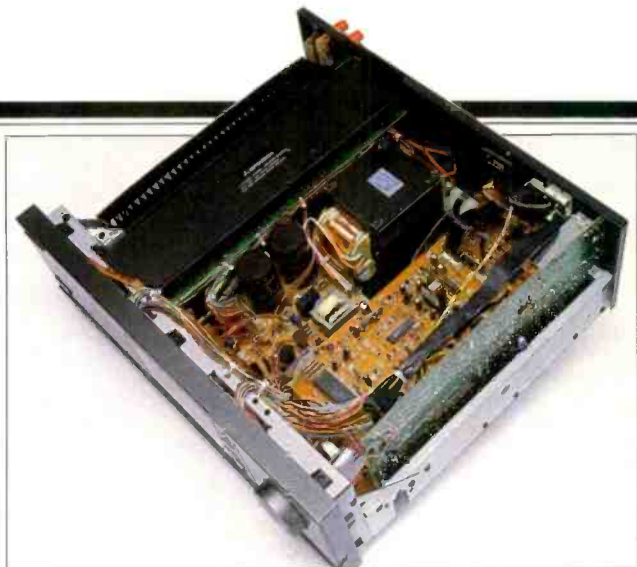
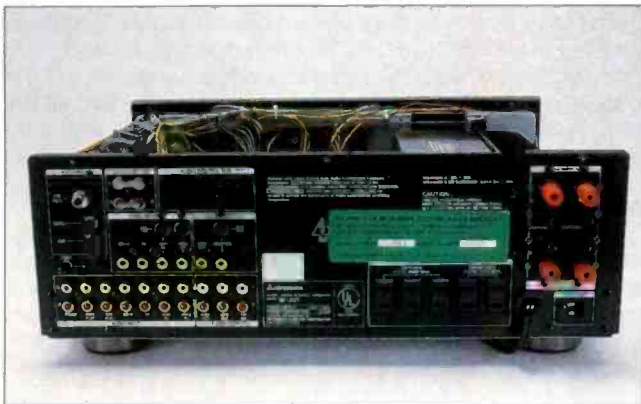

(and hence full brightness) of video signals as they go through the receiver. The preamp section uses a low-noise dual J-FET. A new IC developed specifically for audio equalization is used in the tone control circuitry. Output stages of the amplifier employ discrete components rather than ICs. The power amplifier uses a dual feedback loop; the main loop offers the merits of d.c. amplification, while the secondary servo circuit filters out d.c. or near-d.c. signals using a capacitor in the feedback loop.

Thermal sensors monitor output transistor temperature and adjust bias voltage. Speaker terminals are relay-protected and internally fused.

Control Layout

With the front panel's lower hinged flap closed, only a few controls are visible. A "Power" on/off switch is at the panel's extreme left, and a large calibrated "Volume" control is at the extreme right. To the right of the center display are a pair of "Scan" buttons to scan station presets, a pair of "Input" selector buttons to sequentially scroll through the available inputs (AM/FM, tape, DAT, two VCRs, TV, CD Video, and phono), and a "Push Open" button to release the hinged panel. Depressing this last button gently lowers the hinged flap, disclosing additional controls: A stereo phone jack, an "A" or "A + B" speaker selector switch, a rotary control to alter the angle of the LCD display for best viewing, "Audio" and "Video" record selector buttons to choose taping sources, and a pair of buttons that cycle through available audio functions (FM mode, surround, surround volume, bass, treble, tone defeat, loudness compensation, subsonic filter, high-cut filter, and record monitor). As each of the audio functions appears in the display, a pair of buttons can be used for adjusting these functions or, in the case of loudness compensation and filters, turning them on or off. "Up" and "Down" tuning buttons, a "Preset Memory" button, a rotary "Balance" control, and a "Surround/Input Balance" control for the rear channels complete the complement of controls behind the hinged panel.

The front-panel display shows which input has been selected, what FM or AM frequency has been tuned, the selected audio function and its status, stereo station reception, center tuning, muting status, amplifier clipping, and, when activated, Dolby Surround.

My first reaction was to praise Mitsubishi for the M-AV1's ergonomics, clean appearance, and flexibility.

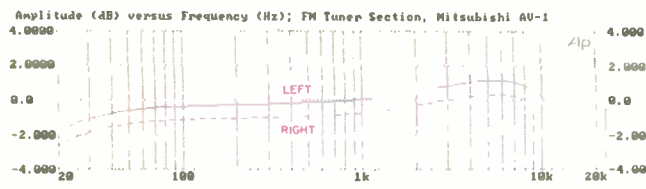

Fig. 1—FM tuner frequency response; right channel has been offset for clarity.

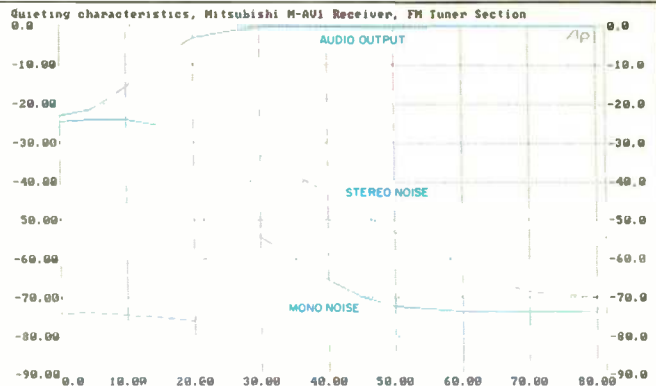

Fig. 2—FM quieting characteristics.

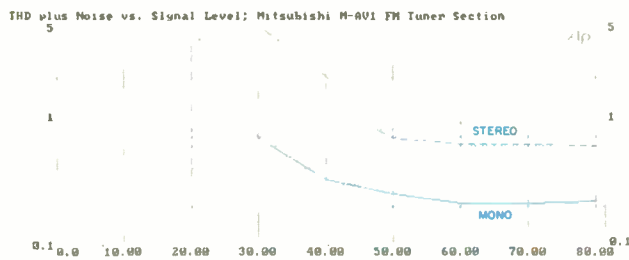

Fig. 3—THD + N vs. FM signal level.

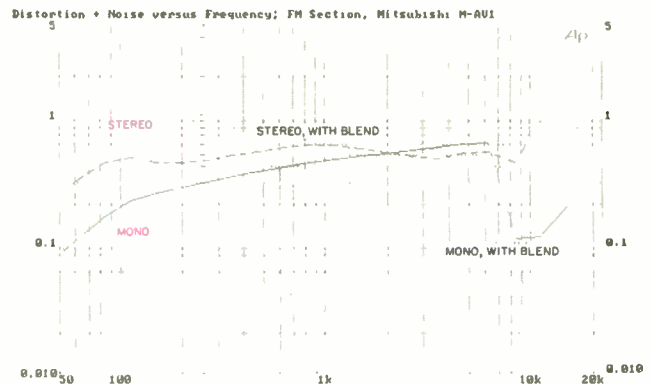

Fig. 4—FM THD + N vs. frequency, with and without high blend.

The rear panel is equipped with seven pairs of audio input jacks, four coaxial video input jacks and two S-type (or Y/C) video connectors, two coaxial video output jacks and an S-connector output, and three pairs of audio output jacks. A 75-ohm F-type antenna connector and a pair of 300-ohm antenna terminals are provided, along with terminals for connecting a supplied AM loop antenna or an external AM antenna. A chassis ground terminal is located near the phono input jacks. A signal processor can be connected by removing two wire jumpers that normally interconnect the preamp and power amp sections of this receiver. A multi-conductor connector on the rear panel is identified as an "Audio Control Bus." When hooking up other Mitsubishi audio components—such as a tape deck, CD player, or turntable—ribbon cables supplied with these units or with the M-AV1 receiver can be connected between components so that the integrated remote control supplied with the M-AV1 will operate the entire setup.

Five convenience a.c. outlets are also on the receiver's rear panel, three switched and two unswitched. Color-coded speaker binding posts are spaced to accept standard

double-banana plugs. Two sets of speakers can be connected and operated in stereo or, if an adjacent switch is set to the "Surround" sound mode and matrix or Dolby Surround is selected via the front panel's audio mode buttons, surround sound can be enjoyed using four properly positioned speakers.

The remote control duplicates major front-panel functions and has a sliding cover which, when opened, allows you to control other Mitsubishi audio and video components. The remote has its own display which illuminates to indicate the remote mode selected. There's even a switch for back-lighting the remote's display at night!

Measurements

I measured the M-AV1's FM tuner performance first. Figure 1 shows overall frequency response of the FM tuner, measured across the amplifier output loads, with the tone controls defeated. Response was flat to within ± 1 dB from 30 Hz to 15 kHz, the audio frequency limits of FM broadcasting. So far, so good! Then the problems began. Figure 2 is a plot of the FM quieting characteristics. It took 27 dB of

33,868,800
times per second.
That's
new
technology.

The most remarkable breakthrough in digital technology since the introduction of compact disc players. That's 3D Bit Stream. Exclusively from Harman Kardon.

3D Bit Stream turns digital data into musical experience at 33,868,800 times per second. (100 times faster than conventional CD players.)



The 3D Bit Stream CD players offer unsurpassed linearity, low-level accuracy, and freedom from phase irregularities. Or, quite simply, 3D Bit Stream lets the music flow.



* Registered trademark of Dolby Laboratories

A more
musical
experience.
That's
Harman Kardon.

From the delicate sound of a classical Spanish guitar to the driving rhythm of a bass, 3D Bit Stream captures all the dynamics, dimension, and drama of a live performance.

Harman Kardon has a history of firsts: from the world's first high fidelity receiver. The first cassette deck to incorporate Dolby*. The introduction of the active tracking tuner. And now, bit stream technology *with* totally discrete analog circuitry in compact disc players. That's Harman Kardon. Pioneering technology for people who love music.

Take your favorite CD to your Harman Kardon dealer. Listen. And experience the music as you never have before.

Also ask for a detailed explanation of 3D Bit Stream, or write: Harman Kardon, Engineering Dept., 240 Crossways Park West, Woodbury, NY 11797.

harman/kardon

H A Harman International Company

The use of a compander in the Dolby Surround circuit and a new tone control IC are some of this receiver's technical innovations.

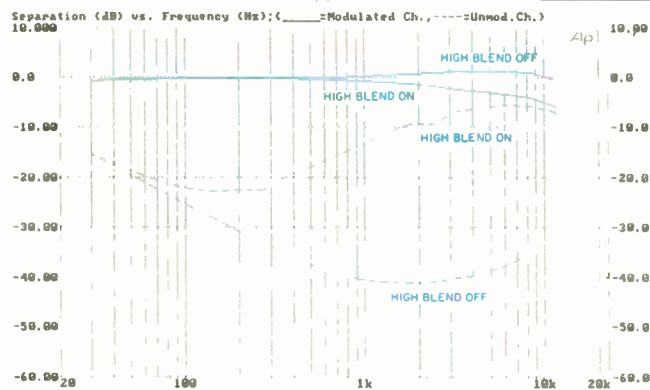

Fig. 5—FM frequency response (top curves) and separation, with and without high blend.

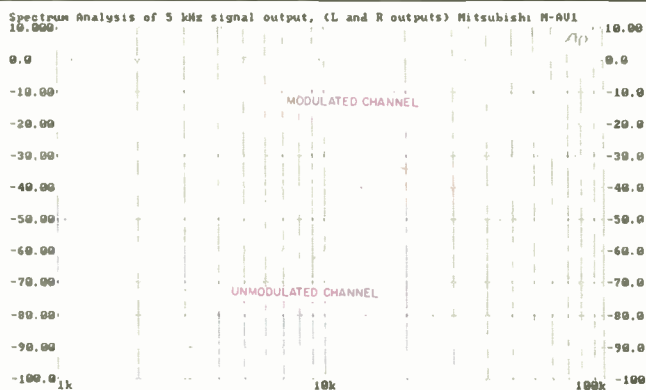

Fig. 6—Separation and crosstalk components for a 5-kHz modulating signal; see text.

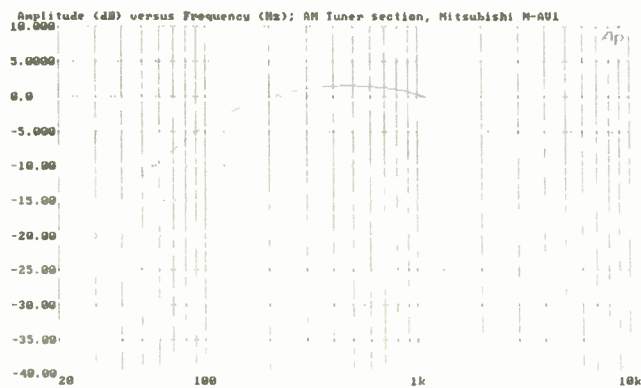

Fig. 7—AM frequency response.

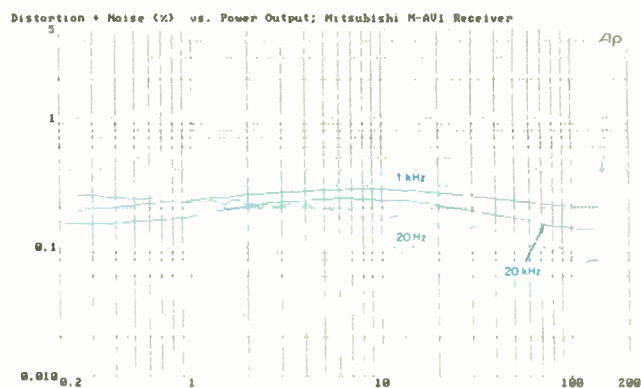

Fig. 8—THD + N vs. power output per channel, for front channels into 8-ohm loads.

input signal to produce a quieting of 50 dB in mono and 46 dB for the same level of quieting in stereo. Obviously, the tuner was either not optimally aligned or had become misaligned in shipment. What is probably *not* a function of alignment, however, is the ultimate S/N capability of the tuner section. In mono, it reached only 73 dB, as against 80 dB claimed. In stereo, maximum S/N was 70 dB at 80 dBf and 67 dB at the EIA test level of 65 dBf, as against 75 dB claimed.

I plotted THD + N versus signal level for mono and stereo operation of the FM tuner. Mitsubishi claims a THD level of 0.06% in mono, but the best I could get was slightly more than 0.2%. In stereo, lowest THD + N for strong signals was 0.6%, as opposed to 0.2% claimed (Fig. 3). The two sets of curves in Fig. 4 are rather similar and represent plots of THD + N versus audio modulating frequency for strong input signals. One set was plotted without "Hi Blend" in the circuit; the other was plotted with "Hi Blend" turned on. While slight detuning may have occurred between the plot-

ting of Figs. 3 and 4, the results are substantially the same. At low frequencies, mono THD + N came closer to Mitsubishi's claim, measuring 0.07% without blend (0.08% with blend) at 50 Hz. However, at 6 kHz, both mono and stereo THD + N were running between 0.7% and 0.8% without blend (slightly lower with blend). At this point, I was convinced something was definitely wrong. One of the things I discovered is that this receiver puts out a tremendous amount of residual 19-kHz signal when in the stereo mode. This would be perceived by my Audio Precision System One test equipment as "noise" in the THD + N measurement and would result in a much higher figure than would be obtained if I were measuring purely harmonic distortion with a narrow-band spectrum analyzer. Nevertheless, this does not provide an excuse for the high THD + N readings obtained in mono.

Additional evidence of the effect of this excessive amount of 19-kHz signal was found when I measured FM separation. Figure 5 shows how separation varied with frequency.

Music Made Beautiful.



In the realm of architectural audio design, we at Sonance believe the classic statement is understatement. ■ Which is precisely why our custom in-wall stereo speakers and controls are made to blend unobtrusively with the most discriminating home decor. ■ Painted or cloth covered. Precision flush mounted.

Each combining the highest aesthetics with the highest fidelity for a highly satisfying sensory experience. ■ For everything you need to make beautiful music throughout your home, Sonance is your one source. To find out the dealer nearest you, call 1-800-582-7777. Outside the U.S.A. 714-661-7558, in Canada 604-873-4475. Or write: Sonance, 32992 Calle Perfecto, San Juan Capistrano, CA 92675, Fax #1-714-240-4995.

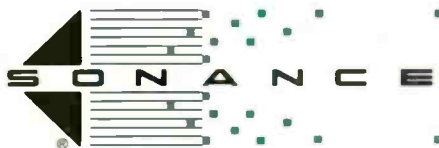

For More Information



Call 1-800-553-4355

T H E • L E A D E R • I N • A R C H I T E C T U R A L • A U D I O

Enter No. 29 on Reader Service Card

Display niceties include an adjustment for the LCD's viewing angle and even a separate, backlit display on the remote.

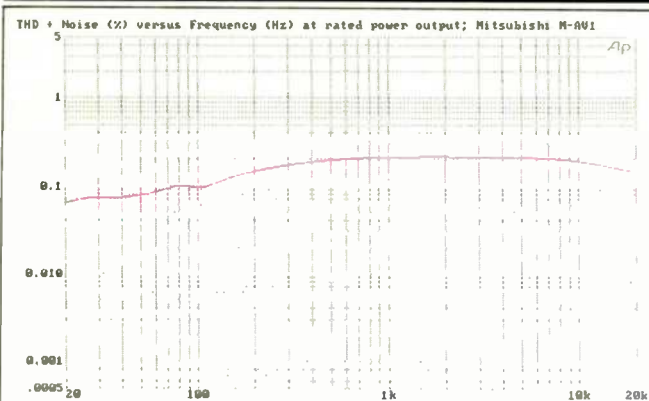

Fig. 9—THD + N vs. frequency, for front channels, at rated output into 8-ohm loads (125 watts per channel).

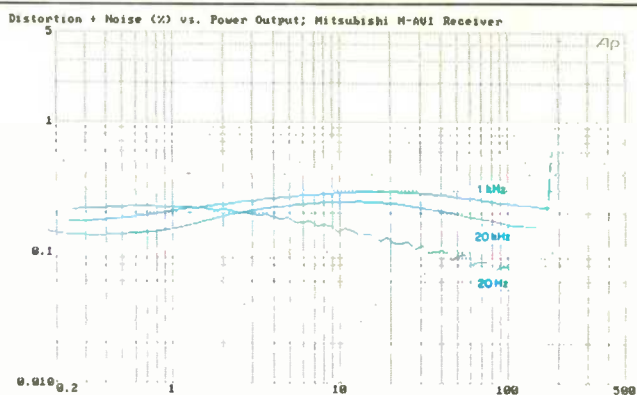
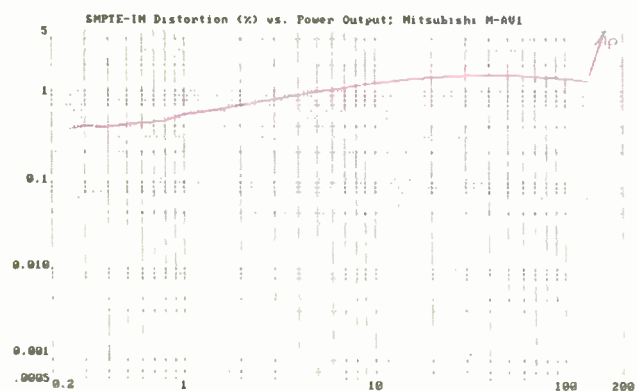
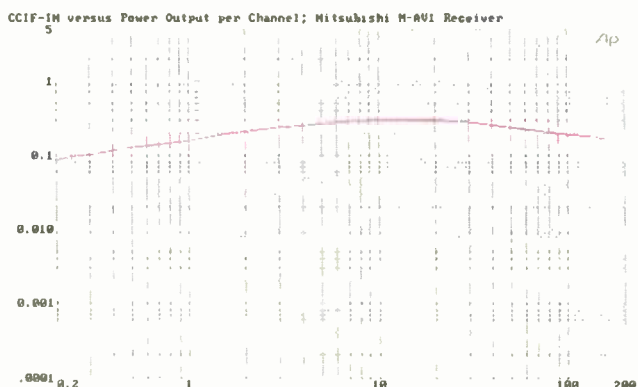

Fig. 10—THD + N vs. power output per channel, for front channels into 4-ohm loads.



A
Fig. 11—SMPTE-IM distortion (A) and CCIF-IM distortion (B) vs. power output per channel, for front channels into 8-ohm loads.



B

The top solid curve and the bottom dashed curve were plotted without the "Hi Blend" circuit activated. At 1 kHz, separation was just over 40 dB, as against 50 dB claimed. At 10 kHz, separation decreased to 33 dB, as opposed to 40 dB claimed, while at 100 Hz, it was only 25 dB. When the blend circuit was turned on, a noticeable roll-off of high frequencies occurred—even in the modulated channel output (lower solid curve)—and separation at high frequencies was practically nil. At 1 kHz, separation was 12 dB with the blend circuit activated.

Now consider the spectrum analyzer plot (Fig. 6). Here, a 5-kHz signal modulated one channel to 100%. Notice the peak at 19 kHz, which represents unfiltered 19-kHz pilot signal. It is only 34 dB below 100% modulation of the main carrier! Surprisingly, when this nonharmonically related sig-

nal is excluded from the measurement—as it is in this spectrum analysis—actual separation (that is, the amount of 5-kHz signal leaking into the unmodulated channel output) is slightly better than 50 dB! That's the figure claimed by Mitsubishi for 1 kHz. Now, most of us would have trouble hearing a 19-kHz signal that's 34 dB below 100% modulation, but if you plan to record anything off the air onto a tape deck equipped with Dolby noise reduction, look out! That constant, high-frequency signal emanating from the M-AV1's record output jacks will really play havoc with the Dolby system. I never object to poor 19-kHz filtering in car FM sets, but this level of residual 19-kHz signal does not belong in a home receiver—especially one that is designed to be the ultimate in centralized A/V control centers and provides connections for two tape decks.



DON'T BUY ONE OF THESE UNTIL YOU TAKE A HEARING TEST.

Warning: If you read this ad you'll wind up at your Sherwood dealer.

Why? Well, it won't be the fact that our current line of home components is the finest we've ever built. Or because our engineers didn't cut corners to assure excellent, long lasting performance. Or because you'll have enough jacks to handle an entire home entertainment center.

No, the reason you'll see your Sherwood dealer is to listen to these components for yourself. Because putting our sensibly priced components to the test is a heck of a lot more important than anything you'll find in an ad.

If you think they sound good now, wait until you hear them.

 **Sherwood**
LIVE PERFORMANCE SOUND™

1-830 ALONDRA BLVD. LA MIRADA, CA 90638 • IN CANADA: NORESCO CANADA INC., TORONTO, ONTARIO © 1990 INKEL CORPORATION

Enter No. 27 on Reader Service Card

I can see where operating all the M-AV1's functions with the remote control could be a lot of fun.

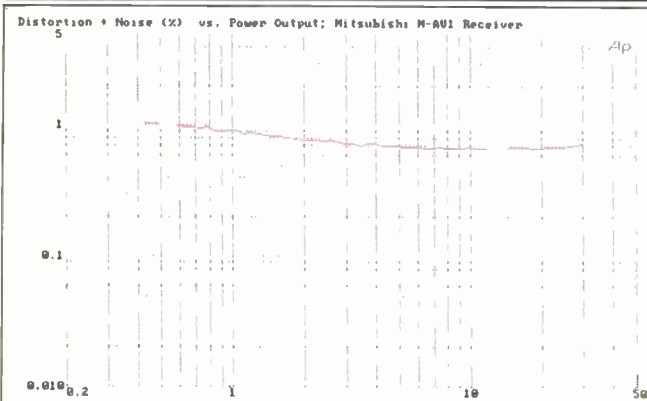

Fig. 12—THD + N vs. power output per channel into 8 ohms, for rear channels, in matrix surround with 1-kHz, L - R signal applied to CD inputs.

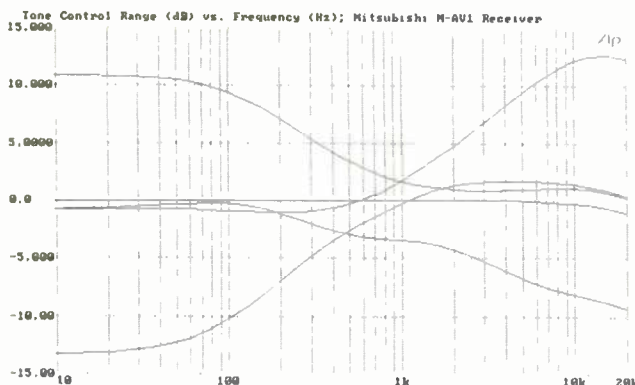

Fig. 13—Bass and treble tone control range.

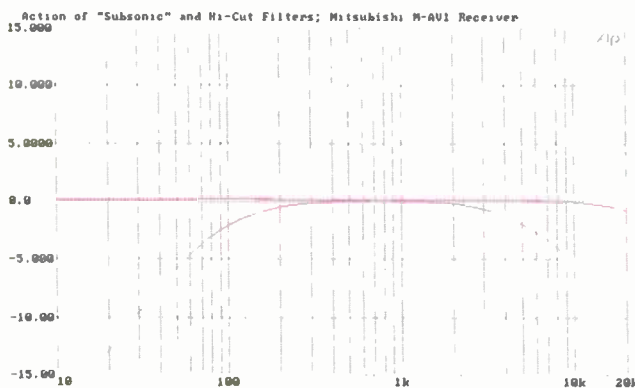

Fig. 14—Range of subsonic and high-cut filters.

As for the secondary FM specifications, I measured a capture ratio closer to 2.0 dB than the 1.0 dB claimed. AM suppression was a moderate 50 dB, as claimed, and alternate-channel selectivity was 62 dB. The i.f. rejection was 78 dB, and spurious-response rejection measured close to the 70 dB claimed.

Figure 7 shows the AM tuner section's frequency response, which extended from around 80 Hz to 2 kHz between the -6 dB points. When tuning to stations that are not employing the new NRSC 75- μ S pre-emphasis standard, expect overall response to be even worse!

Next, I tested the power output capability of the front-channel amplifiers. While these circuits had no problem delivering their rated 125 watts per channel into 8-ohm loads, THD + N was far above the 0.05% claimed by Mitsubishi, both at rated output and lower levels. When I examined the waveforms on an oscilloscope, there was clear evidence of switching distortion at all output levels. In any case, at 125 watts per channel, with 8-ohm loads connected, THD + N was 0.2% at 1 kHz, 0.14% at 20 kHz, and 0.08% at 20 Hz (Fig. 8). Virtually exact confirmation of this data was obtained when I ran a plot of distortion versus frequency, for a constant output of 125 watts per channel (Fig. 9). Damping factor, referred to 8-ohm loads and with an input signal of 50 Hz, was approximately 30. Dynamic headroom was a rather substantial 2.8 dB.

Although Mitsubishi provides no power output rating for 4-ohm loads, I did plot THD + N versus power output into 4 ohms. Clipping occurred at approximately 180 watts per channel at 1 kHz and at around 160 watts per channel at 20 Hz and 20 kHz (Fig. 10).

The M-AV1's SMPTE-IM distortion was quite high with 8-ohm loads, about 1.3% at rated output (Fig. 11A). Even at lower power levels, SMPTE IM exceeded 1%. The results for CCIF IM (using twin tones at 18 and 19 kHz and measuring the resulting 1-kHz beat tone), though lower, were still considerably higher than I am accustomed to seeing in high-quality receivers and amps (Fig. 11B). At the equivalent of rated power output with 8-ohm loads, CCIF IM was 0.2%; it was actually a bit higher at lower power output levels.

Signal-to-noise ratio for the front channels was 75.2 dB, with a signal of 500 mV applied to the high-level inputs and the receiver's volume control adjusted to produce 1 watt output. Input sensitivity for 1 watt output was 15 mV.

The rear-channel amplifiers are rated at 25 watts per channel, with a THD of 0.5%, when 8-ohm loads are connected. THD + N for these channels was also higher than claimed, but not by as wide a margin as for the front channels. As shown in Fig. 12, THD + N was 0.68% for 25 watts of power per channel, but the rear-channel amplifiers were able to pump out in excess of 30 watts per channel before the onset of clipping. For this particular test, I fed a 1-kHz, L - R signal into the high-level inputs and selected matrix surround sound.

Figure 13 is a multiple sweep showing the maximum boost and cut range of the bass and treble controls. Figure 14 compares amplifier frequency response when no filters are employed with response when subsonic and high-cut filters are activated. I would hardly call the low-cut filter a subsonic filter, inasmuch as it is down 3 dB at around 80

CELESTION

3000 5000 7000



THE SCIENCE OF ART

The new Series of Celestion 3000, 5000 and 7000 stand a world apart from the ordinary. Acoustic Ribbon Technology matched to a new concept in speaker design introduces a new vision in sound for music lovers.

Celestion Industries, Inc., 89 Doug Brown Way, Holliston, MA 01746, (508) 429-6705, Fax (508) 429-2426
Member Company of Celestion Industries p.l.c.

Enter No. *0 on Reader Service Card

While the M-AV1's amplifier didn't meet its specs in standard distortion tests, there were no audible problems in listening tests.

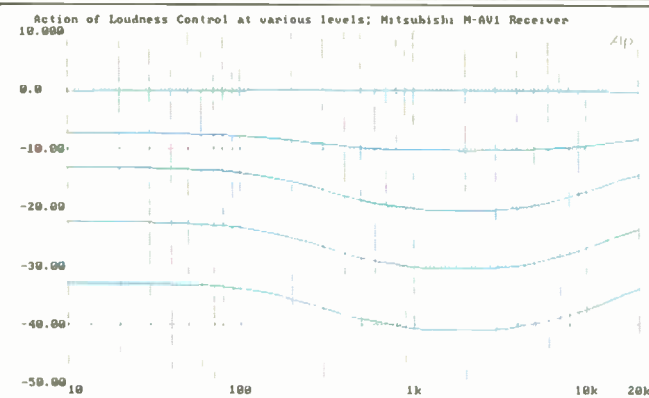

Fig. 15—Loudness compensation curves for volume control settings from 0 to -40 dB.

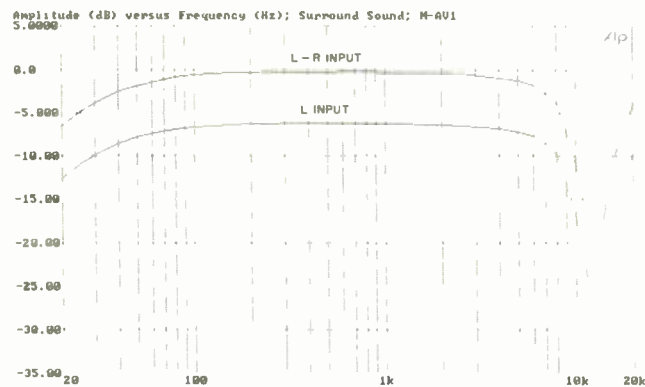

Fig. 16—Frequency response of rear channels was identical in matrix and Dolby Surround modes.

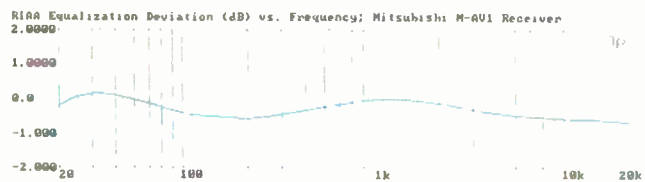

Fig. 17—Deviation from RIAA equalization.

Hz—instead of at 18 Hz, as specified. The high-cut filter action is a bit more reasonable; its 3-dB cutoff point occurs between 6 and 7 kHz.

Figure 15 shows the action of the loudness control at different volume settings, from fully open to -40 dB. The action at both ends of the spectrum is, at least, progressive (unlike some loudness controls that apply their full measure of boost as soon as the volume is turned down 10 dB or so),

even though this much treble compensation is really not needed according to the latest measurements.

Next, I checked frequency response of the rear channels with surround sound switched on (Fig. 16). I did this test once in the matrix surround sound mode, using L - R as well as L-only inputs, and once in the Dolby Surround mode, using the same types of input signals. The results were identical for both modes, with the 3-dB cutoff occurring at approximately 8 kHz.

In checking basic performance of the phono preamplifier section, I found that sensitivity for 1 watt output per channel was 0.25 mV. Input overload for a 1-kHz signal occurred with only 85 mV of signal applied; I consider 100 mV to be an adequate overload figure for MM phono inputs. The A-weighted signal-to-noise ratio for the phono inputs, with 5 mV of a 1-kHz signal applied and the receiver's volume control adjusted for 1 watt output, was 68 dB. Figure 17 is a plot of response deviation from the prescribed RIAA playback curve. Deviation did not exceed 0.65 dB at any frequency.

Use and Listening Tests

The M-AV1's poorer-than-expected FM sensitivity was clearly evident when I connected the receiver to my reference speakers and an outdoor FM antenna. About 40 usable signals were received, some 33 of them in acceptable stereo. With a "hot" tuner, I normally am able to log 50 or more usable signals via this outdoor multi-element antenna and its rotator. Activating the blend control did help to reduce the noise on several of the 33 stereo stations that otherwise would have been too noisy for comfortable listening. Subjectively I wasn't too disturbed by the reduced high-frequency separation that resulted.

I hooked up a TV monitor to the Mitsubishi and was pleased to see some of the information in the receiver's display showed up on-screen. Even such things as "Audio Volume Up" (or "Down") were displayed on my TV as I used the remote to activate the motorized master volume control. I could see how operating all the functions of this receiver via the supplied remote could be a lot of fun if you like remote controls and interactive A/V components.

I played a few CDs through the receiver and once again confirmed that, at high power levels, even distortion levels in excess of 0.2% (as measured earlier) don't detract from listening enjoyment. During some of the quieter music passages, however, I could detect that foe of solid-state design, low-level crossover distortion. And when listening to some complex orchestral works, I'm pretty sure I heard evidence of occasional IM distortion.

Less sensitive ears may not be bothered by the failure of this receiver to meet all of its specifications. After all, in the good old days of tube amplifiers, which some enthusiasts still wish would come back, THD levels of 0.2% were regarded as quite acceptable—nay, excellent. For some, the splendid layout and the convenience features of the M-AV1 could easily outweigh its less than spectacular performance on the test bench. For others, all the features and flexibility in the world may not be enough to counter the absence of distortion numbers that start out with a couple of zeros after the decimal point.

Leonard Feldman

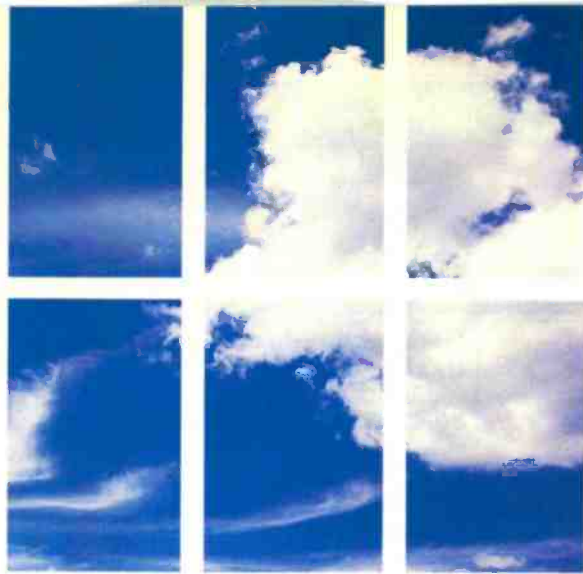

N^o 27

The music begins and a window opens. The boundaries of time and place fade as a unique musical experience is recreated in your home.

Our quest for this ideal has produced the new Mark Levinson No. 27 Dual Monaural Power Amplifier. We believe it is destined to bring more music lovers closer to their ideal than ever before.

To learn why, you are invited to share the experience at your nearest Mark Levinson dealer.



3

HAFLER IRIS FM TUNER

Manufacturer's Specifications

Usable Sensitivity: Mono, 11.3 dBf.

50-dB Quieting Sensitivity: Mono, 17.2 dBf; stereo, 37.2 dBf.

S/N: Mono, 72 dB; stereo, 68 dB.

THD: Mono, 0.1%; stereo, 0.18%.

Capture Ratio: 1.5 dB.

Alternate-Channel Selectivity: 60 dB.

Separation: 45 dB at 1 kHz, 35 dB at 10 kHz.

Dimensions: 17 in. W × 3 in. H × 8½ in. D (43.2 cm × 7.6 cm × 21.6 cm).

Weight: 9 lbs. (4.1 kg).

Price: \$450.

Company Address: 613 South Rockford Dr., Tempe, Ariz. 85281.

For literature, circle No. 92



David Hafler, one of the true pioneers of the audio industry, and his engineering staff always designed components with the user in mind; their products were simple to operate yet laden with *useful* features rather than superficial buttons and controls. Although David Hafler sold his company to the Rockford Corp., the Iris FM tuner tested for this report is very much in the Hafler tradition.

The Iris tuner was clearly designed to operate with the companion Iris preamplifier, for only then can the Hafler Handshake System be utilized. A single cable between the tuner and the preamplifier causes this to detect the tuner's presence; the pushbuttons of the preamp's remote are then automatically redefined to allow control of scanning and station presets. This system also mutes the tuner when other program sources are selected, preventing crosstalk into the other sources.

The Iris employs digitally synthesized, phase-locked-loop tuning, which operates in 50-kHz increments. It has five station presets, and since the "memory" needs no batteries, the last station selected and all presets will be retained if the unit is unplugged and reconnected, or even after a power failure. The Iris features "Scan," during which the tuning

system pauses at each signal received for about 4 S. Scanning normally goes from low frequencies to higher ones, but the direction of scanning can be reversed, if desired.

There are five tuned circuits in the front-end, including a triple-tuned r.f. stage. Three dual-gate MOS-FETs are employed to provide good rejection of spurious signals and to reduce the possibility of generating IM distortion in the presence of high-level signals. Four ceramic filters are in the i.f. stages, and they have a flat group-delay characteristic for improved selectivity and low distortion. The tuner also has selectable muting as well as selectable stereo "Blend."

Control Layout

The five station preset buttons are at the lower left end of the front panel. Above them is an LED display for signal strength, to the right of which is the frequency display, including a small numeral "5" that illuminates when you are 50 kHz from an even or odd tenth of a megahertz. Further to the right, along the bottom section of the panel, are "Down" and "Up" tuning buttons. Holding down either one initiates a slow scrolling of frequencies that speeds up if you continue

California Audio Labs

Aria mkIII

Now, in an all new edition, featuring the latest in CAL technology the Aria mkIII is destined for greatness. Designed by the engineers at CAL to exacting standards, the Aria mkIII features an upgraded version of the CAL linear drive laser system. This all new Aria includes technology so advanced that it uses high quality fiber optics to conduct certain critical areas of the signal path. Three separate transformers isolate the analog, digital and laser drive. Parts selection and quality are the finest audiophile grade.

If Music is the literature of the heart ...
then surely the Aria mkIII embodies its soul

Fall in love with a
classic... Aria mkIII

\$1995.00

There is an all new generation of the best selling compact disc player in high end history. The Aria edition of the CAL CD player line has become legendary for its musicality and breathtaking ability to recreate the emotional quality of the recorded experience.



California Audio Labs
Quality you can Hear™

7830 Garden Grove Blvd. Suite E-F • Garden Grove, CA 92641 • TEL 714/504-4757 FAX 714/894-6706

For More Information

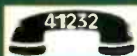

Call 1-800-553-4355

Frequency response was virtually flat over the FM audio range, down by only 0.2 dB at 15 kHz and by 0.5 dB at 30 Hz.

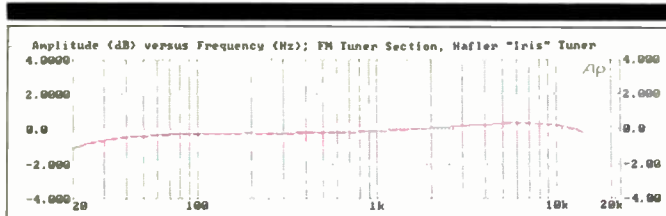

Fig. 1—Frequency response.

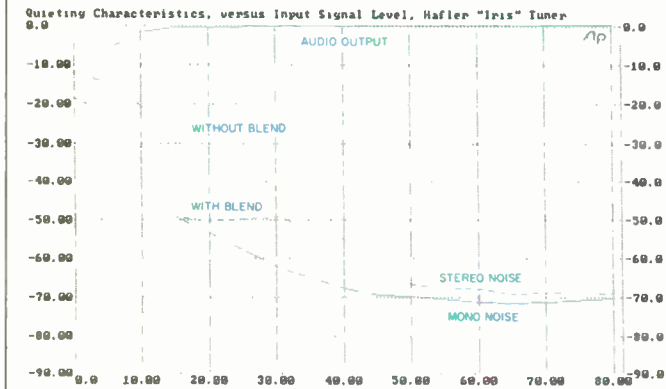

Fig. 2—Quieting characteristics.

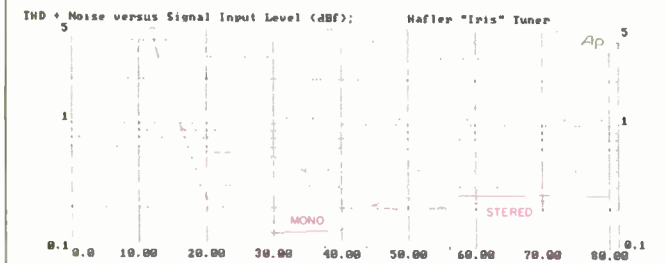

Fig. 3—THD + N vs. signal level.

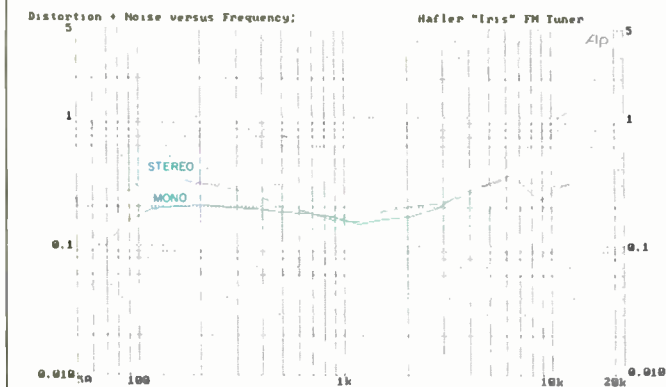

Fig. 4—THD + N vs. frequency.

pressing the button. Next are "Scan" and "Stop" buttons; the latter is required for ending the scan. The "Store" button is deliberately separated from the five preset buttons, to avoid accidental storing of frequencies you really didn't want the tuner to memorize.

What Hafler calls special function switches come next: "Distant Station," "Mute Off," "Blend," and mono/stereo. The "Distant Station" button does not affect sensitivity, which is always set to maximum in this tuner, but selects the signal threshold at which the station scanning function will stop. Above these four function switches are indicator lights for stereo reception, muting, and confirmation that the tuner has received a command from the remote supplied with the Iris preamplifier (if it is part of the system). The power switch is at the lower right corner of the front panel. The color of the panel can best be described as two-tone black, since it consists of a black-painted metal section into which has been installed a gloss-black plastic insert that runs almost the full width of the panel.

The rear panel houses the left and right output jacks, a 75-ohm coaxial connector, a terminal strip for connecting a 300-ohm twin lead, and an identical pair of multiple-pin connectors identified by the legend "Iris Data Bus." If the Iris preamp is in your system, it is to one of these data bus connectors that you would connect the flat ribbon cable supplied with the Iris tuner. The two connectors are internally wired in parallel to allow the digital data bus to "daisy chain" to other Iris-compatible accessories or components.

Measurements

Frequency response, not stated in the manufacturer's brochure, was virtually flat over the entire FM audio range from 30 Hz to 15 kHz. Response was off by no more than -0.2 dB at 15 kHz and by about -0.5 dB at 30 Hz. As shown in Fig. 1, output level for both channels was identical; it measured 600 mV for a 1-kHz signal at 100% modulation.

Figure 2 is a plot of the quieting characteristics of the tuner, in mono and stereo. From the upper solid curve, representing the tuner's audio output, you can see that full audio level has been reached at an input of barely more than 10 dBf. The lower solid curve shows mono quieting characteristics as a function of input signal strength; best S/N ratio for strong signals measured 71 dB. The dashed curves show the quieting obtained at various signal levels for stereo signals; best S/N was exactly 68 dB, as claimed. Note that the stereo plot divides into two dashed curves below about 35 dBf. With the "Blend" control activated, the stereo noise blends with the mono noise so that, at around 15 dBf, full mono performance occurs, even in the presence of a stereo signal. If the "Blend" mode is not selected, full stereo reception is maintained all the way down into the noise. Fifty-dB quieting in mono was reached for signal levels of 16.5 dBf; in full stereo, the 50-dB quieting point was reached with an input of 35.0 dBf. Both results are slightly better than claimed by Hafler.

Figure 3 shows how THD + N varied as a function of signal strength. From this plot, I obtained the figure for the tuner's mono usable sensitivity, which was 12.5 dBf. Best THD + N for strong signals fell somewhat short of the manufacturer's claims, with readings of 0.27% in mono and



For More Information



Call 1-800-553-4355

The Krell KSA-250

- Pure Class A Audio Operation
- Delivers Full Power Into All Loads
 - 250 watts channel into 8 ohms
 - 500 watts channel into 4 ohms
 - 1000 watts channel into 2 ohms
 - 2000 watts channel into 1 ohm
- 110 Amps Impulse Power
- 6 Horsepower
- Balanced and Single Ended Inputs
- Direct Coupled Input to Output
- Automatic Bias and DC Offset Adjustment Independent of Line Voltage
- Programmable to 400 Watt Monaural Operation
- Dimensions: 19" wide, 21" deep, 7 1/2" high

For more information contact your nearest Krell dealer.

KRELL INDUSTRIES • 26 Higgins Drive • Milford, CT 06460
Phone: 203-874-0139 • Fax: 203-878-8373



Enter No. 18 on Reader Service Card

The Iris pulled in every station I have ever been able to pick up at decent signal strengths—54 in all, with 47 in stereo.

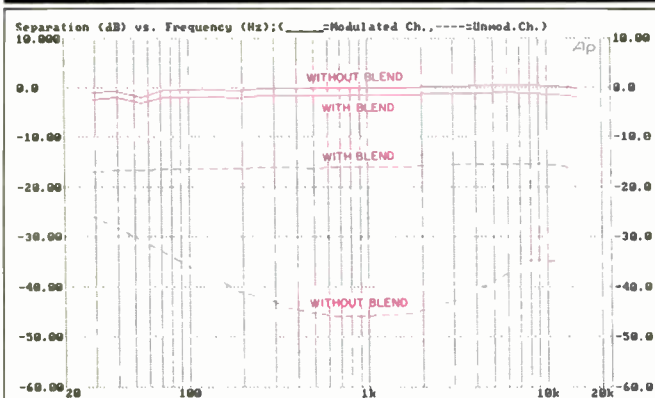

Fig. 5—Frequency response (top curves) and separation.

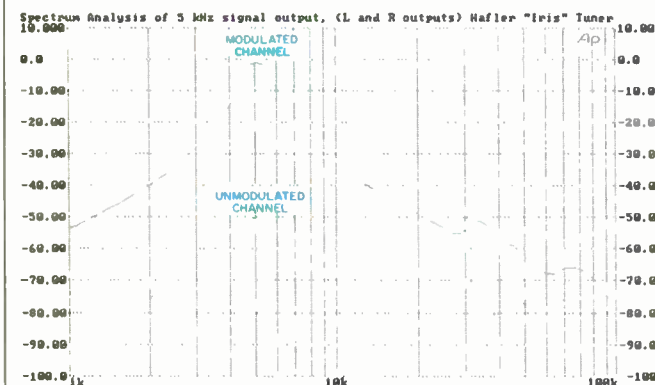

Fig. 6—Spectrum analysis, showing crosstalk products. See text.

0.25% in stereo for signal strengths of 65 dBf or more. In Fig. 4, I plotted THD + N versus frequency, using a constant 65-dBf signal. The very slight difference in distortion at 1 kHz between the tests in Figs. 3 and 4 is due to slight drifting of my FM generator's frequency between these tests. In Fig. 4, both mono and stereo THD + N are approximately 0.15% at this frequency. What's important here, however, are the values for the other two frequencies which must be checked as part of the IHF/IEEE Standard Measurements for FM Tuners, 100 Hz and 6 kHz. At 100 Hz, THD + N was 0.17% in mono and 0.3% in stereo. At 6 kHz, the results were 0.35% in mono and 0.34% in stereo.

Figure 5 is an analysis of separation with and without the "Blend" control activated. Without blend, separation measured just over 45 dB at 1 kHz and was 36 dB at 100 Hz. At 10 kHz, separation measured 35 dB, as claimed. With the "Blend" button pressed and the signal level lowered to around 35 dBf, separation decreased to approximately 17 dB and was fairly uniform over the entire FM audio range.

I plotted a spectrum analysis of the output of both channels while applying a 5-kHz signal at 100% modulation to the tuner's antenna terminals. Results are shown in Fig. 6. The solid curve represents the output of the modulated channel, and the peak at 5 kHz establishes a 0-dB reference for this analysis. There is slight evidence of sidebands along the solid curve, each sideband 5 kHz removed from the 38-kHz difference subcarrier. The dashed curve represents the unmodulated channel's output. Without the extraneous signals present that are not pure 5 kHz, you can see that the actual crosstalk of the 5-kHz signal was down a full 50 dB compared with the signal's amplitude at the output of the modulated channel. Other components visible as crosstalk included some third harmonic of the 5-kHz signal (down some 68 dB below the 0-dB reference level) as well as a 19-kHz component (down around 65 dB) and the sideband components to either side of 38 kHz.

Alternate-channel selectivity for the Iris measured 65 dB, while capture ratio was very close to the 1.5 dB claimed. The figure for i.f. rejection was better than 85 dB, image rejection was 80 dB, spurious responses were down more than 90 dB, and AM suppression was 58 dB.

Use and Listening Tests

I found the Hafler Iris tuner extremely easy to use. About the only unusual operating feature is the need to press the "Stop" button if you want to discontinue the scanning function. Because I am so accustomed to car stereo tuners and receivers that scan until you touch the tuning control (or try to memorize a signal in one of the presets), "Stop" seemed like a needless extra button to push. I found the ability to tune in 50-kHz increments extremely helpful in my listening location, where stations practically climb on top of each other. With strong enough signals, I found that I was able to detune by 50 kHz from the absolute frequency of the desired signal and was still able to enjoy distortion-free reception while eliminating adjacent interfering signals. Then, too, I'm told that many cable FM services are less than accurate when assigning station frequencies, so if you are a subscriber to cable FM, this feature may also prove to be quite useful.

The Iris pulled in every station I have ever been able to pick up at listenable signal strengths, which amounts to about 54 stations, some 47 of which were in stereo. I would hasten to add that this feat was only accomplished with the aid of an outdoor, multi-element rotatable antenna, which is mounted on my roof.

The owner's manual was somewhat on the brief side and did not list the manufacturer's performance specifications. For these, I referred to a brochure supplied by Hafler upon request. Also, I felt that the discussion concerning the possible need for an outdoor antenna should have been placed in the front of the manual, under the section about installation, rather than at the back of the pamphlet, under the heading "Additional Information." Users may never get to the last page of the manual, even though it is only 12 small pages long. Aside from these minor matters, I am happy to report that the new management in charge of the Hafler name has created a component that is worthy of the Hafler designation.

Leonard Feldman

EXPENSIVE SOUNDING SPEAKERS!

Speakers are *the most important part* of your stereo system. It is the speaker that turns amplifier signal into sound and so ultimately determines what you hear. If your speakers do not perform well, your stereo system will simply not sound like music.

The search for musically satisfying speakers, however, can lead to some very expensive products. And if you have already bought those high priced speakers, then you better not listen to Paradigms. But if you haven't, better not miss them. Why? Because from the time they were first introduced, Paradigm's sheer musical ability utterly amazed listeners.... but what caused even more amazement was the *unprecedented low price*.

So go ahead, get expensive sounding speakers.... without the expense. Visit your authorized Paradigm dealer.... *and listen*.

The critics agree:

"... For once we wholeheartedly agree... the Paradigm is most definitely a no-compromise two-way design capable of outperforming systems costing several times as much."

- *Hi Fidelity Magazine*

"... natural, open and clear... excellent depth... lots of hall sound... big, expansive soundstage... well defined... a rare achievement for any loudspeaker, but when the price is taken into account the Paradigm's performance must be considered as nothing short of remarkable."

- *Sound & Vision Magazine*

Sound & Vision



CRITIC'S CHOICE AWARD

Paradigm[®]

music . . . above all.

In the U.S.: **AudioStream**, MPO Box 2410, Niagara Falls, New York 14302
In Canada: **Paradigm Electronics Inc.**, 457 Fenmar Drive, Weston, Ontario M9L 2R6

Enter No. 6 on Reader Service Card

BBE SOUND 1002 SONIC MAXIMIZER

Company Address: 5500 Bolsa Ave., Suite 245, Huntington Beach, Cal. 92649.
For literature, circle No. 93

I've always been fascinated by special-effects and signal-processing equipment. Delay lines, echo units, equalizers, noise-reduction units, noise gates—you name it, I like it. And I'll use them at any opportunity, but not indiscriminately, mind you. There's nothing more annoying than technology used for its own sake. But if there's a need, look out—I'm ready.

In the recording studio, special effects can be a creative extension of the music. Arrangements are often written

with the idea that, during the mixing process, certain beats and notes will be manufactured via special effects. Backward notes and drum beats, phased guitar and vocal passages, all these and more go into the completion of a popular music recording.

Of course, signal processing is often a necessity. Noise reduction, for example, can save or improve a recording if the recording medium is not up to snuff. If, say, a master tape in an archive needs saving, then single-ended noise reduction, filtering, and equalization can sometimes do the job. Hundreds of early jazz recordings have been rescued from musical purgatory through signal processing.

So you see, all those boxes have a purpose. And of all the black boxes available, the ones that truly fascinate me are the ones I call black magic boxes. Vehicles of voodoo voltage. Outboard gear we could probably easily get along without, but which makes us smile when we put it to work. Equipment which, though we know all its components, still makes us wonder just how it does what it does. I'm speaking of harmonic distortion gener-

ators, ambience enhancers, stereo synthesizers, sonic hologram generators, exciters, and, to bring us to the subject at hand, sonic maximizers.

Some years ago, I auditioned the original BBE Sound signal processor, the Model 802. Designed for recording studios, live sound systems, and broadcasting, this two-channel device with balanced inputs and outputs made quite a splash when it first hit the market. BBE Sound went on to manufacture several other units for different markets, including the consumer Model 1002.

BBE's purpose in designing the maximizer was to correct the musical anomalies that occur when sound is sent through speakers on its way to our ears. All music consists of fundamental notes and their accompanying harmonic components. If these fundamentals and harmonics get out of order—that is, if fundamentals reach us after their own harmonics because of speaker inaccuracies—then what we hear will be significantly different from the note as originally played. According to BBE, such time relationship problems are principally a result of



THE NEXT PLATEAU



Kinergetics KCD-40

You Can Hear The Beauty Of The Music Free From Hysteresis Distortion.

In *all* audio equipment, each transistor, wire and connector adds its own minute bit of distortion. The sum total of this is *hysteresis distortion*. It dulls the clarity and obscures the realism of the music.



Only Kinergetics' patented hysteresis canceling circuitry gives you the true quality of the music free from this distortion. We have invented a creative merger of art and technology in music reproduction.



**Our reputation is built on our obsession—
to reproduce music with perfect realism.**

© Kinergetics Research 1989

Our reputation...

"Kinergetics' KCD-20... "the first CD player to crack the Class I Sound barrier"

J. Peter Montcrieff

"International Audio Review", Hotline #43-45

CES Winter '87

"Their KCD-20A puts other CD players in the shade musically... it is a clear first-choice recommendation among CD players."

Neil Levenscn

"Fanfare", Vol.10, No.4

CES — Summer '87

"Pure musicality is the only way I can adequately describe what I heard: no sensation of electronics or speakers, with believable sound staging and tonal accuracy... I think it would be safe to say that this represented the most 'music for dollar' at the show."

Lewis Lipnick

"Stereophile" Vol.10, No.5 Aug. 19E7

CES — Winter '88

"The Death of Mi-Ji-Fi: The Big Chill in Vegas"

Michael Framer

"The Absolute Sound" Vol.13, Issue 52, page 250

CES — Summer '88

We weren't there.

CES — Winter '89

"...I am pleased to note that the sound in the Kinergetics room was stunningly true to the sound of the original Steinway. Nice one, Ken and Tony!"

John Atkinson

"Stereophile" Vol.12, No.3, Mar. 19E9

Kinergetics Research — "constantly reaching for the final plateau — perfection."

KCD-20 Compact Disc Player • KCD-40 Compact Disc Player • KBA-75 Class A Power Amplifier • KBA-202 Mono Power Amplifier • KBT-1 FM Tuner • KPC-1 Passive Control Center • BSC Compusound Systems: SW-200 Sub-Woofer Amplifier • SW-100 Sub-Woofer • SW-100.5 Sub-Woofer • Music Mate Speaker/Sub-Woofer Stands

 **KINERGETICS
RESEARCH**

6029 Reseda Boulevard • Tarzana, California 91356 • Phone (818) 345-5339 • Fax (818) 609-8576

The BBE Sound 1002 is a bargain. It may save you from buying a whole new audio rig—or at least a new pair of speakers.

phase and amplitude distortion. When we hear musical components out of order, the effect is that of a muddy or muffled sound. An instrument's particular tone and personality are compromised, sometimes to the point where some instruments playing in similar registers become indistinguishable. As

a result, the composition suffers from a lack of clarity and distinctiveness. (Imagine a concert where a giant pillow is placed between you and the players.)

BBE's solution to this sonic calamity was to develop a process that would provide a predetermined amount of

phase correction to the high-frequency portion of the audio spectrum. (High frequencies generate greater harmonic information.) This meant separating the musical information into three frequency areas: Low (from the music's lowest note to 150 Hz), midrange (from 150 Hz to 1.2 kHz), and high (from 1.2 to 20 kHz). The low and midrange areas are delayed using, respectively, a passive low-pass filter and an active band-pass filter. The respective delays are 2.5 and 0.5 mS. The midrange frequencies are the reference points used to monitor the dynamic amplitude corrections required in the high-frequency group, with greater or lesser amounts of high frequencies used to establish proper phase correction. The high frequencies are sent through a voltage-controlled amplifier (VCA)—i.e., an amp whose gain is controlled by an external voltage. By continuously comparing the harmonic elements of the mid and high bands, the BBE maximizer is able to send the "correct" amount of control voltage to the high frequencies' VCA, and thus to the device's output.

The BBE Sound 1002 has a simply designed steel outer shell. Aimed at the consumer market, it is not of professional rack width—which is 19 inches—but measures 16½ in. W x 1¾ in. H x 9 in. D. All rear-panel connections are of the RCA type. On the front panel are a detented "Bass Control" knob that is adjustable from -10 to +10 dB and boosts lows at 50 Hz; a "Process Control" knob to regulate the amount of high-frequency content; left and right process LEDs that show how much processing is going on in each channel (full red means no processing, while full green means maximum processing); selector buttons for "Process In/Out" (select/bypass), "Tape Record/Play," and "Program Tape/Source"; an on/off indicator light, and a power switch.

The 1002 sonic maximizer can be inserted into the signal path at several points. The most effective place is in the system's tape loop—in other words, hook up the 1002 as if it were a cassette deck. (There are four connection points on the 1002's rear panel to accept your tape deck.) Connecting the 1002 into the tape loop will let you process all signals from your audio

ONE OF THE BEST BUYS IN AUDIO:

B&K ST-140 Power Amplifier

An audio component that offers both musical sound and excellent value.

In a field littered with supposed giant-killers (i.e., the field of "inexpensive" basic amps with perfectionist aspirations), this solid-state amp is the true standout. The ST-140's sound is musical and wellcontrolled, with good detail and a degree of smoothness that has prompted many to describe the amp as being "tube-like". Good build quality, too — and we've never heard of anyone having reliability problems with this one. Sure, more money, spent wisely, can buy more pitch certainty, stronger bass, an "airer" top end, a little less artificial texture, etc. But then, more money can (and very often does) buy a lot less. For \$500, the B&K ST-140 seems almost unbeatable. reprinted from HIFI Heretic, Number Ten

FEATURES:

- Class A pre-driver circuitry driving class AB Mosfet output stage.
- Toroidal transformers for highly efficient power supply operation.
- Differential input stage with an active current source load, assuring DC stability and extremely wide band width linearity.
- 5-45 K Hz Frequency Response
- 95 dB Signal to Noise Ratio, A Weighted
- 105 Power Rating (1K Hz at less than .09THD, 8 ohms)
- 14 Amperes (peak to peak)
- 1.4 dB Dynamic Headroom



B&K COMPONENTS, LTD.

1971 Abbott Road, Lackawanna, N. Y. 14218 FAX: (716) 822-8306 NY: (716) 822-8488

1-800-543-5252

American Acoustics[®]

**No other loudspeaker offers
these advanced features
and a 10-year warranty.**

From the initial research and development to finished product, we're dedicated to providing the very best in sound to our listener.

For instance, our new Dual Source Format Loudspeakers, a stunning culmination of technical excellence and pure auditory emotion by people who love music just like you do. Features like dual bass transducers for high level bass clarity. Symmetric rear port apertures for quick bass reflex at near zero distortion. Geometric baffle cover configuration that minimizes sound diffraction and improves high frequency dispersion. Midrange driver positioning (above the tweeter) for improved time arrival over the entire sound spectrum. Discrete high-slope crossovers for smooth frequency transition.

And, like all American Acoustics Loudspeakers, an industry-leading 10-year warranty! A full decade of listening confidence. Because we're confident about what goes into every American Acoustics product. Superior componentry, advanced materials and construction techniques along with quality conscious, old-fashioned American craftsmanship.

Whether you choose the exciting new DS-Series, our popular D-Series, or our value-priced AAL Series, you'll hear the pride. Today, tomorrow, and for years to come.



DS Format Series

American Acoustics
One Mitek Plaza
Winslow, IL 61089

LISTENING FOR THE FUTURE

Enter No. 3 on Reader Service Card

For the dealer nearest you please call 1-800-223-5266
When calling, please refer to number 10977

If you're a home recordist, using this box anywhere in the signal chain will result in cleaner, clearer-sounding recordings.

system; all that's required is to hit the tape monitor switch on your receiver or preamp. If you don't have a tape monitor switch or tape loop, you may want to put the 1002 between your preamp and power amp. This will work fine and permits all sources to be processed through the maximizer. However, since

the processing is level-dependent (the lower the volume, the less the amount of processing), you will have to readjust the "Process Control" knob each time you change the system's volume level. Moreover, if the 1002 is between the preamp and power amp, it cannot process signals being fed to the tape

deck for recording. Additional signal processors can be used in line with the BBE; you may also choose to use it with just one signal source.

What were my sonic impressions? Well, the sonic maximizer provides an audio system with a clearer spatial relationship between instruments. Plus, it seems to restore a recording's original depth. However, the most obvious indication that the unit is operating is an increased high end. Music seems brighter and more alive. This is especially true for not-so-state-of-the-art systems. Owners of low- and mid-fi systems might come to consider the BBE a sonic savior.

Particularly interesting is how good a cassette recording sounds when processed through the BBE—whether an original recording or a dub for car/home use. Processing your music via the 1002 will clear up that muddy sound sometimes heard on four-track cassette decks. If you are a home recordist, try using the BBE in the signal chain: Taping instruments, mixing tracks down to stereo, or making tape copies from your master mix. You'll get cleaner, clearer-sounding recordings.

The downside of the 1002 is user-related. Most people feel that if a little is good, a lot will be great. Don't fall into that trap. Processing should be done by ear, and the right amount varies from recording to recording. Cranking the process up too much can result in very brittle, punchless playbacks. More important, use caution when making tapes. As you record, monitor the signal coming from the tape to hear how much processing is right for you. Too much defeats the purpose of the device, and you'll wind up with too-bright, headache-inducing, wimpy-sounding recordings.

At \$189, the BBE Sound 1002 is a bargain. It may save you from having to buy a whole new audio rig or, at the very least, a new pair of speakers. Installed in the tape loop, it can be used or ignored, according to which recordings need the most help. But you'll find yourself using it most of the time. Since the 1002 arrived in my home studio, I've used it to resolve a multitude of audio sins. I need no excuses to use it. In fact, I feel like using it right now. . . . That old black magic's got me in its spell.

Hector G. La Torre

STEREO RECEIVERS/TAPE DECKS/EQUALIZERS/HEADPHONES AMPLIFIERS/COMPACT VIDEO RECORDERS/CAMCORDER/VIDEO/COMPUTER SOFTWARE/TELEPHONE BUS ADAPTERS/TYPewriter AMPLIFIERS/ADPHONES/AMPLIFIERS/COLOR TELEVISION COMPUTERS/BUSINESS

J&R MUSIC WORLD



Sherwood AM-7040
Stereo Power Amplifier

- High instantaneous current & MOSFET output stage for the purest sound
- 200 watts/channel •Relay protection
- Left/right gain control

Our Low Price **\$399⁹⁵** (SHE AM7040)



Sherwood DS-7000R
3-Head Cassette Deck

- 3-head design allows monitoring recordings as they are made •Dolby B/C, MX-Pro expansion system •2 motor
- Auto music search

Our Low Price **\$299⁹⁵** (SHE DS7000R)



Shure V15 Type V-MRLE
Limited Edition Audiophile Cartridge

- Hand-picked •Tighter specifications
- Micro-ridge stylus tip •Dynamic stabilizer •Side-guard stylus protection
- Includes wood case & stylus gauge

Our Low Price **\$189⁹⁵** (SHU V15VMRLE)



Sherwood AP-7020
Stereo Preamplifier

- Discrete pure complementary input circuit •MM & MC phono inputs
- Record out selector •Direct switch
- Active high & subsonic filters

Our Low Price **\$249⁹⁵** (SHE AP7020)



Teac AD-5
CD Player/Cassette Recorder

- Two units that take up only the space of one •Auto-reverse cassette deck
- features Dolby B & C •CD will record direct to cassette

Our Low Price **\$299⁹⁵** (TEA AD5)

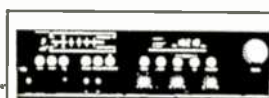

Tandberg TPR-3080A
Audiophile Programmable Receiver

- Ergonomically designed receiver
- outperforms many separate components •80 watts/channel •Ultra-sensitive FM tuner with 16-presets

Our Low Price **\$899⁹⁵** (TAN 3080A)

Audio Specials

Tandberg 3031A
•Digital FM Tuner, auto/manual tuning, 16 presets **\$399⁹⁵**

ADC SS-525X
•Graphic Equalizer/Analyzer, microphone, remote **\$359⁹⁵**

Celestion DLIO-II
•3-Way high accuracy system, black or walnut Pair **\$650**

Dual CS-5000/X3MC
•Belt Drive Turntable, with Ortofon cartridge **\$449⁹⁵**

Nikko A-400
•Power Amplifier, 120 watts/channel, rack-mount **\$399⁹⁵**

Beyer DT-990
•Audiophile quality Headphones, lightweight **\$189⁹⁵**

NEC AV-360E
•Dolby Surround Sound Amp, 30 watts X 4 **\$299⁹⁵**

Teac ADS
•CD Player/Cassette Deck, Dolby B/C **\$299⁹⁵**

Sony D-555
•Portable CD Player, 8X oversampling **CALL**

Audio Specials

Audioquest Feet
•Shock absorbing sorbothane feet, set of 4 **\$34⁹⁵**

Audio Source EG10
•Graphic Equalizer/Analyzer, pink noise, microphone **\$349⁹⁵**

Audio Technica AT170ML
•Phono Cartridge, standard mount, high accuracy **\$149⁹⁵**

Bose AMS
•Acoustimas speaker system, bass module with 2-cubes **\$749⁹⁵**

Gemini XL-1800Q
•Pro Disco Turntable, manual, direct drive, pitch **\$299⁹⁵**

Terk 9500
•Amplified FM Antenna, adjustable gain **\$39⁹⁵**

Teac V-670
•Cassette Deck, 3-head, Dolby B/C, MX-Pro **\$249⁹⁵**

Pinnacle PNS+ /Oak
•Compact 2-way Speakers, oak-trim, viaduct port Pair **\$149⁹⁵**

Parsec ARC
•AM/FM Electronic Antenna, up to 43 db gain **\$149⁹⁵**

Audio Specials

Audio Source SS-Two
•Surround Sound Processor, Dolby, wireless remote **\$199⁹⁵**

Marantz PMD-430
•Portable Stereo Cassette Recorder, Dolby B, DBX **\$429⁹⁵**

JVC JX-S900
•Audio/Video Selector, 5-video terminals, remote **\$649⁹⁵**

Toshiba SV-970
•Super VHS Video Recorder, hi-fi, 4-heads, remote **CALL**

JVC HR-S1000
•Pro Super VHS Video Recorder, 4-heads, MTS, editing **CALL**

NAD MR13
•13" Stereo Monitor/TV, high 440 line resolution **\$399⁹⁵**

Koss JCK/300
•Infrared Wireless Headphones, with transmitter **\$188⁹⁵**

Azden DM-90
•Digital Monitoring Headphone, wide response **\$59⁹⁵**

Discwasher 1160/System
•Compact Disc Table-Top Storage System, holds 20 **\$9⁹⁵**

ORDER TOLL-FREE **1-800-221-8180** Outside U.S.A. 1-718-417-373 BY FAX: 1-718-497-1791

Mail Order Hours: Monday To Friday 8 AM to 8 PM, Saturday 9 AM to 6 PM, Sunday 10 AM to 4 PM

TO ORDER BY MAIL: SEND MONEY ORDER, CERTIFIED OR CASHIER'S CHECK, MASTERCARD, VISA, AMERICAN EXPRESS OR DISCOVER CARD (Please include Interbank No, expiration date and signature.) TO: J&R MUSIC WORLD, DEPT. AMO290, 59-50 QUEENS-MIDTOWN EXPRESSWAY, MASPETH, QUEENS, NY 11378. Personal and business checks must clear our Authorization Center before processing. Shipping, Handling & Insurance Charge is 5% of Total Order with a \$4.95 minimum. (Canadian Orders Add 15% Shipping, with a \$9.95 minimum charge.) For shipments by air, please double these charges. \$25 MINIMUM ORDER. DO NOT SEND CASH. SORRY, NO C.O.D.'S. NEW YORK RESIDENTS PLEASE ADD SALES TAX. ALL MERCHANDISE BRAND NEW, FACTORY FRESH, AND 100% GUARANTEED. Copyright 1990 J&R Music World

J&R Music World, Dept. AMO290, 59-50 Queens-Midtown Expressway, Maspeth, Queens, NY 11378



SPEAKER OF THE HOUSE.

When they call the roll for the finest in bass-specialized speaker systems — the majority in your "house" will vote for **kni LoudSpeakers, inc.**

Smooth, deep bass . . . unparalleled dynamic range and minimum distortion.

Quite simply . . .

The System Works.

Call today for a free brochure.

To order factory direct, contact:



kni LoudSpeakers, inc.

588 McKnight P.O. Box 553
West Fork, Arkansas 72774
Phone: 1-501-839-3320

1-800-USA-DIAL EXT 999

GUITARISMO



Jeff Beck's Guitar Shop: Jeff Beck with Terry Bozzio and Tony Hymas
Epic 44313, CD; AAD; 39:27.

Sound: A Performance: A

Flying in a Blue Dream: Joe Satriani
Relativity 88561-1015, CD; AAD; 64:56.

Sound: A Performance: A

Pyrotechnic guitar displays almost routinely shake today's rock landscape, but periodically a Promethean guitarquake comes along to push the Stratocaster scale up another notch closer to the Big One. One such episode occurred in 1965, when Jeff Beck succeeded Eric Clapton in the lead chair of The Yardbirds; another came in 1986, when Joe Satriani used his credit card to finance his first record. Beck launched a career of changing people's thoughts about *what* a guitar could play, pushing it into heavy metal, fusion, and beyond. A quarter-century later, Satriani, combining unthought-of techniques with highly musical execution, is rearranging notions of *how* the instrument can be played. All of which makes comparison of Beck's and Satriani's new albums that much more interesting.

What's particularly curious is how much these two records have in common. Playing mostly small-combo instrumentals, Beck and Satriani share a remarkably similar sense of soloing and their instrument's voice. Technique serves the music, with blowing saved for just the right moments

(check out Beck's licks on "Day in the House" and Satriani's state-of-the-art chops on "The Mystical Potato Head Groove Thing"). Both guitarists are also very physical, which means that electronics are significantly enhanced by tonal coloration coaxed from the strings by magic fingers (compare the title cuts). Both play with a sweet, singing tone that can burn like dry ice, then melt into the nastiest of growls (compare Beck's "Sling Shot" with Satch's "Back to Shalla-Bal"). And both can be hauntingly lyrical (compare "Two Rivers" and "The Forgotten").

Beck, very ably abetted by drummer Terry Bozzio and keyboardist Tony Hymas, is in topnotch form. Yes, he is still a happening player. The nine songs range from the swinging boogie of "Savoy" through a reggae-fied "Behind the Veil" to the blues-meets-Peter Gunn of "Big Block" and the pedal-to-the-metal of "Stand on It." Vocals appear on two cuts, but mainly as humorous highlights.

Satriani's album is almost *durch-componiert*, opening with an overture (the title cut) and closing with a magnificent "orchestral" postlude, "Into the Light." In between come two-handed tapping, ZZ Top boogie, some mean harmonica and banjo, and exquisitely constructed multi-tracking. Satriani sings on six tunes, but fortunately the album's got 18 cuts, so you can ignore Joe's vocals.

Discriminating ears will hear the different *Zeitgeists* which have molded Beck and Satriani. But one thing's for sure: After the ground-shaking on *Jeff Beck's Guitar Shop* and *Flying in a Blue Dream*, guitar playing is not going to be the same. *Michael Wright*

Journeyman: Eric Clapton
Reprise 26074, CD; ADD; 57:00.

Sound: B+ E.C.'s Performance: A
Material: C+

If you've ever needed an aural definition of the adage, "It's the singer, not the song," here it is: Eric Clapton's *Journeyman*. Clapton's at the top of his game here, and that's fortunate, because it takes every bit of his skillfulness to wrestle this gathering of tunes into a moderately satisfying album.

Producer Russ Titelman (Steve Winwood, Chaka Khan), savvier at mating

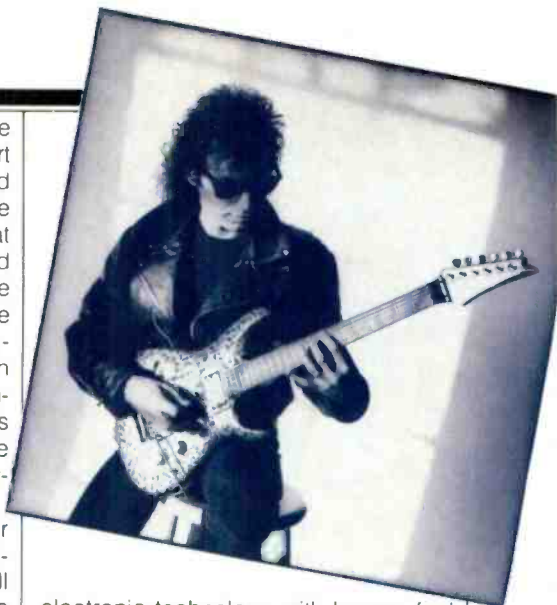

electronic technology with human feel than any other current producer, has gathered a superior group of players. On paper, this album looks like a potential monster, with Robert Cray, David "Fathead" Newman, Phil Collins, George Harrison, Richard Tee, and Jim Keltner, among others, joining in.

The arrangements, thankfully, are sparse and uncluttered, with E.C. playing effective, inventive countermelody, harmony, and lead lines. Further, Clapton is singing with genuine confidence—unafraid even to tackle Leiber and Stoller's "Hound Dog" (yeah, *that* "Hound Dog"). Nonetheless, the album goes awry. The pop songs, the ones radio and MTV will pick, are simply not very good. Take "Pretending," the first single. Lyrically, it says very little. The verses are shallow excuses to hit the chorus, which itself fails to stay with you very long.

With the possible exception of "No Alibis" (Daryl Hall on harmony vocals), the best songs on *Journeyman* are the blues-oriented numbers. Here, Clapton



Photograph of Eric Clapton: ©Ken Settle

has firmer footing; he seems to relax and let his playing flow. His covers of Ray Charles' "Hard Times" and Cecil and Linda Womack's "Lead Me On," as well as the Clapton/Cray collaboration, "Old Love," are seriously enjoyable listening.

On *Journeyman*, Eric Clapton overwhelms the material, forcing it to become better than it really is. The result is an uneven album—one that will have you reaching for past Clapton releases, where talent and material coalesced to create great, enduring rock 'n' roll music. *Hector G. La Torre*

The Sensual World: Kate Bush
Columbia 44164, CD; AAD; 45:59.

Sound: B Performance: B

Had she not been so stubbornly original from the start of her career, it would be tempting to say that Kate Bush is trying to edge toward mainstream accessibility with *The Sensual World*. Compared with earlier albums, there's less here that grates on the unprepared ear, and she has delivered some bluesy, even arguably funky, vocals. But there's also little evidence that she's traded her quirkiness for pop flash. There are no superhooks, no Top 40 bids; even the cover art is subdued. A simple black and white headshot in which a flower obscures Bush's mouth, it betrays exactly why this album may well distance her from old fans and new prospects alike.

As producer, Bush presents a collection of sonic experiments whose success or failure depends largely on whether or not she has obscured her own singing. When she veils her voice, with its amazing range of pitch and mood, the songs simply bog down. On the title track, a tame and uninspiring Bush sounds like Madonna singing Peter Gabriel. Worse, she has often pushed her voice so far back in the mix that it's lost among thick, airless layers of strings, woodwinds, Fairlight wizardry, and zillion-tracked background vocals. Bush's great angry-cat snarl in "Between a Man and a Woman," for example, is ruined whenever it runs into the dense accompaniment.

Without making full use of her voice, the title track and other songs are simply layers of overpowering sensuality—*baklava* without a nip of coffee to

cut the sweetness. Bush chose analog recording for this project; had she worked digitally, there may have been more crispness and separation.

The songs with spare arrangements work better, letting Bush's voice and often exquisite keyboard work shine through. Talk about a sensual world: Few singers have Bush's power to touch the listener this way, to make singing so luscious and physical—carnal and sublime in the same breath. Listen especially to "This Woman's Work," where a breathy whisper tickles the ear like a feather, and "Walk Straight Down the Middle," where the voice is a sinuous and reedy snake.

Bush's canniest move was to enlist the Trio Bulgarka, the hot Bulgarian a cappella group with jackhammer vibratos. The Trio is cleverly used to por-



tray the voice of a "loving" computer on "Deeper Understanding." But it's on "Rocket's Tail" (where Bush gets down to some straight-out blues punched into shape by Dave Gilmour's guitar) that we hear what this matchup was meant to be: A glorious battle of the sopranos, where Bush goes head-on with the Trio, no holds barred.

Susan Borey

Johnny Handsome: Ry Cooder
Warner Bros. 25996, LP; 38:29.

Sound: B+ Performance: A-

Just in passing: Ry Cooder's score to the movie *Johnny Handsome* (long gone from your neighborhood theater)

is the latest snapshot from this 42-year-old musician's ardent, hardheaded journey to mastery. What's really hit me on Cooder's last few projects (listen to, say, "Lipstick Sunset" on John Hiatt's *Bring the Family*) is how gorgeously he's refined his slide-guitar technique. Cooder don't pick notes, he *pours* 'em—in long, heartbreaking sustains. Drummer Jim Keltner, another master of touch, co-composed four songs, and engineer Larry Hirsh's sound quietly envelopes. Not even at its most atmospheric does this music lapse into New Age soporifics; Cooder's most abstract soundwashes are leavened by melody and the blues. Ry Cooder's Hollywood stint has produced an irony: The dictates of a filthy business have forced him up terrain he would not otherwise have scaled. Play that guitar. Score them films. *Tony Scherman*

Steady On: Shawn Colvin
Columbia 45209, CD; AAD; 44:13.

Sound: A- Performance: A

I listen to a lot of albums. Some I hardly remember. With others, one song after another will pop, unbidden, into my mind when I least expect it. That's exactly what happened with Shawn Colvin's debut, *Steady On*.

A South Dakota native who's since lived in lots of places, Shawn has spent the last several years making herself known in New York City's singer/songwriter scene. She sang backups on Suzanne Vega's "Luka" and, more recently, on Eric Andersen's excellent *Ghosts upon the Road* LP. She has a distinctive, reedy voice that's a bit thin. But she is marvelously expressive as she sings all sorts of instinctive little things that make it difficult to imagine her ever singing a song the same way twice.

"Diamond in the Rough" is about keeping in touch with childhood's purity; "Cry Like an Angel" reflects on the distance that can grow between friends as time passes. "Steady On" and "Shotgun Down the Avenue" are about love affairs gone crazy and out of control. And "Another Long One," propelled by the berzerko percussion of Tom Waits' drummer, Michael Blair, is the most nervous song of all, about the emotional traps we go around setting for ourselves.



You'll find the most helpful shopping information in the 116 page Crutchfield catalog.

FREE Stereo Catalog

Refer to the Crutchfield catalog before buying your next car stereo, home stereo, or video product:

- 116 pages of helpful articles, consumer tips, charts, and installation guides.
- Color photos, complete descriptions and technical specifications on hundreds of the finest brand name products.

You get more value shopping at Crutchfield:

- Toll-free product advice, ordering, and customer service.
- 24 hour shipping.
- Absolute satisfaction guaranteed.
- Full 30-day return privileges.
- Discount prices on Sony, Pioneer, JVC, Jensen, Proton, Advent, Clarion, Kenwood, AR, Infinity, Bose, and many more!

Call or send this coupon now for your FREE Catalog

800-336-5566

Be sure to mention *Audio* when calling

Name _____

Address _____ Apt. # _____

City _____ State _____ Zip _____

Optional - Are you in the market for:

- PC products fax/copiers
 security products

CRUTCHFIELD

1 Crutchfield Park, Dept. AU, Charlottesville, VA 22906

No question, Rod Stewart's got one of the greatest voices ever, but most of the heart is gone from his music. And what's a soul singer without heart?

Most of *Steady On* was produced by Steve Addabbo, who also directed the Vega and Andersen albums Shawn sang on, and by her songwriting collaborator on about half the material, multi-instrumentalist John Leventhal. The sound has rich textures and never quite gets too dense for its own good. Blair's percussion (especially the tinkling bells on "Another Long One"), T-Bone Wolk's accordion in "Cry Like an Angel," Bruce Hornsby's signature piano flourishes on "Something to Believe In," and the swirling cello and fiddle of "Another Long One" are delightful, subtle touches.

But this is most assuredly Shawn Colvin's album. She sings as if charged with passions she can barely control. Her voice, seasoned in the heartlands, sounds by turns little-girl-ish and womanly. Its songs knottily rooted in life and experience, memories and dreams, Shawn Colvin's *Steady On* couldn't be a better start.

Michael Tearson

Storyteller: Rod Stewart

Warner Bros. 25987, four CDs; AAD; 73:46, 74:39, 73:45, and 75:27.

Sound: B+

Performance: B

Rod Stewart is the kind of performer despised by rock critics because what he is falls so far short of what he could have been. A humble R&B singer in a seminal late-'60s hard-rock combo (The Jeff Beck Group), in the early '70s he became the Great Blue-Eyed Soulmán, fronting the World's Greatest Goodtime Rock Band (The Faces); as soon as he moved to L.A. full-time, he became a self-obsessed fashion plate standing for everything punk set out to destroy. Though some of his early American recordings had some soul, they soon became a matter of one passable single plus nine attempts at finishing a coherent song. In this context, *Storyteller* seems an honest attempt to anthologize a career which, with a few exceptions, hit its stride in 1967 for an eight-year stretch and then coasted. Even critic Robert Palmer's liner notes seem a bit apologetic. Rod's own annotation shows an astonishing inability to distinguish his finest moments from everything else.

Be that as it is, one shouldn't slag the old cockatoo off too unmercifully.

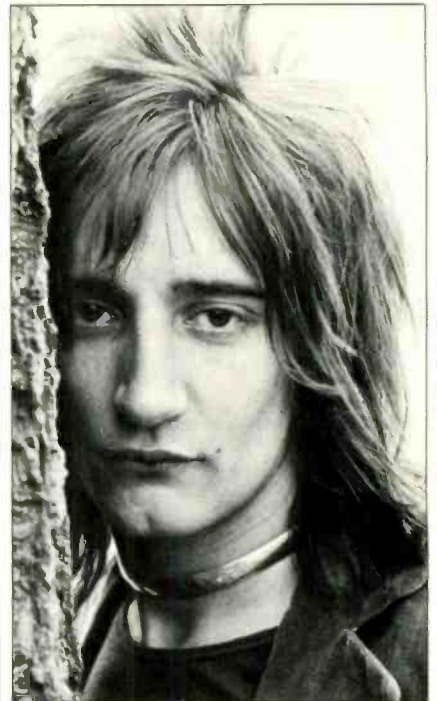

Photograph: ©David Gahr

There are some great moments here—like almost all of the first two discs. "Little Miss Understood," an obscure classic, is unearthed in an unreleased version (too bad they couldn't bury those drums!) along with other rarities and all the hits. Though The Faces sound incredibly rough and out-of-tune by today's standards, the spirit and performances on Rod's recordings with Ronnie Wood, Ian McLagan, Ronnie Lane, and Kenny Jones (either as a unit or in various permutations) hold up exceptionally well and still bring a tear to the eye. The only later moments anywhere close to Rod's Faces-era work are to be found on a previously unreleased version of "To Love Somebody," with Booker T. and the MGs backing. There are a few nice things from 1984 and 1985, but all the recent songs (including gratuitous 1989 recordings of stuff from 1975's *Atlantic Crossing*) sound like the work of a man who cares very little about making music. No question, the guy's got one of the greatest voices ever, but when he and Woody split, most of the heart went out of his music. What's a soul singer without heart?

But discs one and two are pretty much untouchable, if you're any kind of fan of rock music. *Jon & Sally Tiven*

THE LATEST OF THE GREATEST.

THE COLUMBIA JAZZ MASTERPIECES SERIES CONTINUES WITH THESE NEVER-BEFORE-AVAILABLE COLLECTIONS OF CLASSICS.



From Basie to Brubeck, from Miles to Mingus to Monk, the most influential music by the legends of jazz has been digitally-remastered for CD, Cassette and LP. Over 80 original releases and new collections are now available in this landmark series dedicated to preserving the major works in jazz history.



DIGITALLY-REMASTERED.
ON COLUMBIA COMPACT DISCS, CASSETTES AND RECORDS.

PIANO MAN



The London Piano School: Vol. I, Georgian Classicists; Vol. II, Romantic Pioneers; Vol. III, Early Victorian Masters. Ian Hobson, piano.
Arabesque Z6594, Z6595, and Z6596, three CDs; DDD; 72:29, 69:36, and 69:57.

This is one of the great "communication" piano recordings of the new digital era on CD, which does so much for the instrument. The pianist is astonishingly persuasive, with superb musicianship and faultless style and technique. Under his fingers on the Hamburg Steinway, the numerous composers—most of them virtually unknown to the music world today—are absorbingly interesting to hear. And the digital (Sony) recording is one of the finest renditions of piano I have heard. Even more, the Hamburg Steinway, very unlike the American Steinway, turns out to be built clearly within the tonal tradition of the early 19th century, adding a lot to the impact of the music.

Ian Hobson is English, though the recordings were made at Concordia

College in the U.S. I asked a young English colleague of mine, a man of about Hobson's age, what *he* thought of Hobson as a contemporary. His answer astonished me: A cold and unresponsive pianist. *How* could he think such a thing? I immediately asked what Hobson he had heard. Chopin, I think, was what he said. That explained it! Standard keyboard works known to thousands of pianists and audiences, however fine they may be. Like other young pianists, Hobson has been put through these usual paces to pay his way via music everybody knows. Accordingly, he has made a number of such albums. I strongly suspect that this is *not* his game. He lights up and radiates music power when he can learn and play a splendid work that nobody today has ever heard of, let alone performed! There are such people, you must understand—even though to master and to interpret an unknown virtuoso piece takes immensely more musicianship and understanding than to set forth a well-known work, difficult as *that* may be.

Say no more, or not much. The London School was made up of composers writing and performing on the piano in London, beginning with the piano itself. (The first public hearing of the instrument was in 1767.) In typical British fashion, all but a few of these "London" artists were imports from various parts of the continent. Some are familiar names, if not in their works recorded here: Clementi, for instance, J. C. Bach (the "London Bach"), Dussek, John Field, Moscheles. But how about Burton, Busby, Cramer, Pinto, Bennett, and Chipp? You'll be astonished at the wealth of musical talent from these (now) obscure composers.

Since the CDs are available separately, you might start with Volume III if you like big early Romantic, or Volume I if you go for music busting out of the Mozart and Beethoven era with the first of the new Romantic power. Pay attention, if you wish, to William Sterdale Bennett, English to the core and a Schumann protégé, who is represented by an early piece with sturdy Schumannesque overtones and a remarkable late work (1873) that is still in the style of the early century but immensely vigorous. Also note the work of Samuel Wesley, of the Wesleyan tribe of church founders and hymn composers. His piece on this CD is dazzling, based on "God Rest You Merry, Gentlemen." It is breathtakingly brilliant as played by Ian Hobson.

Edward Tatnall Canby

Guitar Masterpieces. Stevan Pasero. **Sugo SR8904**, CD; ADD; 46:17.

Sound: A — Performance: B —

Dvořák: Symphony No. 9 ("From the New World"); Stravinsky: "Firebird" Suite. Kazuhito Yamashita.
RCA 7929-2-RC, CD; DDD; 54:50.

Sound: A — Performance: A —

Debussy/Fauré/Chopin. Amsterdam Guitar Trio.
RCA 7800-2-RC, CD; DDD; 52:53.

Sound: A — Performance: A

When the oft-quoted pundit dubbed the guitar a "miniature orchestra," referring to voicing and coloration, probably no one ever imagined that future artists would take the description literally and perform reductions of symphonic works on this delicate instru-

ORIGINAL MASTER RECORDINGS™

ULTRADISC™



The Sound with the Midas Touch.

*The 24K gold answer in the quest for optimal compact disc reproduction. Original Master Recordings that demand Intelligent Engineering and Proprietary Mastering Technology. Exacting Technical Specifications satisfied by a process that offers a compact disc with the Highest Reflectivity and Enhanced Longevity. Current releases on **ULTRADISC™**: Def Leppard, Jefferson Airplane, John Klemmer, & more. Upcoming titles on **ULTRADISC™**: Moody Blues, Neil Diamond, Jeff Beck & more.*

*The **ULTRADISC™** is protectively packaged in the "Lift-Lock" jewel box*



For a complete free Original Master Recordings catalog, call toll free: 800-423-5759, or write: Mobile Fidelity Sound Lab, 1260 Holm Road, Petaluma, CA 94954.

Enter No. 21 on Reader Service Card



The Amsterdam Guitar Trio plays its transcriptions of Debussy and Chopin works with subtlety, sensitivity, and artistry.

works by Sor and Tarrega as a result of hearing these transcriptions. The Amsterdam Guitar Trio, on the other hand, seems intent on expanding the *repertoire* of the guitar ensemble. With their ability to make these transcriptions sound so naturally suited to the trio form, it is unlikely you'll resist being won over. *Michael Wright*

Handel: The Chandos Anthems, Vols. I and II (Nos. 1-3 and 4-6). The Sixteen Choir and Orchestra, Harry Christophers; Lynne Dawson, soprano; Ian Partridge, tenor; Michael George, bass.

Chandos 8600 and 0504, two CDs; DDD; 61:14 and 58:30.

Well, yes! A little more than half of the splendid Chandos Anthems on, of course, that enterprising English label, Essex-based Chandos. One presumes that the remaining five are due to show up after a short interval, as these first two volumes, recorded in late 1988, came out at a few months' remove from each other. Their appearance is very welcome, for these are definitive performances, lovingly and warmly recorded by producer Martin Compton and engineer Antony Howell, two old Chandos hands. The acoustical venue, St. Jude's Church in London, has been a much-loved site for recordings of this nature for decades and has never sounded more flattering to a composer's intentions, or to the performers'.

ment. Yet that's what Stevan Pasero, Kazuhito Yamashita, and the Amsterdam Guitar Trio do, with varying degrees of success, on these releases.

Pasero, best known for his "Nutcracker" Suite, offers a variety of transcriptions and originals on *Guitar Masterpieces*. Most ambitious is the Allegro con brio from Beethoven's Fifth Symphony, recorded here in a live *solo* performance! Audacious, to say the least, and not unpleasant once you get over the sheer novelty. Also included are Ravel's "Bolero," Bizet's "Habane-ra" from *Carmen*, and excerpts from Prokofiev's "Peter and the Wolf," all arranged for two guitars and small ensemble, plus several of Pasero's own Romantic compositions. The live recordings are a little remote and "roomy" sounding, but the studio cuts are fine. Even realizing that this is "pop classical" guitar, Pasero's *Guitar Masterpieces* comes awfully close to being on the wrong side of kitsch.

Young Japanese virtuoso Kazuhito Yamashita continues his pursuit of the orchestral form with transcriptions of Dvořák's "New World" and Stravinsky's "Firebird," here performed in duo, with Yamashita overdubbing the second guitar parts. Interestingly, he chooses two works with very wide dynamic ranges and then exploits various tricks on his instrument for creating the illusion of reproducing the contrast—e.g., rapid chording in forte sections—albeit in somewhat telescoped

form. Occasionally, Yamashita's vision gets slightly ahead of his technique, although it almost seems presumptuous to point this out under the ambitious circumstances. The digital recording is very clean, although the guitar sound is a bit thin. Also, Yamashita plays an instrument with the strings set unusually close to the fingerboard, which gives him increased speed but also causes a distracting buzzing in certain passages. Still, Yamashita does a creditable job of sustaining these pieces with a pacing that creates an orchestral illusion.

Most convincing of this threesome, however, is the Amsterdam Guitar Trio playing its arrangements on *Debussy/Fauré/Chopin*. Debussy's "Suite Bergamasque" and "Petite Suite" shimmer with unearthly delicacy; Fauré's "Dolly, Opus 56" glistens with light, bouncing harmonies; Chopin's Rondo in C, Opus 73 dances forward, alternately, lilting and moody. The Amsterdam Guitar Trio plays with subtlety, sensitivity and true artistry. The all-digital recording is exquisite.

For Pasero and Yamashita, the intent seems to be to expand the audience for the classical guitar. While this tactic has been known to work occasionally in the pop realm (one is reminded of Walter Carlos' *Switched-On Bach*), I suspect these efforts will be of more interest to the already converted and that few Beethoven or Stravinsky (or Van Halen) fanatics will start pursuing



"For once, an add-on subwoofer actually delivers true subwoofer bass with high quality and high quantity at the same time."

Larry Greenhill
Stereophile, Vol. 12, No. 10, Oct. 1989

Velodyne is one of the hottest names in today's audio/video industry. Why? Because whether you're upgrading a current system or building a new one, there is no other single component that can boost a system's overall performance like a Velodyne subwoofer.

"... the integration was seamless and changed the overall character of the system in a synergistic, beneficial direction."

Larry Greenhill
Stereophile, Vol. 12, No. 10

What makes the difference? Velodyne's patented High Gain Servo (HGS) technology, which represents a major breakthrough in loudspeaker design.

"I determined that a high performance accelerometer based feedback system would be the only way to truly correct the problems that plague low frequency reproduction. Such a system had never been successfully built before. But through a systems approach of

redesigning the driver and electronics from the ground up, I have developed a system that delivers high output levels with unprecedented low levels of distortion."

David Hall, President/Founder
Velodyne Acoustics, Inc.

All Velodyne subwoofers are complete systems. Just plug one in to experience the full audio spectrum: Cleaner mids and highs with low frequency response that you never thought possible. It's a dynamic overhaul for your system.

"Other subwoofers had not moved much air and certainly hadn't coupled with the room. ... Not so with the Velodyne—I was there!"

Larry Greenhill
Stereophile, Vol. 12, No. 10

Experience All The Music:
Experience Velodyne.

Velodyne

Velodyne Acoustics, Inc.
1746 Junction Ave., San Jose, CA 95112
408/436-0688 800/VELODYNE

For More Information



Call 1-800-553-4355



Conductor Robert Shaw has all the elements in perfect focus, and the result is a near-definitive performance of Britten's War Requiem.



James Brydges, first Duke of Chandos, according to Simon Heighes' brief and informative notes, "had so richly lined his own pockets (as paymaster to Marlborough's armies in the first years of the 18th century) that he was able to build for himself a palatial country house . . . nine or ten miles from central London." The man's apparently bottomless budget went for all things "artistic" and "lofty," among which was a proficient, if imbalanced, musical establishment. It lacked violas and altos—never crucial elements of English music until Stainer and Parry and Elgar strode onto the Victorian scene—so Handel wrote for a choir and supporting ensemble that is light, quicksilver bright, haunting.

And haunting this pair of releases is. These are no mere churchly compositions, scribbled on Friday for Sunday's High Church offices. Sacred though the texts may be, and strikingly reminiscent of the later oratorios, too, these are works that revel in sheer opulence of sound, a delight in cosseting the bewigged ear of that time. The anthems feel much like vocal concerti, with cantata-like organization of a worldly and churchly tone Bach never aspired to. The third anthem even has the most beautiful tribute to Buxtehude's exquisite cantatas you are likely to encounter, a duet for soprano and tenor that harks back to the austere moments of the late 17th century in North Germany. The Sixteen Choir and Orchestra (the latter composed of eight violins, a pair of celli, an oboe, and standard period continuo of bassoon, double bass, and organ) are simply gorgeous. They evince the purity of English performers in the early-music tradition of this decade, but with none of the blandness some ensembles mistake for polish. Polished they are, but this is soulful singing, loving playing. Harry Christophers' tempi move right along without falling into that skittering allegro vivace rush that some ensembles consider pleasurable (authentic?) music making. This is rare stuff. Our thanks must go to Christophers and his talented lot, but also to enterprising Chandos Records and to James Brydges, Duke of Chandos, for whom Handel wrought these 11 masterly mementos of his first years in England. *Christopher Greenleaf*

Britten: War Requiem, Opus 66. Atlanta Symphony Orchestra and Chorus and Atlanta Boy Choir, Robert Shaw; Lorna Haywood, soprano; Anthony Rolfe Johnson, tenor; Benjamin Luxon, baritone.
Telarc CD-80157, two CDs; DDD; 46:24 and 36:28.

It would be foolish to insist that a great composition can admit of only one "definitive" performance. John Culshaw has written of the War Requiem, "Like all great music, it yields different values on each hearing." And each conductor—or performer or performing institution—illuminates those values a little differently, giving us a fuller perspective or a finer focus as we synthesize a concept of the piece itself from successive hearings.

At the same time, when Britten has recorded the work with Galina Vishnevskaya, Dietrich Fischer-Dieskau, and Peter Pears, with Culshaw in the control room, and has done so for a company as noted for fine sound as Decca/London and in as famous a venue as Kingsway Hall, any difference between the composer's version and another will perform appear a failing in the second. Britten's recording, made in 1963, is in full-fledged stereo (albeit without Dolby NR), so its existence must have given pause to Shaw and Telarc when they considered a new version.

It is a work that deserves repeated recordings as much as Beethoven's "Missa Solemnis" (which gets too few) and even, perhaps, his Ninth Symphony (which possibly gets too many). It welds Wilfred Owen's bitterly disillusioned anti-war poetry to the Latin

"Missa pro Defunctis" and draws added meaning from the tension between them. The English poetry is sung by the male soloists with a chamber orchestra. The Mass is sung by the soprano and chorus with full orchestra. The Atlanta Boy Choir and the organ are used for Latin texts that savor of the angelic or the innocent.

This is a very beautiful recording and very true to the values staked out by Britten. Even the voices are similar, though Luxon's somewhat reedy baritone is closer in quality to the two tenors than to the incomparable Fischer-Dieskau, whose simplicity of line was a major asset to the original.

If that model did not exist, the Atlanta performance would stand as a monument to one of the most stirring masterworks of this century. Shaw keeps everything in perfect focus. The chorus is the most impressive, but there are many points at which the clarity and articulation of the orchestra top even Britten's very professional job.

The perspective is much more conventional than in the London recording, which placed the chamber orchestra and male soloists up front on the right, with a rather dry ambience, spread the main orchestra and chorus over the widest possible soundstage, with the soprano in the same plane as the choir, and put the boy choir at the far left. Telarc moves the male soloists back near the soprano, thus losing the sonic distinction between them. And, having kept a conventionally axial placement for the rest, Telarc also centers the boys.

Frankly, I prefer the Britten/Culshaw acoustic, though Shaw does let you hear more detail within the textures, despite this loss of intergroup separation. His orchestral balance subtly favors the strings. The underpinning of brass and low winds is clearly audible, but the brass in particular is more careful and has less bite than the London playing. The pickup of the solo voices, especially the men, is a bit colored, giving the impression of a reflective surface nearby. Otherwise, the engineering is above complaint.

In sum, this is a fine recording as well as a modern one, but it certainly doesn't blow away the *Urtext* competition—which, I hasten to add, I have yet to hear on CD. *Robert Long*

THE ORIGINAL CTI RECORDINGS DIGITALLY REMASTERED FOR COMPACT DISC



FEEL THE FIRE

CTI JAZZ SIZZLES ON COMPACT DISC.

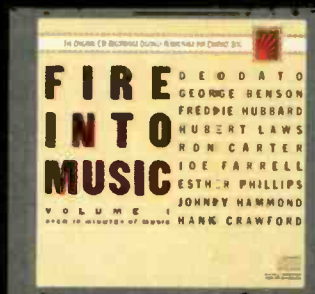

"FIRE INTO MUSIC VOLUMES 1, 2 & 3"

Sample the hot sound of CTI's stable of stars on three volumes of specially priced CDs, each with over 70 minutes of music.



DEODATO "PRELUDE"

The Grammy-winning "Also Sprach Zarathustra" launched the career of Eumie Deodato and still sounds as fresh as it did when first heard in the spring of 1973.



GEORGE BENSON "WHITE RABBIT"

A CTI classic, ranking among the guitarist's best. Benson's all-star band features Herbie Hancock, Ron Carter, Billy Cobham, Hubert Laws and Earl Klugh.



FREDDIE HUBBARD "FIRST LIGHT"

Freddie calls this Grammy-winning album his favorite. The trumpeter is in top form, accompanied by Ron Carter, George Benson and Hubert Laws.

OVER FOUR DOZEN TITLES NOW AVAILABLE—
MANY INCLUDING PREVIOUSLY UNRELEASED MATERIAL.

**PAUL DESMOND • STANLEY TURRENTINE • ESTHER PHILLIPS
RON CARTER • CHET BAKER • HUBERT LAWS • JOE FARRELL
AND MANY MORE TO COME!**



Exclusively On CBS Associated Compact Discs.

THE LATE SAXTIES

| |
|---|
| Om: John Coltrane Impulse 39118 , CD; AAD; 29:09. |
| Sound: C Performance: A- |
| Karma: Pharoah Sanders Impulse 39122 , CD; AAD; 38:45. |
| Sound: B- Performance: A- |
| Fire Music: Archie Shepp Impulse 39121 , CD; AAD; 39:47. |
| Sound: C+ Performance: B+ |
| Streams: Sam Rivers Impulse 39120 , CD; AAD; 49:52. |
| Sound: C+ Performance: B- |

In the '60s and early '70s, Impulse Records was on jazz's leading edge. They billed themselves as "the New Wave in Jazz," and seemed indeed to be sweeping traditions aside with brash experiments, new techniques, and free-form improvisations. But hearing these reissues some two decades on feels oddly dislocating. These all-out assaults on convention sound poignant, almost naive in the context of today's button-down be-bop revisionism. In retrospect, the tenor sax looms as perhaps the emblematic jazz instrument of the late '60s, its near-human cries and honks making it an excellent tool for stripping away artifice to probe pure emotion.

John Coltrane was the aesthetic signpost of the era and the standard-bearer of Impulse's "New Wave," but the very idea of anyone making a record as naked and raw as *Om*, Coltrane's cathartic 1965 meditation, would be ludicrous. After the opening chant, the musicians launch into a furious improv of screaming horns, from which Coltrane soon emerges firing blistering lines of melodic fury. Pianist McCoy Tyner sketches out the harmonic orchestrations, drummer Elvin Jones maintains a pulse by never stating it but constantly circling it, and Jimmy Garrison navigates his bass like

a fighter pilot dodging flak. The quartet is augmented by tenor player Pharoah Sanders, whose hoarse cries seem to emerge straight from the center of his soul.

Sanders' own albums merged spiritual themes with Eastern and African music. Of those, *Karma* is perhaps the best, with its epic "The Creator Has a Master Plan," featuring Leon Thomas' yodelling vocals. Played with a larger ensemble and lots of little percussion instruments, particularly bells, "Creator" is a propulsive piece, centered around Richard Davis' simple, eight-

Karma seems to have the best sound. Its clarity and detail indicate that engineer Bob Simpson had a better than usual understanding of balances in this often chaotic music.

Archie Shepp was another Coltrane collaborator; his music, however, always sought a social and political, rather than a spiritual, context. He also had more of a bluesy, gutbucket sound, which comes through on *Fire Music*, a record that's as influenced by Count Basie as by Coltrane. Playing with an expanded small group, Shepp wrote witty, sharp charts that frame kinetic settings for improvising. Shepp himself was always more of a blues saxophonist, so that even in his wildest forays there was a touchstone to grab onto. His reading of the standard, "Prelude to a Kiss," weeps with quavering pathos.

Sam Rivers offered no touchstones. He had the same blues background, but he shed it completely in free-form improvisations that stormed the gates of structure and sound. *Streams*, recorded live at the Montreux Jazz Festival in 1973, documents what Rivers did nightly for most of the '60s and '70s. You take your chances with this kind of spontaneous creation, and sometimes Rivers made it all work in a stream-of-consciousness flow. Sometimes, as on *Streams*, only bits and fragments emerged.

Most of these Compact Discs hold up sonically as well as musically, though *Om*, *Streams*, and *Fire Music* are a bit thin compared to the Sanders, with details blurred or distant. It's distressing that MCA/Impulse, in preparing these albums for CD, didn't remaster the tapes so that album-length compositions like "Om," "Streams," and "The Creator Has a Master Plan" could be heard without the fade-out, fade-in in the middle that was necessary with vinyl, but a crime on CD. *John Diliberto*



Illustration: Jeffrey Wong

DAVE GRUSIN ON THE MOVE...

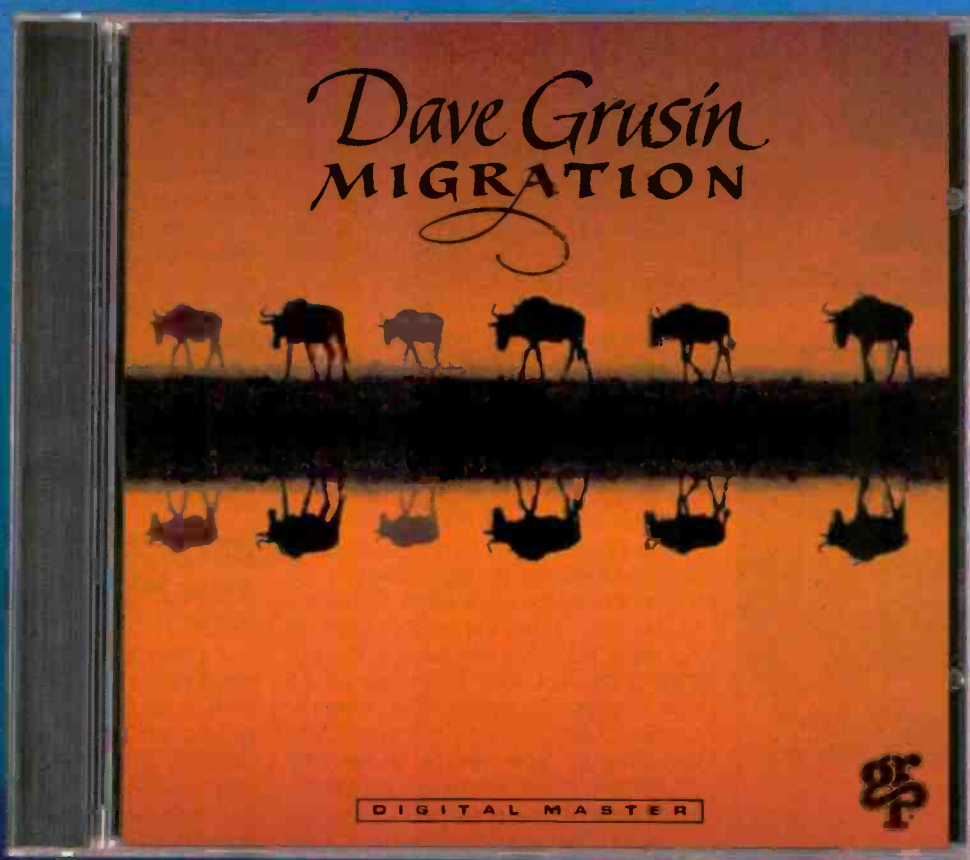

The multiple Grammy Award winning pianist and composer, backed by all-star players Branford Marsalis, Omar Hakim, Marcus Miller and trumpeter Hugh Masekela. All new compositions including his Academy Award winning suite from "The Milagro Beanfield War."



Available on
Compact Disc
HQ Cassette
and Records
©1989 GPR Records

Enter No. 13 on Reader Service Card

THE
DIGITAL MASTER
COMPANY

"Shure's most recent version of its top model, the V15 Type V-MR... strikes this listener as perhaps the most musical-sounding phono cartridge ever made."

Hans Fantel
The New York Times



SHURE®

For product literature, call 1-800-257-4873
(In Illinois, 1-800-624-8522)

Enter No. 28 on Reader Service Card

On display are not only Sun Ra's wisdom, control, and taste but also the stiffness of age.

**Blue Delight: Sun Ra
A & M SP-5260, LP.**

Sound: B- Performance: C+

In 35 years, Sun Ra has made over 200 recordings that navigate a universe of free jazz, swing, hard bop, theater of the absurd, quirky pop, and space music before there was a New Age. On *Blue Delight*, he continues reinvestigating his roots, a process that began in the mid-'70s, when he decompressed from the intergalactic voyages of *Space Is the Place* and returned from the *Heliocentric Worlds*. *Blue Delight* abounds in reflections on his Fletcher Henderson-inspired swing, twisted just a bit by his ragged space rapture.

Ra's swing vamps are refracted through an unusual sense of space and time. On "They Dwell on Other Planes," he turns swing into a trance-like groove; hypnotic horns play a simple chorus as muted trumpets phase in and out in a Doppler effect. Ra eschews the skewed, angular piano solos of his early days for spry, witty runs that could be mistaken for Basie or Erroll Garner. His playing consists of simple sketches with the mere outlines of melody—like elegant, offhand drawings.

The usual Sun Ra crew is aboard, of whom saxophonist John Gilmore remains the most potent force. Gilmore's bluesy tenor lacks the incisive slash of his early work but still evokes the pathos of the lost soul. There are also a few ringers: Drummer Billy Higgins, bassist John Ore, and trombonist Julian Priester (who returns to the fold after many years' absence). Ra's highly personal sense of orchestral color is at work throughout, from his own glassy synthesizer touches on "They



Dwell on Other Planes" to Marshall Allen's Middle Eastern oboe on "Sunrise" and Elloe Omoe's bass clarinet.

But *Blue Delight* has a rote, recycled sound. You'd never know it was separated from, say, 1956's *Sun Song* by 34 years. Except that back then, Ra brought an energy and precision to songs like "Brainville" and "Street Named Hell" that make *Blue Delight* seem dusty and nostalgic—a disappointment, however nicely recorded (a rarity in the Ra discography).

It's difficult to put significance on any recent Sun Ra recording. *Blue Delight* exhibits not only the wisdom, control, and taste of a composer and conceptualist who has bent the shape of jazz more than many are willing to admit, but also the creases, wrinkles, and stiffness of age. Jazz music is about state of mind, and *Blue Delight* is a postcard from Sun Ra, in the autumn of his life.

John Diliberto

**Corruption: Thomas Mapfumo
Mango 9848, CD; AAD; 48:69.**

Sound: B+ Performance: A-

It's rare these days when a musician sings out of conviction for greater ends than those of the marketplace or therapeutic self-reflection. Zimbabwean Thomas Mapfumo is such an artist. That isn't to say that his music is not self-conscious, or that he is unconcerned about his audience. On the contrary, Mapfumo's *chimurenga* music (a Shona word meaning "liberation struggle") evolved out of a sense of necessity and fulfilled a function as the pop music wing of the forces that overthrew white minority rule in Rhodesia. Thus, Mapfumo's music emerged out of a newborn nation's need for a cultural consensus; young Zimbabweans had been exposed to more British and American pop, soul, and jazz and Congolese rumba than to indigenous sounds.

Mapfumo, himself tired of multi-national corporate rock, decided that the Shona tradition of *mbira* music was

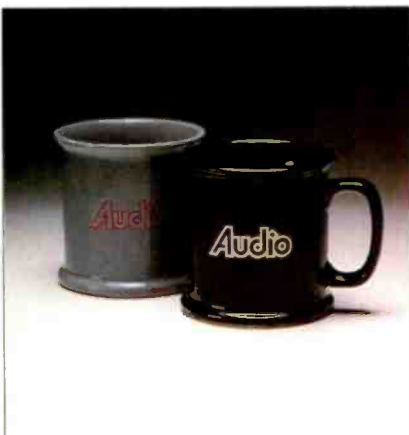
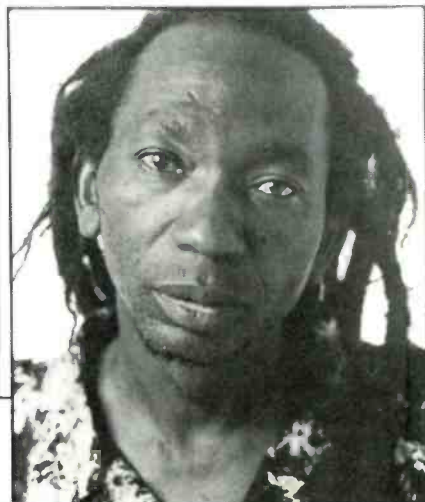

CLASSICAL MUGS

These distinctive 12-ounce English Ironstone mugs with large grip handles boast the logo of your favorite magazine. Available in set of two (black and gray) #65MUGS2 \$16.95 (\$3.00)

To order, call our TOLL FREE lines. We accept Visa, MasterCard and American Express, or send a check plus shipping and handling to AUDIO, P.O. Box #765, Holmes, PA 19043.

ORDER TOLL FREE
800-345-8112

B&W Salutes its #1 NYC *MATRIX* Dealer Stereo Exchange



802 Matrix—\$3,600

801 Matrix—\$5,000

"I was not prepared for what I heard the first time I played the (Matrix) 801's... We sat silent throughout the entire performance (something that has never happened before)..."

"...recovering from the initial shock... someone quietly said 'I've just got to have those speakers.'"

"In my opinion, the B&W 801 matrix 2 represents the pinnacle of current full-range dynamic speaker design"...

"...for the emotional involvement only live performance can provide... with absolute sonic honesty... the B&W 801 Matrix 2 Monitor is musically, the end of the road."

Lewis Lipnick—Stereophile, Vol. 10, No. 9

Come anytime to hear the entire line of B&W Matrix 2 Monitors, or call for an appointment.

STEREO EXCHANGE

The Block-Long Store

Authorized Dealerships:

Apogee, Arcam (#1 U.S. Dealer), Ariston, Audioquest, Boston Acoustics, B&K (#1 N.Y.C. Dealer), B&W (#1 N.Y.C. Matrix Dealer), California Audio Labs, Carver, Celestion SL, Conrad-Johnson, Counterpoint (#1 U.S. Dealer), CWD, Duntech, Eminent Technology, Grado, Infinity, Kimber Kable, Luxman, Magnum Dynalab (#1 E. Coast Dealer), Mod Squad (#1 E. Coast Dealer), MIT, NAD, Nitty-Gritty, ProAc, Revolver, Rogers (#1 U.S. Dealer), Sonus Faber, Sony ES, Sota, Spica (#1 E. Coast Dealer), Stax, Straightwire, Sumiko, Sumo, Target, Threshold & Forte (#1 N.Y.C. Dealer), Tice (#1 U.S. Dealer), Van Den Hul (#1 U.S. Dealer), VPI (#1 U.S. Dealer), Velodyne, Vendetta, VTL (#1 E. Coast Dealer), Wadia, Well Tempered (#1 E. Coast Dealer), etc.

new location: 627 BROADWAY, GREENWICH VILLAGE, NY 10012
our other location: 687-A BROADWAY, GREENWICH VILLAGE, NY 10012 212 505-2273
212 505-1111 800 833-0071 outside NYC MOST MAJOR CREDIT CARDS



No Red Norvo album fails to charm and delight. This one's got subtlety, warmth, passion—and Mrs. Norvo.

both rich and rhythmic enough to fashion into danceable Afro-pop. By transposing the odd meters, muted and buzz tones, and repetitious bouncy melodic patterns to electric guitar, bass, trap set (and now keyboards), Mapfumo established himself as the father of modern Zimbabwean pop. But his goals were more pragmatic. Though he drew on the guttural chants, yodels, and ululating shrieks common to traditional *mbira* music, he eschewed its typical subject matter of domestic affairs. Instead, he used the lyrics in his renowned *chimurenga* singles to condemn racism and oppression and to promote the guerrilla war.

Some 14 years later, Mapfumo and The Blacks Unlimited still sing at the barricades, as indicated by *Corruption*, their first American release. True, as a supporter of Robert Mugabe, Mapfumo is on the winning side, but his concern for the poor and oppressed, and contempt for the corrupt, are unabated. Truer still, the Shona lyrics render the subject matter meaningless to American ears, even as the music bubbles with a bleak, joyful beauty. Mapfumo and the band also evoke a haunting, mystical quality, as if the group were bringing something sacred to a secular form, which in fact they are. With Mapfumo's unforced delivery and the rhythmic clicking and clucking of the band, there are moments on *Corruption* where motion seems simultaneously suspended and headlong. It's as if Mapfumo's music and homilies embody not only the issues of the day, but the perpetual contradiction between tradition and modernity.

Don Palmer

Red Norvo Featuring Mildred Bailey
CBS/Portrait 44118, CD; AAD.

Sound: B/B+ Performance: A/B+

Xylophonist (he changed to vibraphone during the '40s) Red Norvo is one of the most creative, inventive, and

thoughtful musicians in the entire history of jazz.

Born in 1908, Norvo first attracted attention in vaudeville in the late 1920s, worked briefly with Paul Whiteman (where he met Mildred Bailey, the gifted singer he later married—they became known as Mr. and Mrs. Swing), began leading his own groups in 1935, and later worked with Woody Herman and Benny Goodman's big bands and combos. As leader or sideman, he played in dozens of classic big and small band jazz performances from 1933 until recently. No Norvo record fails to charm and delight. This one, culling some of his superb performances from 1933 to 1938 and originally issued on LP in 1969, is well worth owning.

The first dozen selections present some of the best players from the mid-'30s, including clarinetists Jimmy Dorsey, Benny Goodman, Artie Shaw, and Johnny Mince (a vastly underrated player in an era dominated by superstars), Bunny Berigan on trumpet, Charlie Barnet and Chu Berry on tenor sax, Teddy Wilson on piano, and Gene Krupa on drums. These 12 cuts are filled with subtlety, warmth, and passion! I'll single out just one—a version of Bix Beiderbecke's "In a Mist" that is, after Bix's 1927 masterpiece, the composition's best reading ever.

The album's remainder showcases the fine big band, featuring Mildred Bailey, that Norvo led until shortly before World War II. All four big band cuts were arranged by Norvo's then-trumpet-playing sideman, Eddie Sauter, who already displays one of big band writing's freshest, most original approaches. Listen to Sauter's score on what is, as far as I know, the best recording ever of Irving Berlin's "Remember."

Since Columbia's long-out-of-print, 25-year-old Mildred Bailey boxed set, no other Norvo product from the '30s has been made available. So it's a

shame that Portrait did not see fit to add four to six more of the many superb sides Norvo and Bailey recorded, together and separately, for various CBS-family labels up to 1942. Until that happens, do not fail to get this reissue—timeless performances of classic jazz.

Frank Driggs

Sweet and Lovely: James Moody
RCA/Novus 3063, CD; AAD; 71:11.

Sound: A— J.M.'s Performance: A—
Everyone Else: C+

We have some good news here, but we also have some bad. Well, not *bad*, just disappointing. Here's the good news. On *Sweet and Lovely*, James Moody offers an exquisite presentation: A myriad of scintillating alto and tenor sax solos and some elegant flute.

Moody's technique remains masterful, which is nice to know, because it'll be a sad day when this gentle man, whose beginnings date to be-bop's (he's 64), starts to lose it. This hasn't happened yet: Listen to Moody's closing alto contribution to "Melancholy Baby," his Texas tenorisms on "Get the Booty," and his gorgeous, crystal-clear alto on the title track.

As terrific as Moody sounds, the other members of his quartet here—keyboardist Marc Cohen, bassist Todd Coolman, and drummer Akira Tana, as well as dear friend Dizzy Gillespie, who appears in spots—lag behind. Cohen, very prevalent throughout, shows instances of quality ("My Ideal"). But in the end, nobody here, Gillespie included, comes close to Moody.

Yet what really play havoc with *Sweet and Lovely* are the misguided instrumentation and arrangements—specifically, the heavy-handed use of electronic keyboard overlays. Who needs them on a low-keyed version of "Confirmation"? Cohen's own piano work becomes clouded by his synthesizer. A tune like "Skippin'" exposes the good and the bad, with a marvelously strong tenor solo undermined by a synthesizer that smacks of cheesy commercialism. As far as I can tell, there was no need to use electronics on *Sweet and Lovely*, and that has nothing to do with purism; it's just dead wrong in this scenario. It's an element of schlock that deflates Moody's very fine performance.

Jon W. Poses

Photograph: © David Gahr

DEALER SHOWCASE



Steve Campbell, owner

- Spectral
- Bryston
- Magnum Dynalab
- Entec
- McIntosh
- Adcom
- NAD
- Luxman
- CWD
- Well-Tempered
- Van den Hul
- MIT
- Rega
- Grado Signature
- California Audio Labs
- Mitsubishi Video
- Tice Audio
- Component Guard
- Martin Logan
- Klipsch
- Vandersteen
- Celestion SL
- Wilson Audio
- Spica

205-539-9806

Monday-Saturday 10am to 6pm CST

All products priced at manufacturers suggested retail
Major credit cards accepted

2212 Whitesburg Dr., Suite E
Huntsville, AL 35801

SOUTHERN CALIFORNIA'S

most knowledgeable HI-FI Dealer.

atlantic stereo,
29 years at the same location.

Call us for the best advice on how Separate Audio Components can increase your stereo listening enjoyment.

Ask for Ames—
your STEREO ANSWER MAN.

Full-line stocking Dealer on Yamaha, Bose, Sony ES, Boston Acoustics, Niles, Soundcraftsmen, etc.

714-646-8896

445 E. 17th St., Costa Mesa, CA

audio one

ARCICI

BEDINI • CARDAS

CONVERGENT AUDIO TECHNOLOGY

DIMENSIONAL OPTICS

EBONY ACOUSTICS

EMINENT TECHNOLOGY

MAVRICK AUDIO

MELOS • MERRILL

MOREL & FEURING

NONSPEAKER

FREE SHIPPING (US) • IN HOME DEMOS
CUSTOM HOME INSTALLATIONS

LOS ANGELES
SAN DIEGO

818/883-3826
619/480-4804

the
one,
the
only



OVER 25 DIFFERENT MAKES AND MODELS ~
PROFESSIONAL, HOME, AND PORTABLE DAT RECORDERS
WITHOUT COPY CODE OR RECORDING RESTRICTIONS. ALL
MACHINES, ACCESSORIES, & TAPES IN STOCK NOW. WE HAVE
THE MOST EXPERIENCED DAT SALES STAFF ANYWHERE IN
THE U.S.—IN ADDITION TO THE LOWEST PRICES, FASTEST
SERVICE DEPARTMENT AND LARGEST SELECTION.

• FULL WRITTEN WARRANTY PLUS FREE LOANERS •
• IMMEDIATE DELIVERY • NO DEPOSITS REQUIRED •

• HOME & PORTABLE DAT •

| | | | |
|-----------------------------|------|---------------|------|
| AIWA XD-999 | 995 | JVC XD-2700 | 1800 |
| AIWA XD-001 | 1800 | JVC XD-21100 | 2000 |
| SONY DTC-M100 | 1400 | JVC XD-2900 | 2250 |
| SONY DTC-300ES | 1500 | AKAI D-9000 | 1800 |
| SONY DTC-500ES | 1900 | AKAI D-930 | 1400 |
| SONY DTC-1000ES | 2000 | PIONEER D-900 | 1900 |
| SONY TCD-D10 | 2300 | ALPINE 5700 | 1200 |
| • PROFESSIONAL DAT • CALL • | | | |

2624 Wilshire Blvd. (213) 828-6487
Santa Monica, CA 90403 fax: (213) 828-8757

SERIOUS AUDIOPHILES DESERVE SERIOUS SERVICE.

Acoustat • Advent • AKG • Audible Illusions •
Audio Pro • Audioquest • Beyer Dynamic •
Blaupunkt • Bose • Celestion • Counterpoint •
Crest • Dahlquist • dbx • DCM • Dual • Fosgate •
Grado Signature • Haller • Harman Kardon • JBL •
JSE • Lexicon • Magnum Dynalab • Mod Squad •
NEC • Niles Audio • Nitty Gritty • Ohm Acoustics •
Onkyo • Ortofon • Philips • Precise • Proton •
PS Audio • Revox • SAE • SME • Sonance • Sony •
Sumiko • Stax • Straightwire • Superphon •
Talisman • Tannoy • TDK • Teac • Thorens •
Ungo Box • Velodyne • VPI • Wharfedale

Reference AUDIO/VIDEO

Call Us . . . (213) 517-1700

18214 Dalton Ave., Dept. A2, Gardena, CA 90248

Dealers . . . Just
as you're reading
this ad, so are
thousands of
buyers.

For complete
information on
placing your
ad, call
Carol Berman at
(212) 767-6292.

VALUEable

Products, Service and Consultation
designed to give you the maximum
performance for your dollar.

Adcom • B&W • Polk • NAD • Celestion • Carver
PS Audio • Kyocera • M&K • Denon • Terk
Proton • Pioneer Video • ADS • Tera
Canon Video • Stax • Magnum • Linn • Hafler
Ambria • Thorens • Mod Squad • Lexicon
Grado • Signet • Klipsch • Rotel • Nitty Gritty
Tara Labs • Livewire

**Systems
Design
Group**

(213) 370-8575
1310 Kingsdale Ave.
Redondo Beach, CA 90278
Mon-Fri 11am-7pm
Sat 11am-6pm

ProMusica

AUDIO SPECIALIST

WE SELL MUSIC: AUDIO EQUIPMENT
IS SIMPLY A MEANS TO THAT END.

- ACCUSTAT
- ADCOM
- ARAGON
- ARCAM
- ARCICI
- AUDIOTECH
- BEYER
- CREEK
- CWD
- DUAL
- ENERGY
- GOLDRING
- GOODMANS
- GRADO
- HARMAN/KARDON
- JANIS
- LINN
- MOD SQUAD
- NAIM
- PARADIGM



EXPERT ASSISTANCE •
INSTALLATIONS • SERVICE

2236 N. CLARK • CHICAGO, IL 60614 • 312-883-9500

Visit our **SPEAKER FACTORY SHOWROOM**
at 3021 Sangamon Ave., Springfield, IL 62702

Authorized Dealer:

- B&K/Sonata
- Thorens
- Sumo
- Soundcraftsmen
- Parasond
- Belles
- Fosgate
- Audio Dynamics
- Audioquest

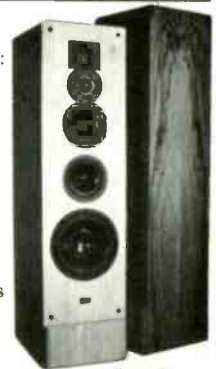

800-283-4644
call for literature

LEGACY
SIGNATURE II

Reel to Real Designs

| | | |
|----------------|---------------|--------------|
| Audio Research | Infinity | Meitner |
| Oracle | Hafler | Vandersteen |
| KEF | Threshold | Rega Planar |
| Tandberg | Revox | Nitty Gritty |
| Snell | CWD | Sony ES |
| Nakamichi | MIT | Sme V |
| Denon | Koetsu | Velodyne |
| Carver | Monster Cable | Adcom |
| Rogers | Linn HiFi | Janis |
| NAD | Perreaux | |
| B&W | | |
| Stax | | |

401
Worcester
Road
Framingham
Massachusetts
01701

Telephone
508
879
3556

The
ultimate
audio
store.

Natural Sound.

O'Coin's

SERVING CENTRAL NEW ENGLAND WITH VALUED PRODUCTS FOR OVER 30 YEARS

ACOUSTAT, AKG, APATURE, ARISTON, ASC, AUDIO CONTROL, AUDIOQUEST, BEYERDYNAMIC, BOULDER, CAMBER, CARVER, DIAL, ESOTERIC, FORTE, HAFLER, HARMAN/KARDON, KEF, LEXICON, MISSION, NAD, NITTY GRITTY, ONKYO, ONKYO GRAND INTEGRA, ORTOFON, PARAGON, PARASOUND, POLK AUDIO, REVOX, SONY, TECHNICS... AND MANY MORE AT PRICES THAT SOUND RIGHT.

O'COIN'S

239 Mill Street Worcester, MA 01602
508-791-3411 x 315
M-F 10-9pm, Sat 9-6pm
DISCOVER, MASTERCARD, VISA ...
FINANCING AVAILABLE

Aragon ... Apogee ... Audible Illusions
... Audioquest ... Audio Research ...
Bryston ... Canon ... Compact Discs
... Counterpoint ... Creek ... CWD ...
Denon ... Dynavecort ... Grado ...
Jamo ... Lexicon ... Livewire ...
Magneplaner ... Magnum Dynalab ...
Mariah ... Mark Levinson ... Mission
... NAD ... Nova ... Pinnacle ...
Revolver ... SME ... Sota ... Sumiko
... Sumo ... Stax ... Symdex ...
Vandersteen ... VPI ...
And Much More!

Hi Fi Exchange

FORESIDE MALL · ROUTE ONE
FALMOUTH, ME 04105
(207) 781-2326

Savant Audio & Video

*The Most In Musical Enjoyment
For The Novice & Connoisseur*

Apogee • Arcici • Audio Prism
AudioQuest • Basis • Benz • Cardas
Chesky • Chicago Speaker Stand • Classé
Clearaudio • Cogan Hall • Creek • Delos
Distech • Dorian • Electron Kinetics
Eminent Technology • Garrott • Garth
Harmonia Mundi • Lantana • Last • Magnan
Merrill • Mod Squad • Mogami • Morch
Nestorovic • Neutrik • Opus 3 • Pro Ac
QED • Rega • Reference Recordings
Sequerra • Sheffield Lab • Sims • Souther
Superphon • Tara Labs • Target
Tice Audio • Vendetta Research • VMPS
VPI • Wadia • Water Lily & More

287 Clarksville Road
Princeton Jct., N.J. 08550
(609) 799-9664

THE FINEST IN HOME AUDIO, CAR STEREO & VIDEO EQUIPMENT

AUTHORIZED DEALER FOR

- ADS
- ADVENT
- AIWA
- AKG
- ALTEC LANSING
- AUDIO CONTROL
- AUDIO SOURCE
- CERWIN-VEGA
- CITIZEN
- CWD
- dbx
- DCM
- DENON
- HAFLER
- INFINITY (car)
- KENWOOD
- KICKER
- MITSUBISHI
- MONSTER CABLE
- MISSION
- ONKYO
- ORION CAR AMPS
- PHILIPS
- PINNACLE AUDIO
- POLK AUDIO (car)
- PROTON
- SAE
- SANSUI
- SONANCE
- SONY
- SOUNDCRAFTSMEN
- STAX
- TOSHIBA
- TRIAD
- YAMAHA

Sound CITY
Meadtown Shopping Center
Route 23 South
Kinneton, N.J. (201) **838-3444**

ALPHA STEREO

Quality Components, Professional Installation & Service



"We are known for the
companies we keep"

Adcom, NAD, Rotel, Onkyo, Dual,
Mission, Celestion, Paradigm,
Soundstream, Audioquest,
Coustic, Monster Cable, Ortofon
Polk Audio, Alpine, AKG

Northern NY's oldest & most renowned dealer.
345 Cornelia St., Plattsburgh, NY 12901

518-561-2822

Fax: 518-561-2961

Monday-Friday 10am-8pm, Saturday 10am-6pm
Mastercard, Visa, Discover, Amex

Hear it all!

Apature • Arcam • ASC Tube Traps • Audio
Control • Audio Research • Audioquest •
B&W • Boston Acoustics • Dual • Entec •
Grace • Grado • Krell • Krell Digital
• Kiseki • L.A.S.T. Products • Laser Video
Discs • Lazarus • Magnum-Dynalab • Martin-
Logan • Mirage • MIT • Monster Products •
Mobile Fidelity Recordings • Premier Stands
• Niles • NAD • Ortofon • Reference
Recordings • RPG Diffusors • Sansui/Vintage
• Shure HTS • Signet • Simply Physics • SME
• Sunrise • Sony ES • Sony AV Laser • Sound-
stream • Stax • Sumiko • Talisman • TDL •
Terk • That's Tape • Theta Digital • Van Den
Hul • VPI • WBT • Well-Tempered • Wilson
Audio, etc.

**Altair
AUDIO**

1980 Central Ave.
Albany, NY 12205
518-452-3525

AUDIO/FEBRUARY 1990

audio experts

Integrity and Service!

SPECIAL EVENT

Wednesday, Feb. 20th 6-9pm

Join us while factory personnel
from **Energy** are on hand to
demonstrate their new line of
loudspeakers. Coming from the
company that brought us the
Pro 22 & Reference Connoisseur.
Refreshments will be served.
Reservations suggested.

We Specialize In Custom Installations.

(914) 698-4444

875 Mamaroneck Ave.,
Mamaroneck, NY 10543

para

WE KNOW ELECTRONICS FROM THE INSIDE OUT

harman/kardon

Hafler vector research

EPIQUIRE **JBL**

Panasonic **CONCORD**
(CAR AUDIO)

maxell **TDK**

APATURE **STANTON**

MAIL ORDERS WELCOME

1-800-542-7443

15 Clinton Street • Plattsburgh, NY 12901

SALES **CITY** SERVICE

ELECTRONICS

DEALER SHOWCASE

ARCH ELECTRONICS INC.

2006 Chestnut St., Phila, PA 19103
(215) 563-4660

Complete Audio Video Store for
All Levels of HiFi Enthusiasts

Featuring:

| | |
|----------------|------------------|
| ADVENT | GRADO |
| ARISTON | HAFLER |
| AUDIO DYNAMICS | JBL |
| BOGEN | MONSTER CABLE |
| CAMBRIDGE | PASO |
| CELESTION | SONY HI-FI/VIDEO |
| DISCWASHER | TECHNICS |

... AND MORE!!

MAIL ORDER INVITED

Accepting Visa & Mastercard

PHILADELPHIA AUDIOPHILES

We proudly represent:

| | | |
|-----------------|---------------|----------------|
| Acoustic Energy | Kimber Kable | Rogers |
| Adcom | Kinergetics | Rotel |
| Apogee | Klyne | Royd Audio |
| Arcam | Koetsu | Snell |
| Ariston | Lazarus | Soundcraftsmen |
| Audioquest | Maplenoll | Sound Lab |
| B&K Components | MFA Systems | Stax |
| Cambridge | Micro Selki | Straightwire |
| Celestion | Mission/Cyrus | Sumiko SME |
| Counterpoint | M&K Sound | Superphon |
| Dynavector | Mod Squad | Systemdek |
| Eminent Tech. | NAD | Target |
| Goldring | Oracle | Triad Design |
| Grace | Parasound | Van Den Hul |
| Grado | PS Audio | VPI |
| Infinite Slope | Rega Planar | Well Tempered |

SOUND SERVICE CO.

8010 Bustleton Ave. Philadelphia, PA 19152
(215) 725-1177-78 Bank Cards Accepted

The Houston Authority

AUDIO

• B&W • B&K • Sony ES • NAD
• Carver • Allison • Arcici • Velocityne
• Lexicon • Canton • Shure • Stax
• Sound Connections • Van den Hull • M&K
• Dual • Ortofon • Fineline • Pinnacle
• Proton • Bose • Sonrise/Xylophile • Target
• Monster Cable • Sonance • Terk

VIDEO

• Sony • Proton • JVC • Minolta • Pioneer

We are not a mail order discounter



The Groove Audio Video
2624 Westheimer at Kirby
Houston, Texas 77098 713-523-2900

OMNI SOUND

For the
sound
mind

Analogic Design Group
ASC Tube Traps
Athena
Audible Illusions
Audioquest
Avalon Acoustics
Chicago Speaker Stand
Clearaudio
Duntech
Eminent Technology
Forte' Audio
Grado
Jeff Rowland Design Group
Kimber Kable
MIT
Monster Cable
Nitty Gritty
Onkyo
Precise Acoustics
Proton
PS Audio
Sony ES
SOTA
Souther
Spectrum
Spica
Thiel
Threshold

NEW ARRIVAL
SONY ES...

DALLAS, TEXAS . . . 214/964-6664
19020 Preston Road (75248)

Vermont's Audio Leader!

DUAL
ARISTON
TOSHIBA
PARADIGM • A&R CAMBRIDGE
DENDN • SUPERPHON • KLIPSCH
KEF • ADVENT • ADS • ROTEL
MARANTZ • REGA • AUDIOQUEST
B&K • AUDIO CONTROL • AKG
SENNHEISER • CREEK • GRADO
TARGET • AVIA • AUDIOLAB
ORTOFON • SPICA • KIMBER
AIWA • PRO-AC • VPI • MAGNUM

"INTELLIGENT AUDIO AT
REASONABLE PRICES"
802-863-4372



207 College St • Burlington, VT 05401

SENSIBLE, PERSONAL HI-FI ADVICE, TOLL-FREE

HERE IN VERMONT, PEOPLE DEMAND VALUE.
WE DON'T WASTE CUSTOMERS' MONEY,
AND NEITHER DO THESE FOLKS:

ADCOM ARISTON CELESTION DUAL
GRADO LABS HAFLER MAGNAOX CD
MOD SQUAD MONSTER CABLE NAGAOKA
ORACLE POLK ROTEL WHARFEDALE
B&W

5-YEAR WARRANTIES ON ALL NEW EQUIPMENT,
INCLUDING CD RAINERS, TURNTABLES, AND TAPE DECKS!
NO CHARGE FOR SHIPPING.

128 MAIN ST.
BRATTLEBORO
VERMONT 05301
SCIENTIFIC STEREO
1-800-456-HIFI

Be as selective
in where you
buy as you
are in what
you buy.

We know they're hard to resist. Guaranteed lowest prices in the universe. Every day's a sale day. Big, bigger, biggest.

But, buying a serious audio or video component isn't the same as buying a dishwasher or microwave. And that's why AUDIO recommends you visit an independent A/V specialty retailer when shopping for equipment.

A/V product is the heart of his business, not a "profitable or trendy" sideline. That means the independent dealer will always be more concerned in helping you select the proper equipment than he will be helping himself to a commission.

So, be as selective in where you buy as you are in what you buy. Support your independent specialty dealer.

Audio The Equipment Authority

AUDIO ON-SALE AT THESE FINE STORES

AUDIO DEALER LISTING

ALABAMA

Huntsville
Audio Video Lab.
2801 Newby Rd., Suite A

ARIZONA

Douglas
DM Electronics
929 G. Ave.

ARKANSAS

Paragould
Sound Choice
1605 W. Kings Hwy

CALIFORNIA

El Centro
Mando's Electronics
244 W. Main

Salinas
Bay Video & Stereo
1168 S. Main

Eureka
Second Wind
3332 T St.

Lakeport
Bruck's Car Stereo
310 Main Street

Pomona
Dr of Audio
575 7th Ave
Auto Sound
546 W. Holt Ave.

Calexico
Seiki Stereo
700 Imperial Ave.

Torrance
Dimensions In Stereo
19800 Hawthorne Blvd.

Harbor City
Tom Tronics Inc.
25904 S. Western Ave.

Ukiah
DFM Car Stereo
1080 N. State St.

Santa Cruz
Auto Sound
546 W. Holt Ave.

Modesto
CD Exchange
435 McHenry

COLORADO

Colorado Springs
Drive In Radio Inc.
165 West Arvada

Grand Junction
Stereo Warehouse
729 North Ave.

The Sound Shop
528 South Tejon
636-1684

CONNECTICUT

Waterbury
Zinno Music Inc.
195 Meriden Rd.

Hartford
New York Sounds
624 Wethersfield Ave.

FLORIDA

Tampa
Audio Visions
14733 Dale Mabry Hwy N.

Fort Pierce
Tape Deck
Sabal Palm Plaza

Vero Beach
Audio Shack
1976 14th Ave.

1190 W. Hwy 151

WEST VIRGINIA

Huntington
Cartunes
436 4th Ave.

GEORGIA

Atlanta
Stereo & Video Designs INC.
6300 Powers Ferry
High Fidelity SSS
322 E. Paces Ferry Rd. N.E.

Douglas
Video Unlimited
Route 3 Box 1170

ILLINOIS

Rockford
Absolute Audio
4227 Maray Dr.

Bloomington
Lasers Edge
512 IAA Dr.

INDIANA

Bloomington
Campus Audio
413 E. Kirkwood Ave.

Portage
Who's Your Entertainment
P.O. Box 22

Huntingburg
Audiosource Electronics
322 W. 4th

KANSAS

Shawnee Mission
Audioport
7329 W. 97th

Wichita
Advance Audio
5507 E. Kellogg

Music, Inc.
3203 E. Douglas

LOUISIANA

New Orleans
Tulane Stereo Hi-Fi Co.
1909 Tulane Ave.

Jim Russel Rare Records
1837 Magazine

MASSACHUSETTS

Plymouth
PM Systems
20 Court St.

MICHIGAN

Holland
Vanden Berg Stereo Svc.
227 James

Grand Rapids
Electronic Sound Equip Co.
2249 Division S

Rochester
Sound Choice
235 S. Main Street

MISSOURI

Joplin
Air and Sound
2010 Virginia Ave.

St. Louis
Hammond Electronics
110164 Watson Rd.

Columbia
National Audio/Video Svc.
1301 Vandiver Square

Monroe City
Rowdy's TV & Electronics
Mark Twain Plaza

Hartville
Coy's Sight & Sound
Rt 2 Box 174A

NEBRASKA

Kearney
Center Stage Audio/Video
3817 2nd Ave.

NORTH CAROLINA

Asheboro
Audiotech
1219 Old Farmer Rd.

Greenville
Todd's Stereo Center
105 Trade

Fayetteville
Tri-M Sounds
831 Bragg Blvd.

NEW HAMPSHIRE

Concord
Audio of New England
31A S. Main

NEW JERSEY

Vincetown
Sound Waves
RD 10 RT 206

Jersey City
Kay's TV Sales & Service
704 Bergen Ave.

Bloomfield
Sound Reproduction
237 Bloomfield Ave.

Chester
Landes Audio
Chester Mall, Rt 24

Verona
Audio Connection
615 Bloomfield Ave.

North Plainfield
Stereo City
950 US Hwy 22

Livingston
Metro Media Design Inc.
15 Tarlton Dr.

Plainsboro
Sound Ideas
Princeton Meadows Shopping
Center

NEW YORK

Liverpool
Audio Excellence
4974 Alexis Drive

Hartsdale
Stereo Depot
155 S. Central Ave.

Depew
Phillips Communications
5335 Transit Rd

New York
Electro Brands Inc.
43 Warren

Montauk
Montauk TV Service
Main Street

De Witt
GP Communications
3330 Erie Blvd. E

Orchard Park
Stereo Chamber Inc.
Union & Orchard Pk. Rds

OKLAHOMA

Oklahoma City
Mobile Connections Inc.
227 NW 63rd

OHIO

Westerville
Audio Horizons
20 Westerview Dr.

Marietta
Photo Center/Sound Room
132 Putnam

Toledo
Siegel Auto Radio
1110 W. Sylvania Ave.

PENNSYLVANIA

Fairless Hills
Audiolab Stereo Center
500 Lincoln Hwy.

Bethlehem
Palmer Audio
3650 Nazareth Pike
Hermitage
Sounds Good To Me
2481 E. State

Waynesboro
Russell's Car Stereo Custom
1077 Buchanan Trl E

SOUTH CAROLINA

Columbia
Sound Advice
2821 Ashland Rd.

Seneca
CrusIn Sounds
916 AA Hwy 123 By Pass

TENNESSEE

Selmer
Electronic Services Ltd.
110 South Y Square

TEXAS

Chireno
Kelly's Video
P.O. Box 52

Dallas
Omni Sound
4833 Keller Springs

Beaumont
Salmar Audio
5904 Eastex Frwy

Houston
Soundscape
2304 Portsmouth
Home Entertainment
2617 Bissonnet

Harlingen
Sound Lab
1042 North Business 77th

Fort Worth
Highland Mobil
7356 Dogwood Pk

San Antonio
Auto Sec & Sound Systems
6893-2 Bandera Rd.

Corpus Christi
Audio Video Designs
4904 S. Staples

Laredo
Audio Systems Inc.
4500 San Bernardo

VIRGINIA

Danville
Aeolian Svcs.
215 Main Street

Newport news
Go-Ho Auto Audio
10817 Warwick Blvd.

VERMONT

Brattleboro
Scientific Stereo
128 Main Street

WASHINGTON

Kirkland
Sound Plus
12407 NE 124th Street

WISCONSIN

Greenbay
Hi-Fi Heaven
1917 S. Webster Ave.

La Crosse
Fiers Electronics
2755 George

Platteville
Tri-Com/Radio Shack

Dealers interested in Audio should call 1-800-221-3148

CLASSIFIED ADVERTISING

CLASSIFIED ADVERTISING LINE ADVERTISING

CLASSIFIED LINE ADS ARE PAYABLE IN ADVANCE BY CHECK OR MONEY ORDER ONLY. (Sorry, we cannot accept credit cards or bill for line advertising.) ALL LINE ORDERS should be mailed to:

AUDIO MAGAZINE, P.O. Box 9125
Dept. 346-01, Stamford, CT 06925

ORDERS WILL NOT BE PROCESSED WITHOUT ACCOMPANYING PAYMENT FOR FULL AMOUNT. Agency discounts do not apply to line advertising.

CLOSING DATE—First of month two months preceding the cover date. If the first of the month falls on a weekend or holiday, the closing date is the last business day preceding the first. ADS RECEIVED AFTER THE CLOSING DATE WILL BE HELD FOR THE NEXT ISSUE UNLESS OTHERWISE STATED.

GENERAL INFORMATION—Ad copy must be typewritten or printed legibly. The publisher in his sole discretion reserves the right to reject any ad copy he deems inappropriate. **ALL ADVERTISERS MUST SUPPLY:** Complete name, Company Name, Full street address (P.O. Box numbers are insufficient) and telephone number. Classified ads do not carry Reader Service Card Numbers. Frequency Discounts not filled will be short rated accordingly.

DISPLAY ADVERTISING

DISPLAY ADVERTISERS should make space reservation on or before the closing date. Ad material (film or velox) may follow by the tenth. **DISPLAY ADVERTISERS MUST SUPPLY CAMERA READY ART.** PRODUCTION CHARGES WILL BE ASSESSED ON ANY AD REQUIRING ADDITIONAL PREPARATION.

ALL DISPLAY CORRESPONDENCE should be sent to:

Carol A. Berman, AUDIO MAGAZINE
1633 Broadway, New York, NY 10019

FOR RATES & ADDITIONAL INFORMATION:
DISPLAY ADS: Carol Berman (212) 767-6292
CLASSIFIED LINE ADS: 800-445-6066

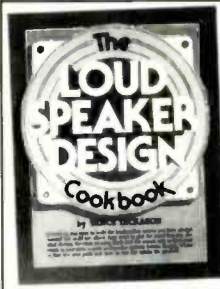

FOR SUPERB SOUND AT HOME AND ABROAD

The world's best resource books on excellent loudspeaker sound whether your listening room is stationary or mobile, and whether you're filthy rich or dirt poor—you can buy smarter or build frugally. Only \$19.95 each (Add \$1.75 P&H). MC/Visa welcome.

OLD COLONY BOOKSHELF

PO Box 243, Dept. A92, Peterborough, NH 03458
(603) 924-6371 FAX: (603) 924-9467



ANNOUNCEMENTS

Aaaannouncinggggg!! Aaaannouncinggggg!!

MOSCODE HYBRID HAFLER

POWER AMPS—Enjoy the benefits of Moscode™ Tube Technology with a Moscode™ Conversion for Hallers. Call/Write: CLASSIC AUDIO, 238 Liberty Ave., New Rochelle, NY 10805. (914) 633-3039.

Audio Abode, Dallas' sensible alternative, features products by Audioquest, Aural Symphonics, B&K, BEL, Chesty, Clearaudio, Eminent Technology, Focus, Maplenoll, Melos, Morrison, Quicksilver, Reference, Sheffield, Superphon, Tice, VPI and others. Auditions by appointment, evenings and weekends. (214) 369-2092.

AUDIO RESOURCE HAS MOVED to its new 4400 sq. ft. store at 3133 EDENBORN AVENUE, METAIRIE, LOUISIANA 70002. We now have five private listening rooms where you can audition one of the LARGEST SELECTIONS of HIGH END AUDIO EQUIPMENT in the country. **AUDIO RESOURCE** continues to offer precision-matched tubes, plus sales, service, and restoration of vintage components. Call or write for information on our products and services **AUDIO RESOURCE**, 3133 EDENBORN AVE, METAIRIE, LA 70002. (504) 885-6988.

ANNOUNCEMENTS

AUDIO CLASSICS

Precision Stereo Components Bought-Sold-Traded-Repaired-Modified-Updated-Appraised. **AMPLIFIERS:** Audio Research D76 \$900; Audionics CC2 \$349; Conrad-Johnson MV50 (\$1685) \$1000, MV75 \$1000, Premier 1B (\$5950) \$3900; Denon POA6600 (\$1500) \$900; Halfer XL280 Demo (\$675) \$575, XL600 Demo (\$1195) \$995; Krell KMA100 II (\$6000) \$3000; McIntosh MC225 \$66-800, MC250 \$400, MC2002 (\$1895) \$1500, MC2205 (\$1895) \$1400; Nakamichi PA5 (\$1195) \$700. **CD PLAYERS:** Analogic CDB560 (\$1200) \$600; Denon DCD3300 (\$1700) \$1000; McIntosh MCD7000 \$7-800, MCD7005 \$1200; Mod Squad CDB650 (\$1200) \$600. **CROSSOVERS:** Krell KRX1 \$930; Levinson LNC2 \$1975. **EQUALIZERS:** Audio Control Richter Scale \$349, Ten Plus (\$329) \$295; McIntosh MQ101 \$175, MQ102 \$60, MQ104 (\$500) \$99-285, MQ107 (\$650) \$400. **HEAD AMPS:** Step-up Transformers, Call: Counterpoint SA2 (\$995) \$595; McIntosh MCP1 (\$649) \$450. **INTEGRATED AMPLIFIERS:** McIntosh MA230 \$399; MA5100 \$400, MA6100 \$500-600. **PREAMPLIFIERS:** Conrad-Johnson PV1 \$375, PV5 (\$1485) \$900; Counterpoint SA3.1 (\$995) \$600; Denon DAP500 (\$1400) \$840; Halfer Iris Demo (\$800) \$679; Krell KRS1A (\$8200) \$4900; McIntosh C20 \$600, C24 \$250, C30 \$1100, C31V (\$1895) \$1500, C32 \$850, C34V (\$2450) \$1700, C35 (\$1999) \$1600; Win Jewel \$600. **PROCESSORS:** Quad 8 Surround Sound Processors. Call. Audio Control Phase Coupled Activator (\$279) \$239; dbx 110 New (\$99) \$49, 124 (\$339) \$150, 224 (\$275) \$175; Fosgate 101A \$300; Lexicon CP1 (\$1295) \$1050, CP2 (\$895) \$799; Shure HTS5200 \$449; Sony SDP505ES \$350. **RECEIVERS:** McIntosh MAC1700 \$450, MAC1900 (\$949) \$500. **SPEAKERS:** Acoustat Spectra 33 (\$2250) \$1999; B&W Active 1 (\$3394) \$2500, 802 (\$2500) \$1500, 808 (\$8000) \$4000, DM100 (\$300) \$180, Matrix 1 \$600, Matrix 3 (\$2198) \$1000; Castle Durham (\$575) \$450; Duntech Marquis (\$5500) \$3300; JSE Infinite Slope Used 2 (\$2295) \$1400; McIntosh ML1C \$500, ML2C (\$1598) \$700, ML4C (\$2400) \$900-1800, XL1W (\$549) \$375, XR5 \$750, XR6 \$800; Velodyne 1200 (\$895) \$815, UL12 (\$1195) \$1095, UL15II (\$1795) \$1669, UL18II (\$2595) \$2395. **TAPE DECKS:** B&O 9000 (\$1299) \$600; Crown Royal \$400; JVC KDABJ \$200; A77 III \$700. **TEST EQUIPMENT:** Audio Control SA3050A 1/3 Octave Real Time Analyzer (\$965) \$877; McIntosh MPI4 \$1400; Sound Technology 1000A \$1500, 1701A (\$4950) \$3250. **TONE ARMS:** Denneson ABLT1 (\$2000) \$1000; Eminent Technology (\$600) \$300; Monks \$90; SME V (\$2250) \$999; many more, call. **TUBES:** Many major brands. **TUNERS:** Halfer Iris \$450; Magnum Dynalab FT101 Demo (\$698) \$599, 205 Demo (\$229) \$199, FT101A Demo (\$1195) \$995; McIntosh MR55 \$100-350, MR65B \$200-500, MR71 \$600. **TUNER PREAMPS:** McIntosh MX110 \$250-500. **TURNTABLES:** Dual CS5000 (\$569) \$390; Luxman PD555 (\$3590) \$1500; Technics SP10II (\$1250) \$625; VPI HW19 III (\$1140) \$700. Audio Repairs-Updates-Modifications Cliff Ramsey, former Senior Service Technician at McIntosh with over 25 years experience. **FREE Catalogue.** Layaway Program. Major Credit Cards accepted. 8AM-5PM EST Mon.-Fri., **AUDIO CLASSICS**, POB 176AAA Walton, NY. 13856

607-865-7200

—Audio Advertiser for over a Decade—

SOTA Panorama: Small is Beautiful

To neutralize the loudspeaker enclosure—so drivers move only with the music—that is the first task of the SOTA design team. Minimize colorations at the source and you neutralize all sorts of room gremlins.

That is what SOTA does best. We neutralize gremlins. Using mass, rigidity and all the energy controls for damping resonances that made us America's pre-eminent turntable maker, we propose to transform the small monitor just as SOTA turntables redefined the high end turntable world eight years ago. Our goals:

- Resolution and coherence second to none, especially in bass extension.
- Compatibility with the widest range of electronics and rooms.
- A gorgeous form equal to the gorgeous performance.



The result of our research: the optimum "truncated pyramid" shape; all curved corners to minimize refraction; and heavily-braced, laminated 1/4" thick walls. Plus, the latest kevlar drivers and ultimate crossover components. The classic two-way speaker may never be the same.

SOTA
industries

P.O. BOX 7075, Berkeley, CA 94707

ANNOUNCEMENTS

ATTENTION TUBE KIT BUILDERS

We are pleased to introduce the first in a series of "complete" kit products in the Dynaco tradition with component quality and performance exceeding that of the mainstream retail competition. The **SFM-75 MONO-BLOCK AMPLIFIER** has been co-designed with Joe Curcio (Audio Amateur/Glass Audio) and features a derivative of his acclaimed input/driver/regulation circuit. The amplifier incorporates the best parts available and can be configured for all international line voltages. **PROJECTED PRICE: \$1495.00 per pair. PROJECTED AVAILABILITY: February 1990.** We also feature upgrade kits for a variety of tube products including the CURCIO ST-70 and MK-III re-designs as well as a designer authorized upgraded version of the DANIEL PreAmp.

WONDERCAP, REL-CAP, SOLEN, WIMA, HOLCO, VISHAY, CARDAS, VANDENHUL, TEFLON, ALPS, TKD, GRAYHILL, WBT, TIFFANY, NEUTRIK, GOLD AERO, ETC. Please CALL, WRITE or FAX for our free 1990 KIT & PARTS Catalogue.

SONIC FRONTIERS

181 KENILWORTH AVENUE, TORONTO, ONTARIO,
CANADA, M4L 3S7. TEL: (416) 691-7877,
FAX: (416) 338-2562.

THE BEST WAY TO BUY AND SELL used audio equipment is thru telephone classified. No charge to buyer. Call (609) 927-2152 anytime.

\$CASH\$ FOR USED AUDIO EQPT. 215-886-1650

THE STEREO TRADING OUTLET, 320 OLD
YORK RD., JENKINTOWN, PA. 19046

"THE CONNECTION"

Professional high definition connector pin for 12 gauge to 8 gauge speaker cable. Tapered, unique, rectangular shape with anti-slip connecting notches and treble enhancement grooves. Precision machined of high conductive brass with 23K gold plating. Fits compression connection size 16 gauge or larger. **TREMENDOUSLY SUPERIOR TO STANDARD ROUND PIN.** twenty times more surface contact and five times more massive (size of 11 gauge speaker cable). Crimpable design. **An inexpensive upgrade that can be heard.** Specify size of cable when ordering. \$17.50 per four pack and \$31.50 per eight, include \$3 ship/hand plus state sales tax where applicable. Send orders or inquires to: JBA ENTERPRISES, 10646 West Sundance Mountain, Littleton, CO. 80127 or phone (303) 973-0292.

DUNTECH/MERLIN Lowest Prices In U.S.

"We will not be undersold."

Authorized Dealer

OEM Audio & Video, 9330 Georgia Avenue, Silver Spring,
MD 20910. (301) 589-1191

HIGH DEFINITION SPEAKER CABLE. Top quality fine strand ropelay design. 10 gauge 95 cents/foot & 12 gauge 75 cents/foot. Custom lengths available. (215)551-7060.

High-end and hard-to-find audio components. New and used. Foreign and domestic. Low, low prices! **AUDIO AMERICA** (Virginia). Call 1-703-745-2223.

"LISTENING ROOM" is IBM compatible software which helps AVOID STANDING WAVE PROBLEMS by determining the optimum loudspeaker and listening positions for your room. \$29.95 Sittling Duck Software PO Box 130 Veneta, OR 97487 (503) 935-3982

MOSCODES, FUTTERMANS, AUDIO RESEARCH SP3, 6 & 8'S MODIFIED & SERVICED BY GEORGE KAYE, Moscode Designer—Tremendous improvement. Protect your investment. CLASSIC AUDIO, 238 Liberty Avenue, New Rochelle, NY 10805. (914) 633-3039.

TRY ANY AUDIO CABLE IN THE BEST POSSIBLE LOCATION. YOUR HOME*.

* 37 cable brands. * Free shipping on EXPORT orders.

The Cable Company

po box 305, Upper Black Eddy, PA 18972 *CALL TOLL FREE FOR DETAILS
VISA/MC 1-800-FAT WYRE
MON.-FRI. 11-5 EST or (215) 294-9576; or fax (215) 294-9586

ANNOUNCEMENTS

LONG ISLAND NEW & DEMO: B&K, Audible Illusions, Merlin, Audioquest, Taddeo, British Fidelity, Musical Concepts & More. AUDIO GALLERY, Bayport, NY (516) 472-4258.

YOUR FIRST CHOICE COULD BE YOUR LAST. BILL'S AUDIO CONSULTANT. CALL BEFORE YOU BUY! (619) 446-7621. WRITE: 1235 ELPRADO, RIDGECREST, CA 93555.

WADIA DIGITAL

BARCLAY CABERNET CD TURNTABLE

Authorized Dealer

OEM Audio & Video, 9330 Georgia Avenue, Silver Springs,
MD 20910. (301) 589-1191.

Music so real you want to touch it!



"We built the G2 kit and it took less than two hours to uncrate assemble and hook up the pair ... Assembly was easy and the sound was terrific." *Home Mechanix* December 1989.

For exceptional sound at affordable prices call 1-800-346-9183 today to receive your free catalog of the finest speaker kits. Audition in your home at no risk. We look forward to serving you!

AUDIO CONCEPTS, INC.

901 S. 4th St., La Crosse, WI 54601
(608) 784-4570

conrad-
johnson
is
Musicality.

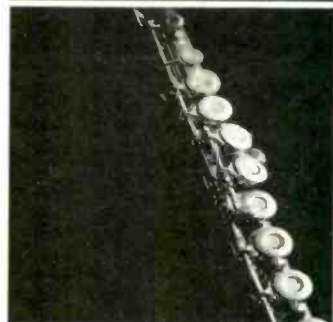
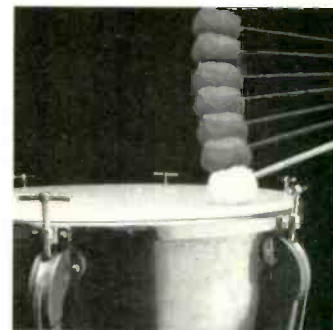

the
conrad-
johnson
group
2800 R
Dorr Avenue
Fairfax,
Virginia
22031
703-698-8581

ABSORB YOURSELF



Sorbothane® has an incredible ability to absorb energy. This allows AudioQuest Sorbothane products to effectively damp and isolate all vibration sensitive equipment — CD/laser players and audio and video electronics.

P.O. Box 3060
San Clemente, CA 92672 USA
Tel: 714-498-2770 Fax: 714-498-5112



CD TEST DISCS

| | |
|---|------|
| CBS CD-1..... | \$45 |
| PIERRE VERANY (2 disc set) | \$34 |
| HI-FI NEWS CD II | \$16 |
| MC/Visa welcome! (Add \$2 shipping per order) | |

OLD COLONY ■ PO Box 243, Dept. A92
PETERBOROUGH, NH 03458
(603) 924-6371 FAX: (603) 924-9467

ANNOUNCEMENTS

MINNESOTA: Sumo, Bedini, Rega, Welltempered, van den Hul, MIT, Sumiko, Target, Audio Prism, Precision Audio & more above-average components. By appointment. (612) 331-3861 AUDITION AUDIO.

ANNOUNCEMENTS

A TRANSDUCER FOR THE PERFECTIONIST AUDIOPHILE ONLY. This state of the art speaker (Pat. Pend.); Utilizes no Woofers, Midranges, Tweeters, Ribbons, Electrostatics or conventional Planar Drives. About the only thing ours has in common with other High-End Transducers, is that it recreates a near perfect sound stage. For free information on our product line, write to: A.W.H., P.O. Box 591, Bellport N.Y. 11713.

Audio Express



Wider Selection of "Best Buys"
Satisfaction Guaranteed
Faster Delivery-2nd Day Air!

Delivers!

We have over 565 items.
Please call!

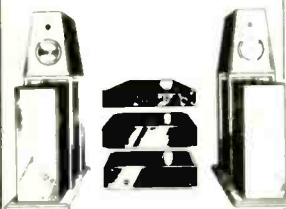

Kinergetics/BSC System

Stunning... and more important, musically honest. "Stereophile CES Review, Aug. '89, 00"
Compatible with: Fried, Spica, Magnepan, WATT, ProAc and more.

Kinergetics KCD40 CD Player \$1995
(or, on a budget, the Kinergetics KCD-20B @ \$1195)

Kinergetics KBA-75 Class A amp \$1495
(shipped ground)

BSC 100 Subwoofers and 200 amp \$1532
(shipped ground)
or the smaller 100.5 woofers for \$438 less)

Music Mate stands \$250 pair
(shipped grnd.)

Call for cables used in CES system above.
Call for system or component prices.

For Records

Revolver Rebel "Best buy" turntable, arm & Bullet cartridge \$389.00
 Grado ZTE+1 \$19.95 ZF3E+ \$44.00
 Others: Call



Signal DC-9 Cartridge
Highly recommended \$379.00
Nitty Gritty fluids & rec. sleeves-Call
AQ and Hunt EDA record brushes \$9.95/\$19.95
Audioquest record mat \$32.95
DB Protrac Alignment \$24.95

Cables

Interconnect & Speaker.
Audioquest, Aural, Cardas, Kimber, Monster, TARA, MIT, Straight Wire.
Please Call.

Power Cords

Aural, Distech, Cardas
Call



Accessories

AQ Cart-Demag \$79.95
Navcom Silencers \$59.00/4
AO Sorbothane Feet \$21.95/4
Signal 302 Contact Cleaner \$22.95
Sonex Jrs. \$49.95/4 (shipped ground)
Tweek \$12.95
Terk Pi 7 Antenna \$79.95
Target Wallmount TT1 \$109.00
Standesign Racks: 2 shelves-\$145.00
4 shelves-\$249.00, 5 shelves-\$265.00

LP's and CD's

Chesky, Reference, Wilson, Sheffield, Harmonia Mundi
Many other items available.

3800 North Lamar Austin, Texas 78756
FAX 512-323-5574 • Service: 512-323-5575

All items are shipped UPS 2nd day air unless otherwise indicated.

Accessories One item \$3.95
Turntables and Stands: \$12.95
Extra items: \$1.25 Electronics: \$8.95
Prices subject to change. Amex add 3%.

Mastercard VISA, Discover, Amex
GUARANTEE: You may return any product, for any reason, within 2 weeks of receipt, for full credit or refund (your choice) if product is undamaged, complete as shipped.



1-800-866-5575
1-800-580-5575 Texas only

TIPS FOR MAIL ORDER PURCHASERS

It is impossible for us to verify all of the claims of advertisers, including product availability and existence of warranties. Therefore, the following information is provided for your protection.

1. Confirm price and merchandise information with the seller, including brand, model, color or finish, accessories and rebates included in the price.

2. Understand the seller's return and refund-policy, including the allowable return period and who pays the postage for returned merchandise.

3. Understand the product's warranty. Is there a manufacturer's warranty, and if so, is it from a U.S. or foreign manufacturer? Does the seller itself offer a warranty? In either case, what is covered by warranty, how long is the warranty period, where will the product be serviced, what do you have to do, and will the product be repaired or replaced? You may want to receive a copy of the written warranty before placing your order.

4. Keep a copy of all transactions, including cancelled checks, receipts and correspondence. For phone orders, make a note of the order including merchandise ordered, price, order date, expected delivery date and salesperson's name.

5. If the merchandise is not shipped within the promised time or if no time was promised, 30 days of receipt of the order, you generally have the right to cancel the order and get a refund.

6. Merchandise substitution without your express prior consent is not allowed.

7. If you have a problem with your order or the merchandise, write a letter to the seller with all the pertinent information and keep a copy.

8. If you are unable to obtain satisfaction from the seller, contact the consumer protection agency in the seller's state or your local U.S. Postal Service.

If, after following the above guidelines, you experience a problem with a mail order advertiser that you are unable to resolve, please let us know. Write to Scott Constantine, Advertising Director, at AUDIO Magazine. Be sure to include copies of all correspondence.

FOR SALE

AAA—AUDIO ELITE IN WISCONSIN!!!
DENON, HAFLER, PS AUDIO, YAMAHA, B&K, JSE, NAKAMICHI, PROTON, CARVER, ONKYO, ADS, VPI, DCM, SPECTRUM, SONOGRAPH, AR, FRIED, NITTY GRITTY, SUMIKO, THORENS, KEF, ADCOM, SUPERPHON, SNELL, M&K, LUXMAN, BOSE, PHILLIPS, DCM, VELODYNE and any others you desire. (414) 725-4431.
CALL US WE CARE!!!

AAA—CALL US LAST! LUXMAN, CARVER, ADS, NAKAMICHI, DENON, BOSTON ACOUSTICS, ADCOM, PS AUDIO, HAFLER, AR, B & K, ONKYO, KEF, PROTON, SNELL, DCM, YAMAHA, INFINITY, JSE, SPICA, SUPERPHON, M & K, BOSE MAGNAVOX, VPI, SONOGRAPH, SUMIKO, THORENS, VELODYNE. **WHY CALL US LAST?** 414-727-0071. **WE HAVE THE LOWEST PRICES!!!**

AAA—LOW PRICES—HIGH END EQUIPMENT!!!
DENON, PS AUDIO, HAFLER, YAMAHA, B&K, CARVER, AR, NAKAMICHI, SUPERPHON, LUXMAN, THORENS, M&K, SNELL, SPECTRUM, INFINITY, ONKYO, PROTON, KEF, SONOGRAPH, FRIED, NITTY GRITTY, SUMIKO, BOSE, PHILLIPS, DCM, VELODYNE and any others you desire. AUDIO ELITE, (414) 725-4431, Menasha, Wisconsin.
OUR PRICES CAN'T BE BEAT!!!

AAA—NAKAMICHI, LUXMAN, CARVER, BOSTON ACOUSTICS, DENON, AR, ADCOM, PS AUDIO, HAFLER, ADS, B & K, ONKYO, KEF, PROTON, SNELL, DCM, YAMAHA, INFINITY, VELODYNE, JSE, SPICA, SUPERPHON, M & K, PHILIPS, VPI, BOSE, SONOGRAPH, SUMIKO, FRIED, THORENS, PLUS A LARGE SELECTION OF OTHERS 414-727-0071.

AAAAH! **FREE UPS SHIPPING!** B&K, PS AUDIO, CELESTION, SUPERPHON, ARISTON, ORTOFON, ONKYO, THRESHOLD AUDIO, 605 HEBRON, NEWARK-HEATH, OHIO 43056. (614) 522-4501.

AA/SOUND ADVICE

LOW PRICES/FAST DELIVERY! CARVER, NAKAMICHI, BOSTON ACOUSTICS, LUXMAN, PS AUDIO, HAFLER, ADS, M&K, ONKYO, B&K, PROTON, DCM, SNELL, BOSE, VELODYNE, PHILIPS, AND MUCH MORE! 414-727-0071.

CALL US!!

ADCOM AND B&K MODS

WE OFFER THE BEST MODIFICATIONS IN THE BUSINESS. EXPECT A MIRACLE TRANSFORMATION OR YOUR MONEY BACK! CLASS "A" F.E.T. CIRCUITRY IS OUR "SECRET". ADCOM AND B&K AMPLIFIERS 269.00 INSTALLED.

CD PLAYERS

DISCOVER THE MUSICALITY AND TRANSPARENCY LYING DORMANT IN YOUR PHILIPS BASED PLAYER; OUR DISCRETE F.E.T. CIRCUITRY IS THE KEY! 199.00 INSTALLED. LOVE IT OR YOUR MONEY BACK. ALSO, OUR COMPLETE CDB-582 WITH CLASS "A" DISCRETE F.E.T. OUTPUT. 599.00 INCLUDING OUR MONEYBACK GUARANTEE. TRY OUR NEW CD PLAYER POWER CORD 89.00.

SUPERMODS

2375 WEST 21ST AVE. EUGENE, OR. 97405
503-344-3696

WAVETRACE TECH.

4215 EAST BAY DR. #1205C CLEARWATER, FL.
34624 813-536-2904

ADS., NAKAMICHI, CARVER, BANG OLUFSEN, REVOX, B&W, KEF, HARMON/KARDON, N.A.D., LUXMAN, HAFLER, TANDBERG, ADCOM, DENON, KLIPSCH, YAMAHA, D.B.X.; INFINITY, J.B.L. AND OTHER QUALITY COMPONENTS. BEST PRICES—LIVE PROFESSIONAL CONSULTATION WEEKDAYS—AUTOMATED PRICING AND INFORMATION AVAILABLE 24 HOURS. ALL PRODUCTS COVERED BY MANUFACTURER'S U.S.A. WARRANTY. AMERISOUND SALES INC., EAST: (904) 262-4000 WEST: (818) 243-1168.

AFFORDABLE HIGH-END. NEW AND DEMO UNITS: B&K, Musical Concepts, Angstrom, Merlin, Kinergetics, Straight Wire, Echo Muffs, Pro Ac & more. ARIEL, Carmel, IN. 46032. VISA/MC. (317) 846-9766 or (317) 254-9817, 5-10 pm.

TRADE IN AND TRADE UP



Convert your old AudioQuest cartridge to one of our current state-of-the-art models. Our very liberal trade in policy allows you from 35% to 125% of the value of your cartridge towards a new AQ cartridge. Any AudioQuest MC cartridge ever made qualifies!

P.O. Box 3060
San Clemente, CA 92672 USA
Tel: 714-458-2770 Fax: 714-498-5112

aq
audioquest

SUPER DAC!

SUPER linear Premium Chip sets with the fabulous TDA1541A S1 CROWN DAC mated with the SAA7220P/B. Improves resolution on all 16-bit Philips/Magnavox CD players. Set includes gold-plated, machine pin IC sockets. Price: \$124.95 plus \$5.00 S&H.

Information: 203 431-6434 Credit Card Orders: 1-800-444-1428

EUPHONIC
technology



19 Danbury Road
Ridgefield, CT 06877

W. New England's Best!

Acoustat • Apogee • Aragon • Boston/Acoustics • B&W • Celestion • CWD • dbx • Dual • Energy • Fried • Halter • Infinity • JSE • JVC Video • Koetsu • Krell • Magnum • Meinel • Meridian • MIT • Mod Squad • Monster • NAD • Onkyo • Ortofon • Rotel • Shure • SME • Snell • Sony ES • SOTA • Star • Sumiko • Velodyne • Well Tempered

Sound & Music

Sales & Service • 351 Pleasant St • Northampton MA 01060 • (413) 584-9547

FORTE

The performance of "exotics" for the heart of your music system

Critical music listeners agree that Forté components furnish a level of performance comparable to state-of-the-art "exotics."

The Forté Model 2 pre-amplifier provides gain for either moving coil or moving magnet cartridges with a single ultra-low noise stage. "Straight-line" circuit design, class A operation throughout, the highest quality parts, and a separate power supply assure that the phase and amplitude characteristics of the source material are precisely maintained.

The Forté Model 1a pure class A, or Model 3 high class AB power amplifiers can be used to bi-amp, tri-wire, or conventionally drive any high-accuracy loudspeaker—even those considered "difficult" as a load.

State-of-the-art musical accuracy coupled with the reliability of superior parts and construction make these Forté components worthy of consideration for any high performance music system.

For more information on these Forté products, write: Forté Audio, 12919 Earhart Avenue, Auburn, California 95603, or call 1 (800) 888 8055. Forté products are exclusively distributed by



division of Threshold Corporation.

Model 3 amplifier
Model 1a amplifier
Model 2 preamplifier





The mark of a true Denon.

This sticker tells you who is an authorized Denon dealer and who isn't.

Some people who offer Denon products are not authorized dealers. That can lead to problems.

First, *only* authorized dealers offer you the protection of a Denon warranty with your purchase: at other dealers, you may have no warranty at all.

Authorized Denon dealers stock only components designed for the U.S., and have the training to help you select the one right for you.

Authorized dealers know Denon technology inside and out and stock factory parts for your Denon to preserve true Denon sound.

So before you buy your Denon, look for this Denon Authorized Dealer Sticker.

It assures you of the authentic Denon technology and support you expect. And nothing less.

To find your nearest AUTHORIZED Denon Dealer call:
1-201-575-7810
(9:00 am-5:00 pm EST) **DENON**

FOR SALE

AFFORDABLE HI-END AUDIO. ACOUSTIC ENERGY, AUDIBLE ILLUSIONS, AUDIOQUEST, ASC TUBE TRAPS, B&K SONATA, CELESTION, CLASSE AUDIO, CARDAS, DYNAVECTOR, ENTEC, EPOS, KEF, KIMBER KABLE, LEXICON, MAGNUM DYNALAB, MISSION CYRUS, MERLIN, MOD SQUAD, NILES, PHILIPS AUDIO VIDEO, REGA PLANAR, SONUS FABER, STAX, SONRISE CABINETS, SOUND ANCHOR, SONANCE, TERA VIDEO, TARA LABS, TARGET, TIFFANY, VELODYNE, WBT, FOR FREE BROCHURE AND LITERATURE CALL-301-890-3232 J S AUDIO ONE CHILDRESS COURT, BURTONSVILLE, MARYLAND 20866 AUDITION BY APPOINTMENT, MONDAY THRU FRIDAY 10AM TO 7PM, SATURDAY 11 TO 5, VISA, MASTERCARD, AMERICAN EXPRESS. FAX 301-890-3819

BEST TRADES OFFERED. We buy sell, trade, consign most high-end products. Audio Doctor. 1518 W. Commercial, Buffalo, MO 65622. 417-345-7245. COD-VISA-MC. Newsletter.

Gifted Listener Audio



Ariston • Audioquest • Celestion • ET • Euphonic Technology • Forte • Mirage • Nitty Gritty • Onkyo • Phantom Acoustics • Premier • Sonrise • SOTA • Sumiko • SME • Talisman • Threshold • Keesee • Dynavector • LiveWire • Books Recordings Accessories

5866 Old Centreville Road
Centreville, Virginia 22020

703-818-8000

DAT

Digital Audio Tape

We have digital audio home, portable and professional cassette recorders and tapes (blank & prerecorded) IN STOCK NOW!

We were the first U.S. company to import both CD and DAT into the U.S. We carry various DAT decks and offer the latest models as soon as they become available. We also carry DAT Rax 60, solid oak cassette holder.

Audio Gallery (213) 829-3429

2716 Wilshire Blvd., Santa Monica, CA 90403

FOR SALE

ARE YOU PLEASUED WITH THE SOUND OF YOUR CD PLAYER? Modify your player and reward your ears with a musical, involving performance. Call us for modifications and accessories that will transform your player into a liquid, tonally accurate source. Products include Select D/A converters, Digital Filters, Damping Materials, Power Supply modifications and more. Call 1-800-648-6637 for details and catalog. Soloist Audio 348 Tuttle, S.A., TX 78209. FAX: (512) 821-5265.

A SOUND EXCHANGE

UTAH'S NEW, USED, DEMO, CLASSICS STORE. EXAMPLES: SUPERPHON DM-220 \$749; LINN LP-12 ITTOK ARM \$1199; MISSION PCM 7000 \$699 (DEMO); PERREAUX PMF 2350 \$1595, TU 3 \$595, SA 3 \$925 (DEMO). SOUND EXCHANGE, 5130 SOUTH STATE STREET, MURRAY, UT 84107. (801) 268-6066.

BUY/SELL IN THE MONTHLY AUDIO/VIDEO TRADER. \$15/yr. SAMPLE \$1 + SASE. FREE ADS! 330 S. MAIN WAKE FOREST, NC 27587

FOR SALE

ATTENTION AUDIO BUYERS!!!

AUTHORIZED DEALER FOR... ADS, ALPHASONIK, BOSTON ACOUSTICS, CARVER, DENON DUAL, HAFLER, INFINITY, KENWOOD, KICKER, MONSTER CABLE, ORTOFON & YAMAHA! THE SOUND APPROACH, 6067, JERICHO TPKE, COMMACK, NY 11725 (516) 499-7680.

ATTENTION HAFLER, DYNA, MAGNAVOX OWNERS!

Audio by Van Alstine builds complete new higher performance circuits for you. Not "modifications," but original new engineering designs that eliminate transient distortion, have no on or off thumps, are durable and rugged, and sound closer to live than anything else at a rational price. Our complete do-it-yourself rebuild kits start at \$200, including all new PC cards. Complete wonderfully-musical factory wired amplifiers, preamplifiers, tuners, CD players, and a great \$99 phono cartridge. Write or call for our new illustrated catalog. Audio by Van Alstine, 2202 River Hills Drive, Burnsville, MN 55337. (612) 890-3517.

AUDIO ARCHIVES IN SAN DIEGO. We sell MERLIN SIGNATURE speakers (Cardas-wired), CARDAS cables, WINGATE Class-A amps, CONVERGENT SL-1 REFERENCE TUBE PRE-AMPS, SOUND ANCHOR stands. Other High-End Items. (619) 455-6326.

AUDIO BEST: LA, ORANGE, SAN BERNADINO, CALIFORNIA. HOT COMPONENTS: CELESTION SL-700, COUNTERPOINT, TARALAB, PS4.6; MIT; AUDIBLE ILLUSIONS; MODSQUAD PRISM CD; ACOUSTAT SPECTRA 33+; SPICA ANGELA; WELL-TEMPERED; VELODYNE, MAGNUM; FOSGATE; B&K, SUPERPHON, MUSIC REFERENCE, SPECTRUM, RAUNA, SOUNDLAB, VPI, MAPLENOLL, SYSTEMDEK, GRADO, GARROTT, VDHUL, MONSTER, STRAIGHTWIRE, MUSIC CONCEPTS. (714) 861-5413. APPOINTMENT.

AUDIO DEN Authorized Sales and Service. ADCOM, ARAGON, ARCAM, B&K, CAL CELESTION, CONRAD JOHNSON, HAFLER, KLIPSCH, MAGNEPAN, MIRAGE, MIT, MONSTER CABLE, NAD, NAKAMICHI, PARADIGM, ROGERS, SHURE ULTRA, SONOGRAPHIE, SOTA, STAX, THETA DIGITAL, VELODYNE, VTL & YAMAHA. Audio Den, 2021 Smith Haven Plaza, Lake Grove, N.Y. 11755 (516) 360-1990.

AUDIO NEXUS = QUALITY

Featuring legendary VANDERSTEEN loudspeakers & COUNTERPOINT electronics.

Apogee • Ariston • Audioquest • Bel • B&K • British Fidelity • Counterpoint • Eminent Technology • Forte • Fried • Jamo • JSE • Kimber Kable • Klyne • Magnum Dynalab • Melos • MIT • Monster Cable • Musical Concepts • Nitty Gritty • Premier • PS Audio • Precise • Rotel • Rowland Research • SME • Sonographie • Sony ES • Sota • Stax • Systemdek • Talisman • Alchemist • Vandersteen • Vendetta SUMMIT, NJ. (201) 277-0333.

AUDIO NOUVEAU

THE NEW WAVE IN VALUE FOR THE DOLLAR EQUIPMENT. FEATURING: MIRAGE, B&K, COUNTERPOINT, SONY ES, DAHLQUIST, NAD, TADDEO, MONSTER, THORENS, REGA, MICHELL, TARGET, SOUNDSTREAM, CONCORD, AUDIOPHILE AND MORE. 71 SOUTH MAIN ST. CANANDAIGUA, NY 14424 (716) 394-6180 AMEX/VISA/MC.

Audio test equipment by Bruel & Kjaer, GenRad, Hewlett Packard, Rockland, Sound Technology, Spectral Dynamics, Tektronix, Wavetek, and others. Used, guaranteed, low prices. Call for complete list. (401) 421-7430.

BOUND FOR SOUND NEWSLETTER. The monthly review emphasizing affordable "Blue Collar Audio" over high-end haughtiness. January highlighted the Muse stereo amplifier and Counterpoint preamplifier. February reviews the Revolver turntable with modest high output moving coil that set our ears on end. Read where the power is in amplifiers with unbiased reviews of the B&K EX-442, AVA Transcendence 500 and more. This is the meat of Audio. Twelve issues—\$12.00. 220 N. Main St., Kewanee, IL 61443

CABLE TV CONVERTERS! ZENITH, TOCOM, JERROLD, OAK, SCIENTIFIC ATLANTA, HAMLIN, VISA-MC-COD, ORDER YOURS TODAY! (800) 327-8544.

CABLE TV WIRELESS REMOTE CONVERTERS/DESCRAMBLERS. SALE/USE REGULATED BY FEDERAL LAW. T.J. SERVICES. (313) 979-8356.

DIMENSIONAL PURITY

VANDERSTEEN AUDIO



Vandersteen Audio was founded in 1977 with the commitment to offer always the finest in music reproduction for the dollar. Toward this goal there will always be a high degree of pride, love, and personal satisfaction involved in each piece before it leaves our facilities. Your Vandersteen dealer shares in this commitment, and has been carefully selected for his ability to deal with the complex task of assembling a musically satisfying system. Although sometimes hard to find, he is well worth seeking out.

Write or call for a brochure and the name of your nearest dealer.

VANDERSTEEN AUDIO
116 WEST FOURTH STREET
HANFORD, CALIFORNIA 93230 USA
(209) 582-0324

MODEL 2C

FOR SALE

C4000T-\$650., C4000-\$350. PS4.5—\$375. COUNTERPOINT SAB, 200 WC, Perfect For MLOGAN. New \$2400. Now \$1295 NAKAMICHI 1000ZXL 10 Hours, \$1400. NAKAMICHI RX202 New \$495 REVOX B710II, Factory Recalibrated, \$895. TANDBERG 3014A, 6 Month Warranty, \$950. Other Amps, 200 WCH, \$500. Plus. MUST A MAN BE BORN AGAIN? JOHN 3:1-18. (313) 949-4567.

CALL TOLL FREE! 1-800-826-0520 FOR: ACOUSTAT, Audio Control. Lexicon. JBL, Nitty Gritty, M&K, Oracle, Proac, Proton, Stax, Thorens, Dahlquist, Hafler, Monster Cable, Belles, CWD, dbx, Fried, Harman Kardon, Onkyo, Grado, Celestion, DCM, Duntech, Niles, Citation, Kinergetics. Sound Seller, 1706 Main St., Marinette, WI 54143. (715) 735-9002.

ADS., NAKAMICHI, CARVER, BANG OLUFSEN, REVOX, B&W, KEF, HARMON/KARDON, N.A.D., LUXMAN, HAF- LER, TANDBERG, ADCOM, DENON, KLIPSCH, YAMAHA, D.B.X.; INFINITY, J.B.L. AND OTHER QUALITY COM- PONENTS. BEST PRICES—LIVE PROFESSIONAL CONSU- LATION WEEKDAYS—AUTOMATED PRICING AND IN- FORMATION AVAILABLE 24 HOURS. ALL PRODUCTS COVERED BY MANUFACTURER'S U.S.A. WARRANTY. AMERISOUND SALES INC., EAST: (904) 262-4000 WEST: (818) 243-1168.

COMPARE . . .

Musical Concepts compact disc players to one thing, LIVE MUSIC! Their transparency and "musical authori- ty" deliver natural, holographic sound. "The best need not cost the most!" Three models available. ENIGMA, ERA AND EPOCH. ENIGMA, "The inexpensive player that forgot to sound like it!". ERA, "Supercedes the CD-3/TPS-highly reviewed in TAS!". EPOCH II, "Must be heard to understand the possibilities of CD!"

MUSICAL CONCEPTS

ONE PATTERSON PLAZA • ST LOUIS, MO 63031 • 314-831-1822

COMPONENT CLEARANCE, NEW AND DEMO—Rega Planar3 table (\$600) \$399. Rotel RCD820BX2 CDplayer (\$750) \$475. Counterpoint SA12 poweramp (\$1145) \$795. Philips CD880 CDplayer (\$750) \$499. Quad34 preamp (\$795) \$495. QuadFM4 tuner (\$695) \$425 free Quad rack with both, Kimber KCAG 1 meter interconnect (\$350) \$229. VelodyneSA7 subwoofer (\$995) \$599, used PS Audio4.5 \$345. Call for other specials. The King's Stereo, 225 High- land, Springfield, IL 62704. (217) 523-5656.

DYNACO ST70 UPGRADES, Gold EL34 Sockets, 1215 Microfarad on-board solid state B+, triode output, more. Complete service, DoReTech Audio Services, Box 6054, South Hackensack, NJ 07606-4354. (201) 233-2659.

ELECTRON TUBES, SOCKETS, FILTER CAPS & SUR- PLUS PARTS, CATALOG \$3.00. KURLUFF ENTERPRISES, 4331 MAXSON RD., EL MONTE, CA. 91732. (818) 444-7079, FAX (818) 444-6863.

ELECTRONIC CROSSOVERS, SUBSONIC FILTERS for mono/stereo subwoofers, bi-amp, tri-amp. Free flyer. ACE AUDIO, #532 5th STREET, EAST NORTHPORT, NY 11731-2399.

HAVE YOU NOTICED?

Reviewers compare our designs against the finest! Our modifications are not merely better than the original, they challenge the best! Ten years of expertise ensure your satisfaction!

ADCOM • B&K • HAFLER

Our famous Hafler modifications are equaled by our Adcom and B&K redesigns. Stunning bass impact, mid- range lucidity and delicate highs distinguish these re- markable designs. Soundstaging and focus replicate the recording site. Dual-mono redesigns available.

TEFLON® PREAMPLIFIER

MC-2TI: TEFLON® RIAA line preamplifier board retro- fits Hafler, B&K, Adcom. Why are owners of \$5000 tube preamps making the switch? ACCESSORIES: Super- Connect III, simply peerless interconnect, money-back guarantee! Toroidal transformers, high density filter ca- pacitors (new lower prices).

MUSICAL CONCEPTS

ONE PATTERSON PLAZA • ST. LOUIS, MO 63031 • 314-831-1822

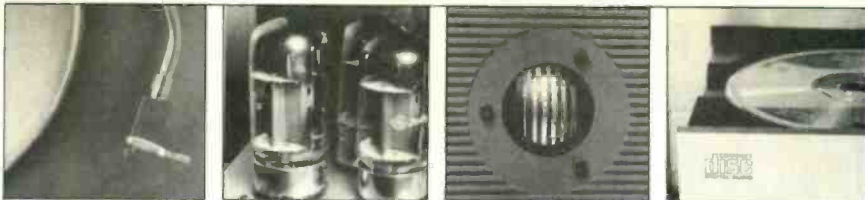

THERE'S MORE TO HEAR AT LYRIC.

At Lyric, you'll find more great components to choose from. And along with all the brands and models on display, more knowledge and experience. More service, too. Which explains why more people around the world make Lyric their choice for high-quality audio.

Let us help improve your system with state-of-the-art models from more than 50 man- ufacturers. We supply 220 volt equipment, and most speaker models are available for export.

Accuphase • Ariston • Audio Research • B & W • Bryston • Cal. Labs • Carnegie • Carver • Celestion • Classe conrad-johnson • Dynavector • Entec • Goldmund • Infinity (including IRS) • JVC • JSE Infinite Slope • Koetsu Magnepplanar • M & K • Manley • Mark Levinson • Mirage • MIT • Mod Squad • Mondial • Monster Cable • Motif NAD • Nakamichi • Oracle • Pioneer • Proton • Quad • Rega • Revox • Rogers • Shure • SME • Sonance Sonograph • Sony ES • Sota • Spectral • Stax • Vandersteen • Velodyne • VPI • VTL • Well Tempered and other fine brands



1221 Lexington Ave.
New York, NY 10028
212-439-1900
800-848-4981

2005 Broadway
New York, NY 10023
212-769-4600

146 East Post Road
White Plains, NY 10601
914-949-7500

FOR SALE

FOR SALE McIntosh, JBL (ALNICO), KRELL, M. LEVIN- SON AND OTHER HIGH END AUDIO COMPONENTS. LET ME FIND YOUR HARD TO GET ITEMS. JOHN WOLFF, 313-229-5191 24HR MACH. 6-11PM EST BEST.

KLIPSCH GAS REGA K-Horns, 7 years, walnut, \$2750. Thoebe/Son, never used, \$1000. Planar3/Grace 707, never used, \$500. All mint, original boxes, shipped insured, any- where USA. 708/682-2512

LIVEWIRE CLOSEOUT SALE! 50% OFF ON AUDIO- QUEST TYPE 12 SPEAKER CABLE! LIMITED SUPPLY! CALL FOR PRICES & ORDERING INFORMATION. HCM AUDIO, 1-800-222-3465, 1-916-345-1341 VISA/MC/AMEX.

tad mini-monitor
and Laug bass
system in one
sleek package.
You deserve Mink!

Lantana

P.O. Box 1958 • Garden Grove, CA 92642
(800) 234 - TADS (8237)

REVAMP YOUR AMP.



We make good amps great.

At Professional Mod Service, we take your Adcom, B&K, or Hafler amp and make the bass more powerful and the mids and highs clearer. By the time we're through, your amp will sound as good as amps costing *twice as much*.

How do we do it? We make real improvements, developed with factory engineers. We use nothing but premium materials. And our technicians are real pros with years of experience.

Pickup service.

Call us and we'll pick up your amp. Or send it to us with \$199.95 plus \$14.95 shipping. We'll revamp your amp, spec it out, and return it insured.

1-800-334-0295

Amex/Visa/MC/Discover

Professional Mod Service, Inc.

225 Oakes SW
Grand Rapids, MI 49503
616-451-3527 FAX 616-451-0709

ESOTERIC SOUND

We present the components that make the artists' performance possible. We are dedicated to the pursuit of excellence that justifies that performance.

High End Components For The Audio Perfectionist

ALTEC LANSING • APOGEE • BARCLAY • BEDINI • COUNTERPOINT • HARTLEY • JANIS • KEF
LEXICON • PRECISE • PULSAR • ROTEL • JEFF ROWLAND • SHAHINIAN • WADIA • AND MORE

COVENTRY COMMONS RTE 347, STONY BROOK, N.Y. 11790, 516-689-7444

FOR SALE

MIT cables, custom terminations, Camacs, XLR balanced, hi-flexibility tonearm sets, Shotgun CVT; MIT hookup for internal rewiring; Athena PolyPhasors; ATMA-SPHERE OTL amplifiers, CLEMENTS speakers, VENETTA RESEARCH, VAN DEN HUL GRASSHOPPER, ASC Tube Traps; Wonder Caps-solder-wire; Resistors; Edison Price, Odyssey, Tiffany connectors; Simply Physics Tone Cones & Isodrive; many accessories-mod parts, \$1 catalog (\$3 overseas); Michael Percy, Box 526, Inverness, CA 94937, (415) 669-7181.

NITTY GRITTY RECORD CLEANING MACHINES & SUPPLIES. MOST ITEMS IN STOCK. AUTHORIZED DEALER. CALL FOR PRICES & ORDERING INFORMATION. HCM AUDIO, 1-800-222-3465, 1-916-345-1341, VISA/MC/AMEX.

NOISE REDUCTION, Clean up & improve records, tapes, FM, AM, TV, VCR, even CDs. Single-ended DNR, Free literature, 24hr. 1-615-822-2737 ext. 2520.

ORDER TOLL-FREE 1-800-222-3465, AUDIOQUEST • B&K • BOSE • CELESTION • GRADO SIGNATURE • HARMAN KARDON • JBL • MONSTER • NITTY GRITTY • PREMIER • SONY • SOTA • STAX • STRAIGHTWIRE • SUMIKO • SUPERPHON • PLUS MANY ACCESSORIES. CALL FOR FREE PRICE LIST! HCM AUDIO, 1015 MANGROVE, CHICO, CA 95926 (916) 345-1341 VISA/MC/AMEX

PAUL HEATH AUDIO

Audible Illusions, B&K, Classe Audio, Cardas, Theta, Iverson Eagle 400, Gryphon, Dynalab, Epos, PS Audio, Philips Audio-video, Melos, MFA, MIT, Mod Squad, Merlin, TDJ, Quicksilver, VPI, Well-tempered, Lineaum, Precise, Deltac, Kuzma, Memmore, Townsend Rock Reference. 217 Alexander, Rochester, NY 14607. (716) 262-4310.

PERREAU PMF5550, 500 WPC MOSFET POWER AMP. Brand new in sealed container with warranty! List \$6500, now \$3495 freight paid. (203) 871-2983.

PHONO ONLY PREAMP, highly reviewed, factory direct, \$149, FREE literature, Dept. 2525, RT1 Box 264A, Hendersonville, TN, 37075, 24hr 1-615-822-2737 Ext. 2525

PS AUDIO—SUPERB!

Fast, FREE shipping! Knowledgeable, friendly service! Audire, Chesky, CWD, Fried, Grado, Kinergetics, Mirage, Monster Cable (M-series), Quad, SME, Sota, Spica, Stax, Straightwire, Thorens, more. READ BROTHERS STEREO, 593 King Street, Charleston, South Carolina 29403. (803) 723-7276.

RANE, SENNHEISER, AKG, A-T, dbx, Fostex, SONY TAPE, LOFTECH, TRIPP-LITE, ELMO TeleCines, LOWEL, Chinon, BOGEN, Hi8, CARPENTER/GHP, BOX 1321, MEADVILLE, PA 16335-0821.

SAVE 40% ON HIGH-END home speakers, subwoofers, amplifiers. FREE CATALOG! CATALOG, 3021 Sangamon Ave., Springfield, IL 62702. 1-800-283-4644.

Savings to 40%. Nobody beats our prices. Midfi to highend. Over 150 product lines. Free Shipping. Full US Warranty. Quality Audio 902-582-3990 7-10pm Eastern Time.

"SOUND YOU CAN TOUCH"

FEATURING CLASSE AUDIO • CREEK • PROAC • EPOS • BARCLAY • MUSICAL CONCEPTS • WELL TEMPERED • TARA LABS • MUSIC METRE • TARGET • SUPERPHON • VANDENHUL • GRADO SIGNATURE • KIMBER KABLE • MAGNUM DYNALAB. "SPECIALIZING IN CUSTOM CABLE TERMINATIONS". VISA MC AUDIO EXCELLENCE LIVERPOOL, N.Y.

(315) 451-2707.



Your search for refinement will end here.

Brown Electronic Labs

2530 Berryessa Rd., Suite 126, San Jose, CA 95132

FOR SALE

McINTOSH Bought-Sold-Traded-Repaired. FREE Catalogue. See our ad at the beginning of the classifieds. AUDIO CLASSICS, POB 176MB, Walton, NY 13856. 607-865-7200. 8AM-5PM EST Mon.-Fri. —Audio Advertiser for over a Decade—

MCINTOSH: BUY/SELL

WANTED: MCINTOSH, MARANTZ, AUDIO RESEARCH, DYNACO, LEVINSON, KRELL, ALTEC, JBL, TANNOY, GJ, SEQUERRA, WESTERN ELECTRIC, TUBE & SOLID STATE, BUY-SELL-TRADE, MAURY CORB, (713) 728-4343, 12325 Ashcroft, Houston, TX 77035.

ACTIVE ELECTRONIC CROSSOVERS

MODEL 120 CABINET & NEW 120-R "RACK AND PANEL" DESIGNS

Made to order in Butterworth bi-amp, tri-amp, or quad-amp configurations with optional level controls, subsonic filters, or summers. Filters, regulated power supplies, equalizers, are also available.

New catalog and price sheet. Free!

DeCoursey Eng. Lab.

11828 Jefferson Bl. Culver City, CA 90230
PHONE (213) 397-9668

FOR SALE

MONSTER CABLE PRODUCTS AT LOW PRICES! CALL FOR PRICES & ORDERING INFORMATION. HCM AUDIO. 1-800-222-3465, 1-916-345-1341 VISA/MC/AMEX.

NEW: B&K ST-202 \$529, Kinergetics KCD-40 \$1699, Dynalab FT-101 \$599, SME 309 \$899, CdSaver \$9, Tweek \$15, Fluxbuster \$139, Edison-Price, Merlin, Sumo, Disc-Ade, Cramolin, Kimber, AudioPrism, Audiolab, Celestion, AudioQuest, Mod Squad, Target, CD/LP's: Chesky, DMP, Dorian, East-Wind, Opus3, Proprius, Reference, Three-BlindMice, Verany, WaterLily, Wilson, Vector Electronics, Portland, OR (503) 233-2603. Visa/MC/Amex/COD. "SINCE 1976"

ONE OF THE TEN BEST BUYS IN AUDIO.



Revelation II Preamp—\$749.95

"With the Superphon equipment, the sound is smooth and detailed, and seemingly effortless. Music has a sense of clarity and openness that is utterly believable, never sounding strident or harsh... the Superphon dazzles... with an unrelenting music rightness..." —Hi Fi Heretic, Issue #10, "The Best Buys In Audio."



Call or write: Superphon Products Inc.
1035 Conger #3, Eugene, OR 97402
503-345-4226 FAX 503-345-0704
Dealer Inquiries Invited

SUPERPHON

FOR SALE

60 YEARS IN BUSINESS...WE MUST BE DOING SOMETHING RIGHT! If it's a much-in-demand audiophile product, we're likely to have it for immediate shipment. Consult with one of our quiet experts or just order U.S.—warranted components directly. VISA/MC. Ask for Steve K. or Dan W. **SQUARE DEAL**, 456 Waverly Ave., Patchogue, N.Y. 11772. (516) 475-1857.

THE STEREO TRADING OUTLET

New and used Audio Components Bought-Sold-Traded. **AMPLIFIERS:** B&K ST-140 \$419, EX-442 \$739, AR D100B 595, Citation 22 \$549, Counterpoint SA-12 \$895, Forle F1A \$675, Parasound HCA-500 \$279, HCA-800II \$299, Rotel RB-850 195 new, RB-870 \$235, Rowland #3 \$2,769, Superphone DM220 \$399, Threshold S200 \$1395, S500 \$2,649, Nec M50 \$239 Nec AV-350 349 new, Nec AVA-505 \$269, **PREAMPS:** B&K MC-101 \$719 new, B&K Pro-5 \$319, Bryston 5B \$359, Carver C4000 \$395, Carver C4000T \$495, Counterpoint 7.1 \$469 new, Hafler dh100 \$195 UP-DATED, MAC MX110 \$329, Nikko Beta III \$169, Beta 20 \$125, Parasound 900 \$239 new, Quad 34 \$369 Quad 44 \$259, Sumiko Alchemist \$450. **SPEAKERS:** AR AV-6 \$169pr, AR STC660 \$429pr, Bose 601 \$495pr, Boston a100 \$149pr, Celestion DL-6 \$249pr DL-8 \$269pr DL-10 \$495pr new, Design Acoustics Ps-6 \$125pr new, Ps-8 \$169pr Ps-10 \$249pr, Infinity SM-80 \$249pr new SM-100 \$339pr new SM-120 \$479pr new SM-150 \$669pr new, Mission 727 \$195pr, Mission 770 \$249pr, Rodgers LS4a \$369pr Rodgers LS35A \$395pr, Janis W1 & 1A \$995. **THE STEREO TRADING OUTLET OFFERS A LARGE SELECTION OF PRE-OWNED AUDIO COMPONENTS. HIGHEST PRICES PAIDSS FOR ALL TYPES OF USED AUDIO COMPONENTS.** Visit our two upper level show rooms at 320 Old York Rd Jenkintown, Pa 19046. Call for mail list, Layaway Credit cards accepted. **AUTHORIZED DEALER FOR:** AR, B&K/SONATO, COUNTERPOINT, AIWA, PARASOUND, STRAIGHTWIRE, CELESTION, NIKKO, INFINITY, ARISTON, NAGACKA, STANTON, TEAC.

CASH 215-886-1650
FOR ALL TYPES OF AUDIO COMPONENTS

STRAIGHTWIRE CABLES IN STOCK! CALL FOR PRICES & ORDERING INFORMATION. AUTHORIZED DEALER. HCM AUDIO, 1-800-222-3465, 1-800-345-1341 VISA/MC/AMEX

TRANSCENDENCE THREE—Finally musical reality! Announcing the stunning original new hybrid Fet-Valve designs from Audio by Van Alstine. The Fet-Valve Amplifiers, the Fet-Valve Preamplifiers, and the Fet-Valve CD Players. A perfect combination of tubes for voltage gain and power fets for current gain, each used ideally! The result is musical reality—the closest approach to live music in your home short of bringing in the musicians. One listen and you will be satisfied with nothing less. Now ultimate musical enjoyment is much less expensive. Write or call for our illustrated catalog. Audio by Van Alstine, 2202 River Hills Drive, Burnsville, MN 55337. (612) 890-3517.

USED AND DEMO EQUIPMENT: Aragon 2004, Audio Research SP-15, Counterpoint SA-11, SA-12 and SA-20, Infinity IRS Gama & Beta, speaker wire and interconnects from Monster and Livewire. Call **Audition Audio** for pricing and details at (801) 467-5918. Visa, MC, Amex accepted.

USED Fosgate 3602ag Surround Sound \$798; Acuphase 80 CD player \$6,000; Klipsch Klipschorns \$2,000; Linn Kans \$395; PS Audio 4.5 Preamp \$399; Tandberg TCD-3014 Cassette \$600; Tandberg TPA3026A Amplifier \$1,295; Meridian MCD-Pro \$695; Call Terry at 402-391-3842.

VAN DEN HUL DISTRIBUTOR'S 60% off NEW gold RCA plugs! #557 (\$8) only \$3.20 pair. Custom Audio, 1548 Center #25, Novato, CA 94947 (415) 898-1464. Components also.

LOUDSPEAKERS

ADS., NAKAMICHI, CARVER, BANG OLUFSEN, REVOX, B&W, KEF, HARMON/KARDON, N.A.D., LUXMAN, HAFLER, TANDBERG, ADCOM, DENON, KLIPSCH, YAMAHA, D.B.X., INFINITY, J.B.L. AND OTHER QUALITY COMPONENTS. BEST PRICES—LIVE PROFESSIONAL CONSULTATION WEEKDAYS—AUTOMATED PRICING AND INFORMATION AVAILABLE 24 HOURS. ALL PRODUCTS COVERED BY MANUFACTURER'S U.S.A. WARRANTY. AMERISOUND SALES INC., EAST: (904) 262-4000 WEST: (818) 243-1168.

Can't afford the loudspeaker of your dreams?

We'll show you how to build it! From bookshelf to horns to electrostatics. Classic kits and new designs. A rich mix of how-to and theory. From the world's only magazine devoted to loudspeakers. Only \$35 for two years (12 issues), 1 year for \$20 (6). U.S. \$ only. Outside U.S., add \$4/year for postage.

SpeakerBuilder
THE LOUDSPEAKER JOURNAL

Box 494, Dept. A84, Peterborough, NH 03458

LOUDSPEAKERS

A&S SPEAKERS offers high-end speaker components, kits and systems in the Bay Area and mail order. We have all of the legends: Audax, Dynaudio, Scan-Speak, SEAS, Morel, Peerless, Focal, Eton, VMPS, others. Free literature. A&S Speakers, 3170 23rd Street, San Francisco, CA 94110. (415) 641-4573.

AUDIO CONCEPTS INC. is the leader in fine speaker kits. Save 50-75%, 30 day full money-back guarantee. 12 models from \$129.90 pair. Call toll-free 1-800-346-9183 for catalog. Audio Concepts Inc. 901 S. 4th St. La Crosse, WI. 54601.

BEST SELECTION—50 HOME SUBWOOFER, CAR & PRO SPEAKERKITS. JBL, B&W, AUDAX, MOREL, PEERLESS, SEAS, VIFA, 24DB ELECTRONIC CROSS-OVER, 40p CATALOG, \$2. GOLD SOUND, BOX 141A, ENGLEWOOD, CO 80151.

dbx Soundfield Ones

Superb sound quality combined with a stable stereo image throughout the room. Light oak cabinets. Reasonably priced at half cost including SFC-1 controller & all original cartons and literature. \$1300. (718) 624-5775.



NOW YOU DON'T NEED TO BUY NEW SPEAKERS FOR YOUR STEREO TV, AND...



YOU DON'T NEED TO RUN YOUR STEREO TV THROUGH YOUR STEREO SYSTEM!



ALL YOU NEED IS THE SI-2!



ALL YOU NEED IS THE SI-2!

The SI-2 is a completely automatic speaker switch that allows you to connect your stereo TV and stereo system to your existing pair of hi-fi speakers. You don't need to buy a separate pair of speakers for your TV and you don't need to run your TV through your stereo's auxiliary input. The SI-2 will automatically detect which component is trying to run the speakers and lock the other out, thus preventing any damage to either stereo component or the speakers. The SI-2 is easily installed and its compact design allows it to be hidden behind the stereo system to provide years of reliable use. Call today to order or for the name of your local dealer.

SI-2 (120 watts max.) \$49.95
SI-3 (900 watts max.) \$69.95
R.F. Engineering, Inc.
 9215 Lowell Blvd., Westminster, CO 80030
 (800) 869-5632 or call collect (303) 130-8281

LOWER SUBWOOFER DISTORTION

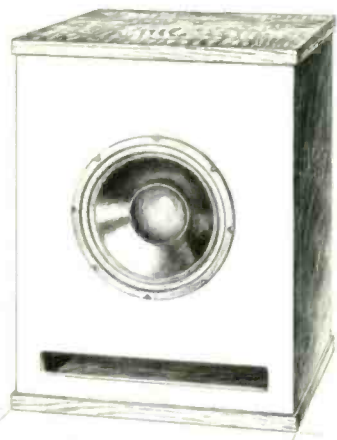

The VMPS Subwoofer, 27x21 1/2x17", 100 lbs. Available in oak or walnut.

The **Original VMPS Subwoofer** (\$329ea kit, \$399ea assem) is one of three high performance, low cost Subwoofers designed to meet every audiophile's particular requirement for bass extension, physical size and first octave output levels.

The **Smaller VMPS Subwoofer** (\$229ea kit, \$299ea assem), achieves a low frequency cut-off of 28Hz (-3dB) and THD below 1.5% (1W drive), and is ideal where space is at a premium. The highly reviewed **Original Subwoofer** provides very low THD (0.5%/1W drive), high 92dB/1W sensitivity, and a -3dB point of 19 Hz. **Soundcoat** cabinet damping (\$40/cab) and our new **Dual Voicecoil** active 12" driver (\$20 add.) enhance performance and flexibility. The 8.25 ft³ **Larger Subwoofer** (\$439ea kit, \$549ea assem) provides outstanding specifications (-3dB at 17Hz, 0.4% THD/1W, 94dB/1W/1m sensitivity) and is available with **Soundcoat** treatment for \$75/cab additional. All woofers operate from our **Passive Cross-over** (\$30kit, \$40assem, two required for Dual VC versions).

Write for brochures and test reports on our Subwoofers, the premium **Super Tower III** (\$3895/pr kit, \$4795/pr assem), the new **Special Edition Tower II** (\$638ea kit, \$838ea assem), and information about luxury options available at extra cost for most models. VMPS also distributes John Curl's **Vendetta Research SCP2b** phono preamp (\$2495), acclaimed by many major audio publications as the finest available.

VMPS AUDIO PRODUCTS

div. Itone Audio

3412 Eric Ct. El Sobrante Ca 94803
(415) 222-4276

Hear VMPS at: The Listening Studio, Boston; Par Troy Sound, Parsippany NJ; Dynamic Sound, Washington DC; Hifi Farm, Beckley WV; Essential Audio, Winchester VA; American Audio, Greenville SC; Arthur Morgan, Lake Mary FL; Audio by Caruso, Miami FL; Audio Specialists, South Bend, IN; Stereoworks, Houston TX; StereoLand, Natrona Hts PA; Parker Enterprises, Garland TX; Shadow Creek Ltd, Minneapolis MN; Encore Audio, Lees Summit MO; Audio Haven, Upland CA; Exclusively Entertainment, San Diego CA; Sounds Unique, San Jose CA; Ultimate Sound, San Francisco CA; Private Line Home Entertainment, Stockton CA; Itone Audio, El Sobrante CA; Sound Room, Vancouver BC Can.

MAGNAVOX



4X Oversampling
COMPACT DISC PLAYERS
 CDB600 \$169.88
 CDB582'B \$179.88
 CDB610 remote \$199.88
 CDB630 Deluxe \$279.88

Special prices on closeouts & factory renewed models. Call. We will not be undersold.

PHILIPS



NEW 1990 CD MODELS
 CD50 \$299.88 CD60 \$399.88
 CD80 & 840... CALL

Visit the world's smallest HI-FI shop for new:

| | | | |
|------------|------------|----------|--------------------|
| SONY ES | MAGNAVOX | PARADIGM | FRIED |
| CARVER | HAFNER | LEXICON | SUMIKO |
| MONSTER | SOTA | APATURE | PLC: Pyramid MET-7 |
| PIONEER LV | JBL | STAX | PHILIPS |
| AR | OBX | MERLIN | PS AUDIO |
| THORENS | AUDIOQUEST | ACOUSTAT | HARMAN KARDON |
| PREMIER | TARGET | GRADO | LUXMAN |

Q AUDIO

95 Vassar Street Cambridge, MA 02139

617-547-2727

A JANIS BASS SYSTEM

IT'S THE CHOICE
 WHEN ONLY THE BEST WILL DO

- Perfect coherence with all speakers
- Flat, calibrated low bass response
- No exaggerated, equalized bass response
- High speed transient response
- Up to four times more amplifier response
- Up to four times more speaker response

John Marovskis Audio Systems, Inc.
 2889 Roebling Avenue
 Bronx, New York 10461 (212) 892-7419

LOUDSPEAKERS

1990 DYNAUDIO LOUDSPEAKERS & SPEAKERKITS. We believe SUPERIOR SOUND QUALITY promotes itself, and invite you to DISCOVER for yourself. ADVANCED AKUSTIC, 4555 PERSHING, SUITE 33(184), STOCKTON, CALIFORNIA 95207. Catalog \$1 or Call 1-209-477-5045.

ELECTRO-VOICE, ALTEC speaker components, low prices! Patrician drivers \$1643.30 (4 pairs left!) Model 19 package \$1382 (last pair!). Carver Professional amplifiers. Flyer. Save this ad! RICK MARDER, AHCo (201) 561-8123.

FRIED SPEAKERS & KITS

State-of-the-art! Amazing performance/price! FREE shipping. Knowledgeable, friendly service! Audire, Chesky, CWD, Grado, Monster, PS, Quad, Sota, Spica, Stax, Thorens, more. READ BROTHERS STEREO, 593 King Street, Charleston, South Carolina 29403. (803) 723-7276.

LEGACY-1 LOUDSPEAKERS BY REEL TO REAL DESIGNS:

Probably the most accurate speaker system you'll ever own. Samarium Cobalt leaf tweeter hands off to a 30mm European dome. Vocals are recreated by the most remarkable cone driver anywhere. A multi-chambered, slot-loaded dual woofer configuration extends bass response to 16 Hz. Biampable through Tiffany gold binding posts and high definition cable. Elegant 43" lower design. Ten year warranty. \$1648/pr shipped prepaid. Ten day home trial. RTRD. 3021 Sangamon Ave., Springfield, IL 62702. 1(800) 283-4644.

LOUDSPEAKER COMPONENTS-KITS. Dynaudio, Morel, Eclipse, Focal, Peerless, Eton, Vifa, more! Crossover parts—design books also. Catalog \$1. Meniscus, 2442 28th St. S.W., Wyoming, Michigan 49509. (616) 534-9121.

SOUND ANCHORS

Specialty Audio Stands

SOUND ANCHORS stands come PREFILLED with special materials to dampen resonances and add mass, you don't have to fool with sand or shot. SOUND ANCHORS stands are engineered to interface with your specific components and speakers so they sound their best...period. Special stands are available for these speakers. **Vandersteen 2-C, B&W 801 Matrix, Spica TC-50, Sota Panarama** and now **Magnepan** models MG 2C/2.5 and MG 3A. For information and the name of your nearest dealer please call (407) 724-1237.

SPEAKER REPAIR & RECONING. Highest quality, lowest prices. Over 15 years experience. NORTHWOODS AUDIO, 4078 Church Rd., Conover, Wisc. 54519. Ph. (715) 479-7532.

LOUDSPEAKERS

SPIKE YOUR SPEAKERS! Case hardened steel spikes mount to the bottom of your speakers. Penetrates carpeting and couples your speaker to the floor. IMPROVES DEFINITION AND IMAGING. Eight spikes with hardware and instructions. \$17.95. Send check or money order to: Speaker Spikes, P.O. Box 14673, Milwaukee, WI 53214.

COMPACT DISC PLAYERS

COMPACT DISC PLAYERS

Knowledgeable, friendly service! Finest brands. FREE shipping. READ BROTHERS STEREO, 593 King Street, Charleston, South Carolina 29403. (803) 723-7276.

PHILIPS REFERENCE STANDARD COMPACT DISC PLAYERS, CDV-CD VIDEO PLAYERS, DIGITAL TO ANALOG CONVERTER'S, AUDIO VIDEO RECEIVERS, DIGITAL INTEGRATED AMPLIFIERS, DIGITAL TUNERS, CASSETTE DECKS, IDTV IMPROVED DEFINITION TELEVISION, COLOR MONITOR RECEIVERS, PROJECTION TELEVISIONS, DIGITAL SUPER VHS HI-FI VCR'S, CAMCORDERS, FOR INFORMATION CALL 301-890-3322 J S AUDIO ONE CHILDRESS COURT, BURTONSVILLE, MARYLAND 20866. VISA, MASTERCARD, AMEX.

COMPACT DISCS

WE'RE MUSIC TO YOUR EARS

- Free Catalog of CD's
- Same day shipping if you order before 12:00noon-EDT.
- \$1⁰⁰ DISCOUNT per disc on orders of 10 or more
- \$2⁵⁰ for UPS Cont. U.S. shipments.

Call Toll Free to order:
 1-800-333-4422

P.O. Box 616, Clifton Park, NY 12065
 518-383-4855



ARCHITECTURALLY DESIGNED

Classical CD cabinets. Solid oak or cherry. FREE brochure. ZEAL HARDWOOD DESIGN CO., Dept. A2, 4 Benjamin Road, Lexington, MA 02173. (617) 861-1705.

COLLECTORS AUDIO AUDIOPHILE CD AND LP SPECIALTY DEALER OF OVER 150 DOMESTIC & IMPORTED LABELS. SPECIALIZING IN CLASSICAL & JAZZ. "FREE" CATALOG AND NEWSLETTER. P.O. BOX 228, LAKE OSWEGO, OR, 97034. (503) 635-2897.

COMPACT DISCS—AT LOW WAREHOUSE PRICES. Now in our 5th year. CATALOG: Send \$2.00. Oz Warehouse, 1575P Hwy 29, Lawrenceville, GA 30244.

FREE CATALOG/NEWSLETTER. CD's, DAT, Cassettes, Reel. Write to DIRECT-TO-TAPE RECORDINGS, 14-R Station Ave., Haddon Heights, NJ 08035.

Have a large music collection? Organize it with Personal Music Librarian software. Quickly find any album or selection. Design custom labels and reports. User-defined fields and free-text notes. Ask for free info. 404-242-0887. 4-10 PM Eastern M-Th. \$75. For IBM PC/compatibles and Atari ST. Coming for Amiga and Mac. Personal Database Applications. Dept. 290-A, 2634 Meadow Bend Court, Duluth, GA 30136-6037.

NEW AGE COMPACT DISC & CASSETTES Catalog "Wind Angels, Shamanic Journeys, Cusco, Intri-Ilumani, Tibetan Choir, Take it to heart." Big selection. Quality Guarantee. \$2.00: BHL, Box 6340Au, San Rafael, CA 94903-0340.



CLASSICAL MUGS

These distinctive 12-ounce English Ironstone mugs with large grip handles boast the logo of your favorite magazine. Available in set of two (black and gray) #65MUGS2 \$16.95 (\$3.00)

To order, call our TOLL FREE lines. We accept Visa, MasterCard and American Express, or send a check plus shipping and handling to AUDIO, P.O. Box #765, Holmes, PA 19043.

ORDER TOLL FREE
 800-345-8112

COMPACT DISCS

TEST YOUR SYSTEM WITH CD'S from Pierre Verany, CBS Labs, etc. Catalog, details: DB SYSTEMS, P.O. BOX 460, RINDGE, NH 03461. (603) 899-5121.

WHICH ONE GOT THE RAVES? Catalog of Award-Winning Classical CDs. Your handiest guide to outstanding recordings. \$10.00. (Sample pages available) KEN'S KOM-PENDIUM, 2400 Hawthorne Dr., Atlanta, GA 30345.

RECORDS

RECORD COLLECTORS SUPPLIES. REPLACEMENT JACKETS, INNER SLEEVES, 78 RPM SLEEVES, OPERA BOXES, LASER DISK BOXES, ETC. FREE CATALOG. CABCO PRODUCTS, BOX 8212, ROOM 662, COLUMBUS, OHIO 43201.

1,000,000 Videomovies/Soundtracks—Broadway LPs. Video catalogue—\$1.00 Soundtracks—\$1.00. Rare Soundtrack-Broadway Valueguide—\$7.95. RTSA2, Box 750579, Petaluma, California 94975.

LASER VIDEO DISCS

LASERDISC NATIONWIDE! Discount Sales + Fast U.P.S. Rentals. WIDESCREEN, IMPORT, NEWEST RELEASES. Free "FRESH VIEWS" Laser Newsletter. HOLLYWOOD NORTH ENTERTAINMENT SERVICES, 840 Piner Rd., Santa Rosa, Ca. 95403. (707) 575-1225.

DAT

Custom DAT tapes. "Three Centuries of French Organ Music" & "Fenstermaker Plays Bach". Both from live concerts at Grace Cathedral, from digital masters. \$30.00 each. T-V Recording, Box 70021, Sunnyvale, CA 94086.

AUDIOPHILE RECORDS

AUDIOPHILE LP'S AND CD'S

IN PRINT

Mobile Fidelity, Reference Recording, Sheffield Labs, Chesky, Wilson, M & K, American Gramophone, Propris, OPUS 3, Gemini, Super Analogue, Concord, ATR Mastercut, Harmonia Mundi, Linn Re-cut, EMI, Waterlily, North Star, Odin, BIS, Hungaroton, Chardos, Hyperion, Japanese and British Imports (lps), Many TAS recommended LP's!

OUT OF PRINTS

Nautilus, Super Disks, Nimbus, UHQ, Lyrata, MFSL, Stones, Sinatra Boxes, Direct to Disc by Crystal Clear, Umbrella, EMI, RCA LSC, Mercury SR, Casino Royal, CBS Mastersounds, Etc.

AUDIOPHILE CD'S

MFSL Gold "Ultra Disk", Bainbridge "Colossus", Elite "Stereo play", Three Blind Mice, East Wind, DMP, plus the above labels.

ACCESSORIES BY:

Nitty Gritty, LAST, Audio Quest

ALSO: ONE STOP distributor pricing for Audio Record store, offering all brands above The LARGEST inventory and FASTEST service!

Call for catalog

Acoustic Sounds
P.O. Box 2043, Salina, Kansas 67402
913-825-8609/FAX 913-825-0156

ORDER DESK: 1-800-525-1630

AUDIOPHILE RECORD WAREHOUSE! Out-Of-Print Direct-To-Disc, halfspeed Quix II & Import Pressings. Great selection of In-Print Records & CD's. Quantity Discounts! Call for free catalog. Elusive Disc, 5436 N. Guilford Ave. Indianapolis, IN. 46220. (317) 255-3446.



BRANDS AND MODELS ON DISPLAY

- QUAD CD PLAYER & REMOTE PREAMP
- MIT BALANCED PROLINE
- KRELL KPA PHONO PREAMP
- DAY-SEQUERRA FM URBAN ANTENNA
- VELODYNE
- WADIA DIGITAL
- DUNTECH SOVEREIGN

1917 S. WEBSTER
GREEN BAY, WI 54301
(414) 437-8727

AUDIOPHILE RECORDS

AUDIOPHILE ALBUMS!! SIXTH ANNUAL CHRISTMAS SALE Get Mobile Fidelity's new releases!! (if they're still available): Pink Floyd—MEDDLE, Jethro Tull—THICK AS A BRICK, Blind Faith—BLIND FAITH and all other MFSL Reference Recordings, Nautilus, Chesky. Also one complete Audiophile Album collection (1000 LP.s) SOUND ADVICE, 8215 Grand Ave., Kansas City, MO 64114. (816) 361-2713. Visa and Mastercard accepted. Show Mobile Fidelity support—Purchase new releases!

Audiophile and Quad records. FREE Catalogue **AUDIO CLASSICS**, POB 176AAQ, Walton, NY 13856 607-865-7200. 8AM-5PM EST Mon.-Fri.

WANTED TO BUY

Always Paying Best For: Studer, CAL, C.J. Levinson, McIntosh, Marantz, Audio Research, Quad, Leak, Sequerra. Vintage speakers, units, from Western Electric, Tannoy, JBL, Altec, Jensen, EV. Tel: 818/701-5633 David Yo. P.O. Box 802, Northridge, Ca. 91328-0802.

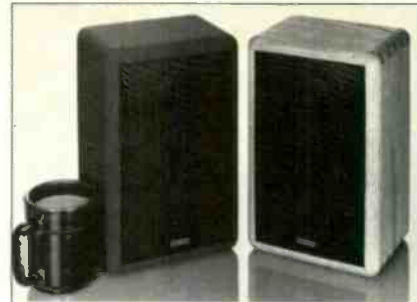

Ambiance™ by Henry Kloss

Ambiance is an ultra-compact speaker that proves high performance, small size and low cost need not be mutually exclusive. Factory direct from Cambridge SoundWorks for \$109-\$129 each (plus freight), depending on finish. 1-800-AKA-HIFI. In Canada 1-800-525-4434.

154 California Street, Newton, Massachusetts 02158

Low-Cost Accessories

For Turntables:

Grado ZTE + I \$20
Grado Bmz, MCZ, TLX Call

For Speakers:

Chicago RT-75 \$20
Chicago Hercules Call
Naual LS-7000 \$49

Monster Cable, Audioquest,
Van den Hul, Vampire Call

TrippLite LC1200, 1800 Call
DBX 1 bx, 3 bx, 120 dx, 400 dx Call

Shipping: \$3 first item, \$1 each extra item

Call 1-800-233-8375 for specials list

AUDIO UNLIMITED

1203 Adams Ave./La Grand, Oregon 97850
(503) 963-5731 — 9-6 M-TH

SPEAKER COMPONENTS

CROSSOVER COMPONENTS

DYNAUDIO

ETON

FOCAL



more!

Peerless

scan-speak

seas

vifa

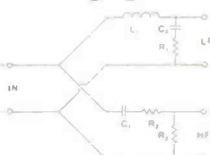

FAST CAPACITORS

Metallized Polypropylene (Non-Polarized)
Values from 1.0 mfd to 200 mfd.
Voltage Rating: 250 VDC / 150 VAC

SOLENOIDS

Perfect Lay Hexagonal Winding Air Cored
Values from 10 mH to 30 mH,
Wire Sizes from #20 AWG to #10 AWG

HEPTA-LITZ INDUCTORS

Seven Strands Litz-Wire Constructions
Values from 10 mH to 30 mH
Wire sizes from #16 AWG to #12 AWG

SOLENOIDS

Custom Computer Design
Passive Crossover for Professional, Hi-Fi and
Car Hi-Fi. Power up to 1000 Watt.

CROSSOVER, SPEAKER PARTS

Gold Speaker Terminals, Gold Banana Plugs
Gold Binding Posts, Crossover Terminals,
Power Resistors, Mylar Capacitors,
Plastic Grill Fasteners, Nylon Ty-Wraps
Grill Cloth, Car Speaker Grills, Misc. Parts.

SOLENOIDS
4470 Thibault Ave.
St-Hubert, QC J3Y 7T9
Canada
Tel: (514) 656-2759
Fax: (514) 443-4949

COMPUTER AIDED DESIGN FOR ENCLOSURE AND CROSSOVER AVAILABLE TO CUSTOMER

Product specifications and prices available upon request.

HIGHER FIDELITY

800-438-6040

FOUR PRIVATE LISTENING ROOMS
1620 South Blvd, Charlotte, NC 28203
704-376-0350

Authorized Dealer for:

AKG • AMERICAN AUDIO • ARAGON • ARISTON
AUDIOPRISM • AUDIOQUEST • AUDIOSOURCE • BEYER
B&W • CAMBRIDGE • CELESTION • CHICAGO
COUNTERPOINT • CRAMOLIN • DAHLQUIST • GRADO
KOSS • MAGNUM DYNALAB • MAY AUDIO • MEITNER
MOD SQUAD • NILES • RATA • ROTEL • SENNHEISER
SHURE • SONRISE • SUMIKO • SUMO • SUMO ARIA
SYSTEMDEK • TERK • TWEAK • VAN DEN HUL
VAMPIRE • VPI • WBT • ZETA AND MORE ALL MAJOR
AUDIOPHILE RECORDINGS AND COMPACT DISCS. ASK
ABOUT OUR PROFESSIONAL AUDIO DIVISION.

DAT—We have legal DAT with full warranty.

WANTED TO BUY

AAAWAYS PAYING TOP \$\$ FOR TUBE OR S.S. McINTOSH, TUBE MARANTZ AND FISHER, SEQUERRA, M. LEVINSON, KRELL, C.J., ARC, ALL JBL PRE-1975 PARTS AND SYSTEMS, EV PATRICIANS, GEORGIANS, EARLY ALTEC AND??? MFSL, NAUTALUS AND OTHER 1/2 SPD. MASTERS, 24HR ANS. MACH. 1-800-628-0266, 6-11PM EST BEST.

DON'T CALL First- MARANTZ, McINTOSH, all tube components, vintage speakers, esoteric hi-end. Outbidding everyone on certain items. N.Y.S.I. (718) 377-7282 afternoons.

HI-FI SUPPLIES—PAYS CASH FOR LEVINSON, ARC, C.J., KRELL, SPECTRAL, ROWLAND & THRESHOLD. (212) 219-3352, 7 DAYS 10AM-6PM (NY).

I WILL PAY RETAIL for all tube MARANTZ or used McINTOSH tube or solid state. Need not work. (504) 885-6988 days.

IT'S WORTH IT CALLING ME! MCINTOSH, MARANTZ TUBE AMP, MCINTOSH SOLID STATE, WESTERN, JBL HARTSFIELD, EV PATRICIAN, JENSEN, TANNOY, ALTEC, TRUSONIC, SPEAKER & HORN, OLD EQUIPMENT. WILL PAY TOP CASH. HENRY CHANG, 115 S. NICHOLSON AVENUE, MONTEREY PARK, CA 91754. (818) 571-6274. FAX: (818) 288-1471 L.A.

SONY PCM-701ES Digital Processor. Will pay good price for clean working unit. Leave message at (212) 254-6360.

TOP PAYING FOR MCINTOSH, MARANTZ TUBE AMP McIntosh Solid State, Western, JBL, Altec, Tannoy, EV, Jensen, Speakers & Horn, EMT Turntable, Ortofon Arm. Temma—(516) 935-2605, (516) 496-2973.

WANT—JBL Hartsfield, EV Patrician, Brociner Transcendent, Singles OK, McIntosh, Marantz & other tube equipment. Larry Dupon, 2638 W. Albion, Chicago, IL 60645. (312) 338-1042 evenings.

WANTED: MARANTZ, McINTOSH, WESTERN, JBL, ALTEC OLD EQUIPMENT. SUNLIGHT ENGINEERING COMPANY, 22130 SOUTH VERMONT AVENUE, TORRANCE, CA 90502. Joe: (213) 320-7020, 9am-5pm.

audio-technica

YOUR SEARCH IS OVER!

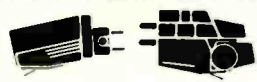

We specialize in hard to find phono cartridges and original replacement styli only!!

(800) 221-0906

CALL TOLL-FREE FOR FREE PRICE QUOTES AND VISAMC ORDERS N.Y. STATE (516) 599-1112
SEND SELF ADDRESSED STAMPED ENVELOPE FOR OUR FREE CATALOG.

LYLE CARTRIDGES

Dept. A, Box 158
Valley Stream, N.Y. 11582

Phones Open Mon-Sat 9 am-8 pm

SHURE

STANTON

AS-ONE™ INTERCONNECT
SYMPHONIC CONDUCTOR™ SPEAKER CABLES
MISSING-LINK™
AUDIOPHILE A.C. POWER CABLE
DIFFERENTIAL BALANCED INTERCONNECT

Aural Symphonics

2016 Flintbury Court San Jose, California 95148 408-270-6033 FAX 408-270-6039
IN CANADA, INTERLINEAR 105 RIVIERA DR. UNIT #3, MARKAM ONTARIO L3R 5J7 416-479-1893

WANTED TO BUY

BUY AND SELL USED HIGH END AUDIO/VIDEO EQUIPMENT. McIntosh, Marantz, Krell, Levinson, Conrad Johnson, ARC, B&W, Tannoy, Etc. Will Pay Top Cash! Call Shim: (201) 943-3761.

WANTED TO BUY

MCINTOSH WILL PAY TOP PRICE FOR MCINTOSH, MARANTZ (TUBE), AUDIO RESEARCH, MARK LEVINSON, OLD JBL, OTHER HIGH-END AUDIO. TRADE WELCOME. YANG (201) 935-4026. (NJ).

MISCELLANEOUS

TERMPAPER assistance. 15,278 papers available! 306-page catalog—rush \$2.00. Research, 11322 Idaho #206AD, Los Angeles 90025. TOLL FREE HOTLINE: (800) 351-0222 (California: (213) 477-8226).

For Purists Only.

"This preamp has no equal. It excels in every important area and does many things no other preamp I have heard can do. This is a breakthrough component in its realistic musicality, eye-opening sound-staging, and intimate dynamic communication."

M. Gindl, Sounds Like... - NO. 4, 1989

Listen.

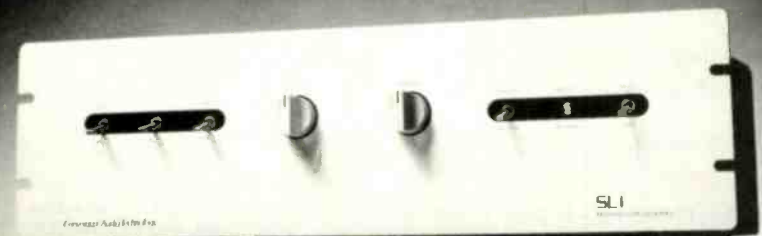

Convergent Audio Technology
24 Falcon Drive • West Henrietta, NY 14586
716-359-2700

The best place to be seen is where people are looking. And each month, both enthusiasts & dealers read **AUDIO's Classifieds** for information.

AUDIO's Classifieds—where consumers shop and dealers buy.

Audio

For details call Carol Berman at (212) 767-6292

INVENTIONS WANTED

A NEW IDEA? Call NATIONAL IDEA CENTER of Washington D.C. FREE INFORMATION-1(800) 247-6600 EXT. 155. Come see THE INVENTION STORE!!

INVENTIONS/NEW PRODUCTS/IDEAS WANTED: Call TLCI for free information 1-800-468-7200, 24 hours/day—USA/CANADA.

SERVICES

Audio Repairs and Restorations by Cliff Ramsey, former Senior Service Technician at McIntosh with over 20 years experience. **AUDIO CLASSICS** POB 176AR, Walton, NY 13856. 607-865-7200, 8AM-5PM EST Mon.-Fri.
—Audio Advertiser for over a Decade—

SPEAKER REPAIR. 4" to 18" speakers reconed. Orban Audio, 119 7th St., N.W., North Canton, OH 44720. (216) 497-9932. 6pm - 9pm EST.

RETAIL MART

HIGH-END AUDIO IN SALT LAKE CITY: Audition Audio features speaker systems by Magneplanar, Vandersteen, Martin Logan, Celestion, Spica, Infinity IRS, Electronics by Audio Research (new Classic 30 & 60 in stock), Mark Levinson, Aragon, Counterpoint, NAD, Adcom, Luxman, Front ends by Versa Dynamics, VPI, Well-Tempered, SME AR, Accuphase CD players. Also Sumiko, MIT, Audioquest, etc. Three hard-wired sound rooms including a new room built for the Infinity IRS. 2144 Highland Dr., Suite 125, SLC, UT 84109. (801) 467-5918. Visa, MC, Amex accepted.

WE HAVE THE FINEST SHOWROOM in our area with the best selection of audio/video components available. We represent Adcom, Infinity, Thorens, NAD, Polk, Yamaha, Canton, Luxman, Klipsch, SONY ES, and more. **CONTINENTAL SOUND**, 98-77 Queens Blvd., Forest Hills, NY 11375. (718) 459-7507.

CAR STEREO

"STEREO WORLD" is your discount mailorder source with super deals on the following car and home stereo lines: Technics, Panasonic, JVC, Sony, Pyle, Pioneer, Sherwood, Philips, Concord, Phase Linear, Hi-Fonics, Blaupunkt, Bazooka, Kenwood, Rockford-Fosgate, and many others. Please call or write for free catalog. Free UPS in 48 states. 10AM-6PM Mon-Fri. Visa/MC; COD extra. *Celebrating our 3rd year.* P.O. Box 596, Monroe, NY 10950 (914) 782-6044.

DECALS/EMBLEMS

CUSTOM EMBROIDERED EMBLEMS, PINS, DECALS. Free catalog/quotes. Rush sketch. STADRI, 61AU JANE STREET, NEW YORK, NY 10014. (212) 929-2293.

BUSINESS OPPORTUNITIES

EASY WORK! EXCELLENT PAY! Assemble Products At Home. Call for Info. 504-641-8003 Ext. 5737.

LET THE GOVERNMENT FINANCE your new or existing small business. Grants/loans to \$500,000. Free recorded message: 707-448-0270 (KF1)

CLASSIFIED ADVERTISERS:

You can reach millions of prime prospects for your mail order products or services through low-cost Marketplace Classified advertising in this or other titles of the

DCI CLASSIFIED MAGNET

To place an ad, or for further information including rates, ad styles, sizes and multi-title discounts, call Toll-Free:

(800) 445-6066

ATTENTION: DYNACO ST-70 OWNERS

HAVE WE GOT A DEAL FOR YOU!

Joe Curcio has modified his ST-70 to 1990 standards and the results are superb. Our readers have responded extremely favorably to this mod and we think you will too. We are offering Audio readers a one-time get-it-while-you-can deal. The kit which originally sells for \$345 will be \$295 for one month only. This means until the March issue of Audio hits. Don't waste time—you must act quickly. If you wish more information on this kit, please send an SASE to the address below. Otherwise call or FAX your order today. Article reprint included.

Just \$295 for beautiful sound!

Old Colony Sound PO Box 243, Dept. C
Peterborough, NH 03458
MC/VISA welcome. (603) 924-8371; FAX: (603) 924-9487

BLANK TAPE

4.95 SHIPPING ANY SIZE ORDER. UPS 1-900-245-6000

| ITEM | QUANTITY | PRICE | ITEM | QUANTITY | PRICE | | |
|-------------|----------|----------|------------------|----------------|-------|-------|------|
| MAY CD | 1.99 | 30-18-15 | SONY UHF PRO-90 | 2.49 | MS-90 | 2.99 | |
| MAR-90 | 2.49 | 31-11-30 | SONY METAL 60-30 | 3.99 | SL-90 | 2.99 | |
| MAR-90 | 2.49 | 37-11-45 | 1.00 | FUJIFILM 90 | 3.99 | SL-90 | 1.99 |
| SAR-90 | 2.49 | 38-11-45 | 1.50 | MAXELL 150-100 | 3.99 | LI-90 | 1.99 |
| ARR-90 | 2.49 | 31-11-30 | 1.39 | MAXELL 150-100 | 2.99 | LI-90 | 1.00 |
| BAT-90 | 2.49 | 32-11-30 | 2.45 | MAXELL 150-100 | 3.99 | LI-90 | 8.99 |
| SA-90 | 1.99 | 11-11-15 | 1.00 | MAXELL 150-100 | 3.99 | LI-90 | 6.99 |
| SA-90 | 1.79 | 11-11-15 | 1.00 | MAXELL 150-100 | 3.99 | LI-90 | 6.99 |
| MAT-10 | 3.69 | | | | | | |
| AD-90 | 1.69 | | | | | | |
| AP-90 | 1.59 | | | | | | |
| D-90 | 1.00 | | | | | | |
| D-90 | 1.00 | | | | | | |
| FUJIFILM 90 | 2.29 | | | | | | |
| FUJIFILM 90 | 2.29 | | | | | | |

TAPE WORLD 220 SPRING ST. BUTLER PA 16001
GENON THATS TRIAD DAT CALL

AMPEX REELS—USED ONCE; 1800'—10 Reels. \$25.00. Sample. \$2.50. Also: New MAXELL reels/cassettes. AUDIO TAPES, Box 9584E, Alexandria, VA 22304. (703) 370-5555, VISA/MC.

PUBLICATIONS

HOME-STUDY SERIES, AUDIO RECORDING COURSE. 3 Affordable levels of study, based on 2 college text books. SKE AUDIO PUBLISHING 1-(800) 284-1258.

MOVIESOUND NEWSLETTER. The state of film audio tracks in theaters and at home. Send \$2 for two sample issues. PO Box 7304, Suite 269A, No. Hollywood, CA. 91603.

SINGERS! REMOVE VOCALS FROM RECORDS AND CDs!

SING WITH THE WORLD'S BEST BANDS!
An Unlimited supply of Backgrounds from standard stereo records! Record with your voice or perform live with the backgrounds. Used in Professional Performance yet connects easily to a home component stereo. This unique product is manufactured and sold exclusively by LT Sound - Not sold through dealers. Call or write for a Free Brochure and Demo Record.

**LT Sound, Dept. AU-3, 7980 LT Parkway
Lithonia, GA 30058 (404) 482-4724**
Manufactured and Sold Exclusively by LT Sound
24 HOUR PHONE DEMO LINE: (404) 482-2485

Say "G'day" to Greencorp's family of Australian tapes.

THE GOOD STUFF—our great XDS tape that the big recording companies (Philips, EMI, & overseas divisions of RCA) buy from Greencorp for their music cassettes.

THE BETTER STUFF—Music-PLUS, the best-sounding tape you ever heard, short of genuine chrome. Its custom formulation produces a higher frequency response and lower noise level than the heavily advertised brands. The result is a noticeably smoother sound, the best in its class.

THE BEST STUFF—genuine chrome tape, which is coated with Dupont's chromium dioxide powder. This is CD-grade tape that performs far better than so-called "chrome-bias" ferric oxide products. The difference is especially audible at silent moments in your recordings.

Greencorp tape; it's the right stuff at the right price. Order your blanks today and listen for yourself!

| | QUANTITY | 25 | 100 | 500 |
|--------------------------|----------|-----|-----|-----|
| XDS Music Grade | C12 | .37 | .26 | .24 |
| <i>The Good Stuff!</i> | C32 | .43 | .32 | .28 |
| | C47 | .47 | .35 | .32 |
| | C62 | .53 | .40 | .35 |
| | C92 | .62 | .50 | .42 |
| Music-PLUS | C12 | .43 | .32 | .30 |
| <i>The Better Stuff!</i> | C32 | .49 | .38 | .36 |
| | C47 | .53 | .41 | .38 |
| | C62 | .60 | .47 | .43 |
| | C92 | .70 | .57 | .51 |
| Genuine Chrome | C12 | .53 | .40 | .38 |
| <i>The Best Stuff!</i> | C32 | .58 | .47 | .45 |
| | C47 | .62 | .50 | .47 |
| | C62 | .68 | .55 | .52 |
| | C92 | .92 | .78 | .74 |

Norelco-type clear plastic boxes, sturdy commercial grade .18 .16 .14

A) Self-adhesive, white cassette labels
B) blank inserts each \$3.00 per 100

TELEPHONE ORDERS:
TOLL FREE: 1 (800) 972-0707
Local: (305) 429-9215
FAX ORDERS: (305) 429-9214

*F.O.B. Deerfield Beach, FL. Taxes (if any) plus shipping extra. CALL FOR SHIPPING CHARGES & LARGER QUANTITY PRICES.
*Minimum quantities are 25 per size, and may be mixed to get the larger quantity discounts.
*Orders of 6,000 or more shipped road freight at cost.

*We accept company or personal checks, or charges to VISA, MASTERCARD, and AMERICAN EXPRESS.
*Prices subject to change without notice.

SATISFACTION GUARANTEED! If not satisfied for any reason, return the cassettes within 30 days for a full refund of the unused portion.

GREENCORP USA inc.



The Right Stuff from Down Under.

Suite 105, 1015 W. Newport Center Drive
Deerfield Beach, Florida 33442

If You Purchased Any High End Audio Component Without Calling Us We Have a Cap For You.



AUDIO OUTLET
The High End Mail Order Store
P.O. Box 673
Bedford Hills, NY 10507
(914) 666-0550

MAIL ORDER

CHADWICK MODIFICATIONS

Our speaker cables and Interconnects bring the music back to you!

- Upgrades for Thorens turntables & Grado cartridges
- Corktone Platter Mat, F-1 Dustcover Weight and more . . .
- Complete catalog \$3.00, refundable with purchase.

1925 Massachusetts Avenue, Cambridge, MA (617)354-8933

ABARGAIN: STAX SIGN/LAMBDA \$1,395, PRO/LAMBDA (#3) \$799, PRO/LAMBDA (#1) \$499, SIGN/SRM1MKII \$1,000, SIGN/SRD7 \$675; GRACE 747 \$129, F9E (SUPER) \$129, F9ERUBY \$195; DENON 103D; DYNAVECTOR 23RS II \$295; FR1MK3F \$235; STG. PEPPER UHOR \$169; ZEISS BINOCULARS; ALL UNUSED; (212) 966-1355.

THE BEST RECORD RACK IN AMERICA. Stackable, portable, oak units hold LP's, CD's and tapes. Free Mailorder Brochure, (please mention Audio). Per Madsen Design; (415) 928-4509, P.O.Box 330101, San Francisco, CA 94133.

NEW AND IMPROVED EARS BY **SERIOUS Listeners®**



THE ORIGINAL LISTENING ENHANCEMENT TOOL
We guarantee you will hear the difference!
Send check or money order for \$24.95 to:
Serious Listeners P.O. Box 565 Burlingame, CA 94011
Phone Orders: 800-326-1201 Dealer inquiries welcome

MAIL ORDER

ADS., NAKAMICHI, CARVER, BANG OLUFSEN, REVOX, B&W, KEF, HARMON KARDON, N.A.D., LUXMAN, HAFNER, TANDBERG, ADCOM, DENON, KLIPSCH, YAMAHA, D.B.X., INFINITY, J.B.L. AND OTHER QUALITY COMPONENTS. BEST PRICES—LIVE PROFESSIONAL CONSULTATION WEEKDAYS—AUTOMATED PRICING AND INFORMATION AVAILABLE 24 HOURS. ALL PRODUCTS COVERED BY MANUFACTURER'S U.S.A. WARRANTY. AMERISOUND SALES INC., EAST: (904) 262-4000 WEST: (818) 243-1168.

High-end and hard-to-find audio components. New and used. Foreign and domestic. Low, low prices! **AUDIO AMERICA** (Virginia). Call 1-703-745-2223.

UNSURPASSED ISOLATION! Our "Tranquilizer" feet upgrade all components. \$19.95 delivered. Money-back guarantee. Isolation Systems catalog included. The WallWorks, RD # 1, Box 503, Sanford's Ridge Road, Glens Falls, NY 12801. (518) 798-1844.

AD INDEX

| Firm (Reader Service No.) | Page |
|---------------------------------|---------------|
| Acoustat (14) | 14 |
| Adcom (2) | 59 |
| Allsop (35) | 63 |
| American Acoustics (3) | 93 |
| Audio Advisor (4) | 65 |
| Audio Research (5) | Cover IV |
| Audiostream (6) | 89 |
| B & K (7) | 92 |
| BMG | 16 & 17 |
| Boston Acoustics | 49 |
| Brystonvermont (8) | 31 |
| California Audio Labs | 85 |
| Cambridge Soundworks (9) | 22 & 23 |
| CBS Records | 99, 105 |
| Celestion (10) | 81 |
| Columbia House | 24 a & b |
| Counterpoint (11) | 69 |
| Crutchfield | 98 |
| Delco/Hafner | 11 & 12 |
| Denon (12) | 1 |
| Design Acoustics (34) | 61 |
| GRP (13) | 107 |
| Harman Kardon (15) | 75 |
| J & R Music World (16) | 94 |
| Kinergetics Research | 91 |
| KNI Loudspeakers | 95 |
| Krell Digital (17) | 19 |
| Krell Industries (18) | 87 |
| Levinson | 83 |
| Madrigal | 20 |
| McIntosh (19, 36) | 57, Cover III |
| Mission Electronics (20) | 21 |
| Mobile Fidelity (21) | 101 |
| Mondial (22) | 15 |
| Music Interface Technology (23) | 67 |
| Pioneer (24) | 7 |
| Polk (25) | 26 & 27 |
| Proceed | 3 |
| Proton (26) | 29 |
| Pyle | 5 |
| Sherwood (27) | 79 |
| Shure Brothers (28) | 108 |
| Sonance (29) | 77 |
| Sony | 35, 71 |
| Soundcraftsmen (30) | 32 & 33 |
| Stereo Exchange (31) | 109 |
| TDK (32) | 4 |
| Velodyne (33) | 103 |
| Wisconsin Discount Stereo | 111 |
| Yamaha | 9 |

Does your system sometimes sound different for no apparent reason?

The reason could be your power. A refrigerator or air conditioner, even in another part of the house, may cause voltage to vary whenever they kick on or off. Or you may be getting line noise—electrical interference that your preamplifier and amplifier amplify and send on to your speakers.

Solution? TrippLite LC-1800. It regulates voltage so it's constant—not too low, not too high. Full voltage—even in brownouts. LEDs show you what TrippLite is doing!

TrippLite's patented ISOBAR circuits provide three "banks" of isolation, two receptacles per bank. You can eliminate interference between critical components. It's like putting your CD player, preamp, and power amp all on separate lines. Sonic benefits may be subtle... but real.

Protection, too

And TrippLite prevents spikes and power from damaging your equipment. This protection is absolutely essential if you leave any of your gear on all of the time.

Take a Power Tripple—No Risk!

Try the TrippLite LC-1800 for 30 days. If not satisfied with the performance (and protection), return it for a full refund of your purchase price. Made in USA by Tripp Manufacturing Co., Est. 1922. Only \$299.00 plus \$9.95 shipping in the US. If you want a clean musical signal, start with clean, consistent power. Order now.



Charge It! Amex / Discover / MC / Visa
1-800-942-0220

audio advisor, inc.
225 Oakes SW • Grand Rapids, MI 49503
616-451-3868 • FAX 616-451-0709

McIntosh[®] is *MUSIC*

Conceived in total dedication to the pursuit of excellence, the time required to develop the research program for this system has spanned at least two decades. The elusive combination of variables required to yield a uniform field has been tantalizing researchers for many years. Finally, after McIntosh built one of the most advanced and best instrumented acoustical laboratories in the world was it possible to follow the many theoretical leads to their conclusion. Then, after this extensive effort of analyzing so many different approaches to uniformity of field, was it possible to synthesize all of this knowledge and in one flash of intuitive genius the director of our acoustical laboratory saw a seemingly simple solution in the correct matching of diameters, masses and compliances and what evolved is a new measure of accuracy and realism. The intellectual and emotional experience of listening to the XR 1052 is something you simply must enjoy in your own home.



For information on McIntosh products and product reviews please send your name, address and phone number to:

McIntosh Laboratory Inc.
Department 290A
PO Box 96 East Side Station
Binghamton, NY 13904-0096

STEINWAY & SONS, STEINWAY and the LYRE Device are Registered Trademarks of Steinway, Inc. and Steinway & Sons, and are used with permission of Steinway, Inc.

Handcrafted with pride in the United States by dedicated, highly trained craftspeople.

The Direct Path to High Performance

Introducing the LS1 Stereo Line Stage Amplifier



To begin with, forget any comparison to ordinary passive line-stage controls. The active LS1 goes far beyond them—in musicality, in technical innovation, in quality of manufacture. Its pedigree, in other words, is pure Audio Research.

But far from being an expensive, limited-audience assault on an esoteric ideal, the LS1 costs \$300 less than our popularly priced SP9 Mark II preamplifier. And, it includes Audio Research's famous hybrid tube/solid-state circuit technology, unstinting parts and manufacture, and service backed by 20 solid years of leadership in audio.

The LS1 offers owners the exceptional convenience of seven inputs, including the new Direct Gain Path,

which bypasses all major controls except Gain—and provides a degree of resolution that challenges the best preamps in the world.

The LS1 features Audio Research's own oxygen-free Lit: wire in critical circuit paths, as well as audiophile-grade connectors selected for their sonic purity. And for audiophiles who own signal processors or who bi-wire, the LS1 offers two main outputs.

If you've forsaken vinyl records, if you collect only tapes or digital source material, audition an LS1 at your nearest Audio Research dealer today. It may seem too good to be true, but we promise: the LS1 will make a believer out of you.

20
classic years
20
1970 - 1990

audio research
HIGH DEFINITION®

6801 Shingle Creek Parkway / Minneapolis, Minnesota 55430 / Phone: 612-566-7570 FAX: 612-566-3402
Enter No. 5 on Reader Service Card