



ANTIQUE RADIO CLASSIFIED



VOLUME 12

NOVEMBER 1995

NUMBER 11

FORD MUSEUM AUCTION



***Auctioneer Estes Sells Rare
Marconi 101 For \$49,000***

A.R.C. — THE NATIONAL PUBLICATION FOR BUYERS AND SELLERS
OF OLD RADIOS AND RELATED ITEMS — PUBLISHED MONTHLY

ANTIQUE RADIO CLASSIFIED

Antique Radio Classified (ISSN:8750-7471) is published monthly, 12 times per year, by John V. Terrey, One River Road, P.O. Box 2, Carlisle, MA 01741. Second-class postage paid at Carlisle, MA, and additional mailing offices. Telephone: (508) 371-0512, 8:30 AM to 6:00 PM ET weekdays; machine answers phone at other times.

Annual subscription rates within the U.S. are \$34.95 by Second Class mail and \$51.95 by First Class mail.

Annual foreign rates. By air: Canada - \$56.00; Mexico - \$56.00; Other foreign countries - \$98.00. Surface mail: Canada - \$45.00; Other foreign countries - \$50.00. (Surface delivery to countries other than Canada may take two or more months and cannot be guaranteed.)

Two-year subscriptions are twice these rates and receive an extra month. Sample issues are available free on request.

© Copyright 1995 by John V. Terrey.

POSTMASTER: Send address changes to Antique Radio Classified, P.O. Box 2, Carlisle, MA 01741. Printed in U.S.A.

STAFF:

Publisher and Editor: John V. Terrey
Production Manager: Scott J. Young
Office Manager: Lisa A. Friedrichs
Advertising Manager: Cindie P. Bryan
Managing Editor: Dorothy Schechter
Radio Events Editor: Chris Frederickson
Publishing & Editorial Staff: Ray Bintliff, Dave Crocker, Dick Desjarlais, Bobby Lyman, Jean Meldonian
Founding Publisher/Editor: Gary B. Schneider
Contributing Writers: Mike Adams, Richard L. Arnold, Ray Bintliff, Ron Boucher, Paul J. Bourbon, Norman S. Brathwaite, Dave Crocker, Alan S. Douglas, Richard C. Foster, Fred Geer, Jim Kreuzer, Ron Ramirez, Henry Rogers, Ian L. Sanders, Gary B. Schneider, Daniel Schoo, Dwane Stevens, Frank R. White, Ralph Williams

PURPOSE: Antique Radio Classified is published for people involved in the radio collecting hobby. Its purpose is to stimulate growth of the hobby through the buying, selling and trading of radios and related items, and to provide a monthly forum for the interchange of ideas and information.

CONTACTING ANTIQUE RADIO CLASSIFIED. All correspondence should be sent to:

A.R.C., P.O. Box 2, Carlisle, MA 01741.

Only UPS, Federal, etc. items to street address: One River Road.

Telephone: (508) 371-0512; Fax: (508) 371-7129

E-mail: ARCMagazine@aol.com

Please, no classified ads by telephone; thanks.

Your ads, renewals, letters, etc. can be handled faster and more efficiently if your name, address and SUB# are written on each.

Unfortunately, A.R.C. is not staffed to answer letters with questions about antique radios or requests for advice. However, A.R.C. does solicit letters of interest to its readers and publishes them as space permits. A.R.C. assumes that permission is given to edit and to publish all correspondence and articles received unless otherwise indicated.

DISPLAY AND BUSINESS CARD ADS - DETAILS AND RATES

The deadline is the first of the month for display and business card ad artwork, payment and repeat requests. Advertising is accepted only for early items related to radio, communication, etc. All items must be described fairly; reproductions, reprints and non-original items must be so identified. Advertisers must agree to respond promptly to inquiries and orders, to resolve problems promptly if the buyer is not satisfied, and to comply with a buyer's refund request on unaltered returned items.

Advertising must be prepaid, except as noted below; see "Payment" paragraph above for details. Late ads will be run only if space and time permit. Since artwork is reduced to 63% in the printing process, originals must be the artwork size listed below. Do not send in artwork on art board or send negatives. Ads should be typeset or typed neatly with a carbon ribbon, black ink (not pencil) on white. If used, reverse type must be limited to 25% of the ad. If you want us to prepare your ad, include the one-time cost below for A.R.C. to make up the ad.

Photos should be at an 85-line screen; otherwise, add \$14.00 per photo for screening. Do not cut or trim photos or glue photos to artwork; submit separately.

If you are confused by these requirements and terms, please

| Page | ARTWORK SIZE (SEND IN THIS SIZE) | | As Printed (size in magazine) | | Cost for 1-month | Cost for 3-months | Cost for 6-months | Cost for 12-months | One Time to make up Ad |
|---------------|-------------------------------------|----------------|----------------------------------|----------------|---------------------|----------------------|----------------------|-----------------------|------------------------------|
| | H x W (inches) | H x W (inches) | H x W (inches) | H x W (inches) | | | | | |
| Full | 12 7/16 x 7 1/2 | 7 3/4 x 4 3/4 | 7 3/4 x 4 3/4 | 7 3/4 x 4 3/4 | \$225.00 | \$599.00 | \$1035.00* | \$1799.00** | \$65.00† |
| 1/2 H | 5 1/4 x 7 1/2 | 3 5/16 x 4 3/4 | 3 5/16 x 4 3/4 | 3 5/16 x 4 3/4 | 113.00 | 299.00 | \$20.00 | 899.00** | 33.00† |
| 1/2 V | 12 7/16 x 3 9/16 | 7 3/4 x 2 1/4 | 7 3/4 x 2 1/4 | 7 3/4 x 2 1/4 | 113.00 | 299.00 | \$20.00 | 899.00** | 33.00† |
| 1/4 | 5 1/4 x 3 9/16 | 3 5/16 x 2 1/4 | 3 5/16 x 2 1/4 | 3 5/16 x 2 1/4 | 57.25 | 151.50 | 263.00 | 459.00 | 17.00† |
| 1/8 | 2 5/8 x 3 9/16 | 1 5/8 x 2 1/4 | 1 5/8 x 2 1/4 | 1 5/8 x 2 1/4 | 29.50 | 78.00 | 135.50 | 236.00 | 8.00† |
| Business Card | 2 x 3 3/4 | 1 1/4 x 2 3/8 | 1 1/4 x 2 3/8 | 1 1/4 x 2 3/8 | not avail. | 41.00 | 70.75 | 122.00 | 6.00† |

* Full page, 6-mos.; 1/2 due with order; 1/2 due in 3 mos. ** Full & 1/2 page, 12-mos.; 1/2 due with order; 1/2 due at 3, 6 & 9 mos.

† For 6 and 12 month ads, no ad make-up charge if no change is made to ad for entire run.

GUARANTEE. You may cancel your subscription at any time and receive a pro rata refund for issues not yet mailed. If errors to ads are made by A.R.C., upon request a free correction will be run in the next available issue.

PAYMENT. Please send in full payment with your order or ad. A.R.C. does not carry accounts; all subscriptions, ads, etc. must be prepaid (except for the 6 and 12 month display ads indicated below). Pay in U.S. funds. Checks drawn on a U.S. bank, money orders, VISA or MasterCard (\$10.00 min.) are preferred. Make check out to "A.R.C." U.S. stamps or cash are OK for small amounts. Canadian payers may send a Canadian check but specify U.S. funds. Subscriptions will be prorated to amount sent if amount is incorrect.

FAX & E-MAIL PROCEDURES/PAYMENT. Subscriptions, book orders, classified ads, display ads, etc. are welcome by fax or e-mail. Deadlines are the same as for ads received by mail. Please calculate the amount due. Payment by VISA or MasterCard is preferred if your order is over \$10. If under \$10, or if you prefer to send a check or money order, state the amount being sent and that the payment is in the mail. Do not send another copy of your ad with your payment; simply indicate that it is a fax or e-mail payment. If you want confirmation of our receipt of your fax, call immediately after sending your fax.

CHANGE OF ADDRESS. Please notify us 4 weeks in advance of a change of address. Send both your new and old addresses, and include your SUB# and effective date of your new address. Temporary address changes can be made also.

SUBMISSION OF MATERIAL. Antique Radio Classified welcomes and solicits information that pertains or relates to radio history or collecting. This may include articles, book reviews, photos, information on upcoming radio events, meetings, antique radio organizations, radio auctions, sources of old radio and restoration supplies, and other related and interesting material. All material submitted should be carefully researched, typed and accompanied by good photos, if appropriate. Computer disks are appreciated. Writing guidelines are available upon request. Unless prior arrangements are made, all submitted materials may be edited, become the property of Antique Radio Classified and will not be returned. Publication is subject to approval by A.R.C. and to time and space constraints.

MAILING OF ISSUES. U.S. subscribers can receive A.R.C. by First or Second Class mail (Second Class is the way most magazines are mailed). The mailing of First Class copies is staggered over one to four days with faraway copies mailed before local copies. Non-U.S. copies are mailed on the first day. Second Class copies are mailed on the last day. Mailing dates change each month, but mailing is usually completed by the 26th of the month. First Class copies usually are received by the 5th of the month; copies by Second Class mail, by the 10th.

ETHICS. No person involved in the production of A.R.C. is to act on any information in the magazine until the first delivery day after local copies are mailed.

DISCLAIMER. The publisher is not responsible for any buying and selling transactions incurred, or for any other use of the contents of this publication.

Antique Radio Classified subscription rates, frequency of publication, content, policies, size and ad details, and rates are subject to change at any time by A.R.C.

contact A.R.C. before beginning to prepare your ad. We will be happy to advise you on your ad ideas, estimate how much the ad will cost, recommend an ad size, etc.

We assume that advertisers want all ads which are submitted to run without delay; therefore, we will run the ad and bill for any additional work required for the ad to meet these specifications. A late ad will run beginning with the next month. "Tear sheets" will be sent only for 1/8-page or larger ads and only if requested when the ad is submitted.

Business card ads are limited to one per advertiser.

The 3-month rates represent about an 11% discount, the 6-month rates 23%, the 12-month rates 30%. Placement requests; add 15% but call first. Clubs: write for discount policy.



ANTIQUE RADIO CLASSIFIED



EDITOR'S COMMENTS

Two radio events that can only be described as "super" share the A.R.C. spotlight this month — the annual AWA conference and the Henry Ford Museum auction in Dearborn, Michigan. At both events, many collectors saw an unprecedented array of early equipment.

The annual 4-day AWA Historical Radio Conference was attended by nearly 1,000 collectors who enjoyed a continuous flea market, four auctions, seminars, a banquet, and other activities. "100 Years of Radio" was the conference theme, and the presence of Marconi's daughter, Gioia Marconi Braga, enriched the event.

Highlights of the extraordinary Henry Ford Museum auction are reported this month with a full report to follow next month. For the first time, at least in the U. S., a single radio sold for \$49,000, while 12 others sold for over \$10,000 each. The auction total was \$590,693. Even more significant than the dollars spent, however, was the rarity of many of the items on the block. Even the most sophisticated collector had to be impressed.

More than 300 attended this auction, and about 85 relaxed and exchanged stories of the day at A.R.C.'s first "Radio Bash" on Saturday evening.

Although the rarities seen in these events are hard to top, another article in this issue proves that there is always something different out there to make us sit up and take notice. Francis Yonker's massive, 20-tube Philco 37-890 does just that. This unusual set appears to have seven speakers, but four are resonators.

Rewinding 1920s transformers is the topic of Stephen Imms' article. Stephen offers detailed solutions to this prevalent problem.

The issue is rounded out with *Photo Review*, *Radio Miscellanea* and a club spotlight on the 25

years of the Buckeye Antique Radio Club.

Cybernaut Alert! Check out our World Wide Web site at "http://www.antiquradio.com". The A.R.C. site is your link to the world of antique radio. Event calendar, radio photos and more, but no ads!

Another year of growth. For the 11th year, A.R.C. has increased its subscribers — 8,222 received our September 1995 issue. The required U.S. Postal Service statement appears below. We thank all of you for your support and especially those of you who include feedback with your ads, renewals, book orders, etc.

Renew Now & Save. Unfortunately, every year, our costs go up, and in order to keep A.R.C. viable, we must increase our rates. For all U.S. subscriptions, we have held this year's rate increase to \$2 (only 17¢ per month). The new rates do not go into effect until January 1, 1996, so you still can extend your subscription at this year's rates. Send in the coupon in the center of this issue today, or call us at 508-371-0512. Also on January 1, 1996, advertising rates will be increased in order to apportion A.R.C.'s costs fairly between readers and advertisers.

Coming Radio Events. Even though the holidays are approaching, there are still 40 events for the collector during the month of November. And for your 1996 planning, we have added many 1996 radio event dates to our "Mark Your Calendar" list.

Happy Collecting.

John V. Terrey, Editor

ON THE COVER

Although old, dirty, and modified, this 1913 Marconi Type 101 tuner brought the top bid at the Henry Ford Museum auction in Dearborn, Michigan, on October 7-8, 1995. The photo proves that Auctioneer Richard Estes was also on "top" of his job.

STATEMENT OF OWNERSHIP, MANAGEMENT AND CIRCULATION

(1) Publication Name: Antique Radio Classified. (2) Publication No.: 8750-7471. (3) Filing Date: Oct. 13, 1995. (4) Issue Frequency: Monthly. (5) No. of issues published annually: 12. (6) Annual subscription price: \$34.95. (7) Complete mailing address of known office of publication: 498 Cross Street, Carlisle, Middlesex County, MA 01741. (8) Complete mailing address of headquarters or general business office of publisher: Same as #7. (9) Full names and complete mailing addresses of publisher, editor and managing editor: John V. Terrey, 498 Cross Street, Carlisle, MA 01741; Same; Same. (10) Owner: Same. (11) Known bondholders, etc.: None. (12) Not applicable. (13) Publication Name: Antique Radio Classified. (14) Issue date for circulation data below: Sept. 1995. (16) Statement of Ownership will be printed in the Nov. 1995 issue of this publication.

| 15. Extent and Nature of Circulation | Average No. Copies Each Issue During Preceding 12 Months | Actual No. Copies of Single Issue Published Nearest to Filing Date |
|---|---|--|
| a. Total No. Copies (Net Press Run) | 9569 | 10016 |
| b. Paid and/or Requested Circulation | | |
| (1) Sales through dealers and carriers, street vendors and counter sales (Not mailed) | 0 | 0 |
| (2) Paid or Requested Mail Subscriptions | 8119 | 8222 |
| c. Total Paid and/or Requested Circulation (Sum of 15b1 and 15b2) | 8119 | 8222 |
| d. Free Distribution by Mail (Samples, Complimentary, and Other Free) | 791 | 1068 |
| e. Free distribution outside the mail (Carriers or other means) | 172 | 249 |
| f. Total Free Distribution (Sum of 15d and 15e) | 963 | 1317 |
| g. Total Distribution (Sum of 15c and 15f) | 9082 | 9539 |
| h. Copies Not Distributed | | |
| (1) Office use, left over, spoiled | 488 | 477 |
| (2) Return from News Agents | 0 | 0 |
| i. Total (Sum of 15c, 15h(1) and 15h(2)) | 9570 | 10016 |
| Percent Paid and/or Requested Circulation (15c/15g x 100) | 89.40% | 86.19% |
| 17. I certify that all information on this form is true and complete. | Signature and Title of Editor, Publisher, Business Manager, or Owner <i>John V. Terrey - Owner</i> | |



FORD MUSEUM AUCTION

The Henry Ford Museum Radio Auction Part 1 — Highlights

BY JOHN V. TERREY

This is the first of a 2-part report on the Henry Ford Museum Radio Auction. Due to publishing deadlines, a full report could not be included in this issue, but we have been able to put together the highlights of the event. A complete report will appear in the December issue. (Editor)



Radio boys Bell, Hite, Lozier, Brown, Sibley, Burgess, Wyborny, Moore and others gather outside the tent awaiting the auction preview.

The much heralded Henry Ford Museum Radio Auction has come and gone, and the attendees may still be reeling from the wonder of it all. Most of the population of Dearborn, Michigan, were no doubt unaware that on October 7 and 8, 1995, their town was the center of perhaps the major radio event of the decade. More than 300 collectors and friends had gathered at the museum to spend a total of \$590,693 — a bonanza for the museum's General Collections Fund.

On Saturday and Sunday, the registered bidders numbered 178 and 105 respectively. Interestingly enough, although the attendance was about one-half that expected, the proceeds totaled almost twice the auctioneer's expectations.

In seven hours on Saturday, 590 lots were sold, while 445 lots hit the block in five hours on Sunday. Bidding was fiercely competitive, as some of the prices noted here attest. The international set, which included representatives from Germany, France, Switzerland, Holland, Sweden, Japan, and Canada, gave the Americans from 28

states stiff competition and were successful on many of the rare items.

The prices were in a range never before seen in a U.S. auction, with a 1913 Marconi 101 tuner (modified by the Marconi factory in 1918) selling for \$49,000. Of the additional items, four sold for over \$20,000, eight more for over \$10,000, and 90 more for over \$1,000.

Among the high-bid items were a very early DeForest 2-step amplifier (missing the audio sockets) selling for \$27,500; an American Marconi magnetic detector selling for \$25,500; an Adams Morgan RA-6 tuner (dirty but complete) selling for \$24,000; and a Canadian Marconi Type 2843 tuner selling for \$20,000.

These prices gave an epicurean taste to the overall event. But, modestly priced purchases were also possible. Auctioneer Richard Estes remarked on the wide range of prices — an \$11,000 item preceded by one for \$5, a \$24,000



Left to right, the larger pictured items are a British Marconi Direction Finder Type 11, a Canadian Marconi Type 2843, an American Marconi Type 122 (or 119 or 120), an American Marconi Type 101, a Wireless Specialty Apparatus Co. IP-77, and a British Marconi Type 55 amplifier. These six items alone brought \$97,800.

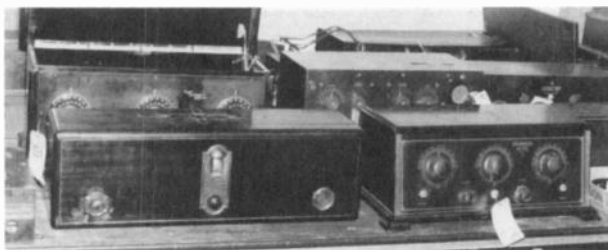

A refinished Radiola 17 with a knob missing, left, and a Standard Master 5, right.

item between \$50 and \$75 items. There were box lots of parts, tubes, transformers, etc., early transmitter racks, crystal detectors, telegraph keys, rare and unusual tubes, horns, and a number of broadcast receivers. And as promised, Estes spread the high-value items over the two days. Bidders marveled at Estes' skill in moving items along at a rate of about 85 an hour.

Some of the more familiar items included a Magnavox TRF-5 receiver for \$100; a Radiola III-A for \$175; a Radiola 28 with loop and table for \$200; a Radiola 33 for \$45; a Radiola X for \$500; two Radiola III sets for \$75 and \$85; a refinished Grebe MU-1 for \$700; two Radiola 17 sets for \$45 and \$55; and a Radiola UZ-1325 horn speaker for \$225.

A selection of additional higher-priced items included the following: a Radiola VII and VII-B for \$10,000 and \$1700; a Radiola 26 for \$1,500; a Grebe CR-18 with coils for \$2,600; two Kennedy Model 110 receivers for \$2,250 and \$2,100; two DeForest Interpanel sets for \$2,450 and \$2,000; a Federal 61, with cabinet in poor condition, for \$950; two Atwater Kent Model 10C breadboards for \$1,100 and \$1,300; a Pittsburgh Radio Supply SP-2, with slide-in amplifier, for \$1,100; a Grebe CR-9 for \$600.

Additional wireless gear included a W.E. CW-938 transmitter for \$11,000; three SE-143 tuners for \$10,500, \$8,000 and \$2,100; two SE-1420 receivers for \$2,200 and \$1,200; and a NESCO CN-240 for \$5,500. The army pack sets, all without receivers, sold for \$4,500, \$8,000 and \$9,000.

As for rare crystal detectors, a 1916 Washington Navy Yard triple detector Type A (looks like an SE-183A) sold for \$3,000, an IP-175 for \$2,400, and two SE-183A triple detectors for \$900 and \$400.

The condition of the items ranged from museum quality (sometimes refinished, however) to dirty from years in storage. Many items were missing knobs and other components. Also, some items were without cabinets or sometimes were only panels stripped of nearly all parts.

Unfortunately, most individual items were not identified by white lot number tags, but museum tags on the majority of items showed a bit of the history of each piece. For example, the items from the RCA George

Clark Collection had red tags, and items from the Edison Institute had white tags.

Another white tag contained the museum's de-accession number (e.g. 40.118.9). This is the number to use if you would like the museum to provide more information on your purchases. Send your request, along with that number and a description of the item to: Attn: Research Center, The Henry Ford Museum, P.O. Box 1970, Dearborn, MI 48121-1970.

Ford Museum's Lisa Korzetz, Sarah Lawrence, and Eric Manthey are to be commended for a very well organized event. The physical setup was convenient, with the auction tent located in a parking lot at the side of the museum. As each item was sold, it was moved to an adjacent tent to await pickup. A food booth served the museum's usual excellent menu, stoking the fires of hot-on-the-trail collectors.

Credit should also be given to the Michigan Antique Radio Club for assistance during the auction.

The first *Antique Radio Classified* Radio Bash on Saturday evening right after the auction was also a great success. Eighty-five collectors from as far away as Germany, Canada, California, and Florida gathered to exchange impressions of the eventful day. Refreshments, a cash bar, and the four books given as door prizes added to the festive spirit. Many contributed to the "Show and Tell" table, which included items from personal collections, as well as auction purchases. In all, the diversity of items and people at the Bash paralleled that of the auction itself. Perhaps the Radio Bash will continue as an A.R.C. tradition.

Next month, a comprehensive listing will appear in A.R.C., as well as more information and photos.

Acknowledgments:

Richard Estes Auctions and Ludwell Sibley.

(John Terrey, c/o A.R.C., Box 2, Carlisle, MA 01741)



The wide variety of items on display was worthy of close examination by collectors Goemans, Stone, Jensby, Renne, Ball and others.

WITH THE COLLECTORS

The Philco Model 37-690

BY DICK DESJARLAIS BASED ON INFORMATION
CONTRIBUTED BY FRANCIS H. YONKER

Occasionally, A.R.C. receives a photo of an old radio for its "Photo Review" section which seems to merit article status. We knew this was the case when subscriber Francis Yonker sent in photos of his Philco 37-690. A telephone conversation with Mr. Yonker confirmed our impression of the unique and sophisticated qualities of this 300-pound floor model. He obliged us with additional photos and information which served as a basis for this photo essay. A.R.C. thanks Mr. Yonker for sharing his Philco Model 37-690 information with our readers. (Editor)

Figure 1 is deceptive, because, with the doors closed, this piece of furniture appears to be anything but a state-of-the-art floor model radio. However, with its doors open, as in Figure 2, this becomes a radio indeed — and one with distinctive features.

What first drew my attention were the 7 speaker-grilles (count them!) gracing the front of an



Figure 1. Have you ever spotted furniture like this in a yard sale or antique shop, hoping that beyond the closed doors was a "hidden radio"? In the case of this Philco Model 37-690, you would be right!



Figure 2. Note the 7 speaker grilles and the automatic tuning dial. There are 6 controls — Tuning, Off-On/Bass, Magnetic Tuning, Band Switch, Volume, and Treble/Selectivity.

otherwise simply designed cabinet. A close inspection of the cabinet's interior, shown in Figure 3, reveals an elaborate speaker system that consists of a woofer, two tweeters and four acoustic resonators. The woofer is the large dynamic speaker located in the lower part of the cabinet. Philco referred to the woofer as a "cathedral high-fidelity speaker."

The four speaker-like devices surrounding the woofer are the acoustic resonators that Philco called "clarifiers." These clarifiers are not connected electrically to the radio, but respond to the acoustic output of the woofer. Judging from the size of the clarifiers, they probably enhanced the mid-frequency response of the speaker system. The two high frequency speakers, or tweeters, are located next to the top of the cabinet.

To complement the speaker system, the radio employs a separate bass amplifier circuit to provide a wide range of bass tone control. Treble response is controlled by IF bandpass and audio control circuitry.

Another distinctive feature is the tuning dial which appears to be similar to the teledial used by other manufacturers, but was, according to Philco ads, the company's "New Automatic Tuning System." This system is described in Ron Ramirez's *Philco Radio* as follows: "To tune in a favorite AM station, all that was required was to press in a lever where the station's call letters were located on the set's escutcheon and turn the lever until it

clicked into place. The radio was then tuned to the station. To keep the station tuned correctly, Philco introduced automatic frequency control, which it named "Magnetic Tuning."

The 37-690 has two separate chassis, the audio output and power supply in the power unit on the bottom shelf, and the receiver on the top shelf. Five bands cover the frequencies between 530 Kc and 18 Mc. There are 20 tubes in all, as noted in the tube layouts in Figures 4 and 5 from Rider's, Volume VIII, page 8-39. Interestingly, Rider needed seven pages to provide the necessary technical information on this large set!

Commenting on the various features of the 37-690, Ramirez states, "Philco seemed to be competing with custom set builder E.H. Scott with its new flagship model — the 37-690X. With its high fidelity reproduction, variable IF bandwidth, and acoustic clarifiers, in addition to automatic tuning and magnetic tuning, the 37-690, along with the Model 37-116 and 38-690, are definitely among the best radios ever made." The Philco radio rarity scale gives the 37-690 an A+, which means that it may be rare.

Acknowledgment: Ray Bintliff, Technical advice.

References:

Ramirez, Ron and Michael Prosis. *Philco Radio 1928-1942*. Atglen, Pa.: Schiffer Publishing, Ltd., 1930.

Rider, John F. *Perpetual Trouble Shooters Manual, Volume VIII*. New York: John F. Rider Publishing, Inc., 1937.

(Dick Desjarlais, Box 629, Littleton, MA 01460))

(Francis Yonker, 1229 Inverary Pl., State College, PA 16801)

Dick Desjarlais is on the staff of A.R.C. His interest in radio began at age 14 when he was an apprentice in a radio repair shop. This interest renewed itself when he retired as a school superintendent. Since 1987, he has been an active collector and dealer, buying and selling radios in his business — "Dick's Radio Days."



Figure 3. This cabinet has to be rugged to withstand the combined weight of the receiver chassis, 3 speakers, 4 resonators, and the power unit chassis. Not surprisingly, Rider's Volume VIII, page 39, gives instructions for removing the cabinet top and adjusting the door hardware.

Francis Yonker is a retired college professor of electrical engineering, specializing in electronics, AM/FM radio and TV broadcasting. Much of his work has been in mobile communications and electromagnetic interference. He continues to design TV and FM stations, and he is a radio ham (W2IBH). As Mr. Yonker says, "I have four workbenches — electrical, mechanical, refinishing, and ham — and I work full time, 10 to 12 hours a day, seven days per week, on my radio hobby!"

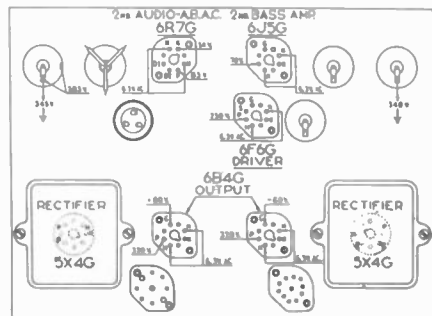

Figure 4. Tube layout for the power unit, containing power supply and audio output. Chassis is located on bottom shelf of cabinet.

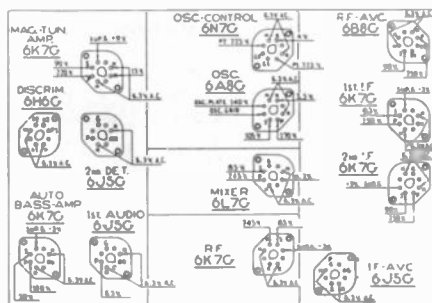

Figure 5. Tube layout for the receiver chassis, mounted on top shelf of cabinet, showing tube layout.

RESTORATION TOPICS

Rewinding 1920s Transformers

BY STEPHEN F. IMMS

Aficionados who restore 1920s radios will sometimes (often) find that their sets have one or more bad audio transformers. From personal experience and through correspondence with Alan Douglas and others, I learned that construction techniques and aggressive manufacturing practices led to the use of other than ideal soldering fluxes, wire insulation and just possibly poor quality control. Transformers will sometimes fail prematurely due to the effect of atmospheric moisture acting on the flux residue (corrosive by-products will eat at the insulation, resulting in a short circuit or open).

Some sets have the audio transformers mounted below the chassis, and it is an easy matter simply to replace the bad component with its modern functional equivalent. The replacement transformer will probably not have a similar mounting pattern, and may require (ouch!) drilling new mounting holes.

Of course, an alternative would be to seek out a good transformer through a want ad or swap meet. Barring an easily obtainable replacement for my RCA Radiola III, and not wishing to butcher the insides of my set, I thought, "I could unwind the bad secondary. How hard could it be to wind a new coil in its place?"

TYPICAL CONSTRUCTION

Having removed the transformer, I began to dissect it to find out how it was constructed and how I might restore it. I was careful to make sketches as I proceeded, and soon found the transformer to be similar in construction to one shown in a typical electrical theory textbook. The transformer consists of iron laminations, held in place by a pair of formed sheet metal jackets called the "channel frame." The channel frame is often a single-piece design, which nowadays is in common use.

I discovered that the laminations are not the typical scrapless E I type, but are of a one-piece form, as shown in Figure 1. However, it is more common to find the typical E I form, as used by Freed-Eisemann and others. The laminations are disassembled easily, but I found that the transformer's coil was not wound on a bobbin, as expected.

Instead, the coil is self-supporting, each layer separated by a thin section of what appeared to be wax paper. So how was I

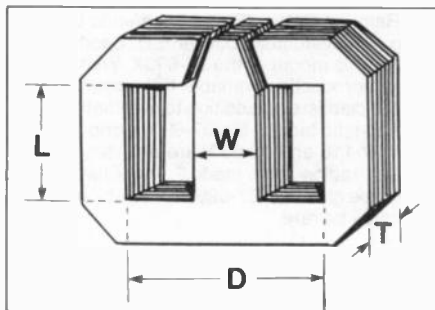

Figure 1. One-piece transformer laminations.

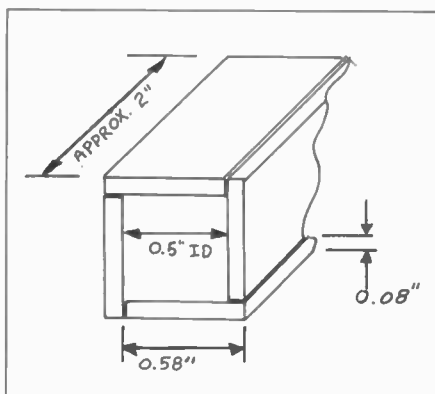

Figure 2. View of the rectangular section of the bobbin.

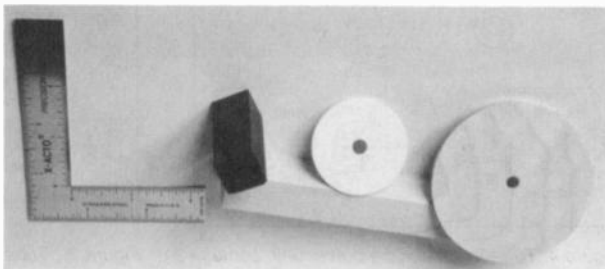

Figure 3. Bobbin, flange, and plywood "donut."

going to wind a new coil — on air? I took careful measurements of the coil and decided to make a bobbin on which to wind my new coil.

WINDING A REPLACEMENT COIL

For those stalwarts who wish to "roll their own," I will list the materials and describe the procedures which I followed. You will need the tools and material listed in Table I.

Table I
Tool and Material list

- A drill press and an adjustable circle cutter.
- 3/8-inch variable speed electric drill.
- 6-inch caliper, dial type preferred.
- Ohmmeter.
- 1 small sheet of styrene plastic (.062 to .080" thick). †
- 1 oz. bottle of Testors plastic cement. †
- 1 small sheet of 1/8-inch plywood, 5" x 10". †
- #8 threaded rod, about 4" long with several flat washers and nuts. †
- About 1' of #22 stranded wire
- One reel of #42 enamel-coated copper wire.
- Several inches of fabric type "spaghetti," solder, soldering iron, wire cutter, masking tape.
- Fine marker, cigarette lighter, 1/16-inch drill bit.
- Lots of patience.

† Obtainable from hobby shops

DISASSEMBLY PROCEDURE

Remove the channel frame, noting how it encloses the laminations and how the laminations pass through the coil.

Disassemble the lamination stack. Note: If the laminations will not slip apart easily, they may have been coated prior to assembly. If so, soak the whole transformer in alcohol for several hours to dissolve the coating. Acetone may also be used if

the laminations will not come apart easily. Acetone is extremely flammable and must not be breathed to excess. Nail polish remover contains acetone.

Note how the coil leads exit and how they are secured to the external tie points.

Restack the laminations on your bench and take careful measurements of the dimensions called out in Figure 1:

| Lamination | Table II Coil Equivalent | Symbol |
|-------------------|--------------------------------------|--------|
| Stack thickness | Bobbin ID | T |
| Center leg width | Bobbin ID | W |
| Lamination length | Bobbin length, plus flange thickness | L |
| Lamination width | Flange diameter | D |

CONSTRUCTION OF THE BOBBIN

Glue thin strips of styrene together to form a bobbin with a rectangular center with inside dimensions that are slightly larger than the lamination stack's thickness and width.

Prepare the styrene for cutting by laying out the width approximately equal to the coil's inside dimension plus one thickness. For example, if your bobbin is to be 0.500" square (ID) and your stock is .080" thick, your styrene strips should be 0.58" wide. Styrene is easy to cut by first scoring it with a small nail dragged across the surface (just deep enough to make an impression). Snap the stock and cut to a length of about 2 inches. Figure 2 shows a view of the bobbin's rectangular center with dimensions for the example given above.

FORMING THE BOBBIN

Line up one edge of your prepared stock perpendicular to the edge of another strip. Use the small brush in the bottle of cement to drip a little of the liquid into the joint formed by the two pieces. Hold the pieces square for about 30 seconds to allow the cement to dissolve the plastic and begin working. Take two more pieces and make up another "angle" as above. Be sure to hold pieces square for at least 30 seconds. Allow to dry for a few hours or overnight, while you are busy cutting out the bobbin flanges and plywood "donuts."

Assemble the two "angles" into one tube by using the capillary gluing technique as above. Allow the tube to set at least overnight, as it will be trimmed to its final dimension, and must be rigid enough to be cut and sanded to length. The tube is to be cut to a length approximately equal to the dimension "L" (See Figure 1) minus two thicknesses of the styrene stock to compensate for the thickness of the bobbin flanges.

BOBBIN FLANGES AND PLYWOOD "DONUTS"

Measure the distance between the "D" legs of the lamination. The outer diameter of the bobbin flanges should be slightly smaller than the lamination's "D" dimension. Use an adjustable circle cutter in a drill press to cut out your flanges. Be sure to clamp the styrene stock to the drill press table before cutting. Make two flanges for the transform-

(Continued on following page)

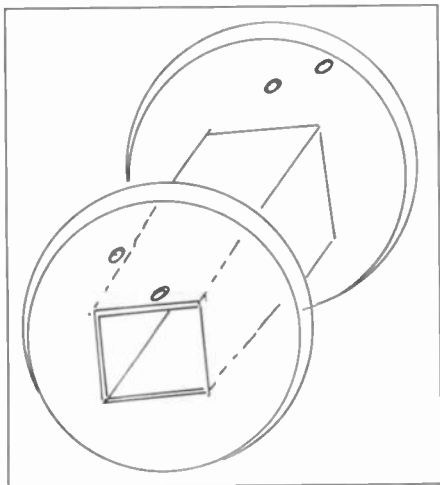

Figure 4. An assembled bobbin ready for winding.

(Rewinding 1920s Transformers, continued)

er, plus a spare or two. Open up the circle cutter and make two plywood "donuts" about $\frac{1}{2}$ " larger in diameter than the styrene pieces. These plywood pieces will be used to protect the coil pigtail as the coil is being wound. A flange, bobbin and plywood donut are shown in Figure 3.

FINAL ASSEMBLY OF THE BOBBIN

Next the flanges are glued to the bobbin's rectangular tube. Center one flange piece onto the end of the tube, and glue together. Be sure the pieces are square and held securely for at least 30 seconds. Assemble the other flange onto the other end of the tube. Allow to dry at least overnight. A sketch of the assembled bobbin is shown in Figure 4.

Use an X-ACTO knife or very fine hacksaw blade to open up the center of each flange. Remember, the core laminations must pass through the center of the bobbin, and the entire stack must fit. Make fine adjustments as necessary.

PREPARATION FOR WINDING

Mark the bobbin flanges with the locations for the coil starting and ending points, and drill the appropriate holes, using an $\frac{1}{16}$ -inch drill bit. See Figure 5 for a sketch of the flanges with typical hole locations. Remove any burrs from inside the flanges. Any burrs inside the flanges will snag and break the wire as it is wound. Figure 6 shows the bobbin with the plywood donuts in place ready for winding.

Use a cigarette lighter to remove carefully the enamel coating from the magnet wire (about 1 inch or so). Very carefully wrap and solder the prepared end to a 2 $\frac{1}{2}$ -inch piece of #22 stranded wire. This pigtail will be the starting point of the primary winding. Note: Some magnet wire may be insulated with a very tough coating which may be difficult to burn off. In this case, use fine sandpaper or a chemical stripper before soldering. On the other hand, some wire uses a solder strippable insulation (rated at 105 or 130°C). This coating will come off when exposed to a little molten ball of solder on the end of your iron.

Pass the end of the pigtail through the bobbin flange from the inside. Allow about $\frac{3}{8}$ - to $\frac{1}{2}$ -inch of the soldered part to remain inside the bobbin. Cut a very small piece of masking tape, and secure the pigtail flat against the surface of the tube closest to its exit point.

Pass the threaded rod through one of the thin plywood "donuts" and then through the bobbin. Put another "donut" onto the other flange, and hold it all together with lockwashers and nuts. The coil starting point is trapped between the flange and its respective plywood "donut" — this prevents damage to the winding.

WINDING THE COIL

Unwind about 3 feet of magnet wire from the supply reel and set it down (on one of its flanges) on the floor in front of you. The wire will come off the top

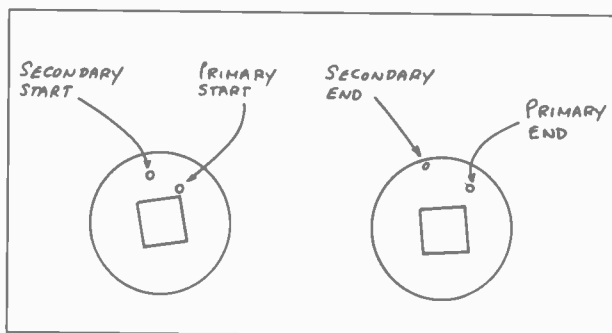

Figure 5. Flanges with typical hole locations.

of the reel as it is pulled and wound onto your work piece. Chuck the free end of the threaded rod into the electric drill. Take a deep breath, sit down, and relax. Pick up the drill with one hand, holding the bobbin horizontally at about waist level. Allow the wire supply to pass between two fingers of your other hand and very slowly pull the trigger.

Observe how the wire begins to fill the bobbin. Make note of the direction in which you are winding. Guide the wire onto the bobbin, but do not make any extraordinary effort to get a perfect level wind. As you gain confidence, you can go full speed with the drill. If you have access to a foot-actuated rheostat, you may want to secure the drill to the bench while you are winding. This may make the winding go more easily. Observe the buildup of wire on the bobbin.

MEASUREMENT OF COIL RESISTANCE

As you approach the "coil end point," determined by your measurement of the coil exit position on the flange, you will want to measure the coil resistance. Stop the drill and carefully set it on your workbench. Gain access to the coil starting point (between the bobbin flange and plywood disk) and clip on one lead of your ohmmeter.

Carefully remove a bit of the enamel near your proposed ending point and take a reading. If it is too low, carefully resume winding until it is what you want. If you accidentally break the wire at this point, simply clean both ends, solder together (use very little solder — don't make a bump) and resume winding. A bit of insulating tape couldn't hurt here, however.

After you reach your end point, terminate it

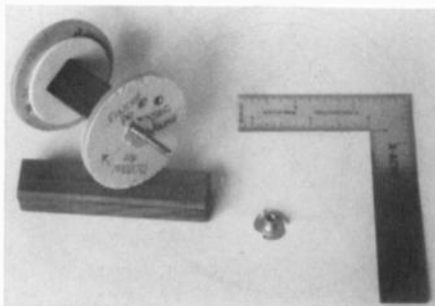

Figure 6. A bobbin with plywood "donuts" in place.

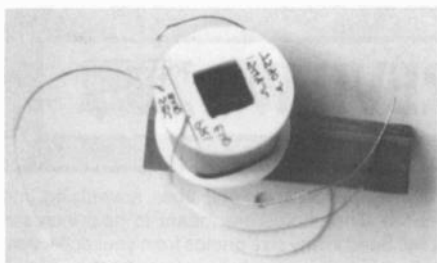

Figure 7. A completed coil ready for laminations.

with another 2½-inch piece of #22 stranded wire. Use a small piece of masking tape to isolate the terminated coil end. Pass the pigtail through the flange from the inside and wrap the coil with another piece of masking tape.

Prepare the secondary, and wind in a similar manner as the primary. Be careful to wind in the same direction as the primary. Overwrap the completed coil with masking tape, and prepare for final assembly. Note: Although I used common masking tape for insulation, it has been brought to my attention that paper tape may contain an adhesive with conductive properties. This may lead to an effect called tracking, which results in arcing between current carrying conductors. A more robust construction may use Scotch Type 33 electrical insulating tape, although I have not yet found my construction technique to be lacking in performance after several years. Figure 7 shows the completed coil ready for laminations.

FINAL ASSEMBLY

Insert the laminations, one at a time into the bobbin. Be sure to alternate them and also put the "I" pieces between each pair (if used). Be careful not to bend the laminations as they are inserted. All of the laminations should fit into the core, and the stack should be squared up. The coil lead wires are insulated with a cotton over-braid form of spaghetti sleeving and soldered onto their respective tie points. (A VFB type of sleeving, which is a braided fiberglass tube covered with a PVC outer jacket, may be used when the transformer is operated with a higher than usual B+ voltage.)

The coil pigtails are carefully dressed to avoid short circuiting to the laminations or channel frame. Figure 8 depicts the rewound and rewired transformer ready for installation of the channel frame. The channel frame is then put in place and secured with screws and nuts.

No attempt is made to duplicate the exact turns ratio of the original transformer; the object here is to approximate the effect of the appropriate turns ratio by means of resistance measurements. In the case of the Radiola, the resistance ratio is about 1500 to 7500 ohms, which indicates a turns ratio of about 5:1.

The actual turns ratio is not very critical, but it will be possible to measure the voltage step-up ratio by using a bell transformer to excite the primary and by reading the secondary voltage with your voltmeter.

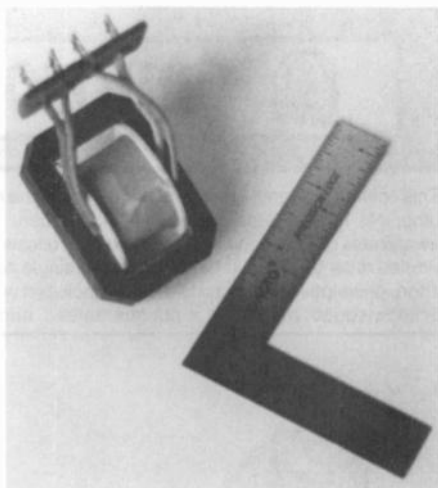

Figure 8. A rewound, rewired transformer ready for installation of the channel frame.

ter. This approach has proven to be acceptable in winding replacement transformers for the Radiola III, Freed-Eisemann models and others. I believe that many of the transformers made in the 1920s were of similar construction, and replacements for them should be equally possible using the technique thus described.

Acknowledgment for technical and material assistance:

Derek Brooke of PREM Magnetics
Alan Douglas, author of *Radio Manufacturers of the 1920's*.

(Stephen F. Imms, 51a Old Shannock Road, Wakefield, RI 02879)

Steve has been interested in antique radios since 1986 after receiving a sample copy of A.R.C. and attending an estate auction where he paid way too much money for a home-brew one-tuber — the subject of a future article.

©1994 by Stephen F. Imms. All rights reserved.

Nomenclature Note: "Scrapless laminations" are so-called because there is no scrap metal left over when they are punched from individual sheets of metal. The two "E" sections and "I" sections are laid out in such a manner that the "I" sections are surrounded by a pair of "E" sections. The laminations used by the Radiola transformers are a one-piece design, but the very design causes two scrap pieces to be left over from each punched lamination.



PHOTO REVIEW



This column presents in pictorial form many of the more unusual radios, speakers, tubes, advertising, and other old radio-related items from our readers' collections. The photos are meant to help increase awareness of what's available in the radio collecting hobby. Send in any size photos from your collection. Photos must be sharp in detail, contain a single item, and preferably have a light-colored background. A short, descriptive paragraph **MUST** be included with each photo. Please note that receipt of photos is not acknowledged, publishing is not guaranteed, and photos are not returned.



RADIO NOVELTY – A little Dutch girl listens to a radio. In case you haven't guessed, this radio novelty is intended to be a toothpick holder. (Gary Schneider – Cleveland, OH)



NEWCOMB MODEL B-100A – This simply designed AC/DC radio was made by a West Coast manufacturer of well known audio amplifiers. The chassis uses a combination of miniature and octal tubes. The cabinet has a leatherette covering. (Harry Pawowaruk – St. Cloud, MN)

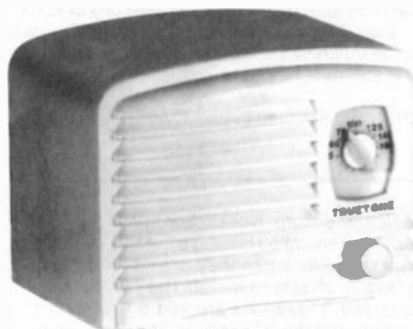

TRUETONE MODEL D909 – Nicknamed the Truetone "Junior," this little radio measures only 6¼" wide and 4½" tall. Western Auto sold this set in the 1940s for about \$7. (Robert Bailey – Jacksonville, FL)

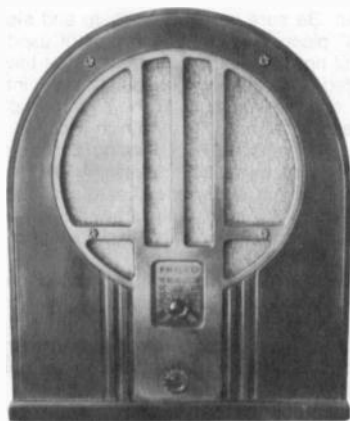

PHILCO MODEL 84B – Philco squeezed quite a good performance from this little 1934 superhet, considering that it uses only 4 tubes, a Type 77 1st detector/oscillator, a Type 77 1F/2nd detector, a Type 42 audio output, and a Type 80 rectifier. The single IF stage uses regeneration to increase sensitivity. (Bill Harris – Roanoke, TX)

PHOTO REVIEW

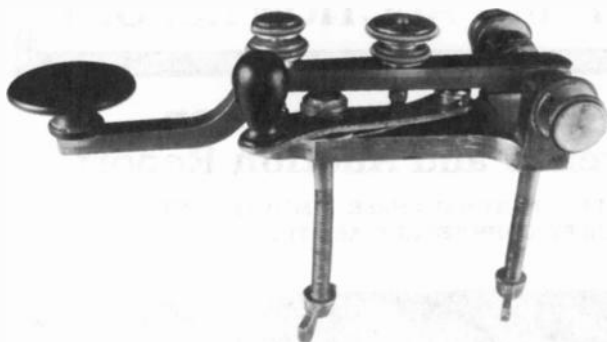

PHILLIPS CURVED LEVER KEY – Patented on May 25, 1880, by Walter P. Phillips, this key features removable iron contacts and an unusual arrangement of the pivot, gap adjustment, contact and spring functions. More details are given in AWA's *Old Timer's Bulletin*, August 1993, in "Key and Telegraph," edited by Roger Reinke. (John Kelly – Ashton, MD)



PHILCO MODEL 38-10 – This 1938 standard broadcast and shortwave receiver has a walnut veneer cabinet with photofinishing on the front panel. (Robert Bailey – Jacksonville, FL)



RADIO NOVELTY – This 1920s radio with a miniature horn is really a cardboard candy container. (Gary Schneider – Cleveland, OH)



JOSEPH W. JONES BATTERY SET – This TRF set, ca. 1924, has 5 exposed tubes, plus the usual 3-dial tuning arrangement. (Larry Chestnut – Ellington, CT)



SUPREME MODEL 546 – This 1930s vintage oscilloscope features a brass front and an oak cabinet. (John Schehrer – Joplin, MO)



Antique Wireless Association 1995 Conference and Auction Report

COMPILED FROM REPORTS BY RAY CHASE, TIMOTHY MARTIN,
LUDWELL SIBLEY, JOHN TERREY, AND THE AWA

The Antique Wireless Association (AWA) held its 34th annual Historical Radio Conference in Rochester, New York, September 6-9, 1995, with 981 attending. The conference, held at the Thruway Marriott Hotel south of Rochester, had 270 outdoor flea market vendors, an indoor book fair, 4 auctions, an old equipment contest, an extensive display of Marconi equipment, seminars, a grand banquet, and trips to the AWA Museum. The photos accompanying this article give a sense of the seriousness and variety of this annual event.

This year's theme — "100 Years of Radio" — was the focus of the Old Equipment Contest. The categories were arranged by time, not type of radio. The ten decades of radio, from 1895 to 1995, were well represented.

The highlight of the conference occurred at the "100 Years of Radio" Banquet on Friday evening where Gioia Marconi Braga, Marconi's daughter, gave a presentation on her father's life from her perspective.

Equally enjoyable was the Marconi presenta-



Is the colorful bird in this outstanding Crosley display piece competing with Auctioneer Walt Buffington?

tion and equipment display on Thursday by Felicia and Jim Kreuzer. Other seminar topics included early radio communication, telegraph, collecting books and magazines (hosted by A.R.C.'s editor), amateur radio, very unusual Federal sets and the evolution of the radio receiver.

The flea market activity began early Wednesday morning as cars, trucks and vans were unloaded. By Wednesday noon, nearly 200 active vendors were counted by your editor. The weather

was generally kind, although there were some strong winds and threats of rain on Thursday.

The four auctions were generally kind, although there were some strong winds and threats of rain on Thursday. The four auctions were generally kind, although there were some strong winds and threats of rain on Thursday. At the communications equipment auction, all but two of the approximately 71 lots sold and brought a total of \$3,660. The sale of approximately 434 lots in the main auctions went smoothly with only 22 passed lots. Although the audience seemed to be smaller than usual, the bidding was still strong and spirited. Total sales were \$47,507.

While no spherical Audions were presented, the tube auction had some fantastic box lots, including several with Western Electric and highly sought audio tubes, such as Types 45, 2A3, and KT88.

Highlights of the paper and



Well preserved cathedrals and tombstones mount to the sky in this distinctive display.



A speech by Marconi's daughter, Gioia Marconi Braga, highlighted the banquet. She is shown here against the Marconi display picturing her father.

advertising auction were two outstanding large Crosley display pieces which featured very colorful birds, and an autographed photo of Marconi which brought \$650.

The radio selection was as broad as usual, with \$5 box lots, very nice English crystal sets, outstanding telegraph gear and a wide range of collectible battery sets. Two plastic Sonora Deco AC table radios drew \$800 and \$900.

A World War I field telegraph set brought the best price of the day — \$2,500. Other highlights were an Ericsson Model 800 Morse register selling at \$1,200, a Marconiphone M-2 tuner and amplifier at \$625, and a Paragon RA-10 tuner at \$975. A Federal 401 "Pleiphone" horn may have drawn a record price for a speaker at \$1,200.

This auction report is our best attempt to combine all the information from our reporters. We have not listed items with inadequate description, some items in poor condition, and some with low selling prices. For reading ease, when the final price ended in ".50," the price has been rounded down to an even dollar amount.

e=excellent, vg=very good, g=good, f=fair, p=poor, unk=unknown, BB=Brass Based, TT=Tipped, w/manual=original manual, w/manual(c)=photocopy of manual, N.I.B.=new in box, NT=no tubes, PS=power supply, WT=with tubes.

Communications-Equipment:

| | |
|---|------|
| Ameco TX-62 6/2-m transceiver, e | \$30 |
| Collins 75A-3 receiver, w/manual, 1 mechanical filter, e | 275 |
| Eico 720 transmitter, vg | 30 |

A warning: Auction prices are not current values. A listing such as this cannot adequately include the condition of cabinets, chassis, transformers, tubes, the operating status of the set, and the inclusion of incorrect, restored or replica components, etc. Auction prices are the result of the excitement of the auction process, the skill of the auctioneer and the specific interests of the participants. Nevertheless, auction prices serve as useful references and as another element in the value determining process. The possibility of error always exists, and if we are notified, corrections will be reported.

| | |
|--|-----|
| GE YRS-1 sideband selector, w/manual, vg... | 17 |
| Hallicrafters FPM-300 transceiver, w/manual, e | 55 |
| Hallicrafters HT-17 transmitter, meter added.. | 75 |
| Hallicrafters HT-32 transmitter, e | 40 |
| Hallicrafters HT-40 transmitter, g | 20 |
| Hallicrafters R-46B speaker, clean, vg | 50 |
| Hallicrafters S-20R receiver, vg | 30 |
| Hallicrafters S-240 receiver, e | 30 |
| Hallicrafters S-85 receiver, knobs changed, vg. | 26 |
| Hallicrafters Sky Buddy receiver, vg | 52 |
| Hallicrafters SX-133, e | 30 |
| Hallicrafters SX-17 receiver w/speaker, vg ... | 185 |
| Hallicrafters SX-25 receiver, g | 82 |
| Hallicrafters SX-28, w/rack cabinet, vg | 114 |
| Hallicrafters SX-42 receiver w/manual, vg ... | 200 |
| Hammarlund HQ-140X receiver, vg | 105 |
| Hammarlund HQ-170 receiver, 1 knob changed.. | 65 |
| Hammarlund SP-200 receiver, w/PS, g | 50 |
| Harvey-Wells Bandmaster Z-match, g | 65 |
| Heathkit DX-40 transmitter | 30 |
| Heathkit DX-60 transmitter, w/VFO, vg | 30 |
| Heathkit DX-60B transmitter, w/manual, vg ... | 35 |
| Heathkit HR-10B receiver, vg | 32 |
| Heathkit HR-20 receiver & HX-20 transmitter, w/manuals, e | 52 |



High tech infiltrates the antique radio world, as Ludwell Sibley records the auction results.

| | |
|--|-----|
| Heathkit QF-1 Q-multiplier, e | 3 |
| Heathkit SB-301/401 transmitter/receiver combo, microphone, speaker, cables, e . | 100 |
| Heathkit SB-630 phone patch/SWR bridge/clock, vg. | 16 |
| Home brew 6V6 40-m CW transmitter, e | 70 |
| Howard 430 receiver, no dial glass, vg | 50 |
| Link UF-11 mobile FM receiver, g | 5 |
| Military AN/ARC-5 transmitter, 7-9.1 MHz, less cover, w/manual(c) | 14 |
| Military BC-348 receiver, lightly converted, clean | 36 |
| Military BC-348P receiver, meter added, modified to dual conversion | 42 |
| Military BC-454B receiver, converted, w/ dynamotor | 27 |
| Military BC-455 receiver, converted, w/ dynamotor, less top cover | 21 |
| Military BC-457 transmitter, coil window changed, key jack added, less covers | 10 |
| Military Bendix TA-12G transmitter, w/carton and shock mount, w/manual, e | 185 |

(Continued on following page)



A mint National Model HFS and power supply from the communications equipment auction.

(AWA Auction, continued)

| | |
|--|-----|
| Military Federal R-266A/URR-13A UHF receiver, vg | 10 |
| Military RDR UHF receiver, vg | 5 |
| Military RT-67/GRC transceiver and PP-112/GR, w/PS, f | 32 |
| Military spare-parts box for ATB transmitter | 5 |
| Military TCS-12 transmitter, COL-52245, scruffy, less shock mount | 24 |
| Military TCS-9 transmitter, COL-52245, vg; w/ shock mount, e | 35 |
| Military TG-34A code-practice keyer, no tapes, e .. | 5 |
| National 7100 B-supply, NT, g | 40 |
| National FB-7 receiver, less dial & coil sockets, g .. | 80 |
| National HFC 5/10-meter converter, e | 325 |
| National HFS receiver, later version, w/coils, no PS, scruffy | 32 |
| National HFS receiver, w/coils, orig. carton, 6-V vibrator, PS, mint | 270 |
| National HRO coil sets, w/storage box, postwar, (3), vg | 45 |
| National NC-270 receiver, rusty, f | 20 |
| National NC-46 receiver, dial glass bad, vg | 28 |
| National SW-54 receiver, w/manual, e | 26 |
| Realistic DX-150A receiver, (1) knob bad, vg .. | 23 |
| Realistic DX-160 receiver w/speaker, e | 48 |
| Realistic TRC-6 tube CB transceiver, e | 10 |
| Scott RBO-2 military receiver, less shock mount, f | 30 |
| Swan 600R receiver, w/speaker, less cover, knobs changed | 25 |
| Western Electric police-car radio, 18A transmitter, NT, and 18B receiver, vg | 39 |
| WRL Globe Scout Deluxe transmitter, w/manual, vg | 50 |

Vacuum Tubes:

| | |
|---|-------|
| 01-A, (45), g; 45, (5); blue, (5) | \$320 |
| 01-A, 199, 215, 811, 227 | 32 |
| 2A3, (12), (4) in CeCo boxes, g | 180 |
| 2A3, in boxes, (12), g | 130 |
| 24, etc., in good boxes, (27), g | 95 |
| 47, 199, tubular Audiotron, etc., g, [Incorrectly identified as a "tubular audion"] | 250 |

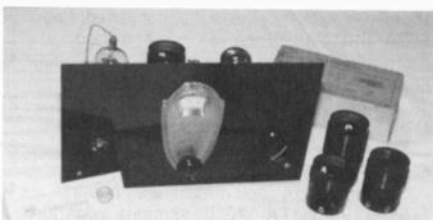

This National SW-2 with coil set, (exterior, left, and interior, right), was a ribbon winner in the equipment contest.

| | |
|---|--------------------|
| 199, (4), (2) g, (2) dud, | 20 |
| 199, 120, 205A, CeCo "K," (2) RCA photocells, (15), g | 180 |
| 199, 216A, odd specials | 110 |
| 802, 26, 71 (18), g | 30 |
| 8013, 815, 615, transmitting, N.I.B., (9) | 10 |
| 8020, 5R4, 829, etc. | 10 |
| AC types in nice cartons, unusual brands, including Rogers, Sparton, (16) | 80 |
| Airline gold-globe 201As, N.I.B., (2) | 90 |
| Arcturus blue 47 globe, 59 ST bulb, g | 45 |
| Arcturus blue RD-1 Sonora, N.I.B., nice | 55 |
| Arcturus blue, (9), (8 g) | 75 |
| Arcturus Wunderlich, blue, (2), 1 w/cap, g .. | 100 |
| Audiotron, tubular, open fil | 55 |
| Ballasts, boxed, (40), g | 25 |
| Big-pin and octal mixed, 1.5 cu. ft. | 45 |
| Crookes CRT, repro, Maltese Cross target on stand | 210 |
| Crookes CRT, repro, vertical style, on stand | 200 |
| Cunningham Audiotron | 95 |
| Daven MU-20, De Forest DV-2, RCA UV-199, all open fil, (3); others, (9); foreign, (1) | 60 |
| DeForest DV-3s, open fil, (3) | 20 |
| Electrad Diode, open fil, w/box | 70 |
| GEC KT88 in boxes, (3), and 45, (1) | 350 |
| Japanese UV-814, screw-on-top variant, open fil | .65 |
| Kellogg 401s, (2) | 47 |
| Loktals, loose, (100) | 25 |
| Miniatures, loose, (250) | (250) 17; (500) 10 |
| Moorhead VT and De Forest 20, dud | 65 |
| Mullard DFA1 in big original carton | 17 |
| Northern Electric 221D, DX-235, orig boxes .. | 22 |
| Octals, loose | (120) 27; (180) 20 |
| Octals, metal, loose, (150) | 25 |
| Octals, tested/reboxed, (96) | 27 |
| Osram V-24 in display frame, (incorrectly identified as a VI-24) | 75 |
| Osram, 01-A, sub-miniatures, etc., g | 120 |
| QRS dud, Myers dud, 0-1A, BB, TT, g | 47 |
| QRS Red-Top w/boxes, (4), nice | 200 |
| Raytheon Kino-Lamp, scanning disc neon TV tube | .130 |
| RCA "Original Nine" octals on display stand w/copy of promo book | 55 |
| RCA 199, (2), g | 22 |
| RCA 203A, N.I.B., (2) | 80 |
| RCA 811, in boxes, (2), g | 20 |
| RCA UV-200 & -201, BB, boxed, g | 55 |

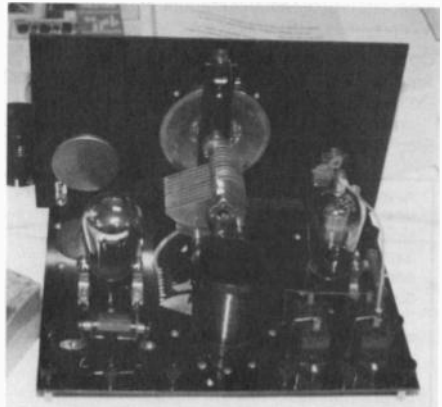

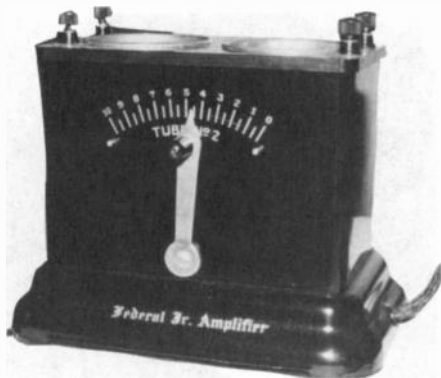

This Federal Jr. crystal set, right, and the rare matching amplifier, above, were displayed by Larry Babcock.

| | |
|--|------|
| RCA UV-202, N.I.B. | 25 |
| RCA UV-207, unk | 70 |
| RCA UV-849 | 20 |
| RCA UX-120, (2), g | 25 |
| RCA UX-852, g | 5 |
| RCA/De Forest 203A, (2) | 12 |
| Spectrum-glow, O ₂ , He, Ne, etc., (5), WE 216A, (1) | 100 |
| Sylvania 6SQ7, odd round-top metal | 5 |
| TB-1 and (2) tipped light bulbs | 35 |
| TB-1, (3), and UV-202, g | 37 |
| Telefunken RS-214 on base | 100 |
| Telefunken RXV-275A on display stand | 80 |
| Transvision empty tube cartons, (10) | 5 |
| TV neon, like 601, arbor broken | 65 |
| UX-199, w/shock-mount adapter, g | 15 |
| UX-204A, mounted w/socket | 30 |
| VT-2, g; 216A (2), g; DeForest DL-14, Westinghouse KU-series protector; rest mostly duds, (20) | 250 |
| WE 101D, 102F, 104D; GE CG-1162; Ediswan Type C, open fil, (rest good), many N.I.B., (16) | 1050 |
| WE 102F (2), 216A, VT-1, g | 190 |
| WE 205D | 70 |
| WE 216A, g | 35 |
| WE 216A (3) | 210 |
| WE 216A, (2), VT-1, (1), g | 110 |
| WE 216A, 200, 201, in boxes, (11), g | 100 |
| WE 224A CRT | 260 |
| WE 264C, g | 10 |
| WE CW-105 ballast | 37 |
| WE photocells 2A (4), 9B (1) | 37 |
| WE VT-1, N.I.B., TT, g | 75 |
| WE VT-2, g | 42 |
| Weagant valve, open fil | 150 |
| Westinghouse WR-21 Aeriotron, g | 70 |

Paper and Advertising:

| | |
|---|--------|
| <i>ARRL Handbook, Rider Oscillator at Work, Jones 1937 Radio Handbook</i> | \$35 |
| ARRL Handbooks, '56, '65, '67, '69, vg | 15 |
| AT&T Telephone Almanac, 1933 | 20 |
| Atwater Kent Jolly Dancer figure, uncut, e | 55 |
| Atwater Kent signs, '20s, repro tin 12" x 10" color lithos, (2) | 20 |
| Audel's Radioman's Guide, vg | 9 |
| Berliner, Emile, <i>Maker of the Microphone</i> , 1926 | 40 |
| Bucher, <i>Practical Wireless Telegraphy</i> , vg | 20 |
| Bucher, <i>Vacuum Tubes in Wireless Communication</i> , g | 20 |
| Bucher, <i>Wireless Experimenter's Manual</i> , 1920, (2), f, g | 17, 25 |
| Bucher, <i>Wireless Experimenter's Manual</i> , 1920, f 25 | |
| <i>Citizens Radio Callbook</i> , 1926, g | 15 |

| | |
|--|-------|
| CQ, 1945, (8), g | 42 |
| CQ, Vol. 1 No. 1, Jan. 1945, g | 20 |
| Crosley bluebird store display, "Sweetest Singer of the Air," e | 300 |
| Crosley cardinal bird store display, 30" high, vg | 300 |
| <i>Detroit News</i> poster, '30s full-page ad for console radios, appliances, framed | 22 |
| <i>Detroit News</i> poster, full page ad for WWJ-WE-Graybar, framed | 10 |
| <i>Electrician & Mechanic</i> , 1906-07, (13) | 45 |
| <i>Electronics</i> , 1939, (3) | 6 |
| Eveready Batteries sign, 10" x 14", '20s, repro, e | 20 |
| Fleming, <i>Thermionic Valve in Radio Telegraphy & Telephony</i> , 1924 | 37 |
| Halicrafters Radio-TV sign, outdoor plastic, 30" x 40" | 42 |
| Hopalong Cassidy sign, tin repro, e | 11 |
| Marconi history booklet, '90s British, vg | 30 |
| Marconi, autographed photo, w/certificate of authenticity | 650 |
| Marconi, <i>Yearbook of Wireless Telegraphy & Telephony</i> , 1916, g | 60 |
| Marconi-Victor wireless-telegraph code set, 78-rpm records, in box, g | 70 |
| Maria Cristina Marconi to Taylor at Rocky Point, letter facsimile | 30 |
| Modern Radio, Continental Radio Corp. catalog, 1922, vg | 40 |
| <i>Most Often Needed Radio Diagrams 1926-38</i> , '39, '40, '50, Beitman/Supreme, vg | 12 |
| <i>Old Timer's Bulletin</i> , 1986-91 | 22 |
| Playing cards, Philco Hi-Hat Club, (2) decks in box | 40 |
| Poster, "RCA Radiotrons," 18" x 30", boy on antenna pole, heavily faded | 75 |
| QST 1925-34, bound vols., (10), vg | 60 |
| QST, 1922-29, (19); (61) others, g | 50 |
| QST, 1926, (5) | 25 |
| QST, 1942-49 in ARRL binders | 35 |
| QST, 1944, 1949 | 5 |
| QST, midget, first post-WWI issue, g | 70 |
| <i>Radio Apparatus for Amateur & Experimental Use</i> , RCA catalog, ca. 1921, e | 85 |
| Radio Boys style books, incl. <i>Tom the Telegrapher</i> , (12), f | 22 |
| <i>Radio Revuo</i> , 1927, in Esperanto, (2) | 5, 13 |
| <i>Raytheon Receiving Tube Handbook</i> , 1937; RCA CRTs TS-2, 1 supplement, g | 32 |
| <i>RCA Radio Service Bulletins</i> , 1948-66, w/indexes | 12 |
| <i>RCA Red Books</i> , '33-'35-'36-'37, service data 70 | |

(Continued on following page)



It was standing room only for Felicia and Jim Kreuzer's presentation on Marconi. Felicia's authentic Marconi Wireless operator's uniform was an eyecatcher.

(AWA Auction, continued)

| | |
|--|----|
| RCA tube product line poster, ca. 1928, 18" x 30", g | 90 |
| Regulations Governing Commerce Between Signal Corps Ship and Shore Stations, 1914, g | 27 |
| Rider on Basic Electricity, (4), g | 5 |
| Rider, TV Manuals, Vols. 1-14, w/index | 37 |
| Rider, Vol. 1, f-g | 37 |
| Rider, Robison, Radiotron Designer's Handbook, etc. | 55 |
| Robison, Manual of Wireless Telegraphy, 1915 ed., g27 | |
| Robison, Manual of Radio Telegraphy and Telephony, 1918 ed., vg | 32 |
| Sams Photofact No. 1 in envelope | 6 |
| Sams transistor radio manuals and Sylvania TV servicing, modern softcover | 16 |
| Short Wave Craft, Zenith, Crosley 51 copy, (12) .. | 10 |
| Snodgrass and Camp, Radio Receiving for Beginners, 1922, g | 12 |
| Textbook on Wireless Telegraphy, Stanley, 1914, vg | 27 |
| Vogue picture disc, 10" record, one chip | 37 |
| Wireless Telegraphy, DU-series, 1921 | 10 |
| Wiretappers, novel, g | 35 |

Radio/Miscellaneous Equipment:

| | |
|---|------|
| AC Dayton XL-50, NT, vg | \$30 |
| Atec 150A microphone, in box | 52 |
| American Bosch 28, WT, e | 70 |
| American electric service buzzer 1914, military, w/phones (2), vg | 100 |
| Ampex 600 recorder, works, e | 60 |
| Amplion 835 horn, some petals chipped, vg .. | 170 |

| | |
|---|-------|
| Amrad single-dial TRF, partial tubes, vg | 35 |
| Atwater Kent 10B breadboard, BB, TT, tags, w/Atwater Kent horn, vg | 1,050 |
| Atwater Kent 20 big box, tags, NT, vg | 60 |
| Atwater Kent 725, painted (factory?), vg | 52 |
| Baldwin horn, wood-grain composition, 12" bell, e .. | 220 |
| Bell 625 PA amp, no bottom, g | 5 |
| Birmingham Wireless Laddo crystal set, vg .. | 300 |
| Bogen intercom, Series 0, (2) stations | 5 |
| Bogen M-330 PA amp, works, vg | 17 |
| Boonton Univerter (2) & 202B signal gen., g .. | 22 |
| Bosch Ambertone cone speaker, g | 140 |
| Brach 1917 military, inductive telegraph set, vg .. | 2,500 |
| Branston R-47 Hetrola Five, NT, g | 130 |
| Braun Volksempfänger VE301 Dyn, vg | 260 |
| Brownie No. 2 crystal set, w/box, e | 450 |
| Bunnell Morse relay, e | 30 |
| Bunnell pen register in carry case, vg | 220 |
| Bunnell telegraph relay, large, vg | 42 |
| Canadian Marconi LFR-2SB.57830 LF receiver, 6-volt DC, vg | 35 |
| Capacitors, variable, '20s, (4) | 15 |
| Cenco galvanometer, vertical boxed style, vg .. | 85 |
| Cenco spark coil, 12" overall, vg | 270 |
| Christie tester, electrical, utility, portable | 10 |
| Clapp-Eastham Blitzen wavemeter, other parts, g .. | 190 |
| Clearstone battery set, WT, vg | 70 |
| Craftsman 2-dialer, NT, vg | 50 |
| Crosley 5M3 tombstone, vg | 100 |
| Crosley 50, (1) BB, TT, vg | 150 |
| Crosley 51 portable, NT, g | 110 |
| Crosley 51, NT, vg | 95 |
| Crosley Pup complete, WT, vg | 240 |
| Crosley Reado 118 home newspaper-fax printer, w/manual, test prints, g | 270 |
| Crosley subminiature tube book-radio "As You Like It," vg | 100 |
| Crosley-DeForest 51, (2) g tubes, BB, TT, e .. | 250 |
| Crystal set, Teco (Telefunken) w/Telefunken phones, ca. 1926 | 150 |
| David Grimes 6D, NT, vg | 160 |
| David Grimes Baby Grand, vg | 140 |
| De Forest BC-14A, less coil, tube socket added, military, g | 310 |
| DeForest Canadian Ind. Tel. Co. SC-10, vg .. | 475 |
| Detector, Carborundum Stabilizing Unit, vg .. | 45 |
| DuMont 224A oscilloscope, partial working, ... | 10 |
| E.I.Co. No. 10000 condenser, fixed, Bakelite mount, .40 | |
| E.I.Co. spark coil and Leyden jars, (2 small), vg .. | 240 |
| E.J. Rose spark control panels, (2), g | 10 |
| E.I.Co. sparkgap, vertical, vg | 110 |
| Edison cylinders (17), and spare cans | 35 |
| Ericsson Model 800, Morse register, ca. 1900, w/manual(c), spare tape, vg | 1200 |
| ESCO motor-generator, vg | 37 |
| Fada 263, black Bakelite, vg | 110 |
| Federal 401 Pleiophone horn pedal-type speaker .. | 1,200 |
| Federal E-10 Ortho-Sonic, WT and crate | 50 |
| Ferris 18-C microvolter signal generator, e .. | 10 |





This pedal-type Federal 401 Pleiphone sold for \$1,200, possibly a record price.

| | |
|--|-----|
| Firestone A-366, e | 40 |
| Firth 1-tube amp, WT, vg | 260 |
| Fisher 800-B stereo receiver, w/manual, vg .. | 85 |
| Freed-Eisemann NR-5, NT, g | 55 |
| Freed-Eisemann NR-6, NT, vg | 55 |
| GE J-82 cathedral, g | 390 |
| Gecophone No. 1 crystal set, e | 320 |
| Gecophone No. 1 crystal set, "given by Sir Oliver Lodge to his daughter," e | 360 |
| Geloso reel-to-reel tape recorder, papers, works, vg .. | 20 |
| General Instrument Corp. 3-dialer, NT, vg .. | 80 |
| General Instrument Neutrodyne, in orig box, WT, panel ripply | 230 |
| General Motors Day-Fan 7 TRF, NT, vg | 45 |
| General Radio 3-mH inductors, (2) | 20 |
| General Radio ham-band wavemeter, (3) coils ... | 10 |
| General Radio microphone hummer and variable lab inductor | 45 |
| Gibson Girl BC-778/SCR-578 military transmitter, no accessories, vg | 55 |
| Giffillan GN-4, g tubes, e | 200 |
| Graybar 300 (Radiola 16), vg | 50 |
| Grebe CR-8, WT, vg | 450 |
| Grebe MU-1 Synchrophase (pre-chain version), NT | 100 |
| Grebe Synchrophase Seven, vg | 100 |
| Grunow 660, g | 32 |
| Guild Country Belle, less shelf, g | 10 |
| Hallicrafters S-20R Sky Champion, g | 47 |
| Headsets, assorted, clean and bagged, (10) | 120 |
| Heath HD-10 keyer/paddle, vg | 20 |
| Hewlett-Packard 200A oscillators, (3), vg | 5 |
| Hickok oscilloscope, military OS-121C/USM- 140, w/manual, vg | 10 |
| Home brew crystal set, vg | 50 |
| Home brew crystal set-breadboard | 17 |
| Home brew European 2-tuber, Valvo & Novus tubes, vg | 50 |
| Home brew Neutrodyne on breadboard, NT ... | 30 |



A Marconi multiple tuner, ca. 1907, in the Marconi exhibit by the Kreuzers.

| | |
|--|--------|
| Home brew regenerative 2-dialer, tubes OK .. | 40 |
| Home brew table case, crystal set, large | 30 |
| Home brew, rotary sparkgap, small, g | 30 |
| Hoyt AC-DC meter in case, e | 20 |
| Jewell 199 radio analyzer, some adapters, vg | 27 |
| Kennedy VI, WT, panel replaced, vg | 340 |
| Kennedy 220, less tickler winding on coil, g | 280 |
| Key, Ericsson 810, European style, ca. 1900, vg | 400 |
| Key, Japanese training, Euro-style, Bakelite .. | 40 |
| Kodel C-112, tube type, paper, vg | 300 |
| L. E. Knott mirror galvanometer, | 90 |
| Lafayette Explor-Air w/diagram, vg | 25 |
| Lafayette stereo amp, tube type, g | 5 |
| Lincoln Radio Corp. fold-up loop, w/original carton, e | 250 |
| Lumofon VE301 Volksempfänger, vg | 300 |
| Lyric Mohawk cabinet, no chassis | 50 |
| Magnavox M-20 speaker, less grille, g | 22 |
| Magnavox R2B horn, working, vg | 200 |
| Majestic 440 Deco wood tombstone, all-brown | 300 |
| Majestic Super B power supply, vg | 30 |
| Malone-Lemmon 3-dialer, NT, vg | 47 |
| Marconi wavemeters, modern, in carrying cases, (2), e | 100 |
| Marconiphone M-2 tuner and amp, (2 pieces), vg | 625 |
| McMillan AC 1-dialer, WT, vg | 85 |
| Mercury Super 10, papers, 215A tubes, e . | 1100 |
| Michigan M-10, NT, vg | 95 |
| Michigan Midget, WT, vg | 75 |
| Michigan MRC-12, NT, vg | 230 |
| Military, Japanese Mark 32 field transmitter, canvas-cased version, w/UZ12C tube and crystal, less charts, g | 540 |
| Murdock antenna switch and other parts | 30 |
| National CRM oscilloscope, 1" | 220 |
| Navy training kit, Model BE-100, '60s vintage | 17 |
| Neutrowound, blue, 1926, g. | 470 |
| Nordemende Sterling, vg | 20 |
| Northern Electric 5708, Bakelite, AC-DC, vg . | 55 |
| Pacific Electric 5-tube AC-DC, All-American Five, never-built kit, (2) | 30, 32 |
| Padre (Giffillan) mantel radio-phonograph, vg .. | 210 |
| Pakette crystal set, 1946 | 32 |
| Paragon RA-10 tuner, e | 975 |
| Pentrola 1-tuber, vg | 65 |

(Continued on following page)



(AWA Auction, continued)

Philco 28 or 45, vg 100
 Philco 37-333 cathedral, Canadian, vg 110
 Philco 49-09, inoperative, g 20
 Philco 50 cathedral, vg, works 105
 Philco 55-22, wood, vg 45
 Philco 84 cathedral, works, vg 90
 Philco 90 chassis, w/tubes, g 42
 Philco 444 (British), People's Set, Bakelite, cloth
 tom 925
 Philco drum speaker, vg 110
 Philco Transitone wood AC-DC, g 12
 Philips-Norelco receiver kit, '60s, unopened, e 47
 Philmore pocket radio, w/box, vg 75
 Play-O-Tone wind-up portable phono, vg 20
 Pocket-watch meters, early, (6) 42
 Pony rocket ship germanium crystal set, vg 22
 Precision signal tracer, vg 11
 Priess Straight Nine, loop antenna, w/manual, vg 140
 RCA 56X3, wood, vg 20
 RCA 74B microphone, w/o stand or cord 140
 RCA 75X11, g 20
 RCA 155-B oscilloscope, 3", g 30
 RCA advertising cased table clock, old logo, vg 50

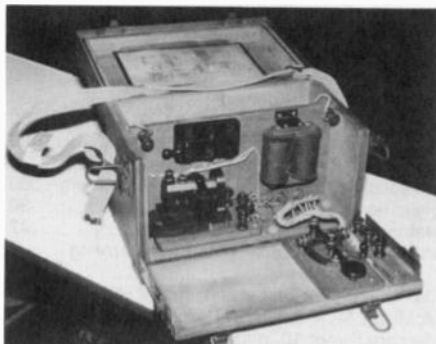

This Brach, U.S. Army Signal Corps World War I, field inductive telegraph brought an unexpected \$2,500, the best price of the day.

RCA dummy load & RF wattmeter, WW II 10
 RCA memento, 16" CRT faceplate engraved
 with picture of Marion, Indiana, tube plant. 17
 RCA promo wine glasses, monogrammed w/old
 logo, in RCA box 62
 RCA Radiola 20, tubes g, vg 190
 RCA Radiola 24, w/loop, NT, g 190
 RCA Radiola 26, NT, no handle, vg 230
 RCA Radiola 44, NT, vg 30
 RCA Radiola III-A, NT, vg 75
 RCA Radiola Special, no cabinet 160
 RCA Radiola V, brown, top and bottom OK, WT, vg 475
 RCA UZ-1325 horn, g 80
 RCA Victor 9T246 7", no pic, vg 32
 RCAF, Brandes Canadian headsets, (3), 1 other .. 15
 Remco Radio Science crystal-set kit, blue, in box 40
 Revophone crystal set, British, refinished, vg 450
 Rogers R-250, tubes, vg 270
 Saal horn, vg 90
 Scott 800-B tuner and amp, works, vg 100
 Silver-Marshall TRF kit, partly wired, w/papers, vg60
 Silvertone 3-dialer, dud tubes, e 90
 Silvertone radio/phono/wire recorder, e 27

Solex model A 1-tuber, vg 250
 Sonora 301A, large, Deco, Bakelite, vg 800
 Sonora Sonorette, small, rounded, Deco,
 Bakelite, vg 900
 Soundscribe dictating machine, g 5
 Spark coil, French, g 52
 Spark transformer, medical, wood-case, e 50
 Sprague Tel-Ohmike R-C analyzer, g 5
 Sterling tube reactor, g 15
 Sterling tube tester-reactivator, vg 12
 Stolling galvanometer, in bell jar, small compass-style 75
 Stromberg-Carlson cone speaker, repro cone,
 vertical stand, e 160
 Telegraph box lot: (2) sounders, relays,
 repeater relay, 150
 Telegraph sounder in resonator on swivel stand .220
 Telemonic 3-dialer, NT, e 85
 Thomson-Houston (BTH) crystal set, e 450
 Thorola Jr. Islodyne 3-dialer, NT, 1 AFT
 replaced, vg 105
 Toshiba velocity microphone, in wood case,
 1946, cord bad 320
 Tuner, long-wave slide, ca. 18", g 35
 TV color wheel 40
 U.S. Navy World War II RBS-2 receiver,
 modified, w/home-brew PS, g 110
 Universal microphone, double-button carbon,
 ring-mount, g 90
 US Apex 7 cathedral, works, vg 120
 Vagabond portable, NT, loop and cover, e 90
 WE 4-B receiver, 215A tubes g, clean, vg 475
 Westinghouse DB double crystal, detector, vg 425
 Westinghouse DB double crystal, detector, vg 500
 Wilson Co. key and buzzer set, RCAF WW II, vg 60
 Wimshurst machine, '20s, German, 8", w/
 Leyden jars, works 260
 Wurlitzer extension speaker, w/mirrors, needs
 work 80
 Zenith 6D311, e 85
 Zenith 6E029, wood, vg 42
 Zenith 6S637, e 75
 Zenith 7S633, one knob off, veneer cracked, g 50
 Zenith glass-rod set, DC chassis, dirty, g 120
 Zenith H500 Trans-Oceanic, g 35
 Zenith H500 Trans-Oceanic, needs dial cord,
 AC line cord, antenna tip, vg 42
 Zenith Royal 500, black w/leather case, not
 working, vg 60
 Zenith toy truck, 18 wheeler, ad on side, vg ... 35
 Zenith Y600 Trans-Oceanic, w/manual, vg 27
 Zenith Y600 Trans-Oceanic, vg 35
 Zenith, Deco, Bakelite, ca. 1940, clean, vg ... 100

Information on joining the Antique Wireless Association (AWA) may be obtained from Joyce Peckham, Box E, Breesport, NY 14816. Annual dues are \$12, and a quarterly newsletter, "The Old Timer's Bulletin," is published. In addition to the annual conference, regional meets are held.

Photo Credits: AWA, Ray Bintliff, John Maurer, John Terry.

(Ray Chase, 1350 Marlborough Ave., Plainfield, NJ 07060; Timothy Martin, Shaker Heights - Rte. 49, Pittsfield, MA 01201; Ludwell Sibley, 44 E. Main St., Flemington, NJ 08822; John V. Terrey, c/o A.R.C., Box 2, Carlisle, MA 01741)

CLUB SPOTLIGHT

Buckeye Antique Radio and Phonograph Club BARPC — 25 Years

The oldest regional antique radio club in the U.S.A. — the Buckeye Antique Radio and Phonograph Club (BARPC) — celebrated its 25th anniversary this past spring. BARPC has grown steadily since its start in April of 1970 at radio station WHLO (still 640 AM on the dial), in Akron, Ohio. Of the approximately 25 founding members of the club, about 4 are still members. While the early BARPC meetings were held at a meeting room at WHLO, later meetings took place at such historic locations as the John Brown House in West Akron and the Perkins Mansion across the street.

The purpose of the club is to preserve the history of early antique phonograph and radio entertainment — such as early phonograph machines, crystal sets, wireless, battery and early electric sets, broadcast equipment and literature.

BARPC's membership of about 80 covers 57 cities in Ohio and 6 surrounding states. The youngest member is 14 years old, and the oldest member is 95. The interesting mix of people in the club includes some radio personalities from the "Golden Age" — i.e., Wayne Mack and Dean Griffin. Some members are serious Edison and early DeForest collectors who are recognized experts in the field. One member has over 3,000 battery sets, with tubes, in his collection. Member Gary B. Schneider was the founding publisher/editor of *A.R.C.*, and now owns a radio shop — Play Things of Past — on the old "Radio Row" in Cleveland.

Club members include engineers and technicians as well as teachers, school administrators, and professors. Several members own their own museums. Some of the older members were known as "radiotricians" before they retired.

The club publishes a newsletter — *News From: The Buckeye Antique Radio and Phonograph Club* — every two to three months. This four-page publication informs members of upcoming BARPC and other events and also features "for sale/wanted ads" free to members.

BARPC has two types of membership. Active

members have all the privileges of the club. Associate members belong to a group, business or organization desiring to affiliate with the club's activities. Also, out-of-state collectors may join as associates.

The club meets about once per month at the Brunswick Library on Rt. 303 (Center Road) in Brunswick, Ohio. BARPC encourages members to bring items from their collections to display at meetings, and hopes members will volunteer their homes for future meetings.

Besides the monthly meetings, BARPC's other activities include several library shows a year, the Chapel Hill Mall Show in October, and a large club picnic each summer, a family event. The club also cosponsors the March "Spring Fever" swap meet, held in Washington, Pa., with the Pittsburgh Antique Radio Society.

Buckeye Antique Radio and Phonograph Club BARPC

Active dues: \$7.00 per year, spouse included

Associate dues: \$10.00 per year

Publication: *News From: The Buckeye Antique Radio and Phonograph Club*, 4 to 6 per year

Membership year: Jan. 1 to Dec. 31

Officers:

President: Richard E. Bradley

Vice President: Ralph Ohlrich

Treasurer: Steve Dando

Secretary: Ken Lowther

Editor: position vacant

For membership information:

Steve Dando

4572 Mark Trail

Copley, OH 44321

(216) 666-7222

News From: The Buckeye Antique Radio and Phonograph Club





RADIO MISCELLANEA

"Antique Radio Classified" invites its readers to contribute letters and information for inclusion in "Radio Miscellanea" and elsewhere in the magazine. The topic should be of general interest and sent to A.R.C., P.O. Box 2, Carlisle, MA 01741. All material submitted should be verified for accuracy and may be edited for publication, which is not guaranteed. See the masthead for more details.

Sprucing Up Plastic Sets

Dear Editor:

Here are a few home hints on sprucing up plastic sets which may be of interest to your readers. I've had good results with these shortcuts using household materials and tools.

Minor scuffs are easily polished away with toothpaste on a paper towel. It also works for removing plastic dial window and watch crystal scratches.

For minor abrasions use *Barkeeper's Friend* until you reach a patina; then polish with toothpaste.

For deeper scratches use scouring powder or an emery board to smooth the surface before working up the line with *Barkeeper's Friend* and toothpaste.

Emery boards are handy for reshaping dinged corners before grinding and polishing the damage away.

Brass hardware and trim can be brightened by soaking it in full-strength *Top Job* until the tarnish loosens; then remove it with a toothbrush. *Top Job* tends to etch brass after it is clean, so do not overdo soaking.

Deteriorated lacquer on metal parts can often be stripped away with nail polish remover. Take care, for it will damage plastics.

Clear nail polish is handy for protecting bright metal hardware after stripping.

A little vinegar in wash water will help rid water spots caused by lime in tap water.

If you must remove a headphone jack with slotted ring nut and you don't have a wrench, cut off a paper clip end loop, form the wires to span and fit the slots, grip the loop end near the tips with pliers, and use the combination as a wrench.

Serge L. Krauss, Elkhart, IN

More on Doerle/Binneweg

Dear Editor:

Recovering from a prolonged synaptic lapse, I remembered the name A. Binneweg, Jr. as mentioned in your March 1995 article on the Doerle receiver. Hastening to the garage, I leafed through a box of old radio magazines and found an article by A. Binneweg, Jr. in the April 1928 *Radio News*. It seems that Binneweg, Jr. was around and producing articles well before the Doerle articles in *Radio Craft* in the 1930s.

A search through the magazine produced no further information on who A. Binneweg, Jr. was. I had hoped that he might be listed either as a contributing author or as an official with the magazine.

This does little to answer the questions posed by Robert Merriam in the March issue. However, this information does show that A. Binneweg, Jr. was writing some years before the *Short Wave Craft* offerings.

Hopefully someone else will be able to shed another ray of light on this most interesting writer who was more prolific perhaps than the *Short Wave Craft* articles indicate.

Dale Davenport, Fort Smith, AR

Kokomo, Kingston & The Internet

Dear Editor:

I need some help. I have a battery eliminator made by the Kokomo Electric Company, Kokomo, Indiana. The only thing I know about it is that the front panel reads "Kingston" and "Type 2." I can find no literature on it. It needs to be restored, and I need any info you might be able to provide.

P.S. Please keep the format as is. I prefer to read the magazine over and over again rather than boot up the PC and check out the items.

Thanks. Keep up the good work.

Dave Stott, Hartford, CT

The Internet

Dear Editor:

As I type this letter on the old word processor, I wonder if I should jump on the Internet band wagon for submitting information. I do not subscribe to any "On-Line" services, but that may need to change as more and more services and data become available through modems. Keeping up with old technology through new technology is certainly not a new concept, only more convenient. I look forward to the day that I can order that Amrad crystal set easily by simply clicking the mouse. Well, maybe not that easily!

Still, a lot of the thrill for me, and I know for other collectors comes from driving up to a run-down looking building with a weathered sign hanging in front announcing "Antiques and Oddities," walking inside as a cloud of dust hits you, and then spotting the elusive Philco 90 over in a dark (hopefully dry) corner. In this cooler weather, we collectors feel the "go out and look around" fever rising again. Who knows what may turn up — on line or off.

Sam Wrenn, Arlington, TX

Heathkit IT-12 Article

Dear Editor:

I want to thank everyone who wrote to me about my A.R.C. article "The Heathkit IT-12 Visual-Aural Signal Tracer" (August 1995). The response was almost overwhelming and tells us two things: first, that a lot of Heathkit equipment is still floating around out there, and second, a lot of people are interested in repairing those old radios.

I'm still sending out packets, so if you haven't received yours yet, you should receive it shortly. If not, please contact me again.

A special thanks also to A.R.C. for providing this means of communication for collectors and restorers.

Dwane Stevens, Ardmore, OK

You Get What You Pay For!

Dear Editor:

Love the format! As to the price of A.R.C. — you get what you pay for!! Keep up the good work.

Greg Nelson, Cameron, NC



CLASSIFIED ADVERTISEMENTS

WANTED: Lists of radio stations pre-1980, including World Radio Handbook, Broadcasting Yearbook, Whites Radio Log (including photocopies). Ralph Marson, 8070 Busch, Centerline, MI 48015. (810) 754-3808

WANTED: Up to \$1,000 paid for certain 78 rpm records! Send \$2 + LSASE for our illustrated want list with actual prices paid. Nauck's Vintage Records, 6323 Inway Dr., Spring, TX 77389-3643

WANTED: Trophy cup award as presented by Short Wave Craft, or other, magazines. Harry Blesy, N9CQX, 9S740 Clarendon Hills Rd., Hinsdale, IL 60521. (708) 789-1793

WANTED: Pre-1926 one-tube sets with exposed tube such as: Carco, Martian Beauty, Radio Shop, Giblin, Baby Emerson, etc. Ed Bell, 5311 Wooddale Rd., Raleigh, NC 27606. Fax/phone: (919) 851-1517

WANTED: E.F. Johnson Valiants, Rangers, Vikings, other EFJ transmitters, amplifiers. Will buy mint to parts. Also buy Drake, Collins, National, Hammarlund. Dee Almquist, 920B Alexander Ln., Waynesboro, VA 22980. (540) 949-8300, leave message

WANTED: Old tube-type CB radios and CB operating/owners manuals, CB call books. Warren Belles, 1421 E. Royal Palm Rd., Phoenix, AZ 85020. (602) 943-4135

WANTED: Stock market ticker tape machine. Rick Hardin, 1750 Coleman Rd., Anniston, AL 36207. (205) 835-0900, day; (205) 237-2008, night. Fax: (205) 835-0992

WANTED: Old guitar and musical amplifiers including Fender, Vox, Gibson, Supro, Magnatone, and others. Frank Czaja, 8968 W. Forest Home, #4, Greenfield WI 53228

WANTED: AM mobile ham gear. Globe or Johnson 500. State models, condition, price, first letter. Captain Larry Rau, KF6WV, Occidental Radio Workshop, Box 1139, Occidental, CA 95465. (707) 874-1000

WANTED: Japanese transistor radios, pocket or coat-pocket size, need not work. Call or write: Bob Davidson, 310 Main St., Concord, MA 01742. (508) 369-2007

WANTED: Eveready radios, speakers, old flashlights, flashlight catalogs, related items. Subscribe Flashlight Newsletter - \$12 year. Bill Utley, PO Box 4095, Tustin, CA 92681. (714) 730-1252

WANTED: Philco Model 47-1227 in good condition. Mike Lander, 2594 Camrose Cove, Memphis, TN 38119. (901) 759-0477

WANTED: QSTs prior to 1920. Raymond Smith, 2313 Stannye Dr., Louisville, KY 40222. (502) 425-6423

WANTED: Anyone have a Grunow chassis 11A/11B (Model 1151/1151), a large console about 1935? Need a few coils off chassis if yours is available to cannibalize? Gary B. Schneider, 9511 Sunrise Blvd., #J-23, North Royalton, OH 44133. (216) 251-3714

WANTED: Junker or better chassis for Philco Model 40-216 or 39-116. Ray Sanders, 342 South Third St., Cottage Grove, OR 97424

WANTED: Old guitars, guitar amps, effects boxes. (Reverb, Echo, Fuzz, Wah-Wah, etc.). Fender, Vox, Gibson, Rickenbacker, Gretsch, Martin, Univibe, Fuzz Face, Maestro, Reverb. Also, power tubes KT-66, KT-77, KT-88. Western Electric 300B, 350B, 274, 275, 211 UT-4C, 845 etc. Sonny Goldson, 1413 Magnolia Ln., Midwest City, OK 73110. (405) 737-3312. Fax: (405) 737-3355

.....
 • A.R.C. Advertising Policy
 • Sellers and Buyers, Please Note!
 • Advertising is accepted only for early items
 • related to radio, communication, etc. All
 • items must be described fairly; reproductions,
 • reprints and not-original items must
 • be so identified. Advertisers must agree to
 • respond promptly to inquiries and orders, to
 • resolve problems promptly if the buyer is not
 • satisfied, and to comply with a buyer's
 • refund request on unaltered returned items.
 •

WANTED: Any National Radio Institute Experiment (not lesson) booklets from before 1930. Robert Stapleford, 1800 S.W. Randolph Ave., Topeka, KS 66604

WANTED: Reasonably priced small AM transistor radios, working or not, will buy your collection. Douglas Ferrero, WB8YNZ, 33673 Chatsworth, Sterling Heights, MI 48312. (810) 268-3677

WANTED: Microphones. Older styles made for PA/dispatch use. Such as Shure 520, 707; EV 605, 606; Astatic T-3, JT-30 and others. Thank you. Dennis Gruening, 26 Dupont Ave., Piscataway, NJ 08854. (908) 752-5737

WANTED: GE 66A convertible portable clock/radio (AC battery). Also handle or junker for Zenith 601D Portable Series. Bill Campbell, 1221 Littlebrook Ln., Birmingham, AL 35235. (205) 853-8227

WANTED: Philco Model 47-1227 in good condition. Mike Lander, 2594 Camrose Cove, Memphis, TN 38119. (901) 759-0477

WANTED: Any information about Page 5 or Granada radios. I have bought one of each at estate auctions but find neither listed in Johnson (1989 ed.) or Bunis (1992 ed.). Theodore Garrison, 318 North Ward St., Macomb, IL 61455. (309) 837-1313

WANTED: Zenith Deluxe Model L518W clock radio in vg original condition. Prefer white case. Geo. Boettcher, Jr., PO Box 100, Dingman's Ferry, PA 18328. (717) 686-1200

WANTED: Crystal sets, collection now at 353 pieces; seeking more. Erwin Macho, Ambrosweg 17A/8, A-1230 Vienna, Austria

FOR SALE: Rider's Abridged 1-5 and 6-15, good condition, complete set only - \$275. Michael Franzen, 405 East Sinto, Spokane, WA 99202. (509) 325-7354

FOR SALE: Shortwave radios: Sony CRF 1 - \$1,200; CRF 150 - \$225; CRF 230B - \$700; CRF 320 - \$1,200; CRF 330K - \$1,500; CRF 5100 - \$250; ICF 6700W - \$325. Panasonic RF 2600 - \$225; RF 4800 - \$275; RF 4900 - \$325. All vg to exc. James A. Weil, 824 Heather Lake Dr., Clarkston, MI 48348-3648. (810) 391-7687 until 10 pm EST

FOR SALE: Cleaning out 1000's of items, lists of for sale, offer, pickup. Page of lists - SASE. Krantz, 100 Osage Ave., Somerdale, NJ 08083-1136

FOR SALE: Used tubes: 9-807 tubes - \$5 ea.; (2) 866 - \$8; (1) boxed 866 - \$14; (2) 829B - \$7 ea.; (1) 808 globular - \$50; (1) VT101 - \$10; (1) JAN VT 42A - \$10; (1) JAN 878 - \$10; (2) 6044 - \$10 ea.; (1) 1625 - \$3; (1) RK60 - \$5. All with good filaments. Plus (3) 2A3, good - \$30 ea. Plus shipping. J.J. Papovich, 53 Magnolia Ave., Pitman, NJ 08071. (609) 582-8279

FOR SALE: RCA-103 loudspeaker replacement tapestry grille cloths. These high quality tapestries were manufactured in China in the 1970's. They not only meet RCA's original specifications, but are very rare and absolutely beautiful - \$125 ea. which includes insurance and shipping cost. Refundable if not satisfied. Contact: Kenneth Ericksen, 1049 Felspar, #33, San Diego, CA 92109-2844. (619) 483-2183, evenings after 6 PST

FOR SALE: Classic tube CB's - List LSASE. Collins R390, R390A, R391 manuals (copies) & blueprints. Charles Zafonte, RFD 1, Box 75, Fort Kent, ME 04743. (207) 834-6273, eves.

FOR SALE: Sterling 35 amp, 10-volt DC watch-case meter, works, no rust - \$10 ppd. Ken Greenberg, 4858 Lee, Skokie, IL 60077. (708) 679-8641



**DELAWARE VALLEY
HISTORIC
RADIO CLUB**

FALL SWAPMEET

SOUDERTON, PA

SATURDAY, NOV. 18, 8 AM - 1 PM

DVHRC will offer its close-the-season outdoor flea market and tailgate auction at 117 Main St. (PA Route 113) in Souderton.

Rates to sellers: \$5 per space in advance, \$8 on the day of the event. A few spaces with electricity are available at \$2 additional. Parking for buyers is available in the municipal lot behind the pizza shop across the street.

Contact: Dave Abramson, (610) 827-9757. Reservations for spaces are strongly advised - just send a check payable to DVHRC, to 1649 Yellow Spring Rd., Chester Springs, PA 19425 by Nov. 11.

FOR SALE: For sale. 2B sold. After 60 years of radio sales, service, collecting, radios and other items. Selling out contents of large basement, attic, house, 2-car garage, full of radios, tubes, tuners, amps, books, magazines. Drawers full of parts. A tube collection in showcase. Toys, cameras and other items. Cash and carry only, no checks. F. Krantz, 100 Osage Ave., Somerdale, NJ 08083-1136. (609) 783-0400

FOR SALE: Books and magazines on radio and TV from \$1 up: Popular Elect., Radio Experimenter, Amateur Radio, Radio Theory Course, Basic Radio Course. Send \$1 for eleven-page price list. Ben Martin, 18334 Pepper St., Castro Valley, CA 94546

FOR SALE: (3) early Sony table radios: TR-712, 712Y and TR7170 - \$150/all. MESSAGE: Actively buying transistor collections especially in N. California/Nevada. Sell now before the party is over! Tom Christopher, 5350 Alum Rock Ave., San Jose, CA 95127. (408) 926-2808

FOR SALE: Collection of old Radio/TV/Phono/etc. Also 50 yrs. collection of schematics/parts/tubes. Store being sold, so all must go, regardless of price. G.R. Marcelletti, 31087 56th Ave., Paw Paw, MI 49079. (616) 657-4259

FOR SALE: AES Collection, 1953 to present, over (330) issues, value over \$3,500 - Make Offer. M.C. Agress, 891 Fulton St., Valley Stream, NY 11580-1213. (516) 825-8955

FOR SALE: Hoffman Trans-Solar portable radio. Call: Jimmy Brown, 620 North Grant Suite 910, Odessa, TX 79761. (915) 335-4583, or (915) 362-7811

FOR SALE: DY-17A/ART-13, complete in following conditions: N.O.S. - \$55; good - \$40; parts units - \$25 or individual parts. UPS about \$20. Robert W. Downs, WA5CAB, 2027 Mapleton Dr., Houston, TX 77043. (713) 467-5614

FOR SALE: Crystal radio kits, complete with face panel and baseboard, 365 variable capacitor, large prewound coil, and many other parts for an old style crystal radio - remit \$19.50 plus \$3 shipping. Carl & Grace Ent., 5636 Romeyn, Detroit, MI 48209

FOR SALE: PSM-13 battery tester for PC-6, -10, -25, manual, new - \$25, add \$5 shipping. Tartan Electronics, Inc., PO Box 36841, Tucson, AZ 85740-6841. (520) 577-1022

FOR SALE: New RCA-103 speaker rear canopy fiber cones - \$60 each. Kenneth Ericksen, 1049 Felspar, #33, San Diego, CA 92109-2844. (619) 483-2183, after 6 pm

ANTIQUE VACUUM TUBE DATA BOOK

For the years 1918-1944

- 
- # 56 pages; 960 types
 - # Includes Receiving tubes
 - # Transmitting tubes
 - # Klystrons, Magnetrons
 - # Cold Cathodes, Thyrotrons
 - # VT-Comm cross reference
 - # Testing-Restoration Data
 - # Deluxe 8x10 flip pages

FREE 1st Class Shipping World Wide
\$10 USA Can. \$12 Mex. \$14 Foreign
R.J. Buchan 28490 Portsmouth Drive
Sun City, Ca . 92586 U.S.A.

WANTED: Anything made by Standard Radio and Electric Co. or Giblin, Pawtucket, R.I. Ed Bell, 5311 Woodsdale Rd., Raleigh, NC 27606. Fax/phone: (919) 851-1517

WANTED: Audio equipment. Western Electric, RCA, McIntosh, Dynaco ST-70 (chrome), Altec. Other equipment considered. Dee Almquist, 920B Alexander Ln., Waynesboro, VA 22980. (540) 949-8300

WANTED: Original tube-type CB radio operating/owners manuals & CB call books, old tube-type CB radios. Warren Belles, 1421 E. Royal Palm Rd., Phoenix, AZ 85020. (602) 943-4135

WANTED: All types of telegraph items. I will buy whole collection. Rick Hardin, 1750 Coleman Rd., Anniston, AL 36207. (205) 835-0900, day; (205) 237-2008, night. Fax: (205) 835-0992

HAS YOUR SUBSCRIPTION

EXPIRED?

It has if your mailing label reads
"EXP=NOV95" or earlier.
Renew now!

*BONUS: Renew before
your "EXP" month and receive
13 issues per year instead of 12!*

Renewal rates are:

\$34.95 for Second-Class Mailing

\$51.95 for First-Class Mailing

(Two-year renewals are twice above rates.)

WANTED: Power transformer for Grundig Model 50 191 PX. Ray Sanders, 342 South Third St., Cottage Grove, OR 97424

WANTED: Tube hi-fi, tube theatre/commercial amps, equalizers, preamps, tuners, etc. Altec, Western Electric, McIntosh, Marantz, Ampex, Fisher, Scott, Dynaco, Pultec, etc. Sonny Goldson, 1413 Magnolia Ln., Midwest City, OK 73110. (405) 737-3312. Fax: (405) 737-3355

WANTED: Original tube-type CB radio operating/owners manuals & CB call books, old tube-type CB radios. Warren Belles, 1421 E. Royal Palm Rd., Phoenix, AZ 85020. (602) 943-4135

WANTED: Portable radios. Collector looking for unique portables from any manufacturer. Must be battery operated, in good condition and complete (doesn't have to operate). (I also collect Kodak Brownie cameras). Send description, photo preferred, and asking price to: Don Bridge, 194 Kempton Dr., Berea, OH 44017 or E-mail: 71420.2635@compuserve.com.

WANTED: RCA 816K plastic dial escutcheon, Hallcrafters SX-11 dial plate, National diamond speaker logo. James Millen Co. power supplies. National SW-3 Model 1 versions 2+3. Ham xtals and holders made pre-WWII. Dean Showalter, WA6PJR, 72 Buckboard Rd., Tijeras, NM 87059. (505) 286-1370

WANTED: Manual/schematic for Lafayette HA-250 mobile linear amplifier (28MHz or CB?). James J. McGrath, W2IOJ, 2 Centerville Ln., West Seneca, NY 14224. (716) 675-0160

ORDER TODAY!

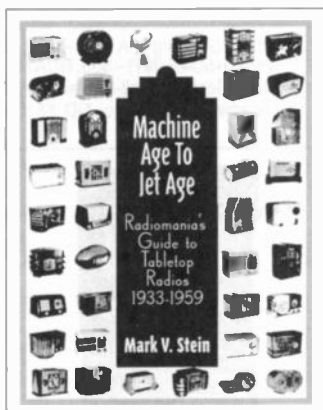

OVER 250 PAGES 1,400 RADIOS

Most not in any other reference
EACH RADIO INDIVIDUALLY PICTURED,
IDENTIFIED AND VALUED

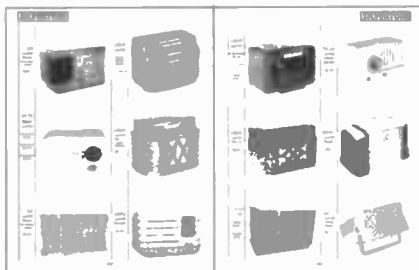

Special For
ARC Readers!

\$24.95 List Price
Now \$21.95!

Only When Purchased From Radiomania Directly
All ARC Orders Autographed by Author

Add \$1.75 Shipping U.S.A., \$3.50 Canada, \$5.00 All Other Countries

Send Check or Money Order Payable to:
Radiomania
2109 Carterdale Road, Baltimore, MD 21209

Maryland Residents add 5% Sales Tax. Allow 2-4 Weeks for domestic orders.



Radiomania™

FOR SALE/TRADE: ARBE III batt. elim., like new - \$100. Fisher FM200C - \$125/BO. Thorens 125 MKII w/ arm - BO. **WANTED:** Antique McIntosh equip., MC 30 60, 75 preamps, tuners, early cabs., Thorens 124 w/ base, Garrard 301 w/base or just base, Fisher 80AZ, Heath W4, E.V. Aristocrat mahog. cab. Walt Fleming, 182 Plain Hill Rd., Norwich, CT 06360. (860) 889-5018

FOR SALE: Amps: Seeburg MA1-L6 - \$95; Rockola uses 1-76, 2-6L6G, 1-5U4G(NT) - \$95; RCA MI-12205, 175 watts - \$175; Seeburg wall-box amp - \$85. Del Tysdal, 812 Broadway, #4, Fargo, ND 58102. (218) 287-2562



FOR SALE: Your wife dresses up the house for Christmas, the kids dress up the dog. Now you can dress up your classic Zenith for the season. Reproduction of original window banners 4" red ribbon 5' long, reads: Have a Zenith Christmas take me home! \$15 each (add \$1.50 for bow), postage paid. (US). Jon Prabel, 2733 Wood Eagles, St. Charles, MO 63303. (314) 947-1543

FOR SALE: Multi Elmac AF-67, AF-68, PMR-7 & 1070 supply, units as is, no manuals - \$165. Clem Duval, W8VO, 33727 Brownlea, Sterling Heights, MI 48312. (810) 795-4670

CLASSIFIED AD NOTICE

Please check your ads carefully before sending them in. Once ads are received, it is not always possible to refund the amount sent, pull the ad or make changes.

FOR SALE: New tubes: EM34, 75, 80, 6A3, 805, 814, 829B - \$110, includes UPS. Hank Andreoni, c/o 250-D So. Lyon Ave., Hemet, CA 92543

FOR SALE: (50) transistor radios including Zenith Royal 500, Hitachi TH666 and Emerson 911. Also over (2,000) N.O.S. tubes. Joe Smith, 1051 N.E. 55th Rd., Lamar, MO 64759. (417) 398-2504

FOR SALE: Heath Apache, Mohawk, Marauder, DX100, SB10, SB220 panel refinishing. SASE for information packet. Ron Eisenbrey, AB5WG, 115 First St., Sugar Land, TX 77478. (713) 491-7823

FOR SALE: Circulators, Melabs XH1250, Western Microwave Labs CTU 2928 - \$25 ea. Don Carver, 174 84th Ave. N, St. Petersburg, FL 33702. (813) 577-5355

FOR SALE: (Copies). Schematics for radios, also kit radios 1922-1950. Manuals: Test equip., ham gear, etc. No list. Contact me for prices, availability. Duane Ballew, KB7QZK, 6813 152nd St. Ct. NW, Gig Harbor, WA 98332. (206) 851-4505

FOR SALE: Emerson Aristocrat, yellow - \$1,200. Bluebird Spartan - \$4,700. Fada Catalin, yellow/red, Model 1000 Bullet - \$2,600. All are museum quality. Call: A. English, 4 E. Main St., Myerstown, PA 17067. (717) 866-9036

FOR SALE: Older stereo equipment: Marantz, Pilot, etc.; some tube type, some solid-state with speakers, all working condition - \$250 + shipping, firm. All brands of tube caddies with tubes. Philco, RCA, Sears, GE, etc., (10) to choose from - \$55 ea. + shipping. Vince Bomba, 331 Akron Ave., Pittsburgh, PA 15216. (412) 344-7926

FOR SALE: Zenith Royal phone magnet in box - \$25. Hallicrafters S-72 - \$35. **WANTED:** FRG-7. Mike Brillhart, 12551 Maiden Creek Rd., Abingdon, VA 24210. (540) 944-4387

FOR SALE: Amrad Det. 2-stage amplifier 2634, good condition - \$300. RCA 1X53, green - \$30. Arthur Kreitner, 2013 E. Belle Ave., Belleville, IL 62221. (618) 233-5610

FOR SALE: Woven fabric OEM radio dial belts, most pre-1950's - \$10 ea. Richard Loban, 3848, W. 80th St., Chicago, IL 60652. (312) 735-4308

FOR SALE: Portable radios. Send for list & photos. Robert Stone, 721 Fisk St., Piqua, OH 45356-3729. (513) 773-2217

FOR SALE: Westinghouse Aeriola Sr. with tube (open), has been restored - \$135. Crosley: Gem Box untested, g - \$65. AK 53 mini-console, metal case, works - \$90. Majestic Super B elim. - \$25. RCA Radiola 60, good with minor spots - \$135. Rare Philco 44, some veneer problems on front, grille cloth bad (early version) - \$300. Philco 20 Deluxe, complete, some veneer damage - \$225. Philco 90 cathedral complete, good cloth finish needs help, tight cabinet - \$450. Philco 50 chassis and speaker - \$50. Brush microphone on stand, 40's? - Offers. RCA AR 812 Superhet, 1925, with tubes, not tested - \$90. Music Master horn speaker, mahogany bell - \$145. UPS is extra on all items. Richard Foster, 12 Shawmut Ave., Cochituate, MA 01778



ORDER NOW FOR CHRISTMAS!!

FOR SALE: As shown Radio USA mike style 16-inch tall, all metal, AM/FM - \$35. Red racing car, AM/FM with clock built into sunroof - \$25. Great buy. 1912 Simplex car AM - \$25. 1828 locomotive AM - \$25. Ferrari AM car - \$25. All N.I.B., all transistor. Also (22) Phillips/Grundig/Telefunken radios, please ask for prices. Postage UPS and insurance included in all prices. Richard Brill, PO Box 5367, Old Bridge, NJ 08857. (908) 679-8026. Fax: (908) 679-8524

FOR SALE: Auto Radio Manual, Sams AR8, Service Data 1957-1958 Auto Radios - \$15 ppd. Jack Shaymore, Vintique Electronics, 52-C Tifford, Deerfield Beach, FL 33442. (305) 427-1222

FOR SALE: General Radio wavemeters: 358 w/(4) coils in wood box, charts - \$65; 1140A - \$50. Henry 2KD amp - \$495. Heath A9 amp - \$95. 6-page list LSASE. Tim Martin, WB2VVQ, Shaker Heights, Rt. 49, Pittsfield, MA 01201. (413) 499-7482, call evens., week-ends only please

WANTED: Old speakers, horns, enclosures, drivers, corner boxes, crossovers (hi-fi, commercial, theatre, coax/triax), Jensen, Tannoy, Altec, Western Electric, JBL, Electro-Voice, Stephens, Oxford, University, Klipsch, etc. Sonny Goldson, 1413 Magnolia Ln., Midwest City, OK 73110. (405) 737-3312. Fax: (405) 737-3355

WANTED: Stancor and Thordarson transmitters and manual. Thanks! Tom Smith, N5AMA, 13034 Elmington Dr., Cypress, TX 77429-2062. (713) 376-3436, evenings

WANTED: Philco 48-285 console radio, will buy parts. Peter Triestman, 182 Washington Valley Rd., Morristown, NJ 07960. (201) 586-8749

WANTED: Tabletop, windup-style outside horn, Edison, Victor and Columbia phonographs, working condition or not. Also want all types of phonograph-related items: Vogue picture records, Edison, Columbia and any other wax cylinder records, toy phonographs, needle tins and cutters, record dusters, puzzles, fans, calendars, pocket advertising mirrors, dealer lapel pins, phonograph toys, posters, broadsides, original dealer and giveaway advertising items from Edison, Victor, RCA and Columbia. Please write or call with description, condition and your price. Thanks. Bernie Seiberg, 714 Moreton Rd., Meadowbrook, PA 19046-1907. (215) 886-6124

WANTED: Manuals or copies for Heathkit HD1250 grid dip meter, Regency HR220 transceiver, Sideband Engineers SB450 TRC transceiver converter. R. Cartier, 1035 Cilley Rd., Manchester, NH 03103

WANTED: Coil and dial scale E and F for the HRO-60. Richard J. LaMark, N2TXL, 6822 Tuckahoe Rd., Williamston, NY 14589-9589. (315) 589-2552

WANTED: Fada bullet chassis. Buying any Catalin knobs, parts or damaged sets. Ray Carroll, 158 Oakwood Dr., Wayne, NJ 07470. (201) 696-1149

A. G. Tannenbaum

Electronic Service Data

PO Box 386, Ambler, PA 19002

Phone: (215) 540-8055

Fax: (215) 540-8327

THE



FOR

**Vintage Parts &
Service Data
1920's - Present**

Free Catalog

Credit Cards Welcome

WANTED: Your collection. If you have a quality collection, mainly pre-1926, it will pay you to contact me. Large or small. Ed Bell, 5311 Woodsdale Rd., Raleigh, NC 27606. Fax/phone: (919) 851-1517

WANTED: 1939 Zenith outside dial ring for shutter dial, owner's manual for Zenith 9S367. Curt Brohard, 2026 Santa Clara Ave., Alameda, CA 94501. (510) 521-4299

WANTED: Crosley hi-fi G205MY HF on grille. 8" x 12" Crosley speakers with green cones. John May, 205 Wren, Scotia, NY 12302. (518) 377-9522

WANTED: 1933 Automatic Tom Thumb, (Bunis 1, p. 33). Victor Zummo, 20344 Mobile St., Canoga Park, CA 91306. (818) 883-8468

WANTED: Zenith Trans-Oceanic Royal D7000Y, good condition. Peter Pompe, 38 Val du Prince, B-1950 Kraainem, Belgium. Tel./fax: 322-731-62-84

WANTED: Allied, Heath, Eico, Lafayette catalogs. Allied Knight kits, especially shortwave sets; Star Roamer, Span Master Ocean Hopper, Space Spanner. Also Vox amps and guitars. Please write: Steve Donahue, 1773 Sterling Pointe, Cleveland, TN 37312

WANTED: Pilot Wasp set literature. Also Pilot Universal Super Wasp set, your price. A.C. Stoddard, 1502 Briarwood, Lansing, MI 48917. (517) 321-1598

WANTED: Admiral table model radio 5S22AN with front curved in circular louver. Write to: Harrigan, PO Box 2741, Champlain, NY 12919

WANTED: Philco table models: 42-PT94, 46-4201, 42-PT7, 42-PT95, 42-PT94, 42-390, 42-323. Donn Frederick, 8402 Hwy. 30, SE, Chatfield, MN 55923. (507) 867-4868

WANTED: Stewart-Warner Boy Scout (green & white), Cub Scout (yellow & blue) radios. Maurice Lambert, 1921 Bluebird Ave., Ft. Worth, TX 76111. (817) 838-8858

RADIO ★ GRILLE ★ CLOTH

Now **31** patterns & color combinations
are available to suit most radio needs!
55c LSASE for samples

**More Good News!
Even More Variety!**

- 1) Four new patterns designed to look great with late 1930's consoles - large patterns and designs to fill those empty and lonely open grille spaces.
- 2) Selling off my remaining stock of green Philco V cloth, Now only \$15 for a full 1 1/2 square yard piece. Enough for up to 10 sets.
- 3) Still offering sampler packages of 5 or 10 pieces of cloth for \$20 and \$38, postpaid. See prior issues of A.R.C. for details, or call.

**MICHAEL KATZ
3987 DALEVIEW AVENUE
SEAFORD, NY 11783
(516) 781-6202 (EVENINGS)**

FOR SALE: Radio parts, tubes, galena crystals, very low prices. L. Gardner, 458 Two Mile Creek Rd., Tonawanda, NY 14150. (716) 873-0447

FOR SALE: Directional Gyro Model 4000C T.S.O.C5C Type 1 out of my Cherokee Lance airplane - \$65, 1 ship. Carlos Gimenez, 15091 Shamrock Dr., Fort Myers, FL 33912. (941) 482-0198

FOR SALE: (1) RCA RE-45 chassis less tubes, works - \$25 plus shipping. Rick Parrish, 1260 Marilyn Dr., Cape Girardeau, MO 63701

FOR SALE: Radios, misc., SASE list. International Radio News Map, first edition looks like gas station road map, events thru late 1940! - \$15 ppd. The Radio Electronic Master catalog, 1598 pages - \$15 + UPS. Tom Tetzlaff, 23 Nelson Dr., Silver Bay, MN 55614. No phone

FOR SALE: DuMont TV, RA-112 early 19" - \$50. Looking for Bendix, Garod and odd brands. Glenn Bubenheimer, 27851 Terrence, Livonia, MI 48154

FOR SALE: Sony transistors #TR1814, TFM3850W, 2R-31, 3F-77W - \$25 ea. (1) Sony TV 5-303W, (1) 5-307UW - \$35 ea. David Koesche, 61 S. Barrington Rd., South Barrington, IL 60010. (708) 382-7997

FOR SALE: Western Electric Loli-pop (600A) microphone - \$750. Fada bullet Model 1000, maroon/yellow, nice! - \$600. James Kroegel, 856 Old Farm Rd., Columbus, OH 43213. (614) 864-8327

FOR SALE/TRADE: Kenwood TR2500 with many accessories, excellent - \$195 OBO. WANTED: Vibroplex key, mint condition. Ray Gehard, WA0HSX, 821 S. Spring Ave., Sioux Falls, SD 57104. (605) 334-9125

FOR SALE: Sarns Dial Restranging Guide Books DC1 - \$15; DC2, DC3, DC4, DC6 and DC8 - \$10 ea. + shipping \$2 per book. J.J. Papovich, 53 Magnolia Ave., Pitman, NJ 08071. (609) 582-8279

FOR SALE: Adjust-A-Volt variable transformer - \$50 plus shipping. Eico battery eliminator & charger - \$30 plus shipping. Heathkit tube checker Model TC2 - \$30 plus shipping. Robert Stone, 721 Fisk St., Piqua, OH 45356-3729. (513) 773-2217

FOR SALE: Drake R4C w/filters, extra xtals, & manual exc cond. - \$250 OBO. National NC-125 mech. OK but dead w/manual - \$40. Sanyo RP-8880, dead - \$25. UPS extra. Hugh Watson, 2734 Hillcrest, Alton, IL 62002. (618) 462-3979

FOR SALE: N.O.S. tested with 30-day warranty: 3AT2A - \$2.50; 3CN3B - \$4; 5CL8A - \$3; 6AG9 - \$4; 6AV5GA - \$9; 6AW8A - \$2.50; 6GE5 - \$9; 6GX7 - \$3; 6HS5 - \$5; 17JN6 - \$5; 38HE7 - \$10; 50C5 - \$3.50; 7258 - \$5. \$3 shipping. Enquire about others, new or used. Bob Holladay, 5 East Plaza, Paris, TX 75460-5841

FOR SALE: 1941 Radio Troubleshooters Handbook - \$40. 1934 RTI radio work sheets - \$20. 1969 Allied Catalog - \$20. 1923 QST issue - \$15. Add UPS. Clark Trissell, 2520 Pawnee, Lincoln, NE 68506. (402) 488-5263

FOR SALE: Expansion large plug AM-FM Bozo/box; Scoobie Doo; Stutz-Bearcat, Mack truck oil filter, Channel Master 6501 dark red, Spica It. blue. Many items. Don May, 16 Gulley Dr., S. Windsor, CT 06074. (860) 644-0258

FOR SALE: Variacs, 0-140 vac, 20 amp, panel mount, now 1/2 price - \$30. Bob Bakinowski, 1524 Saint Tropaz, Tucson, AZ 85713. (520) 624-8029

FOR SALE: 21" Philco Predicta TV, front plastic picture tube cover missing, could be restored - \$140 plus \$50 shipping. Walnut finish picture lights. Don Maurer, Sr., 29 South 4th St., Lebanon, PA 17042. (717) 272-2481

FOR SALE: Western Electric 101-D "tennis balls", used, good filament, have only (2) - BO. J. Arndt, 1215 Division St., Manitowoc, WI 54220



VISIT CLEVELAND'S RADIO ROW

THREE STORES SELLING VINTAGE RADIOS!
ALL WITHIN 500 FEET OF EACH OTHER.

(Easy access from I-71 or I-90 interstates, just south of Lorain Ave.)

TIMELESS ELECTRONICS

3554 West 105th St.
Cleveland, Ohio 44111
216-251-4070

- AUDIO, VIDEO REPAIR
- SURPLUS PARTS
- TUBES, NEW AND USED thousands available
- VINTAGE RADIO & TV SALES

HOURS: 1-6pm Mon
10-6pm Tues - Thurs
10-2pm Fri & Sat.

PLAY THINGS OF PAST

3552 West 105th St.
Cleveland, Ohio 44111
216-251-3714

RADIOS - PARTS - LITERATURE
Sales - Service - Restoration

OUR SPECIALTY

Pre-1928 Literature/Parts
Mail Order & Retail Store

** CATALOG #3 **

54 Pages - \$3.50
Parts - Tubes - Literature

Mail Inquiries: 9511-23 Sunrise Blvd
Cleveland, Ohio 44133. 216-251-3714

VINTAGE TV & RADIO

3498 West 105th St.
Cleveland, Ohio 44111
216-671-6712

PARTS & LITERATURE
FOR THE COLLECTOR

RADIOS - TV's - TUBES
REPRODUCTION KNOBS
REFINISHING SUPPLIES
NEW - OLD - STOCK PARTS

CATALOG AVAILABLE
PHONE ORDERS ACCEPTED

STORE HOURS
Tues. - Fri. 10-4PM
Saturday 1-4PM

WANTED: Red Books, Red Books, Red Books. Want to complete my RCA Service Data Book collection. Looking for the following Red Books: 1929-30, 1940, 1941-42, 1950, 1951, 1953 up to 1958. Thanks. Robert Bailey, 2451-3 Whispering Woods Blvd., Jacksonville, FL 32246. (904) 642-5837, ans. mach. after 4 rings



WANTED: Round Fada dial and bezel from any of the pictured 1937 Fada radios. Also need 12-tube chassis with 7-knob layout and one or more of the correct wooden knobs. Will buy junkers in any condition or parts. Please don't hesitate to call or write: Mark V. Stein, 2109 Carterdale Rd., Baltimore, MD 21209. (410) 466-2814. Fax: (410) 466-0815

WANTED: Hallicrafters PS-500-AC power supply with speaker; Galaxy F-3 CW filter; Galaxy RV-1 remote VFO. Manual for Hallicrafters SR-500 Tornado. Manuals for HP140T, HP8552A and HP8553B spectrum analyzer system. Bob Smith, KC4WJO, 14779 Kogan Dr., Woodbridge, VA 22193-3314

WANTED: Decals for 1949 Coca-Cola cooler radio. Pat Bukiri, 14711 Middle Pinecreek Dr., Orland Park, IL 60462. (708) 403-9222, home; (312) 735-3800, work

WANTED: Spring or tape reverb unit, Fisher, Hammond, Schober Reverbatape, Hallderson audios good/dud. Dave McClellan, 1086 Trailridge Ln., Atlanta, GA 30338. (770) 399-6704

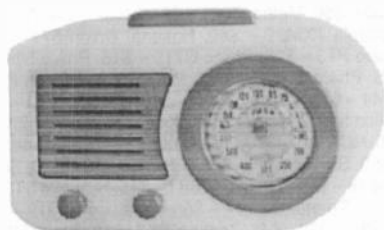

WANTED: Fada Catalin radios. Help! My entire collection spontaneously combusted during an interview with the "Enquirer." Replenish and repent ye sinners. Please write or call collect: Rain Buttignol, 214 State St, #7, Portsmouth, NH 03801. (603) 427-1384

WANTED: Hoppy radio in good condition. Will pay the max for boyhood dream. Don Brodie, 215 Curwen Rd., Rosemont, PA 19010. (610) 525-4447. Fax: (610) 525-0269

WANTED: Sams DC1, DC4, DC6, WRTH, 1974, 1983, 1988-90. pre-1971 WRTH. John R. Eickhof, PO Box 258, Wendell, ID 83355-0258

WANTED: 6-button station bezel module for right side Zenith Model 8S463 console. Jerry Graves, 2 Haverstock Rd., Massena, NY 13662. (315) 769-6305

WANTED: Working Philco 39-55 remote control unit. Terry Dowling, 12225 Royal Oak Ln., Ashland, VA 23005. (804) 798-7237. E-mail: aol-RadioTerry. Cserve: 73312,1702. Internet: tdowling@freenet.vcu.edu.

WANTED: J.J. & William B. Duck Co. (1908-1932) materials: catalogs, crystal sets, radios. DeForest DV & DL series tubes. Sodian S-13, D-21. N.I.B., used, and dud. ARC military xmtrs. Pre-1929 light bulbs. Edison two-minute cylinders, playable preferred in boxes. Send postcard, e-mail or fax. Jeff Brooks, 512 West Park St., Lakeland, FL 33803-1232. (941) 686-5186, voice. (941) 683-3471, fax business hours. E-mail: Vacuum2be@aol.com

WANTED: Mic buyer: Turner, EV, Shure, Astatic, etc. Connectors and parts. Tom Ellis, Box 140093, Dallas, TX 75214. (214) 328-3225. Fax: (214) 328-4217

WANTED: Chassis in restorable condition, speaker and knobs for my Crosley 58 Buddy Boy cabinet. Also need dial face, indicator, glass, and knobs for my Zenith 6S229. Anybody? Mike Biddison, 148 Via Pasito, Ventura, CA 93003. (805) 642-3018

WANTED: Zenith Golden Triangle, excellent or better condition. Gordon Wilson, 11108 50 Ave., Edmonton, Alberta, Canada T6H 0H9. (403) 434-6257

WANTED: 6 terminal synchronous vibrator, Oak Mfg. Model 126-4 or equivalent. Andy Williams, 500 Wall Blvd., Apt. 81, Gretna, LA 70056. (504) 398-0860. E-mail: awilliam@neosoft.com

WANTED: Cylinder records in nice original containers with tops. Please, give me your price including UPS charge. Martin Lamonde, 265 Du Pont, Apt. 101, Quebec, Canada G1K 6L8

WANTED: 01-A tubes, new or good used, globe or ST. Specify shape, condition, qty., price - include UPS. Write: Anton George, 7203 39th Ave., Kenosha, WI 53142



Radiomania!

Catalog Of Investment Quality Vintage Radios For Sale
Is Now On The World Wide Web
In Full Color, And Continuously Updated

http://www.sscsi.com/machine_age/radiomania

Only On...

MACHINE AGE

20th

century design

THE TWENTIETH CENTURY DESIGN SUPER-SITE

FOR SALE: Philco 38-62 console parts sets. Call with needs. Cabinets only: Admiral Y3038A6 C/R with clock, RCA X4JE Filtermatic. RCA 8X542, white painted brown.

WANTED: speaker for National NC 183D. Mark Shoup, 27 Dogwood Dr., Newton, NJ 07860. (201) 383-6417

FOR SALE: B&K 440 cathode rejuvenator tester w/ inst., Heathkit TV alignment gen., Superior TV 40 CRT tester w/inst. Lafayette 223 transistor tester, all good cond. - \$35/all + UPS. Radiola 100A speaker (V.R., p. 209), nice cond. - \$30 + UPS. Harvey W. Hunt, 455 Gladstone St., Sheridan, WY 82801-4828

FOR SALE: (61) new in boxes Sonotone cartridges; (11) needles, black; (8) new tape heads; (4) needles, gray; all items new. Send for list and make offer + S/H. Carlos Gimenez, 15091 Shamrock Dr., Fort Meyers, FL 33912. (941) 482-0198

FOR SALE: Projection kinescopes for RCA or Philco. Steve Mayo, 162 S.W. Eyerly Ave., Port St. Lucie, FL 34983. (407) 878-8866

FOR SALE: Excellent gift idea: 77DX tie tacks and lapel pins. These are N.O.S. salesman giveaways. If you know a collector of mikes, a radio or TV nut, an on-air personality, or heaven forbid a station owner, these are for you, from the Blue Network - \$25 ea. Don't hesitate brass 1 1/2" tall RCA logo. Sure 55 pins - \$20. Jon Prabel, 2733 Wood Eagles, St. Charles, MO 63303. (314) 947-1543

FOR SALE: Shure #530 microphone and #533B desk stand, both N.I.B. - Offers. Zenith #9S262, good - \$295. Westinghouse refrigerator radio, cracked side, plays - \$39. Silvertone #1 metal radio, good - \$50; #6202 wood radio - \$60. Pair Altec horn speakers #H-811B with 802D drivers and N800E dividing network - Offers. Pair Electro-Voice 15" speakers #15W - Offers. Altec 15" speaker #803B - Offers. James Lansing 15" speaker #130A - Offers. All excellent. Rick Yerke, PO Box 392, Moscow, PA 18444. (717) 842-4857

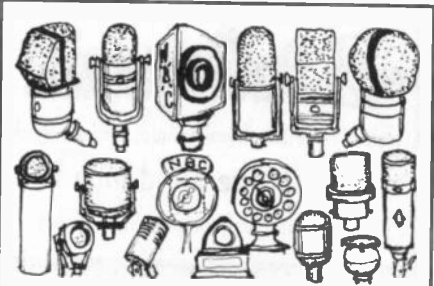

WANTED

FOR MY BROADCASTING MUSEUM

Microphones, stands, call letter plates. Tube amplifiers, mixers, compressors, Hi-Fi equipment. Speakers, on-air lights, equalizers. Disk, wire & tape recorders. Blank recording disks. Catalogs, magazines, manuals. 16" transcriptions, turntables, arms, pickups. Early TV cameras & receivers. Elaborate console, deco, plastic, mirror, novelty & wireless radios. Jukeboxes & parts. Acoustic phonographs.

We are looking for all makes of equipment, and especially Western Electric, Telefunken, Neumann and RCA. The museum contains various duplicates and items surplus to our needs, and many of these articles are available for sale or trade. The collection is located in my Victorian seaside inn, The Caffrey House, situated on a bay next to the ocean, in the Southampton resort area of Long Island. A trade of equipment for a stay at the hotel is always encouraged.

Robert Van Dyke, 2 Squires Ave., East Quogue NY 11942
516-728-9835

FOR SALE: Get back at your know-it-all radio buddies, 3-color reproductions of original 1920's comic valentines (put-downs) for - \$9.90 ppd. 2 for men, 1 for women. Buy now for Valentine's Day. Don Maurer, Sr., 29 South 4th St., Lebanon, PA 17042. (717) 272-2481

FOR SALE: TV-7 operator's and organizational maintenance manual w/changes, 62 pages - \$18. TS-323/UR manuals, 80 pages - \$20. Bob Bakinowski, 1524 Saint Tropaz, Tucson, AZ 85713. (520) 624-8029

FOR SALE: Western Electric 212D, N.O.S., (2) available with bronze sockets - \$125 ea. with sockets. Henry Galbraith, 1214 South Alvord, Evansville, IN 47714. (812) 476-7601

One Month Free!

BONUS FOR EARLY RENEWALS

If you renew before the month shown on your mailing label (your expiration month), you will receive an extra month on your subscription: 13 months instead of 12! 26 months for an early 2-year renewal!

FOR SALE: Motorola HS67, not mint, appears complete - \$10 + 18 lbs. John Uscinowski, RR 1 Box 379, Greenwich, NY 12834-9519

FOR SALE: Emerson 601A wood, table, cosmetically vg, excellent back cover - \$35 + UPS. Kenneth Miller, 10027 Calvin St., Pittsburgh, PA 15235. (412) 242-4701

FOR SALE: Airline 93BR715A - \$30. Airline GSL1564 - \$25. Airline 74W61510A - \$30. Admiral Y3523 - \$15. Admiral U532 - \$25. Admiral 4L28A - \$25. Crosley 56TC - \$35. Dunlop 500 - \$50. Emerson SIMAX217 - \$35. Emerson red 805B? - \$25. Emerson SIM519 - \$30. Emerson 456 - \$45. Emerson 523? - \$35. Emerson SIMFL715 - \$35. Emerson 343 - \$50. Emerson 920 - \$25. Fada PL22 - \$50. GE T165A - \$20. GE Art Deco - \$35. GE 408 - \$20. Howard 225 - \$100. Jewel 5030 - \$50. Meteor 7001 - \$35. Motorola A1W - \$15. Motorola 7XM21 - \$40. National Union 571 - \$15. Philco PT3 - \$25. Philco C716 - \$15. Philco 51631 - \$35. Philco 51532 - \$25. Philco 610 - \$100. Philco PT44 - \$70. Philco 5395A - \$70. Philco 50621 - \$35. Philco 51930 - \$40. RCA 4X641 - \$35. RCA 2X62 - \$40. RCA 96T - \$70. RCA 66X2 - \$40. Silvertone 2421 - \$50. Silvertone ? - \$25. Silvertone 25 - \$20. Silvertone 18 - \$30. Sentinel 118BT - \$15. Sylvania BT3-1W - \$30. Truetone D117 - \$55. Truetone D2919 - \$15. Zenith 4K035 - \$45. Zenith Y723 - \$40. Zenith H509 - \$25. Zenith 555 solar - \$125. S/H extra. Bud Santoro, 3715 Bower Rd., Roanoke, VA 24018. (703) 774-9153

TUBES WANTED

HIGHEST PRICES PAID \$\$\$

101D, F.205D, F. Tennis Ball. 300B, 274B, 211, 845, KT66, KT77, KT88, EL34, PX25, 280, 250, 102F, Telefunken, Bugle Boy, Mullard, ECC81, 82, 83, 801S, 802S, 803S.

AUDIO EQUIPMENT WANTED

Fisher, Scott, Dynaco, McIntosh, Marantz, JBL, Altec 604, B, C, D, E, 515, B, C, 288, B, C. UTC trans.; Black Beauty, A&B Resistor, etc...

FULL RANGE ELECTRON TUBE SHOP

Jonathan Woo Yik Fan
Flat B, 37/F, Block 5, Greenfield Garden
Tsing Yi, NT, Hong Kong
Tel: (852) 24349466 - Fax: (852) 24344963

This Holiday Season, Give a Gift To a Friend... Or Treat Yourself !!



-
- SubscriptionsCenter Coupon
 - Books & Videos pgs. 49, 52-55, 57, 62, 99-105
 - Gift Subscriptionspg. 70
 - New Item: Radio Poster.....pg. 36
 - New Item: Crystal Clear, Vol. 2pg. 53
 - Back Issues (*Great for new subscribers*)pg. 40
- Full Calendar Year of Back Issues - only \$24!
-



Antique Radio Classified

Is Your
Gift Source !!

— Call Us At (508) 371-0512
or Fax Us At (508) 371-7129



FOR SALE: Atwater Kent #80, needs cosmetics - \$300. AK #40, excellent, no speaker - \$60. AK #20 vgc globe tubes - \$125. Radiola #18, complete with 100A speaker, add \$30 if you want a junker set too. Radiola III, NT - \$75. Arvin 422, white - \$60, add \$25 if you want a rough #522 too. All plus UPS/P.O. Jon Prabel, 2733 Wood Eagles, St. Charles, MO 63303. (314) 947-1543

FOR SALE: Free photos, all radios excellent and working + shipping. Philco cathedrals: 52B (Ramirez, p. 38) - \$275; 144 (Ramirez, p. 64) - \$465; 91 (Bunis 1) - \$450; 71, shadow tuning, escutcheon - \$360; 71 (Bunis 2), small escutcheon - \$285; 90 Special, brass escutcheon, 2-45 output - \$550; 70 - \$335; 20 - \$225; 20 Delux (Bunis 2) - \$285; 50 (Ramirez, p. 27) - \$195; 60 (F.O.S., p. 118), brass escutcheon - \$185; 60 Art Deco, Bakelite, escutcheon - \$185; 89-19 (E.O.R., p. 163) - \$190. Philco 37-610 bullet cabinet - \$135. Philco tombstones: 118 (Bunis 2, p. 139) - \$160; 620 (Bunis 1, p. 120) - \$185. RCA 9T (E.O.R. 2, p. 161) - \$360. Gloritone 99 (E.O.R., p. 145) - \$230. Apex 8A (Bunis 3, p. 26) - \$435. GE K80 (F.O.S., p. 90) - \$450. Crosley 124 original grandfather clock radio - \$425. Joe Milano, 61 Furman Dr., Wayne, NJ 07470. (201) 694-3721

FOR SALE: Scott tube amps: #99-B - \$95; #208 power amp, rare - \$400. Amps work, excellent condition. UPS extra. Sell or trade for Fisher tube audio, or German/Dutch portable or table radios. Steve Kelsay, 33 Clover Ln., Aliso Viejo, CA 92656. (714) 831-7258

FOR SALE/TRADE: 1 pr. Hammond 2A3 amps, gd. cond., no tubes - \$350/pr. 1 pr. 12" Jensen field coil speakers, exc cond. - \$295/pr. 1 pr. potted Thordarson output trans. Mod 22S39 - \$95/pr. Used tubes: (4) RCA 2A3 - \$15 ea.; (5) grn. labeled 6SN7GTB - \$4 ea. UTC trans. 1 ls. 40 - \$35, (1) LS10X - \$35. WANTED: Audio note 300B Kit-1 amps. Audio Ele. Supply SE-1. Any other fun 300B amps. All + shipping. Greg Lee, 2421 Kestral Blvd., W. Lafayette, IN 47906. Phone/fax: (317) 463-2758

FOR SALE: Blue Arcturus used tubes, 7-124A, 6-127, 2-126. Best offer two weeks after publication. J.J. Pavovich, 53 Magnolia Ave., Pitman, NJ 08071. (609) 582-8279

FOR SALE: Dynaco PAT-4 (2)/stereo 120 amplifier, clean, need work, all - \$85, plus shipping. Rudy Purcell, 4473 W. 136th St., Cleveland, OH 44135. (216) 251-6511

FOR SALE: Zenith 10A4 console, fair condition - BO. Save from dumpster, no shipping. Bill Jaber, 22470 Charter, Southfield, MI 48034. (810) 354-0428

FOR SALE: Panasonic TR-005 Jetson's TV, mint and working - \$350. Motorola VT-71 7" TV - \$125. Kirk Lundstrom, 22 Forest St., Lewiston, ME 04240. (207) 782-2367

FOR SALE: Newly acquired! (45) early transistor & novelty radios - \$5-\$25 ea. Guild phone radio - \$65. Cracked-up Emerson Catalin - \$65. Nice DeWald A501 Catalin - \$200. Zenith 6D315U w/spare - \$185. Medical quack devices - \$10-\$65. Sams Radio hndbk - \$18. Jeff VanAssche, 103 West Silvermeadow, Midwest City, OK 73110. (405) 732-5747

FOR SALE: TSMS: 9, 52, 53, 54, 56, 58, 61, 62, 64, 67, 71, 77, 83, 84; all have upper right-hand corner of cover torn off and are \$6 ea., except #9 which is \$10 and mint - \$60 all. GE P-808H, yellowed - \$5. RCA 3-RH10 - \$20. Zenith 5-S-250 chassis with original knobs, missing one tube shield and speaker - \$40. SASE for transistor list. Jerry Nutter, Audio Carpetorium, 111-32 112th St. Jamaica, NY 11420-1026. (718) 835-1132

FOR SALE: EICO Model HFT-90 FM tuner - \$10 plus UPS. Henry Boersma, 6253 Dolores Dr., Oak Forest, IL 60452. (708) 687-9444

FOR SALE: Rider's Radio Manuals: #6, 7, 9, 10, 11 12 - \$25 ea. plus shipping Joseph R. Forth, 321 Long Vue Acres, Wheeling, WV 26003. (304) 277-3154

"Do you know me?"

I started the world's first broadcasting station. I'm Charles Herrold, and between 1912 and 1917 I was sending music and news to an audience in San Jose, California, on a regular schedule. But while I may have been first, most people forgot all about me. Now there's hope; my story is told in this exciting new videotape from the creator of the award-winning PBS series 'Radio Collector.' It's available from the Perham Foundation. Don't leave home without it!"



"Broadcasting's Forgotten Father: The Charles Herrold Story"

VHS-Hi-Fi, close-captioned, \$29.95 plus \$3.50 S&H.

Order directly from the Perham Foundation,
101 First St., Suite 394, Los Altos, CA 94022.

Or call 1-800-771-KTEH and use your credit card.

All profits go to support the preservation of electronics history.

WANTED: Altec #515 woofer, & UTC-LSS2 output transformer. Rich Kovarovic, Box 104A, Dover Plains, NY 12522. (914) 877-3424

WANTED: Crank phonographs, incomplete machines, horns and related parts and items. Any kind and any condition. Dave Faehrich, 8215 Stone Rd., Independence, OH 44131. (216) 447-0837

WANTED: SW3 coils, parts and a Flewelling converter, Flewelling schematics. Fred Sodemann, 2603 N. Greenwood, Pueblo, CO 81003. (719) 543-6654, evenings Mountain Time

WANTED: External speaker for Philco 16-RX-T chair-side. Cabinets for AK 80, 246, 367. Bob Nicholson, 3423 S. Long, Topeka, KS 66605-2486. (913) 266-9473

WANTED: Atwater Kent 2000(?) 1920's console with oriental painting on cabinet; speaker on side. Gerald Schneider, 3101 Blueford Rd., Kensington, MD 20895-2726. (301) 929-8593

WANTED: RCA theremin, working or not. Phil Mac Arthur, 701 Spanish Main Dr., Cudjoe Key, FL 33042. (305) 296-9081, ext. 219

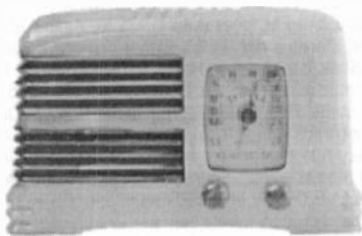

WANTED: Symphony and Detrola Catalin radios. I am not a human being; I am a radio collector. God forbid! Pity me the lost soul that I am and fulfill my humble needs. Please write or call collect: Rain Buttignol, 214 State St, #7, Portsmouth, NH 03801. (603) 427-1384

WANTED: Leather case for Sony TFM-121 and also users manual for same (photocopies OK). Marty Dzik, 412 Gregory St., Schererville, IN 46375-2290. (219) 322-4104

WANTED: Book: Servicing By Signal Tracing by John F. Rider. L.W. Weatherby, 811 So. Jordan, Liberal, KS 67901. (316) 624-6047

WANTED: Complete phonograph for Philco 46-1209 and Emerson CG-298. Also need operable 99A chassis with speaker. Dwaine Fisher, 600 Nauvoo Rd., Clarksville, OH 45113

WANTED: Output transformer for Philco Transitone TH-3, Part Number 32-8040 for speaker #36-1461-2. Ed Martin, 485 Benwood Hill Rd., Benwood, WV 26031-1301

WANTED: Telegraph keys wanted! Buy/trade. SASE for 500 key trade list. Tom Perera, 11 Squirehill Rd., North Caldwell, NJ 07006

WANTED: Zenith robot dial chassis. Need good black dial face and shutters for 12S265. Mark W. Hilliard, N3NBL, 921 South Edward St., Allentown, PA 18103-4657. (610) 432-8089

WANTED: Any condition Radiola Special lid/manual/schematic, or Radiola VII-B cabinet. William Boyd, 74 Atsion Ct., Medford, NJ 08055. (609) 722-2369

WANTED: Any condition, complete sets, speakers or chassis. Brunswick IIA tombstone. AK 627. AK 228. Or any AK cathedrals. Joe Milano, 61 Furman Dr., Wayne, NJ 07470. (201) 694-3721



WANTED: I will pay top dollar or trade generously for the pictured 1937 Midwest tabletop radio Model K-11 in any restorable condition. Also seeking any other restorable Midwest tabletop radios 1933-1941. Please call or write: Mark V. Stein, 2109 Carterdale Rd., Baltimore, MD 21209. (410) 466-2814. Fax: (410) 466-0815

WANTED: Abbotwares radios for parts. Will buy your broken, damaged and/or unwanted Abbotwares radios for salvage. Please call or write: Mark V. Stein, 2109 Carterdale Rd., Baltimore, MD 21209. (410) 466-2814. Fax: (410) 466-0815

WANTED: Chassis and escutcheon for Zenith 12S370. M. Thornton, 4201 West Bertona St., Seattle, WA 98199. (206) 284-4624

WANTED: Following radios in good condition. Zenith 701 or 7S529, RCA 56X3, Stromberg-Carlson 641A or Silvertone 7108. Wayne Dempsey, 2720 Woodhaven Ct., Clearwater, FL 34621. (813) 725-3785

WANTED: Vibrator sockets 3 and 4 pin, 7-pin miniature tube sockets printed circuit mount. Fred Cranshaw, 1624 Bitter Ck., Garland, TX 75040. (214) 494-4917

WANTED: Manual, copy OK, of Eico 950 R-C bridge tester. Steve Bartkowski, 4923 W. 28 St., Cicero, IL 60650. (708) 863-3090

WANTED: Your unwanted new and used tubes, receiving and transmitting types. P. Hamersma, 87 Philph Ave., Elmwood Park, NJ 07407

WANTED: Dumont RA103D tabletop television, 1949, in working condition. Mike Sarno, 236 Ridge Rd., Nutley, NJ 07110. (201) 687-7857

WANTED: Collins 51RV2 and 51Y4 for air-worthy restoration of Vickers Viscount. Jeary Vogt, 3 Brampton Rd., Malvern, PA 19355. (610) 296-2162. E-mail: Jeary@aol.com

TRANSISTOR NETWORK

If you buy, sell, or collect transistor radios, you need the Transistor Network, a monthly transistor newsletter featuring transistor related articles and classified ads. Only \$17.00 for a one year subscription (12 issues) US, \$20.00 Canada, \$30.00 Foreign Air, \$22.00 Foreign Surface. US funds only.

Not sure? Send \$1 (refundable toward a subscription) for a sample copy. Transistor Network, 32 West Main Street, Bradford, NH 03221. Published by Marty & Sue Bunis.

FOR SALE: Ware Model W with 3 tipped DeForest DV2's. Larry Dowell, 8490 Hurdle Mills Rd., Hurdle Mills, NC 27541. (910) 364-2756

FOR SALE: Emerson AX235 marbled blue, like Sideli book Plate #51, no cracks, no hairlines. Maurice Giroux, 559 Hudon, Laval, Quebec, Canada H7P 2L4. (514) 963-1601

FOR SALE: Many novelty and transistor radios from the 1960's, new in box. SASE. Bill Hyde, 34 Cerrado Loop, Santa Fe, NM 87505. (505) 466-6613

FOR SALE: Arvin 12R23 Scarlett, plays, clean, complete, red Catalin, has 1" crack top back to front - Best Offer before December issue. R.A. Ruhf, 316 South Broad St., Nazareth, PA 18064-2803

FOR SALE: Automobile radio vibrators. Free catalog. See our boxed classified ad. Dan Schulz, Antique Automobile Radio, Inc., 700 Tampa Rd., Palm Harbor, FL 34683. (800) 933-4926. Fax: (813) 789-0283

**PHONE NUMBER FOR
ANTIQUÉ RADIO CLASSIFIED
(508) 371-0512**

**Best time to call is weekdays:
8:30 am to 6 pm Eastern Time**

(Please no classified ads by phone. Thanks!)

FOR SALE: Westinghouse 25 amplifier, Federal 58DX receiver, ACE 2B amplifier. Send SASE for information. Jerry Van, 1150 Kellogg St., Green Bay, WI 54303

FOR SALE: Original owners manuals for Motorola TVs: #VT107, #VT121, #VT71, new Horizon models - \$20 ea. Zenith porthole manual - \$30. Motorola #VK101 - \$30. All are N.O.S. Jon Prabel, 2733 Wood Eagles, St. Charles, MO 63303. (314) 947-1543

FOR SALE: Manuals (copies), spiral bound: R390A, 400 pages - \$58; SP-600-JX-17, 332 pages - \$55; R-648/ARR-41, 362 pages - \$45. Bob Bakinowski, 1524 Saint Tropaz, Tucson, AZ 85713. (520) 624-8029

FOR SALE: 1950's Norwegian Radionette Combi portable with concealed 45 rpm player - \$45. Red Mitchell 1258 Rondeau - \$35. Black Packard Bell 5R1 - \$20. Graymark 506 kit BC/SW tube receiver - \$25. Add UPS. Walt Kiefner, 6233 51st Ave., NE, Seattle, WA 98115. (206) 526-1452

FOR SALE: Prices reduced on remaining (110) novelty radios. SASE for new sell-out list. Rod Galloway, 2220 Woodbury Rd., Melbourne, FL 32935

FOR SALE/TRADE: HosHo reel-reel 3" recorder Mod 105, exc condition - \$45 plus UPS. Paul Fulton, 711 Jacquelyn Rd., Westwood, NJ 07675. (201) 664-5260

FOR SALE: Rider's Radio Manuals: Volume I to V Abridged - \$40; Volumes IV, VI, VII, VIII, IX, X - \$20 ea.; Volumes XI, XII, XIV - \$15 ea., all + UPS. Rider's TV Vol. I and II with index - \$30. GE recording voltmeter Type CF1 with paper - \$40. Dumont oscillograph record camera Type 296 with book - \$35. Waterman pocket scope Model S-14-B, works - \$85. All + UPS. Phil Guinan, 106 Page Rd., Litchfield, NH 03052. (603) 889-6213

FOR SALE: Setchell-Carlson 427 - \$60. Metal Arvin 341T - \$50. Detroita 568 chrome-front - \$100. Belmont 6D111 - \$150. Emerson 744 chipped grille - \$125. Emerson 199 - \$100. Plus shipping. Ross Mason, 715 S. Penn, Mason City, IA 50401. (515) 423-4687

FOR SALE: Radio News from 1919 to Dec. 1928, (124 issues, (3) have covers missing, 1927 Dec. missing - Best Offers via mail only, will not break up. Have random copies Radio News 1921 to 1953. Pound assd. resistors - \$6.50. (50) assd. dial drive belts - \$25. Line voltage regulator Model LR-10, 350 watts high or low - \$6.50. Have radio-TV test eqpt. untested, from closed-up repair shops, may need some work, probe or manuals - write wants or SASE for list. Automatic 2 to 4 speed players and changers - list SASE. 7-tube AC amp and speaker for Brush recorder, clean - \$30. Bench cast iron drill press, use your own drill (20 pounds) - \$35. Jensen 9" PM speaker, metal case, needs clean up - \$12. RCA 45 player 8EY31, port. case, still works - \$25. Heath BE2 6-volt, 10 amps, power - \$40. Heath Model PT1 FM-AM 14-tube (AC) tuner - \$40. Harman Kardon A230 amp, 10 tubes - \$40. Hewlett-Packard 412-2 VTVM, needs recal. - \$35. Eico 950-B res.-con. tester - \$37.50. RCA Nipper items, (6) assd. - \$20. IRC shop metal box and some vol. controls - \$22.50. Assd. parts from Model 20-25-28 RCA Radiolas. .022-200v wax bypass cons. LB - \$1.50. Bakelite GE bar knobs brass bushing, less set screws, 12 for - \$1.75. Push-on bar knobs with springs, 6 for - \$1. Realistic audio crossover units - \$5. Knight stereo speaker control unit - \$10. Realistic hi-fi FM tuner (tubes) - \$20. Airline AM-FM (tubes) stereo tuner - \$20. Fisher preamp equalizer, H.H. Scott 2-tube tuner, Harman Kardon 2-tube tuner from chassis, all - \$17.50. Heath amp W5M - \$95. Still have some RCA Nipper, (5+) items - \$20. Oneac isolating transformer, 2 amps, case, cord, outlets - \$35. Mercury 501 component substitutor res. con.,, needs some repairs - \$12. Voltmeter(s) new sealed carton, Model LVE 0-120v or 0-500v hallmark; this works on electrostatic action between var. condenser plates; these were shook up, need bearing adjustment, makes good display how it works?, large scale, case worth the price - \$25 ea. Leeds and Northrup res. bridge less lid - \$20. Assd. brands headphones less cords - \$8 set; with cords - \$12. Mae West em. boat transmitter - \$75. (10) assd. sizes PM speakers - \$15. Spool radio solder, not full - \$3.50. Nordemende Elektra AM-FM, (2) SW bands, wood case, plays good - \$40. Nipper print 12 1/2" x 12 1/2" - \$17.50. Ace Radio Repair print - \$15; with mat - \$19 ppd. 1937 Radio News Data Book - \$9. Radio Receiver Servicing Guide and 25 Fun To Build Projects, both for - \$8.50. Auto radio hi-fi boosters - \$12.50. Have over (75) assd. test eqpt. units from repair shops, low price sold as removed. Also N.O.S. and pull-outs from junked radios, tubes, parts. (20) radio-TV inst. booklets - \$15. DeVry Tech. Inst. TV-Radio Course booklets, (45+), all - \$22.50. Nat. Radio Inst. 53, all - \$30. Have some items on pickup only: 10" Philco TV 2 low freq. rec's lab type test eqpt. Philco Models 512 - \$70; 65 - \$70. Stromberg-Carlson table radio 58-T - \$150. Kellogg batt. radio - \$175. Edison wax cyl. office recorder, stand - \$100. Reel-to-reel tape recorders players. Some photo eqpt., cameras. 1000's of unlisted items. All plus shipping. Min. orders \$8. Sales service since 1930. Krantz, 100 Osage Ave., Somerdale, NJ 08083-1136. (609) 783-0400

FOR SALE: Cutting & Washington 11A with extras, rare condition - \$800 or Best Offer. Jim Ellis, Box 822, Rochester, MN 55903. (507) 288-1201

FOR SALE: Radios: Pilot X1252 - \$35. RCA 6-RF-9 - \$35. Zenith G730 - \$35. Arvin 3586-1, metal - \$95. Stewart-Warner 9152-B - \$30. Herb Ratner, 3542 Westminster Ct., Holiday, FL 34691. (813) 937-7452

Radio Restoration Parts

Vacuum Tube Repair Wafers

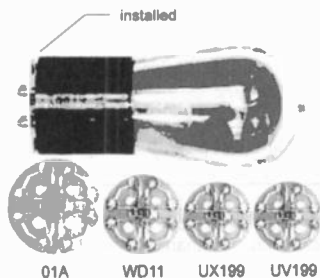

These tube repair wafers are solid-state devices for quick and easy repair of early vacuum tubes. The wafer is installed by simply sliding it over the tube pins and reinserting the tube into its socket. If the filament is intact, but there is little or no emission, the filament may be lit for best visual effect. However, the tube can be open filament.

No change in radio operating voltages is required. Any number of tubes may be repaired in a radio. If wafers are installed on all tubes, the B+ voltage may usually be reduced without sacrificing volume or sensitivity. Performance will vary with radio model.

\$10.00/each (\$7.50/ea. 3 or more)

| Model # | Also fits |
|---------|---|
| 01A | 00, 00A, 01, 201A, 301A, 12, 112, WD12, 40, 71, 171 |
| UX199 | 20, 120, X120, UX120, 30, X130, UX130 |
| UV199 | — |
| WD11 | — |

1920's styled Universal Loop Antenna

Features solid hardwood construction, available in oak or mahogany, with solid brass hardware. Tuning control is built into the base or can be tuned from the radio.

Applications as:

1. A loop for early battery radios.
2. A signal & selectivity booster for transistor & tube sets.
3. A loop for radios designed for long wire antenna.

The loop is rotatable for strongest signal or best interference rejection. A small auxiliary loop is supplied for radio to Universal Loop coupling; when used to couple to a radio with a ferrite antenna/loop no electrical connection to the radio is required.

Ready to use: \$79.95 (specify oak or mahogany)

Kit: \$49.95 (unfinished oak or mahogany, specify)

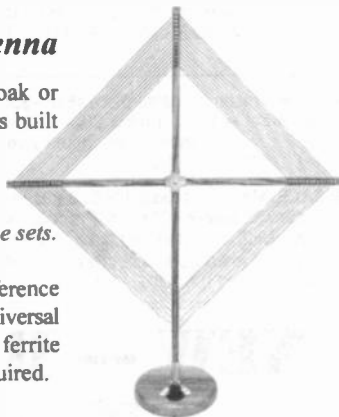

Size: 28" wide x 35" tall

Active Antenna

Allows antique radios that were designed for a long wire outdoor antenna to operate on a 42" indoor whip antenna. Portable, operates from a 9 volt battery.

Only \$34.95

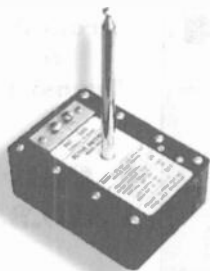

Also: **New Atwater Kent Breadboard Switch**

Thermoset plastic, same as AK - new mfg. \$50.00/ea

Order from: PTI, 7925 Mabelvale Cutoff, Mabelvale, AR 72103

Orders shipped UPS, prepaid in continental U.S. Please allow 3 weeks for delivery.

Arkansas residents add 6% sales tax.

To Order: Call (501) 568-1995



FOR SALE: Scott LK-150 amplifier with Scott LC-21 Control Center, Scott 312 tuner and two large Scott wood cabinet floor speakers, Type S-12. Magnificent original condition with booming sound! Sold only as a set to highest bidder; seller may reject any bid. Bids accepted by letter or by phone, between 5-9 pm, each day until November 30, 1995. On November 30, callers may check highest bid and increase their bids by 10% of highest bid. Buyer responsible for shipping costs. Contact: R. Whetstone, HC 84, Box 44, Arthur, WV 26816. (304) 749-7295

FOR SALE: Very rare "secret" WWII airborne radar manual, dated 1944, 350 pages of highly technical information on intercept radars, IFF's, bombing aids, APA's, APX's, APQ's, APS's, Navy sets, all airborne radars at the time, classified secret, softbound high quality reproduction, most complete information I've ever seen - \$27 + \$3 air mail U.S., 1 1/2 pound postage foreign. Sam Hevener, The Signal Corps, 3583 Everett Rd., Richfield, OH 44286-9723. (216) 659-3244

FOR SALE: Zenith R3000 - \$60. Zenith R1000-D, looks great but not working - \$65. Westinghouse RPM5020A, 5 band, 15 transistor - \$25. Arvin 80R77-18 transistor, 5 band - \$25. Philco T909BR 3 band, German - \$20. Philco T701-126 U.S.A. - \$20. Ross Mark 400 3" reel recorder - \$10. UPS extra. Victor Marett, 3201 N.W. 18 St., Miami, FL 33125. (305) 634-9569

FOR SALE: Freshman Masterpiece #675 - \$345. Stromberg cathedral - \$395. Philco 20 - \$335. All mint. LSASE. Richard Bednarcik, 28 Steele Ave., Lincoln Park, NJ 07035. (201) 694-6374

FOR SALE: Meissner Mod 9-1065 78/33 rpm recorder/reproducer with built-in AM radio. Precision wood case tube tester Mod 612. Both untested. AK 145, cabinet and radio both need work. Allan Haasken, 8422 Berea Dr., Vienna, VA 22180. (703) 560-4869

FOR SALE: 1. Telefunken Jubilate, AM/FM/SW - \$60. 2. Grundig Satellit 650, mint - \$750 firm. 3. Grundig 80U, AM/FM - \$25. 4. Sanyo car cassette/radio MW/SW1/SW2, new - \$90. Call: Nisar Ahmad, 34 Saccheri Ct., Staten Island, NY 10308. (718) 966-9018, 7-10 pm EST

FOR SALE: Sony CRF-320 multiband portable very rare - \$650 + shipping. Grundig transistor 700 multiband portable, fantastic sound - \$125 + shipping. Gerald Silver, 10863 W. Clairmont Cir., Tamarac, FL 33321. (305) 720-1972

FOR SALE: 3-piece Ediphone Edison cylinder reproducer, g - \$200, must pick up. George Glann, 4440 North Creek Rd., Palmyra, NY 14522. (315) 597-4438

FOR SALE: 1951 Zenith H500 Trans-Oceanic, fully operational - \$70 plus shipping. Jerome A. Wieland, 780 Charleston Ln., Hoffman Estates, IL 60195. (708) 934-1790

FOR SALE: 1930's and 1940's wood cabinet battery radios, they do work - \$59.50 ea. Price includes UPS shipping. Truetone D1035. Motorola 41-B-12. GE 180 and a Silvertone 2551X. Call evenings. Ron Marley, 172 Brandt Way, Winchester, TN 37398. (615) 967-7219

FOR SALE: New book on Transmitters, Transceivers, Linears and more, 1922 through 1970, (500) pictures, (105) manufacturers, (550) models of xmtrs/xcvrs, and more - \$17.95 including U.S. postage. Add \$2 for Canada. Calif. residents add appropriate sales tax. Now in stock. Sound Values, PO Box 9, Auburn, CA 95604

FOR SALE: AM/FM's: Sonora #WEU240 - \$60. RCA's: #8R71 - \$50, & #8X71 - \$35. Westinghouse #H-38977 - \$45. JVC Del Monaco - \$70. Ripley, Box 9374, N. St. Paul, MN 55109. (612) 777-6791

FOR SALE: Hickok 539C tube tester, no lid - \$140 plus shipping. James W. Poitviant, 3 Darby Cir. East, Mt. Holly, NJ 08060. (609) 261-0059

NEW — RADIO POSTER

**FULL
COLOR
26" x 20"**

**An
Illustrated
Radio
Timeline**



**GREAT
GIFT**

**20 Radios
From Pup
to
Transistor**

**Only
\$10.95**

U.S. Orders - Enclose \$3.00 per order for packing & book-rate shipping if total order is under \$35.00. If using VISA or MasterCard, include name on card, card number and expiration date. Send payment with order. Mass. residents please add 5% sales tax. Money back return policy. Most orders shipped the same day received, but allow 2-4 weeks to receive order. Foreign orders - write for shipping costs, or use credit card and specify air or surface (allow 2-3 months for surface shipping).



**Send Order To: A.R.C., P.O. Box 2, Carlisle, MA 01741
or Call: (508) 371-0512**

Fax: (508) 371-7129



(Nov-95)

WANTED: Metal ballast tube for Hallicrafters Model S-47, (8) pins 3 1/8 overall, schematic #RH-330 #Hytron 24B870. Richard Hallet, 19 Plymouth Ave., Hyannis, MA 02601. (508) 775-7090

WANTED/TRADE: Bizarre trance-like fixation with global GR-711's. Hypnotic impulse to buy or make trades. Mike Brooks, 7335 Skyline, Oakland, CA 94611. (510) 339-1751

WANTED: TV chassis for Emerson #571 10-inch set. Needs to be complete, but does not have to work. Thanks. Robert Bailey, 2451-3 Whispering Woods Blvd., Jacksonville, FL 32246. (904) 642-5837, ans. mach. after 4 rings

WANTED: Electro-Voice mic. Model No. 640 HI Z Gain. Denise LeMoal, 5757 Westheimer, #3139, Houston, TX 77057. (713) 680-8110, 24 hours. Fax: (713) 680-8102

WANTED: Small knob maroon with gold trim for H.H. Scott LK-72. F coil for HRO-60. Al Manieri, 384 Bates St., Phillipsburg, NJ 08865. (908) 454-3699

WANTED: Junker Grunow Model 901/902 chassis 1A with oscillator coil. Ben Mast, 3253 O St., Northwest, Washington, DC 20007. (202) 338-7145



WANTED: Motorola Catalins #'s 50XC, 51X15, and 52, as complete or "parts" sets. I am a very serious collector seriously looking for serious stuff (leaving all kidding aside, of course)! Please write or call collect: Rain Buttignol, 214 State St, #7, Portsmouth, NH 03801. (603) 427-1384

WANTED: JVC Videosphere TV, must have clock in base & be nice. GI Joes from the '60's. Also parts & accessories. Tony DeMara, 40231 Day, Clinton Twp., MI 48038

WANTED: Rider's Radio #22, offering \$55 ppd. Dave Metz, 1016 Ridgemont Dr., Staunton, VA 24401. (540) 885-7914, evenings till 10 pm EDT

WANTED: Aeriola Sr. receiver (molded panel), clean, pricey OK. Gary Gordon, 21112 Bank Mill Rd., Saratoga, CA 95070. (415) 857-4958, days

WANTED: GE 660-A Convertible portable clock/radio. Also handle for Zenith 601-D portable 1942 or junker with handle. Bill Campbell, 1221 Littlebrook Ln., Birmingham, AL 35235. (205) 853-8227

WANTED: Cabinet for Federal #1. Restorable or better condition. Charlie Poulton, 25626 Oaks Blvd., Land O' Lakes, FL 34639. (813) 973-7030

WANTED: Glass dial scale for Philco, Model 41-608, Part #27-7637, 50mmx220mm. Glass dial scale, Stewart-Warner, #502505, used in Models 9014E, 62T36 and possibly others. Joe Vititow, 1341 Harrodsburg Rd., Lawrenceburg, KY 40342. (502) 839-5444, call collect

WANTED: Western Electric 285K line/bridging transformer, Triad HSM-79 output transformer, 1950's Vade Mecum manual. Leif Blackmon, 4 Larson Rd., North Reading, MA 01864-1071. (508) 664-0174

WANTED: The three gears, or whole roll chart assembly for Hickock tube tester; tube test info TV3, TV10 (have TV7, not the same). Philco 20, 70, 90 speaker, chassis, cabinets, what have you? 10FP4 CRT N.I.B., or rebuilt; print for any broadcast modulator using PP833. John Grady, XRE Corp., PO Box 1154, Littleton, MA 01460



WANTED: This Colonial Model 300 and other similar early plastic radios. I'll pay cash, or I have good trade items. Please contact Jon Steinhauser, 1205 E. Broadway, F-15, Hewlett, NY 11557. (516) 295-3147

WANTED: Rider's Volumes 18, 19 and 20. William F. Koch, Jr., RR1 Box 301, Haverhill, NH 03765. (603) 989-5574

WANTED: Philco 81 Jr. chassis or IF coil osc. coil & ant. coil. Jack A. Muhlhahn, 87 Lafayette St., Piscataway, NJ 08854. (908) 752-9448

WANTED: Need a schematic for a Gen. Elec. radio, Model 7-4725. Raymond Busch, 1911 Quincy St., NE, Minneapolis, MN 55418-4515

WANTED: Power supply or battery charger for a Zenith Model 4V-31, black dial, AM/SW, needs to be 6-volt, about 10 amps. Tom Bates, 1928 N. Braeswood, #11, Houston, TX 77030



WANTED: I will pay top dollar for the pictured 1940 Detrola wood tabletop. Also seeking other interesting wood Detrola radios ca. 1933-42. Call or write: Mark V. Stein, 2109 Carterdale Rd., Baltimore, MD 21209. (410) 466-2814. Fax: (410) 466-0815

WANTED: Motorola man: Always looking for Motorola stuff. Currently need schematic for Model 63X tabletop. Also service monitors. Jim Gibbins, PO Box 200, Aydtlett, NC 27916. (919) 453-2004

WANTED: Hallicrafters R-46 speaker (black), Lafayette HA-600A. FOR SALE: Jackson 106 signal generator - \$15. Bill Regan, 4566 O'dell Pl., Jamesville, NY 13078. (315) 492-2817

FOR SALE: WWII R.A.F. T1154 airborne transmitter, mint with tubes; R1224A receiver 1930's (pre-WW2) with tubes, original air ministry wood transit box; 1937 Marelli pink mirror glass 5-tube radio, rare - \$650. S.G. Brown magnetic crystal set loudspeaker amplifier, this is the rare large one - \$450. Jim Taylor, G4ERU, 5 Luther Rd., Winton, Bournemouth, United Kingdom BH9 1LH. Tel/fax: 01202-510400

FOR SALE: Philco 91 chassis - \$42. Speaker - \$20. Echoboard - \$12. Escutcheon - \$10. Zenith 5R236W chassis, white. Bill Timoszyk, 35283 Leon, Livonia, MI 48150. (313) 421-2076

FOR SALE: Radiola 62, hums, lights, no play, nice cabinet - \$240. Pick up only. Radiola 103 speakers, (2), some wear - \$100 ea. Gary Nitkin, 102 Long Highway, Little Compton, RI 02837. (401) 635-2816

FOR SALE: Automatic 612X - \$90. AM/FM Coke bottle - \$50. Tubes D86326 T20 - Offer. Claude Chafin, 4223 E. 42nd Way, Independence, MO 64055. (816) 478-4518

FOR SALE: VU111S GE tube in sealed carton. Unusual collector's item - \$10 and I ship! Info SASE. No phone calls. Maurice Pope, 39 Highland Ave., Gorham, ME 04038

FOR SALE: Cleaning out radios, parts, books, literature. 4-page list LSASE. Dave Dameron, KG6BP, 819 Boundary Pl., Manhattan Beach, CA 90266-8621. (310) 318-5311

FOR SALE: A.R.C. back issues '89 thru '94 - \$10/yr plus 4 lbs. UPS each year. Serge L. Krauss, 141 Homan Ave., Elkhart, IN 46516-5027

FOR SALE: Over (100) interesting tube-type table radios. Novelty, urea, marbled plastic, Bakelite & wood. Ask for list #TTR. Send SASE. Bob Zelenack, PO Box 460642, Escondido, CA 92046. (619) 749-9652, or fax: (619) 749-4291

FOR SALE: Bendix 626A - \$55. Crosley 56TD - \$85. Emerson 561, ivory, Plaskon - \$60. CG 276 - \$75; 132 - \$75. Crosley 10-135 - \$80. Fada 790 - \$80; 260B - \$190. GE YRB Deco - \$55. Belmont 6019 - \$55. Motorola 5T22 - \$70. 5X3-IU, mint - \$95. 65X11 - \$70. Normande K 57 - \$40. Philco 53-566 - \$45; 52-939 - \$45; PT-25 - \$55; 37-602 - \$95; 38-15 - \$60. RCA 75X11 - \$75. Arvin 440T - \$50. Northern Electric 5500 - \$70. Send \$1 + LSASE + 2 stamps for new 160+ photo catalog. Bob Masterson, Box 172, Valley Cottage, NY 10989. (914) 353-3151

FOR SALE: HP-23 - \$50. WANTED: Nice Hallicrafters SX101 or SX101A, other nice receivers. Ron Merrell, 10701 W. 54th St., Shawnee, KS 66203

FOR SALE/TRADE: Garod Catalin, yel. orange, nice - Offers. Zenith 3000-1 recapped, v nice - \$150. Zenith 755, nice - \$50. Military R-744 mobile receiver 20-102 MC AM/FM/CW - Offers. Altec 1592, 1598 mixer 351-C. SS mono pwr amp - Offers. Heath W4 AM, exc - \$150. WAP-2 - \$50. Eico HF 20, exc - \$125. Mac C-8 - \$150. Pair MC 30's, vg - \$1,100/pr. Pan Locs, 2-3 sets - Offers. Fisher 400 tube rec. mahog. case, exc - \$125. Dynakit 70, vg - \$175. Sony 8-301 TV, no visor, nice - \$150. Brush sound mirrors, exc BK-403 - \$500. BK 403 - \$500. BK 401 - \$400. RCA 77-D exc TV grey, small chip, works great - \$1,400. WANTED: Mac C11, C20, C22, (one), cabinets for 604's, 1 pair. Collins 26-U limiter. Will trade for above stuff or buy. LSASE for new list. Ward Kremer, 301 S.W. 16th St., Ft. Lauderdale, FL 33315. Phone/fax: (305) 524-5652

FOR SALE/TRADE: 1920's Gillfillan 25 - \$225. WE 10D horn - \$225. WANTED: Zenith 9-S-232 cabinet only. Wayne Childress, KC7KUE, 1903 Jerome Pl., #3, Helena, MT 59601. (406) 443-7255

FOR SALE: Leeds-Northrup W-10150 inductance unbalanced bridge, rack mount - \$45 + UPS. Allen Jochem, 2205 Broadway, Quincy, IL 62301. (217) 223-6751

The "Radio Collector" Video

Writer-producer Mike Adams and the Perham Foundation Electronics Museum are pleased to present the original, best-selling PBS series, "Radio Collector". Nominated for an Emmy, Best Information Series, "Radio Collector" is now available complete and uncut. All five half hour shows have been newly duplicated from the original broadcast masters.

Order the Popular VHS
Videotape "Radio Collector"
Directly From
the Perham Foundation!



Writer-producer Mike Adams

You'll meet dozens of collectors and experts, see hundreds of radios made between 1900 and 1960, plus you'll learn about radio restoration!

Send \$29.95 plus \$3.00 S&H to:
Perham Foundation,
101 First Street, Suite 394,
Los Altos, CA 94022

For more information,
call us at 408-734-4453
Proceeds support construction
of our new museum!

AUCTION

Nov. 18th, 1995 (Saturday) 10:00 A.M.

Preview Time: Fri. Nov. 17th 10:00 am to 10:00 pm

Sat. Nov. 18th 8:00 A.M. to 10:00 am

Antique radios, vintage hi-fi equipment, vintage acoustics, meters and test equip., receivers, etc.

Location: Downingtown Marketplace, Downingtown, PA., 6.5 miles from Exit 23 Pa. Turnpike, take Rt. 100S. Go W. on Bus. Rt. 30 to Downingtown Marketplace. From Lancaster E. on Bus. Rt. 30 to 1 mile past Downingtown. Auction & parking west end rear of bldg.

Radios: 200 plus tabletop radios. Tombstones. Zenith, Westinghouse, Silvertone, Stromberg-Carlson, Atwater Kent #40, Philco cathedral #71, Emerson book radio, Crosley band box, Philco 37-62 and 37-610 battery sets, AK 20 small, AK 20 Deluxe.

Consoles: Philco, Atwater Kent, RCA, GE, Philco 620, RCA 813K, RCA 240 lowboy, Philco 20 mini console, Zenith 8AOZ, Ansley Dynaphone chairside radio record player, Story and Clark grandfather clock radio, Marwal jewel console, Airline Mohawk one dial, Freshman Masterpiece, Westinghouse refrigerator, Guild Town Cryer.

Commercial receivers: National 125, National SW-3, Hallicrafters 51, Espy 581, RME 41, Knight KG221, Hallicrafters SX-71 and S-77, Signal Corps transmitter TU8B and receiver TU9B, National NC183 MR, Magnavox horn. Dynatuner FM-1, Heathkit AR-15 Fisher 80C Chicago amp, Fisher the 600, Fisher tuners, Macintosh MC60, other amps and older high quality turntables, Warfdale speakers, University, Altec, Lansing N-1200 huge, Electro-Voice, etc.

20 pcs. plus telegraph equip. Kearfott register and case, 1887 Bunnell galvanometer and resistance box in round leather case, keys, sounders, relays, practice sets, toy sets, etc. Early 40's teletype. Sams Photofacts, 10 file drawers full. Tubes and parts, tube caddy, books, test equipment, and just too much to list. We anticipate a 500 plus lot sale!

Auctioneers note: This is Part II of the Electronics Auction we held June 17th, 1995 Refer to A.R.C. June issue page 45. For the review refer to A.R.C. Sept. 1995 issue page 16.

10% buyers premium applied to purchase price.

Out-of-state checks with prior authorization or accompanied with bank letter of credit.

Catalogue available by mail for \$5, or \$3 at door

SMITH AUCTION COMPANY

Harold Smith, AU-002163-L

Downingtown Marketplace, Downingtown, Pa.

(610) 269-1036 or (610) 942-2367

FOR SALE: Over (60) pocket transistor radios. Ask for list #PTR. Send SASE to: Bob Zelenack, PO Box 460642, Escondido, CA 92046. (619) 749-9652, or fax: (619) 749-4291

FOR SALE: Plastic dial covers for AK 145, Belmont 6D111, Emerson 375, 400, 520, USA, AU190, Fada 5F60, 711, 1000, Hallicrafters S-38, Northern Electric B5000, Zenith 8G005, 6D311 and many others - \$14.50 ea. ppd or yours with old cover or drawing. Doyle Roberts, HC63 Box 236-1, Clinton, AR 72031. (501) 745-6690

FOR SALE: McMurdo-Silver Masterpiece II w/amp, speaker & antenna tuner - \$750. Majestic Model Cruiser Model 1549, early version, 1938 - \$400. Beautiful back-lit advertising clock "Radio-TV Service," Tung-Sol Tubes - \$300. C.E. Clutter, 14407 N.E. Fremont St., Portland, OR 97230. (503) 254-9296

FOR SALE: Emerson hybrid, plastic portable, Model 838, red with silver front, (3) tubes plus (2) transistors, working and vg to excellent condition. Provided with new A and B batteries - \$175 includes shipping. Bill Walker, Box 1444, Groton, CT 06340-1444

FOR SALE: New photo catalog. 160+ radios, good for reference - \$1 + LSASE + 2 stamps. Bob Masterston, Box 172, Valley Cottage, NY 10989. (914) 353-3151

FOR SALE: Philco 42-322 BC/SW (Ramirez, p. 149) - \$60. Emerson BM 212 BC/SW Ingraham cabinet - \$70. Clarion 40 wood, 30's mantel - \$55. Westinghouse 2-tone wood tombstone like RCA R7 Superette - \$115. All above have original finish and work. Transvision 7" kit TV in factory wood case, untested - \$250. Emerson 662 14" TV Bakelite case - \$150. Old 200 watt brass-based light bulb - \$8. Norelco L1X75T-52 transistor, mint w/ case and instructions - \$65. Sam Mannino, PO Box 233, Swarthmore, PA 19081. (610) 353-6747

A.R.C. BACK ISSUES

April '87 to current issue: Originals available
32 to 100 pages each.

Oct. '86 to Mar. '87: Reprints available
Reprinted from original artwork; 26 to 32 pgs. ea.
Quality & appearance same as an original copy.

June '84 to Sept. '86: Photocopies available
Not original quality, useful for info.; 16 to 28 pages each.

Publication of *Antique Radio Classified* began in 1984 which had only five issues: June, Sept., Oct., Nov. & Dec. 1984. 1985 through current year have had 12 issues each.

**\$4.00 each - Postpaid to
U.S., Canada and Mexico.**

Orders of 6 issues or more may take a 10% discount. Orders for a full calendar year may take a 50% discount. Foreign orders other than Canada and Mexico: \$6.00 each by air. Mass. residents, please add 5% sales tax.

A.R.C. UN CUT, UN FOLDED COVERS

June 1991 to the present

9.25" x 12.5" - \$9.95 each

Postpaid to U.S., Canada, & Mexico
Mass. residents, please add 5% sales tax.

Send Order To:

A.R.C., P.O. Box 2, Carlisle MA 01741

Or Call (508) 371-0512



FOR SALE: Thousands of tested tubes w/warranty! Send for new list with improved discounts and monthly specials. Both xmit and rec tubes. I have acquired many common tubes recently. Buy those spare tubes for your tube radio, audio, ham and electronics. Most tubes are used at about 33% of new, many are about \$1. I have bunches of octal, older, 7- and 9-pin tubes. All tubes are tested on TV-7D/U tester and then boxed. I give a 30-day warranty. Send wants or SASE with two stamps for list. Daniel Nelson, 1025 E. Desert Ln., Phoenix, AZ 85040. (602) 243-7421, evenings. E-mail: djn@indirect.com.

FOR SALE: Transistors: Raytheon 8TP-4, the first portable transistor radio made by Raytheon, (see Lane, p. 83), works and is in vg cond. - \$350. Realtone TR-1088, white Comet with leather carry case, in working order and in vvg cond. - \$175. Westinghouse Model H619P7, red/black, CD marks, sharp looking radio in exc cond., (see Lane, p. 121), works - \$75. Realtone TR-861, white, is about 1/2" shorter than the 1088 with a bubble eye, CD marks, 6 transistor, made in Ryukyus - \$60. Regency XR2A, earphone only radio, great cond. - \$275. How about a radio that measures 1 3/4" x 1" x 1/4", earphone only, Art Deco style, M.I.B. with original sleeve, instructions and made in Russia - \$60. Olympic hybrid Model 447 portable radio, aqua & ivory grille, great shape and works too - \$175. Hybrid, Emerson 838 portable, yellow, and a nice radio in vg cond. - \$125. Boys radios: Champlone, red, no chips - \$35; Champ-tone, white - \$35; Mars, white - \$30; Sceptre, blue, with box - \$50; Queen black/white/gold, exc cond. - \$30. Shipping extra. Kay Botzum, R.D. 2, Box 419, Morgantown, PA 19543. (610) 286-0047, or fax (610) 286-5315

FOR SALE: Hawkins Electrical Guides, 1917, Vols. 1-2, 4 to 6, 8 to 10, mostly fair condition, several slightly frayed - \$20 plus \$4 UPS. R.J. Eastwick, N2AWC, 224 Chestnut St., Haddonfield, NJ 08033. (609) 429-2477

OLD TECH BOOKS & THINGS

Early
Technical
Books &
Apparatus

**Announcing - Catalog No. 1
Available Soon*
Write For Free Copy.**

We Specialize In:

Wireless - Radio - Television - Telegraph
Telephone - Electricity - Computers - Slide Rules
Electro-Medical - Calculators - Typewriters
Atomic Energy - Astronomy - Skiing

We Buy & Sell:

Books - Juveniles - Catalogs - Magazines
Manuals - Ephemera - Novelties - Apparatus
Anything Related!
Send us a list of your general & specific wants.

OLD TECH - BOOKS & THINGS
John V. Terrey, Proprietor
P.O. Box 803, Carlisle, MA 01741 U.S.A.

**Still delayed, but eventually I will get it finished!*

WANTED: AK Model R horn speaker base only (no driver okay). Sam W. Wrenn, 2314 Seminole Dr., #1207, Arlington, TX 76010

WANTED: Help me please. Desperate for a schematic and information concerning Howard radio console Model Q. Radio has "STANRAD" printed on dial. Did Howard make radios for Standard Radio? Loren H. Dudley, 14 Valley Rd., Bath, ME 04530. (207) 442-8419, after 6 pm EST

WANTED: Micronic Ruby #SR-H55, Zenith Suncharger or any Sony ICR series radios, must be in excellent condition and complete. Top dollar paid. Stuart Dunis, 18095 Westview Dr., Lake Oswego, OR 97034. (503) 638-3322, anytime

WANTED: Motorola wireless record player and a GE Model 417, 5 band console, with 78 rpm record player. Ray Rice, 525 E. 4th St., Newport, KY 41071 (606) 491-0693. E-mail: Careercom@aol.com.

WANTED: Wimshurst static electricity generating machine with large rotating disks, Leyden jars, music boxes. Louie Scribner, 1415 West Leigh Dr., Charlottesville, VA 22901. (804) 977-5521

WANTED: British tubes: EL37, EL34/6CA7 especially metal base, N.I.B. Also, TV-7 tube tester. Mitch Colby, 2730 Schurz Ave., Bronx, NY 10465. (718) 829-3063



WANTED: I will pay top dollar for the pictured Emerson 60 wood tombstone in any condition. Also seeking other unusual wood Deco radios. Call or write: Mark V. Stein, 2109 Carterdale Rd., Baltimore, MD 21209. (410) 466-2814. Fax: (410) 466-0815

WANTED: Wanted to buy: Drake AL4 loop antenna for SW4A or SPR4 radios. Randy Cook, 21680 Olive Ave., Cupertino, CA 95014. (415) 786-7834. E-mail: randyc3@aol.com

WANTED: Beetle plastics, radio drama transcriptions, AK 60 speaker, Philco 86 grillework, Remler Skipper chassis. Merrill Mabbs, 709 Pluma Dr., Rapid City, SD 57702. E-mail: Radio@aol.com

WANTED: Chassis or the good IF coil for an Emerson R-156 series radio. Tone control knob for a Stromberg-Carlson 130H. Octagon-shaped tuning knob for Philco 60 tombstone. Dave Stott, 29 Willow Bee Ln., Middletown, CT 06457. (203) 344-0697

WANTED: Sonatron red MU-X30 tube, dud OK, and/or tube carton; MU-X20 carton only. Bill Ross, 875 Gordon Ter., Winnetka, IL 60093. (800) 621-0687

WANTED: Electron tubes, ball bearings, Collins radio parts and equipment, aircraft parts & instruments, helicopter parts, lambs synchronos. Hy Ness Company, 709B Delair Rd., Cranbury, NJ 08512. (609) 395-1116. Fax: (609) 395-1117

WANTED: General Television piano parts set. Motorola 56CD clock radio, GE H510 Beetle. Bob Masterson, Box 172, Valley Cottage, NY 10989. (914) 353-3151

WANTED: Zenith wood AM-FM radios Y832E-1956, C8351-1960, clean in good shape. Frank Conti, 1015 Gayley, Box 106, Los Angeles, CA 90024. (310) 534-5489

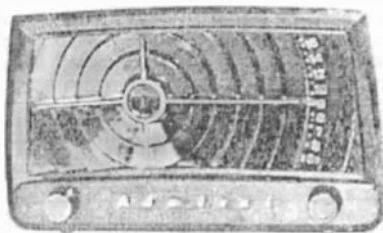

WANTED: 1951 Admiral radio Model 5S22AN. Write to: M. Harrigan, PO Box 2741, Champlain, NY 12919

WANTED: Nightingale Radio Manufacturing Co., 1929-1937, Memphis, literature, advertising, pictures or radios. Hal Kravig, 2615 Juneway Dr., Memphis, TN 38134. (901) 388-2857. Fax: (901) 388-5102

WANTED: Truetone Boomerang D2018, vg to mint only. Joseph Del Mastro, 100 E. Hartsdale Ave., 6HW, Hartsdale, NY 10530. (914) 725-9712

WANTED: Zenith shutter dial table model radios. Bill Campbell, 2167 Rivera Dr., Santa Rosa, CA 95409. (707) 539-8480

WANTED: Good cabinet or parts for Zenith Model 12. Need horn for Silvervoice base. Charles Combs, 508 E. Daniel, Albany, MO 64402. (816) 726-3038

WANTED: Body for Philco 46-250, mint preferred. Gary Ziroli, c/o Mantler, 500 Broadway, #4, New York, NY 10012. (212) 925-4496

WANTED: Arvin clock radio Model 657T. State condition and price. A.J. Long, 11830 Heath Rd., Chesterland, OH 44026. (216) 729-8451



WANTED: This Zenith Model 15S495 1940 radio-phonograph combination. Also Zenith combinations 15S308, 12S205 and 12S595. Richard Bosch, PO Box 172, Lacerter, WA 98629. (360) 687-4414

WANTED: Fada 845, not brown or white. Emerson 744B. Excellent + condition. Gary Mac Norius, 14770 N.W. Garden Dr., Miami, FL 33168-4925. (305) 681-6589

WANTED: Thordarson T-56R05 or T5605 power transformer. It has three 2.5-volt windings. Gary B. Schneider, 9511 Sunrise Blvd., #J-23, North Royalton, OH 44133. (216) 251-3714

FOR SALE: AN-PRR-9 transistorized receiver and AN-PRT-4 transistorized transmitter, FM, hand-held 47-57 MHz (six meters) units, two each in excellent condition, .5 microvolt sensitivity, .5 WRF out, many new spare batteries and manual, works very well - \$245/all. Western Electric 7A amplifier, original transformers, vvg, works well, NT - \$275. Atwater Kent Type E2 speaker, works - \$35. Signal Electric key and buzzer with Morse Code plate, vg - \$35. Signal Corps Model 1914 service buzzer telegraph set, two-inch key leather case with strap, made by Stromberg-Carlson, vg - \$150. Shipping extra. Richard A. Boltzum, R.D. 2, Box 419, Morgantown, PA 19543. (610) 286-0047, or fax (610) 286-5315

FOR SALE: Belmont Model 6D110 Series A with (6) push buttons, Ivory, reconditioned, vg condition - \$95 plus shipping. Bill Walker, Box 1444, Groton, CT 06340-1444

FOR SALE: GE GD-600 - \$35. Philco 38-10T - \$80. Stromberg-Carlson 1100H - \$60. Philco 40-130T - \$80. Stromberg-Carlson 500H - \$60. Philco 42-322 - \$75. Philco portable 52-643 - \$30. Philco 51-530 - \$40. AK Model E speaker, needs repainting - \$60. Philco 96 speaker - \$50. Prices do not include UPS. Dave Stott, 29 Willow Bee Ln., Middletown, CT 06457. (203) 344-0697

FOR SALE: Sony ICF-Pro 80 digital handheld mint cvr, orig. box w/wo indoor ant. - \$225 radio postpaid. Joel H. Levy, 8 Waterloo Dr., Morris Plains, NJ 07950. (201) 285-0233

FOR SALE: Motorola 56-R, aqua, good to very good condition - \$40. Windsor, transistor cathedral - \$20. Truetone 725, wood horizontal with round black dial, original finish - \$40. General Electric L-631 mirror dial, AM & SW bands, works - \$35. RCA 118 tombstone, original finish, complete, easy restoration - \$100. All prices plus UPS, call between 4 pm & 9 pm EST. James M. Seal, 3309 Boatman's Mountain Rd., Morristown, TN 37814. (423) 581-8269

FOR SALE: Cathedral cabinet with speaker, no chassis, solid - \$25. Stewart-Warner 801 metal box, AC - \$40. Kellogg 520 - \$50. Meissner chassis, no speaker, 9 tubes - \$75. **WANTED:** Tuning knob Zenith 3000-1 T-O. Vance Rayburn, 2718 Homestead Rd., Madison, WI 53711. (608) 274-3002

FOR SALE/TRADE: Over (800) xtals in six different FT and HC holders, all - \$110 ppd. Hank Bredehorst, 2440 Adrian St., Newbury Park, CA 91320. (805) 498-8907

FOR SALE: Guild Hurdy Gurdy pictured in Evolution of Radio Vol. 2 - \$250 plus shipping. Dan Olson, E. 4913 Sumac Dr., Spokane, WA 99223. (509) 448-8828

FOR SALE: Radiola RCA, Model 100 in nice shape - \$80. Kevin Williams, 2115 Golden Gate Ave., Kingman, AZ 86401. (520) 753-5473

FOR SALE: Various common Hallicrafters receivers, thinning my collection. Loren H. Dudley, 14 Valley Rd., Bath, ME 04530. (207) 442-8419, after 6 pm EST

FOR SALE: Emerson transistor radio Model 849 brick red - \$165. Tokai Musen transistor Model B-46 - \$75. JVC Videosphere TV, white - \$90. Toshiba baseball radio Model 6TP 515, exc in presentation box w/instructions, missing baseball bat stand - \$175. Emerson Trojan 4 brass-blade electric fan with Victorian base - \$275. Admiral 10" Bakelite TV Model 20X122 console - \$225. (2) Hallicrafters T-54 7" TVs, as is, parts - \$100. Bill Constantine, PO Box 493, Glens Falls, NY 12801. (518) 792-7065

FOR SALE: Crosley XJ, nice condition - \$140. RCA 1946 coin-operated radio - \$45. Mitchell bed-lamp radios for parts - \$10 ea. Knight 600 tube tester - \$18. Simpson #555 tube tester - \$25. Air Radio Model SU-52B - \$25. Lear Catalin aircraft radio #TR-1B - \$150. **WANTED:** Pilot radios, any model, any condition. Bill Moore, 3049 Box Canyon Rd., Huntsville, AL 35803. (205) 880-1207

TUBES • PARTS • SUPPLIES YOUR COMPLETE SOURCE

TUBES:

3000 audio, receiving and industrial types in stock, including early and foreign types. Discount prices!

TRANSFORMERS:

Hard-to-find power transformers, audio transformers, and filter chokes for tube equipment.

PARTS:

Resistors, lamps, tube sockets, potentiometers, grill cloth, knobs, vibrators, etc.

CAPACITORS:

High voltage electrolytic and mylar capacitors for tube circuits.

LITERATURE:

Extensive offering of literature and books on antique radios, hi-fi, communications equipment, tube data, and circuit diagrams.

SUPPLIES:

Chemicals, grill cloths, wire, batteries, tools, etc.



"Write or call for our 36 page wholesale catalog"

ANTIQUE ELECTRONIC SUPPLY

6221 S. Maple Avenue, Tempe, AZ 85283, Phone (602) 820-5411, FAX (602) 820-4643
Toll Free Fax (800) 706-6789 (U.S. & Canada)

WANTED: Any strange or unusual tubes out there? Let me know what you have. Duds, too! Sam W. Wrenn, 2314 Seminole Dr., #1207, Arlington, TX 76010

WANTED: Zenith 6S137 Zephyr tombstone with wrap-around louver. Johnny Johnson, 7075 W. 32nd Ave., Wheat Ridge, CO 80033. (303) 274-5474

WANTED: Copy of manual for military radio Model RDR made by RCA. John Martin, 111 Bancroft, Rochester, NY 14616. (716) 663-4182

WANTED: Hallicrafters HT-9 transmitter and spare parts. Robert Braza, N1PRS, 23 Harvard St., Pawtucket, RI 02860. (401) 723-1603

WANTED: Power cord and antenna/ground card for AK Kiel table. Jack Ghere, 1753 Community Beach Rd., Odin, IL 62870. (618) 532-5548

WANTED: TMC GPR-90 receiver. James Okubo, W6OU, 529 Kevin Way, Placentia, CA 92670. (714) 528-5652

WANTED: Restored Emerson Snow White DB-247, BM-247 or Q-236. Lloyd Burton, 11657 Roseglenn St., El Monte, CA 91732. (818) 443-7960



WANTED: Air King Skyscraper radios, except for that unbearably ugly model with the third (tuning) eye at the top that bears better resemblance to a flounder than to the face of a building. Please write or call collect: Rain Buttignol, 214 State St, #7, Portsmouth, NH 03801. (603) 427-1384

WANTED: Motorola 77XM22 (Bunis 2, p. 119). Handle and tag for Zenith acoustic adapter. Larry Schiebel, 818 W. Lakeside St., Madison, WI 53715. (608) 255-0459

WANTED: BC-342-N receiver, and Philco 70 early model w/walnut cabinet. Michael Harrington, PO Box 7619, Little Rock, AR 72217. (501) 223-9056

WANTED: Dials, 3 or 4 inch, also BC tuning condensers. Len Gardner, 458 Two Mile Creek Rd., Tonawanda, NY 14150. (716) 873-0447

WANTED: Old telephones: parts, pieces, attachments, what have you. Stanley Schreier, 350 Hendrickson Ave., Lynbrook, NY 11563. (516) 887-4966. Fax: (516) 887-4780

WANTED: Cabinet for Zenith 10S130, 10S147, 10S153, 10S155, 10S156, or 10S160. Also AK 89. Mark S. Rauber, PO Box 1077, Minden, NV 89423. (702) 782-3596

WANTED: Heathkit catalogs of the 1950s-1960s. Information on any Heath tube hi-fi equipment. Doug Fox, 603 S. 12th Ave., St. Charles, IL 60174. (708) 584-5915

WANTED: Chassis, escutcheon, for Philco 39/39A cathedral (similar to 89B, Bunis 3, p. 171). Chuck Regen, 2724 N. 27th St., Sheboygan, WI 53083

WANTED: Table radios, transistors, wood, Bakelite, plastic, etc. All makes. Bob Masterson, Box 172, Valley Cottage, NY 10989. (914) 353-3151

WANTED: Still looking for manuals for a National NC120 or RAO receiver, copies OK. Larry Ware, 7436 Fieldcrest Ave., Winter Park, FL 32792. (407) 679-6975



WANTED: Atwater Kent green tube shields & misc. AK parts. AK & Zenith advertising items. Jim Peters, 983 Chapel Ct. South, Glen Ellyn, IL 60137. (708) 790-9699

WANTED: Manual for Hickok Model 820 tube, transistor tester, VTVM. (Tube caddy Pal). Manual for BC 175, or SGR 189. Manual for Dynamotor power unit Type COL 21881 for TCS radio equipment. Paul Dilliard, WA8IBT, 1313 E. Wheeling St., Lancaster, OH 43130. (614) 653-5268

WANTED: Theodore (T.R.) McElroy oscillators, tape machines, Mac keys, key boxes, catalogs, fliers. Tom French, W1IMQ, The McElroy Collector, 151 Barton Rd., Stow, MA 01775. (508) 562-5573

WANTED: Chassis for Fada Model 711, must be complete but need not work. Junker with cracked cabinet OK. Dan Clayton, 12441 Coconut Creek Ct., Fort Myers, FL 33908. (941) 466-6644

WANTED: Offering \$300+ for: Toshiba 5TR-221; Penny's 41-7TM-285S; Realtone TR-701; TR-870. Also, RCA 95X-. David Mednick, 1450 Palisade Ave., #5H, Fort Lee, NJ 07024. (201) 461-3082

WANTED: Cabinet for AK206, also Philco 20. Douglas Wright, 1343 Hoffman Ln., New Braunfels, TX 78132. (210) 625-5577

WANTED: Delco transistors DS-64 (4) leads metal T05 can. Fred Cranshaw, 1624 Bitter Ck., Garland, TX 75040. (214) 494-4917

WANTED: Reel-to-reel tape recorders. What do you have? And price wanted. Alvin Sydnor, 806 Meetinghouse Rd., Boothwyn, PA 19061-3504

WANTED: Western Electric 540A-W hornless loudspeaker (see illustration). Please make offer including photo to: Erwin Macho, Ambrosweg 171/A/8, A-1230 Vienna, Austria. Fax: 431-81111-3535



WANTED: Canadian friends please help. Need dial glass for Marconi console Model 219. Nice radio but I don't know what station I'm at. Loren H. Dudley, 14 Valley Rd., Bath, ME 04530. (207) 442-8419, after 6 pm EST

WANTED: Escutcheon and knobs for Philco Mod 70 cathedral. Also back for Emerson violin. N. Ziroli, 2168 Rte. 29, Galway, NY 12074. (518) 882-9436

FOR SALE: Special sale: RCA radios, special prices. Send for photo list. Robert J. Stone, 721 Fisk St., Piqua, OH 45356-3729. (513) 773-2217

FOR SALE/TRADE: AK Mod 165 cathedral - \$465. Philco Mod 38 cathedral, two-tone finish - \$200. Traveler M-1 cathedral, two-tone maple and walnut finish - \$250. Crosley Buddy Boy - \$650. Zenith tombstone Mod 136 - \$175. Zenith Mod 319 brass escutcheon w/ ivory knobs - \$225. Graybar GT8 eight-tube tombstone - \$300. American Bosch Mod 28 w/cathedral style speaker - \$250. Larry Drago, 383 Lincoln Dr., Cheshire, CT 06410. (203) 272-6030

FOR SALE: Rainbow tubes, 101A brass-base tipped, beautiful, good emission, singles - \$55, set of five - \$250 plus postage. Ed Bell, 5311 Wooddale Rd., Randleigh, NC 27206. Fax/phone: (919) 851-1517

FOR SALE: Sams TSM 1, 4, 5, 21 thru 155; C.I.E. Manuals, Popular Radio magazines dated Aug. 1924, Oct. 1924, Dec. 1924, June 1925, good cond. VT 1293C4TL Eimac tube, 4-prong, original carton; WE 215-A tube; Zenith table Mod 5S320, push-button; two Zenith Trans-Oceanics Mod 8G005YT, 1946, Mod 8G005721; E.H. Scott Phantom Deluxe, AM, great Braemar cabinet, chrome, needs voice coil replaced; Drake TR4 transceiver w/MS4 power supply, speaker; many novelty and transistor radios. Many radios and magazines too numerous to mention. Call for needs & prices. Richard Bruning, 1901 U.S. Highway 150, N, Apt. B, Galesburg, IL 61401. (309) 344-1968

FOR SALE: 1938 Marconi TV cabinet only, beautiful veneer - \$500. Racks of tube ham gear includes (2) R390A, receivers, Harris HFL1000 1KW amp. Harris SG70 Exciter, displays, range extenders, tuners, SSB converter, manuals - \$3,000/all. Altec VOT - \$1,500. Tannoy Orbitus - \$2,000. Single EV Georgian 600 - \$1,000. V. Vogt, 2311 Pimmit Dr., #114E, Falls Church, VA 22043. (703) 573-8142

FOR SALE: 1960's Zenith light-up wall clock - \$50. Crosley clock radio #JC-8BK (Bunis) - \$20. Hickok tie clip - \$5. Photofacts Auto Radio Volumes #1-200 - 75¢ ea. or \$50 for all; CB Series 1-10 - \$2 ea.; Beiman Radio Series - \$8 ea.; TV Series - \$3 ea. Bendix #526 N.O.S. cabinet - \$10. 1961 vintage radar detector N.I.B. - \$20. VM tape recorder 1960's N.O.S. - \$20. **WANTED:** Pilot radios, any model, any condition. Bill Moore, 3049 Box Canyon Rd., Huntsville, AL 35803. (205) 880-1207

FOR SALE: List of high end radios: Paragon, Grebe, etc. Merrill Bancroft, 169 S. Row Rd., Townsend, MA 01469

FOR SALE: Standard A rear mount, flat disk phono, w/ blue horn, nice, all original parts - \$625. Victor #100 crank phono - \$150. Zenith #9S367 console, black dial, working as found - \$175. 1960's Fender Vibro Master guitar amp, new spkrs, working - \$150. RCA #100 & 100A spkrs - \$35 ea. Rider's TV Manuals 1, 2, 3, 4, 5, & 6 - \$90 all. Spare Riders: 6, 12, 13, 14, 15, 17, 18, 19, 21 - \$15 ea. **WANTED:** Outside horn phonographs & parts by Victor, Columbia, Edison, Zonophone, Berliner, etc. Also need Crosley Buddy Boy chassis. Have Philco 20, 70, 89 chassis to trade. Call Jahan eves.: J.L. Acciavatti, PO Box 231, Southborough, MA 01772. (508) 476-3229

FOR SALE: Classic TV, Philco Predicta Model #H3408 with 10L43 chassis, TV works fine, all original - \$1,000. Tom Muller, KE6FDL, PO Box 6128, March A.F.B., CA 92518. (909) 655-7689

FOR SALE: Kenwood TS-700A 1976 2-meter all mode transceiver, all solid-state, aligned - \$300. Robyn T-123 B tube CB - \$40. RCA audio amp #12155 W 2-6L6 - \$50. Eico #680 transistor tester - \$15. Hickok portable tube and transistor tester #820 - \$40. All plus UPS. Kevin and Kathy Moe, 616 Lockrem St., Ottawa, IL 61350. (815) 433-4598, eves.

New Wireless Pioneers Books, Magazines, Literature Bought and Sold

New Wireless Pioneers buys and sells books, catalogs, magazines and other literature from the 1800's to 1950 that deal with early radio, wireless and electricity. A selection from our list of specialties:

Pre-1900 Electricity
Pre-1925 Radio or Wireless
Pre-1950 Computers

Pre-1900 Telegraphy
Pre-1940 Television
Early X-Ray

Magazines, Catalogs, Autographs or Ephemera related to the above topics. Also: Pre-1920 Wireless and Telegraph Apparatus - Radio-Related Novelties and Advertising - Early Vacuum Tubes and Electrical Devices.

Some items available in other technical subject areas also.

Several catalogs featuring items for sale are published each year.

New Wireless Pioneers - Jim & Felicia Kreuzer

P.O. Box 398, Elma, NY 14059

(716) 681-3186

The Most Important Book Ever Written About Radio.



In Commemoration of Radio's 75th Anniversary

Streamline Press announces the limited advance lithography of an extraordinary coffee-table collector's book – The Deluxe Edition of *Blast From The Past: A Pictorial History of Radio's First 75 Years*.

And NOW, during a limited advance publishing period, the first Deluxe Collector's Edition is available at a special discount price to commemorate the 75th anniversary issue of radio – only \$75.

UNPRECEDENTED PUBLISHING

The Deluxe Collector's Edition of *Blast From The Past: A Pictorial History of Radio's First 75 Years* is an undertaking of unparalleled proportion. Author B. Eric Rhoads has searched archives across America and found hundreds of rare, never-before-published historical photographs featuring radio from its early experimental stages, personalities of radio's golden era of the '30s and '40s, the first disc jockeys of the '50s, the boss jocks of the '60s, the start of underground radio in the '70s, and the personalities and talk show hosts of the '80s and '90s. This is a landmark in limited edition publishing with more than 900 rare photographs

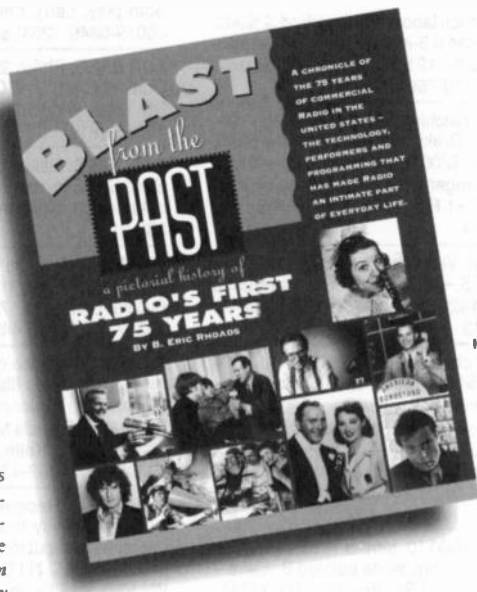

NO RISK GUARANTEE:
I UNDERSTAND THAT IF I AM NOT SATISFIED FOR ANY REASON, I MAY RETURN THE BOOK WITHIN 30 DAYS.

in rich quality, hard-bound printing. This special collector's book is for anyone who loves radio. Historically this book redefines radio's history as it reveals significant facts never before published.

Radio has never been pictured more beautifully. This handsome Deluxe Collector's Edition will give you years of nostalgic pleasure and historic intrigue.

Each Limited Deluxe Collector's Edition:

- Has a certificate of authenticity
- Is numbered
- Is signed by the author
- Has 75th anniversary price of \$75 (50% off the \$150 list price)

ONLY 15,000 AVAILABLE

Orders will be accepted on a strict first-come, first-serve basis according to the time and the date of the order. CUSTOMERS ARE STRONGLY ADVISED TO SECURE THEIR RESERVATIONS IMMEDIATELY BY CALLING:

TOLL FREE 1-800-226-7857

This is the first offer made. This advance publishing price means the Deluxe Collector's Edition will go fast. Order today to be sure of availability. (Target shipping date: August 30, 1995*)

* Estimated date: Actual date may vary.



FAX IN YOUR ORDER: 1-407-655-6164
MAIL IN YOUR ORDER: 224 DATURA STREET
SUITE 701 • WEST PALM BEACH, FL 33401

FOR SALE: TV tuner subber - \$25 plus shipping. Robert J. Stone, 721 Fisk St., Piqua, OH 45356-3729. (513) 773-2217

FOR SALE: Instruction manual, reprint, for National SW-3 universal receiver, 12 pages - \$5 ppd. High voltage mica capacitors, .01-1200, .002-1200, .02-600 and .0001-2500 - \$1 ea. plus \$2 per order shpg. Quarterly Transactions of AIEE, 18 vols. 1929 to 1934 - \$5 ea. + \$2 ea. shipping. James Fred, R1, Cutler, IN 46920. (317) 268-2214

FOR SALE: Singer Thach laboratory standard. 2% AC/DC volt-amp-milliammeter 6.3-inch scale length, mint - Inquire. Henry Galbraith, 1214 South Alvord, Evansville, IN 47714. (812) 476-7601

FOR SALE: NC101X, matching speaker - \$275; SX100, R47 speaker - \$275; Drake 2C, 2AC, 2CQ - \$250; Hammarlund HC-10 - \$200; HRO coils G&H - \$150; Johnson Viking Messenger CB - \$60. Others, request list. Richard Prester, 131 Ridge Rd., West Milford, NJ 07480. (201) 728-2454

FOR SALE: National Velvet vernier dial to Alaska caller. (2) 7027A, N.O.S. - \$30 ppd. 6L6GC tubes, used - \$4 ea. Pete Putra, 1429 Lawndale Ave., Racine, WI 53403. (414) 632-2543

FOR SALE: Philco 70 chassis - \$75. National SW-54 - \$80. Grundig 100U - \$40. Heathkit QF-1 Q multiplier - \$30. Jensen A-12 electrodynamic speaker - \$20. WANTED: 1933 RCA Redbook. Bunis No. 1. Operating manual for Akai X2000SD. FOR TRADE: My Philco 80 mantle clock for your AK tombstone. Armand Cote, 11 Berge Ln., Derry, NH 03038. (603) 437-4431, before 10 pm EDT

FOR SALE: Belmont A6D110, similar to 6D111, push button tuning, vertical louvers, white painted Bakelite - \$250. Joe Holdner, 443 2nd St., Brooklyn, NY 11215. (718) 768-6212

FOR SALE: GE L50 press wood 1932 n/km n/handle, @8 - \$100. Minerva Tropic Master, metal port. A/O, chass. clean, @8 - \$45. Weltron Mod 2001 JAP715 (Space Helmet), AC-DC 8D cell A/O N/O - \$60. Spkrs: Rolla Mod 15 A/O pops (Oakland) - \$60. Newcombe Hawley Mod 83, @9, pops - \$70. Book: Turning Night Into Day, M. Ilim, reel HB, 1936 - \$10. Plus pkgg & shpg. Bernie Samek, 113 Old Palmer Rd., Palmer, MA 01069. (413) 245-7174

FOR SALE: Zenith 500D - \$50. Zenith Royal 755 - \$25. Both play. Larry Kellough, PO Box 849, Canton, CT 06019-0849. (203) 693-8269

FOR SALE: Philco 39-116 - BO. Emerson 888 - \$100. Dumont RA-105 - BO. Zenith 6GQQ - BO. RCA BX6 - BO. Allan Winston, 22 Greendale Rd., Scarsdale, NY 10583. (914) 967-7112

FOR SALE: Hallicrafters collectors, original literature. Send SASE for list. Ellsworth O. Johnson, 364 S. Coeur d'Alene St., Spokane, WA 99204. Phone/fax: (509) 838-2161

FOR SALE: Radiola 103 tapestry speaker replacement rear cloth bonnet, matches original color - \$16 ppd. Buford Chidester, 785 Locust St., Mount Wolf, PA 17347. (717) 266-4450

FOR SALE: Philco cathedral Model 71, good cabinet with tubes, needs filters and (2) knobs - \$150. Clarion Model AC60 Junior cathedral, cabinet good condition - \$150. RCA Radiola Model R7 tombstone, good cabinet - \$100. Walter Keith, 269 White St., So. Burlington, VT 05403. (802) 862-4394

FOR SALE: Receivers/amplifiers: Commercial grade with high quality music amplifiers, 6V6 output tubes, microphone input for paging, fifty nine left! Also UX199, 6MH6, 6JS6C N.I.B. Phone calls only. Glen Fichie, W4JGO, 643 Diamond Rd., Salem, VA 24153. (703) 389-3356

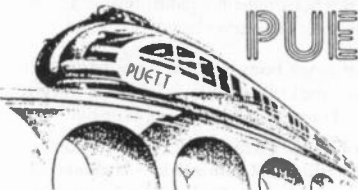

PUETT ELECTRONICS

P.O. BOX 28572 DALLAS TX 75228



CATALOG 77

CATALOG 77/PLL-2 (56-PAGES) ----- \$5.00 POSTPAID

YOU RECEIVE A \$6.00 DISCOUNT COUPON WITH THIS CATALOG!

MORE THAN 1,500 DIFFERENT ANTIQUE RADIO PUBLICATIONS FROM 1902 TO THE 1960'S OFFERED, REPRINTED BOTH SIDES OF THE PAGE AND BOUND!

WE OFFER BOOKS, INSTRUMENT MANUALS, SERVICE DATA, SALES BROCHURES, ATWATER KENT, RCA, CROSLY, ZENITH, ETC. FACTORY SERVICE MANUALS, SCOTT, MC MURDO SILVER, STROMBERG CARLSON, CAPEHART, FISHER CLASSIC RADIO LITERATURE, DIRECTORY OF ANTIQUE RADIO SERVICES, SCHEMATIC DIAGRAMS, OLD TIME RADIO PROGRAMS ON CASSETTES, TUBES, TUNING DIALS, KNOBS, 30-SERVICES & DISCOUNTS WITH THE PUETT ELECTRONICS ANTIQUE RADIO CLUB AND MUCH MORE - ORDER YOUR CATALOG TODAY!

OUR NEW BOOK "THE WORLDS LARGEST RADIOS" IS NOW AVAILABLE, PHOTOS, SCHEMATICS, BY J.W.F. PUETT - \$14.95 PLUS \$2.00 HANDLING. INCLUDES SCOTT, MC MURDO SILVER, PHILCO, RCA, ZENITH, LINCOLN, FREED EISEMANN, FISHER, MEISSNER, MAGNAVOX, CROSLY + MANY MORE!

WANTED: Sideli book: Catalin Radios. Call: Hall Radios, 28024 Sealane, Malibu, CA 90265. (310) 457-9650

WANTED: Pre-recorded open-reel tapes, jazz & classical; SME & Ortofon 16" tonearms. Richard Brown, PO Box 686, Farmington, CT 06034. (203) 677-4828

WANTED: Chassis and knobs for Emerson Model 540. Red cabinet for Fleetwood transistor radio. Russ Abrams, 2330 Villaret Dr., SW, Huntsville, AL 35803. (205) 883-7322

WANTED: Escutcheon for a 44 Philco or something similar. James Caudle, 50 Rangeview Acres, Candler, NC 28715. (704) 667-9717

WANTED: Fairchild tube amplifiers, limiters, record cutting lathes, Wurlitzer jukeboxes 1700, 1800, 1900, 2000, 2100. Kim Gutzke, 7134 15th Ave. S, Minneapolis, MN 55423. Phone/fax: (612) 869-4963

WANTED: Microphones and stands, American D9A and Amperite Model RBM and RBB microphones, also Shure S-36 Teardrop stands and EV 418/419 stands. Dick Igou, 8435 Twisted Oaks, Garden Ridge, TX 78266. (210) 651-9049, after 5 pm CST

WANTED: Thanks for the response to last month's ad! I still want to purchase the following Philco radios and will pay top dollar: PT 10-C, P/T 61, PT 35, PT 55, PT 47, PT 59, PT 67, and 42-1002. Call or write anytime. Larry Drago, 383 Lincoln Dr., Cheshire, CT 06410. (203) 272-6030

WANTED: Utah cone speaker, has round heavily carved wood case with two feet. Westinghouse Aeriola RS binding post caps and wood case. Ralph Zarins, RR#1, Beaverton, Ontario, Canada L0K 1A0. (705) 426-9422



WANTED: Early (prewar II) plastic radios. I collect these objects of beauty to enhance my otherwise dull and uneventful life to which I am forever bound by by sad-but true unworthiness and shortcomings: physical, emotional, and intellectual. Please write or call collect: Rain Buttignol, 214 State St, #7, Portsmouth, NH 03801. (603) 427-1384

WANTED: 1946 Zenith console #6-R-087, need not be working. John Theisen, 917 Broadway Ave., Valley Springs, SD 57068. (605) 757-8775

WANTED: Matching speakers for a National NC173T. Hallicrafters SX25 and an S76. In need of an S76 for parts. Must have the original knobs and a good tuning dial. Also looking for an SX28A and a Johnson Viking Ranger in exc condition. QST magazines Jan. '47, Nov. '47, Dec. '47, Sept. '49. CQ April '48. Alan Deplae, 28648 Floral, Roseville, MI 48066. (810) 776-7870

WANTED: Conar Model 311 resistor-capacitor tester in very good condition. Matt Kachmarchi, RD2 Box 150, Cherry Tree, PA 15724. (814) 948-7526

WANTED: Desperately need Lyric chassis with small escutcheon dial opening and three controls with knobs. I have a beautiful cabinet with speaker but need chassis Please help. Loren H. Dudley, 14 Valley Rd., Bath, ME 04530. (207) 442-8419, after 6 pm EST

WANTED: Zenith Trans-Oceanics: 1000, 3000, 7000's. Must be in excellent + condition. Gary Mac Norius, 14770 N.W. Garden Dr., Miami, FL 33168-4925. (305) 681-6589

WANTED: Microvox wireless microphone from 1955. Gene Greneker, 184 Lake Somerset Dr., Marietta, GA 30064. (770) 422-2979



WANTED: Any radios with this dial. Jay Malkin, 1250 Galapago, #206, Denver, CO 80204. (303) 623-6451

WANTED: Ringer ass'y and wiring info for Western Electric candlestick phone, pulse dial type. Byron Bernor, 2479 W. Sierra, Acton, CA 93510. (805) 269-5459

WANTED: Zenith console Model 12S266 and Walton's set. I have some trades or cash. Dave Stamper, 45 High St., Stewartstown, PA 17363. (717) 993-3571

WANTED: M-i-t-c-h-e-l-l-s. Mitchell brand radios, TVs and other Mitchell appliances. Free calls now to: Lee Mitchell, The Mitchell Collector, 175 E. Delaware, 8210, Chicago, IL 60611. (800) 869-7869

WANTED: EICO 150 solid-state signal tracer. Heathkit manuals, good copies OK: IM-4100 frequency counter, PS-4 power supply. FOR SALE: New Staco 0-140v 10 amp variacs - \$75. Much more, list - LSASE. Kirk Ellis, KK4YP, 203 Edgebrook Dr., Pikeville, NC 27863. (919) 242-6000, evenings

WANTED: Radio or TV or servicing advertising clocks and lights. Large glass transmitting tubes and manuals. Send description and price. Steve Leffel, 1709 Edison, Green Bay, WI 54302

WANTED: Round plastic handle & spring to fit into frame to restore old telegraph key. Also 150 or 140 pF variable condensers. Rodney K. Schrock, 402 Lincoln St., Somerset, PA 15501

WANTED: Good speaker for Philco 71 cathedral. Good cabinet for Philco 37-61 cathedral. Raymond Humphreys, 1044 N. Jackson St., Macon, MO 63552. (816) 385-2821

WANTED: Reasonably priced Heathkit DX-100 step-by-step kit assembly manual. Pat Stewart, W7GVC, 1404 Ruth Ave., Walla Walla, WA 99362-3558

WANTED: Echophone cathedrals Models 60, 80, and S-5, nice condition - \$450 ea. Robert Alexander, 20 Haycamp Rd., St. Paul, MN 55127. (612) 483-6177

WANTED: Any radio made by Radio Products Corporation of Birmingham, Al., Superflex, etc. Terry Browning, 312 11th St. SW, Alabaster, AL 35007. (205) 620-4345

FOR SALE: Many Radio World, Radio News, Radio Digest and Radio Star magazines in great condition - \$10 & \$20 ea. Send or call me with your date and year requests. Larry Drago, 383 Lincoln Dr., Cheshire, CT 06410. (203) 272-6030

FOR SALE: Books, books, books, hardbound, most like new. Tech manuals, various subjects. Two stamps for list. Henry Galbraith, 1214 South Alvord, Evansville, IN 47714. (812) 476-7601

FOR SALE: Radio schematics - \$275. Photocopies: Rider's index 1 through 23 - \$25. Service manuals: AK 463 pgs. - \$35; Philco 354, Crosley I 322, Crosley II 340 - \$25 ea. Plus S&H. Dick Oliver, 28604 Schwalm Dr., Elkhart, IN 46517. (219) 522-4516

FOR SALE/TRADE: Fada P-111 - \$60. Emerson's 645 - \$45. EC-301 - \$55. DP-332 - \$55. Stromberg-Carlson 1204 - \$100. Transistors: Channel Master 6506 - \$40; Sony 2R-61 - \$15. Peter DeGregorio, 85 Burroughs Rd., Fairfield, CT 06430-3504. (203) 331-9155, eves.

FOR SALE: Lafayette FS91 w/leather case, stunning underpaint - \$150. Bulova 620 Comet, turquoise w/ handle - \$65. Emerson 555, white - \$50. Emerson 911, coral - \$70. Panasonic T-50, black - \$20. RCA 9-BT-9J, gray - \$35. Motorola: 7X25W yellow, 7X25P coral - \$15 ea. Zenith Royal 50L, light blue w/case - \$35. Novelties: Early large Japanese wristwatch - \$50. Ladybug N.I.B. - \$35. Binocular w/case, early Japanese - \$35. **WANTED:** Mitchell 1101-1103. Harald Herp, 6615 Michele Ct., Huntingtown, MD 20639. (301) 855-7071

FOR SALE: New-in-box RCA WX-12's - \$50 ea. AK 10C breadboard base - \$125. **WANTED:** Knobs & escutcheon for Silvertone tombstone 1745 (Bunis 2, p. 166). RCA & Magnavox horn drivers. Schematics for Eico HF22 mono amp & Scott LC21 preamp. Thanks, Kent Leech, 16 El Rincon, Orinda, CA 94563. (510) 253-9757

WANTED
Indian Head brand
pocket meter
& other unusual brands.



Frankenstein's Radio Laboratory
4010 Fairmont Parkway, Suite 285
Pasadena, Texas 77504
(713)998-0130

FOR SALE: Dukane amp Mod 1A385A 127V-90 watts, 1949, grey - \$125. Globe Trotter Mod 65-320, 4 bands, Globe Clever - \$45. FM rcvr 30 to 50 monitor radio M4D - \$40. Plus P&S. David Roche, 10 Hospital Rd., Monson, MA 01057. (413) 289-1037

FOR SALE: Coca Cola cooler radio - \$550. RCAs: 7T1 - \$150; 5T - \$130; 118 - \$135; R-7 - \$150. Philcos 77-610 - \$130; 40-180 - \$150. Ton Funk - \$60. AKs: 725 - \$140; 185-A, exc - \$270. Emerson 104 - \$140. Philco 71 - \$110. U.S. Radio Apex #7 cathedral, exc restored - \$280. Zenith 5808 exc - \$200 as is or \$325 restored. **WANTED:** Chassis for Graybar console #IE4B. **MES-SAGE:** Thanks to all who attended the Plainville, Ct., show on Oct. 1. Plan ahead for the March show. Date will be announced in Dec. A.R.C. Ray Lamont, 70 Litchfield Rd., Unionville, CT 06085. (203) 675-6327

FOR SALE: Hewlett Packard spectrum analyzer 141T/8552B/8554L, .5-1250 MHz, very good condition - \$1,500. **WANTED:** Schematic/manual for EICO 460 oscilloscope. Pat Bartol, 82 Pawnee Rd., New Britain, PA 18901. (215) 345-1025

FOR SALE: Motorola Handi-Talkies, pr., near mint with extra coils, as seen in Motorola cellular telephone ads, a piece of D-Day, WWII, Model BC 611-F - \$300 shipped Con. U.S. J.M. England, PO Box 59136, Schaumburg, IL 60159. (708) 823-5287

FOR SALE: RCA Master voltohmyst, WV-87A - \$40. Industrial Instruments Wheatstone bridge, Model RN-1 - \$50. Heath RF signal generator, Model 1G-102 w/ leads, manual - \$40. Philco radio Model 48-460, like new - \$80. All plus UPS. Stephen L. Bonino, 107 Georgetown Rd., Glassboro, NJ 08028. (609) 881-0244

FOR SALE: 1908 Sears catalog, replica. Buck Rogers comics complete coffee table size, textbooks, radio, physics, ARRL, ham items, parts, SASE list. Bill Tucker, W4FXE, 1965 S. Ocean Dr., Apt. 15-G, Hallandale, FL 33009. (954) 456-1349

FOR SALE: Photocopied book of Amrad sales literature from 1920-1922 - \$15 ppd. Andrew Mooradian, 5 Priscilla Ln., Winchester, MA 01890

FOR SALE: SR38B - \$65. Bendix 753M - \$50. Transistors: Philco 8, Magnavox AM 80, Sony TR1814 AM - \$20 ea. Military 4X4 RT 285 A/URC-11 - BO. Realistic FM wireless system - BO. Lists old items, (1) stamp each. Radio-related, microphone/headset, miscellaneous electrical, fire, police, flashlights, meters, quack, lighters, slide rules, etc. **WANTED:** Telegraphs/catalogs. A. R. Jacobs, 60 Seaview Ter., Northport, NY 11768. (516) 261-1576

Radio Grille Cloth

É. H. SCOTT
Philco, Emerson, RCA
& ZENITH

radios & speakers
Send LSASE for FREE
samples to:

John Okolowicz
624 Cedar Hill Rd.
Ambler, PA 19002

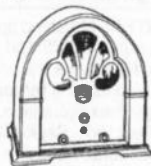

Select from
12 patterns

The Radio Collector's Directory and Price Guide, 1921-1965, 2nd Ed.

by Robert E. Grinder

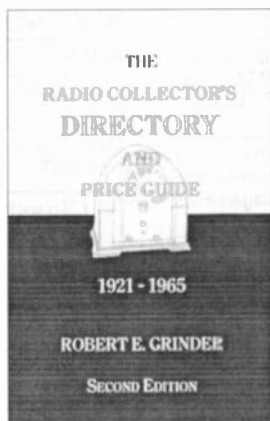

**Don't Delay,
Order Today!**

20,000+ Models Listed

U.S. models manufactured from 1921-1965.

Listing includes:

*Model Name,
Year of Production,
Type of Power,
Cabinet Style, and
Current Market Value Range.*

Rewritten Chapters On:

*Early Broadcasting,
Radio Broadcasting Regulation,
Advances Made in Receivers,
The Evolution of Radio Cabinet Styles.*

\$26.95 - Softcover

U.S. Orders - Enclose \$3.00 per order for packing & book-rate shipping if total order is under \$35.00. If using VISA or MasterCard, include name on card, card number and expiration date. Send payment with order. Mass. residents please add 5% sales tax. Money back return policy. Most orders shipped the same day received, but allow 2-4 weeks to receive order. Foreign orders - write for shipping costs, or use credit card and specify air or surface (allow 2-3 months for surface shipping).



**Send Order To: A.R.C., P.O. Box 2, Carlisle, MA 01741
or Call: (508) 371-0512 Fax: (508) 371-7129**



FOR SALE: Phono records 78 rpm & 33 1/3 rpm, mostly big band, some classical. Send for list. Robert J. Stone, 721 Fisk St., Piqua, OH 45356-3729. (513) 773-2217

FOR SALE: Zenith oriental table radio. This custom factory Zenith cabinet with brass handles and pulls has a roll-out front door that exposes a red radio. The cabinet is a dark titanium color with hand-painted gold, green and red oriental scenes and figures, absolutely beautiful and one of the rarest Zeniths known. This classic piece works and is in excellent condition - \$550. Larry Drago, 383 Lincoln Dr., Cheshire, CT 06410. (203) 272-6030

FOR SALE: Older pair Seeburg jukebox control heads - \$250. Zephyr ZR620, rough - \$45. **WANTED:** Zenith Royal 500. Don M. Maurer, 29 South 4th St., Lebanon, PA 17042. (717) 272-2481

FOR SALE: Kennedy (Coronet) Model 42, Bosch Model SX4A, Majestic Model 51, 2 Star Trek Communicators (working). Gary J. Formica, 823 91st St., Niagara Falls, NY 14304. (716) 283-2274

FOR SALE: Dahlberg pillow - \$175 + UPS. Kolster chassis and speaker - Best Offer. H.N. Felder, 7517 Granada Dr., Bethesda, MD 20817

FOR SALE: Copies of manuals for Eico, Heathkit, PACO, Precision and other test equipment. **WANTED:** Test equipment manuals. Send two-stamp large envelope for manual list. Clayton Mundine, 6112 S. Flores St., San Antonio, TX 78214

FOR SALE/TRADE: Statue of Liberty 17" cone speaker by Pal Radio, reconed, works, very scarce - \$1,000. Ed Bell, 5311 Woodsdale Rd., Raleigh, NC 27606. Fax/phone: (919) 851-1517

FOR SALE: Allied catalogs, 1960 - \$25; 1970, 71, 72 - \$18 ea. B/A 1973, 74 - \$10 ea. **WANTED:** Allied 1955 & 57. Joe Esdale, 1769 Eastwood Ave., Highland Park, IL 60035. (708) 831-2544

Catalins Wanted



Fada • Emerson • Motorola
Addison • Air King • Arvin • Detrola
Crosley • Symphony • Tom Thumb
I buy all makes and models.

Michael Lawlor
P.O. Box 179 • Santa Barbara, CA 93102
(805) 682-2336

FOR SALE: Transistors: Arvin 62R48 - \$10. Silvertone Medalist - \$5. Zenith RD52Y, Philco extension speakers (for transistor) - \$10 ea. Motorola 6X31C N.O.S. replacement grille - \$10. RCA T-2K - \$10. RCA BCS-4 aux. battery charger & speaker, N.O.S. - \$15. Viscount N.I.B. transistor radio, mid-60's - \$25. **WANTED:** Pilot radios, any model, any condition. Bill Moore, 3049 Box Canyon Rd., Huntsville, AL 35803. (205) 880-1207

FOR SALE: Grebe CR9 - \$275. Freed-Eisemann NR-5 - \$90. **WANTED:** R/9 and Radio magazines. Wayne Steiner, NÖTE, 1212 17th Rd. NW, Burlington, KS 66839. (316) 364-5353

FOR SALE: Ampex 600 recorder and 620 amplifier, mint - \$300/pr. Emerson CF-255, vg - \$125. Philco 41-240, vg - \$50. Hallicrafters 8R40, slide rule dial version of S-40, excellent - \$150. Dick Igou, 8435 Twisted Oaks, Garden Ridge, TX 78266. (210) 651-9049, after 5 pm CST

Classified Ad Deadline Noon

Nov. 10 for Dec. 1995 Issue

Dec. 10 for Jan. 1996 Issue

Boxed, Photo, & Display Ads - 1st

FOR SALE: KLH-8 hi-fi receiver, 1933 Radiokeg Prohibition novelty, AK-944 cathedral, all excellent original. Walt Curry, 10035 Country View Rd., La Mesa, CA 91941. (619) 461-9327

FOR SALE: G.R. 5A variacs with case, switch, outlets, etc. - \$15 ea. 1A powerstats - \$5 ea. Lamda 0-200 Vdc + 6.3 regulated supplies - \$15 ea. (5) National[?] & (1) RCA VTVM - \$10/lot. Joe Brady, Box 8 Star Rt., Huntingdon, PA 16652. (814) 643-0603

FOR SALE: Over (100) first time offered radio books, magazines and paper. SASE for November list. Merrill Bancroft, 169 S. Row Rd., Townsend, MA 01469

FOR SALE: Scott amplifier, uses two Type #381 tubes and one Type #350 tube, Selectone transformer numbers 641, 642, 643, 644 and Selectone condenser bank Type #250, excellent original condition - Best Offer. Bob Putnak, 1507 4th St., Monongahela, PA 15063. (412) 258-6236

FOR SALE: ARRL Handbook 11 edition (1934) - \$20 plus \$3 for mailing. Earle Drake, Box 1808, Hyannis, MA 02601

FOR SALE: Rider's manuals: Radio, Volumes 6-14. Prices range from \$25 to \$50. Television, Volumes 1-27, complete set - \$25 ea. LSASE for price list. Sam Faust, PO Box 94, Changewater, NJ 07831



WANTED

Amrad 3670 as shown, any condition. Also a Type E crystal set, 3500-2 and other pre-1926 Amrad sets & parts.

**Andrew Mooradian, 5 Priscilla Lane
Winchester, Massachusetts 01890
tel. 617-729-1873 after 7 pm**



ESTES AUCTIONS

WILL CONDUCT A RADIO AUCTION OF:

Vintage Radios and Radio related items Saturday November 18, 1995 at the **Seville Antique Auction Barn** 8240 Wooster Pike Road in Medina, Ohio. The sale starts at 10:00 a.m., and the preview starts at 9:00 a.m. E.S.T.

This auction will consist of two private collections. One of which is from Louisville, KY and one from the Pittsburgh area, plus several small collections will be included in the sale also.

This will be a very large auction and will consist of:

- ~ 1920's Battery Sets ~
- ~ Horn Speakers and other types ~
- ~ Small A.C. Table Radios Wood and Bakelite ~
- ~ A Model 10 Bread Board ~
- ~ Tubes ~
- ~ Books and Magazines ~
- ~ Crystal Sets ~
- ~ Catlin Radios ~
- ~ Transistor - Novelty Radios ~
- ~ Amateur Radio Equipment ~
- ~ Old Recording Studio Items ~
- ~ Test Equipment ~
- ~ Televisions ~
- ~ Cathedrals and Tombstones ~
- ~ Phonographs ~
- ~ Records ~
- ~ Advertising ~
- ~ Hardware & Parts ~
- ~ Console Radios ~

(Flyers will be available the first week of November. Send S.A.S.E. Please.)

Our next Radio Auction will be in February of 1996, watch A.R.C. for ad. Please call or write to sell your items in the February sale.

ESTES AUCTIONS
7404 Ryan Road
Medina, Ohio 44256

216-769-4992
216-769-3987
FAX 216-769-4116

Richard Estes Auctioneer:
ARS K8LRY/ Member of AWA, ARCO, MAARC, MARC, IHRS, SPARK, BARPC

CRYSTAL CLEAR, Vol. 1

By Maurice L. Sievers

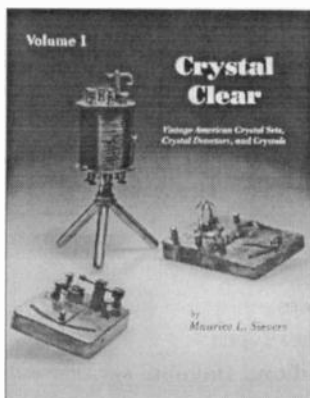

750 Illustrations – 570 Crystal Sets
341 Detectors – 207 Crystals
Perfect for the beginning collector!
Useful for the experienced too!

Crystal Clear is the most comprehensive reference for collectors, historians and anyone interested in early radio. In addition to the many excellent photos and reproductions of ads, *Crystal Clear* includes lists showing all sets by manufacturer, set name, selling price and date of manufacture. 8 1/2" x 11", 282 pages.

New Low Price — \$29.95

(original price was \$39.95)

* **Crystal Clear, Vol. 2 — \$29.95 ***

COMMUNICATIONS RECEIVERS

3rd Edition – Revised & Expanded

By Raymond S. Moore

402 radios pictured!

Sharper, clearer photographs

A comprehensive guide to 700 vacuum tube communications receivers from 1932 to 1981. In addition to Collins, Hallicrafters, Hammarlund and National, 66 other manufacturers from Allied to Tobe are included. New section on military receivers.

The description of each set includes years, band coverage, type, filters, tubes, a photo in many cases and other info. 8 1/2" x 11", 115 pages.

\$19.95 – Softcover



U.S. Orders - Enclose \$3.00 per order for packing & book-rate shipping if total order is under \$35.00. If using VISA or MasterCard, include name on card, card number and expiration date. Send payment with order. Mass. residents please add 5% sales tax. Money back return policy. Most orders shipped the same day received, but allow 2-4 weeks to receive order. Foreign orders - write for shipping costs, or use credit card and specify air or surface (allow 2-3 months for surface shipping).



Send Order To: A.R.C., P.O. Box 2, Carlisle, MA 01741
or Call: (508) 371-0512 Fax: (508) 371-7129



CRYSTAL CLEAR, Vol. 2

By Maurice L. Sievers

**ORDER
TODAY**



NEW

479 All New Photographs and Illustrations Cumulative Index of Both Volumes

Crystal Clear, Vol. 2 supplements the first volume. It identifies an additional 172 crystal radio sets, 91 crystal detectors and 26 crystals by manufacturer, model, year produced, description and original selling price. Further research on many of the crystal sets covered in Volume 1. Detailed history on the Philmore Manufacturing Company and the Western Manufacturing Company. 8 1/2" x 11", 252 pages, softcover.

\$29.95

*** Crystal Clear, Vol. 1 is also available for \$29.95 ***

U.S. Orders - Enclose \$3.00 per order for packing & book-rate shipping if total order is under \$35.00. If using VISA or MasterCard, include name on card, card number and expiration date. Send payment with order. Mass. residents please add 5% sales tax. Money back return policy. Most orders shipped the same day received, but allow 2-4 weeks to receive order. Foreign orders - write for shipping costs, or use credit card and specify air or surface (allow 2-3 months for surface shipping).



**Send Order To: A.R.C., P.O. Box 2, Carlisle, MA 01741
or Call: (508) 371-0512**

Fax: (508) 371-7129



Our Most Popular Titles Make Great Gifts This Holiday Season



Price Guide

The Collector's Guide to Antique Radios 3rd Edition by Marty & Sue Bunis. 8,500+ Battery & AC sets from the '20s to the '60s. Updated prices. Over 650 all new photos, 278 pages. — \$18.95



Price Guide

The Collector's Guide to Transistor Radios by Marty & Sue Bunis. This book will help you identify the most sought-after vintage transistor radios. Over 2,200 models, all with current prices. Over 400 color photos, 256 pages. — \$15.95

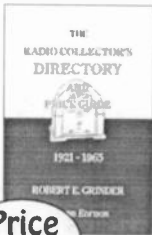

Price Guide

The Radio Collector's Directory and Price Guide, 1921-1965, 2nd Ed. by Robert Grinder. Over 20,000 radios by manufacturer, model number, year, etc. with prices. Radio history, cabinet style chapters. No photos, 264 pages. — \$26.95

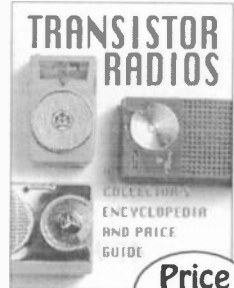

Price Guide

Transistor Radios, A Collector's Encyclopedia and Price Guide by Robert Lane and David Lane. Identification guide to over 2,500 transistor and novelty radios. History and key to collecting chapters, 170 pages. — \$19.95

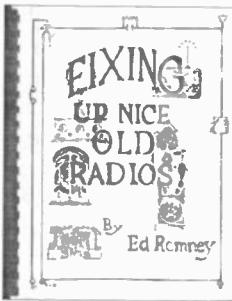

Fixing Up Nice Old Radios by Ed Romney. Written by a retired radio instructor. Plastic binding. 300+ figures, 185 pages. — \$19.00



Old Time Radios Restoration and Repair by Joseph J. Carr. A self-paced training guide. History, theory and practical operation of antique and classic radios. 200 illustrations, 256 pages. — \$18.95

U.S. Orders - Enclose \$3.00 per order for packing & book-rate shipping if total order is under \$35.00. If using VISA or MasterCard, include name on card, card number and expiration date. Send payment with order. Mass. residents please add 5% sales tax. Money back return policy. Most orders shipped the same day received, but allow 2-4 weeks to receive order. Foreign orders - write for shipping costs, or use credit card and specify air or surface (allow 2-3 months for surface shipping).



Send Order To: A.R.C., P.O. Box 2, Carlisle, MA 01741
or Call: (508) 371-0512 Fax: (508) 371-7129



(Nov-95)

Our Most Popular Titles Make Great Gifts This Holiday Season

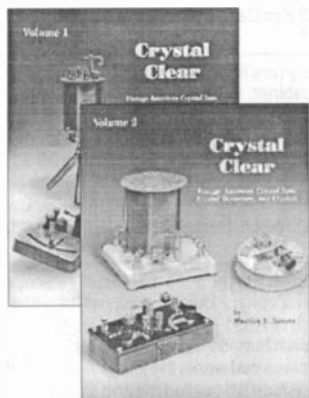

Crystal Clear Volume 1 and Crystal Clear Volume 2 by Sievers. *Comprehensive reference to crystal sets, crystal detectors, and crystals. Each volume contains different illustrations and information. Order by volume. — \$29.95*

Flick of the Switch by Morgan McMahon. *The classic photo reference guide for 1930s - 1950s radios. 1000+ photos of radios, 5" x 8", 263 pages. — \$11.95*



Guide to Old Radios, Pointers, Pictures, and Prices, 2nd Ed. by Johnson. *Introduction to radio collecting. Includes hundreds of photos and a price guide. 272 pages. Available late October. — \$19.95*

Antique Radios Restoration and Repair, by Johnson. *Beginner's introduction to troubleshooting and repairing AC table model radios. 145 pages. — \$14.95*



Price Guide



The Zenith Trans-Oceanic: The Royalty of Radios by Bryant and Cones. *Presents the fascinating story of the development and use of the Trans-Oceanic. Several photos, documents, ads, etc. 160 pages. — \$24.95*

Communications Receivers, 3rd Ed. by Ray Moore. *Information on vacuum tube receivers by 66 manufacturers. 402 radios illustrated, 115 pages. — \$19.95*



U.S. Orders - Enclose \$3.00 per order for packing & book-rate shipping if total order is under \$35.00. If using VISA or MasterCard, include name on card, card number and expiration date. Send payment with order. Mass. residents please add 5% sales tax. Money back return policy. Most orders shipped the same day received, but allow 2-4 weeks to receive order. Foreign orders - write for shipping costs, or use credit card and specify air or surface (allow 2-3 months for surface shipping).



Send Order To: A.R.C., P.O. Box 2, Carlisle, MA 01741
or Call: (508) 371-0512 Fax: (508) 371-7129



(Nov-95)

FOR SALE: Novelty radios: Piano, (B/B, Pl. 449), exc cond. - \$100; Spark Plug, plug in, AM, exc cond. - \$125; Harp, (B, Pl. 410), vvg - \$75; Cabin Cruiser, (B, Pl. 39), mint cond. - \$80; Waldorf Scott bathroom tissue, M.I.B. - \$65; Stagecoach, (B, Pl. 38), exc cond - \$60; Camcorder M.I.B., (B/B, Pl. 292) - \$50; Gas Pump, (B/B, Pl. 560), M.I.B. - \$85; Telephone, (B/B, Pl. 329), exc cond. - \$100. Shipping extra. Kay Botzum, R.D. 2, Box 419, Morgantown, PA 19543. (610) 286-0047, or fax (610) 286-5315

FOR SALE: Loop antenna, roll of loop antenna wire, N.O.S., large old German loop antenna. Clyde Powell, 3822 Edwards Ter., Chattanooga, TN 37412. (423) 867-5022

FOR SALE: Zenith Trans-Oceanic 3000-1 - \$145. Hallicrafters S-38E SW, works - \$55. Harman Kardon A-300 stereo tube amp, works - \$150. Heathkit AR-14 - \$50. Sony 8F-88W AM/FM radio with stereo adapter - \$85. Sansui 1000 stereo tube receiver - \$100. Add shipping. Ted Demski, 5806 225 Pl., SW, Mountlake Terrace, WA 98043. Fax/phone: (206) 778-7100

**HAVE YOU MOVED? ARE YOU MOVING?
PLEASE NOTIFY US A.S.A.P.
SEND US YOUR...
OLD ADDRESS
NEW ADDRESS and
SUB #
MANY THANKS!!!!**

FOR SALE: Olsen tube amp Model AM-158, w/box, etc., plays weak but all complete - \$30 OBO + shipping. Ed Turner, 730 E. Martin St., East Palestine, OH 44413. (216) 426-4968

FOR SALE: Zenith Royal 500, black, good, plays - Best Offer, you ship. Pete Hittle, 5415 Bushnell Ave., Sioux City, IA 51106-3834. (712) 276-2316

FOR SALE: Red Regency TR-1 w/c, has fine unnoticeable crack by dial, untested - \$425. Toshiba 8TM-294B - \$50. Commodore pocket CD marks - \$12. Add \$5 shipping. WANTED: Standard SR-F25. Jim Martes, 15400 E. 2nd St. S, Independence, MO 64050. (816) 836-0668

FOR SALE: Radio literature from McMurdo Silver Corp. and E.H. Scott Radio Laboratories, (33) pieces - Offer. Jim Morrow, 29508 Lincoln Rd., Bay Village, OH 44140. (216) 892-8614, am

FOR SALE: 350 globe tube, good emission base slightly loose - \$100 plus \$6 shipping. Bill Jewell, 6828 Trinity Landing N, Fort Worth, TX 76132. (817) 294-9061

FOR SALE: Transistor Radio Photo Guides: Realtone Guide identifies and shows 59 models; Toshiba Guide has 61; Sony Guide has 94 - \$7 ea. includes postage. Eric Wrobbel, 20802 Exhibit Ct., Woodland Hills, CA 91367. (818) 884-2282

FOR SALE: Receiver Saver 200 provides 3-way protection for vintage radio receivers - only \$25 ppd., or SASE brings flyer. Jeff Kincaid, WA6BIL, 5529 West 140 St., Hawthorne, CA 90250

FOR SALE: Capehart with flip-changer, Philco 48-2500 TV. Tom Carroll, 118 W. 6th St., Dunkirk, NY 14048. (716) 366-4631

FOR SALE: Original 1937 Mickey Mouse and Snow White Emerson radio chassis - \$200 ea. Larry Drago, 383 Lincoln Dr., Cheshire, CT 06410. (203) 272-6030

FOR SALE: QSTs from 1923-29, (5) - \$3 ea. Stewart-Warner Catalin knob, original - \$35. Westinghouse H-161 - \$15. JD 701 porcelain antenna anchor, very large - \$15. National NC-46 - \$45. Navy transmitter C-1107/URN-5 - \$45. Army jack box BC-366 - \$12. Old Eveready wooden store display unit - \$25. Large 18" cabinet for rack mount - \$35. Mounted galena crystals - \$1.50 with order. Motorola chassis #6C, fits round console cabinet - \$15. N.O.S. mike stands, bases - \$10 ea. WANTED: Pilot radios, any model, any condition. Bill Moore, 3049 Box Canyon Rd., Huntsville, AL 35803. (205) 880-1207

FOR SALE: Very rare finds. AK 33 in a Red Lion writing desk console cabinet; this beauty must be seen to be appreciated - \$250. AK 36 with tubes, warranty card & Type Y power supply - \$200. Battery eliminator made by Kokomo Electric Company - \$75. Philco 39-7T in mint condition - \$125. Sorry can't safely ship the console, pick up only. Prices do not include UPS. Dave Stott, 29 Willow Bee Ln., Middletown, CT 06457. (203) 344-0697

FOR SALE: Zenith Royal 500s transistor radios, (2) Emerson 888s, Zephyr, Bulova 620, white, others. WANTED: Zenith 6R631 junker or parts that hold call letters around push buttons, Zenith knobs 1936-42. Still need pot metal piece that works the shutters on a 9S367 Zenith. Will the person who called me and said you have this piece, please call collect. Thank you. Merritt Livingston, 4709 N.W. 76 St., Oklahoma City, OK 73132. (405) 722-7034

FOR SALE: Transistors: Zenith "My Radio Ultra Miniature" Royal RD-14, N.I.B. - \$45. Clairtone mini hi-fi, "World's Smallest Transistor Radio," with box - \$45. Zenith Royal 20, N.I.B. - \$45. Sony TR-84 with case - \$30. Mark Yeshe, 610 Hollins Ave., Helena, MT 59601. (406) 442-1942

FOR SALE: Rider's 6 thru 9 and No. 15 - \$14 ea. Million tube tester, Model BG - \$20. Telex T-6 coin radio/lamp, with pillow speaker - \$45. Silvertone WLS horn speaker - \$90. Two AK horns, Model A and L, no bases - \$45. Seven B&W TV yokes, all - \$40. WWII aircraft compass - \$40. All plus UPS. Dennis W. McDonald, 1813 Main Ave., Clear Lake, IA 50428. (515) 357-2446

FOR SALE: T&H analyzer made by T&H Mfg. Co. Kansas, Mo. - \$25 plus shipping. Robert J. Stone, 721 Fisk St., Piqua, OH 45356-3729. (513) 773-2217

FOR SALE/TRAOE: Heathkit GR64 - \$35. Emerson Model 87B - \$60. RCA Model 4X641 - \$40. Emerson Model 569 w/o cord - \$50. Motorola Model 68L11 parts radio, works - \$50. Trade for mini keychain license plates, made by Disabled American Veterans. Also motorcycle license plates, any states. Brunswick 1923 phonograph Model 101, excellent condition - \$350 OBO plus UPS. John Williams, Jr., PO Box 1545, Scarborough, ME 04070-1575. (207) 883-8249

FOR SALE: Grebe RORO amplifier - \$350. BC 1031-C panadapter - \$150. F.P. Heineman, 87 Cove Rd., Lyme, CT 06371

FOR SALE: Grundig Model 87 radio, fine condition, working - \$85 plus UPS. Rob Loesser, 390 Beech St., South Hempstead, NY 11550. (516) 483-0463

FOR SALE: (75) N.I.B. loctal tubes - \$75. Three N.I.B. Realistic brand 6LQ6/6JE6 - \$35. Plus UPS. John Schehrer, 58 Gray, Joplin, MO 64801. (417) 781-4028

The Collector's Guide To Antique Radios - 3rd Edition

By Marty & Sue Bunis

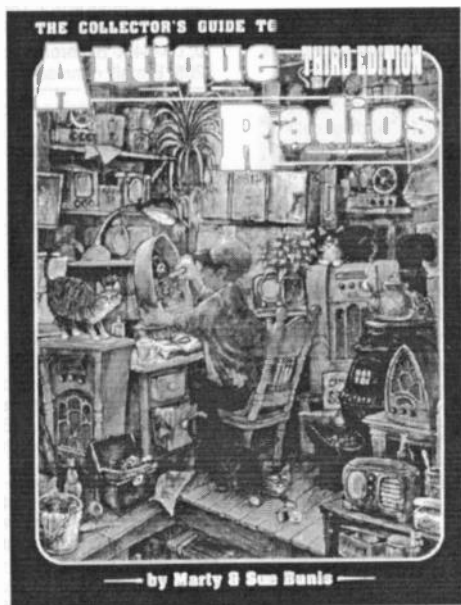

8,500+ Battery & AC sets from the '20s - '60s
Expanded listing of radios from the '60s
Over 650 all new color photographs
Updated prices
\$18.95 - Softcover

There are no transistor radios listed in the third edition. You will find them in *The Collector's Guide to Transistor Radios* available from A.R.C. for \$15.95.

U.S. Orders - Enclose \$3.00 per order for packing & book-rate shipping if total order is under \$35.00. If using VISA or MasterCard, include name on card, card number and expiration date. Send payment with order. Mass. residents please add 5% sales tax. Money back return policy. Most orders shipped the same day received, but allow 2-4 weeks to receive order. Foreign orders - write for shipping costs, or use credit card and specify air or surface (allow 2-3 months for surface shipping).



Send Order To: A.R.C., P.O. Box 2, Carlisle, MA 01741
or Call: (508) 371-0512 Fax: (508) 371-7129



FOR SALE: Radio novelty items. Things that look like radios but are not! Banks, games, etc. Send SASE. Ask for list #RNI. Bob Zelenack, PO Box 460642, Escondido, CA 92046. (619) 749-9652, or fax: (619) 749-4291

FOR SALE: German radios. Telefunken Opus 2550 hi-fi - \$150. Saba W5-3D - \$125. Grundig Majestic 3192 - \$100. Knight KG-65 & Knight #83YX amplifier - \$25. Sterling chassis #7C356 - \$25. CTI #TC-20 tube tester - \$25. Zenith cast iron sign - \$25. (11) assorted meters - \$15. Jackson #715 tube tester - \$30. **WANTED:** Parts chassis for Crosley Elf & for Emerson #520. Walt Wrabek, Rt. 4, Box 370, Menahga, MN 56464. (218) 564-4623

FOR SALE: Bozak 15-inch speaker, Craftsman Solitair amplifier. List \$1 and SASE. Joseph Bedlovics, PO Box 139, Stratford, CT 06497

FOR SALE: Music Master wood horn speaker, mahogany cabinet 17" long, 9" wide, 10" high, excellent, working condition - \$295 plus shipping. Bill Walker, Box 1444, Groton, CT 06340-1444

FOR SALE: Wide selection of radio books/magazines at reduced prices. SASE for list. **WANTED:** Tube cover plate for Radiola 26 in vgc, will buy junker set if necessary. Good base/driver for Thorola horn. British Geophone sets/paper/accessories. Roger Hart, 4533 Harvard Ave., Montreal, Quebec, Canada H4A 2X3. (514) 483-3857. Fax: (514) 483-6114

FOR SALE: 50's styled retro radios. Emerson, Motorola, Trav-Ler, more. Send SASE to Don Moody, 1600-M Glenwood Ave., Raleigh, NC 27608. (919) 821-3530

FOR SALE: Transistors: Sony TR-620 w/case - \$75. Arvins, 61R13, salmon, w/case - \$40. Arvins 61R16, mint green - \$60. GE 766-A - \$55. GE 806-A, it, green, vg - \$15. GE 807-A, black, vg - \$15. GE 808-A, white, vg - \$25; or all three - \$35. Hitachi TH-848 - \$50. Toshiba 6TP-314 - \$45. Hitachi TH-627-R - \$45. Hitachi TH-666, gold & black - \$100. Hitachi TH-680 - \$40. Gary Willoughby, 5930 W. Jefferson Blvd., Los Angeles, CA 90016. (310) 559-0706

FOR SALE: Used test equipment. **FOR SALE/TRADE:** Assorted tubes, some with good filaments, some duds. LSASE for lists. Please specify which list. Sam W. Wrenn, 2314 Seminole Dr., #1207, Arlington, TX 76010

FOR SALE: Zenith 7S363 parts/set. Call/write with needs. EICO 772W tube-type C.B. - \$10. RCA 8-X-541 (Bunis 3, p. 185) - \$30. Shipping extra. Mark Shoup, 27 Dogwood Dr., Newton, NJ 07860. (201) 383-6417

FOR SALE: Transistors, pocket, mint, GE. P1730A with leather case - \$20; P1758 - \$20 plus shipping. Rich Yoch, 22410 Bartlett Dr., Rocky River, OH 44116. (216) 331-9206

FOR SALE: Central Electric Catalog, 1924, 86 pages - \$24. Operating instructions, Majestic Model 91 & 92, July 1929 - \$18. Phil Birk, PO Box 158, Middle Amana, IA 52307

FOR SALE: Drake R4B with MS4 and manual, top condition - \$200. Trade for Hallicrafters SX100. Daniel Seidler, 3721 W. 80 St., Chicago, IL 60652. (312) 284-8221

FOR SALE: Garod peak-top yellow with red trim - \$1,800 or BO. Radio tubes WD11's, 0-1A's. Ed Kendall, 679 Westhampton Rd., Northampton, MA 01060. (413) 586-3390

FOR SALE: Silvertone 4500 - \$85; 7004 - \$85; 8005 - \$35. Junk lot (10) radios - \$75. Bob Masterson, Box 172, Valley Cottage, NY 10989. (914) 353-3151

FOR SALE: Parts: used, original for vintage radio, audio & test equipment. Electrical parts, case parts (wood or plastic) and cosmetic parts available. Send brand name & model number of the piece of equipment along with a description of the needed part(s) by fax: (410) 877-1697, by e-mail: vintell@aol.com, or by U.S. mail addressed to: VE Parts, PO Box 436, Fallston, MD 21047

FOR SALE: Siemens high performance HF receiver, 1960's. German WW2: Torn Eb HF receiver. **WANTED:** German FuHe-receivers. Rag Otterstad, Hosterkobvej 10, DK-3460 Birkerød, Denmark. Phone: 011-45-4281 5205. E-mail: danmec@inet.uni-c.dk

FOR SALE: Thinning my collection of antique, transistor, and novelty radios. LSASE gets list. Hank Trabold, 2058 Nakiska Ct., Toms River, NJ 08755. (908) 244-2345

FOR SALE: Crosley 56PB (F.O.S., p. 78) - \$90. Emersons: 422 wood refinished - \$90; 610 red polished - \$65; 811 tiny white - \$45; small polished brown - \$60. Gilfillan 56A refinished two-tone wood - \$90. Motorola white, repainted, like 50X1 in Machine Age with handle - \$95. Temple metal white - \$100. Zeniths: 5D027 refinished wood - \$100; 6S222 original finish cube - \$250. Trans-Oceanics: 1000's - \$85, and junker, plays - \$45; 3000-1's - \$125 and \$100. Send for list of tubes, parts, literature, transistors and novelties. LSASE appreciated. Stan Lopes, KB6LGV, 1201-74 Monument Blvd., Concord, CA 94520. (510) 825-6865. E-mail: bqn71a@prodigy.com

FOR SALE: Attention past buyers: Hundreds of items added. Please send for new list. Antique and collectible radios, televisions, transistors, novelty radios; old aircraft, radio, German, Norwegian, Croatian, medical, scientific books. WWI, WWII uniforms, equipment. For list, send two-stamp LSASE to: John Enigi, Sr., K9HJL, 5425 Cherry Ln., Egg Harbor, WI 54209. (414) 743-3672

FOR SALE: Television chassis. 1950 RCA KCS47, complete with tubes, whole or parts - \$20. Richard Korb, 43 River St., Holden, MA 01520. (508) 829-2063

FOR SALE: Crystal detectors, wireless apparatus, Faradon variable condenser, audio transformer and other goodies. SASE list. Harry Cap, 190 Beech St., Bridgewater, MA 02324. (508) 697-8648

FOR SALE: Tubes: New old stock and used (cleaned, tested and boxed). List #3 is now available. Send LSASE with two stamps. International inquiries welcome. (3) good used Genalex KT-66 are available at - \$65 ea. Neal Simpson, 27-1 Queen Rd., Lambertville, NJ 08530. (609) 397-3346

FOR SALE: Plastic dial covers for most radios or will make you one - \$14.50 ea. ppd. Doyle Roberts, HC63 Box 236-1, Clinton, AR 72031. (501) 745-6690

FOR SALE: (19) small AC phones, mostly 45's, some 78's - sell as lot. C.E. Clutter, 14407 N.E. Fremont St., Portland, OR 97230. (503) 254-9296

FOR SALE: (50) radios, mostly '30s-'50s table sets. Send SASE for list. Mark Thornquist, 45 Second St., Glens Falls, NY 12801. (518) 761-4143

WANTED: Automobile 45 rpm record player; reel-to-reel (tube) stereo tape recorder; wallbox for Rowe AMI RI-5 (1984); Seeburg teardrops speakers, small. Bill South 13101 Foster Rd., Anchorage, AK 99516. (907) 345-9006

WANTED: Copies of Blast from the Past and Bunis 1. R.J. Dial, 4409 Valley Ave., Apt. Q, Pleasanton, CA 94566. (510) 426-1470

WANTED: Philco 49-501, 49-503, 49-506. Emerson 706, 707B, 713, 744B, 788B. Zenith G503. Royal 950. KLH's and accessories. Mint Philco Predictas, plus instructions, service information, sales literature. AR-1 speakers. Marantz, Acrosound, Fairchild, Fisher, Hadley, Karg, REL, etc., tube hi-fi equipment, accessories, and sales literature. 1950's-1960's Gernsback, Fawcett, etc., hi-fi books. Allied, Lafayette, Heathkit, etc., catalogs, 1950-1965. Promotional items, such as signs, banners, clocks, tube caddies, etc., by hi-fi manufacturers and tube companies. Paul Creasy, 6216 Worlington Rd., Bloomfield Township, MI 48301. (810) 737-0429. E-mail: 74664.1153@compuserve.com

WANTED: GE F51 Machine Age Bakelite, no cracks, original and complete. Karen McCoy, 8104 N.W. 114th St., Oklahoma City, OK 73162. (405) 722-0595. E-mail: karen.mccoy@oubs.telecom.uoknor.edu

WANTED: EICO HF22, EICO HF22, EICO HF22 mono power amps. I need two in good shape. Call me with your price. Ken Brown, 217 Sweet Thorne Rd., Irmo, SC 29063. (803) 781-0869

WANTED: Early crystal sets, detectors, packaged crystals, etc. Also, 1950's germanium sets. Matt Erdahl, 6506 S. Dorsey Ln., Tempe, AZ 85283. (602) 730-0570. E-mail: mderdahl@ix.netcom.com

WANTED: Stereo Commander FM multiplex generator (Amphenol) manual (or copy). Chris Jones, 38 South Ridge Trl., Fairport, NY 14450. (716) 223-0095

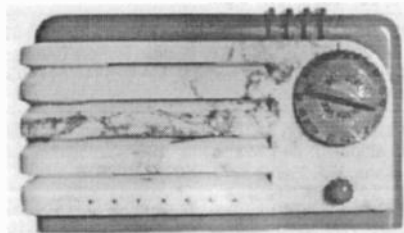

WANTED: More prewar plastics by Detrola, RCA, Kadette, Air King, et al. Take all my money before the relatives do. They are trying to hurry my already imminent demise. Please write or call collect: Rain Buttignol, 314 State St., #7, Portsmouth, NH 03801. (603) 427-1384

WANTED: Operator's manual for Paco Model S-50 oscilloscope. Photocopy OK. Jon E. Penrose, 225A West Main St., Palmyra, PA 17078. (717) 838-2163. E-mail: xnel39a@prodigy.com

WANTED: Bendix radios, ads, signs, etc. Radios need not work. Aaron Mall, 903 Dropleaf Ct., Baltimore, MD 21208. (410) 486-8813

WANTED: To purchase a good set of coils for my Pilot Super Wasp DC. Les Rayner, 5512 N. 71st Pl., Scottsdale, AZ 85253. (602) 947-1375

WANTED: Desperately, Hammarlund 4-prong plug-in coils and APR-5 maintenance manual. Dick Lowe, Box 296, Santa Clara, CA 95052-0296. (408) 984-1555

WANTED: Stromberg-Carlson Chinese-style pre-1950 radio phono console. Harold E. Larson, 1533 Grandview, Upland, CA 91784. E-mail: hlarsen@Primnet.com



WANTED: RCAs hi-fi/stereo console Model SHF-1 (pictured) or other similar RCA consoles/home entertainment centers, late 50's-early 60's (especially blond Danish moderne look). Also, RCA Product Catalogs from 1956-1962. Any help appreciated. John McLawhorn, 112 Walnut St., Cary, NC 27511. (919) 467-8018

WANTED: Radio-Craft June, July, August, October 1943; January, May, August 1940; August 1942. Alvin Bernard, PO Box 690098, Orlando, FL 32869-0098. (407) 351-5536

WANTED: Philco PT-87, 41-81, Belmont Boulevard 5P113. Ichiro Yamada, 10-21 Chiyodadai-cho, Kawachi Nagano-shi, Osaka, Japan 586. Phone/fax: 011-81-721-52-4695, eve/mid. local

WANTED: An FB7 with schematic. Hugo B. Eckman, 9 Blaine Ave., Augusta, ME 04330. (207) 622-0967

**IF YOUR EXPIRATION DATE IS
NOVEMBER OR BEFORE, RENEW TODAY!
EARLY RENEWALS
RECEIVE AN EXTRA ISSUE!**

WANTED: Philco 43B. Zenith wooden Z knobs, 1 1/8" skirt with 3/4" round or dimpled body. Zenith red Split Second hand for 1939 Zenith. Rider's Vols. 4 & 5. HELP: Can anyone suggest a decent commercially available product for black lacquering? Thanks. Paul Froehlich, 4152 Hwy. J, Cross Plains, WI 53528. (608) 798-4905. E-mail: pafroehlich@hosp.wisc.edu

WANTED: WW2 Japanese military radio of any kind. Japanese-made tube portable radios like Crown, Koyo, Excel, Grobal and so on. Anything Graf Zeppelin related. Takashi Doi, 1-21-4, Minamidai, Seyaku, Yokohama, Japan. Fax: 011-8145-301-8069

WANTED: Vacuum tubes; write or fax for list showing the prices I pay. Antique Triode, Box A2, Farnham, NY 14061. Phone/fax: (716) 549-5379

WANTED: Music Master base with driver; Western Electric 10D base; GGH driver. Bob Barnes, Box 275, Monroe City, MO 63456

WANTED: Dynaco stereo 70! Need one set in excellent condition including cage and one junker set with good transformers. Ray Moore, 312 Candletree Cir., Monument, CO 80132. (719) 481-3320, may call collect

WANTED: Book: The Boy Electrician by Morgan. Anything having to do with Ray-O-Vac signs, books, etc. Tom Farkas, 14847 Fremont Ave., N, Seattle, WA 98133. (206) 363-7980

FOR SALE/TRADE: Tower Castle Cone speaker, similar to Tower Adventurer size, design, and craftsmanship. This incredibly beautiful gold tone "Castle atop a mountain" scene with trumpet boys at base of entrance w/a dark green paper cone background is a true collectors' dream - \$495. Also Western Electric 10-D horn base in perfect condition - \$200. Larry Drago, 383 Lincoln Dr., Cheshire, CT 06410. (203) 272-6030

FOR SALE: Thinning out my E.H. Scott collection. Send SASE for list of radios for sale, many rare. Jim Clark, 1292 Starboard Dr., Okemos, MI 48864

FOR SALE: Panasonic AM/FM/WX table radio RE-7273, 115v, wood, needs work - \$12 + UPS. Onorio L. Sabetto, 1717 Burgess Rd., Cleveland, OH 44112-1103. (216) 481-1036

FOR SALE: Acme headsets by Trimm, ICC, 4K ohm N.I.B. - \$30 ea. ppd. Kelly Nichols, RD 1, Box 103K, Greenwood, DE 19950. (302) 349-5059

FOR SALE: Deco table radios: Detrola 134 - \$95. Crosley ? - \$60. Crosley 11-100U - \$160. (2) Airline (Belmont) 04BR-508A - \$125 & \$75. Zenith 6D510 - \$65. Zenith X509R - \$20. Coronado ? - \$45. RCA 8-X-541 - \$25. RCA 8-X-542 - \$25. Majestic SLA50 - \$60. Stromberg-Carlson 1500H - \$60. Belmont 6D111 Series B - \$150. Fada bullet Model 1000, yellow w/red - \$475. Fada 700, yellow/white - \$350. Zenith 6D512 - \$125. Dahlberg green pillow radio - \$125. (2) white Dahlberg pillow radios - \$125 & \$100. Crosley 11-118U - \$160. Transistor & novelty: Gas pump transistors Amoco & Sunoco - \$25. (3) microphone novelty (tube), white - \$200 & \$225; black - \$250. Miscellaneous: Tektronix solid-state oscilloscope - \$150. Wood-cased VOM - \$35. Many more antique items too numerous to mention. Send SASE for complete list. Photos available for \$1 plus SASE. Mark Miller, 3899 Woodman, Troy, MI 48084. (810) 649-6108. Or e-mail: 71241,1106@compuserve.com

The National Vintage Communications Fair

will be presenting a

Christmas Special at the

NEC, BIRMINGHAM • UK

• Sunday 3rd Dec 1995 •

"Electrical & Mechanical Antiques and Collectables"

Britain's premier event for buying

V I N T A G E
R A D I O S,

E A R L Y
T V S, and
G R A M S

etc. etc.



For further details/bookings:

NVCF, 2-4 Brook St, Bampton, Devon, ENGLAND

Telephone: (01398) 331532

FOR SALE: Quack medical device, Metabulator Model 10, lung efficiency machine, in beautiful condition, filled with drawers of accessories. Made by Sanborn Co. of Cambridge, Mass. Bill Manny, 1103 N.W. Despain Ave., Pendleton, OR 97801. (503) 276-3152 days. (503) 276-7439, evenings and weekends

FOR SALE: Got to make room, hundreds of tubes: 1920's short base, 1922 four pin, 1928 long pin ST-4, 5-, 6-pin, metal octal base, glass octal base, loctal tubes and miniature, 35% in cartons, 90% have been tested, blue Arcturus, Cardons, H66s 199, 201A, acquired from nearby college 20 years ago. A big buy at \$500 plus \$50 for shipping. Dan Claus, 2305 W. Rice, Sioux Falls, SD 57104. (605) 332-3747

FOR SALE: N.O.S. U.S. tubes: 7591A (2) - \$70; 8417 (2) - \$70; 5932 (4) - \$60; 6EU7 - \$9; 12AY7 - \$5; 6L6GC - \$16; 6GM5 - \$12; 809 (2) - \$40; 813 (2) - \$40. Roland Barbeito, 19 Murray Ave., Westfield, MA 01085. (413) 572-4745

FOR SALE: Eico 2200 tuner - \$30. Tram Titan II - \$150. Browning Mark IV - \$200. Johnson Viking Messenger - \$35. Stromberg-Carlson slimline 15" speaker - \$40. Wood case for Crosley 50 - \$20. Military tube tester TV-3B/U - \$100. Sony ICF-5500W - \$60. Dynakit PAS-2 preamp - \$60. Johnson Viking 6&2 meter converter - \$80. Popular Electronics: complete 1954, 1955, 1956, most 1957 & 1958 - call. Heathkit transceiver pair GW-21 - \$40/both. Panasonic RF-1115 UHF-PBS-FM-AM - \$60. Novelties: Spad XIII Fighter Old Timer bi-plane radio (Waco, Japanese), N.I.B. - \$110. Stanley Powerlock II rule radio - \$25. Budweiser can radio - \$25. President by Peerless desk set calendar radio - \$35. Beer keg radio (no advertisement) - \$60. John Malley, 19 Claremont Ave., Enfield, CT 06082. (860) 745-0733

FOR SALE: Hickok 6000A tube tester. Looks rough, good parts unit - \$20 plus UPS. Kevin Kuehn, 1615 13 1/2 Ave., Barron, WI 54812. (715) 537-3225, 9-4:30; (715) 537-9395, after 5 pm

FOR SALE: Hallicrafters 1940 25 watt hi-fi, S-31A N.I.B. WANTED: S-19 Sky Buddy, Robert Enemark, W1EC, PO Box 1607, Duxbury, MA 02331. (617) 934-5043

FOR SALE: Arvin 740T, all original and working - \$80 plus shipping. Jim Montague, 1907 S. Stanley Ln., Spokane, WA 99212-3273. (509) 535-9576

FOR SALE: Crown, Crown Prince tubes O.R. recorder - \$100. Audiopulse digital time delay 1 or 2 - \$100. Proton 50/50 power amp & preamp - \$250. Offers. B. Bank, 303 Devoe Ave., Yonker, NY 10705. (914) 476-5933

Antique Radio Components

We Buy and Sell Antique, Audio, Industrial and Collector Tubes.

— WE 300Bs just \$350! —

— 572Bs just \$39.95! —

Call Us First For the Best Prices!

1065 Faith Dr.

Meadow Vista, CA 95722

(800) 649-6550, Fax (916) 878-9421

WANTED: 1930-1950 Popular Mechanics magazines for radio articles, WWII Bendix ATD transmitter and dynamotor, National NC120 receiver, Model G410 or G415 or G521 Temple portable radio. Harry L. McCall, KB4CSY, Rt. 1, Box 244, Ennice NC 28623-9641. (910) 657-8248

WANTED: Fisher AM tuner #AM-80. Will consider non-working, but repairable unit. Thanks. John Sampson, 75 Glenwood Dr., Leominster, MA 01453. (508) 537-0092

WANTED: Manual/schematic for HP5300A/5302A counter, Texscan VS-90A sweep generator, Heathkit IG-42 signal generator and Precision E-300 signal standard. Warren Sprague, 114 Wellington Cir., Williamsburg, VA 23185. (804) 229-4710

WANTED: Wanted to buy: a legible copy of the A.C. Gilbert book, "Radio Telephone and Broadcasting," circa 1922, 112 pages. Amphenol, M.I.P., 5-pin, black plastic tube sockets, paying - \$1 ea. James Fred, R1, Cutler, IN 46920

WANTED: Atwater Kent breadboard Type II tuner with tag, will pay your reasonable price. John Koop, 48 Wheelbarrow Ln., Wantagh, NY 11793. (516) 731-6711, pm machine

WANTED: Please check junk box: Need 2-piece aluminum tube shields. 1 5/8 dia., 1 1/2 high, 24 holes. David Montgomery, 20 Overlook Dr., Florence, MA 01060. (413) 686-0605

WANTED: Info on Tobe Detuchman RPN14, 7E3-0.37-700-15P2T PFN? Also mil. radar equip. Krajovic, 546 Sheridan Ave., Pittsburgh, PA 15206

WANTED: Manual for a Simpson Model 315 signal generator. Frequency counter in good condition. Ron Robinson, 2200 Ely Ave., Columbia, MO 65202. (314) 445-3772

WANTED: Zenith radios, the various models with Bakelite chassis. Mike Keller, 5861 Riverton Rd., Columbus, OH 43232. (614) 866-7725. E-mail: zuxq63a@prodigy.com

WANTED: Tubes 3, UV199 brass base, will consider duds. Donald R. Schoenheide, 1830 S. Christine, Westland, MI 48185-4455. (313) 595-7762



WANTED: Western Television serial numbers. Contributors get list of serial numbers. Confidentiality assured. Don Hauff, Box 16351, Minneapolis, MN 55416. (800) 769-9980. E-mail: McMurdoDon@aol.com

WANTED: TVs, odd brand, for my collection. Also, dial for RCA T10-1 tombstone. Thanks! Glenn Bubenheimer, 27851 Terrence, Livonia, MI 48154. (313) 421-5574

WANTED: Dial pointer knob & volume control knob for green Zenith Model #H615-Z. Marv Glassman, 19300 Romar St., Northridge, CA 91324. (818) 993-4560

WANTED: Col-R-Tel color wheel w/electronics, Radiart 8-wire antenna rotor. Dave Abramson, 1649 Yellow Springs Rd., Chester Springs, PA 19425. (610) 827-9757

WANTED: Squires Sanders SSiBS receiver & manual. Harry Weber, 4845 West 107th St., Oak Lawn, IL 60438-5252

WANTED: Escutcheon for Philco 118, two openings, 2 1/4" spaced mounting holes. Pay your price. Robert F. Haworth, 112 Tilford Rd., Somerdale, NJ 08083. (609) 783-4175



WANTED: E.H. Scott Laureate Grande with Philharmonic chassis, or any E.H. Scott radio with wireless remote. Eddie Burris, 2837 Winterbrook Dr., Lawrence, KS 66047-2454. E-mail: burris@CSTP.umkc.edu

WANTED: Early home brew radios: broadcast and ham radios and associated materials, books, magazines, spark equipment for my collection and for display. John H. Dilks, K2TQN, 125 Warf Rd., English Creek, Egg Harbor Twp., NJ 08234-8501. (609) 927-3873. Internet: john.dilks@academia.com

CLASSIFIED AD NOTICE

Please check your ads carefully before sending them in. Once ads are received, it is not always possible to refund the amount sent, pull the ad or make changes.

WANTED: Dead or alive! Jensen special design and Alnico 5 loudspeakers. Fairest bounty paid!! Peter DeGregorio, 85 Burroughs Rd., Fairfield, CT 06430-3504. (203) 331-9155, evs.

WANTED: Sony TR-510 and Packard Bell (AIWA) AR-665. Have British portables to trade or buy outright. Enrico Tedeschi, 54 Easthill Dr., Brighton, BN41 2FD, United Kingdom. Tel/fax: 00441273 410749

WANTED: E.H. Scott and McMurdo Silver cabinets; Catalin radios, quality tube hi-fi, reasonable. Al Wirtenberg, 15 Wilson Rd., Weston, CT 06883. (203) 544-9270

WANTED: Drugstore type tube tester, must work! Aborn True Value, (Jerry), 438 Harvard St., Brookline, MA 02146. (617) 277-4533, day; 262-2171, eve.

WANTED: Chassis for Emerson Catalin AU190 or Emerson wood AU213. C. Moriarty, 4928 North 105 St., Omaha, NE 68134. (402) 494-1474. (402) 636-3055. E-mail: cmoriarty@oppd.gov

WANTED: Becker Mexico two-piece T.G. Series auto radio, need not work, 1955 to 1959 model year. Joe Ingrassia, 183 Colonade Cir., Naples, FL 33940. Phone/fax: (941) 434-7571

WANTED: Zenith Royal 55 Converta transistor table radio or Converta speaker, box only. Condition very important. Jack Philpot, 632 E. 160th Ct., South Holland, IL 60473. (708) 596-0580

FOR SALE: RCA 1935 Mod 4-C amplifier used at early radio station. This rack-mounted w/metal enclosure unit has 3 microphone inputs on front panel plus those old toggle levers. Condition is beautiful w/all tubes - \$300. Larry Drago, 383 Lincoln Dr., Cheshire, CT 06410. (203) 272-6030

FOR SALE/TRADE: Mitchell #1268 AM clock - \$39. Philco #39-6294 AM/FM - \$45. Zenith #7H921 AM/FM - \$39. Bob Fuerderer, Holly Farm, 813 Rt. 12A, Surry, NH 03431. (603) 352-3005

One Month Free!

BONUS FOR EARLY RENEWALS

If you renew before the month shown on your mailing label (your expiration month), you will receive an extra month on your subscription: 13 months instead of 12! 26 months for an early 2-year renewal!

FOR SALE: Picture tubes 75P4 & 10BP4 - \$25 ea. **WANTED:** Thompson battery set Model S-70. Thompson horn speaker. Tony DeMara, 40231 Day, Clinton Twp., MI 48038

FOR SALE: Steinite Seville highboy - \$395. Mahogany Brunswick Ultona phonograph - \$350. TV-2/U tester - \$150. All OBO. Richard Rubin, 227 Riverside Dr., Apt. 5-A, New York, NY 10025. (212) 864-8416

FOR SALE: Tubes, used: 807, ST type - \$3; 12AU7WA - \$2; 50L6, 35Z5, 6V6, 6L6, 12AX7 - \$3. Power Brothers Electronics, PO Box 295, Gladys, VA 24554-0295

FOR SALE: Airline cathedral cabinet - \$50. Delco 3203 tombstone, 32V - \$75. RCA 18T - \$50. Richard Haneline, 3600 Cuba Blvd., Monroe, LA 71201. (318) 387-6764

FOR SALE/TRADE: Blue Global GR711 - \$120. Motorola 56T1 - \$160. Novelty radios: Helping Hand - \$45; Mr. Peanut - \$65; Kent or Winston package - \$45; Mark Twain - \$75 and others. SASE for list. **WANTED:** Early 1960's Japanese transistor radios, Toshiba 9TM40 handle. Ken Wong, 1460 Belleville Way, Sunnyvale, CA 94087. (408) 735-1815

FOR SALE: Scott 23-tube Allwave in Windsor cabinet - \$1,900. Scott 15-tube Allwave in Warrington cabinet - \$1,750. Clapp-Eastham HR & HZ - \$525. Mir Ray glass radio - \$995. RCA Model 140 tombstone - \$325. Philco mantle clock radio, exc - \$475. Arrow mini transistor radio, N.I.B. - \$20. Teletone 7-inch tabletop TV w/cover - \$195. RCA Model 128 radio - \$275. Prices do no include packing and shipping. Contact: Waves, 32 E. 13 St., New York, NY 10003. Hrs.: 12-6 Tues.-Fri., 12-5 Sat., closed Sun. & Mon. Tel.: (212) 989-9284 (we will not return long distance calls, please call during business hours). Fax: (201) 461-7121. E-mail: clwave@aol.com

FOR SALE: Early vacuum tube computer items. Heathkit EC1 vacuum tube analog computer. Offers. IBM demonstration/presentation unit; it contains (20) individual tube modules, a chassis with (10) tube sockets, interconnection sockets, and patch wires, contained in a 7 x 12 x 20-inch wooden case - Offers. Call for details. Raymond Filozof, 339 Howertown Rd., Catasauqua, PA 18032. (610) 264-4733

FOR SALE: RCA SHF-6 stereo. Farnsworth/Capehart Model EK264 blond chairside radio/phono completely serviced and running excellent, RCA Model 65U table radio/phono. Frank D. Atwood, Nostalgia Radio, 117 E. Main St., Merrimac, MA 01860. (508) 374-1030

FOR SALE: Ampex parts, power and audio transformers, tubes, antique radios and tubes. Bob Lindahl, 10680 S.W. Wedgewood St., Portland, OR 97225. (503) 644-9643

NEW BOOKS FOR COLLECTORS OF AMPLIFIERS, SYNTHESIZERS & JUKEBOXES

The History of Marshall, Michael Doyle. Forward by Billy "F" Gibbons. *Essential reading for musicians, technicians and collectors alike. Follows the rise of the company. Complete list of all Marshall products ever made. 62 color pages. 254 pages. Softcover.\$32.95*

Amps! The Other Half of Rock 'n Roll, Ritchie Fliegler. *How the amplifier evolved & how it works. Fender, Vox, Ampeg, Marshall histories, etc. 20-page full color photo gallery. Troubleshooting chapter. 120 pages. Softcover.\$24.95*

Vintage Synthesizers, Mark Vail. *Looks at the history (1962-1992) of the electronic music synthesizer. Over 200 photos. Dealer tips on finding and buying synthesizers. Price guide. 300 pages. Softcover.\$19.95*

Jukeboxes - Obscure, Mysterious and Innovative American Jukeboxes, Adams. *First volume of a history of the lesser known manufacturers of phonographs, music boxes and jukeboxes. 182 pgs.\$29.95*

Jukebox Art, Pearce. *The evolution of the jukebox from the coin-operated record changer to the flashing lights of the rock-and-roll generation. 250 photos, 128 pgs. Hardcover. \$29.95*

Jukebox Art Postcard Deck. *30 colorful photos from Pearce's book.\$9.95*

U.S. Orders - Enclose \$3.00 per order for packing & book-rate shipping if total order is under \$35.00. If using VISA or MasterCard, include name on card, card number and expiration date. Send payment with order. Mass. residents please add 5% sales tax. Money back return policy. Most orders shipped the same day received, but allow 2-4 weeks to receive order. Foreign orders - write for shipping costs, or use credit card and specify air or surface (allow 2-3 months for surface shipping).

Send Order To: A.R.C., P.O. Box 2, Carlisle, MA 01741

Phone: (508) 371-0512 — Fax: (508) 371-7129



(Mar-95)

WANTED: Will pay top dollar or trade generously for a Stromberg-Carlson 130U tombstone in any restorable condition (Radiomania, p. 197). Please call or write: Mark V. Stein, 2109 Carterdale Rd., Baltimore, MD 21209. (410) 466-2814. Fax: (410) 466-0815

WANTED: Hallicrafters Sky Buddy S19R. Art Brittingham, 9450 S. Tropical Trl., Merritt Island, FL 32952. (407) 773-0774

WANTED: Crosley Showbox Model 706, working or not. Paul H. Putnam, 406 Gentian Rd., St. Augustine, FL 32086. (904) 797-3236

WANTED: RCA microphones, Neuman tube models, AKG tube models, tube mic preamps, tube equalizers, literature on above. Jim Kollens, 29 W. Commercial, Addison, IL 60101. (708) 628-0810, days, (708) 691-8890, evenings

WANTED: Zenith 10S-130 or 8S-129 tombstone. Please write or call anytime. Thank you. Mark Hewitt, 6659 Tipperary Trl., Roscoe, IL 61073. (815) 623-8729

WANTED: Western Electric pre-1940. RCA AVR5 tombstone. Navy GP6. RS76 throat mike. James Treherne, 11909 Chapel Rd., Clifton, VA 22024. (703) 830-6272. E-mail: treheme@c2east.convex.com

WANTED: Working Stromberg-Carlson radios. J. Finkelstein, 205 Alapocas Dr., Wilmington, DE 19803



WANTED: Emerson Catalin radios. Nobody pays more than I. What an arrogant and inaccurate thing to say. I mean, like there isn't anyone wealthy enough, dumb enough, desperate enough—or any combination of the three—to pay even a dollar more than I would pay. I mean, c'mon, who am I trying to kid! Please write or call collect: Rain Buttignol, 214 State St, #7, Portsmouth, NH 03801. (603) 427-1384

WANTED: Flyback transformer for a Magnavox color TV Part #361197-2F, chassis #T933-12-AA. Joseph Loubriel, 524 James St., New Milford, NJ 07646. (201) 387-6665

WANTED: Red crescent second hand for Philco grand-father clock radio. Sam Zuckerberg, 578 Fifth Ave., New York, NY 10036. (212) 354-7407

WANTED: Wooden radios with metal grilles or trim. Jay Malkin, 1250 Galapago, #206, Denver, CO 80204. (303) 623-6451

WANTED: Collins Signal magazines promotional items and accessories. Coil cover for 75A2/75A3. Brian Roberts, K9VKY, 3068 Evergreen Rd., Pittsburgh, PA 15237. (412) 931-4846

WANTED: Garod peaktop chassis and yellow knobs. Fada bullet chassis and yellow bezel. Will buy or trade. Ray Carroll, 158 Oakwood Dr., Wayne, NJ 07470. (201) 696-1149

WANTED: TMC GPR 90 or 92, Hallicrafters SX 73, 88, 100, 122, Collins or other quality gen. coverage rcvr. Hugh Watson, 2734 Hillcrest, Alton, IL 62002. (618) 462-3979

WANTED: Manual (or copy) for Heathkit IT-18 transistor tester. Richard B. Ahlvin, 3 Shadow Wood Dr., Vicksburg, MS 39180-9741. (601) 636-9110, evenings



WANTED: Pilot Model 364 or 365 wanted. \$100 finders fee for whereabouts of this set, shipping from anywhere no problem. Pilot radios wanted, any model, any condition. Bill Moore, 3049 Box Canyon Rd., Huntsville, AL 35803. (205) 880-1207

WANTED: 1920's-1940's Japanese civilian, military radios, communication equipment, related components; 1940's-1950's Japanese tube hi-fi components: amps, preamps, speakers, recorders, related literature by Pioneer (Fukui Electric), Sansui, Sony, etc. Randy Liebermann, 2874 South Abingdon St., A1, Arlington, VA 22206-1363. (703) 824-9733. Fax: (703) 998-6457

**IF YOUR EXPIRATION DATE IS
NOVEMBER OR BEFORE, RENEW TODAY!
EARLY RENEWALS
RECEIVE AN EXTRA ISSUE!**

WANTED: Volume control Zenith #63-688, Mallory DT295-SS1. IRC D18, 139XX 2 meg, audio control with 2 tone taps. John Shafer, 2275 S. Canal St., Newton Falls, OH 44444. (216) 872-7777

WANTED: Arvin 8584 portable, red, as shown in Bunis page 37. Also want Magnavox transistor AM-23 (Bunis, p. 113). Also Olympic 771 and Zenith K412R portable. James Martes, 15400 E. 2nd St. So., Independence, MO 64050. (816) 836-0668

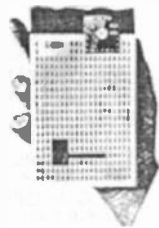

WANTED: Sony TR-52, offering \$1,500 (U.S.). Also seeking other early Sony transistor radios. Tom Christopher, 5350 Alum Rock Ave., San Jose, CA 95127. (408) 926-2808

WANTED: Instruction manual for tube testers TD55 Superior Instruments Co. and Mercury Mod 1000. Giovanni Labbiento, 2335 Deschambault, Laval, Quebec, Canada H7E 1E2. (514) 871-6536

WANTED: Circular volume dial for Zenith console 9S262. Also I'm still looking for these Philco table models 91B, 116B, 118B, 37-660B, 37-665B, 37-670B, 38-2670B or other big tube table models. Please call or write. Don Hughes, 219 21st St., Huntington Beach, CA 92648. (714) 969-4542

THE RADIO DOCTOR

VINTAGE RADIO RESTORATION VIDEO TAPES

VOLUME 1: VINTAGE RADIO REPAIR AND RESTORATION
COVERS THE COMPLETE START TO FINISH ELECTRONIC AND
COSMETIC RESTORATION OF A TYPICAL 1930s WOOD TABLE SET

VOLUME 2: CONSOLE RESTORATIONS
USES SEVERAL DIFFERENT SETS TO COVER SELECTED TOPICS
CONSOLES RESTORED BUT METHODS APPLY TO ALL TYPES OF SETS

EACH VOLUME IS 4 HOURS ON 2 VHS VIDEOTAPES
TAPE PRICES \$23.95 EACH VOLUME PLUS SHIPPING
TAPE SHIPPING \$4.00 FOR ONE OR BOTH VOLUMES

DISCOUNT BOOKS

HERE NOW! NOW SHIPPING! HERE NOW! NOW SHIPPING!
CRYSTAL CLEAR, VOLUME 2 by Sievers
LIST PRICE \$29.95 **OUR PRICE \$25.50** plus shipping

MADE IN JAPAN Transistor Radios of the 1950s & 1960s
LIST PRICE \$16.95 **OUR PRICE \$14.25**

MACHINE AGE TO JET AGE RADIO MANIA'S GUIDE
LIST PRICE \$24.95 **NEW!** **OUR PRICE \$21.25**

Z) THE RADIO COLLECTOR'S DIRECTORY and PRICE
GUIDE 1921-1965, 2nd EDITION by GRINDER
LIST PRICE \$26.95 **NEW!** **OUR PRICE \$23.00**

A) COLLECTOR'S GUIDE to ANTIQUE RADIOS 3rd Ed
by Bunis LIST \$18.95 **OUR PRICE \$16.00**

B) TRANSISTOR RADIOS: Collector's Encyclopedia & Price Guide
by Lane LIST \$19.95 **OUR PRICE \$17.00**

C) COLLECTOR'S GUIDE to NOVELTY RADIOS
by Bunis LIST \$18.95 **OUR PRICE \$16.00**

D) COLLECTOR'S GUIDE to TRANSISTOR RADIOS
by Bunis LIST \$15.95 **OUR PRICE \$13.25**

E) EVOLUTION of the RADIO, VOLUME 1
LIST PRICE \$22.95 **OUR PRICE \$19.50**

F) EVOLUTION of the RADIO, VOLUME 2
LIST PRICE \$24.95 **OUR PRICE \$21.25**

G) PHILCO RADIO: 1928-1942 by Ramirez
LIST PRICE \$29.95 **OUR PRICE \$25.50**

J) RADIO MANUFACTURERS of the 1920s by Douglas
1) VOLUME 1: A.C. DAYTON to J.B. FERGUSON
LIST PRICE \$24.95 **OUR PRICE \$21.25**

2) VOLUME 2: FREED-EISEMANN to PREISS
LIST PRICE \$29.95 **Back In Print!** **OUR PRICE \$25.50**

3) VOLUME 3: RCA to ZENITH
LIST PRICE \$29.95 **OUR PRICE \$25.50**

K) CRYSTAL CLEAR: Vintage American Crystal Sets
LIST PRICE \$29.95 **Back In Print!** **OUR PRICE \$25.50**

L) CLASSIC TVs: PREWAR thru 1950's WITH PRICES
LIST PRICE \$16.95 **OUR PRICE \$14.25**

R) OFFICIAL RADIO SERVICE MANUAL 1930 reprint
LIST PRICE \$24.95 **OUR PRICE \$21.25**

S) 70 YEARS of RADIO TUBES and VALVES by Stokes
LIST PRICE \$25.95 **OUR PRICE \$22.00**

X) ZENITH TRANS-OCEANIC The Royalty of Radios
LIST PRICE \$24.95 **NEW!** **OUR PRICE \$21.25**

BOOK SHIPPING \$2.75 FOR ONE AND \$1.25 EACH ADDITIONAL
PAYMENT VIA CHECK or MONEY ORDER PLEASE
SHIPPING APPLIES TO USA, OTHERS INQUIRE
SEND LSASE FOR OUR COMPLETE LIST

OZARK VINTAGE RADIO

3923 EAST LATOKA STREET
SPRINGFIELD, MO 65809

FOR SALE: Atwater Kent Model 32, complete - \$150
OBO. Also tubes, tube manuals and many inexpensive
radios. Some tube audio. SASE for latest list. Charles D.
Blair, 815 N. 5th St., Cambridge, OH 43725. (614) 432-
4453, 9-5

FOR SALE: Tube testers. Weston Model 777 - \$60.
Seco 98 - \$55. B&K 500 - \$40. Heath TC-2 - \$35.
Knight, no model - \$20. All include all documentation,
and do work. I have tested them all and repaired where
necessary, including replacing sockets. Shipping in-
cluded as well. Kim Herron, 16141 24th Ave.,
Coopersville, MI 49404. (616) 677-3706

FOR SALE/TRADE: RCA 77DX microphone w/floor
stand in perfect condition w/red logo and shock mount
- \$875. Also RCA 77DX w/table stand as seen on Larry
King and David Letterman shows, in original condition
and highly polished chrome w/shock mount - \$1,350.
Larry Drago, 383 Lincoln Dr., Cheshire, CT 06410. (203)
272-6030

FOR SALE: Seagrams Benchmark Whiskey novelty
bottle 1950 - \$150. Sir Roberts Burnett, white satin
whiskey novelty bottle - \$125. General Elect. cathedral
K63 - \$150. RCA 103 tapestry speaker, excellent - \$75.
Dan Claus, 2305 W. Rice, Sioux Falls, SD 57104. (605)
332-3747

RATE FOR ADDITIONAL WORDS:

22¢ per word

FIRST 20 WORDS FREE!

Cash or stamps OK for small amounts.
Your payment helps to keep A.R.C. healthy!

FOR SALE: Dyna MK3 w/N.O.S. Tung-Sol 6550, FM-1,
PAS-2 - \$500+. **WANTED: Stancor and Thordarson**
transmitters and manual. Thanks! Tom Smith, N5AMA,
13034 Elmington Dr., Cypress, TX 77429-2062. (713)
376-3436, evenings

FOR SALE: Crosley Bakelite, brn. #9-103, exc - \$65.
Sentinel tombstone, 2 band, 32v, vg-exc - \$75. As is,
untried + UPS. Darrell Combs, 6587 Pacheco Way,
Citrus Heights, CA 95610. (916) 969-0635

FOR SALE: Airline 62-288 Miracle, (Bunis 2, p. 17), very
nice, plays - \$100. U-ship. Lloyd "Bud" Noel, 494 Clark
St., Galesburg, IL 61401. (309) 342-2825

FOR SALE: Garod 6AU-1, bright red body, butter-
scotch trim, excellent original - \$1,050 firm. Robert
Shuck, 10512 Winston Ln., Fishers, IN 46038. (317)
849-0381

FOR SALE: Sony Boy Dolls, I have two, (1) fair condi-
tion - \$200; (2) new in package - \$450. On vacation until
November 4th. Transistor Sister, 2327 E. Livingston
Ave., Columbus, OH 43209. (614) 237-2621

FOR SALE: Sony CRF 160 shortwave portable, 13
bands with FM in good condition. Call: Sheldon Kane,
360 Rhinecliff Dr., Rochester, NY 14618. (716) 442-
6338

FOR SALE: Stromberg-Carlson 180-L console - \$115.
RCA 262 Globe Trotter console, excellent - \$100. Both
in Poughkeepsie. Bob Puttre, 637 Stratford Rd., Bald-
win, NY 11510. (516) 223-9667

FOR SALE: RCA Victor Service Data Vol. I and Vol II,
1923 thru 1942 - \$95. T21 ARC5, N.I.B. - \$45. JT-30
mic - \$35. (122) issues A.R.C. - \$40. All plus shipping.
W.M. Ernst, 16300 Campbell Rd., Comins, MI 48619.
(517) 848-5002

WANTED: Ozarka Jr., cathedrals and literature. Also want battery superhets. Don Patterson, 636 Cambridge Rd., Augusta, GA 30909. (706) 738-7227

WANTED: BC-222 (SCR-195), TBY-7; WW2 Japanese military radio of any kind. Anything Pan American China Clipper related. Takashi Doi, 1-21-4, Minamidai, Seyaku, Yokohama, Japan. Fax: 011-8145-301-8069

WANTED: Cabinet/spkr for Atwater Kent Mod 627 cathedral. Floor cabinet for AK47. Thanks. Lars Roose, 10100 Chapala Ct., NE, Albuquerque, NM 87111. (505) 296-4129

WANTED: Radiovision wood table radio with built-in motion lamp having scene of war ship in harbor. Have trade items or would purchase outright. Jim Clark, 1292 Starboard Dr., Okemos, MI 48864. (517) 349-2249

WANTED: Anyone know if a meter movement and indicating tube were ever used together in same case? Is there a book which shows photos of almost every kind of meter ever made? Chris Cross, Box 94, McConnell, IL 61050

WANTED: These cosmetically excellent transistor radios (playing \$200-\$500+ each): Admiral (must have accessories) 6S22, 6S24, 6S26, or 6S28; Arvin 8576; Bulova 250; Firestone F-4D; Hoffman Home & Travel Solaradio; any Mantola; any Mitchell; Motorola 7X24W; any coat pocket Raytheon; any pocket-size Regency; Sony TR-63 or any plastic cabinet Sony marked "Tokyo Tsushin Kogyo, Ltd."; Toshiba 8TP-90; pink Zenith 500. Bill Burkett, PO Box 2488, Sun City, AZ 85372. (800) 507-7234

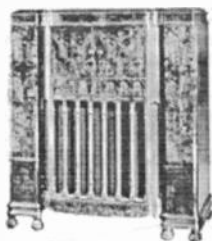

WANTED: This Stromberg-Carlson Model 74, any parts of same, or any information as to one's existence for research and/or collection. Finders fee. Also Models 734, 744, (early AC); #2 console neodyne, 2A horn, 240S, 145SP, 160P, consoles. Other S-C's sought, inquire. Will pick up. Always want S-C paper, ephemera. John M. England Jr., PO Box 59136, Schaumburg, IL 60159. (708) 823-5287

WANTED: HQ145A, 180, 180A. QMult circuitry for HQ150. B+ transformer for TV2 tube tester. George Fallenbeck, 608 Brookhaven Way, Niceville, FL 32578. (904) 897-5434

WANTED: Dial escutcheon for Philco 70. Prefer original. Thanks. Don Hughes, 219 21st St., Huntington Beach, CA 92648. (714) 969-4542

WANTED: 01-A tubes, globe type, new or good used. Give condition, qty., price, include UPS. Write: Anton George, 7203-39th Ave., Kenosha, WI 53142

WANTED: General Television Model 49 and Pilot Lone Ranger chassis and knobs. Alan Piorek, WB9RAD, 1050N. Paulina St., Chicago, IL 60622. (312) 235-1523

WANTED: Need two loop antennas for GE Model H-116 and L-916. Antenna is called a Bean O Scope and was used on many models, oval-shaped, measure 12" dia. x 24" long. Please write or call and price please. Jim Cirner, 149 Tyler Ave., San Jose, CA 95117. (408) 296-0860

WANTED: Old microphones, any shape or style. Or microphone literature. Mike Dupuis, 116 First Ave., Tuckerton, NJ 08087. (609) 296-4883



WANTED: The pictured Stromberg-Carlson tombstone, any condition. Restorable preferred. Thanks. Bob Schafbuch, 2811 Highland Ave., Carrollton, KY 41008. (502) 732-9650

WANTED: Solid-state regulator by Motorola or equal 2N6576 for 12 Vdc, 20 amp power supply, where available, price. FOR SALE: 1951, 1977 ARRL Radio Handbooks; American Electrician Handbook, 9th edition; Digital Electronics Music Synthesizer 2nd edition, Electrical Electronics Eng. series, 4th edition by Terman, all good condition - \$6 ea. plus shipping. Randy Blevins, W3LGI, 48836 Haviland Rd., Lexington Park, MD 20653. (301) 863-8687

WANTED: Vintage audio eqpt. Collecting and trading fairly since 1972. Consistently topping other offers, especially on following: Marantz 7 - \$2,100; 8B - \$1,500; Consolettes - \$3000; Twos - \$3,500; McIntosh: MI200AB - \$3K; Fisher SA1000 - \$1,300; FMR-1 - \$800; MF320 - \$1K; Scott: 4310 - \$1K; 4120, 4100 - \$1K; Regency HF1000 - \$1K; E.V. Patrician IV - \$5K; Jensen Imperial - \$2K; Hadley amp - \$1,800; WE 1086 - \$4K; Leak TL12 \$600; S. Carlson 475 RF system - \$1,800; Technics stylus gauge - \$350; REL - \$1K; Altec 1570A - \$1,800; Laguna, Capistrano - \$1,600; Ionovac - \$600; EL 34 metal base - \$60. Also: Tung-Sol 6550, Telefunken & Bugle Boy 12AX7, 6DJ8, 50, 8045, 6LF6, KT6, 77, 88, EL87, 7591, 8005, 811, 845 WE 300. Xfmr's: Partridge, Acro, Dyna, Peerless, U.T.C. Sprague black caps, 400Vt electros, seleniums. Tube x'overs. Shure cart. analyzer. Win Cart. Cotter eqpt. Lowthers, AR: LST/LST2, 3a, 1 and tweeters. Sequerra FM1, SME3012, FR66, Garrard 301, Beveridge. Brociner, EV amps, Fairchild, Futterman, Gray, Grommes, Heath, HKGT II, V, JBL, Sinclair TV, Karg XT3, Klipsborn, KLH8, 27, Pilot, Puresonic. Quad: II, ESL, Radiocraftsman, Rogers, RCA amps, spkrs, WE eqpt. Interesting wristwatches: American or Swiss 1918-1970 steel/gold/g.f. I'll call back on all items of interest only, please be very specific. Ed Schneck, 1401 Ocean Ave., Brooklyn, NY 11230. (718) 377-7282, M-F, 3-6 pm

WANTED: Will the person who bought the real nice Motorola 7" portable TV at Elgin please contact me. Don Patterson, 636 Cambridge Rd., Augusta, GA 30909. (706) 738-7277

FOR SALE: Collins 75-A4, decent condition - \$585. Collins 75-A4 w/2 mechanical filters in excellent working and most beautiful condition - \$795. Larry Drago, 383 Lincoln Dr., Cheshire, CT 06410. (203) 272-6030

FOR SALE: Morris coil winder like new in box with gears, complete - \$35. Henry Galbraith, 1214 South Alvord, Evansville, IN 47714. (812) 476-7601

FOR SALE/TRADE: Heathkit tuner - \$60. Newcomb E-20's (4) - \$300. Scott L-48-K - \$150. Scott 99B's - \$250/pr. Knight KN-940 - \$100. Harman Kardon Trio - \$100. Channel Master 6601 - \$125. Scott 340-B - \$150. Newcomb E-40 - \$125. Trade for guitar amps, Jensen speakers, or N.O.S. tubes. Peter DeGregorio, 85 Burroughs Rd., Fairfield, CT 06430-3504. (203) 331-9155, eves.

FOR SALE: Chinese heavy chrome keys, N.O.S. - \$65 ea. ppd. Sony book, Gearyu Sony Challenges, 1946-1986 - \$25 ppd. Int'l. Postal M.O. please. **WANTED:** 6D5, not 6D5G/6D5MG Sony TR8. Panasonic R111. Japanese mt. & sub-mt. tube portables. Japanese tr. radios using oval-shaped tr. Solar radios. Hallicrafters 505, doghouse TV. European-made tube+tr. hybrid radios. Japanese WW2 sets. WW2 German people's radios. Noriyoshi Tezuka, 1-11-2-403, Hiroo, Shibuyaku, Tokyo 150, Japan. Fax: 011-813-3440-8396

FOR SALE: Green apple novelty radio, N.I.B. - \$14. Cellular phone radio, N.I.B. - \$15. WWI aeroplane antenna reel DR-2, dated 1918 - \$25. Reproduction Marconi stock certificates - \$10. All plus shipping. Norm Hertz, 4904 Amboy Rd., Staten Island, NY 10312. (718) 967-1025

The Olde Tyme Radio Services Directory is now available. Find the services and parts needed to restore that old radio or t.v., also included are clubs and publications all categorized and sorted by state for easy look-up. Over 225 suppliers listed, and always adding more each year. Send \$4.00 ppd. Andrew Mooradian, 5 Priscilla Lane, Winchester, MA 01890

WANTED: Tubes: 300A/B, 274A/B, 262A/B, 275A, 252A, 101D, 104D/F, 211A/D/E, 271A, VT2, 205D/E/F, VT52, 272A, 244A, 284D, 348A, 349A, 293A, 290A, 285A, 301A, 216A, 345A, 351A, 339A, 306A, 422A, 303A, 292A, 347A, 398A, 440A, 442A, 310A (S. H.M. H). Other: 50/250/350/450, 183/483, 45A, 845/W, VT52, VT62, 5C24, AB150, HF120, HF140, 211B/D, C182, C183, 2A3H, 1276, 2A3 (M. P). European tubes, old power tube only. Transformers: WE, Peerless, Langevin, UTC, Triad, other. Parts: Capacitor, resistors, cloth-covered wire, other. Jazz LPs: 1950's, 1960's. Speakers unit: 8"-15", old only. Kouji Matsuo, 6-2, Tsurumi-Cho, Beppu-Shi, Oita 874, Japan. Tel/fax: 81-977-23-9579

WANTED: Collins Radio Company Catalogs, promotional literature, manuals 1933-1983. Jim Stitzinger, 23800 Via Irana, Valencia, CA 91355. 1-805-259-2011

KEYSTONE BIBLIOPOLIST - "Re-cyclers of technical literature since 1981" Radio and Electronics Books/Manuals...Large inventory, thousands of individual titles covering Equipment and General-Subjects: Amateur/Commercial/Military for a list of catalogs; send large SASE to: P.O. Box 34427 Omaha, NE. 68134

FOR SALE: Radiola III-A - \$175. Crosley 51-S - \$125. Plus shipping. Tom Tamberelli, 106 Carpenter St., Muncy, PA 17756. (717) 546-6515

FOR SALE: Restored cabinets: Philco 70, Philco 38/38A, Stewart-Warner R-1401A, Kennedy cathedral. Reproduction parts for Philco 70 cabinet: bottom moulding - \$15; rear arch - \$14; front panel - \$40; bottom board - \$18; parts ppd. Dick Oliver, 28604 Schwalm Dr., Elkhart, IN 46517. (219) 522-4516

FOR SALE: Donald Duck transistor radio, M.I.B., circa 70's - \$45. Blabber Mouth transistor - \$45. Tropicana Orange - \$35. Heinz Ketchup - \$60. Knights Head - \$30. GE Model P2760, see thru glow in moon space display box, mint - \$75. Tony Tiger, missing bat. door - \$30. Panasonic Model R-70 - \$30. Skeletor & He-Man, missing bat. door - \$30. Continental TR622, missing grille face - \$20. GE small brass-blade table fan, Whiz - \$60. Bill Constanine, PO Box 493, Glens Falls, NY 12801. (518) 792-7065

FOR SALE: RCA UX250 tube, used, tests very good - \$75. Westinghouse 53; Canadian Radiola III; 3 peanut tube homebrew, very nice; Radiola IIIA, no cabinet. Crosley 3R3 Trirdyn, no cabinet - \$40. Motorola MK-56R, green - \$45. Trav-Ler white/blue grille - \$60. Transistors: GE 76 - \$20; Bellvoice jet grille, wht/blk - \$80; Sharp TR-203, lavender/blue - \$50. Czech Comet 9, turq. leath. - \$60; Global GR-900, lt. blue, damaged - \$40; Sony TR-63, green. Mike Herman, #2-1731 Rockland Ave., Victoria, British Columbia, Canada V8S 1W6. (604) 595-2829

FOR SALE: Philco Safari, Model H-2010, tan, works, very nice - \$250. Mort Jones, W6KLG, PO Box 2131, Ramona, CA 92065. (619) 789-6794

FOR SALE: Sams, below #1000, as low as 50¢ ea. Must sell, overstocked. Send SASE for list. John E. Kendall, PO Box 436, Fallston, MD 21047

FOR SALE: Zenith Z70 - \$25. Channel Master 6514 - \$25. Bulova 840 - \$35. Solar visor - \$45. Jim Smith, KB7LBY, 1228 S. 40th Dr., Yuma, AZ 85364. (520) 329-0384

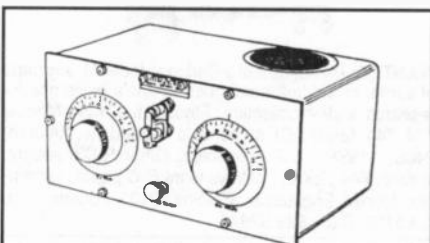

WANTED: Pre-1926 radios by AMRAD. Also, Amrad radio parts, accessories, and literature. Richard Sharisky, PO Box 521, Belmont, MA 02178. (617) 484-5784

WANTED: Radio Callbooks 1900 thru 1927. Bob Arrowsmith, W4JNN, PO Box 166, Annandale, VA 22003. Collect (703) 560-7161

WANTED: Fairbanks Morse console Model 9C or 12B preferred. Charles E. Patterson, 2621 Sweetwater Rd. SP#33, National City, CA 91950. (619) 475-7141

WANTED: Radiotron Designer's Handbook, fourth edition only, paying up to \$45. Call or write. Frank Bequaert, Rainy Day Books, PO Box 775, Fitzwilliam, NH 03447-0775. (800) 215-0046

WANTED: E.H. Scott, McMurdo Silver, World's Record radios wanted. Cash and/or trade. Mike Greene, 19113 Alpenglow Ln., Brookeville, MD 20833. (301) 774-3203

WANTED: Goat tube shields, 2- or 3-piece style, 5", 6" field coil speakers. Dennis Smith, KN8H, Box 113, Trenton, MI 48183. (313) 675-5847

WANTED: Antique medical devices, especially violet rays and induction coils. Also scientific apparatus. Richard Cane, 1333 N.W. 127th Dr., Sunrise, FL 33323. (305) 846-7116

WANTED: Good Rider's Manual #23. Good amplifier for Crosley 50. Good Crosley Model VI. Bill Moss Settle, 120 Clarksdale Cir., Glasgow, KY 42141

WANTED: GE K-60 chassis for parts. John Webb, W6RCW, 12736 Erin Dr., Auburn, CA 95603. (916) 885-9556

WANTED: UX213's, Clapp-Eastham HZ, Paragon DA2, Paragon detector, early Collins transmitters. FOR SALE/TRADE: Federal 141 w/o cabinet. Radiola V. Stuart Mount, K2OA, 35 Grand, Highland, NY 12528. (914) 691-7957

WANTED: Eye tube, 6T5 to complete my collection of these in a display for shows. 110v/6v farm radios, 32v farm sets. Charles W. Rhodes, 3906 Quisenberry Dr., Alexandria, VA 22309. (703) 780-0719

WANTED: Schematics/alignment instructions for Barlow Wadley Model XCR-30 Mark 2 transistorized portable radio receiver. Thanks! Sylvain Gregoire, 1405 Cremazie, Laval, Quebec, Canada H76 4E8. (514) 662-1962

FOR SALE: PHONO NEEDLES & CARTRIDGES (ceramic - magnetic). What do you need? Send SASE. J. J. Papovich, 53 Magnolia Ave., Pitman, NJ 08071. (609) 582-8279

SERVICES: Chassis restoration, prior 1960, satisfaction guaranteed. \$87.50 PLUS PARTS. 48 years experience. Ray Sanders, 342 South Third, Cottage Grove, OR 97424. (503) 942-0866

SOLID-STATE VIBRATORS for automobile radios 1932-58. Exact duplicates of originals in metal cans. Synchronous, Non-sync, European. Dealer inquiry invited. Free catalog. Visa, MasterCard, Discover. Antique Automobile Radio Inc., 700 Tampa Road, Palm Harbor, FL 34683. (800) WE FIX AM 933-4926, or Fax (813) 789-0283

RADIO SCHEMATICS PLUS DATA STILL \$3.00 EACH. TV \$4.00, POSTPAID USA. STAMP FOR TUBE AND TEST EQUIPMENT LIST. JOSEPH R. FORTH, 321 LONG VUE ACRES, WHEELING, WV. 26003. (304) 277-3154

FOR SALE: All working, NT, Amrad S522 vg, Fuerst Famous 5G, Case Model 60 solid mahogany, 1 chip, needs refinishing. All 3 for \$300 or interesting trade. Dave Rinehart, 85 N. Edison, Suite 1, Reno, NV 89502. (702) 856-4122

WANTED: Zenith Trans-Oceanics: all models, any condition, tube and transistor. Zenith military Trans-Oceanics R520/URR and R520A/URR. All Zenith WTM manufactured between 1935 and 1942. Frank J. Manzano, 82 Monhegan Ave., Oakland, NJ 07436. (201) 337-5263

WANTED: The Philco Collector would like to remind you that this is still a hobby with me as I also have other interests. Still looking for that elusive Philco 17B cathedral. **FOR SALE:** Midwest Miraco Ultra 5, complete - \$125. Ted Depto, 818 5th Ave., Patton, PA 16668. (814) 674-8834

WANTED: Help me help you. Still looking for new cloth patterns to reproduce. Current preferences are console patterns from 1936 to 1942, especially Zenith. Send me a decent-sized piece in good condition (non-returnable), and if I can get a good copy made, I'll send you a console-sized piece of it in return. Michael Katz, 3987 Daleview Ave., Seaford, NY 11783

WANTED: Freed-Eisemann NR5 battery connection standoffs. Owners manual for Freed-Eisemann Model NR12. Gary Carter, WA4IAM, 1405 Sherwood Dr., Reidsville, NC 27320. (910) 349-1991

WANTED: Schematic, copies OK, will pay \$5 for Jackson signal generator schematic for Model #641. Peter Anderson, W5VYV, 601 N. Turner, Hobbs, NM 88240. (505) 397-3022

WANTED: RCA Selectavision video records. Prewar FM tuners. Free: RCA 118 cabinet. Parting out: RCA 648PTK projection set with tambour doors. Craig Roberts, 132 Northway, Greenbelt, MD 20770. (301) 474-3506

Victrola Repair Service: Windup phonograph repairs, parts, springs, needles via U.P.S. Rod Lauman, 19 Cliff St., St. Johnsbury, VT 05819. (800) 239-4188, eves.

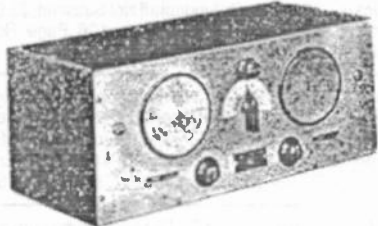

WANTED: Any condition, this Hallicrafters/Silver-Marshall radio, and very similar units. Chuck Dachis, The Hallicrafters Collector, 4500 Russell Dr., Austin, TX 78745. (512) 443-5027

WANTED, ANY CONDITION: RBY, Hallicrafters S-35, PR-1, Heath SB-620, Squires-Sanders SS-1V panadaptors; also schematics, manuals, ads, articles, technical data on them. John A. Benyo, 25 Schley Street, Garfield, NJ 07026

MESSAGE: The Michigan Antique Radio Club announces that EXTRAVAGANZA '96 will be held July 12-14, 1996, in Lansing, Michigan. Please MARC your calendars now! To be put on the EXTRAVAGANZA '96 mailing list, send postcard to: EXTRAVAGANZA '96, PO Box 585, Okemos, MI 48805-0585

FOR SALE/TRADE: Hallicrafters S-20R Sky Champi-on - \$200. Hallicrafters S-77A - \$325. Hammarlund Comet Pro, variation 5, with crystal and all coils - \$825. Larry Drago, 383 Lincoln Dr., Cheshire, CT 06410. (203) 272-6030

FOR SALE: Eico 460 scopes, good CRTs, manuals, repairable - \$20 ea. Local only. Louis D'Antuono, 8802 Ridge Blvd., Brooklyn, NY 11209. (718) 748-9612, after 6 pm

FOR SALE: Heathkit scope 3" Model OL1 - \$50. Heathkit tube tester Model IT17 - \$35. Sencore tube tester Model TC136 - \$50. Sencore CRT checker Big Mack Model CR168 - \$75. RCA vacuum tube voltmeter WV98C - \$55. Hallicrafters S38D - \$50. Plus shipping. J.J. Papovich, 53 Magnolia Ave., Pitman, NJ 08071. (609) 582-8279

FOR SALE: Addison A2A, maroon/white Plaskon, vg. Mike Sullivan, 212 Beechwood Ln., Coppell, TX 75019. (214) 393-5084

FOR SALE: Military N.O.S. tubes, Eimac CIM 4X150A, have (5) - \$75 ea. John Leier, Puro Oro Cache Co., PO Box 27004, Tucson, AZ 85726. (520) 573-0632

FOR SALE/TRADE: The following last minute items: Johnson Viking Ranger - \$175. Johnson Viking Adventurer - \$75. Collins KWM2 w/power supply - \$425. Collins 390A - \$325; 390A parts (Collins) set - \$175. HRO M w/3 coils - \$350. Admiral neon sign, 24 x 6, lt. green neon - \$275. Larry Drago, 383 Lincoln Dr., Cheshire, CT 06410. (203) 272-6030

FOR SALE: Electro-Voice 644 sound spot microphones - \$300/pair. RCA HB-3 xmitter tube manual - \$30. Zenith Royal 500, maroon, exc cond. - \$40. Bill Chersensky, 6 Kate Ln., Metuchen, NJ 08840. (908) 549-2165

REPLACEMENT GRILLE CLOTH for Radiola 103 Speakers, Excellent Silkscreen Reproduction of the Tapestry, \$32 each. Refundable if Not Satisfied, \$3.00 Shipping & Handling. Phil Guinan, 106 Page Rd., Litchfield, New Hampshire 03052. (603) 889-6213

WANTED/FOR TRADE: Will trade namebrand high quality radios for old fountain pens by Parker, Sheaffer, Waterman, Mont Blanc, Conklin, etc., or pay cash for the pens. Contact: Frank Weissman, 4 Shadbush Ln., Westport, CT 06880. (203) 454-1267, after 9 pm EST

WANTED: Silver-Marshall Z-Deluxe 13-tube console and Z-10 seven-tube console. Chuck Dachis, The Hallicrafter Collector, 4500 Russell Dr., Austin, Texas 78745. (512) 443-5027

VINTAGE MANUALS AVAILABLE for amateur, audio, and radio-related equipment. Quality is always our number one customer priority. Satisfaction guaranteed. Send two 32¢ stamps for catalog. Pete Markavage, THE MANUAL MAN, 27 Walling St., Sayreville, NJ 08872-1818. (908) 238-8964

FOR SALE: JIM CLARK'S E.H. SCOTT RADIO COLLECTORS GUIDE (1925-1946), 88 pages with over 190 pictures that identify their radios, cabinets and accessories including their original prices. Send \$29.95 plus \$2.00 handling to: JCE, 1292 Starboard, Okemos, MI 48864 or VISA/MAS-TERCARD orders call (517) 349-2249

FOR SALE/TRADE: Fender reverb. unit, 1965 - BO. 1960's Premier reverb. unit - \$225. Rauland amp EL-34's - \$85. Bogen J-050 - \$95. Challenger 2-6V6 - \$85. P.A. column 4X12 - \$100. Tuner dial restringing guides, set of five - \$25. Peter DeGregorio, 85 Burroughs Rd., Fairfield, CT 06430-3504. (203) 331-9155, evs.

FOR SALE: Motorola radio frequency amp AM-494/GF w/ps PP-638/U w/1953 manuals, (135) 6GH8. Dave Barth, 8320 Bevan St., San Gabriel, CA 91775. (818) 286-6503

FOR SALE: Zenith transistors: maroon 500D - \$35; black 500D - \$50; maroon 500E - \$35; black 500, hand-wired - \$125. Paul Ernst, 238 Meadow Ln., Webster, NY 14580. (716) 787-9879

FOR SALE: Graetz Super 160W German radio. WANTED: RCA V209 or V210 radio. Charles Harper, 2000 Jackstown Rd., Paris, KY 40361. (502) 769-0404

FOR SALE: Colonial cathedral 36AC, untested - \$90. Consoles: Zenith 12H-670; Freshman Masterpiece, untested; Philco 41-285, working - \$80 ea. Pickup only. John Walch, 381 Co. Rt. #17, Bernhards Bay, NY 13028

FOR SALE: Sparton 410 Junior, works - \$200. Crosley 10-139, green - \$60. Zenith 6-D-512W - \$90. WANTED: Chassis for Fada 1000 and Echophone 6 cathedral. Gary Watkins, 8006 Greenwald, Belton, MO 64012. (816) 322-0773

FOR SALE/TRADE: For swap or BO: H.H. Scott speakers, unused, new in box, walnut cabinets, 3-way, their best in 1959, Craftsman C-500, pr. Mac C8 preamps, pr. MC30 power xmfrs, Fisher 70 amp, Fisher 80 AZ amp, and Quad II amp/preamp. Michael Payne, 803 S. Taylor, Alvin, TX 77511. (713) 331-9217. Fax: (713) 585-2727, or e-mail: we300b@aol.com

FOR SALE: Axial lead electrolytics, fresh new Nichicon miniature 22mFd. at 450 VDC - \$1.25 ea. for 8 or more. Includes P&H. Many other types in stock. Write, phone, or fax for free flyer. DH Distributors, PO Box 48623, Wichita, KS 67201. (316) 684-0050, v/f

FOR SALE/TRADE: Freed-Eisemann Aeolian Model FM 40, No. 401022, excellent condition, with original hand-painted oriental scenes, works, a fantastic radio - \$750 or Catalin radio trade. Joe Matuska, 2523 Sunset Blvd., Steubenville, OH 43952. (614) 254-7806

WANTED: Broadcast-type MICROPHONES. Early carbon, condenser, ribbon, dynamic, etc. Cash or trade. James Steele, PO Box 620, Kingsland, GA 31548-0620. (912) 729-2242

ARCTURUS TEESHIRT SALE! I've acquired the remaining stock of Arcturus tube box art teeshirts issued formerly by Wireless World (see previous issues of A.R.C.), and I'm offering all sizes at the reduced price of \$12 plus \$3 shipping. These shirts are limited editions so once they're gone, that's it! Make checks payable to: Charles G. Carter, PO Box 354, Reidsville, NC 27323

WANTED: Parts for a 1961 Columbia Masterworks, Model 1066. The parts needed: pot transformer number #507-1 and a push-button slide type made by Oak Inc. switch number #69589-130. Call or write. Kurt A. Wieseman, 25735 Lorain Rd., North Omsted, OH 44070. (216) 777-6038

WANTED: BC-312 receiver and Philco 70 cabinet. Michael Harrington, PO Box 7619, Little Rock, AR 72217. (501) 223-9056

WANTED: Stromberg-Carlson Model 140 3rd IF transformer Part #26270 465K. Vance Rayburn, 2718 Homestead Rd., Madison, WI 53711. (608) 274-3002

WANTED: I will pay \$100+ for the little doll with Sony on its chest. Bob Wood, 3612 N. 12th Ave., Pensacola, FL 32503. (904) 432-3782

WANTED: Hoffman solar radio Model KP-706 or any other solar-powered transistor radios. Thanks! Marty Dzik, 412 Gregory St., Schererville, IN 46375-2290. (219) 322-4104

WANTED: 1st and 2nd IF xformer for GE S22, 175 Kc. Also case or junker set with good case for Emerson Model No. FU424 chassis. Edward B. Standifer, 3607 Forest Highland Dr., Chattanooga, TN 37415. (615) 877-3111

WANTED: EICO H60, Heath W6 amps. Scott 121-B preamp EQ; Heath XO-1 crossover. GEC KT77 tubes. John Birck, 458 E. 600 N, Orem, UT 84057. (801) 224-4809

WANTED: Philco 84B chassis, knobs. Emerson 587 knobs. **FOR SALE:** Majestic 72 cabinet. Andrew Mitz, WA3LTJ, 4207 Ambler Dr., Kensington, MD 20895. (301) 897-5531. E-mail: arm@helix.nih.gov

BOXED CLASSIFIED ADS WORK! This is a boxed classified ad. These ads can be run more than two months. See the inside back cover for details. Boxed ad deadline: the 1st of the month.



WANTED: Tube Hi-Fi components & commercial amplifiers by Marantz, McIntosh, Tannoy, Acrosound, Brook, Brociner, Fairchild, Hadley and others. Also want Western Electric theater amplifiers, speakers, tubes, & microphones. Richard Sharisky, PO Box 521, Belmont, MA 02178. Phone (617) 484-5784. Fax (617) 489-6592

WANTED: Vintage Electronic Music Synthesizers and modules by the following manufacturers, especially the listed models. Aires Modular, System III. ARP 2500. Buchia Modular, 100, 400. E-mu Modular. EML Electrocomp 100, 101, 200. EMS Synthi A, Synthi AKS, VCS3. Korg Modular PS-3100, PS-3200, PS-3300. Moog Theramin, Modular, Series 15, 35, 55. Oberhelm SEM modules, 2-, 4- & 8-Voice Systems. Pala Modular 2700, 4700. Roland Modular Systems 100, 700. Serge Modulars, System 79. Synton Modular System. Call and surprise me; make my day! John V. Terrey, 498 Cross St., Carlisle, MA 01741. (508) 369-9770. Fax: (508) 371-7129.

WANTED: Philips very large multi-speaker, table model (bi-amplified?). Jim Johnson, 1227 Haven Ave., Ocean City, NJ 08226. (609) 398-1151, anytime, no machine

WANTED: Roberts 720 stereo recorder service manual (or copy, or Sams data), and parts source. Chris Jones, 38 South Ridge Trl., Fairport, NY 14450. (716) 223-0095

— **WANTED** —
PICTURES FOR PHOTO REVIEW OR TELEGRAPH REVIEW PHOTOS MUST BE SHARP IN DETAIL A SHORT DESCRIPTION IS A MUST! SEE PHOTO REVIEW PAGES FOR ADDITIONAL INFORMATION

WANTED: Antenna for RCA K-62. Dial escutcheon and glass for RCA 810K. Front door for Zenith 7G605. Escutcheon and glass for Silvertone Model 4584. Leon Gann, 1134 E. 50 Pl., N, Tulsa, OK 74126. (918) 425-3590

WANTED: Zenith Royal 3000 battery case and cabinet right side; Crosley 124 IF xfmr. J.C. Woychowski, 17 Hope St., Niantic, CT 06357. (203) 739-6579

WANTED: Sonora Topper TW49, WAV 243 back, no cracks, original. RCA 96X13 Machine Age Bakelite, no cracks and complete. Karen McCoy, 8104 N.W. 114th St., Oklahoma City, OK 73162. (405) 722-0595. E-mail: karen.mccoy@oubbs.telecom.uoknor.edu

WANTED: N.O.S. tubes, broadcast equalizers, limiters, microphones, guitar amps. Mike States, Box 81485, Fairbanks, AK 99708. PH/fax: (907) 456-3419

WANTED: Maintenance and surplus conversion manual for the BC-348-R. Gary A. Reed, WB8OFU, 25395 Edgemont, Southfield, MI 48034. (313) 248-2446

WANTED: Power transformer for Zenith chassis 5808. Also, coil antenna for Zenith Model 7S432. Lance Latten, 10 Edison Dr., Huntington Station, NY 11746. (516) 427-2419

WANTED: Black videosphere Seiko TV watch, Sony Watchman TV FD-210, FD-20A. Lee White, 86 Spruce St., Framingham, MA 01701. (508) 788-0359

ELECTRON TUBES: Over 1 Million Tubes in Stock. Buy & Sell. Daily Electronics, 10914 NE 39th St. #B-6, Vancouver, WA 98682. 800-346-6667. 360-896-8856. 360-896-5476, fax

CAPACITORS - We rebuild Twist-Loc Capacitors. Custom Build Tubulars, Test capacitors to 6KV., and Sell new Capacitors. **SPECIALS:** 33uF. @ 400V. DIP 3/\$1.00; .0068uF. @ 600V. Sprague 160P Axial 3/\$1.00; .0033uF. @ 800V. Sprague 715P Orange Drops @ 50¢ ea. Expect 3. to 6. weeks backlog on rebuilding caps. **Commercials Call. FRONTIER ELECTRONICS/CAPACITORS - P.O. BOX 218 or 403 S. MCINTOSH ST., LEHR, N.D. 58460 PHONE/FAX 701-378-2341 EVERETT HOARD - owner.**

WANTED: Hallicrafters Models S-2, S-33, S-35, SX-112, EP-132, HT-2, HT-3, HT-8, HT-12, HT-14, console speaker R-8, RCA Model AVR-1, AR-88, Philco 3B-690, Midwest 20-38 chassis & speaker. Chuck Dachis, The Hallicrafter Collector, 4500 Russell Dr., Austin, TX 78745. (512) 443-5027

FOR SALE: Air King A-600, complete minus 1 knob, plays well, cabinet perfect - \$300. Air King shortwave adapter in original box with coils, rare - \$250. Emerson 1930's plastic, model unknown, center speaker with knobs on either side, nice - \$135. Crosley 124 cathedral, plays well - \$125. Crosley small cathedral 167, plays - \$110. Detroit, wood cabinet with beetleware around dial - \$195. Eico Model HF20 amplifier - \$100. Bell Model 2212-B amplifier 80W - \$50. Edison Amberola 30, nice - \$310. Edison Amberola X, nice - \$550. (50) cylinder records, 4-M - \$3 ea. Tubes, N.I.B.: 46 - \$10; 1P29 - \$25; 42 - \$10; 6F6 - \$10; 75 - \$10; 35Z5 - \$2; 5016 - \$2; 2050/A - \$7; 6080 - \$6; 024 - \$1.25; 0A3 - \$1.50; WL-868 - \$18; 866 - \$15; 6JS6 - \$20; 6BK4 - \$7; 6EA4 - \$5; 12AX7 - \$15; 7027 - \$20. Used: 12AX7 (U.S.A.) - \$4; 42 - \$5; 7027 - \$10; 7868 - \$10. Minimum orders - \$15. Contact: R. Whetstone, HC 84, Box 44, Arthur, WV 26816. (304) 749-7295, between 5-9 pm only

FOR SALE: Grundig SO-290/US, Bogen MTB60, Roberts 990, McMartin L252-B, Masterpiece 49509, Sound Power telephones. Francis H. Yonker, P.E., W21BH, 1229 Inverary Pl., State College, PA 16801. (814) 867-1400

FOR SALE: Catalin Fada 711, butterscotch, exc cond., no knobs - Best Offer over \$525. Jon Prabel, 2733 Wood Eagles, St. Charles, MO 63303. (314) 947-1543

FOR SALE: Public Address Equip. Man. Rider's Vol. I - \$50. Sams Photofact Transistor Radio Series - \$10 ea. All plus ship. Have list of many other radio, TV, electronics books, magazines - send SASE. Ben Martin, 18334 Pepper St., Castro Valley, CA 94546. (510) 582-6804

FOR SALE: (12) Radio News, July '24-June '25 in a bound volume, water stained, no stuck pages - \$145 ppd. Radio Relics, 15556 Sandra Ln., Sylmar, CA 91342. (818) 364-0491. Fax: (818) 367-1442

FOR SALE: DeForest Audion tube can, vg - \$17.50. Variotector galena crystal can, vg - \$17.50. Kacti needle envelope w/needles - \$8. Set (4) radio postcards Economy Radio Service, 1930's advertising, unused - \$12. Ray-O-Vac Radio Manual and Station Directory 1925, mint - \$25. Commodore 774D calculator in box - \$25. Tonearm and reproducer W.W. Kimball & Co., good - \$25. Grieshaber Baby Grand mini fountain pen/pencil set in case - Offer. Postage extra. R.C. Moore, 452 West Park, Aurora, IL 60506. (708) 264-0488

FOR SALE: N.O.S. CX-299, 2X199, WX226, WV-224, 20LF6-6LF6-6JE6, 6JG6, 21JS6 - BO, LSASE. Louis L. Veltre, 643A Sherwood Ct., Lakehurst, NJ 08733-4207. (908) 657-7592

FOR SALE: Hallicrafters SX-100 with matching speaker, mint - \$250. Silvertone 4763 chassis 101.471, 1940's, very clean - \$75. Both work. Lewis J. Newmire, 217 South 103rd East Ave., Tulsa, OK 74128. (918) 835-3737

FOR SALE: Industrial Instruments DK-10 decade capacitor 0-.111 mFd. 100 pF steps, oak case, Bakelite panel, nice - \$35 + UPS. Alan J. Kriss, 1872 Portsmouth Way, Union, NJ 07083. (908) 688-2092

FOR SALE: Weston Model 705 Sensitrol relay, looks unused w/instruction and in Weston box - Best Offer. Paul H. Putnam, 406 Gentian Rd., St. Augustine, FL 32086. (904) 797-3236

FOR SALE/TRADE: Revox A77 reel-to-reel nice condition. Joe Grace, 183 Colonade Cir., Naples, FL 33940. (941) 434-7571

FOR SALE: Radiola 17, needs p-transformer - \$35. Stewart-Warner battery radio, needs audios - \$35. Emergency boat radio, Mae West - \$40. Radiola 61-9 tan - \$25. Early Readrite tube tester - \$30. Add UPS. Clark Trissell, 3530 Pawnee, Lincoln, NE 68506. (402) 488-5263

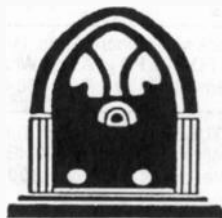

Craig L. Graybar Furniture Works Ltd.

(414) 258-2390

SPECIALISTS IN RESTORING,
REPAIRING AND REPRODUCING
CLASSIC STYLED ANTIQUE TV,
RADIO & PHONOGRAPH CABINETS

Send us your plans or your project
via UPS for immediate price quotes



1535 S. 84th St.
West Allis, WI 53214



"We Turn Ideas Into Heirlooms"

This Holiday Season... Give A Gift Subscription to Antique Radio Classified

BONUS: December 1995 Free!
All gift subscriptions received before
December 31 will be sent the December
1995 issue free!*

To Order:

1. Fill out the card in this issue with the recipient's name and address.
2. Enclose a gift card which we will send along with the bonus issue. (We will enclose our card with your name if you wish.)
3. Include payment or charge to VISA or MasterCard, and send to:
A.R.C., PO Box 2, Carlisle, MA 01741

Or Call (508) 371-0512.

P.S. There are more gift ideas from
A.R.C. on page 31.

* If already a subscriber, a 13-month extension
will be made to the recipient's subscription.

WANTED: Old style air-gap lightning arrestors that can accommodate longwire antennas. Paul Froehlich, 4152 Hwy. J, Cross Plains, WI 53528. (608) 798-4905. E-mail: pafroehlich@hosp.wisc.edu

WANTED: Copy of manual and schematic of: RCA 70 watt power amp. Model MI-12182 Serial in 3000's, output uses pair 6146, total (7) tubes. Also manual & schematic for Eico HF-20. Gladly pay copy & postage cost. Edward R. Barbcow, 330 Ceylon Rd., Carmichaels, PA 15320

WANTED: Music Master 21" wood bell speaker, have driver. Radiola II case lid. Severin T. Dvorsky, 380 Morrison Dr., Pittsburgh, PA 15216. (412) 344-6633

WANTED: Zenith Stratosphere and other high-tube count radios. Also Zenith and other pre-1950 advertising. We will buy or trade. Alan Jespersion, PO Box 17338, Minneapolis, MN 55417. (612) 727-2489

WANTED: Information on Zenith Wincharger, such as installation instructions, wiring diagrams, etc. Thanks. Butch Grieves, 2313 W. Summit Pl., Chandler, AZ 85224. (602) 820-1644

WANTED: Central Scientific (Cenco), L.E. Knott and W.M. Welch Electrical items and catalogs before 1942. Tom Burgess, #9 Belle Meadow Ln., Little Rock, AR 72210. (501) 455-0773

WANTED: Few good UV199 any brand; DeForest D10 plug-in coils; large Addison Model 5 yellow knobs; Fada 652 yellow or red knobs; DeWald yellow knobs; Burns black horn bell, can be broken; Music Master wood bell; UZ1325 base; also need horn speakers and parts; Catalin radios, cabinets and parts; early battery and crystal sets. Call before 2 pm EST or call later and leave message. Joe Pisanski, 114 Evans Rd., Norristown, PA 19403. (610) 539-0756



WANTED: RX-5600 Panasonic FM/AM FM stereo radio cassette or JVC equivalent or bigger Panasonic radio. Bill Veenstra, 15 Richmond Dr., Brampton, Ontario, Canada L6W 2E7. (905) 451-1026, evenings

WANTED: Regency TR-1, Sony TR-63. Japanese-made tube portable radios. Anything Hughes Spruce Goose related. Takashi Doi, 1-21-4, Minamidai, Seyaku, Yokohama, Japan. Fax: 011-8145-301-8069

WANTED: Paying the following for new in original box Western Electric tubes: VT 52 - \$80; 101D T.B. - \$150; 101D ST - \$40; 104D T.B. - \$150; 104D ST - \$40; 205D - \$195; 205F - \$65; 231D - \$40; 262 A/B - \$40; 264 A/B/C - \$40; 271A - \$110; 272A - \$30; 274 A/B - \$150; 300A - \$400; 310 A/B - \$10; 301A - \$75; 314A - \$70; 345A - \$40; 348A - \$35; 349A - \$35; 350B - \$120; 398A - \$10; 404A - \$5; 422A - \$35. Others also wanted. Tim Metz, 221 Wheatland, Fairview, OK 73737. (405) 227-2456

WANTED: Paying the following for good used tubes: 2A3, any brand, flat-plate (single plate) - \$60; C-585 - \$100; WE used: VT52 - \$45; 101D T.B. - \$100; 101D ST - \$20; 104D - \$100; 205D - \$150; 231D, 262 A/B, 264 A/B/C - \$20; 271A - \$60; 274 A/B - \$80. Others wanted, any brand: VT52, 211/VT 4C, 50, 250, 845, KT88, KT66, mesh plate tubes, tennis ball. Call or write for quote. Tim Metz, 221 Wheatland, Fairview, OK 73737. (405) 227-2456

WANTED: WW2 Japanese military radios of any kind. BC-222, TBY-7. Anything German V-1, V-2 rockets related. Takashi Doi, 1-21-4, Minamidai, Seyaku, Yokohama, Japan. Fax: 011-8145-301-8069



WANTED: RX-7700 Panasonic stereo cassette recorder with FM/MW/SW1/SW2/SW3 radio or JVC equivalent or bigger Panasonic or Grundig. Bill Veenstra, 15 Richmond Dr., Brampton, Ontario, Canada L6W 2E7. (905) 451-1026, evenings

WANTED: Breting Models 9, 40, 49 for my private collection. I am desperately seeking BC-14A detector top cap and glass, maybe from a DeForest detector. Also any pre-1929 radios and Duck catalogs. Thanks! Steve Lipsky, W2VVN, 1254 Cox Rd., Rydal, PA 19046-1207. (215) 884-1817, alt. (609) 361-8175

WANTED: N.O.S. tubes. 5881/6L6GC, 12AX7/7025, 5AR4/G234, 7027, 6550, 7591, 6BQ5/EL84. 6CA7/EL34, 6V6 GT, 5Y3 GT, 5U4G, old Jensen Alnico speakers 10" & 12". Old harmonicas, all makes & models. John McGrath, 29 Ripley Rd., Belmont, MA 02178. (617) 484-0515. Fax: (617) 492-7921

WANTED: Yaesu FP-757 switching power supply. Cash or swap from my long list. George H. Goldstone, W8AP, 1010 Burnham, Bloomfield Hills, MI 48304. (810) 647-3399

WANTED: Cabinet for Kennedy Model 281, Grebe Synchronphase Model MU-1, Crosley Model 51, Hartman 4-tube, Crosley Model D-25MN & Model 555, DeForest Model F-5, Echophone Model 3, Zenith Model 5R-317, Workrite 3 tubes, Nunn Landon-Cascade, Thompson Model S-70, Montgomery Ward Model 62-197, Silvertone 4500A. Speaker for Thompson Minuet, dial for Airline Model 62-274. Dial glass for Westinghouse Model H-188. Complete reproducer & turntable for Victrola Model 9-16. Complete radios Majestic Models 666, 776, 886 & 906. Larry Porter, 4115 Beam Rd., Crestline, OH 44827. (419) 683-2540

WANTED: Zenith Trans-Oceanics 7000 American and 3000-1, need not be working. Jim Montague, 1907 South Stanley Ln., Spokane, WA 99212-3273. (509) 535-9576

WANTED: Tube chart (copy) for B&K #650 and the 610 adapter for Mod 550. Thanks a bunch! William Miller, 3410 Hunnicutt Ln., Sacramento, CA 95821-3520

FOR SALE/TRADE: Novelties: Violin, Adam Eve, Gumbly, Owl, Standing Knight, and others. SASE for list. Ken Wong, 1460 Belleville Way, Sunnyvale, CA 94087. (408) 735-1815

FOR SALE: (9,550) N.O.S. tubes, semiconductors, protected in (31) tube caddies. Send want list and a fair price you'll pay, (1) piece or all. Also, free use of my Sams #100-#1800, all letters answered promptly with LSASE. Visit: Jim Brown Audio, 7708 Main St., West Rushville, OH 43163. (614) 536-7322

FOR SALE: Atwater Kent 2000? Model 20 console cabinet (like pictured in Flick of the Switch, p. 64). This is not metal but beautiful mahogany with power supply. Picture available. You pick up. Joe Rauch, 215 S. Lombard Ave., Lombard, IL 60148. (708) 627-2605

FOR SALE: Meissner Model 1093 mahogany console, (22) tubes, tuning eye, 190 watts, Webster changer, cannot ship - \$150. Jack Bailiff, 3310 S. Elm-Eugene St., Greensboro, NC 27406. (910) 273-0011

FOR SALE: Philco 84B/150, 48-482/75, 42-355/100, 41-250/125, 60/125. Thousands of old TV knobs, many new, about 75 lbs. for - \$100, plus UPS. Frank D. Atwood, Nostalgia Radio, 117 E. Main St., Merrimac, MA 01860. (508) 374-1030

FOR SALE: Philco 66 tombstone - \$100. GE J-60 cathedral, needs refinished & restored - \$150. Emerson Ingraham cabinet, dual speakers, good cond. - \$100. Magic-Tone bottle radio - \$300. Silvertone metal candy cane type - \$75. RCA R-15 Repwood front floor model - \$150. McMillan 6-tube battery operated - \$100. Chassis & speaker for Zenith 96365 Stars & Stripes - \$125. Chassis for Zenith 8-tube for 1937 model, 1 shaft missing - \$100. National SW3, paint touch-up, no power supply - \$250. Bulova transistor radio store rack - \$150. Majestic 776 Ritz console. Trans. extra. Joe Szabat, 1019 Hilland Ave., Coraopolis, PA 15708. (412) 264-7498

Wanted

(Top Prices Paid)

1. Western Electric Tubes, Amps, Drivers, Horns, Speakers, Parts, etc.
2. Tube-type amps from Marantz, McIntosh, ARC, Quad, Leak, Dynaco, Fisher, etc.
3. Telefunken audio tubes & KT-66/77/88, etc.

Also Wanted... Vintage watches from Patek Philippe, Vacheron Constantin & Audemars Piguet

David Yo — Audio City USA
PO Box 80371
San Marino, CA 91118-8371
Telephone: (818) 441-3942

FOR SALE: Scott Masterpiece 14 tube, excellent, shiny chrome, chassis, knobs, speaker only, plays fair - \$650. Untested Federal Jr. crystal set & Baldwin earphones, original & complete except whisker - \$275. 1933 brown Kadette Jr. 2-tuber (Bunis 2, p. 102), no power cord & one almost invisible rear hairline - \$275. Three Emerson 6 3/4" wide midgets, Model 811-B, non-painted solid color plastics, (Bunis 3, p. 77), cosmetically perfect - \$150 for all. Bill Burkett, PO Box 2488, Sun City, AZ 85372. (602) 974-4535. Fax: (602) 974-4323

FOR SALE: Vibrators N.O.S., Hallicrafters 5R10A, good chrome - \$40. Emerson 705, fair, no handle - \$20. AK 30 - \$50. Jackson tube tester 648S - \$50. EV 12" speaker 12BWS in cabinet w/tweeter & crossover, Utah 12" speaker G12R, Shure mic #545 Unidyne III Dynamic - \$40. Philco 38-7 dial assembly incl. lens - \$20. Xerox Zenith A600 & A600L owner's manual - \$5. Chassis & spkrs: GE E-81. Zeniths: 61, 12S568E (Chassis 12A1). Sony EFM-117 (damaged, good leather case), many used tubes, Photofact Folders, new & used parts. Send SASE. Tell me what you need. Thanks. Wilbur Gilroy, 129 Belmont Ave., Clarks Green, PA 18411. (717) 586-7356

FOR SALE: Zenith T-shirts: New!! Fabulous 1938 robot dial design with a green 6T5 tuning eye and Zenith long distance radio, ivory and green on black. Also, the classic Zenith logo, ivory on black or black on white. All shirts cotton high-quality heavyweight. Large, XL - \$12; XXL - \$14; XXXL - \$15. Add \$4 shipping per shirt. We accept Visa and MasterCard. Alan Jespersen, PO Box 17338, Minneapolis, MN 55417. (612) 727-2489

FOR SALE: Shure 330 ribbon mic - \$250. Fada 252 Temple - \$250. TV tubes, N.I.B. (no list) - 10¢ ea. by the box full. WANTED: Theremin or any information about this 1930's musical instrument. Walt Murray, PO Box 231340, San Diego, CA 92123. (619) 271-1858. Fax: (619) 271-1859



Greenbaum
Radio
Refinishing

**Professional Radio Refinishing
Using Hand-Rubbed Locquers**

From Cleanup/Touchup to Full Refinishing
Veneer Repair
Faux Graining
Glazing/Shadowing
Reasonable Prices
Satisfaction Guaranteed!

**Call Joe Greenbaum
Weekdays 5pm-10pm est
Weekends 10am -10pm est**

(410) 752-2438

FOR SALE: Radiola 26 incomplete but in good condition - \$75. Trav-Ler 1928 portable, (see Douglas 2, p. 214), vg, NT - \$175. Radiola 24, complete, vvg panel and chassis, poor cover, NT - \$375. Peerless speaker, vg, all original, works - \$40. Aeriola Sr., vvg, works, original paper, NT - \$190. Western Electric telegraph relay No. 22A and No. 24A, vvg, brass on slate - \$35 ea. Aeriola AC amplifier, vg, good original transformers, NT - \$225. Aeriola Sr., good case, vvg chassis, works, original paper, NT - \$180. Marconiphone II one-tube regen. receiver and Marconiphone II two-tube audio amplifier, vg, both play very well, NT - \$775 for both. Hawley horn speaker, vg, plays well - \$125. Aeriola Sr., good case, good chassis, works, NT - \$160. Shipping extra. Richard A. Botzum, R.D. 2, Box 419, Morgantown, PA 19543. (610) 286-0047, or fax (610) 286-5315

**E-MAIL ADDRESS FOR
ANTIQUE RADIO CLASSIFIED**

ARCMagzine@aol.com

**Ads - Subscriptions - Book Orders
See inside front cover for details**

FOR SALE: Catalins: RCA 66X black/gold and a red one, (2) Garod Commanders, Stewart-Warner, green open grille bullet, Addison 5 black/gold, Bendix 526C. Also Trans-Oceanic 7000s, Royal 200, 500D, blue Explorer chip, tiny Marvel chip, gray Pioneer, Philco T-51 in box, (2) micros, Rambler, Crosley book radio, Sterling hybrid chip. Also Delco ribbon grille, Emerson 540 midget bottom chip, Marlins helmet radio, Catalin clock, new in box Catalin poker chips, a great Philco neon advertising clock and old circus posters cheap. Ted Chronister, 7073 Carlisle Pike, #26, Carlisle, PA 17013. (717) 766-6436

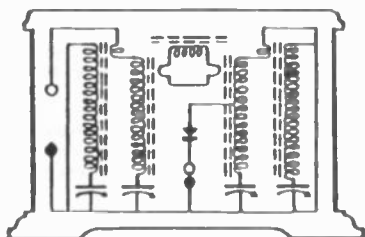

FOR SALE: Disclosure of all that's inside my unbeatable crystal set - \$20. John Stanley, 6156 Summit Ave., Brown Summit, NC 27214

FOR SALE: GM Little General 250 - \$115. Grundig 2540 - \$65. Philco T702-124 VII - \$25. RCA 65X1 - \$30. Zenith Royal 755 - \$35. Charles Voigt, 94 Cleveland St., Norfolk, MA 02056. (508) 528-7928

FOR SALE: Book: From Tin Foil To Stereo, first edition, 1959, by Oliver Reed and Walter L. Welch - \$160 ppd. Alvin Sydnor, 806 Meetinghouse Rd., Boothwyn, PA 19061-3504

FOR SALE: Midwest Chassis 37-18 - \$125. American Bosch 66 with instructions, very nice original condition - \$120. Radiola 25 with loop, needs refinish - \$100. Price does not include shipping. Leonard Aquino, 2 Somerset Ln., Putnam Valley, NY 10579. (914) 528-6857, 7:30-10 pm EST

FOR SALE: AES Collection, 1953 to present, over (330) issues, value over \$3,500 - Make Offer. M.C. Agress, 891 Fulton St., Valley Stream, NY 11580-1213. (516) 825-8955

FOR SALE: Clapp-Eastham R4 Radak - \$275. Freed-Eisemann NR60 - \$85. Crosley 21 and Dynacone loudspeaker - \$75. Grebe Synchronphase MU1 - \$175. Atwater Kent 47 with matching F2 loudspeaker - \$115. Crosley 5-38 - \$85. RCA R7 tombstone - \$80. RCA 16T4 - \$40. Three early home brew or kit radios - \$75 ea. Shamrock battery set - \$75. Magnavox loudspeaker horn only - \$30. Radiola 100 loudspeaker - \$40. CBs and communication equipment: Johnson 124 Messenger with Turner desk mic - \$40. Polytronics PCN12 in original box - \$60. Regency Imperial - \$20. Robyn T240D with Turner Plus 3 mic - \$40. (2) Vocaline JRC400 transceivers - \$35. Heathkit DX60 - \$35. Galaxy 5 transceiver and power supply - \$35. Hammarlund HQ110 - \$50. Heathkit QF1 Q-Multiplier - \$20. Heathkit AM2 reflected power and SWR bridge - \$20. Heathkit HG-10 VFO - \$25. Televisions: Hallicrafters 513 Sky-rider Bakelite TV - \$165. Teletone Bakelite porthole TV - \$150. Microphones: Astatic D104 - \$30. Electro-Voice 636 Slimair with adjustable line matching transformer - \$45. Electro-Voice 729 desk mic - \$25. Electro-Voice 915 mic and stand - \$25. Turner desk mic - \$20. Argonne AR54 mic and stand - \$25. Argonne AR57 broadcast style mic and stand - \$75. Pilot FA680 tube tuner with Heathkit A7 amplifier - \$50. Large assortment of test equipment, books, magazines, catalogs, etc. available. Send SASE for list. Thanks! David Petrozello, 80 Lincoln Ave., Johnson City, NY 13790. (607) 770-4026

FOR SALE: RCA Model 1-X-56, table plastic, maroon, upper front half-round dial, reconditioned, vg condition, (Grinder, 2nd) - \$60 plus shipping. Bill Walker, Box 1444, Groton, CT 06340-1444

FOR SALE: (8) Catalin radios. Ask for list #CATR. Send SASE. Bob Zelenack, PO Box 460642, Escondido, CA 92046. (619) 749-9652, or fax: (619) 749-4291

FOR SALE: Rare blue Fada 1000 unrestored, mint. Best offer over \$2,500. Bob Masterson, Box 172, Valley Cottage, NY 10989. (914) 353-3151

FOR SALE: Collection of (18) portable, tube radios, all mini tubes except Motorola Pixie. C.E. Clutter, 14407 N.E. Fremont St., Portland, OR 97230. (503) 254-9296

FOR SALE: Heathkits with manuals: IT-28 capacitor tester, test leakage to 600WVDC - \$35; IG-28 color/dot generator - \$42; PS-4 0-400VB+, 0-125VC power supply, no manual - \$48; IT-5230 CRT tester/revivinator - \$55. Military MX-1258/U tube test adaptor sets, 9 sockets, vg - \$48. Eico 667 mutual conductance tube tester - \$75. Much more, list - LSASE. Kirk Ellis, KK4YP, 203 Edgebrook Dr., Pikeville, NC 27863. (919) 242-6000, evenings

**REPLACEMENT DRIVERS FOR
ATWATER KENT HORNS**

Driver w/housing for Model M & Pooley horns (this assembly replaces all pot metal) \$65.75 + \$4.75 s&h

Driver w/repair ring for Models G, H, & L (repair ring replaces threads in base) \$59.85 + \$4.75 s&h

All drivers above include diaphragm, gaskets, spacer, and spring. All parts are also sold separately. Send SASE for price list.

**M. Harold Ezzone, 4861 Park Drive
West Des Moines, IA 50265 - (515) 221-9447**

FOR SALE: McIntosh MR-71 tuner, near mint - \$850. McIntosh 1700 tube/solid-state receiver - \$850. McIntosh Mod 2100 all chrome solid-state amp, 100 watts per channel, in exquisite condition - \$875. McIntosh C-24+C-26 tuners - \$600 ea. Heath W5M mono amps - \$495 pair. McMartin LX40 solid-state mixer/preamp - \$200. Citation II w/four KT 88's - \$850. Larry Drago, 383 Lincoln Dr., Cheshire, CT 06410. (203) 272-6030

FOR SALE: GE P-711A transistor - \$50. Westinghouse H791P6/GP transistor - \$20. Zenith Royal 20 IB - \$25. Matsushita T-50 - \$30. Zenith Royal 20 - \$25. Zenith Trans-Oceanic 8G005YT - \$50. Sentinel 32B tombstone - \$50. Air King A450 Midget - \$40. Knight KG-250 stereo amp - \$40. Emerson 508 - \$35. Pilot tuner FM, wood - \$25. Rogers-Majestic 6R511 1936 table - \$65. Science Electronics Inc. 1955 radio kit T-200, build (15) different radio circuits, N.I.B. - \$100. All + UPS. Terry Browning, 312 11th St. SW, Alabaster, AL 35007. (205) 620-4345



FOR SALE: RCA tube display from early 30s - BO. RCA baffles MI-4428 and speaker MI-6243 - \$600 or BO. RCA 77DX - \$1,100. RCA MI-6225 mics - \$75 ea. MacIntosh MA-230 - \$350. Robert Ramirez, 376 H St., Lincoln, CA 95648 (916) 645-3406

FOR SALE: Motorola 53H, perfect - \$100. Emerson Model 19 Miracle Six Deco Bakelite (Stein, p. 75) - \$125. Remler intercom set, matching Bakelite cabinets - \$100. All plus UPS. Thank you. Bob Furtado, 23 Garden Rd., Alameda, CA 94502. (510) 521-3084

FOR SALE: Weston meters, Models 528, 628, 689, with carrying cases, all - \$45 plus UPS. SASE information. George Greenberg, KD4OBV, 1701 Andros Isle K-2, Coconut Creek, FL 33066. (305) 971-9053

FOR SALE: Receivers, Collins VLF - \$300. Drake 2B w/2BQ speaker - \$175. Plus UPS. Best regards. Chuck Bray, 1322 Ivy Rd., Bremerton, WA 98310. (360) 373-1013

FOR SALE: Zenith '28-'48 Index to Service Bulletin: serial number, model, year, chassis, 30 pgs. - \$15. Gary A. Micanek, 226 Henry Ave., Manchester, MO 63011. (314) 227-7046

FOR SALE: McIntosh MA5100, vg - \$350. Eico HF81, vg - \$95. Empire 598 turntable, good - \$195. Akai X-1800SD R-to-R & 8-track, vg - \$85. Pioneer CTF1250 cassette deck, good - \$85. Harman Kardon 720 receiver, vg - \$75. All items plus shipping. Vince Rhea, 2407 Lore Rd., Anchorage, AK 99507. (907) 349-5519, evenings, machine on 4th ring

FOR SALE: Radios, parts, tubes, 6A3, 6L6GB/G, 6LQ6/6JE6C, 6146, 6883, 7591A, 7984, 8560A, others; LSASE. W.F. Horn, 13110 Marsh Rd., Bealeton, VA 22712. (540) 439-9781

FOR SALE: Special offer: GE radios, very reasonable prices. Send for photo list. Robert J. Stone, 721 Fisk St., Piqua, OH 45356-3729. (513) 773-2217

FOR SALE: One each. Tennis balls. WE. VT-2 - \$125. 205 by J&A. Bakelite base - \$100. Good filaments. VT-1 - \$60. Ed Bell, 5311 Wooddale Rd., Raleigh, NC 27606. Fax/phone: (919) 851-1517

FOR SALE: Command 857 CRT tester, rejuvenator - \$60. RCA WV-98C Senior Voltohmmyst - \$40. Dynaco PAS2 and Stereo 70 - \$250. Eico amps HF-35 and HF-50 - \$65 ea. Philco butterfly Model 45, restored - \$175. Emerson 744B - \$150. Everready three-shelf battery display stand, nice promo - \$75. Victor VV-50 player - \$100. WANTED: Video cassettes for technicolor format VCR. Richard Leizure, PO Box 245, Granby, CT 06035. (203) 653-6477

FOR SALE: Zenith 7S529 - \$85. Magnavox AC amp cabinet - \$45. Tri-City W-2 - \$100. DeForest LS 300, no driver, repainted - \$100. Stewart-Warner 520 - \$40. QRS - \$25. Daven MU - \$15. Emerson chassis, same as Mickey - \$100. Clock from Jackson Bell - \$40. Blonder Tongue UHF converter in box - \$20. Zenith 10-tube chassis - \$20. Cross World Master - \$35. USAPF output meter - \$20. Magnavox Model T chassis - \$25. Charles Haynes, 219 W. Spring, Marissa, IL 62257. (618) 295-3664

FOR SALE: Mantola (BF Goodrich) Model R662N portable - \$20 plus UPS. Jim Clifford, KE4DSP, 108 Bayfield Dr., Brandon, FL 33511. (813) 654-7531

FOR SALE: Zenith 1000D Trans-Oceanic with orig. books & service manual, exc cond. - \$135. AK 275 & Philco 45 ch. only for both & both restored - \$65 ea. or will buy your cabinets. (2) Dayrad tube testers, Bakelite, small case for 4- & 5-pin tubes - \$35. Other one in solid wood case Series 27 with chart for 4- to 8-pin tubes - \$45. Joe Svihel, 17227 Co. Rd. 54, Avon, MN 56310. (612) 356-7601

FOR SALE: Working Grunow 1297 Teledial chassis and sprk - \$50. Silvertone Model 70 wire recorder - \$35. Leon Bitters, 4209 Logtown Rd., Lena, WI 54139. (414) 834-3707



FOR SALE: 1930 Serenader, 6 ft., 5 in. high stained glass windows on front and sides and candelabra all light up, General Electric clock in top - \$2,000/BO. You pick up. Kenneth Zander, PO Box 2652, Sunnyvale, CA 94087. (408) 286-1104

FOR SALE: RCA Model U46 radio-phonograph console mahogany cabinet. (10) push buttons front-adjustable antenna, tuning eye, AM, SW but missing self-contained power supply - Best Offer. Ken Slegler, 2424 Taylor Ave., Alexandria, VA 22302. (703) 836-7242, night. (202) 767-3894, day. E-mail: slegler@es-td.nrl.navy.mil.

FOR SALE: Zenith Trans-Oceanic Royal 3000-1, nice - \$125. Guild Buccaneer Chest - \$125. Assorted Bakelites - \$75 choice. Will trade any above toward any Catalin or white Emerson USA. Plus UPS. Vernon Shatwell, Rt. 5, Box 195, Sapulpa, OK 74066. (918) 224-4551, after 7 pm CT

FOR SALE: Swan 400E and 400G SSB transceivers - \$50 ea. Meissner Deluxe signal shifter - \$75. Morrow Model 5W-3 three-channel CB - \$15. Wasee Electronics Model JB 76 10-11 meter linear with two 8417 tubes - \$25 + UPS. Mervyn Ellsworth, 2309 N. 25 St., Boise, ID 83702. (208) 345-6878

FOR SALE: The information you need on capacitors, from Crys Tech, The Crystal Set Techniques Company. Restoring a crystal set? Want to reproduce a 1910 home brew? Need a variable capacitor for experimenting? Answers to your questions and much more about capacitors, comes in this latest publication. Order Report No. 4 Capacitors for Crystal Sets, postpaid in U.S.A. for \$5.50, from: Crys Tech, c/o P.A. Kinzie, PO Box 8605, Kingman AZ 86402

FOR SALE: Beautiful miniature replica working radios of the 30's and 40's. Models include Emerson BA199, RCA 9X12, Crosley 56TD, Majestic 5LA5, Motorola 51X16, Addison A2A, Addison 5F and Philips cathedral. Great detail and colors. Only \$19.95 ppd. Herb Parsons, 5 Surrey Ln., Peabody, MA 01960. (508) 535-1009

FOR SALE: Plastic Zenith sign, 70x27, in box, black background big gold "Zenith" with smaller "quality goes in, etc." - Best Offer. RCA Senior VoltOhmyst - \$25. Box of (19) transistor radios - \$100 (SASE for list). Plus shipping. Steve Adams, 919 Poplar St., Moody, AL 35004. (205) 640-2701

FOR SALE: Zenith Royal 500 Deluxe, black with carrying case, papers & original leather box for all items, pristine mint, set never used - \$150. T. Romano, 8 Howe Ln., Millbury, MA 01527. (508) 865-6293

OLD TIME

RADIO BROADCASTS ON CASSETTES

Many of your old time radio favorites are available on quality cassettes at a reasonable cost. You select the shows you want and purchase them by the hour. Fast, friendly service too.

The Great Gildersleeve

The Whistler

Suspense

Jack Benny

Sherlock Holmes



Lux Radio Theater

Amos 'N' Andy

Sgt. Preston

The Lone Ranger

Fibber McGee & Molly

Send for our catalog listing nearly 5,000 shows arranged by show category and title, many including original broadcast dates.

Only \$2.00 (P & H). Send request to:

ERSTWHILE RADIO
P.O. BOX 2284
PEABODY, MA 01960

FOR SALE: Philco 40-155 - \$40. Philco 41-250 - \$40. Plus shipping. Both need repair. Robert J. Stone, 721 Fisk St., Piqua, OH 45356-3729. (513) 773-2217

FOR SALE: Rare Tuska Mod 300 in beautiful condition - \$450. Federal DX-58 - \$950. Metrodyne Super Five - \$350. Polly Royal with beautiful twin gold parrots and tree scene on front black Bakelite panel, stunning art work - \$500. Larry Drago, 383 Lincoln Dr., Cheshire, CT 06410. (203) 272-6030

FOR SALE: Spartan Junior 410 cathedral - BO. N.O.S. tubes: 5U4GB - \$7; 6AU6, 6BE6, 12AV6, 12BA6, 12BE6 - \$2.50 ea. 6SL7 - \$4.50 ea. 6X4 - \$3. 25L6 - \$3.50. 35L6 - \$3. 50L6 - \$4. Bulk 60K6 - \$1 ea. Used tubes: 1B3, 1K3, 1X2, 3A3, 3AT2, 3BT2, 3CB6, 3CU3, 6AG5, 6AH6, 6AL5, 6AU4, 6AU6, 6AX4, 6CB6, 6GY6, 6HZ6, 6K6, 6SN7, 6W4, 6W6, 12AX4, 12SN7, three for - \$1. 4JC6, 5AQ5, 5U8, 6AK5, 6AQ5, 6AW8, 6BA8, 6DT6, 6BU8, 6EA8, 6EH7, 6EJ7, 6GH8, 6GU7, 6H58, 6JC6, 6U8, 8CG7, 9U8, two for - \$1. 5Y3GT, 6BQ6, 5963/5814, 12AU7 - \$1 ea. Used metal tubes: 6AC7, 6AG7, 6C5, 6H6, 6J7 - \$1 ea. Most Compactrons and loctals - \$1 ea. 2GK5, 3GK5, 4GKA5, 5U4GB, 6ES8, 6BG6, 6GK5 - \$2 ea. 2A4, 27 - \$2.50 ea. 6AS7/5998 - \$5 ea. Metal 6L6 - \$4 ea. Minimum order \$40 plus \$9 S/H. \$100 order gets \$10 worth of free tubes plus free shipping. Mail MO or check to: George Stagakis, George's Radio and TV Repair, 1714A 41st St., North Bergen NJ 07047. (201) 867-9136

FOR SALE: HRO 60 coils F&J with dial plates - \$150 set. Pete Malvasi, WB2BYQ, 75 Church St., Ramsey, NJ 07446. (201) 934-0321

FOR SALE: Pup, Crosley Pup, vg condition - \$375. Steve Dando, 4572 Mark Trail, Copley, OH 44321. (216) 666-7222

FOR SALE: Hallicrafters S-38 comm. receiver, 1946, untested - \$25. Donald Sochurek, W191 S7500 Richdorff Dr., Muskego, WI 53150. (414) 679-0212

ARBE-III - Universal Battery Eliminator

- ⇒ Specifically designed for early battery-operated radios.
 - ⇒ Custom wound xfomer
 - ⇒ Quality components used
 - ⇒ Five-year warranty
 - ⇒ Proven accurate specifications
 - ⇒ Isolated A, B and C supplies for maximum flexibility
 - ⇒ Safety features not found in kits
 - ⇒ Over 450 satisfied customers
 - ⇒ Technical assistance available
- \$149.95 Shipped USA**

Contact:

Antique Radios Inc.

Box 6352, Jackson, MI 49204

(517) 787-2985 or

Fax (517) 782-7422



FOR SALE/TRADE: Circa 1930's all chrome McMurdo Silver Masterpiece VI with power supply and speaker, no cabinet, in magnificent original rust-free condition - \$1,650. Also another Masteriece VI with slight rust, no speaker, no cabinet - \$950. Larry Drago, 383 Lincoln Dr., Cheshire, CT 06410. (203) 272-6030

FOR SALE: (36) table and console radios, test equipment, tubes, literature, books. Send SASE for list.

WANTED: Needed: Schematic diagram for Supreme Model 561AF and RF signal generator. Antenna coil RFT#1 for AK Model 82 radio, PRF-11 probe for Eico VTVM Model 249. Paul M. Williams, 2364 Beaver Valley Pike, New Providence, PA 17560-9622. (717) 786-3803

FOR SALE: Cleaned out old TV shop. Something for everyone! Box of assorted microphones. Box of assorted transistor radios. Box of speaker drivers. 7S-633 Zenith, working, complete except cabinet. Fisher X-100 and 100-R working in hand-made cabinet. Two .05-6000v caps, N.I.B., look like dynamite sticks!, (8) N.I.B. 35TG tubes. Box of 2050W tubes, used. Sylvania tube tester with scroll chart, Eico VTVM, etc. Call or write for details. Trades? Eric Miller, PO Box 778, Linn, MO 65051. (314) 897-4121, evenings

FOR SALE: Model A-1 wirecorder - \$40. NRI multi-tester - \$25. N.O.S. 7" rack panels - \$10 ea. Plus UPS. Ed Povraznik, 9606 Biddulph Rd., Brooklyn, OH 44144. (216) 661-0032

FOR SALE: Heathkit W-5M amplifier - \$350/pr. Heathkit SP-2 stereo preamp - \$60. Heathkit W4 AM amplifier - \$140. Heathkit A9 amplifier - \$60. Radio Craftsmen Model 10 AM/FM chrome tuner - \$60. Model 62-9023 chrome guitar amp chassis - \$20. James Homan, 401 Valley Dr., Valley Springs, SD 57068. (605) 757-6424

FOR SALE: Pyramid capacitor, resistor analyzer, Model CRA-1, manual - \$30. Heathkit FET/transistor tester #IT-3120 manual - \$35. Knight RF signal generator #KG-650 - \$12. Heathkit RF signal generator #SG-7, manual - \$15. Heathkit RLC bridge #1B-5281, manual - \$20. Plus UPS. Large list of catalogs and magazines from 1940's-1970's. Large SASE 2 stamps please. Jim Watson, PO Box 104, Coarsegold, CA 93614. (209) 683-7260, evenings

FOR SALE: Collection of wooden and Bakelite radios. Regal, Emerson, RCA, Admiral, Philco, Zenith, GE, etc. - \$200 for nine. Old radio books, magazines, manuals, catalogues - SASE for large list. Patrick Henry Jr. crystal set - \$395. Pop-up Zenith - \$65. Westinghouse refrigerator, brown - \$150. Heathkit grid dip meter - \$30. Bill Rolf, 30131 Center Ridge, Westlake, OH 44145. (216) 871-4547

FOR SALE: Zenith 6D2615 - \$55. Zenith Consolestone 6D015ZY - \$50. Zenith Consolestone 6D615 - \$50. All plus UPS. James W. Poitviant, 3 Darby Cir., E. Mt. Holly, NJ 08060. (609) 261-0059

FOR SALE/TRADE: Fada Temple Mod 652 reproduction dial faces, glass in full color w/gold background - \$45 ea. + \$5 shipping while supplies last. Larry Drago, 383 Lincoln Dr., Cheshire, CT 06410. (203) 272-6030

FOR SALE: Magnificent Telefunken Allegro stereo, 7-tube receiver, delight to the rich, full-bodied sounds and elegance of the Allegro - \$300. Nordemende Othello, rare, large, superphonic, high fidelity true stereo receiver, (9) tubes, (4) speakers; many exciting features incl. 360° direction finder display in same league as the Tannhauser, flawless - \$400. Telefunken Opus stereo high fidelity system incl. multiplex decoder - \$300. Grundig 5000 world-class 14 band portable twin speakers, flawless - \$400. Loewe-Opta Bella Luxus, dual-tone shimmering beauty, high performance medium-size receiver - \$150. Telefunken Jubilee, a medium-size beauty, world-band performance. **WANTED:** Telefunken Operette 6, as is OK. Also wanted SABAs and Telefunken's European-made tube/transistor portables, as is. John Sarkies, 75 Breakwater Shores Dr., Hyannis, MA 02601. (508) 771-5955

FOR SALE: Grunow & GE L660 chrome grille radios, Zenith Trans-Oceanic B600L brown, Tom Thumb Jr. & tuner, Trav-Ler T201, Motorola 59T2. Matt Kurzdorfer, 107 Falconer St., N. Tonawanda, NY 14120. (716) 695-0036



FOR SALE: Large crystal set, uses fixed type crystal detector, no markings on set - Best Offer. Spark generator coil with key, coil has one secondary terminal missing, coil base is wood and key base is heavy copper, no markings on coil or key - Best Offer. James W. Poitviant, 3 Darby Cir. East, Mt. Holly NJ 08060. (609) 261-0059

FOR SALE: Beautiful Zenith black lacquer AM/FM stereo floor console with Cobra-matic changer fully restored - \$275. Black Zenith Cobra-matic changer - \$25. Zenith 75 hearing aid in gold aluminum case - \$75. Zenith salesman case full of hearing aids, parts and tools - \$160. (40) misc. Zenith tubes, N.O.S. - \$40. Richard Leizure, PO Box 245, Granby, CT 06035. (203) 653-6477

FOR SALE: R390A rcvr/manual - \$250. Collins R388 (51J-3) rcvr/manual - \$300. Clapp-Eastham HR-HZ, pair - \$550. HRO-5TA1, four coil sets, wood box, speaker, P/S, manual, all mint - \$600. AK horn speaker, exc - \$250. Westinghouse RADA - \$290. Federal 59, vg - \$1,200. Working replica Audion, porcelain rheostat, box to make RJ-4 detector - \$350. Send SASE for old CQ, QST, meter wants. Glen Fritz, N4WDX, 15321 San Pedro Ave., #102, San Antonio, TX 78232. (210) 497-5665

WILL PAY \$1,500 FOR:



SONY TR 55

Any Color, Any Condition
\$ TOP DOLLAR PAID \$
Marty Bunis, 32 W. Main St.
Bradford, NH 03221
Phone (603) 938-5051
Fax (603) 938-2430

FOR SALE/TRADE: KT-66, Emitron, pair, N.I.B. Mail bid by 12/1/95. Peter DeGregorio, 85 Burroughs Rd., Fairfield, CT 06430-3504

FOR SALE: Forty-five antiques including: AK-70 with owners manual; Coronado 908 - \$75; RCA Model 66X3 - \$50; Setchell-Carlson Dorophone radio/intercom with remotes - \$50; Coronado Model 686 - \$50. Send addressed envelope for complete list. **WANTED:** Need dial plastic for Motorola 61X17; speaker and trans. for Zenith 6S254. Alfred Welch, 2248 S. 33rd St., Milwaukee, WI 53215. (414) 383-9908

FOR SALE: Fisher 49T tuner & 49A amp - \$100/pr. RCA 8-BT-10K portable transistor AM radio, 1956 - \$35. RCA 6-B-5-B portable tube-type AM radio, 1955 - \$35. Zenith H724 AM/FM table radio, 1951 - \$35. University 8" trumpet speaker #1B-8, N.I.B. - \$20. Radiola 42 - \$75. Eico 944 flyback/yoke tester - \$25. Remington Model 5 portable typewriter - \$35. Garrard RC88/4 record changer - \$75. Scott LT-112 stereo transistor FM tuner - \$45. Stromberg-Carlson 17CM2, 17-inch B&W console TV - \$75. Eico 625 tube tester - \$50. Blonder-Tongue Type #HAB TV/FM tube-type antenna booster, N.O.S., N.I.B. - \$20. B&K transistor/FET tester, Model #162 - \$35. Picture tube brighteners for 1950's vintage B&W TV's - \$5 ea. Hickock \$546 tube tester with manual - \$375. Electro-Voice #EV-38 mono phono cartridges (same as Sonotone 2TA-S or Astatic 55T etc.), and can be used in RCA 45 players - \$9 ea. or \$50/6. Tektronix 502A dual beam oscilloscope - \$200. All prices plus UPS. Bob Lynn, 26 E. Orchard St., Somerville, NJ 08876. (908) 685-9070

FOR SALE: Sylvania Thunderbird, missing foil/logo - \$150. Radiola 103 tapestry speaker - \$125. Deluxe AC/DC, chrome grille - \$90. AK 24 - \$130. Tuska 224 - \$225. Hit Parade 1-TR - \$75. **WANTED:** International Kadette radios, horn speakers, and pre-1926 radios/crystal sets. Greg Farmer, 71 Rice Creek Way, Fridley, MN 55432. (612) 571-6062

FOR SALE/TRADE: Emerson Moderne Mod511 bright red w/gold marbling - \$425. Fada Mod 254 ivory Plaskon w/gold-plated metal trim all over, flawless, (see Collins 1, p. 27) - \$475. 1934 wood table Grunow Mod 501, (see Stein, p. 112), with chrome grille and body trim absolutely exquisite - \$275. JVC Space Helmet TV a k a video sphere Mod 3240, (see Poster 2nd edition, p. 85) - \$250. 1947 Pilot TV-37 w/3" screen - \$295. Larry Drago, 383 Lincoln Dr., Cheshire, CT 06410. (203) 272-6030

FOR SALE: Dynaco ST70 - \$300. SCA35 - \$150. PAS2 - \$115. MKII - \$450/pr. MKIII - \$600/pr. FM3 - \$65. Fisher SA300/cage - \$500. 400C - \$250. 400 - \$175. KX100 - \$125. KN60 - \$120. 80T - \$65. FM100B - \$140. Heathkit W-4M - \$450/pr. W5M - \$520/pr. W2M - \$490/pr. W3M - \$540/pr. Mohican SW rcrv - \$100. EICO HF20 - \$100. HF85 - \$100. HF86 - \$200. HF87 - \$420. HFT90 - \$30. McIntosh 1700 - \$500. MX110 - \$285. MC30 - \$890/pr. Ampex 40w EL34 amps - \$300/pr. Scott LK48 - \$195; 222B - \$175; 350 - \$175; LT10 - \$50; 320 - \$50; 299D - \$235; 272/case - \$300. Sherwood S-2000 - \$45; S-3000 - \$40; S-5000 - \$90. Hallicrafters SX117, mint - \$250. HQ100A - \$175. National NC300 - \$265; NC173 - \$150. All equipment checked out and working. Plus UPS. List of hi-fi schematics books - SASE. Special!! Vintage Hi-Fi Spotters Guides, Vol. I and II - \$25 both ppd. Vintage Hi-Fi Price Guide - \$20 ppd. Vintage Hi-Fi The Golden Era Video - \$20 ppd. Until 12/1. C. Kittleson, PO Box 691, Belmont, CA 94002. (415) 595-4164, 7-10 PST

FOR SALE: Zephyr AR-600 - \$75. Standard SR-F22 - \$90. Emerson 747 - \$110. All have small chips. Larry Gilbert, 2602 Amapola Dr., Davis, CA 95616. (916) 758-5025

FOR SALE: Vacuum tubes: Reasonably priced N.O.S. receiving tubes for 1920's-1950's radios. Free price list. Antique Triode, Box A2, Farnham, NY 14061. Phone/fax: (716) 549-5379



The California Historical Radio Society

- ✓ *Eight meets per year all over Northern California*
- ✓ *Two or more Journals per year featuring original historical and technical articles*
- ✓ *Join now and get our 75-page collection of restoration articles from 20 years of CHRS!*
- ✓ *A mere \$15 per year!*

For more information, or to join...
write to: PO Box 31659
San Francisco CA 94131
or Call 415-978-9100

Announcing...

The Pocket Guide to Collins Amateur Radio Equipment 1946 - 1980

Everything you've ever needed to know about Collins amateur gear is in this NEW book!

- A "must have" for
 - Collins Collectors
 - Collins Users
 - All Vintage Radio Enthusiasts

\$19⁹⁵
+ P&H*

- 106 pages of descriptive listings, technical information, connectors, tube charts, rear panel diagrams, mechanical filters and more.
- Digital-laser scanned photographs of every piece of Collins ham gear manufactured since World War II - exclusively for this book.
- Professionally designed, typeset and lithographed on heavy paper.
- Pocket Size ■ Laminated Cover ■ Lay-Flat Wire Binding
- All Receivers, Transmitters, Transceivers and Accessories.
- A "must-have" for a Collins user, collector or vintage radio buff.

Checks or Money Orders:
Trinity Graphics Systems
5402 1/2 Morningside • Dept. ARC
Dallas, TX 75206

Phone Visa/MC Orders:
Sound Impressions
1-800-233-0484
M-F 9-6 (CT) or 24 hour V-Mail

*Add \$3 P&H USA, \$4 Canada and Mexico, \$6 Foreign by air. Texas residents must add sales tax.

FOR SALE/TRADE: Rare 1911 Electrolytic Barepoint crystal detector in original wood box, labels, envelopes w/galena chips, and one platinum woleston wire - \$725. Also Murdock and Clapp-Eastham spark gaps, both w/white marble bases - \$150 ea. Baldwin Baldie headsets, like new condition - \$50 ea. Larry Drago, 383 Lincoln Dr., Cheshire, CT 06410. (203) 272-6030

FOR SALE/TRADE: Hallicrafters S-37 with manuals. WANTED: Philco chassis 89 Code 123 with or w/o tubes. Also Rider Vol. #7-9. Have tubes to trade, also Mullard 34 metal base, etc. Thanks. Carlos Gimenez, 15091 Shamrock Dr., Fort Myers, FL 33912. (941) 482-0198

FOR SALE: Silvertone #4564 American tombstone, new caps., nice cabinet - \$175. Zenith Wavemagnet #6D-315, new caps., a beautiful radio - \$225. Hallicrafters #S-120, new caps., metal case - \$50. Please send large SASE for list. Don J. Scher, 3705 57th Ave., Vero Beach, FL 32966. Or call: (407) 562-5149

FOR SALE: Philco refrigerator polish manufactured by Philco Radio & TV Company. Sealed half-pint in cobalt-blue glass bottles - \$5 ea. Mike Gumino, PO Box 562, Cranbury, NJ 08512. (609) 490-2465. E-mail: gumino#m#_mike@msgw.vf.mmc.com.

FOR SALE: (5) B&K 283 DVM - \$30 ea. (2) B&K 283 DVM, as is - \$15 ea. Harry Pewowaruk, 1535 No. 8th Ave., St. Cloud, MN 56303. (612) 252-9910. E-mail: PewowarukH@aol.com

FOR SALE: RCA Victor space helmet, new in box, with sealed 45 RPM albums - \$495. Dennis Gjersteth, PO Box 20823, Milwaukee, WI 53220. (414) 529-1727

FOR SALE: Abbotwares horse radio in excellent condition, the nicest one I've seen - \$250 plus shipping Bill Manny, 1103 N.W. Despain Ave., Pendleton, OR 97801. (503) 276-3152 days. (503) 276-7439, evenings and weekends

FOR SALE/TRADE: RCA's 9-X-562 - \$55. Radiola 60 - \$115. 75-X-11 - \$65. 45-X-13 - \$55. Victon National 4T - \$65. 96-K - \$75. Peter DeGregorio, 85 Burroughs Rd., Fairfield, CT 06430-3504. (203) 331-9155, eves.

FOR SALE: High-voltage lab/bench power supplies. Kepco HB4AM, 0-325 Vdc, 400 mA. (4) 7581 regulator tubes, with meters, N.I.B. - \$175 ea. N.I.B. U.S. tubes: 83, 7587 - \$9.50; 5U4GB, 5998A, 6082WB - \$5; 2E26, 5670, 5R4WGB, 8113 - \$2. Lowell Thomas, AA6ZD, PO Box 15026, Fresno, CA 93702. (209) 227-1605

FOR SALE: Zenith 6S229 - \$275. Reverse tape recorder/radio - \$75. Westinghouse H-204A - \$50. 17-page radio list. 7-page literature list. Dave Sutherland, PO Box 201, Spofford, NH 03462. (603) 363-4459

FOR SALE: TSM 1 thru 4 and 7; Sams Transistor Serving Made Easy. Preston Meeks, 13839 Aspen Cove Dr., Houston, TX 77077. (713) 531-0227

FOR SALE: (2) 45 N.I.B. tubes - \$35 ea. plus UPS. Cecil L. McLaggan, Jr., 2005 Pearl Ave., Albany, GA 31707. (912) 436-8396

FOR SALE: Airline Midget 93BR-420B - \$40. Bendix 0526-A - \$50. Knight Star Roamer - \$60. SX-100 - \$60. SX-25 - \$100. S-19R - \$100. S-85 - \$100. WANTED: Drake R-4C, SPR-4. Mike Brillhart, 12551 Maiden Creek Rd., Abingdon, VA 24210. (540) 944-4387

FOR SALE: Filament transformer new, 220 5v 30 amps. WANTED: HRO coil C. Dan Speck, 6693 Grove Rd., Clinton, OH 44216. (216) 379-6308

FOR SALE: Cathedrals: Zenith Model 805 - \$290; Radiotrope (Gloritone Model 27) round top, excellent cond. - \$250; Sterling Model 7-C-709 - \$165; Era - \$295; Majestic Model 370 - \$240; Philco Model 84B - \$140; Philco 70 chassis and speaker - \$95; Philco 90 chassis and speaker - \$135. Sid Stivland, 17725 6th Ave., N, Plymouth, MN 55447. (612) 475-1332



FOR SALE: Repro Radios

| | |
|--|------|
| Cathedral/Metro/Empire | \$55 |
| Dinner/Slot/Juke "47" | 65 |
| 1960 Juke Light-Up | 55 |
| Red Bullet/Blue Belmont/Brown Truetone | 45 |
| Mike Radio | 30 |

Ralph's Radios

c/o Ralph Bonamo
229 Ramona Ave.
Staten Island, NY 10312

Please call for FREE Color
Flyer, with FREE S/H Info
(718) 356-3410

- AM/FM, with cassette player
- Retail/Wholesale — Lowest Prices
- N.I.B. — With Warranty
- Add Five Dollars each for S/H
- All checks to Ralph Bonamo
- Full Size
- Shows, Stores, Flea, etc.

FOR SALE/TRADE: McIntosh Mod 225 stereo power amp in original unblemished condition w/original Mac tubes and beautiful chrome - \$1,000. McIntosh Mod 240 stereo power amplifier in unbelievable condition - \$2,200. Altec mono amp Model 340A w/6550 push/pull tubes 50 watts - \$500. Altec Mod 1569A mono bick amp powerful, w/4-EL34 tubes - \$450. Citation II stereo amp, awesome w/4-KT 88 tube - \$875. Larry Drago, 383 Lincoln Dr., Cheshire, CT 06410. (203) 272-6030

FOR SALE: N.I.B. Sparten Bluebird replica - \$250. Portophone field telephone - \$20. Westinghouse 962-TCR8 AM/walkie-talkie - \$20. (1) 5-amp, (1) 3-amp variac - \$20 ea. Nipper "Master's Voice" tin - \$10. Atwater Kent 30 - \$40. Zenith Trans-Oceanic Chassis #6L40, maybe a R-600? works. Wings Model BR-777 round dial tombstone, plays, hums - \$150. DBX noise reduction box - \$15. TV wireless transmitter, UHF - \$45. Book: Basic Radio by Hoag, 1942 - \$15. **WANTED:** For Victor Model E Monarch Jr.: horn, lid latch, support arm (nickel plated) 7" turntable, crank. Color picture of existing unit for comparison purposes. Wood cabinet for Revox A-77. Also need original horn for Edison Model A Standard phonograph. Bret F. Johnson, 13495 102nd Ter., N. Largo, FL 34644. (813) 595-9287

FOR SALE: Stancor SRT-120 transmitter - \$140. Stancor ST-202A transmitter - \$165. Heath AT-1 transmitter plus VF-1 VFO - \$185. Knight T-50 transmitter - \$75. Knight T-60 transmitter - \$75. Conar Model 400 transmitter - \$60. (2) Johnson Viking transmitter, with VFO 122's - \$200 all four units. F.P. Heinemann, 87 Cove Rd., Lyme, CT 06371

FOR SALE: Arvin 444A, midget, ivory, plays - \$75. Atwater Kent 145, tombstone, BC/SW, untested - \$110. Crosley 167 cathedral, plays - \$160. Emerson R156, small tombstone, square dial, refinished, plays - \$90. Emerson 572 small, ivory, gold center grille and dial - \$95. Emerson 587 small, ivory, center speaker, slide rule dial - \$60. Emerson 737B, brown/orange, (similar to 706, Bunis 3, p. 76) - \$45. Fada 790, AM/FM, brown, plays - \$80. Grundig 3000, transistor, ocean boy, portable, AM/FM, (4) SW bands, plays - \$120. Midland M6A coin opr., wood, restored - \$75; unrestored - \$30. Parts available. Philco 511, metal case, center dial - \$95. Philco PT25 Transitone, brown - \$40. Philco 42PT95, wood, ivory handle, knobs, feet and escutcheon - \$50. Philco remote speaker cabinet for chairside - \$85. Silvertone 1908 tombstone, plays (like Model 1906, Bunis 3) - \$135. Trans-O-Dyne 5 battery set, Sears, (3) dials, untested - \$75. Trav-Ler 5028A, portable, gray snakeskin, blue leatherette, plays - \$65. Hallicrafters SX110 receiver w/R48A speaker, plays - \$125. Hallicrafters HT18 transmitter, untested - \$50. Heathkit GW42 CB transceiver, untested, no cover - \$50. Dynaco Mark III amplifier 6550's, (2) ea. - \$375/pr. Scott 210B, Dynaural Laboratory amplifier, (2) 6L6's - \$100. Scott 345 Stereomaster, FM receiver/amplifier 7591's, case - \$150. B&K 500, tube tester, mutual conductance - \$65. Heathkit AA-1 audio analyzer - \$45. EICO 955 in-circuit capacitor checker - \$30. Astatic D104 microphone - \$38. Shure 565SD microphone, dynamic, unispher - \$75. Shipping extra. Three lists available. (1) Pocket transistors, table radios, test equipment and more. (2) 10,000+ transmitting/receiving tubes. (3) Books, catalogs, magazines and manuals. Send SASE. Ray Nowak, 30513 Ednil Dr., Bay Village, OH 44140. (216) 871-8303

FOR SALE/TRADE: G.E.'s: 62-C - \$45; 535-C - \$50; X-216-V - \$65; wooden tabletop AM/phonograph - \$45. Peter DeGregorio, 85 Burroughs Rd., Fairfield, CT 06430-3504. (203) 331-9155, evs.

FOR SALE: Test equipment. Sprague Tel-Ohmike Model T0 5, very nice cosmetically - \$75. Have two laboratory quality bridge instruments. One, a Guildline Instrument Company thermometer bridge, Type 9500, in beautiful, working condition. Two, a Leeds and Northrup resistance bridge, Catalog #8071, near mint, in 24 x 12 x 8-inch wooden case. Both of these lab instruments are for best offer. Also have a B&K transistor analyst, Model 960, in good condition with original book - \$75. Bill Manny, 1103 N.W. Despain Ave., Pendleton, OR 97801. (503) 276-3152 days. (503) 276-7439, evenings and weekends

FOR SALE: The following CRT's new and rebuilt, popular brands for - \$35 plus shipping: 12CDP4, 23ASP4, 19CVP4, 21FLP4, 71CFP4, 17DQP4, 21MP4, 23DCP4, 17QP4, 19BWP4, 17CRP4, 17EBP4. Don Patterson, 636 Cambridge Rd., Augusta, GA 30909. (706) 738-7227

FOR SALE: TVs: Fada TV-30; RCA C30 chassis; RCA T-100; RCA 9-T-240; Admiral 21F1 Bakelite; take all for - \$400, pick up only. Sony reel-to-reel VCR, portable with camera & power supply, 1972 Model AV-3400 - \$350 plus UPS. Peter Dieguez, 36-48 34th St., Long Island City, NY 11106. (516) 625-0429

FOR SALE: Transistor radios for Bulova to Hoffman & also to Zenith. Also, a couple of novelty sets. Send SASE for list. Jim Berg, 4261 Wilcox Rd., Box A, Northport, WA 99157. (509) 732-4047

FOR SALE: Hickock 533 tube tester with manual - \$150. Polar bear cub 4-inch 1900's fan - \$100. R&M brass fan 12 inch - \$125. Brass Westinghouse Mazela lamp with mazela bulb - \$100. Edison long brass base bulb, good filaments pat. 1880 - \$100. VT1 tube in carton - \$80. (20) early 1930 Radio Craft mag - \$40. Northrup 20's potentiometer in oak case - \$20. Dictaphone - \$30. Dan Claus, 2305 W. Rice, Sioux Falls, SD 57104. (605) 332-3747

FOR SALE/TRADE: Two (TM 11-235) World War II military walkie-talkies in excellent condition w/manuals and spare battery sticks - \$350 for pair. Larry Drago, 383 Lincoln Dr., Cheshire, CT 06410. (203) 272-6030

FOR SALE: Hickok roll chart transistor tester. Just like a tube checker, except sets up from roll chart for PNP or NPN transistors, very nice cosmetically, seems to work - \$75 or Best Offer. Bill Manny, 1103 N.W. Despain Ave., Pendleton, OR 97801. (503) 276-3152 days. (503) 276-7439, evenings and weekends

I am not a dealer, but a serious collector and historian interested in all aspects of E. H. Scott.

Please contact me first if you are selling your E. H. Scott Radio, Selec- E-H-SCO-TONE Coils, World's Record Superhet, or Scott Transfor-mer Co. items.



Always interested in any E. H. Scott stock certificates, literature, and military sets.

John T. Meredith
2462 Statonsburg Rd., Suite 152
Greenville, NC 27834 - (919) 551-1882

FOR SALE/TRADE: Very, very nice cabinet only for a Freed-Eisemann Model 48. Tags, schematic on back, all in nice shape. Make me an offer or trade I can't refuse. Bill Manny, 1103 N.W. Despain Ave., Pendleton, OR 97801. (503) 276-3152 days. (503) 276-7439, evenings and weekends

FOR SALE/TRADE: Grundig 2066 - \$125. Zenith 6-D-510 - \$55. Bogen Communophone 4A - \$60. Peter DeGregorio, 85 Burroughs Rd., Fairfield, CT 06430-3504. (203) 331-9155, eves.

FOR SALE: Western Union brass sounder on board 1A, 1883 with matching 2A brass key. 1880's Elect. Supply Co. brass sounder on board. 1890's signal elect. Menomene Mid serindes[?] with open coils and matching brass key. Speed X key in box. 1890's telegraph transformer, switchboard hook up on one side, telegraph and line on the other - \$300 buys all. Dan Claus, 2305 W. Rice, Sioux Falls, SD 57104. (605) 332-3747

FREE - 20 WORD AD EACH MONTH
To get your free 20 words,
include your SUB# with your Ad.
Additional words are 22¢ each.
Read inside back cover for details.
MANY THANKS!!!!

FOR SALE: MC-40. WANTED: 7591 and 6CA7/EL34 tubes. Thank you. Mike Fletcher, 1204 Cedar St., Niles, MI 49120. (616) 684-2174

FOR SALE: Grundig instruction book Model 50-60, U.S.A. - \$15. Crosley 11 AB - \$20. GE P-807B - \$15. Westinghouse WR100 - \$35. Emerson Model 295 - \$160. Tom Thumb - \$700. Emerson suitcase w/louvers - \$15. Rider's manual Vol. 13 - \$7. Antique Majestic floor model metal bank - \$140. Prices are negotiable. George Kollar, 137 Harris Hill Rd., Shavertown, PA 18708. (717) 696-2523

FOR SALE/TRADE: Magnavox AC-2C, 2 stage/2 tube, speaker amplifier, (see Douglas 2, p. 135), in beautiful/working condition - \$500. Optional RC-3 horn speaker available - \$275. Larry Drago, 383 Lincoln Dr., Cheshire, CT 06410. (203) 272-6030

FOR SALE: Output transformers. Halldorson, Jensen single, P.P. 6-8 ohm, N.I.B. - \$14 ea. ppd. Volume controls and switches, N.O.S. I.B. direct replacement Clarostat controls for 30's radios - \$5 ea. Kelly Nichols, RD 1, Box 103K, Greenwood, DE 19950. (302) 349-5059

FOR SALE: Tabletop AM tube-type 115v radios. GE 115, 235, 423, 871. Zenith M512W - \$15 ea. Also Zenith M723 AM-FM, needs work - \$20. All plus UPS. Onorio L. Sabetto, 1717 Burgess Rd., Cleveland, OH 44112-1103. (216) 481-1036

FOR SALE: Stellar Mickey Mantle, missing (1) knob and nameplate, otherwise excellent, (Collins 1, p. 103) - \$475. Crosley Elf, excellent - \$475. Freed-Eisemann NR-20 w/speaker table, near mint - \$400. Radiola AR-12, excellent, NT - \$135. Zenith 6S527, excellent - \$70. AK cardboard stand-up advertising sign, excellent - \$160. WANTED: Chassis for Crosley Showboy #59, Philco 90 cathedral speaker. Mark Delauter, 6253 S.H. 120, Metamora, OH 43540. (419) 923-7737

FOR SALE: Atwater Kent variometer as used on breadboard - \$350 OBO. Also A.C. Dayton variometer - \$150 OBO. Both look new. Jerry DeWitt, 1937 Love Cir., Simi Valley, CA 93063. (805) 526-5093

FOR SALE/TRADE: 1924 Connecticut Tel. and Tel. Telegraph set for boys in original box with literature, contains a pair of professional looking mahogany boxes w/brass keys and sounder of top w/original battery inside - \$450. Larry Drago, 383 Lincoln Dr., Cheshire, CT 06410. (203) 272-6030

FOR SALE/TRADE: Rare Zenith 10S157 Zephyr console radio in near-mint condition - \$895 OBO, or would trade for case and Radiovision radio, with scene of ship in harbor, with built-in motion lamp. Jim Clark, 1292 Starboard Dr., Okemos, MI 48864. (517) 349-2249

FOR SALE: Hoffman RP706, solar, exc, no cracks, chips, plays - \$250. Zenith T-O 1000, exc - \$100. Radiotron Designer's Handbook, 3rd edition - \$30. WANTED: RCA tube Manuals RC1-RC10. Roland Barbeito, 19 Murray Ave., Westfield, MA 01085. (413) 572-4745

FOR SALE: Super scarce electric questioner game by Knapp, extra clean coil on buzzer, needs wire soldered - \$95. Stewart-Wamer 07-514 - \$45. Crosley 628-B - \$60. Lark mini cathedral - \$90. Splitdorf Lab. spark box - \$75. Zenith 12S268, extra clean - \$485. Joe M. Nocera, 1222 Finch St., New Castle, PA 16101-4840

FOR SALE: Oreo Cookie radio, works - \$20. Bell PA amplifier, untested, complete - \$75 plus P/H. Wayne Himel, 5230 August Ave., Marrero, LA 70072. (504) 348-4076

FOR SALE: Two 1946 Fada bullets; restored white with red grille inserts, etc; purple with pumpkin trim, reasonable offers. Chuck Sundgren, 1818 Alder Ave., Richland, WA 99352-2424. (509) 943-2753

FOR SALE: SASE for list of operational test equipment, most w/manuals - \$100 or less. Chase Hearn, 104 Glenwood Dr., Williamsburg, VA 23185. (804) 229-7263

FOR SALE: WE output trans. 112A - \$35. Philco 60 chassis - \$20. Music Master driver - \$20. Two Zenith Royal 500's - \$65 and \$75. Philco Safari, excellent working condition - \$300. Charles Haynes, 219 W. Spring, Marissa, IL 62257. (618) 295-3664

FOR SALE: 14" Champion spark plug radio, M.I.B. - \$185. STP, Space Ball, Treesweet - \$50 ea. Frank Rose, 1600 Olympic Blvd., Santa Monica, CA 90404. (310) 450-1736. (818) 789-1106

FOR SALE: Modern Radio Servicing by Ghirardi, first edition - \$30. Eico Model 950 resistance capacitance comparator bridge - \$30. General Radio Model 740 capacitance bridge - \$35. Eico VTM Model 249, less probe - \$15. Knight Model KG-635 oscilloscope - \$40. RCA Model WR-504A sine-square wave audio generator - \$35. Hallicrafters Model S-38 communication radio - \$48. Plus shipping. Elbert Marshall, Rt. 2, Box 239, Hillsville, VA 24343. (540) 398-2283

FOR SALE: Heathkit W5M - \$100. Tubes: KT66 - \$50; and KT88 - \$75. Jim Berg, 4261 Wilcox Rd., Box A, Northport, WA 99157. (509) 732-4047

FOR SALE: Rider's 1-5 abridged, 6-16, good cond. - \$160 plus shipping. John O'Brian, 3439 Clearwater, Bettendorf, IA 52722

FOR SALE/TRADE: DeForest D-12 radio w/tubes and correct original loop antenna, all in excellent condition - \$975. Larry Drago, 383 Lincoln Dr., Cheshire, CT 06410. (203) 272-6030

FOR SALE: Kennedy 52 cathedral - \$295. Echophone S-4 cathedral - \$195. Kolster K-21 - \$140. Stewart-Warner A51T3 - \$95. American Bosch 28 - \$130. American Bosch 828L - \$70. Philco PT-44 - \$75. Philco 39-6 - \$50. Crosley 11-AB - \$50. Crosley 66T - \$55. Automatic Tom Thumb ATTP - \$95. Emerson 671B - \$45. Emerson DP332 - \$50. Airline 04BR-511A - \$70. AK 55 chassis - \$75. RCA 46X24 - \$60. Radiola 18 - \$80. RCA 9X571 - \$40. GE 60 - \$55. GE 250 - \$35. GE 202 - \$45. GE HJ618AC - \$60. Olympic LP313 - \$60. Zenith 6G601 - \$50. Zenith B600 Trans-Oceanic - \$75. Majestic horn speaker - \$65. Radiola 100A speaker - \$30. Radiola 100 cone speaker - \$50. J. Gary Cameron, 824 Andrews St., Southington, CT 06489. (203) 276-9200

FOR SALE: Tubes, over (1,000) types, all new: 7591A - \$35 ea.; 8417 - \$25 ea. SASE for latest list. New bulk packed tubes: OA3's, OC3's, OD3's - \$1 ea; OB3's - 75¢ ea.; 6AN4's - 25¢; 6AV6's - 50¢ ea.; 6AF4's - 10¢ ea. Others at 25¢ and up. Tube testers: Hickock 534A - \$65; Jackson 648 - \$45. **WANTED:** 7027A's and Lafayette KT-600, any condition. Charles D. Blair, 815 N. 5th St., Cambridge, OH 43725. (614) 432-4453, 9-5

FOR SALE: Have several banana boxes of 1920's battery set parts. I would like to trade for 1930's, 40's AC radio parts. Will consider cash or trade deal. Call or write: Jim Cirner, 149 Tyler Ave., San Jose, CA 95117. (408) 296-0860

FOR SALE/TRADE: Philco bar radio, clean, possibly complete glassware - Best Offer, call. Hallicrafters SX62 w/spkr, exc - Best Offer over \$150. S120 - \$25. **WANTED:** E.V. Aristocrat, mahog., empty cab. OK; Regency, Empire cabinets, parts. A.R.1, Thorens 124, bases. Garrard 301, bases, 201 base. Scott 310 Series tuners. McIntosh tube components, whole systems, mint tuners, early cabinets. MA6 mpx adaptor. D8 power supplies. Walt Fleming, 182 Plain Hill Rd., Norwich, CT 06360. (860) 889-5018, 9 pm EST best

FORSALE/TRADE: Hammarlund Comet Pro w/crystal and all coils - \$795. Hammarlund 180 w/speaker and manual in near mint condition - \$485. National 183-D - \$375. National 183 - \$250. Breting 12 all chrome communication receiver w/all manuals - \$600. National HRO 500 - \$700. National RAS 5 w/speaker, power supply rack full of coils, and manuals - \$675. Larry Drago, 383 Lincoln Dr., Cheshire, CT 06410. (203) 272-6030

FOR SALE: The new house will be ready in December; therefore, after ten years of acquiring radios, I have to liquidate my collection. This is a great investment opportunity to own some of the rarest pre-war colored plastics on the planet. I am compiling a fresh photo list. For a copy send a LSASE to: Mark Aizapiedi, 103 Newell Hill Rd., Sterling, MA 01564, or call me at (508) 422-0181

FOR SALE: Schulmerich amps Model 6-107B and 6-106 power supply, amps use 805 tubes, P/S uses 866's, amps use Kenyon transformers #S-21669 and S-21294. Included are Chicago transformer 8714 and 8715 inter-stage and driver transformers. No tubes. Look nice cosmetically - \$200 for all shipped, or \$150 plus shipping. Power resistors, 100 to 250 ohm, 100 to 250 watt - \$1.50 ea. or \$25 for all, plus shipping. Kim Herron, 16141 24th Ave., Coopersville, MI 49404. (616) 677-3706

FOR SALE: Jukeboxes: Wurlitzer 616, AMI Model C - \$1,200 ea. Tim Dugan, 415 N. White Oak, Marshfield, MO 65706. (417) 859-5710

FOR SALE: Popular Electronics, 1956 to 1974; Ashly FET-2000C MOSFET amplifier, 500 WPC (4 ohms) - \$400. Dave Minchella, KE2GE, 80 Campfire Rd. North, Henrietta, NY 14467. (716) 359-3337

FOR SALE: Atwater Kent 84, other radios, tubes, parts, etc. Send SASE for list. Larry Kays, 6 Old Ivy Dr., Harwich, MA 02645. (508) 430-0462

Vacuum Tubes for Audio are Back!

Glass Audio

brings together the tube & today's improved components, voltage control and the new, exciting premium Soviet tubes, to make smooth sound again possible in your living room.

Ask for your first FREE issue, without obligation.

Glass Audio

PO BOX 176, DEPT. ARC
Peterborough, NH 03458-0176 USA
FAX (603) 924-9467

WANTED

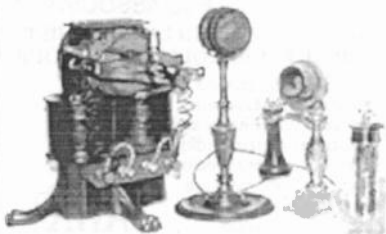

Batteries, Broadcasting Microphones, Telephones, Bi-Polar Motors, Related Parts, Catalogs, and Early or Unusual Fans.

Alan Willms
1823 El Camino Real
Redwood City, CA 94061
(415) 571-9070

FOR SALE: H.P.R. Simplex one-tube 1922 pre-broad-cast radio; Ediswan one-tube loudspeaker wireless in original box, brand new unused! Fitted rare 2 in one tube; rare crystal sets. Curtis Silver Ghost; Ericsson miniature round Bakelite; Sparta brown Bakelite; Burndept No. 1. Jim Taylor, G4ERU, 5 Luther Rd., Winton, Bourmemouth, United Kingdom BH9 1LH. Tel/fax: 01202-510400

FOR SALE: Satisfaction guaranteed. Nice Philco cathedral Model 60 - \$100. 1934 RCA tombstone Model 118 - \$75. Crosley 10-137 dashboard green Deco set - \$90. 1928 Steinite Model 261 - \$85. Temple drum speaker - \$40. 1936 Airline tombstone 62-177 - \$70. Super nice Zenith Trans-Oceanic Model G500 - \$90. 1933 RCA cathedral Model 121 - \$120. Nice Mitchell Lullaby - \$35. Philco 46-420, (Bunis 2) - \$35. Trav-Ler nice wood set Model 5009 - \$25. Hickock Model 532 tube tester (works well) - \$35. Hickock Model 352 tube tester in excellent condition - \$75. Raytheon TV M-1750K, working & excellent - \$50. RCA TV-8-PT-7032, excellent and working great - \$55. RCA WO-91B o-scope with probe, super condition - \$45. Hickock 750 tube tester in super condition - \$95. Western Electric Model 324 amp and voltmeters - \$10 ea. Good used tubes - \$3.50 ea. 6DQ6A, 6V6G, 5U4G(B), 5W4G, 6BG6G, 6CD6G, good used 6L6G - \$7 ea. One good 673 power tube - \$20. Plus more radios, test equipment, and lots of literature. Please send a SASE or call between 7:30 pm and 9:30 pm Montana time. Neil O'Donnell, 1809 Sampson St., Butte, MT 59701. (406) 494-8162

FOR SALE: Elba Systems Corp. VIP. E. 5741 projector with record player in a Samsonite suitcase, like new - \$30 + S/H. Carlos Gimenez, 15091 Shamrock Dr., Fort Myers, FL 33912. (941) 482-0198

FOR SALE: I have radio and TV tubes new in cartons & Photofacts 1-1709. Ann Bichanich (Jay's), 15 1/2 W. Lake St., Chisholm, MN 55719. (218) 254-4421

JOIN THE
AWA

**ANTIQUE WIRELESS ASSOCIATION
THE ORIGINAL AND LARGEST HISTORICAL RADIO-COLLECTOR GROUP**

- Publishes *Old Timer's Bulletin* with:
 - Battery and AC receiver restoration
 - Vacuum-tube history and collecting
 - Old-time amateur-radio contests
 - Communications receivers
 - Free want-sell-swap ads
 - Early television
 - Horn loudspeakers
 - Reviews of current books
 - Keys and land-line telegraphy
 - News of U. S. and foreign clubs
 - Information on public radio museums.
- Maintains unique radio-TV museum.
- Produces the annual Rochester meet.
- Co-sponsors local meets.
- Publishes the annual **AWA Review**.

Membership is only \$12.00 per year (\$22.00 for two years). Mail check to:

Antique Wireless Association, Inc.
Box E, Breesport, NY 14816



FOR SALE: Over (300) novelty transistor radios. Ask for list #NTR. Send SASE with two stamps. Bob Zelenack, PO Box 460642, Escondido, CA 92046. (619) 749-9652, or fax: (619) 749-4291

FOR SALE: Norelco FM-AM 7-band portable - \$125. Emerson 888 black - \$40. ITT pocket transistor G15 - \$20. Zenith L401 mini-tube portable - \$25. Weltron 2001 AM/FM tape space helmet - \$60. Emerson 570 picture box radio - \$40. Conrad Johnson PV-2 MC tube preamp - \$250. Bang-Olufson BCO gram 4002 turntable, new cartridge - \$100. Scott 340 receiver - \$100. Fisher CA-40 amp - \$60. RCA mono amp SVP-10 - \$35. Philips turntable - \$75. Harman Kardon Citation X-111 FM tuner - \$100. Dynaco PAT-4 - \$50. Fairchild 260 power amp and 240 Fairchild preamp - \$250. Brooks FM tuner, needs work - \$25. National NC-98, plays - \$75. Guild Country Belle - \$40. KLH Model 21 FM radio - \$75. 1947 Magnavox tuner & amp, 5 6V6 output - \$75. Silvertone metal radio - \$50. Kay guitar amp 8-inch speaker, 1950s - \$75. Ampeg Gemini II guitar amp - \$300. Bozak stereo preamp - \$80. Scott 350-C FM tuner - \$100. Scott 299-D amp - \$125. All plus shipping. Frank DeFilippi, 62 Second Ave., Massapequa Park, NY 11762. (516) 798-6577, 6 to 10 pm EST

**FAX NUMBER FOR
ANTIQUE RADIO CLASSIFIED
(508) 371-7129 - 24 hours a day
Ads - Subscriptions - Book Orders
See inside front cover for details**

FOR SALE: Crosley Pup with good WD12 and good label, good condition - \$400. Buyer pays shipping and handling. Jim Barrows, 15121 41st Ave. SE, Bothell, WA 98012-6113. (206) 337-4880

FOR SALE: Philco #70 grandfather clock radio, complete, needs refinishing - \$395. Zenith 500H, white, plays, good condition, small chip - \$125. 500H, black, fair - \$50. Flick Yerke, PO Box 392, Moscow, PA 18444. (717) 842-4857

FOR SALE/TRADE: My extra copies of Radio News 1925, 1927, 1929; Radio 1922-1925; Popular Radio March '24; 1923 Yearbook of Wireless (British), rare; DeForest DV5 tube can. Also, 78 rpm records of Caruso. Looking for chassis for Gillfillan GN-2. SASE for list. Ron Kramer, 120 Wimer, Ashland, OR 97520. (503) 482-4944, or e-mail: kramer@jeffnet.org

FOR SALE: Transistors. Emerson 888 turquoise - \$60; 888 black - \$45; white - \$45; 911 coral - \$35. Zenith 500 black - \$700. 500D maroon - \$40. Fada 1000 repro, N.I.B. - \$50. Bob Masterson, Box 172, Valley Cottage, NY 10989. (914) 353-3151

WANTED: E. H. Scott Special Communications Receiver. It may be sometime before one of these receivers becomes available. When you are ready to part with yours, please contact me. John T. Meredith, 2462 Statonsburg Rd., Ste. 152, Greenville, NC 27834. (919) 551-1882. Refer to O.T.B. Nov. 92.

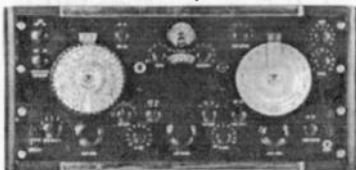

FOR SALE: Chassis: Stewart-Warner 900 - \$20; Crosley 6U2 - \$25; Midwest - \$30. Others, SASE. Jim Collings, 12005 Victoria Pl., Oklahoma City, OK 73120. (405) 755-4139

FOR SALE: General Radio amp Type 514-A, uses (3) #30 tubes - \$60. Wilcox-Gay console A-70 with mic - \$75. Hallicrafters SX-42, plays - \$250. RCA console 813K, needs some veneer - \$80. Radio keg 1933, no chassis - \$100. Guild buccaneer chest - \$200. Crosley Bulls-eye, lime green, no cracks - \$125. WANTED: Wall radios. Greg Bogel, 312 Peg Run Rd., Cherry Tree, PA 15724. (814) 743-9028

FOR SALE: (12) E.H. Scott consoles, call for info. We accept Visa and MasterCard. Alan Jesperson, PO Box 17338, Minneapolis, MN 55417. (612) 727-2489, 8 am to 8 pm, 7 days. Fax only: (612) 727-1908

FOR SALE: Fada 652 butterscotch Catalin - \$600. Fada 1000 bullet Catalin, maroon with butterscotch trim - \$1,000. J. Gary Cameron, 824 Andrews St., Southington, CT 06489. (203) 276-9200

FOR SALE: Admiral Catalin, works, white, (like Gloritone, Machine Age Jet Age, p. 234) - \$235. Joe Quinn, 30511 Manhasset Dr., Bay Village, OH 44140. (216) 835-8420



FOR SALE: Seldom offered AK Model 21, dry cell receiver with brass 199 sockets inside, all tags - \$375. AK Model 36, their first AC receiver, complete with tubes - \$45. AK Model 49, rarely seen wood cabinet battery receiver - \$50. Polle-Royal, a neat little battery TRF set, all there, mfg. in Prov., R.I. - \$65. One-tube Tri-City receiver, socket for 199, mfg in Davenport, Iowa, has unusual sliding coil inside, nice - \$175. Kodak 3-tube Model C-13, with leatherette cabinet - \$145. Chelsea Model 122, 3-tube receiver with tap switches, binding posts and phone jacks on panel, unique clam-shell moving coil inside - \$145. AK Model 37, their first AC set in metal box, with all tubes and nice brass sailing ship emblem on cover - \$45. Unusual 1-tube Airophone receiver, with both plug-in coils, and separate, matching 1-tube amplifier, also with coil, rare pair - \$650. Westinghouse Model WR-12X4, prewar receiver, in beautiful, working cond. - \$35. Cutting & Washington Model 15, a 1-tube (199) receiver, hard to come by, complete with tube - \$600. Michigan 1-tube Model 10, unusual lever dials, all work, nice green coils - \$165. (Not shown) AK Type E cone speaker, works - \$45. Radiola 100 speaker, very nice one, works - \$35. Zenith Model 7G-605, the very first Trans-Oceanic with sailboat grille, decent cond. - \$125. Dave Crocker, 6 Raymond St., Sandwich, MA 02563. (508) 888-6236, before 9 pm please

FOR SALE: Amplion/Brown speakers; Marconi phone baby, in box; Marconiphone SE(?); NE R-4. A.R. Nolf, VE3NLF, 539 Kastelic Pl., Burlington, Ontario, Canada L7N 3S9. (905) 333-4557

FOR SALE: (23) good used 5U4 tubes - \$35. Charles Haynes, 219 W. Spring, Marissa, IL 62257. (618) 295-3664

FOR SALE: Crosley Blue Bulls-eye Mod 11-101U, absolutely mint - \$450. Jerry Luttrell, 123 Ward, Independence, MO 64050. (816) 836-4002

PHONE NUMBER FOR
ANTIQUÉ RADIO CLASSIFIED
(508) 371-0512

Best time to call is weekdays:
8:30 am to 6 pm Eastern Time
(Please no classified ads by phone. Thanks!)

FOR SALE: Zenith 9S232 Walton's set. Zenith 10S130 tombstone. Japanese Bell xstr camera radio, with box in leather case, radio excellent - \$150. Charlie McCarthy - \$995. Early 1950's Zenith brass and plate glass fluorescent sign, double-sided multi-colored, 24" x 16" - \$295. 1936 Philco 651 8-tube tombstone - \$225. Emerson Victory model, Ingraham cabinet with red, white and blue stripes - \$150. Atwater Kent 112 high fidelity console. Wells Gardner F6 Series 16-tube chrome twin speaker console, rebuilt. Philco 39-116 remote console - \$325. Chipper (Nipper Jr.) stuffed animal, 9", new - \$15. Zenith Cobra record demonstrator - \$95. Atwater Kent 82 cathedral - \$495. RCA cathedral 121 - \$295. Zenith LH cathedral, original finish - \$350. Beautiful original Zenith BH cathedral - \$495. Refinished Stromberg-Carlson 225H, rosewood - \$325. 1933 Deco Zenith 288 tombstone, variable IF - \$525. AK 627 cathedral - \$400. Rider's manuals: 8-14 - \$15 ea. Call for current availability on other numbers. We have available all tube-type Trans-Oceanics, electrically restored, if requested and guaranteed. Transistor Trans-Oceanics: 1000 - \$200; 3000 - \$225; American 7000 - \$325; Taiwanese 7000 - \$395. Excellent laser reprint of the original Trans-Oceanic 7G605 brochure - \$10 ppd. We have for sale many console radios not advertised: Stromberg, Philco, RCA, Airline and many others, call. Universal Radio dit belt kit - 5 for \$6.50, \$2 shipping. To reference most Zenith models from 1920 to 1946 we offer our own 60-page 11 x 17 Zenith Brochure Book, with pictures and specs on most models - \$28.95 ppd. Our 1936 Zenith poster reprint, shows all (3) Stratospheres, art poster quality - \$20 ppd. Zenith consoles: 15S372, 15U270, 15U269, excellent; 12S569, 12S471, 12U159, 12U158, 12S267 excellent, 12S370, 12S371, 12S265, 12S266, 10S153, 10S155, 10S156, 10S160, 9S262, 9S367, 8S154, 8S463 (5808), 8S359, 7S366, 7S363, 7S260, 7S258; 410 and many others. Zenith chairside: 12S245, 9S344, 9S244, 8S451, 7S343, 6S249, 6S241 bar radio, 6S239. If you are looking for a set not listed, please call for more info. We can and do ship consoles anywhere and we do it right. Zenith table models: 5S319, 5S228, 5S127, 6D219, 6S330, 7S28, 7S323, 6S229, 6V27, 6S27, 6S128, 7S529, 7S633, 807, 809 chrome, and many others, call. All radios unrestored electrically unless noted. Shipping extra unless noted. Satisfaction guaranteed, highest quality possible assured. Send for our free catalog showing restoration and shop supplies, owner's manual reprints, etc. When in Minneapolis, be sure to visit our retail location: Great Northern Antiques, 5159 Bloomington Ave., just five minutes from the airport. We accept Visa and MasterCard. Alan Jesperson/Mike Emery, PO Box 17338, Minneapolis, MN 55417. (612) 727-2489, or fax only: (612) 727-1908, ans. mach. after 4 rings, 8 am to 8 pm, 7 days

FOR SALE: Zeniths: 9S262, 10S153, 7S260, 6S362, 10S567. WE amps 118-A. Hallicrafters TW-1000A, nice - \$225. RCA Radiola 61-9, restored - \$65. RCA Duo-rectron - \$45. Silvertone 6437A, 13-tube console - \$55. Silver Marshall 34-A - \$45. Grunow 1152, 11-tube chassis & spkr - \$50. Liberty Bell transistor - \$45. Merc-radio transistor HT-1409 - \$30. TVs: Zenith port-hole 24H20 - \$100. Philco 49-1240 - \$30. Emerson 673 - \$30. Balfour RC-1 changer w/cartridge, N.O.S. - \$35. Rider books: Vol. 6 - \$25; Vol. 7, 8, 15, 16 - \$20 ea.; Vol. 9-14 - \$15 ea.; TV-1 - \$40; PA-1 - \$45. RCA Redbook Vol. 2 - \$40. Mercury 1000 mutual conductance tester - \$60. N.O.S. Dr. Pepper embossed metal sign, 12"x27" - \$20. Colorful corrugated cardboard Motorola TV sign, 1955, 15"x56" - \$40. Prices do not include shipping. Call 11 to 3, Tues.-Fri. Vintage TV & Radio, 3498 W. 105 St., Cleveland, OH 44111. (216) 671-6712

FOR SALE: Antique (not reproduction) Atwater Kent 10C breadboard parts. RCA 3-BX-671 Strato-World portable, seven bands, tan leather, excellent condition, working, but dial belt broken - \$100 + shipping. Bob Warren, Church Street, PO Box 279, Waverly, PA 18471. (717) 587-2405

FOR SALE: 872A Sylvania tubes N.I.B. - \$17.50 ea. plus postage. Barry McDaniel, PO Box 5544, Little Rock, AR 72215. (800) 755-3326, days

FOR SALE: Hundreds of trade manuals of 40's, 50's, 60's. LSASE for list of mgrs. John Snow, 4539 Bartlett, Shorewood, WI 53211

FOR SALE: Eveready 2, with stand and speaker - \$275. Sparton Junior - \$250. GE K-64 - \$220. All in excellent, playing condition. Geoff Shearer, 14101 Mesita Cliff Rd., NE, Albuquerque, NM 87112. (505) 293-8544

FOR SALE: Tube amplifiers: Eico ST-40 integrated stereo - \$65. Small Grommes and Allied - \$15 ea. Heathkit Apache TX-1 AM/CW ham transmitter - \$195. Fada 192-A Neutrolette battery set - \$95. Silvertones: 6230A wood inductive tuning farm set - \$25; 9000 brown Deco - \$25. Astatic JT-30 microphone - \$35. McIntosh room equalizers: MQ-102 - \$50; MQ-104 - \$75. Transistors: NEC NT-660A AM/SW - \$25. Philco TC57-124 early clock portable - \$35. Standard SR-H436, black, vg, w/box - \$115. Realtone 970 ivory - \$40. RCA 8-BT-8FE pink, rough tuning knob - \$30. Gulf battery - \$35. Virginia lottery - \$15. Hamburger Helper - \$35. Sams TSM books - \$75. (12) AR books - \$9. Send LSASE for long updated list of goodies! Jon Hall, 39 Spring Oaks Ln., Fluckersville, VA 22968. (804) 985-3827, 8:30-10:30 pm EST. Fax: (804) 984-3299

WANTED

WESTERN ELECTRIC
TUBES, SPEAKERS, HORNS & AMPS

TUBES: Telefunken, Genalex, RCA, Radiotron, etc. General Electric, Amperex, JAN, Sylvania, GEC, National Union

McIntosh, Marantz, Dynaco, Jensen, Linn, Levinson, Fisher, Leak, Tannoy, Altec, EV, Thorens, EMT, JBL ... Amps, Spkrs., Turntables

MAURY CORB

12325 Ashcrott, Houston, TX 77035

Tel: (713) 728-4343 Fax: (713) 723-1301

MESSAGE: Catalin collectors, will swap butterscotch Emerson Aristocrat for bizarre looking Climax Ruby radio. Ed Sage, PO Box 13025, Albuquerque, NM 87192. (505) 298-0840

MESSAGE: Will the girl who called about the Channel Master 6506 please call again? It works! Mike Wilcox, 105 Daryl Dr., Goldsboro, NC 27534. (919) 751-3908

**HAVE YOU MOVED? ARE YOU MOVING?
PLEASE NOTIFY US A.S.A.P.**

SEND US YOUR...

OLD ADDRESS

NEW ADDRESS and

SUB #

MANY THANKS!!!!!!

FOR TRADE: Perfect Catalin, Plaskon or valuable radio for equally nice International Kadette or Arbor- phone for: Nevins Museum of Radio, Ken Nevins, 406 Jipson St., Blissfield, MI 49228. (517) 486-3019, evenings please

FOR TRADE: No logo Cal Ripken Wheaties, for nice vintage radios, horn speaker, etc. Brian Kurrie, 406 Crafton Rd., Bel Air, MD 21014. (410) 838-6534

AUCTION: First radio auction in Vienna on Dec. 9, '95. Order auction catalog from: Auktionshaus Dorotheum, Subscription Department, Dorotheergasse 17, 1010 Vienna, Austria. +431-51560-289. Fax: -443

HELP: Wanted: Chassis for AK 82, 246, RCA 342; cabinets for AK 66, 308, 328. Thomas Foral, N1RFF, 38 Summer Hill Rd., Apt. #58, Middletown, CT 06457. (401) 863-5856

SERVICES: Hickok, military test equipment repaired & calibrated. FOR SALE: Hickok 6000 Series obsolete 4-5-6-7. Pin test adapters & test data - \$65 shipped. Wendell E. Hall, 3 Mockingbird Cir., Jeffersonville, IN 47130. (812) 282-9709, 8-10 pm EDST. Fax: (812) 280-7773, anytime

E. H. Scott Historical Society

The primary source
concerning the radios
and history of E. H. Scott

- Quarterly Bulletin: Scott News
- Service Manuals
- Reproduction Parts and Service
- Scott Video
- E. H. Scott the Dean by Marvin Hobbs

For more information write:

E. H. Scott Historical Society
3712 N. Broadway #4450
Chicago, Illinois 60613

*"Your One-Stop Spot
For All Things Scott"*

SERVICES: Rider Radio Schematics, 1930 through 1950's. Includes alignment data. Send \$3 with make, model and SASE to: George M. Bonanno, WA2KPE, 34 Charles St., Clifton, NJ 07013. (201) 746-5953

SERVICES: Manuals for Lafayette Radio and other manufacturers. Send two 32¢ stamps for catalog. Pete Markavage, The Manual Man, 27 Walling St., Sayreville, NJ 08872. (908) 238-8964

SERVICES: Loudspeaker repairs and reconing, antique and modern plus refoaming edges. Jackson Speaker Service, 217 Crestbrook Dr., Jackson, MI 49203. (517) 789-6400

SERVICES: Schematics 1920's thru 1950's mailed or faxed - \$3, radios; \$4 TVs, ppd. Robert Schrantz, 610 E. Juanita Ave., San Dimas, CA 91773. Phone/fax: (909) 394-1194

SERVICES: Repair of TV-7 tube testers w/calibration: I will fix and then verify calibration of your TV-7 tube tester for \$45 plus all shipping or return it no charge. Daniel Nelson, 1025 E. Desert Ln., Phoenix, AZ 85040. (602) 243-7421, evenings. E-mail: djn@indirect.com.

SERVICES: 3-year guarantee. Radio Overhaul. Enjoy original performance, everyday. Professional shortwave specialist. Free: brochure, estimates, shipping boxes. Captain Larry Rau's Occidental Radio Workshop, Box 1139, Occidental CA 95465. (707) 874-3018

SERVICES: Fine restoration of nameplates, dials, logos, lettering, and other radio graphics. Eric Wrobbel, 20802 Exhibit Ct., Woodland Hills, CA 91367. (818) 884-2282

HELP: Locating the International J cathedral that sold at the Larry Canon sale 6/24/95. Nevins Museum of Radio, Ken Nevins, 406 Jipson St., Blissfield, MI 49228. (517) 486-3019, evenings please

HELP: Need schematic and junker auto radio for Becker Mexico T.G. Series. Head, typ. Mexico 23+U. Power supply, typ. Umricter 24+E. Lookalike on page 25 Sams AR 17. My model all tubes. Joe Grace, 183 Colonade Cir., Naples, FL 33940. (941) 434-7571



HELP: Wanted to buy Electro Dynamic speaker for this 1929 Stewart-Warner 900 Series radio. Speaker fits in cabinet under radio baffle board, hole is approx 7 1/2 inches; the cabinet has 4 bolt holes in the bottom where the speaker mounts, in width the holes are 4 1/4 inches apart and in depth 2 1/4 inches apart. Richard Howarth, PO Box 9, Junortoun 3551, Victoria, Australia. Phone: (054) 493207

HELP: Need picture or drawing of front grille panel of Story Clark colonial style grandfather clock radio. Thank you. Model #? Joe Cosgriff, PO Box 126, Brandamore, PA 19316

HELP: Dates when Heathkit AT1, DX20, CR1 made. Also instructions or copy of CR1. Gregory Sheppard, 4402 Jupiter St., Rockville, MD 20853-3255

HELP: I still need (8) push buttons and (3) knobs for my Philco 40-180. Ben Martin, 18334 Pepper St., Castro Valley, CA 94546. (510) 582-6804



HELP: Wanted to buy this pickup arm as pictured to complete my 1929 Model 940 Columbia Radiogram. Richard Howarth, PO Box 9, Junortoun 3551, Victoria, Australia. Phone: (054) 493207

HELP: Need diagram, service information for Sentinel Portrola. I can't find it in Rider's or Gernsback. Have I overlooked it? Gerald Cromer, K4NHN, 1014 Summerland Dr., Cayce, SC 29033. (803) 794-1483

HELP: Need N.O.S. Walsco/EV-Game belts, wheels, rollers; N.O.S., Shure, Nortronics, Michigan Magnetics, etc. Recording heads. Kevin Wheeler, 3907 Sunbeam Ave., Chattanooga, TN 37411. (423) 698-3643

HELP: Need schematic and information on Learadio AMT-12 and AMR-1. Thanks. Will compensate. Phil Grant, 119 Hoeshop Rd., Bernardston, MA 01337. (413) 648-9077, eves.

**NOTICE TO ALL
CLASSIFIED ADVERTISERS!
OUR CLASSIFIED AD DEADLINE IS
12:00 NOON
ON THE 10th OF EACH MONTH**

FOR TRADE: Radiocraft D5 amp for DeForest DT800 amp or ?. Merrill Bancroft, 169 S. Row Rd., Townsend, MA 01469. (508) 597-6623

FOR TRADE: (15) Bakelite & plastic radios. WANTED: Antlers or bright red, coral, turquoise, green Zeniths. SASE. Phil Brunais, 14185 Pleasanton Hwy., Bear Lake, MI 49614

FOR TRADE: Victor RE-57, untested, similar to one shown in A.R.C. March '93, for an Edison Amberola or other Edison 4-minute cylinder phonograph that is complete and rebuildable. Eastern Pennsylvania and New Jersey only! Cannot ship. Neal Simpson, 27-1 Queen Rd., Lambertville, NJ 08530. (609) 397-3346

FOR TRADE: My Stromberg-Carlson Models 1A & 2A (battery set & horn) which works, for your four Deco consoles. A. Bruno, 24 Butternut Dr., New City, NY 10956. (914) 354-8899

FOR TRADE: My Zenith 9S262 in vgc for your 1950's speakers and amps. Tim Phelan, 1521 Virginia Ave., Ellisville, MO 63011. (314) 227-9284

FOR TRADE: National doghouse, have 697 (powers HRO, FB-7), need 5880-AB for 2.5v SW-3. John J. Martin, PO Box 6222, Mesa, AZ 85216. (602) 981-8389

FOR TRADE: A.R.C. back issues for AWA O.T.B. back issues - 2 for 1. Don Merz, 47 Hazel Dr., Pittsburgh, PA 15228. (412) 234-8819, weekdays



N.Y.C. – Oct. 23-Nov. 3

MUSEUM OF TELEVISION & RADIO FIRST ANNUAL RADIO FESTIVAL

New York, NY – 25 West 52 Street

Broadcasts From the MT&R Studio

Oct. 26: 2-6 pm – The Ken Hamblin Show

Oct. 28: 1-4 pm – WABC-AM, New York
The Curtis Sliwa Show

Seminars

Oct. 26: 12:30 pm – “See You On The
Radio” w/Charles Osgood

Oct. 26: 6 pm – Talk Radio’s Other Voices

Oct. 30: 6 pm – Casey Kasem

Oct. 31: 12:30 pm – *Let’s Pretend* - A Reunion

Oct. 31: 6 pm – Greetings From Lake
Wobegon: An Evening w/Garrison Keillor

Nov. 1: 6 pm – Hot Formats in Contemp. Radio

Nov. 2: 6 pm – Legends of N.Y., Top 40 AM

Family Fun with Recreating Radio

Oct. 28 & Oct. 29: 10 am, 1 pm, & 3:30 pm

Five Listening Series in The Ralph

Guild Radio Listening Room

Radio’s 1st 50 Years; Black Music; Poets;
Auto Ads; and Baseball

Radio Festival Info Line: (212) 621-6709

TEXAS – Oct. 27-29

VINTAGE RADIO & PHONO. SOCIETY ANTIQUE WIRELESS ASSN. – CONVENTION '95

Irving, TX – Holiday Inn DFW Airport South
4440 W. Airport Freeway – (214) 399-1010

Oct. 27

10:30-11:30 am – “Solid-State
Vacuum Tube Devices” w/Tom Burgess

1-2 pm – “Robert Davol Budlong,
Commander McDonald and Zenith” w/John Bryant

1-3 pm – Contest judging

3-6 pm – Contest viewing

6-10 pm – Fri. Regular Auction

Oct. 28

9 am-3 pm – Contest viewing

10-10:30 am – Silent Auction

12 noon-5 pm – Sat. Main Auction

6:30-7:30 pm – Reception

7:30-9:30 pm – Annual Awards Banquet

Guest speaker: John Bryant w/slides
“A Stroll Through The Zenith Archives”

Oct. 29

8 am-12 noon – Indoor Flea Market

Info: VRPS, PO Box 165345, Irving, TX 75016

S. CAROLINA – Oct. 27-28

VINTAGE RADIO UNIQUE SOCIETY “DIEHARD” RADIO COLLECTORS TRADE/SHOW

Greenville, SC – Comfort Inn, I-85 Exit 46
Mauldin Rd., (Just No.) – (803) 277-6730

Oct. 27

1-5 pm – Open-air Trade, bring table

6:30 pm Casual Social, Palmetto Room

7 pm – Program: “Mics as Collectibles”

Guest Speaker - Ellis Huguley

7:30 pm – Special Trade Market only for
Advertising & Publications

Oct. 28

7 am-2 pm – Open-air Trade, bring table

11-11:30 am – Contest Awards Viewing

Amateur Radio Talk-in: +147,285 WD4MGM

Info: George Hall – (803) 244-9797, or
Jerryl Sears – (910) 765-4302

MICHIGAN – Oct. 28

MICHIGAN ANTIQUE RADIO CLUB FALL SWAP MEET

Dearborn, MI – Armenian Community
Center, 19319 Ford Road

8 am-1 pm

Advance seller table reservations advised

Info: Don/Nancy Colbert – (313) 274-1948

NEW HAMPSHIRE – Oct. 28

NEW ENGLAND ANTIQUE RADIO CLUB SWAP MEET

Nashua, NH – Resurrection Center

Rt. 3 (Everett Turnpike), Exit 6

1½ miles West on Rt. 130, 449 Broad St.

8 am – Early Admission

9 am-1 pm – General Admission

Over 100 tables – 50/50 Raffle – CATERED

Old Equipment Contest

Reservations required to sell

Info: Gregg Thompson, PO Box 298
Newtonville, MA 02160

LOUISIANA

LOUISIANA GULF COAST CLUB NEW CLUB FORMING

Info: Phil Boydston, 102 Concorde Place
Mandeville, LA 70471 – (504) 845-0867

Enclose a SASE when requesting info.

TENNESSEE - Oct. 28

MEMPHIS ANTIQUE RADIO CLUB FALL TRUNK SALE & SWAP MEET

Memphis, TN - Area behind The
Antique Warehouse, 2563 Summer Ave.
8 am

Info: Hal Kravig, Box 341361
Memphis, TN 38184 - (901) 388-2857

INDIANA - Nov. 4

ANTIQUE RADIO ESTATE AUCTION

Lafayette, IN - Judi Painter's Banquet Hall
101 Plaza Ln., fr. I-65 take Hwy 38 Exit W. to
Hwy 25, follow 25 S. to Hwy 231, turn left
10 am

Info: Doug Davies, PO Box 5542
Lafayette, IN 47903 - (317) 449-4515

ILLINOIS - Oct. 29

ANTIQUE RADIO AUCTION

Olney, IL - Eric's Auction Barn
1000 S. West St., 1/2 mile North of Rt. 50
11 am

Info: Eric Bruner, Auctioneer - (618) 392-2343
Wayne Martin - (314) 547-4292

MINNESOTA - Nov. 4

NORTHLAND ANTIQUE RADIO CLUB FALL SWAP MEET

West St. Paul, MN - St. Croix Lutheran
High School, 1200 Oakdale Ave.
8 am-1 pm

Info: Joe Gruber - (612) 489-5552

PENNSYLVANIA - Oct. 31

SOCIETY OF BROADCAST ENGINEERS CONVENTION/PARS DISPLAY

Mars, PA - Sheraton Inn North
8-9 am - Symposiums
9 am-6 pm - Show, including Pittsburgh
Antique Radio Society display of old radios
"Diamond Jubilee of Radio Broadcasting"
Info: Nick Cap - (412) 788-8989

CALIFORNIA - Nov. 4

CALIF. HISTORICAL RADIO SOCIETY MEET

Redwood, CA - Ampex Corp. Parking Lot
Bay Rd., Hwy. 101, 3 Blocks S. of Woodside Rd.
8 am

Info: CHRS 24-hr. Hotline - (415) 978-9100

VIRGINIA - Nov. 1

TIDEWATER ANTIQUE RADIO ASSN. NEW CLUB FORMING - MEETING

7 pm - Call for location & directions
Info: Phil Stroud, 2328 Springfield Ave.
Norfolk, VA 23523 - (804) 481-2561, after 6 pm

NEW YORK - Nov. 5

GREATER NEW YORK VINTAGE WIRELESS ASSN. - SWAP MEET

Lake Ronkonkoma, NY - 367 Hawkins Ave.
North of Long Island Expressway
lg. white house across fr. Dairy Barn store
9-12 am

Info: Steve Conklin - (516) 324-3012, or
Chris Bacon - (516) 981-6538

ARKANSAS - Nov. 2

ANTIQUE RADIO COLLECTORS CLUB OF FORT SMITH - CLUB MEETING

Fort Smith, AR - St. Luke Lutheran Church
Waldron Road, at Free Ferry
7:30 pm

Info: Paul Tucker, 4700 N. "N" Street
Fort Smith, AR 72904 - (501) 782-8178

WASHINGTON - Nov. 5

VINTAGE AUDIO LISTENERS AND VALVE ENTHUSIASTS - MEETING

Poulsbo, WA - Classic Radio
1127 N.W. Bright Star Ln.
10 am-2 pm

Info: Dan Schmale - (360) 697-1936

WASHINGTON - Nov. 4

RADIO ENTHUSIASTS OF PUGET SOUND MEETING

Seattle, WA - Queen Anne Library
400 W. Garfield
2 pm

Info: REPS, 9936 NE 197th Street
Bothell, WA 98011 - (206) 488-9518

ONTARIO - Nov. 8

OTTAWA VINTAGE RADIO CLUB MEETING

Ottawa, Ontario - Ottawa Citizen
Conference Room, 1101 Baxter Road
7 pm

Info: Tom Devey, 810 Edgeworth Avenue
Ottawa, Ontario K2B 5L5 - (613) 828-5152

MARK YOUR CALENDAR

Oct. 23-Nov. 3 - NY, New York - Radio Festival*
Oct. 27-28 - SC, Greenville - VRUS Trade/Show*
Oct. 27-29 - TX, Irving - VRPS/AWA '95*
Oct. 28 - MI, Dearborn - MARC Swap Meet*
Oct. 28 - NH, Nashua - NEARC Swap Meet*
Oct. 28 - TN, Memphis - MARC Sale/Meet*
Oct. 29 - IL, Olney - Radio Auction*
Oct. 31 - PA, Mars - SBE Convention*
Nov. 1 - VA, TBA - TARA Meeting §
Nov. 2 - AR, Fort Smith - ARCCFS Meeting §*
Nov. 4 - CA, Redwood City - CHRS Meet*
Nov. 4 - IN, Lafayette - Radio Auction*
Nov. 4 - MN, W. St. Paul - NARC Swap Meet*
Nov. 4 - WA, Seattle - REPS Meeting §*
Nov. 5 - NY, Lake Ronkonkoma - GNYVWA §*
Nov. 5 - WA, Poulsbo - VALVE Meeting §*
Nov. 8 - Ontario, Ottawa - OVRC Meeting*
Nov. 9 - AR, Little Rock - AARC Meeting §*
Nov. 10 - NJ, Freehold - NJARC Meeting §*
Nov. 11 - AZ, Tempe - AARC Fall Swap Meet*
Nov. 11 - OK, Okla. City - OKVRC Meeting §*
Nov. 11 - OR, Portland - NWRVS Show & Sale*
Nov. 11 - TX, Houston - HVRA Meet/Auction*
Nov. 12 - CO, Denver - CRC Meeting*
Nov. 12 - MS, Meridian - MHR&BS Meeting §*
Nov. 13 - GA, Norcross - SARS Meeting §*
Nov. 13 - IL, Belleville - BAARC Meeting §*
Nov. 14 - MO, St. Louis - ARCH Meeting §*
Nov. 14 - OH, Kettering - ARCO Meeting §*
Nov. 14 - PA, Souderton - DVHRC Meeting §*
Nov. 14 - TX, Houston - HVRA Meeting §*
Nov. 15 - CA, N. Highlands - SHRS Meeting §*
Nov. 15 - OH, Cincinnati - SPARK Meeting §*
Nov. 15 - OH, Columbus - SPARK Meeting §*
Nov. 16 - NY, Goshen - HARPS Meeting §*
Nov. 18 - AL, Decatur - SVWA Fall Swap Meet*
† Nov. 18-19 - CA, Ontario - SCARS Meet*
Nov. 18 - MD, Burtonsville - MAARC Meeting §*
Nov. 18 - OH, Medina - Estes Radio Auction*
Nov. 18 - PA, Downingtown - Radio Auction*
Nov. 18 - PA, Souderton - DVHRC Swap Meet*
Nov. 18 - TX, Irving - VRPS Meeting §*
Nov. 19 - NM, Albuquerque - NMRCC Meeting §*
Nov. 19 - WA, Seattle - PSARA Meeting §*
Nov. 25 - Ontario, London - LVRC Meeting*
Nov. 26 - BC, Richmond - CVRS/BC Meeting §*
Nov. 27 - AL, Birmingham - ALHRS Meeting §*
Nov. 28 - OH, Kettering - SPARK Meeting §*
Dec. 2 - PA, Forest Hills - PARS Meeting*
Dec. 2 - TX, Houston - HVRA Christmas Party*
Dec. 9 - AZ, Scottsdale - AARC Christmas Social
Dec. 9 - Austria, Vienna - Radio Auction*
Dec. 10 - WA, Seattle - PSARA Meeting §
Dec. 12 - CA, Redding - CHRS-NVC Meeting*
Dec. 16 - MD, Burtonsville - MAARC Meeting §
1996
Jan. 13 - AZ, Phoenix - AARC Meeting
Jan. 14 - CO, Denver - CRC Meeting
Jan. 20 - NH, Nashua - NEARC Swap Meet
Jan. 20 - TX, Irving - VRPS Meeting
Jan. 27 - Ontario, London - LVRC Meeting
Feb. 3 - MI, Grand Rapids - MARC Meet
Feb. 17 - AZ, Phoenix - AARC Radio Roundup
Feb. 25 - MA, Westford - GBARC Radio XXVII
Mar. 9 - AZ, Scottsdale - AARC Swap Meet
Mar. 22-23 - NC, Charlotte - AWA Spring Meet
Mar. 30 - Ontario, London - LVRC Meeting
Apr. 20 - NH, Nashua - NEARC Swap Meet
May 17-19 - OH, Dayton - 1996 Hamvention
May 18 - TX, Irving - VRPS Swap Meet
May 25 - Ontario, London - LVRC Meeting

(Continued at top of next column)

MARK YOUR CALENDAR

(Continued from bottom left column)

Jun. 29 - Ontario, London - LVRC Meeting
Jul. 12-14 - MI, Lansing - Extravaganza '96
Jul. 20 - NH, Nashua - NEARC Swap Meet
Aug. 17 - TX, Irving - VRPS Swap Meet
Sep. 4-7 - NY, Rochester - AWA Conference
Oct. 26 - NH, Nashua - NEARC Swap Meet

* See expanded listing this month. § Monthly Meeting
† Date changed from original announcement

ARKANSAS - Nov. 9

ARKANSAS ANTIQUE RADIO CLUB MEETING

Little Rock, AR - SW Bell Tel. Building
1111 W. Capitol
7 pm

Info: Tom Burgess - (501) 455-0773

NEW JERSEY - Nov. 10

NEW JERSEY ANTIQUE RADIO CLUB MEETING

Freehold, NJ - Grace Lutheran Church
West Main St. & Park Ave. (old Rt. 33)
7:30-9:30 pm - Meeting & Swap

Info: Don Cruse - (908) 542-2848
Tony or Kathleen Flanagan - (908) 462-6638

ARIZONA - Nov. 11

ARIZONA ANTIQUE RADIO CLUB FALL SWAP MEET

Tempe, AZ - Antique Electronic Supply
6221 S. Maple Street

7 am - Swap Meet and Auction

Info: Steve Smith - (602) 814-0539, or
Dennis Craft - (602) 860-8951

OKLAHOMA - Nov. 11

OKLA. VINTAGE RADIO COLLECTORS MEETING

Oklahoma City, OK - Location to be
announced

8-10 am - Swap Meet

Info: Mike Lapuzza - (405) 745-3394, after 6 pm
OKVRC, PO Box 332, Wheatland, OK 73097

OREGON - Nov. 11

NORTHWEST VINTAGE RADIO SOCIETY FALL SWAP MEET/SHOW & SALE

Portland, OR - Multnomah Arts Center
7688 S.W. Capitol Highway
9 am-1 pm

Info: Dick Dielschneider - (503) 246-1062

TEXAS - Nov. 11

**HOUSTON VINTAGE RADIO ASSN.
SWAP MEET/TAILGATE AUCTION**

W. Houston, TX - Molina's Restaurant, Hwy. 6
8-12 noon

Info: Bill Werzner - (713) 721-2242

COLORADO - Nov. 12

**COLORADO RADIO COLLECTORS
MEETING**

Denver, CO - 2020 West Barberry Place
Wazee Electric Bldg., Community Room
1 pm - Meeting, followed by Swap Meet

Info: Rick Ammon - (970) 221-4001

MISSISSIPPI - Nov. 12

**MISSISSIPPI HISTORICAL RADIO &
BROADCASTING SOCIETY - MEETING**

Meridian, MS - 2412 C Street
3 pm

Info: Randy Guttery, 2412 C. Street
Meridian, MS 39301 - (601) 693-5958

GEORGIA - Nov. 13

**SOUTHEASTERN ANTIQUE RADIO SOCIETY
MEETING**

Norcross, GA - Picadilly Cafeteria
3400 Holcomb Bridge Road

6 pm - Mini-Meet; 6:30 pm - Meeting

Info: Charles Milton - (404) 922-6507, or
SARS, PO Box 500025 - Atlanta, GA 31150

ILLINOIS - Nov. 13

**BELLEVILLE AREA ANTIQUE RADIO CLUB
MEETING**

Belleville, IL - Belleville Area College
7 pm

Info: Karl Stegman, 4 Cresthaven Drive
Belleville, IL 62221 - (618) 234-7992

OHIO - Nov. 14

**ANTIQUERADIO COLLECTORS OF OHIO
MEETING**

Kettering, OH - National City Bank Basement
4100 Far Hills Ave.

SE corner of Far Hills Ave. & Stroop Rd.

7:30 pm - Tubes: "Electrons On the Move"

Info: Steve Geary - (513) 492-0972

**SUBMISSION DEADLINE
5th OF MONTH**

MISSOURI - Nov. 14

**ANTIQUERADIO COLLECTORS & HISTORIANS
OF GREATER ST. LOUIS - MEETING**

St. Louis, MO - Kirkwood Community Center
7 pm

Info: Charles Juedemann, 2015 Hickory
Ridge Rd., Union, MO 63084 - (314) 583-5116

PENNSYLVANIA - Nov. 14

**DELAWARE VALLEY HISTORICAL RADIO CLUB
MEETING - SWAP MEET - AUCTION**

Souderton, PA - 113 Main St.,
N. Penn Amusements Bldg.

7:30 pm

Info: DVHRC, PO Box 41031, Philadelphia,
PA 19127-0031 - Mike Koste - (215) 646-6488

TEXAS - Nov. 14

**HOUSTON VINTAGE RADIO ASSN.
MEETING**

Houston, TX - Tides II Hotel, Lai Lai
Restaurant, NW corner of Holcolm & Main
(Texas Medical Center)

7-10 pm - Auction & Program

Info: Bill Werzner - (713) 721-2242

CALIFORNIA - Nov. 15

**SACRAMENTO HISTORICAL RADIO
SOCIETY - MEETING**

N. Highlands, CA - SMUD Foothill Service
Center, Room D, 5026 Don Julio
Approx. 1 mile West of I-80

7-9 pm

Info: SHRS, PO Box 162612, Sacramento
CA 95816, or Don Steger - (916) 929-8274

OHIO - Nov. 15

**SOCIETY FOR PRES. OF ANTIQUE RADIO
KNOWLEDGE/CINCINNATI CPT. - MEETING**

Cincinnati, OH - Richards Radio & TV
4041 Edwards Rd., I-71, Exit 6

7:30 pm

Info: Tim Kaiser, PO Box 81
Newport, KY 41071 - (606) 441-2548

OHIO - Nov. 15

**SOCIETY FOR PRES. OF ANTIQUE RADIO
KNOWLEDGE/COLUMBUS CPT. - MEETING**

Columbus, OH - DeVry Institute of Tech.
1350 Alum Creek Road, I-70 Exit 103B

7:30 pm

Info: Sharon/Ken Fullerton - (614) 237-2621

NEW YORK – Nov. 16

**HUDSON VALLEY ANTIQUE RADIO AND
PHONO. SOCIETY/AWA — MEETING**
Goshen, NY – Cataract Firehouse, Main St.
7-9 pm

Info: John & Linda Gramm, Box 1, Campbell
Hall, NY 10916 – (914) 427-2602, 6-9 pm

PENNSYLVANIA – Nov. 18

ANTIQUE RADIO AUCTION
Downingtown, PA – Downingtown Marketplace
Sat.: 10 am – Auction
(Preview: Fri. 10 am-10 pm, Sat. 8-10 am)
Info: Smith Auction Co. – (610) 269-1036

ALABAMA – Nov. 18

**SOUTHERN VINTAGE RADIO SOCIETY
FALL SWAP MEET**

Decatur, AL – 9th St. Methodist Church
7 am-12:30 pm

Info: Jim Makar – (205) 233-8357

PENNSYLVANIA – Nov. 18

**DELAWARE VALLEY HISTORIC RADIO CLUB
FALL SWAP MEET**

Souderton, PA – 117 Main St., Pa. Rt. 113
8 am-1 pm

Info: Dave Abramson – (610) 827-9757

CALIFORNIA – Nov. 18-19

**SO. CALIF. ANTIQUE RADIO SOCIETY
ANNUAL MEETING & SWAP MEET**

Ontario, CA – Holiday Inn, Ontario Airport
3400 Shelby Street, I-10 at Haven
(909) 466-9600 – airport courtesy van

Fri. Nov. 17th:

5-8 pm – Collectors reception w/Rich & Kosh
Radio Collectors video – Supper & drinks

Sat. Nov. 18th:

7 am-3 pm – Flea Market

5-6 pm – Contest

6-7:30 pm – Gourmet Mexican Buffet,
big band music & old-time radio show

7:30-7:40 pm – Meeting

7:40-8 pm – Awards

8 pm – Stump the Experts: Bring your
most unusual item

Sun. Nov. 19th:

7:00-noon – Flea Market

9:30-10:30 am – Donation Auction

Packing and shipping available on site

Info: Kosh – (213) 465-9919

Fax: (213) 465-2956

TEXAS – Nov. 18

**VINTAGE RADIO & PHONO. SOCIETY
MEETING**

Irving, TX – Garden Arts Building
1-5 pm

Info: George Potter – (214) 315-2553

NEW MEXICO – Nov. 19

**NEW MEXICO RADIO COLLECTORS CLUB
MEETING**

Albuquerque, NM – Sierra Vista Bible
Church, 7509 Paseo Del Norte

1:30 pm – Deco Radios

Info: Bill Schultz, 11605 Versailles Ave. NE
Albuquerque, NM 87111 – (505) 294-5302

WASHINGTON – Nov. 19

**PUGET SOUND ANTIQUE RADIO ASSN.
MEETING**

N. Seattle, WA – Shoreline Museum
parking lot, 749 No. 175th St. & Linden Ave.

9 am – Swap Meet

12 noon – Annual Contest

Info: Al Atworth, PO Box 125
Snohomish, WA 98291-0125 – (360) 568-2698

MARYLAND – Nov. 18

**MID-ATLANTIC ANTIQUE RADIO CLUB
MEETING**

Burtonsville, MD – New Hope Seventh Day
Adventist Church gym – 6:30 pm

Info: Sam Cannan, 1010 Siske Road
Stony Creek, MD 21226 – (410) 255-7728

ONTARIO – Nov. 25

**LONDON VINTAGE RADIO CLUB
MEETING**

London, Ontario – Jaycee Building
317 Adelaide St. South

1 pm

Info: Don Hatch, 14 Kingspark Cres., London
Ontario, Canada N6H 4C4 – (519) 472-6167

OHIO – Nov. 18

ESTES RADIO AUCTION

Medina, OH – 8240 Wooster Pike Rd.
Seville Antique Auction Barn

10 am EST – Auction; 9 am – Preview

Info: Estes Auctions – (216) 769-4992

**MENTION A.R.C.
WHEN CONTACTING CLUBS!**

BRITISH COLUMBIA - Nov. 26

CANADIAN VINTAGE RADIO SOCIETY BRITISH COLUMBIA CHAPTER — MEETING

Richmond, BC - Steveston Hotel
Steveston Village on Fraser River, min. fr.
Vancouver, 30 min. fr. U.S. via Hwy 99 (I-5)

12 noon - Swap Meet
2 pm - Meeting

Info: Fred Tutt, 4895 Mahood Dr., Richmond,
BC, Canada V7E 5C3 - (604) 275-2033

PENNSYLVANIA - Dec. 2

PITTSBURGH ANTIQUE RADIO SOCIETY QUARTERLY MEETING

Forest Hills, PA - Westinghouse Lodge
on Greensburg Pike

9 am - Flea Market
12 noon - Meeting

Info: Bonnie Novak - (412) 481-1563, or
Seth Ward - (412) 835-6603

ALABAMA - Nov. 27

ALABAMA HISTORICAL RADIO SOCIETY MEETING

Birmingham, AL - Homewood Public Library
1721 Oxmoor Road

7 pm

Info: Earl Ridolphi, 2413 Old Briar Trail
Birmingham, AL 35226 - (205) 823-3314

TEXAS - Dec. 2

HOUSTON VINTAGE RADIO ASSN. CHRISTMAS PARTY

Houston, TX - Tides II Hotel, Lai Lai
Restaurant, NW corner of Holcolm & Main
(Texas Medical Center)

Info: Bill Werzner - (713) 721-2242

OHIO - Nov. 28

SOCIETY FOR PRESERVATION OF ANTIQUE RADIO KNOWLEDGE — MEETING

Kettering, OH - Cassano's Pizza
1700 E. Stroop Rd.

7:30 pm

Info: Harold Parshall - (513) 865-5900, days
(513) 268-2909, eves. until 9 pm

AUSTRIA - Dec. 9

FIRST RADIO AUCTION

Vienna, Austria - order Auction Catalog fr.:
Auktionshaus Dorotheum, Subscription
Dept., Dorotheergasse 17, 1010 Vienna,
Austria - +432-51560-289, fax: -443

CALIFORNIA - Dec. 12

CALIF. HISTORICAL RADIO SOCIETY NORTH VALLEY CHAPTER MEETING

Redding, CA - 7 pm

Info: Chris Galantine, 15853 Ontario Place
Redding, CA 96001-9785 - (916) 244-2337

Although non-members are welcome at all
events, joining may be required at some.
Admission is charged at some events.

A free* listing on these pages is available for
each coming radio event. Sponsors should
provide description of event, date, time,
place, directions, & information/contact
person. Since listings are on a "space avail-
able" basis, no guarantee of listing is made.

Submission Deadline - 5th of month.

*Club/museum/non-profit events are listed
free; other events are obtained from adver-
tisements placed elsewhere in A.R.C.

INDIANA

INDIANA HISTORICAL RADIO SOCIETY INDIANA HISTORIC RADIO MUSEUM

Ligonier, IN - Ligonier Visitors Center
2 blocks N. of US 6, US 33, & State Rd. 5

Open Tues., Wed. & Sat.: 10 am-3 pm

Info: Fred M. Schultz, 800 S. Lincolnway
Ligonier, IN 46767 - (219) 894-9000

BUSINESS CARD ADS - \$41.00 FOR 3 MONTHS

* * WANTED * *

Masco, Newcomb PA Systems
Turner, Shure, Astatic Mics
Jensen 8", 10" speakers,
any condition.

* Gary (203) 777-7426 *

LOGANS TV-RADIO

SINCE 1952

BUY • SELL • TRADE

100's of N.O.S. PARTS, TUBES IN STOCK.
PARTIAL OR TOTAL RESTORATION AVAILABLE.

412-837-5580

REAR 526 MT, PLEASANT ST., GREENSBURG, PA 15601

BUSINESS CARD ADS - \$41.00 FOR 3 MONTHS

Carbon Resistors • Capacitors • Vacuum Tubes

ALLTRONICS

Electronic Component Supply

2300 Zanker Road • San Jose, CA 95131
Voice (408) 943-9773 • Fax (408) 943-9776
BBS (408) 943-0622 • 24 Hrs. • N-8-1

Call or Fax for Catalog

50 years **CHUCKS** of service!

**Any Tube Radio Repaired and
Guaranteed to work good.
\$25 plus parts & UPS**

CHUCKS
167 LYNN DRIVE - PO Box 598
NEW HAVEN, WV 25265 - PH (304) 882-2220

78 RPM Cartridges Repaired



Dead cartridges rebuilt right. New crystals etc., as needed. Allow 3-4 weeks. Most crystal and "horseshoe" magnet types \$34.50
 100 hr. sapphire setscrew needles (list \$2.50 ea.) . . . 4/\$5.50



Inquiries: (508) 879-2778, evenings and weekends. Prices include return postage. Please include payment with order.

Joe Smolick
 635-A Pleasant Street
 Framingham, MA 01701

PHILCO PREDICTAS WANTED!



BUY • SELL • TRADE • RENT • RESTORE

DAVID WEDDINGTON
 (615) 890-7498

2702 Albany Ct.
Murfreesboro, TN 37129

ELECTRON TUBE ENTERPRISES

(Dealers in Surplus Electron Tubes)

Box 8311

Essex, VT. 05451

TEL: 802-879-1844

FAX: 802-879-7764

FREE 1995 CATALOG AVAILABLE

(Lowest prices on New & Used tubes)

INSTRUMENTS

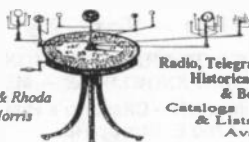

*Jim & Rhoda
Morris*

**Radio, Telegraph,
Historical Instruments,
& Books For Sale**
 Catalogs
& Lists
Available

Antiques of Science & Technology
 A of ST Box 1852 Wakefield Ma. 01880 U.S.A.
 Tel 617 243 2897 Fax 617 243 3572

COMMNAV EQUIP
 RADIO SETS
 NAVAL AIR FIELD
 U.S. FOREIGN

CHARLES DICICCA EA100N
 561 MYSTIC VALLEY PIKWY
 LEEFORD, MASS 02155
 PHONE: 617-394-9354



MILITARY ELECTRONICS

BUY WANTED TRADE

Mr. John Adolina, Jr.
"The Early Sound Man"
REPRODUCERS rebuilt

(716) 247-3056
 28 Glen Oaks Dr.
 Rochester, NY 14624

Antique Phonographs Buy - Sell - Trade



AND
 RELATED ADVERTISING ITEMS
 Any Brand - Any Condition
 Also Cylinders, Disc Records
 "One Item or Entire Collection"
 Quality Repairs Since 1973
 Edison, Victor, Columbia



THE FINISHING TOUCH



Jodd E. Hinman Restorations

SHOW WINNING FINISHES

— AUTO INTERIOR WOOD —

- RADIOS • MECHANICAL
- 78 RPM JUKEBOXES • ELECTRONICS



203-274-0705

203-268-6080



182 JUDD FARM ROAD
WATERTOWN, CONN. 06795

All New 1995

VINTAGE RADIO VIDEOS



This series shows hundreds of vintage radios 1920's-1980's in clear detail. These videos are educational and entertaining. For information, phone 1-941-533-4650. For brochure, write to: WBW Entertainment, 970 E. Lake Drive, Bartow, FL 33830-5917.

SUNSHINE SOUNDS

WANTED:



Hi Fi TUBE & COMMERCIAL AMPS

SPEAKERS & HORNS

McIntosh, Marantz, Dynaco, Heath, Altec, Scott, RCA, Fisher, Craftsman, Grommes, Fender, Ampex, W.E. Vox, Brook, Acro, Pultec, Fairchild

Altec, Jensen, RCA, E.V., Western Electric, JBL, Tannoy

Phone: 405-737-3312 or Fax: 405-737-3355
Sonny - 1413 Magnolia Ln., Midwest City, OK 73110

Looking for early, portable electronic calculators (1970-78)

(Any that have LED or other "lighted" displays)

• **Will Trade Transistor Radios (or buy outright) •**
 Especially: Basicom, Berkey/Keystone, Calfax, Columbia, Commodore, Decimo, Educalc, Garrett, Ian Jones, JCE, Kingspoint, M.I.T.S., Monroe/Litton, Olympia, Royal, Sanyo, Sinclair, Sperry Remington, Summit, Victor.
Guy "Mr. Calculator" Ball Fax-(714) 730-6140
14561 Livingston St., Tustin, CA 92680

BUSINESS CARD ADS - \$41.00 FOR 3 MONTHS

SPY EQUIPMENT WANTED!

- Code Machines
- Secret Radios
- Clandestine Weapons
- Secret Cameras
- OSS, SOE, CIA, KGBI
- I Buy or Trade!

Keith Mellon
P.O. Box 5755 Bossier City, LA 71171
(318) 747-9616 Days: FAX (318) 747-9010



If you buy, sell or like jukeboxes you need **ALWAYS JUKIN--THE MONTHLY JUKEBOX MAGAZINE!!** Subscribers in 23 countries, **ALWAYS JUKIN LEADS THE WAY:** Articles, photos, show reports, ads, new products, price guides, restoration tips, repairs--everything you need to know about **JUKE-BOXES--the fastest appreciating collectible in the world!!** Fun & a great investment. Sample copy, \$3. \$33 per year. **ALWAYS JUKIN, 221 YESLER WAY AR, SEATTLE, WA. 98104. (206) 233-8460. Master/Visa ok.**



HAROLD C. BRAMSTEDT

C & N ELECTRONICS
8104 Egg Lake Road North
Hugo, MN 55038

- Buy
- Sell
- Transmitting & Industrial Tubes

812-429-9397
800-421-9397
Fax 812-429-0292



SECOND CHANCE COLLECTIBLES

399 Maplewood (Corner of 4th St.)
Ambridge, PA 15003 266-2565

* BUY & SELL



Vintage Radio



30 years experience 

Jackson Speaker Service
Expert Antique Loudspeaker Repairs (Cone Types) And Rebuilding A Speciality. Speaker Parts And Repair Service On Virtually Any Speaker Made Including Stereo, P.A., And Antique Auto Speakers. 217 Crestbrook Dr. Owner Jackson Mich 49203 Ron McGee Ph. - (517) 789-6400, Ans. 4th ring Wk-days 10: am-7pm Wk-Ends 9-5pm

RELIABLE - PROMPT - GUARANTEED

SOUND REMEDY LOUSPEAKER REPAIR SERVICE

331 Virginia Avenue
Collingswood, New Jersey 08108

Richard G. Stamer

Telephone
(609) 869-0238



CRYSTAL SETS

PARTS - PLANS - KITS - BOOKS
CATALOG \$1.00

Largest source of Vintage and New Variable Air Condensers, Variometers, Vario-Couplers, Tap Switches, Tap Points, Galena and Germanium Detectors, Detector Stands, Cat Whiskers, Terminals, Sliders, Headsets, Dial Knobs, Coil Forms, Magnetic Wire, etc.

MIDCO
P.O. Box 2288
Hollywood, FL 33022
(305) 925-3670
B.A. Turbo, Ph D E E



Martin

Gibson

We Buy, Sell, and Trade

"PLAY IT AGAIN"

Vintage Guitars, Amps,
Stereo Equip, Alnico Speakers, & Antique Radios
Tube Equipment Our Specialty

1-203-331-9155

McIntosh * PETER DeGREGORIO * Marantz
85 Burroughs Rd, Fairfield, Conn.
06430-3504

(510) 490-5842

Fax (510) 490-1961

Speakerworld®

Expert Speaker Refoaming and Reconing

2000 Warm Springs Ct. #6 Visa/ *Free Return
Fremont, CA 94539 MC Freight By UPS

**For Antique Speakers Only*

Vintage Radio

Bob's Radio & TV

- ◆ Repairs
 - ◆ Restorations
 - ◆ Specializing in all tube type car and home radios
 - ◆ FM additions
- 2300 Broad St
San Luis Obispo
California 93401
(805) 543-2946
- Full warranty on work performed, walk-ins welcome, stop by and see our antique radio museum

CAPACITORS - TUBES RADIO SERVICE ITEMS
Thousands in jam-packed illustrated 24-page catalog No. 49

INFORMATIVE INTERESTING FUN-TO-READ

Send \$3 U.S./Canada \$5 overseas (U.S. funds) for a Heavy-Paper limited edition copy NOW!

DON DIERS 4276 North 50 St. Dept. AB8
Milwaukee, WI 53216-1313

Phono Needles/Stylei
1500 Types
Magnetic - Ceramic -
Crystal Cartridges

Rebuild Astatic
and All Types
of Crystal Cer-
amic Cartridges



Rebuild Obsolete Idlers
New Idlers and Belts
Fabricate 78 RPM Needles

West-Tech Services

648 N. Ridgewood Dr. #11
P.O. Box 1415
Sebring, FL 33871

STEVE KARPIAK C.E.T.
Phone (941) 471-0922

BUSINESS CARD ADS - \$41.00 FOR 3 MONTHS



K4GIT

Box 2790 RR#2
Melrose, FL 32666

RADIO ELECTRIC SUPPLY

We Specialize In Receiving and Special Purpose Tubes
Send For Price List

Dorothy and Don Gies
Owners

904-475-1950
Phone or Fax

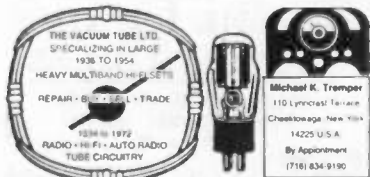

MAGNAVOX STROMBERG-CARLSON MIDWEST HOWARD

PUT YOUR BUSINESS CARD HERE!

\$41 FOR 3
MONTHS
\$70.75 FOR 6
MONTHS

DON'T HAVE ONE?
SEND AN EXTRA
\$6.00
AND WE WILL
TYPESET ONE
FOR YOU.

Radio Overhuls 3-Year Guarantee



Endangered Species 1928-1965

707-874-1000

- Estimates Gladly Given
- Total Overhuls Only
- No Parts Calls Please

Captain Larry Rau's
**OCCIDENTAL
RADIO WORKSHOP**

5,000,000 Vacuum Tubes In Stock Industrial & Receiving Types

Electronics Emporium Inc.

107 Trumbull Street
Elizabeth, NJ 07206

Buying & Selling, Call For Prices & Delivery

800 - OLD TUBE
(653 - 8823)

Ph: 908-351-0100

Fax: 908-351-8600

Allan H. Weiner

Radio Engineer Antiques of Technology

Electrical, Electronic, Scientific, and
Mechanical Artifacts.
Early WWII Radar a Speciality.

97 High St.
Kennebunk, ME 04043 (207) 985-7547

Buy • Sell • Trade

• GRUNDIG • SABA • TELEFUNKEN • NORDMENDE • PHILIPS • SIEMENS •
- SPECIALIZING IN REPAIR OF EUROPEAN RADIO SETS -

The Bavarian Radio Works



Ross A. Hoegstrasser
(617) 447-4299

162 BELLAH ST.
WHITMAN, MA 02382

WRIGHT'S ELECTRONIC SERVICE THE RADIO DOCTOR

"You Don't Have To Worry When It's Done Wright"

1920-1960's RADIOS-PHONOS-CAR RADIOS-TUBE AMPS

CHASSIS REPAIRS FROM SIMPLE TO COMPLETE REFURBISHMENT
MOST REPAIRS FROM \$25 MOST REFURBS \$50 TO \$100

WRIGHT'S ELECTRONIC SERVICE P.O. BOX 8252
(206) 859-3592 FEDERAL WAY, WA 98003

WANTED PRE 1900 ELECTRICITY

MEDICAL • X-RAY
TELEGRAPHY • TELEPHONE

PRE 1925
RADIO • WIRELESS
PRE 1940
TELEVISION

BOOKS • TUBES • ARTIFACTS
MAGAZINES • AUTOGRAPHS
CATALOGS • EPHEMERA



**NEW WIRELESS
PIONEERS**
P.O. BOX 398
ELMA, NY 14059
716-681-3186

WHAT... You have CATALINS?

I'll Pay Top \$'s — Any Models

Please Send a Photo and Price To:
Kunihiro Suzuki

2173 Takao, Fukuroi-Shizuoka, Japan 437
(Fax) 81 538 43 3188

RADIO BOOKS FOR SALE

Large selection of books on Radio and Related Technology
Call or write for our List of Catalogs.
Always buying, single items or collections.

RAINY DAY BOOKS

P.O. BOX 775, FITZWILLIAM NH 03447
(603)-585-3448

Antique Radio Hardware

- Knobs, handles, pendants, pulls, etc.
- Original dies for hundreds of different patterns dating back to 1920
- Specializing in solid brass hardware

Will cater to your needs - Even single piece orders
Send \$3 for catalog (refunded from 1st order)

GUY FREDERICK — (616) 456-9378
1121 Powers NW, Grand Rapids, MI 49504

BUSINESS CARD ADS - \$41.00 FOR 3 MONTHS

VINTAGE RADIO SERVICES

Ken Hubbard
KA9WRN

P.O. Box 792
Beloit, WI 53512-0792
(608) 362-1896
6 pm Evenings

Repair of
Vacuum Tube
Equipment

Home-Auto



ELECTRO TECHNICS Specializing in Repairs

...of European and Made in U.S.A. Tubes & Transistor Model Radios, Consoles, Hi-Fi Stereos, Cassette Players, Communication Receivers, and Amplifiers.

BRAND NAMES: Grundig • Saba • Telefunken • Philips • Norde Mende • Loewe Opta • Braun • RCA • GE • Philco • Emerson • Scott • Fisher • Marantz

Reasonable Prices. **FAST** Service

Call **ELECTRO TECHNICS** Today! **508-771-5955**
75 Breakwater Shores Drive, Hyannis, MA 02601



ESTES AUCTIONS

Specializing in Vintage Radios

7404 Ryan Rd.
Medina, Ohio 44256

Bus. Phone 216-769-4992
Fax 216-769-4116
Res. Phone 216-769-3987

IF YOU VISIT THE BRIMFIELD FLEA MARKET...
STOP BY FIRST!



TEL: 413-245-7174
COUNTRY ROAD BARN - BERNIE SAMEK
OLD PALMER ROAD, BRIMFIELD, MASS.



ANTIQUE RADIO RESTORATIONS

109 S. Oak St., O'Fallon, IL 62269
618-632-7423

*Collectors of Old Radios
Electronic Consultant, Dial Reproductions
Hickok Tube Testers, Service & Calibration*

Clinton Blais, P.E.
Life Member I.E.E.E.
AWA, ARCA

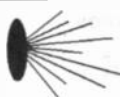

718-380-4009
Fax : 718-380-9793

WANTED OLD STOCK & BOND CERTIFICATES BETTER AUTOGRAPHS COMMUNICATIONS MEMORABILIA

Norrico Inc • PO Box 6688 • Flushing, NY 11365

Are You Looking For Antique Radios, Parts, Tubes, Schematics and Restoration Services?

For Free Flyer, a **2-Stamp LSASE** is required to insure a response to your request. Send to:

Olde Tyme Radio Company
2445 Lyttonsville Road, Suite 317
Silver Spring, MD 20910

Wish to contact us by phone or fax?
Our number is (301) 587-5280.
Please call 10 am to 10 pm (Local Time)

Antique Radios



David & Nancy Snow
P.O. Box 6352
Jackson, MI 49204
(517) 787-2985

We Buy, Sell, Repair
ARBE - III Battery Eliminators

**1920-1970
SCHEMATICS + PAGES OF INFO
\$5.00 POSTPAID**

**MANUAL PRICES - SASE
RADIO/TV/HAM/MISC.**

**"IF I DON'T HAVE IT, YOU
PROBABLY DON'T NEED IT."**

**ALTON H. BOWMAN — 4172 EAST AVENUE
CANANDAIGUA, NY 14424-9564**

ANTIQUE RADIO REPAIR
Repair - Restore - Buy & Sell

Schematic Service
Radios \$2.⁹⁹, TVs \$4.⁹⁹

DAMASKE ELECTRONICS
S74-W16834 Janesville Road
Muskego, WI 53150
Phone: (414) 679-0838



**New/Old Stock Parts
Reproduction Items
Books & Refinishing Supplies**

\$2.00 for 20 page catalog.
Refundable with first order.

Vintage TV & Radio

3498 West 105 St. Cleveland, OH 44111
216-871-8712

Radio & TV Tubes

— New Old Stock —

Call/write for price list & availability

db ELECTRONICS — 105 Rt. 47 South
Cape May Court House, NJ 08210
609-465-5005

BUSINESS CARD ADS - \$41.00 FOR 3 MONTHS

784-9417

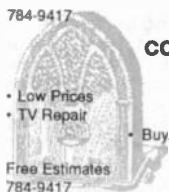

COSMOS TV

- Low Prices
- TV Repair

Free Estimates
784-9417

784-9417



- Quality Used TV's
 - Antique Radio Repair
- Buy, Sell, Trade

5919 15th Ave. N.W.
Seattle, WA 98107

WANTED

SONY CRF320 CRF330

Chris Clark, 117 Hudson Street, NYC, 10013
TEL. (212) 219-1783

Free Estimates
Mrs. - 10 AM - 7 PM
Tues. - Sat.

Tel./Fax (203) 928-2828



ANTIQUE RADIO RESTORATION & REPAIR

1920 - 1980's



Reasonable Rates. Tubes, Professional
Overhauls, Cabinet Refinishing Service
For All Antique Car, Table & Console
Radios, Communication Receivers &
Tube Amplifiers.

Buy & Sell

20 Gary School Road
BOB ESLINGER Pomfret Center, CT 06259

VINTAGE HI-FI EQUIPMENT & NEW OLD STOCK TUBES WANTED

We also buy Used, New, & Vintage
Speakers, amps, parts, guitars, and pedals
Any condition - working or not
Top prices and shipping paid

GUITAR OASIS

7451 Warner Avenue, Suite 1 - Huntington Beach, CA 92647
Phone (714) 842-7402 - Fax: (714) 842-7482
MON-FRI 9:30-7:00 PST • SAT 12:00-8:00 PST

ANTIQUE RADIO RESTORATION

Since 1936 Repair - Buy - Sell
Complete Restorations • Prompt Service

COOPER'S RADIO SERVICE

425 Court Street
Rockwell City, Iowa 50579



LARRY COOPER
712-297-7232



PR NOVELTY

Glass Audio Specialists
Amplifier Rebuilding • Service
Serpent Parts Brokerage
(New Old Stock and Used)

"The Home of Mr. Happy Amp"

Paul Horobinski Audio Technician PO Box 148 • Milwaukee • WI 53281
Robin Richards General Manager 414 964 3392

Old Time Applications

"TURN TO US WHEN YOU NEED KNOBS"
KNOBS • PUSHBUTTONS • ESCUTCHEONS
PLASTIC GRILLS • HANLES

LARRY BORDONARO

5744 TOBIAS AVE. VAN NUYS, CA 91411
PHONE (818) 786-2500 • FAX (818) 909-0241

WANTED !
JAPANESE MILITARY RADIOS
any kind of WW-2 radios & aircraft instruments

Takashi Doi



FAX : 011-8145-301-8069
1-21-4, Minamidai, Seyaku, Yokohama, Japan



HARD TO FIND BATTERIES

that really run your antique radios!!
1 1/2 to 135 volts of various sizes &
shapes! Also available: new & used panel
meters; VTVM & multimeters; JAN
16mm projectors, UHER reel-to-reel
recorders and more! Wanted: Meters &
reel-to-reel recorders.

S&G ELECTRONICS 618 S 62nd St, Phila, PA 19143
Phone 215-474-7663 - Fax# 215-726-9761

BETA-TEK ANTIQUE RADIO SERVICE

- Repair of Radios, Communications
Receivers & Test Equipment
- Power Supplies for Battery Sets



RAY BINTLIFF
2 Powder Horn Lane
Acton, MA 01720
508 283-7435



THE RADIO MAN

Buy-Sell-Trade
Antique Radios • Tubes • Parts

DICK MORGAN
RES: (214) 564-6464

P.O. BOX 461485
GARLAND, TX 75046-1485

20 Years
Experience

Telephone/Fax
1-615-456-2529

Specializing in Antique Speaker Repair

- Very large stock of vintage parts
- Can repair most any cone-type speaker
- Field coils rewound • Fast turn-around
- Reasonable prices

Work
Guaranteed

Hank Brazeal
103 N. Lake Point Ct.
Crossville, TN 38555

Books with Great Photographs



Radio Art by Robert Hawes. *This outstanding book is an illustrated history of radio that celebrates the technical and stylistic progress of the radio. Although focusing primarily on British sets, this book also contains the following American sets: Addison, Airline, Atwater Kent, Bendix, Colonial, Country Belle, Dahlberg, E.H. Scott, Emerson, Fada, General Electric, Grunow, Majestic, Motorola, Philco, RCA, Sparton, Westinghouse, & Zenith. 250 photos, 150 in color. 9 1/4" x 12". 128 pages.*

Hardcover only: \$9.95 — New Low Price

Radio! Radio! 2nd Edition by Jonathan Hill. *Comprehensive coverage of British radios from the 1920s to the 1960s. Illustrated chapter on the history of wireless. Descriptive information on each radio pictured. Over 900 photographs. 8 1/2" x 12". 244 pages.*

**Hardcover only: \$44.95
Individually Signed & Numbered**

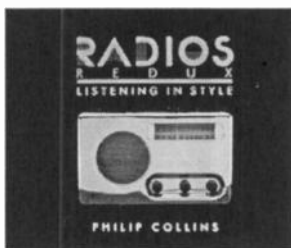

Radios Redux by Philip Collins. *Subtitled "Listening in Style," this book showcases the sleek lines and luscious colors of over 80 gleaming sets from the collection of Philip Collins. 121 color photographs. 10" x 8 3/4". 120 pages.*

Hardcover: \$29.95. Softcover: \$17.95

Radios: The Golden Age by Philip Collins. *Collins' first book of the colorful Catalin and Bakelite radios from the late 1930s to the early 1940s. Over 100 color photographs. 128 pages. 10" x 8 3/4".*

Hardcover: \$29.95. Softcover: \$17.95



U.S. Orders - Enclose \$3.00 per order for packing & book-rate shipping if total order is under \$35.00. If using VISA or MasterCard, include name on card, card number and expiration date. Send payment with order. Mass. residents please add 5% sales tax. Money back return policy. Most orders shipped the same day received, but allow 2-4 weeks to receive order. Foreign orders - write for shipping costs, or use credit card and specify air or surface (allow 2-3 months for surface shipping).



**Send Order To: A.R.C., P.O. Box 2, Carlisle, MA 01741
or Call: (508) 371-0512**

Fax: (508) 371-7129



Books on Radio History



Empire of the Air by Tom Lewis. *A biographical history of radio focusing on Lee de Forest, Edwin H. Armstrong and David Sarnoff.* 1991. Illustrated. 421 pages.

\$13.00 - Softcover
\$24.95 - Video

Hertz: The Beginning of Microwaves by John H. Bryant. *Photos and descriptions of Hertz's apparatus and experiments. A book prepared for the IEEE Hertz Centennial exhibit.* 50 pages.

\$15.00 - Softcover



Wireless Communication in the United States by Thorn L. Mayes. *Early development of American radio operating companies. Alternators, coherers, stock promotions, unpublished letters, etc.* 160 illustrations. 240 pages.

\$29.95 - Softcover

Inventing American Broadcasting by Susan J. Douglas. *A careful weaving of technology, social forces, and business decision making from the days of Marconi to broadcasting in the 1920s.* 1987. 363 pages.

\$14.95 - Softcover



Syntony and Spark by Hugh G. J. Aiken. *Subtitled "The Origins of Radio." Describes the development of radio from Maxwell's work in the 1860s through the contributions of Hertz, Lodge and Marconi.* Reprint. 1976. 347 pages.

\$16.95 - Softcover

U.S. Orders - Enclose \$3.00 per order for packing & book-rate shipping if total order is under \$35.00. If using VISA or MasterCard, include name on card, card number and expiration date. Send payment with order. Mass. residents please add 5% sales tax. Money back return policy. Most orders shipped the same day received, but allow 2-4 weeks to receive order. Foreign orders - write for shipping costs, or use credit card and specify air or surface (allow 2-3 months for surface shipping).



Send Order To: A.R.C., P.O. Box 2, Carlisle, MA 01741
or Call: (508) 371-0512

Fax: (508) 371-7129



(Mar-95)

Radio Manufacturers of the 1920's

BY ALAN DOUGLAS

VOLUME 2
IS BACK!
ORDER NOW!



"The definitive book on American broadcast receivers of the 1920s"

Volume 1: A-C Dayton - Adams Morgan - Air-Way - All-American Mohawk - American Bosch - Amrad - Amrad S-Tube - Apex - Atwater Kent - Bremer Tully - Browning-Drake - Clapp-Eastham - Crosley - Cutting & Washington - Day-Fan - DeForest - Eagle - ERLA - FADA - Federal - Ferguson. 225 Pages.

Volume 1: \$24.95 (softcover only)

Volume 2: Freed-Eisemann - Eisemann - Freshman - Garod - Gilfillan - Grebe - Howard - Jones (Lester/Melco) - Jones (Jos.) - Kellogg - Kennedy - King - Kodel - Kolster - Leutz - Magnavox - Majestic - Marti - Metro - Klitzen/Michigan - Midwest - Mu-Rad - Murdock - Music Master - Neutrowound - Operadio - Ozarka - Pfanstiehl - Philco - Pilot - Priess. 266 Pages.

Volume 2: \$29.95 (softcover only)

Volume 3: RCA - Scott - Silver-Marshall - Slagle - Sleeper - Sonora - Sparton - Splittorf - Steinite - Stewart-Warner - Stromberg-Carlson - Thermiodyne - R.E. Thompson - Thorola - Tri-City - C. D. Tuska - Ware - Western Coil - Western Electric - Workrite - Zenith. 292 Pages.

Volume 3: \$29.95 (hardcover: \$39.95)

U.S. Orders - Enclose \$3.00 per order for packing & book-rate shipping if total order is under \$35.00. If using VISA or MasterCard, include name on card, card number and expiration date. Send payment with order. Mass. residents please add 5% sales tax. Money back return policy. Most orders shipped the same day received, but allow 2-4 weeks to receive order. Foreign orders - write for shipping costs, or use credit card and specify air or surface (allow 2-3 months for surface shipping).



Send Order To: A.R.C., P.O. Box 2, Carlisle, MA 01741
or Call: (508) 371-0512 Fax: (508) 371-7129



Radios

of the Baby Boom Era

Six Volumes — 2000 pages — From Sams' Archives
 1946 to 1960 — 274 Brands — 3494 Illustrations (B&W)
 6769 Models — Catalin, Bakelite, Wood, Transistor Radios & More



All Volumes Available!

| Vol. | Brands | Included |
|------|--------|-----------------------------|
| 1 | 56 | Admiral to Clearsonic |
| 2 | 54 | Co-op to Gelo |
| 3 | 58 | GE to Monitoradio |
| 4 | 36 | Motorola to RCA Victor |
| 5 | 35 | Realtone to Stratovox |
| 6 | 35 | Stromberg-Carlson to Zenith |

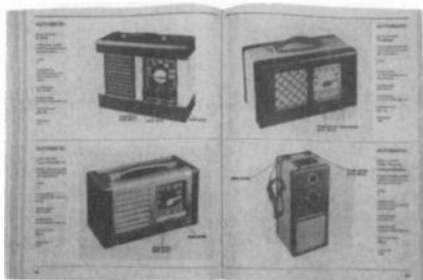

1/2 Page for each illustrated radio including:

- Large illustration of the radio including knob functions
- Short description of the radio
- Number of tubes
- Power supply type (AC, Battery, etc.)
- Tuning range
- Manufacturer
- Sams Photofact Set number & year Photofact published.

ALSO

- Index by model number listing tubes in radio
- List of similar radio models indexed to pictured radio
- List of manufacturers and suppliers indicating their brand names
- Basic trouble-shooting hints

Each Volume: \$16.95 – Softcover
 8 1/2" x 11" – Approx. 328 pages

U.S. Orders - Enclose \$3.00 per order for packing & book-rate shipping if total order is under \$35.00. If using VISA or MasterCard, include name on card, card number and expiration date. Send payment with order. Mass. residents please add 5% sales tax. Money back return policy. Most orders shipped the same day received, but allow 2-4 weeks to receive order. Foreign orders - write for shipping costs, or use credit card and specify air or surface (allow 2-3 months for surface shipping).



Send Order To: A.R.C., P.O. Box 2, Carlisle, MA 01741
 or Call: (508) 371-0512 Fax: (508) 371-7129



(Jan-95)

Transistor Radio Books



The Collector's Guide to Transistor Radios by Marty & Sue Bunis. *This book will help you identify the most sought-after vintage transistor radios. Over 2,200 models, all with current prices. Over 400 color photos. 5 1/4" x 8 1/4". 256 pgs.*

\$15.95 - Softcover

Made In Japan by Roger Handy. *A stunning book on the development and growth of the transistor radio featuring over 175 transistor radios in full color. 10" x 9 3/4". 108 pgs.*

\$16.95 - Softcover

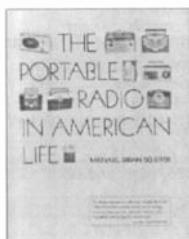

The Portable Radio in American Life by Michael Schiffer. *Approximately 50 pages on transistor radios, beginning with the Regency TR-1 through to the later sets made overseas. 450 photographs, 193 transistor radios pictured. 8 1/4" x 11". 259 pgs.*

\$24.95 - Softcover
\$45.00 - Hardcover

Collector's Guide to Novelty Radios by Marty Bunis & Robert Breed. *This book is the source for novelty transistor radios in all shapes and sizes. Radios are described in detail with current prices. Over 600 all new color photographs. 8 1/2" x 11". 224 pgs.*

\$18.95 - Softcover



Transistor Radios, A Collector's Encyclopedia and Price Guide by David Lane & Robert Lane. *Identification & price guide to over 2,500 transistor and novelty radios. History & key to collecting chapters. 8 1/2" x 11". 170 pgs.*

\$19.95 - Softcover

U.S. Orders - Enclose \$3.00 per order for packing & book-rate shipping if total order is under \$35.00. If using VISA or MasterCard, include name on card, card number and expiration date. Send payment with order. Mass. residents please add 5% sales tax. Money back return policy. Most orders shipped the same day received, but allow 2-4 weeks to receive order. Foreign orders - write for shipping costs, or use credit card and specify air or surface (allow 2-3 months for surface shipping).



Send Order To: A.R.C., P.O. Box 2, Carlisle, MA 01741
or Call: (508) 371-0512 Fax: (508) 371-7129



(Nov-95)

COLLECTOR BOOKS AVAILABLE FROM A.R.C.

BOOKS MARKED WITH "€" ARE THE MOST POPULAR AND ARE ESPECIALLY RECOMMENDED FOR NEW COLLECTORS!

- Antique Radio Restoration Guide, 2nd Ed., Johnson.** *Beginner's introduction to troubleshooting and repairing AC table model radios.* 1992. 145 pgs. \$14.95
- The AWA Review. *Collections of articles.* Vol. 6: *Hawaiian Wireless, U.K. TV, SCR-RC-BC Dir., NYC Wireless, etc.* Vol. 7: *Poldhu xmitters, Navy Equipment, Arc xmitters, etc.* Vol. 8: *Keys, Federal Co., KFS-Federal-Mackay Story, Nat'l Electrical Supply Co., Navy Electronics Dir., etc.* Vol. 6-8, ea. \$10.00
- Vol. 9: *Marconi, The Int'l Contest for Radar, The Magnetron Story, F. Lowenstein, Ham Licensing.* Vol. 9, NEW \$17.00
- The Antique Radio Boys and the Garrulous Grebe, Dryer.** *Thrilling adventure story written in the traditions of the '20s and '30s.* 5 1/2" by 8 1/2". 51 pgs. \$4.95
- The Auto Radio: A Romantic Genealogy, Matteson.** *Info, photos & ads from the early days of the auto radio through the 1950s.* 316 pgs. (hardcover) \$34.95
- Behind the Front Panel, Rutland.** *Reviews radio circuits and radio history. Easy descriptions.* 25 pics. 158 pgs. \$18.95
- Blast from the Past, A Pictorial History of Radio's First 75 Years, Rhoades.** *The technology, performers, & programs that made radio a vital part of the everyday life. 100s of rare, never-before-published photos.* NEW \$39.95
- Broadcasting's Forgotten Father: The Charles Herrold Story, Adams.** (Videotape, VHS). *One-hour documentary on this amazing inventor. Featuring his family, students, and photos to document his work.* \$29.95
- Classic TVs, Wood.** *Prewar to 1950s, with price guide. 140+ color photos, plus repro of catalogs & ads.* 86 pgs. \$16.95
- € **The Collector's Guide to Antique Radios, 3rd Ed., Bunis.** *This guide covers radios from 1920s to 1960s. Over 8,500 prices and over 650 all new color photos are included.* 1994. 278 pgs. \$18.95
- The Collector's Guide to Novelty Radios, Bunis & Breed.** *The source for novelty transistor radios. Full descriptions with current prices. Over 600 color photos.* 1994. 224 pgs. \$18.95
- The Collector's Guide to Transistor Radios, Bunis.** *Identifies the most sought-after vintage transistor radios. Over 2,000 models, 400+ color photos, with current prices.* 1993. 256 pgs. \$15.95
- Communication Receivers, 3rd Ed., Moore.** *Information on 738, 1932 to 1981, vacuum tube receivers by 66 manufacturers. 402 radios illustrated. New section: 3 pages of military receivers.* 125 pgs. \$19.95
- The Compleat Talking Machine, Reiss.** *A guide to restoration of antique phonographs.* 183 pgs. \$19.95
- Crystal Clear - Vintage American Crystal Sets, Crystal Detectors and Crystals, Sievers.**
Vol. 1 - *Comprehensive reference with 750 illustrations, 570 crystal sets, 341 detectors, 207 crystals.* 282 pgs. \$29.95
Vol. 2 - *479 All new & different illustrations, more crystal sets, detectors and crystals identified.* 252 pgs. NEW \$29.95
- E.H. Scott Radio Collectors Guide, 1925-1946, Clark.** *The reference for collectors of Scott radios, cabinets and accessories. Lists original prices of cabinets and accessories. Over 200 photos with descriptions.* 88 pgs. NEW \$29.95
- Early Radio, In Marconi's Footsteps, Jensen.** *Realistic description of Marconi's work and his surroundings. Early construction projects with diagrams. Color and B&W photographs.* 170 pgs. (hardcover only) NEW \$39.95
- Empire of the Air, Burns.** (Videotape, VHS). *2-hour video based on Lewis' book.* \$24.95
- Empire of the Air, Lewis.** *Biographical radio history on De Forest, Armstrong and Sarnoff.* 1991. 421 pgs. \$13.00
- Evolution of the Radio, L-W Books.** *Radios pictured and priced, plus reproductions of catalog pages and ads.*
Vol. 1 - *Eight-hundred + radios.* 1991. 227 pgs., 118 pgs. in color. \$22.95
Vol. 2 - *Totally different from volume one with new photos, etc.* 1993. 654 color photos. 226 pgs. \$24.95
- Firco Radio Equipment, John Firth & Co., Inc. (reprint).** *Twenty-six-page booklet of the Firco Co.* \$4.95
- Fixing Up Nice Old Radios, Romney.** *Written by an old radio instructor, this book covers Ohm's law, through battery sets, superhets and communications receivers.* 1990. 300+ figures, 185 pgs. \$19.00
- € **Flick of the Switch, McMahon.** *The classic photo reference guide for '30s - '50s radios. 1000+ photos.* 263 pgs. \$11.95
- Great Radio Personalities (reprint).** *B&W pics of the golden days of radio - Abbott & Costello, etc.* 128 pgs. \$11.95
- € **Guide to Old Radios - Pointers, Pictures & Prices, 2nd Ed., Johnson.** *Introduction to radio collecting. Includes hundreds of photos and a price guide.* 1995. 272 pgs. (Available Late Oct.) NEW \$19.95
- Hake's Guide to TV Collectibles.** *Price guide and photos for 1600 TV shows, comic books, etc.* 1990. 185 pgs. \$14.95
- Hallcrafters Co. 1932-1982: A Partial Product Listing Covering 50 Years of Production, 5th Ed., Dachis.**
Listing of over 500 receivers, transmitters, televisions, speakers and accessories. No photos, 44 pgs. \$12.50
- Hertz: The Beginning of Microwaves, Bryant.** *Photos and descriptions of Hertz's apparatus and experiments. A book prepared for the IEEE Hertz Centennial exhibit.* 50 pgs. \$15.00
- Inventing American Broadcasting, Douglas.** *A careful weaving of technology, social forces, and business decision making from the days of Marconi to broadcasting in the 1920s.* 1987. 363 pgs. \$14.95
- Los Angeles Radio Manufacturing, Paul.** *History of radio manufacturers in the L.A. area from 1922 to 1942. Features Echophone, Giffilan, Jackson Bell & 9 others.* 88 pgs. \$10.50
- Supplement No. 1, Paul.** *Coverage of additional manufacturers, people and sets.* 1993. 48 pgs. \$6.75
- Made in Japan, Handy.** *A stunning book on the rise of the transistor radio. 175+ radios in color.* 1993. 108 pgs. \$16.95
- The Mechanics of Television, Yanczer.** *History and explanation of mechanical television, plus construction details for a working system.* 1987. 5 1/2" by 7 1/2". 170 pgs. \$24.95
- Most Often Needed 1926-38 Radio Diagrams and Servicing Information (reprint).** *600+ diagrams for mostly AC radios from '26-'38.* 240 pgs. \$11.95
- Novelty Radios, Breed.** *500+ transistor novelty radios in full color with current prices.* 1990. 217 pgs. \$24.95
- 1994 Price Update - Novelty Radios, Breed and Bunis.** 14 pgs. \$4.95
- Official Radio Service Manual (reprint).** *100s of pre-1930 circuits & notes.* 356 pgs. \$24.95
- Old Gramophones, Bergonzi.** *The development of phonographs and gramophones.* 64 photos 32 pgs. NEW \$4.95
- Old-Time Radios! Restoration and Repair, Carr.** *How to repair vacuum-tube and transistor radios. A self-paced training guide. 200 illustrations, 256 pgs.* \$18.95
- Philco Radio: 1928-1942, Ramirez.** *A reference book on Philco. Shows receivers and company history year-by-year. 464 color photos, 364 black & white photos and drawings.* 1993. 160 pgs. \$29.95
- Portable Radio In American Life, Schiffer.** *Traces the development of the portable radio and how it affected American culture and society. 450 photos and drawings, 259 pgs.* (hardcover: \$45.00) \$24.95
- Poster's Radio & Television Price Guide, 1920 - 1990, 2nd Ed.** *875+ TV's, 650 transistor radios and 2,200 other radios listed. 600 sets illustrated, 75 in color.* 1993. 7" x 10". 264 pgs. \$17.95
- Price Guide to Plastic Collectibles, McNulty.** *Describes types of plastics, etc. (Radio is 8 of 207 pgs.)* \$17.95
- RCA Radiolas, Radiotrons, and Accessories (reprint).** *Twenty-page booklet summarizing RCA's 1926 product line including the Radiola III, 20, 25, 26, 28, etc.* \$4.50
- Radio Art, Hawes.** *A chronological, illustrated history of the technical and stylistic progress of the radio. Mostly British, but American sets are featured as well. 250 photos, 150 in color, 128 pgs.* (hardcover only) Low Price \$9.95

COLLECTOR BOOKS AVAILABLE FROM A.R.C.

BOOKS MARKED WITH "E" ARE THE MOST POPULAR AND ARE ESPECIALLY RECOMMENDED FOR NEW COLLECTORS!

- Radio Art Postcard Deck.** 30 full-color photographs from Hawes' book. \$7.50
- Radio Collector.** (Videotape, VHS). The five-part Emmy-nominated PBS series combined on one 130-minute videotape. Meet collectors, see collections, attend swap meets, learn about radio restoration. \$29.95
- The Radio Collector's Directory and Price Guide, 1921-1965, 2nd Ed.** Grinder. Directory of over 20,000 radios by manufacturer, model number, year, etc., with prices. Radio history, cabinet styles, vacuum tube development chapters. Over 1,200 trade names listed. Thoroughly revised and expanded. 500 pgs. NEW \$26.95
- Radio Collector's Guide, McMahon.** Listing of 9,000+ radios made by some 1200 companies from 1921 to 1932. Gives manufacturer, year, model name and other info. No photos, 264 pgs. \$11.95
- The Radio Collector's Guide to Philco Bakelite Block Condensers, Bintliff.** A detailed description of Philco Bakelite block condensers with illustrations and parts lists. 1994. 52 pgs. \$9.95
- Radio Craft - 50 Years of Radio** (reprint). March 1938 issue of Radio Craft magazine. Numerous articles on the development of radio, then 50-years old, and on early radio pioneers. 144 pgs. \$15.95
- Radio Equip. & Supplies,** (reprint). 1922 radio catalog, accessories, etc. RCA, Clapp-Eastham, etc. 168 pgs. \$19.95
- ☞ Radios-The Golden Age,** Collins. Full-color book on the colorful Catalin and Bakelite radios from the late 1930s to the early 1940s. 128 pgs. (hardcover \$29.95) \$17.95
- Radio Horn Speaker Encyclopedia,** Paul. Listing of horn speakers for over 320 manufacturers for the 1920s. Expanded information on ten manufacturers. Over 145 photos, 80 pgs. \$14.90
- Radio Horn Speaker Notebook, Rev. H. Paul.** The companion to the Encyclopedia. Over 450 horn picture ads are shown, over 325 manufacturers are identified. Photocopy. New Index. 1995. 72 pgs. \$15.90
- ☞ Radio Manufacturers of the 1920's,** Douglas. Three comprehensive volumes. Vol. 1 covers A-C Dayton thru Ferguson. 225 pgs. (softcover only) \$24.95
Vol. 2 covers Freed-Eisemann thru Priess. 266 pgs. (softcover only) \$29.95
Vol. 3 covers RCA thru Zenith. 292 pgs. (hardcover: \$39.95) \$29.95
- Radio Poster,** Sonoran Publishing. Color 20"x26". A radio timeline. 20 radios from the Pup to transistors. NEW \$10.95
- Radiol Radiol,** 2nd Ed., Hill. Revised easy-to-read subject index, separate A-Z directory listing of 1,000+ British radio models with clearer photographs than first edition. 978 photos, 244 pgs. (hardcover only) \$44.95
- Radio Redux,** Collins. Subtitled "Listening in Style." This book showcases the sleek lines and luscious colors of over 80 glowing sets from the collection of Philip Collins. 120 pgs. (hardcover: \$29.95) \$17.95
- Radio/TV Finder,** Okolowicz. Reference to nearly 7,000 radio and TV pics found in 24 books. No photos, 110 pgs. \$13.95
- Radio & T.V. Collector's Guide Book, Biraud.** The "Vintage Radio" illustrated guide to European sets from early wireless to the 1930s (a few later). Text is in both French and English. Vol. 1: History & Manufacturers A to P. 256 pgs. Vol. 2: P to Z & T.V., Speakers, Tubes, Loops, Parts & Novelties. 256 pgs. (Per Volume) \$49.95
- Radios of the Baby Boom Era.** Pictures and info from Sams Photofacts. 3,494 radios illustrated plus 3,275 additional radios listed. 274 brands. 1946 thru 1960. Six volumes. 300+ pages per volume. Order by volume: Vol. 1: Admiral - Clearsonic. Vol. 2: Co-op - Geloso. Vol. 3: GE - Monitoradio. Vol. 4: Motorola - RCA. Vol. 5: Realtone - Stratovox. Vol. 6: Stromberg-Carlson - Zenith. (Per Volume) \$16.95
- Refinishing Old Furniture, Wagoner.** Written by a furniture restoration instructor. A step-by-step guide to furniture (or radio) restoration, from removal of finishes right up to the final polish. 178 pgs. \$14.95
- Saga of the Vacuum Tube, Tyne.** The development of vacuum tubes - 1880 to 1930. From Edison, Thomson and Fleming to de Forest, Philips, Siemens and many more. 100+ tube photos, 495 pgs. \$18.95
- Sound & Vision Yearbook 1995/96.** An annual directory of radio & TV collectors, primarily European. NEW \$6.95
- Syntony and Spark, Aiken** (reprint). Subtitled "The Origins of Radio." Describes the development of radio from Maxwell's work in the 1860s through the contributions of Hertz, Lodge and Marconi. 1976. 347 pgs. \$16.95
- S. Gernsback Radio Encyclopedia** (reprint). 1927 classic encyclopedia on radio. From "A Battery to Zirconium, with 1000s of entries in between. 100s of illustrations, 175 pgs. \$9.95
- 70 Years of Radio Tubes and Valves, Stokes.** The story of the radio tube from the laboratory to the commercial market. 247 pgs. \$25.95
- 75 Years of WE Tube Manufacturing, Magers.** A log book history 750+ WE tubes. Illustrated. 133 pgs. \$16.95
- Tomart's Price Guide to Radio Premium and Cereal Box Collectibles, Tumbusch.** Includes comic character, pulp hero, TV and other premiums. 1991, 3,000+ illustrations, 176 pgs. \$22.95
- Transistor Radios, A Collector's Encyclopedia and Price Guide, Lane.** Identification guide to over 2,500 transistor and novelty radios. History and key to collecting chapters. 1994. 170 pgs. \$19.95
- ☞ Vintage Radio, McMahon.** The classic photo reference guide for collectors of radios prior to 1930. Crystal sets, battery sets, tubes, horns, parts, etc. Over 1000 pictures, 263 pgs. (Temporarily Out-Of-Print) \$41.95
- The Weekend Refinisher, Johnson.** A complete guide to stains and finishes and tips for setting up your own workshop. A handy furniture "first aid" kit for quick repairs. Illustrated. 296 pgs. \$10.00
- Westinghouse Catalog** (reprint). 1920s catalog of the RA-DA and other early Westinghouse equip. 8 pgs. \$4.00
- Wireless Communication in the U.S., Mayes.** Early development of American radio operating companies. Alternators, coherers, stock promotions, unpublished letters, etc. 160 illustrations, 240 pgs. \$29.95
- The Xtal Set Society Newsletter, Anderson.** Complete set of the Society's newsletter. Order by volume. Vol. 1: 7/91 to 5/92 - Field Strength Meter, HF Broadcasting, FM Xtal Set, Xtal Sets & Wireless, & more. Vol. 2: 7/92 to 5/93 - The Lead Pencil Detector, Detector Biasing, The Universal Xtal Set, etc. Vol. 4: 1/94 to 11/94 - Measuring Coil Capacitance, home-brew headphones and curve tracers, etc. (Per Vol.) \$9.95
- The Xtal Set Handbook, Anderson.** Formulas for coil inductance, a procedure for measuring coil capacitance, circuit matching theory, & more. Also included is Vol. 3 of the Xtal Set Society Newsletter. \$10.95
- Zenith Radio Corporation** (reprint). The instructions for installation and operation for Models 39-39A Models 392-392A, and Electric Zenith Receivers. 3 schematics, 3 photos, 7 1/2" by 5", 16 pgs. \$4.50
- The Zenith Trans-Oceanic: The Royalty of Radios, Bryant and Cones.** Presents the fascinating story of the development and use of the Trans-Oceanic. Several photos, documents, ads, etc. 160 pgs. NEW \$24.95

U.S. Orders - Enclose \$3.00 per order for packing & book-rate shipping if total order is under \$35.00. If using VISA or MasterCard, include name on card, card number and expiration date. Send payment with order. Mass. residents please add 5% sales tax. Money back return policy. Most orders shipped the same day received, but allow 2-4 weeks to receive order. Foreign orders - write for shipping costs, or use credit card and specify air or surface (allow 2-3 months for surface shipping).



Send Order To: A.R.C., P.O. Box 2, Carlisle, MA 01741

or Call: (508) 371-0512

Fax: (508) 371-7129



(Nov-95)



24 Hour Phone
(Machine after 4 rings)
(201)794-9606

P. O. BOX 1883 • SO. HACKENSACK, NJ • 07606

**HARRY
POSTER**

FAX 24 Hours:
(201)794-9553

Just in time for the Holidays.....

Poster's Radio and Television Price Guide, Second Edition, 1920-1990 (pub. by Chilton Books/Wallace Homestead; 195 pgs, illustrated, with average retail prices.) **We have about 4 dozen copies left, and we'd like to offer a bargain to our readers!**

Buy a copy for **\$8.00** delivered, or buy a dozen for only **\$60!!!**

This is the only price guide which includes it all: information, illustrations and pricing of early battery and AC radios; portable, table-top and console radios; early and novelty transistor radios; plus vintage television sets!

It illustrates over 400 TVs and radios in B&W and 75 televisions and radios in color. Introductions briefly take the reader through the history, style, and composition of vintage radios, both early and novelty transistor radios, and information on mechanical scanning disc and electronic pre- and post-war televisions, including early color TVs. With prices for over 2,000 models of old radios and vintage televisions.



FOR SALE: TV Chassis. These are "as found" but clean, with all parts and most vacuum tubes still there! The following for common, and not-so-common, TVs:

- Arvin 4080T, from the small metal table-top \$35
- Automatic 7" chassis \$65
- DuMont RA-103, Chatham "dog-house" \$45
- Hallicrafter 7" with 13 pushbuttons (2-13) \$50
- Hallicrafter 7" with 14 push buttons (1-13) ... \$65
- National 7", split style chassis \$75
- Philco 48-2500 projection TV chassis \$45
- Philco 48-2500 CRT and projection assembly, \$40
- Radio Craftsman RC-100A, Chrome \$85
- RCA 721-TS, From their 10" wood TV \$45
- 721-TCS (console version) \$65
- RCA 8PT, from small portable. With CRT \$40
- Raytheon 7", for several table-top styles \$50
- Tele-Tone 7". Several styles available \$50

UPS charges are about: 7"-\$5-\$10; 10"-\$10-\$20

FOR SALE: Hand Painted signs!

These are 28" high by 48" wide 1940s or 1950s hand-painted signs from a closed TV shop. All on heavy masonite board, and all nice condition except for typical nail holes or chipped corners. Don't miss 'em:

**Paying more than 10¢ for your tubes?
Then you're paying too much!**

FOR SALE: Radio-TV tubes...10¢ each! We bought out a local TV shop: their loss is your gain. From 1 and 2 volt types, to 6 and 12 volters, 17's up to 110's. Miniature, octal, loctal, boxed, unboxed. At this price, you've found your winter project! We'll offer them by the box: 500+ tubes...\$50; 1,000+...\$95. Plus UPS.



FOR SALE: RCA Alice in Wonderland Phono.

This child's phonograph Model 45-EY-26, is covered with pictures of Alice, Twiddle-Dee-Dee, the Chesire Cat, the Queen of Hearts, and lots more! In very nice, complete condition except for a bit of peeling near the volume control knob. Alice in all her confusion, and it's priced at half the typical meet price.....\$85



- RCA: For tubes, parts, batteries, etc. It's red, yellow and white \$65
- Sprague: Capacitors-four good illustrations. Painted in brown, green and white \$55
- Tung-Sol: Tube manufacturer. Nice sign with a CRT and vacuum tube shown \$50
- Stancor: Transformer maker; with illustrations. Yellow, black and grey \$35
- Hickok: "World famous" test-equipment maker. Yellow and red, with blue globe \$50
- University: Horns for PA systems. This sign painted in black and brown plus white ... \$30
- Bogen: Sign for this amplifier manufacturer painted in brown, green and white \$25
- General Cement: Adhesives and chemical makers sign in brown, black and white...\$25
- Blonder-Tongue: Converters. Painted in red, blue and white \$45. All plus boxing/shipping.

CLASSIFIED ADVERTISING POLICY

ONE FREE 20-WORD AD for subscribers in each issue; additional words are 22¢ each. See details below. Classified ads sent by mail, fax or by any other method must be received (not just postmarked!) by Noon Eastern Time on the classified ad deadline date to guarantee inclusion in the current issue. Late ads are held for the following issue. Please enclose correct payment with all ads. Stamps or cash are OK for small amounts. (Canadian and other foreign advertisers please see Payment on page 2 for methods.) *Free words* cannot be accumulated from month to month; free words must be requested when ad is submitted

Faxed & e-mailed ads: Please see additional information on the inside front cover.

When including ads with other A.R.C. correspondence, write the ads on a separate piece of paper. Include SUB# with ad. Ads may be sent in advance; but, write each ad on a separate piece of paper and indicate the month (or successive two months) you want the ad to run.

To minimize our typing errors: Please write legibly. Use both capital and small letters. Do not use a dash between words. Carefully write the following numbers and letters (especially in model numbers) since some can look alike: for example 1 and l (the number one, the capital i and the small l.) Also: 0, O, o, Q and D; r and n; 6, b and G; V, U, u, v and Y A and R 5 S and s; 2, Z and z. We try to correct spelling errors, so when using an uncommon word or manufacturer which we might mistake as a more common word or manufacturer, note it so that we do not "correct" it. Editor's annotations are in [brackets].

Advertising is accepted only for early items related to radio, communication, etc. All items must be described fairly reproductions, reprints and non-original items must be so identified. Advertisers must agree to respond promptly to inquiries and orders, to resolve problems promptly if the buyer is not satisfied, and to comply with a buyer's refund request on unaltered returned items.

The publisher reserves the right to edit ads without notification to the advertiser and to reject ads for any reason. Names other than the advertiser will be edited out of ads. Ads with non-radio-related items will be returned or edited unless the non-radio related items are for trade of radio-related items, or they are incidental to and appear at the end of an otherwise acceptable ad. The publisher is not responsible for errors due to illegibly written ads or for any other reason.

Clubs: Since club activities receive free coverage on the *Coming Radio Events* pages, the free 20 words may not be used for club activity ads. See inside front cover for additional information.

CLASSIFIED AD DETAILS

Deadline: NOON ET— 10th of the month!

Classified ads must have a standard heading such as **WANTED, FOR SALE, FOR TRADE, FOR SALE/TRADE, SERVICES, MESSAGE, HELP, AUCTION, MEET**, etc. This heading is the only bold or all-capitalized words allowed in the ad. Capitalize only manufacturer names, model names, etc. This standard ad format makes scanning the ads easier.

Before writing your ad, please look over the ads in a recent issue of A.R.C., and try to write your ad in the same style. Full name (or company name) and address is required in all classified ads; we will add it if you forget.

To encourage varied content of the ads, the same classified ad may be run only once per issue and for only two consecutive months. (To run an ad longer, use a boxed classified or display ad.)

Classified Ad Rates per Month

Subscribers:

First 20 words: **FREE***
22¢ per word for extra words over 20 **plus**
10¢ per word for a shaded ad (count all words including free words).

* Subscribers may take 20 free words on only **one** ad each month.

Non-Subscribers:

38¢ per word **plus**
10¢ per word for shaded ad.

Please do not forget to send in the extra 22¢ per word when your classified ad runs over the free 20 words; your payment will be appreciated, and it will help to keep A.R.C. healthy.

BOXED CLASSIFIED AD DETAILS

Deadline: 1st of the month!

Boxed classified ads can run unchanged for three months or more. No words are free. Ads may be shaded and may include bold and all-capitalized words freely. The ad need not begin with "For Sale," etc. Minimum run is 3 months prepaid. Discount: 10% for 6 months, 20% for 12 months.

Boxed Classified Ad Rates per Month

Nonshaded ads:

33¢ per word for all words.* none free **plus**
10¢ per word for each bold word **plus**

10¢ per word for each all-caps word

Shaded Ads (All words are bold at no charge)

44¢ per word for all words* **plus**

10¢ per word for each all-caps word

Non-Subscribers:

Add 20¢ per word to above costs

*Three words can be bold-all-caps at no extra charge

PHOTO & DRAWING DETAILS

Deadline: 1st of the month

for all ads with drawings or photos!

Drawings and photos are encouraged as the response to your ad is much larger and the reader knows better what you want or are selling. Send in your drawing or photograph, and A.R.C. will reduce it or enlarge it as needed.

Photo and Drawing Rates per Month

\$14.00 per month for each photo or drawing (If ad is canceled, this amount cannot always be refunded.)

CHANGES & CANCELLATIONS

Please check your ads carefully before sending them in. Once ads are received, it is not always possible to refund the amount sent, pull the ad or make changes.

IMPORTANT — COUNTING WORDS — IMPORTANT

The standard headings: **WANTED, FOR SALE**, etc., count as **one word** each time used in an ad. Name and (one) telephone number, count as **6 words**, regardless of length. Ham call letters and business name can be included in the 6 words and do not count extra. Full name (or company name) and address is required in all classified ads. Each additional word, abbreviation, model number or number group extra telephone numbers, fax, e-mail, etc. count as one word each. Hyphenated words count as two words.

SECOND CLASS

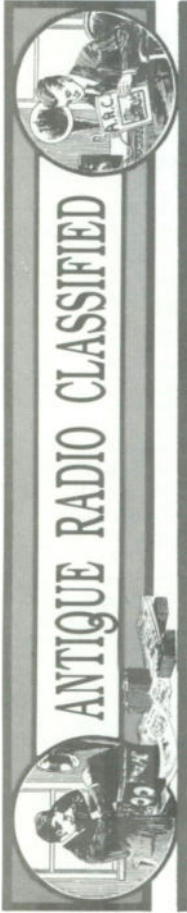

A.R.C., P.O. Box 2, CARLISLE, MA 01741

RETURN POSTAGE GUARANTEED

**CLASSIFIED AD
DEADLINE NOV. 10th
Noon Eastern Time**