

RADIO

TODAY

BAN MOBILE RADIO!

Is road safety coming second?



▲ TIME TO RE-CANNEL TWO? ▲ BEGINNERS GUIDE TO 'FOXHUNTS'

▲ REVIEWED-ICOM'S 1296 HANDHELD & AZDEN'S 2m MOBILE ▲

R. WITHERS COMMUNICATIONS LTD

Manufacturers, importers and suppliers of world famous communications products

584 HAGLEY ROAD WEST OLDBURY, WARLEY, BIRMINGHAM B68 0BS

021-421 8201/2/3. CELLNET 0860 323056. PRESTEL MBX 214218216 FAX 0215614074

Amateur Radio. Business Radio. Radio Telephones. Sales. Service Accessories and antenna systems.



YAESU



THE TECHNICALLY ORIENTATED
RADIO COMMUNICATIONS
SPECIALISTS.

A WORLD FIRST FROM RWC LTD

YAESU FRG9600/RWC MK3 HF-UHF SERIES

After many months of research and development RWC LTD are pleased to announce their latest HF modification for the Yaesu FRG9600 which now includes LF/HF/VHF/UHF coverage from 100kHz to 950MHz and improved 'S' Meter and a typical receiver +sensitivity now $>2\mu\text{V pD HF}$, $>1.5\mu\text{V}$ 60-950MHz all @ 12dB SINAD. (Please contact us for detailed specifications).

We have fitted a High performance HF Front-End made for us by AKD. The new HF section is fitted internally with switching circuits and a small toggle Switch on the rear apron to enable band change whereby the display changes to read actual frequency (100kHz-60MHz). The standard SO239 antenna connector has now been changed for an 'N' connector for coverage from 60-950MHz and an SO239 connector fitted for HF coverage 100kHz-60MHz. (UHF extended coverage is now standard as per our original MK2 modification up to 950MHz).

As an 'N' connector is now fitted to all RWC FRG9600s for VHF-UHF coverage it is possible to use a wide-band discone antenna such as the ICOM AH7000 which is supplied with low-loss coaxial cable and 'N' connectors. A dipole or long-wire antenna can be used for HF coverage with very good results. **This facilitates use of two antennas for all bands.**

All modifications are Fully Guaranteed for twelve months from date of purchase/modification providing our modifications seals are unbroken.

© RWC LTD 1987

* We reserve the right to change specifications due to continuous development and modification of this product.



YAESU FRG9600/RWC MK3

AM-FM (WIDE & NARROW) LSB, USB. 100kHz-950MHz
BROADCAST MONITOR AND SCANNING RECEIVER



GENEROUS PART EXCHANGE ON SHORTWAVE RECEIVERS,
E.G., FRG7 up to £125, FRG7700 up to £225, WHY NOT UPGRADE NOW!?!

FRG9600 MK2 Model 60-950MHz 'N' connector @ £519.00 + £5.00 carriage.
(Modified unit only).

FRG9600 MK3 Model 100kHz-950MHz 'N' connector and SO239 for HF @ £625.00 + £5.00 carriage. (Modified unit only).

RWC Exclusive Base Station Complete HF-UHF Package FRG9600 MK3 Model, Icom AH7000 ant, G5RV HF multiband, PA4C ac-13V dc adaptor, inclusive carriage UK £725.00.

STOP PRESS: BBC Model B computer controller available soon (call for details). Or see it at the N.E.C.

Tel: 021 421 8201 (24hr answerphone)

Telex: 334303 G TXAGWM



AH-7000

SUPER WIDEBAND
OMNIDIRECTIONAL ANTENNA

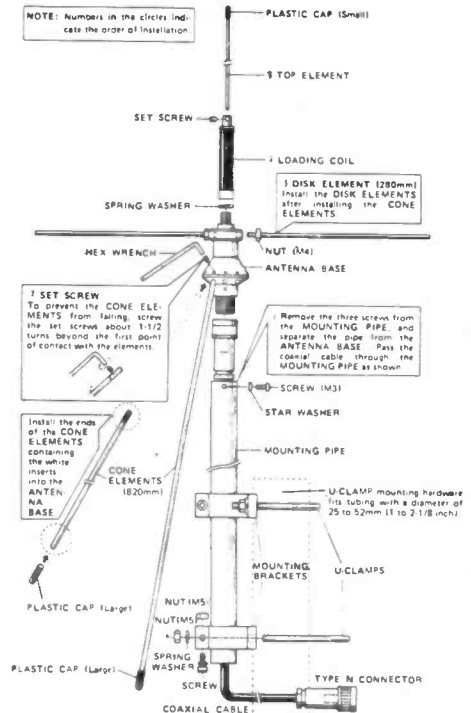

SPECIFICATIONS	
Frequency coverage	Receive 25 to 1300MHz Transmit 50, 144, 430, 900, 1200MHz bands
Input power rating	200 watts
Input impedance	50 ohms
Supplied connectors	Type N
Supplied coaxial cable	SD-2V (50 ohm)
Type of antenna	Discone
Length	1.7 meters
Weight	1kg

Icom AH7000 @ £82.50 (inc free carriage UK mainland).

YAESU/RWC FRG9600 Options

PA4C ac adaptor £16.50 inc post.

FIF232C RS232 computer interface @ £75.00 inc post.

Raycom GP900 900-950MHz 3dB, base station ant @ £22.00 inc post.

AM-FM wide & narrow IF filters POA.

RWC 9600 MK2 owners HF mod @ £99.00 inc carriage (send unit).

FRG9600 existing owners HF & UHF mod - 100kHz-950MHz. Send unit carriage paid @ £129.00.

YAESU FRG9600 Service Manual (inc Cat Prog) @ £12.50 inc post.

Raycom VHF-UHF Discone 60-600MHz SO239 connector @ £27.50 inc carriage.

RWC Modified Video Unit. 6.00MHz IF video (modified from NTSC) @ £27.50 inc post.

ASK FOR COLOUR BROCHURE & SPECIFICATIONS.

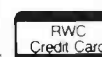

HAM RADIO CONTENTS

TODAY

VOLUME FIVE NO 5 MAY 1987

Editor

Dave Bradshaw, G1HRT

Assistant Editor

Dave Bobbett, G4IRQ

Consultant Editor

Steve Ireland, G3ZZD

Advertisement Manager

Dave Gadsden, G4NXV

Classified Sales Executive

Sue Curtis

Published by:

Argus Specialist Publications Ltd

Distributed by:

SM Distribution Ltd

Printed by:

Adlard & Son Ltd

The Garden City Press,
Letchworth, Herts SG6 1JS

Design by:

Argus Design Ltd

Editorial and Advertising address:

(please mark your letter for the appropriate department)

Ham Radio Today

ASP Ltd

1 Golden Square

London W1R 3AB

Tel: 01 437 0626

Subscriptions and back-issues:

Ham Radio Today Subscription
Dept, Infonet Ltd, Times House,
179 The Marlowes, Hemel Hemp-
stead, Herts HP1 1BB.

Tel: (0442) 48432

Subscription rates:

UK £17.30, o/seas surface £21,

USA surface \$28, o/seas air £39.

Back issues: £1.70 inc p&p

Member of the Audit
Bureau of Circulation



Ham Radio Today is normally published on the first Friday in the month preceding cover date. The contents of this publication including all articles, designs, plans, drawings and programs and all copyright and other intellectual property rights therein belong to Argus Specialist Publications Limited. All rights conferred by the Law of Copyright and other intellectual property rights and by virtue of international copyright conventions are specifically reserved to Argus Specialist Publications Limited and any reproduction requires the prior written consent of the Company. © 1987 Argus Specialist Publications Ltd.

All reasonable care is taken in the preparation of the magazine contents, but the publishers cannot be held legally responsible for errors. Where mistakes do occur, a correction will normally be published as soon as possible afterwards. All prices and data contained in advertisements are accepted by us in good faith as correct at the time of going to press. Neither the advertisers nor the publishers can be held responsible, however, for any variations affecting price or availability which may occur after the publication has closed for press.

REGULAR COLUMNS

LETTERS	10
Our readers opine that the RAE is fair to disabled candidates	
RADIO TODAY	12
A new super-rig? A new contest or two? It's all here	
LED BATTERY MONITOR	39
A simple and useful device to help stop you fading away!	
RADIO TOMORROW	45
What's where and when	
LISTENING ON	48
Bible-thumping on the air waves? Radio HCJB is a little more subtle	

CONSTRUCTION

HAM INTERNATIONAL UPDATE	18
Curing a few sproggy, disabling a few bells and adding the whistles	
A PIECE OF THE PAST	36
A case study in reviving a vintage crystal set	

FEATURES

FOXHUNTS ARE FUN	15
If you've never been direction finding, give it a go!	
SARDINES FOR TWO	24
Isn't it time we re-channeled VHF? It's long overdue, according to Jack Hum	
MOBILE RADIO SAFETY	27
Time to tune into road safety, says Chris Lorek	

REVIEWS

AZDEN PCS5000	41
A 'me-too' mobile or a worthy challenger?	
IC12E 1296 MHz HANDIE	52
Actually, 'chunkie' might describe this rig better	
WEATHER SATELLITES THE EASY WAY	56
We review Timestep's satellite receiver and framestore	

FREE READERS' ADS	60
Classified	64
Emporium Guide	65
Advertisers' Index	66

THE RUMOURS ARE TRUE, WE COULD NOT KEEP THIS NEW HIGH-GRADE HF TRANSCEIVER QUIET FOR LONG.



IC-751A.



IC-751A

Features:

- All mode.
- 100kHz-30MHz General Coverage Receiver.
- 100 watts.
- 12v Operation.
- 105dB Dynamic Range.
- 32 Memories.
- Electronic Keyer.
- Full Break In (40wpm).
- 500 Hz CW Filter.
- HM36 Microphone.



British TELECOM
Agent/Dealer for
Mars/Phonix/Donner

Tha-net ICOM Tha-net ICOM Tha-net ICOM Tha-net ICOM Tha-net ICOM Tha-net ICOM Tha-net ICOM Tha-net ICOM

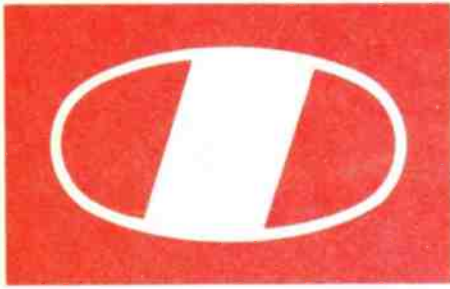

ICOM

IC-761, HF TRANSCEIVER with General coverage receiver.



The new ICOM IC-761 H.F. Transceiver has many features making it probably the best top of the line Amateur transceiver available today. This all mode transceiver features an internal aerial tuning unit and A.C. power supply. The A.T.U. boasts a 3 second band selection and tune up with a VSWR matching of less than 1.3:1.

For the serious operator the 100kHz-30MHz general coverage receiver and 105dB dynamic range make it ideal for DX chasing. Frequency selection is by the main VFO or via the front panel direct access keypad.

And for when reception is difficult, pass band tuning, I.F. shift, notch filter, noise blanker, pre-amp and attenuator should enable you to copy even those weak DX stations whether amateur or broadcast.

The C.W. operator will appreciate the electronic keyer, 500Hz filter and full break in (40wpm) other filter options are available.

The IC-CR64 high stability crystal is standard as is the CI-V communications interface for computer control. Twin VFO's and split mode for cross band contacts the IC-761 features program scanning, memory scan and mode select scan and the 32 memories can store frequency and mode.

The transceivers operating system is held permanently in ROM and is not dependant upon the lithium battery. The cell is used for memory back up only. A new style meter gives P.O., A.L.C., IC, VC, COMP and SWR readings.

This new equipment is fully compatible with existing ICOM accessories such as the IC-2KL 500 watt linear amplifier. Here at THANET we believe the IC-761 will set a new trend that others will surely follow. For more information please contact your nearest ICOM dealer or THANET ELECTRONICS LTD.

Telephone us free-of-charge on:
HELPLINE 0800-521145.

— Mon-Fri 09.00-13.00 and 1400-17.30 —

This is strictly a helpline for obtaining information about or ordering ICOM equipment. We regret this service cannot be used by dealers or for repair enquiries and parts orders. Thank you.

You can get what you want just by picking up the telephone. Our mail order department offers you free same day despatch whenever possible, instant credit, interest free H.P. Barclaycard and Access facility, 24 hour answerphone service.

Datapost

IC-735.



IC-735

- Small Compact Size.
- 100kHz-30MHz General Coverage Receiver.
- 100 watts.
- 105dB Dynamic Range.
- FM Standard.
- 13v Operation.
- Large LCD Readout.
- 12 Memories.
- CI-V Communications Interface.
- HM12 Microphone.

Thanet ICOM Thanet ICOM Thanet ICOM Thanet ICOM Thanet ICOM Thanet ICOM Thanet ICOM Thanet ICOM
Thanet Electronics
 Sea Street, Herne Bay, Kent CT16 8LD
 Tel: (0227) 363859
 Dept. HRT

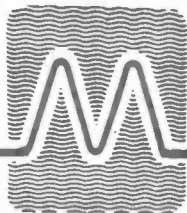

MICROWAVE MODULES LTD

**BRING A TOUCH OF CLASS IN 1987
WITH THE CONNOISSEUR'S CHOICE
IN POWER AND PERFECTION**

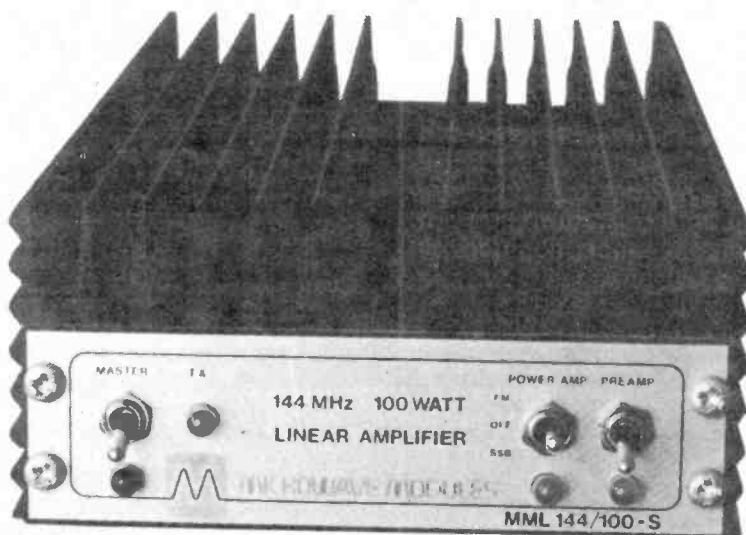

At Microwave Modules Ltd, we believe that the new look of our range of linear amplifiers makes them simply the best. The addition of the new brushed aluminium front panel has transformed the appearance of an already superb range of products. Our company's policy is customer satisfaction, not just with service, but also with products that have style.

We're ahead of the times with our range and will be staying that way. Visit one of the many retailers who handle our range, perhaps the Lowe chain of shops, or SMC. Alternatively, our roadshow is visiting many of the mobile rallies this year, so stop and say hello and look at perfection for yourselves.

IF IT'S MICROWAVE MODULES IT'S GOT TO BE GOOD

LINEAR AMPS

		TOTAL Inc. VAT	POST RATE
MML28/100-S	10m 100W Linear, 10W input	129.95	C
MML144/30-LS	2m 30W Linear, 1 or 3W input	98.90	B
MML144/50-S	2m 50W Linear, 10W input	106.95	B
MML144/100-S	2m 100W Linear, 10W input	149.96	C
MML144/100-HS	2m 100W Linear, 25W input	159.85	C
MML144/100-LS	2m 100W Linear, 1 or 3W input	169.97	C
MML144/200-S	2m 200W Linear, 3, 10, 25W input	369.84	D
MML432/30-L	70cm 30W Linear, 1 or 3W input	169.05	C
MML432/50	70cm 50W Linear, 10W input	149.50	C
MML432/100	70cm 100W Linear, 10W input	334.65	D

TRANSVERTERS

MMT144/28	2m Linear Transverter, 10W o/p	139.84	B
MMT144/28-R	2m Linear Transverter, 25W o/p	289.80	B
MMT432/28-S	70cm Linear Transverter	195.50	B
MMT1296/144-G	23cm Linear Transverter	258.75	D
MMX1268/144	1268MHz Transmit Up-Converter	195.50	D
MMT 50/144	6m Linear Transverter 20W o/p	289.80	B

MICROPROCESSOR

MM2001	RTTY to TV Converter	188.83	B
MM4001-KB	RTTY Transceiver with keyboard	299.00	D
MMS1	The Morsetalker	129.95	B
MMS2	Advanced Morse Trainer	168.82	B

ATV

MMC435/600	70cm ATV Converter, UHF output	35.65	A
MTV435	70cm ATV 20W Transmitter	197.80	B

CONVERTERS

MMC50/28	6m down to 10m Converter	37.95	A
MMC144/28	2m down to 10m Converter	37.95	A
MMC144/28-HP	2m High Performance Converter	47.84	A
MMC432/28-S	70cm down to 10m Converter	44.85	A
MMC432/144-S	70cm down to 2m Converter	44.85	A
MMK1296/144	23cm down to 2m Converter	129.95	B
MMK1691/137.5	1690MHz WX Satellite Converter	144.90	B

PRE AMPS

MMG144V	2m RF Switched GaAsFET Preamp	37.95	A
MMG1296	23cm GaAsFET Preamplifier	74.98	A
MMG1691	1690MHz GaAsFET Preamp	129.95	B

OTHER PRODUCTS

MMD1500P	1500MHz Divide by Ten Prescaler	119.60	A
MMR3/25	3dB 25 Watt Attenuator	19.78	A
MMR7/3	7 dB 3 Watt Attenuator	19.78	A
MMR15/10	15 dB 10 Watt Attenuator	19.78	A

Postage/Packing Charges:(inc VAT)

A = 2.35 C = 5.60
B = 4.91 D = 6.98

DURING THIS YEAR OUR TEAM WILL BE FOR MORE CLUB LECTURES. TO BE SURE THAT WE DO NOT MISS YOURS PLEASE RING MICK, G4EFO, ON 0403 730 767.



VISA

WELCOME

MICROWAVE MODULES Ltd

BROOKFIELD DRIVE, AINTREE, LIVERPOOL L9 7AN, ENGLAND

Telephone: 051-523 4011. Telex: 628608 MICRO G

CALLERS ARE WELCOME, PLEASE TELEPHONE FIRST

HOURS:
MONDAY-FRIDAY
9-12.30, 1-5.00
E & O.E.

TX-3 RTTY/CW/ASCII TRANSCEIVE

All the features you've ever wanted in this really top class program. Some of the facilities are:

Split-screen, type-ahead, receive screen unwrap, 24 large memories, clock, review store, call sign capture, RTTY auto CR/LF. CW software filtering and much more. Uses interface or T.U. for **BBC-B** and **CBM64**. Tape £20, disc £22. For **VIC20** we have our RTTY/CW transceive program. Tape £20.

RX-4 RTTY/CW/SSTV/AMTOR RECEIVE

This is still a best-selling program and it's easy to see why. Superb performance on 4 modes, switch modes at a keypress to catch all the action. Text and picture store with dump to screen, printer or tape/disc. An essential piece of software for trawling the bands. **SPECTRUM** needs no hardware, **BBC-B**, **CBM64** and **VIC20** need interface. Tape £25, BBC or CBM64 disc £27.

TIFI Interface has 2-stage RTTY and CW filters for improved reception and transmit outputs for MIC, PTT and KEY. Kit £15 (assembled PCB + cables and connectors) or ready-made £25 in a box with all connections. Extra MIC leads for extra rigs £3 each.

BBC Wqrd map and locator shows daylight and darkness zones and realtime clock updated as program runs. Accepts input of lat/long, QTH or maidenhead locator, NGR or one of 245 placenames. Prints distance, bearing, VHF contest score and long path details. Plots distant station and great circle path on map. Runs on **ELECTRON** also. Tape £7, disc £9.

For **CBM64**, **VIC20**, **SPECTRUM** we have our original locator program (no map, NGR or placenames) tape £7.

Morse tutor is now fully revised with every feature to learn morse the quick and easy way. Graded learning for beginners and 40 plain language texts for test preparation. Tape £6 for **BBC-B**, **ELECTRON**, **CBM64**, **VIC20**, **SPECTRUM**. The original **ZX81-16k** program is still available at £6.

Logbook date, band, mode, call and remarks for all your contacts. Easy to use, printout to screen or printer, callsearch. For all the above computers, tape £8.

RAE Maths All the practice and testing you need for the exam. For all the above computers inc. **ZX81-16k**, tape £9.

All BBC and CBM64 programs are available on disc at £2 extra. All VIC20 programs (except locator) need expansion.

Prices include VAT and p&p, 1st class inland, airmail overseas, normally by return. Eire, C.I., BFPO deduct 13%.

technical software (HRT)

Fron, Upper Llandwrog, Caernarfon LL54 7RF.

Tel: 0286 881886



23cm Receiver

NEW!

With interest in the 23cm band on the increase, we are pleased to introduce this new 23cm receiver. This high spec FM receiver will provide a low cost, effective way of monitoring the band without the need to tie up rigs plugged into converters. An IF of 145MHz enables the receiver to double as a 2m FM receiver. A companion transmitter is planned for the near future.

Specification

* Freq Range	1296 to 1298MHz
* IF Freq	144-146MHz
* 3 Channel	Xtal Controlled
* RF Sensitivity	<0.25µV for 12dB SINAD
* Adjacent Channel	>60dB
* AFC Range	±5kHz
* Audio Output	600mW into 8 ohms
* Power required	12-15 volts DC
* Size	185-135mm

Kit includes: Double-sided glass fibre PCB, all components, helical filter, surface mount components and potentiometer (Ch. Xtal not included).

Minimum of test equipment required - multimeter and diode probe.

Please allow 21 days for delivery.



Circuit Distribution Limited, Park Lane, Broxbourne, Herts EN10 7NQ
Telephone: (0992) 444111 Telex: 22478

SPECTRUM COMMUNICATIONS MANUFACTURERS OF RADIO EQUIPMENT AND KITS

NEW PRODUCT

FOUNDATION TRANSMITTER, Ideal for the newly licensed amateur. 2 meter FM, crystal controlled unit with 6 crystal positions, nominal output 750mW. Complete system comprises RF generator FTX201 with S20 crystal, £31, Frequency modulator board FM1000T £4.00, and Transmit Switching board TS25, £3.75.

CB TO 10 FM CONVERSION BOARDS, The first commercially available, suits all UK FM CB rigs to give 29.31 to 29.70MHz. Size only 63*40*13mm. Built and aligned board SC29 £15. Or send your rig and we'll fit it. £28. Inc. return P&P for mobiles. £31 inc. for base rigs.

MULTIMODE CB CONVERSIONS, send your 120 channel rig and we'll convert it to give 28.01 to 29.70MHz in straight sequences without gaps. Colt 1200DX, Cobra 148, Hy Gain 5, Multimode 2, Major M360, Tristar 747 & 777, Super Star 360, Concorde, etc., £62 inc. return P&P. Jumbo or Colt Excalibur 1200, £65. 80 Channel rigs such as Stalker 9 or Major M588 are modified to give 28.31 to 29.70MHz in straight sequence without gaps. £45.00 inc. return P&P. 200 Channel in 4 bands of 50 are converted to give 28.00 to 30.00MHz or 28.00 to 29.70MHz as required. Super Hy Gain 5, Lafayette 1800, Super Star 2000. £45.50 inc. return P&P. Nato 2000 £52.50, Super Star 2000-5*40CH £70. Colt 1600, 4*40CH. £65.50.

FREQUENCY MODEM adds FM to synthesised rigs with 455KHz IF. Type FM 455, PCB Kit £6.50, PCB built £9.50.

FREQUENCY MODULATOR adds FM to receivers with 455KHz IF, suits R600, R1000, FRG7000. Type FD455, PCB kit £5.50, PCB built £7.50.

FREQUENCY MODULATOR adds FM to synthesised rigs or rigs with clarifier. Type FM1000, PCB kit £3.00, PCB built £4.00.

RECEIVE CONVERTERS 2, 4 or 6 Metre aerial input with 10 metre IF or 4, 6, 10 or 20 metre aerial input with 2 metre IF, 26dB gain, low noise with OSC output. Types RC2-10, RC4-10, RC6-10, RC4-2, RC6-2, RC10-2, RC20-2. pcb KIT £17.25, PCB built and tested £24.50, Boxed kit £29.25. Boxed built and tested £41.

TRANSCIEVE CONVERTER, single board version of receive & transmit converters, 500mW output, with repeater shift facility. Types TRC2-10, TRC4-10, TRC6-10, PCB kit £39, PCB built and tested £54, Boxed kit £54, Boxed built and tested £83.25.

TRANSMIT AMPLIFIER unswitched, suitable for Transmit Converters, Transcieve Converters and MEON, 500mW in, 20W min output. Types TA2U2, TA4U2, TA6U2 PCB kit £40.50, PCB built & tested £48.75. Boxed kit £45.00, boxed, built and tested £53.00.

RECEIVE PREAMPS 2, 4, 6 or 10 metre, RF & DC switched, 0-2dB variable gain, low noise, 100W handling. Types RP2S, RP4S, RP6S, RP10S. Also masthead version DC coax fed, types RP2SM, RP4SM, RP6SM, PCB kit £12, PCB built and tested £16.75, Boxed kit £20.25, Boxed built and tested £27.00.

NOISE SQUELCH squelches rig when noise is high. Allows reception between noise bursts, Type NS1000, PCB kit £7.25, PCB built £10.25.

VAT & P&P PRICES

Delivery within 14 days subject to availability. 24 hr answering.



UNIT B6, MARABOUT INDUSTRIAL ESTATE,
DORCHESTER, DORSET. TEL: 0305 62250



MET

ANTENNAS

**HIGH
QUALITY
BRITISH**



SHOP OPENING TIMES
 Mon. — 1.00am-5.30pm.
 Tue.-Fri. — 9.00am-5.30pm
 Sat. — 9.00am-3.30pm.
**EVENING BY
 APPOINTMENT**

0527 71165

MET ANTENNAS ARE STILL MANUFACTURED TO THE SAME HIGH N.B.S. STANDARD

	CODE	MODEL	GAIN	COST inc.	VAT		CODE	MODEL	GAIN	COST inc.	VAT
70cms	432-5B	5 Ele	9.2 dBd	£19.49	B	6M	50/2	2 Ele	4.7 dBd	£32.00	A
	432-19T/ATV	19 Ele	14.2dBd	£40.94	A		50/3	3 Ele	7.1 dBd	£39.95	A
	432-17X	17 Ele crossed	13.4 dBd	£56.55	A		50/5	5 Ele	9.2 dBd	£59.90	A
	432-17T	17 Ele long	15.0 dBd	£45.08	A		CK50	50/2-50/3 Conversion Kit		£11.50	B
2M	144-5	5 Ele	9.2 dBd	£22.48	A	POWER SPLITTERS					
	144-7T	7 Ele	10.0 dBd	£27.77	A	70cms	2 way		£23.46	B	
	144-8T	8 Ele long	11.0 dBd	£35.95	A	4 way			£27.60	B	
	144-14T	14 Ele	13.0 dBd	£53.72	A	2M	2 way		£30.60	B	
	144-19T	19 Ele	14.2 dBd	£64.26	A	SF4/432	4 way		£34.50	B	
	144-6X	6 Ele crossed	10.2 dBd	£45.71	A		Stacking Frame		£29.75	B	
	144-GP	Ground Plane	Unity	£16.57	B	NON METALLIC MAST					
						R.P.M. 1.5 M (1 1/2" dia.)	With Fixing Clamp		£19.75	B	
4M	70/3	3 Ele	7.1 dBd	£34.64	C	R.P.M. 3 M (1 1/2" dia.)	With Joiner and Resin		£39.50	B	
	70/5	5 Ele	9.2 dBd	£52.60	C	R.P.M. 1.5 M (2" dia.)	With Fixing Clamp		£22.25	B	
					R.P.M. 3 M (2" dia.)	With Joiner and Resin		£44.50	A		

A £3.50 B£1.95 C £6.50

To all our existing customers, we will still have available a large range of new and secondhand products. We also stock MICROWAVE MODULES, DRAE, RSGB and P.W. Publications, S.E.M. and lots more to suit your every need. Please acil in and see us. We give a 3 month warranty on all second-hand equipment sold.

MET Antennas are avialable from your Local Emporium. We can now offer credit facilities to all licenced amateurs. Written details on request. Mail Order despatched same day if you call before 3.00pm. Many good deals — come in and visit the showroom.

SEE OUR STAND AT ALL THE MOBILE RALLIES

Trade and Export Enquiries Welcomed.

PHONE

0527

71165

TODAY

**3 STOKER ROAD, ASTON FIELDS,
 BROMSGROVE, WORCS B60 3EQ**



**24 Hr Answerphone
 OPEN 6 DAYS A WEEK**

A. KELLY

**ELECTRONICS &
 COMMUNICATIONS**

Rainbow Communications

ATTENTION!!! FT101ZD OWNERS

A PLUG-IN FM BOARD.....

This compact FM unit has been specially developed for your 101ZD utilising the latest chip technology and design techniques. Now making it possible to use 10FM and 2M.FM with a suitable transverter. No holes to drill — directly replaces the old A.M. board without degrading the performance of any other mode. **Price of Board is ONLY £75 + p&p.**
 Or you old AM board in PX for **JUST £70 + p&p.**

**GET READY FOR THE
 SUNSPOT-CYDE.**



Or we'll fit the unit for you in our workshop's for a small charge.

Please specify channel spacing for appropriate filtering, 10 or 25KHZ.

Comes complete with fitting instructions and takes less than 10 mins to install.

We also specialise in conversions and modifications to most H/F equipment, technical queries welcome.

Specialists in design of broadcast and community radio equipment to specification.

Wide range of antennas, PSU's, vast stock of secondhand VHF/HF amateur equipment available.

For further details of advice contact us now!!!

68 GORRINGE PARK AVENUE, MITCHAM, SURREY.

01-640 1904



YOUR ONE SOURCE FOR RADIO

ARROW

**ELECTRONICS
LIMITED**
5, The Street,
Hatfield Peverel,
Chelmsford, Essex

FOR IMMEDIATE DESPATCH
phone with your Access, Eurocard,
Mastercharge or Visa number to

0245 (Chelmsford) 381673 or 381626.
Telex 995801 (ref: A5)

**OVER
500
LINES AT
UNBEATABLE
PRICES**

**IT WILL
PAY YOU
TO PAY
US A
VISIT!**

THE NAME YOU CAN TRUST FOR PRICE & AFTER SALES SERVICE

INTEREST FREE FINANCE

Yes, you really can spread the cost of your new rig over 6, 9 or 12 months and ARROW pays the interest charges for you. Three schemes: 20% deposit, balance over 6 monthly payments. 1/3rd deposit, balance over 9 monthly payments. 50% deposit, balance over 12 monthly payments. And remember, you pay no more than the normal RR price!! Just call us and we will send agreement for your new gear same day!!!



One of the country's largest Yaesu stockists you can see all the new models at ARROW plus get the very best deals - take advantage of our Interest Free Credit or call us for a really keen price - Nobody does it better!!! DAIWA equipment is of the highest quality, we stock the unique Cross-pointer meters, VHF & HF aerial tuners, Power units, excellent Linears, etc.



"Bencher" Paddles stocked and "Vibroplex", Hi-Mound see and try a key or paddle at the ARROW shops. BNOS make some of the finest British made PSUs we have seen and the Linears are superb with 5 year warranty

ARROW are franchised dealers for TRIO/KENWOOD CORP. PRODUCTS., & guarantee the availability of spare parts & technical back-up service during the life of any equipment purchased through the authorised TRIO/KENWOOD dealership.



**AR2001 Receiver
25/500MHz**



IC751, IC745, R71, R70, IC271E, IC471E, IC2E, IC4E, IC02E, IC04E, all stocked with accessory ranges - Call us for price

**AUTHORISED
ICOM
DEALER**



Rotators stocked include the new Daiwa multi-torque with up to 4 motors possible. Also the full Daiwa range at competitive prices, Kenpro from KR2000RC to KR250 inc KR500 Elevation type.



We stock the full WELZ range & often have stock when others don't. NEW Models now in!!



WELZ full range stocked

Come and see the new Trix-tower at Chelmsford, 30 or 40ft folds down really low, tilt or wall mounted. Keen prices

Our normal despatch is one or two days (as thousands of satisfied customers will tell you). Subject to manufacturers supplies being available. CARRIAGE FREE on all orders of £300 value and over (UK Mainland only)

Access and Barclaycard accepted. Save time - phone over your order with your Access or Barclaycard number. Express delivery can be arranged on all items for a total charge of £7.50. Please phone for details. This offer applies to UK Mainland only. N.B. The F.O.C. carriage offer does not apply when Express Delivery is requested.



THIS MONTH'S SPECIAL OFFERS!

**FT23R YAESU'S
SUPER MINI
2M FM HANDY
£229.00**

**FRG8800 YAESU
GEN. COV.
RECEIVER
£575.00**

**FT290R MK II
NEW YAESU
ALLMODE
£399.00**

**IC-R7000 ICOM
UNIQUE
SCANNER
£865.00**

**FT209R
YAESU KEYBOARD
2M HANDY
£209.00**

**TR2600E
SUPERB
KEYBOARD
2M HANDY
£199.00**

The Cost Cutters

**SOME OF OUR
PRICES ARE SO LOW WE
DARE NOT QUOTE THEM - CALL IN NOW!**



**ROTATOR
BARGAIN
EMR400 550KG/
CM 1500KG/CM
BRAKE £134.75**

**FT767GX NEW
YAESU HF.
SPECIAL MODEL
2M & 70CM
SPECIAL
UNBEATABLE
PRICE- PLEASE
PHONE**



**All mail orders to
ARROW ELECTRONICS LTD
5 The Street, Hatfield Peverel,
Chelmsford, Essex**

Hatfield Peverel showrooms which are just off the A12 trunk road, are open 9-5pm Mon, Tues, Weds, Fri, Sat. Closed all day Thursdays. Approach by road via M25 & A12. By rail to BR Hatfield Peverel (3 mins from shop). We will taxi you back to rail station with heavy equipment. Buses from Chelmsford and Colchester pass the door. Free parking in our own car park. Local repeater GB3DA R5.

Scottish customers welcome at ARROW ELECTRONICS (SCOTLAND) Glasgow. Tel:041-339 6445 ask for Jim. Parking free outside the shop, which is near the Clyde Tunnel and Kelvin Museum. Open six days (closed Sunday) 9-5.30

In Leicester area Tel:0858 62827 you will find Alan G4TZY who will be pleased to assist you. Alan lives at 32 Fairway, Market Harborough, Leics. but please telephone first.

In Manchester Mr. J. Cook, 106, Wirral Drive, Winstanley Wigan. W3 6LD. Tel:0942 214969

In N. Wales area John Lewis GW8UZL waits to talk to you in English or Welsh! John is an expert on Satellite work. Tel:0248 714657. 14 Carr-y-gad Llanfair-p-g Anglesey N Wales.

LETTERS

Disabled Operators — Another View

Dear HRT, I would like to reply to the letter signed Charioteer! published in the March issue. I am also disabled, having a progressive illness. I can understand your reader's frustration at not being able to join in QSOs he hears, but I do not agree with his views on the RAE.

I know that I will never be able to construct or install equipment, but at least I know the workings of my equipment, how it works and why it works.

Because one is disabled it doesn't detract from your mental abilities. Why should the RAE be divided for the disabled, mentally most of us are on a par with able bodied operators.

I studied for my RAE with the help of RAIBC and my local radio club, I sat the RAE at home last May and passed both parts and am now aiming for my CW test in the near future.

Working for your license makes you appreciate it all the more when you get it. Why should it be handed on a plate to you because of your disability. Good luck in your studying. Chris Cameron (Mrs) GM1TXX.

We have had similar (and somewhat less tactfully put!) letters from other disabled operators on this subject voicing the opinion that if they could do it then so can others. The main stumbling block would seem to be that the special provisions and level of support available varies considerably from one part of the country to another. If you are unfortunate enough to live in a 'problem' area the only suggestion I could make would be to kick up such a fuss that it is easier for the people concerned to cater for your needs than to have to suffer your incessant stirring! Get support from the RSGB and RAIBC, find out who the organiser is, and work your way upwards — you'll be doing future disabled candidates a favour too.

QRP'ed Off!

Dear HRT, I would like to comment on Ian Wade's recent article in your magazine on the 'Psychology of QRP

working'. It is worth considering the other side of the argument; in particular, from the angle of the G station who is calling CQ DX.

There is a time and place for everything in amateur radio, why Ian Wade feels the need to impose his QRP on people who are genuinely trying to work long haul DX is beyond me.

There have been several times recently when I have suffered severe QRM from QRP operators whilst trying to work DX on 3.5MHz CW; a cursory check on a rather insensitive direct conversion. Rx is not the way to decide whether there has been a response to the CQ DX call. It is most annoying to have a very weak JA or VK obliterated by a 50mW QRP fanatic in the next town. The QRP operator may consider himself as DX, however my definition of DX is for stations outside Europe. Sometimes, the only way to get rid of the QRP station is to work him, could this be the 'Psychology of DX working'?

I may be what Ian Wade terms 'a hard nut' however, I have no objection to QRP; providing sensible attitudes prevail. I have enjoyed many good QSOs with a home made transceiver running at 5 watts or less. I would add that I see no real achievement in signals in the presence of QRM, QSB, QRN etc.

QRP to QRP is another story altogether and there are some creditable signals to be worked around 3.560MHz from the G-QRP Club members, who manage excellent QSO's with 3 watts or less. Stephen Wilson G3VMW.

Er . . . maybe I've missed something here but what is the difference between copying an S1 QRP station from Cornwall and an S1 QRO station from Kuwait? Your aerial, receiver and ears will have to do the same amount of work in either case so it would seem logical that you would be equally pleased with your station's performance. After all ham radio is a hobby, so how about a little bit of give and take?

. . . and QRPlensed

Dear HRT, I read the 'Psychology of

QRP' article with mixed feelings, my initial reaction was that the prescribed practice was a bit deceitful. However upon re-reading, I thought, all's fair in love and war etc. . . . the 1000/500w directional beam brigade don't care who they blast out so why not have a go?

Like Ian, I have tried QRP on and off withing nothing spectacular in the log. So I screwed down the power to about 5 watts out and following Ian's instructions, promptly netted a VE1 station on 80mtrs, followed by various EU stations all giving good reports. I would add to the author's comments to remember that the receiving station is doing all the hard work in copying your QRP signal and should be thanked for same without prolonging the QSO.

Thanks HRT for an interesting and very readable magazine. J.J. Griffiths G0FTT.

Constructor Emptor!

Dear HRT, May I be permitted through your column to give some advice to 'Novice Radio Hams' or 'Cbers'?

By reason of experience, if you are a SWL or you now have a licence to operate — take caution. Do not erect huge towers or buy long wires or become an aerial farm (unless your house is isolated) it is most unwise to assume that your neighbours are decent people and we live in a free world — we do not! In my view, part of the delight of Ham Radio is doing that which to others may at first thought seem impossible.

Do not allow your QTH to be disclosed in any register or book, insist on 'Particulars Withheld'. Many seem to forget not only SWL/licenced amateurs have access to these directories and in many cases equipment has been stolen or people 'land' upon you from a distant base without so much as a 'by your leave'. QSL *only* via a bureau. Do *not* tell your neighbours about your hobby and if they remark to you of CB or Ham radio interference try and improve your filters or operate at other times. Do *not* offer to fit an HPF because you will be called upon

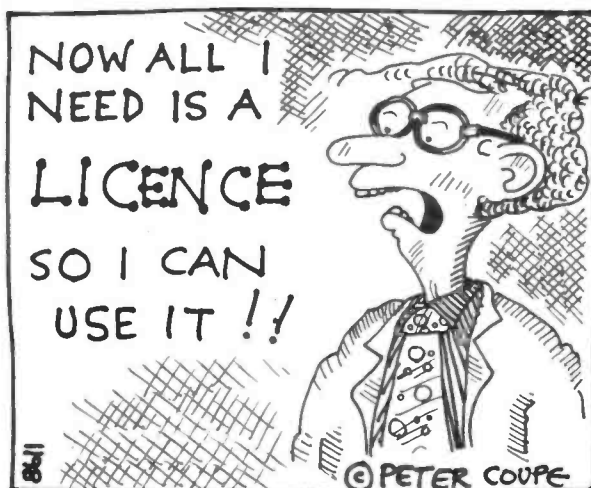

at all hours to 'look at my TV/radio it's doing strange things'. You will be held responsible for the chap doing his DIY with a saw or a drill and the French station blotting out 'The Sweeny'. So do not say you are a Radio Ham or a radio engineer because if you do — on your head be it!

Rob Jones, G0CJM

More on Morse Keys

Dear HRT, A few months back you published an article of mine on morse keys. The response from this article was nothing short of phenomenal, and anyone who believes that CW is an outdated and unwanted mode should see the mountains of mail I received!

A lot of the letters concerned the two ex RAF keys mentioned, the type 'B' and the 'bathtub'. Most of these letters were from ex World War Two pilots who flew aircraft fitted with them. The type 'B' seems to have been fitted to a fair few aircraft types, mainly single and dual seater fighters, notably the Spitfire. The key was purely to activate identification lights on top of, and underneath, the fuselage. The lights were used for requesting take off etc. when on the ground (and under radio silence) and for sending the letter of the day to anti-aircraft gunners when in the air. Being a pilot myself I can appreciate the effort required to control a plane and send morse at once. Mind you, if you know that someone might shoot you if you don't, it must concentrate the mind wonderfully!

The bathtub key seems to have been used in the bigger bombers, and was used on the transmitters. One ex radio operator pointed out that the front clip of the key can be used to hold the key 'on' by slipping it over the knob fingerplate. This was a facility I pointed out in my article on

other keys that I did not realise the 'bathtub' was possessed!

May I take this opportunity to thank everyone who wrote in. Every letter, without exception, was fascinating.

Hugh Allison G3XSE.

Bouquets . . .

Dear HRT, I just had to write endorsing Trevor Lund's (G0FUG) letter referring to KW Communications Ltd.

Recently I also acquired a KW 2000A and wrote to KW. They were most helpful and were able to supply me with two black legs missing from my KW107 free of charge and with the compliments of KW. They were also able to offer service on what must be a twenty year old model and are obviously proud of their products.

The pleasant experience I and Trevor have both had would ensure that if ever I had thoughts of buying a new rig I would have no hesitation about buying one from KW.

So thanks from another satisfied customer without a Japanese screw in sight!

Ron Evans

. . . and Brickbats

Dear HRT, Having been an avid collector and reader of HRT since 1983, I'd like to start a new trend in Readers' Letters. Instead of trying to change the course of that self-perpetuating and mindless juggernaut, the RSGB, let's all agree that it's best to leave spoilt brats to play alone, you never know they might pick up their marbles and go away, if nothing at all is said for or against them. Miracles still happen now and then!

The new idea is for Amateurs, SWL and CBers who all buy your mag to write about their hilarious, sad or frustrating times either by phone or by mail or eyeball-to-eyeball with the

good, the bad, the ugly, the funny, the helpful and the downright bloody-minded ignorant peasants who sell Radio TX/RX equipment. As well as component suppliers and kit construction firms.

Recently I've tried phoning and have written four very polite requests to North London Communications, or is it Standard Communications, or is it Lee Electronics? Well, whichever one it was or is, so far I've not received any reply. The first request was made in June 1986.

All I needed was (a) Carrycase for C58 multimode portable. (b) Has anyone done any mods for the front end? (c) Why, if the schematic shows 2 x 3SK101BL in the balanced mixer, are there 2 x 25K41-Ys fitted instead?

Simple questions, but as I'm disabled I need answers that come from the horses mouth before passing it on to be modified out of its deafness.

So let's hear more about good or bad suppliers from hams, etc.

PS I think SMC Chandlersford deserves a gold star.

J D Bolton, G4XPP.

Dear HRT, At last, with the 1296 receiver, something for the listeners in Ham Radio instead of the talkers! Please keep up the good work and follow it with a stand alone 2 metre monitor. I've been wanting to build one for a long time but none of the current electronics magazines have featured one as a constructional project for several years.

J S Hind BSc.

Well, just between you and me it might be worth your while keeping an eye on HRT in the near future . . . nuff said!

Please address correspondence to:
Letters, Ham Radio Today,
1, Golden Square,
LONDON W1R 3AB.

RADIO TODAY

New Icom HF Super-rig revealed

The latest addition to the Icom stable of high performance HF transceivers has been announced by Thanet Electronics. The Icom IC-761 is a 100W output, all mode, all band rig which incorporates an internal ATU and PSU in the standard unit.

Intended to compete with the Trio TS-940 and Yaesu FT-1 end of the market, the '761 offers a number of other features designed to appeal to the 'serious' HF operator. Covering AM, FM, SSB, CW and RTTY the rig offers switchable AGC, noise blanker, inboard electronic keyer, keypad frequency entry together with a 'normal' dial tuning system, digital frequency readout, 32 memories, PTB/IF shift, notch filter and a switchable preamp/attenuator.

Also included in the price is the CI-V interface which can be driven by any computer RS232 socket in the same way as the R7000 receiver. Software will be available for the BBC micro early on in the launch but the JT602 interface cable (£19.95) will also be needed. We are assuming that the reason for this is that the Icom requires a TTL type 0/+5 volt signal level as opposed to the +5/-5 volt standard used by the Beeb, although canny programmers should be able to get around this.

Icom has attracted a fair deal of criticism with some of their more recent rigs by virtue of the fact that the operating systems to control the microprocessors were held in RAM and not ROM, so if the lithium back-up battery expired or the owner removed it, the rig was useless and had to be sent away for re-programming. This is *not* a problem on the new IC-761 as the operating system is now held in non-volatile ROM and only things such as memory data are held in RAM.

The receiver is said to have a 105dB dynamic range and uses the FL32 IF filter as standard; and there is also a CR64 high stability crystal unit employing an oven and close tolerance crystal to ensure optimum frequency accuracy.

The provisional price for the Icom IC-271 is £1,999 including VAT, and the rig is expected to make its debut at the RSGB National Convention on 27th and 28th of March this year.



The new Icom IC-761.

Help Wanted

We have recently heard from Mr Jones of Sydenham, Kent who contacted us concerning help with RAE studies for a small group of handicapped radio enthusiasts. We feel sure that

there must be people in that area who would want to give a helping hand (mainly with the basic electronics part of the exam) so if you would like to help out please write to us here at the HRT editorial offices and we will pass the letters on.

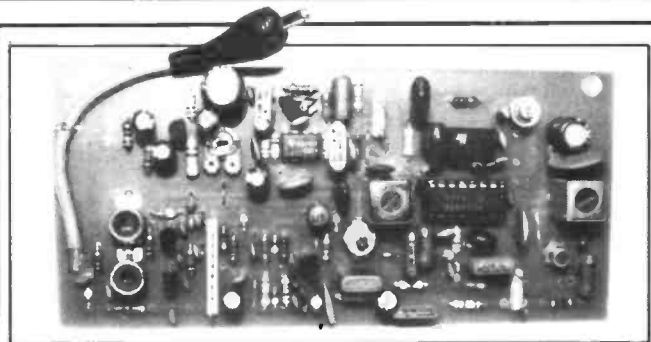

FT101Z gets FM

One of the shortcomings of the FT101Z series of transceivers has been the lack of an FM facility, something which could be rather useful when 10m propagation conditions begin to pick up a little. That is where the new FM modification from Rainbow Electronics will come in handy — this directly replaces the original AM board simply by plugging it in and making a couple of coax solder connections.

If you already have the AM board fitted you can trade this in with Rainbow to get £5 knock off the price of the upgrade. The board costs £75 inc VAT and p&p and is available from: Rainbow Communications, 68 Gorringer Park Avenue, Mitcham, Surrey. Tel: 01-640 1904.

Between 8 and 23 August 1987 it is planned to operate a Special Event Station in connection with the celebrations for the 850th Anniversary of the founding of St Magnus Cathedral in Kirkwall in 1137, with the call

GB2SMC. The primary mode will be SSB on HF bands 80 to 10 metres as appropriate. There might be VHF activity on 2 metres. Details from Bill, GM3IBU QTHR.

New Solent Award
The month of April 1987 will see the introduction of a new award for amateur radio. It is based on the many defences of the Solent. A maximum of 26 locations will be selected and during each year it is hoped to activate all stations on at least four consecutive weekends. Operating will be conducted by various local clubs and newly

formed groups. Both HF and VHF are catered for and signal reports from short wave listeners are welcome. All contacts will receive detailed individual QSL cards for each fortification worked. Details have yet to be finalised, but comments or queries to Vic Harris, G6MWY, 72 Elmore Avenue, Lee-on-Solent, Hants PO13 9ES.

Morse Tutor Updated
Technical Software have recently released a much improved version of their very successful Morse Tutor program. The program introduces the alphabet in easy stages and has comprehensive facilities for the student to learn the characters by ear. The pitch of the tone used for sending can be varied from the keyboard and, with most computers, the volume also. Random characters are used for initial learning and new groups of letters are introduced quickly to allow the student to become fluent in the whole alphabet as soon as possible. After each sending run, the copy can be checked so that any problems can be quickly identified and corrected. When the student has reached test speed on random characters, he or she can prepare for the plain language test by having the program send the 40 pre-recorded texts supplied with it. It is also possible to have someone type in a text for sending. The program is available for BBC-B, Electron, Spectrum, CBM64 and VIC20 (+ at least 8k) at £6 on tape and £8 on BBC or CBM64 disc. Owners of the previous program can get a 50% discount by sending their old program as part exchange. The original ZX81-16k program is still available for a limited period at £6 on tape. Available from: Technical Software, Fron, Upper Llandwrog, Caernarfon, Gwynedd LL54 7RF. Tel: (0286) 881886.

ASTRID is alive and well

But has moved house. The Automatic Satellite Telemetry Receiver and Information Decoder, designed primarily for use with UOSAT space vehicles is now available from a company which has been specifically set up by the receiver's designer, Steve Webb.

The system enables both the BBC micro and the Spectrum 48k computer to automatically access and display the 2m telemetry downlinks. The original set-up is available for £149 but there are also various software options for data decoding and hardware options in the form of aerials

intended to improve the duration of usable signals.

The simplest of these costing £5.48 is a reflector element which can be clamped onto the original dipole (supplied with the system) to reduce local interference and increase signal strength. There is also a circular polarised two element aerial and a five element linear yagi available, costing £35 and £28 respectively.

Further details of these and the ASTRID system itself can be obtained from: SRW Communications Ltd, ASTRID House, The Green, Swinton, Malton, N. Yorkshire YO17 0SN. Tel: Malton (0653) 697513.



New roller coaster

No more grubbing about in the depths of neolithic oddment bins looking for roller coaster inductors. Telecomms of Portsmouth have just announced that they are stocking the RC26 unit which has an adjustment range of 1 to 27 microhenries, power handling of up to 1kW, silver plated windings and a roller 'suspension system' which

ensures contact between the coil and the moving contact.

Weighing in at 580gms and designed to fit in between the company's existing range of QRO capacitors, the unit is made in the UK, costs £27 inc VAT and p&p and is available from: Telecomms, 189 London Road, North End, Portsmouth, Hants PO2 9AE. Tel: (0705) 698113.

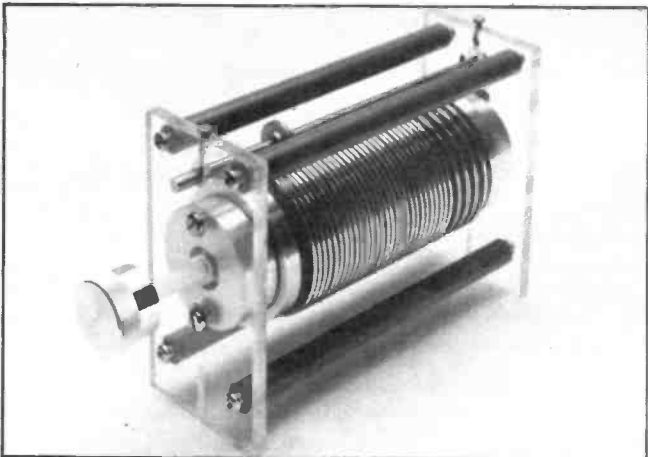

Physical disabilities are no deterrent to the really dedicated CW operator. Despite being confined to a wheelchair with severe muscular and hearing problems, Fred Huntley G0DIW has made over 2,000 CW contacts worldwide on 80 and 20 metres since obtaining his class A licence in October 1985. His current target is to work more than 100 Russian Oblasts before mid-summer.

Go Dragon Hunting

Just to prove that the English are as patriotic as anyone else (as if anyone had ever doubted it...), there will be three special event stations on the air to celebrate St George's Day and there will also be a competition.

The three stations taking part in the celebrations are GB0SGD, GB4SGD and GB6SGD. The three stations will be active from April 19th until May 16th on as many bands as possible. A contact with any of the three will count towards the 'St George's Day' award. This award, which is now in its fifth year of operation, will

also be available to SWLs. As well as contact with any of the above three stations, all those wishing to apply for the award may do so by fulfilling the following:

Applications from G stations need eight further QSOs with stations from England;

Applications from Europe need five further QSOs with England;

Applications from the rest of the world need three further QSOs with England.

QSL cards are not required to confirm the other stations. Log extracts only are needed.

For those stations who

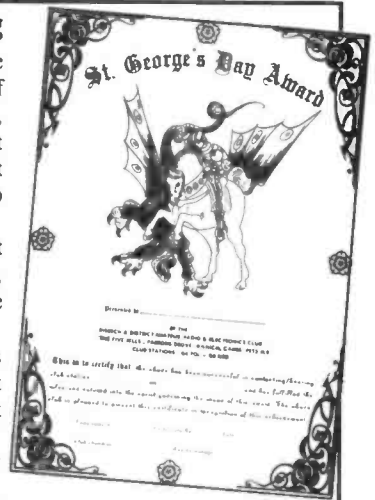

contact any of the above a special QSL card will be available either direct via G4KHF (QTHR) or via the bureau. The cost of the award is from the U.K. £1.50, from Europe 6 IRC, from the World 8 IRC. The qualification period is between the 19th April and the 16th May during which all QSOs must take place.

The event is being organised by Wisbech and District ARC; further details if required can be obtained from David Wilkinson, G4KHF, QTHR or via the bureau.

By the way, when is St George's day?

Orkney calling!

Orkney is a relatively rare part of the UK. The Call Book shows 34 licences (14 'A' and 20 'B'), but not all are active. With a view to stimulating some interest and to provide others with a chance to work Orkney, the Orkney Group of Radio Amateurs have decided to consider June as an 'activity month', during which as many as

can will make a special effort to be on the various bands. The suggested frequencies for operations are (all in MHz and +/-): 1.973, 3.753, 7.023, 7.053, 14.033, 14.253, 21.253, 28.8, 29.6, 70.26, 144.033, 144.353. Modes: CW, SSB, FM and possibly RTTY. Information from either Bill, GM3IBU or John, GM4YBJ, both QTHR.

K W TEN — TEC

ARGOSY II

A TOP OF THE RANGE WINNER

A 100 watt, 6 - Band SSB/CW Transceiver that combines excellent performance, Reliability, Simplicity of operation, and low cost:

HOME STATION - MOBILE - PORTABLE



Price: £446 (Incl VAT) PSU extra Carriage £4.00

- ★ Full Break-in (QSK)
- ★ Full Band coverage - 3,5,7,10.1,14,21,28.0 MHz
- ★ Separate PSU. (if required)
- ★ Sidetone, adjustable for volume and pitch
- ★ 100 watts Input, QRP switch. Receiver sensitivity 0.3 uV, typical.
- ★ Offset Receiver Tuning and 'Notch'
- ★ Improved Dynamic Range
- ★ Automatic Sideband Selection
- ★ Linear Crystal Mixer VFO
- ★ Operates on 12VDC.

For further information on the above, together with the CORSAIR II, CENTURY 22, KW TRAP DIPOLE AND TRAPS, ATU's KW BALUN and ANTENNAS please contact:

KW TEN-TEC LIMITED, Vanguard Works, Jenkins Dale, Chatham, Kent. ME4 5RT.
 Telephone 0634-815173
 HP & CREDIT CARD PURCHASE FACILITIES AVAILABLE.

NEW FROM KENPRO

FULLY COMPUTERIZED HAND HELD KT220 EE/T

With facilities not yet available in other brands, look at the outstanding list of features and incorporating Kenpro's Legendary quality. This is a Top Line transceiver which should be amongst the most expensive, but our low overheads make it the Best Value for money available today.

- ★ Built in LCD Clock
 - ★ 10 Memories for 10 Repeaters
 - ★ 4 Scan Models * "Scanlock" locks out unwanted channels
 - ★ 3.5 - 5 Watts Output
 - ★ 1750 Tone Burst
 - ★ CTCSS, DTMF, & Auto Dial
 - ★ Very Sensitive L/Noise Rcvr
 - ★ Auto Battery Save Function
- Don't forget the trusty economy version continues to be available.

- KT 220 C/W ST ACC Basic £229.00
- KT 220 C/W Nicads etc £249.00
- KT 200 C/W ST ACC Basic £165.00
- KT 200 C/W Nicads etc £189.00
- KT 400 C/W Nicads etc £209.00

Full range of accessories available
 Post, PK & Ins Transceivers £5.00

HP/PERSONAL LOANS

RWC

HI-TEC WORLDWIDE LIMITED
 Importers, Exporters and Distributors of Specialist Communications



584 Hagley Road West, Qulnton, Birmingham B68 OBS.
 Tel: 021-421 8201 (24hr) Telex: 334303 TXAGWM-G.

Books for radio amateurs

FDK

ELLIOTT ELECTRONICS

THE 'HAM SHACK'

APPOINTED DISTRIBUTOR

INSTANT HP AVAILABLE

QSY OLD MAN TO

AERIAL ACCESSORIES AND MASTS

JAYBEAM AMATEUR ANTENNAS

RIGS, ANTENNAS, SWR BRIDGES, POWER SUPPLIES, TEST GEAR, COMPONENTS, MORSE KEYS, COAXIAL CABLES, ROTATORS, MICS, PLUGS AND SOCKETS, SWITCHES

Call us on (0533) 553293
 OR COME AND LOOK AROUND AT
 26/28 Braunstone Gate, Leicester

REG WARD & CO LTD

1 Western Parade,
 Axminster, Devon EX13 5NY

appointed agent for

YAESU

FDK

Ancillary equipment by Adonis, AKD, AOR, Bencher, BNOS, Cap. Co., Datong, Diawa, Drae, Hansen, Himound, JIL, Kenpro, Microwave Modules, Mutek, SEM, Shure, Tokyo Hypower, Tono, Toyo, Welz, Wood & Douglas.

Aerials by: G. Whip, Hygain, Jaybeam, Mini Products, MET, Revco, Tonna

full range of Wood & Douglas kits:

Opening hours:
 Tues-Sat 9.00-5.30 (lunch 1-2) Closed Mondays

The Southwest's largest Amateur Radio Dealer

ICOM

★ Yaesu, Trio, Icom, FDS ★
 ★ Complete range stocked ★
 ★ Full demonstration facilities ★
 ★ Mail/Phone orders on all items ★
 ★ Barclaycard, Instant Credit, Access ★

Tel. Axminster (0297) 34918

AMATEUR ELECTRONICS UK

R.A.S. (Nottingham)
 Radio Amateur Supplies
 Tel: 0602 280267

Visit your Local Emporium
 Large selection of New/Used Equipment on Show

<p>AGENTS FOR: F.D.K. AZDEN ICOM YAESU ALINCO KENPRO</p>	<p>ACCESSORIES: Welz Range Microwave Modules Adonis Mics Mutek Pre-Amps Barenco Mast Supports Agents for VODAPHONE & CELLNET</p>	<p>DRAE products BNOS Linears and PSUs</p>
---	---	--

AERIALS: Tonna, Halbar, Jaybeam, New Diamond Range of Mobile Whips
 Bring in your secondhand equipment for sale

JUST GIVE US A RING
 Monday: CLOSED Tuesday-Saturday: 10am to 5pm

3 Farndon Green, Wollaton Park, Nottingham NG8 1DU
 Off Ring Rd, between A52 (Derby Road) & A609 (Ilkeston Road)

SLOW SCAN T.V.
48K SPECTRUM 128K
TRANSMIT SCREENS AND TEXT

Receive and Transmit pictures from your Spectrum. This superb programme and hardware allows you to join the exciting world of Slow Scan T.V. using your Spectrum to send and receive pictures around the world.

Allows you to Tx/Rx text and graphics.
 Capture and re-transmit pictures.
 Store pictures, print pictures, save pictures to tape.
 8 picture stores on 48K, many more on 128K.
 Picture Design Programme allows you to design personal test card, CQ call and much, much more.
 If you have a camera and digitiser, these may be used with the programme to send personal pictures.
 Tone Generator Hardware allows maximum computer processing time for accurate, clean signals.

The two programmes and very comprehensive instruction book, Inc. P & P £25
 Ready built interface and tone generator £42.75
 As above with automatic PTT £47.50

S.A.E. for detail of interface and tone generator kits.

J.E.P. ELECTRONICS LTD.
 New Road Complex, New Road, Kidderminster, DY10 1AL
 Tel: (0562) 753893

FOXHUNTS ARE FUN

For many years now the Dover club has been running 'foxhunts', using both two metres and top band, and as we always have a lot of fun it seemed to be a good idea to produce this beginners guide to DFing.

First is the beam antenna, and this needs to have as high a front to back ratio as possible together with a very narrow beam width. This can be a very difficult balance to achieve but by careful checking, a good com-

tion along the beam heading. In theory the fox is somewhere along this line — note I did say *in theory!*

There are now two ways the hunters may proceed . . . follow along this bearing until the signal is overpowering and then moving onto stage two or, moving to a second point on the outskirts of the hunt area and taking a second, or in some cases a third beam heading. If the latter is the case then a cross will appear on the map and after the third bearing, most likely a triangle, hence the term 'triangulation'. The fox should (we hope) be somewhere inside this triangle. Now we can move onto stage two.

. . . even for the fox, in radio. Dick Pascoe, G0BPS, gives some practical advice for foxhunting on 2m and top band, so now everyone can have a go.

On two metres signals do tend to 'bounce' around the hills and vales somewhat but that just adds to the enjoyment, whilst on top band we are still very much 'at the top of the learning wave' as the Americans put it. After doing well on two metres I still wanted to improve my chances the next time and came to realize that everything was not as easy as it may first have seemed.

Starting from scratch, let us look at the basic equipment which is required to take part in a two metre foxhunt:

- 1 Radio with signal strength metre
- 2 Antennas
- 3 Large scale map of the area
- 4 A board to hold map open & flat
- 5 Compass
- 6 Pencils
- 7 Long straight edge
- 8 Rule

Antennas

We have used many types of antenna over the years, even using just a small branch from a tree and two pieces of wire run along it to form a dipole. But, as most foxes seem to favour vertical polarisation, careful choice of the antenna is important. There are two basic types to consider and both have their uses in the hunt.

promise can be obtained. It is impossible to give hard and fast rules here as there are so many antennas on the market, personally I have used an old 8 element Parabeam which I found quite useful. Some may have a quad antenna which is occasionally easier to get into and out of a car.

The beam antenna is used in the early stages of the hunt at a fair distance from the centre of the hunt area to give the first bearing. By rotating the beam the operator will be able to 'peak' the signal, and thus decide from which direction the signal is coming. By careful use of the compass a note of the beam heading is made and this is transferred to the large scale map and a line drawn from the operators posi-

Getting in close

In most cases the hunter will not need to transmit, so it is not necessary for the antennas in use to be resonant, thus measurements quoted are not absolute. If the ability to transmit *is* required then clearly aerials must be tuned to the frequency in use.

Once the rough location of the fox has been determined the beam is no longer of any use and may be dispensed with. There is now a choice of antennas for the close-in-work and here again there are two

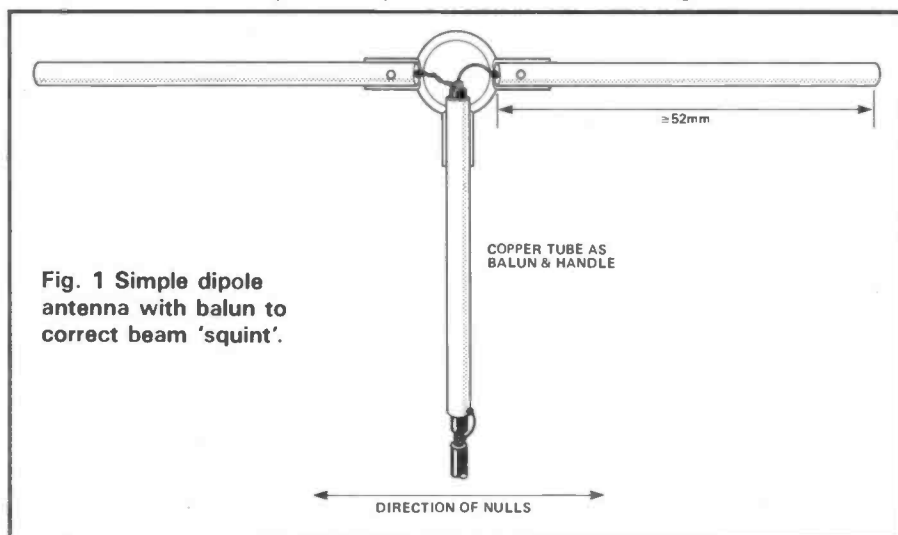

Fig. 1 Simple dipole antenna with balun to correct beam 'squint'.

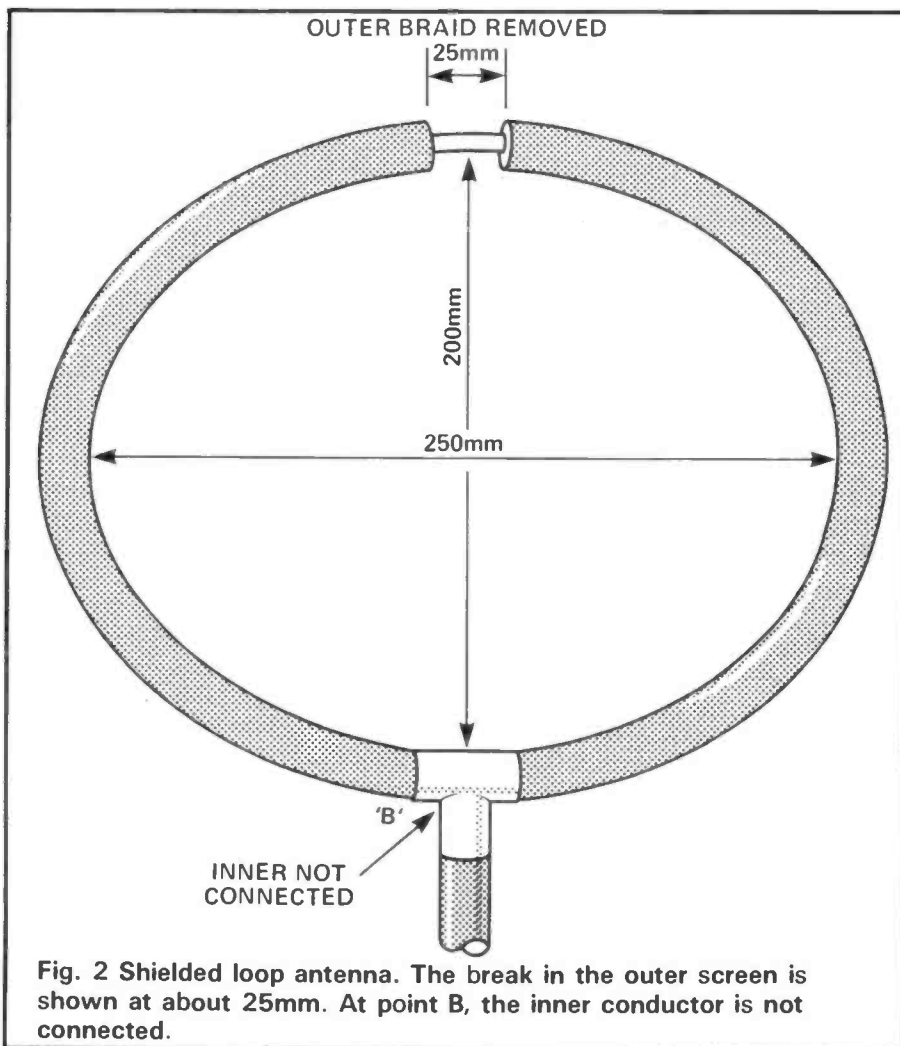

Fig. 2 Shielded loop antenna. The break in the outer screen is shown at about 25mm. At point B, the inner conductor is not connected.

options: dipole or shielded loop. The dipole is the easiest to construct and may be made from an old band I TV antenna cut to size as shown in Fig.1. Only one element is used and the dipole is operated in the horizontal plane. Needless to say, if it was used in the vertical position it would be omni-directional and of no use whatever! It is also important that all antennas are used well away from the vehicle used, so as to remove any chance of reflected images from the metalwork. Ideally the antenna should also be used as high as is practical to reduce ground proximity effects.

Dipole construction

Having cut the dipole to size it must first be tested. The user may be very surprised to find that when the antenna is tested on a known fixed station it may have a distinct 'squint' to one side in its beam pattern, testing is the only way to find how much this is offset from the true heading. To correct this a 1:1

balun is required (see Fig.1). The quarter wavelength of copper tube is slid over the cable and the bottom of the tube is soldered to the outer braid of the feeder, the joint is then taped to make it waterproof. This balun then serves two purposes: to correct the beam squint and to act as the handle for the dipole.

In operation it will be found that when either end of the dipole is pointing directly towards the signal source, the signal will fade to almost nothing, giving the operator a bearing to use.

The other method available for close in work is to use a 'shielded loop' (see Fig.2), in practice this is simply an untuned loop of feeder. As it is shielded only a small amount of RF reaches the rig thus accurate readings may be taken. Unlike the dipole, the shielded loop is used in the vertical plane.

A pas de loup!

Having got in close to the fox it will be almost certain that the

signals will be swamping the receiver and perhaps bouncing off some buildings etc, but we still have one more trick up our sleeves, the attenuator. In the junkbox there will surely be a large value variable potentiometer, preferably of the old volume control type (they are still very cheap to buy new). To build, simply instal the pot in an old metal box (a tobacco tin is perfect) together with a switch with the contacts reasonably close together (see Fig.3).

In use the attenuator is titted as close to the rig as possible, preferably with a 'back to back' plug to ensure that there is as little signal leakage as possible from this joint. The antenna is beamed up onto the fox and the hunter can now start to move in. As the signal increases the attenuator may be gradually brought into play so as to reduce the strength of the wanted signal until the 'pot' is at full travel (ie maximum value).

Finally the switch can be used so that the signal is fed from the antenna to the rig purely by the capacitive coupling between the switch contacts. By this time the fox can only be a few tens of yards away so keep your eyes open, have a quick walk round and you should have found your quarry.

Top Band

As I have already mentioned we are still very much novices using top band for the foxhunts but the rules and regulations still hold as for two metres — except of course the distance rule. We now specify that the fox must be within twenty miles of the club HQ. If you think is too easy (or too difficult) just think of the propagation on 160 metres after dark.

Whilst we are novices at foxhunts on this band we have arrived at a cheap and easy way that enables nearly all members of the club to take part whereby an expensive mobile top band rig is not required. The antenna is very, very simple, so much so that I could almost guarantee that most readers will already have a suitable top band receiver at home. It only needs slight retuning to work on the frequencies required.

The simplest method is to convert an old medium wave receiver to cover the 160 metre band. At first this may seem to be a very difficult

thing to do, but if we take a look at what is happening inside the set it will soon become apparent that everything is working in our favour.

The typical superhet receiver has an IF of between 455 and 470kHz, it is immaterial which one we have as the figures are so close together that it makes little difference. To convert the medium wave of between 600kHz and 1600kHz the local oscillator has to run between 1055 and 2055kHz. That is using the local oscillator signal *minus* the IF to give the received frequency. If we now look at the local oscillator *plus* the IF (in other words the image frequency) we will see that 1100kHz to 2510kHz will be covered, which encompasses the 160m band of 1.81 to 2MHz.

Retuning

To make the receiver sensitive over this range all we have to do is to retune the ferrite rod aerial, as this is the main front end selectivity component in such simple sets. There is a problem in making the RF tuned circuits and local oscillator track properly over the complete range, but as we only need the small section that covers 160m, we need not bother with that. If your set covers medium and long wave we first have to identify which is the medium wave aerial coil, in fact this is not too difficult as it is the smaller of the two! The long wave one is almost always layer or basket wound, and the medium wave coil is a single layer. It is usually held in place with a small piece (or if you are unlucky, large mass!) of bees wax. Scrape this away carefully so as not to break the windings and work the coil former so that it will slide along the rod.

It will be necessary at this stage to have a 160m Tx available that can be fired into a dummy load or of course you could use a signal generator. All we require is a signal on the band to get the set somewhere near maximum sensitivity, then we can find a signal to finally peak it up. Set the signal generator or Tx to 1.950MHz (the recommended DF frequency) and tune the receiver into the signal. Move the set so that the signal is not too strong and slide the coil towards the end of the ferrite rod until the signal peaks. Turn off the signal source and tune the receiver

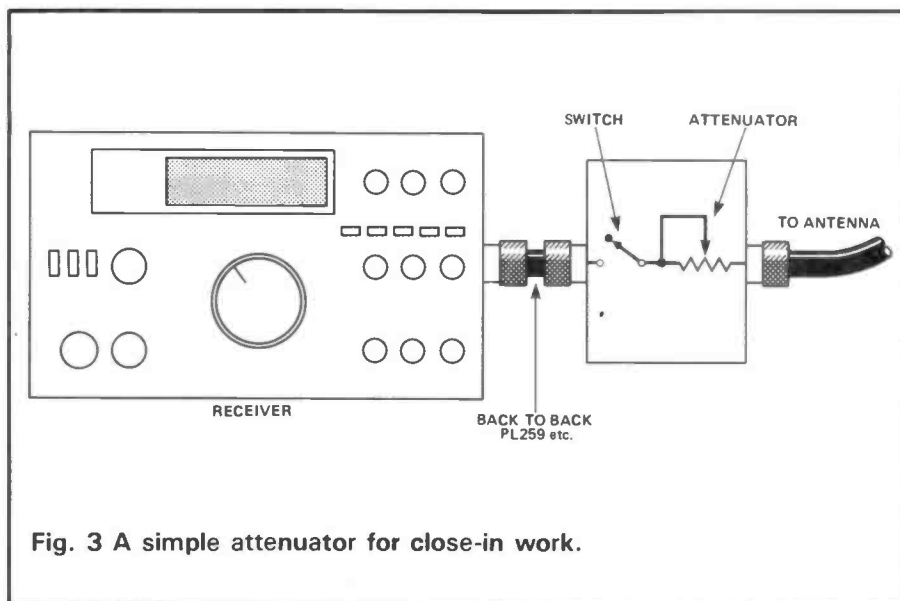

Fig. 3 A simple attenuator for close-in work.

to find an 'off air' signal. A suitable one in our area is on 1.924MHz which is nice and strong. The coil should then be carefully peaked for maximum signal and resealed in place using the old bees wax.

The signal source can now be used to calibrate the receiver so that it will be possible to find the DF fox with the minimum of difficulty. A piece of white tape on the front of the receiver is sufficient and then if the set has to be retuned onto the medium wave it can be done quickly and easily.

Once this mod has been completed the transistor radio is ready for use, out in the field it is treated exactly the same as a dipole with 'nulls' at each end of the ferrite rod.

Hints and Tips

Never try to rush the hunt, it is much better to take your time and be accurate. A few moments matching the map to the terrain and ensuring that the north point of the map is pointing north will make the transference of the beam heading easier and quicker. It will also enable the hunter to get a visual idea of the fox's likely location.

Three bearings are always better than two, and should give a triangle around the location of the fox. In hilly country try to get as high as possible for your bearings, signals do very funny things and can appear to come from very strange places. I can remember a fox being in one valley and the whole club was searching another just because the signals were bouncing off a hillside.

Keep an eye out for competitors, they may be taking bearings from a similar position. Cheat a little and try to see which way they think the fox is.

The Format

For clubs that have never tried a DF foxhunt, it does provide the chance for everyone to get out for the evening and also to have a lot of fun.

There are two ways to go about it. The first is to operate as teams with each taking bearings and passing the information to each other, keeping in contact on the air. This does however permit cheating as competitors can listen in on your comments but, this is probably the best way for newcomers to gain experience. The second way is for individuals or groups to take part using a vehicle whilst keeping radio silence. This can be done with a few 'hunters' sharing a car, especially useful if the DF rig is a permanent or bulky unit.

The latter method is much more difficult but does allow the individual to work on his or her own and is much more satisfying. It is also better if the fox does not announce that he has been found, thus keeping the remaining hunters searching.

So if you have never tried a DF foxhunt give your club a nudge. If they have only used two metres why not try one on top band, you can see how easy it is. Further information on our own club's DF rules may be obtained from the author who is QTHR — meanwhile good hunting!

HAM

International Update

Soon after the original article was published, the author was using his converted set on the FM calling frequency of 29.60MHz, when he received a telephone call. The call originated from a close neighbour

signal could be heard at approximately 27.9807MHz. Oh dear! What can be causing the generation of this unwanted frequency? For example, had the transmitter been tuned properly?

Interested in converting the Ham International to the 10m band? Roger Alban adds a few notes and updates, plus information on different rig variations.

who claimed that he could hear the author on channel 40 of his legal CB rig. After some discussion it was agreed that the probable cause of the interference problem was due to the poor design of the front end of the CB receiver. However, a few days later, the author was using the set on 29.61MHz, when an amateur living within a distance of half a mile called in on the frequency to report that he was able to receive my transmissions close to the bottom of the ten metre band. Apparently Ron, GW2DPD, was experimenting with some home-built kit to transvert from ten metres up to six metres when he accidentally came across my signal.

A detailed investigation was carried out by the author using the main station receiver. The unwanted

The S-meter on the main station receiver indicated that the unwanted signal was 50dB down on the main carrier. With a signal sniffer tee piece inserted between the set and the dummy load, the main station receiver was connected directly to the centre of the tee piece. The 29.60MHz carrier was measured to be S9 plus 55dB, and the unwanted 27.9807MHz signal was measured to be S9 plus 5dB.

On the air experiments were carried out and the author concluded that the signal was audible over a distance of one mile. However, if a high-Q aerial tuning unit was used, the signal was not audible outside the author's garden. The author was amazed how a signal of such low-level could be radiated over such a comparatively long distance: there is

something to be said for QRP rigs!

It was noticed that the unwanted sprog jumped 30kHz in frequency for every increment of the channel switch. Therefore it was deduced that the generation of the unwanted frequency was the result of an unfortunate mix of the third harmonic of the VCO frequency with other frequencies within the set; in fact the frequency of the unwanted signal was the third harmonic of the VCO less the frequency of the down-mixer crystal oscillator, F_{xtl} . The mixing action was taking place in IC2 which forms part of the amplifier for the VCO and low level mixer. There was absolutely nothing that could be done to resolve the problem except to select a new value of frequency for the down mixer crystal oscillator.

The way to solve this problem is to take one step backwards and examine closely the original design of the set manufacturer. Fig. 1 shows the frequency spectrum of all the frequencies that are likely to occur within the original design with the set tuned to channel 30 on the high band. It should be noted that the second harmonic of the down mixer crystal oscillator, $2F_{xtl}$, is at 41.11MHz, just outside the bottom skirt of the band pass filter formed by T2 and T3.

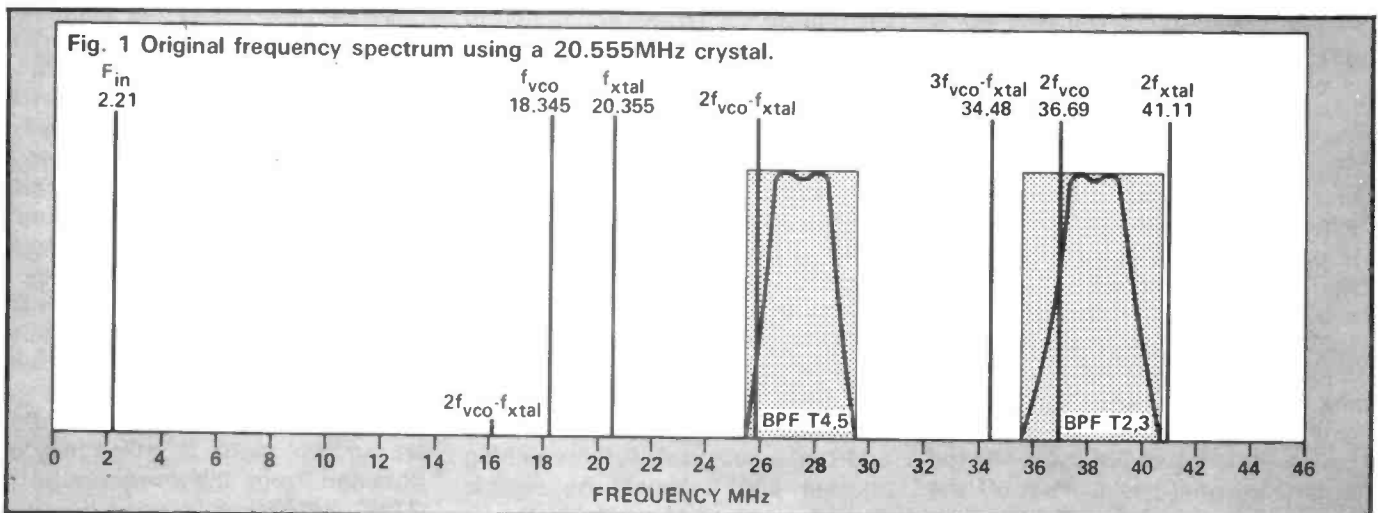

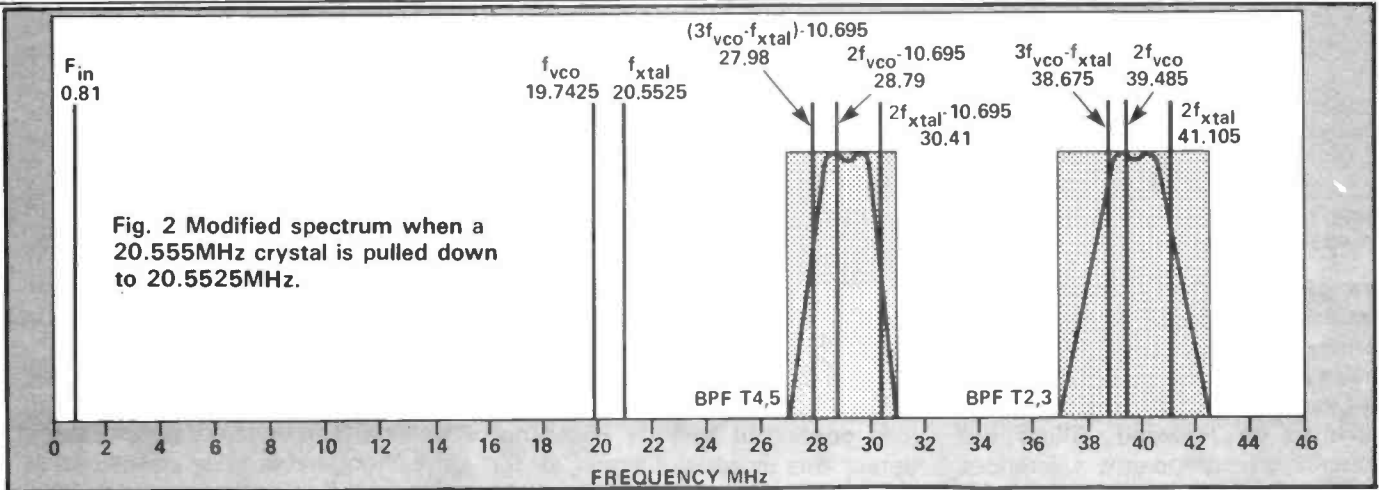

Fig. 2 Modified spectrum when a 20.555MHz crystal is pulled down to 20.5525MHz.

It is interesting to observe that the second harmonic of the VCO, $2F_{vco}$ at 36.69MHz, appears on the side-wall of the band pass filter formed by T2 and T3. Presumably this does not cause any serious effect.

The unwanted frequency which caused the trouble, generated by subtracting F_{xtl} from $3F_{vco}$, will occur in the unmodified set at a frequency of 34.48MHz, well outside the reaches of the pass-bands of the band-pass filters.

The frequency spectrum produced by the author's EPROM modification using the 20.555MHz crystal is shown in Fig. 2. A number of unwanted frequency mixes now occur within the pass-bands of the two band-pass filters. Unwanted frequencies that appear within the pass-band of the filter formed by T2 and T3 will be amplified by the pre-driver stages of the transmitter.

Also $2F_{vco}$ on channel 30 on the high band appears within the pass-band of the filter formed by T2 and T3 and results in the transmitter amplifying an unwanted frequency which at the aerial socket is only

25dB down on the carrier frequency. Also the second harmonic of the down mixer crystal, $2F_{xtl}$, is now inside the pass band of the filter formed by T2 and T3.

The answer to the problem seems to be to ensure that the second harmonic of the down-mixer crystal oscillator is just outside the high frequency end of the pass-band formed by T2 and T3, the design technique used by the set manufacturer. Unfortunately, this necessitates buying a new crystal as the old one cannot be pulled this far.

Another problem arises because the PLL02 phase locked loop chip used in the VCO has nine programme lines, P0 through to P8, which select the N used in the divide-by-N chain. The EPROM employed in the original version, a 2716, stores the programming data in blocks of eight. A lot of fancy electronics, or an EPROM with more than eight data lines (these are a bit thin on the ground) would be needed to change all the programme lines as the set is switched between channels. For this reason, the frequencies in the original version were

contrived to make the top programme line, P8, logic zero all the time, so it could simply be grounded. After a false start, it proved impossible to do this with the new frequencies required, so it was chosen to make P8 logic 1, ie. Vdd, all the time.

The upshot of this is that the author chose a down-mixer crystal frequency of 21.4775MHz, resulting in a second harmonic at 42.955MHz, just high of the T2/T3 filter pass-band. The unwanted frequency which caused the trouble, $3F_{vco} - F_{xtl}$, will now lie well outside the pass-band of the two filters. Indeed, so far as the author can see, the two pass-bands should be free from any unfortunate combinations of frequencies.

Figure 3 shows the situation graphically and Table 1 shows the frequencies used in the rig with a 21.4775MHz crystal.

The VCO will now have to vary between 17.7275 and 18.9175MHz, not very far from the range it was designed for, 17.555 to 18.445MHz. In some cases, usually those where the VCO block is covered with

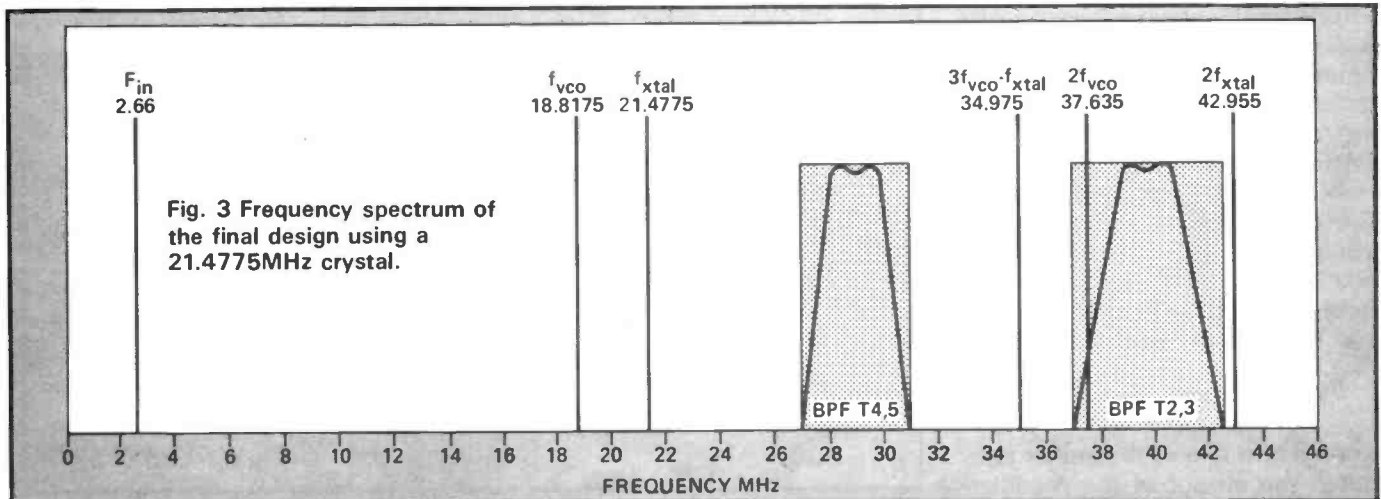

Fig. 3 Frequency spectrum of the final design using a 21.4775MHz crystal.

CHANNEL/ BAND	MHz			
	F _{in}	VCO	BPF	T _x Freq
1 LOW	3.75	17.7275	39.205	28.51
40 LOW	3.36	18.1175	39.595	28.90
1 MID	3.35	18.1275	39.605	28.91
40 MID	2.96	18.5175	39.995	29.30
1 HIGH	2.95	18.5275	40.005	29.31
40 HIGH	2.56	18.9175	40.395	29.70

Table 1. Frequency table using a 21.4775MHz crystal.

orange plastic, the VCO will function perfectly well over the new required range. In others, usually those with green plastic covering, the VCO will not operate in this range and will have to be replaced. Much will depend on component tolerances and you may be lucky with the green block or unlucky with the orange — you will not know until you try. If the block has to be replaced, the design given in the author's previous article on converting this set can be used.

From Table 1, the binary values for channels 1 and 40 on the low, mid, and high bands can be calculated and the results have been tabulated in Table 2. It should be noted that programme line P8 will remain at logic level 1, or V_{dd}, throughout the 3 bands of 40 channels. Programme lines P0 through to P7 can be connected directly to the data highway of the 2716 EPROM, as described in the previous articles.

Other than the differences described above, namely the change of down-converter crystal, the change to P8, and the possible retention of the original VCO block, the conversion method employed is exactly the same as before. To connect P8 to V_d, cut the PCB track close to pin 7 of the PLL02 PLL chip and solder a wire between pin 7 and pin 1, the positive supply to the chip, V_{dd}.

Obviously, the contents of the EPROM will have to be different. If you have already purchased the EPROM for the previously published mod, then the author will update the contents to the new data for you if you return it to him with £1 to cover the costs. Alternatively, new EPROMs with the appropriate data pre-programmed are available for £8.50. If you want to programme your own EPROM, you can obtain a copy of the data by sending a stamped addressed envelope to the Ham Radio Today editorial office.

Final Tests

As a final check, the author connected the output of the modified

set to the input of the main station receiver using a signal sniffer tee connector. The transmitter was keyed on channel 30 on the high band, 29.60MHz, into a 50 ohm dummy load. The main station receiver was tuned from just below 28.0MHz up to 30.00MHz and a low level unwanted signal was detected on a frequency of 29.5125MHz. It was estimated that this unwanted signal was at least 50dB down on the carrier. Air tests carried out with Ron GW2DPD living within half a mile confirmed that he could not detect this unwanted signal, or for that matter any other unwanted signals.

Further investigation revealed that the unwanted signal was produced by leakage of signal from the VCO, operating at a frequency of 18.8175MHz, finding its way into the input of the transmit mixer and being added to the 10.695MHz signal to produce the unwanted frequency of 29.5125MHz. Some models of the Ham International sets (such as the Trystar 777) contain a screen partition to separate the VCO from the mixer circuitry. It would therefore appear that the set designer was aware of this problem as it will be potentially worse on the unmodified design. If you should find that this unwanted signal is being radiated at an unacceptable high level, then you will need to screen the VCO from the transmitter mixer IC.

Roger Bleep

Some readers have enquired regarding the finer points concerning

the modification for the various models of Ham International which were not covered in detail within the original article. For example, the Multimode 11 and other models have a roger bleep sub-PCB. Obviously this facility will not be required on ten metres. The roger bleep circuitry was found inside the Multimode 11 on a separate sub-PCB with six wire-wrap terminals, as illustrated in Fig. 4.

The transmit contact of the press-to-talk switch will ground terminal 3 on transmit, which causes the change-over relay connected to terminal 5 to become energised. When the press-to-talk button is released, the sub-PCB circuitry holds the change-over relay energised and also outputs an audible tone on terminal 1 connected to terminal 27 on the main PCB microphone circuitry. The roger bleep circuitry is fed directly from the 13.8 volt supply via terminal 2 on the sub-PCB.

To remove the roger bleep circuit from the set, it will be necessary to disconnect all five wires from the roger bleep sub-PCB. Connect together the wires which were connected to terminals 3 and 5 and cover the ends of the three remaining wires using insulating tape. The sub-PCB can now be removed from the set and discarded. This modification has now connected the transmit contact of the press-to-talk button directly to the change over relay which will be energised only when the microphone button is pressed.

If you find that you have a Ham International model which has the

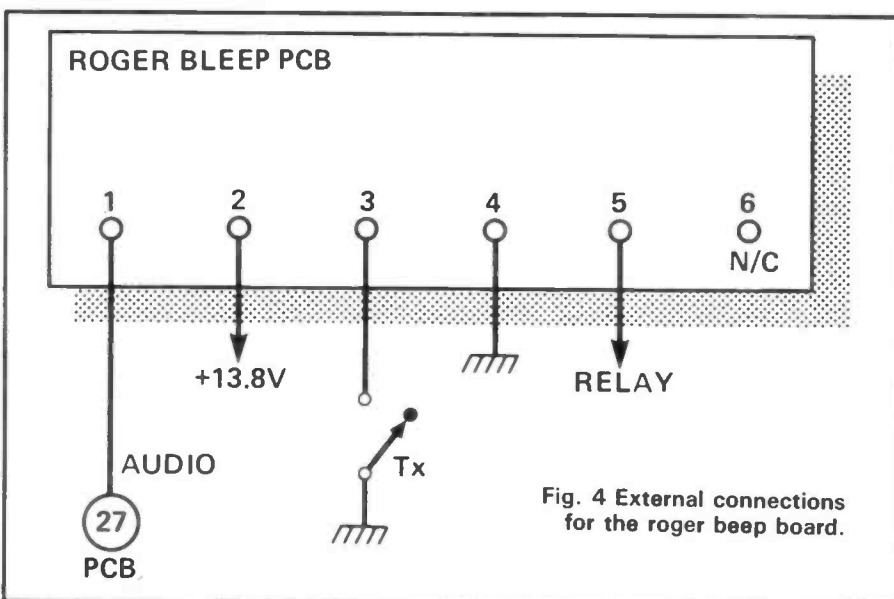

Fig. 4 External connections for the roger bleep board.

CHANNEL/ BAND	BINARY VALUE	256	128	64	32	16	8	4	2	1	HEX	
		P8	P7	P6	P5	P4	P3	P2	P1	P0		
1 LOW	375	1	0	1	1	1	0	1	1	1	7	7
40 LOW	336	1	0	1	0	1	0	0	0	0	5	0
1 MID	335	1	0	1	0	0	1	1	1	1	4	F
40 MID	296	1	0	0	1	0	1	0	0	0	2	8
1 HIGH	295	1	0	0	1	0	0	1	1	1	2	7
40 HIGH	256	1	0	0	0	0	0	0	0	0	0	0

Table 2. Program lines logic table for a 21.4775MHz crystal.

roger bleep facility but does not contain the sub-PCB, this is likely to be a set which contains the PTBM121D4X PCB. This main PCB is very versatile. The author found that the Ham International High Gain 5 model contained a main PCB numbered PTBM121D4X which was fully populated with the components to provide the roger bleep facility.

To remove the roger bleep facility from such sets it will be necessary to remove the audio oscillator transistor Q43, located on the component side of the PCB near to the centre of the board, and the time constant capacitor C207, which can be found in the same proximity as Q43. You should now find that you have completely removed the roger bleep facility.

Transmit Tuning

A number of readers have experienced difficulty in tuning the transmitter section of the set. It is important to set up the two band-pass filters correctly. The author in his earlier article suggested tuning the two band-pass filters for maximum recorded output power with the set tuned to channel 20 on the mid-band. Without extreme care, method of tuning can lead to the band-pass filters not being correctly tuned.

The method of tuning recommended by the set manufacturer is as follows: With the set tuned to channel 1 on the low band, adjust T3 and T5 for maximum output signal on transmit. Then switch the set to channel 40 on the high band and adjust T2 and T4 for maximum output signal. Repeat this procedure until there is no further improvement. Next tune the set to channel 20 on the mid band and adjust L11, L12, L13, and L14 for maximum output power.

If you have tuned the transmitter correctly you should now find that you will have within 3dB even out-

put power over the frequency range from channel 1 on the low band through to channel 40 on the high band. This transmitter tuning procedure is intended for models with the printed circuit board numbers PTBM059COX and PTBM121DAX.

If you own a set with the main PCB number PTBM125AX, such as a Lafayette 1800 or Colt 1600DX, then you will find that the two band-pass filters comprise of T1 and T2, and T3 and T4. The tuning procedure will be to adjust T2 and T4 on channel 1 on the low band and adjust T1 and T3 on channel 40 on the high band. The remaining tuned circuits of the transmitter comprises T5, L13, L15, and L16 which should be tuned for maximum output power on channel 20 on the mid band. The transmitter section of the set should now be fully tuned.

Receiver Tuning

Again, a small number of readers have experienced problems in tuning the receiver front end. The tuning procedures will again vary slightly depending upon the PCB number you have in your set.

For example, if you own a Colt 1600DX which contains the PCB number PTBM125AX, you will experience difficulty in tuning T9. To solve this problem T9 will have to be unsoldered and removed from the PCB; remove the screen can to obtain access to the 82pF internal tuning capacitor. With the aid of a sharp knife carefully cut the internal tuning capacitor leads and remove it. Replace the screen can and resolder T9 back onto the PCB. A 68pF capacitor should be soldered onto the track side of the PCB to replace the internal tuning capacitor. With a signal generator tuned to 29.10MHz and the set switched to channel 20 on the high band, tune T8, T9, and T10 to obtain a maximum S-meter reading.

However if you should own a

Ham International set containing either the PTBM059COX or the PTBM121D4X, such as the Ham Major or Trystar 747 models, the receiver tuning procedure will be slightly different again. You will experience difficulty in tuning T7 and T8; T7 should be unsoldered and removed from the PCB. Carefully remove the screen can. Inside the screened can you will find a small ferrite pot core. Remove this pot core and resolder the coil former back into the PCB making sure that it is perpendicular to the PCB. Carefully replace the screen can to ensure that it is positioned such that the coil former is in the middle of the screened can and resolder the two earth lugs of the screen can back into the PCB. T8 should be unsoldered and removed from the PCB. Remove the screen can and locate the internal tuning capacitor. This capacitor should be removed from the coil former in the manner described earlier. Resolder T8 back onto the PCB and solder a 68pF capacitor onto the track side of the PCB to replace the internal tuning capacitor. Again, the set should be tuned with a signal generator tuned to 29.10MHz with the set tuned to channel 20 on the mid band.

With the signal generator connected to the set it is worth while checking the calibration of the S-meter. Adjust the signal generator to provide an output of 100uV. The S-meter should now be reading S9. If not, you will need to adjust the internal pre-set RV8 for the PTBM125A4X PCB, or RV7 for the PTBM121D4X PCB, and RV6 for the PTBM059COX PCB.

General Adjustments

The vast majority of sets obtained by amateurs for conversion onto the ten metre band have come from the secondhand market where the pedigree of the set is unknown. A few readers have obtained sets which have either been abused, mistreated by a so-called rig doctor, or the lid has been removed by the previous owner and the various pre-set controls adjusted in the vain attempt to improve the performance of the rig. Out of the twelve sets purchased by the author, one-third had suffered some form of mistreatment.

To readjust the set you will require the following test equipment:

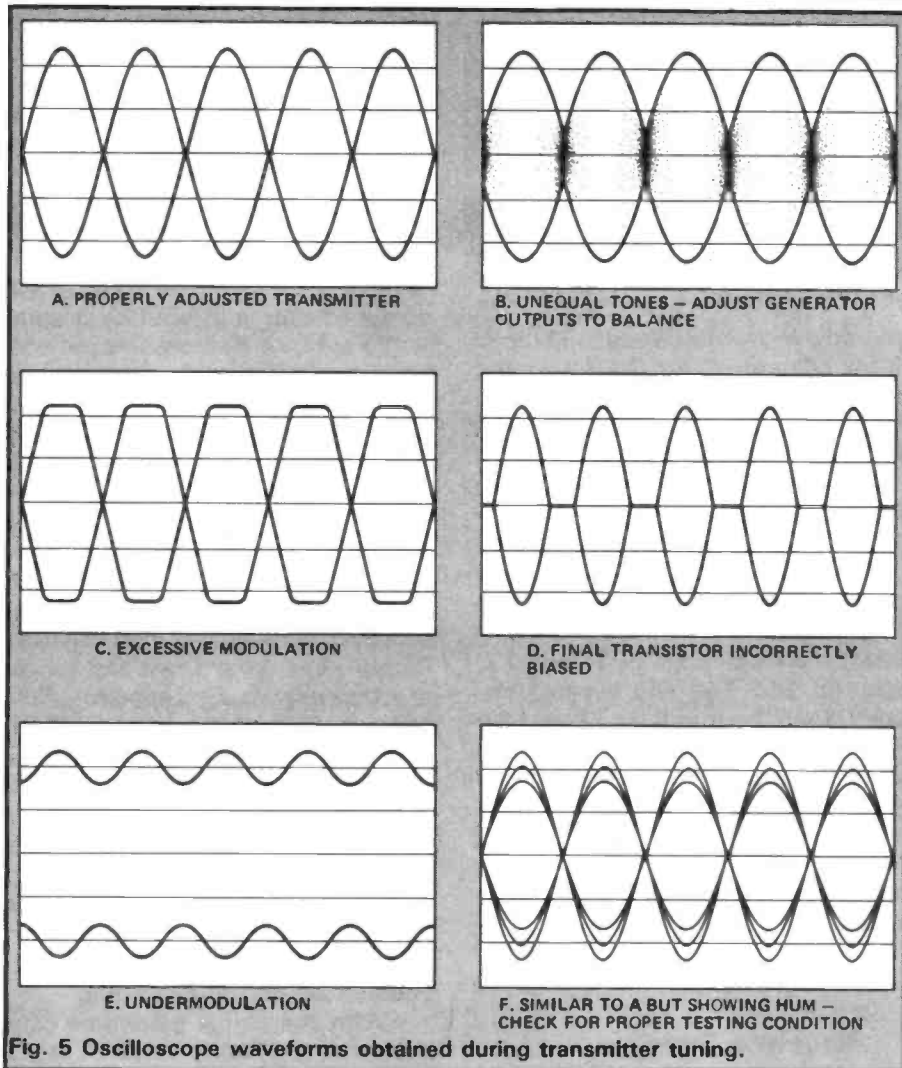

Fig. 5 Oscilloscope waveforms obtained during transmitter tuning.

- A 50 ohm, 20 watt resistive dummy load;
- A frequency counter capable of operating up to 30MHz;
- A HF signal generator capable of operating between 50kHz up to 60MHz;
- An oscilloscope capable of working up to 20MHz;
- Two audio signal generators capable of operating between 10Hz up to 20kHz.

It is wise to check the performance of your Ham International rig before you start the conversion to ensure that it is operating correctly. However, if you have completed the conversion, and have discovered that the set does not perform correctly, you will have to carry out any re-adjustments on ten metres. It should not be necessary to repeat the tuning procedures previously given in the author's earlier article for the tuning of the PLL circuitry.

If you find that the quality of the transmitted SSB leaves a lot to be desired, it is likely that some of the

pre-set controls have been tampered with. The control most often tampered with is the PA bias pot which will upset the linearity of the transistor PA. To readjust this pre-set you will have to inject two audio tones into the microphone socket and observe the shape of the RF output on an oscilloscope sniffing part of the transmitted signal. Feed 500Hz and 2400Hz audio tones into the microphone socket simultaneously. Adjust the output levels of the two audio oscillators to obtain the oscilloscope waveform as shown in Fig. 5a when the set is transmitting in the SSB mode. If the two audio tones are not balanced then the waveform shown in Fig. 5b will be obtained.

When you have obtained the correct balance in tones disconnect the two generators from the microphone socket and check the adjustment of the balance modulator for minimum leakage of carrier. The main station receiver may help you here. On the PTBM059COX PCB adjust

VR4 and VR5, or on the PTBM121D4X adjust VR5 and VR6, or on the PTBM125A4X adjust VR5 to obtain minimum leakage of carrier.

Reconnect the two audio oscillators and check that the audio feed to the balanced modulator is at the correct level. If you find that the shape of the waveform shown on the oscilloscope has flattened peaks as illustrated in Fig. 5c, then you should reduce the audio level being fed to the balanced mixer. On the PTBM059COX, adjust VR12, and on the PTBM125A4X adjust VR6 to obtain the correct waveform. If the audio level entering the balanced mixer is too low then you are likely to see the waveform shown in Fig. 5e. To obtain the correct waveform as shown in Fig. 5a, you will need to adjust either VR11, VR12, or VR6 depending upon the model of set you happen to own.

As mentioned earlier, probably the most common form of mal-adjustment will be with the PA bias pot. This is because if the "rig doctor" has changed the PA transistor, he will probably have adjusted the bias pot, mistaking it for a control which alters the RF output power. If you find the waveform shown in Fig. 5d, then you have a bias problem and will need to adjust VR1 on the PTBM059COX PCB or VR2 on the PTBM121D4X PCB and PTBM125A4X PCB to obtain the correct shaped waveform. If you should find the waveform shown in Fig. 5f you probably have some mains hum on the input signal to the microphone socket and will therefore need to check the audio oscillator outputs for hum or for a loose lead.

Another pre-set often tampered with is the adjustment for the deviation level when the set is used in the FM mode. With the set switched to the FM mode, key the transmitter and apply 2400Hz audio tone to the microphone socket at a level of 10mV. With a deviation meter connected to the aerial socket of the set, adjust VR3 on the PTBM059COX PCB, or VR1 on either the PTBM121D4X or PTBM125A4X PCB to obtain 1.5kHz deviation.

If you suspect that the receiver is not as sensitive as it should be then someone has possibly altered the adjustments of one of the tuning cores. Connect a signal generator to the aerial socket of the set. Adjust

the signal generator to operate on a frequency of 29.10MHz modulated by a 1kHz audio signal to a level which produces 30 per cent modulation. Set the transceiver to channel 20 on the mid band and adjust the output of the signal generator to an audible low level to avoid any AGC action that might occur during the alignment procedure. Now adjust the tuning cores of T7, T8, T9, T10, T13, T14, and T15 for maximum audio output across the speaker with the set switched to the AM mode. The set should now be functioning correctly and be ready to use on the air.

Conclusions

The author's modified Multi-mode II has worked very well from the home QTH. A large number of DX contacts have been obtained both on FM and SSB, with the assistance of a 50 watt linear amplifier feeding a home-made quarter wave vertical antenna with four radials. The lesson learned in rearranging the frequency of the down-mixer crystal oscillator has stopped the author from proceeding with the design of

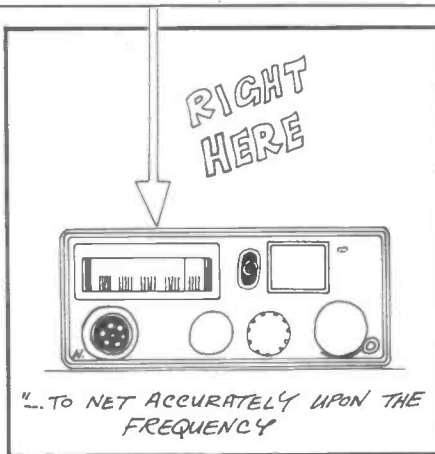

a six metre modification utilising the existing EPROM. However, a suitable frequency for the down-mixer crystal oscillator has now been chosen using the criterion described earlier which does not cause the set to generate any unwanted frequencies. It is hoped that the design will be finalised shortly and will be the subject of a future article relating to the modifications of the Ham International series of sets to operate on the amateur bands.

If you do not have the facilities to blow your own EPROM, you can still proceed with the modification

and obtain a ready blown EPROM from this magazine by enclosing £8.50 which includes the cost of postage and packaging. When ordering, please make your cheque or postal order payable to C.B. Alban and send your order to Roger Alan, c/o Ham Radio Today, 1 Golden Square, London W1R 3AB.

Finally, I would like to wish you the best of luck with your set conversion and look forward to working you on ten metres.

Unfortunately, the issues containing the original article are now out of stock; however, photocopies of the articles can be obtained from our photocopies service, at a cost of £1.50 per article. You should state that you want photocopies of the 'Converting the Ham International Series to 10m' article(s) from the December 1985 and/or the January 1986 issues, as appropriate, and send your order to: Ham Radio Today Photocopies, 1 Golden Square, London W1R 3AB. Cheques or postal orders should be made out to Argus Specialist Publications Ltd, and please allow two weeks for your order to be dealt with.



FABULOUS SONY AIR-7 MONITOR

AM 150KHz-2194KHz AM 108-136MHz
WFM 76-108MHz NFM 144-174MHz

The new Sony Air-7 is a superb new monitor having features so far unmatched in a single hand-held monitor by any other manufacturer. Its frequency coverage makes it ideal for airband, public service or marine band monitoring, plus normal domestic use. Highly sensitive, this receiver does everything you could ever desire in one package. The LCD digital display means clear frequency display even under bright illumination and the PLL circuitry ensures drift free reception. Frequency is selected by keypad entry or electronic tuning and there is provision for disabling the keyboard. 10 memories are provided for each of the 4 main ranges (40 in total) and comprehensive scanning is provided in the bands 108-174MHz. Either full band or memory scanning is possible at a rapid rate. Additionally, delays may be programmed into each memory channel, certain channels only may be scanned and any channel can be designated the "priority" channel. Accessories include BNC helical, battery cartridge shoulder strap etc. Options available: rechargeable battery cartridge £15.95; Mains PSU/charger £13.

£249

THE COMPLETE VHF/UHF FREQUENCY GUIDE 26MHz-2.25GHz!

- ★ MARINE CHANNELS
- ★ CIVIL & MILITARY AIR
- ★ POLICE, FIRE, AMBULANCE
- ★ SPACE VEHICLES
- ★ HAM RADIO REPEATERS
- ★ UHF TV CHANNELS
- ★ FULL DUPLEX DETAILS
- ★ PMR
- ★ RADIOPHONES

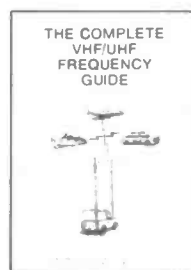

£4.95
p&p 70p

The book that every VHF/UHF listener should have beside him! Don't waste time hunting around in the dark. This guide will take you quickly and efficiently to the frequencies that interest you. Everything is listed including: MARINE, CIVIL & MILITARY AIR, POLICE, FIRE, AMBULANCE, SPACE VEHICLES, AMATEUR RADIO REPEATERS, FULL DUPLEX FREQUENCY INFORMATION, PMR CHANNELS, RADIOPHONES, CELLULAR RADIO etc. Now that's value for money! Beware the expensive American imports. This is designed for the UK listener. Order your copy today.

PANASONIC DR-B600 COMMUNICATIONS RECEIVER

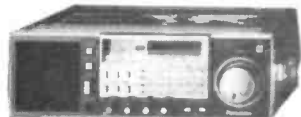

150kHz-30MHz AM/USB/LSB/CW £459
(Send for brochure) FREE DELIVERY

A receiver for the enthusiast who wants a modern high performance base unit. Beautifully built by Panasonic for the DX-er. 150KHz-30MHz USB/LSB/AMW/AMN/FM (87.5-108MHz). Features include S-meter, Fast/slow tuning, 10 memories, scanning, Rf gain, bass & treble controls, dial lock, and digital readout to 100Hz. Runs from 110/240c Ac or 12v Dc plus internal batteries. A high class communications receiver at a very competitive price. Send for brochure.

"POCKET" COMMUNICATIONS RECEIVER! SONY ICF7600D



150KHz-30MHz AM/SSB

Undoubtedly the best compact portable available for serious short wave listening. Complete coverage 150MHz-30MHz without gaps. Good SSB reception plus AM and FM broadcast (78-108MHz). Digital display, 10 memories, built-in timer/clock, Ac mains (110/240v PSU), etc. etc. You will be amazed at its performance. Definitely not a toy, but a purpose designed pocket communications receiver. Ideal for listening to the 80m ragchews or 20m Dx whilst at the office, hotel etc. Supplies with every conceivable extra including case, antenna, and free broadcast frequency list. Act now before price increase!

£169

NEW

NEW 1987 EDITION VHF/UHF AIRBAND FREQUENCY GUIDE

£5.95
p&p 70p

118-400MHz PACKED WITH GEN!

Just published this is the UK's foremost list of military and civil frequencies. Nearly three times as much information as the 1986 issue and right up to date. Every conceivable airfield is listed from the smallest grass strips to the major civil airports. Also now included are full airways listings plus helipads and North Sea rigs. In addition there are listings of company frequencies, VOLMETS and miscellaneous air band frequencies. For the newcomer there is some interesting editorial text plus a very useful telephony designation list. Full colour semi-stiff cover plus illustrations and nearly 100 pages packed with information. Undoubtedly the best specialist publication available in this field.

STOP PRESS! AVAILABLE EARLY APRIL: 4TH EDITION UK CONFIDENTIAL FREQUENCY LIST

The new 1987 edition of this well respected publication. Much expanded and completely updated. It guides you through the complete spectrum 1.6-30MHz. Listings include shipping, aircraft, military, RTTY news and embassy, FAX broadcasts, AM broadcast etc. £5.95 p&p 70p

WATERS & STANTON

RETAIL & MAIL ORDER:- 18-20, Main Road, Hockley, Essex SS5 4QS.

Tel: (0702) 206835, 204965

RETAIL ONLY:- 12, North Street, Hornchurch, Essex RM11 1QX.

Tel: (04024) 44765

Visa and Access by telephone. 24hr. Answerphone.

SARDINES ON TWO

In many conurbations in Britain the occupancy of the FM segment of the 2-metre band has now reached saturation proportions. At peak evening hours it is often difficult to find a clear frequency on which to carry on a QSO — a fact which the disbelieving lucky ones in less populous areas should hear for themselves next time they are visiting a big city with a high density of hams in it.

A few thoughts from Jack Hum, G5UM, on methods for tackling the increasing problem of QRM on 2m FM

Current FM channels in the 2-metre band are spaced 25kHz from one another, that is, S20 or 145.5MHz is 25kHz above S19 at 145.475kHz and 25kHz below the 'next one up', S21 at 145.525MHz. If you think about it for a moment, you will soon come to the conclusion that to have 25kHz spacing is a prodigal waste of the spectrum available to us in the 2-metre band. Just *how* wasteful is apparent if you look at the situation at the low end — the ssb end — of Two. Transmissions there are no wider than the audio waveform generated by the human voice, say 3½kHz. Let's be generous and admit to 5kHz to allow for those over-processed transmissions sometimes to be heard, and particularly that very loud station down the road which *sounds* as if it might be occupying that order of bandwidth but probably isn't.

Yes, you can see what we're coming to, and that is the conclusion that you could fit *five* ssb transmissions even at a generous 5kHz width, into the space occupied by *one* FM transmission, and even more than that if you accept that most J3E emanations don't much exceed 3½kHz in width. In practice, very many more than five ssb transmissions can be accommodated into 25kHz because a lot of them are not audible where they are not wanted simply through the use of directional antennas that put the signal where it *is* wanted. This means that a 10 watt station in Yorkshire beaming south will not be heard except under very anomalous conditions by a station, say, in Suffolk who is beaming east.

This is not to suggest that we should do away with all FM transmissions and replace them with single sideband. Although such an operation would make better use of the frequency allocation we enjoy, it would remove one of the special delights of FM communication, and that is the superb audio quality

which it delivers. There is as it happens another means of providing more space in the crowded, FM, part of Two and that is to make the transmissions only 12½kHz in width instead of the present prodigal 25kHz, thus doubling the number of channels you have available to use on the F3E mode. But to suggest changing over to 12½kHz spacing is a counsel of perfection at a time when perhaps 30,000 hams are getting on quite well with the present 25kHz spacing and see no need to make the change. Their FM talks around corners satisfactorily — just as many remember from the CB days — in spite of the overwhelming QRM they often experience. Take note of the phrase 'overwhelming QRM': we'll come back to it in a moment.

From what has been said it should be clear that occupying 25kHz when 12½kHz will do is, to put it mildly, selfish. But the realism of day to day amateur radio operations compels the thought that 25kHz spacing will be with us for a long time yet, if only because of the cost of conversion. To change a typical transceiver to 12½kHz would, according to one authority cost about £20. Another — more realistic guesstimate — is around £80 if you take into account the needful components plus skilled technician's time (this assumes that the majority of black box users among the 30,000 mentioned above will prefer not to tamper with the insides of their transceivers).

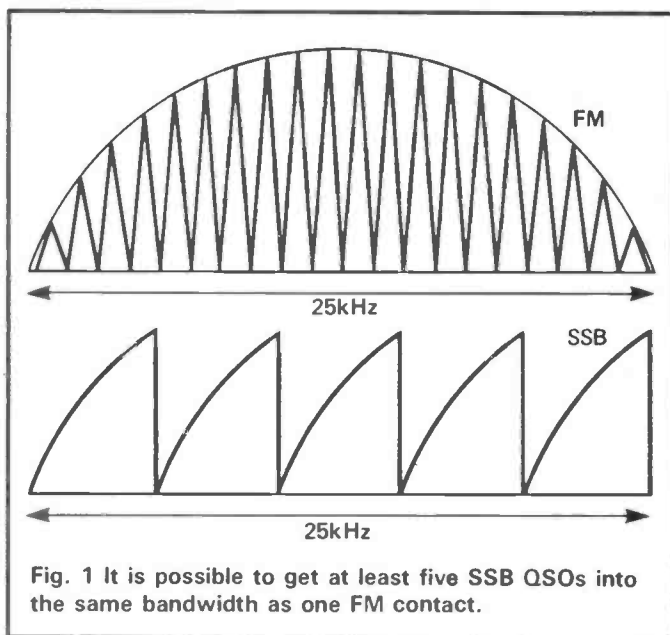

Fig. 1 It is possible to get at least five SSB QSOs into the same bandwidth as one FM contact.

Even though you may not wish to put your head inside the box you may well feel a head-in-the-sands attitude suffusing you that prompts you to brush off 12½kHz spacing as something not likely to happen to you for a very long time, if at all. Be not so assured: less prodigality of our available spectrum *must* come, and this means eventually 12½kHz spacing for FM channels, maybe not within the present decade but certainly in the fullness of time. Already some of the major importers can see it on the horizon and are offering rigs with a '25 to 12½' position on them. As soon as these gain a firm hold on the ham market it is clear that existing rigs without the 12½kHz facility will suffer a rapid depreciation.

But that, as we say, may not be within the present decade (yet possibly it might: be warned). So what can FM operators do *now* to combat that overwhelming QRM referred to just now? They can do several things, of which two are so obvious and have so often been aired on this page that one is diffident about trotting them out again. It is worth doing so because of the many new licensees who have appeared on the scene but who may not have read the options before.

Right: here they are, then:

Better antennas

Much of that overwhelming QRM is caused by stations (sadly a majority) who radiate their transmissions in all directions and not just in the wanted one, by means of one of those all too ineffective omni verticals which allow all too easy start-up on Two. If the use of 25kHz is selfish as I have suggested then so is the use of antennas that waste 75 per cent of the RF offered to them, at the same time causing needless QRM to other band users. Even more selfish is the practice of piling on the power in order to blast through (another bad old tactic from the CB days) when the use of an effective aerial will allow your signal to make an impression at much lower cost and much greater social benefit to other occupants of the band.

Accepting the reasoning behind the need for a directional aerial, many FM users will ask: should it be vertical or horizontal? The reality of the situation suggest that vertical polarisation should be employed because nearly all FM users on Two are already vertically polarised. And so of course are repeaters and mobile installations; all of which suggest the use of a vertical beam at the home base, such as one of the 4, 5 or 8 element designs obtainable over any supplier's counter, together with an appropriate rotator.

Another question which FM users ask is: 'What is this horizontal FM movement I have heard about?'. Answer: it is a laudable attempt to persuade operators to adopt gainy antennas functioning in the horizontal mode to put the signal where it is wanted. If while you are improving your antenna system you are able to buy and erect a horizontal antenna on your mast, carrying the vertical beam, then do so. You will be able to talk with horizontal FM-users and, if

you have a multi-mode rig, talk with sidebanders down at the bottom end of Two where 'horizontalis' prevails.

But if you don't want to put up a horizontal and if you are predominantly a user of FM, you will lose little with vertical, for there is little to choose between the horizontal and vertical polarisations. The small extra attenuation which occurs in the vertical mode, simply because most artefacts on the earth's surface are vertical, like church steeples and factory chimneys, is minimal and not likely to be noticed by the average operator accustomed to high level,

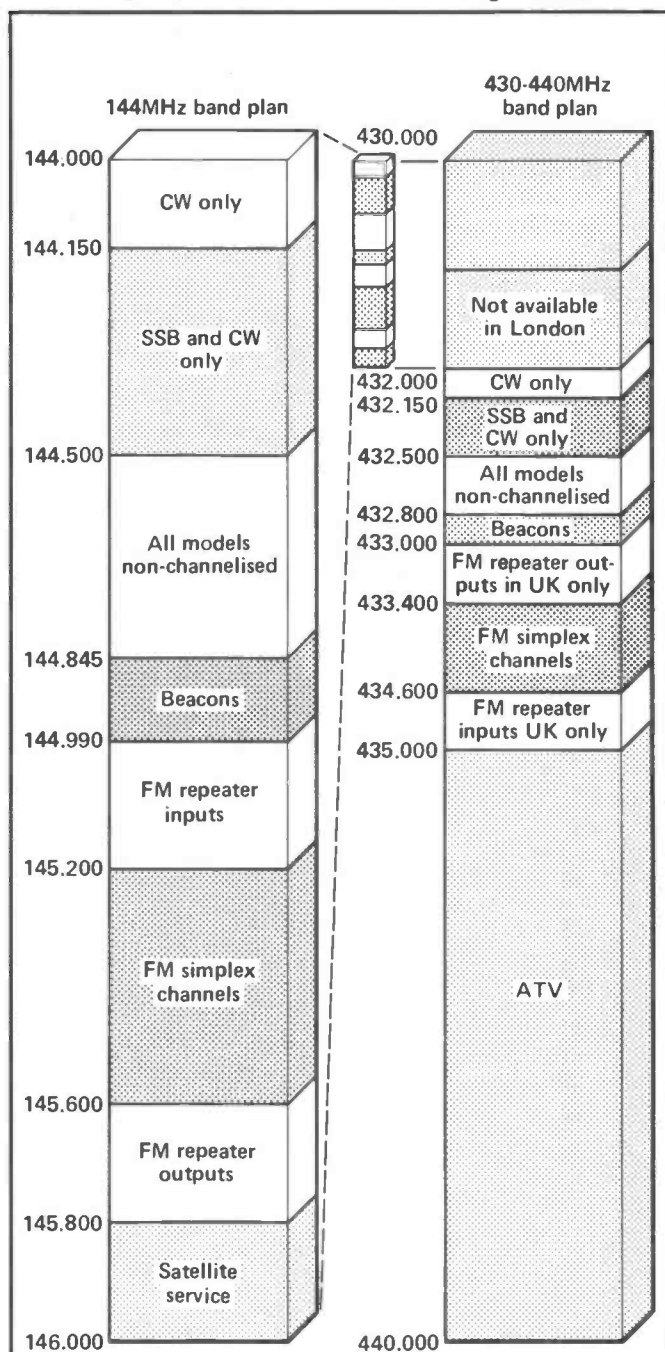

Fig. 2 If HF operators think that 2 metres is spacious, just compare that with the space available on 70cms. As the small column shows, the entire 2m band will fit inside the 70cm allocation five times over — use it or lose it!

reasonably local signals.

Result: much less QRM from the operator down the road when you turn your vertical beam off him.

Spread out a bit

So much for the first of the two alternatives suggested above. What is the other one? Answer: simply to spread out a bit and to use FM in that area below the beacon segment but above the ssb area, avoiding of course the special allocations and spot frequencies which occur here. Regrettably, emissions have been heard from thoughtless FM operators perhaps ignorant of the 2-metre band plan who QSY to frequencies in the beacon part of the band, or even in the ssb part. 'I couldn't hear anybody there so I thought it was safe to go there' is the plaint heard. It isn't, you know!

Spreading out on Two is only a partial palliative to the increasing QRM situation; a far better one is not to use Two at all! Yes, here it comes: you've seen it before on this page if you are a regular reader, and it may be expressed in three words: QSY TO SEVENTY.

How the legend got around that 70cm is quiet we wouldn't know. There are as many repeaters (probably more: we haven't counted them up lately) on Seventy as there are on Two. In turn they stimulate a lot of simplex activity, far more than you

might think. The QRM level is far less than on Two and there is an immense amount of space to move to if you should find all the available SU channels filled up. You can go below the beacon band of 432.8 to 433MHz and enjoy contacts uncluttered by QRM and of superb audio quality.

As has been urged here before, use an adequate antenna when you start on Seventy. Remember that a quarter-wavelength is only six inches at 433MHz and *that* doesn't have much radiation capability even if you stack it with additional quarter-wave units. Yagi antennas with five to eight elements for 433 are available in profusion and have the great advantage of being almost invisible when erected.

Just as on Two, an adequate antenna on Seventy is equivalent to buttoning a power amplifier on to your rig. Just 1W to its base will work wonders — and the signal will be directed at your target and not splattered all around the compass. So when you next hear the comment that '... there's no life on Seventy' counter it with the reply that activity begets activity, and that if you don't send a signal you won't get an answer.

If only half the 2-metre nets to be heard in most conurbations were to be transferred to Seventy, the QRM situation would itself be halved overnight. Most 2-metre nets at high level FM are so close packed geographically that if they were to be transferred to Seventy the difference in signal levels would be barely noticeable. Try it and hear!

PROFESSIONALS AND DISCERNING
RADIO AMATEURS ALWAYS CHOOSE**ALTRON**THE TOWER
PEOPLE

COMPACT LATTICE TOWERS—SLIMLINE TUBULAR MASTS

Telescopic—Tiltover, Fixed—Mobile from 3M to 60M.
Over 50 Models, suitable for a wide range of civil and military applications such as:

- Radio Communications
- Amateur Radio
- CCTV and Surveillance
- Meteorological Monitoring
- Aero & Marine Nav Aids
- Flood Lighting etc.

Purpose designed using 4.5m and 3m section modules for low retracted heights and cost effective shipping. Engineered to B.S.I. standards and hot dip galvanised to BS729 for protection. Wind loads are based on BS CP3 CHAP V PT 2 1972 for wind speeds up to 100mph/160kph.

RELIABILITY—QUALITY—KNOW HOW.
SEND S.A.E. FOR FULL DETAILS.

WE DESIGN—WE MAKE—WE SELL—DIRECT. No Middle Man.
At manufacturers prices—you get best value.

ALSO SPACE SAVER 3ele 4 BAND AQ6-20 BEAM
169-00 + 7-00 CARR.

Stock items normally sent within 7 days:
HP TERMS AVAILABLE

ALLWELD ENGINEERING

Factory 6, 232 Selsdon Road,
South Croydon, Surrey, CR2 6PL
Tel: 01-680 2995 (24 hr) 01-681 6734

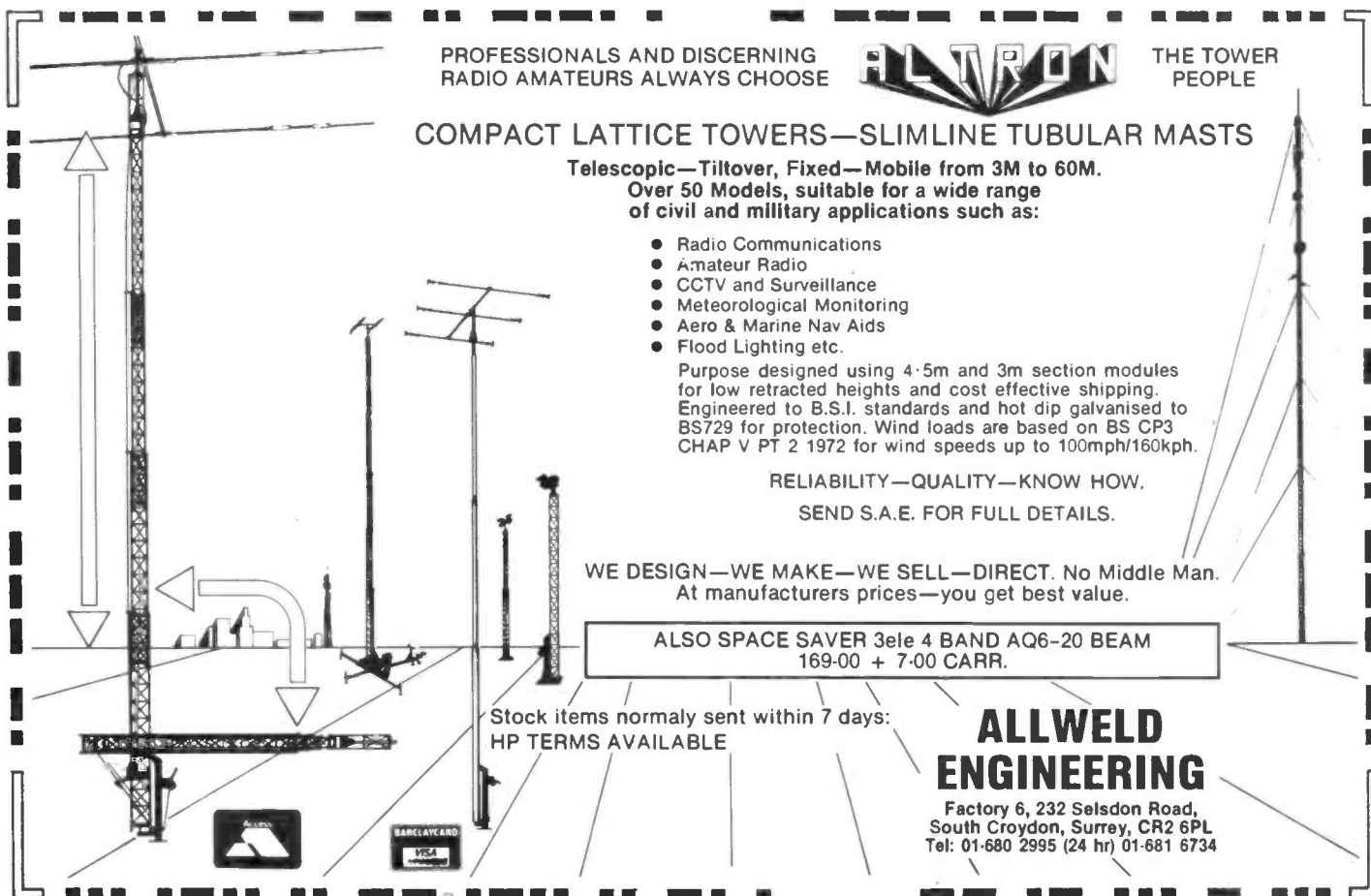

MAKE MOBILING SAFE

50% of UK amateurs have a mobile set installed, a few use HF but the vast majority operate on VHF/UHF FM for it's simplicity and safety.

because there are some accidents that are difficult to avoid, such as those due to an unknown mechanical defect; however these

operating a radio. Car manufacturers take a lot of trouble to make driving their cars as easy and safe as possible. This is done firstly by minimising the eye travel distance required between instruments and windscreen (Fig. 1), so you need take your eyes off the road for as little time as possible.

Secondly they position major safety controls such as those for lights, windscreen wiper, and heated rear window within easy reach (Fig.2) and make them large enough to be operated by touch only. Thirdly, they reduce the number of hard projections in the passenger compartment as far as possible to prevent body damage in the event of a collision; you should be wearing a seat belt but your arms, leg and head can still move violently.

All this careful planning and manufacture is then ruined if you fit a mobile transceiver with its flashing lights and projecting mic plug and knobs under the dashboard, where it can't easily be seen (but where you can hit it with your knee) together with a curly lead draped over the steering wheel!

Mobile Microphones

This topic is the current source of many heated discussions between mobile operators on the air, with arguments for an against, so I shall try to be as factual as possible. It is widely reported that the new edition of the Highway Code will make specific mention of hand-held microphones and car phones, with regard to their use stopping a driver from being in full control of the vehicle or paying the fullest possible attention to the road. The Highway Code is *not* the law, but being in 'proper control' of your car is covered in the 1978 Regulation 119 Motor Vehicle (Construction and Use) HMSO document, and this can be (and indeed already has been) acted

Mobile radio may be fun, but just how safe is it in today's traffic conditions? Chris Lorek, G4HCL, has been looking at the situation, the statistics and some solutions.

However, if you operate mobile, are you endangering the lives of innocent people, as well as your own, by using your installation? Consider the following:

In a QSO with a nearby station established on a local repeater, the operator suggests 'going simplex';
1) Operator looks down to flick switch(es) to listen on input;
2) Goes back to repeater output, tells QSO partner to find clear simplex channel;
3) QSY to S21, OK?
4) Thinks . . . S21, that's 145.525, lack of concentration on driving;
5) Now, I'm on R6, so look down, tune to 145.525, now I've got to switch in the +5kHz offset, where's that? . . . why can't they hear me, oh I'm still transmitting - 600kHz so the display shows, find the simplex/repeater shift, there we are . . . BANG . . . sorry officer, I was operating my radio.

Does this sound typical to you? It applies to many people, but they often don't realise it. Another cause for concern is the army of one-handed drivers who practice holding a fist-mic while changing gear and steering with their free elbow rather than dropping the mic for a moment.

Causes Of Accidents

The reasons why people cause accidents are many and varied, but 'not paying due care and attention' could cover the vast majority of cases. I say *cause* rather than *have*

are in the minority, most accidents being caused by human error.

Distractions from your ability to concentrate on the road ahead include looking at instruments such as your speedometer, watching out for signposts or looking at advertisements at the side of the road, talking with passengers, lighting a cigarette, and of course

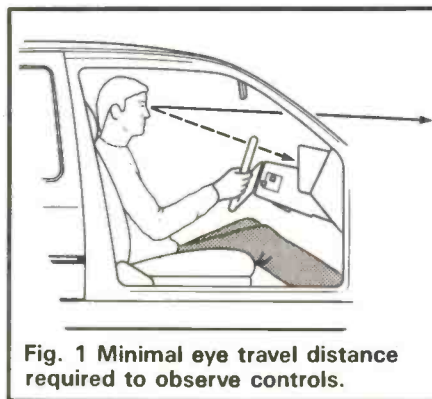

Fig. 1 Minimal eye travel distance required to observe controls.



Fig. 2 All controls within easy reach of the driver.

on when a police officer stops a driver.

Fist mics could interfere with driving in several respects. The main problem is that they require the use of one hand whenever you are transmitting, but also leads can get snagged on other controls such as the indicator stalks, gear lever or steering wheel. We've all been drilled since childhood not to drop things, so when faced with a serious on-coming hazard, you may find your instinctive reaction is to hold onto the microphone rather than drop it, as you ought to, and deal with the driving hazard ahead.

As a result, several alternatives to the hand-held microphone are available, some of which we shall examine in greater detail shortly. Each have their advantages and disadvantages, and there are also worries about possible additional facial injuries in the event of an accident.

However, let's try to help stop you having accidents in the first place . . .

Transceiver Design

The simpler your set is to operate, the less chance there is of you causing an accident. Changing frequency is often the most complicated operation, staying on one channel is the easiest but hogging the calling channel or the local repeater is often socially unpopular! From the early days of entertainment car radios this had been observed and improved upon by push-button station access, and modern in-car entertainment systems strive to give fully automatic operation wherever possible. Mobile 2m FM transceivers in the early days were limited to a few crystal controlled channels and were the height of simplicity to use, but technology has progressed and has brought with it many bells and whistles like digital frequency readouts, keypad entry, and multiple VFOs in sets designed for mobile use.

Choose Your Rig Carefully

Fig. 3 shows the results from a professional study conducted by Bell Laboratories for cellular radio usage in the USA, where people generally drive automatic cars at lower speeds on wider roads. However the results are still useful and show that operat-

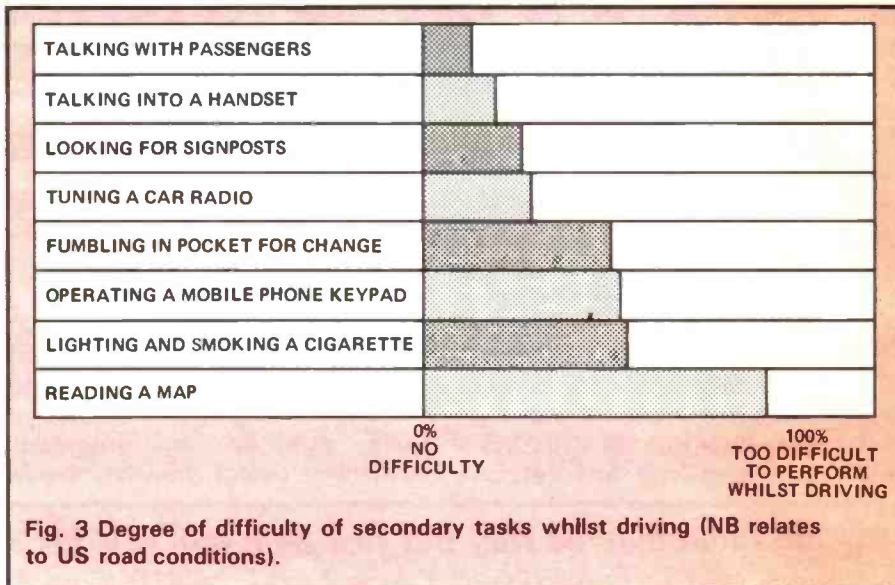

ing the set is far more dangerous than using the handset to converse with. This should lead us to seriously consider the positioning of the set in the car, to ease control identification, and to prefer the use of memories combined with up/down buttons for frequency control rather than VFO/thumbwheels and digital display. My own synthesised 2m rig has a two-digit readout of channel number, automatic repeater shift on repeater channels, and one-touch reverse repeater operation. I haven't yet found any Japanese transceivers that have met this ideal, although the TR7500 has come very close.

Knowing what frequency you are on is often the one thing that makes you shift your eyes off the road; many other functions can be identified by 'feel' with detented knobs, assuming that the set is so positioned that you don't have to stretch over to operate it. A simple display is the best one that indicates only what is required, rather than showing everything but with markers to show which is operational. With rigs getting smaller and smaller, it is often possible to place them on top of the dashboard to minimise the required eye movement off the road. 'Head up' displays are very useful for this also, they may be positioned in virtually ideal positions where the set itself could never be used due to depth limitations. Combined with operation of the set's functions by 'feel', this represents an almost ideal installation. I say almost, as you've still got to glance quickly to see where you are in the spectrum, but maybe you can get

over this one too . . .

The 'big three' manufacturers, namely Kenwood (Trio), Icom, and Yaesu, have introduced digital selective calling combined with auto QSY into many of their VHF/UHF equipments, either fitted as standard or available as a low-cost option.

Auto QSY

The first auto-QSY to be introduced was the digital channel link (DCL) by Kenwood. Upon command, this searches a previously selected range of channels for a clear frequency, goes back to the original channel and transmits a burst of data to the QSO partner's set, the end result being that both transceivers automatically QSY to a free channel. In addition you may also program a five digit access code, together with your callsign in ASCII to use as a digital code squelch for silent monitoring when waiting for a planned call, hence increasing your attention to the road. An optional head-up display allows you to observe the callsigns of similarly-equipped stations who have called you. Further details of this may be found in the Sept 1986 edition of HRT, where the TM2550E fitted with this facility was successfully tested.

Icom and Yaesu have joined forces to provide the amateur quinmatic system (AQS), although I have not seen this option available in the UK as yet. Basically it appears to be in competition to the Kenwood DCS, offering automatic selection of empty channels for QSY purposes as well as callsign squelch, five digit

code squelch, CQ mode for general calling, and an optional head-up display allowing message storage of up to 14 characters. This system uses the same tone frequencies as DCL but unfortunately a different protocol is used making the two systems incompatible. Even so, the most dangerous operation of a mobile transceiver can potentially be made as simple as pushing a button, showing that the technology is certainly here and is worthy of serious consideration.

Safety Mics

Now that we've discussed the most dangerous parts of mobile operation, let's have a look at some alternatives to one-handed driving. A high gain microphone fitted onto the rig, such as often found in cassette tape recorders, would be virtually useless due to the large amount of vibration and road noise it would also pick up. The easiest way of overcoming this is of course to get a hands-free mic near to the user's mouth, and from the earliest days of two-way mobile radio taxi drivers have often been seen with their microphones on the end of a flexible gooseneck. The increase in taxi service air-time congestion has rendered the microphone virtually obsolete in areas such as central London, however for us amateurs it can be a useful tool. Suitable goosenecks can be obtained from motorists shops, alternatively purpose-designed gooseneck microphones are manufactured, such as the Maldol HS-MX2 and the Kenwood MC-55. These are normally clipped onto the sunvisor or fixed to a window pillar, and the microphone element itself is fitted at the end of the gooseneck and is brought close to the operator's face in use.

An alternative to this is a small mic element clipped onto the user's clothing near the mouth, or fitted to a head or neckband. The former may suffer from excessive road noise due to the often remote positioning of the element, but numerous home made versions of the latter are in everyday use. Several years ago, a small company started making these for amateurs, the resulting Heatherlite microphones are now extremely popular.

Some amateurs still feel restrained by something in front of their face, and until recently there



Operating by touch alone — without stretching away from the normal driving position is important.

was little else to choose from. From work carried out for cellular telephone usage, small highly directional microphones such as the Adonis FX-8 are now coming onto the market; these fit onto your dashboard or sunvisor pointing towards your mouth and are very inconspicuous.

I spent many miles driving around testing various microphones, fitted to my Mk 3 Ford Escort to simulate typical amateur family car usage. Audio reports from other amateurs as well as many tape recordings were used to arrive at the conclusions. The Tx audio response of the test transceiver was measured to show a very close match to international FM two-way radio recom-

Kenwood mic with installation kit.

mendations for bandwidth and response. This would give a fair test to the microphones, hopefully independent of 'quirks' found in the responses of some transceivers on the market.

KENWOOD MC-55

This is a silver gooseneck type, about 36cm long, with a noise-cancelling element fitted to the end. This element is shrouded with a sponge windshield, offering protection to your eyes in the event of an accident. A control box is supplied, this has a plastic toggle lever for Tx/Rx, an adjustable mic gain control, LED arrow indicators for Tx and Rx states, up/down buttons for frequency control, and a tiny power

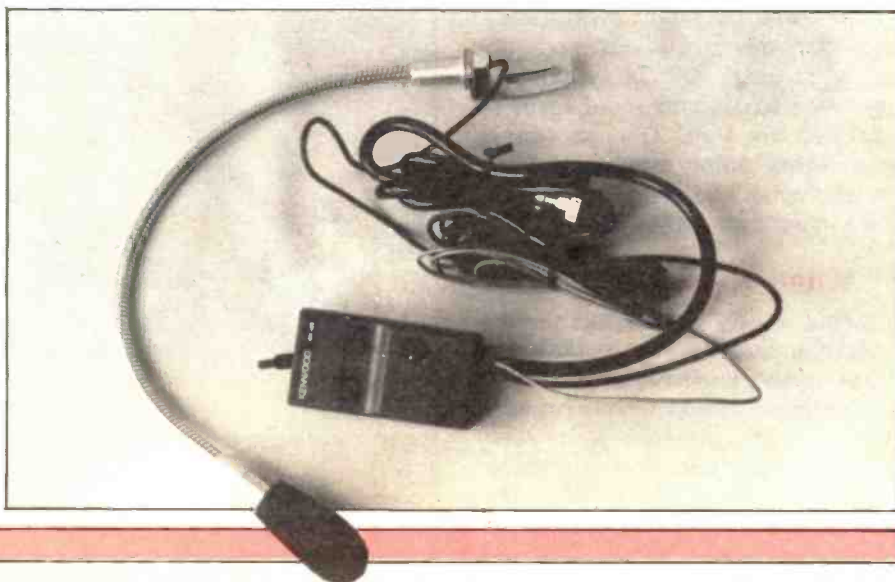

on/off switch. The control box has facilities for mounting either on your gearstick or any flat surface in the car. The lead length between mic fixing point and control box is around 2m, and between box and mic plug is 1m. Naturally it's designed to match with Kenwood transceivers, and comes pre-wired with a 6 or 8 pin plug to suit.

The bracket at the end of the gooseneck allows you to fit it using the sunvisor retaining screen, or of course by clamping or drilling into your window pillar. The cost of this mic at the time of writing is £55.53.

In Use

The mic was fixed to my sunvisor in a matter of seconds and the lead to the control box was just long enough to neatly reach the gear lever mounted control box. My 2m transceiver is positioned on the driver's side of the car so the lead from the control box to this was not long enough unfortunately, this is worth bearing in mind if your set is not positioned in the middle of the dash. In the end, rather than make up an extension lead, I positioned the control box on top of the dashboard near to the set. After a little experimentation in gain setting, the mic performed admirably, giving very good audio with hardly any trace of background noise. The quality was in fact preferred to my fist mic!

I had wired the positive supply to the control box to my purpose-wired 12V supply, this being taken directly from the battery via a hefty relay controlled by the accessory supply. With this I noticed no trace of alternator whine, but note that if I had connected it to an unswitched supply the green LED would be permanently lit, the on/off switch being extremely tiny and would in practice rarely be used. The Tx switch was very easy to use and could easily be operated by feel. The gooseneck was rather shiny and hence very conspicuous, and sometimes reflected sunlight into my eyes.

MALDOL HS-MX2

This is very similar to the Kenwood mic, and is in fact marketed by the importers currently at £39.80 as a lower cost option to it. This time a matt black gooseneck is used, approx. 32cm long, with a sponge windshield covering the noise can-

celling mic element, the gooseneck fixing method is identical. A small black plastic control box is provided, this comes with a gear lever mounting bracket, and features a Tx/Rx toggle switch with a 'momentary transmit' position also fitted, a Tx LED, screwdriver adjustable mic gain pot, and up/down push buttons for frequency control. The lead length between the gooseneck fixing point and control box is approximately 2.95m, and the length of lead provided from the control box to your transceiver mic socket is 1.4m. This lead is unterminated, but comes with all wires stripped and tinned, with wiring information provided for most amateur sets.

In Use

In my opinion the black gooseneck gave a far better appearance than the Kenwood mic, but unfortunately it did not stay in position as I went along the road, constant readjustment was necessary. On getting in and out of the car, the sponge windshield sometimes brushed against my shoulder and promptly came off, a drop of glue would however cure this. There was mic gain to spare from the amplifier and I only needed the adjustment to be hardly off the zero audio position to give an adequate amount, this made initial adjustment a little tricky but once set it did not vary. The audio reports were reasonable but not overcomplementary, with little background noise but a slightly 'boomy' audio response being evident. Backing off from the mic improved the boominess problem, but this of course required a slight

Mandol mic with installation kit.

increase in gain and hence brought the background noise up a little. I must confess that I found the 'momentary Tx' position on the control box very much to my liking, allowing quick comments to be passed more easily.

HEATHERLITE MOBILE MIC

The basic microphone, at a current cost of £7.50, is a small electret element with internal FET amplifier on the end of a flexible stem, this in turn being fixed to a black plastic covered steel band which you place around your neck or on your head. An unterminated light-grey screened lead, approx. 2m long, carries the mic audio. This may be used directly with many hand-portable sets, but instructions together with a simple diagram (Fig. 4) are given showing the circuitry required to interface with many mobile sets. This allows operators to economise by building their own control boxes with whatever up/down buttons or transmit switching requirements they need.

For those not wishing to build extra circuitry themselves, a range of options are available pre-wired for particular types of equipment, with a black metal control box incorporating the required circuitry and Tx switch with LED indicator, screwdriver adjustable mic gain pot, and optional up/down push buttons. A double sided sticky pad is provided to fix the box to a smooth flat surface. The lead length between mic and control box is 2m, and between mic plug and control box is 1.25m. Typical price, wired for the

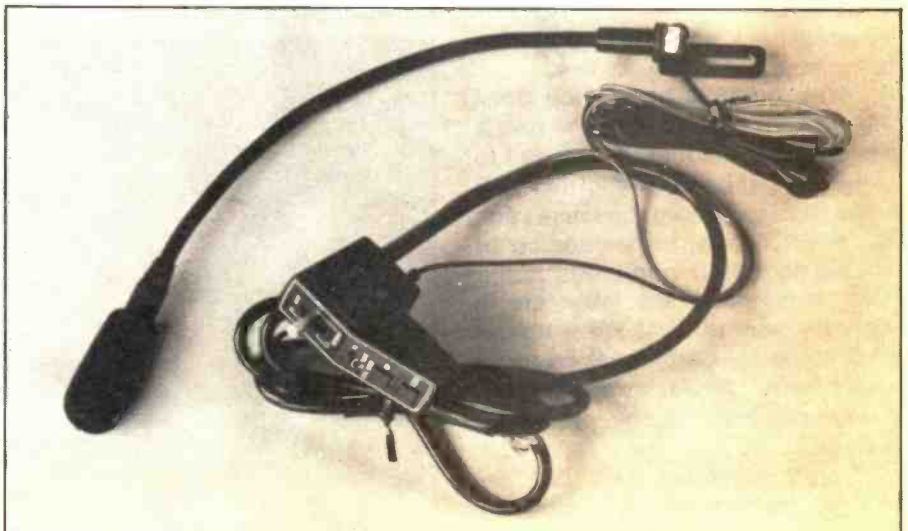

Kenwood TM201 with up/down buttons, is £26.00. Another version is available for handportable use, with a sponge covered earphone fitted to one end of the headband together with the microphone stalk, a black plastic control box being used with a toggle switch for Tx keying. These are individually made to order for hand held portable sets, and typically cost £15.50 for the Yaesu FT209. The earphone option may also be added to versions made for mobile transceivers if required, and the manufacturers state they are also willing to consider incorporating other custom requirements.

In Use

Audio reports were such that no difference was noticed from my usual fist mic, the background noise was very low in level and the quality very good. This of course is due to the ideal positioning between mic and mouth being available from this type of construction. When moving

Heatherlite headset in use.



Heatherlite mobile mic and control box with up/down buttons.

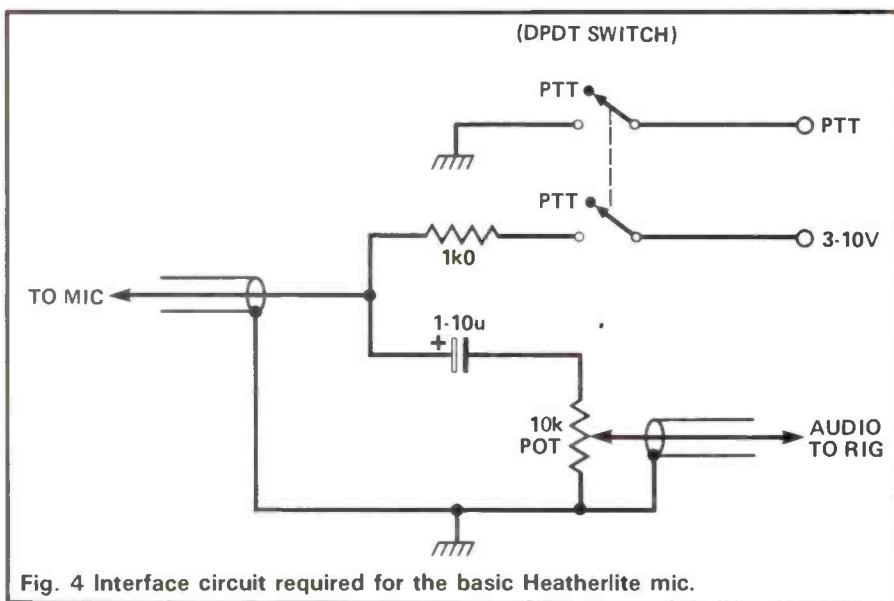

Fig. 4 Interface circuit required for the basic Heatherlite mic.

my head around, such as when manoeuvring the car into parking spots, the mic followed my mouth and didn't suffer from the fade in modulation level given by the boom mics. The mic was very light and

using it as a neckband at first it was only when getting out of the car that I remembered I was wearing it, with comical results! This I got used to in time, but I didn't like the fact that I was 'wired up' to the car, a purely personal feeling but others may also have this aversion.

When testing the version wired for the Kenwood range on a TM201, the audio was different from the supplied fist mic in that it was 'fuller', with more bass but not lacking in treble to the extent of being 'muffled' or 'woolly', the overall readability in my opinion was in fact slightly better. The Tx switch was easy to use with a positive 'feel' to it. I initially had doubts about the double-sided tape coming loose over the years, but the manufacturers have advised that the adhesive actually hardens with age rather than the reverse. Mounting the control box on a gearstick lever is possible using this tape supplemented by a pair of tie-wraps. The large up/down buttons were particularly easy to use.

I was very pleased with the results from this mic and at £7.50 a time for the basic mic I believe it represents excellent value for money.

ADONIS FX-8 DIRECTIONAL MIC

This is a small uni-directional mic, around 80mm long x 20mm diameter, and uses a pair of electret elements to differentiate between the desired audio and the surrounding noise. Mountings are provided for both dashboard and sunvisor fixing,

and a navy blue sponge windshield is supplied to cover the microphone if required. An in-line amplifier is fitted between the mic and the control box, the latter fitting to the gear lever stalk. The control box has a long metal toggle controlling Tx/Rx, a red Tx LED, small up/down frequency control buttons, and a screwdriver adjustable mic gain pot. A useful feature of this mic is a 'non modulation prevention circuit with alarm sound'! This is in fact a transmission time limiter, with a piezo alarm bleeper to make sure you don't cause untold misery by accidentally driving around with your transmitter permanently keyed. This may of course be disabled if required, full instructions being given. The mic output lead is fitted with an 8-pin socket which is designed to interface with a series of adaptor leads for the different types of transceivers in use, or a common unterminated lead. The latter was supplied, and has wiring details given to suit most transceivers in use. The overall lead length from mic to control box is 2m, that from control box to mic plug termination is 1.2m.

At a current cost of £69.00, this mic is not for the thrifty, but it releases the user from the need to feel constrained by a boom or neck/headband mic each time they wish to operate mobile from the car. It is also very inconspicuous.

In Use

I initially mounted the mic directly in front of me, on the flat portion of my instrument console with the element pointing at my mouth. After setting up the gain level for perfect readability when stationary, I set off on the move to receive absolutely abysmal reports! I found little difference when using the supplied windshield. The mic was removed and tested in my workshop, the audio output feeding into an oscilloscope. Sure enough, the mic was very directional, moving it about 15 degrees off caused several dB reduction in output level. Further tests using an unquelled FM receiver as a noise source and suitable positioning showed the mic to have good rejection of noise from the sides, but poorer rejection from behind it. As most of my car noise emanates from the front mounted engine, this nicely explained it, and

further tests were performed with the mic at an angle to the windshield.

There was ample interconnection lead length available allowing a high degree of flexibility in mounting position. These tests were far more satisfactory, the best position was found to be fitted to the sunvisor pointing down towards my mouth. Some mechanical vibration was noted from this method of bolting the mic down, but otherwise far less mobile background noise was evident. Overall, there was more noise evident from this than from the other mics tested, but this must be offset by the fact that no incumbrance to driving or movement is made by using this installation. In use, it was found to be important not to position the mic too near a highly sound reflective surface, such as the windscreen for instance, as the reflected voice audio could be seen by the microphone to be ambient noise, and hence be nicely cancelled!

The control box was a delight to use, the large toggle switch was easily operated and I must say I was very pleased with the thoughtful incorporation of the Tx timer. After just short of two minutes, an intermittent bleeper sounded, 15 seconds later the transmitter de-keyed auto-

matically. Excellent, one should be incorporated in all mobile mic installations in my opinion, judging by the amount of annoyance caused in my area from forgetful users of toggle Tx switches. (See HRT Aug 86, pp 53-54 for a simple do-it-yourself circuit).

PRO-LITE HEADSET

This is sold at a basic price of £13.00, to include the headset and boom microphone combination, with a 1.3m long lead terminated in a 3.5mm stereo type jack plug. An electret element is used for the microphone, this is shrouded by a black sponge windshield and mounted on a flexible stem. The earphone is a fairly large affair with a sponge outer, to cover the ear and reduce extraneous noise. The headband is adjustable in length, and the mic stem may be positioned so as to allow right or left ear use of the earphone. This headset looks remarkably similar to the Ace MH1 reported on in the June 86 edition of HRT.

Various black plastic control box options are available to suit some mobile and handportable equipments, containing the bias circuitry for the mic together with a metal Tx



Adonis mic with installation kit.



Detail of the Adonis directional pickup.

toggle switch and LED indicator where appropriate. The box may be fixed to a flat surface by two self-adhesive strips provided and a short flying lead is terminated with a matching socket to suit the headset plug. A 1m long lead from the control box has stripped and tinned leads with interconnection information provided and an extra 0.5m lead from this end comes terminated in a 3.5mm jack plug to fit the external speaker socket of your transceiver.

In Use

I found the earphone did improve readability of received signals under high speed motoring conditions, even though I normally use an external speaker at head level. The microphone picked up very little background noise, but was described as slightly 'woolly' in use, ie lacking in its reproduction of higher audio frequencies. Further tests were performed using different mouth-mic spacings which did not improve matters greatly, this could possibly be improved upon by the user if required by using a resistor-capacitor shaping network.

I didn't like the constrained feeling the headset gave when in use, it made me feel like a light aircraft pilot rather than a car driver. It was also rather conspicuous to other drivers and passers by, which made me feel even more of an oddball. However, the relatively low price makes it certainly worthy of consideration where economy is required as well as an earphone option. The plug and socket arrangement of the headset was useful in that little force was required to pull them apart, in an accident the headset would be unlikely to strangle the user as a result. The rather short lead length provided between the control box and mic plug may limit positioning of the unit.

Overall Conclusions

As we have seen, there are many alternatives to the use of a handheld microphone, all having their individual merits. The most economic is a simple headband affair with a homemade control box for those who prefer this type of arrangement, rather than a boom mic which could limit forward visibility slightly. The latter however gives the user the advantage of not needing to get 'wired in' as well as 'strapped in'



Pro-lite headset and control box.

Suppliers

Kenwood/Maldol Boom Mics:	Low Electronics, Chesterfield Road, Matlock, Derbyshire, DE4 5LE (0629 2817)
Heatherlite Mic:	Heatherlite Products, 1 Beverley Business Centre, St. Nicholas Road, Beverley, N. Humberside (0482 871762)
Adonis FX-8:	Waters and Stanton, 18-20 Main Road, Hockley, Essex, SS5 4QS. (0702 206835).
Pro-Lite Headset:	Mr. N. Barker, 10 Mallard Close, Lower Wick, Worcester, Worcs, WR2 4BB. (0905 421857)

each time they use the car. The best solution ergonomically is a remote unit such as the Adonis, but the price reflects this of course. Overall, you tend to get what you pay for, certainly none of the mics I tested when correctly installed sounded as horrible as some mobile mics, often home-made lapel ones, which I have previously encountered on the air!

Readers may be interested to know that, just as we were closing for press Mr Peter Bottomly MP, speaking on behalf of the Department of Transport, referred to the relevant section of the new Highway Code concerning the operation of mobile radio equipment. The Code

will contain advice on the following lines: 'Do not use a hand held microphone or telephone handset while your vehicle is moving, except in an emergency. You should only speak into a fixed, neck-slung or clipped-on microphone when it would not distract your attention from the road. Do not stop on the hard shoulder of a motorway to answer or make a call, however urgent.' . . . So now you know.

My thanks go to the above suppliers for provision of the review samples, and to the many amateurs, especially Mark G1MKP, for their assistance.

HOKUSHIN aerials.

BASE STATION AERIALS

HF5...80 to 10 metre vertical, no radials required when ground mounted £83.39 inc vat, carriage £7.00.
HF5R...Radial kit for use with HF5 when mounted on chimney or gable end.....£54.81 inc vat, carriage £7.00
GFV5...Two metre base station colinear, 6.5 dB gain, 3.1 metres high£54.92 inc vat, carriage £7.00.
GFV23...as above but 3 section colinear, 7.8 dB gain, 4.45 metres high£51.97 inc vat, carriage £7.00.
GFV7...Seventy centimetre triple 5/8 base station colinear, 6.8 dB gain£45.59 inc vat, carriage £7.00.
GFV720...Dual band (144/430 MHz) base station aerial. £45.68 inc vat, carriage £7.00.

MOBILE AERIALS

2E...Two metres 5/8 whip, 3.4 dB gain, foldover base £14.55 inc vat, carriage £2.00.
2NE...Two metres 7/8 whip, 4.5 dB gain, foldover base £24.23 inc vat, carriage £2.00.
OSCAR430...Seventy centimetre triple 5/8 whip, 6.3 dB gain£27.72 inc vat, carriage £2.00.
OSCAR720...Dual band (144/430 MHz) whip ... £24.59 inc vat, carriage £2.00.
HS770...144/430 MHz diplexer for use with OSCAR720 .£18.02 inc vat, carriage £1.50.
GSS...Gutter mount (requires RG4M cable assembly) .£6.26 inc vat, carriage £1.25.
RG4M...Cable assembly for GSS base, complete with 90239 and PL259 plug£6.26 inc vat, carriage £1.00.
12B...Car wing mount with 90239 top and bottom.£5.73 inc vat, carriage £1.00.
HSTMB...Car boot mount including cable and PL259 £16.42 inc vat, carriage £1.50.
MA2008...High quality mag mount with cable and strong protective cover to prevent paintwork damage.. £22.90 inc vat, carriage £2.00.

KEYS & keyers.

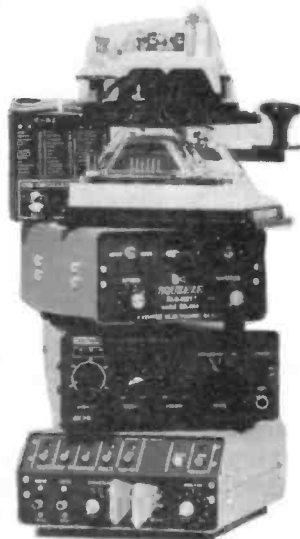

TK3 Morse practice oscillator £13.65 inc vat, carriage £1.50
HK708 Straight key £21.82 inc vat, carriage £2.50
HK708 Deluxe version on heavy base £43.30 inc vat, carriage £3.00
HK704 Squeeze paddle £20.25 inc VAT, carriage £1.50
EK150 Electronic keyer with built-in side tone, solid state or relay keying £133.75 inc vat, carriage £3.00.
EK1024 Electronic keyer with 1024 bit memory £241.98 inc vat, carriage £3.00.
DK210 Daiwa electronic keyer, requires paddle £73.96 inc vat, carriage £2.50.

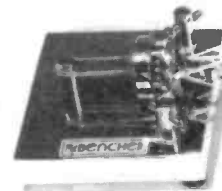

BY1 black base £67.42 **BY2** chrome base £76.97 **BY3** gold plated base £141.75 Vat inc.

Bencher Single Paddle
BST1 black base £67.42 **BST2** chrome base £76.97 Vat inc.
 Carriage on BENCHER keys £3.00.

data equipment

CD600 ... RTTY, CW, ASCII, TOR, AMTOR decoder, output for UHF television, monitor and printer, can also be used as morse tutor.
CD600 ... £215.14 inc VAT, carriage £7.00.
CD670 ... A higher specification RTTY, CW, ASCII, TOR and AMTOR decoder complete with liquid crystal dot matrix display, variable RTTY shift, normal/reverse mode switch, outputs for TV, monitor and printer and can also be used as morse tutor.
CD670 ... £327.77 inc VAT, carriage £7.00.
CD660 ... Similar in specification to the CD670 but without the built-in dot matrix display.
CD660 ... £264.97 inc VAT, carriage £7.00.



DAIWA meters

CN410M ... Frequency range 3.5 to 150 MHz, forward power switchable 15/150 Watts, reflected 5/50 Watts, SO239 connectors.
CN460M ... Frequency range 140 to 450 MHz, forward power switchable 15/150 Watts, reflected 5/50 Watts, SO239 connectors.
NS448 with remote head ... Frequency range 900 to 1300 MHz, forward power switchable 5/20 Watts, reflected 1.6/6.6 Watts, N type connectors.
NS660P ... switchable meter reading (average, normal PEP and hold PEP) and provision for optional remote head (U66V), frequency range 1.8 to 150 MHz, forward power switchable 15/150/1500 Watts, SO239 connectors.
U66V ... remote head, frequency range 140/525 MHz, max 300 Watts, N type connectors.
SC20 ... extension cable for U66V, approx 20 metres long.
CN410M ... £61.72 inc VAT, carriage £1.50.



NS660P ... £115.00 inc VAT, carriage £2.50.

CN460M ... £65.40 inc VAT, carr £1.50.

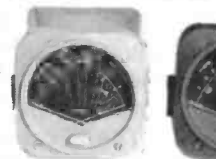

NS448 ... £86.60 inc VAT, carriage £2.50.

LOWE ELECTRONICS LTD.

Chesterfield Road, Matlock, Derbyshire DE4 5LE

Telephone 0629 2817, 2430, 4057, 4995.

Send £1 for complete mail order catalogue.



LOWE SHOPS.

In Glasgow,
the shop manager is Sim, GM3SAN,
the address, 4/5 Queen Margaret Road,
off Queen Margaret Drive, Glasgow,
telephone 041-945 2626.

In the North East,
the shop manager is Hank, G3ASM,
the address, 56 North Road, Darlington,
telephone 0325 486121.

In Cambridge,
the shop manager is Tony, G4NBS,
the address, 162 High Street, Chesterton, Cambridge,
telephone 0223 311230.

In Cardiff,
the shop manager is Carl, GWOCAB,
the address, c/o South Wales Carpets, Clifton Street, Cardiff,
telephone 0222 464154.

In London,
the shop manager is Andy, G4DHQ,
the address, 223/225 Field End Road, Eastcote, Middlesex,
telephone 01-429 3256.

In Bournemouth,
the shop manager is Colin, G3XAS,
the address, 27 Gillam Road, Northbourne, Bournemouth,
telephone 0202 577760.

Although not a shop, there is on the South Coast a source of good advice and equipment, John, G3JYG. His address is Abbotsley, 14 Grovelands Road, Hallsham, East Sussex. An evening or weekend call will put you in touch with him. His telephone number 0323 848077.

Lowe Electronic Shops are open from 9.00 am to 5.30 pm, Tuesday to Friday and from 9.00 am to 5.00 pm on Saturday. Shop lunch hours vary and are timed to suit local needs. For exact details please telephone the shop manager.

AR2002 receiver



Frequency range of the AR2002 is from 25 to 550 and from 800 to 1300 MHz. Modes of operation are wide band FM, narrow band FM and AM. The receiver has 20 memories, memory scan and a search mode which checks frequencies between user designated limits.

The receiver has a push button keypad for easy frequency entry and operation.

A front panel knob allows the listener to quickly step up or down in either 5, 12.5 or 25 kHz steps from the frequency initially chosen.

The AR2002 has a front panel LED bar "S" meter.

There is a front panel 3.5 mm jack socket for headphone use.

A socket for the optional RS232 interface (RC PACK) is provided on the rear panel. The RC PACK consists of an 8 bit CPU with its own ROM and RAM and with your own computer acting as a dumb terminal many additional operating facilities become available. Of course, if you want to write your own programs using the RC PACK as an interface then "the sky's the limit".

AR2002 Receiver . . . £487.30 inc VAT, carriage £7.00

TWO METRE MULTIMODE from KENWOOD, the TR751E



There has been a **KENWOOD** two metre multi-mode mobile transceiver for the last six years. Beginning with the successful TR9000 and continuing with the TR9130, amateurs have always found the series to be reliable and above all easy to operate, especially whilst mobile. Advances in technology have enabled KENWOOD to further improve on the TR9130. Additional operating features have resulted in an even easier to use and smaller transceiver. However KENWOOD have not discarded the valuable experience gained over the last six years. The result is the TR751E, a new generation of multi-mode mobile transceiver.

The **TR751E** is the first multi-mode mobile transceiver that can be set to select the correct mode whilst scanning the band. By setting the rig to vfo and selecting AUTO mode before pressing the SCAN button, the TR751E will move up or down the band changing both mode and step rate according to the plan (5kHz/SSB, 12.5kHz/FM, or 1kHz/SSB, 5kHz/FM depending on the selected frequency step).

The transceiver has two VFO's and 10 memory channels. Memory information is easily transferred to either vfo. Each memory holds information on frequency, mode and also the step rate to be set when transferring the memory information to vfo. Memory channel one is also the ALERT frequency, memories 7 and 8 relate to DCL and memory 0 programs the user defined limits of frequency scan.

The **TR751E** can be set to scan between user programmed limits or around them depending on the frequency set when the scan is started. When AUTO mode is set the transceiver will select the correct mode as it scans. In addition

to scanning each memory, the TR751E can be set to scan those memories programmed with the same mode. Pause on an occupied channel is time operated but can be changed to carrier hold by an internal modification.

Operating on 13.8 volts DC, power output from the transceiver is 25 watts (high) and approximately 6 watts (low). The low power setting applies to all modes. When compared with the TR9130, the TR751E is smaller and lighter. TR751E (TR9130) 180mm (175mm) wide, 60mm (68mm) high, 213mm (253mm) deep, 2.1 Kgs (2.4 Kgs).

The TR751E is perfect for base station use. When operating on SSB, signals can easily be found using the frequency step set to 5 kHz, fine tuning quickly achieved by switching to the 50 Hz rate. Operation is also ideal on FM, the rig stepping in either 12.5 or 5 kHz steps. Full repeater facilities are also available including reverse repeater. Receiver performance is excellent, our first sample amazed us, FM, 0.14uV for 12dB SINAD and SSB, 0.09uV for 10dB S+N/N.

As an option, the TR751E can be fitted with DCL. Compatible with the DCS system, DCL (Digital Channel Link) enables your rig to automatically QSY to an open channel. The DCL system searches for an open channel (checks the next eleven 25KHz spaced frequencies above the one stored in memory 7), remembers it, returns to the original frequency and transmits control information to the other DCL equipped station that switches BOTH rigs to the clear channel.

For the blind operator the KENWOOD TR751E is perfect. As each mode is selected a tone which give the appropriate morse letter (F for FM, U for USB, etc) and when fitted with the optional VBI board, a digitally encoded girl's voice will announce on request the operating frequency.

In addition, the TR751E has an illuminated analogue 2/Rf metre, all mode squelch, MHz select keys, a noise blander, semi break-in CW with side tone, RIT, memory channel up/down keys and a frequency lock. KENWOOD's attention to detail can be seen in the design of the included mobile mount, a clamp system with rubber pads protecting the rig as it is slid in and out and for security, the clamp can be easily locked in the closed position.

There is so much more to say about the TR751E, so why not ring us and let's talk about it.

TR751E £649 inc VAT, carriage £7.00
MU1 (DCL modem) £32.63 inc VAT carriage £7.00

LOWE ELECTRONICS LTD.

Chesterfield Road, Matlock, Derbyshire DE4 5LE

Telephone 0629 2817, 2430, 4057, 4995.

send £1 for complete mail order catalogue.



A PIECE OF THE PAST



The finished article, complete with vintage high impedance earphones — your personal piece of the past.

It won't give you pride of place on the 'Antiques Roadshow' but Tim Wander, G4RPS, discovered that renovating defunct crystal sets can be great fun — and a good bit cheaper than a Chippendale!

An article on early crystal radio sets published in HRT led to enquiries about their availability as souvenirs for the radio shack. It is of course still possible to buy new 'crystal sets' off the shelf and most newcomers to electronics have at sometime played with the rectification properties of a germanium diode. The something for nothing aspect still intrigues and excites radio enthusiasts to this day. Unfortunately the 'classic' crystal sets of the early 1920s have now become true collectors items, often with price tags to match their rarity. However it is still possible to find 'original' homemade crystal sets for more reasonable sums although they often need a large amount of restoration work. If an intact set can't be found then the simplicity of the

crystal set means that even odd bits of old sets or individual components can be collected over a period of time, and then assembled using one of the many straight forward crystal circuits.

The accompanying photographs show one such survivor of the crystal set age, bought for the enormous sum of one pound from a bric-a-brac stall. The main board was a write off, stained and split with age, but the components were all present including an unusual crystal detector. The box was bought for an equally huge sum and actually started life as an Edison Bell crystal set — which is now quite rare. Unfortunately its 65 year history had turned it into a nail and screw box long ago, all trace of components

and board having long since gone. The first job in restoring anything is to adhere to a few basic principles.

Getting started

In my view restoration should mean just that. The idea should not be to produce a 'brand new' shiny crystal set, by acid dipping the brass, rewiring the complete circuit and using a modern box. Nor is the idea to produce a 'fake', the use of an original box in this case was purely coincidence, no serious collector would be fooled, it was just a convenient size and it seemed a shame to lose the original 'BBC Approved' transfer. The aim should be to preserve as much of the original as possible, and to attempt to get it working without destroying the character of the set. The first job is to record the format of the existing board, both the components position and the coil connections underneath, remembering that orientation reverses as you turn the board over! From this 'circuit diagram' any disconnected wires can be matched



Coil and wiring of the original set, plus a rather bent top panel.



The new box and top panel before construction begins.

up for eventual complete reconstruction, as crystal set circuits are rarely complicated.

After desoldering and removing all the brass components the original board and its 'BBC approved wood-worm' are consigned to the fire for an honourable cremation. A traditional (and G4RPS) technique for cleaning the brass components, removing dirt, grime and the well known green verdigris is to gently warm the brass in ordinary vinegar. This is highly recommended because it doesn't destroy the pleasant patina of age, although it does tend to turn the house into something approaching a pickle factory very quickly. A gentle application of very fine emery paper can be used to remove stubborn pitting or marks, but overuse can quickly spoil the appearance of the final set.

The new board to mount the crystal set on is obviously very important, as this is the main 'show' element of the radio. Often sheets of traditional bakelite can be found lying in the scrap bin, old bakelite trays or boxes are also still surprisingly common. The board used for the renovation of this set actually belonged to an unknown larger crystal set, long ago dismantled when the crystal gave way to the valve. It is carefully measured, sawn to shape and drilled in the same configuration as the deceased board. The brass terminals are then bolted back into position. A coating of light oil before reassembly will help protect the aged terminals and screws, but be careful as overuse will stain the bakelite board. The surface and coil wiring is then resoldered using the original cotton insulated copper wire. The ends of

such sixty year old wires are usually corroded and very brittle. The wire must be clipped back (not too far as it won't fit!) and its ends must then be completely cleaned) with sandpaper ready for resoldering.

Finishing the case

The few missing brass screws and bolts should be replaced with as close a match as possible from the bit tin and the completed board married to the new box, hopefully it will fit snugly. There are many boxes suitable for mounting crystal sets in, available from Grandad's shed or the junk stall on the market and often old tea caddies can be transformed for a matter of pence. The preparation of the box obviously depends on its existing finish, in this case the box was very lightly sanded (except the transfer!) to break the grime of 60 years and then rubbed with several coats of teak oil to 'feed' the wood and mask the inevitable scratches. In

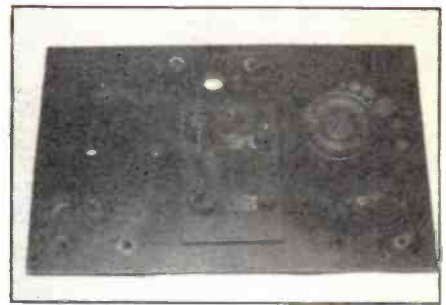

Rebuilding the top panel.

some cases it may be necessary to dye or stain the wood before polishing, but these days the range of different fluids and colours is enormous. Depending on the original finish the home constructor may decide to build a box from scratch, clear or coloured varnish providing a smart housing for his cats whisker radio set. Any wood worm holes can be filled with a suitable matching wood stopper, after the evil little critters have been killed off with a suitable proprietary fluid. Don't do this in the kitchen as it might ruin your whole day. Finally, a light wax polish finishes the completed crystal set — saved from the waste bin as a souvenir and memento of the first days of wireless.

Are you QRV?

But will it work? Connecting it up to the HRO wire strung out the window, an earth to the well watered earth spike, (an unpainted piece of radiator will do just as well) and a pair of refurbished period headphones should provide the answer. Vintage high impedance headphones are still quite common, and can be shown to be working by putting the earpiece to your ear and placing a 'moist' tongue across its leads, a click will show if they are live. Non functioning versoins can be carefully disassembled by unscrewing the bakelite earpiece (don't force it as they are brittle) and cleaning out the dirt, cobwebs and corrosion. The surface of the galena crystal must also be carefully 'shaved' to expose a new area for detecting. Tickling the whisker (no it isn't illegal in this country!) can then begin.

The answer to all the hard work? Nothing is a good description, but such is life. Perhaps these were the same problems that the original builder met three generations ago. The trusty swinging needle of the

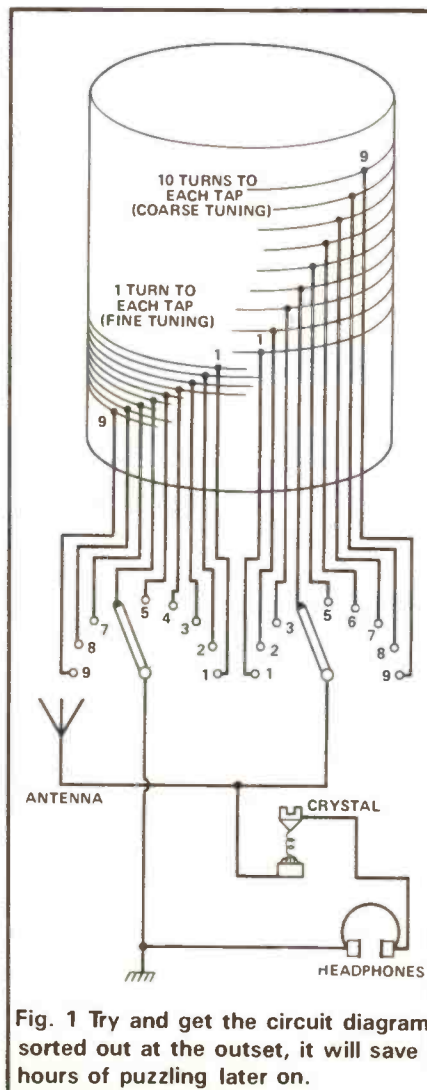
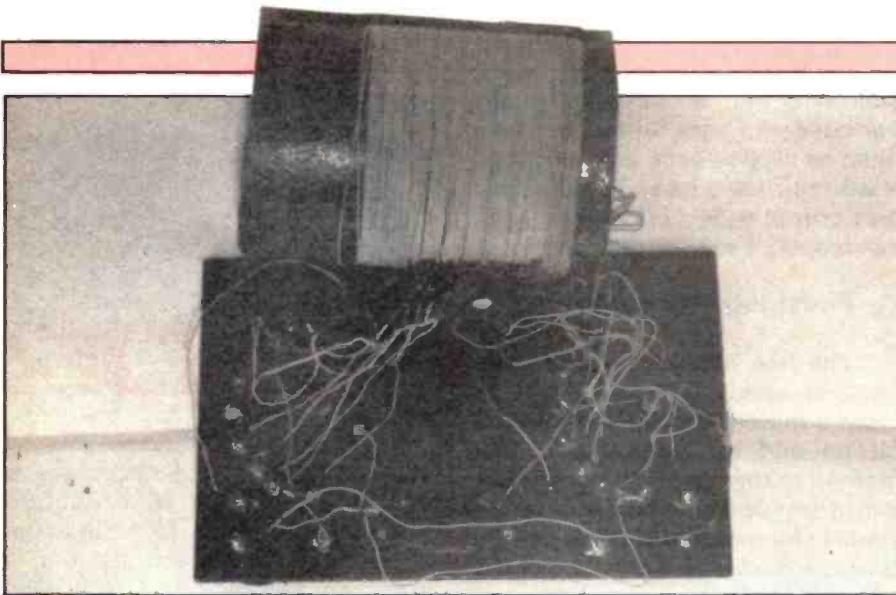

Fig. 1 Try and get the circuit diagram sorted out at the outset, it will save hours of puzzling later on.



Rewiring the coil and switching to the rear of the top panel.



The moment of truth, will it all fit together as planned!

AVO (despite a career in computers I don't get on with digital voltmeters) soon finds the dry joints. These were caused by reusing the original solder on the ends of the brass terminals. Bakers soldering fluid in moderation makes a good clean solder joint, but again watch the fumes as I believe they are actually hydrochloric acid.

Hopefully the original 'amateur' enthusiast solved his problems with as much ease. By late evening,

65 years on, a crackle faintly returns. Far away a small voice speaking rapid French fades in and out. But the Writtle wireless station 2MT and the first voice of the BBC, London's 2LO slipped into history long ago. It does not matter that it is unreliable, for it is a very old lady now, and even in its prime it was never hi-fidelity. However it was radio — simple, cheap and very crude, but still the birthplace of a revolution. It now sits

on the desk next to my slightly battered FT290R, and it may not have 2MHz coverage but at least it doesn't suffer from flat nicads. There it will survive (along with quite a few other vintage friends) as a reminder of a time when every radio amateur was an experimenter tickling the whisker and radio was still just ripples in a very empty ether.

AKD

TEL.
0438 351710

Unit 5
Parsons Green Estate
Boulton Road
Stevenage
Herts SG1 4QG

MAIL ORDER DEPT.
Stock Items Normally
Despatched within 48 hours,
21 days latest.



Unifilter 'CLAMP-ON' RADIO-FREQUENCY CHOKE

PHONE OR SAE FOR PRODUCT SPECIFICATION & APPLICATION NOTES



Allows leads to be toroidially protected without the need to cut or remove plugs or connectors. Ideally suited for moulded plugs, leads, ribbon, and large diameter cables. Can easily be fitted and stacked in multiples to increase rejection. 'UNIFILTER' works by suppressing the interference currents that flow along the outside of cables without affecting the signals or power flowing inside. This means that you don't need to worry about upsetting normal operation or invalidating guarantees. Suitable for both reducing the emission of, or rejecting the effect of, 'common mode' interference as experienced on computer, hi-fi & speaker leads, as well as the normal mains & aerial cables.



UF 4 KIT (SUITABLE FOR SMALLER INSTALLATIONS) £9.89

UF 8 KIT (FOR MULTI INSTALLATIONS) £19.55

WA1 WAVEMETER £24.95



Our Waveabsorption meter for 2 Mtre transmitters meets licensing requirements range 120Mhz to 450Mhz, very sensitive, can also be used as field strength meter within its range. Requires PP3 type battery (not supplied).

HFC1 CONVERTER £49.00



For the FRG 9600/965 our new HF Converter, connects to the aerial socket, and powered direct from the 8 Volt o/p of the FRG 9600. Tune from 100, 1Mhz to 160Mhz, gives tuning range of 100Khz to 60Mhz, uses double balanced mixer, with low pass filter on input.

GPA1 PRE-AMP £24.95



2 Mtre RF Pre-amp using BF961 dual gate FET 18 db gain: Low noise, 2Mhz Bandwidth SO 239 termination 25 watts through power. Failsafe switching, can be left in line when not required, auto RF sensing even at 1/2 watt, can be factory tuned between 28-170Mhz.

A SELECTION OF OUR MOST POPULAR FILTERS (PHONE OR SEND SAE FOR FULL RANGE DATA SHEET)

RBF1

A range of UHF notch filters (for inner only) stocked at the following frequencies: 435MHz (70cms) channel 36 (for radar blips), 846MHz (RAF Boulmer interference) can be factory tuned from 420MHz to 890MHz. £6.75 each

HPF1

Low insertion loss high pass filter with capacitive braid breaker for use with UHF TV, VIDEO & PRE-AMPS. £6.75 each

HPFS

High pass filter with transformer braid breaker, better performance than HPF1 but the insertion loss is a little higher. 1-2db best for severe problems for UHF only. £7.00 each

TNF2

A range of notch filters specifically tuned for the frequency of interference on inner and outer bandwidth >1Mhz (2Mhz above 100Mhz). VERY LOW INSERTION LOSS TYPICALLY <0.5db. Stocked for the following frequencies: 14Mhz, 21Mhz, 27.5Mhz (CB), 29Mhz, 50Mhz, 71Mhz, 145Mhz. Also spot tuned at any frequency to 300Mhz. £7.75 each

To order quote TNF2/ and the frequency.

BB1

Transformer braid breaker >25db at 30Mhz, often used with other filters in our range for very severe interference. Ideal at the input of VCR and PRE-AMPS. £6.75 each

IDEAL FOR CLUBS OR EMC GROUPS FOR EVALUATION OF INDIVIDUAL SITUATIONS DK1 FILTER KIT

Kit of all filters in our range (11 in all) except for RBF1/846Mhz. £41.70

WE ALSO STOCK TORROID RINGS @ £2.50 PER PAIR.

★ EMC PROBLEMS ★

PHONE OUR TECHNICAL HELPLINE ON THE ABOVE PHONE NO. BETWEEN 10am & 12 NOON ANY WEEKDAY.

ALL PRODUCTS ARE AVAILABLE FROM US DIRECT MAIL ORDER OR C.O.D. ALSO AVAILABLE FROM LEADING AMATEUR RADIO DEALERS

ALL OUR PRODUCTS CARRY THE USUAL AKD 2 YEAR GUARANTEE. PRICES QUOTED ARE CORRECT AT TIME OF GOING TO PRESS AND INCLUDE VAT, POSTAGE & PACKING

RSGB NOW STOCK OUR FILTERS AND MEMBERS CAN OBTAIN THEM AT A DISCOUNT FROM RSGB HQ.

Props: RT & VEL Wagstaffe. Technical Adviser: John Armstrong

LED BATTERY MONITOR

One of the perennial problems with the battery packs in portable equipment is that they have an irritating habit of expiring at the most inopportune times, such as on a moun-

minimum in view of the restricted space inside today's rigs. ZTX108s are shown in the diagram simply because they are significantly smaller than their metal can counterparts

begins to turn off and allow its collector voltage to rise. The rising collector voltage switches on Q2 which then illuminates the light emitting diode LED1, warning you that the supply is failing.

Are you sick and tired of fading quietly away when you're out working portable? We can't stop your batteries going flat but this simple circuit from Brian, Kent, G6EXX, will at least allow you a dignified retreat!

tain top when you've just spent half a day climbing up the thing to try and make a few unusual contacts. Most people invest in a spare pack for these occasions but there is still the problem of not having any sort of warning of the impending demise of the power source. Some rigs have a battery-test function connected to the S-meter, which in the majority of cases involves fumbling about at the back of the rig to find the switch, whilst others have an LED which conveniently dies a death at around the same time as the rig does!

What is needed then, is some sort of device which takes negligible current as long as the batteries are still going strong (to get the maximum life out of them) but which warns you that you are about to fade quietly into oblivion. The unit should also be small enough to either be fitted inside the set or be easily carried in a pocket. It was with these considerations in mind that the 'LED battery monitor' was designed — and following the American adage of KISS 'keep it simple stupid', I decided to go for a lo-tech design; no micro-processors, just a pair of BC108s and a few other bits and pieces — in fact a junk-box builders dream!

The Circuit

The main priority was to try and keep the physical dimensions to a

and in some applications every millimetre counts. The 'monitor' can be wired permanently across the battery supply if desired or alternatively build up into some sort of quick test box — obviously it is preferable to opt for the first approach if at all possible.

The circuit uses two NPN transistors, Q1 and Q2, with Q1 receiving its base bias from the potential divider network made up of RV1 and R1, the network being connected across the full battery supply. Do be a little cautious when installing this circuit, to ensure that your chosen tapping points are at full battery potential — there's not much point in monitoring a regulated supply line by mistake! Q1 is biased 'on' by adjusting RV1 which in turn brings the collector potential of Q1 towards 0V and holds off any forward bias to Q2. As the battery voltage falls, so does the bias to Q1 which then

Construction

Although the circuit can obviously be built on veroboard, the kit version's PCB measures only 18mm square so this may be a wise option if space is at premium. There are no real problems at all in putting this circuit together other than making sure that the LED is connected the correct way round and that there is no chance of the supply being shorted out. Nicads are capable of delivering very high currents for short periods and a loosely fitted PCB could seriously damage the rig. As for installation many people are rather reluctant to start drilling holes in their pride and joy, especially as this can affect the resale value in the future, so one solution may be to convert an already existing LED on the rig into a battery warning light. Another could be to make use of any spare lines in the microphone cable and mount the LED inside the microphone case, after all a microphone is cheaper to replace, easier to dismantle and drill and the warning light would be right in front of you — no excuse for 'fading away' then!

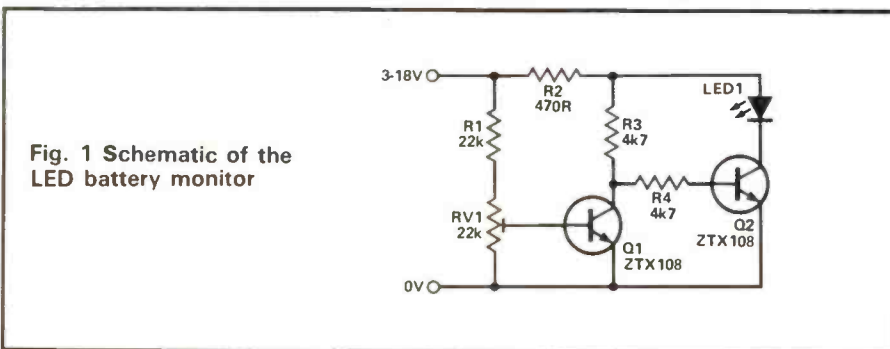

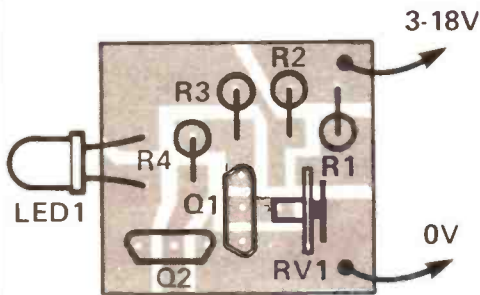

Fig. 2 Component overlay for the PCB



Fig. 3 The PCB foil pattern (actual size).

The easiest way of setting up the trigger point is to connect the circuit to a variable voltage power supply and, using a digital voltmeter, adjust RV1 so that when the supply is set to 10.35V (in this example) the LED is just reaching its fully on state. The other way of doing it is to check the battery pack voltage with a DVM as it becomes discharged and adjust RV1 when the required voltage is reached.

Components List	
RESISTORS	
R1	22k

before everything goes awfully quiet, it is wise to set the device to trigger when the cell voltage is about 1.15V. Working out how many cells

This is the minimum value which the pack should be allowed to reach as cells could be damaged if allowed to discharge further.

able for £4.60 (£6.55 ready built) from: Southern Electronics, 47 Jocketts Road, Hemel Hempstead, Herts HP1 2JX.

GAREX THE SCANNER SPECIALISTS

JIL SX-400

THE PROFESSIONAL SCANNER

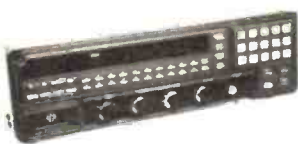

- Basic coverage 26-520MHz
- AM, NFM & WFM
- Expandable from 100kHz to 1.4GHz with SSB and CW
- Computer control options
- IF output terminals
- Specifications set by professionals

£649

AOR 2002

THE WIDER RANGE SCANNER



- The receiver with the most Megahertz for your money
- Covers: 25-550MHz, 800MHz-1.3GHz
- AM & NFM & WFM on all bands
- Computer interface socket
- 20 memories
- Compact size
- 12v dc operation
- Up/down step control knob

£487

REVCO RS-2000E

THE VERSATILE SCANNER



- Covers: 60-180MHz, 380-520MHz
- AM & NFM on all bands
- Search & store of active channels
- Channel activity counter
- 70 memories
- 12v dc & 240v ac

£279

REGENCY HX-850E

THE SMALLER HANDY-SCANNER



- Covers 75-106MHz OR 60-90MHz plus 118-175MHz, 406-496MHz
- AM & NFM on all bands
- Full scan & search functions
- 20 memories
- Nicads, charger & BNC whip antenna included

• ONLY 2 1/2" x 5 1/2" x 2"

£279

JIL SX-200N

THE SUPERIOR SCANNER



- The choice of the professionals
- Proven reliability
- Covers: 26-88MHz, 108-180MHz, 380-514MHz
- AM & NFM on all bands
- Positive action keyboard
- 16 memories
- 12v dc & 240v ac

£325

DON'T FORGET THE ANTENNA!

All receivers need a good antenna and the ideal one for a scanner is the REVCONE, a 16 element disccone. Made in Britain by Revco, a company that has been manufacturing quality antennas for the last 25 years, the REVCONE covers 50-500MHz, is extremely well made and very good value at just... £29.95

Also available - the RADAC dipole nest, 25-500MHz with extra performance designed for transmitting use... £89.95

PRE-AMPLIFIERS
Broadband antennas usually have no gain, so pre-amps are often desirable. One mounted at the masthead amplifies the weak signals but not the noise generated in the feeder cable.
• New range of high performance broadband amplifiers from REVCO now available.
ASK FOR DETAILS*



GAREX ELECTRONICS

MAIN DISTRIBUTOR OF REVCO PRODUCTS. PRICES INCLUDE UK P&P and 15% VAT. Ask for details of our interest free credit.

Extensive range of PYE radiotelephone spares - S.A.E. for list.

7 NORVIC ROAD, MARSWORTH, TRING, HERTS. HP23 4LS.

Phone 0296 666684. Callers by appointment only.

Ask for details of our interest free credit.

Ask for our list of second-hand scanner bargains.



REVIEW

AZDEN PCS 5000



Most of my operating time is spent operating mobile, so I was delighted to get the opportunity to review the new AZDEN PCS 5000 two metre transceiver. This transceiver is FM

memory mode and a few other details. The one most noticeable difference to the front panel on this transceiver is the lack of a tuning knob. For the amateur who likes

contacts and 25 watts for the more distant DX.

Looking at the circuit diagram, I noticed that this model has done away with the normal PIN diode aerial switching arrangement and reverted to the 'old aerial relay' system. I call it an old aerial relay system tongue in cheek, because closer examination reveals a small relay no bigger than the average finger nail. One can't help but wonder if our Japanese friends have discovered that PIN diodes can be troublesome when switching VHF RF at high power or that another enterprising oriental company can produce relays cheaper than diodes!

Before I go on to describe the rig and operating procedure I feel I should have my first grumble, in fact my only one, about this unit, I do not like the way that the microphone and aerial connectors are on moulded flying leads that come via grommets from the back of the transceiver. Having met this in the commercial field I know that all too often the lead becomes worn and in both cases, eventually severed. I think that most mobile operators have at one time or another experienced poor microphone connections — imagine having to replace the complete lead into the set, instead of just the microphone plug. I think that this is

Mick Senior, G4EFO, gets out on the road to test out the Azden PCS-5000 two metre mobile — so how did it rate? Read on!

only and is different in many respects to its predecessors, and contemporaries.

Perhaps the main variation is that it has almost taken on a commercial PMR approach in the way that the aerial and microphone sockets come out of the unit. Up until now the radio amateur has been used to a chassis mounted aerial socket and a microphone socket on the front panel. Not so with the new Azden, it is a similar method to that seen on the Pye 'Reporter' range of equipment where the aerial and microphone sockets are on moulded fly leads emerging from the back of the unit.

First Thoughts

About 50% of the front panel is taken up with the keypad used for controlling the microprocessor. There is a very large liquid crystal display unit which also shows RF output power, repeater shift,

sitting in the car twiddling away, this is most disconcerting, however as this radio has been designed with the mobile operator in mind transceiver tuning can all be done from the microphone.

Two versions are available, the first is designed for the American market and covers from 144.000-147.995MHz, the European version covers from 144.00-145.9875MHz and can be programmed in 12.5kHz channel steps — or so it says in the accompanying manual, however the review unit could not be programmed in 12.5kHz steps. With simple modifications and a small tune up the transceiver will cover from 140.000 — 152.000MHz. The transceiver incorporates most of the usual FM transceiver facilities including scan, delayed scan, reverse repeater, switchable tone burst and non-standard split operation for duplex working. There are two power levels, five watts for local

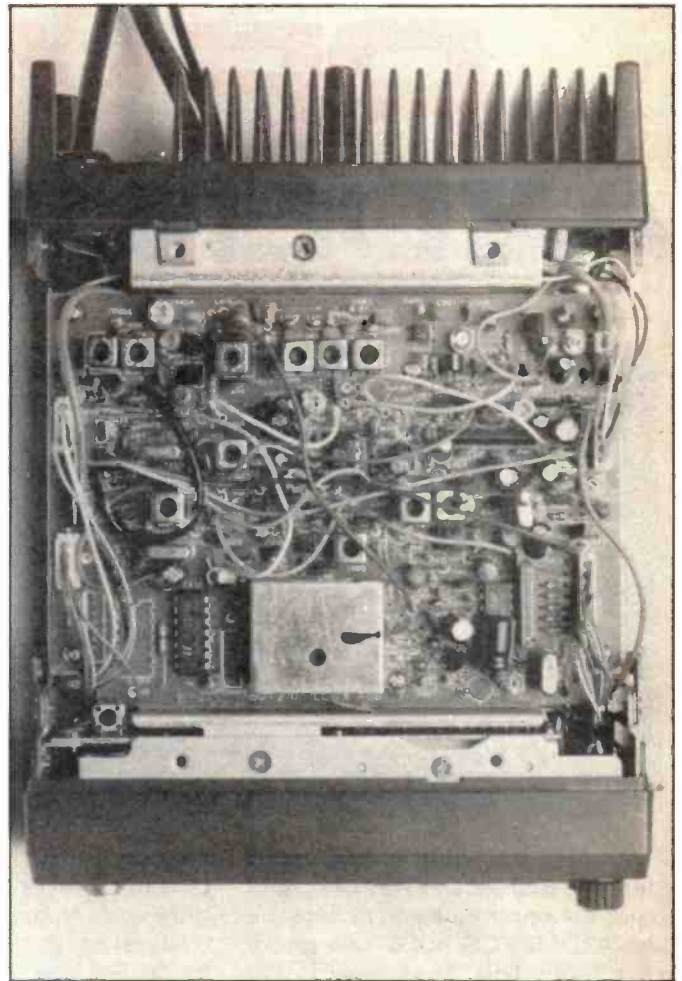
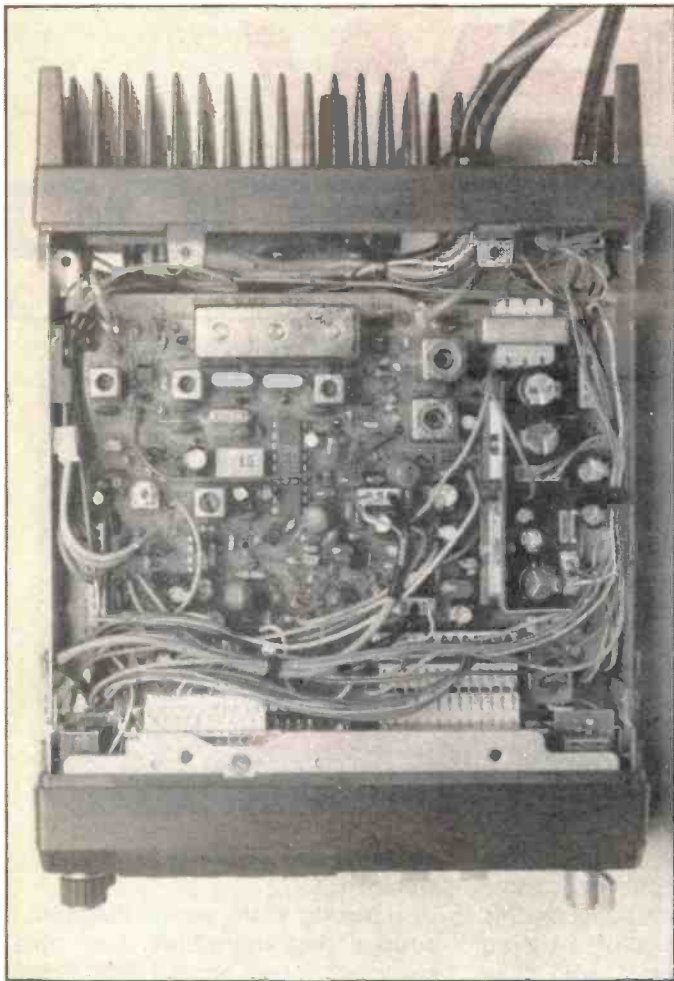

bad planning on these rigs and I am sure it's been done just to save a few yen!

'Driving' the rig

The LCD (which takes up almost a third of the front panel) is illuminated, and shows up well under all lighting conditions. The frequency readout is large making it useful for the mobile operator to see at a glance and as an integral part of the LCD, the makers have incorporated several other features. These include a relative power meter, a low power transmit indicator and '+' or '-' signs to indicate the mode of repeater shift. There are also indicators of 'busy channel', priority channel' and hold on the display. Last, but not least (and in 'reverse video') is an indication that the user has selected memory mode.

Just below the LCD is a four position switch marked 'M Mode'. It has positions A, B, A-B and AxB — when used in conjunction with the keypad, position 'A' allows the user to programme ten frequencies into

memory A, likewise when B is selected another ten channels can be programmed into memory B. When the operator selects the scan mode it will scan whichever memory bank has been selected or, if the user then decides to select A-B, the transceiver first scans memory A and then B. Now comes the clever bit, when AxB is selected, the transceiver scans memory A for received signals but transmits on the frequency stored on 'B' of the corresponding number. In this manner totally odd frequency shifts can be utilised.

The remaining three function switches on the left side of the front panel are toneburst on and off, Hi-low power switch and 'Rev' for checking repeater inputs. This is a really useful addition to an FM rig because it prevents the frequency synthesiser 'rusting into position' by tempting the user off the local repeater.

If we turn to the keypad we can see that this takes up almost 50% of the front panel. Using the keypad the operator can select a number of

options, starting with repeater shift (which can be varied between 5kHz and 1MHz) the user must ensure first that the transceiver is not in the memory mode by checking the LCD, if 'M Mode' is showing the M/D button is pressed, then the amount of shift required is selected. If, for example the usual 600kHz shift is required, select '0.600', for '0'MHz and '600'kHz then press the 'SHF' button. Two pips will be heard indicating correct entry.

Channel spacing can also be varied from 5 to 125kHz depending on which model you have — the method of entry is simple and similar to that of selecting repeater shift. Referring to Table 1, you must first decide what channel spacing you require, press the appropriate button and then press the 'SCN' button. Again two pips will be heard signifying correct entry.

The transceiver also has a priority channel function which is located in memory A and stored in position 0, and this should be borne in mind before programming the memories. To program memories,

first select either the A or B memory bank with the mode switch. Then as previously, make sure that the transceiver is not in memory mode, select the frequency required (the first two digits are permanently displayed, so for S20 we just add 5,500) then press the 'ENT' button, then the 'MW' button to get into 'memory write' mode. At this point, the memory channel in the top left of the LCD will start to flash so you then simply enter the memory number where you want this frequency stored. For example press '6', and S20 is then programmed into memory six. If you wanted to programme five simplex and five repeater channels into memory A, simply follow the same procedure as described but when you want to enter the repeater channels, select the repeater output frequency. Push the enter button and before pressing the 'MW' selection, enter the shift you want with the 'SHF' button. One press gives you + shift, a second press gives - shift and the third press reverts back to simplex. So it is very useful to be able to store both simplex and repeater frequencies in each memory bank.

If we return to the priority channel mentioned earlier (stored in memory A0) by pressing the 'PRI' button this frequency is checked every four seconds and if a signal is present it is indicated by a series of pips. So you must be careful what you program into this channel or you may find that the local repeater starts to give you the 'pip', literally!

Complete control of the transceiver, both up and down scan, priority channel and PTT is given by four simple controls on the microphone.

The controls are:—

1. . . . PTT
2. . . . Priority channel switch
3. . . . Frequency adjust upwards
4. . . . Frequency adjust downwards

Switch 1 needs no explanation being a conventional press to talk system, Switch 2 allows the operator to QSY to a frequency programmed into channel A0, the priority channel and a second press reverts back to the previous frequency. Pressing this button when in scan mode stops the receiver scanning. Buttons 2 and 3 are for frequency shift both up and down. If either button is held for more than half a second, the fre-

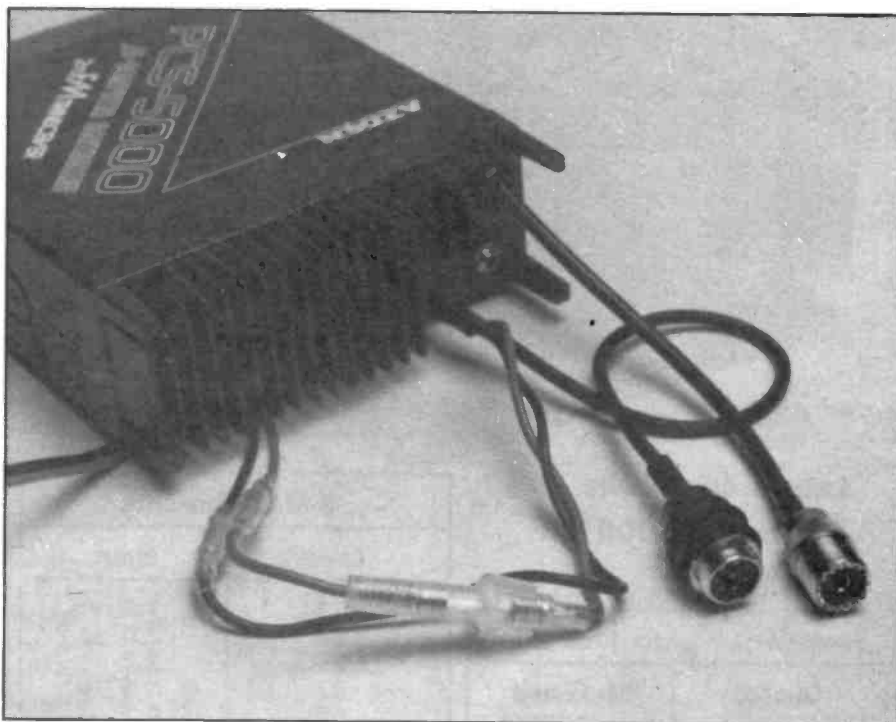

you manage to tune back to the station he's probably already gone QRT.

The transmitter has separate preset controls for mic gain and deviation which can be adjusted to a maximum of 10kHz. The access tone generator, which is crystal controlled, also has a preset on the output allowing the tone-burst deviation to be adjusted between 2 and 6kHz. The frequency modulation is derived at 16.9MHz, buffered and then amplified before being mixed with the PLL circuit in a double balanced pair of 2SK125 FeT's. Three stages of filtering ensure that an extremely 'clean' signal at low level is amplified at low-level before being

frequency will increment upwards or downwards at the rate of 12 channels per second.

There are two levels of scanning on this receiver which I found quite useful. The first scan mode pauses on a signal for six seconds and then moves on. The second mode, ideal for use in remote areas when looking for a contact, stops on a signal and will not start scanning again until the carrier drops. How often has your scanner stopped when you're mobile, you attempt to join the QSO, but the scanner has moved on before you know who you're listening to or have had a chance to stop the transceiver on the frequency. By the time





**Laboratory results —
Azden PCS-5000**

Receiver

Sensitivity: μV pd for 12dB SINAD	
Quoted	Measured
0.15 μV	0.14 μV

Squelch Sensitivity	
Threshold	0.1 μV
Maximum	0.5 μV

Receive Current Consumption	
Quoted	0.6A
No signal	0.22A
Max volume	0.49A

S Meter Linearity	
Level	Input
S1	1.2 μV
S3	2.0
S5	3.2
S7	4.5
S9	5.7

Adjacent Channel Selectivity: Measured as a 6dB degradation of a 12dB SINAD signal on the wanted frequency	
Separation	Rejection
+ 25kHz	66dB
- 25kHz	66dB

Image Rejection: 93dB

Transmitter

TX Power and Current Consumption		
	Quoted	Measured
Low Power	5W/-	5W/2.2A
High Power	25W/6.0A	25W/4.5A

Harmonics/Spurii	
Quoted	- 60dB
2nd harmonic	- 76dB
3rd	- 74dB
All other outputs less than - 85dB	

Deviation		
	Quoted	Measured
Maximum range	+/- 5kHz	+/- 10kHz
Preset level		+/- 4.5kHz

Step (kHz)	Code	0	1	2	3	4	5	6	7	8	9
for USA Model		5	10	15	20	25	30	35	40	45	50
for EU Model		12.5	25	37.5	50	62.5	75	87.5	100	112.5	125

* European model can have the USA step according to an order.

sent to the now well known M57737 PA block.

I was impressed by the RF 'cleanliness' of the review model. Sampling a small amount of RF energy on the spectrum analyser showed the 2nd and 3rd harmonic content to be the best part of 80dB lower than the fundamental frequency. Even with the gain controls at maximum no other emission, spurious or otherwise, could be detected.

Technical considerations

The overall sensitivity of the receiver is very good. Signals well below 0.2 μV are easily readable and the audio output, even when used in my car, is adequate. As for the circuit design the signal is fed through a double tuned transformer/filter arrangement before passing to the first RF stage. This giving the 3SK77 dual gate MosFet a degree of isolation from unwanted signals. The amplified signal is then fed to a second 3SK77 in the mixer stage via a triple screened helical filter which provides excellent rejection to unwanted spurious signals. A crystal filter arrangement and amplifier stage then feeds the conventional MC3359 IF strip, the output being passed to a TA72222AP audio amplifier IC capable of giving over 2 watts into an 8 ohm speaker. The design of this transceiver seems to follow well practiced and conventional methods which has been borne out by the workshop tests proving that the unit performs very well.

The transmitter was very clean when looked at on the spectrum analyser, and the modulation, which the accompanying spec sheet claims to be 'true FM not phase modulation giving unsurpassed intelligibility and audio fidelity' is excellent. Remarks such as 'very nice' and 'what pleasant audio' seem to confirm the makers claim — or perhaps the locals have succumbed to my dulcet tones at last!

To sum up, the unit is compact, neat, works very well and more important easy to operate if you spend ten minutes reading the manual. The Azden PCS-5000 costs £299.00.

My thanks go to Waters & Stanton of Hockley for the loan of the review model.

RADIO Tomorrow

- 1 Apr** Three Counties ARC: Talk 'The real hobby' by Dick Ganderton.
SE Kent YMCA ARC: AGM.
Trowbridge DARC: Natter night — all fools welcome!
Cheshunt DARC: Watch this space! — G3TIK.
Rolls Royce ARC: Invitation to local clubs for a social and games night.
- 2 Apr** Spen Valley ARS: AGM.
Salop ARS: Construction contest.
Pontefract DARS: Arrangements for Components Fair.
Bredhurst RTS: Talk 'DXpedition to Andorra' by Burt Mengerink, G1LAC.
Vale of Evesham RAC: Quiz v Cheltenham ARA, Round of Gras, Badsey.
North Wakefield RC: Junk sale.
- 3 Apr** Axe Valley ARC: 2 metre fox hunt.
AMRAC: Meeting.
Aberdeen ARS: Junk sale.
Maidstone YMCA ARS: HF NFD arrangements.
Coventry ARS: Talk 'Fifty years of amateur radio' by G3BA.
Harrow RS: Activity night.
Loughborough DARC: Night on the air.
Dunstable Downs RC: Talk/demo 'Night vision' by Adrian, G8XQN.
- 5 Apr** **Cambridgeshire Repeater Group: 'Junk Sale Rally Extravaganza' Pye Telecom Canteen, St Andrews Road, Chesterton, Cambridge. Opens 10.30 am, trade stands, junk sale, bring & buy, talk-in on S22 and RB14 by G5PI.**
Pontefract DARS: Components Fair, Carleton Community Centre, Pontefract. Admission free, open 11 am to 4.30 pm, talk-in on S22, trade stands, bring & buy, bookstall, refreshments and bar.
- 6 Apr** Felixstowe DARS: Talk 'BBC transmitter engineering' by Chris Driver, G6CMD.
Braintree DARS: Construction contest.
Welwyn/Hatfield ARC: Basic power supplies.
Burnham Beeches RC: Talk 'Cable TV' by Joe Delahunty of Windsor TV.
Rhyl DARC: Talk 'Fire prevention'.
Todmorden DARS: Talk by CEGB.
Sutton & Cheam RS: Natter night.
Stourbridge DARS: Night on the air.
- 7 Apr** Worksop ARS: Junk sale.
Harpenden ARC: Junk sale.
Fylde ARS: Talk 'Aurora, what causes it' part 2, with tape and slide show.
Wakefield DRS: Computer evening.
Warrington ARC: AGM.
- 8 Apr** Cheshunt DARC: Quiz with Harlow RS.
- 8 Apr** Stockport RS: Talk 'Fire-fighting on North Sea oil rigs' by Ray Kepper.
Fareham DARC: Talk 'Contest operating' by GOERS.
- 9 Apr** Edgware DRS: Talk 'The origins of morse' by Tony Smith, G4FAI.
Southgate ARC: Surplus equipment sale.
Salop ARS: Natter night.
North Wakefield RC: Talk 'First aid for the shack' by Tony Dixon.
- 10 Apr** Loughton DARS: AGM.
N Bristol ARC: Lecture 'QRP' by Bill Beacham.
Wimbledon DARS: Surplus equipment sale.
Maidstone YMCA ARS: Natter night, RAE & CW.
Itchen Valley RC: Talk 'The electron microscope' by Mike, G4NMP.
Coventry ARS: Talk 'Radio Communications & the Police' by Ch. Insp. Hornbrook.
Dunstable Downs RC: SSTV Demo by Clive, G4ENB.
- 11 Apr** Wakefield DRS: Science Museum visit.
- 13 Apr** Milton Keynes DARS: Bring and buy.
Atherstone ARC: Talk by officers of the DTI RIS.
- 14 Apr** Wakefield DRS: AGM.
Keighly ARS: Junk sale.
Bury RS: Social evening.
Dartford Heath DFC: Pre-hunt meeting, Horse & Groom, Leyton Cross Road, Dartford.
Loughborough DARC: Talk 'Medical electronics' by Chris, G1ETZ.
Reading DARC: Natter night.
Midland ARS: AMTOR demonstration by Bob, G4YUI.
Verulam ARC: Activity evening.
Warrington ARC: Talk 'Photography' by Gordon Carter, G4SCI.
- 15 Apr** Three Counties ARC: Talk 'Radio Society of Great Britain' by John Nelson, G4FRX.
Trowbridge DARC: Activity night — details from sec.
Hastings ERC: Junk auction.
Cheshunt DARC: Natter night.
Stockport RS: Informal natter night.
- 16 Apr** Spen Valley ARS: Film night.
Bredhurst RTS: Talk 'Crime prevention in the home'.
Vale of Evesham RAC: Informal meeting, Gardeners Arms, Charlton.
Salop ARS: Gunpowder 2!
North Wakefield RC: Talk by the RIS.
- 17 Apr** Maidstone YMCA ARS: Good Friday (shack only).
Coventry ARS: Morse tuition & night on the air.
Harrow RS: Activity night.
Sutton & Cheam RS: Junk sale.

- 19 Apr Dartford Heath DFC: Club hunt, 2.30 pm, Dartford Heath.
- 20 Apr Burnham Beeches RC: No meeting — foxhunt at 5 pm.
Rhyl DARC: Talk 'Satellites'.
Todmorden DARS: Chat night.
- 21 Apr Worksop ARS: Visit to local police station (voluntary we hope! — Ed).
Harpenden ARC: Talk 'Antennas' by Don, G3JVN.
Fylde ARS: Informal meeting and morse.
Wakefield DRS: On the air & club project problems.
Loughborough DARC: Pub night — Black Swan Shepshed, perhaps some /P first.
Bury St Edmunds ARS: Packet radio talk and demo by G4XRK.
Warrington ARC: Inter club quiz v Bury ARS.
- 22 Apr Cheshunt DARC: Discussion on TVI, BCI, AFI.
Stockport RS: Natter night.
Chiltern ARC: Film show.
- 23 Apr Edgware DRS: Informal meeting.
Southgate ARC: Informal evening.
Salop ARS: HF night on the air.
North Wakefield RC: Night on the air.
- 24 Apr Halifax DARS: Club dinner.
N Bristol ARC: Homebrew competition.
Wimbledon DARS: Talk 'HF maritime radio' by Mike Blunden, G3PFH.
Maidstone YMCA ARS: Natter night, RAE & CW.
Itchen Valley RC: Talk 'Metal detecting'.
Coventry ARS: The 'Fun' Construction Competition.
- 25 Apr Loughton DARS: Special event weekend.
- 26 Apr Lough Erne ARC: Annual mobile rally at Killyhevlin Hotel, Enneskilen. Opens at noon with trade stands and speakers.
Sutton & Cheam RS: RSGB VHF Convention, Sandown Park.
- 27 Apr Atherstone ARC: Club night & night on the air.
Stourbridge DARS: Main meeting.
- 28 Apr Wakefield DRS: Talk on Egypt by G4AAU.
Keighley ARS: Visit to HMS Forest Moor, Harrogate.
Loughborough DARC: DF event No.1.
Reading DARC: Alignment evening.
Verulam ARC: Talk 'Amateur rigs of the year' by Angus McKenzie, G3OSS.
Warrington ARC: Open forum.
- 29 Apr Three Counties ARC: AGM.
SE Kent YMCA ARC: Talk 'Top Band' by John Heys.
Trowbridge DARC: Natter night.
Cheshunt DARC: Natter night.
- 30 Apr Edgware DRS: Straight key evening.
Bredhurst RTS: Talk 'QSL bureau' by Martin, G4RVV.
Salop ARC: Junk sale.
North Wakefield RC: Monthly meeting.
- 1 May Axe Vale ARC: Talk and film on HM Coastguard plus meteosat equipment at Allhallows school.
Maidstone YMCA ARS: Rally meeting.
Dartford Heath DFC: AGM, Scout House, Broomhill Rd, Dartford.
Coventry ARS: Two metre DF contest.
Sutton & Cheam RS: Sutton & Cheam RS Ruby Anniversary — Special event station GB4SAC.
Dunstable Downs RC: Rig doctor Phil, G6EES makes another visit!
- 2 May BATC Rally, Rugby Post House Hotel, 10.30am, lectures, demonstrations and trade stands.
- 2 May Burnham Beeches RC: Bank Holiday picnic.
Kelso ARS: 4th Anglo-Scottish Rally, Tait Hall, Kelso from 11am to 5pm, talk-in S22, traders, club stalls, snacks, bar morse tests. Entry £1.
- 4 May Felixstowe DARS: Social.
Welwyn/Hatfield ARC: Contesting.
Burnham Beeches RC: Bank holiday picnic.
Rhyl DARC: Talk 'Computers in radio'.
Sutton & Cheam RS: Natter night.
- 5 May Fylde ARS: Equipment sale.
Wakefield DRS: Bring & buy.
Dartford Heath DFC: pre-hunt meeting, Horse & Groom, Leyton Cross Road.
Loughborough DARC: Night on the air.
Warrington ARC: Talk 'The new transceiver' by George Fare, G3OGQ.
- 6 May Cheshunt DARC: Construction contest judging.
Rolls Royce ARC: Foxhunt.
Fareham DARC: Talk 'Six to Ten metre operation' by G4JCC.
- 7 May Spen Valley ARS: Visit (TBA).
Vale of Evesham RAC: Talk & demo 'Satellite TV' by Simon G6AHX — Round of Gras, Badsey.
Salop ARS: Natter night.
North Wakefield RC: Homebrew night.
- 8 May N Bristol ARC: Bullseye inter-club darts competition.
Wimbledon DARS: Constructors contest.
Maidstone YMCA ARS: Natter night, RAE & CW.
Coventry ARS: Morse tuition & night on the air.
Stourbridge DARS: Contest CQ MIR 24 hrs duration.
- 9 May
- 10 May Drayton Manor Rally.
Third Yeovil QRP Convention, The Preston Centre, Monks Dale, Yeovil. Entrance £1, talk-in on S22, open 0900 to 1700, lectures, special event station GB2LOW, refreshments. Details from: Eric Godfrey, G3GC on Yeovil 75533 or 21246.
Dartford Heath DFC: Club hunt, 2.30pm, Dartford Heath.
Swindon DARC: Radio & Electronics Rally, Oakfield School, Marlow Ave, Swindon. Opens 10am, talk-in on S22 and SU8. Free parking plus film show and other amusements for children. Further details — G8SFM on (066689) 307.
- 11 May Milton Keynes DARS: Talk 'Airborne radar' by GEC Avionics.
Atherstone ARC: Talk 'HF propagation' by Prof. Martin Harrison G3USF.
Exeter ARS: Surplus sale.

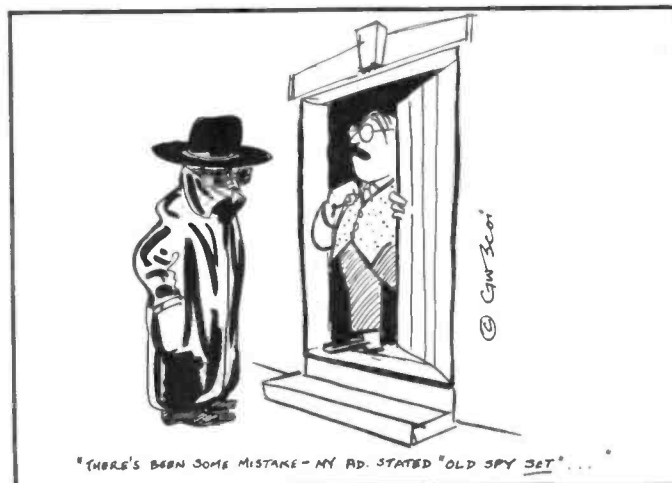



- 12 May Wakefield DRS: Quiz night.
Keighley ARS: Informal meeting.
Loughborough DARC: Talk 'Weather satellites' & demo by Don, G8AYG.
Reading DARC: HF NFD discussion & RSGB videos.
- 13 May Bury RS: Talk 'Maths with Maurice' by GOWBN.
Three Counties ARC: Talk 'Portsdown hill repeater' by Arthur Price.
Cheshunt DARC: Natter night.
Stockport RS: Talk 'Op-amps and active filters' by Andrew, G8OMH.
- 14 May Salop ARS: Foxhunt.
North Wakefield RC: Night on the air.
- 15 May N Bristol ARC: Home-brew wine tasting.
Maidstone YMCA ARS: Test equipment.
Bredhurst RTS: Special event station GBOBRC.
Coventry ARS: Talk 'Earliest days of radio' by GOAJB.
Sutton & Cheam RS: AGM.
Dunstable Downs RC: Junk sale.
- 16 May Bredhurst RTS: Special event station.
- 17 May Bredhurst RTS: Special event station.
- 18 May Felixstowe DARS: Construction contest.
Burnham Beeches RC: Talk 'Satellites' by Neill Taylor G4HLX, RSGB Region 6 repl
Rhyl DARC: Visit to fire station command centre.
Stourbridge DARS: Main meeting.
- 19 May Halifax DRS: Film night — Sellafield.
Loughborough DARS: DF event No.2.
Midland ARS: Junk sale and natter night.
Bury St Edmunds ARS: third Marconi lecture.
- 20 May Hastings ERC: Talk 'Cellphones'.
Atherstone ERC: Guest speaker — TBA.
Stockport RS: Informal natter night.
Fareham DARC: Members lecturettes 'I did it my way' by G3CCB.
- 21 May Spen Valley ARS: Talk 'Advances in communications systems in the last 10 years' by Anthony Galvin G8YZR.
Vale of Evesham RAC: Informal meeting, Gardeners Arms, Charlton.
Salop ARS: HF night on the air.
North Wakefield RC: Talk 'Bee keeping' by Dave Marriott.
- 22 May N Bristol ARC: Live demo on satellite TV.
Maidstone YMCA ARS: Final rally arrangements.
- 24 May Coventry ARS: Morse tuition & night on the air.
Maidstone Mobile Rally — details from Alan Judge on Maidstone 50709.
East Suffolk Wireless Revival: Civil Service Sportsground, Straight Road, Bucklesham, Ipswich, Suffolk. Traders, car-boot sale, aerial testing range, transceiver testing. Talk-in on S22, GB3PO & GB3IH, Admission including car parking £1.
Plymouth ARC: Mobile Rally, Plymstock Comprehensive School, Plymstock, Plymouth. 10am till 5pm, bring and buy, raffles, refreshments, free parking. Talk-in S22.
- 25 May Atherstone ARC: Informal at The Bull, Witherley, 8pm.
Sutton & Cheam RS: Cheam Carnival — Special event station.
- 26 May Wakefield DRS: On the air.
Keighley ARS: Annual foxhunt.
Loughborough DARC: Portable evening.
- 27 May Three Counties ARC: Talk 'Crofton beam engines' by Peter Hiron.
Atherstone ARC: DF hunt 1.
Cheshunt DARC: Natter night.
Stockport RS: Pre-NFD planning meeting.
Sutton & Cheam RS: Talk to Ewell Rotaract.
Chiltern ARC: TBA.
- 28 May Edgeware DRS: Constructors contest and NFD briefing.
Salop ARS: Visit to ROC Headquarters.
North Wakefield RC: Monthly meeting.
- 29 May N Bristol ARC: HF activity night.
Wimbledon DARS: Talk 'The new collectors' by Tony G31EE.
Maidstone YMCA ARS: Natter night, RAE & CW.
Keighley ARS: Annual field event.
Coventry ARS: The (indoor!) direction finding game.
Dunstable Downs RC: TV show (repeat).
- 30 May Keighley ARS: Annual field event.
- 31 May Keighley ARS: Annual field event.
Sutton & Cheam RS: 'Sutton & Cheam RS Ruby Anniversary, Special event station — GB4SAC.

Will club secretaries please note that the deadline for the July 1987 segment of Radio Tomorrow (covering radio activities from 1st June to 1st August) is 21st April.



The power behind the Word — we look at religious broadcasters and also find that the USSR is cutting back on jamming.

Christian religious stations are different, and are worth giving a second hearing to. One of the best of them is Radio Station HCJB, in Quito, Ecuador, South America.

HCJB, which also calls itself 'The Voice of the Andes', was founded as far back as 1931, and is financed by an organisation called the World Radio Missinary Fellowship, Inc. This is an American charitable organisation, which means that American tax-payers can deduct their contributions from their income tax. Most of the religious broadcasting stations are financed in a similar way. Although they do broadcast programmes made by independent programme makers usually in the USA but also in Britain and other countries, a far higher proportion of HCJB's output is produced at their own studios in Quito, compared with other religious stations such as Trans World Radio in Monte Carlo. This gives the station a far more *intimate* style than the norm, more like a local station than an international radio station. Even after listening a couple of times, you will begin to recognise the presenters, if only by their accents. HCHB has recruited programme staff from all over the world, and in their

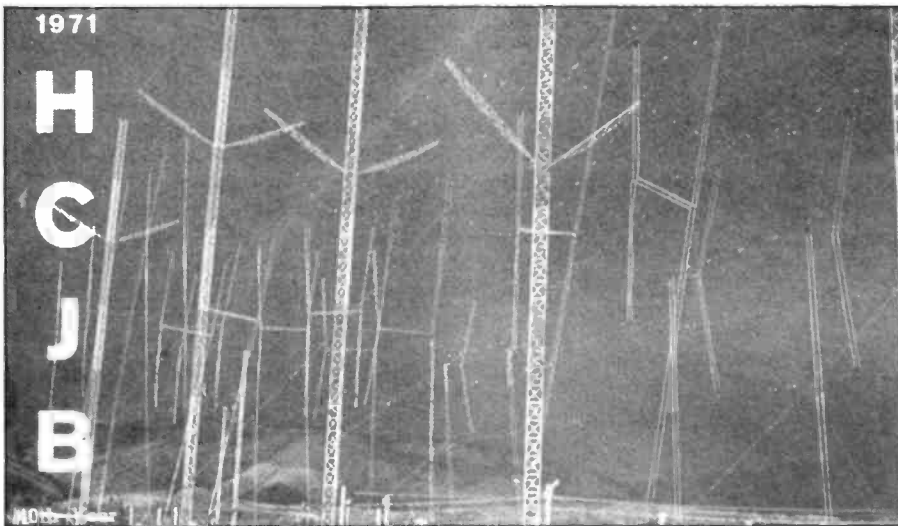

Part of HCJB's antenna complex at the transmitting site at Pifo.

In this *Listening On* we take a look at some of the world's religious broadcasting stations, and in particular Radio Station HCJB in Ecuador, as well as giving you some of the latest news of some of the more popular world radio stations.

Almost all short wave listeners, after listening to the broadcast bands for a while, will have heard the so-called 'Bible thumping' stations: stations broadcasting seemingly endless sermons by typically 'deep South'-accented American pastors, urging you to repent your sins and accept Jesus Christ. Even the most committed Christian would re-tune to another station after listening to a few minutes of some of these programmes, in the same way that your average Marxist would probably get fed up after a short while of listening to some of Radio Tirana's

more vitriolic broadcasts. In short, many such programmes are way 'over the top', at least for British tastes. However, a few of the

One of HCJB's "Galapagos Islands" series of QSL cards.



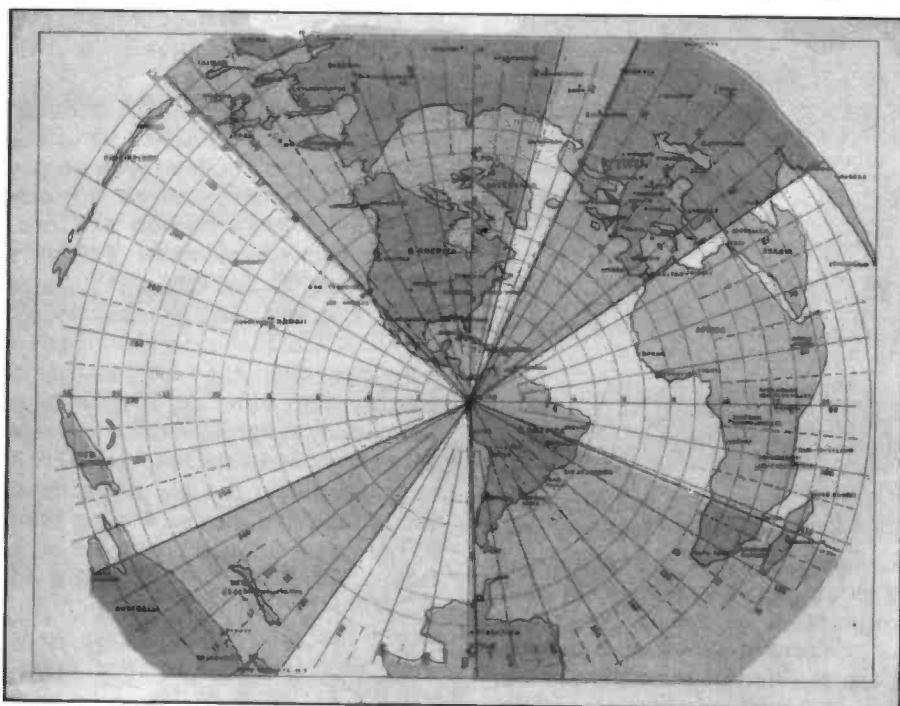

This great-circle map based on Quito shows HCJB's main target areas (shaded).

English-language programmes you will hear the accents of Scotland, New Zealand, Ireland, Canada and even Cockney mixing with the Americans.

HCJB has also recruited excellent engineers who also happen to be committed Christians, and they have designed and built whole studios, antenna systems and even some of the HCJB transmitters. It was, in fact, an HCJB engineer who invented the now famous cubical quad antenna, as used by radio amateurs all over the world. The story goes that, back in the early 1930's, shortly after HCJB's inception, it was noticed that under certain conditions the ends of the yagi-type elements glowed and even melted in the rarified atmosphere of the Andes. The power used in those days was relatively low by today's standards, but nevertheless was probably around 10,000 watts of continuous, AM, carrier power. Something had to be done, and one of the engineers came up with the then novel idea of folding the element ends back into a square shape, so that they no longer had any "ends" which could be destroyed by coronal discharge, and so the quad antenna was born.

These days, the HCJB transmitting site, which is at Pifo, several miles from Quito, uses curtain antenna arrays, but they still have an HCJB quad antenna directed on

Europe and reversible towards Australasia, which is used in the 13 metre band (21 MHz). During the last sunspot maximum, it used to put an extremely strong signal into Britain every evening. The HCJB engineers also seem keen to try any idea in order to help their programmes be heard — during the last sunspot maximum, and probably encouraged by the reception reports received on their 21MHz transmissions, they built and operated a very low power transmitter in the 11 metre-band (26 MHz). Despite being only 10 watts (one 50-thousandth of the power typically used by professional broadcasters today) it was widely heard with fair signals in Europe, thus proving that when conditions are right, and there is no interference, high powers are not required. I cannot believe that the BBC or Radio Moscow engineers would try such an idea!

From its beginnings until the 1960s, HCJB was well heard in North America and Europe, its two main target areas, but with the increase in transmitter powers being used by other radio stations and because more and more stations were coming on the air, reception quality, especially in Europe, began to deteriorate. To overcome this, HCJB engineers mounted the so-called 'Project Outreach' in the mid-1960s. It was realised that increased transmitter power was

required, as well as improved antenna facilities. But in a country like Ecuador, there was not sufficient electric power available to supply the amounts required for the project. So HCJB engineers designed and built their own hydroelectric generating station at Papallacta, which meant that twenty-five miles of transmission line had to be constructed, over one of the world's highest mountain ranges to get the power to Pifo. Three RCA 100 kilowatt transmitters were ordered, but meanwhile the engineers designed and built a 50kW transmitter which, reception reports indicated, improved reception all over the world. To make room for the new equipment the transmitter building was enlarged considerably in 1967, and then on 8th October of that year, the three RCA transmitters arrived from the States by specially chartered jets. During 1967 and 1968 they were brought into service, bringing HCJB's combined transmit-

The QSL for HCJBs 'project Outreach'.



Phase #3 - 50 Kilowatt Transmitter

While our representatives were contacting transmitter manufacturers regarding the possible purchase of a number of 100,000 watt transmitters, our engineering staff in Quito and Pifo designed and constructed this 50,000 watt model. When this transmitter went into service, reports indicated better reception all over the world.



The HCJB studio and administrative buildings in Quito.

ter power up to 570kW. Project Outreach was complete and once again 'The Voice of the Andes' was heard with clarity throughout the world.

Today, HCJB is far more than just a radio station. There is also HCJB-TV which broadcasts religious and cultural programmes in Spanish and Quechua, the local language, for the inhabitants of Quito. On top of this the staff, who are missionaries first and broadcasters second, are also involved in more traditional missionary work. There is a hospital, there are Bible correspondence schools in Spanish and Portuguese and a fully-equipped printing press, for printing religious tracts as well as station programme schedules, QSL cards etc.

Apart from the imported programmes made by independent programme makers, which tend to be of the hard-sell religious type, most of HCJB's programmes are

quite subtle in style, and are often more cultural rather than specifically religious in character. One such programme is called 'Happiness Is...'; presented by Dee Barklenko. It has a different theme every day, from anti-drink or anti-drug talks to moral guidance. Another programme, which may be of more immediate interest to most short wave listeners, is the 'DX Party Line'. For years presented by American Clayton Howard, it has recently been taken over by Brent Aldred, a New Zealander. This thirty-minute programme gives latest loggings made in North America, which sometimes can be of interest to European DXers as well, a 'Station Profile' which the operating schedule, frequency, verification policy and address is given for some hard to hear stations, such as 'La Cruz del Sur' in Bolivia. News of happenings in the ASWLC, the American Short Wave Listening Clubs (an umbrella organisation of

DX clubs similar to the European DX council) is also given in the programme.

HCJB has its own DX club for listeners. Called ANDREX it offers members a club bulletin with propagation information, antenna projects, HCJB's full transmission and programme schedules, news of HCJB's developments and QSLs etc. Apart from English programmes, HCJB also broadcasts in a number of other languages such as Finnish, Swedish, German and Spanish. They have a completely separate service for local listeners in Spanish Quechua, which is broadcast in the 90 metre band and on medium wave. A good time to hear their English programmes is from about 0645 GMT onwards, on 6.205MHz, which is beamed towards Europe. A second frequency, 9.860MHz is also in use, but is not usually as good as the 49 metre band outlet. Confusingly, there is also a service in English to North America running with different programmes at around the same time on 6.230MHz and this can often be heard as well, though with considerably weaker signals than 6.205 — proving that their beam antennas are very good indeed! The DX Party Line programme can be heard, for example, on Tuesdays at 0630 in the North American programme on 6.230MHz. It is a little more difficult to hear HCJB in the evenings at present, as the MUF is often below their frequency of 15.300MHz.

HCJB welcomes listeners' reception reports and comments on their programmes, often replying with personal letters of acknowledgment. Correct reception reports are verified with attractive QSL cards, the design of which is changed every few months. Series in the past have included 'Oil in Ecuador', 'Ecuador's Mountains', the 'Galapagos Islands' and Inca designs. Write to them at Radio Station HCJB, Box 691, Quito, Ecuador, South America.

Another new religious station?

The respected Christian Science Monitor newspaper has been broadcasting for a number of years in the USA and more recently via Radio Luxembourg, but for some time they have been planning a new short

Recording a music programme in one of HCJB's studios.





The stereo control room, used for HCJB's VHF/FM service in Spanish for the Quito area.

wave radio station, which should already have come on the air. The latest news is that test transmissions were supposed to begin by late February, but at the time of writing none had yet been heard. The Christian Science Monitor organisation also owns a station on the island of Saipan, in the Marianas Islands. For some years this has been broadcasting rock music to Japan, with Japanese DJs and English station identification jingles. This station, KYOI, is unfortunately not often heard in Europe. One that is, though, is KTWR, which is owned by the Trans World Radio organisation, whose main stations are in Monte Carlo and on the island of Bonaire in the Netherlands Antilles. KTWR is on Guam, and broadcasts Christian religious programmes in the languages of the Far East and English. Recently it has been booming in on 9.820MHz at 0900 GMT, when they start their programme in Chinese.

Now for the news...

Some of the best news from the broadcast bands recently has been that the Russians have stopped jamming the BBC's Russian service since the beginning of this year. These jammers consist of a buzzing noise which has been likened to the sound of a diesel motor, often with a morse identification such as "P.B.....P.B." interspersed, and they are intended to obliterate specific frequencies only. However, most jammer transmitters seem to be extremely badly adjusted and spread

many kHz, so that a jammer on, say, 11.780MHz (a long-time BBC Russian-language frequency) would also obliterate programmes on 11.770, 11.775, 11.785 and 11.790MHz, and more besides if you were unlucky. Unfortunately the Russians still see fit to jam America's Radio Liberty broadcasts, so the broadcast bands are by no means free of jamming signals yet, but at least it is a small start.

I have commented recently on the good signals to be heard from Radio Australia via the long path on 9.655MHz in the mornings. Lately however, there have also been good

The lights of Johannesburg at night are featured on this QSL from Radio RSA, "The Voice of South Africa".



signals via the short path, on 17.715MHz, from about 0600-0800 GMT. This frequency comes from a transmitter at Carnarvon in Western Australia. Always more difficult to hear, because of their low power (7½kW) and lack of highly directional antennas, is Radio New Zealand. At the time of writing though, RNZ is being heard with weak signals at around 0900 GMT on both 9.600 and 11.780MHz. Both of these frequencies seem to be coming via the long path.

Despite repeated rumours about its imminent closure, due to lack of listener response, VOA Europe is still going strong. Programmes are presented in Washington and sent by satellite to Europe from where they are broadcast by, for example, private VHF stations in Paris and on cable networks in the Netherlands. For listeners in Britain though, the only way to hear these programmes is via the Voice of America's medium wave station in Munich, West Germany, on 1197kHz. VOA Europe programmes are broadcast at all times when the transmitter is not in use for other language VOA programmes.

Finally, Radio RSA, "The Voice of South Africa" has a programme in English for listeners in West Africa and Europe at 0630-0730 GMT on 7.270, 11.900, 15.245 (a new frequency) and 17.780MHz (often well-received).

IC12E REVIEW



The IC-12E, at first sight very similar to the O2E

So Icom have taken the plunge! Not content with producing rigs from HF up to 70cm they have brought out what I believe is the first mass-market 1296MHz handheld. 'Who on earth needs it?' I hear you ask. At around £400 the black (well actually grey) box market is getting a bit pricey. So here follows a look at the 23cm band and Icom's newest offering.

It isn't really that surprising that Icom should bring out a portable 23cm rig. After all they have the experience in GHz technology gained from their superb 1271E base station multimode, and there's also an IC120 1W FM mobile on the market. Along with Microwave Modules and other companies offering transverters,

there is now quite a choice of 23cm gear and it all goes to making the band not nearly as deserted as first impressions seem to indicate, especially on SSB.

This is probably a very good thing for here I believe the adage 'use

haven't all converted to A licenses, just check the call book!) try listening on 70cm and above! Now with the advent of Icom's new range, 23cm is opening up to those nervous of UHF construction, despite our efforts elsewhere in this magazine.

Want to get onto 1296 but not keen on construction? Well, Icom have just introduced a handie for the band. Peter Metcalfe, G8DCZ, has a spin on it.

it or lose it' could apply. The RSGB are actively involved in working towards a solution to the radar situation on 23cm. Looking at the facts shows that this could become a very great problem in the future. For example, in the south east of England there are at least three strong radar signals from Pease Pottage (Gatwick) and Heathrow in the 1260-1270MHz region.

Another potential worry is that the proposed DBS (Direct Broadcasting by Satellite) systems could involve a first IF of around 1.3GHz! Problems with the neighbours could become acute; for who is going to accept the argument 'it's because you haven't got a very good TV' when they've just paid out close on £1,000? (Come on RSGB, supply a set of filters for this problem!).

Even with these potential hazards 23cm is still an attractive band. At this frequency aerials become a definite homebrew possibility, with the opportunity to experiment with some of the more exotic designs such as corner reflectors and even dishes. Commercially available aerials include such 'monsters' as 55 element Yagis. Just think . . . a pair of these would be little larger than a single six or seven element beam at 2m, and weigh rather less! What with large gain arrays, satellites and obscure propagation effects, 23cm can offer possibilities to satisfy any DX hunter.

As far as hardware is concerned, up until recently this has been a true pioneering band where valves still ruled. If you've ever wondered where all those G8s have gone to (no, they

Incidentally, a colleague of mine in the Electronics industry maintains that 'UHF construction isn't Electronics . . . it's an art form!' Art form indeed. Consider the IC12E, imagine designing an input stage and PA block with a flat response over a 40MHz bandwidth and still make it 'bombproof'! (TV designers take note please). Well Icom have tried it so let's take a look at the IC12E.

On The Surface

The first impression is that externally the 12E is very similar to the O2E or O4E. In fact the keypad and display are identical, giving the same synthesiser functions. The difference between this rig and its 2m and 70cm brothers become apparent when viewing the top panel. The controls are rearranged to make room for a dual colour led (green for Rx, red for Tx), an extra push button switching either RIT or VXO and the variable RIT/VXO control, which is positioned concentrically above the squelch pot. The general construction of the rig is that of an aluminium frame, around which the various boards are mounted, with a plastic front panel and a metal case to provide better heat sinking and degree of RF screening.

All in all, the rig is strongly built and I am sure that it would withstand considerable rough treatment just like its 2E and 4E ancestors. At approximately 70 x 180 x 40mm and weighing around 600g it does not compete with the current trend to subminiaturise handheld rigs. However, it fits nicely in the hand and if the trade off for size is strength of

construction, I know which I prefer!

It is nice to see that Icom have obviously thought about the type of environment in which a portable rig is used. The provision of rubber gaskets on case joints and rubber covering plugs for all top panel sockets should ensure a degree of moisture-proofing, making it ideal for all-weather operation.

The microphone is situated quite low down on the front panel and, being used to earlier Icom and other portables, I found myself talking into the wrong area. However this position does keep the aerial a little further from one's grey matter which can't be a bad thing! The battery pack is the standard Icom slip on/slip off unit with the addition of a locking catch, making it very easy to 'quick change' (ideal for those long all-night Raynet exercises!).

Powering the rig presents one with a whole range of options. The supplied battery pack is an 8.4V, 270mAh unit and, although they are not mentioned in the literature, I can see no reason why the alternative packs providing 425mAh (BP2) or 800mAh (BP8) should not be used for longer life between charging. I feel that this could be a very useful modification as the quoted current consumption on transmit (1W) is around 900mA and on receive 65mA (compared to the IC2E's 550mA at 1.5W Tx and 20mA Rx).

An alternative to battery power is to use the top panel DC power jack. Here the rig can be used with anything from 12V to 15V (eg. power supply, car battery etc) and if the battery pack is connected it is charged automatically, or of course the pack could be removed for remote charging.

Under The Surface

Internally the 12E is extremely well-built and comprises of three main circuit boards. One carries the synthesiser control logic; another carries the audio, second IF and the supply monitoring and metering circuits; the final board carries the higher frequency areas, eg. relay aerial switching (pretty well essential at these frequencies), first IF, Tx multipliers and VCO circuitry, etc. This final board is surrounded by shielding and bolted to the metal case back.

One or two novel features are



Close-up of the top panel controls — note the RIT control needed for these frequencies

apparent when scanning the circuit diagram. The control logic is down to just two integrated circuits; the main CPU with its associated memory, logic, D/A, etc, being dealt with by the first and an LCD driver by the second. Along with three transistors

that's all there is to it. (I wonder how long it will be before the advent of the single chip transceiver?).

The phase-locked VCO runs at a surprisingly high 630MHz to 649.995MHz followed by a simple doubler for transmit and 600.225 to

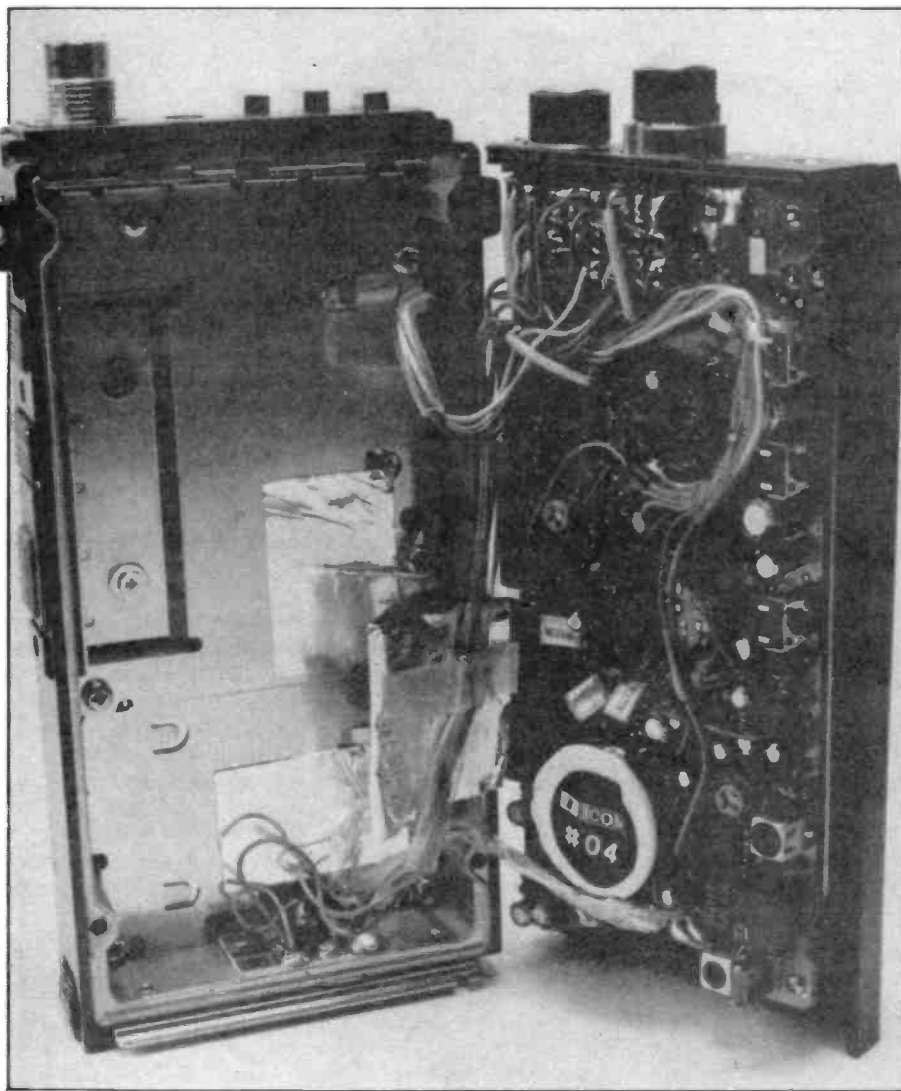

Internal view showing the extensive screening and case cum heatsink

620.22MHz on receive. After doubling, this gives a first IF of 55MHz — quite a jump from 1.3GHz! The second IF amplifier (435kHz), local oscillator, detector, noise amplifier and squelch are all contained within a single integrated circuit, following what is now fairly standard practice.

The general feel is of a no frills, tried and tested RF design, so much so that the front end is bipolar and not the more common FET device. Many will hail this as a useful reversion to older design techniques.

Icom's major breakthrough is in the use of what must be one of the first thick-film 1.3GHz PA modules to be used in the amateur market. Now considering my experience with 2m PA modules (they always seem to blow up!) I went a little white when I discovered this. Perhaps I'm being a bit pessimistic but I feel that I would rather see how it stands the test of time before I take the plunge.

The receive sensitivity is quoted as 0.32uV for 12dB SINAD and, although I had no means of measuring this, I certainly found the rig sensitive enough in use. The range of 1260 to 1299.9875MHz seems rather excessive considering that most of the time only the top 10MHz would be used. The stability is quoted as 5ppm at 0-50°C which seems good at first sight until you remember that at this sort of frequency it means a possible drift of up to 6.5kHz! No wonder they provide an RIT/VXO control! The audio output is around 500mW at 10% distortion and this proved more than adequate for outdoor use.

Manually Speaking

I was a little disappointed with the manual supplied as it is essentially an 'operators guide' and, unlike most Icom manuals, gives no circuit

description or 'tweaking' hints. There are, however, a couple of inside views showing the locations of major components and some adjustment points, so I suppose I shouldn't complain! Considering the wealth of functions available, wading through the manual took quite some time and I found the small 'pocket guide' invaluable. Perhaps, in view of the rough treatment that this will receive, it could be made rather more robust, eg. laminated?

The simple 'fault finding chart' incorporated in the manual is rather an insult as the level is pitched just below 'moron'! For example:

Fault: 'No sound comes from the speaker'

Cause: 'Power control completely counterclockwise'

Solution: 'Turn power control clockwise'

This goes on for three pages!!

The LCD display takes a little getting used to as it can show a profusion of indications. The full frequency is displayed which is no mean feat when tuned to, say, 1291.5250MHz. But the display doesn't stop here . . . it includes: memory number, call channel, + or - shift, 'T' for Tx, 'S' for scan, 'L' for dial lock, a low battery indicator, a second decimal point for priority function, a thirty bar signal strength/output power display and a 'U' to indicate that the synthesiser is unlocked. This final 'bug' can apparently occur occasionally at switch on and a CPU reset routine is explained in the manual.

The provision of an 'S'-meter is very welcome and is particularly useful when tuning the RIT. Incorporating this facility on the LCD display alleviates the space and mechanical ruggedness problems found with other moving coil S-meters.

I found the viewing angle of the display rather small and reflections on the front glass made it difficult to read under bright lights or in sunshine. However, the backlight, which is operated by a switch on the top panel, gave good display legibility under poor lighting conditions.

An irritating feature of the 12E is the use of TNC connectors for the aerial. I accept that these are excellent devices at this sort of frequency but a good quality BNC is adequate up to around 4GHz. How

many people carry adaptor leads? BNC is fairly standard, so why change?

Keyboard Crazy

Having three switches on the side of the rig (PTT, non-automatic toneburst and function key) made it rather awkward to use. Also as these switches are rubber overlays to internal switches I found it very tiring on the fingers during long transmissions. (OK, so I know that short overs are best). The function key provides second, and sometimes third, uses for the front panel push buttons; this gives the rig a Sinclairish feel and is jolly confusing too. But then, with the number of functions that this rig boasts, how else could Icom do it other than with a 30 or 40 button panel!

As to the synthesiser functions, they are basically the same as on the O2E and O4E. They include such things such as a keyboard lock (handy when the rig is clipped to your belt), the programming of any offset frequency, manual up/down tuning in either 12.5, 25, 37.5, 50 or 62.5kHz steps and of course, reverse repeater (ie, listen on the input). There are ten memories which are rather more versatile than one initially thinks. For example, memories 1-6 must have the same offset frequency but memories 7-10 (10) can be programmed independently. But it doesn't stop there; M3 is designated as a special call frequency and can be instantly brought into play by a single button push; M4 is the 'priority channel'; M5 and M6 store the limits of the programmed scan function with the scan stopping on busy channels.

Finally, a 'beep' function is available to announce keyboard entries. However, it isn't the simple piezoelectric device common to most rigs, its volume depends on the audio level setting. This is useful under noisy conditions where the gain would be turned up and other types of beep would be lost. Thankfully this function can be totally disabled!

In Action

In operation audio reports indicated typical Icom quality, which I have always found to be excellent. Experiments with a hastily lashed up



Icom's first 1296 handy

23cm transverter produced slightly noisy but perfectly copyable signals over ranges of a couple of miles (and over a path which isn't too good on 70cm) to a newly constructed HB9-CV at 23cm. If you think that unspectacular just think about the size of an HB9-CV for 23cm!!

The low population of 23cm along with the growing number of repeaters makes it an ideal band for long natters without worrying about hogging the airwaves. Perhaps Icom will change this situation for I feel that this IC12E could catch on quickly. At £400 it isn't a cheap rig, but considering the technology and the potentially low sales market this isn't really surprising. Icom seemed to have produced a winner and by sticking to their well proven design formula, most of their 2m and 70cm add-on unit (eg. mic) will fit the 12E. I wonder when they will bring out a combined 2/70/23 portable rig?

Safety note: Please note that there is a growing concern over the use of microwave radiation and its effects on health. As yet the exact effect is not fully known but one should always bear in mind the possible hazards involved. A good operating practice would be to use a speaker/mic and to hold the rig at arms length! ~

Fig 1. Current UK 1.3GHz bandplan. (Please note that only the sections relevant to the 12E are reproduced. For a fuller picture see RadCom November 1986 page 795).

Sub-band	Recommended Use
1260 - 1270	Space (Earth to space only)
1270 - 1286	TV
1286 - 1291	All modes
1291 - 1291.5	Repeater inputs (20 channels with 25kHz spacing)
1291.5 - 1296	All modes
1296 - 1296.025	Earth - Moon - Earth
1296.025 - 1296.5	Narrowband modes
1296.5 - 1296.6	Linear transponder input
1296.6 - 1296.7	Linear transponder output
1296.8 - 1296.990	Beacons exclusive
1297.0 - 1297.5	Repeater outputs (20 channels with 25kHz spacing)
1297.5 - 1298	FM simplex (20 channels with 25kHz spacing)
1298 - 1300	All modes

WEATHER SATELLITES THE EASY WAY



When I reviewed the Timestep Electronics equipment for resolving signals from the weather satellites in this magazine a while ago (October 1985), it was my first venture into the field of satellite reception and I

Russian satellite, 137.50MHz for NOAA6 and NOAA10 and 137.62 for NOAA9, but of course, there are nine spare positions which can be fitted with crystals for channels of the owner's choice. The receiver is de-

'VHF' and 'SHF' (used when receiving Meteosat) but if the Meteosat converter is not plugged in nothing will be picked up despite the presence of receiver noise. The third switch selects the 'mute' circuit which is built into the unit — immediately a signal appears and is of sufficient strength, the circuit is cut out and the receiver becomes active. Readers will recognise this as the 'squelch' option fitted to amateur receivers and transceivers except that the operating level is preset. The last switch on the panel is the 'power' switch, except for a rotary control which sets the volume of the received signal sent to the external speaker. The adjustment of this control has no effect on the received signal so that one can turn it right back and still have the 'squelch/mute' operate as soon as the satellite appears.

The rear panel has seven inlet/outlet positions on it and again looking from left to right they are as follows. 12 volts DC in (2.5mm power socket), 12 volts DC out (3.5mm socket), Speaker (3.5mm socket), Antenna (BNC), Aux (BNC for the optional Meteosat converter), Audio (5 pin DIN socket) and finally a second Aux (5 pin DIN socket) intended for Meteosat control functions. In my review setup, I used the 12 volts DC out to supply the Timestep masthead amplifier, a very convenient way of doing it.

A brief resumé of the technical specification might be of interest.

Ken Michaelson, G3RDG, gives a user's review of the Timestep Electronics weather satellite receiver and framestore.

found it a very exciting experience. The equipment at that time used the BBC computer together with an EPROM supplied by the makers, however the definition was not all that it might have been, only having four colours, or if a black and white monitor was used, four shades of grey. The new units are different altogether. I say 'units' because there is not only the 12 channel receiver specially designed with a wide bandwidth suitable for satellite reception but also the actual 'frame store' box.

The Receiver

This measures 32x6.5x16cms or 12.5(W) x 2.5(H) x 6.5(D) inches. The front and back panels are finished in cream matt paint with the lettering in dark chocolate. The case itself is also finished in this dark chocolate shade which makes for a most attractive appearance. As supplied for review, the receiver was fitted with crystals for three channels, 137.30MHz for the new

signed as an integral part of a complete setup, and as such full Meteosat switching is incorporated. This is an excellent idea because it means that the owner can expand the equipment at any time without the worry of having to make alterations before the expansion can operate. The actual equipment under review however, did not cover the reception of Meteosat. To do that would have required the additional dish antenna and down converter.

Controls

There are six controls on the front panel of the receiver and they are, from left to right, the twelve channel selector switch marked clearly from '1' to '12', then three switches close together. First a toggle switch marked CH1/CH2, which is only used when receiving Meteosat, giving a choice of two channels. This switch has no effect in normal use, that is to say, in the VHF range. The next switch is also a toggle type, switching between

First of all, it has no RF amplifier stages at all, Timestep Electronics claim that this leads to much superior interference rejection and yet still gives a sensitivity of 0.4uV PD for 12dB SINAD. They also state that by adding their masthead pre-amplifier to the antenna thus making it an 'active antenna', the receiver becomes the most sensitive currently available with a sensitivity of 0.15uV PD. I cannot confirm or deny these statements, but I can only say that by using the 'active' antenna with the receiver, I was able to obtain superlative pictures from both the NOAA and Russian satellites. The pictures shown elsewhere cannot do justice to the actual ones shown on the monitor screen, they must be seen to be believed!

The input frequency range is 137-138MHz. The bandwidth is 30kHz at 3dB achieved by a unique four pole ceramic filter. The unit has twelve channel operation as I mentioned above, and requires an input of between 12 and 18 volts DC. The current required ranges from a nominal 50mA to 300mA maximum. Audio output is nominally 1watt into 4 ohms and it will supply speakers in the impedance range of 2 to 32 ohms. It has full Meteosat switching including 'channel select' and AFC (automatic frequency control). The mute/squelch is preset to operate at 8dB SINAD but one can switch it out.

Frame Store Unit

Which now brings me to the Colour Frame Store unit. This is larger than the receiver, having greater depth. Its width and height are the same, being 12.5(W) x 2.5(H) inches but the depth is 12 inches. The unit I had for review had the

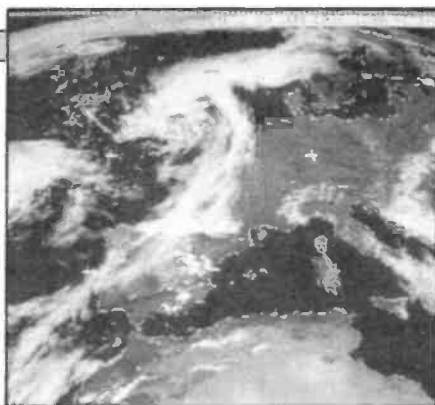

Meteosat view of the Northern hemisphere.

same colour front and back panels with the lettering in the same chocolate brown as the receiver, but the case was finished in black crackle paint, having four 'L' section aluminium bars fitted horizontally at the top and bottom of the front and back panels (two at the front and two at the back). This appearance was the same as the original Satellite Unit I reviewed last year, but I understand that all future Frame Store units will be assembled in cases to match those of the receiver, that is, cream and chocolate brown.

This frame store is quite different from the 'run of the mill' systems which are available at the moment, not only does it have a high quality RGB synthesiser but is also caters for 64 levels of colour as against the normal 16. The unit has full tape recorder switching and provision is also made for the connection of two separate receivers, so that one can connect up the 12 channel receiver to one socket and also connect a scanning receiver for any other transmissions which might be required, merely pressing a switch to change from one to the other. The front panel uses 'push on/push off' switches presenting an uncluttered appearance. The unit is completely

self-contained taking its power from the mains supply and only requiring an antenna and receiver to produce first class professional pictures.

Front Panel

Dealing with the front panel controls first, there are seventeen 'push on/push off' switches and three rotary controls. They are as follows, from left to right. Rotary control — SEA, rotary control — CLOUD, both labelled from 1 to 10, then three switches, ENHANCE, LEFT and RIGHT. These are followed by a batch of six switches controlling the 'scanning line frequency' and speed and labelled 0.5, 1.0, 2.0 at 120 lines/minute and 0.5, 1.0, 2.0 at 240 lines/minute. Next are a series of seven switches lettered HOLD, START, N-S, XTAL, RX1, RX2 and TAPE. RX1, RX2 and TAPE are labelled 'INPUT' below the switches. There is also a red LED which illuminates when 'POWER' switch is depressed. It is interesting to note that the unit, wired according to accepted modern practice, does not switch the mains on or off when the power switch is operated, it only switches the 12volt feed to the equipment. As the current consumption is so low, Timestep recommend that one does not switch the mains off when the frame store is not being used. Finally there is a rotary control labelled 'LEVEL' which has a green LED as an indicator.

The rear panel of the Frame Store has nine sockets for various operations. These are (from left to right) TAPE (5 pin DIN socket), RX2 (5 pin DIN socket), RX1 (5 pin DIN socket), VIDEO (BNC socket for monochrome monitor), RGB (6 pin DIN socket), AUX (5 pin DIN socket),

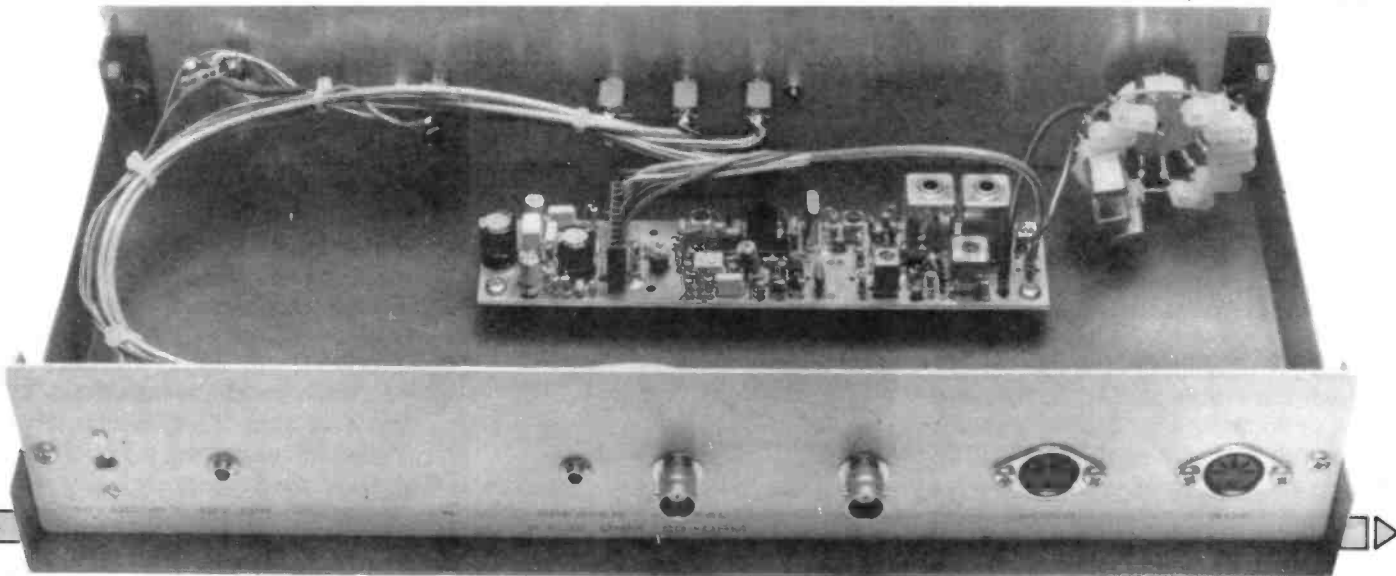

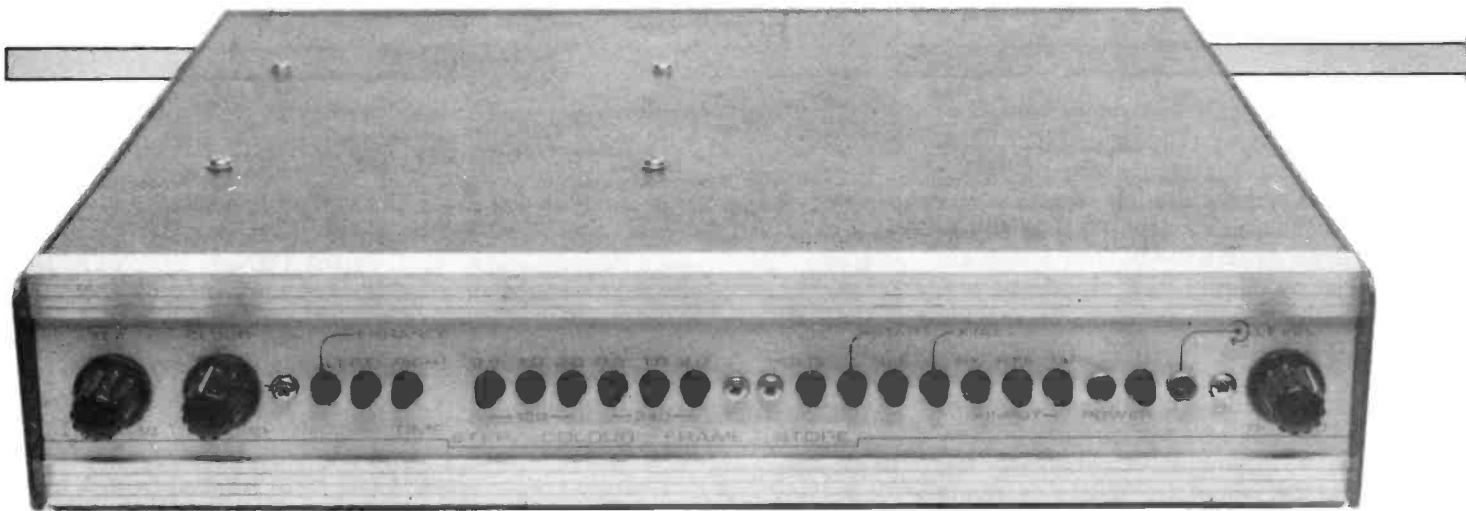

12 volt OUTPUT (3.5mm socket) and finally another 12 volt OUTPUT (2.5mm power socket). Both of the 12V sockets are wired in parallel and have a total output capacity of 400mA which is enough to run a receiver and pre-amp, or a receiver and the Meteosat converter. The supply is quite suitable for running a scanning receiver which is normally sensitive to voltage.

I have given a detailed description of the controls as with a total of twenty on the panel, they do require some explanation! Again starting from the left, the 'SEA' control adjusts the level of the sea sensor. One should set it just to fill in the sea on visible pictures, as opposed to infra red pictures, which work on the heat emitted by the atmosphere instead of the amount of light given off. The next control, 'CLOUD', adjusts the level of the cloud sensor and should be set to fill in the land and give the level of cloud resolution required. One has to remember that both controls will only work on visible light pictures in good daylight conditions, so if the light is poor or infra red pictures are being received, both the controls have to be turned anti-clockwise to their minimum position. The 'ENHANCE' switch is used in conjunction with the 'SEA' control to give a brighter sea image and I found that I always had this switch on in use. The next two switches, 'LEFT' and 'RIGHT' are two very useful facilities. Their use enables one to move the picture from side to side, as for example, when receiving NOAA9. Two pictures are transmitted at the same time by this satellite, one infra red and the other visible. In daylight hours you usually want the visible picture, so by using these controls, it is possible to centre the visible picture on the screen. The next two groups of switches are for

the scan line rate. The left hand three are for 120 lines/minute, and the right hand group for 240 lpm. The 120 lpm group is normally used for NOAA and Russian satellites. The 0.5 position gives the two pictures together, mentioned above, the 1.0 position gives either the infra red or visible picture depending on whether you move the picture with the 'LEFT' and 'RIGHT' switches mentioned above, and the 2.0 position gives a 'zoom' function using the 'LEFT' and 'RIGHT' controls to position that part of the screen where you want it. I found this facility particularly interesting.

The next group of three switches perform the same functions as the previous set, but at a speed of 240 lpm. It is these controls which are used for the reception of Meteosat and very occasionally, some Russian satellites. In *this* group the 0.5 position gives 1.5 images and would only be used if one wanted to see every edge of the picture, whole earth for example. The 1.0 position gives nearly all the picture transmitted from Meteosat and is the most commonly used whilst the 2.0 'zoom' function in this group is particularly useful on the 'CO2' and 'CO3' sections of Europe. In order to zoom in on western and central Eng-

More detailed view of Europe, centred on Italy.



land, one simply presses the 2.0 switch and waits for section 'CO2' to be transmitted. You stop the picture by means of the 'HOLD' switch just before Scotland goes off the screen. To zoom in on East Anglia press the 2.0 switch, wait for the 'CO3' image and press the 'LEFT' switch to get the grated strip, which isn't normally seen, to the far left of the screen, and there it is.

The next switch, 'HOLD' is self-explanatory. I mentioned it briefly above, but as soon as you have the picture you want, be it from NOAA or Meteosat, you just press 'HOLD' and the picture will remain on the screen as long as the power is on. This is very useful for making video recordings, should you so desire. Following this control is 'START'. In the 'out' position this gives automatic start when receiving Meteosat, since a start signal is sent at the beginning of each section transmitted. If you switch it on in the middle of a transmission it will be necessary to push it in for the duration of that particular picture, it can then be left out for automatic starting on the next complete frame. But for any other satellite, such as I was receiving on VHF, you have to push the control in to start operations (it is normally left in).

Next follows the control labelled 'N-S'. Normally this switch is left out but on some administration messages and a few picture on the 'CH2' section from Meteosat the picture is reversed, and one should press it in at the commencement of the transmission. Occasionally on VHF, orbiting satellites go from North to South instead of the usual direction of South to North, and in this case too, the switch should be pressed in. The next switch is 'XTAL' which (when pushed in) makes the synchronizing of the Frame Store operate under the

internal crystal control. The idea of this is that synchronisation will not be lost with a weak signal, and that any disturbance, electrical noise etc, will not affect the picture position. When the switch is 'out', the synchronisation is derived from the satellite signal itself. With Meteosat the signal is always strong and stable and the button can be left out, but when receiving NOAA or any other satellite on VHF, the crystal has to be left in circuit. This crystal also has an output to the tape socket so that a stereo tape recorder can be used to record the signal on one track while the 'synch' signal is recorded on the other. Following on from 'XTAL' we have two more switches, 'RX1' and 'RX2'. These select whichever receiver is connected at the rear to that particular socket. The makers recommend that the 12 channel receiver be connected to 'RX1', and any secondary receiver connected to 'RX2', so as to give maximum versatility to the system. Next to the 'POWER' switch is the 'LEVEL' control which controls the amplitude of information being processed, and should be adjusted with an incoming signal so that the green panel LED just flashes on peaks. The control will compensate for different satellites and tape recorders, but does not require frequent adjustment.

When receiving Meteosat at SHF, the signals are transmitted day and night and the Frame Store can be made to start and stop automatically, as well as positioning the picture centrally on the screen. As far as I was concerned with the review equipment, I could obtain pictures without any difficulty by using the 'MUTE' control which allowed the Frame Store to commence operation as soon as the signal was usable. I did not, in fact, have to be present as I connected the output to my mono tape recorder and examined the signals at my leisure when I returned. The result was quite stunning. The sea had variations of blue according to the brightness level received, and the clouds appeared as white with shades of grey with complete realism. The land, of course, was green, and as mentioned above, the 'SEA' and 'CLOUD' controls could be adjusted to suit the operator. The 'CLOUD' control allowed the cloud densities to be more precisely defined compared, as far as my own personal experience

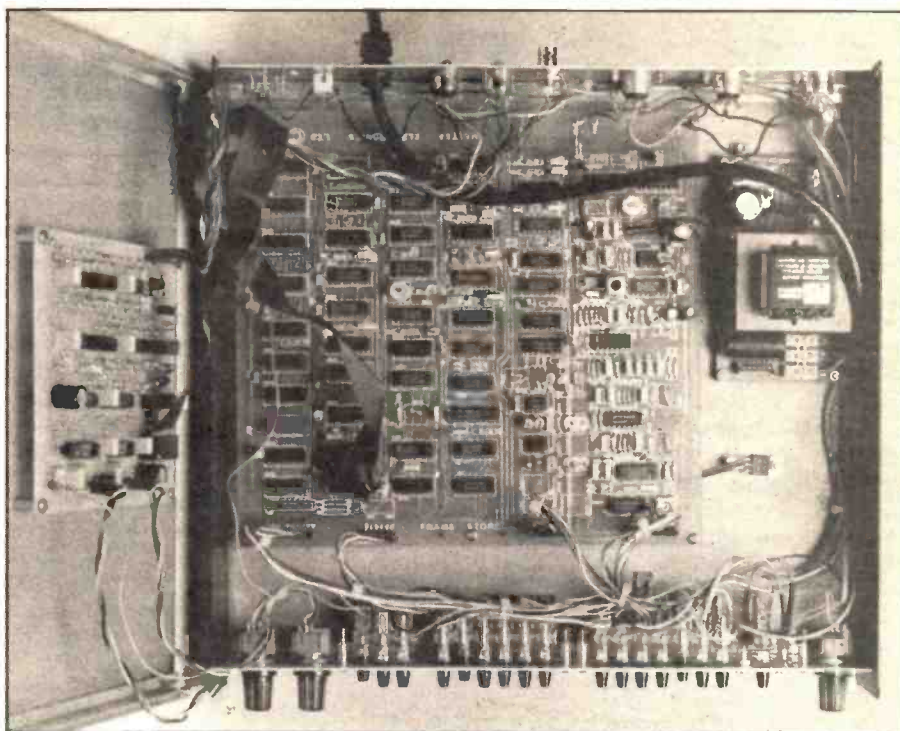

was concerned, with the original equipment using the BBC computer. No photograph or reproduction can really show this. All the colour and black and white processing is performed digitally and gives the improved quality of the image. The colour output is in linear RGB format to ensure that none of this quality is lost.

Summing up

In conclusion, I would say that these two units represent a great step forward from the previous offering of Timestep. They are beautifully made, attractive in appearance and for anyone wanting to follow the weather, the setup represents an interesting and engrossing pastime. I should point out that I have not mentioned the 137MHz antenna, nor the program called 'SATFOOT'. I can only tell you that I have a pair of crossed dipoles on the chimney stack which I use for two metres and it is almost impossible to receive NOAA9 or any other satellite on 137/138MHz with them, but as soon as the active antenna is connected, they all come in. My 12 volt supply for the pre-amp was

wired up separately as it is an earlier type, but the result is the same. SATFOOT is an Orbital Prediction program for the BBC micro which presents a choice of world projections and superimposes the radio footprints of all the weather satellites (and incidentally the UoSATS). Once I had told the computer the time and date, I was given the footprints of the satellites moving across the earth's surface. Without it I would have been listening at quite the wrong times. I must say that once you have tried out the VHF frequencies, you won't be satisfied until you have the dish and 'down converter' for Meteosat. That is the ultimate: All units are fully built, boxed, tested and ready to go. Timestep Electronics say that no extra cables are required, even a mains plug is fitted to the Frame Store lead. However, if you do not use the Frame Store then you will need a separate 12/15 volt DC supply for the rest of the items. Prices are as follows correct at time of going to press, all plus VAT:—

Thanks are due to Timestep Electronics Ltd of Newmarket, for the loan of the review equipment.

Colour frame store	£395 + VAT
Receiver 12 channel (3 crystals supplied)	£115 + VAT

Please note that Timestep no longer deal directly with the public, and all orders for amateur equipment are dealt with by Garex Electronics, 7 Norvic Road, Marsworth, Tring HP23 4LS, telephone 0296 668684.

Free Readers' ADS!

FOR SALE

KENWOOD TR 2500 case, spkr mic, needs new display, £145; **MM 2m** converter, £12; **5/8 mag** mount, £10; **JVC TMP3 3"** col video monitor, new, £120; **Marantz CD 54B** as new CD player (Philips CD104), £145; **Technics SUV4X 60wpc**, £115; **ZX Spectrum Plus** with Prism VTX5000 modem, get into Prestel cheap, £95 for the two. Call Bob (0227) 354378 anytime (Essex), GOZGI.

AR88 gen coverage receiver for sale, gwo, 550kHz to 31.0MHz, re-valved, £60. Phone (0362) 5772, Norfolk. **FOR SALE**, Sommerkamp 788DX, vgc, £250 or exchange for Superstar 2000, vgc, and £150. Tele Morecambe (0524) 422423.

YAESU for FT101, matched pair, NEC, 6JS6C's, £15; 1986 International Listing Callbook, £9; postage extra; Heath 0-12-U 5" lab scope with manual, £15; airbrush, type 52, retouching paint sprayer with compressor, £120, buyer collects as housebound. No phone. Jess, C4GOF, QTHR.

CYBERNET Delta, one transceiver, 934MHz, preamp Halbar, 17 element beam, colinear, all in vgc, £360 or exchange for HF 70cms or six metre transceiver, KW, E-Zee match tuning unit, £45 plus postage. Woodstock 812278.

TEAC disc drive, half-height, double sided density, uncased, £87.50; cased and cabled for BBC micro, £97.50, brand new; 8271 FDC chip, £30; switched mode PSU for dual drives, Astel, new, £15. Tel. 06845 68676 after 6 pm. Steve.

STANDARD 8800 2mtr FM trans, vgc, £120 ono; **Trio 7010 2m SSB** CW trans, boxed, vgc, £90 ono. Tel. 0375 678833, G4KIQ, Essex. **FOR SALE**, MMT432/285 transverter, 70cm, 4CX250B amplifier, C/W, built-in PSU, serial 8056, printer for Spectrum +128 or exchange FT780, FT790 or FT680, FT690, w.h.y. Phone Martyn

03635 471 (Devon).

FOR SALE, two 70cm 12XY's, £20 each, buyer collects. **G1BAS**, phone 0536 743748. **GRANDSTAND**, 27MHz CB homebase, twin meters, PWR/signal and SWR controls, RF gain, squelch, tone, clarifier, noise blanker, digital clock with auto time and sleep, £100 ono or w.h.y. 0303 862118.

TRIO TR-9000 2 metre multimode homebrew PSU, Jaybeam, 10 element, crossed Yagi plus all cables, coax, SWR, bridge, etc, £300 ovno, buyer collects and help dismantle, G40XE, QTHR. Tel. Burton upon Trent 761856.

ASR33 Teletype printer, 4 (four) card machine by Data Dynamics, spare paper and tapes, RS232 input, fully operational circuit and manuals, £30. 01-440 7874. **PYE** pocket phone 70, xtalled, RB2, RB4, SU8, spare Nicad and charger, £45; EC10, RX Mk2, £45; Codar AT5 TX 160/80m C/W, 12v PSU and change over switch, £30. Wanted, cheap 2m eqpt, or swaps, w.h.y. Bob, GODOK, 0705 473323.

FT102 AM/FM board fitted, FC102, ex cond, £650. **Black Star** freq counter, 600MHz, £80; **Spectrum 48K C/W**, PSU, £30. **Steve GOBBZ**, QTHR, 0705 472708.

COMMODORE 64 computer 1541 disc drive, data recorder, PSU, joystick, some disc based games, all handbooks and connecting leads. All brand new condition, two hours' use (honest!) Can deliver free 20 miles radius Wolverhampton, £175 ovno. Tel. Cannock 05435 77360. **FT290R C/W** Nicads charger, original packing, no mods, £220 or exchange PTX for AOR2001 or AOR2002. Raybould, 9 Upper Albert Road, Sheffield S8 9HR.

AZDEN PCS4000 2m, FM, 25w, RF out. 16 memories/scanning up/down, mic control. Repeater shift, mobile bracket/mic. Excellent condition. Offers? Tel. Bedford 0234 742139.

TRIO TS711E 2m multimode (base), used only twice, still boxed and obtained from Lowe, £840 new, will accept only £690, will also include Jaybeam 14 element parabeam, 60ft mast plus 50 metres H-100, will deliver. Phone Rick Selby 0757 701881 after 5.30 pm weekdays.

FOR SALE, Tele-reader, model CWR 675 EP, for receiving RTTY, CW, Baudot Asc II morse. With 5 1/2" green screen, as new, still in box, £400. Phone Marlborough (0672) 52571.

R-600 RX, vgc, £200. Tel. 0908 642398 G3JXR, QTHR. **HAND-HELD Yaesu 209 RH**, spare battery pack, mains charger, NC15 charges in 50 mins. Vox unit, mobile bracket, leather case, in perfect working order, £245 ono. Phone Michael GOCDD 01-958 8516 or 01-958 1164.

YAESU FT2700 dual bander, 8 months old, £360; 19 ele X-Y 70cm ant, £28; **FT290R** with mobile mount, charger, case and new Nicads, £225, Howes 80 meter transverter kit, assembled but not cased, £30. Tel. Les G4DBX 0270 71369.

MULLARD valve tester, 400 cards, £25; telequipment scope D33, £45; turntables in plinths, £10 each; stereo amps and tuner amp, £5; counters got faults, £5 each; two valve cone radio, £5; 2m converter valves, £5; 160m TX valves, £5; Avo Mod 40, £25. 01-883 3474.

SCANNER receiver, AR-2002 25-500MHz, 800-1300MHz plus Mac mount and antenna, £400. Tel. Leyland 0772 434014.

SCANNER PRO2003, 60 chan, programmable memory, £175; Philips World Receiver, 9 memory, AM/FM/SSB/CW, direct entry keypad, 146-29999, 87.5-108 FM, £146. Sandown, IOW (0983) 402273.

MUTEK 2m transverter, £190; **BNOS LPT 1443-180** linear, £220; **Daiwa MT20 2m** handheld with SD1 mobile adaptor,

£120; books, Radio Amateurs, Q + A manual, basic computer games, introducing Spectrum m/c, programming the 6809, £5 each, postage extra. Tel. GOGBD, 01-300 7323.

R1000 160 10 receiver, remote timer, mute, digital read-out, £195 or exchange for TS 130v, cash adjustment or buy. G1SSM, QTHR, 0482 863467 (Beverley).

R107, CR100, R1132, £30 ono each, or swap WWII RAF airborne radio, radar, w.h.y. Also wanted suitcase plus spares box for B2. Phil G6MQJ, 160 Worplesdon Road, Guildford GU2 6RX. Tel. 0483 572653.

TRIO TS130S 100w Solid State HF, MC35S mic, vgc, matching VFO120, brand new, boxed, £450. Yaesu MH1B8 scanning mic, brand new, boxed, £14; Trio LF30A LP filter brand, new, boxed, £20. GMOBVG, Dumfriesshire, phone 057-63615 or 057-63494.

FOR SALE, LA600 HF linear amplifier in good order, £250 ono; roller coasters from £15; ITT UHF base station or repeater type 30LRU43A, £50 ono. Buyer pays carriage. Telephone John Moxham after 6 pm, 0458 34105.

SALE, Dressler D200S, £600; Hammarlund HXL1 HF linear C/W spare valves, £250; Datong FL2, £45; 13 ele portable tonna, £25; pair Wharfedale 2XP 25w speakers, £25; variable bench PSU 1A, £5, all vgc. G4JBH, QTHR, 0935 23873.

TWO Amstrad CB900/901 27MHz FM transceivers, one mint, other excellent condition, suitable for legal CB or conversion to 10FM, both boxed, £25 each, seeking Trio TS440S or accessories. Phone Rob on 05057 4163, evenings please.

HRO-M, excellent condition, with PSU nine coil packs, covering 50kHz to 30MHz, re-valved, re-condensed, £125, offers. K. E. Franklin, 50 Abingdon Street, Burnham on Sea, Somerset. Tel. 0278 784205.

FOR SALE, TS520SE transceiver, immaculate condition with hand-held mic, £350, prefer buyer collects, but could deliver up to 50 miles. Trio TR2400 2 meter transceiver with charger and leather case, £120. Hallicrafter 5X28 receiver, working, with handbook, £45, buyer must collect as it weighs 75lbs. Call Bedford 213985.

OSCILLOSCOPE, 2½" military type, very robust, vgc, ideal field service, small and light, £40, offers; also scope tubes, DG7-5 2½", £18; 3AFP31 2½", £15; CV320 1½", £10. K. E. Franklin, 50 Abingdon Street, Burnham on Sea, Somerset. Tel. 0278 784205.

ICOM IC25E 25 watt 2 metre transceiver scan mic, Sanyo Betamax video recorder, VTC5150, cost £289, £100; stereo graphic equalizer, five band, £20; perfect or swap for Koss Pro headphones or vgc similar Icom IC25E, £150. Write 310 Anerley Park, Penge SE20 8NF.

STRUMECH 30ft telescopic lattice mast, base mounted, with top section and centre bearing. Rotator and control, plus DX32 2 ele triband beam, also 10 ele parabeam 2mtrs, cables if required. No split except parabeam, £350. Bargain. Your transport. G4HZF, Grimsby 71215.

QRP equipment, DSB-2 transceiver, top band, digital display, 3 watts output, ex WD, A14 manpack, 2-8MHz, all Solid State. Ex WD Mark 128 CW transceiver with accessories and homebrew power supplies. All with circuits and data. Offers. G3VKM, QTHR or tel. Aldeby 622 (Norfolk). **YAESU FT401B** QRO HF transceiver, matching FV401 VFO, speaker, all mint condition, £250, may exchange 70cm gear, w.h.y. Phone (0246) 569527, Derbyshire after 6 pm.

20 AMP 19UDC unstabilized power supply, 6v, 12v, 20v, secondary tapings, £20. Phone after 6 pm, 031-668 3451.

SELLING assembled CTX80 3WRF with full constructional details, £5; also CB regulated PSU by Fremark Electronics, Melksham, £5. Oldfield, 49 Stansfield Street, Todmorden, Lancs OL14 5EB. Telephone

Todmorden 6165.

FOR SALE, Advance O-30v 2A/0-15v 4A variable power supply, £100 ovno; Racal O-30MHz frequency meter, £70 ovno; 70cms 88X Yagi, offers only; 2 x SWR/PWR meters, offers only; Safe blocks, £3.50 each plus 24v/+12/-12v/+5v switch mode power supply, £40. Telephone Redhill 69251.

VOIGTLANDER VSL 3-E 1.8/50 power winder, Tamron mount, 2x converter, Tamron 28-70 wide angle, new Tamron 80-210 macro zoom, Vivitar 2500 bounce zoom thyristor flash, Hitacon auto 3000C cut off bounce flash, mint; exchange for modern digital communication receiver. A. Palmer, 68 Meadowvale Cres., Clifton Estate, Nottingham NE11 9NB.

ZENITH Royal 3000 transoceanic portable radio, as new, complete with leather case, handbook and service manual, £110 ono. Phone eves. 01-393 9115, Epsom area.

YAESU FRG7700 ATU with memory, £325, as new; FRG7B, £250; Nato 2000, suitable for conversion, £130 ovno. 02832 21870.

FOR SALE, TV502, matching 2m transverter for TS520S, TS520SE, orig packing, manual and all phono plugs, as new, £85. Tel. Chesterfield 0246 36496.

TRIO TW4000A 2 meter/70cms dual-bander BBC B computer with d/drive, Yaesu FTV 707 2 meter transverter Oscar dual band colinear; Trio dual band, mobile colinear with duplexer, all as new. Telephone Irvine 217611. Wanted: Yaesu FT726. Must be mint! TWO Admiralty receivers, one B41, 15kcs to 700kcs, one B40, 0.64mcs to 30mcs, £35 each, or £60 for both! Wanted: HF tcvr, 4C2E, also old musical boxes, polyphons or phonographs. Please write Mr Chesters, G4NXW (QTHR) or phone 0706 224617.

FOR SALE, HF transceiver, Yaesu FT101E, with matching units, remote VFO, ext. loudspeaker and two metre transverter, £375 ovno. Phone (0268) 551462, Essex.

MORSE Baudot ASCII reader, AEA MBA reader, model MBA-RO, vgc, manual and rest monitors up to 100wpm, MBA-RO, can monitor your

own keying, £110. West, 0705 371183.

FOR SALE, Philips D2999 receiver, two months old, excellent condition, digital display scan 0-30MHz plus 87.5-108MHz, also Superstar 360 FM SSB, suitable for 10 meters, mint, HF linear, 200 watts, plus more goodies, looking for HF transceiver. Telephone Shaun, 021 5251254.

VFO 30G for TR7200G including repeater shift, manual and connecting cable, vgc, £70. West, 0705 371183.

ICOM IC-245E 2 metre multi-mode with IC-RM3 remote controller, good working order, £250; Microwave modules, MMT432-144, 70cms transverter, 2 metre I.F. £95. K. Greenough, 2 Bexley Close, The Heath, Glossop, Derbyshire SK13 9BG.

DRAGON 32 computer with joysticks and various games, and Dragon books, £40. Telephone (0544) 318743.

TRIO TR2300, excellent condition, boxed with all accessories, £100; Concorde II, professionally converted to 28.0-29.7 MHz, no gaps, all modes, £100; Oxford Pascal compiler for BBC2, £20; Ade, assembler-debugger-editor for BBC, £20. Telephone Nottingham (0602) 392554.

KENWOOD TS530SP transceiver for sale, boxed, in immaculate condition, very rarely used, forced to reduce price due to emigrating, first reasonable offer secures sale. No time wasters please. Buyer collects outside of Merseyside area, after 6 pm. Tony, 051 260 9296.

HALLICRAFTERS Sky Challenger, circa 1939, working, £100; Sony ICF 2001, portable, £75; Amstrad 27MHz rig, 27/81, £25; DX302 communications receiver, digital, £175; two metre Xtal controlled transceiver, £50. Mike, 10 Doverfield Road, Brixton, London SW2 5NB, 01-671 3545.

YAESU FT290R, Nicads, charger, case, manual, +50 watt linear, 5/8 mobile ant, 2 mtr colinear ant, the lot £320. Tel. 0256 882486.

SONY ICF 7600D, PLL synthesized receiver, 87-108MHz, 0.5-30MHz, AM, FM, SSB, PSU, frequency list and manual, 5 months old, as new, boxed, £120. Phone Braintree

(0376) 43243.

COMMTEL PS1310S PSU 240 vac variable 4-12 ADC 8-15v DC, twin meters, protected, £60 ono; Ham broadband linear LA120 13.5v DC, .5-30MHz switched power, low med, high, 200 SSB 100 FM pre-amp, £80. York 768545.

SX200N scanning receiver, AM/FM modes, coverage 26-58MHz, 108-180MHz, 380-514MHz with MPU and scanning antenna and manual, vgc, £160, carriage extra; SWL Global ATU 1000, mint con, boxed, with data, £20. Tel. 01-390 2650.

FT980, all filters Curtis Keyer, mint, unmarked, £900. G3AGT, QTHR, 0823 76349.

AVO Minor, good condition, two for sale, £25 each. Phone Shrewsbury 247661.

DAIWA MT20 hand-held with LA 20 linear 20 watts mobile, 10 watts portable, complete with shoulder bag, Nicads, chargers, rubber duck, antenna, buyer collects, £150. Phone 01-422 2508, Colin G11SX.

PHILIPS recording system desk, transcribing desk, console, LFH0086/15 c/w ear set, foot control, 240 mains, two pocket memos, 0085/15 c/w cassettes, value £140; exchange for working UHF hand-held multi channel or ditto 2mtrs. Malvern 62385.

TANDY model 102 lap-held computer, as new, with manual, £200 ono. Tel. 01-471 0669 after 6 pm, ask for Danny.

BROTHER M-1109, NLQ dot matrix printer, boxed, as new, bought September 1986, it has both RS-232 and centronics interfaces, £200 ono. Tel. 01-471 0669 after 6 pm, ask for Danny.

BBC B, two 80TDS drives, torch Z80, second processor, 12 inch amber monitor, speech chips and multitude software, both BBC and CPM, £640; SASI plus ZEBEC Winchester boards, PSU case, £150; new Zomb Winchester drive, £155; Sinclair QL, £60. Phone Mike 0954 82223.

COMMUNICATION receiver R209, 1-20MHz in four bands, AM/CW/FM, dimensions, 32x 23x22 CM, 12v operation, built-in speaker, in working order, with manual, £70. Phone 021 350 4748.

FOR SALE, Eddystone, EA12, covers 160-10M, amateur bands, good condition, £140, would exchange Trio R1000, but must be in mint, cash adjustment. Tadley 07356 2476, Hants.

SELL or swap Sinclair ZX81, power pack, manual, tape lead and 16K Panda ram pack, good condition and still boxed, sell together for £15 or swap for walkie talkie (CB/Pye) or any electronic bits/pieces, i.e. leads, resistors, capacitors, etc. Call David, 4 Beach Grove, Hartford, Northwich, Cheshire CW8 1LN, or phone 0606 781862 after 5 pm.

ICOM 720A general coverage transceiver, £515; power supply, ICSMS, desk mic, boxed, good condition, £650; Trio TRTT30 2m FM, mobile, £150; Semis transmitter, ATU, £25; Hinould, HK707, morse key, £7. Contact G0CDH. Tel. Bristol (0272) 694757.

WANTED

WANTED. Recording head number RP102-2902 to suit Sony TC366 to 500 series. Reel tape recorders. Cash. Bank draft. Write: W. Boules, Box 1324 Ingil, New Zealand (please).

WANTED. Pye PFI's, 2x Tx, 2x Rx, for project. Also R1155, 9R59DS or R208, condition unimportant, also for project. PFI's with or without xtal's accepted. Details and prices please to: M. Whyte, Box 205, Edinburgh EH6 6HX. All letters answered.

WANTED. Heathkit RA1 and RG1 receivers for spares and testbeds for research projects. Please send details of price and condition to Richard Marris, 35 Kingswood House, Farnham Road, Slough, Berks SL2 1DA.

WANTED. A speaker of the permanent magnet dynamic type, should include a speaker voice-coil to a 600ohm matching transformer for the connection to the 600ohm audio-output terminals of the receiver Hammarlund S.P. 600. Also required 4 track mono reel

to reel tape recorder. Phone Eastleigh 0703 616721.

WANTED. Trio TS130v. Donald GM10IN QTHR. Tel: 0383 414283.

WANTED. Information on use of Philips VCR N1700 and any tapes used or blank. For disabled person. Will buy and refund postage. John Sitton BRS88837, 29 Hudson Rd, Stevenage, Herts SG2 0ER.

WANTED. FC901 A.T.U. to match 101ZD also FTV-910R VHF/UHF Oscar transverter. Tel: Doncaster (0302) 531927 with price etc. Also a disk drive for Dragon 32 computer required. QTH 7 Castell Cres, Cantley 2, Doncaster DN4 6LG.

IMPECUNIOUS new licensee looking for low cost 2m FM mobile transceiver (might consider handheld). Can collect if reasonable distance, say up to 100 miles. Mr Kerry Morris, 44 Leamington Road, Weymouth, Dorset DT4 0EZ. Tel: 0305 788591 evenings/weekends.

WANTED. Sem tranzmatch with Ezitune, any condition but must be working ok. Phone Colin on 0623 513758 after 6.30 pm.

WANTED. 10meter FM rig with repeater shift. Tel: 0935 815616 (Dorset).

WANTED. 3-ele triband beam for new club preferably within 50 miles Merseyside. Tel: 051 356 2472 between 5.30 pm and 8.30 pm only please. Mike G1JBQ.

WANTED. Trio TS830S HF transceiver with or without filters fitted. Must be in good condition. Ring Terry G4OXD 0462 35248 after 6 pm.

WANTED. SSB accessory for Grundig satellit 1000 receiver or details to enable one to be constructed. Chichester 783651.

WANTED. Instruction book for Tech Tradiper model TE15. Can photocopy and return to sender if required. Fair price paid for either of-

fer. Clarke, Flat 4, Shirly House, Compton Road, Cradley Heath, West Midlands B64 5BB.

WANTED. HF linear amplifier, commercial or homebrew. Tel: (0634) 572306, ask for David.

GRUNDIG TK145 R to R tape recorder instruction book required or copy. Ferguson model 3210R to R tape recorder instruction book or copy required. G. Leigh 31 Tewkesbury Road, Handsworth, Birmingham B20 3DX.

WANTED. For restoration - CR100 RX. Must be cheap, so duff one ok as long as it is complete. From fairly local-ish area please, unless it's practically a give-away! Please write: Mr A. Hawkins, 166c Kestrels View, Southgate, Runcorn, Cheshire WA7 2RX.

2M MOBILE multimode rig wanted, also base unit, reasonable prices please. G3GZT 0273 503869.

WANTED. Tektronics 555 dual beam scope complete or parts, especially need high voltage transformers and associated components, also plug-in extenders. Write Mick Lee, Baroda, Lower Waites Lane, Fairlight, Hastings, East Sussex TN35 4DB.

WANTED. HF TCVR and ATU etc, just obtained Class A, want to set up station, will travel up to 150 miles to view equipment, must be in vgc. Phone John Coventry 0203 450476 anytime.

WANTED. Sinclair QL users for exchange software and hardware. ON1KPW Denis Goffaux, 57 Route De Bastogne, B-6630, Martelange, Belgium.

EXCHANGE

EXCHANGE KR400RC rotator T.E.T. HB 33M, 10-15-20 mtrs, 3 element antenna, both excellent condition, Mercury 3.5 outboard motor, 1 hours use only, as new, for HF mobile transceiver or possible HF

receiver, cash adjustment with any items if required. P. Williams, 5 Charles Court, Gwaun Helyg, Ebbw Vale, Gwent NP3 6GG.

EXCHANGE: Mint Trio 9130 and 100 watt linear with pre-amp for mint FT77 or FT707 with FM and ATV, must be in good working order, HF considered like Trio 530SP + ATU, in which case trade, 24 amp PSU included. Terry GM06LH. 0506 34235.

EXCHANGE mint Trio MC85 desk mike for Shure 444D in same condition. Blackburn 0254 673184, 9-4.

EXCHANGE FT280R 2 mtr hand held with charger, spare Nicad PA3 adaptor, spkrmic, all mint, for FT230R or similar 2 mtr: FM mobile, must be complete with brackets etc and vgc. Contact Ray, GW1FJI QTHR. Phone Chepstow (02912) 2808 after 6 pm or w/ends.

EXCHANGE 48K Spectrum, Interface 1 and micro-drive with two games cassettes, for FP707 or similar, 20 to 40 amp, HD PSU. J. D. Bolton, G4XPP QTHR, 10 Bowness Road, Comston Park Estate, Timpenley, Cheshire WA15 7YA.

HAVE Kenwood R600 receiver, perfect working order, will exchange for Sony ICF 2001D or Bearcat DX1000, must be in working order. Also Realistic DX400 receiver for sale, £65, very stable and perfect. Phone Lincoln 41223, Mr Goodhall, 9 Gregg Hall Crescent, Lincoln LN6 8AQ. Thank you.

EXCHANGE new Realistic hand held scanner, Pro 32 with 200 programmable frequencies in memory, Nicads plus matched Archer indoor antenna and coax for FT290 multimode or dual bander, in good condition. Tel: 0603 867005 (Norwich) G1WQW.

HAM RADIO CLASSIFIED

TODAY

Lineage: 48p per word VAT inclusive (minimum 15 words) Semi Display: (minimum 2 cms) £7.35 per single column centimetre. Ring for information on series bookings/ discounts. All advertisements in this section must be prepaid. Advertisements are accepted subject to the terms and conditions printed on the advertisement rate card (available on request).



01-437 0699 Ext 289. Send your requirements to: Ham Radio Today Class. Dept., ASP Ltd., 1 Golden Square, London W1R 3AB

COURSES

RADIO AMATEUR LICENCE

Start training now - No previous knowledge required. Study for 3-6 months. Post Coupon now for free brochure - without obligation:

Radio & Telecommunications Correspondence School, 12 Moor View Drive, Teignmouth, Devon. Tel: 06267 - 79398.

(HRT/5)

NAME:

ADDRESS:

..... POST CODE.....

SOFTWARE

ZX SPECTRUM SOFTWARE

1. SSTV TX/RX
2. MORSE TX/RX
3. MORSE TUTOR
4. ATV TEST CARDS
5. FREQUENCY COUNTER

NO HARDWARE NEEDED
★SPECIAL OFFER
All 5 programmes only
£9.95

9 Ryston Close,
Downham Market, Norfolk,
PE38 9BD Tel: 0366 388615

AERIALS

WHO ARE ?

SEE

TENNAMAST
SCOTLAND

**NEXT ISSUE OR TEL:
05055 3824 GM4VHZ**

RYLANDS (HR), 39 Parkside Avenue, Southampton SO1 9AF. HF long and medium wave. loop antennas. SAE for details.

NEW SHOP LUTON: Come to us for your aerial requirements! We also repair, install and calibrate amateur equipment. Wide range of CB & p.m.r. also available. Ring 0582-458310.

RALLIES

SCARBOROUGH AMATEUR RADIO SOCIETY RALLY
26TH JULY 1987
AT THE SPA
DOORS OPEN 11.00
Tel: 0723 376847

RTTY

PLEASE NOTE:
PNP Communications
Have Moved To:
The Old Boat Yard,
Robinson Road,
Newhaven, East Sussex
BN9 9BL
Tel: 0273 514761

PACKET RADIO SOFTWARE

GROSVENOR SOFTWARE

G4BMK

AX25 Packet Radio
DRAGON 32/64 and TANDY Color
A breakthrough in Packet Radio-AX25 stand-alone software in ROM cartridge, plus a built VHF/HF 1200 Baud modem for just £99! Full AX25 implementation with up to 6 simultaneous connections, optional beacon, and digipeater operation. HF kit available soon. Modem Kits & PCB's available. Send SAE for full details of this & RTTY, CW, SSTV & AMTOR.
2 Beacon Close, Seaford, East Sussex BN25 2JZ (0323) 893378

ANTI-T.V.I. Aerials, traps for beams or wire aerials, baluns, kits etc. Data 26p large SAE. Aerial guide £1. G2DYM Uplowman, Tiverton, Devon EX16 7PH (03986) 215.

TEST EQUIPMENT

CAVITY WAVEMETERS AS REVIEW IN FEB H.R.T.

144 MHz to 2500 MHz, and 430 MHz to 2500 MHz.
10 GHz Wavemeter Kits, Electronic Weather Stations, Solid Brass Based Morse Keys.

S.A.E. for more information to:-
PAUL SERGENT G4 ONF
8 GURNEY CLOSE,
COSTESSEY,
NORWICH NR5 0HB
(0603) 747782
Prestel no: 603747782

FOR SALE

NEW PRODUCT

An electronic morse keyer that will help you send well formed and spaced morse code. Can be powered from battery or mains. Tested under a wide variety of R.F. conditions and at a price considerably less than similar products advertised elsewhere.
Send SAE for full spec.

TARGA ELECTRONICS
3 Raven Ave., Tibshelf,
Derbyshire DE5 5NR.

COMPUTER EQUIPMENT

*** 68008 SINGLE BOARD COMPUTER, contains:- Disc Interface, Colour Display, 8K Monitor, Megabyte RAM, 2 Serial/Parallel Ports, RTC, runs SK-DOS-68K. Bare P.C.B. or built. Also 6809 Micro-Set System. S.A.E. Ralph Allen Eng. Fornsett-End, Norwich.

WALKIE TALKIES

QUALITY WALKIE TALKIES. Long Range, Private Satisfaction or refund. £24.99/pair, (normally £31.49), 48 Hrs delivery. Xenon (Dept CB9), 24 Wharncliffe Street, Barnsley, Yorkshire.

CB AND ACCESSORIES

THE NORTH'S Leading C.B. Distributors including 934 Mhz equipment. Please ring 0388-528464. Ian Fisher Communications, CB Works, Stanhope, Co. Durham DL13 2YT.

MISCELLANEOUS

HEATHKIT U.K. spares and service centre. CEDAR ELECTRONICS, Unit 12, Station Drive, Bredon, Tewkesbury, Glos. Tel: 0684 73127.

SERVICE MANUALS

TIS HR

76 Church Street, Larkhall,
Lanarks ML9 1HE.
Tel (0698) 884585/883334
For all service sheets and manuals sole M.O. suppliers.
TV & Video repair manuals.
Newnes Technical books.
S.A.E. for free quotation etc.

SERVICE MANUALS. Amateur radio, test, audio, TV, video etc. Thousands stocked. SAE enquiries. Mauritron (HRT), 8 Cherrytree Road, Chinnor, Oxon.

CARDS, STICKERS

QSL CARDS. - try me for quality and price. S.A.E. for samples. A.W. Bailey (G3YNI) Breandown Press, Wick Lane, Lympham, Somerset.

OUR NEXT DEADLINE
27TH APRIL
FOR THE
JULY ISSUE

01-437 0699
= RESULTS

EMPORIUM GUIDE

BIRMINGHAM

AE AMATEUR ELECTRONICS LTD
510-512 Alum Rock Road, Alum Rock,
Birmingham B8 3HX.
Tel: 021-327 1497/6313
YAESU DISTRIBUTORS
TO THE UK.

BIRMINGHAM

R. WITHERS COMMUNICATIONS
584 Hagley Road West
Oldbury, Warley B68 0BS
(Quinton B'Ham) Tel: 021-421 8201/2/3
Opening hours 9-5.30pm Late nights Thurs-Fri.
Send just £1.00 (refundable against purchase)
for latest catalogue + our exclusive products & used list.

BIRMINGHAM

HEWARD'S HOME STORES LTD.
(Est. 1963)
822/4 Kingstanding Rd., Birmingham B44 9RT.
Tel: 021-354 2083
G4RJM with 38 years in The Radio Trade
Ham Equipment urgently wanted!
Open: Mon-Sat 9-6

CHESHIRE

DW ELECTRONICS G3 XCF
Amateur Radio Supplies
71 Victoria Rd, Widnes
Tel: 051-420 2559
Open Mon-Sat 9.30-6 (closed Thurs)
We supply Yaesu, Icom, Tonna, Jaybeam,
Microwave Modules, Datongs, etc.

DEVON

AGRIMOTORS
Merton CB & Radio Centre
Merton Garage & Post Office, Merton,
Nr. Oakhampton EX20 3DZ.
Open 6 days 9-6
(Sundays by appointment)
Specialists in 934MHz
Suppliers of all 27MHz and 934MHz equipment

DORSET

**BUSINESS COMMUNICATION
IS EASY IN HRT.
FOR ADVERTISING PHONE
SUE CURTIS ON 01-437-0699**

KENT

Thanet
ELECTRONICS
2 Stanley Road, Herne Bay, Kent
Tel: (0227) 369464
Open Mon-Sat 9-5.30pm
except Thursday 9-1pm

LANCASHIRE

AMATEUR ELECTRONICS/HOLDINGS G3LLL.
YAESU, JAYBEAM, DRAE, DATONG, BLACK STAR COUNTERS,
ETC. FT 101 EXPERTS.
6JS6C 6KD6 12BY7A Original type approved
valves & our own Double Balanced Mixer and
new band WARC Kits for original FT 101 MK1-E.
S.A.E. List. Full Yaesu range. 15 mins Junction
31 M6. Free parking. Call and consult G3LLL
without obligation. Holidays? Phone, check
we are open before calling.
45 JOHNSTON STREET, BLACKBURN BB2 1EF.
(0254) 56595. CLOSED THURSDAY.

LANCASHIRE

G4 DXH
VIDEO ELECTRONICS
For DRAY, WELLS, DAIWA
DATONG, 934 MHz Equipment, Log-
books, Rotators, Cable etc.
Open 9-5pm, Closed Wednesdays.
141 LANCASTER ROAD, MORECAMBE,
LANCASHIRE LA4 5QJ
PHONE (0524) 418873

LONDON

DRESSLER UK LTD
191 Francis Rd., Leyton, E10
Open 9-5.30 Monday-Friday 10-5 Saturday
Authorised dealers for:
Dressler, Yaesu, Icom, Standard, Kenwood,
Datong, SCM, Microwave Modules, Tonna
Tel: 01-558 0854/556-1415 Telex: 8953609

MERSEYSIDE

ARE COMMUNICATIONS LTD
For Yaesu Icom & Kenwood
Phone us for the best deals on all
amateur radio equipment.
38 Bridge St, Earlestown,
Newton-le-Willows, Merseyside.
Phone Peter G4KKN on 09252-29881
Opening hours Monday-Saturday 10am-5pm

NORFOLK

D.P. HOBBS (Norwich) Ltd
13 St. Benedicts Street, Norwich
Tel: 615786
Open Mon-Sat 9-5.30
Thurs 9-1pm.
Stockists of:
YAESU, FDK, ICOM, JAYBEAM
& Electronic Component Specialists

NOTTINGHAMSHIRE

SP ELECTRONICS
48 Limby Road
Huckhall, Nottingham
Tel: (0602) 640377
Open Monday-Saturday 8.30-5.30

SURREY

GUILDFORD COMMUNICATIONS
34 Aldershot Rd., Guildford
Open Mon-Fri 8am-6.30pm
Sat 8am-5.30pm
Secondhand wanted
ASDEN
0483-574434

WILTSHIRE

Get on the right
wavelength. Use Ham
Radio Today and
Citizen Band for
Advertising.

WORCESTERSHIRE

A. KELLY
Electronics & Communication equipment.
3 Stoke Road, Aston Fields, Bromsgrave,
Worcs B60 3EQ.
RSGB Publications, Mutek, DRAE, Microwave
Modules, Star Masterkeys, TAL aprials; Alinco.
OPEN 6 DAYS A WEEK EVENINGS
BY APPT. 0527-71165.

YORKSHIRE

Amateur Electronics UK
Alan Hooker
42 Netherhall Road,
Doncaster
Tel - 0302 25690
Large stocks of electronic
components.

N. WALES

**NORTH WALES AMATEUR
RADIO MART**
AMATEUR RADIO — CB RADIO — MARINE
RADIO — P.M.R.
25 ABBEY STREET
RHYL
Open Monday-Saturday: 11am-5.30pm
All repairs and accessories available ex
stock. Mail order welcome.
Tel: 0745-51579



Lineage 48p per word (inc VAT). Minimum 15 words. Semi display £7.35 + VAT per single column centimetre. Minimum 2cms. No reimbursements for cancellations. All ads must be pre-paid. Write your advert in **BLOCK CAPITALS** in the grid below, ticking the section you wish it to appear under, **INCLUDING YOUR NAME AND ADDRESS IN THE WORD COUNT** and send it to **HAM RADIO TODAY, ADVERTISEMENT DEPARTMENT, NO: 1 GOLDEN SQUARE, LONDON W1R 3AB.**

FOR SALE
 COURSES
 COILS & CHOKES
 AERIALS
 CB & ACCESSORIES
 OTHER Please state

CLASSIFIED COUPON

ALL CLASSIFIED ADVERTISEMENTS MUST BE PRE-PAID. THERE ARE NO REIMBURSEMENTS FOR CANCELLATIONS.

I enclose my Cheque/Postal Order for £.....for..... insertions, made payable to Argus Specialist Publications. (Delete as necessary)

PLEASE DEBIT MY ACCESS/BARCLAYCARD NO

--	--	--	--	--	--	--	--	--	--	--	--

EXPIRY DATE

£..... FOR..... INSERTIONS



Name

Address

..... POST CODE

DAYTIME TEL NO.

Signature Date

IF YOU DO NOT WISH TO CUT YOUR MAGAZINE, PHOTOCOPIY THIS FORM





BINDERS

FOR YOUR VALUABLE COLLECTION OF HAM RADIO TODAY MAGAZINES

• SMART • EASY TO USE • TOP QUALITY

To ASP Readers Services, PO Box 35, Wolsey House, Wolsey Road, Hemel Hempstead, Herts HP2 4SS (0442-41221)

£5.20
inc
P&P

Please supplyHam Radio Today Binders @ £5.20 inc. P&P

Total £..... (Please make cheques payable to ASP Ltd.)

Years Required — 198.....198.....198.....198.....

Name

Address

Please allow 21 days for delivery



ADVERTISERS INDEX

AKD	38
Allweld Engineering	26
Arrow Electronics	9
Cirkit	7
Dressler UK	IBC
Elliot	33
Garex	40
Hi Tec Worldwide	14
JEP Electronics	4
Kellys	8
KW Ten Tec	33
Lowe Electronics	34&35
Microwave Modules	6
Rainbow Software	8
RAS Nottingham	14
Spectrum Communications	7
Technical Software	7
Relecomms	OBC
Thanet	4&5
Ward & Co	33
R Withers	IFC

If an advertisement is wrong we're here to put it right.

If you see an advertisement in the press, in print, on posters or in the cinema which you find unacceptable, write to us at the address below.

The Advertising Standards Authority. ✓

ASA Ltd, Dept 3 Brook House, Torrington Place, London WC1E 7HN

THE LONDON AMATEUR EMPORIUM
FOR EVERYTHING RADIO

dressler
FOR ICOM

191 FRANCIS ROAD
LEYTON, LONDON E10 6NQ
TELEX 8953609 LEXTON G
OPEN MON -
SAT 9AM - 5.30PM
INTEREST FREE
HP FACILITIES AVAILABLE
ON MANY ITEMS
PROMPT MAIL ORDER



PHONE
01-558 0854
01-556 1415

dressler
FOR YAESU

IC28E/IC48E



VERY LATEST MINI-MOBILE
25/45 watts. RX 138-174MHz
£££ unbelievable value.

ICOM R7000 25MHZ-2000MHZ

SPECIAL OFFER!! COMPLETE WITH



FREE
ARA 500.
ACTIVE ANTENNA
WORTH £139.00
£957

YAESU FT 290 MKII

A NEW
VERSION
OF THIS
POPULAR
PORTABLE
inc. Nicad
+ charger



£425

ICOM MICRO 2
HANDHELD

ICOM IC-02E

ALSO
AVAILABLE
IC275E

ICOM IC-735



EPOA



£275



£854

SPECIAL OFFER

ALL SONY UK SUPPLIED

SONY AIR 7

PORTABLE-AM-FM

144-174MHz

108-136MHz

150KHz-2194KHz

£249



SONY ICF 200ID

76-108 MHz
116-136 AIRBAND
160KHz-29995MHz
FM - AM - SSB 32 MEMORIES
INC PSU

£325



SONY ICF 7600D

76-108MHz
162kHz-29995MHz
MEMORIES, FM, AM, SSB.

£164



DUAL BAND

FT727R
£P.O.A.

NEW



FT23/
FT73
£P.O.A.



BUY A R71 FOR
£825 AND RECEIVE
AN ARA30 FREE
WORTH £129.00

WIDE RANGE OF YAESU/ICOM,
TRIO/KENWOOD, H.F., V.H.F., U.H.F.
SCANNING RECEIVERS AND
TRANSCIVERS IN STOCK ICOM ICA2 ALL
CHANNELS TX/RX 5 WATTS, 108-135 AND
175 MHz £450 — COMMERCIAL,
PROFESSIONAL, MARINE, CELLULAR
AND AMATEUR RADIO SALES AND
SERVICE.

FRG 8800 £575



NEW

FT767 YAESU



FULL HF
GENERAL COVERAGE
TRANSCIVER
£1395

FRG 9600 £475



ACTIVE ANTENNAS

dressler - ara 30 -
active antenna

200 kHz . . . 40 MHz

Professional electronic circuitry with very wide
dynamic range. Meets professional demands
both in electronics and mechanical ruggedness.
120 cm long glass fibre rod. Circuit is built into
waterproof 2.5 mm thick aluminium tube. Ideal
for commercial and swl-receiving systems. £129.
See Review in August Issue p.15



**DRESSLER
ARA 500
ACTIVE ANTENNA**

50MHz to 1300MHz
Gain 17dB Typical

TECHNICAL SPECIFICATIONS
FOR ARA 500

Gain 17dB Typical (14-17dB)
Frequency Range 50-1300MHz
Noise Figure 1dB at 50-180MHz
1.5dB below 300MHz
2.0dB below 350MHz
2.7dB below 400MHz
3.0dB below 500MHz
3.8dB below 650MHz

£139.00

Operation is possible up to 1300MHz
with gain of 10dB

Noise 4-6dB
Intercept Point 3rd Order: +18dbm at Input
Post £3.00 or Securicor £7.00 extra



LINEARS

SPECIAL OFFER !!
10 only

D200S - £925

D200 2 MTR 500W SSB

D200S 2 MTR 750W SSB

D70 70 CMS 550W SSB

£858

see panel above

£1030

Carriage Free Securicor



PRE-AMPS - NEW MODELS

MODEL	FREQ.	NOISE	GAIN	POWER	PRICE
EVV1296C	1.25-1.3GHz	0.9-1.2	16-18dB	100W	£162
EVV700SMD	430-440MHz	0.5-0.9	15-18dB	500W PEP	£124
EVV2000SMD	144-146	0.6-0.9	16-18dB	1KW PEP	£124
EVV200VOX	144-146	0.6-0.9	16-18dB	700W PEP	£112
EV2GAAS	144-146	0.6-0.9	15-18dB	100W PEP	£75
VV INTERFACE FOR ABOVE PRE-AMPS					£31

RECEIVE PRE-AMPS

MODEL	FREQUENCY	NOISE	GAIN	PRICE
EWPA 560	50-600-1GHz		16.5dB-1dB	£79
EWPA 560(N)	50-600-1GHz		16.5dB-1dB	£89
IP3 order	+18dBm			
ERPA 1296	1.25-1.30	0.8	17-18dB	£120
ERPA 435	430-440	0.5	15-18dB	£70
ERPA 144	144-146	0.7	16-18dB	£66
ASA 12	0-1GHz		Masthead Antenna Switch	£59

NEVADA 934 MHz EQUIPMENT

Have you tried this exciting new band yet? Available for private or business use, by simply purchasing a £10 licence from any post office. Range is from 10 - 250 miles according to your location and WX conditions.

DELTA 1 934 Mhz TRANSCIEVER



£365

THE DELTA 1 IS A STATE OF THE ART TRANSCIEVER AND NOW IN USE BY OVER 70% OF 934 MHz ENTHUSIASTS!

- FEATURES:
- Scan facility.
 - 16 channel memory/scan.
 - Sensitive RX.

ACCESSORIES

P7M-E Mag. Mount, 7dBi Antenna	£49.72
P714R-E GTR Mount 7dBi Antenna	£49.72
PA7-E Base Colinear 7dBi Antenna	£67.75
PA15 Base Colinear 11dBi Antenna	£79
TC12L 12 Element Beam 18dBi Antenna	£39
HRA 934L in line Pre-amp	£139.95
HRA 900 Masthead Pre-amp	£139.95

PLUS MANY MORE ITEMS

Send £1 for our full 934 Mhz catalogue.

Packed full of CB, 934MHz & Amateur Equipment—plus useful info. **Only £2.00** Includes a £2 voucher

NEVADA AMATEUR PRODUCTS

HIGH POWER VARIABLE CAPACITORS

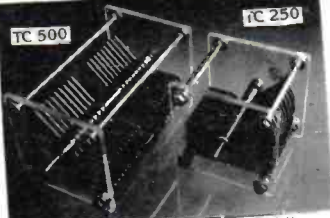

IDEAL FOR ATU'S OR AMPLIFIERS UP TO 3KW
 TC 500... 26-500 pF **£28 (£2 p.p.)**
 TC 250... 13-250 pF **£19.95 (£1 p.p.)**

HIGH POWER "ROLLER COASTER" VARIABLE INDUCTOR

NEW

£24
(£1 p.p.)

Suitable for 1 KW ATU
 Frequency: 1.8...30MHz
 IND: 26.5 uH
 SIZE: 5 1/2 x 10 1/2 x 14 1/2 cm

SPECIAL OFFER

TC250, TC500, & ROLLER COASTER.
 COMPLETE FOR **£59**
(£2 p.p.)

NEW LOW PRICE

2 MTR HAND HELD

CT1600 Through bulk buying we can now offer this superbly sensitive handheld at an all time low price. Unit covers 2 Mtr Ham Band Plus 142-149 MHz (For Export)

- Repeater Shift
- Hi/Low power 1/2 - 1 1/2 Watts.
- Thumbwheel Freq. Selector.

Each set supplied C/W re-chargeable battery pack and free mains charger unit.

VHF MOBILE AMPLIFIERS

MOD. B110	144 MHz 110 Watt FM Plus Low Noise	£169
Pre-amplifier Switchable		
MOD. B42	144 MHz 40 Watt FM Mobile AMP.	£84.66

SEE OUR HAM CATALOGUE FOR FULL RANGE



RF AMPLIFIERS

All amplifiers except broadband (2-30 MHz) models are tuned for 29.6 MHz centre freq. Should you require a lower freq. ie. 28.5 MHz please state when ordering. Export models available for 26-30 MHz.

C.T.E. MOD 767

76 Watts FM (150W P.E.P.)
 INPUT: 0.5-10 Watts
 SWITCHABLE:- Class AB, Class C
 SUPPLY:- 13.8 Volt
 REMOTE CONTROL FACILITY



MOBILE AMPLIFIERS

C.T.E. MOD. 737 50W FM (80W P.E.P.)	£44.76
C.T.E. MOD. 767 80W FM (150W P.E.P.)	£49.90
C.T.E. MOD. 757 150W FM (300W P.E.P.) (3-30MHz)	£116.87

ABOVE MODELS HAVE REMOTE CONTROL FACILITY PLUS CLASS AB & CLASS C SWITCHING. (NOT MOD. 737).
 ZETAGI B35 25W FM (26-30MHz) **£23.72**
 ZETAGI B150 70W FM (160W P.E.P.) **£49.96**
 ZETAGI B300 200W FM (400W P.E.P.) 2-30 MHz **£136**
 NEVADA TC35 DX 25W FM (W/Low PASS FILTER) **£23.99**

MAINS AMPLIFIER

ZETAGI B132 SOLID STATE (240W P.E.P.) 2-30 MHz **£119**

SCANNING RECEIVERS

£26

C.T.E. DISCONE WIDEBAND ANTENNA

RECEIVE 70-700 MHz
 TRANSMIT 70-500MHz
 MAX POWER 500W
 GAIN 3.5dB

WIDEBAND DISCONE RECEIVING ANTENNA

(3 Element) 70-500MHz **£24.95**



HANDHELD SCANNING RX BEARCAT 100XL

A super sensitive low cost hand-held which covers: 66-88MHz, 118-174MHz, 405-512MHz

Includes Public Service, Aircraft, Marine, etc.

- ★ 16 Channels memory scan
- ★ Priority keyboard lock
- ★ Lighted display

£229



BASE SCANNING RX BEARCAT 175XL

For the enthusiast a sensitive base receiver which covers: 66-88MHz, 118-174MHz, 405-512MHz

Same specifications as the popular 100XL hand held model

£209



TEST EQUIPMENT

ZETAGI DL150

RF DUMMY LOAD AND POWER METER

A very accurate unit for the service dept. or discerning enthusiast.
 FREQ:- 0.5MHz-500MHz
 POWER:- 150 Watt Max in 3 ranges 0-3, 0-15, 0-150W.

£85.19



ZETAGI 500

SWR AND POWER METER

For the enthusiast who wants the very best: A twin meter unit with push button control for either 75 OHM or 50 OHM cable.
 FREQ:- 3-200MHz
 POWER:- Up to 2kW

£41.46



FD 1350 1.3GHz FREQUENCY COUNTER

FREQ:- 10Hz-1.35GHz
 SENSITIVITY:- 43mV at 1GHz
 DISPLAY:- 8 Digit
 SUPPLY:- 9-12 Volt DC

£139.53



NEVADA

HIGH QUALITY BRITISH MADE 29MHz FM PRODUCTS

NEVADA TC35 DX

£23.99

RF. POWER AMP. WITH HARMONIC FILTER

INPUT: 1-4 Watts
 OUTPUT: 25-30 Watts
 SUPPLY:- 13.8V DC
 FREQ:- 26-30 MHz

Can be centred on 29.6 MHz or 28.5 MHz (state which). A new top quality amp. which now features harmonic filter to reduce harmonic O/P.

NEVADA TC27 RX

RECEIVER PRE-AMP FOR 26-30MHz

A superior low noise pre-amplifier for 29MHz FM operation. Variable gain -6dB's to +18dB's suitable for use with transceivers up to 25 Watts output.

£23.99



TELECOMMS

HOTLINE (24 HOURS)

0705 662145

189 LONDON ROAD, PORTSMOUTH, HANTS, PO2 9AE, TELEX 869107 TELCOM G

USE YOUR CREDIT CARD (AMERICAN EXPRESS, ACCESS OR VISA) FOR IMMEDIATE DESPATCH.

TRADE ENQUIRIES WELCOME.